

Contents page for responses to the Workgroup Consultation Report

The responses received to the Workgroup Consultation Report are listed below with the page references:

Company name that responded to the Workgroup Consultation Report			Pages	Company name that responded to the Workgroup Consultation Report			Pages
1	Consolidated responses to questions 1 – 4, 10, 13 & 18	2 – 104	26	Infinis	471 – 478		
2	Consolidated responses to questions 5 – 8, 11 & 14	105 – 151	27	London Waste	479 – 486		
3	Consolidated responses to questions 9, 12, 15, 16, 17 & 19	152 – 211	28	Octopus Investment	487 – 497		
4	Covering letters: Cornwall Energy Highlands and Islands Enterprises REA Statera Energy Vattenfall Veolia	212 – 214 215 – 217 218 – 221 222 – 223 224 – 225 226	29	Peakgen	498 /512		
5	ADE	227 – 239	30	Plutus Powergen	513 – 521		
6	Alkane	240 – 256	31	Reliance Energy	522 – 530		
7	Calon	257 – 264	32	Renewable UK	531 – 542		
8	Centrica	265 – 274	33	ReStore	543 – 549		
9	CLP Envirogas	275 – 281	34	Rockpool Investment	550 – 558		
10	Drax	282 – 290	35	Innogy Renewables and npower	559 – 576		
11	EON	291 – 305	36	RWE Supply and Trading	577 – 588		
12	Ecotricity	306 – 312	37	Savvi Energy	589 – 597		
13	EDF	313- 327	38	Silva Renewable Energy	598 – 608		
14	Eider Power Reserve	328 – 334	40	Scottish Power	609 – 619		
15	ELEXON	335 – 344	41	SembCorp Utilities	620 – 622		
16	EPR Ely	345 – 351	42	Smartest Energy	623 – 630		
17	Engie	352 – 372	43	SSE	631 – 659		
18	EPR Scotland	373 – 379	44	Statera Energy	660 – 667		
19	EPR Thetford	380 – 386	45	Statoil ASA	668 – 673		
20	EPR Eye	387 – 393	46	Tees Valley Combined Authority	674 – 681		
21	EPR Glanford	394 – 400	47	UKPR	682 – 723		
22	Good Energy	401 – 411	48	Uniper	724 – 731		
23	Green Frog	412 – 454	49	Watt Power	732 – 753		
24	Green Investment Bank	455 – 461	50	Welsh Power	754 – 770		
25	Greenspan Agency	462 – 470					

Note that TATA have requested that their response is not published and Renewable Energy Systems have been asked to re-send their response as corrupted.

These are the questions that related to CMP264 only and cover questions:

Questions: 1, 2, 3, 4, 10, 13 & 18

Question 1: Do you believe that the CMP264 Original Proposal better facilitates the Applicable CUSC Objectives?

Response No	Company	Response
1	CLP Envirogas	No. Given the rules around allocating transmission system costs between Generation and Demand, embedded generation is effectively negative demand at GSP and should be treated as such.
2	Engie	We do not support this proposal as presently crafted. It discriminates between existing and new users based on date of construction/first running. We believe that embedded generators should see an appropriate locational signal and an embedded substation benefit relating to avoided substation cost.
3	RWE Generation UK plc, RWE Supply & Trading GmbH	<p>CMP264 Original proposal may better meet the CUSC objectives, particularly with regard to Objective (a). The proposal will ensure that investment decisions for new embedded generation are not distorted by the residual component of the demand TNUoS tariffs.</p> <p>However, the proposal fails to address the wider issues associated with the defect for existing generators and also introduces discriminatory treatment between new and existing generation (which continue to receive the growing Triad benefit).</p> <p>In addition, we have concerns that under the proposal the locational element of the demand tariffs, as applied to new embedded generation, is not cost reflective since it does not appropriately represent the peak and year round backgrounds and also does not address issues associated with the demand charging base (half hourly and non half hourly). As a consequence, the original proposal can only be described as a temporary solution until such time that a comprehensive and enduring approach towards demand transmission charging is developed.</p>
4	EPR Ely	No. Given the rules around allocating transmission system costs between Generation and Demand, embedded

	<i>Limited</i>	generation is effectively negative demand at GSP and should be treated as such.
5	<i>EPR Glanford Limited</i>	No. Given the rules around allocating transmission system costs between Generation and Demand, embedded generation is effectively negative demand at GSP and should be treated as such.
6	<i>EPR Eye Limited</i>	No. Given the rules around allocating transmission system costs between Generation and Demand, embedded generation is effectively negative demand at GSP and should be treated as such.
7	Statera Energy	a) No this Modification distorts competition between new generation and transmission and distribution generation. b) No, not enough evidence has been demonstrated that this modification results in a more cost-reflective system. A more holistic review of all the economics of different plant types is required, not just TNUoS at Triad. It is not the fault of embedded plant that there is an EU cap on generators, nor that the cost of transmission is increasing. An ill considered change will not address the fundamental problems.
8	<i>EPR Scotland Limited</i>	No. Given the rules around allocating transmission system costs between Generation and Demand, embedded generation is effectively negative demand at GSP and should be treated as such.
9	TATA Chemicals Europe	Comments removed for publication of report
10	<i>EPR Thetford Limited</i>	No. Given the rules around allocating transmission system costs between Generation and Demand, embedded generation is effectively negative demand at GSP and should be treated as such.
11	<i>LondonWaste Ltd</i>	No we do not and we argue that it would do the opposite by reducing competition in generation by creating a barrier to new entry into the generation market in the form of regulatory risk. This proposal seems to be based on the flawed premise that embedded generators (and the demand they offset) are ‘using’ the transmission system. What was the lowest level of total embedded generation during a triad Settlement Period? As a collective they provide a significant generation base which is “always there” at triad times in the same way the demand they offset is “always there” and so the transmission system has never had to cater for that demand. It cannot be argued that anything more than a minority of such generators are using the transmission system. It might be argued that the embedded generators have stolen this load away – but that is competition which is to be encouraged. The proposal claims that it seeks to “level playing field between new embedded generators and other generation <u>plant</u> ”, but in fact the effective competition in the long term arises between <u>companies</u> and results from the investment decisions they make. The playing field is already level, because the proposer of CMP264 is quite free to build embedded plants as well as any other company. CMP264 would significantly stifle the building of new embedded plant and thus stifle competition in generation.
12	<i>PeakGen</i>	No.

	<i>Power Ltd</i>	<p>Given the CUSC objective “that compliance with the charging methodology [for the transmission system] facilitates effective competition in the sale distribution and purchase of electricity”, it would seem reasonable that where a supplier takes energy from a local generator, rather than use the transmission system, the supplier should avoid having to pay the cost of the transmission system. Given the competitive nature of the market, it is also reasonable that the local generator ought to be able to realize a price consistent with the marginal provider (who does have to pay the transmission cost). The current method of charging delivers this principle without creating issues of market power where supply of generation within a GSP is dominated by either a limited number of suppliers or generators. For clarity, this situation is analogous with the provision of fresh vegetables where a local provider competes with international providers. At the supermarket both the locally provided vegetables and the imported providers achieve the same price (assuming an identical product), however the local producer does not incur the cost of international shipping and therefore, if other costs are identical, achieve a higher margin. This modification appears to be suggesting that the local supplier should pay a part of his competitor’s transport fees. We also note that by not using the international shipper, the local supplier is able to avoid the shippers full cost (which includes overheads, return on capital etc.) rather than the shippers marginal cost.</p>
13	<i>Statoil ASA</i>	<p>No, we believe that CMP 264 should be rejected and that any changes to embedded benefits and the triad system is done through a holistic review, as initiated through Ofgem’s open letter on charging arrangements for embedded generation dated 29 July 2016.</p>
14	Good Energy	<p>A – It is evident that CMP264 undermines objective A of the CUSC.</p> <ul style="list-style-type: none"> - It is clear that CMP264 risks undermining investor confidence, leading to decreased competition in the generation market in addition to increasing cost of capital for investors. - CMP264 also introduces perverse incentives encouraging economically inefficient investment in private distribution networks to create behind-the-meter arrangements. Such generators generally do not participate in the wholesale market. This could lead to reduced numbers of participants in the wholesale market, leading to a reduction in both competition and market liquidity. - This is also likely to significantly increase barriers to entry to the smaller generation market, again reducing competition going forward. <p>(B) It is evident that CMP264 undermines objective B of the CUSC.</p> <ul style="list-style-type: none"> - The commissioning date of a generation facility has little or no impact on the costs or benefits it brings to the transmission system. It is therefore inappropriate to discriminate by commissioning date in the way set out in CMP264.

		<p>- CMP264 also frames new embedded generation as offering no benefit in terms of cost saving to the transmission network – this is clearly not the case.</p> <p>(C) It is clear that CMP264 is not supportive of objective C of the CUSC. As outlined in the proposal documentation this change may lead to significant systems and procedural change for National Grid. Should OFGEM’s final decision on the future of the TNUoS charging regime not align with CMP264, there are likely then to be significant abortive costs to be borne by the industry.</p>
15	<i>REstore</i>	No, see introduction.
16	EDF Energy	<p>Yes. CMP264 better facilitates charging objective a, effective competition – but only to a small extent. CMP264 also slightly better facilitates charging objective b, cost-reflectivity. CMP264 also slightly better facilitates charging objective c, because as to developments in transmission licensees' transmission businesses, there has been a marked growth in the amount of embedded generation impacting the ways the system is developed and operated – the charging distortion to which both CMP264 and CMP265 relate, may have been a contributory factor to that.</p> <p>CMP264 is neutral as to the remaining charging objective d, on Europe.</p> <p>Within this overall judgement, we are counter-balancing competing considerations :</p> <ol style="list-style-type: none"> 1. we believe that the “grandfathering” that is inherent in CMP264, as between plant that commissioned before and after June 2017, is probably distortive of competition and hard to justify in this case 2. the unjustified crediting to relevant embedded generation of the demand HH residual charge element, which is an artifice to ensure correct overall revenue recovery and not a cost-reflective charge (unlike locational charge elements), is distortive across the patch, and CMP264 addresses this (but see (3) below); there is no logic to netting-off the output of embedded generators from HH demand as far as the demand residual charge element is concerned. Note that this distortion has its most marked effect within the capacity mechanism. <p>CMP264 original as proposed, removes not only the demand HH residual charge element, but also the locational charge signals from embedded generation. This, if passed, would be distortive of competition as between these (<100 MW embedded) generators and others (those which are bigger than 100 MW, or those which are transmission-connected). We know that the proposer has acceded to the possibility of altering this aspect of CMP264 Original so that the locational charge signals are not removed; such a change would improve CMP264 Original.</p>

17	Tees Valley Combined Authority	<p>We believe that the proposals may run counter to the objective of the CUSC. The proposals have the potential to reduce competition, by increasing uncertainty (due to regulatory risk) as to the impact of new investment in the local provision of generating plant.</p> <p>Evidence from the local market would assert that a large proportion of embedded generators do not 'use' the transmission system at all. That is because, during Settlement Periods when the TNUOS charges are determined (the Triads), there is a consistency of offset between embedded generation and demand. It may be the case that the size of this offset has grown over the years, taking load off the transmission system and stranding NGC assets, but that is a separate issue which needs to be addresses in a more holistic manner.</p>
18	Octopus Investments	<p>No. OI considers that this proposal is discriminatory between those generators that are already generating and new entrants. Depending on where the CM closes in future auctions (including December 2016), CMP264 is likely to favour existing embedded generators taking one-year CM contracts that will benefit from continued TRIADs as well as higher CM prices. This would lead to identical capital cost units having different variable costs against which they dispatch. In our view this proposal runs counter to objective (a) above by distorting competition between embedded generators and results in greater costs to consumers overall.</p> <p>This proposal would also have an impact wider than small flexible generators that are the supposed target in order to increase the CM clearing price. Any new generation would be impacted and this particularly includes new renewable generation which is central to the government's efforts to meet the climate change and decarbonisation targets. It would seem perverse that Ofgem would approve a measure that penalises such an important element of the government's energy policy and we believe this should be reflected in the Panel's consideration of this proposed amendment.</p> <p>Further, as stated in the recent Ofgem letter, this measure is designed to specifically disincentivise new embedded generation in favour of large gas turbines. However we do not believe that it is possible to reach a conclusion regarding the composition of the future energy mix without a detailed review. See below for further comment on this point.</p>
19	The Greenspan Agency Limited	Unsure.
20	Centrica	No.

		<p>On applicable objective (a), we recognise the status quo is not conducive to effective competition in generation. However, we are concerned that CMP264 would create further distortions between new and existing embedded generation. There would also be distortions to competition between new embedded generators in different geographical locations, because all new embedded generators would face a zero tariff despite their different effects on transmission network flows (and therefore transmission investment needs). Finally, we note that the effective continuation of status quo embedded TNUoS benefits for existing embedded generation would leave a significant competitive distortion between transmission connected and existing embedded generation unaddressed.</p> <p>On applicable objective (b), we have concerns about the non-cost reflectivity of CMP264, because it will result in generators having similar effects on transmission network flows (and therefore transmission investment needs) facing materially different charges (according to whether they are transmission connected, existing embedded or new embedded). Whilst we accept that the status quo is not cost reflective, we do not believe CMP264 enhances cost reflectivity.</p>
21	<i>ScottishPower Energy Management Limited</i>	<p>Yes. Overall, CMP264 will better meet the Applicable Charging Objectives (ACOs) than the current baseline. CMP264 will remove a distortion in competition between investing in embedded and transmission connected generation by removing a non-cost reflective payment from embedded generation. This better facilitates ACO (a). CMP264 will better facilitate ACO (b) by removing a non-cost reflective payment realised by embedded generators. Developments in the transmission system have resulted in a significant increase in the demand residual TNUoS tariff which is significantly in excess of any savings in transmission investment resulting from connecting generation at a distribution level. By addressing which generators can access the demand residual TNUoS charge as an embedded benefit, CMP264 better facilitates ACO (c).</p>
22	Eider Power Reserve	<p>No we do not as changes to Triad payments as suggested suggested would strongly favour transmission connected projects in a manner we consider to be anti-competitive, self-serving on the part of the proposer, damaging to long term consider cost savings and not reflective of the level of embedded benefits brought to the market by embedded generation</p>
23	Infinis Energy	<p>No – the proposal as is creates a clearly distortive effect between existing and new build embedded generation, therefore impacting objective 1. Exempting all new embedded generation also adversely impacts objective 2 – there are avoided transmission-related costs for embedded generation to connect behind the majority of grid supply points and these are not being reflected by removing all triad embedded benefit.</p>
24	<i>RWE Innogy UK- RWE</i>	<p>No, on balance it does not better facilitate the CUSC Objectives. CMP 264 could prevent any new directly DNO connected embedded CM party factoring in the benefit of net metering into their bids in future auction rounds.</p>

	<i>npower joint submission</i>	<p>However, the overall impact of CMP264 is that it is detrimental to competition in the energy market. CMP264 introduces a new Defect. It introduces undue discrimination in the treatment of 'new' and 'old' generation. The network impact of both new and old embedded generation is the same, differential charging treatment is unjustified and discriminatory. Also, CMP264 does not actually propose a solution that reflects the costs/benefits of embedded generation on the network. The Proposer established that the defect is that the level of Triad Avoidance signals are too high because the Triad Avoidance signal is not cost reflective in terms of the transmission reinforcement avoided by reducing flows from the transmission system to meet demand. The Modification has very limited impact on the Triad Avoidance signal for 'old' embedded generation and does not actually put forward a cost reflective methodology for 'new' embedded generation either. CMP264 has the following impact on the CUSC objectives: a) Does not facilitate better competition, as different rules for different Embedded Generators. (old vs new) b) Not cost reflective as the defect raised has not been addressed c) Neutral on developments in the transmission licensees' transmission businesses d) Neutral on EU Overall CMP264 fails to address the defect that the Proposer identifies and it introduces a New Defect of discrimination.</p>
25	Sembcorp Utilities (UK) Limited	Please see our opinion in Q2 below
26	<i>Smartest Energy</i>	<p>No. The charging methodology is meant to result in charges which reflect the costs incurred by transmission licensees. The recipients of these charges are suppliers. Embedded generators are not "Users" as captured in the requirements to be cost reflective. As far as NGT are concerned there is no difference between a MW of reduced demand or a MW of increased embedded generation. It is therefore not more cost reflective in the CUSC environment to change the charging from net demand to gross demand. There may be a differential between the charges seen by transmission connected generators and embedded generators but the focus should be on NGT's residual and apportioning this in a more sophisticated manner.</p> <p>What is really at odds here is the fact that the residual is increasing because of the €2.50 cap and the aforementioned differential. However, the €2.50 cap is a massive benefit to transmission connected generation in itself and it is this that creates much of the differential.</p> <p>Charging embedded generation differently from behind the meter would introduce an artificial distinction that does not currently exist because the net charging of suppliers is consistent with the regulatory arrangements.</p> <p>Given that the greater concern, expressed both by the proposer and Ofgem, is the projected increase of the</p>

		residual, coupled with the fact that removing the embedded benefit would adversely affect the economics of existing plant it is essential that if there is to be any change made along the currently proposed lines, it is to new plant only.
27	<i>Ecotricity</i>	We believe that this does not better facilitate the applicable CUSC objectives.
28	UK Green Investment Bank plc	No comment
29	Alkane Energy Limited	<p>We note that the Proposer (ScottishPower) was involved in the National Grid 2013/14 process. In referring to the consultation document in footnote 1 of its original proposal form, the Proposer is offering no new evidence to change the outcome which was the recognition that net charging is the most appropriate charging methodology.</p> <p>It appears the Workgroup has reached some consensus that the increasing size of the Triad benefit is driven by a combination of (i) recovery of stranded costs of the existing transmission network, which has been sized for the historic flows of power that no longer take place (ii) the significant costs of new transmission needed to support offshore wind and (iii) the EU cap of EUR2.50/MWh on all transmission connected generation. These result in the “demand residual” increasing dramatically <u>AND a net benefit being received by almost ALL E&W transmission connected generation by 2020/21.</u></p> <p>There is also a recognition that EG in locations of generation deficit does avoid transmission investment and so should benefit from long term transmission costs avoided.</p> <p>While we recognise that the Triad benefit is set to increase, the CMP264 proposal does not set out to provide an enduring solution and therefore does not offer investor stability, nor does it attempt to address the system benefit of new EG investment. In Workgroup meetings the Proposer has merely asserted that zero is closer than existing Triad payments to the genuine EG benefit in his view. He has backed up by a single datapoint from one historic data source, but in meetings has acknowledged that the reality is almost certainly greater than the £1.62/kW/year. The most recent analysis presented by Cornwall Energy quotes a value of £32.30/kW. No one has to date refuted the basis of this analysis and undermined the value it delivers.</p> <p>The Proposal does not address whether the reduction is the result of exported distributed generation, on site generation or demand reduction. The analysis in section 7.7 of the consultation document shows that the same net effect on the transmission system occurs whichever of these actions takes place. In setting out that the current</p>

		<p>system of charging does not reflect this, the analysis also clearly shows that the Proposer is dealing with only one of the three potential actions that give rise to this. This is self evidently discriminatory and therefore cannot be seen as “facilitating effective competition in the generation and supply...sale, distribution and purchase of electricity”. It should be noted that the analysis in 7.7 muddies the waters by suggesting that the delta cost of transmission is much higher if an embedded generator connects, rather than on site generation or demand reduction. Put simply the £0.63m additional paid for by consumers occurs in every case of 100MW reduced transmission demand and in every case the £4.55m benefit is shared between those putting or facilitating the 100MW onto the system. The three cases affect consumers and unassociated EG equally.</p>
30	Uniper UK	<p>Although it is not a perfect solution, on balance yes, as it sets out to avoid further distortion from present high and increasing levels of embedded benefit arising from the Demand Residual component of the TNUoS tariff for the forthcoming Capacity Market auctions. It is therefore an incremental improvement against Objectives a), b) and c).</p>
31	<i>E.ON</i>	<p>We do not believe sufficient analysis has been carried out to assess whether or not CMP264 (or associated alternatives) better facilitates the applicable CUSC objectives.</p> <p>We understand the proposer’s view that the forecasted level of triad avoidance benefit under the current methodology may over-estimate the value of the avoided transmission costs and may distort the market. However, without thorough analysis of the true value of these avoided costs, the extent of any defect is not clear and we cannot agree that CMP264 better meets the applicable CUSC objectives.</p> <p>If independent analysis were to demonstrate that the current level of benefit was excessive, but a lower value of avoided cost was appropriate, it may be that a move to £0/kW benefit as proposed by CMP264 is further away from this justified value than the current level. Therefore CMP264 could be more distorting than the current level.</p> <p>We would highlight that CMP264 was originally envisaged as a temporary change in the context of a more substantial review and as such it affects only new embedded generation. This highlights the importance of a thorough and substantial review to ensure an enduring solution can be found. Ofgem’s open letter on charging arrangements for embedded generation states that it may be difficult to justify grandfathering of the current arrangements for existing plant, CMP 264 appears to conflict with this view.</p> <p>As a permanent change therefore, CMP264 appears to be less effective in meeting the CUSC objectives than the status quo.</p>
32	<i>Welsh Power Group Limited</i>	<p>No we do not believe that CMP264 better facilitates the CUSC objectives. Excluding a subset of embedded generators from a material income stream creates a new distortion in the electricity market. By targeting only those generators connecting after 30 June 2017 the vast majority of embedded generators will be unaffected by the proposal.</p>

		<p>In addition the proposed modification will introduce differential treatment between embedded generators metered at the boundary of the distribution network and those which are located behind the meter. It is not sufficient to permit this difference in treatment simply because it is a challenging area and the argument that the proposal needs to just be an incremental improvement is an inadequate justification.</p> <p>We do not consider a proposal that introduces new discrimination into the market can meet the CUSC objective of better ‘facilitating competition in the sale, distribution and purchase of electricity.’</p> <p>We consider that the most significant driver of the costs ‘incurred by transmission licencees in their transmission businesses’ is the absolute size of the transmission system. This total cost is influenced by the amount of capacity connected to and transporting electricity through the transmission system. Embedded generation, over time, reduces the size of the transmission system and as a consequence it is appropriate that embedded generators receive a share of the benefit arising from the reduced size and cost of the transmission system.</p> <p>We do not consider that proposal CMP264 would result in charge which better reflect the costs ‘incurred by transmission licencees in their transmission businesses’</p> <p>The proposer, by its own admission, does not consider that this modification should be the enduring solution and as a result this modification, if it were to be accepted, would likely lead to a series of similar modifications, each of which would lead to a period of uncertainty and a further erosion of investor confidence in the UK electricity market.</p>
33	SSE	<p>Yes, we believe that the Original CMP264 better facilitates the competition and cost reflectivity objectives but we consider that some of the alternatives would facilitate these even more effectively (e.g. the approached suggested by proposed alternative Centrica 1 & Centrica 2 with some additional further changes). Our reasoning is outlined below.</p> <p>a) CUSC Objective “a” - Better facilitates effective competition – Yes, CMP264 Original does better facilitate effective competition as compared with the Baseline with regard to “New Embedded Generators”. There are other aspects of effective competition where the Original does not improve upon the Baseline and these shortcomings may be better addressed through an alternative such that proposed by Centrica option 1, or Centrica option 2, or a future modification. These shortcomings regarding the CMP264 Original in include: With regard to Network Connected Embedded generators i. Would Discriminate between : Existing Embedded vs Transmission Connected and New Embedded – Although the Original successfully removes one element of discrimination (between New Embedded vs Transmission Connected), it leaves in place existing Baseline discrimination between Existing Embedded vs Transmission Connected (and also New Embedded). ii. Would not correct Baseline distortion regarding investment/closure decisions for existing stations – CMP264 Original would not represent an improvement compared with the Baseline with regard to non cost reflective charges/benefits for existing embedded generators. This would continue to distort their investment or closure decisions which in turn would</p>

		<p>continue to distort the Capacity and Wholesale Power markets. iii. Would not correct Baseline distortion regarding dispatch decisions for existing stations – CMP264 Original would not represent an improvement compared with Baseline of the defect regarding the dispatch decisions made by existing Embedded generators. The resulting dispatch decisions will continue to distort wholesale prices and therefore continue to distort competition in new investment and the capacity market. iv. Would not correct Baseline distortion regarding discrimination: Customers Vs Existing Embedded Generators – CMP264 Original would not improve the defect, compared with Baseline, regarding the discriminatory nature of the additional cost collected from customers to be used to pay the Embedded Benefit to existing Embedded generators With regard to behind a demand meter The following behind the meter defects may be out of scope of CMP264, however, the fact that CMP264 may not have a wide enough scope to correct all of these existing Baseline defects should not prevent or delay the implementation of a modification which does implement some elements better than the Baseline. If a number of defects remain, then these can be left to be addressed by a future modification with a wider scope. i. Does not address Baseline distortion of investment/closure decisions for Existing and New Embedded generators behind a demand meter - It is not able to address the Baseline defect with regard to New Embedded generation behind a demand meter. This type of user will continue to be able to receive a benefit equivalent to continued net charging even though the justification for receipt of such a benefit is absent. ii. Does not address Baseline distortion of investment/closure and dispatch decisions for existing and new DSR - It is not able to correct the defect with regard to DSR since this will continue to benefit from the non cost reflective value of avoiding the Triad demand charge and this will continue to distort the market for new investment. iii. Does not address Baseline discriminatory distribution Customers vs Customers - It fails to correct the discriminatory nature of the additional cost to some groups of customers which is collected to pay for the reduced cost of other groups of customers who are still able to avoid paying the “tax” element of TNUoS charges i.e. the Demand Residual. b) CUSC Objective “b” - Better facilitates cost reflectivity of charges – Yes with regard “New Embedded Generators”, CMP264 Original does better facilitate cost reflectivity of charges as compared with the Baseline. However CMP264 Original is no better than the baseline with regard to the cost reflectivity of charges for 1) Existing embedded generators, or 2) Behind a demand meter. This would result in the CMP264 Original not correcting the selection of existing Baseline defects as already described above.</p>
34	UKPR	See separate response
35	Green Frog Power	Green Frog Power do not believe that the current system charging methodology properly takes account of the developments in transmission licensees’ transmission businesses. There have been vast sums of money invested in transmission assets far removed from demand, despite the application of locational price signals, indicating that the locational signals are not sufficient to dissuade generation from locating far from demand. This is, of course, largely due to renewables projects located in offshore and/or in Scotland. Because the locational signals are not sufficiently

	<p>high to dissuade these generation investments, the cost of the resulting transmission investment is being smeared across all transmission network users.</p> <p>Whereas this has always been an underlying issue in charging methodology, it is the excessive costs of connecting these faraway generation assets that brings the matter into the stark light.</p> <p>To the extent that this underlying problem results by a chain reaction into ever increasing payments to embedded generators, we agree that this is problematic. We think that the current methodology should be changed to reflect better the impacts of these spiralling costs.</p> <p>We do not believe that CMP264 or CMP265 better facilitates the remaining CUSC objectives. The original intent of embedded “benefits” was to excluded embedded parties from exposure to the costs of a system that they do not use. CMP264 and CMP265 each propose to charge some, but not others, recipients of embedded benefits for the cost of the transmission system that they do not use.</p> <p>Some parties who use the transmission system would be charged and others would not. Some generators who do not use the transmission system would be charged at the same rate as generators that do use the system. Amongst generators that do not use the system, they’d be distinguished between each other on the basis of an arbitrary cut-off date for first commissioning, or by virtue of having specific contractual arrangements (Capacity Market agreements). This is very clear discrimination.</p> <p>Either of these proposals would clearly create distortions that wou grow in significance if the underlying size of the residual TNUoS were not addressed in the first instance. We fail to see that an arbitrary distinction and discrimination against certain parties better facilitates the CUSC objectives and, in fact, both proposals, as they stand would cause a worsening situation compared to the CUSC objectives.</p> <p>Moreover, the attempt to increase the costs of competitors’ generation through charging them for the use of assets they do not in fact use is, at its heart, fundamentally absurd. A better approach would be to address the issue of spiralling residual costs through a full, top-to-bottom SCR.</p> <p>There has been a notable lack of evidence provided to support the proposers’ claims that the current system leads to inefficient dispatch or to the inefficient closure of transmission connected generators, so we are unable to comment on whether the proposal better facilitates CUSC objectives in these regards.</p>
--	--

36	The ADE	<p>No, neither CMP264 nor CMP265 better facilitate the Applicable CUSC Objectives.</p> <p>The Applicable CUSC Objectives are to “facilitate effective competition in the generation and supply of electricity” and for the use of system charging methodology to result “in charges which reflect, as far as is reasonably practicable, the costs ... incurred by transmission licensees in their transmission businesses.”</p> <p>Increasing cost reflectivity must lead to the most cost effective and competitive system. Charges for connection to the transmission system should be based upon the net power flows modelled onto and off the system as it these net flows that drive incremental transmission investment. CMP264 and CMP265 are attempts to make the costs of using the network comparable between different types of generators. However, equalising all or some components of network changes to promote competition is no more relevant than by equalising fuel costs between different types of generation. A generator or demand user’s position in the electricity market should reflect the costs and charges, including network charges, required to provide or receive their service.</p> <p>We feel it is necessary to highlight that the proposer of CMP264, Scottish Power, agreed with the net charging approach when responding to the informal National Grid consultation on embedded benefits in February 2014, stating “We believe that the charging methodology should be based upon the net flows onto and off the transmission system and therefore we do not believe that there is any justification for basing any element of the transmission charge upon gross demand2.” We agree with Scottish Power’s previous assessment, especially since February 2014 no new evidence has been provided to change the recognition that net charging is the most effective and cost reflective charging methodology.</p> <p>The defect identified in in CMP264 and CMP265 would represent a significant shift in the competitive nature of the electricity generation marketplace, without the support of any robust analysis or quantitative investigation on the part of the proposers and despite the presence of robust quantitative analysis to the contrary. The accelerated timetable required by the Regulator for this work group, the CUSC group neither sought nor performed any analysis or evidence to establish the cost reflectivity or otherwise of the embedded benefit. The work group was not permitted to investigate either the cost-reflective value of the embedded benefit, nor was it permitted to investigate the costs which are included within the TNUoS demand residual.</p> <p>The proposer has noted that National Grid has estimated the cost reflective value for the embedded benefit at approximately £1.58/kW. In contrast, recent analysis by Cornwall Energy commissioned by the Association for Decentralised Energy found that embedded generation offset the cost of new transmission network assets required for new generation and that this value was the equivalent of £32.0/kW. However the work group did not discuss the methodology behind these figures, allowing for a consensus to be found.</p> <p>The concept of net charging, and subsequently the embedded benefit, has been a transmission network principle since before 2001. The proposal to remove this principle and implement an entirely different charging regime within nine months is unrealistic and likely to result in significant harm to generators and consumers.</p>
----	---------	---

		<p>The appropriate way to meet the Applicable CUSC Objectives is to be take a careful, considered, holistic and system approach, starting with a Significant Code Review. National Grid’s Charging Seminar Summary, published in August 2016, found that stakeholders advised the key attributes of any charging review should be to:</p> <ul style="list-style-type: none"> ☐ <i>Balance delivering review as soon as possible while maintaining a process including open and transparent consultation</i> ☐ <i>Clear responsibilities for parties</i> ☐ <i>Use clear objectives for the review in order to focus on proactively driving alignment between the long term vision and policy</i> ☐ <i>Use evidenced based/objective methodologies to determine the most appropriate options to progress</i> ☐ <i>Deliver an efficient change process – limiting re-work and reusing/building on previous analysis (and Modifications) wherever possible to ensure that participants’ time is used effectively</i> ☐ <i>Initiate a progressive transition to the future, taking into account changing technologies/behaviour whilst recognising the journey to date and implementing changes in appropriate timescales</i> <p>None of these attributes is being delivered on this issue through the current CUSC process for CMP264 and CMP265.</p> <p>The triad charge is the methodology by which the transmission system estimates a consumer or a generator’s use of the network in order to apply appropriate costs. The triad avoidance benefit, whether received by exporting distributed generation, on site generation or demand reduction, is the value of avoiding the use of the network, as determined by the triad methodology. The cost of using a network, and the value of not using a network, should be mirror images of one other.</p> <p>The implementation of CMP264 and CMP265 would create new distortions in the electricity market, treating the cost of increasing flows on the transmission network (the triad charge) differently from the value of reducing flows from it (the triad benefit). In the case of CMP264 the proposals treat the reduction of net demand differently depending on whether a distributed generator is existing or new .Both proposals seek to create disparate treatment of net demand reduction dependent on whether that reduction is delivered by exported distributed generation, on site generation or demand reduction. These distortions are the result of approaching this issue in a piecemeal fashion and addressing the incorrect defect.</p> <p>An appropriate approach to address this complex issue in a fair and equitable manner, across all users, would be to</p>
--	--	--

		<p>review the triad charge itself – both the triad methodology, as well as the size of the residual. However, we would note that as most of the Association for Decentralised Energy’s members are not CUSC parties, they are unable to propose CUSC modifications to address this defect, and due to the limited nature of the defect identified by the proposers of CMP264 and CMP265, alternatives addressing this defect are unlikely to be accepted within the working group process.</p> <p>While CMP264 and CMP265 have identified the avoided triad charge as a distortion for exported distributed generation, on site generation and demand reduction, they have only proposed a solution that attempts to fix one of those three i.e. exported distributed generation. There are no indications that their proposals could be extended to the other two types of avoidance, on site generation and demand reduction. In fact, it is our view that extending gross charging to on site generation and demand reduction will be extremely difficult to implement in practice, and the result will be that the new distortions created would exist for significant periods of time. If gross charging were to be extended:</p> <p>The charge for using the transmission network, as determined by the triad charge, will be set at a different level than the value of reducing the use of the transmission network.</p> <p>☒ The cost of reducing net demand on the transmission network will be different depending on the type of action – exported distributed generation, on-site generation, or demand reduction – taken to reduce net demand.</p> <p>☒ The total cost placed on DG for claimed use of the TN could be higher than the cost of Transmission connected generation as a result of them having the €2.50 MWh limit which is clearly not cost reflective.</p> <p>The types of harm identified by the proposer do not stand up to scrutiny, and identify the embedded benefit as the cause of the distortion when it would be more appropriate to identify other defects:</p> <p>☒ Claim of harm from inefficient investment/closure: No evidence was provided that plant are closing as a result of the embedded benefit. No evidence was provided on the impact of reduced net demand to long-run marginal costs of the transmission network.</p> <p>Claim of harm from inefficient dispatch: The proposer states that the size of the demand residual is so large that it creates inefficient dispatch signals. This distortion does not reflect a problem with the embedded benefit, but may instead indicate a problem with the cost recovery methodology for demand, which is based on peak demand and creates a signal to operate or reduce demand during the triad periods. CMP264 does not directly address the appropriate defect.</p>
--	--	---

	<p> ☒ Claim of harm from discriminatory redistribution of transmission costs between customers and generators: The proposer states that the “total sunk cost of the Transmission network still has to be collected from customer bills”. However, the work group was not permitted to explore the value of the residual and what elements of the residual should be identified as ‘sunk costs’. Furthermore, the reduction of net demand on the transmission network reduces long run marginal costs by reducing the need for future infrastructure investment. </p> <p> ☒ Claim of harm from discriminatory redistribution of transmission costs between generators: The proposer states that the payment represents discrimination between types of generators. This is incorrect. A generator or demand user’s position in the electricity market should reflect the costs and charges, including network charges, required to provide or receive their service. The current method for measuring use of the transmission network by demand users, including distributed generation, is through the triad methodology. From the perspective of the transmission network, embedded generators are negative demand and they reduce overall transmission network demand. The difference in value between the embedded and transmission-connected generator reflects: </p> <ul style="list-style-type: none"> (a) The difference in charging between generation – based on capacity – and demand – based on peak demand (b) The European cap on generation transmission network charges, which increases the share of the demand residual relative to generation (c) A share of the demand residual not being demand related, leading to less cost-reflective recognition for net demand reduction <p> If the proposer does not believe the current triad methodology accurately reflects use of the transmission network, then they have identified the incorrect distortion in the embedded benefit. In fact, both CMP264 and CMP265 would increase discrimination in the marketplace. CMP264 will reward transmission network net demand reduction via exported embedded generation, on-site embedded generation and embedded demand reduction in different ways, creating new charging distortions. CMP265 will treat Capacity Market generators differently from other generators. </p> <p> Finally, CMP264 was proposed as a temporary measure and that position helped guide the working group process, based on the expectation that Ofgem would announce a formal review process. The proposer repeatedly emphasised the temporary nature of CMP264, and stated that it was not necessary to undergo more quantitative analysis of the correct value of the embedded benefit, as this value would be determined following the Ofgem review. The proposal specifically notes that “it is not aimed at solving the bigger question of what should be the appropriate methodology for allocating supplier contributions towards TNUoS costs.” However, Ofgem’s Open Letter, published in August 2016, indicates that Ofgem does not intend to launch a full review. As CMP264 was not intended as an enduring solution, it would not be appropriate to look to implement it as an enduring solution. </p>
--	---

37	Renewable UK	<p>RenewableUK does not believe that the CMP 264 Original proposal facilitates the Applicable CUSC Objectives.</p> <p>☒ Nor does RUK believe that either of the Alternative CMP 264 proposals meet these objectives either.</p> <p>☒ The objective of enabling “<i>effective competition</i>” is undermined with the introduction of an arbitrary distinction between the access to embedded benefits for established and new distributed generators.</p> <p>☒ This arbitrary asymmetry does not remedy any misallocation of “<i>the costs incurred by the transmission licensees</i>”. Indeed, the open ended nature of CMP 264, with its lack of sunset clause, and considering Ofgem’s apparent disinclination, expressed in its recent letter on the matter, to engage in a full and detailed review of embedded benefits, means that it would bring much uncertainty to the market.</p> <p>☒ CMP 264 therefore introduces a further defect to the market, rather than fixing an existing defect, through the arbitrary establishment of a distinction between new and existing generation.</p> <p>☒ With regards to the Alternative proposals, both of the suggestions of offering the locational element of the demand TNUoS benefit and either a frozen residual component or an as-yet-to-be defined sum are arbitrary in nature if there is no detailed study of the value of embedded benefits to the system and the nature of the triad system against which to judge them. We restate our view that a holistic review of embedded benefits should be carried out to support any action taken.</p> <p>☒ Many of our members object to the lack of grandfathering in any of these proposals, as financial commitments have been made against the existing set of charging arrangements. Were grandfathering to be brought in for the purposes of fairly treating existing parties, it would count against the Centrica alternative modifications, which apply to all generators</p> <p>RenewableUK believes that neither CMP 264 nor the several Alternatives proposed in this consultation facilitates the Applicable CUSC Objectives:</p> <p>a) CMP 264 does not facilitate effective competition in the generation and supply of electricity because it arbitrarily divides embedded generation into new and existing plant, which will be treated differently even though they may have exactly the same impact on the network.</p> <p>b) It is not cost reflective as it creates an uneven playing field for embedded generation.</p> <p>c) It does not take account of the developments in the transmission licensees’ transmission businesses.</p> <p>d) It has no impact on EU law</p>

38	Savvi Energy	No
39	RES	No
40	Watt Power	<p>Firstly, we assert that we are not supportive of the CMP264 proposal as the scope of the defect is too narrow and overemphasises the link between Triad avoidance payments available to distribution connected generators and the lack of investment in alternative forms of new generation. The issues surrounding current investment in the UK generation mix are far greater than those described by CMP264 and should be addressed by Ofgem through a SCR or via a more suitable modification proposal.</p> <p>Secondly, the proposed solution creates a defect, since all parties appear to accept that embedded generation provides some grid cost reduction, which would not be reflected in the payments to generators affected by the modification. There is no firm evidence that this defect is less significant than the defect that the modification seeks to address.</p> <p>Notwithstanding the above, we are of the opinion that the potential WACM raised by Green Frog et al best addresses the defect defined by CMP264.</p>
41	Plutus	No – the proposal as is creates a clearly distortive effect between existing and new build embedded generation, therefore impacting objective 1. Exempting all new embedded generation also adversely impacts objective 2 – there are avoided transmission-related costs for embedded generation to connect behind the majority of grid supply points and these are not being reflected by removing all of the demand residual embedded benefit.
42	Reliance	No – the proposal as is creates a clearly distortive effect between existing and new build embedded generation, therefore impacting objective 1. Exempting all new embedded generation also adversely impacts objective 2 – there are avoided transmission-related costs for embedded generation to connect behind the majority of grid supply points and these are not being reflected by removing all of the demand residual embedded benefit.
43	Silva Renewable Energy Limited – Bilateral Connection Contract holder Renewable	<p>No</p> <p>We do not support either of the proposed two modifications because we believe they do not provide an enduring solution to the distortions their sponsors seek to address or the defects identified subsequently by Ofgem. Indeed neither improves on the current CUSC baseline, and could be argued to be regressive under charging objectives a), b) and c).</p> <p>Indeed, we are strongly opposed to the standstill proposal for embedded benefits (CMP264) which discriminates against developers like us and would not support competition under the CUSC charging objectives. By design it does not provide an enduring solution, and hence the stability, which is what the market requires.</p> <p>It is also relevant that Ofgem has raised concerns over the cost-reflectivity of the triad benefit and wishes to see</p>

		<p>change. We do not believe either of the two tabled solutions address this problem, and they would simply introduce further distortions and discriminations into the current CUSC baseline. They do not bring charges in line with costs nor reflect developments in the transmission system. It is clear that for a robust solution to be identified considerable further work is needed, and the key is coming forward with a revised charging methodology that captures the true benefits of distribution-connected to the system, and not just National Grid's avoided reinforcement costs.</p>
44	Drax	<p>Yes. CMP264 addresses the disparity in competition between sub 100MW embedded generators and other generators caused by the excessive benefit arising from Embedded Benefits (EBs) based on the increasing and non-cost reflective demand residual tariff. The modification will put all generators on a more level playing field better facilitating competition. We believe that the true benefit that Embedded Generation (EG) brings the system is far less than the c.£45/kW they receive currently (and rising excessively in future). With respect to ACO (b), CMP264 will ensure a better reflection of actual costs (benefits).</p> <p>A rough approximation for the EB, mentioned in paragraph 2.3.14 in the workgroup report is the Total Allowable Revenue divided by Net Demand. The increasing amount of EG (effectively negative demand) on the distribution network has resulted in a decrease in the Net Demand (the denominator) thereby increasing the value of the EB. This artificially increases the profitability of building EG resulting in a positive feedback mechanism that encourages new EG to be built. This discernible increase in EG is impacting the ways in which the system is developed and operated therefore CMP264 will better facilitate ACO (c) with respect to the baseline.</p> <p>We would note that CMP264 has a number of shortfalls and that the potential option for change, denoted as Centrica 1 in the workgroup report, will better facilitate the ACOs. Firstly, while we agree with the principle of grandfathering in some circumstances, given these circumstances we do not agree that it is appropriate in this instance. This is because the charging arrangements have never been subject to any form of grandfathering meaning that a prudent investor will not have expected any form of grandfathering when making investment decisions. To apply grandfathering to the charging arrangements will create moral hazard, rewarding inefficient investment decisions and entrenching ineffective competition. Secondly, CMP264 removes any reference to the wider tariff in the EB. Under Centrica 1, all EGs will be subject to the modification and would receive the locational TNUoS tariff element as an EB. From the evidence provided and the time we have had to review, we believe that the locational TNUoS tariff element reflects a better approximation of the EB. Centrica 1 however has a proposed implementation date of 1st April 2020 which we see as being excessive. The precedence set for charging changes (such as those seen in CMP213) was one full charging year.</p>

45	ELEXON	No text provided
46	Rockpool	No – the proposal as is creates a clearly distortive effect between existing and new build embedded generation, therefore impacting objective 1. Exempting all new embedded generation also adversely impacts objective 2 – there are avoided transmission-related costs for embedded generation to connect behind the majority of grid supply points and these are not being reflected by removing all of the demand residual embedded benefit.
47 late response (rec'd 1 Sept 16)	Calon Energy	Yes. Calon believes that the modification will create a more level playing field between generators and thus remove market distortions and enhance competition, in line with objective a. It will also better reflect the costs associated with transmission, which should not reward third parties, and thus meet objective b.

Question 2: Do you support the proposed implementation approach? Or are there any further implementation implications that need to be considered?

Response No	Company	Response
1	<i>CLP Envirogas</i>	No. The proposal sits outside the CUSC objectives, does not address the fundamental issue of increasing transmission system costs and their allocation, and unfairly targets new embedded generators, some of whom may have included this revenue when designing their projects.
2	Engie	We do not support this proposal as presently crafted. It discriminates between existing and new users based on date of construction/first running. We believe that embedded generators should see an appropriate locational signal and an embedded substation benefit relating to avoided substation cost.
3	RWE Generation UK plc, RWE Supply & Trading GmbH	The scale and extent of the distortions associated with the residual component of the demand TNUoS tariffs as identified under the modification proposal (and in Ofgem’s Open Letter ¹) suggests that it is appropriate that the defect is addressed as soon as practicable. However, we have concerns about the feasibility of the proposed solution and its impact on suppliers if implemented with effect from 30 th June 2017. In particular it may be difficult to develop and deliver efficient central reporting mechanisms and supplier billing systems in the required timescale. These are required to ensure the identification of relevant embedded generation and the introduction of gross charging for such parties. 1. Ofgem “ Open letter: Charging arrangements for embedded generation ”, : 29 th July at https://www.ofgem.gov.uk/system/files/docs/2016/07/open_letter_-_charging_arrangments_for_embedded_generation.pdf
4	<i>EPR Ely Limited</i>	No. The proposal sits outside the CUSC objectives, does not address the fundamental issue of increasing transmission system costs and their allocation, and unfairly targets new embedded generators, some of whom may have included this revenue when designing their projects.
5	<i>EPR Glanford Limited</i>	No. The proposal sits outside the CUSC objectives, does not address the fundamental issue of increasing transmission system costs and their allocation, and unfairly targets new embedded generators, some of whom may have included this revenue when designing their projects.
6	<i>EPR Eye Limited</i>	No. The proposal sits outside the CUSC objectives, does not address the fundamental issue of increasing transmission system costs and their allocation, and unfairly targets new embedded generators, some of whom may have included this revenue when

		designing their projects.
7	Statera Energy	<p>No, this implementation approach is not justified and will severely damage investor confidence.</p> <p>The modifications do not fully consider the following issues:</p> <ol style="list-style-type: none"> i. The incentives for existing plant to default on CM agreements signed in good faith due to the changes in plant economics; ii. The impact on the CM clearing prices, and thus customer bills; iii. The impact on supply security if plant stops running during Triad periods and no new plant is forthcoming on the transmission network; iv. The impact on the TO costs of reinforcement to meet peak demand; v. The impact on longer term security if new, flexible generation is not built to support the intermittent plant; vi. The impact on wholesale prices, notably at peak, as embedded plant have little market access except via the Triad signal; and vii. The unduly discriminatory nature of any change that targets only one group of generators - if embedded plant is over rewarded then it is all over rewarded.
8	<i>EPR Scotland Limited</i>	<p>No.</p> <p>The proposal sits outside the CUSC objectives, does not address the fundamental issue of increasing transmission system costs and their allocation, and unfairly targets new embedded generators, some of whom may have included this revenue when designing their projects.</p>
9	TATA Chemicals Europe	Comments removed for publication of report
10	<i>EPR Thetford Limited</i>	<p>No. The proposal sits outside the CUSC objectives, does not address the fundamental issue of increasing transmission system costs and their allocation, and unfairly targets new embedded generators, some of whom may have included this revenue when designing their projects.</p>
11	<i>LondonWaste Ltd</i>	<p>We do not support this form of approach at all and we believe that the status quo should remain.</p> <p>Clearly when the current arrangements were set up people considered generation and demand reduction to equivalent with respect to the Triad charge. Since then, nothing has fundamentally changed other than the volumes and the price. It would be inappropriate change these long established principle in the rushed manner that has been proposed.</p>
12	<i>PeakGen</i>	If the proposal were to be approved, the suggested implementation approach appears reasonable.

	<i>Power Ltd</i>	
13	<i>Statoil ASA</i>	We do not support CMP 264 as proposed. However, if CMP 264 is implemented, the cut of date for New Embedded Generators” should be delayed to 30 September 2018, ref our response to question 10.
14	Good Energy	The short timescale proposed for implementation of CMP264 would be highly disruptive for PPA negotiations which are already in progress. The timescale could also introduce significant risk to any projects for which significant investment commitment has already been made, but which may not be commissioned by 30 th June 2017. Implementation of CMP264 is also likely to lead to significant administrative and cost burdens relating to mixed sites, both in the immediate and longer term.
15	<i>REstore</i>	No, see introduction.
16	EDF Energy	Yes. We do have concerns about whether implementation by June 2017 can be achieved in terms of BSC system releases, but this is not an objection on our part, and might be overcome.
17	Tees Valley Combined Authority	At this present time, we are not in a position to be able to assess the full implications of the proposed implementation approach and would strongly recommend an extension of the consultation period. Only after such a consultation period would we be in a position to provide a robust response.
18	Octopus Investments	No, we do not think it is appropriate to simply halt TRIADs during the review or indeed permanently with grandfathering as this proposal would imply absent a review. We consider freezing TRIADs at the current level and undertaking the full planned review is the most appropriate approach.
19	The Greenspan Agency Limited	No
20	Centrica	We believe there is significant implementation risk associated with CMP264, notably in ensuring that “new” embedded generation is captured, reported and charged as intended. We also believe the proposed 30 June 2017 cut-off date for being deemed an “existing” embedded generator could put pressure on system / process delivery timelines. It seems to us that a good deal of system / process work needs to be undertaken before June 2017 to give effect to CMP264 and we question whether this is practicable.
21	<i>ScottishPower Energy Management Limited</i>	Parties participating in the Capacity Mechanism auction process require certainty over future costs and revenues in order to bid efficiently. The implementation approach for CMP264 can provide that certainty by allowing for an Authority determination before the December 2016 CM auction and a cut-off date for entitlement to embedded benefits of June 2017. In line with when Triad periods can occur, the actual implementation of the system changes needs to be no later than 1 November 2017.
22	Eider Power	No. Aside from our view that the proposal has no merit we note that the regulator has sought in the past not to undermine

	Reserve	investment decisions already made. This proposal, if implemented in the manner suggested, would cause new embedded generation with capacity market agreements and committed arrangements for grid and other expenditure to have to cancel with losses to all concerned and a reduction in much needed generation capacity in the market at a time of short supply, increasing the risk of damaging wide area power outages
23	Infinis Energy	<p>No – we feel the proposed implementation approach significantly distorts the market environment for a number of plant including:</p> <p>☐☐☐☐</p> <p>A number of plant awarded a capacity market contract</p> <p>☐ a number of plant awarded a contract-for-difference over the past two years</p> <p>☐ new build embedded generators at a time of concerns over system security.</p>
24	<i>RWE Innogy UK- RWE npower joint submission</i>	<p>No we do not support the suggested implementation approach. The proposed date of introduction: April 2017 is unacceptable for the following reasons:</p> <ul style="list-style-type: none"> - this is a highly significant charging methodology change switching from net metering to gross metering. - Elexon, NGET billing system changes need to be accommodated in the timeline - Supplier system changes need to be accommodated in the timeline. <p>Internal pricing and billing systems would require changes along with customer contractual arrangements. While we are against the implementation of CMP264, we want to make the point that any Mod that makes such significant changes to the demand charging principles should allow 3 years from the date of the Ofgem decision to implementation. The Ofgem decision itself will provide the correct signal to CM (the date of implementation is less critical). This delay is necessary for suppliers and consumers because it will enable systems and processes to be updated to accommodate the changes required. In addition it will enable current contractual agreements to unwind which will facilitate required changes to be factored into future contracts. There could be a Negative Impact on suppliers who are contracted with embedded generators. Customers typically will sign a 1, 2 or 3 year contract with their suppliers. It is only at the point of contract renewal that the supplier can incorporate these additional charges into customer contracts. Longer term contracts covering 25 years plus also exist . These highlight the increased risks around changing industry rules / charging methodologies. Regarding impact on embedded generation investor certainty: This proposal does avoid step changes in charging for existing projects. Avoiding sharp charging changes in general is important for UK generation investor confidence. Investors in generation have in good faith made investments based on locational signals established by NGET and approved by Ofgem – this Modification proposal recognises that this is the case and only applies a solution to new generators. CMP264 aims to provide due time for the implementation of a new comprehensive charging arrangement. It is suggested that CMP264 is intended as a “stop-gap”</p>

		<p>solution with a sunset clause anticipating a SCR that Ofgem's Letter suggests is not forthcoming. Since the SCR is not forthcoming we would say that a stop gap solution is inappropriate. For a proposal that presents a partial, temporary solution it is associated with very high disruption. A comprehensive, enduring solution would be preferable. We feel that the development of systems and data flows to support such a change are prohibitively expensive and disproportionate in terms of the terms of the temporary and partial nature of the solution suggested. There are additional loopholes (behind the meter generation) that cannot be covered. In addition the expectation that suppliers can obtain appropriate information from Embedded Generators without supporting central data flows when quoting for an Embedded Generator that is not part of their current portfolio is unrealistic. It is unclear whether the associated BSc change is perceived as a prerequisite to this change or an option. This proposal opens up wider questions on the governance framework required on the data quality in addition to the resource implications this would have across the industry. Appropriate SLAs would need to be put in place to ensure suppliers can readily access the required information for their tendering process.</p>
25	Sembcorp Utilities (UK) Limited	We support the review of charging arrangements for embedded generation however CMP264's proposal to remove triad avoidance revenue, even temporarily, for existing and sanctioned new-build generation would send the wrong signal to investors.
26	<i>Smartest Energy</i>	No
27	<i>Ecotricity</i>	We believe that the proposed implementation is too soon to allow industry parties to be ready for the implementation of CMP264.
28	UK Green Investment Bank plc	No comment
29	Alkane Energy Limited	<p>The proposal would require investors with CM contracts secured in the 2014 & 2015 auctions with a requirement to build plant earlier than required under those contracts.</p> <p>It is unreasonable to suggest that 13 months from becoming aware of the proposal is sufficient to complete construction and commission the embedded plant that has capacity market contracts. We are subject to a number of constraints including the raising of finance, supply chain capacity, gas and power distribution network capacity upgrades etc. Some of these (notably the last) are outside our control.</p> <p>Both forecast Triad revenue and capacity market income are required to support the economics of our embedded plant. Without either of these streams the revenue from other sources, which is more uncertain, becomes critical. As the project economics become less certain this raises cost of capital and means that revenue streams from other sources need to be that</p>

		<p>much greater to justify investment.</p> <p>As of today we face a choice whether to build out our capacity market commitments or terminate the contracts. Our capacity market bids were based in good faith on the outcome of reviews of Triads that concluded the status quo was acceptable. We accepted the risk that the forecasts may change because of changed assumptions, but not the risk of a wholesale change to Triad calculation in isolation, nor what is proposed by CMP264 i.e. the removal of Triad benefits completely.</p> <p>If this proposal went through it is doubtful whether we would be able to justify building to meet our existing contracts. This would place increased costs on consumers today and in the medium term future as more capacity would need to be procured at higher prices, in part driven by increasing investor nervousness over the regulatory risk faced by investing in the UK, as well as risking medium term security of supply</p>
30	Uniper UK	CMP264 aims to be implemented in April 2017. This seems ambitious, particularly in terms of getting the necessary data to enable National Grid to bill accordingly. However, it needs to be implemented by then in order to provide charging for the early year 2017/18 capacity market auction.
31	<i>E.ON</i>	<p>Notwithstanding our belief that CMP 264 cannot be justified without further analysis, we support the proposed implementation approach (see response to Q10(i) for comments on the 30th June 2017 cut-off date).</p> <p>However, we note that implementing changes by June 2017 is likely to require a number of changes in suppliers' processes and billing systems in a short period of time. It has not been possible for us to assess the impacts and quantify the associated costs in the time available but we would highlight that, in the context of a number of major changes to industry rules in recent months (not least as a result of the CMA investigation), IT change plans of suppliers are likely to be highly stretched already. More time is required to explore more thorough the impacts on suppliers' processes and systems before any proposal is approved.</p>
32	<i>Welsh Power Group Limited</i>	We do not support the proposed implementation approach. We believe that the required code and system changes, were this proposal to be taken forward, would take significantly longer than the timescales for implementation outlined in the proposal. Insufficient time has been allowed during the working group process to sufficiently investigate the impact on suppliers, systems and consumers of the proposed modification and that any change so fundamental in its approach to charging arrangements should not be rushed into implementation in such short timescales with the potential for requiring manual work arounds and rushed changes to systems and processes
33	SSE	<p>We support the proposed implementation approach, but we think that the following aspects need to be taken into account in the final implementation. 1) How much of the Demand Residual should be charged gross ? i. Support the implementation principle that the Demand Residual is charged Gross. ii. Gross on all embedded generation - Agree that the "Centrica 1" or "Centrica 2" proposed alternatives are likely to improve cost reflectivity and facilitate effective competition better than CMP264 Original. If the Centrica 2 alternative used a value of "x £/kW" set equal to the Generator TNUoS Residual this would</p>

		<p>contribute to maintain a level playing field between transmission connected generation and embedded generation. 2) Short transition period with stepped down cap to the net element If the Start date were to be delayed beyond 2017/18, then it would be better to also include a short transition period with does have a start date as early as practicable. The transition arrangements should take the form of a cap on the element of the Demand Residual charged net which should step down in straight line annual increments towards the enduring level. The starting level for the calculation of the transitional cap should be the level of the 2016/17 Demand Residual. This transition period would better enable the market to adjust to the new charging arrangements.3) Peak Security tariff element should be charged net Support the Centrica 1&2 proposed alternatives which apply the Peak Security Tariff element on a net basis. This is more cost reflective than applying the Peak Security tariff element gross. 4) Support the CMP264 Original proposal for the Year Round tariff element to also be charged gross - Until a future more comprehensive solution is implemented to change the definition of the Demand TNUoS charging base. i. A more comprehensive solution would apply the Year Round tariff on a net basis but only on a different definition of charging base such as using an ALF, or a commoditised £/MWh basis (definitely not peak, and not Triad). Project TransmiT identified that the Year Round tariff reflects year round network conditions (not just at peak), which is why the Generator TNUoS Year Round element is effectively commoditised via each station’s “ALF”. However, if it is out of scope for CMP264 to change the definition of the Triad charging base, then the Year Round tariff element is not useful for providing an economic price signal because it is not cost reflective when it is applied to the Triad charging base. ii. As an interim solution until the charging base can be improved, we would support the CMP264 Original proposal of continuing to charge the Year Round tariff element on a gross basis in order to avoid causing additional harm. If the Year Round tariff element were to be charged net on Triad demand charging base, then the Year Round tariff element of the Triad price signal would be spurious, discriminatory and not cost reflective. This would tend to distort investment and dispatch decisions and cause a reduction in social welfare: E.g. For embedded generators in positive Year Round charging zones – They would face a dispatch signal to generate at Triad peaks in order to earn a Year Round tariff element benefit, the value of which does not reflect the value to the network of their generation at Triad periods. E.g. For embedded generators in negative Year Round tariff zones - Net charging of Year Round tariff on Triad demand would result in perverse dispatch behaviour because the embedded generator would face the incentive to generate up to an expected Triad period, then switch off and not generate at all during the expected Triad period, only to switch back on again once the Triad period had ended. This incentive to change dispatch behaviour at peak would not change the year round network cost caused by that embedded generator, so their response to the price signal, corresponding to the Year Round tariff element, would fail to achieve the intended purpose of that price signal. Therefore the Year Round tariff element charged net on Triad demand would fail to provide a useful price signal.</p>
34	UKPR	See separate response
35	Green Frog Power	Green Frog Power believe that the proposed implementation is overly complicated, discriminatory, and does not address the underlying issue of spiralling transmission costs and the consequent spiralling embedded benefits.

		<p>We are also concerned that the Mods fail to address effectively behind-the-meter generation and DSR providers. If the fundamental way in which the transmission residual is collected is not addressed, the spiralling value will cause increasing distortions. This will result in yet another review and further dragging out of the uncertainty in an already inhospitable investment environment created by the proposed change.</p> <p>Serious consideration needs to be given as to how the system will react to a relatively sudden change to triads and to the ensuing adjustments to embedded generators' behaviour. Triads enable the provision of a valuable service – reduction of peak transmitted demand. If triads are reduced or eliminated (as proposed), consideration must be taken of the impact on security of supply and on peak prices for consumers.</p> <p>Though these issues have been raised regularly through the workgroup meetings, the timetable did not permit a thorough impact study. Triads have been an integral part of the power system for decades – changing them without thoroughly reviewing the impact on consumers would be short-sighted.</p> <p>As well as a lack of analysis of the impact on security of supply and on consumers' costs, there has not been sufficient time to conduct a thorough system-wide study of the value of embedded generation to the system –in other words, what the cost-reflective value should be that embedded generators receive. Scottish Power have honed in on a number of ~£1.60/kW, identified in a cursory study by National Grid some years ago. In contrast, Cornwall Energy have identified, in their own more recent study, that ~£32/kW was the appropriate cost-reflective level. The workgroup had no time to consider the methodology underpinning these studies nor to propose or conduct additional studies. Nonetheless, we note that £32 is the level closest to that which has endured over recent history and which has had the desired impact on security of supply (i.e. keeping the lights on during winter peaks).</p>
36	The ADE	<p>The proposed implementation approach raises significant risks to gaming as a result of the rushed timetable. If suppliers do not have automated systems in place by June 2017, the proposal will require manual intervention, significantly increasing risks of errors.</p> <p>We do not agree with the proposer's assessment that 13 months from becoming aware of the proposal is sufficient to complete construction and commission "given the smaller nature of embedded plant". This statement is not accurate. Embedded plant can reach sizes of up to 100 MW, and include highly complex gas CCGT and biomass generation assets. These assets have build times of at least two years, and engineering complications can extend this build time for several additional years. For example, the most recent 50 MW biomass CHP plant in Scotland took five years to complete construction.</p> <p>The proposal would put plant currently in development at risk by removing value for plant which have already received either</p>

		<p>CfD contracts or Capacity Market contracts for delivery in 2017, 2018 and 2019. This raises significant concern that the implementation timetable will harm market certainty, increasing costs for consumers.</p> <p>The proposer recognises the distortion resulting from generators serving load behind the meter in paragraph 3.3.17, but does not does recognise the remaining distortion where behind the meter generation will be treated differently from demand reduction, despite both reducing transmission network net demand in the identical way.</p> <p>The proposer’s identification of the embedded benefit as the defect, instead of either the demand residual or the triad methodology, means that the proposer’s modification adds new distortions to the charging methodology while not addressing the correct defect.</p>
37	Renewable UK	<p>No, we do not support the implementation approach of CMP 264.</p> <p>The Proposal makes no effort to address directly the defects which it lists, namely:</p> <ul style="list-style-type: none"> o uncertainty over the correctly cost-reflective value of embedded benefits to distributed generation which is producing during triad periods; o the nature of the triad structure itself; o distorted investment decisions, which favour smaller, distribution connected generation over larger, transmission connected generation. <p>☒ We disagree with the proposition that CMP 264 is a “proportionate response”.</p>
38	Savvi Energy	No text provided
39	RES	No
40	Watt Power	<p>As stated above, we are not supportive of proposal CMP264. Regardless, it appears that the implementation approach for the original CMP264 proposal raised by Scottish Power is not appropriate or achievable. The post June 30th 2017 cut-off date for “new” embedded generation would require complementary changes to a number of billing and charging systems. It is highly unlikely that the tight timeframe would allow sufficient time for these changes to be brought forward. Further, the timeframe for implementation does not allow sufficient time for parties to bring forward plants which are already under development (i.e. planning consent granted, connections secured and where relevant capacity contracts are in place) though the plant is not yet constructed or commissioned.</p>
41	Plutus	No – we feel the proposed implementation approach significantly distorts the market environment for a number of plant including:

		<ul style="list-style-type: none"> ▪ a number of plant awarded a capacity market contract ▪ a number of plant awarded a contract-for-difference over the past two years new build embedded generators at a time of concerns over system security.
42	Reliance	<p>No – we feel the proposed implementation approach significantly distorts the market environment for a number of plant including:</p> <ul style="list-style-type: none"> ▪ a number of plant awarded a capacity market contract ▪ a number of plant awarded a contract-for-difference over the past two years new build embedded generators at a time of concerns over system security.
43	Silva Renewable Energy Limited – Bilateral Connection Contract holder Renewable	<p>No</p> <p>This situation – especially the prospect of no early resolution - gives rise to considerable risks to us and other developers. It is virtually impossible at this stage to call what enduring solution might emerge. Whilst some reduction in the triad benefit may be one outcome, we estimate that in our case, any such result could add materially to the required CfD strike price. We would expect other developers in similar circumstances to encounter a similar issue. This is contrary to HM Government’s key objective for CfD, namely that any subsidy for renewable energy must achieve value for money to the energy consumer.</p> <p>There needs to be a clear implementation path way for addressing the defect and the Ofgem issues communicated to the industry well ahead of CFD auction processes.</p> <p>We would be happy to share with the code administrator our confidential estimates on the size of the potential impact.</p>
44	Drax	<p>We see the benefit of swift action being taken to address the inappropriateness of the current and future EBs. We agree with the implementation date of CMP264 but for any EGs not subject to grandfathering, a more pragmatic approach should be taken such as the one mentioned in the answer to question 1 above i.e. One full charging year from Authority decision.</p>
45	ELEXON	<p>ELEXON is the Balancing and Settlement Code Company (BSCCo). ELEXON fulfils the role of the BSC’s code administrator. As such we have focused our responses to this consultation on the implications of CMP264 and 265 for the BSC and the interdependencies between CMP264 and 265, and BSC Modifications P348 and P3491. Our responses do not represent the views of the BSC Panel or of BSC Parties.</p> <p>ELEXON is in the process of consulting the industry and completing an impact assessment of P348 and P349. Consequently we cannot say what the implications of CMP264 and 265 might be for the BSC. Any conclusions drawn from P348/349 consultation responses and the IA will help us to better understand the timescales, costs and feasibility of achieving the proposed</p>

		<p>implementation timetables.</p> <p>Nevertheless ELEXON has highlighted to the CMP264/265 and P348/349 workgroups, and at BSC Panel meetings that BSC Scheduled Releases over the next 12-18 months already pose a challenge to implement. Including additional changes to BSC Systems in forthcoming Scheduled Releases is likely to be expensive and possibly at the cost of other competing changes. This risk is particularly relevant to CMP264 and P349 because the proposer would like these changes implemented in 2017. It may be appropriate to consider an interim solution that avoids or minimises changes to BSC Systems in order to achieve an implementation date in 2017.</p> <p>ELEXON has also highlighted the need for careful coordination between the principal CUSC modifications and supporting industry code modifications. We believe that overall the proposed CUSC requirements are driving all changes. Therefore we recommend that primary requirements and definitions should originate in the CUSC which supporting industry codes can refer to or draw their vires from. In addition, as CMP264 and 265 are principal modifications that rely on changes to other industry codes we believe that the Code Administrators' Joint Working Practices should be more clearly employed and that in this case National Grid is the lead Code Administrator. Therefore National Grid should take a clearer role in ensuring that any consequential changes, e.g. to the BSC or the DTC, are co-ordinated effectively (e.g. where appropriate through joint workgroup meetings and consultations).</p> <p>With co-ordination in mind, the consultation document correctly recognises that the implementation of the technical solutions proposed by P348 and P349 may require changes to the Data Transfer Catalogue (DTC). That is, changes may be required to modify existing or introduce new data flows used by Suppliers, their agents and Supplier Volume Allocation Agent (SVAA) to facilitate the collection and reporting of metered data necessary to support CMP264 and 265. However, ELEXON nor any Party has raised a corresponding DTC Change Proposal (in part because the workgroups have not finalised the technical solutions yet) and we note that this process can take several months to progress through design, assessment, decision and implementation.</p> <p>Finally, BSC changes tend to be implemented as part of a Scheduled Release in February, June and November each year, whereas CUSC changes are implemented on an ad hoc basis. At the moment the proposed implementation date for CMP264 is 1 April 2017 whereas for P349 it is 29 June 2017 (as part of the June 2017 Release), and the implementation date for CMP265 is 1 April 2020 whereas it is 7 November 2019 (as part of the November 2019 Release) for P348. We encourage the CMP264/265 and P348/349 workgroups to consider the implications of not implementing these changes on the same day.</p>
46	Rockpool	<p>No – we feel the proposed implementation approach significantly distorts the market environment for a number of plant including:</p> <ul style="list-style-type: none"> ▪ a number of plant awarded a capacity market contract ▪ a number of plant awarded a contract-for-difference over the past two years

		new build embedded generators at a time of concerns over system security.
47 late response (rec'd 1 Sept 16)	Calon Energy	Yes. However, we note that there remains an incentive for embedded generators to move behind the meter, so would propose that Ofgem modify the CM rules to allow EMR Settlements to provide details of all CM meters for the purposes of TNUoS charging. These meters could then be incorporated into an expanded solution.

Question 3: Do you have any other comments?

Response No	Company	Response
1	<i>CLP Envirogas</i>	No.
2	Engie	Please see Technical Appendices for detailed analysis
3	RWE Generation UK plc, RWE Supply & Trading GmbH	<p>We are concerned about the accelerated timescales required for consideration of the issues identified under this modification proposal. As can be seen from the scale and materiality of the impact together with the complexity of the proposed solutions detailed consideration is required to determine whether this proposal or its alternatives can address the defects identified and lead to an enduring solution.</p> <p>The proposed modification is at best a partial solution and further change will be required to develop enduring arrangements. In particular the nature of the locational component of the demand tariff and the appropriate charging bases for these tariffs require careful assessment. We believe that a partial and potentially discriminatory solution, as proposed, carries the risk of creating more harm than good, and introducing considerable uncertainty in the electricity market.</p>
4	<i>EPR Ely Limited</i>	No.
5	<i>EPR Glanford Limited</i>	No.
6	<i>EPR Eye Limited</i>	No.
7	Statera Energy	See cover letter attached.
8	<i>EPR Scotland Limited</i>	No.
9	TATA Chemicals Europe	Comments removed for publication of report
10	<i>EPR Thetford Limited</i>	No.
11	<i>LondonWaste Ltd</i>	The contorted nature of the proposal is revealed by the proposal that generators commissioned after June 2017 should not be able to avoid paying for NGC's sunk costs while those built before then could.

12	<i>PeakGen Power Ltd</i>	We note that there appear to be defects in the current charging regime and it is appropriate to solve these. Given the complexity of this issues we think that a significant code review should be undertaken and note that an interim solution could have a benefit. Please refer to our general comments to the consultation for details.
13	<i>Statoil ASA</i>	Any changes to embedded benefits would need to have sufficient grandfathering protection for projects that have made investment protection based on receiving embedded benefits.
14	Good Energy	Introduction of a modification such as CMP264, ahead of OFGEM's final decision on the future of embedded benefits, could lead to the introduction of changes which are not consistent with OFGEM's final viewpoint. This risks leading industry participants to incur significant abortive costs. Additionally, introduction of interim measures such as CMP264 risks reducing the pressure on OFGEM to implement a lasting solution in a timely fashion.
15	<i>REstore</i>	While concerning only new built generation assets from 2017, CMP264 would probably have less impacts for the whole market, and in particular would not bring and retroactive change for market players that have already developed capacities based on the existing framework. Still, this could only be a temporary "freeze" of the embedded benefit system, in order to avoid an uncontrolled increase of those capacities, while a deep revision of network charges is undertaken.
16	EDF Energy	No
17	Tees Valley Combined Authority	While the CMP264 proposal to grandfather existing generators will protect existing embedded generators in our region, the proposed date of June 2017 does not provide a sufficient investment window for a region such as the Tees Valley, which is currently undertaking significant industrial restructuring following recent closures.
18	Octopus Investments	We believe that Ofgem's approach of not undertaking its intended Significant Code Review (SCR) is a significant abrogation of its responsibilities. The energy industry has been subject to substantial change in the last few years and innovation is likely to have further material impact over the next 5-10 years, for instance from increased renewables, development of storage, smart grid applications and decarbonisation of transport infrastructure. As such it is not at all clear that promoting one form of generation (CCGT) over others as is indicated in Ofgem's letter without a full review is tenable. As a result of the absence of an SCR it is not clear how the panel or Ofgem can consider this option as it is predicated as a stop gap pending that review. If the review is no longer occurring we believe that this is no longer a valid modification proposal. We would encourage the panel to consider not just the cost of TRIADs and the claimed negative impact on contracting new large gas generation but also the benefits to the UK system. The current structure of TRIAD regime incentivises 6-10GW of additional capacity to generate during the Winter darkness peak which significantly enhances security of supply and reduces costs for consumers. If TRIADs are removed or limited a substantial proportion of this capacity is likely not to generate as

		<p>baseload and enter the STOR market instead, causing greater volatility in system prices and higher costs of balancing which will overall be to the detriment of consumers as the higher costs feed through to their bills.</p> <p>The crucial role that embedded generators, incentivised through TRIADs, play in delivering security of supply over the Winter should be considered in the context of DEFRA’s proposals for implementation for the MCPD which would substantially reduce the volume of diesel generation. Without diesel it is even more critical to provide appropriate incentives for gas-fired embedded generators to deliver supply in the peaks. In reviewing all the proposed code modifications related to TRIADs Ofgem should be mindful of the full energy policy landscape rather than making piecemeal changes based on lobbying from interested parties.</p> <p>There has been a suggestion from Ofgem that TRIADs cause embedded plants to dispatch out of merit (ie generate when it is not economic for them to do so) as a result of chasing TRIADs. It is not clear where the consumer detriment arises in this behaviour as dampening peak prices offsets the additional cost of TRIADs.</p> <p>Outside of the Winter peak conventional embedded plants have no incentive to dispatch out of merit which limits any negative market impact. Of considerably greater impact on prices and running hours for large conventional plant is the volume of renewable energy that is effectively dispatching out of merit due to its subsidies. Therefore it cannot be suggested that amending the TRIAD regime will create a perfect energy market with all players competing on equal terms nor are conventional embedded generators the primary factor inhibiting the commissioning of new transmission connected plant. This proposal by contrast would deliver significant windfall gains to existing generation, particularly large transmission connected plant that would benefit from higher annual CM clearing prices and higher peak prices, all to the consumer’s detriment.</p> <p>All responses below are caveated that we do not believe this proposal is valid in the absence of an SCR and therefore should be struck down or put on hold until Ofgem commits to undertake such a review.</p>
19	The Greenspan Agency Limited	<p>We have endeavoured to consider this consultation as best we can before writing our response. However the volume of documents relating to this modification is extremely large and presents a challenge for any interested parties within the time allowed. Therefore, although our comments are general in nature and do not address more technical aspects of the modification and the CUSC, by participating we wish to make all parties aware that we are interested in, and affected by, the process and its outcome.</p> <p>DECC (now BEIS) published a consultation on a review to the Capacity Market on 1st March year. It is widely considered that the Capacity Market is not providing a sufficiently high auction price for new build transmission generation to be built. This may be the case however we are concerned that the blame is unfairly being squared on embedded generation and the ‘embedded benefits’ that DECC considers are preventing a ‘level playing field’ with transmission generation. It appears this has led to efforts being concentrated on issues such as the one in question, Triad benefit, at the expense of other matters that may be of more pressing concern to the CM.</p>

		<p>For example, the IPPR published a report in March 2016 titled ‘Incapacitated’ which shows that the vast majority of the winners in the 2014 and 2015 Capacity Market auctions were existing transmission generators, the majority of whom do not require CM payments to generate. This raises important questions about the extent to which the CM clearing price was reduced by <i>proposed</i> embedded generation versus <i>existing</i> transmission generation.</p> <p>Therefore we are concerned that embedded generation is being singled out for scrutiny despite it providing extremely valuable benefits to the electricity system and society as a whole. More energy is being delivered closer to the point of use than ever before. This has reduced energy losses from long-distance transmission. It has reduced GB’s dependency on larger, often fossil-fuelled power stations. The increasing proportion of ‘fuel-free’ renewables such as wind, solar and hydro has reduced the wholesale price of electricity.</p> <p>A carefully considered review of TNUoS – but more importantly the electricity system as a whole – is sorely needed. It is widely understood in the Industry that TNUoS and the method by which TOs recover their revenue is overdue for a proper review. However, despite being labelled a temporary measure, we are concerned that this modification proposal would endure for too long. It is also poorly timed – the GB electricity system requires new-build supply to come forward as soon as possible. Non-intermittent embedded generating capacity such as gas engines are relatively quick to consent, build and commission and so should not be discouraged.</p> <p>Should it be deemed that the Triad benefit must be amended in the short term, we would argue that the reduction should be: temporary, and; shared across all distribution connected generation, rather than being removed solely for new embedded generation.</p> <p>Further general thoughts include the following:</p> <ul style="list-style-type: none"> ☐ Has COMMISSION REGULATION (EU) No 838/2010 been reviewed yet, in accordance with Annex Part B Section 5? Is the 2.5 EURO cap still appropriate? Or is this arbitrary measure undervaluing the contribution transmission generation should be making towards overall transmission system costs? (Instead of the 27:73 split). ☐ The Triad signals between demand and generation should be equal. <p>These modifications should be considered in the context of the wider review of the electricity system proposed by Ofgem in their recent letter. We intend to respond to this also.</p>
20	Centrica	No
21	ScottishPower Energy Management Limited	No
22	Eider Power	We consider that there are elements of transmission costs, principally those related to offshore generation, that cannot be

	Reserve	avoided by building more embedded generation as they are policy objectives of the UK Government with fixed price arrangements through the Contract for Difference structure. These offshore generation costs are the principal driver of TNUoS growth in the years to come and have not been addressed by any of the amendment proposals to date. We would support and are submitting an alternative to address this obvious issue. Note that in our view this still does not mean that the adjusted Triad benefits or indeed other charging is fully fit for purpose so we would continue to argue for an SCR
23	Infinis Energy	Infinis Energy disagrees with the principle of altering the market landscape in order to drive through market signals for a policy tool. While the current level of triads have never been a certainty, removing them altogether for a select number of plant will reduce investor confidence in the market.
24	<i>RWE Innogy UK- RWE npower joint submission</i>	A) The Working Group should bear in mind that new hydro, wind and biomass generators will be detrimentally impacted by these proposals- the arrangements are not exclusive to fossil fuelled peaking plant. Providing sufficient lead time for any changes to current charging arrangements is very important for the economics of such projects too – they will be losing a significant annual income stream. B) The proposed ‘CMP264 potential WACMs’ all fail to present a new cost reflective charging solution and some introduce new layers of discrimination and complexities for suppliers. This all lends itself to introducing considerable uncertainty in the electricity market. C) We have a question regarding implementation: - What are the implications of switching suppliers? How can it be ensured that existing sites and new sites continue to be correctly categorised between switches? Suppliers would require industry supporting data held centrally by Elexon to manage this. Will this be available? D) When an embedded generator changes supplier we don’t understand how a potential new supplier would have access to their EREC 59 data and therefore we feel this is unrealistic .This would present one of the following challenges: i) Relying on suppliers for information (data quality / governance) ii) Cost and time for implementing robust data flows for a temporary solution It is unclear whether the associated BSc change is perceived as a prerequisite to this change or an option
25	Sembcorp Utilities (UK) Limited	No
26	<i>Smartest Energy</i>	No
27	<i>Ecotricity</i>	We believe these benefits should vary by GSP group or at least a fractional benefit, as opposed to a suspension of benefit. -Ideally, we would like the current stance on these embedded benefits to remain the same or to charge on gross demand then have a separate benefit. This benefit shall reflect what you are putting into the system.
28	UK Green	No comment

	Investment Bank plc	
29	Alkane Energy Limited	<p>CMP264 was framed as a stop gap until Ofgem undertook a comprehensive review of all the issues. Through Workgroup discussion and the release of the Ofgem open letter it has, midway through the process, morphed into a proposal for an enduring solution. We believe this to be a totally inadequate approach and as a consequence, we do not consider the original modification and its implementation to be supportable.</p> <p>The Proposer now invites a future change via the CUSC process to be brought forward with indeterminate outcome and timescale. For an EG like Alkane who is not a CUSC member this is a totally inappropriate route. It also prolongs regulatory uncertainty that increases consumer costs and puts in jeopardy investments that help secure supplies, keep power prices low and so help enhance industry competitiveness.</p> <p>The EG community is a wide ranging group all of whom will be impacted by the proposed modifications. This investment community need clear medium to long term signals. We have received clear feedback that implementation of the Original CMP264 will ensure capacity not already built is not financeable.</p>
30	Uniper UK	No
31	<i>E.ON</i>	<p>As an enduring change, the Centrica 2 alternative provides a sensible framework to reflect the locational charge in the triad benefit plus any additional, justifiable costs avoided that are currently recovered through the residual charge (the additional £X/kW). However, we disagree that £X/kW should be set equal to the generation residual as proposed. This level is arbitrary as it is not based on analysis of the transmission costs avoided; it also further embeds the impact of the EU's non-cost reflective €2.50/MWh cap on generation charges.</p> <p>As we highlight throughout this response, more detailed analysis of the transmission costs that can be avoided by the use of embedded generation is needed in order to determine a cost reflective value of £X/kW.</p>
32	<i>Welsh Power Group Limited</i>	<p>Noting OFGEM's recent open letter on this matter we would question whether the description of CMP264 as a 'stop-gap' measure is appropriate. Since OFGEM appear to be content for the CUSC modification proposal to run its course the proposal will become an enduring change to the charging arrangements.</p> <p>We believe that the proposal is entirely unsuitable as an enduring solution to the identified defect and appears to be little more than a swift and crude move designed to impact on clearing prices in the 2016 Capacity Market auction.</p> <p>National Grid identifies over 7.5GW of embedded generation operating during the Triad periods all of which would be unaffected by the current proposal</p>
33	SSE	<p>Cost reflectivity vs Revenue collection It is essential that each charging element should be clearly identified as having one out of two purposes (never both). The two types of classification of purpose could be described as either: 1) Economic Price Signal</p>

or 2) Revenue Collection as described below: **1) Economic Price Signal** - E.g. TNUoS Locational tariff elements. These charging elements should be consistent with the CUSC objectives of being cost reflective and facilitating effective competition (among Transmission connected generators, among Distribution connected generators, among demand and between all of these groups). These are the price signals which society wants parties to respond to. However, for these charging elements to be appropriate, it is a prerequisite that the tariff elements are applied to an appropriate definition of charging base so that the decisions which parties make in response to the price signals do actually cause a corresponding change in the cost of the network. If these economic price signals are not applied in a cost reflective way (either in terms of the charging base they are applied to, their magnitude, whether they are positive/negative, or locational distribution), then they may be no longer useful as economic price signals. This is because when parties respond to an economic price signal which is not cost reflective, then their resulting behaviour will tend to cause an economically inefficient outcome, discrimination and higher cost to customers. Therefore when applying charges which have the purpose of being cost reflective, it is important to be aware of the risk of unintended consequences which may be detrimental to social welfare. **2) Revenue Collection** - Effectively a form of tax. E.g. TNUoS Demand Residual. Economic theory regarding optimal tax theory indicates these types of charges should be equitable and difficult to avoid. This is because these charges do not reflect an avoidable cost, so these should not be used as an economic price signal for behaviour, but instead they should be applied in a way which is fair and explicitly attempts to avoid causing distortions to market behaviour. Society does not want parties to even try to avoid these “taxes” because avoidance behaviour is economically inefficient so would result in a less socially efficient result, higher cost to society and higher cost to customers. Economic resources which society expends on avoiding these “taxes” is not economically useful for society (although it can be rational for each individual taking the action). It is important to note that there can be circumstances where there may be a trade-off between the various CUSC objectives and Ofgem further objectives of: cost reflectivity, effective competition, transparency, accuracy, stability and practicality. If there are circumstances where for a particular charging element, this trade-off can't be adequately resolved, then a better solution can be to discard the (failed) attempt to be cost reflective and instead use an approach based on socialised revenue collection.

Implications for system security The concerns which the consultation raises regarding capacity adequacy and system security appear overblown. The proposed changes should not detrimentally affect system security for the following reasons: 1) **Removal of the benefit does not change the system margin.** As long as embedded generators remain available, then they will dispatch in merit due to wholesale price signals if they are needed by the system.. 2) **Only if the loss of the Triad benefit makes some generators unable to recover their short-run operating costs, then some may close or not build so they may not be available.** Only then would this tend to reduce the system margin. 3) **It is the purpose of the Capacity Mechanism to source sufficient capacity to maintain adequate system margin.** Capacity adequacy and system security is not and should not be the purpose of transmission network charging. Also noting a system stress even can happen any time (not necessarily at a Triad) so the Capacity Mechanism provides the right

		incentives to address this, but the Triad signal does not. 4) A short transitional period may be helpful – Ofgem should consider how best to manage any transition to a new charging arrangement. Any concern regarding the risk of short-term system security issues should be considered in the context of how best to implement the change, but this does not have any bearing on the question of if the change should take place.
34	UKPR	See separate response
35	Green Frog Power	<p>CMP264 was proposed as a temporary, interim solution, as it was envisioned that Ofgem would be conducting a full SCR. Ofgem has since announced that they will not be doing so.</p> <p>We reiterate our view that an SCR is required to address the issue of the TNUoS residual and embedded benefits appropriately and in a manner that will ensure we are not all back together in a similar workgroup in six or twelve months.</p> <p>Since CMP264 was intended to be a temporary fix, we do not feel it remains a valid proposal. The cut-off date (1 June 2017) and the impact on generators that have gained a CM agreement for 2018/19 or 2019/20 in previous CM auctions needs to be very carefully considered.</p> <p>The best approach would be to apply a fixed or capped level of triads, at this winter’s level for example, to all embedded generators. This would be a compromise solution that would endure through an SCR process, or indeed without one, providing stability and consistency to the market and to investors. This would still leave the significant issue of distortions between the rewards for different types of parties whose actions, in different ways, both reduce transmission demand. Nonetheless it would be acceptable for an interim solution.</p>
36	The ADE	No
37	Renewable UK	<p>We believe that CMP 264 was proposed in a rush, without adequate analysis of the effects which halting the provision of embedded benefits would have on the majority of new Distributed Generation projects, many of which may be relying upon embedded benefit income as a key revenue component in order to attain financial close.</p> <p>☒ The lack of a sunset clause will deliver only uncertainty to the market, rather than certainty, given Ofgem’s clear disinclination to undertake a full response.</p> <p>☒ The arbitrary difference in treatment between new and existing embedded generation, both of which classes, howsoever they are delimited, will have identical impacts on the network, creates another defect which CMP 264 does not solve</p>

38	Sarvi Energy	<p>Until the real underlying benefits of embedded generation are independently reviewed, in conjunction with a wider review of the TNUoS charging arrangements both CMP264 and CMP265 are premature.</p> <p>The impact of the removal of the triad revenue stream on new renewable energy projects should be reviewed.</p> <p>Renewable energy projects are often distribution connected due to their size. Although Triad revenues are less relevant for solar the impact will be large for potential Hydro projects and will be a significant for wind farms, especially in the context of reduced subsidy, removal of the LEC and lower wholesale prices (which will be partly driven by the capacity market). This will have an environmental impact.</p>
39	RES	<p>Please see comments made against “Views regarding the workgroup” section above.</p>
40	Watt Power	<p>The “temporary nature” implied by the CMP264, though the proposal is no longer accompanied by a disapplication date, is made void by the recent Ofgem Open Letter on embedded benefits. If Ofgem are not minded to undertake a Significant Code Review and undertake a holistic review of charging arrangements in order to examine the cost-reflectivity of embedded benefits and instead have chosen to focus on bringing forward change through the CUSC modification proposals currently under consideration, CMP264 would be no more temporary than any other CUSC modification. In effect, CMP264 would introduce an indefinite freeze of Triad payments to any ‘new’ embedded generator (‘new’ defined by the proposal as any embedded generator commissioned on or after 1st July 2017). This could endanger security of supply by sparking the termination of existing Capacity Market contracts, and result in higher costs to consumers as significantly less small-scale flexible and affordable generation is brought forward following the implementation date.</p>
41	Plutus	<p>Plutus is a developer of standby generation, and an active bidder in the recent CM and forthcoming auctions.</p> <p>We strongly disagree with the principle of altering the market landscape in order to drive through market signals for a policy tool. While the current level of triads have never been a certainty, removing them altogether for a select number of plant will reduce investor confidence in the market.</p> <p>We would also note that the consultation does not address the problems that will arise as and when the generator residual charge turns negative.</p>
42	Reliance	<p>REL is a professional services company who work with active developers of low-carbon generation schemes in GB.</p> <p>We strongly disagree with the principle of altering the market landscape in order to drive through market signals for a policy tool. While the current level of triads have never been a certainty, removing them altogether for a select number of plant will</p>

		<p>reduce investor confidence in the market.</p> <p>We would also note that the consultation does not address the problems that will arise as and when the generator residual charge turns negative.</p>
43	Silva Renewable Energy Limited – Bilateral Connection Contract holder Renewable	<p>Silva is the developer behind the Grangemouth renewable energy scheme, a s36 consented 120MWe biomass CHP in the strategically important Grangemouth petrochemical and industrial processing zone. Grangemouth CHP is being prepared for the second CfD allocation round which is expected imminently.</p> <p>Grangemouth CHP already has a transmission connection agreement in place, but is also advancing the option of a distribution connection which is now at offer stage. Assuming a successful outcome at CfD, Grangemouth CHP would be constructed and commissioned in time for the 2021 delivery year. It is a project that has immense economic benefit for the Grangemouth industrial area and broader Falkirk community, and is being closely followed at all levels of local and national government.</p> <p>Against this background we have been preparing our bid in the forthcoming CfD auction using the transmission charging baseline as it stands, but following closely the recent developments with regard to the embedded benefit review and the Consultation and how these may impact our distribution connection offer. This is particularly important to Grangemouth CHP as, in unchanged circumstances unaffected by the embedded benefit review and Consultation, a distribution connection would help greatly the project economics and enhance the deliverability of Grangemouth CHP under the CfD regime with the commensurate benefits to the local community and wider national interest.</p> <p>Given the huge uncertainty surrounding the transmission charging regime, the significant regulatory risk that has been introduced into the process and the probability this will not be resolved by the two modifications in process, the Working Group should consider the interactions of these change proposals (and alternatives) with the CfD regime.</p> <p>The only obvious solution we can see at this stage is to respect the assumptions made by developers in making their CfD bids, in effect “grandfathering” them, and the next stage of the assessment process should explicitly address this. Some accommodation to address other potential material changes to the regulatory regime in the future also needs consideration as regulatory risk has significantly increased in the eyes of the financial community.</p> <p>As a separate comment we believe the Working Group has failed to consider the implications of the generator residual turning negative in the near time and the further distorting effect this would have on the competitive process for CFDs.</p>
44	Drax	<p>The temporary nature of CMP264 has been addressed a number of times in workgroup meetings. The modification proposal assumes a level of Ofgem intervention after its approval. However, the recent Ofgem letter on their minded-to position on</p>

		<p>charging arrangements for EB suggested that the CMP264/CMP265 work stream may be sufficient to address the defect. Given this it was suggested that CMP264 was no longer fit for purpose.</p> <p>We would highlight that the CUSC is not permanent in nature and that modifications can be raised by any party to the CUSC or any materially affected party. Therefore CMP264 can quickly address the defect in the short term and can be followed up by a modification that could take a more detailed holistic view of EBs as a whole or not if no further change is required. As such we believe CMP264 is still fit for purpose</p>
45	ELEXON	No text provided
46	Rockpool	<p>Rockpool is an independent investment firm dedicated to creating direct private company investment opportunities for individuals. We are actively investing in a portfolio of companies that are designed to provide standby power to the GB electricity system, and the current projects will all be distribution-connected. Their viability will be directly impacted by the outcome of the process for considering these modifications and their respective alternatives.</p> <p>We strongly disagree with the principle of altering the market landscape in order to drive through market signals for a policy tool. While the current level of triads have never been a certainty, removing them altogether for a select number of plant will reduce investor confidence in the market.</p> <p>We would also note that the consultation does not address the problems that will arise as and when the generator residual charge turns negative.</p>
47 late response (rec'd 1 Sept 16)	Calon Energy	No

Question 4: Do you wish to raise a WG Consultation Alternative Request for the Workgroup to consider?

Response No	Company	Response
1	CLP Envirogas	<i>No WACM indicated in response</i>
2	Engie	No: This may be raised via the working group and would be based on the Centrica (2) proposal with an embedded substation benefit of £3-4/kW applied in addition to the locational tariff in accordance with CUSC 14.15.119. Practically, setting the lowest location tariff to zero may achieve both objectives. Implementation would be the next following 1st April after an Authority decision i.e. a decision in March 17 would result in implementation 1st April 18. This will give the maximum benefit to consumers
3	RWE Generation UK plc, RWE Supply & Trading GmbH	We have considered the potential development of an alternative based on improving the cost reflectivity of the locational component of demand tariffs and the relevant charging base and addressing the issues associated with the cost recovery through the residual component of the tariff. However, we believe that these issues are potentially outside the limited scope of the defects identified in the modification proposals. We believe that further consideration is required by the Workgroup to determine whether the proposed solution or alternatives are capable of the addressing the issues identified by the workgroup in its consultation and Ofgem in its Open Letter.
4	EPR Ely Limited	<i>No WACM indicated in response</i>
5	EPR Glanford Limited	<i>No WACM indicated in response</i>
6	EPR Eye Limited	<i>No WACM indicated in response</i>
7	Statera Energy	<p>The working group should consider the Green Frog alternative, but conditional on a proper Ofgem review.</p> <p>We think there is merit in considering different ways to address the residual issue Ofgem raises, such as a fixed charge on all demand meters, more cost recovery via the locational charges, and difference in the structure of the Triad system.</p> <p>However, it is not obvious that these sit as alternatives in this case, and hence we would ask Ofgem to undertake a proper, well considered and researched review before accepting any modifications along the lines raised in CMP264/5.</p>

8	<i>EPR Scotland Limited</i>	<i>No WACM indicated in response</i>
9	TATA Chemicals Europe	Comments removed for publication of report
10	<i>EPR Thetford Limited</i>	<i>No WACM indicated in response</i>
11	<i>LondonWaste Ltd</i>	<i>No WACM indicated in response</i>
12	<i>PeakGen Power Ltd</i>	<i>No. It is our view that s Significant Code Review should take place with appropriate modifications raised once a proper overview has been taken. As an interim solution to allow time to undertake an SCR maintaining embedded benefit at current levels seems most appropriate – we have supported the draft WACM produced by Green Frog et al on this basis.</i>
13	<i>Statoil ASA</i>	<i>No WACM indicated in response</i>
14	Good Energy	We do not wish to introduce an alternative modification at this time.
15	<i>REstore</i>	No text provided
16	EDF Energy	No
17	Tees Valley Combined Authority	No
18	Octopus Investments	No – we support the proposed Greenfrog amendment with a requirement for Ofgem to undertake its intended SCR
19	The Greenspan Agency Limited	No text provided
20	Centrica	We do not wish to raise a WG Consultation Alternative Request given the potential alternatives already mooted by Centrica in the Workgroup Consultation report
21	<i>ScottishPower Energy</i>	No

	<i>Management Limited</i>	
22	Eider Power Reserve	Yes – see alternative.
23	Infinis Energy	Yes we have raised two alternatives seeking to implement a more enduring solution to the triad embedded benefit calculation including its current over-valuation. These are attached.
24	<i>RWE Innogy UK- RWE npower joint submission</i>	No
25	Sembcorp Utilities (UK) Limited	No
26	<i>Smartest Energy</i>	Yes. Please see accompanying attachment.
27	<i>Ecotricity</i>	<i>No WACM indicated in response</i>
28	UK Green Investment Bank plc	No
29	Alkane Energy Limited	Yes see attached
30	Uniper UK	Yes. Please see separate WG Consultation Alternative Request form attachment
31	<i>E.ON</i>	No
32	<i>Welsh Power Group Limited</i>	No. We are supportive of the alternative proposed by Green Frog and believe that this is the most appropriate way of mitigating the real defect which we consider to be the rapid rise in supplier TNUoS rates as a result of the large annual increases in transmission allowed revenues compounded by a cap on charges to transmission connected power plants.
33	SSE	Yes – Alternative Request form to follow.
34	UKPR	See separate response
35	Green Frog	

	Power	
36	The ADE	Yes
37	Renewable UK	No
38	Savvi Energy	<i>No WACM indicated in response</i>
39	RES	We request returned focus on holistic review via the National Grid review of commercial arrangements to best avoid further market distortion from unintended consequences.
40	Watt Power	<i>No WACM indicated in response</i>
41	Plutus	No but we will support the two alternatives being raised by Infinis seeking to implement a more enduring solution to the triad embedded benefit calculation including its current over-valuation. A much more considered approach than that being pursued on CMP264 and CMP265 is needed with wider impacts taken into account
42	Reliance	No but we will support the two alternatives being raised by Infinis seeking to implement a more enduring solution to the triad embedded benefit calculation including its current over-valuation. A much more considered approach than that being pursued on CMP264 and CMP265 is needed with wider impacts taken into account.
43	Silva Renewable Energy Limited – Bilateral Connection Contract holder Renewable	No but I support Infinis Energy’s proposed WACMs
44	Drax	If we decide to do so it will be in my capacity as a workgroup member.
45	ELEXON	<i>No WACM indicated in response</i>
46	Rockpool	No but we will support the two alternatives being raised by Infinis seeking to implement a more enduring solution to the triad embedded benefit calculation including its current over-valuation. A much more considered approach than that being pursued on CMP264 and CMP265 is needed with wider impacts taken into account.
47 late response (rec’d 1	Calon Energy	Yes but no text provided.

Sept 16)		
----------	--	--

Question 10:

i) Do you think a cut-off date for “new embedded generation” of 30 June 2017 is appropriate? What other date would you propose?

Response No	Company	Response
1	<i>CLP Envirogas</i>	We do not agree with the change so do not comment on the selected date.
2	<i>Engie</i>	The date (if there is one) should be the date the modification was raised as this is normal practice for changes of this nature.
3	RWE Generation UK plc, RWE Supply & Trading GmbH	Given the nature of the issue identified in the modification proposal (i.e. in relation to the capacity market) it is appropriate to define a specific implementation date in the proposed solution. The date of 30 th June 2017 represents a cut off point with respect to a potential 2017/18 capacity market auction process and as such is appropriately justified. However we have concerns about the practicality of this implementation date (see answer to Q2).
4	<i>EPR Ely Limited</i>	We do not agree with the change so do not comment on the selected date.
5	<i>EPR Glanford Limited</i>	We do not agree with the change so do not comment on the selected date.
6	<i>EPR Eye Limited</i>	We do not agree with the change so do not comment on the selected date.
7	Statera Energy	No. what happens if plant is delayed for no fault of their own, such as DNO issues? In particular it discriminates against participants in the T-4 auctions for 2014 and 2015, and also those planning to participate in 2016.
8	<i>EPR Scotland Limited</i>	We do not agree with the change so do not comment on the selected date.
9	TATA Chemicals Europe	Comments removed for publication of report
10	<i>EPR Thetford</i>	We do not agree with the change so do not

	<i>Limited</i>	comment on the selected date.
11	<i>LondonWaste Ltd</i>	This date would be wholly inappropriate.
12	<i>PeakGen Power Ltd</i>	Given commitments already entered into and lead times, 1 January 2018 appears more reasonable.
13	<i>Statoil ASA</i>	We do not believe that the proposed cut-off date of 30 June 2017 is appropriate. Any change to embedded benefits would need to have sufficient grandfathering protection of projects that have made their investments decisions based on receiving embedded benefits. We disagree with the proposer's assessment that the proposed cut-off date would be sufficient as it in our view will negatively affect projects currently under construction. In our view the cut-off date would need to be later to protect projects under construction. We would propose that the cut-off date is after 30 September 2018 which is similar to the deadline for accrediting under the Renewables Obligation (including graced periods).
14	Good Energy	The short timescale proposed for implementation would be highly disruptive for PPA negotiations which are already in progress. The timescale could also introduce significant risk to any projects for which significant investment commitment has already been made, but which may not be commissioned by 30 th June 2017.
15	<i>REstore</i>	No text provided
16	EDF Energy	The cut off date appears to be a difficult date for Elexon to meet in terms of its part in creating a necessary new data flow under BSC P349. A date in 2018, perhaps just after the 2017/18 triad season via the February 2018 Elexon systems release, would certainly be achievable for Elexon
17	Tees Valley Combined Authority	This date is much too soon, there are plants under construction now which will not be online for several years
18	Octopus Investments	No, we support freezing the TRIADs at the current rate during an SCR
19	The Greenspan Agency Limited	No text provided
20	Centrica	We have overarching concerns about the administrative complexity and impracticality of CMP264. We believe it is unnecessary and undesirable to create sub categories of embedded generation, with some sub categories being eligible for transmission embedded benefits and others not.

		A more straightforward and cost reflective approach is to treat all exports from embedded generation equivalently for transmission charging purposes, irrespective of whether they are “new” or “existing”.
21	<i>ScottishPower Energy Management Limited</i>	Yes. The cut-off date should be early enough to prevent distortion of future investment decisions but late enough to allow Parties who have already made such a decision sufficient time to construct and commission the new plant. As most of the new plant will be smaller scale in nature, 30 June 2017 is appropriate
22	Eider Power Reserve	No because we have embedded generation in course of construction with expenditure made on grid, engines etc which would be uneconomic if this date was to be adopted. We would support a date of 31 December 2018 but no earlier.
23	Infinis Energy	Yes considering the timeframes within which Ofgem is looking to place a solution. However we would recommend some carve out for plant that reached a final investment decision under the current market arrangements (for example plant awarded contracts under the CfD or CM).
24	<i>RWE Innogy UK- RWE npower joint submission</i>	Although this date has a clear link to the upcoming Capacity Mechanism Auction in network charging terms the impact of an embedded generator connecting before or after this date could be the same and therefore it is difficult to justify this cutoff. In network charging terms it is arbitrary. There is also a practical problem with this cut-off: it does not allow the due time for Elexon, NGET and supplier metering and billing systems to adapt
25	Sembcorp Utilities (UK) Limited	No text provided
26	<i>Smartest Energy</i>	i) It's as good a date as any that is not retrospective.
27	<i>Ecotricity</i>	We believe that the industry deserves a few more years before the cut-off date is introduced, as generation commissioned after this date may have been based on investment decisions made with this embedded benefit in mind and it would be unfair to penalise those parties
28	UK Green Investment Bank plc	A cut-off date for new embedded generation of 30 June 2017 is not appropriate. Our experience in the financing of larger embedded generators utilising steam turbines indicates that a typical period from financial close to commissioning will be in the region of 24 to 28 months. Allowing for a reasonable contingency period to allow for overruns in construction or commissioning suggests that allowing for a 3 year construction and commissioning period would be more appropriate in setting a cut off date.
29	Alkane Energy Limited	A 13 month period is not appropriate. We would propose a date that is reflective of capacity market contract commitments, namely October 2018 and October 2019 for 2014 and 2015 CM contracted capacity respectively.

		<p>If this is considered unreasonable the earliest we could anticipate as a reasonable timeframe to apply to both years is October 2018.</p> <p>We are unable to comply with 30 June 2017 for all our capacity market contract obligations and feel it is unreasonable for our investors to be penalised for working to a date set out in the capacity market rules.</p>
30	Uniper UK	<p>This appears to be the earliest potential cut-off date, although it grandfathers the benefit for those embedded generators prior to the cut-off date. This would create a further distortion in the market between new and existing embedded generation and transmission connected generation. Ofgem's letter of 29 July 2016 questions whether the cost of continuing with the embedded benefit for existing embedded generators and continuing with a distortion between the different categories can be justified or is fair. As the Original Proposal, if approved, would be an enduring arrangement, until such time as a replacement arrangement was to be introduced; there would be a clear and continuing non-cost reflective distortion that would still need to be addressed</p>
31	<i>E.ON</i>	<p>We believe this date is too soon. New embedded generators who entered the Capacity Market in good faith have an expectation of a 4 year lead time to commission their projects. New generators from the 2015 Capacity Auction have a reasonable expectation that they have until October 2019 to commission their plant (the CM Rules actually allow for a further 12 months beyond this).</p> <p>We note that the alternative proposal UKPR1 proposes that plant that currently holds CM Agreements or CfD Contracts should be excluded from the definition of "new embedded generator". We are concerned that embedded generators not covered by this exclusion, who do not participate in the Capacity Market, work to similar timescales and are likely to be just as committed financially to a project.</p> <p>Under CMP264 or its alternates, the cut-off date for all new embedded generation should be the same, and should not be any earlier than 1st October 2019.</p>
32	<i>Welsh Power Group Limited</i>	<p>we believe that the cut-off date is arbitrary and entirely inappropriate . The date appears to be an attempt at grandfathering and at providing some level of protection for investments that have already been made. Since the date falls little more than 6 months after the planned determination date by OFGEM this appears to be too short a period for affected parties to react. If CMP264 were to be progressed we would expect a later cut-off date, perhaps 30 June 2018, or a derogation for plants which have made substantial commitments similar to the concept of Financial Commitment Milestone in the Capacity Market</p>
33	SSE	<p>We would propose there should be no cut-off date such that any element of the Demand TNUoS tariff charged gross applies to all embedded generators irrespective of whether they are new or existing. However, if a cut-off date is used for "new</p>

		embedded generation”, then any cut-off date should be as early as practicable, in which case the proposed date of 30th June 2017 would appear reasonable.
34	UKPR	See separate response
35	Green Frog Power	Subject to concerns noted above, we think that the June 2017 cut-off date is as random and inappropriate as any other. It is likely to result in significant financial harm to some parties, all of them smaller market participants, and will, overall, benefit larger market players with a proportionately larger market presence. Choosing a later date would mitigate some of the obvious damage this Mod will cause
36	The ADE	No. We would recommend a cut-off date of May 2018, as this would be reflect a two year period from the original notification of the modification. Two to three years is a standard build time for many decentralised energy projects, including gas and renewable CHP plant, which can reach sizes of up to 100 MW
37	Renewable UK	RenewableUK is not in a position to comment on this matter.
38	Savvi Energy	If implemented the proposed date would be appropriate – it is an interim solution, ofgem have indicated they would look to implement changes by 2019/20 so any later date would remove the impact of the interim solution (it could be hard to argue the modification would be worth making if it only applied to a single triad season).
39	RES	No. A cut-off date creates arbitrary and undue discrimination so we would not propose an alternative.
40	Watt Power	In the first instance, we are opposed to proposal CMP264. Further, the proposed cut-off date is wholly inappropriate as it does not allow time for any complementary system changes to be brought forward
41	Plutus	Any implementation of this proposal should carve plant that reached a final investment decision under the current market arrangements (for example plant awarded contracts under the CfD or CM).
42	Reliance	Any implementation of this proposal should carve plant that reached a final investment decision under the current market arrangements (for example plant awarded contracts under the CfD or CM).
43	Silva Renewable Energy Limited – Bilateral Connection	Not appropriate.

	Contract holder Renewable	
44	Drax	<p>We agree that if CMP264 were to be implemented this date is acceptable provided a timely decision by The Authority. However, while we agree with the principle of grandfathering, we do not agree that it is appropriate in this instance.</p>
45	ELEXON	<p>In keeping with our role as the BSCCo, we have only responded to sub-questions ii) and vi).</p> <p>In general, because of the interdependency between the CUSC and other industry codes to deliver CMP264 and 265, and the potential complexity of these arrangements, we believe that the clarity of any requirements and definitions is vitally important. It was clear at the CMP264/265 Workgroup meeting on 11 August that the CMP Workgroup had not thoroughly explored the detail and the implications of a technical solution previously considered by the P348/349 workgroup. Nevertheless we are encouraged that the CMP workgroup's meeting on 11 August began to consider in more detail what is necessary to ensure a robust solution. We look forward to the focused CMP264/265 sub-group and the coordinated drafting of legal texts.</p> <p>As part of the P348/349 workgroup meeting it was apparent that the activity at a New Embedded Generator (NEG) site may be more complicated than first thought. That is, in reality any generating site is metered for any on-site demand as well as any generation it exports to the system. Furthermore, the site may be a combination of generating units, some of which the developer may have commissioned after the 'cut-off' date proposed (therefore qualifying as NEG) and some may not. The P348/349 workgroup recognised that the 'mixed site' nature of generating sites may require special attention.</p> <p>In terms of CMP264 and P349, these modifications propose that Suppliers only report gross metered data from export metering systems that measure energy at sites consisting NEGs. This is irrespective of whether the site consists of generating units that are non-NEG. The proposer was not convinced the workgroup had made a strong case for a more complicated set of arrangements for mixed sites. Therefore we believe CMP264 and P349 propose a technical solution which is simpler than CMP265 and P348 because it avoids the challenges of identifying complicated mixed site configurations and determining rules for netting import from export volumes. However, we also note that the consultation considers whether suppliers could provide additional evidence to National Grid (over and above what is reported in accordance with the BSC solution). The means of collecting and providing this additional data has not been specified under P349 and the CMP workgroup should give consideration to how this process would work in practice.</p> <p>ELEXON does not have a view whether the definition of 'commissioned' is appropriate. However, as noted above, we believe</p>

		<p>definitions need to be clear so parties are able to effectively discharge their obligations and because other industry code requirements will rely on those set out in the CUSC.</p> <p>For example, in addition to relying on suppliers determining whether a site has received EREC G59 certification, the definition of NEG and 'commissioned' relies on a handful of exceptional circumstances (see paragraph 3.3.15) and the site being a 'sufficient size'. It is clear the definitions will require precise drafting to ensure the definitions are clear and unambiguous.</p> <p>Finally, in light of the reliance on suppliers to self-certify a site and to provide metered data, the CMP264/265 workgroup should consider how compliance will be monitored and assured. In keeping with our comments relating to primacy, we believe the CUSC should take the primary role in any assurance requirements.</p>
46	Rockpool	Any implementation of this proposal should carve plant that reached a final investment decision under the current market arrangements (for example plant awarded contracts under the CfD or CM).
47 late response (rec'd 1 Sept 16)	Calon Energy	Yes, that seems long enough for all T-4 capacity to finish building.

ii) Do you have any views on how mixed sites are being addressed in CMP264 Original?

Response No	Company	Response
1	CLP Envirogas	No comment
2	Engie	All export meters should be covered by the proposal set at the maximum size prior to the cut-off date.
3	RWE Generation UK plc, RWE Supply & Trading	It is essential that the incentives on new generation are consistent and enduring. We do not believe that the modification should create potential loopholes in relation to mixed sites (where new embedded generation could continue to enjoy the embedded benefit). Therefore we support an approach that addresses mixed sites. However, we note that this increases the complexity of the potential solution and its costs. Furthermore it may not be practical to deliver such a solution.

	GmbH	
4	<i>EPR Ely Limited</i>	No comment
5	<i>EPR Glanford Limited</i>	No comment
6	<i>EPR Eye Limited</i>	No comment
7	Statera Energy	If embedded plant is to be excluded from Traids then so should on-site generation. This may mean a change to the CM rules, but it would be less distortionary.
8	<i>EPR Scotland Limited</i>	No comment
9	TATA Chemicals Europe	Comments removed for publication of report
10	<i>EPR Thetford Limited</i>	No comment
11	<i>LondonWaste Ltd</i>	No, we see the national aggregate embedded generation and national aggregate demand reduction at times of triad as being equivalent from the point of view of the transmission system. A large proportion of the offset is constant (that is at triad times year to year).
12	<i>PeakGen Power Ltd</i>	We note that most sites considered as generation have ancillary load and therefore are formally mixed sites. We therefore think that it is important that mixed sites are properly addressed.
13	<i>Statoil ASA</i>	We do not believe that the proposed cut-off date of 30 June 2017 is appropriate. Any change to embedded benefits would need to have sufficient grandfathering protection of projects that have made their investments decisions based on receiving embedded benefits. We disagree with the proposer's assessment that the proposed cut-off date would be sufficient as it in our view will negatively affect projects currently under construction. In our view the cut-off date would need to be later to protect projects under construction. We would propose that the cut-off date is after 30 September 2018 which is similar to the deadline for accrediting under the Renewables Obligation (including graced periods).
14	Good Energy	CMP264 is also likely to lead to significant administrative and cost burdens relating to mixed sites, both in the immediate and

		longer term.
15	<i>REstore</i>	No text provided
16	EDF Energy	As to mixed sites, the solutions in 3.3.15 and 3.3.16 of the consultation appear reasonable, pragmatic and workable
17	Tees Valley Combined Authority	We see the embedded generation and demand reduction as being entirely equivalent and disagree with the treatment at the DNO level, let alone the site level
18	Octopus Investments	No
19	The Greenspan Agency Limited	No text provided
20	Centrica	See 10 i)
21	<i>ScottishPower Energy Management Limited</i>	Under the current baseline there is an issue with being able to capture generation behind the meter as only boundary metering enters the settlement process.CMP264 does not attempt to address this separate issue and will only capture exporting half-hourly settlement metering. We consider that mixed sites should be addressed as part of Ofgem’s further review of charging or via a separate modification
22	Eider Power Reserve	No
23	Infinis Energy	No views
24	<i>RWE Innogy UK- RWE npower joint submission</i>	Mixed sites and DSR are hard to capture under this proposal even though their network impact is the same as that of embedded generation
25	Sembcorp Utilities (UK) Limited	No text provided
26	<i>Smartest Energy</i>	If the supplier net model is retained then the issue of random boundaries in localised netting falls away.

27	<i>Ecotricity</i>	In the whole, we do agree with the views on mixed sites. We do however seek clarification on the scenario where additional generating capacity is connected behind an existing exporting meter. We believe it will be hard to calculate this and seek clarification if sub-metering will be introduced or if it will be calculated by estimates. We also seek clarification in the scenario where there isn't an existing export meter and there is no increase in capacity, what would this be classed as?
28	UK Green Investment Bank plc	No comment
29	Alkane Energy Limited	We think all embedded generation, behind the meter onsite generation and demand reduction should be treated the same since all have the same impact on the transmission system
30	Uniper UK	In so far as the Original Proposal is only intended to capture new embedded export meters after the cut-off date, we note the scenarios presented in the consultation and agree that providing the G59 commissioning process certificate would be a method to validate whether an export was new or not. This does however add additional administrative burden and complexity to identify how a particular metered volume should be treated for charging purposes
31	<i>E.ON</i>	In general we agree with the approach to mixed sites in CMP264. Where a mixed site sees an increase in generation capacity behind an export meter it should be made clear that CMP264 only applies to the additional generation capacity. To remain consistent with the intent of CMP264 and its treatment of equivalent sites, the original generation capacity at the site should remain unaffected.
32	<i>Welsh Power Group Limited</i>	We believe that there should be consistency in how similar assets are treated. Location behind the meter should not confer an advantage. As currently designed the proposal treats the same asset with different metering configurations in different ways, this approach is discriminatory
33	SSE	A better all encompassing solution for dealing with mixed sites would be to change the definition of the Triad charging base such that each of the TNUoS tariff elements (Peak Security, Year Round and Residual) are applied to a different and more appropriate definition of charging base, therefore applied to Demand and affect embedded generation in a way which is consistent and cost reflective. However if this type of all encompassing solution is out of scope for CMP264, then it is reasonable that the modifications should affect as much embedded generation as is reasonably practicable giving the limitations of the scope. In this context, the proposed treatment of mixed site by CMP264 Original would appear to be reasonable.
34	UKPR	See separate response
35	Green Frog	No comment

	Power	
36	The ADE	The ADE has no comment.
37	Renewable UK	<p>RenewableUK believes that the issue of mixed sites has not been considered adequately by this Modification proposal. There is neither a remedy applicable to co-located technology types nor to sites with ‘behind the meter’ generation in this proposal.</p> <p>Both of these forms of site make-up have the potential to have exactly the same net effect on the network as single technology generation sites. RenewableUK is concerned that, as the number of mixed sites increases on the system, the processes will not be in place to deal fairly with their network effects. We encourage greater consideration of the impacts of the various types of mixed sites</p>
38	Savvi Energy	No
39	RES	Yes. It would appear introduce arbitrary and undue discrimination in favour of mixed sites.
40	Watt Power	No comment.
41	Plutus	No views
42	Reliance	No views
43	Silva Renewable Energy Limited – Bilateral Connection Contract holder Renewable	No
44	Drax	We believe that this should be applied to export from mixed sites.
45	ELEXON	See 10 i)
46	Rockpool	No views
47 late response	Calon Energy	In an ideal world it would be easy to capture on-site generation in the general principles of the modification, but that may prove difficult in practice. We therefore suspect a pragmatic solution is to ignore these sites.

(rec'd 1 Sept 16)		
----------------------	--	--

iii) **Do you think new-build embedded generation capacity that has entered into long term financial and performance commitment obligations via 2014 and 2015 capacity market or contracts for difference auctions (prior to this modification proposal) should be given exceptions to this cut-off date?**

Response No	Company	Response
1	<i>CLP Envirogas</i>	Yes, we do not agree with retrospective change to revenue and support mechanisms.
2	<i>Engie</i>	Charging arrangements are and have consistently been subject to change. The Ofgem- led Transmit project clearly indicated to the industry that all charging arrangements could be changed and parties entering auctions or other commercial arrangements would have been able to take account of potential changes in any commercial arrangements. There should be no exemptions.
3	RWE Generation UK plc, RWE Supply & Trading GmbH	Since the modification proposal itself introduces discrimination (between new and old generation), the potential for further discrimination such as between new-build embedded generation capacity that has entered into long term financial and performance commitment obligations via 2014 and 2015 capacity market and generation that has entered into contracts for difference auctions prior to this modification proposal requires detailed consideration. Evidence is required to justify such discrimination, and further work is required to provide such justification. Given the nature of the defect identified with respect to the residual component of the demand TNUoS tariffs it may be challenging to demonstrate that the discrimination of the nature identified in the question would be justified.
4	<i>EPR Ely Limited</i>	Yes, we do not agree with retrospective change to revenue and support mechanisms.
5	<i>EPR Glanford Limited</i>	Yes, we do not agree with retrospective change to revenue and support mechanisms.
6	<i>EPR Eye Limited</i>	Yes, we do not agree with retrospective change to revenue and support mechanisms.
7	Statera	Yes, but who and how you police that is difficult to see.

	Energy	
8	<i>EPR Scotland Limited</i>	Yes, we do not agree with retrospective change to revenue and support mechanisms.
9	TATA Chemicals Europe	Comments removed for publication of report
10	<i>EPR Thetford Limited</i>	Yes, we do not agree with retrospective change to revenue and support mechanisms.
11	<i>LondonWaste Ltd</i>	Yes. Some new build plants will complete after that date and cannot now back out of their projects, including some which will have 15 year Capacity Market obligations to deliver. There will undoubtedly be some plants which would not have entered into 15 year contracts with the Delivery Body had they not also had the benefit of the Embedded Benefit. Such plants could not simply “tear up” their CM contracts as suggested in 3.4.9 as it would not be (and should not be) possible to ‘escape’ the CM contract by simply breaching it. This suggestion must really call into question the seriousness of whoever put forward this comment and their understanding of the situation for CM providers.
12	<i>PeakGen Power Ltd</i>	To ensure investor confidence and to deliver security of supply, yes.
13	<i>Statoil ASA</i>	We do not believe that the proposed cut-off date of 30 June 2017 is appropriate. Any change to embedded benefits would need to have sufficient grandfathering protection of projects that have made their investments decisions based on receiving embedded benefits. We disagree with the proposer’s assessment that the proposed cut-off date would be sufficient as it in our view will negatively affect projects currently under construction. In our view the cut-off date would need to be later to protect projects under construction. We would propose that the cut-off date is after 30 September 2018 which is similar to the deadline for accrediting under the Renewables Obligation (including graced periods).
14	Good Energy	Whilst generators with capacity market or CfD contracts should be exempted from any modification proposal changes, it is important to note that these are not the only forms of long-term contract that generators may have entered into which would be affected by CMP264. Therefore any changes to embedded benefits must take consideration of the long timescales over which contracts are set.
15	<i>REstore</i>	No text provided
16	EDF Energy	We do not see merit in exceptions to CMP264 of this nature (see comments on grandfathering in replies to questions 4 and 5)
17	Tees Valley Combined	Yes and especially so for those plants which have met the CM Extended Years Criteria.

	Authority	
18	Octopus Investments	No, see answer to (i). Exempting certain CMUs from this measure is entirely random and does not support the objective of facilitating effective competition as there will have been no systematic approach to determining which plants should and should not receive TRIADs
19	The Greenspan Agency Limited	No text provided
20	Centrica	See 10 i)
21	<i>ScottishPower Energy Management Limited</i>	No. As outlined in our answer to (i) above, we believe that projects which were sufficiently advanced to be eligible to secure contracts in the Capacity Mechanism or CFD auctions should be able to construct and commission before the cut-off date. However, if firm evidence to the contrary is provided, it may also be appropriate to offer additional carve outs to those who have already won CM agreements or CFDs, until such time as CMP265 is implemented
22	Eider Power Reserve	Yes unless the cut-off date is set late enough to allow such projects to not be impacted. It would be very damaging to long term investor confidence in the UK power market to do otherwise
23	Infinis Energy	Yes as outlined in our WACMs to this proposal. Existing CM and CfD contract holders tendered and won contracts based on the existing transmission charging rules. We propose to grandfather the current arrangements for these contract holders to avoid unforeseen losses. The grandfathering period would be a minimum of ten years.
24	<i>RWE Innogy UK- RWE npower joint submission</i>	This seems like a proposal that would add a further level of undue discrimination. The network impact of such parties could be the same as that of other embedded generators old and new, with or without CM/CfD contracts.
25	Sembcorp Utilities (UK) Limited	No text provided
26	<i>Smartest Energy</i>	No. It is generally not desirable to create exceptions for interactions with other codes/arrangements. If necessary, changes should be proposed under EMR governance
27	<i>Ecotricity</i>	We believe that they should not have an exception to the cut-off date, but instead be given a longer notice period for their cut-off date. This is due to the fact that they bid for this on the assumption they would have this benefit

28	UK Green Investment Bank plc	New build plant that has entered into these long-term financial and performance obligations should certainly be given exceptions to this cut-off date. This would recognise that the basis upon which investment and wider commercial decisions have been made will include a reasonable assumption over the future level of embedded benefits. Similarly any plant that is expected to accredit under the Renewables Obligation and which has satisfied relevant eligibility criteria for applicable grace period should be given an exception. Consideration should also be given to the circumstances of plant that may be subject to a municipal waste contract that has been entered into prior to the development of these proposals: whilst some contracts may contain strong Change In Law protections this should not be assumed.
29	Alkane Energy Limited	Yes we think the cut-off date should be set based on the timetable to meet 2014 and 2015 CM and CfD capacity obligations. We do not consider it likely that there will be significant new-build embedded generation built outside these initiatives. If any such investment were to take place such as CHP and projects under the Renewables Obligation they should be given exceptions to any cut-off date but provide evidence that a site was under construction prior to the end of 2016.
30	Uniper UK	No. There is no justification for continuing with a non-cost reflective revenue stream at the consumers' expense
31	<i>E.ON</i>	As highlighted above, we believe this cut-off date should be extended for all embedded generators. Addressing this issue for CM or CfD plant alone introduces new distortions between CM or CfD plant and other new embedded generators who may have entered long term financial obligations or contracts outside of the Capacity Market or CfD schemes.
32	<i>Welsh Power Group Limited</i>	We believe that all classes of generation should be treated in the same way. Providing derogations for certain classes of embedded generation risks creating distortions in the market and bestowing windfall gains on certain generators. Whilst this response is potentially contradictory to our answer to (i) above we believe this highlights the inherent deficiencies of CMP264
33	SSE	No, there should be no exceptions to the cutoff date. It would be worse for cost reflectivity and worse for effective competition to allow any group of embedded generators to be treated differently from any other group of embedded generators. The same argument applies that there should be no cut-off date at all. The possibility of the charging methodology being varied to take into account new situations or new thinking has been well understood since the methodology was first introduced and therefore the possibility of substantial change should have been accepted by all parties entering into long term financial obligations.
34	UKPR	See separate response
35	Green Frog Power	We agree that embedded generation capacity that has already been awarded a capacity market contract should be provided exceptions to this cut-off date. They have invested in good faith on the basis of trust in the policy makers, the regulator and trust in the broad endurance of a sensible long-term system.

36	The ADE	Yes. In addition, there are gas and renewable CHP projects which are under construction and which have neither capacity market nor CfD contracts, such as those which are proceeding without subsidy and those which are proceeding under the Renewables Obligation. We believe that CMP264 should not be implemented and would create regrettable distortions if it were implemented. Given that implementation is a possibility the following proposals are made to minimise the harm caused by its implementation. If CMP 264 were implemented, any CHP plant already under construction as of May 2016 should be given exceptions to the proposed cut-off date. We would propose the way to provide evidence that a site was under construction is that the CHP site would have to provide a CHP Quality Assurance F3 certificate, provided to pre-commissioned CHP plants, dated before May 2016. The number of projects to which this would apply would be small, and it would be the responsibility of the CHP site to provide the certificate to suppliers in order for their meter to be recognised as eligible for the embedded benefit.
37	Renewable UK	RenewableUK is not in a position to comment on this matter.
38	Savvi Energy	Yes, there is a real threat that industry regulation constantly changing value streams after auction events (such as the removal of the LEC from renewable generation after CfD bids) undermine investor confidence in the wider industry. There is neither an industry consensus or a robust independent (unbiased by vested interests) calculation of the true long and short term benefits EG brings, hopefully this will be done as part of the ofgem investigation, however a change at this stage would be premature.
39	RES	No. It is unnecessarily complex, likely to cause further market distortion through twotiered approach with inefficient market signal.
40	Watt Power	As above, we are not in support of proposal CMP264, however, we support the notion that new-build generation capacity that has entered into long term obligations via the capacity market or similar auctions prior to this modification proposal should continue to have access to some form of Triad payment if they are providing the relevant services. Prices taken in the capacity market auction, and subsequent financial deals and decisions made by the affected developers have been informed on the basis of access to Triad avoidance payments – the indefinite suspension of Triad payments may impact the viability of existing contracts and result in the termination of contracts. This would force the procurement of additional capacity as a replacement, most likely at much inflated prices, resulting in both security of supply problems and unnecessarily inflated costs to consumers.
41	Plutus	Yes, see response to 10 (i) . Existing CM and CfD contract holders tendered and won contracts based on the existing transmission charging rules. We propose to grandfather the current arrangements for these contract holders to avoid

		unforeseen losses. The grandfathering period would be a minimum of ten years.
42	Reliance	Yes, see response to 10 (i) . Existing CM and CfD contract holders tendered and won contracts based on the existing transmission charging rules. We propose to grandfather the current arrangements for these contract holders to avoid unforeseen losses. The grandfathering period would be a minimum of ten years.
43	Silva Renewable Energy Limited – Bilateral Connection Contract holder Renewable	They should be grandfathered at prevailing rates.
44	Drax	No. It has never been an expectation that grandfathering will be applied to the charging arrangements. To make an exception rewards reckless behaviour and represents moral hazard that could set a damaging precedence. It is inherent to the CUSC that the charging methodology is subject to change and insulating generators that have held the view that the charging arrangements will remain unchanged in perpetuity only rewards inefficient investments and entrenches ineffective competition.
45	ELEXON	See 10 i)
46	Rockpool	Yes, see response to 10 (i) . Existing CM and CfD contract holders tendered and won contracts based on the existing transmission charging rules. We propose to grandfather the current arrangements for these contract holders to avoid unforeseen losses. The grandfathering period would be a minimum of ten years.
47 late response (rec'd 1	Calon Energy	All plant economics are subject to regulatory changes and all should be treated equally. However, we recognise that the changes could undermine the economics of these plants, which investors have built in good faith, so we think there is a good case for some form of grandfathering. However, that should be at the current level of benefits and should not go on

Sept 16)		escalating over time.
----------	--	-----------------------

iv) Do you agree that ignoring demand behind the meter is unlikely to create a significant “loophole” or material discrimination risk in relation to the CMP264 arrangements in the short term

Response No	Company	Response
1	<i>CLP Envirogas</i>	No, to not include a specific category of embedded generators is discriminatory.
2	<i>Engie</i>	This proposal deals with the supplier netting arrangements; behind the meter onsite/ DSR will need to be tackled with a different arrangement, e.g. by “spreading the triad”
3	RWE Generation UK plc, RWE Supply & Trading GmbH	The modification should not introduce potential loopholes such as encouraging “behind the meter generation” in order to continue receipt of the embedded benefit. Therefore we support an approach that addresses “behind the meter generation”. However, we note that this approach would increase the complexity of the potential solution and costs.
4	<i>EPR Ely Limited</i>	No, to not include a specific category of embedded generators is discriminatory.
5	<i>EPR Glanford Limited</i>	No, to not include a specific category of embedded generators is discriminatory.
6	<i>EPR Eye Limited</i>	No, to not include a specific category of embedded generators is discriminatory.
7	Statera Energy	No. It clearly sends a signal to go behind meters and for many new plant that is an option.
8	<i>EPR Scotland Limited</i>	No, to not include a specific category of embedded generators is discriminatory.
9	TATA Chemicals Europe	Comments removed for publication of report
10	<i>EPR Thetford</i>	No, to not include a specific category of embedded generators is discriminatory.

	<i>Limited</i>	
11	<i>LondonWaste Ltd</i>	Yes. For the same reasons we disagree with the proposals we disagree with driving it now to start examining the on-site and private wire arrangements. We see no distinction between reduction of demand and generation.
12	<i>PeakGen Power Ltd</i>	Provided that this is an interim solution and a short and achievable timetable is set out and followed for a more permanent solution, the loophole will be small.
13	<i>Statoil ASA</i>	We do not believe that the proposed cut-off date of 30 June 2017 is appropriate. Any change to embedded benefits would need to have sufficient grandfathering protection of projects that have made their investments decisions based on receiving embedded benefits. We disagree with the proposer's assessment that the proposed cut-off date would be sufficient as it in our view will negatively affect projects currently under construction. In our view the cut-off date would need to be later to protect projects under construction. We would propose that the cut-off date is after 30 September 2018 which is similar to the deadline for accrediting under the Renewables Obligation (including graced periods).
14	Good Energy	It is not viable to use the CUSC to affect changes on behind-the-meter generation.
15	<i>REstore</i>	No text provided
16	EDF Energy	We do agree that ignoring generation behind the meter is unlikely to create a significant "loophole" or material discrimination risk in relation to CMP264; indeed, attempting to encompass difficult cases in this mod, could slow the mod's progress down and prevent its main benefit being realised through the mod being approved in a reasonable timeframe. If there are loopholes, if the arrangements seem to lead to embedded generation being developed in particular/novel configurations, these can be addressed via a further future modification receiving specific detailed consideration on this matter
17	Tees Valley Combined Authority	Yes. The electricity industry should not be attempting to interfere with what happens at a site level.
18	Octopus Investments	Yes, we consider this will create a loophole and do not understand the basis for any discrimination
19	The Greenspan Agency Limited	No text provided
20	Centrica	See 10 i)

21	<i>ScottishPower Energy Management Limited</i>	We do not believe that capturing only exporting boundary metering will present a significant “loophole” in the short term and in particular with respect to the forthcoming capacity auction. As outlined in our response to (ii), we consider that it would be appropriate for mixed sites to be addressed as part of Ofgem’s further review of charging or via a separate modification
22	Eider Power Reserve	Yes. It will create a clear way to structure around the concept and is discriminatory
23	Infinis Energy	Current market conditions incentivise private wire or behind the meter solutions as these can avoid a very significant proportion of a consumer’s costs. However this solution can result in significant investment in network assets in order to deliver electricity between generator and consumer, and this increases with distance between the two. By removing the triad benefit for all new generators, this modification is consequently further pushing embedded generators to locate “behind the meter” or under a private wire solution because it further increases the potential revenue differential between supply over a public network and a private network.
24	<i>RWE Innogy UK- RWE npower joint submission</i>	This does create a loophole. There has not been any assessment of the materiality so we cannot comment on this. We feel that the costs and complexity of a solution to address this is disproportionate with the temporary and unsustainable nature of this proposal.
25	Sembcorp Utilities (UK) Limited	No text provided
26	<i>Smartest Energy</i>	We would have agreed with this if the proposal were a stop-gap arrangement. However, as it would now appear that the result of this modification would be for an enduring solution, as per the Ofgem open letter and alternatives on the table, building in an arbitrary boundary will lead to material discrimination. In short we do not agree with the assertion behind this question
27	<i>Ecotricity</i>	We agree that it is unlikely
28	UK Green Investment Bank plc	or any plant that is contracted under a municipal waste PFI contract prior to this date
29	Alkane Energy Limited	This is a significant loophole and very likely will continue to remain a distortion between embedded generators and to other parties that reduce net demand on the transmission network such as demand reduction. We as an embedded generator would be incentivised to “re-locate” our generation activities behind the meter and would actively seek to do so wherever possible.
30	Uniper UK	In our view, no. The volume is most likely much smaller compared to the volume of embedded generation connected to the

		Total System. Reducing a Demand TNUoS liability with behind the meter generation is arguably the right signal to provide as opposed to making additional benefits to netted volume where no clear benefit has been demonstrated
31	<i>E.ON</i>	<p>As a temporary solution whilst a more thorough review is carried out, as CMP264 was originally presented, we agree that any distortion from ignoring behind the meter generation is minimal.</p> <p>However, over the longer term and without further change we believe developers are likely to seek opportunities to develop generation projects behind the meter to avoid being captured. This means any possible defect will not be addressed and the proposal will not better meet the CUSC objectives</p>
32	<i>Welsh Power Group Limited</i>	We believe that ignoring behind the meter generation is discriminatory and given the size of the potential reward presents a significant motivation for generators to alter their metering arrangements.
33	SSE	Whilst we agree that CMP264 is unlikely to create a significant “loophole”, or discrimination for behind the meter situations in the short term, this is partly because these loopholes already exist within the Baseline, so they are not new. However, it is essential to address the outstanding defects that are responsible for the “loophole” that exists in the Baseline quickly (within the next 2 years) through a subsequent future modification proposal. Importantly regarding generation, or demand behind the meter, these loopholes and discrimination already exist within the Baseline as compared with transmission connected generation. Therefore CMP264 does not create these defects, but instead it appears to be limited by its scope from implementing a modification which is wide enough in scope to include the correction of these defects.
34	UKPR	See separate response
35	Green Frog Power	We do believe that ignoring the effects of spiralling benefits to other market participants will provide an obvious loophole and clear and financially material discrimination, in addition to the discrimination between those who hit the deadline and those who do not.
36	The ADE	No. The reduction of transmission network net demand is the same, whether that net demand is caused by exported generation on the distribution network, on-site generation or demand reduction. The proposer has suggested that charges could be applied to these other users at a later date, but has not provided any practical solutions to repair this discrimination. The likely effect will be that the distortion between different users remains over a long term period, or new distortions will have to be introduced to prevent the identified ‘loopholes’
37	Renewable UK	<p>It is a question of fairness. Were CMP 264 to be effected as-is, then there would clearly and automatically be discriminatory treatment between generators connected directly to the distribution network and those connected behind the meter of a demand location. As the physical effects on the network from these two locations would be indistinguishable, it is clear that a defect would have been introduced to the system.</p> <p>It is not clear, however, whether or not a “loophole” would be introduced in the short term, nor whether indeed it would be</p>

		exploited. There are no studies against which to assess the possible impacts, so, beyond highlighting the inherent potential conflicts, RenewableUK cannot take anything other than a principled position in this matter.
38	Savvi Energy	Yes – demand reduction via onsite generation should not be considered a loophole anymore/less than shifting use or energy or using less energy over the triad periods is a loophole. If the current demand charging methodology gives non cost reflective time based signals, these should be amended as part of a wider review – onsite generation should not be singled out and amended piecemeal.
39	RES	<i>No. It will</i> materially discriminate
40	Watt Power	We believe that ignoring demand behind the meter would create a loophole that allows for parties to circumvent the arrangements of proposal CMP264. The different treatment would not be cost reflective and is not consistent with the CUSC objectives.
41	Plutus	<p>Current market conditions incentivise private wire or behind the meter solutions as these can avoid a very significant proportion of a consumer’s costs. However this solution can result in significant investment in network assets in order to deliver electricity between generator and consumer, and this increases with distance between the two.</p> <p>By removing the triad benefit for all new generators, this modification is consequently further pushing embedded generators to locate “behind the meter” or under a private wire solution because it further increases the potential revenue differential between supply over a public network and a private network.</p>
42	Reliance	<p>Current market conditions incentivise private wire or behind the meter solutions as these can avoid a very significant proportion of a consumer’s costs. However this solution can result in significant investment in network assets in order to deliver electricity between generator and consumer, and this increases with distance between the two.</p> <p>By removing the triad benefit for all new generators, this modification is consequently further pushing embedded generators to locate “behind the meter” or under a private wire solution because it further increases the potential revenue differential between supply over a public network and a private network.</p>
43	Silva Renewable Energy Limited –	Yes

	Bilateral Connection Contract holder Renewable	
44	Drax	If it becomes an issue it can be addressed with a follow up modification. CMP264 is designed to address a much bigger defect quickly and an issue such as this should not frustrate the process. We believe that any EG who invests in utilising the “loophole” will do so at the risk of the “loophole” being closed at a later date.
45	ELEXON	See 10 i)
46	Rockpool	<p>Current market conditions incentivise private wire or behind the meter solutions as these can avoid a very significant proportion of a consumer’s costs. However this solution can result in significant investment in network assets in order to deliver electricity between generator and consumer, and this increases with distance between the two.</p> <p>By removing the triad benefit for all new generators, this modification is consequently further pushing embedded generators to locate “behind the meter” or under a private wire solution because it further increases the potential revenue differential between supply over a public network and a private network.</p>
47 late response (rec’d 1 Sept 16)	Calon Energy	This is clearly a loophole, but it is one of many that exist for on-site generation. If the proposal can ensure it picks up exporting meter that would be better than nothing, but otherwise we may have to accept that do nothing is the pragmatic solution.

- v) **Question to suppliers: Do you consider that the wording of your existing contracts allow you to reflect the changes provided by these modifications in a cost reflective manner. For example, these changes will apply to existing PPAs and generators who significantly alter their output (EREC 59).**

Response No	Company	Response
1	<i>CLP Envirogas</i>	No comment
2	<i>Engie</i>	From a supplier perspective contracts are flexible enough to pass through increases or reductions in embedded benefits from the various sources and this would not be barrier to implementation as long as sufficient (12 months) notice was given. Whereas passing through a smaller benefit is relatively easy, adding a charge (negative locational charge) may be more troublesome
3	RWE Generation UK plc, RWE Supply & Trading GmbH	No Comment
4	<i>EPR Ely Limited</i>	No comment
5	<i>EPR Glanford Limited</i>	No comment
6	<i>EPR Eye Limited</i>	No comment
7	Statera Energy	No comment.
8	<i>EPR Scotland Limited</i>	No comment.
9	TATA Chemicals Europe	No comment
10	<i>EPR Thetford Limited</i>	No Comment
11	<i>LondonWaste Ltd</i>	No comment
12	<i>PeakGen Power Ltd</i>	NA.

13	<i>Statoil ASA</i>	We do not believe that the proposed cut-off date of 30 June 2017 is appropriate. Any change to embedded benefits would need to have sufficient grandfathering protection of projects that have made their investments decisions based on receiving embedded benefits. We disagree with the proposer's assessment that the proposed cut-off date would be sufficient as it in our view will negatively affect projects currently under construction. In our view the cut-off date would need to be later to protect projects under construction. We would propose that the cut-off date is after 30 September 2018 which is similar to the deadline for accrediting under the Renewables Obligation (including graced periods).
14	Good Energy	No - A number of our generators are locked into contracts whose value was set on the assumption that triad would remain at current levels
15	<i>REstore</i>	No text provided
16	EDF Energy	As a Supplier: we consider that the wording of our existing contracts allow us to reflect the changes provided by these modifications in a competitive manner
17	Tees Valley Combined Authority	No comment
18	Octopus Investments	n/a
19	The Greenspan Agency Limited	No text provided
20	Centrica	See 10 i)
21	<i>ScottishPower Energy Management Limited</i>	In most cases, PPAs with existing generators will not be caught by the definition of New Embedded Generator. Wording will be required in future PPA agreements to ensure that commission dates can be verified by reference to the EREC59 commissioning certificate and to allow the metering data to be provided to National Grid for billing purposes if required
22	Eider Power Reserve	n/a
23	Infinis Energy	n/a
24	<i>RWE Innogy UK-RWE npower joint submission</i>	As discussed in question 2, existing wording of some contracts with embedded generators may not easily allow us to reflect the changes provided by these modifications in a cost reflective manner. Some contracts could be addressed via a contract variation or upon renewal / acquisition, others would require contracts to be reopened with Embedded Generator who may not be open to large reductions in their

		income. Long term PPAs will usually have provisions for legal industry changes e.g. BSC changes.
25	Sembcorp Utilities (UK) Limited	No text provided
26	<i>Smartest Energy</i>	Yes, the proposed changes would constitute a material change which would allow us to invoke a Change in Law clause
27	<i>Ecotricity</i>	We believe that this shouldn't be an issue and could be resolved at contract renewals
28	UK Green Investment Bank plc	It is agreed that demand behind the meter is unlikely to create a significant loophole or material discrimination risk in relation to CMP264 arrangements in the short term.
29	Alkane Energy Limited	n/a
30	Uniper UK	We have no comments in response to this question
31	<i>E.ON</i>	No comment
32	<i>Welsh Power Group Limited</i>	n/a
33	SSE	Yes, the wording of PPA contracts does allow these changes to be reflected
34	UKPR	See separate response
35	Green Frog Power	n/a
36	The ADE	The ADE has no comment.
37	Renewable UK	RenewableUK is not in a position to comment on this matter.
38	Savvi Energy	No text provided
39	RES	n/a
40	Watt Power	n/a
41	Plutus	n/a
42	Reliance	n/a
43	Silva Renewable Energy Limited – Bilateral Connection Contract holder	No text provided

	Renewable	
44	Drax	No response
45	ELEXON	See 10 i)
46	Rockpool	n/a
47 late response (rec'd 1 Sept 16)	Calon Energy	n/a

vi) **Do you agree with the definition of commissioned and do you agree that it is appropriate? If you do not agree with the definition or that it is appropriate please provide alternative definitions and rationale for this definition.**

Response No	Company	Response
1	<i>CLP Envirogas</i>	No comment
2	<i>Engie</i>	We think all embedded generation should be treated the same. The date (if there is one) should be the date the modification was raised as this is normal practice for changes of this nature otherwise individual parties can select against the scheme.
3	RWE Generation UK plc, RWE Supply & Trading GmbH	The modification proposal requires an appropriate definition of commissioned and the process outlined appears an appropriate basis for determining whether an embedded generator is capable of operation.
4	<i>EPR Ely Limited</i>	No comment
5	<i>EPR Glanford Limited</i>	No comment
6	<i>EPR Eye Limited</i>	No comment

7	Statera Energy	how does this address plants on private wires?
8	<i>EPR Scotland Limited</i>	No comment.
9	TATA Chemicals Europe	Comments removed for publication of report
10	<i>EPR Thetford Limited</i>	No comment.
11	<i>LondonWaste Ltd</i>	No comment
12	<i>PeakGen Power Ltd</i>	Yes – the proposed definition is appropriate
13	<i>Statoil ASA</i>	We do not believe that the proposed cut-off date of 30 June 2017 is appropriate. Any change to embedded benefits would need to have sufficient grandfathering protection of projects that have made their investments decisions based on receiving embedded benefits. We disagree with the proposer’s assessment that the proposed cut-off date would be sufficient as it in our view will negatively affect projects currently under construction. In our view the cut-off date would need to be later to protect projects under construction. We would propose that the cut-off date is after 30 September 2018 which is similar to the deadline for accrediting under the Renewables Obligation (including graced periods).
14	Good Energy	No - A number of our generators are locked into contracts whose value was set on the assumption that triad would remain at current levels
15	<i>REstore</i>	No text provided
16	EDF Energy	We agree with the definition of commissioned. The focus on the G59/2 commissioning process does exclude single phase embedded generators of up to 80 amps (up to 19 kW), which might tend to be domestic and other (e.g. schools, churches) solar PV, even when these are half hourly metered. Such installations are presently only rarely half hourly metered anyway. If they do become half hourly metered, it is arguable whether or not they <i>should</i> be caught by CMP264; we are uncertain on this point as there are good arguments both for and against
17	Tees Valley Combined Authority	No comment
18	Octopus	yes

	Investments	
19	The Greenspan Agency Limited	No text provided
20	Centrica	See 10 i)
21	<i>ScottishPower Energy Management Limited</i>	Yes. We believe that EREC G59 process provides a consistent, conclusive and verifiable record of the date of commissioning of new embedded generation
22	Eider Power Reserve	No view
23	Infinis Energy	yes
24	<i>RWE Innogy UK- RWE npower joint submission</i>	G59 testing is a standard test for confirming that a commercial site is commissioned under regulated schemes that generators are familiar with. From a generators perspective it is therefore a logical definition to be used. This would capture all sites that have embedded benefit arrangements with suppliers.
25	Sembcorp Utilities (UK) Limited	No text provided
26	<i>Smartest Energy</i>	No comment
27	<i>Ecotricity</i>	We believe the definition of commissioned is appropriate
28	UK Green Investment Bank plc	No comment
29	Alkane Energy Limited	We support the definition of commissioned and that this should be used provided the dates set take account of CM/CfD contractual commitments.
30	Uniper UK	The G59 process seems sensible
31	<i>E.ON</i>	

		We agree with the definition of commissioned.
32	<i>Welsh Power Group Limited</i>	We believe the definition of commissioned will require further development and consideration as CMP264 is further developed. We would comment that there should be consistency of treatment across embedded generators and as we believe the creation of a separate register of excluded embedded generation is likely to be problematic and is unnecessary.
33	SSE	It would be a better solution to apply the change to all embedded generators instead of using a cut-off. However, if a cut-off is to be used, then the proposed definition of “commissioned” appears to be reasonable
34	UKPR	See separate response
35	Green Frog Power	The definition is fine although the idea is not
36	The ADE	No. We do not believe the proposer’s method will be sufficiently accurate and will likely create new distortions. By linking the definition to the registration of exporting MSIDs, there is a significant risk of users registering exporting MSIDs ahead of the cut-off date. Furthermore, it is unclear if suppliers will be able to implement the necessary changes to incorporate these changes in time for the proposed June 2017 cut-off date.
37	Renewable UK	RenewableUK is not in a position to comment on this matter.
38	Savvi Energy	No text provided
39	RES	We would repeat the view that a cut-off date creates arbitrary and undue discrimination but would accept the proposed definition of “commissioned” in the proposal.
40	Watt Power	believe As above, we are opposed to proposal CMP264. Further, we do not support the definition of “commissioned” and that relying on certification produced by the DNO in advance of any “cut-off” date will result in undue strain on DNOs, create backlogs and delays. A plant that has an MPAN and has been constructed before the cut-off date should qualify as commissioned and be eligible for Triad payments.
41	Plutus	No text provided
42	Reliance	n/a
43	Silva Renewable Energy Limited – Bilateral	No text provided

	Connection Contract holder Renewable	
44	Drax	Notwithstanding our issues with grandfathering we agree with the wording of commissioned.
45	ELEXON	See 10 i)
46	Rockpool	n/a
47 late response (rec'd 1 Sept 16)	Calon Energy	using the G59 statement for commissioning seems appropriate.

Question 13:**Do you have a view of whether implementation for the 2017/18 Triad season is sufficient to allow changes for:****i) supplier contracts and billing system;**

Response No	Company	Response
1	<i>CLP Envirogas</i>	No comment, we do not agree with the change.
2	<i>Engie</i>	We believe that implementation should be the next following 1st April after an Authority decision. This will give 12 months to implement the change.
3	RWE Generation UK plc, RWE Supply & Trading GmbH	We are concerned about whether efficient central reporting mechanisms and supplier billing systems can be developed and delivered in the required timescale to capture the relevant embedded generators and the introduction of gross charging for such parties.
4	<i>EPR Ely Limited</i>	No comment, we do not agree with the change.
5	<i>EPR Glanford Limited</i>	No comment, we do not agree with the change.
6	<i>EPR Eye Limited</i>	No comment, we do not agree with the change.
7	Statera Energy	No, this is an extremely short time period to allow stakeholders to make changes.
8	<i>EPR Scotland Limited</i>	No comment, we do not agree with the change.
9	TATA Chemicals Europe	No comment
10	<i>EPR Thetford</i>	No comment, we do not agree with the change.

	<i>Limited</i>	
11	<i>LondonWaste Ltd</i>	Neutral
12	<i>PeakGen Power Ltd</i>	Given our experience of other changes, this timeline looks challenging.
13	<i>Statoil ASA</i>	We do not believe that the proposed cut-off date of 30 June 2017 is appropriate. Any change to embedded benefits would need to have sufficient grandfathering protection of projects that have made their investments decisions based on receiving embedded benefits. We disagree with the proposer's assessment that the proposed cut-off date would be sufficient as it in our view will negatively affect projects currently under construction. In our view the cut-off date would need to be later to protect projects under construction. We would propose that the cut-off date is after 30 September 2018 which is similar to the deadline for accrediting under the Renewables Obligation (including graced periods).
14	Good Energy	This time period is not sufficient to allow changes to take place - a number of our generators are locked into contracts whose value was set on the assumption that triad would remain at current levels
15	<i>REstore</i>	No text provided
16	EDF Energy	Yes, there is sufficient time for these matters if any decision to approve were made by The Authority late in 2016 or very early in 2017. It is the time needed for Elexon systems development that is the critical potential stumbling block, albeit it might just about be able to be circumvented by a manual workaround for the first year, if reliable data could be obtained to bill against, given the relatively small number of units forecast to be captured in the first year
17	Tees Valley Combined Authority	We have no comments on this
18	Octopus Investments	We consider that to avoid retrospectively impacting investment the cut-off date should be delayed to allow projects that have reached financial close at the implementation date (ie the date on which Ofgem announces any implementation of this proposal) should be allowed to continue to receive TRIADs. This would give a cut-off date of say 15 months after implementation. Alternatively the financial commitment milestone definition from the CM could be used – all projects meeting the FCM by the cut-off date would retain TRIADs
19	The Greenspan Agency Limited	No text provided
20	Centrica	We have concerns about the timeline associated with CMP264. We would favour a simpler implementation approach and a longer lead time, as per the potential alternatives mooted by Centrica in the Workgroup Consultation report

21	<i>ScottishPower Energy Management Limited</i>	As CMP264 only affects embedded generation commissioned after the cut-off date, there is no need for retrospective registration of existing plant. As the commissioning of new embedded plant after the cut-off date is expected to reduce after the removal of the distortion to investment decisions as a result of the implementation of CMP264 and the remaining new plant would be expected to register with many individual suppliers due to competition, the burden on each supplier, registering a small number of New Embedded generators should not be onerous. Table 8 in the Workgroup report indicates that the number of affected sites (assuming CMP264 does not reduce the number of new embedded generators that come forward) would be between 12 and 122 per annum in the period 2017/18 to 2020/21. In practice, we believe that implementation of CMP264 would lead to lower volumes than this, especially in later years. As a supplier, we do not foresee any issues
22	Eider Power Reserve	This is a supplier question rather than one for us ss a generato
23	Infinis Energy	As the modification only seeks to remove the triad benefit from new plant, we would expect this to have very little impact on suppliers' systems. The exception being whether they have agreed a PPA or offtake arrangement with a generator ahead of plant commissioning, in which case the supplier would need to have the processes and technology in place to flag said generation as "new" and to exempt them from triad benefits.
24	<i>RWE Innogy UK- RWE npower joint submission</i>	No this implementation for the 17/18 Triad season is insufficient to allow for supplier contracts and pricing / billing system changes. Receiving 3 years notice from the point of a Ofgem decision is important for suppliers and consumers because it will enable systems and processes to be updated to accommodate the changes required. In addition it will enable current contractual agreements to unwind which will allow changes to be factored into future contracts. In general it is only acceptable for generation projects to be provided with completely new investment signals, if they have sufficient time to model and adapt investment decisions. From the perspective of the owner operator of existing and new non-peaking embedded generation plants: CMP264 has the advantage over CMP265 of avoiding step changes in charging for existing projects. Investors in wind and hydro generation have in good faith made investments based on locational signals established in the current charging methodology by NGET and approved by Ofgem – CMP264 proposal does recognise that this is the case and only applies a solution to new generators.
25	Sembcorp Utilities (UK) Limited	No text provided
26	<i>Smartest Energy</i>	No. We believe that the processes required for aggregating affected sites would mean that implementation for the 2017/18 Triad season would not be feasible
27	<i>Ecotricity</i>	We believe that this isn't sufficient. Parties are already quoting beyond this period and other stakeholders have already made financial investments. We believe a further year should be provided to make it fairer

28	UK Green Investment Bank plc	No text provided
29	Alkane Energy Limited	<p>A significant change to the charging regime which has been established for so many years should be done with due consideration and full assessment of the impacts.</p> <p>Based on our participation in the discussions to date we consider it is very unlikely to be able to address all the issues including Elexon IT system changes and agree relevant proposals in time to be able to introduce a change prior to 2018/19 Triad season.</p>
30	Uniper UK	There appears to be some doubt as to whether a robust billing system could be introduced in time for the 2017/18 Triad season, particularly if the onus is on Suppliers to provide the necessary information to enable National Grid to issue its invoices, as opposed to a central systems led approach. However, as noted by Ofgem in its letter of 29 July 2016, we would agree that it is challenging to identify any benefit from continuing with the present arrangements and that these should be revised at the earliest possible opportunity and certainly no later than April 2019
31	<i>E.ON</i>	<p>As noted in the consultation document, it is unlikely that many suppliers will be able to implement changes to billing systems and contracts in time for the 2017/18 Triad season. Manual workarounds are therefore likely to be required which increase administrative costs and risks of error.</p> <p>As highlighted above, should this proposal be taken forward we believe the cut-off for new embedded generators should be pushed back to October 2019 at the earliest; this is likely to give sufficient time to implement any necessary changes.</p>
32	<i>Welsh Power Group Limited</i>	<p>Were this modification to be implemented we believe it essential that adequate time be given to allow all affected parties to adjust their business models and processes.</p> <p>For those power plants under construction that have raised debt financing a cliff edge commissioning date will create risks of stranded assets and default on debt financing arrangements.</p> <p>Suppliers will need sufficient time to adjust systems, change contracts (if this is possible), recalculate and implement new customer tariffs.</p>
33	SSE	Suppliers-customer supply contracts - Regarding supply contracts and billing system between the supplier and customers, this timescale would be sufficient. Supply contracts are already based on the gross supply volume and the TNUoS tariffs published by National Grid.
34	UKPR	See separate response
35	Green Frog Power	Please see response to question 16.
36	The ADE	The ADE has no comment
37	Renewable	RenewableUK is not in a position to comment on this matter.

	UK	
38	Savvi Energy	No view
39	RES	No clear view at this stage.
40	Watt Power	As stated above, we are not supportive of proposal CMP264. Regardless, it appears that the implementation approach for the original CMP264 proposal raised by Scottish Power is not appropriate or achievable. The post June 30th 2017 cut-off date for “new” embedded generation would require complementary changes to a number of billing and charging systems. It is highly unlikely that the tight timeframe would allow sufficient time for these changes to be brought forward. Further, the timeframe for implementation does not allow sufficient time for parties to bring forward plants which are already under development (i.e. planning consent granted, connections secured and where relevant capacity contracts are in place) though the plant is not yet constructed or commissioned.
41	Plutus	This is much too quick as all commercial arrangements would need to be reconsidered with supplier offtakers.
42	Reliance	This is much too quick as all commercial arrangements would need to be reconsidered with supplier offtakers.
43	Silva Renewable Energy Limited – Bilateral Connection Contract holder Renewable	No view
44	Drax	We understand that supplier billing systems are generally complex and therefore making changes can often be time-consuming.
45	ELEXON	This response is in addition to our more general response to Q2. We have assumed that implementation for the 2017/18 Triad season means by the proposed implementation date, i.e. 1 April 2017. ELEXON is still waiting for responses to the P349 Assessment Consultation and Impact Assessment. Until ELEXON receives these responses and the P349 workgroup has considered them, we cannot say whether implementation of CMP264 in time for the 2017/18 Triad is achievable.

		<p>ELEXON note that the Scheduled BSC Releases over the next 12-18 months are already expected to be challenging to implement because of the volume and complexity of changes required. Additional changes to BSC Systems, such as P349, are likely to make these Releases more of a challenge.</p> <p>We note that National Grid may be considering its own temporary manual workaround to enable the implementation of CMP264 in time for the 2017/18 Triad. We'd welcome more detail on National Grid's plans to ensure compatibility with any BSC solution.</p>
46	Rockpool	This is much too quick as all commercial arrangements would need to be reconsidered with supplier offtakers.
47 late response (rec'd 1 Sept 16)	Calon Energy	We would be surprised if the BSC systems could be altered that fast. While in principle we support the date, we would suggest that the implementation fits with the timetable for system changes, allowing for a full test of any changes. Recent experience with IT projects suggests that rushed implementation results in unforeseen consequences that would best be avoided.

ii) for other stakeholders?

Response No	Company	Response
1	CLP Envirogas	No comment, we do not agree with the change.
2	Engie	We believe that implementation should be the next following 1st April after an Authority decision. This will give 12 months to implement the change.
3	RWE Generation UK plc, RWE Supply & Trading GmbH	We are concerned about whether efficient central reporting mechanisms and supplier billing systems can be developed and delivered in the required timescale to capture the relevant embedded generators and the introduction of gross charging for such parties.
4	EPR Ely Limited	No comment, we do not agree with the change.
5	EPR Glanford Limited	No comment, we do not agree with the change.
6	EPR Eye	No comment, we do not agree with the change.

	<i>Limited</i>	
7	Statera Energy	No, this is an extremely short time period to allow stakeholders to make changes.
8	<i>EPR Scotland Limited</i>	No comment, we do not agree with the change.
9	TATA Chemicals Europe	Comments removed for publication of report
10	<i>EPR Thetford Limited</i>	No comment, we do not agree with the change.
11	<i>LondonWaste Ltd</i>	This would be a wholly inappropriate timescale for parties to adjust their business plans and risks rushing the consultation process.
12	<i>PeakGen Power Ltd</i>	Given our experience of other changes, this timeline looks challenging.
13	<i>Statoil ASA</i>	We do not believe that the proposed cut-off date of 30 June 2017 is appropriate. Any change to embedded benefits would need to have sufficient grandfathering protection of projects that have made their investments decisions based on receiving embedded benefits. We disagree with the proposer's assessment that the proposed cut-off date would be sufficient as it in our view will negatively affect projects currently under construction. In our view the cut-off date would need to be later to protect projects under construction. We would propose that the cut-off date is after 30 September 2018 which is similar to the deadline for accrediting under the Renewables Obligation (including graced periods).
14	Good Energy	We are not in a position to comment on impacts for other stakeholders.
15	<i>REstore</i>	No text provided
16	EDF Energy	Yes, there is sufficient time for these matters if any decision to approve were made by The Authority late in 2016 or very early in 2017. It is the time needed for Elexon systems development that is the critical potential stumbling block, albeit it might just about be able to be circumvented by a manual workaround for the first year, if reliable data could be obtained to bill against, given the relatively small number of units forecast to be captured in the first year
17	Tees Valley Combined Authority	This would be a wholly inappropriate when the timescale for the build of some embedded plants is 3 years.
18	Octopus Investments	We consider that to avoid retrospectively impacting investment the cut-off date should be delayed to allow projects that have reached financial close at the implementation date (ie the date on which Ofgem announces any implementation of this proposal) should be allowed to continue to receive TRIADs. This would give a cut-off date of say 15 months after

		implementation. Alternatively the financial commitment milestone definition from the CM could be used – all projects meeting the FCM by the cut-off date would retain TRIADS
19	The Greenspan Agency Limited	No text provided
20	Centrica	We have concerns about the timeline associated with CMP264. We would favour a simpler implementation approach and a longer lead time, as per the potential alternatives mooted by Centrica in the Workgroup Consultation report
21	<i>ScottishPower Energy Management Limited</i>	See 13 i)
22	Eider Power Reserve	No text provided
23	Infinis Energy	See response to 13 i)
24	<i>RWE Innogy UK- RWE npower joint submission</i>	See response to 13 i)
25	Sembcorp Utilities (UK) Limited	No text provided
26	<i>Smartest Energy</i>	No comment
27	<i>Ecotricity</i>	No comment
28	UK Green Investment Bank plc	No text provided
29	Alkane Energy Limited	See 13 i)

30	Uniper UK	See 13 i)
31	E.ON	See response to 13 i)
32	Welsh Power Group Limited	See response to 13 i)
33	SSE	Supplier-Embedded generator PPA offtake contracts - Regarding supplier PPA offtaker contracts with embedded generators, this may take some time to implement. However, the proposed timescale should enable sufficient time.
34	UKPR	See separate response
35	Green Frog Power	Please see response to question 16.
36	The ADE	<p>The implementation timetable is too short for such a significant change to the charging regime. The concept of net charging, and subsequently the embedded benefit, has been a transmission network principle since before 2001. The proposal to remove this principle and implement an entirely different charging regime within nine months is unrealistic and likely to result in significant harm to generators and consumers.</p> <p>The proposer's assessment is that 13 months from becoming aware of the proposal is sufficient to complete construction and commission "given the smaller nature of embedded plant". This statement is not accurate as demonstrated by the proposer's own project repowering Carland Cross Windfarm near Newquay in Cornwall. Embedded plant can reach sizes of up to 100 MW, and include highly complex gas CCGT and biomass generation assets. These assets have build times of at least two years, and engineering complexities or complications can extend this build time for additional years. For example, the most recent 50 MW biomass CHP plant in Scotland took five years to complete.</p> <p>The proposal would put plant currently in development at risk by removing value for plant which have already received CfD contracts, undermining earlier auctions, or Capacity Market contracts for delivery in 2017, 2018 and 2019. This raises significant concern that the implementation timetable will harm market certainty, increasing costs for consumers.</p>
37	Renewable UK	RenewableUK is not in a position to comment on this matter.
38	Sarvi Energy	No text provided
39	RES	No clear view at this stage.
40	Watt Power	See response to 13 i)
41	Plutus	This is much too quick as all commercial arrangements would need to be reconsidered with supplier offtakers.
42	Reliance	This is much too quick as all commercial arrangements would need to be reconsidered with supplier offtakers.
43	Silva Renewable	No view

	Energy Limited – Bilateral Connection Contract holder Renewable	
44	Drax	We agree that this is sufficient to allow appropriate changes. If other respondents are keen for a longer implementation there needs to be robust justification.
45	ELEXON	See 13 i)
46	Rockpool	See response to 13 i)
47 late response (rec'd 1 Sept 16)	Calon Energy	See 13 i)

Question 18: Do you have a view if embedded benefits are frozen at a non-zero value, what should that value be as a £/kW tariff (2016/17 value is £45.33 / kW)?

Response No	Company	Response
1	<i>CLP Envirogas</i>	We do not believe that the embedded benefit should be frozen. However, if the tariffs are frozen, the value should be no less than the 2016/17 value (£45.33 per kW) as this would result in least damage to investor confidence.
2	<i>Engie</i>	We believe this is an embedded substation benefit of £3-4/kW applied in addition to the locational tariff in accordance with CUSC 14.15.119. Practically setting the lowest location tariff to zero may achieve both objectives -see the Technical appendices to this response.
3	RWE Generation UK plc, RWE Supply & Trading GmbH	The embedded benefit should not be frozen at any level. We are concerned that freezing the embedded benefit at an arbitrary level merely creates other issues associated with discrimination and cost reflectivity of charges.
4	<i>EPR Ely Limited</i>	We do not believe that the embedded benefit should be frozen. However, if the tariffs are frozen, the value should be no less than the 2016/17 value (£45.33 per kW) as this would result in least damage to investor confidence.
5	<i>EPR Glanford Limited</i>	We do not believe that the embedded benefit should be frozen. However, if the tariffs are frozen, the value should be no less than the 2016/17 value (£45.33 per kW) as this would result in least damage to investor confidence.
6	<i>EPR Eye Limited</i>	We do not believe that the embedded benefit should be frozen. However, if the tariffs are frozen, the value should be no less than the 2016/17 value (£45.33 per kW) as this would result in least damage to investor confidence.
7	Statera Energy	We believe the value should be at the value set in April 2014 charging year (valued at £35/kW) as National Grid's embedded benefit review did not identify a reason to remove the benefit at this time.
8	<i>EPR Scotland Limited</i>	We do not believe that the embedded benefit should be frozen. However, if the tariffs are frozen, the value should be no less than the 2016/17 value (£45.33 per kW) as this would result in least damage to investor confidence.
9	TATA Chemicals Europe	Comments removed for publication of report
10	<i>EPR Thetford</i>	We do not believe that the embedded benefit should be frozen. However, if the tariffs are frozen, the value should be no less

	<i>Limited</i>	than the 2016/17 value (£45.33 per kW) as this would result in least damage to investor confidence.
11	<i>LondonWaste Ltd</i>	This would be the 'least bad' option and might be considered as means of buying time for more thorough consideration of solutions to the perceived problems.
12	<i>PeakGen Power Ltd</i>	As an interim solution, this seems appropriate as it reflects the current level that will have been built into most investment and open/close decisions. This level should provide the stability to allow investments to deliver security of supply to be delivered whilst a proper investigation takes place, and to be consistent with investors expectation to date. Therefore, a freeze at the current level of £45.33/kW seems logical.
13	<i>Statoil ASA</i>	No text provided.
14	Good Energy	Embedded benefits should be frozen at current levels of £45.33 in order to protect investor confidence in the sector. Any revenue shortfall from future years could be reversed through a kWh charge, levied over the 4-7pm period across the entire year – as with Non-half hourly customers
15	<i>REstore</i>	No text provided
16	EDF Energy	We do not favour this concept of freezing at what we would see as an arbitrary value that destroys potential consumer benefit, at all.
17	Tees Valley Combined Authority	This might be used as a stop-gap to allow a more considered approach to be taken.
18	Octopus Investments	We believe TRIADs should be frozen at the 2016/17 for all generators, existing and future new build
19	The Greenspan Agency Limited	No text provided
20	Centrica	We do not believe that transmission tariffs for embedded generation (whether new or existing) should be frozen. We believe embedded generation tariffs should be broadly equivalent in value to the tariffs applying to transmission connected generators in similar locations. Because transmission connected generator tariffs can (and should) change over time, freezing tariffs for any embedded generation at any level would work against cost reflectivity and effective competition in generation.
21	<i>ScottishPower Energy Management Limited</i>	If embedded benefits were to be frozen at a non-zero value this should be based upon the £1.62/kW/year identified in NGET's Review of the Embedded (Distributed) Generation Benefit, December 2013. Further analysis would require to be undertaken by NGET to re-validate and update this figure. However it is clear that with the current Triad avoidance benefit in 2018/19 estimated at around £52.91/kW/year ⁱ , adopting a

		zero value would be closer to cost reflectivity than the current baseline
22	Eider Power Reserve	£45.33, i.e. current value but only as a temporary measure pending an SCR
23	Infinis Energy	<p>If they are to be frozen, triad embedded benefit should be set at a level that is reflective of the avoided costs for the transmission network.</p> <p>We believe that, as a minimum, the value of embedded benefits should be set at:</p> <ol style="list-style-type: none"> 1) the Locational Charge: The existing locational charge as derived each year using ICRP. 2) an Avoided Local Reinforcement Charge: An additional credit will be added to the locational element to reflect the saving to the transmission company on infrastructure costs around the GSP. 3) an Avoided Wider Reinforcement Charge: A further credit will be added to represent wider network savings. The rationale for the inclusion of this element is contained below and further relevant information is set out in the supporting paper attached to this document. 4) TNUoS Generation Residual: The generation residual applied to transmission has reduced substantially and is forecast to become negative in the future. This is likely to lead to further distortions between transmission and distribution connected generation within the energy and capacity markets in the future. To remove this potential distortion, the TNUoS generation residual should be applied to the charge for embedded generation with a negative value treated as an additional credit for embedded generation <p>We have brought forward two WACMs to this effect</p>
24	RWE Innogy UK- RWE npower joint submission	<p>There is no clear justification for freezing the embedded benefit tariff at 2016/17 value is £45.33 / kW nor is there evidence that it should be set at zero. There has not been an assessment of the appropriate value by the workgroup of the cost reflective value to the network from embedded generators. <i>If</i> embedded benefits are frozen they should be frozen at a level that is a best estimate of cost reflective impact. There are a number of reports that have set out their assessment of what these cost reflective charges would be: E.g. Cornwall Energy-ADE have conducted an in-depth assessment of the impact of embedded generation on network flows and suggest a value of £32.3/kW is appropriate for the 2015/16 charging year. Alternatively, the 2014/15 tariff could be justified given that this is when NGET's last review assessed the appropriateness of the embedded benefit. Our preference is that an enduring solution is developed and implemented that can ensure that a more cost reflective tariff is applied to embedded generators. There is a valid and varied locational benefit to the networks from embedded generation that should be recognised. We also contest the conclusion that transmission and distribution connection charges are on par with one another. The embedded benefit In addition to considering the impact does currently</p>

		help offset some of the distortion in connection charges. of tariff changes on embedded generation the Working Group should also consider what signal is the set value going to deliver for Demand Side Response and storage.
25	Sembcorp Utilities (UK) Limited	No text provided
26	<i>Smartest Energy</i>	If industry insists on hitting on a number which may or may not be reflective of the “embedded benefit” then we believe that a value of £35/kW would not be unreasonable. But this value will change over time and should not be fixed in this way. The level of the embedded benefit is a function of the TNUoS pricing methodology. If NGT apportioned the residual in a more sophisticated manner the “embedded benefit” would not be an issue.
27	<i>Ecotricity</i>	We believe that it should depends on the benefits to the system. A generational calculation to the benefit will be more cost-reflective.
28	UK Green Investment Bank plc	It would be appropriate to freeze benefits at the 2016/17 value of £45.33/kW.
29	Alkane Energy Limited	<p>We agree that embedded benefits could be frozen at a non-zero value. It is important to give investors certainty to allow for investment in new and existing generation. Any value should be frozen for a period that enables businesses and their investors to make investment decisions.</p> <p>We consider existing embedded generators and new generators with 2014 & 2015 CM and CfD contracts should continue to receive Triads at the 2016/17 rate throughout the period of their contracts. In terms of costs to consumers, cost reflectivity and competitive positioning this is an improvement on the CMP 264 Original Proposal which would allow forecast increases in Triad payments to flow through to all existing generators. However it does provide investors who have made past investment decisions across all technologies a reasonable level of revenue in line with likely forecasts they would have made at the time of making the investment decisions.</p> <p>New embedded generators should receive a payment that is set at a level that can be supported by the limited evidence available on what the cost reflective level of the embedded benefit should be. For example the Cornwall Energy analysis that shows that total capital and operating costs of new network assets to deliver TG assets displaced by embedded generation at £32.30/kW. We have seen no counter evidence to dispute this very recent analysis. As we have stated we think all parties need time to acquire and present further analysis in evidence to support a value that can be viewed as certain for a period of time sufficient to support investment decisions.</p> <p>Investors need this clear long term signal to make investment decisions. Any uncertainty creates regulatory risk which is not</p>

		<p>conducive to competition or likely to benefit consumers.</p> <p>Absent a more rigorously defined number that has been through comprehensive peer group scrutiny and review we would recommend that the embedded benefit be frozen for new embedded generators at a national average of £20-30/kW for a minimum five-year period. A new generator would be a party that has undertaken a G59 and does not have a 2014 & 2015 capacity market or CfD contract.</p>
30	Uniper UK	<p>The benefit should be at a level which is a reasonable estimate of the actual benefit provided to the system. We would observe that, whilst estimates of the total value of the embedded benefit have been presented under certain scenarios, to date the workgroup has not presented any evidence as to what the true avoided cost of transmission investment arising from connecting 1kW to a distribution network is and therefore what the correct value should be. This makes it difficult to justify any value above zero, at this point, on the basis that the TNUoS Demand Residual element is simply a non-cost reflective component of the TNUoS tariff to enable National Grid to recover the correct amount of allowed revenue in a given year.</p>
31	<i>E.ON</i>	<p>Understanding the true value of embedded generation in terms of the avoided cost of the transmission network is central to CMP264, CMP265 and the various alternatives proposed.</p> <p>There have been various attempts to calculate a true value with results ranging from very high (in some cases above the current level of triad benefit) down to £0/kW.</p> <p>Without thorough, independent analysis we do not believe any of these values can be justified as a permanent change. It is not clear to us that freezing the value at £0/kW as proposed in CMP264 better meets the CUSC objectives than a freeze at any other level (including the current level).</p>
32	<i>Welsh Power Group Limited</i>	<p>We believe the value of the embedded benefit should be frozen at current rates to alleviate the impact of a rapidly escalating transmission system cost.</p> <p>We believe that a full holistic review of the appropriate value of embedded benefits should be conducted outside of the CUSC process.</p>
33	SSE	<p>The embedded benefit should not be frozen in its entirety at any non-zero value. However, there may be a case for charging a part of the value of the Demand Residual on a net basis and linking the value of this element to another number as outlined in 1 to 2 below. We further consider that the fixing of the benefits with reference to Cost of avoided transmission infrastructure investment at GSPs (see 3 below) or cost savings identified by Cornwall Energy (see 4 below) are not justified.</p> <p>1) Link to generator TNUoS Residual – If a part of the Demand Residual remained net, then it would better facilitate effective competition between transmission connected generators and embedded generators if this remaining net element was linked to the value of the TNUoS Generator Residual in each year. This aspect is consistent with the “Centrica 2” proposed</p>

alternative.

2) Step reduction during a transition period – If the Start date were to be delayed beyond 2017/18, then it would be better to also include a short transition period with does have a start date as early as practicable. The transition arrangements should take the form of a cap on the element of the Demand Residual charged net which should step down in straight line annual increments towards enduring level. The starting level for the calculation of the transitional cap should be the level of the 2016/17 Demand Residual.

3) Cost of avoided transmission infrastructure investment at GSPs - Previous evidence from National Grid is out of date following CMP213 decision, so would be best considered as part of the wider review of charging as indicated in Ofgem’s open letter and not considered within this modification. This is because it is not cost reflective to apply the average number identified by National Grid when in practice, the value at a particular GSP may be substantially smaller, or even negative. The National grid published average embedded benefit of £1.62 (Review of the Embedded (Distributed) Generation Benefit arising from transmission charges, December 2013). This should not be used of evidence of a non zero value for “x” without further analysis. Reasons why this can not be relied upon include:

i. **Demand Security vs. Economy Criterion of the SQSS** - As is the case with the wider network, the cost of transmission infrastructure investment at GSP will be driven by the maximum flow, which may be either during “peak” conditions, or “year round” conditions. In order to apply any associated benefit in a cost reflective way, it would be essential to first identify what are the conditions which drive the cost at each GSP, then identify whether particular embedded generator either contributed to higher cost, or avoided cost.

ii. **Exporting GSPs may result in additional embedded generation further increasing transmission infrastructure investment cost at GSPs** – Depending on the circumstances at a particular GSP and the performance characteristics of the particular embedded generator, the embedded generator may contribute to additional cost at the GSP instead of reduced cost. Therefore applying an “average benefit” to all embedded generators would not be cost reflective.

4) Evidence from Cornwall Energy for the Association of Decentralised Energy uses flawed assumptions so the analysis can not be relied upon (*A Review of the Embedded Benefits accruing to Distribution Connected Generation in GB*). Contrary to Cornwall’s analysis, the existing locational elements of the TNUoS tariff already provide the appropriate cost reflective economic price signal on a locational basis, so the potential costs which Cornwall identify are already taken into account in the existing locational price signals. The existing charging methodology already takes this into account through the application of “expansion constant” and “expansion factors” to the MWkm derived from the ICRP Transport model:

❏❏ **Long-term capital cost** – “The expansion constant, expressed in £/MWkm, represents the annuitized value of the transmission infrastructure capital investment required to transport 1 MW over 1 km. Its magnitude is derived from the projected cost of 400kV overhead line, including an estimate of the cost of capital, to provide for future system expansion.” (CUSC v1.12, 14.15.59)

❏❏ **Overhead costs** - “The final step in calculating the expansion constant is to add a share of the annual transmission overheads (maintenance, rates etc.). This is done by multiplying the average weighted cost (J) by an ‘overhead factor’. The factors are then derived by dividing the calculated expansion constant by the 400kV overhead line expansion constant.” (CUSC v1.12, 14.15.66)

❏❏ **Different cost of different types of network reinforcement** – “Base onshore expansion factors are calculated by deriving individual expansion constants for the various types of circuit, following the same principles used to calculate the 400kV overhead line expansion constant.” (CUSC v1.12, 14.15.70). “AC subsea cable and HVDC circuit expansion factors are calculated on a case by case basis using actual project costs (Specific Circuit Expansion Factors).” (CUSC v1.12, 14.15.75). The Cornwall Report builds up a sum of different components, all of which used flawed assumptions, as described below:

i. £18.5/kW for average cost of new network reinforcement – Cornwall calculated this from the capital cost of a number of National Grid network reinforcement schemes currently under construction (£8.8bn), divided by the total GW of additional generation made possible by that reinforcement (35.56GW) to calculate an annualised average network cost per kW of generation capacity. However, there are logical flaws in Cornwall’s next steps because it is not a valid conclusion to draw that this can be used as a generalised value of embedded benefits:

❏❏ **Capital, operations and maintenance costs already included in locational tariff elements** - Cornwall suggest existing locational tariff elements do not take account of operations and maintenance costs, but to the contrary, as described above, the TNUoS locational tariff elements do already take these operational and maintenance costs into account.

❏❏ **Location matters (national average price is not cost reflective)** – Cost and benefit of embedded generation is dependent on its location, so it would be contrary to both cost reflectivity and effective competition to apply a flat average embedded benefit irrespective of location. Only if an embedded generator was built in a location on the transmission network which reduced flows on the network could there be a cost saving, but Cornwall fail to take this locational effect into account. This cost of this locational effect is already reflected by the TNUoS locational tariff elements such as the Peak Security tariff which is positive in some locations and negative in other locations.

❏❏ **Technology and operating characteristics matter (national average price is not cost reflective)** – Project TransmiT recognised that different types of plant cause a different cost/benefit to the transmission network, whether they are

intermittent, low carbon, high or low load factor. The locational elements of the TNUoS generation tariff is applied to different definitions of charging base to take this into account, but a flat national average value for embedded benefit would fail to reflect this difference in cost.

❏❏ **Inconsistent methodology for calculating the average cost of the network** – For a great many good reasons, the TNUoS charging methodology uses a measure of the average cost of the existing network to calculate TNUoS tariffs, not the cost of a small number of current, or possible specific future network investment decisions. Therefore Cornwall’s approach of using current network investment is not consistent with the recognised practice of the TNUoS charging methodology.

ii. **£13.8/kW Long-term cost of existing network** – Cornwall calculate this as the longterm cost which they claim embedded generation can avoid, but their methodology and conclusions are not valid:

❏❏ **Location matters** – As above, location matters, so if an embedded generator does not cause any avoided new investment cost of the transmission network, then it clearly does not cause any avoided long-term cost of the existing transmission network either. As described above, with regard to avoided long-term cost, these locational differences are already reflected by the locational elements of the TNUoS tariff.

❏❏ **Long-term costs are already accounted for** – As described above, the TNUoS charging methodology already takes the long-term cost of network either caused, or avoided into account when calculating the Peak Security and Year Round locational tariff elements.

3) Cornwall argues “Use of peak demand over states the value of the triad benefit by approximately £9.2/kW” – However, the existing TNUoS tariff elements already provide the answer to this question on a locational basis through providing separate Peak Security and Year Round tariff elements which vary by location. A more appropriate solution to this defect would be to change the definition of the charging base so that the Peak Security and Year Round tariff price signals can operate independently of each other on different charging bases, but if this change is beyond the scope of these modifications, then a change to the charging base should be considered as part of Ofgem’s wider review.

The costs associated with building and maintaining a transmission network and would still be needed even if embedded generation entirely displaced transmission connected generation

A further flaw in Cornwall’s logic is the fallacy that if the total volume of electricity demand in a year could be matched by generation from embedded generators, then there would be no need for a transmission network. This is false because in both the short-term and long-term, as described by National Grid in their 2010 NETS Seven Year Statement: Chapter 6 – The Transmission System p8. In this, National Grid clearly explain why the transmission network does exist for more than simply carrying the flow of power from transmission connected generators, but by contrast, the transmission system exists to carry

		<p>the flow of power from all generators including embedded generators: “Until the 1930's electricity supply in Great Britain was the responsibility of a multiplicity of private and municipally owned utilities, each operating largely in isolation. The Electricity Supply Act (1926) recognised that this was a wasteful duplication of resources. In particular, each authority had to install enough generating plant to cover the breakdown and maintenance of its generation. Once installed, it was necessary to run more plant than the expected demand to allow for possible sudden plant failure.</p> <p>By interconnecting separate utilities with the high voltage transmission system, it is possible to pool both generation and demand, providing a number of economic and other benefits, including:</p> <ul style="list-style-type: none"> • An interconnected transmission system providing a more efficient bulk transfer of power from generation to demand centres. • The interconnected transmission system, by linking together all participants across the transmission system, makes it is possible to select the cheapest generation available. • Transmission circuits tend to be far more reliable than individual generating units, and enhanced security of supply is achieved because the transmission system is better able to exploit the diversity between individual generation sources and demand. • An interconnected transmission system enables surplus generation capacity in one area to be used to cover shortfalls elsewhere on the system, resulting in lower requirements for additional installed generation capacity, to provide sufficient generation security for the whole system. • Without transmission interconnection, each separate system would need to carry its own frequency response to meet demand variations, but with interconnection the net response requirement only needs to match the highest of the individual system requirements to cover for the largest potential loss of power (generation) rather than the sum of them all.”
34	UKPR	See separate response
35	Green Frog Power	We think that the triad value should be frozen at current levels while Ofgem conducts a thorough top-to-bottom SCR. For the reasons outlined in question 1, we believe that there are some flaws underpinning the charging methodology and the current proposed solutions are merely a plaster on a gaping wound. If the underlying issue of how to charge for those spiralling transmission costs is not effectively addressed in the reasonably near term, then we shall be back having these same discussions, but about other new distortions. If the wound is not adequately attended to, we shall have failed to have taken the opportunity to have created a sustained and healthy investment climate. This applies to all market participants, not just embedded generators.

36	The ADE	<p>We strongly agree that the appropriate approach to this issue is to freeze the embedded benefit at an appropriate level, pending a full review that considers both the triad methodology and the demand residual.</p> <p>We would note that no analysis was undertaken in the working group, and that working group requests for new analysis were rejected due to accelerated timescales. This has prevented the working group from fully considering evidence on what the cost-reflective level of the embedded benefit should be. There is a need to undertake a proper review of the cost-reflectivity of the triad charging arrangement for demand users and distributed generators.</p> <p>Network charging is a complicated and integrated area, with knock-on effects across the energy system. A rushed decision to remove the TNUoS embedded benefit will have significant real world impacts on Government policy which cannot be reversed.</p> <p>Pending such a full and proper review, we would recommend freezing the residual at the level of £32.30/kW, which reflects the total capital and operating costs of new network assets required to deliver transmission generation assets which are displaced by embedded generation as found by Cornwall Energy. This is the minimum fair value possible for the Embedded Benefit.</p> <ul style="list-style-type: none"> • Cornwall Energy’s analysis assessed the capital cost of a number of National Grid schemes under consideration with a total potential spend of £8.8bn. The average annuitised cost across all the schemes is £18.5/kW on a 2015-16 price basis. The minimum embedded benefit attributable to embedded generation is £18.5/kW, as this is the ‘replacement’ cost of embedded generation if it were to be removed and replaced with transmission generation. • However, this estimated cost does not include the ongoing costs associated with these schemes such as operations and maintenance or the non-quantifiable impacts such as visual amenity. As the investment in embedded generation is a long term decision and they offset demand over the life of their connection, it is appropriate that embedded generation should benefit from offsetting long term costs in addition to short term costs. Cornwall Energy estimated these elements to equate to c£13.8/kW in 2016-17. <p>Therefore, Cornwall Energy assessed the total capital and operating cost of new network assets required to deliver transmission generation assets which are displaced by embedded generation at £32.30/kW. We would note that no other analysis or estimate was offered to the working group on the value of the embedded benefit to transmission network long run marginal costs. Both proposers referred to a previous National Grid estimate of £1.58, but no detailed discussion or debate was had about the methodology behind that approach.</p>
----	---------	---

		We would recommend the embedded benefit should be frozen at £32.30/kW while a full review is undertaken. To remove the embedded benefit based on proposals that are not backed up with quantitative evidence and in a process in which additional evidence could not be sought would be a very poor piece of policy making. Finally it would have substantial impact on a number of market players who are competitors to the proposer so the adoption of such proposals without evidence would rightly raise questions about the appropriateness of the process used.
37	Renewable UK	RenewableUK is not in a position to comment on this matter.
38	Savvi Energy	Any value would be arbitrary as a robust in depth analysis of the true value of embedded generation has not been determined.
39	RES	We do not believe any single value at this stage can be justified in light of other industry changes, not least NGET's own review, and would reiterate that such considerations should be postponed pending completion of the holistic review of commercial arrangements.
40	Watt Power	If embedded benefits are frozen at a non-zero value, we suggest that they are frozen at the forecast 2016/2017 tariff values. The 2016/17 residual is a reasonable starting point for temporary solutions such as those proposed in CMP264 and CMP265. This is a known value and will have been built into the calculations of many generators planning to build embedded plant. The 2016/17 tariff values have a locational element and therefore there should not be frozen at a blanket rate of £45.33 / kW for all embedded generators as the question seems to suggest. In some areas the value is higher, in others it is lower, and the locational element should vary from year to year so that it remains cost reflective.
41	Plutus	<p>If they are to be frozen, triad embedded benefit should be set at a level that is reflective of the avoided costs for the transmission network.</p> <p>We believe that, as a minimum, the value of embedded benefits should be set at:</p> <ol style="list-style-type: none"> 1) the Locational Charge: The existing locational charge as derived each year using ICRP. 2) an Avoided Local Reinforcement Charge: An additional credit will be added to the locational element to reflect the saving to the transmission company on infrastructure costs around the GSP. 3) an Avoided Wider Reinforcement Charge: A further credit will be added to represent wider network savings. 4) TNUoS Generation Residual: The generation residual applied to transmission has reduced substantially and is forecast to become negative in the future. This is likely to lead to further distortions between transmission and distribution connected generation within the energy and capacity markets in the future.
42	Reliance	If they are to be frozen, triad embedded benefit should be set at a level that is reflective of the avoided costs for the

		<p>transmission network.</p> <p>We believe that, as a minimum, the value of embedded benefits should be set at:</p> <p>1) the Locational Charge: The existing locational charge as derived each year using ICRP.</p> <p>2) an Avoided Local Reinforcement Charge: An additional credit will be added to the locational element to reflect the saving to the transmission company on infrastructure costs around the GSP.</p> <p>3) an Avoided Wider Reinforcement Charge: A further credit will be added to represent wider network savings.</p> <p>4) TNUoS Generation Residual: The generation residual applied to transmission has reduced substantially and is forecast to become negative in the future. This is likely to lead to further distortions between transmission and distribution connected generation within the energy and capacity markets in the future</p>
43	Silva Renewable Energy Limited – Bilateral Connection Contract holder Renewable	The values should reflect the value to the grid in investment and operational terms. Interaction with distribution charges also needs to be assessed before firm reform proposals are committed to.
44	Drax	We are unsure about a frozen value but given the evidence the wider demand tariff seems to be an appropriate approximation of the true value of the EB.
45	ELEXON	No text provided
46	Rockpool	<p>If they are to be frozen, triad embedded benefit should be set at a level that is reflective of the avoided costs for the transmission network.</p> <p>We believe that, as a minimum, the value of embedded benefits should be set at:</p> <p>1) the Locational Charge: The existing locational charge as derived each year using ICRP.</p>

		<p>2) an Avoided Local Reinforcement Charge: An additional credit will be added to the locational element to reflect the saving to the transmission company on infrastructure costs around the GSP.</p> <p>3) an Avoided Wider Reinforcement Charge: A further credit will be added to represent wider network savings.</p> <p>4) TNUoS Generation Residual: The generation residual applied to transmission has reduced substantially and is forecast to become negative in the future. This is likely to lead to further distortions between transmission and distribution connected generation within the energy and capacity markets in the future.</p>
47 late response (rec'd 1 Sept 16)	Calon Energy	Were benefits to be frozen we would suggest that around the 2014/15 levels (£30.05/kW) would be acceptable as that aligns with the last embedded benefits review when NG seemed to conclude that there was no material issues that needed resolving. Since then the growth in both embedded generation and TO costs has probably been far beyond what the review envisaged.

ⁱ Table 23, NGET forecast of TNUoS tariffs from 2017/18 to 2020/21, 11 February 2016

These are the questions that related to CMP265 only and cover questions:

Questions: 5, 6, 7, 8, 11, & 14

Question 5: Do you believe that the CMP265 Original Proposal better facilitates the Applicable CUSC Objectives?

Response No	Company	Response
1	<i>CLP Envirogas</i>	No. Given the rules around allocating transmission system costs between Generation and Demand, embedded generation is effectively negative demand at GSP and should be treated as such.
2	Engie	We are minded to support this proposal as being an improvement on the baseline CUSC; although we have concerns that as presently drafted it discriminates between classes of users and we would like to see an earlier implementation date. We would prefer this proposal to apply to all embedded generators with an implementation date set by the Authority.
3	RWE Generation UK plc, RWE Supply & Trading GmbH	CMP264 Original proposal may better meet the CUSC objectives, particularly with regard to Objective (a). The proposal will ensure that investment decisions for new embedded generation with a capacity market agreement are not distorted by the residual component of the demand TNUoS tariffs. However, the proposal fails to address the wider issues associated with the defect for existing generators and also introduces discriminatory treatment between new embedded generation with a capacity market and remaining embedded generators which do not have a capacity market agreement but continue to receive the growing Triad benefit). In addition, we have concerns that under the proposal that the locational element of the demand TNUoS tariffs for new generation is not cost reflective since it does not appropriately represent the peak and year round backgrounds and does not address issues associated with the demand charging base (half hourly and non half hourly). As a consequence the modification can only be described as a temporary solution until such time that a comprehensive and enduring approach towards demand transmission charging is developed.
4	<i>EPR Ely Limited</i>	No. Given the rules around allocating transmission system costs between Generation and Demand, embedded generation is effectively negative demand at GSP and should be treated as such.

5	<i>EPR Glanford Limited</i>	No. Given the rules around allocating transmission system costs between Generation and Demand, embedded generation is effectively negative demand at GSP and should be treated as such.
6	<i>EPR Eye Limited</i>	No. Given the rules around allocating transmission system costs between Generation and Demand, embedded generation is effectively negative demand at GSP and should be treated as such.
7	Statera Energy	a) No, the proposal discriminates against embedded generation only in the capacity market without justification. b) Again, no justification why this would be cost-reflective
8	<i>EPR Scotland Limited</i>	No. Given the rules around allocating transmission system costs between Generation and Demand, embedded generation is effectively negative demand at GSP and should be treated as such.
9	TATA Chemicals Europe	Comments removed for publication of report
10	<i>EPR Thetford Limited</i>	No. Given the rules around allocating transmission system costs between Generation and Demand, embedded generation is effectively negative demand at GSP and should be treated as such.
11	<i>LondonWaste Ltd</i>	No we do not and we argue that it would do the opposite by reducing competition in generation by creating a barrier to new entry into the generation market in the form of regulatory risk. This proposal seems to be based on the flawed premise that embedded generators (and the demand they offset) are ‘using’ the transmission system. What was the lowest level of total embedded generation during a triad Settlement Period? As a collective they provide a significant generation base which is “always there” at triad times in the same way the demand they offset is “always there” and so the transmission system has never had to cater for that demand. It cannot be argued that anything more than a minority of such generators are using the transmission system. It might be argued that the embedded generators have stolen this load away – but that is competition which is to be encouraged. The proposal claims that it seeks to “level playing field between new embedded generators and other generation <u>plant</u> ”, but in fact the effective competition in the long term arises between <u>companies</u> and results from the investment decisions they make. The playing field is already level, because the proposer of CMP265 is quite free to build embedded plants as well as any other company. CMP265 would significantly stifle the building of new embedded plant and thus stifle competition in generation.
12	PeakGen	No.

	Power Ltd	<p>Under the proposed modification, the “modification is limited to only embedded generation with capacity market contracts”, whilst the defect identified by the proposer relates to the “netting-off of the output of embedded generation ...is causing a distortion to the generation market; to the extent that they run at times of triad, embedded generators are given an artificial advantage over others, which among other effects, distorts the outcome of capacity market tenders”</p> <p>This modification proposal, if approved, would apply from 2020, where the residual tariff is forecast to have risen to around 65 £/kW (stage 02, workgroup consultations, page 17, figure 4). At this level, embedded benefit would be three times the highest price that a capacity market auction has cleared at, and is clearly high enough to justify ongoing investment in new embedded plant without any capacity market payment.</p> <p>We therefore conclude that if this modification were applied, and the forecast level of embedded benefit were correct, embedded plant would simply opt out of the capacity market and continue to run at peak. We assume the volume targeted in the capacity market would be reduced by the level of opted out embedded generation and the capacity market would clear at the same level as if the modification had not been raised.</p> <p>Hence if you accept the defect as specified by the proposer (and please see our initial comments as to why we think this is not correct) the proposed modification would not solve them.</p>
13	Statoil ASA	No text provided
14	Good Energy	<p>A) It is evident that CMP265 undermines objective A of the CUSC.</p> <ul style="list-style-type: none"> - It is clear that CMP265 risks undermining investor confidence, leading to decreased competition in the generation market in addition to increasing cost of capital for investors. - Removal of embedded benefits for Capacity Market participants is likely to lead to a number of generators not participating in the Capacity Market auction – leading to a reduced level of competition in the auction. <p>(B) It is clear that CMP265 undermines objective B of the CUSC.</p> <ul style="list-style-type: none"> - The holding of a Capacity Market (CM) contract has no impact on the costs or benefits that a generator brings to the transmission system. It is therefore inappropriate to discriminate between generators in this way. - CMP265 also frames embedded generation with CM contracts as offering no benefit in terms of cost saving to the transmission network – this is clearly not the case, and therefore such a modification would not be cost reflective. <p>(C) It is evident that CMP265 is not supportive of objective C of the CUSC.</p> <p>Any changes that are made which are not consistent with OFGEM’s final decision on the future of the TNUoS charging regime risk leading to industry participants facing significant abortive costs</p>

15	<i>REstore</i>	No, see introduction.
16	EDF Energy	<p>Yes. CMP265 better facilitates charging objective a, effective competition. It also better facilitates charging objective b, cost-reflectivity, and it better facilitates charging objective c, because as to developments in transmission licensees' transmission businesses, there has been a marked growth in the amount of embedded generation impacting the ways the system is developed and operated – the charging distortion may have been a contributory factor to that. CMP265 is neutral as to the remaining charging objective d, on Europe.</p> <p>We believe it is beneficial that CMP265 entails no “grandfathering”. We recognise the importance of investment decisions but in this case reform of embedded benefits has been clear to the market for some time and therefore given grandfathering could be distortive of competition between different, otherwise-identical, generators, and could take away some consumer benefit we do not support it in this case.</p> <p>A key benefit of CMP265 is removing the unjustified crediting to relevant embedded generation of the demand HH residual charge element, which is an artifice to ensure correct overall revenue recovery and not a cost-reflective charge (unlike locational charge elements). This is distortive across the patch, and CMP264 addresses this; there is no logic to netting-off the output of embedded generators from HH demand as far as the demand residual charge element is concerned. Addressing this distortion explains how CMP264 better facilitates charging objective b. Note that this distortion has its most marked effect within the capacity mechanism</p>
17	Tees Valley Combined Authority	<p>We believe that the proposals may run counter to the objective of the CUSC. The proposals have the potential to reduce competition, by increasing uncertainty (due to regulatory risk) as to the impact of new investment in the local provision of generating plant.</p> <p>Evidence from the local market would assert that a large proportion of embedded generators do not ‘use’ the transmission system at all. That is because, during Settlement Periods when the TNUOS charges are determined (the Triads), there is a consistency of offset between embedded generation and demand. It may be the case that the size of this offset has grown over the years, taking load off the transmission system and stranding NGC assets, but that is a separate issue which needs to be addressed in a more holistic manner.</p>
18	Octopus Investments	No. OI considers that this proposal is designed to specifically disincentivise new embedded generation in favour of large gas turbines and therefore is contrary to objective (a) above. However we do not believe that it is possible to reach a conclusion regarding the composition of the future energy mix without a detailed review. The only alternative is to leave it to the market to determine which plants enter. See below for further comment on this point.
19	The	unsure

	Greenspan Agency Limited	
20	Centrica	<p>No.</p> <p>On applicable objective (a), we recognise the status quo is not conducive to effective competition in generation. However, we have concerns that CMP265 may not facilitate effective competition either. CMP265 effectively gives embedded generators a choice between status quo transmission embedded benefits and Capacity Market (CM) payments. This will likely result in embedded generators opting out of future CM auctions in order to retain non-cost reflective transmission embedded benefits. The projected increases in (status quo) transmission embedded benefits are such that we would likely see continued roll out of new embedded generation, even with the loss of CM payments. The level of roll out would likely exceed the economic and efficient level, because embedded generation would continue to be over-remunerated by the status quo transmission embedded benefit. Because expected contributions from non-CM capacity are taken into account when CM auction demand is calculated, we believe the continued roll out of embedded generation would result in a corresponding reduction in CM target demand in future CM auctions, with a growing subset of the total market sustained by alternative (and higher) payments outside the CM (i.e. status quo embedded benefits). We therefore believe that status quo embedded benefits will continue to have adverse competitive impacts on the Capacity Market / generation mix and electricity market more broadly, even if embedded generation does not participate in the CM directly.</p> <p>On applicable objective (b), we have concerns about the non-cost reflectivity of CMP265, because it will result in generators having similar effects on transmission network flows (and therefore forward looking transmission costs) facing materially different charges (according to whether they are transmission connected, embedded and in the CM or embedded and outside the CM). Whilst we agree that the status quo is not cost reflective, we are unconvinced that CMP265 enhances cost reflectivity.</p>
21	<i>ScottishPower Energy Management Limited</i>	<p>Yes. Overall, CMP265 will better meet the Applicable Charging Objectives (ACOs) than the current baseline. CMP265 will remove a distortion in competition between investing in embedded and transmission connected generation, in particular in connection with the Capacity Market, by removing a non-cost reflective payment from embedded generation. This better facilitates Applicable Charging Objective (ACO) (a). CMP265 will better facilitate ACO (b) by removing a non-cost reflective payment realised by embedded generators. Developments in the transmission system, in particular the increase in the amount of embedded generation connected and a significant increase in the demand residual TNUoS tariff have resulted in payments to embedded generators which are significantly in excess of any savings in transmission investment resulting from connecting generation at a distribution level. By</p>

		addressing which generators can access the demand residual TNUoS charge as an embedded benefit, CMP265 better facilitates ACO (c).
22	Eider Power Reserve	No we do not as changes to Triad payments in the manner suggested would strongly favour transmission connected projects in a manner we consider to be anti-competitive, self-serving on the part of the proposer and not reflective of the level of embedded benefits brought to the market by embedded generation
23	<i>Infinis Energy</i>	No – the proposal as is creates a clearly distortive effect between embedded generation awarded a capacity market contract and those without, therefore impacting objective 1. Exempting all plant with a capacity market contract also adversely impacts objective 2 – successful capacity market bidders are not costing transmission owners more in terms of transmission system investment; indeed they are helping manage peak demand.
24	<i>RWE Innogy UK- RWE npower joint submission</i>	<p>No, on balance it does not better facilitate the CUSC Objectives. CMP265 could prevent any directly DNO connected embedded CM party factoring in the benefit of net metering and residual tariff into their bids.</p> <p>However, to the detriment of energy market competition CMP265 introduces a new Defect. It introduces undue discrimination in the treatment of ‘CM’ and ‘non-CM’ generation. The network impact of both types of embedded generation is the same, differential charging treatment appears as discriminatory.</p> <p>Additionally, gross charging for the Demand Residual element and applying the net charging for the current locational element of Demand TNUoS does not create a correct cost reflective signal for ‘CM embedded generators’.</p> <p>The current locational signal is not aligned with SQSS. It is our view that the current demand charging methodology should as a first step be updated in line with SQSS in the way that generation charging was under Transmit.</p> <p>Demand charging should appropriately represent the peak and year round backgrounds and address issues associated with the half hourly and nonhalf hourly demand charging base.</p> <p>CMP265 has the following impact on the CUSC objectives:</p> <ul style="list-style-type: none"> a) Does not improve competition, as different rules for different Embedded Generators. (CM vs non CM) b) Not cost reflective as the defect raised has not been addressed c) Neutral on developments in the transmission licensees' transmission businesses d) Neutral on EU <p>Overall CMP265 introduces a New Defect of discrimination and does not introduce a more cost reflective charging arrangement than the baseline.</p>
25	Sembcorp Utilities (UK) Limited	Please see our opinion in Q6 below
26	Smartest Energy	No. The CUSC and EMR arrangements are two separate things, as are Triad payments and capacity payments. It is wrong to discriminate within the CUSC for impacts within the EMR arrangements

27	UK Green Investment Bank plc	No comment
28	Alkane Energy Limited	<p>We view this Proposal as blatantly discriminatory and in the Proposer's corporate self-interest. It is recognised by the Proposer as only a partial solution to something that has been through many previous reviews, and throughout the Workgroup discussions has been demonstrated to have much wider impact and implications than simply impact with the Capacity Market. The reason for the narrow definition is purported to be to achieve a specific aim of removing distortion from the coming Capacity Market auction, yet it is proposed as an enduring not temporary solution. It would provide extremely limited cost savings to consumers through removing the Triad benefit from capacity contracted embedded generators in the capacity market; however the choice of an embedded generator to opt for Triads would remove it from the capacity market stack and so incrementally increase the price in the capacity market for over 50GW of capacity. It seems extraordinary to claim that this would benefit consumers.</p> <p>EDF has about 400MW of distribution connected onshore windfarms in the UK. To the extent these are generating at time of Triad they would receive the Triad payment. Statistically they would receive 100-150MW worth of Triad payments, but they do not provide firm capacity. This capacity is equivalent to Alkane's existing portfolio of firm capacity. To deprive Alkane of equivalent Triad revenue because Alkane can provide firm capacity and can contribute that to the Capacity Market seems self evidently anti competitive.</p> <p>Accordingly we cannot support this proposal. We believe a modification to the CMP264 Proposal is a much more appropriate basis for a way forward</p>
29	Uniper UK	<p>Although it is not a perfect solution, on balance yes, as, although it does not address the payments received by eligible embedded generators before the end of the decade and is limited to only those eligible generators in the Capacity Market; it sets out to remove the distortion from present high and increasing levels of embedded benefit arising from the Demand Residual component of the TNUoS tariff for the forthcoming Capacity Market auctions. It is therefore an incremental improvement against Objectives a), b) and c).</p> <p>1 http://</p>
30	EON UK	<p>As outlined in our views on CMP264, whilst we accept that the current methodology may overstate the value of embedded generation in future, we do not believe sufficient analysis has been carried out to demonstrate that CMP265 better meets the CUSC objectives.</p> <p>Were independent analysis to show that some level of embedded benefit beyond the current locational element was appropriate (albeit lower than today's level), it may be that CMP265 is further from this justified level than today's embedded benefit. Therefore CMP265 could be more distorting.</p>

		Without thorough, independent analysis of the overall value of avoided transmission costs as a result of embedded generation we do not believe an assessment of whether or not CMP265 better meets the CUSC objectives can be made.
31	<i>Welsh Power Group Limited</i>	<p>No we do not believe that CMP265 better facilitates the CUSC objectives. Excluding a subset of embedded generators from a material income stream creates a new distortion in the electricity market. There appears to be no rationale for excluding only those embedded generators with CM contracts from receiving Triad payments and the vast majority of embedded generators will be unaffected by the proposal.</p> <p>In addition the proposed modification will introduce differential treatment between embedded generators metered at the boundary of the distribution network and those which are located behind the meter. It is not sufficient to permit this difference in treatment simply because it is a challenging area and the argument that the proposal needs to just be an incremental improvement is an inadequate justification.</p> <p>We do not consider a proposal that introduces new discrimination into the market can meet the CUSC objective of better ‘facilitating competition in the sale, distribution and purchase of electricity.’</p> <p>We consider that the most significant driver of the costs ‘incurred by transmission licencees in their transmission businesses’ is the absolute size of the transmission system. This total cost is influenced by the amount of capacity connected to and transporting electricity through the transmission system. Embedded generation, over time, reduces the size of the transmission system and as a consequence it is appropriate that embedded generators receive a share of the benefit arising from the reduced size and cost of the transmission system.</p> <p>We do not consider that proposal CMP265 would result in charge which better reflect the costs ‘incurred by transmission licencees in their transmission businesses’</p>
32	SSE	<p>Yes, we believe that the Original CMP265 better facilitates the competition and cost reflectivity Objectives but we consider that some of the alternatives would facilitate these even more effectively (e.g. the approached suggested by proposed alternative Centrica 1 & Centrica 2 with some additional further changes). Our reasoning is outlined below.</p> <p>a) CUSC Objective “A” - Better facilitates effective competition – Yes with regard to the specific sub group classed as having a Capacity Mechanism contract, CMP265 Original does better facilitate effective competition as compared with the Baseline. However there are many aspects of effective competition where the Original is not better than the Baseline, including:</p> <p>i. It would likely fail to address the identified defect with regard to the distortion to the capacity market clearing price. This is because the Triad avoidance benefit appears to be of much greater value than the recent capacity market clearing price which means that embedded generation given the choice may be expected to choose to continue to receive the TNUoS Triad benefit and forego the capacity mechanism revenue. However, it is likely that when BEIS decide how much capacity to procure in the Capacity Market, then they will take this embedded generation into account as being available whether that embedded generation chooses to participate in the capacity mechanism or not. Therefore even if these generators do not participate in the Capacity Market, it is likely to result in the</p>

		<p>capacity market clearing with roughly the same marginal plant at roughly the same clearing price as it otherwise would have done. This will therefore fail to correct the defect with regard to competition within the capacity market and fail to correct the defect with regard to new investment.</p> <p>ii. It creates a new defect regarding further distorting and reducing competition in the Capacity Market. The purpose of the capacity market is to provide a competitive market where suppliers of capacity can compete with each other so that society can procure the level of capacity it requires at an efficient price. However, if a select group of market participants, namely embedded generators, face the economic incentive to avoid participating in this competitive market Capacity Market, then this reduces the effectiveness of the capacity market. Unless the defect is corrected with regard to the cost reflectivity of the Triad avoidance benefit, Triad avoiding embedded generators may to continue to invest and build in new capacity (based on the Triad benefit incentive instead of the Capacity Mechanism incentive), which would continue to crowd out other potentially lower cost generators and progressively reduce the capacity which BEIS are required to source competitively from the Capacity Market.</p> <p>i. Discrimination between generators and customers - Fails to correct the existing Baseline discriminatory nature of the additional cost to customers collected to pay for the embedded benefit for embedded generators without capacity mechanism contracts.</p> <p>b) CUSC Objective “B” - Better facilitates cost reflectivity of charges – Yes with regard to the specific sub group classed as Embedded Generators with a Capacity Mechanism contract, CMP265 Original does better facilitate cost reflectivity of charges as compared with the Baseline. However CMP265 Original is no better, than the Baseline with regard to the cost reflectivity of charges for embedded generators who do not have a capacity contract.</p>
33	UKPR	Please see separate attachment
34	<i>Green Frog Power</i>	No. Our response to the same question for CMP264 holds for CMP265, except that this proposal runs the significantly increased risk of causing embedded generators with long-term capacity agreements to have to walk away from their CM agreements with their assets unbuilt. With a significant income stream removed for 13-14 years of a 15-year agreement, many (new) market participants already feel that they have been let down by the Regulator for even entertaining the notion.
35	The ADE	Please see our response to Question 1.
36	Renewable UK	No, We do not believe that either the CMP 265 Original proposal or the alternatives facilitate the Applicable CUSC objectives <input checked="" type="checkbox"/> RenewableUK does not believe that problems with the Capacity Market, which this modification expressly intends to solve, are best resolved with CUSC modifications absent a broad and holistic review of all related issues, such as the nature of the

		<p>triad system, the relationship between the locational and residual components of the demand TNUoS charge, and the nature of embedded benefits themselves.</p> <p>This CUSC modification does not “<i>properly [take] account of the developments in transmission licensees’ transmission businesses</i>”, in that it does not aim to solve any of the underlying problems which it purports to say are causing harm to the outcomes of the Capacity Market.</p> <p>RenewableUK believes that neither CMP 265 nor the several Alternatives proposed in this consultation facilitates the Applicable CUSC Objectives:</p> <p>a) CMP 265 does not facilitate effective competition in the generation and supply of electricity because it arbitrarily divides embedded generation into those with CM contracts and those without, which will be treated differently even though they may have exactly the same impact on the network.</p> <p>b) It is not cost reflective as its remedies purport to solve issues with the Capacity Market and not issues arising because of the current shape and scale of the residual component of the demand TNUoS element of embedded benefits. Penalising a participant in one market because of the perceived failures to achieve certain desired outcomes in another market is discriminatory.</p> <p>c) It does not take account of the developments in the transmission licensees’ transmission businesses.</p> <p>d) It has no impact on EU law</p>
37	Savvi Energy	No
38	RES	No
39	Watt Power	<p>We are not supportive of the CMP265 proposal as the scope of the defect is too narrow and unjustly targets distribution connected generators as a cause for distorted capacity market outcomes. The issues surrounding charging arrangements and transmission network costs are far more complex than set out in the defect described by CMP264 and should be addressed by Ofgem through a SCR or via a more suitable modification proposal. The proposed solution creates a defect, since all parties appear to accept that embedded generation provides some grid cost reduction, which would not be reflected in the payments to generators affected by the modification. There is no firm evidence that this defect is less significant than the defect that the modification seeks to address.</p>
40	Plutus	<p>No – the proposal as is creates a clearly distortive effect between embedded generation awarded a capacity market contract and those without, therefore impacting objective 1. Exempting all plant with a capacity market contract also adversely impacts objective 2 – successful capacity market bidders are not costing transmission owners more in terms of transmission system</p>

		investment; indeed they are helping manage peak demand.
41	Reliance	No – the proposal as is creates a clearly distortive effect between embedded generation awarded a capacity market contract and those without, therefore impacting objective 1. Exempting all plant with a capacity market contract also adversely impacts objective 2 – successful capacity market bidders are not costing transmission owners more in terms of transmission system investment; indeed they are helping manage peak demand.
42	<i>Silva Renewable Energy Limited – Bilateral Connection Contract holder Renewable Energy Limited – Bilateral Connection Contract holder</i>	<p>No</p> <p>We do not support either of the proposed two modifications because we believe they do not provide an enduring solution to the distortions their sponsors seek to address.</p> <p>We believe this proposal is discriminatory. If it transpired we were not successful in the CFD auction, one alternative way forward under consideration is for us to seek a long-term capacity market contract rewarding the firm availability we bring. In the event it made more sense to pursue the distribution connection, it would be distortive to deny equivalent access to the triad benefit as past and future investors given the beneficial impact we would bring to the regional system.</p> <p>It is also relevant that Ofgem has raised concerns over the cost-reflectivity of the triad benefit and wishes to see change. We do not believe either of the two tabled solutions address this problem, and they would simply introduce further distortions and discriminations into the current CUSC baseline. They do not bring charges in line with costs nor reflect developments in the transmission system. It is clear that for a robust solution to be identified considerable further work is needed, and the key is coming forward with a revised charging methodology that captures the true benefits of distribution-connected to the system, and not just National Grid’s avoided reinforcement costs.</p>
43	Drax	<p>Yes for the same reasons seen in our answer to question 1</p> <p>Both CMP264 and CMP265 have drawbacks: CMP264 gets rid of the wider tariff as an EB and grandfathers current EGs, and CMP265 only applies to Capacity Market Units (CMUs). We believe that the wider tariff should be used to calculate the EB and that this should be applied to <i>all</i> embedded plant sub 100MW. The defect exists in the CUSC and relates to the demand residual being not cost reflective and thus distorting effective competition. Whether an EG is a CMU is irrelevant. We believe that the Centrica 1 potential option for change can address the issues described under CMP264 and CMP265.</p> <p>Centrica 1 however has a proposed implementation date of 1st April 2020 which we see as being excessive. The precedence set for charging changes (such as those seen in CMP213) was one full charging year.</p>
44	ELEXON	No text provided
45	Rockpool	No – the proposal as is creates a clearly distortive effect between embedded generation awarded a capacity market contract and those without, therefore impacting objective 1. Exempting all plant with a capacity market contract also adversely impacts

		objective 2 – successful capacity market bidders are not costing transmission owners more in terms of transmission system investment; indeed they are helping manage peak demand.
46 late response (rec'd 1 Sept 16)	Calon Energy	Yes, as with CMP264 it does reduce the distortions in competition in line with objective a and improves the cost reflexivity of the charging structure, in line with objective b.

Question 6: Do you support the proposed implementation approach? Or are there any further implementation implications that need to be considered?

Response No	Company	Response
1	<i>CLP Envirogas</i>	No. The proposal sits outside the CUSC objectives, does not address the fundamental issue of increasing transmission system costs and their allocation, and unfairly targets CM embedded generators, who are likely to have included this ongoing revenue when designing their projects.
2	Engie	We would prefer the implementation date to be linked to an Ofgem decision with implementation the “next following 1st April after an Authority decision” i.e. a decision in March 17 would result in implementation 1st April 18. This would see a consumer benefit in a timely fashion whilst always giving a minimum 12 months prior to implementation.
3	RWE Generation UK plc, RWE Supply & Trading GmbH	The scale and extent of the distortions associated with the residual component of the demand TNUoS tariffs as identified under the modification proposal (and in Ofgem’s Open Letter ¹) suggests that it is appropriate that the defect is addressed as soon as practicable. However, we have concerns about the feasibility of the proposed solution and its impact on suppliers. In particular it may be difficult to develop and deliver efficient central reporting mechanisms and supplier billing systems. These are required to ensure the identification of relevant embedded generators and the introduction of gross charging for such parties. 1. Ofgem “ Open letter: Charging arrangements for embedded generation ”, : 29 th July at https://www.ofgem.gov.uk/system/files/docs/2016/07/open_letter_-_charging_arrangments_for_embedded_generation.pdf
4	<i>EPR Ely Limited</i>	No. The proposal sits outside the CUSC objectives, does not address the fundamental issue of increasing transmission system costs and their allocation, and unfairly targets CM embedded generators, who are likely to have included this ongoing revenue when designing their projects.
5	<i>EPR Glanford Limited</i>	No. The proposal sits outside the CUSC objectives, does not address the fundamental issue of increasing transmission system costs and their allocation, and unfairly targets CM embedded generators, who are likely to have included this ongoing revenue when designing their projects.
6	<i>EPR Eye Limited</i>	No. The proposal sits outside the CUSC objectives, does not address the fundamental issue of increasing transmission system costs and their allocation, and unfairly targets CM embedded generators, who are likely to have included this ongoing revenue when designing their projects.

7	Statera Energy	No a) No, the proposal discriminates against embedded generation only in the capacity market without justification. b) Again, no justification why this would be cost-reflective
8	<i>EPR Scotland Limited</i>	No. The proposal sits outside the CUSC objectives, does not address the fundamental issue of increasing transmission system costs and their allocation, and unfairly targets CM embedded generators, who are likely to have included this ongoing revenue when designing their projects.
9	TATA Chemicals Europe	Comments removed for publication of report
10	<i>EPR Thetford Limited</i>	No. The proposal sits outside the CUSC objectives, does not address the fundamental issue of increasing transmission system costs and their allocation, and unfairly targets CM embedded generators, who are likely to have included this ongoing revenue when designing their projects.
11	<i>LondonWaste Ltd</i>	We do not support this form of approach at all and we believe that the status quo should remain or the transmission charging regime should be overhauled in its entirety. The approach adopted seems to be to address the symptom rather than the cause which is the ever increasing projected triad demand charge in turn at part at least driven by the €2.50 /MWh limit (which of course benefits the class of generators which support these two proposals).
12	PeakGen Power Ltd	If the modification were to be adopted, the proposed solution appears reasonable
13	<i>Statoil ASA</i>	No text provided
14	Good Energy	As a 100% renewable energy supplier, none of our generators currently participate in the Capacity Market. We therefore have no view on implementation of CMP265 at this time.
15	<i>REstore</i>	No, see introduction.
16	EDF Energy	Yes, the proposed implementation approach is appropriate
17	Tees Valley Combined Authority	At this present time, we are not in a position to be able to assess the full implications of the proposed implementation approach and would strongly recommend an extension of the consultation period. Only after such a consultation period would we be in a position to provide a robust response.
18	Octopus	No. This proposal takes no account of the impact on Winter peak energy supply needs. In the absence of TRIADs 6-10 GW of

	Investments	supply is likely to cease supplying in the Winter evening peak and instead enter STOR. The resulting impact is potentially substantially higher peak pricing plus materially greater costs of balancing services, increasing costs for consumers. Overall this proposal is detrimental to consumers by aiming to increase the cost of the CM and resulting in higher costs of meeting the Winter peak demand.
19	The Greenspan Agency Limited	No
20	Centrica	We support the principle of reasonable lead times prior to major industry change being implemented. In this instance, we believe change should be sympathetic to the Capacity Market bidding cycle, which requires price commitments to be made four years ahead, based in part on assumptions about transmission charges. However, we recognise that cost reflective transmission charges can (and should) change over time and do not support grandfathering of transmission tariffs. An implementation date of April 2020 strikes the right balance between cost reflectivity, effective competition and certainty/risk mitigation for existing embedded generators
21	<i>ScottishPower Energy Management Limited</i>	No. By delaying implementation until 2020 (and assuming CMP264 is not also adopted) there is the opportunity for embedded generators to bid into the capacity market on the basis of receipt of escalating embedded benefits in the period between construction and CMP265 implementation. The NPV of these benefits could amount to as much as £17/kW ⁱ which could represent a significant distortion in the CM auction. An earlier implementation date would prevent this potential distortion. Alternatively, if CMP264 were also to be adopted, we would support the proposed implementation approach
22	Eider Power Reserve	No. Aside from our view that the proposal has no merit we note that the regulator has sought in the past not to undermine investment decisions already made. This proposal, if implemented in the manner suggested, would cause new embedded generation with capacity market agreements and committed arrangements for grid and other expenditure to have to cancel with losses to all concerned and a reduction in much needed generation capacity in the market at a time of short supply
23	<i>Infinis Energy</i>	No – we feel the proposed implementation approach massively distorts the market rules within which capacity market providers made their investment decisions and bids into the capacity market. This proposal could affect system security during peak periods.
24	<i>RWE Innogy UK- RWE npower joint submission</i>	While we are unsupportive of the implementation of CMP265, we want to make the point that any Mod that makes such significant changes to the demand charging principles should allow a minimum of 3 years from the date of the Ofgem decision to implementation. This delay is necessary for suppliers and consumers because it will enable systems and processes to be updated to accommodate the changes required. In addition it will enable current contractual agreements to unwind which will facilitate required changes to be factored into future contracts. Assuming that Ofgem make a decision on the proposal and approve it between now and April 2017 the proposed timeline of

		<p>April 2020 for implementation is acceptable since this will fulfil our requirement of receiving 3 years notice from the point of a decision to implementation. - Supplier system changes need to be accommodated in the timeline. Internal pricing and billing systems would require changes along with customer contractual arrangements. Without this notice there could be a negative Impact on suppliers Customers typically will sign a 1, 2 or 3 year contract with their suppliers.</p> <p>It is only at the point of contract renewal that the supplier can incorporate these additional charges into customer contracts. Should the locational element of TNUoS remain for these embedded generators but the residual removed, some will have negative TNUoS charges and some positive. Where pass through benefits have been specified explicitly and exclusively for TNUoS within a contract with an embedded generator there will not be scope to pass on charges. Should the industry not receive 3 years notice from the point of a decision to implementation then future TNUoS rates charged by suppliers will need to factor in appropriate additional risk premia for potential future methodology changes Longer term contracts covering 25 years plus also exist . These highlight the increased risks around changing industry rules / charging methodologies.</p> <p>In practical terms CMP265 seems impossible to achieve. It anticipates that suppliers must identify sites with CM contracts. This is challenging as the proposal does not establish a means for suppliers to have visibility of CM contracts. Also, CM contracts are temporary- how would suppliers deal with detecting and dealing with customers entering and leaving CM agreements? CMP265 is practically impossible to implement for behind the meter embedded generation, thereby creating another dimension of discrimination.</p> <p>We feel that the development of systems and data flows to support such a change are prohibitively expensive and disproportionate in terms of the partial nature of the solution suggested. There are additional loopholes (behind the meter generation) that cannot be covered. In addition the expectation that suppliers can obtain appropriate information from Embedded Generators without supporting central data flows when quoting for an Embedded Generator that is not part of their current portfolio is unrealistic. We are unclear whether the associated BSc change is perceived as a prerequisite to this change or an option. This opens up wider questions on the governance framework required on the data quality in addition to the resource implications this would have across the industry. Appropriate SLAs would need to be put in place to ensure suppliers can readily access the required information for their tendering process.</p>
25	Sembcorp Utilities (UK) Limited	We support the review of charging arrangements for embedded generation and the proposed CMP265 gives a fair opportunity for developers and investors to assess the viability of distribution connection generation without the over-compensation of the current triad avoidance arrangements, thus moving towards a more level playing-field for all generation.

26	Smartest Energy	No
27	UK Green Investment Bank plc	No comment
28	Alkane Energy Limited	<p>We note the comment of the Elexon representative at the Working group that implementation of CMP264 or a variant of it would be easier in system terms.</p> <p>We have received feedback from our funders that this change would mean the capacity that has been built is at risk of default. Contrary to assertions that the capacity would be there anyway and certain to generate, albeit with other owners, a more likely outcome would be an international sale of the generators with capacity leaving the UK within months of a default.</p> <p>Also, we have been advised that this will be seen by investors/lenders as retrospective regulatory change, in what is perceived as a relatively mature UK environment. Ultimately this will cause investor capital to move to more stable regulatory environments.</p>
29	Uniper UK	This would seem less challenging to implement given the proposed implementation date is further out. However, there would be a significant potential benefit for embedded plant which could be connected well before the Capacity Market delivery date that continue to receive the large TNUoS embedded benefit in the interim period, at the expense of the consumer
30	EON UK	<p>Notwithstanding our belief that CMP 265 cannot be justified without further analysis, we support the proposed implementation approach.</p> <p>The implementation date of April 2020 gives sufficient time for suppliers and other stakeholders to make the necessary changes in their billing and administration systems.</p>
31	<i>Welsh Power Group Limited</i>	We believe that the proposed implementation approach on CMP265 is preferable to CMP264 allowing sufficient time to amend industry documents and systems prior to the effective date of the changes. However, we are not supportive of the proposal and therefore do not support the implementation proposal.
32	SSE	See question 2
33	UKPR	Please see separate attachment
34	<i>Green Frog Power</i>	No. Green Frog Power believe that CMP265 has the same issues as CMP264 in terms of maintaining spiralling embedded benefits for a select group of market participants, in addition to the issues of potential distortion caused by largely ignoring the issue of behind-the-meter generation and DSR continuing to receive those spiralling benefits.
35	The ADE	We do not think sufficient consideration has been given to how suppliers will be able to manage the case of mixed sites,

		especially those which have CM embedded generation and other generation assets which can operate during triad periods. The need for manual consideration for these hundreds of sites is likely to lead to significant complications and cost impacts for both suppliers and customers.
36	Renewable UK	RenewableUK is concerned with the potential problems which would be faced by mixed sites when renewables and storage – which may seek a Capacity Market contract – are co-located. We believe that this could be many sites in the future. Detailed and careful work will have to be carried out to ensure that equitable treatment is ensured.
37	Savvi Energy	No text provided
38	RES	No
39	Watt Power	No comment
40	Plutus	No – we feel the proposed implementation approach massively distorts the market rules within which capacity market providers made their investment decisions and bids into the capacity market. This proposal could affect system security during peak periods.
41	Reliance	No – we feel the proposed implementation approach massively distorts the market rules within which capacity market providers made their investment decisions and bids into the capacity market. This proposal could affect system security during peak periods.
42	<i>Silva Renewable Energy Limited – Bilateral Connection Contract holder Renewable Energy Limited – Bilateral Connection Contract holder</i>	<p>No. But the Working Group urgently needs to consider the interactions and implications for the imminent CFD award process.</p> <p>This situation – especially the prospect of no early resolution - gives rise to considerable risks to us and other developers. It is virtually impossible at this stage to call what enduring solution might emerge. Whilst some reduction in the triad benefit may be one outcome, we estimate that there could be a material impact on the required CfD strike price. We would expect other developers in similar circumstances to encounter a similar issue. This is contrary to HM Government’s key objective for CfD, namely that any subsidy for renewable energy must achieve value for money to the energy consumer.</p> <p>There needs to be a clear implementation path way for addressing the defect and the Ofgem issues communicated to the industry well ahead of CFD auction processes.</p> <p>We would be happy to share with the code administrator our confidential estimates on the size of the potential impact.</p>
43	Drax	Please see the answer to question 2 above.

44	ELEXON	Please see our responses to Q2, 13 and 14.
45	Rockpool	No – we feel the proposed implementation approach massively distorts the market rules within which capacity market providers made their investment decisions and bids into the capacity market. This proposal could affect system security during peak periods.
46 late response (rec'd 1 Sept 16)	Calon Energy	Yes. The timing seems to be a sensible approach given the issues associated with systems.

Question 7: Do you have any other comments?

Response No	Company	Response
1	<i>CLP Envirogas</i>	If such an amendment is appropriate in respect of CM embedded generators, it should not be applied retrospectively. it should be clear at the time of future Capacity Market auctions, it can then be reflected in the bid price.
2	Engie	Whereas passing through a smaller benefit is relatively easy, adding a charge (negative locational charge) may be more troublesome. So we would prefer the lowest locational charge to be zero. Please see Technical Appendices for other information
3	RWE Generation UK plc, RWE Supply & Trading GmbH	We are concerned about the accelerated timescales required for consideration of the issues identified under this modification proposal. As can be seen from the scale and materiality of the impact together with the complexity of the proposed solutions that detailed consideration is required to determine whether this proposal or its alternatives can adequately address the defects identified and provide an enduring solution. The proposed solution is at best a partial solution and further change will be required to develop enduring arrangements. In particular the nature of the locational component of the demand TNUoS tariffs and the appropriate charging bases for these tariffs require careful assessment. We believe that a partial and potentially discriminatory solution, as proposed, carries the risk of creating more harm than good, and introducing considerable uncertainty into the electricity market.
4	<i>EPR Ely Limited</i>	If such an amendment is appropriate in respect of CM embedded generators, it should not be applied retrospectively. it should be clear at the time of future Capacity Market auctions, it can then be reflected in the bid price.
5	<i>EPR Glanford Limited</i>	If such an amendment is appropriate in respect of CM embedded generators, it should not be applied retrospectively. it should be clear at the time of future Capacity Market auctions, it can then be reflected in the bid price.
6	<i>EPR Eye Limited</i>	If such an amendment is appropriate in respect of CM embedded generators, it should not be applied retrospectively. it should be clear at the time of future Capacity Market auctions, it can then be reflected in the bid price.
7	Statera Energy	See cover letter.
8	<i>EPR Scotland Limited</i>	If such an amendment is appropriate in respect of CM embedded generators, it should not be applied retrospectively. It should be clear at the time of future Capacity Market auctions, it can then be reflected in the bid price.
9	TATA Chemicals Europe	Comments removed for publication of report

10	<i>EPR Thetford Limited</i>	If such an amendment is appropriate in respect of CM embedded generators, it should not be applied retrospectively. it should be clear at the time of future Capacity Market auctions, it can then be reflected in the bid price.
11	<i>LondonWaste Ltd</i>	This issue supposedly was triggered by a concern over air quality issues arising from diesel generating plants bidding into the Capacity Market and being over rewarded. However, somehow, that has been taken as an excuse to remove the benefit for all new embedded generators?
12	PeakGen Power Ltd	Please refer to our opening comments for a full discussion.
13	<i>Statoil ASA</i>	No text provided
14	Good Energy	Introduction of a modification such as CMP265, ahead of OFGEM's final decision on the future of embedded benefits, could lead to the introduction of changes which are not consistent with OFGEM's final viewpoint. This risks leading industry participants to incur significant abortive costs. Additionally, introduction of interim measures such as CMP265 risks reducing the pressure on OFGEM to implement a lasting solution in a timely fashion.
15	<i>REstore</i>	On the contrary to CMP264, this proposal clearly intends to exclude capacities that benefit from embedded benefit from CM auctions, in order to create more space and value for the transmission connected generators. While embedded benefit may indeed send incentives and revenues that overstep the actual value for the system, and therefore favour some capacities that participate to the CM auctions, REstore does not believe that freezing the embedded benefit for all capacities that participate to CM is a rational and fair solution. Indeed, it will not solve at all the situation from distributed generators that would not participate to CM auctions, since they would still be able to keep the embedded benefit. CMP265 only addresses the distortion created on CM auctions, and not the core of the issue
16	EDF Energy	No
17	Tees Valley Combined Authority	The proposal to backdate the changes and to discriminate against plants in the CM is completely unacceptable. (It is as if CMP 265 is there to make 264 look less bad.). Companies who have entered into Capacity Market contracts in good faith would find themselves singled out to take a hit much bigger than the benefit of the CM payments, but they would still have the CM obligation. It was suggested in the consultation that companies would simply tear up their CM contracts, but this suggestion is misguided and irresponsible as there is no mechanism in the CM for them to walk away.
18	Octopus Investments	Our general comments in relation to CMP264 (Q3) also apply here. In addition the impact of this proposal is that even plant that took CM contracts in the 2014 and 2015 auctions may struggle to be constructed. Financing banks have taken comfort from TRIADs as a contracted revenue stream in support of new embedded generation loan facilities. Without TRIADs the plants are reliant on uncertain merchant of balancing services income and financing is substantially harder, if not impossible, to achieve. This will deprive the UK market of the only new

		<p>dispatchable generation being constructed at a time when supply margins are extremely tight and the growing supply of intermittent renewable generation necessitates increased flexible capacity.</p> <p>This appears to be an entirely self-serving amendment put forward by a large generator so that their large plant(s) are able to clear in the CM. As noted in our comments in relation to CMP264 OI considers that the industry is best served by an SCR undertaken by Ofgem and the freezing of TRIADs in the meantime. CCGTs may well be required but unless and until a full review is undertaken it is not possible to be determinative on this and measures to promote one technology above another should not be implemented.</p>
19	The Greenspan Agency Limited	Please refer to general comments made under CMP264. (Q3)
20	Centrica	No
21	<i>ScottishPower Energy Management Limited</i>	No
22	Eider Power Reserve	We consider that there are elements of transmission costs, principally those related to offshore generation, that cannot be avoided by building more embedded generation as they are policy objectives of the UK Government with fixed price arrangements through the Contract for Difference structure. These offshore generation costs are the principal driver of TNUoS growth in the years to come and have not been addressed by any of the amendment proposals to date. We would support and are submitting an alternative to address this obvious issue. Note that in our view this still does not mean that the adjusted Triad benefits or indeed other charging is fully fit for purpose so we would continue to argue for an SCR.
23	<i>Infinis Energy</i>	We disagree with the principle of altering the market landscape in order to drive through market signals for a policy tool. While the current level of triad benefit has been questioned by some market participants for some time, removing them altogether for a select number of plant will reduce investor confidence in the market.
24	<i>RWE Innogy UK- RWE npower joint submission</i>	<p>A) The Working Group should bear in mind that hydro, wind and biomass generators will be detrimentally impacted by these proposals- the arrangements are not exclusive to fossil fuelled peaking plant. Providing sufficient lead time for any change to current charging arrangements is very important for the economics of such projects too – they will be losing a significant annual income stream.</p> <p>B) In addition to considering the impact of tariff changes on embedded generation the Working Group should also consider what signal is the set value going to deliver for Demand Side Response and storage</p>

		<p>C) The proposed 'CMP265 potential WACMs' all fail to present a new cost reflective charging solution and some introduce new layers of discrimination and complexity for suppliers.</p> <p>D) We have a question regarding implementation: How would we find the relevant CM contract information? Suppliers would require industry supporting data held centrally by Elexon to manage this. This would present one of the following challenges:</p> <p>I. Relying on customers/suppliers for information (data quality / governance)</p> <p>II. Cost and time for implementing robust data flows for a temporary solution</p> <p>We are unclear whether the associated BSc change is perceived as a prerequisite to this change or an option.</p>
25	Sembcorp Utilities (UK) Limited	No
26	Smartest Energy	No
27	UK Green Investment Bank plc	No comment
28	Alkane Energy Limited	No text provided
29	Uniper UK	No
30	EON UK	CMP 265 highlights the defect as <i>"unwarranted distortion of capacity market tenders"</i> . If this is true, it is as a result of the charging methodology (specifically the triad avoidance arrangements) not being cost reflective. By focussing only on generators with Capacity Market Agreements, CMP265 does not address the underlying cause of the potential defect identified in the CUSC.
31	<i>Welsh Power Group Limited</i>	<p>We believe that the proposal is entirely unsuitable as an enduring solution to the identified defect and appears to be little more than a swift and crude move designed to impact on clearing prices in the 2016 Capacity Market auction. National Grid identifies over 7.5GW of embedded generation operating during the Triad periods. A significant majority of this capacity would be unaffected by the current proposal.</p> <p>The proposal is likely to lead to gaming behaviour as embedded generators switch between capacity market and Triad revenue streams depending on which is the most commercially advantageous. We remain unconvinced that this proposal could be</p>

		administered and fear that the burden placed on suppliers would be unacceptable as generators move between excluded and eligible categories from year to year. This would also make it difficult for National Grid to accurately calculate its charging base.
32	SSE	See question 3
33	UKPR	Please see separate attachment
34	<i>Green Frog Power</i>	n/a
35	The ADE	No
36	Renewable UK	<p>We have concerns about the seemingly widely accepted view that the Capacity Market is not achieving certain desired outcomes largely because of the effects of embedded benefits. We are not convinced that this is the case, and no solid evidence has been put forth to justify this point.</p> <p>☐ The Government may be concerned about the impact of small gas and diesel generators distorting the Capacity Market auctions, but it is distinctly possible that these technologies' previous access to various favourable tax schemes have contributed to the distortion to a greater extent.</p> <p>☐ We also point out that as "[t]he CM is technology neutral", according to DECC's March 2016 Capacity Market consultation, then the technologies which can deliver capacity at the lowest cost to consumers should be winning the auctions. CMP 265 presupposes that the Capacity Market is delivering the 'wrong' outcome and needs to be amended to deliver 'correctly'. There has been no analysis presented which examines the benefits of having smaller generation units focused on generation mainly at times of system peak, which, were they to be transplanted to the transmission network would need to be larger, and which would impose more costs on the system.</p> <p>☐ We raise this to illustrate the lack of evidence presented in the modifications for the demonstration of the whole-system benefits of embedded generation, in terms of the reduction in peak demand, the flattening of demand, or for the reduction in transmission network reinforcement costs.</p> <p>☐ We would like to see an analysis of the counterfactual case of delivering the same peak generation capacity from transmission connected plant as is currently supplied over the distribution networks, acting as negative demand.</p>
37	Savvi Energy	<p>Until the real underlying benefits of embedded generation are independently reviewed, in conjunction with a wider review of the demand TNUoS charging arrangements both CMP264 and CMP265 are premature.</p> <p>If the building of a particular technology/connection is the desired outcome of the capacity market, there are more direct changes that can be made to the CM auction process than amending Triad Avoidance payments.</p> <p>In many ways the change is not necessary, an enduring solution at this stage will be a missed opportunity to review the logic of the wider EB and TNUoS charging methodology holistically – ofgem's open letter stating its intention to review embedded</p>

		benefits, in particular the demand residual is enough to ensure EG bidders in the next CM auction are unlikely to include significant triads receipts in their financial modelling.
38	RES	Please see comments made against “Views regarding the workgroup” section above.
39	Watt Power	No comment
40	Plutus	We disagree with the principle of altering the market landscape in order to drive through market signals for a policy tool. While the current level of triad benefit has been questioned by some market participants for some time, removing them altogether for a select number of plant will reduce investor confidence in the market.
41	Reliance	We disagree with the principle of altering the market landscape in order to drive through market signals for a policy tool. While the current level of triad benefit has been questioned by some market participants for some time, removing them altogether for a select number of plant will reduce investor confidence in the market.
42	Silva Renewable Energy Limited – Bilateral Connection Contract holder	Given the huge uncertainty surrounding the charging regime, the significant regulatory risk that has been introduced into the process and the probability this will not be resolved by the two modifications in process, I believe the Working Group should explicitly consider the interactions of these change proposals (and alternatives) with the CfD regime. The only obvious solution we can see at this stage is to respect the assumptions made by developers in making their CfD bids, in effect “grandfathering” them, and the next stage of the assessment process should explicitly address this. Some accommodation to address other potential material changes to the regulatory regime in the future also needs consideration as regulatory risk has significantly increased in the eyes of the developer and financial community.
43	Drax	Not at this time.
44	ELEXON	No text provided
45	Rockpool	We disagree with the principle of altering the market landscape in order to drive through market signals for a policy tool. While the current level of triad benefit has been questioned by some market participants for some time, removing them altogether for a select number of plant will reduce investor confidence in the market.
46 late response (rec'd 1 Sept 16)	Calon Energy	No

Question 8: Do you wish to raise a WG Consultation Alternative Request for the Workgroup to consider?

Response No	Company	Response
1	CLP Envirogas	<i>No WACM indicated in response</i>
2	Engie	No :- this may be raised via the working group and would be based on the Centrica (2) proposal with an embedded substation benefit of £3-4/kW applied in addition to the locational tariff in accordance with CUSC 14.15. Practically setting the lowest location tariff to zero may achieve both objectives. Implementation would be the next following 1st April after an Authority decision. This will give the maximum benefit to consumers.
3	RWE Generation UK plc, RWE Supply & Trading GmbH	We have considered the potential development of an alternative based on improving the cost reflectivity of the locational component of demand TNUoS tariffs and the relevant charging base and also addressing the issues associated with the cost recovery through the residual component of the tariff. However, these issues are potentially outside the scope of the defects identified in the modification proposal. We believe that more discussion is required to determine whether the proposed modifications or alternatives are capable of the addressing the issues identified by workgroup in its consultation and Ofgem in its Open Letter.
4	<i>EPR Ely Limited</i>	<i>No WACM indicated in response</i>
5	<i>EPR Glanford Limited</i>	<i>No WACM indicated in response</i>
6	<i>EPR Eye Limited</i>	<i>No WACM indicated in response</i>
7	Statera Energy	<i>No WACM indicated in response</i>
8	<i>EPR Scotland Limited</i>	<i>No WACM indicated in response</i>
9	TATA Chemicals Europe	Comments removed for publication of report

10	<i>EPR Thetford Limited</i>	<i>No WACM indicated in response</i>
11	<i>LondonWaste Ltd</i>	<i>No WACM indicated in response</i>
12	PeakGen Power Ltd	<i>No. It is our view that s Significant Code Review should take place with appropriate modifications raised once a proper overview has been taken. As an interim solution to allow time to undertake an SCR maintaining embedded benefit at current levels seems most appropriate.</i>
13	<i>Statoil ASA</i>	No text provided
14	Good Energy	We do not wish to introduce an alternative modification at this time.
15	<i>REstore</i>	No text provided
16	EDF Energy	No
17	Tees Valley Combined Authority	No
18	Octopus Investments	nO
19	The Greenspan Agency Limited	No text provided
20	Centrica	We do not wish to raise a WG Consultation Alternative Request given the potential alternatives already mooted by Centrica in the Workgroup Consultation report
21	<i>ScottishPower Energy Management Limited</i>	No
22	Eider Power Reserve	Yes – see alternative.

23	<i>Infinis Energy</i>	See response to question 4.
24	<i>RWE Innogy UK- RWE npower joint submission</i>	No
25	Sembcorp Utilities (UK) Limited	No
26	Smartest Energy	No
27	UK Green Investment Bank plc	No
28	Alkane Energy Limited	<i>No WACM indicated in response</i>
29	Uniper UK	Yes. Please see separate WG Consultation Alternative Request form attachment.
30	EON UK	No
31	<i>Welsh Power Group Limited</i>	No. We are supportive of the alternative proposed by Green Frog and believe that this is the most appropriate way of mitigating the real defect which we consider to be the rapid rise in supplier TNUoS rates as a result of the large annual increases in transmission allowed revenues compounded by a cap on charges to transmission connected power plants.
32	SSE	Yes – Alternative request form to follow
33	UKPR	Please see separate attachment
34	<i>Green Frog Power</i>	No text provided; already raised at WG
35	The ADE	Yes
36	Renewable UK	No

37	Sarvi Energy	<i>No WACM indicated in response</i>
38	RES	We request returned focus on holistic review to best avoid further market distortion from unintended consequences.
39	Watt Power	<i>No WACM indicated in response</i>
40	Plutus	See response to question 4.
41	Reliance	See response to question 4.
42	Silva Renewable Energy Limited – Bilateral Connection Contract holder	No but I support Infinis Energy’s proposed WACMs
43	Drax	If we decide to do so it will be in my capacity as a workgroup member.
44	ELEXON	<i>No WACM indicated in response</i>
45	Rockpool	See response to question 4.
46 late response (rec’d 1 Sept 16)	Calon Energy	Yes but no text provided.

Question 11:**i) Views are sought on the implication for mixed sites discussed in 3.4.10.**

Response No	Company	Response
1	<i>CLP Envirogas</i>	No comment.
2	<i>Engie</i>	We believe that this level of complexity (to try to unpick sites with some capacity in the CM and some not) is fraught with challenges. For this reason we believe that this modification should apply to all site exports on an equal basis.
3	RWE Generation UK plc, RWE Supply & Trading GmbH	It is essential that the incentives on new generators are consistent with existing generators and are enduring. We do not believe that the solution should create potential loopholes in relation to mixed sites (where new embedded generation could also enjoy the embedded benefit). Therefore we support an approach that addresses mixed sites. However, we note that this approach would increase the complexity of the potential solution and its costs.
4	<i>EPR Ely Limited</i>	No comment.
5	<i>EPR Glanford Limited</i>	No comment.
6	<i>EPR Eye Limited</i>	No comment.
7	Statera Energy	No comments
8	<i>EPR Scotland Limited</i>	No comment.
9	TATA Chemicals Europe	Comments removed for publication of report

10	<i>EPR Thetford Limited</i>	No comment.
11	<i>LondonWaste Ltd</i>	This is overly complex and impossible to police.
12	PeakGen Power Ltd	The proposed solution seems over complex. Given that metering schemes have to be registered for all CMU, then identification of output from capacity market units at time of a triad should be trivial.
13	<i>Statoil ASA</i>	No text provided
14	Good Energy	As a 100% renewable energy supplier, none of our generators currently participate in the Capacity Market. We therefore have no view on these issues at this time.
15	<i>REstore</i>	No text provided
16	EDF Energy	Regarding 3.4.10, we do not believe that it would necessarily matter if these mixed sites were not addressed at all in this modification proposal. For if they were not, and the omission began to prove problematic, a later modification could allow detailed attention to be directed to this very matter; yet, the risk of attempting to address it now might be that the mod itself could be delayed, resulting in delay to the consumer benefits, because of seeking perfection in the treatment of a minority amongst embedded generators in the CM. If the approach in 3.4.10 were to be taken, it is our view that there needn't be a requirement (or obligation), whether via the CUSC or BSC, on the Supplier to do or declare anything; merely the possibility to declare this data if the embedded generator in the CM on a mixed site with non-BSC-accessible embedded generation in the CM, was being disadvantaged due to other, non-CM embedded generation contributing to net site export as seen at the BSC-accessible site boundary meter – or due to another, import, meter to that site in a novel configuration. There would be every incentive for the customers and its supplier to co-operate in identifying the requisite data. It is perfectly acceptable for mod 265 to give no treatment to mixed sites, though, as it only has to be better than baseline; it doesn't have to be agreed by all as "perfect". Perfection is rarely arrived at in one mod
17	Tees Valley Combined Authority	We do not see these proposals as workable.
18	Octopus Investments	We do not have a particular views but consider that all embedded generation should be treated consistently
19	The	No text provided

	Greenspan Agency Limited	
20	Centrica	<p>We believe it is unnecessary and undesirable to create sub-categories of embedded generation, with some sub-categories being eligible for transmission embedded benefits and others not.</p> <p>A more straightforward and cost reflective approach is to treat all exports from embedded generation equivalently for transmission charging purposes, irrespective of their status in the CM.</p>
21	<i>ScottishPower Energy Management Limited</i>	Given the scale of potential Triad avoidance benefits available to non-CM embedded plant post 1 April 2020 (£72.03/kW Demand Residual per NGET forecast of TNUoS tariffs from 2017/18 to 2020/21 ⁱⁱ) there would be a strong commercial incentive on mixed sites to assign separate settlement metering on all generation plant not covered by the CMEG definition. We would therefore not advocate complex alternative arrangement within the CUSC and BSC to cater for these sites
22	Eider Power Reserve	No view
23	<i>Infinis Energy</i>	No views.
24	<i>RWE Innogy UK- RWE npower joint submission</i>	<p>The problems identified for mixed sites demonstrate that the solution is unworkable. While it may be possible to develop a more costly solution to address some of the issues, there is no way of capturing all the sites.</p> <p>We feel that time and effort would be better spent on developing an enduring solution that addresses the underlying problem, which does not lead to such complexities and provides something simple and, workable.</p>
25	Sembcorp Utilities (UK) Limited	No text provided
26	Smartest Energy	i) No comment
27	UK Green Investment Bank plc	No comment
28	Alkane Energy	Whilst we appreciate that to attempt to capture generation assets at mixed sites differently will be fraught with difficulty, we consider any on site generation should be treated no differently to demand reduction or other discrete embedded generation

	Limited	<p>since all have the same impact on the transmission network.</p> <p>The complexity involved here demonstrates how discriminatory the proposal of CMP265 is. We therefore think it is a question that should not be asked since it gives spurious credibility around deliverability to the original proposal.</p>
29	Uniper UK	Mixed sites should be very rare. It does highlight the complexity of a solution which seeks to apply this to a subset of distributed generation
30	EON UK	<p>Under CMP265 we agree that a process should be established to allow for sites with a mixture of CM and non-CM embedded generation. In principle the proposal put forward in 3.4.10(a) seems sensible for a limited number of cases.</p> <p>However, this process would require a number of manual inputs and would be extremely difficult to audit to ensure the triad benefit was only paid on the applicable generation.</p>
31	<i>Welsh Power Group Limited</i>	<p>We are not in favour of implementing changes to the CUSC that differentiate between different customers performing ostensibly the same activity.</p> <p>We do not support the proposal and as such do not wish to comment on which category of CMU will be discriminated against under this proposal.</p>
32	SSE	<p>i. It would be better address the defect if the element of the TNUoS tariff applied on a gross basis applied to all embedded generation irrespective of whether or not they had a capacity mechanism contract.</p> <p>However, if embedded generators without a capacity contract are to receive an exemption from gross charging, then the approach described appears to be reasonable.</p>
33	UKPR	Please see separate attachment
34	<i>Green Frog Power</i>	i) N/A
35	The ADE	<p>We do not agree with the proposals for mixed sites and do not agree that mixed sites with combinations of Capacity Market generation and non-Capacity Market generation are 'rare'.</p> <p>There are almost 3 GW of CHP assets in the UK connected at the distribution level, with nearly 90% of those assets located on more than 300 industrial sites. These industrial sites regularly include gas CHP assets (which may be in the Capacity Market), renewable generation assets (largely excluded from the Capacity Market) and back-up generators for emergencies and which may, or may not, be used to reduce net demand during triad periods. For example, there are approximately 100 sewage works in the UK, and in 2012 75% of sewage sludge was processed using renewable anaerobic digestion and are likely ineligible for the Capacity Market. All of these sewage work sites would also have back up fossil fuel generation which is likely to participate in the Capacity Market. There are other types of industries and users with similarly complex arrangements which would be</p>

		<p>similarly impacted.</p> <p>Based on this evidence, we expect that the number of sites for which suppliers are going to be expected to manage bespoke arrangements are likely to be significantly higher than expected by the proposer and the working group, adding to complications, costs and delays. The lack of understanding of mixed site arrangements indicates a lack of thorough review necessary to implement such a significant change as proposed in CMP265</p>
36	Renewable UK	Please see our answer to question 10.ii
37	Savvi Energy	No text provided
38	RES	We consider that the sheer complexity of the measures under consideration in order to avoid the potential for “gaming” or to address a perceived defect outside of CUSC, serves to demonstrate the arbitrary and knee jerk nature of the proposal. This clearly underlines the need for completion of the holistic review of commercial arrangements in order to arrive at charging proposals that align with the applicable CUSC objectives.
39	Watt Power	No comment.
40	Plutus	No views
41	Reliance	No views.
42	Silva Renewable Energy Limited – Bilateral Connection Contract holder	No view on these matters.
43	Drax	We believe that this should be applied to export from mixed sites.
44	ELEXON	keeping with our role as the BSCCo, we have only responded to sub-question i). Furthermore, our response to this question should be read in conjunction with our response to Q10 – particularly in relation to the need for clear requirements and definitions.

		<p>As originally drawn out during the P348 workgroup discussion and summarised above in our response to Q10, CMP265 and P348 propose that a net value of export metered data should be reported for qualifying CMU sites. The process for calculating a net value is potentially complicated in terms of i) identifying all related metering systems (some of which may not be registered to the supplier responsible for the CMU metering system), ii) determining and sharing an appropriate method for calculating a net export volume for each CMU site, iii) performing individual site net calculations, iv) aggregating the data and v) reporting the results to National Grid.</p> <p>P348 would require BSC Systems to handle data and perform calculations that it is unfamiliar with. That is BSC Systems don't currently receive and process metered data for individual SVA metering systems. Nor do they execute SVA site specific netting rules. BSC Systems may require considerable changes to facilitate P348.</p> <p>In light of this complexity it is important that the requirements and definitions are clearly specified within the CUSC and BSC. This is so the arrangements are robust and that parties involved in these processes are clear of what their responsibilities are.</p> <p>Furthermore, the CMP265 workgroup should pay particular attention to how they expect the CUSC to monitor compliance with these requirements and provide assurance.</p>
45	Rockpool	No views
46 late response (rec'd 1 Sept 16)	Calon Energy	As noted above, mixed site are treated in a different way on a number of fronts, so it may be pragmatic ignore them for now. While this creates some incentives to go "behind the meter" we suspect the impact in terms of volume will be limited.

ii) Views are sought on the preference of categories of capacity Market CMU captured by this proposal, please indicate your preference from the following list and reasons:

- All existing and new distribution generation CMUs
- All existing and new distribution generation CMUs and DSR CMUs (proven and unproven)
- All price maker CMUs
- All newbuild/prospective distribution generation CMUs only (defined as >1year contracts)

Response No	Company	Response
1	CLP Envirogas	No comment.

2	<i>Engie</i>	We believe that all embedded generation should be included in this modification not just those with CM agreements.
3	RWE Generation UK plc, RWE Supply & Trading GmbH	In our view all embedded CMUs with a capacity market agreement should be considered in scope for the modification proposal (both generation and DSR). A proposal based on selective capacity market CMUs carries with it the risk of distorting the capacity market clearing prices and creating perverse incentives for certain categories of CMU.
4	<i>EPR Ely Limited</i>	No comment.
5	<i>EPR Glanford Limited</i>	No comment.
6	<i>EPR Eye Limited</i>	No comment.
7	Statera Energy	No comments
8	<i>EPR Scotland Limited</i>	No comment.
9	TATA Chemicals Europe	No comment
10	<i>EPR Thetford Limited</i>	No comment.
11	<i>LondonWaste Ltd</i>	We do not agree to the discrimination against any CM provider. CM providers have in good faith entered into contracts of up to 15 years to provide a service to the total system. They should not now lose a benefit far in excess of the CM payment, just because they are providing e CM service. This proposal is outrageous.
12	PeakGen Power Ltd	These definitions seem flawed, and they should presumably relate to a capacity market unit with a capacity market obligation and exclude units that either opted out or were unsuccessful in the auction. Given the capacity market allows for secondary trading of obligations it is unclear how a unit should be treated that only held an obligation for half the winter (and perhaps a single triad day). Again it is difficult to see how this would work if a unit traded part of its obligation. For example, if the unit had a capacity of 20 MW but only held an obligation for 5 MW how would the rest of its capacity be treated? How would such

		a unit be treated if during a stress event it over delivered and either received an over delivery payment from the capacity market or used an over delivery volume reallocation?
13	<i>Statoil ASA</i>	No text provided
14	Good Energy	As a 100% renewable energy supplier, none of our generators currently participate in the Capacity Market. We therefore have no view on these issues at this time.
15	<i>REstore</i>	No text provided
16	EDF Energy	Regarding 3.4.10, we do not believe that it would necessarily matter if these mixed sites were not addressed at all in this modification proposal. For if they were not, and the omission began to prove problematic, a later modification could allow detailed attention to be directed to this very matter; yet, the risk of attempting to address it now might be that the mod itself could be delayed, resulting in delay to the consumer benefits, because of seeking perfection in the treatment of a minority amongst embedded generators in the CM. If the approach in 3.4.10 were to be taken, it is our view that there needn't be a requirement (or obligation), whether via the CUSC or BSC, on the Supplier to do or declare anything; merely the possibility to declare this data if the embedded generator in the CM on a mixed site with non-BSC-accessible embedded generation in the CM, was being disadvantaged due to other, non-CM embedded generation contributing to net site export as seen at the BSC-accessible site boundary meter – or due to another, import, meter to that site in a novel configuration. There would be every incentive for the customers and its supplier to co-operate in identifying the requisite data. It is perfectly acceptable for mod 265 to give no treatment to mixed sites, though, as it only has to be better than baseline; it doesn't have to be agreed by all as "perfect". Perfection is rarely arrived at in one mod
17	Tees Valley Combined Authority	We do not agree that CM providers should be targeted. Since the TNUoS benefit to be lost would be much greater than the CM benefit to be earned, this would instantly kill off all CM driven investment in the embedded generation. We wish to see all investment encouraged.
18	Octopus Investments	Our first preference is that this proposal is not implemented. However if it is taken forward it should apply equally to all CMUs
19	The Greenspan Agency Limited	No text provided
20	Centrica	We believe it is unnecessary and undesirable to create sub-categories of embedded generation, with some sub-categories being eligible for transmission embedded benefits and others not. A more straightforward and cost reflective approach is to treat all exports from embedded generation equivalently for

		transmission charging purposes, irrespective of their status in the CM.
21	<i>ScottishPower Energy Management Limited</i>	<p>We believe that CMP265 should apply to all existing and new distribution- connected generation CMUs. Given that CMP 265 is intended to be an enduring solution, this prevents potential discrimination between those CMUs connected before the CMP265 implementation date (1 April 2020), and those connected after.</p> <p>Ofgem acknowledges in its open letter of 29 July 2016 that a consequence of not fully addressing all market defects could be to push more generation to connect behind the meter or via private wires, which is likely to lead to inefficient outcomes. We believe that similar considerations could also apply to DSR investments. We consider that these aspects are likely to be addressed by reviewing the whole concept of charging according to triad demand – whether as a result of work initiated by Ofgem or following a .further code modification proposal</p>
22	Eider Power Reserve	It is our view that the CUSC should not discriminate in this manner between generators in receipt of revenues external to the CUSC. It is inappropriate and hence we consider all the following to be unacceptable
23	<i>Infinis Energy</i>	Not material to Infinis.
24	<i>RWE Innogy UK- RWE npower joint submission</i>	See response 11 i)
25	Sembcorp Utilities (UK) Limited	No text provided
26	Smartest Energy	<p>ii) Our preference in descending order of desirability would be:</p> <ol style="list-style-type: none"> 1) All new build/prospective distribution generation CMUs only (defined as >1year contracts) 2) All price maker CMUs 3) All existing and new distribution generation CMUs <p>All existing and new distribution generation CMUs and DSR CMUs (proven and unproven)</p>
27	UK Green Investment Bank plc	No comment

28	Alkane Energy Limited	See response 11 i)
29	Uniper UK	It would be appropriate to limit the impact to existing and new distribution generation CMU's
30	EON UK	We do not believe an approach which targets a particular category of generator is appropriate (in the case of CMP265 those generators with CM agreements versus those without).
31	<i>Welsh Power Group Limited</i>	See response 11 i)
32	SSE	ii. From the list provided, the preference would be "All existing and new distribution generation CMUs and DSR CMUs (proven and unproven)" The reasoning is that this appears to be the widest definition of CMUs to be captured by the proposal. Any attempt to narrow the scope of CMUs captured would result in a less effective solution to the defect. It would result in more CMUs continuing to be exposed to non-cost reflective price signals, which would continue to be detrimental for facilitating effective competition and it would increase the level of discrimination. The only reason to exclude specific CMU groups from being captured by the proposal would be if it was not practicable for this modification to include them.
33	UKPR	Please see separate attachment
34	<i>Green Frog Power</i>	<p>CMP265 is unacceptably discriminatory. It is specifically designed to undermine the income of the proposers' competition in the Capacity Market, but conveniently maintains the income stream for embedded generation interests within its own renewables portfolio.</p> <p>Keeping in mind the desire to reduce the discrimination caused by this proposal, we feel that this mod is totally inappropriate, but if it is implemented, it should be applied to all existing and new embedded generation and DSR CMUs.</p>
35	The ADE	<p>As we do not agree with the proposer's defect, our preference is for an approach which is aimed at the smallest number of market participants i.e. 'all price maker CMUs'.</p> <p>The proposal to apply this change to all existing distribution generation CMUs will result in the removal of embedded benefits from legacy industrial CHP assets, which operate in response to a heat demand and were designed to have limited flexibility to react to market signals, including triad events. As these assets largely operate as baseload generators, they reduce net demand on transmission networks consistently over the course of the year.</p> <p>There are more than 3 GW of distribution-connected CHP assets in the UK, located on more than 300 industrial sites. These</p>

		assets are particularly focussed in the chemicals, paper, and food and drink sectors, and these CHP assets help support tens of thousands of jobs by helping these sites control their energy costs. Changes to these sites' energy costs will result in reduced profitability and, in some cases, job losses as site production is reduced. In allowing a proposal such as this to go forward, the proposer, National Grid and the regulator must be sure that any resulting loss of jobs was justified on a clear case backed up by compelling evidence. The absence of evidence produced by the proposer or during the CUSC process makes such a conclusion impossible to reach.
36	Renewable UK	RenewableUK is not in a position to comment on this matter.
37	Savvi Energy	No text provided
38	RES	See response 11 i)
39	Watt Power	To avoid discrimination, this should apply to all embedded generation and demand reduction.
40	Plutus	Price maker CMUs only. They can price their capacity value into their bid. Price takers if they were successful in the auction would simply be rewarded for capacity value they bring to the system (which is not reflected in the triad benefit anyway).
41	Reliance	Price maker CMUs only. They can price their capacity value into their bid. Price takers if they were successful in the auction would simply be rewarded for capacity value they bring to the system (which is not reflected in the triad benefit anyway).
42	Silva Renewable Energy Limited – Bilateral Connection Contract holder	No view on these matters.
43	Drax	<p>If CMP265 were to be implemented then our preference would be the second option <i>All existing and new distribution generation CMUs and DSR CMUs (proven and unproven)</i>. While all the options better facilitate against the ACOs, the second option best limits the current distortions in the market as it applies to the widest category of EG.</p> <p>We fundamentally believe that the residual demand tariff is not an appropriate measurement of the EB. The wider tariff better reflects the 'true' EB.</p>

44	ELEXON	See response 11 i)
45	Rockpool	Price maker CMUs only. They can price their capacity value into their bid. Price takers if they were successful in the auction would simply be rewarded for capacity value they bring to the system (which is not reflected in the triad benefit anyway).
46 late response (rec'd 1 Sept 16)	Calon Energy	<p>We believe that all CMUs, both DSR and generation, should be covered by the proposal. What we are not sure about is why it is only CM parties and not all embedded generation.</p> <p>As noted under P264, there may be a case for grandfathering embedded benefits to sites that had signed longer term agreements in the 2014/15 T-4 auctions on the basis of the benefits at that time. All CMUs in auctions after those dates should have rationally been aware of the risk of changes to embedded benefits and have factored those into their CM bids.</p>

Question 14:

Do you have a view of whether implementation for the 2020/21 Triad season is sufficient to allow changes for i) supplier contracts and billing system, and ii) for other stakeholders?

Response No	Company	Response
1	<i>CLP Envirogas</i>	No comment.
2	<i>Engie</i>	<p>We believe that implementation should be the next following 1st April after an Authority decision this give sufficient time for change.</p> <p>Whereas passing through a smaller benefit is relatively easy, adding a charge (negative locational charge) may be more troublesome so we would prefer the lowest locational charge to be zero.</p>
3	RWE Generation UK plc, RWE Supply & Trading GmbH	We are concerned about whether efficient central reporting mechanisms and supplier billing systems can be developed and delivered in the required timescale to allow for the capture of relevant embedded generators and the introduction of gross charging for such parties.
4	<i>EPR Ely Limited</i>	No comment.
5	<i>EPR Glanford Limited</i>	No comment.
6	<i>EPR Eye Limited</i>	No comment.
7	Statera Energy	No comments
8	<i>EPR Scotland Limited</i>	No comment.
9	TATA	Comments removed for publication of report

	Chemicals Europe	
10	<i>EPR Thetford Limited</i>	No comment.
11	<i>LondonWaste Ltd</i>	The proposals are not at all acceptable.
12	PeakGen Power Ltd	No view Such a change could delay/deter investment in new plant in anticipation of the rise of triad benefit in later years, and trigger a capacity crisis.
13	<i>Statoil ASA</i>	No text provided
14	Good Energy	i) As a 100% renewable energy supplier, none of our generators currently participate in the Capacity Market. We therefore have no view on implementation of CMP265 at this time ii) We are not in a position to comment on impacts for other stakeholders.
15	<i>REstore</i>	No text provided
16	EDF Energy	Yes, the 2020/21 triad season is a long time away and affords more than ample time for these matters
17	Tees Valley Combined Authority	We do not consider to proposals to be acceptable on any timescale.
18	Octopus Investments	We do not have any view on the practicability of implementing changes but consider that a delay until 20/21 for implementation would be sufficient time for market participants to determine the impact and address issues such as bank financing.
19	The Greenspan Agency Limited	No text provided
20	Centrica	Whilst we have sympathy with an April 2020 implementation date, implementation risk could be reduced further if all exports from embedded generation were treated equivalently for transmission charging purposes, irrespective of their status in the CM.

21	<i>ScottishPower Energy Management Limited</i>	Yes. Implementation for the 2020/21 Triad season provides around 4 years for suppliers to amend PPA contracts with embedded generators and for National Grid to amend its billing systems. Even allowing for the fact that CMP265 affects existing plant (unlike CMP264) this should be more than adequate
22	Eider Power Reserve	From our position as a generator the time line appears viable for changes but as we have expressed a strong preference for an SCR, we consider that one argument among the many for rejection of this Modification Proposal is the required time for implementation of something that should be superseded within that time by new regulations introduced following an SCR
23	<i>Infinis Energy</i>	Depending on potential date of approval, implementation in 2020-21 provides generators with a reasonable three year grace period. Plant that have already bid into capacity auctions will have factored the triad residual into their bid prices. Without this value these plant may not be constructed, affecting future security of supply.
24	<i>RWE Innogy UK- RWE npower joint submission</i>	Essentially we do not see how the arrangements can be practically implementable at all. Suppliers do not have visibility of CM contract status of their customers. Regarding whether 2020/21 is acceptable this is dependent upon when a solution is approved, since we require 3 years clear notice of changes from the point of a decision to the implementation of changes to the charging methodology in order to address our pricing and billing systems.
25	Sembcorp Utilities (UK) Limited	No text provided
26	Smartest Energy	This is probably feasible.
27	UK Green Investment Bank plc	No comment
28	Alkane Energy Limited	(i) No view (ii) We believe a change for the 2020/21 Triad season is an appropriate time since it allows for change to be priced into the coming CM auctions for new plant. From discussions at the Workgroups involving Elexon we believe this should be sufficient time to make central system changes, but we have no other experience of this
29	Uniper UK	We would anticipate that it should be reasonable for industry to implement changes in this time. We would note however that implementation for the 2020/21 Triad season is one year later than the latest date set out in Ofgem's letter of 29 July 2016, which suggests that in its view it will be challenging to demonstrate that consumers would benefit from any delay in its implementation beyond 2019/20
30	EON UK	Depending on the final scope of CMP265, implementation for the 2020/21 Triad season does seem plausible. This is likely to

		give sufficient time for suppliers and other stakeholders to update their systems as appropriate.
31	<i>Welsh Power Group Limited</i>	Were this modification to be implemented then we believe 2020/21 is a realistic timescale
32	SSE	<p>Yes, an implementation for the 2020/21 Triad season would be more than sufficient time to allow changes for supplier contracts, billing systems and other stakeholders. It would be possible to implement the required changes in a much shorter time scale.</p> <p>However, it would be better if there was a transitional cap on the value of the demand Residual charged net implemented as soon as practicable. Any delay to this would delay the cost savings received by customers of reduced embedded benefit payments.</p>
33	UKPR	Please see separate attachment
34	<i>Green Frog Power</i>	N/A
35	The ADE	The ADE has no comment
36	Renewable UK	RenewableUK is not in a position to comment on this matter.
37	Sarvi Energy	No text provided
38	RES	No clear view at this stage.
39	Watt Power	Implementing the necessary changes by 2020/21 should be possible.
40	Plutus	Four years would allow us to adapt our behaviour in future capacity auction rounds. We nevertheless oppose this change.
41	Reliance	Four years would allow us to adapt our behaviour in future capacity auction rounds. We nevertheless oppose this change.
42	Silva Renewable Energy Limited – Bilateral Connection Contract holder	<p>The key will be communicating to the industry a clear implementation pathway in good time ahead of next CfD auction.</p> <p>Given the huge uncertainty surrounding the transmission charging regime, the significant regulatory risk that has been introduced into the process and the probability this will not be resolved by the two modifications in process, the Working Group should consider the interactions of these change proposals (and alternatives) with the CfD regime.</p> <p>The only obvious solution we can see at this stage is to respect the assumptions made by developers in making their CfD bids, in effect “grandfathering” them, and the next stage of the assessment process should explicitly address this. Some accommodation to address other potential material changes to the regulatory regime in the future also needs consideration as regulatory risk has</p>

		significantly increased in the eyes of the financial community.
43	Drax	We believe that this is too long. As previously stated, the precedence set for implementation of charging changes (under CMP213) is 1 full charging year.
44	ELEXON	<p>This response is in addition to our more general response to Q2. We have assumed that implementation for the 2020/21 Triad season means by the proposed implementation date, i.e. 1 April 2020. ELEXON is still waiting for responses to the P348 Assessment Consultation and Impact Assessment. Until ELEXON receives these responses and the P348 workgroup has considered them, we cannot say whether implementation of CMP264 in time for the 2020/21 Triad is achievable.</p> <p>Whilst we must wait for consultation and IA responses, on the one hand it is reasonable to expect the challenges of implementing CMP265 in four years' time are fewer than we are likely to face for CMP264 because CMP265 and P348 have longer lead times before implementing any solution. However, whilst there may be more time in which to implement a solution, CMP265 and P348 propose more complicated solutions which may pose more of a challenge to design and implement for Suppliers and ELEXON.</p>
45	Rockpool	Four years would allow us to adapt our behaviour in future capacity auction rounds. We nevertheless oppose this change.
46 late response (rec'd 1 Sept 16)	Calon Energy	This seems like a perfectly acceptable timetable to allow for changes to contracts and systems. If anything we believe that the modification should be implemented by 2019/20 which is in line with Ofgem's letter of 29/7/16.

ⁱ Please see attached estimate of the equivalent CM contract value (£/kW) of securing Triad Avoidance benefit in the Charging Years 2017/18 to 2019/20

ⁱⁱ Table 23, NGET forecast of TNUoS tariffs from 2017/18 to 2020/21, 11 February 2016

These are the questions that related to CMP264 and CMP265 and cover questions:

Questions: 9, 12, 15, 16, 17, & 19

Question 9: both CMP264/265

- i) **Suppliers:** In setting charges for your demand customers, do you charge them at the same tariff as National Grid charges you (i.e. gross), to enable you to pay the embedded benefit to embedded generators, or please explain the way in which it is funded?

Response No	Company	Response
1	CLP Envirogas	No comment.
2	Engie	It is standard industry practice to charge gross demand at the tariff rate (£/kw) set by National Grid.
3	RWE Generation UK plc, RWE Supply & Trading GmbH	We note that the Ofgem Open Letter states that <i>“the payments to EG are an extra cost to suppliers over and above the payment of transmission charges to National Grid, and therefore an additional cost to consumers to the extent that this cost of passed on the consumers”</i> (Ofgem “Open letter: Charging arrangements for embedded generation” , : 29 th July page 4)
4	EPR Ely Limited	No comment.
5	EPR Glanford Limited	No comment.
6	EPR Eye Limited	No comment.
7	Statera Energy	No comments.
8	EPR Scotland Limited	No comment.
9	TATA Chemicals Europe	No comment

10	EPR Thetford Limited	No comment.
11	<i>LondonWaste Ltd</i>	No text provided
12	PeakGen Power Ltd	n/a
13	<i>Statoil ASA</i>	No text provided
14	Good Energy	Yes, in setting charges for our demand customers we recover transmission use of system charges at the same level as National Grid charges
15	<i>REstore</i>	No text provided
16	EDF Energy	Customer tariffs are set independent of contracts with embedded generators. The manner in which we determine what charges to offer to demand customers in the competitive market will take good account of all actual Supply costs, including charges to us, as a result of having that customer's volume on our books (in our chargeable TNUoS volume in that GSP group as a Supplier), from Grid; for if this were not so, we would either be over-charging the customer, who would find his quotes from other, rival Suppliers to be preferable – or we would be under-pricing, and supplying at a loss, or failing to supply at the expected profit margin. Insofar as embedded generation. The purpose of this consultation question is of course to discern whether Suppliers give most of the embedded benefit in relation to embedded generators with whom they contract, to those embedded generators, or to other customers as a discount. Any Supplier, including us, will give most of the embedded benefit in relation to embedded generators with whom they contract, as otherwise those embedded generators would use their leverage to negotiate with a different Supplier. Also, if Suppliers gave the benefit of any embedded generation with whom they might contract to their other HH (or NHH) customers that are not associated with embedded generation, the prices quoted to those other customers would vary randomly with how much embedded generation that supplier happened to have contracted with, in comparison to its total volumes; this would not be the characteristic of a normal competitive market
17	Tees Valley Combined Authority	No text provided
18	Octopus Investments	n/a
19	The Greenspan Agency	No text provided

	Limited	
20	Centrica	No text provided
21	<i>ScottishPower Energy Management Limited</i>	i) Suppliers require to recover both the demand TNUoS charges levied on them by National Grid and payments for Triad Avoidance benefit (made to embedded generation under the terms of power purchase agreements) from consumers. A supplier which fails to recover both of these costs (plus an appropriate profit) from its customer portfolio over time will be unable to cover its cost of capital.
22	Eider Power Reserve	Not applicable to us – we are not a supplier.
23	Renewable Energy Association	The REA has no comment
24	Infinis Energy	n/a
25	<i>RWE Innogy UK- RWE npower joint submission</i>	If tariffs have been published, we will charge our customers this rate. Customers who are exporting at the time of triads will have this rate applied to a negative demand, and so will receive a credit i.e. net
26	Sembcorp Utilities (UK) Limited	No text provided
27	Smartest Energy	We pass through (or price in) at the NGT tariff for both demand and embedded generation. This means that we can reconcile our net bill from NGT to a fair degree of accuracy (i.e. aside from forecasting issues on fixed contracts) payments to generators netted off receipts from customers equal our TNUoS bill
28	UK Green Investment Bank plc	No comment.
29	Alkane Energy Limited	n/a
30	Uniper	We have no comments in response to this question.

31	EON UK	Confidential, response sent separately.
32	<i>Welsh Power Group Limited</i>	No response
33	SSE	To the first question: Yes, as a supplier, we do charge customers on their gross demand at the same published Final TNUoS tariff rate as National Grid charges the supply business. To the second question: Yes, any resulting surplus between the TNUoS revenue collected from customers (based on gross demand) and the TNUoS charge paid to National Grid (based on net demand) is used by the supply business to pay the value of the embedded benefit to the embedded generator. This has an important implication: Any reduction in the published £/kW unit rate of TNUoS tariffs (following an increase in the TNUoS demand charging base) would result in a corresponding reduction in the total TNUoS cost paid by customers
34	UKPR	See separate attachment
35	Green Frog Power	n/a
36	The ADE	The ADE has no comment
37	Renewable UK	RenewableUK is not in a position to comment on this matter.
38	Savvi Energy	No text provided
39	RES	n/a
40	Watt Power	n/a
40	Plutus	n/a
41	Reliance	n/a
42	Silva Renewable Energy Limited – Bilateral Connection Contract holder	No text provided
43	Drax	Confidential repose given.

44	ELEXON	No text provided
45	Rockpool	n/a

ii) **Suppliers: Does the estimate that 7.58GW of embedded generation output and 2.5GW of demand side reduction at the time of Triad for 2016/17 seem reasonable based on your knowledge of the UK market? If not what is your estimate of embedded generator output and DSR at time of Triad?**

Response No	Company	Response
1	<i>CLP Envirogas</i>	No comment.
2	Engie	Yes, it is reasonable based on our knowledge
3	RWE Generation UK plc, RWE Supply & Trading GmbH	No comment.
4	<i>EPR Ely Limited</i>	No comment.
5	<i>EPR Glanford Limited</i>	No comment.
6	<i>EPR Eye Limited</i>	No comment.
7	Statera Energy	No comments.
8	<i>EPR Scotland Limited</i>	No comment.
9	TATA	Comments removed for publication of report

	Chemicals Europe	
10	EPR Thetford Limited	No comment.
11	<i>LondonWaste Ltd</i>	No text provided
12	PeakGen Power Ltd	n/a
13	<i>Statoil ASA</i>	No text provided
14	Good Energy	We do not have access to the relevant data to assess the accuracy of these estimates
15	<i>REstore</i>	No text provided
16	EDF Energy	Yes, those seem like reasonable estimates, which were explained by Grid as underlying Future Energy Scenarios (FES) (in the FES dataset, it is estimated that there will be 7.58GW of distributed generation output at the time of Triads)
17	Tees Valley Combined Authority	No text provided
18	Octopus Investments	n/a
19	The Greenspan Agency Limited	No text provided
20	Centrica	No text provided
21	<i>ScottishPower Energy Management Limited</i>	We do not have an independent view of the volume of embedded generation output and DSR at Triad but the Future Energy Scenarios document would appear to be an acceptable source for the estimates
22	Eider Power Reserve	Not applicable to us – we are not a supplier.
23	Renewable Energy	The REA has no comment

	Association	
24	Infinis Energy	n/a
25	<i>RWE Innogy UK- RWE npower joint submission</i>	No comment. The National Grid Future Energy scenarios should consider industry input.
26	Sembcorp Utilities (UK) Limited	No text provided
27	Smartest Energy	This estimate seems sensible
28	UK Green Investment Bank plc	No comment.
29	Alkane Energy Limited	n/a
30	Uniper	We have no comments in response to this question.
31	EON UK	Confidential, response sent separately.
32	<i>Welsh Power Group Limited</i>	No response
33	SSE	Yes, the estimates provided appear to be reasonable.
34	UKPR	See separate attachment
35	Green Frog Power	n/a
36	The ADE	The ADE has no comment
37	Renewable UK	RenewableUK is not in a position to comment on this matter.

38	Sarvi Energy	No text provided
39	RES	n/a
40	Watt Power	n/a
40	Plutus	n/a
41	Reliance	n/a
42	Silva Renewable Energy Limited – Bilateral Connection Contract holder	No text provided
43	Drax	No response
44	ELEXON	No text provided
45	Rockpool	n/a
46 late response (rec'd 1 Sept 16)	Calon Energy	No comment as we are not suppliers.

Question 12: Can you identify – either quantitatively or qualitatively - the impact of the demand TNUoS embedded benefit on your decisions made in making capacity market decisions? (BOTH CMP264/265)

Response No	Company	Response
1	<i>CLP Envirogas</i>	No comment.
2	<i>Engie</i>	All sources of income and cost (including the risk that income and costs may change) would be considered.
3	RWE Generation UK plc, RWE Supply & Trading GmbH	No comment.
4	<i>EPR Ely Limited</i>	No comment.
5	<i>EPR Glanford Limited</i>	No comment.
6	<i>EPR Eye Limited</i>	No comment.
7	Statera Energy	While not commenting on a company strategy we would expect that parties will increase their bids and thus the clearing price will be higher, to the detriment of consumers. This we assume was the intent of these proposed modifications. However, we are concerned about all of the wider impacts that the changes will have on the market and believe they need a better considered solution.
8	<i>EPR Scotland Limited</i>	No comment.
9	TATA Chemicals Europe	Comments noted as confidential for report
10	EPR Thetford Limited	No comment.
11	<i>LondonWaste Ltd</i>	Since the embedded benefit to be removed would most likely greatly exceed the TNUOS benefits the TNUOS benefits would always be the dominant consideration.
12	PeakGen	Yes. Capacity market pricing reflects the ranges of income and costs we expect to receive.

	Power Ltd	If different rules had been in place, we would have priced differently. Lower income streams would lead to higher CM pricing. We would assume that transmission connected generation would price higher if generation TNUoS was to rise.
13	<i>Statoil ASA</i>	No text provided
14	Good Energy	As a supplier of 100% renewable electricity, none of the generators with whom we are contracted, or have any other commercial interest, are currently eligible to participate in the Capacity Market.
15	<i>REstore</i>	No text provided
16	EDF Energy	As our CM-participating assets do not earn embedded benefits, our CM bids are not ‘subsidised’ by the embedded benefits relating to the HH demand residual TNUoS charge element, and our bids therefore reflect the fundamental economic value of our plant. The effect of the likely participation of a class of generation that, through being lower voltage-connected and of less than 100 MW capacity per site, will benefit from the non-cost-reflective credit from its partner Supplier, in relation to its output at triads, of the HH demand TNUoS residual charge element, there being no rational for this, is that it is much less likely that more efficient larger generation plant will be constructed. This is probably why little or no such new efficient larger plant is being realised. (DELIBERATE PAGE BREAK BEFORE next question PTO
17	Tees Valley Combined Authority	It should be fairly clear that the larger benefit (so far), which is the TNUoS saving will dominate people’s decision making.
18	Octopus Investments	TRIADs are one revenue stream available to embedded plants which contribute to their overall economics. CM bidding decisions are taken on the basis of the expected total profitability of the plant, so if TRIADs are changed this will be taken into account along with countervailing market impacts which will result from the withdrawal of 6-10GW of embedded capacity from the energy market in the Winter peak and other times of the year
19	The Greenspan Agency Limited	No text provided
20	Centrica	No text provided
21	<i>ScottishPower Energy Management Limited</i>	TNUoS embedded benefit is one of a number of potential income streams to be considered when considering an investment in embedded generation plant; others include power prices and Capacity Mechanism or CFD income. Being able to assume an additional income stream from Triad avoidance benefit enables embedded generation to reflect lower costs into Capacity Mechanism bids.
22	Eider Power	Yes. The existence of this benefit has been key to our investment decisions to date. Whilst it is possible that Capacity Market

	Reserve	payments in the future could be received at a level sufficient to compensate for any reduction in the embedded benefit, we are not presently convinced that this will happen
23	Renewable Energy Association	<p>The current uncertainty in the marketplace, as a result of both the CMP264 and CMP265 proposals, is that members would not rely on embedded benefit value when making their Capacity Market investment decisions. Members have advised us they will not bank embedded benefit value when making their investment decisions, and lenders and investors will not invest against embedded benefit value.</p> <p>Analysis by Cornwall Energy found that the removal of the TNUoS and BSUoS embedded benefit would increase Capacity Market prices in the 2016 auction by £2/kW. This difference would add more than £100m to Capacity Market costs. However, the analysis found that the increase in Capacity Market price was insufficient to make any significant difference to whether new transmission-connected generation assets were successful in the market</p>
24	Infinis Energy	They are key to our investment decisions, but the schemes we develop do not qualify for the capacity market.
25	<i>RWE Innogy UK- RWE npower joint submission</i>	No. RWE Innogy does not participate in the CM.
26	Sembcorp Utilities (UK) Limited	No text provided
27	Smartest Energy	No comment.
28	UK Green Investment Bank plc	No comment.
29	Alkane Energy Limited	<p>The removal of the Triad benefit will have a significant negative impact on the economics of both existing and new embedded generation. If Triad revenues were to fall below the 2016/17 level and there to be continued regulatory uncertainty, we do not expect to meet our 2014 & 2015 Capacity Market contract obligations due to a lack of investor/lender appetite.</p> <p>The stability of future Triad benefit is crucial to allow generators to accurately forecast revenue and provide investor/lender confidence.</p>

		The uncertainty that now arises will have a significant impact on our decisions in the 2016 capacity market auction. We will only be an investor if the auction price is materially higher than in the previous auctions. The pricing in of risk and uncertainty of outcome is almost certainly going to deliver a price that is higher than it would otherwise have been
30	Uniper	In our view the removal of the Demand Residual component of the TNUoS embedded benefit will remove a distortion from the CM and better enable a true price of generation capacity to be discovered. It may result in marginally higher clearing prices in some years by avoiding artificially lower clearing prices as a result of removing this source of revenue from some embedded generation. It may also still result in new embedded generation displacing some transmission connected generation where this is truly cost competitive.
31	EON UK	<p>The demand TNUoS embedded benefit is an income stream for embedded generators. The Capacity Market (CM) has been designed as a competitive auction which encourages participants to offer prices as low as possible. Therefore participants will account for all other sources of income when calculating their CM offer prices (taking account of the likelihood of receiving that income).</p> <p>If CM participants who previously assumed they would receive some or all of the TNUoS embedded benefit now assume they will not receive it (or perceive a higher risk of not receiving it) – in other words those generators affected by these proposals – other things being equal you would expect the income they need from the CM to either justify investment or to remain open (i.e. their offer price) to increase as a result. This means that some new build projects may no longer be viable and some existing plants may close if their required capacity price in the absence of the TNUoS benefit is too high and they are unsuccessful in the Capacity Auction.</p> <p>Both proposers highlight distortions in the Capacity Market as a result of a TNUoS embedded benefit which they judge is too high. We would add that a TNUoS embedded benefit that is too low may be equally distorting. A TNUoS embedded benefit that undervalues any transmission cost savings as a result of embedded generation will result in a less than efficient number of embedded generators being successful, increasing costs for customers overall. Therefore, without thorough analysis of the value of the avoided transmission costs from embedded generation, it is not possible to quantify the extent of any current distortion or to suggest a level of embedded benefit which reduces that distortion.</p> <p>The uncertainty surrounding the TNUoS embedded benefit, and therefore any impact on CM offer prices, exists in the market already. Any impact on the 2016 CM auction is unlikely to be different as a result of approving (or not) either of the proposed modifications or alternatives. We do not, therefore, believe there is any value in rushing decisions, without thorough analysis, in order to meet the 2016 Capacity Auction timescale. On the contrary, a rushed decision is likely to be challenged or changed by further modifications, and therefore gives no more certainty (and arguably less certainty) than already exists today.</p> <p>Without thorough, independent analysis of the true value of embedded generation in terms of avoided transmission costs we believe this uncertainty will continue. In other words, embedded generators who are unaffected by any approved modification (for example existing generators in the case of CMP264) are unlikely to assume the TNUoS benefit will remain unchanged</p>

		<p>indefinitely given the limited scope of the modifications.</p> <p>To remove this uncertainty it is crucial that this issue is explored and addressed thoroughly and robustly; we do not believe the modifications proposed and the timescales within which to assess and analyse them have been sufficient to develop proposals that can be demonstrated to better meet the CUSC objectives.</p>
32	<i>Welsh Power Group Limited</i>	The Triad revenue stream was an important consideration in formulating bids into the past two CM auctions. As one of the few significant, stable and forecastable revenue streams for an embedded generator it was a key determinant of the bids placed in the CM auctions.
33	SSE	<p>For embedded generation assets – A reduction in the value of the TNUoS embedded benefit would result in a corresponding increase in required price within the Capacity Mechanism. For Transmission connected generation assets – If the Baseline embedded benefit persisted, then this would result in the “playing field” continuing to become further progressively stacked against transmission connected generators in a way which is discriminatory and not cost reflective. A continuation of the Baseline would cause a progressively worsening investment environment with an increasingly high risk associated with developing a transmission connected generation asset. Economic theory would suggest this higher risk environment would tend to require higher risk margins, therefore higher bid prices in the capacity market, so a higher cost to customers.</p>
34	UKPR	See separate attachment
35	Green Frog Power	The most important factor is a fair and stable regime. If financiers and investors do not feel that the regime is reliable then it is not fit for purpose. It is therefore important to ensure that a thorough review of the charging regime is undertaken.
36	The ADE	<p>The current uncertainty in the marketplace, as a result of both the CMP264 and CMP265 proposals, is that ADE members would not rely on embedded benefit value when making future Capacity Market investment decisions. Members have advised us they will not bank embedded benefit value when making future investment decisions, and lenders and investors will not invest against embedded benefit value.</p> <p>Analysis by Cornwall Energy found that the removal of the TNUoS and BSUoS embedded benefit would increase Capacity Market prices in the 2016 auction by £2/kW. This difference would add more than £100m to Capacity Market costs. However, the analysis found that the increase in Capacity Market price was insufficient to make any significant difference to whether new transmission-connected generation assets were successful in the market.</p> <p>We are concerned that the proposal put forward was aimed at raising the price of the Capacity Market to benefit the businesses of the proposers. While this an understandable aim, it is not the role of the charging regime to support a given business model and making such changes to achieve these ends would be a poor decision not in the interests of energy consumers.</p>
37	Renewable	RenewableUK is not in a position to comment on this matter.

	UK	
38	Savvi Energy	No text provided
39	RES	No clear view at this stage.
40	Watt Power	<p>TRIAD revenues are not long term contracts/agreements and are therefore not 'guaranteed', but they are part of a stable charging mechanism and it has been possible to take a reasonable view about the level of these revenues over the next few years. Further, Ofgem reviewed embedded benefits in 2014 and found no reason to make extensive changes, so generators would have received some assurance as to the continuation of the TNUoS charging methodology.</p> <p>Different lenders treat Triad revenues in different ways, and the exact treatment will vary over time. Triad revenues are not viewed as being as certain as a Capacity Agreement or PPA/Tolling Deal. The impact on any financing of having access to this income stream is difficult to quantify.</p> <p>Triad revenues are at risk from a number of operational and commercial factors and each bidder in the Capacity Market will take a different view about the impact of these revenues on their exit price in the auction. However, these revenues are a substantial element in the income of plant generating mainly at peak or to cover for intermittent generation. It is clear that the clearing price in the capacity market would have been significantly higher had embedded benefits not been available.</p>
40	Plutus	They are key to our investment decisions. If there is to be change to the current regime, the impact on security of supply needs to be fully considered.
41	Reliance	They are key to our investment decisions. If there is to be change to the current regime, the impact on security of supply needs to be fully considered.
42	Silva Renewable Energy Limited – Bilateral Connection Contract holder	<p>We estimate that in our case, any reduction in triad revenue could materially impact on our required CfD strike price. We would expect other developers in similar circumstances to encounter a similar issue. This is contrary to HM Government's key objective for CfD, namely that any subsidy for renewable energy must achieve value for money to the energy consumer.</p> <p>We would be happy to share with the code administrator our estimates on the size of the potential impact.</p>
43	Drax	Assuming rational market behaviour, we believe the current system makes EG artificially more competitive compared to other generators. This lowers their exit price, directly lowering the clearing price of the Capacity Market. This stifles the build of potential new transmission connected generators and lowers the profitability of older conventional generators that are needed to maintain an effective system. More economic generation is disadvantaged, resulting in a reduction of allocative efficiency and ultimately increasing costs for customers.
44	ELEXON	No text provided

45	Rockpool	They are key to our investment decisions. If there is to be change to the current regime, the impact on security of supply needs to be fully considered.
46 late response (rec'd 1 Sept 16)	Calon Energy	As a company we have been very concerned by the growth in embedded benefits, but as the owners of TO connected plant there has been little we can do. The TNUOS embedded benefit is distorting peak pricing economics meaning that price signals are not reflective of marginal economics or scarcity pricing. This is not efficient and we do not believe the situation to be sustainable. This in turn makes CM decisions highly problematic as they are subject to considerable regulatory uncertainty.

Question 15: both CMP264/265**i) What are your views on the 2 broad options to enable the reporting of gross export metered data?**

Response No	Company	Response
1	<i>CLP Envirogas</i>	No comment.
2	<i>Engie</i>	We would expect Elexon to determine appropriate sites to include/exclude from the netting arrangements. A verification report should be available to the Supplier from Elexon that shows which meters are excluded from netting. The final TNUoS bill from National Grid should include a breakdown netted/not-netted by volume. The process should be seamless without Supplier interactions.
3	RWE Generation UK plc, RWE Supply & Trading GmbH	We favour a fair and equitable approach towards the reporting of gross export metered data. We believe that suppliers are best placed to provide the required information, given the direct physical and contractual relationship with relevant embedded generator. However we have concerns about the practicality of this solution.
4	<i>EPR Ely Limited</i>	No comment.
5	<i>EPR Glanford Limited</i>	No comment.
6	<i>EPR Eye Limited</i>	No comment.
7	Statera Energy	No comments.
8	<i>EPR Scotland Limited</i>	No comment.
9	TATA Chemicals Europe	No comment
10	EPR Thetford	No comment.

	Limited	
11	<i>LondonWaste Ltd</i>	Neutral
12	PeakGen Power Ltd	Not our area of expertise
13	<i>Statoil ASA</i>	No text provided
14	Good Energy	i) Of the two proposed options, we strongly favour option A. This is because option B places significant onus on suppliers to obtain and collate the data – this burden is likely to be significant for small suppliers, particularly those which contract with large numbers of embedded generators.
15	<i>REstore</i>	No text provided
16	EDF Energy	The first of these two broad options for enabling the reporting of gross export metered data is to develop a more detailed set of BSC requirements and processes that describe specifically how Suppliers, their Party Agents and the SVAA collaborate to collect, aggregate and report data to National Grid (e.g. using the existing TUOS Report). This seems as though it should work, details being worked up at the BSC P348/349 workgroups. The second of these two broad options, option B, for enabling the reporting of gross export metered data, would lie in a simple set of BSC requirements that simply require Suppliers to provide metered data (at triads) for individual Metering Systems to National Grid – this second option provides the Supplier flexibility to decide how to report but places greater pressure on National Grid to aggregate the metered data from individual Metering Systems for its purposes. We prefer this second approach, although both are to the same net effect
17	Tees Valley Combined Authority	Neutral
18	Octopus Investments	No view on this
19	The Greenspan Agency Limited	No text provided
20	Centrica	We have concerns about the implementation of both CMP264 and CMP265 because they introduce subcategories of embedded generation (e.g. new/existing and CM/non-CM) that may prove difficult to capture in industry codes. We favour a

		CUSC modification based around identifying embedded generation “exports” and establishing corresponding export tariffs for each GSP group that ensure effective competition between embedded and transmission connected generation. This has been mooted by Centrica as a potential alternative in the Workgroup Consultation report) and may also simplify the BSC modification requirements.
21	<i>ScottishPower Energy Management Limited</i>	We believe that the simpler requirement to require Suppliers to provide the appropriate meter data for individual metering systems to National Grid is the most efficient solution given the limited number of sites potentially affected (see our response to Q13). Such a solution is also more easily implemented as a manual workaround to achieve implementation in time for the 2017/18 Triad season
22	Eider Power Reserve	This is a question for suppliers only to answer
23	Renewable Energy Association	The REA has no comment.
24	Infinis Energy	No text provided
25	<i>RWE Innogy UK- RWE npower joint submission</i>	<p>We do not support the 2 broad options to enable the reporting of gross export metered data as outlined below: A. Cost and time for implementing robust data flows for a temporary solution B. Relying on customers/suppliers for information (data quality /governance) We are unclear whether the associated BSc change is perceived as a prerequisite to this change or an option. The terminology “broad” sounds vague and costs are already being incurred through the BSc change request. We feel that the development of systems and data flows to support such a change are prohibitively expensive and disproportionate in terms of the temporary and partial nature of the solution suggested. There are additional loopholes (behind the meter generation) that cannot be covered. In addition the expectation that suppliers can obtain appropriate information from Embedded Generators without supporting central data flows when quoting for an Embedded Generator that is not part of their current portfolio is unrealistic. This opens up wider questions on the governance framework required on the data quality in addition to the resource implications this would have across the industry. Appropriate SLAs would need to be put in place to ensure suppliers can readily access the required information for their tendering process. ii) We would not have this information available for either new or existing contracts.</p> <p>iii) We would require at least 3 years notice from the point of formal decision to implementation date. iv) We feel that the development of systems and data flows to support such a change are prohibitively expensive and disproportionate in terms of the temporary and partial nature of the solution suggested. We do not feel there are any pros associated with P348 / P349 due</p>

		to the temporary and partial nature of the solutions.
26	Sembcorp Utilities (UK) Limited	No text provided
27	Smartest Energy	Reporting gross data is inappropriate. The triad charge is on suppliers and should be net. As far as NGT are concerned there is no difference between a MW of reduced demand or a MW of increased embedded generation
28	UK Green Investment Bank plc	No comment.
29	Alkane Energy Limited	We have no comment as this is handled by our supplier/PPA provider
30	Uniper	The issues demonstrate why a simpler, more generic option should be adopted which would use the general Supplier Gross Demand data file, which already exists, benefits from existing assurance arrangements and is robust for billing purposes.
31	EON UK	<p>Of the two options we prefer option (a). It is important that a thorough and robust process is developed to ensure gross metered export data is recorded and reported accurately.</p> <p>We are concerned that option (b), while simpler and easier to implement, could result in different standards of data from different suppliers. This is likely to be less effective in the long run.</p> <p>Whichever option is implemented it is crucial that aggregated data reflecting any changes as a result of CMP264 or CMP265 is published regularly and transparently (for example as part of the SO142 report).</p> <p>Similarly, any changes to the calculation of triad demand itself should be made clear (presumably the demand in each triad period would reflect any change from net to gross demand for the categories of plant affected by CMP264 or CMP265).</p>
32	<i>Welsh Power Group Limited</i>	We do not believe sufficient information has been presented in the consultation document to enable informed comment on the question.
33	SSE	It is our view that option “A” would be a better solution because it leverages existing systems and agents in a robust way which better enables the collection and transfer of data with strong assurance and auditability. By contrast, option “B” could also deliver the desired result, however it would require new direct interfaces between suppliers and National Grid which may not as easily provide as strong data assurance and auditability.
34	UKPR	See separate attachment

35	Green Frog Power	n/a
36	The ADE	The ADE has no comment.
37	Renewable UK	RenewableUK is not in a position to comment on this matter.
38	Sarvi Energy	No text provided
39	RES	We understands the rationale behind the respective BSC change proposals in light of the relevant applicable CMPs, but, given that we do not support the implementation of either CMP at this stage nor would support any CMP until the holistic review of commercial arrangements has concluded, we will therefore not comment at this stage.
40	Watt Power	If metering is to be gross it needs to look at all metering systems as suggested in option 2. It should not simply add back the output of embedded generators.
40	Plutus	n/a
41	Reliance	n/a
42	Silva Renewable Energy Limited – Bilateral Connection Contract holder	No opinion
43	Drax	No response
44	ELEXON	<p>We have already provided thoughts on the two primary solutions (i.e. 'Option A') proposed by P348 and P349 for reporting data in our responses to Q13 and 14.</p> <p>The P348 and P349 workgroup considered alternative solutions to both P348 and P349 (i.e. 'Option B'). Put simply the main proposals of each modification specify solutions that require Suppliers, their Data Aggregators and the Supplier Volume Allocation Agent to collect, correct for line losses and aggregate (which may require following netting rules provided by Suppliers) metered data to Supplier BMU level before reporting these values to National Grid (i.e. Option A). The alternative solutions considered for each of P348 and P349 propose simpler solutions in terms of the BSC. That is, they would only specify in the BSC that Suppliers and their Data Collectors report HH metered data for individual metering systems to National Grid. This approach would avoid the need for any changes to BSC Systems. Instead it would be National Grid's responsibility to aggregate the individual metering system metered data (which may include import metered data and require following netting</p>

		rules provided by Suppliers) to determine export volumes for each Supplier BMU. At present P348 and P349 do not envisage specifying the additional steps National Grid would need to follow in the BSC. These would need to be specified in the CUSC. Please note that the P348/349 Workgroup has not yet formally raised these options as Alternative Modifications.
45	Rockpool	n/a
46 late response (rec'd 1 Sept 16)	Calon Energy	We would prefer that settlement data is managed centrally and provided by Elexon to NG. The industry should have one set of robustly remained settlement data and not rely on their parties more than they have to.

ii) Would you have the data available required for Option B (both CMP264 and CMP265) for both new contracts and existing contracts where a customer may be partially exempt?

Response No	Company	Response
1	CLP Envirogas	No comment.
2	Engie	We would expect Elexon to determine appropriate sites to include/exclude from the netting arrangements. A verification report should be available to the Supplier from Elexon that shows which meters are excluded from netting. The final TNUoS bill from National Grid should include a breakdown netted/not-netted by volume. The process should be seamless without Supplier interactions.
3	RWE Generation UK plc, RWE Supply & Trading GmbH	We believe that the relevant information should be available from suppliers, given the introduction of an obligation to report such information for the purpose of demand transmission charging. However we have concerns about the practicality of this solution.
4	EPR Ely Limited	No comment.
5	EPR Glanford Limited	No comment.

6	<i>EPR Eye Limited</i>	No comment.
7	Statera Energy	No comments.
8	<i>EPR Scotland Limited</i>	No comment.
9	TATA Chemicals Europe	No comment
10	EPR Thetford Limited	No comment.
11	<i>LondonWaste Ltd</i>	Neutral
12	PeakGen Power Ltd	n/a
13	<i>Statoil ASA</i>	No text provided
14	Good Energy	No – under present arrangements we would not have access to the data required for Option B. Obtaining this data for each site would be likely to come at a significant cost relative to the value of the triad
15	<i>REstore</i>	No text provided
16	EDF Energy	Yes. Note that it is our view that there needn't be a requirement (or obligation), whether via the CUSC or BSC, on the Supplier to do or declare anything; merely the possibility to declare this data. The customer could only gain from co-operating with its Supplier in this matter
17	Tees Valley Combined Authority	Neutral
18	Octopus Investments	No view on this
19	The Greenspan Agency Limited	No text provided

20	Centrica	See response 15 i)
21	<i>ScottishPower Energy Management Limited</i>	For SVA Generation sites that have MPANs associated to them, we are not always the Supplier for both the Import and Export and therefore netting could be a problem. We do hold line loss factor information and GCF values, so if we had to adjust data and send this to NG, potentially this could be done, albeit the rules/criteria to apply would have to be explicit and applied consistently across all Suppliers. For CVA sites we may also hold the information if these sites were within the Manweb and SP GSP Group areas
22	Eider Power Reserve	A supplier question
23	Renewable Energy Association	The REA has no comment.
24	Infinis Energy	n/a
25	<i>RWE Innogy UK- RWE npower joint submission</i>	See response to 15 i)
26	Sembcorp Utilities (UK) Limited	No text provided
27	Smartest Energy	We do not hold this data.
28	UK Green Investment Bank plc	No comment.
29	Alkane Energy Limited	We have no comment as this is handled by our supplier/PPA provider
30	Uniper	We have no comments in response to this question.
31	EON UK	In principle the data required is available. Similarly the data required to identify the different categories of embedded generator (new generators or those with Capacity Market Agreements) is available to suppliers, either through their

		<p>agreements with those generators or through external sources such as the Capacity Market Register.</p> <p>However, referencing between different systems (for example meter level data in a supplier's systems with CMU level data in the Capacity Market Register) could be complex. These processes need to be explored more thoroughly.</p>
32	<i>Welsh Power Group Limited</i>	No comment
33	SSE	Yes
34	UKPR	See separate attachment
35	Green Frog Power	n/a
36	The ADE	The ADE has no comment.
37	Renewable UK	RenewableUK is not in a position to comment on this matter.
38	Savvi Energy	No text provided
39	RES	See response 15 i)
40	Watt Power	n/a
40	Plutus	n/a
41	Reliance	n/a
42	Silva Renewable Energy Limited – Bilateral Connection Contract holder	No opinion
43	Drax	No response
44	ELEXON	See response 15 i)
45	Rockpool	n/a
46 late response	Calon Energy	No comment

(rec'd 1 Sept 16)		
----------------------	--	--

iii) Do you believe you can implement the proposed changes by the respective implementation dates?

Response No	Company	Response
1	<i>CLP Envirogas</i>	No comment.
2	<i>Engie</i>	We believe that implementation should be the next following 1st April after an Authority decision. This should give sufficient time for change.
3	RWE Generation UK plc, RWE Supply & Trading GmbH	The scale and extent of the distortions associated with the residual component of the demand TNUoS tariffs as identified in the modification proposal and in Ofgem's Open Letter suggests that it is appropriate that the defect is addressed as soon as practicable. However, we have concerns about the feasibility of the solution and its potential impact on suppliers. In particular, the requirement for economic and efficient central reporting mechanisms and supplier billing systems enable the identification of relevant embedded generators and the introduction of gross charging for such parties may be difficult to deliver.
4	<i>EPR Ely Limited</i>	No comment.
5	<i>EPR Glanford Limited</i>	No comment.
6	<i>EPR Eye Limited</i>	No comment.
7	Statera Energy	No comments.
8	<i>EPR Scotland Limited</i>	No comment.
9	TATA Chemicals Europe	No comment

10	EPR Thetford Limited	No comment.
11	<i>LondonWaste Ltd</i>	Neutral
12	PeakGen Power Ltd	n/a
13	<i>Statoil ASA</i>	No text provided
14	Good Energy	No – given the short timescale of implementation, it is unlikely we could make all the required changes for CMP264. This is particularly the case for mixed sites
15	<i>REstore</i>	No text provided
16	EDF Energy	Yes
17	Tees Valley Combined Authority	Neutral
18	Octopus Investments	No view on this
19	The Greenspan Agency Limited	No text provided
20	Centrica	See response 15 i)
21	<i>ScottishPower Energy Management Limited</i>	Yes. Due to the limited number of sites affected we believe that initial manual and later enduring systems can be put in place to deliver the required data
22	Eider Power Reserve	A supplier question
23	Renewable Energy Association	The REA has no comment.
24		n/a

	Infinis Energy	
25	<i>RWE Innogy UK- RWE npower joint submission</i>	See response to 15 i)
26	Sembcorp Utilities (UK) Limited	No text provided
27	Smartest Energy	No. We would require another year
28	UK Green Investment Bank plc	No comment.
29	Alkane Energy Limited	We have no comment as this is handled by our supplier/PPA provider
30	Uniper	We have no comments in response to this question.
31	EON UK	As highlighted above, implementing changes by June 2017 will be extremely challenging
32	<i>Welsh Power Group Limited</i>	No comment
33	SSE	Yes
34	UKPR	See separate attachment
35	Green Frog Power	n/a
36	The ADE	The ADE has no comment.
37	Renewable UK	RenewableUK is not in a position to comment on this matter.
38	Sarvi Energy	No text provided

39	RES	See response 15 i)
40	Watt Power	n/a
40	Plutus	n/a
41	Reliance	n/a
42	Silva Renewable Energy Limited – Bilateral Connection Contract holder	No opinion
43	Drax	No response
44	ELEXON	See response 15 i)
45	Rockpool	n/a
46 late response (rec'd 1 Sept 16)	Calon Energy	No comment

iv) What are the pros and cons of the 2 proposals that ELEXON are considering to implement this (P348 for CMP265/ P349 for CMP264)?

Response No	Company	Response
1	CLP Envirogas	No comment.
2	Engie	We have not been involved in these proposals and we may respond directly to them.
3	RWE Generation UK plc, RWE	We believe that the relevant information should be available from suppliers, given an obligation to report such information for the purpose of charging. However we have concerns about the practicality of this solution.

	Supply & Trading GmbH	
4	<i>EPR Ely Limited</i>	No comment.
5	<i>EPR Glanford Limited</i>	No comment.
6	<i>EPR Eye Limited</i>	No comment.
7	Statera Energy	No comments.
8	<i>EPR Scotland Limited</i>	No comment.
9	TATA Chemicals Europe	No comment
10	EPR Thetford Limited	No comment.
11	<i>LondonWaste Ltd</i>	Neutral
12	PeakGen Power Ltd	Not our area of expertise
13	<i>Statoil ASA</i>	No text provided
14	Good Energy	We will be reviewing P348 and P349 in time, and will engage with the modifications directly as appropriate
15	<i>REstore</i>	No text provided
16	EDF Energy	We are responding separately in parallel to detailed consultation on BSC P348 and BSC P349 on a comparable timeframe. Our responses will not be marked confidential
17	Tees Valley Combined Authority	Neutral

18	Octopus Investments	No view on this
19	The Greenspan Agency Limited	No text provided
20	Centrica	See response 15 i)
21	<i>ScottishPower Energy Management Limited</i>	<p>i) Option (a) with detailed BSC requirements and processes would provide a robust enduring solution. However, it may require considerable development and would require more resource both during development and on an enduring basis.</p> <p>Option (b) could be more easily deliverable given the implementation date for CMP264 and may be delivered at a cost and effort more appropriate to the number of embedded generation sites potentially affected</p>
22	Eider Power Reserve	A supplier question
23	Renewable Energy Association	The REA has no comment.
24	Infinis Energy	No text provided
25	<i>RWE Innogy UK- RWE npower joint submission</i>	See response to 15 i)
26	Sembcorp Utilities (UK) Limited	No text provided
27	Smartest Energy	No comment
28	UK Green Investment Bank plc	No comment.

29	Alkane Energy Limited	We have no comment as this is handled by our supplier/PPA provider
30	Uniper	This is a matter for the P348 and P349 Assessment Procedure Consultation, however we would refer you to our response to question 15(i) above
31	EON UK	No comment. This is a matter for the workgroups and associated processes reviewing these proposals
32	<i>Welsh Power Group Limited</i>	We do not believe sufficient information has been presented in the consultation document to enable informed comment on the question.
33	SSE	We support the approaches proposed for both modifications. The solutions present challenges of complexity and additional administrative burden, although they both appear to provide reasonable solutions given the inherent challenges they are designed to address
34	UKPR	See separate attachment
35	Green Frog Power	n/a
36	The ADE	The ADE has no comment.
37	Renewable UK	RenewableUK is not in a position to comment on this matter.
38	Savvi Energy	No text provided
39	RES	See response 15 i)
40	Watt Power	We have not been party to the Elexon discussions
40	Plutus	n/a
41	Reliance	n/a
42	Silva Renewable Energy Limited – Bilateral Connection Contract	No opinion

	holder	
43	Drax	No response
44	ELEXON	See response 15 i)
45	Rockpool	n/a
46 late response (rec'd 1 Sept 16)	Calon Energy	No comment

Question 16: Do you have any further evidence / comments on the consumer impact of changing the demand TNUoS embedded benefit in either the short-run or long-run? (Both CMP264/265)

Response No	Company	Response
1	<i>CLP Envirogas</i>	No comment.
2	<i>Engie</i>	Yes, please see analysis in Appendices. We consider that embedded benefits at the current level are not cost reflective and overstate the benefit by a factor of 10.
3	RWE Generation UK plc, RWE Supply & Trading GmbH	No comment
4	<i>EPR Ely Limited</i>	No comment.
5	<i>EPR Glanford Limited</i>	No comment.
6	<i>EPR Eye Limited</i>	No comment.
7	Statera Energy	Please refer to our attached cover letter.
8	<i>EPR Scotland Limited</i>	No comment.
9	TATA Chemicals Europe	Comments removed for publication
10	EPR Thetford Limited	No comment.
11	<i>LondonWaste</i>	Reducing the triad benefit can only serve to reduce embedded generation at triad times and therefore increase net demand

	<i>Ltd</i>	on the system and reduce system security. This would ultimately increase total system costs.
12	PeakGen Power Ltd	<p>Changes to transmission charging can and will cause loss of investor confidence resulting in delays and/or cancellations of committed contracts. This could lead to a potential shortage of capacity and again further expensive actions (such as SBR) having to be undertaken by the SO to deliver security of supply</p> <p>If economic embedded generation is removed from the capacity market, then the clearing price will increase (increasing the price paid to existing generators). Inspection of the reports published by National Grid suggests, very approximately, then a 1 GW adjustment of the clearing volume would increase the clearing price by 5 £/kW, assuming that 50 GW of capacity is held the extra cost to the customer would be £250 million per annum. This should be compared to the presented saving in embedded benefit (Stage 2, workgroup consultations, page 43, figure 8) which shows the impact of CMP264 as a saving of £78 million in 2018/19 (465-387).</p> <p>If embedded plant is not running at peak, this might lead to higher peak power prices. However, these are difficult to forecast (and unhedgable, therefore unlikely to appear in lower capacity market bids from generators).</p>
13	<i>Statoil ASA</i>	No text provided
14	Good Energy	<p>The recent report from Cornwall Energy on embedded benefits estimates the appropriate level of Triad benefit as £32.30/kW for 2015/16, taking account of both short term and long term cost benefits.</p> <p>It is essential that any changes to embedded benefits do not undermine investor confidence in the industry – this is particularly important given the energy security implications of falling levels of de-rated margin</p>
15	<i>REstore</i>	No text provided
16	EDF Energy	The first order detriment to consumers that arises as a result of demand TNUoS residual being paid out to embedded generators, is that charges to consumers from suppliers to recover transmission costs are greater than the cost of the transmission system (the difference is the embedded benefit). Under the current TNUoS arrangement this first order detriment could grow quite significantly a) if substantial incremental new build EG comes forward under the CM and b) will grow anyway as TNUoS tariffs increase. In addition to this first order effect there is the wider negative impact of the resulting distortions. We do foresee consumer benefit from addressing distortions, as if price signals are cost-reflective, then the decisions which users make in response to those price signals will be aligned with the interest of society – they will make efficient decisions that minimise whole-system costs, which ultimately fall on consumers. The costs of non-cost-reflective embedded benefits will tend to fall on consumers.
17	Tees Valley Combined Authority	Reducing the triad benefit can only serve to reduce embedded generation at triad times and therefore increase net demand on the system and reduce system security. This would ultimately increase total system costs.
18	Octopus Investments	As detailed in response to Q3 we believe that changing TRIADs will increase the clearing price of the CM and drive much greater volatility and an overall uplift in system prices in the Winter peak. Overall we believe this will be a substantially

		negative impact on consumers by increasing the costs of power supply. It will also increase the risks of a supply shortfall in the Winter peaks.
19	The Greenspan Agency Limited	No text provided
20	Centrica	No text provided
21	<i>ScottishPower Energy Management Limited</i>	We believe that Table 5 and Figure 6 provide a reasonable estimation of the cost of Triad Avoidance benefit borne by consumers.
22	Eider Power Reserve	We are prepared to work with industry appointed consultants to develop robust economic material to demonstrate the adverse impact of the proposed changes on consumers.
23	Renewable Energy Association	<p>The following short-term impacts are likely to occur as a result of removing the demand TNUoS embedded benefit:</p> <ul style="list-style-type: none"> • Distributed generators are likely to decrease export during triad periods, resulting in higher net demand. As more than 7.5 GW of distributed generation operates at peak, even a reduction of 15% would result in a 1 GW shortfall in coming winters, during a period of significantly tight security of supply margins. Legacy, large-scale industrial CHP plant are largely operated as baseload generators, but are able to reduce on-site demand and have some flexibility to increase generation during system peak. As these operators are industrial manufacturers with limited engagement in the electricity market, they often struggle to respond directly to market signals and are likely to operate less flexibly during periods of peak demand if the triad charge is removed. • Reports by both Cornwall Energy and KPMG have highlighted that approximately 2 GW of existing distributed generation has received Capacity Market contracts. The removal of the embedded benefit could result in those plant under construction not being completed and existing plant shutting down, resulting in further capacity shortfalls in 2018 and 2019. • Industrial sites which use CHP to improve their efficiency and control their energy costs would see significant cost rises. Some industrial sites would see their costs rise by £5m a year during a time of economic uncertainty, putting manufacturing jobs at risk. Some industrial sites have indicated they will shut down their CHP assets in response to

		<p>the removal of embedded benefits.</p> <ul style="list-style-type: none"> • District heating sites which use combined heat and power will see their revenue decrease, in the case of one large scheme by 15%, requiring these networks to increase their heat prices to householders. District heating schemes often serve council houses and the fuel poor. • Higher wholesale prices, reflecting an increase in the marginal cost of embedded generation and the potential closure of embedded generation in response to the removal of triad benefits. • An increase in the cost of ancillary services as embedded generators need to make up for a shortfall in their revenue through higher contract prices. <p>Over a longer-term, we would expect:</p> <ul style="list-style-type: none"> • Higher levels of reinforcement and other costs at the transmission network level as embedded generation is replaced by transmission connected generation. • Higher levels of reinforcement and other costs at the distribution network level as the export from embedded generation is reduced. • A higher cost of capital for all generation due to the increased risk associated with industry change.
24	Infinis Energy	As noted previously, if the suggested modifications were to remove triad benefit for new plant and/ or those with a CM contract, this would further incentivise investors to construct on-site or private wire generation. We believe there are potentially significant impacts from simply removing the triad benefit without wider consideration of the costs currently dealt with by the residual.
25	<i>RWE Innogy UK- RWE npower joint submission</i>	This is a complex area that needs Ofgem’s thorough scrutiny. There will be impacts on the wholesale price, security of supply etc. from changes that need to be considered in addition to simply how much suppliers pay generators under the status quo and alternatives. A neutral quantitative impact assessment should be conducted by Ofgem. As a supplier we can only comment that embedded benefits are a direct result of the signals being given by the current TNUoS charging methodology. Bearing in mind that in 5 years’ time following smart metering roll-out all customers should be charged based on their triad demands. It is up to National Grid to

		<p>say whether the demand reductions seen are cost effective in terms of managing the system. We believe that the current demand charging methodology is not cost reflective, since the system peaks do not necessarily coincide with problem times. In the short term, the Triad signal will increase costs to consumers because as more and more customers will load manage to avoid and simultaneously self-perpetuate these spiralling costs, it will be the customers who cannot respond who will pick up the bill. The proposals do nothing to address this underlying problem.</p>
26	Semcorp Utilities (UK) Limited	No text provided
27	Smartest Energy	No
28	UK Green Investment Bank plc	No comment.
29	Alkane Energy Limited	<p>We understand from analysis shared within the Workgroup that some 2GW of new build embedded generation secured contracts in the 2014 & 15 Capacity Market auctions. This resulted in significant benefits to consumers as the auction clearing prices were lower than almost all earlier forecasts.</p> <p>We expect the removal of the embedded benefit as proposed by CMP265 and by CMP264 unless delivery timescales are extended or an exemption given to those holding CM contracts to result in some of this plant not being built. This could result in capacity shortfalls in 2018 and 2019 and will require higher cost capacity to be procured to fill the gap.</p> <p>In addition to the new build embedded generation that secured capacity market contracts there is well in excess of 10GW of embedded generation. Much of this (we would suggest well in excess of 30% but have not yet had time to refine this number) is onshore wind which does not contribute towards firm capacity but does nonetheless benefit in exactly the same way as firm capacity at time of Triad. We would question whether this capacity which also receives a direct subsidy via ROCs should continue to benefit from unadjusted rising Triad prices as forecast, while that EG which is a major contributor to the security of supply and the provision of balancing services has the benefit removed in a discriminatory way.</p> <p>Over the longer term we would expect distribution network costs to rise especially at the EHV voltage levels as the export from embedded generation is reduced. We also expect transmission network costs to be higher over the long term if embedded generation is replaced with transmission connected generation.</p> <p>Our ability to gather evidence to support our analysis is limited by both the time made available to us to comment (given</p>

		resources) and the time it takes to tender for and procure third party support to conduct appropriate analysis.
30	Uniper	No
31	EON UK	<p>The consultation document highlights a number of areas where consumers may see impacts, positive or negative, as a result of changes to the demand TNUOS embedded benefit.</p> <p>The overall impact on consumers is very complex and has many interactions and dependencies on other schemes. As stated in the consultation document itself (paragraph 3.8.57), based on the analysis carried out so far it is not possible to state whether consumers will be better or worse off as a result of these proposals. Until a robust view of the overall benefit (or not) to consumers can be established, or even a view of whether customers are better or worse off as a result of the changes, we do not believe it appropriate to implement permanent changes to the CUSC.</p> <p>The consultation document references a view of one workgroup member that, as a general principle, if price signals are cost reflective then the decisions which users make in response to these price signals will be aligned with the interest of society. We fully support this principle but are concerned that:</p> <p>(i) CMP264 and 265 assume the cost reflective signal is either very low (the locational element for CMP265) or £0/kW (CMP264). There has not been sufficient analysis or evidence to justify this view. Implementing CMP264 or 265 risks undervaluing embedded generation which could lead to investment decisions which are not in the best interests of society.</p> <p>(ii) Changing one price signal (the TNUOS embedded benefit in this case) in isolation from others which may be equally or even more distorting could simply move distortions from one market or one technology to another.</p> <p>We would also highlight that industrial or business energy customers could be affected by the proposals in a number of ways. For example, these customers could well be benefitting from the current demand TNUOS embedded benefit either through on site generation or demand shifting. The overall impact on such customers should also be captured.</p> <p>As we have highlighted throughout this response, it is crucial that a thorough and independent review of the value of embedded generation is carried out before any changes are adopted. This will ensure any remaining benefit is truly cost reflective.</p>
32	<i>Welsh Power Group Limited</i>	<p>Welsh Power has commissioned a study to quantify the value of embedded generation and to quantify the significant cost to consumers which will be a direct and immediate result of proposed changes. The results of this report are not yet available. However it is clear that both of the proposed modifications are intended to increase the clearing price in the upcoming capacity market auction and to raise electricity prices. The proposers of CMP264 and CMP265 hypothesize that this will lead to more efficient investment decisions in the future which will lead to lower costs to consumer in the long run. Whilst it was generally accepted by the working group that the short term impact of the proposals would be a clear increase in consumer costs no evidence was presented to the work group to justify how the anticipated reduction would materialise in the longer term. Purist economic arguments tabled by the proposers about efficient market signals and rational investment decisions</p>

		<p>ignore the facts of the UK energy market which has over the past decade relied increasingly on subsidy and regulatory intervention to bring forward new build capacity. The Capacity Market is the most recent and obvious example of intervention in the market to bring forward new capacity and compensate for market failures. It is nonsensical to argue that the removal of Triad benefits would lead to a more efficient investment signal given the evidence of the past years and to do so would risk shouldering consumers with significant increased cost in the near term in the hope that lower costs would materialise at some point in the future.</p>
33	SSE	<p>Embedded benefit - The benefit to customers from reduced customer cost which is clearest and most important is the reduction in the cost which customers are currently paying for the embedded benefits. The National Grid analysis in Figure 8 shows the cost to customers of paying for the TNUoS Demand Residual embedded benefit to embedded generators is £343m per year in 2016/17, increasing to £650m per year by 2020/21 (real 2016/17 prices). Further analysis by National Grid indicated that if the Baseline was permitted to continue, then this cost to customers could be expected to reach £1Bn per year by 2030, or using the National Grid Consumer Power scenario, increasing to £2Bn per year by 2032, which would equal 70% of the entire cost of the Transmission network in 2016/17 (12 August 2016, p4, Charging Seminar - Case for change: National Grid Analysis of a Do Nothing Scenario, http://www2.nationalgrid.com/UK/Industryinformation/System-charges/Electricitytransmission/charging_review/). Capacity Mechanism - Potential offsetting increase in Capacity Mechanism cost to customers is relatively small. The Cornwall report indicated a corresponding increase in the Capacity Mechanism clearing price of £4.7/kW equating to an increase in cost to customers of £214m per year (2019/20), or up to £282m (2020/21). It should not be surprising that the removal of a subsidy from a group of participants in a market may result in a higher clearing price for that market, however: i. The purpose of TNUoS charging is not and should not be to provide a subsidy to the Capacity Market to achieve a lower clearing price. ii. Even if it was accepted in principle that TNUoS could be used to subsidise the Capacity Mechanism clearing price, then it is a very inefficient tool since the embedded benefit paid to reduce the Capacity Market clearing price results in a much higher cost to customers than the benefit to customers obtain from the lower clearing price. iii. The use of a non cost reflective policy tool to subsidise a different policy tool would result in an outcome which is progressively less economically efficient and results in a progressively higher cost to customers.</p> <p>Wholesale power price – Cornwall carried out analysis and estimated that the removal of the Triad incentive could result in an increase in wholesale power price which equated to an increase in cost to customers of between £10m and £45m. This is a relatively small value compared to the customer benefit of not having to pay for the value of the embedded benefit. It is important to note: i. Feedback to lower Capacity Market price - Cornwall failed to take account of the fact that a higher peak power price will increase the profit (infra marginal rent) of generators operating during peak times, so will tend to cause a corresponding reduction in the capacity mechanism clearing price. Therefore the net impact on of the increase in wholesale price on customers, may be close to zero. Better economic efficiency should result in even lower cost to customers over the long-term – A more towards more cost reflective price signals will tend to result in competitive markets delivering a more</p>

		<p>economically efficient result at a lower total system cost, therefore lower cost to society (regarding both network cost and generation cost). It is reasonable to expect that this lower total system cost would result in even greater reductions in cost to customers over the longer term. The net customer benefit for CMP264 Original and CMP265 Original are not as large. 100% gross charging of the Demand Residual (as per Centrica alternative) would deliver the highest cost saving for customers The analysis provided in the Workgroup Consultation Fig. 8 and Fig. 9 show that the benefit to customers by 2020/21 would be much larger if 100% of the Demand residual was applied gross. ⓂCMP264 Original – Avoided embedded benefit saving is £155 (£650m minus £495m), compared with the 100% gross charging which would save the full £650m. CMP265 Original - Avoided embedded benefit saving is £204 (£650m minus £446m), compared with the 100% gross charging which would save the full £650m. Although some of this saving may never materialise if embedded generators choose to cancel Capacity Mechanism contracts to continue to earn Triad benefits instead.</p>
34	UKPR	See separate attachment
35	Green Frog Power	<p>In the short-term we believe there will be significant problems with security of supply and ensuing price increases in level and volatility. We provide a report published by the highly respected energy-market analysts Enappsys, in which they calculate the extent of the impact on system costs in the event of a reduction or removal of triads. If just 10-20 per cent of embedded generation chooses to remain idle through peaks, there will be a very significant impact on security of supply. Very likely the proportion will be higher.</p> <p>It is not in the interest of the consumer to eliminate triads. Though not perfect, it has been effective for many years. If the spiralling of pricing is mitigated, the system could successfully endure for another four decades.</p> <p>In the absence of triads, the market access to small generators would need to improve significantly. Brave souls can of course operate in the BM or day-ahead market, and they can hope to monetise the value of their fast and flexible peaks in those limited sectors. But removing triads takes a very important risk-management tool away from the market. Suppliers and small generators are able to hedge winter peaks well in advance of delivery using triads as the tool to engage with each other and, in effect, lock in value. These products are not (yet) tradable otherwise, and removing triads increases the risk exposure for any parties who are unable to forward hedge because they are not large enough or not vertically integrated. This provides an unfair advantage to larger players (generators and suppliers) and increases the overall risk profile of the electricity market and impacts competition – which will have an adverse impact on consumers.</p> <p>Secure and Promote is not ready to address these issues, as the focus is not yet on the appropriate products. We think Ofgem should reconsider the scope of Secure and Promote when making a decision about undertaking an SCR and approving the final CUSC-modification proposal.</p>

		<p>There have not been any studies of the additional network costs at both the transmission and distribution levels if embedded generation does not generate at peaks. This is clearly a fundamental question that must be addressed before any full and enduring solution is decided upon, ideally in an SCR.</p>
36	The ADE	<p>The following short-term impacts are likely to occur as a result of removing the demand TNUoS embedded benefit:</p> <ul style="list-style-type: none"> ☒ Distributed generators are likely to decrease export during triad periods, resulting in higher net demand. As more than 7.5 GW of distributed generation operates at peak, even a reduction of 15% would result in a 1 GW shortfall in coming winters, during a period of significantly tight security of supply margins. Legacy, large-scale industrial CHP plant are largely operated as baseload generators, but are able to reduce on-site demand and have some flexibility to increase generation during system peak. As these operators are industrial manufacturers with limited engagement in the electricity market, they often struggle to respond directly to market signals and are likely to operate less flexibly during periods of peak demand if the triad charge is removed. ☒ Reports by both Cornwall Energy and KPMG have highlighted that approximately 2 GW of existing distributed generation has received Capacity Market contracts. The removal of the embedded benefit could result in those plant under construction not being completed and existing plant shutting down, resulting in further capacity shortfalls in 2018 and 2019. ☒ Industrial sites which use CHP to improve their efficiency and control their energy costs would see significant cost rises. Some industrial sites would see their costs rise by £5m a year during a time of economic uncertainty, putting manufacturing jobs at risk. Some industrial sites have indicated they will shut down their CHP assets in response to the removal of embedded benefits. <p>District heating sites which use combined heat and power will see their revenue decrease, in the case of one large scheme by 15%, requiring these networks to increase their heat prices to householders. District heating schemes often serve council houses and the fuel poor.</p> <ul style="list-style-type: none"> ☒ Higher wholesale prices, reflecting an increase in the marginal cost of embedded generation and the potential closure of embedded generation in response to the removal of triad benefits. ☒ An increase in the cost of ancillary services as embedded generators need to make up for a shortfall in their revenue through higher contract prices. <p>Over a longer-term, we would expect:</p> <ul style="list-style-type: none"> ☒ Higher levels of reinforcement and other costs at the transmission network level as embedded generation is replaced by transmission connected generation.

		<p>☒ Higher levels of reinforcement and other costs at the distribution network level as the export from embedded generation is reduced.</p> <p>☒ A higher cost of capital for all generation due to the increased risk associated with industry change.</p>
37	Renewable UK	<p>We refer the reader to RenewableUK’s Principles section above, and add here only that the Workgroup has not been permitted to consider in enough detail either the long term or the short term impacts of these CUSC Mods. It is inappropriate to make such material changes to the charging regime on such little evidence and analysis. Paragraph 2.3.37 indicates that the Workgroup has been operating on the assumption that embedded generation contributes 7.5GW of generation (or, via the netting of SVA accounts, reduction in demand) at time of system peak. Too little consideration has been given to the impacts of the loss of portions of this supply in the absence of embedded benefits. We strongly encourage both the Workgroup and Ofgem to conduct in-depth analysis of the impacts/benefits of embedded generation on the system, and to begin a holistic review of the embedded benefits system and all the attendant and associated issues around it.</p>
38	Savvi Energy	<p>There are two perspectives to consider - practical and ideological.</p> <p>Ideological:</p> <ol style="list-style-type: none"> (1) Cost reflective can be taken to mean the marginal cost to the existing transmission system, although a logical approach it cannot really be fully adhered to, as sunk/fixed costs are also need to be assigned. If a truly marginal approach was taken new build generation which did not cause those costs would not be charged. (2) It is the opinion of some that TNUoS charging should be a treated as a tax on generation paying for the greater good of the transmission network (consultation document 3.2.24), if EG pays even when it doesn’t use the transmission network does this imply all onsite/off grid users also pay? Decisions regarding tax should be decided by the government, cost recovery is fundamentally different in nature. (3) A tax like approach on generation to fund TNUoS would be a strong pull to the status quo, and bar any real long term potential for a more distributed network (even if it were to become more cost effective in the long run), sites paying for a system they do not use also has a monopolistic aspect, and could be seen as anti-competitive. (4) Cost reflective could also be taken to mean the cost of a system should be borne by its users, so arguably electricity produced by EG (if used in same GSP)/onsite generation/Off grid should not bear any cost. EG in importing GSPs could argue they do not use the transmission networks, but this would be more difficult for EG in exporting GSPs as some of the electricity produced by EG does use the transmission system. <p>Practical:</p> <ol style="list-style-type: none"> (1) The current system not system does not facilitate effective competition between TG/EG/Demand response.

		<p>(2) It is very hard for most parties to the debate to be unbiased as there are potentially large financial implications to most asset owners. Modelling needs to be completed by a genuinely independent party.</p> <p>(3) The strong time related price signal given to demand and EG currently is a result of increasing transmission network costs and EU legislation, it has not been calculated for the optimal response and is likely not to be cost reflective of its impact on transmission charges. This does not mean that a complete absence of time based signal is optimal: a combination of volume used, time based element and maximum capacity may all be a better reflection.</p> <p>(4) It is important any solution does not discriminate between demand reduction/generation, as this is the bigger distortion, none of the current proposals / alternatives address this.</p> <p>(5) Thought should be given to monetising the less tangible benefits: smaller more numerous distributed generators are less vulnerable to large outages caused by a major plant going offline or intentional attacks on the system. As the cost of such an outage is very high, the reduced risk/impact can be small, but still have a significant value.</p> <p>(6) It is unclear from the information available the extent to which TNUoS costs are incurred by:</p> <ul style="list-style-type: none"> a) Transporting electricity between GSPs b) Transporting TG to the local DNO c) Overheads d) How peak capacity effects these costs in long/short run <p>It is also unclear the extent to which Transmission connection charges are recovered via TNUoS (compared to the distribution charges, which are to be more expensive upfront). Without the above calculations and in the absence of the context of a wider TNUoS</p>
39	RES	No
40	Watt Power	It is impossible to predict with any precision the impact on consumers, since it will depend on a host of market factors. However, it is certain that, in both the short and long run, the Capacity Market clearing price would need to be significantly increased and that the wholesale electricity price at peak will be higher. These factors mean that there will be a large and unequivocal windfall transfer from consumers to grid connected generators that will dwarf any reduction in embedded benefits.
40	Plutus	As noted previously, if the suggested modifications were to remove triad benefit for new plant and/ or those with a CM contract, this would further incentivise investors to construct on-site or private wire generation. We believe there are potentially significant impacts from simply removing the triad benefit without wider consideration of the costs currently dealt with by the residual.

		<p>We also believe that depending on the extent of the cut in the residual, there could be a significant impact on existing and proposed generation. We believe the Working Group should specifically consider the impact on distribution-connected plant economics. If this is out of scope, Ofgem needs to pick this up in its Regulatory Impact Assessment.</p>
41	Reliance	<p>As noted previously, if the suggested modifications were to remove triad benefit for new plant and/ or those with a CM contract, this would further incentivise investors to construct on-site or private wire generation. We believe there are potentially significant impacts from simply removing the triad benefit without wider consideration of the costs currently dealt with by the residual.</p> <p>We also believe that depending on the extent of the cut in the residual, there could be a significant impact on existing and proposed generation. We believe the Working Group should specifically consider the impact on distribution-connected plant economics. If this is out of scope, Ofgem needs to pick this up in its Regulatory Impact Assessment.</p>
42	Silva Renewable Energy Limited – Bilateral Connection Contract holder	No
43	Drax	<p>Currently the consumer is paying too much. Therefore if the issue is not addressed in a timely manner the customer will be paying more. Therefore a pragmatic timescale should be used. For all EGs not subject to grandfathering, the implementation period should not be longer than one full charging year from an Authority decision.</p>
44	ELEXON	No text provided
45	Rockpool	<p>As noted previously, if the suggested modifications were to remove triad benefit for new plant and/ or those with a CM contract, this would further incentivise investors to construct on-site or private wire generation. We believe there are potentially significant impacts from simply removing the triad benefit without wider consideration of the costs currently dealt with by the residual.</p> <p>We also believe that depending on the extent of the cut in the residual, there could be a significant impact on existing and proposed generation. We believe the Working Group should specifically consider the impact on distribution-connected plant economics. If this is out of scope, Ofgem needs to pick this up in its Regulatory Impact Assessment.</p>

<p>46 late response (rec'd 1 Sept 16)</p>	<p>Calon Energy</p>	<p>We note that there have been concerns about the impact of the proposals on peak prices were the embedded generation to no longer despatch at peak for Triad payments. However, these parties should be able to find different routes to market, either directly or via a supplier. We note that some companies are now BSC parties, so we are not convinced that market access is the problem. However, setting that aside, there is a problem that the longer term prices are not creating signals to build new plant without substantial CM payments. We believe that the energy price signals should not only be telling parties when to generate, but also sending strong signals on demand to load shed.</p> <p>For a given peak half hour, the TNUOS embedded benefit is high and the predictability is decreasing as there is greater embedded generation. As a result, half hourly prices no longer reflect marginal economics or scarcity but instead reflect the desire to reduce annual charges. We believe this leads to an inefficiency to an extent that was not envisaged when the current market mechanisms were established.</p>
---	---------------------	--

Question 17: Do you feel that both the locational and residual component of the demand TNUoS should be removed as an embedded benefit (as CMP264 Original) or just the residual component (as CMP265 Original) or some other method? (Both CMP264/265)

Response No	Company	Response
1	CLP Envirogas	Neither should be removed.
2	Engie	We believe that the locational element should remain plus an embedded substation benefit of £3-4/kW applied in addition to the locational tariff in accordance with CUSC 14.15.119 possibly added to the demand locational tariff for simplicity. Please see analysis in the Appendices.
3	RWE Generation UK plc, RWE Supply & Trading GmbH	<p>We do not believe that the locational component of the demand TNUoS tariff should be removed as embedded benefit. In this context we note that Ofgem state that “<i>We support the current approach of “forward looking locational signals being provided that network users”</i>” and that “<i>We think that this should continue to apply to EG in relation to its impact on the transmission system</i>” (Ofgem “Open letter: Charging arrangements for embedded generation”, 29th July page 4). We endorse this approach. However further work is required to explore the cost reflectivity of the locational component of the tariff and the relevant charging base.</p> <p>We agree with Ofgem that the residual component of the demand TNUoS tariffs relates to cost recovery and this element of the tariff may result in market distortions that “<i>will continue and will likely increase</i>” Ofgem “Open letter: Charging arrangements for embedded generation”, 29th July page 5). Therefore it is essential that any modification proposal addresses the underlying issues associated with this element of the tariff.</p>
4	EPR Ely Limited	Neither should be removed.
5	EPR Glanford Limited	Neither should be removed.
6	EPR Eye Limited	Neither should be removed.
7	Statera Energy	We believe the locational element should be retained (and possibly enhanced). We also believe a review of whether the Demand zones are appropriate for netting embedded output (i.e. there are 2 demand zones in Scotland so the embedded generation might not be local to it’s actual demand – and may use substantial amounts of the network).

		We believe it is not justified to completely remove the residual element as there is clearly dispute as to the actual benefit embedded generation provides. Until a holistic review is completed to ensure a level-playing field, a sudden removal of the residual element would cause severe damage to the embedded industry. Instead fixing it at £35/kW + RPI would resolve the concerns around being linked to the Demand Residual and would allow more thorough review of all connection and use of system charging.
8	<i>EPR Scotland Limited</i>	Neither should be removed.
9	TATA Chemicals Europe	Comments removed for publication
10	EPR Thetford Limited	Neither should be removed.
11	<i>LondonWaste Ltd</i>	Neither should be removed.
12	PeakGen Power Ltd	We believe that the removal of the location and / or residual element is incorrect. We have detailed out thinking on other methods in our introduction. We support a review of the value of the locational element of the TNUoS charge which could lead to sharper locational pricing and reduced residual charges.
13	<i>Statoil ASA</i>	No text provided
14	Good Energy	For reasons set out above, it would not be appropriate to remove either the locational or residual elements of TNUoS benefit. However, it should be highlighted that there is absolutely no sound economic justification for the removal of the locational element
15	<i>REstore</i>	No text provided
16	EDF Energy	Only the residual component of the demand TNUoS should be removed, as is the case in CMP 265 Original. The approach in calculating demand and generation TNUoS is to compute forward-looking locational signals for application via their tariffs to these network users. The signals are designed to promote efficient use of the network by providing a signal to generators of the impact that their location decision has on the estimated need for transmission network investment. This currently applies also to embedded generation, because a consequence of the fact that EG is charged the negative of the demand raw locational charge, is that it is exposed to roughly the same signal as the generation raw locational charge for transmission-connected,

		and >100 MW embedded, generators – as it should be.
17	Tees Valley Combined Authority	We disagree with the removal of either. We do however note the irony that CMP264 would leave new plants supporting sunk transmission costs and old plant not doing so – this reveals the false premise of the proposals.
18	Octopus Investments	We feel that neither should be removed
19	The Greenspan Agency Limited	No text provided
20	Centrica	We believe embedded generation exports should face a cost reflective locational signal and their overall tariff should be broadly equivalent in value to that of transmission connected generators in similar locations
21	<i>ScottishPower Energy Management Limited</i>	The locational component of the demand TNUoS tariff provides a signal to embedded generation which is analogous to the locational components of the Generation. However, there is a risk that retention of the demand location component could result in perverse incentives on embedded generation in demand zones with a negative locational component to avoid generating over the Triad period. This would not assist the System Operator or DSOs to manage the system at times of high demand and could result in additional costs to consumers through the requirement to dispatch additional transmission connected plant. We would recommend that, should the demand locational component be retained, this should be “floored” at zero. Retention of the demand locational component may also require more complex TNUoS billing systems.
22	Eider Power Reserve	Absolutely not in either case. These are both fundamentally incorrect approaches
23	Renewable Energy Association	No. All forms of transmission network net demand reduction should be treated equally. The locational element of the TNUoS demand charge was not reviewed as part of the Project TransMIT process, and it may not be as cost-reflective as it could be. We would recommend a review of the TNUoS demand charge to consider whether the balance of the charge between locational and residual is appropriate before implementing any changes to the embedded benefit regime.
24	Infinis Energy	The locational aspect should be maintained in order to drive a locational signal to generators. In addition embedded generators should receive an additional amount reflecting their support for the wider system. This might include: an Avoided Local Reinforcement Charge to reflect the saving to the transmission company on infrastructure costs around the GSP; an Avoided Wider Reinforcement Charge to represent wider network savings; and the TNUoS

		Generation Residual where negative to prevent further market distortion between embedded and transmission-connected plant.
25	<i>RWE Innogy UK- RWE npower joint submission</i>	Some other method is required, we do not support either CMP264, CMP265 or any of the associated WACM proposals. We feel that some form of locational element of the charge should remain. We also feel that there needs to be sufficient residual such that no demand tariff becomes negative. Negative demand tariffs could lead to escalating demands during system peak which would utilise all available generation, push up energy costs and threaten security of supply. We also believe a certain amount of the residual should remain in addition to the locational signal to reward any load management which is beneficial to the SO. Total removal of the residual component would be detrimental to the overall cost of maintaining the transmission network.
26	Sembcorp Utilities (UK) Limited	No text provided
27	Smartest Energy	Some other method. We do not believe that the residual needs to be removed. Some of the costs within it need to be moved into the locational element or recovered in some other way
28	UK Green Investment Bank plc	In present circumstances it is inappropriate to address removal of either the locational or residual component of demand TNUoS in isolation. A preferred approach would be to consider all aspects of demand TNUoS and related embedded benefits as part of a comprehensive review of network system charging, taking full account of expected developments in system operation, future generation mix and behaviour of demand-side participants. This would best be undertaken as a Significant Code Review.
29	Alkane Energy Limited	<p>We believe a further thorough review of the TNUoS charging regime must be undertaken given the demand residual outcomes now being forecast. Retaining the locational benefit for EG is preferable to removal of the total benefit including residual, but still is we believe not fully cost reflective of the benefit delivered by EG.</p> <p>There is an increasing conflict between cost reflectivity and “fair” competition. The group behind the December 2013 consultation on embedded benefits issued by NG felt cost reflectivity was most important. <i>“There was a general agreement within the focus group that the following two remits were areas for consideration when discussing potential defects.</i></p> <ul style="list-style-type: none"> • <i>Cost reflectivity of transmission charges on distribution connected generation.</i> • <i>Impact of transmissions charges on competition between transmission and distribution connected generation.</i> <p><i>These were primarily based on the charging objectives of cost reflectivity and facilitating competition. These were presented to the focus group by the Chair for their views on whether the remits should be classed as defects themselves. Most of the focus group felt that there was no clear defect or impact on the embedded benefit within the two apparent defects presented and preferred the term ‘remit’ over ‘apparent defect’. Some members believed that cost reflectivity should take priority over</i></p>

		<p><i>competition and that by addressing cost reflectivity it should in turn address competition. A view was expressed that applicable CUSC objective b (cost reflectivity) should always be considered first as competition can only be considered in a broader sense. Therefore the review should focus on cost reflectivity. There was general support that, even if there were no apparent defect, that cost reflectivity of the embedded benefit could be improved."</i></p> <p>In practice it is however the desire of a "level playing field" for competition that is actually causing the issue and driving both Proposers to define the defect. The EU Directive imposing the EUR2.50/MWh cap on transmission costs passed to generators was largely driven by improving the fairness of competition between member states. However as already noted, the implementation of this in the UK will drive payments to be made to almost all onshore transmission connected generators by 2020/21. This cannot be considered cost reflective and could paradoxically put the UK transmission generators at a competitive advantage from this date when it comes to exports across interconnectors.</p> <p>It is this cap which is driving demand residual up so high – demand residual is (in the current charging regime) the only place to allocate costs. Ultimately the consumer is obliged to pay the costs– in question is the route through to the consumer and what distortions this this may deliver along the way.</p>
30	Uniper	The locational signal is not an issue, as it provides a cost reflective forward looking signal. We agree that the issue lies with non-cost reflective distortion arising from the Demand TNUoS Residual component of the tariff.
31	EON UK	<p>We believe there is a clear case that a locational element of the demand TNUoS embedded benefit should be retained. However, whether the current locational element represents the total value of the transmission costs avoided as a result of embedded generation is not clear based on the analysis conducted so far.</p> <p>The residual component, whilst not cost reflective in the sense that it is not built up of a series of separate, explicit costs, nevertheless covers a number of costs associated with running and investing in the transmission network. Some of these may well be avoided if embedded generation is used.</p> <p>Understanding the components of the demand residual is crucial in order to determine how much of it should be reflected in any embedded benefit. We note that a number of bodies have attempted to draw conclusions about elements of the demand residual which should be reflected in a benefit, with conclusions ranging from very low numbers in the case of the proposers of CMP 264 & 265 but much higher numbers from other analysis such as Cornwall Energy's recent review of embedded benefits.</p> <p>Until a robust, independent and thorough review is carried out we do not believe it is possible to conclude how much of the current residual component should be reflected in an embedded benefit.</p> <p>Implementing CMP 264 or 265 moves to an extreme position where the benefit of embedded generation in terms of transmission costs is valued either at zero or very low. Without concrete analysis to support this view we do not believe such a position is justified</p>

32	Welsh Power Group Limited	We do not support either proposal and consequently do not believe removal of either element is appropriate
33	SSE	<p>We agree that the Demand Residual should be removed as an embedded benefit, although it would also be beneficial to maintain a part of the Demand Residual embedded benefit for a short transitional period and also to enable a level playing field with transmission connected generators by including a net element equal to the generation TNUoS residual. The Year Round tariff element should also be removed as an embedded benefit on the Triad demand charging base, because it would only be cost reflective to provide a Year Round embedded benefit if this was applied to a year round charging base (not a peak charging base such as Triad). The Peak Security tariff embedded benefit should be maintained. The reasoning is provided below: Demand Residual tariff element (gross) – Yes, agree with both CMP264 and CMP265 Original that this should be removed as an embedded benefit i.e. charged on a gross basis. Year Round tariff element (gross) – Agree with CMP264 that this should be removed as an embedded benefit i.e. charged on a gross basis. As per the reasoning provided in answer to question 2 of this consultation response - the Year Round tariff element does not provide a cost reflective price signal when it is applied to the Triad charging base. However, there is an opportunity for a future modification to change the definition of the charging base used for the Year Round tariff element such as to a commoditised £/MWh basis. Only after the charging base has been appropriately changed would it be appropriate to reinstate the Year Round tariff element on a net basis to be re-included in the price signal provided to embedded generators by the value of the embedded benefit. Peak Security tariff element (net) – Agree with CMP265 that this tariff element should be maintained charged on a net basis, so the embedded benefit with regard to this tariff element is maintained. New interim element of Demand Residual (net) – Support the approach used in the Centrica 2 proposed alternative which would set a value of “£x/MWh” equal to the value of the Generator TNUoS Residual. This may not be justified by cost reflectivity, but could be a good interim solution to address the issues of “level playing field” and effective competition until a wider review of charging can be carried out. New Transitional element of the Demand Residual (net) – If the date of the removal of the Demand Residual embedded benefit is relatively late (such as 2020/21), then a transitional step change descending cap should be applied to the net element of the Demand Residual as soon as practicable (ideally 2017/18). This would limit the cost to customers during the intervening time. This approach is described in the answer to question 2.</p>
34	UKPR	See separate attachment
35	Green Frog Power	<p>A full SCR is required to address this question in a way that will truly offer long-term stability. In the meantime, we think that the level of TNUoS residual should be frozen or capped at a level that will enable appropriate levels of investment across the industry while a full review is undertaken.</p> <p>As noted in our response to earlier questions, we think that the locational signal needs to be sharpened rather than removed.</p>

36	The ADE	No. All forms of transmission network net demand reduction should be treated equally. The locational element of the TNUoS demand charge was not reviewed as part of the Project TransmiT process, and it may not be as cost-reflective as it could be. We would recommend a review of the TNUoS demand charge to consider whether the balance of the charge between locational and residual is appropriate before implementing any changes to the embedded benefit regime.
37	Renewable UK	RenewableUK believes that both the locational and residual components of the demand TNUoS tariff should continue to be paid to embedded generators until such times as the elements of the demand TNUoS tariff are brought into line with the generator TNUoS tariffs via the Project TransmiT methodologies, and until a holistic review of the impacts/benefits of embedded generation is conducted by Ofgem. This way, an assessment of cost reflectivity can be conducted in an evidence-based manner.
38	Savvi Energy	There should never be a locational signal that causes a negative Triad Charge. If any EG were subject to this, they would have to switch off over any period they that might be a triad. Any time there is an expectation of high demand, EG switching off would exacerbate the demand. In reality, it would bar EG from Triads <u>and</u> generating over any winter peak price periods -this would be of particular impact to onshore wind in Scotland. Affected windfarms would have to switch off whenever demand looked high, distorting the merit order, reducing system stability and increasing balancing costs.
39	RES	At this stage, RES considers that both approaches have been insufficiently considered, are arbitrary in nature and are likely to create undue discrimination. To this extent, we would not support either option until the holistic review of commercial arrangements has concluded.
40	Watt Power	As stated previously, we are not in support of either proposal and feel that changes to the charging arrangements should be brought about through a more holistic review under an Ofgem SCR. Alternatively, a wider reaching CUSC modification proposal should be raised, which could better address current concerns. However, focusing on the assessment of the two proposals currently under review, we strongly oppose the removal of both the locational and residual component of the demand TNUoS (as proposed by CMP264 Original). We would suggest an embedded benefit of the demand TNUoS locational component + 2016/2017 residual.
40	Plutus	The locational aspect should be maintained in order to drive a locational signal to generators. In addition embedded generators should receive an additional amount reflecting their support for the wider system. This might include (as noted in response to question 18): an Avoided Local Reinforcement Charge to reflect the saving to the transmission company on infrastructure costs around the GSP; an Avoided Wider Reinforcement Charge to represent wider network savings; and the TNUoS Generation Residual where negative to prevent further market distortion between embedded and transmission-connected plant
41	Reliance	The locational aspect should be maintained in order to drive a locational signal to generators. In addition embedded generators should receive an additional amount reflecting their support for the wider system. This might include (as noted in response to question 18): an Avoided Local Reinforcement Charge to reflect the saving to the transmission company on infrastructure costs around the GSP; an Avoided Wider Reinforcement Charge to represent wider

		network savings; and the TNUoS Generation Residual where negative to prevent further market distortion between embedded and transmission-connected plant.
42	Silva Renewable Energy Limited – Bilateral Connection Contract holder	<p>No at the very least the locational should remain in order to drive a locational signal to generators and therefore better meet CUSC charging objectives.</p> <p>Further work is required to understand what part of the residual charge is sensitive to local netting.</p>
43	Drax	We believe that the residual element of the demand TNUoS should be removed. Please see answer to question 1 above.
44	ELEXON	No text provided
45	Rockpool	<p>The locational aspect should be maintained in order to drive a locational signal to generators.</p> <p>In addition embedded generators should receive an additional amount reflecting their support for the wider system. This might include (as noted in response to question 18): an Avoided Local Reinforcement Charge to reflect the saving to the transmission company on infrastructure costs around the GSP; an Avoided Wider Reinforcement Charge to represent wider network savings; and the TNUoS Generation Residual where negative to prevent further market distortion between embedded and transmission-connected plant.</p>
46 late response (rec'd 1 Sept 16)	Calon Energy	Yes. We can see no case for any embedded benefits unless they are truly reflective of all externalities and do not create distortions in either short-run or long-run pricing.

Question 19: Regarding the proposed alternatives what are your views on the suggested implementation dates? Are these achievable? Please give reasons for your view (Both CMP264/265)

Response No	Company	Response
1	<i>CLP Envirogas</i>	No comment.
2	<i>Engie</i>	<p>Please see Appendix F for further comments on the Green Frog and UK Power Reserve proposals:</p> <p>Green Frog:- We do not support this proposal. The level of residual proposed exceeds the cost reflective value by a factor of 10 and there is no evidence to support the proposed value.</p> <p>UK Power Reserve (1 and 2): We do not support these modifications, it protects existing/nearly built embedded generators with CM/CFD contracts with grandfathering. As such they are discriminatory and the level of residual (even at the current level) exceeds by a factor of 10 the cost reflective value. There is no evidence to support the proposed value.</p> <p>Centrica (1): We support this proposal as being an improvement over the current CUSC arrangements</p> <p>Centrica (2): We support this proposal as being an improvement over the current CUSC arrangements. We think an embedded substation benefit of £3-4/kW applied in addition to the locational tariff in set in accordance with CUSC 14.15.119. Practically, setting the lowest location tariff to zero may achieve both objectives. Implementation should be next following 1st April after an Authority decision. This gives sufficient time for change and the maximum benefit to consumers. See the Technical Appendices for detailed analysis.</p>
3	RWE Generation UK plc, RWE Supply & Trading GmbH	The workgroup report and Ofgem's Open letter highlight the issues associated with the cost reflectivity of demand TNUoS charges and potential market distortions. A comprehensive and enduring solution is required. The modification proposals and possible alternatives proposed in the workgroup consultation do not represent such a solution. Therefore further work is required to identify and develop appropriate cost reflective enduring arrangements for demand TNUoS charging.
4	<i>EPR Ely Limited</i>	No comment.
5	<i>EPR Glanford Limited</i>	No comment.
6	<i>EPR Eye Limited</i>	No comment.
7	Statera Energy	No comments.

8	<i>EPR Scotland Limited</i>	No comment.
9	TATA Chemicals Europe	No comment
10	EPR Thetford Limited	No comment.
11	<i>LondonWaste Ltd</i>	Neutral
12	PeakGen Power Ltd	We would suggest that adoption of the Green Frog alternate proposal as an interim solution would provide the appropriate stability that the industry needs to deliver security of supply in the short term, and allow a significant code review to be undertaken.
13	<i>Statoil ASA</i>	No text provided
14	Good Energy	As set out above, implementing any significant changes as set out here by June 2017 would be highly disruptive for PPA negotiations which are already in progress. This timescale could also introduce substantial risk to any projects for which significant investment commitment has already been made, but which may not be commissioned by 30th June 2017
15	<i>REstore</i>	No text provided
16	EDF Energy	<p>Centrica's alternative features an implementation date of 1st April 2020 which matches CMP265 original, giving a generous amount of time for all parties to prepare for this change.</p> <p>Green Frog's alternative to CMP264 has a nominal implementation date of 1st April 2017, and an actual implementation date of 30th June 2017. This is so soon as to be potentially problematic in systems terms. In terms of notice to parties, since it grandfathers today's embedded residual-charge-related embedded benefit of £45/kW plus RPI, it does not represent a step change, and so may have less need of notice; although this is shorter notice of change that is generally preferred.</p> <p>UKPR's alternative to CMP264 also has a nominal implementation date of 1st April 2017, and an actual implementation date of 30th June 2017. It mirrors CMP264, yet making the application of the 30th June 2017 threshold date more lenient such that more generation can qualify for "grandfathering", since qualification under this alternative is no longer G59/2 commissioning, but the award of a CM or CFD contract much earlier in the project's life. Our comment on UKPR's alternative to CMP264 would be the same as for CMP264 original : the date is rather early, and hard for BSC systems changes to accommodate. It may need a workaround. It represents a little less notice that is normally preferable for such a change.</p>

		UKPR's alternative to CMP265 matches CMP265 original in its implementation date in 2020. The timeframe is workable, it is other features of UKPR's alternative to CMP265 that are not desirable
17	Tees Valley Combined Authority	We have no comments on this.
18	Octopus Investments	We do not support the Centrica or UKPR proposals and believe that the Greenfrog proposal is the best approach. The implementation dates are achievable on all the proposals except the UKPR option which is not deliverable due to the complexities of its implementation. A consolidated register of CMU that took contracts in the 2014 and 2015 auctions does not currently exist and suppliers and National Grid would need to undertake significant adjustments to their payment/billing systems in order to differentiate between embedded generators based on their CM contract position. We do not believe that this could be achieved by April 2017.
19	The Greenspan Agency Limited	No text provided
20	Centrica	In general, the April 2017 implementation dates appear challenging and the April 2020 implementation dates appear feasible.
21	<i>ScottishPower Energy Management Limited</i>	While we do not support the "Green Frog et al" Alternative, their implementation dates appear achievable. We do not support the implementation date for "UKPR2" and "Centrica 1 &2" of 1 April 2020 as we believe that the ability to secure embedded benefits in the period until 1 April 2020 has the potential to distort Capacity Mechanism auction in the intervening period.
22	Eider Power Reserve	We consider that any change pending an SCR should be both minimal in impact, be supportable and be capable of rapid and easy implementation to make any difference within the time line of an SCR. We consider that all of the alternatives fail to achieve this goal
23	Renewable Energy Association	The REA has no comment.
24	Infinis Energy	No views.
25	<i>RWE Innogy UK- RWE npower joint</i>	We do not support either CMP264, CMP265 or any of the associated WACM proposals. Clearly this is a complex charging problem that needs to be addressed in a timely manner in the interest of the consumer and generator competition. Given its complexity we anticipate any viable solution would be a significant change to the charging methodology. It is important that

	<i>submission</i>	any such solution is implemented minimum 3 years after the Authority Decision. The Ofgem decision itself will provide the correct signal to CM (the date of implementation is less critical). A robust enduring solution is required to address the defect identified. Further consideration is also required on the future of TNUoS charging so as to ensure stability.
26	Sembcorp Utilities (UK) Limited	No text provided
27	Smartest Energy	Centrica's proposals (2020) are achievable. Greenfrog's et al.'s and UKPR 1 proposals (2017) are not achievable. UKPR 2 (2020) is achievable
28	UK Green Investment Bank plc	No comment.
29	Alkane Energy Limited	Based on Workgroup discussions to date and the complexity of the issues involved and interaction with industry systems including suppliers and Elexon, we do not think implementation by the 2017/8 season is credible (we recollect it has been variously described as "challenging" and "impossible"). An earliest implementation date of 2018/9 seems more reasonable and deliverable. Although this means the existing Triad regime would influence the Early Capacity Auction of 2017/8, this is a one year auction and it would be extremely difficult at this stage to build more capacity on sites without existing contracts in place and guarantee those would be able to deliver by October 2017. It would however ensure that capacity bidding into the T-4 auction for delivery in 2020/21 would certainly be affected as would non CM plants built to deliver after October 2018. Early certainty would be welcomed therefore consistent with not undermining past investment decisions we would support the earliest possible credible implementation date.
30	Uniper	Whilst they seem achievable, they do not remove the distortion early enough.
31	EON UK	Centrica 1, Centrica 2 and UKPR2 all have implementation dates of April 2020. We believe this does give sufficient time to implement any necessary changes should any of these proposals or a variation of them be approved (although we note that Centrica's proposals are likely to require more change than others given the wider scope of plant affected). As highlighted in response to Q2, implementing changes as early as April 2017 is likely to require costly manual workarounds and risks undermining investment decisions that have already been made (although we note that the impact of this is limited in Green Frog et al's proposal)
32	<i>Welsh Power Group Limited</i>	We believe any proposed implementation date before 2020/21 is unrealistic. The changes required to business models, charging arrangement, supplier contracts and industry processes require significant lead times. We also consider that the rush to implement a partial solution is unnecessary and unwarranted. Neither proposal adequately addresses the defect and it is unlikely that either will survive as an enduring solution. To rush implementation risks continual changes and flux in market

		arrangements.
33	SSE	It is easily achievable for implementation to begin 2020/21. As described above, a transitional cap to the net element of the Demand Residual should be implemented as early as practicable – ideally 2017/18.
34	UKPR	See separate attachment
35	Green Frog Power	n/a
36	The ADE	The ADE has no additional comment
37	Renewable UK	RenewableUK is not in a position to comment on this matter.
38	Sarvi Energy	No text provided
39	RES	No clear view at this stage.
40	Watt Power	It is highly unlikely that the necessary changes could be implemented by April 2017. Implementing changes by April 2020 should be possible.
40	Plutus	No views
41	Reliance	No views
42	Silva Renewable Energy Limited – Bilateral Connection Contract holder	No view
43	Drax	See answers above.
44	ELEXON	We note that the CMP264/265 workgroup has considered several Workgroup Alternative CUSC Modifications (WACMs). As we have raised at workgroup meetings, based on what we know about the potential WACMs, we are concerned that defects identified by P348 and P349 are narrow (i.e. they specifically relate to NEGs or CMUs) and may not accommodate the proposed WACMs. The CMP264/265 workgroup will need to urgently consider whether any WACM requires a new BSC Modification Proposal to be raised – particularly if the intention is for the WACM to be implemented over the next 12-18 months.

45	Rockpool	No views
46 late response (rec'd 1 Sept 16)	Calon Energy	We are not experts in the IT systems, but we would urge implementation be aligned with the timing for altering the systems and testing them to make sure that the changes are robust.



Cornwall Energy Ltd
2 Millennium Plain
Bethel Street
Norwich
NR2 1TF
23 August 2016

Dear Sir/ Madam,

Thank you for the opportunity to respond to the Connection and Use of System Code (CUSC) code modification proposals (CMP) 264 *Generation Triad Avoidance Standstill* and 265 *Gross charging of TNUoS for HH demand where Embedded Generation is in the Capacity Market*.

This response to the workgroup consultation attached to this letter is from Infinis. But it also reflects some of the views of other merchant industry participants and investors, including:

- REG Power Management;
- Silva Renewables;
- PlutusPowerGen;
- Reliance Energy; and
- Rockpool.

All of these parties support the need for an holistic solution to the issue of embedded benefits now that change has been initiated, though not all of them see the issues and proposed solutions in the same way. Infinis and REG are concerned about the impact on their existing business and new projects in the pipeline. Silva are very worried about interactions with the forthcoming CFD auction, which seem not to have been thought about by the Working Group, and Plutus, Reliance and Rockpool are more focussed on changes that they feel unduly discriminate between participants in the Capacity Market and a bias to try to tilt the market in favour of transmission-connected generators.

Where they are aligned is in their shared view that both of the changes brought forward to date, and various of the alternatives flagged to the Working Group, do not provide a joined-up solution because they address one particular aspect of the problem or reflect the advocates' specific commercial interests. If not managed carefully, the change process could have significant adverse impacts on both operator and investor sentiment.

We recognise that the transmission network demand residual has increased substantially over the past decade and is forecast to continue doing so due to a range of factors¹. This is not sustainable. But the

¹ Including EU regulations to limit generation transmission charges, increasing allowed revenues and a decreasing demand base.



parties we have been working with believe it would be reckless to withdraw in full the part of the benefit based on the demand residual without careful consideration of National Grid's costs and their drivers. They also believe there are important interactions with the local distribution systems to which they are connected, but these cannot be taken into account under CUSC governance.

One conclusion we have reached from the work we have done in this area is that the value to National Grid and the wider system is greater than the £1.62/kW it maintains based on old analysis. However removing the entire demand embedded benefit (as suggested under CMP264 and 265 in defined circumstances) simply replaces (in different ways) one distortion with another. Neither address the basic cause of the asymmetry, which is the transmission charging methodology itself, which is now out-of-date and does not reflect changes within the wider GB system and has not done so for some time.

We also think the report needs to flag a number of other distortions in the wider energy market to ensure a balanced solution is identified, but which are not taken into account in the current assessment work. These include:

- the different connection policies at distribution and transmission, which are more costly for distribution connected generation and therefore provides transmission connected generation with an advantage when bidding into the capacity market;
- the negative generation residual within TNUoS, which is likely to lead to distortions in the capacity market in future years that favour transmission connected generators; and
- the stronger incentives that will arise to go off-grid.

We have helped Infinis design two workgroup alternative code modifications (WACMs) alongside their consultation response which are designed to provide a more enduring solution. We have tried to take into account the "lines in the sand" included in its 29 July letter.

The first has five main elements:

1. apply an immediate cap to the triad benefit ("transitional cap"). The transitional cap would apply until April 2019, which is the point at which it is envisaged National Grid will have in place a revised methodology;
2. the solution is to move from a net to a gross charging basis for TNUoS for all embedded generation over a set threshold from April 2019;
3. a revised methodology for the purposes of setting the current demand residual charge and its application to output produced by generation above the threshold from April 2019, to be developed by National Grid, which would specifically identify local and wider avoided costs presently recovered through the demand residual charge; and
4. for those generators above the threshold, a further distinction will be drawn between existing plant, which will include plant that already has a CM contract or CfD, who would continue to be subject to net charging and the cap described at (1) after the introduction of gross charging described at (2) and the introduction of the new methodology described at (3);
5. this methodology would also set the triad charge to a minimum value of £0/kW.

The second proposal mimics the same core elements as the first with one exception. Generation connected as of April 2017 would be subject to the transitional cap for an extended period, which we propose should be ten years. This would, we believe, mitigate many of the adverse impacts of a radical and sudden reduction in distribution-connected generators revenue streams, which we believe could undermine security of supply over the short-term. Generators who connect before the 1 April change-over date would benefit from the transitional cap for the remainder of its ten-year life.

Both WACMs provide for:

- an enduring holistic approach that provides a runway transition period for existing embedded generation, which makes an important contribution to system security;

- a cost-reflective market-neutral approach to charging or awarding cost exemption to embedded generation, further meeting the applicable CUSC objectives and charging objectives;
- reduction of avoided transmission charges, limiting the benefits available to distribution-connected generation and thereby reducing consumer costs; and
- certainty for plant already committed to under the capacity market and contracts-for-difference schemes.

On behalf of Infinis and the other interested parties, I would like to thank you for considering these alternative modifications.

Kind regards,



Nigel Cornwall

CUSC.team@nationalgrid.com

24 August 2016

Dear Caroline,

CMP264/265 – WORK GROUP CONSULTATION RESPONSE

Thank you for providing the opportunity to respond to this consultation on the proposals 'CMP264: Embedded Generation Triad Avoidance Standstill' and 'CMP265: Gross charging of TNUoS for HH demand where Embedded Generation is in the Capacity Market' published on 02 August 2016. Within this letter we set out our position as Highlands and Islands Enterprise (HIE).

HIE along with its local partners - the democratically elected local authorities covering the north of Scotland and the islands; Shetland Islands Council, Orkney Islands Council, Comhairle nan Eilan Siar, Highlands Council and Argyll & Bute Council, make representations to key participants on behalf of industry to influence the way in which regulation of the electricity industry is managed in order to ensure the needs and interests of the Highlands and Islands are understood and taken into consideration. HIE also works closely with Scottish Government in relation to regulatory matters.

Covering more than half of Scotland's land mass, the Highlands and Islands is a region that contributes significantly to national economic growth, being rich in opportunities founded on natural and created resources, the skills and talent of its people, a diverse and dynamic business base, culture and creativity, and an active community spirit particularly in rural mainland and island areas. Renewable energy represents a significant opportunity for the region, and embedded intermittent renewable generation features significantly within our communities and key to sustainable economic growth.

Overview

The proposed CMP264 and CMP265 Connection and Use of System Code (CUSC) modifications and the Ofgem open letter 'Charging arrangements for embedded benefits' 29 July 2016 reflect a growing concern within the GB electricity sector with embedded benefit charging arrangements. As a priority, Ofgem is considering the extent to which the Transmission Network Use of System (TNUoS) demand residual payment is cost-reflective as an overvaluation is considered to be distorting investment and dispatch decisions and the outcome of the Capacity Market (DECC Capacity Market Reform, March 2016).

Initial evidence indicates that some embedded benefits are overvalued (Cornwall Energy, May 2016). A reconsideration of current practice to assess whether system-wide and consumer benefits can be derived from changes to current arrangements is therefore welcome.

HIE considers that greater clarity over the potential level of efficiency and consumer savings to be derived from changes in embedded benefit arrangements is required. The extent to

which consumers are exposed to the costs incurred by suppliers through the payment of triad avoidance to embedded generators is unclear as is the potential impact that increased uncertainty from regulatory change could have on overall cost savings to consumers (for instance due increased financing costs for projects).

It is therefore imperative that a careful, systematic approach is taken including a robust impact assessment to understand the market-wide impacts of the proposed changes on generators and consumers. Greater clarity is also needed on the long-term impact of the changes to ensure that charging arrangements are fit for purpose and lead to describable outcomes for the future energy system.

A primary concern for HIE is that while dispatchable generators can capture triad avoidance benefit more readily than intermittent generators, triad avoidance benefit represents an important revenue stream for embedded renewable energy projects. Due consideration must be given to the potential impact new charging arrangements could have upon these generators and the short-term and long-term network benefits investment in distributed renewable generation and storage can offer should be reflected in any new arrangements.

HIE is also concerned that such significant changes to the charging regime would, at this time of ongoing wider uncertainty within the energy industry, further undermine investor confidence – leading to delays on new generation projects, reduced capacity margins and security of supply, increased marginal costs for wholesale electricity and higher financing costs – all of which will result in higher costs for consumers.

CMP 264 and CMP 265

HIE does not support the fundamental principle that sits at the foundation of both of the modification proposals – that suppliers should be charged for gross, not net, demand during triads. We believe that both proposals are likely to result in discrimination between different user types (i.e. DSR and behind-the-meter generators Vs embedded generators), further distorting the electricity market. Whether a demand customer within a GSP group reduces demand during the triads (via DSR or behind the meter generation/storage) or an embedded generator increases its output during the triads, the net impact on the transmission system is the same – a reduction in flows from the transmission system to the distribution network and therefore a reduction in demand TNUoS charged to the relevant supplier. It is not clear why the charging arrangements should discriminate between these two actors – as the impact on the transmission system is indistinguishable. Therefore, we do not agree that there is a clear argument to differentiate between these groups of embedded customers from a transmission charging perspective.

Further, HIE does not see strong evidence for retaining locational tariffs only for embedded generation. There is no evidence provided which supports this approach to indicate that it is more cost reflective and fair. Applying one element of the TNUoS charge to one group of system users is further discrimination – as no other system users are exposed to only the locational element of transmission charges.

There is a particular impact on generators in Scotland from this specific proposed change as the locational demand charge is heavily negative in both the north and south of Scotland (circa -£17/kW). Therefore, removing the residual element (but maintaining liability for the locational) would not only remove a benefit from generators but would introduce a significant additional charge, over and above the distribution use of system charges faced by these projects. This would therefore provide a perverse incentive to generators in these areas to minimise output (and perhaps maximise demand) during triad periods.

As set out in the modification proposal form, CMP264 is predicated on halting “*New Embedded Generators*” from achieving triad avoidance from 01 April 2017 until “*Ofgem has*

completed its consideration of the current electricity transmission Charging Arrangements.” However, Ofgem has stated in its recent open letter (dated 29 July 2016) that “the [CUSC] modifications” are better suited for taking forward changes in relation to embedded benefits. Therefore, we believe that CMP264 is no longer relevant and cannot achieve an enduring solution.

Further, this proposal will in effect ‘grandfather’ triad avoidance benefit for existing generators. In its decision notice (12 August 2015), Ofgem rejected the modification proposals under CMP239 for grandfathering small generator discount as it would discriminate between new and existing generators. Therefore, given this precedent set by Ofgem, we do not believe that protecting existing customers over new customers is appropriate.

We note that the premise of CMP265 is that the netting of output from embedded generators with Capacity Market contracts should be removed when determining liability for the residual HH demand TNUoS charges. In its consultation, dated 01 March 2016, on reforms to the Capacity Market, DECC (now BEIS) raised concerns about embedded benefits and they may “over-reward distribution-connected generators such as diesel reciprocating engines”.

It is clear therefore that the perceived charging defect raised in this modification proposal is specific to the Capacity Market. Therefore, we consider that instead of the current attempts to make corrections to the transmission charging regime to address the issue, it is more appropriate to seek remedies within the Capacity Market arrangements.

We hope this response is helpful, and look forward to seeing the results of this consultation in due course.

Yours sincerely

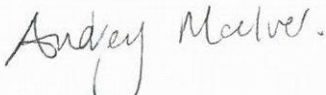

Audrey MacIver
Head of Energy

In partnership with:-
Shetland Islands Council
Orkney Islands Council
Comhairle nan Eilean Siar
Highland Council
Argyll & Bute Council

Dear CUSC Team,

The REA is the largest renewable energy trade association in the UK. Our members range across the supply chain and vary in size from vertically integrated supply companies to small installers. The REA would like to make the following comments regarding the CUSC Modification proposals CMP264 and CMP 265 being consulted on.

In general, we are opposed to a proposed change to the Embedded Benefit without a major and appropriately timed review. Such a major industry change being proposed through the CUSC group is also undesirable as it limits opportunities for industry engagement across all affected stakeholders.

We would highlight in particular:

- The concept of net charging, and subsequently the embedded benefit, has been a transmission network principle from before 2001. The proposal to remove this principle and implement an entirely different charging regime within nine months is unrealistic and likely to result in significant harm to generators and consumers.
- The defect identified in CMP264 and CMP265 would represent a significant shift in the competitive nature of the electricity generation marketplace, yet will have been made without any robust analysis or quantitative investigation.
- Due to the accelerated timetable required by the Regulator for this work group, no analysis was performed and no evidence was provided on the cost reflectivity of the embedded benefit. The work group was not permitted to investigate either the cost-reflective value of the embedded benefit, nor was it permitted to investigate the costs which are included within the TNUoS demand residual.
- The best approach to address this issue in a fair and equitable manner, across all users, is to review the TRIAD charge itself – both the triad methodology and its use of peak charging, as well as the size of the residual. To meet the Applicable CUSC Objectives, the CUSC Panel and the Regulator should take a careful, considered, holistic and system approach to this issue.

Please don't hesitate to contact us to discuss this further using the details below.

Kind regards,
Frank

Frank Gordon
Senior Policy Analyst



25 Eccleston Place

Victoria

London, SW1W 9NF

DD: +44 (0)207 981 0860

Switchboard: +44 (0)20 7925 3570

Web: www.r-e-a.net

Follow the REA on Twitter: [@REAssociation](https://twitter.com/REAssociation)

Specific questions for both CMP264 and CMP265

9 i) Suppliers: In setting charges for your demand customers, do you charge them at the same tariff as National Grid charges you (i.e. gross), to enable you to pay the embedded benefit to embedded generators, or please explain the way in which it is funded?

ii) Suppliers: Does the estimate that 7.58GW of embedded generation output and 2.5GW of demand side reduction at the time of Triad for 2016/17 seem reasonable based on your knowledge of the UK market? If not what is your estimate of embedded generator output and DSR at time of Triad?

The REA has no comment.

12. Can you identify – either quantitatively or qualitatively - the impact of the demand TNUoS embedded benefit on your decisions made in making capacity market decisions?

The current uncertainty in the marketplace, as a result of both the CMP264 and CMP265 proposals, is that members would not rely on embedded benefit value when making their Capacity Market investment decisions. Members have advised us they will not bank embedded benefit value when making their investment decisions, and lenders and investors will not invest against embedded benefit value.

Analysis by Cornwall Energy found that the removal of the TNUoS and BSUoS embedded benefit would increase Capacity Market prices in the 2016 auction by £2/kW. This difference would add more than £100m to Capacity Market costs. However, the analysis found that the increase in Capacity Market price was insufficient to make any significant difference to whether new transmission-connected generation assets were successful in the market.

15. i) What are your views on the 2 broad options to enable the reporting of gross export metered data?

ii) Would you have the data available required for Option B (both CMP264 and CMP265) for both new contracts and existing contracts where a customer may be partially exempt?

iii) Do you believe you can implement the proposed changes by the respective implementation dates?

iv) What are the pros and cons of the 2 proposals that ELEXON are considering to implement this (P348 for CMP265/ P349 for CMP264)?

The REA has no comment.

16. Do you have any further evidence / comments on the consumer impact of changing the demand TNUoS embedded benefit in either the short-run or long-run?

The following short-term impacts are likely to occur as a result of removing the demand TNUoS embedded benefit:

- Distributed generators are likely to decrease export during triad periods, resulting in higher net demand. As more than 7.5 GW of distributed generation operates at peak, even a reduction of 15% would result in a 1 GW shortfall in coming winters, during a period of significantly tight security of supply margins. Legacy, large-scale industrial CHP plant are largely operated as baseload generators, but are able to reduce on-site demand and have some flexibility to increase generation during system peak. As these operators are industrial manufacturers with limited engagement in the electricity market, they often struggle to respond directly to market signals and are likely to operate less flexibly during periods of peak demand if the triad charge is removed.
- Reports by both Cornwall Energy and KPMG have highlighted that approximately 2 GW of existing distributed generation has received Capacity Market contracts. The removal of the embedded benefit could result in those plant under construction not being completed and existing plant shutting down, resulting in further capacity shortfalls in 2018 and 2019.
- Industrial sites which use CHP to improve their efficiency and control their energy costs would see significant cost rises. Some industrial sites would see their costs rise by £5m a year during a time of economic uncertainty, putting manufacturing jobs at risk. Some industrial sites have indicated they will shut down their CHP assets in response to the removal of embedded benefits.
- District heating sites which use combined heat and power will see their revenue decrease, in the case of one large scheme by 15%, requiring these networks to increase their heat prices to householders. District heating schemes often serve council houses and the fuel poor.
- Higher wholesale prices, reflecting an increase in the marginal cost of embedded generation and the potential closure of embedded generation in response to the removal of triad benefits.
- An increase in the cost of ancillary services as embedded generators need to make up for a shortfall in their revenue through higher contract prices.

Over a longer-term, we would expect:

- Higher levels of reinforcement and other costs at the transmission network level as embedded generation is replaced by transmission connected generation.
- Higher levels of reinforcement and other costs at the distribution network level as the export from embedded generation is reduced.
- A higher cost of capital for all generation due to the increased risk associated with industry change.

17. Do you feel that both the locational and residual component of the demand TNUoS should be removed as an embedded benefit (as CMP264 Original) or just the residual component (as CMP265 Original) or some other method?

No. All forms of transmission network net demand reduction should be treated equally. The locational element of the TNUoS demand charge was not reviewed as

part of the Project TransmIT process, and it may not be as cost-reflective as it could be. We would recommend a review of the TNUoS demand charge to consider whether the balance of the charge between locational and residual is appropriate before implementing any changes to the embedded benefit regime.

19. Regarding the proposed alternatives what are your views on the suggested implementation dates? Are these achievable? Please give reasons for your view.

The REA has no comment.

Statera Energy Limited

Name: Tom Vernon

Phone: 07515923893

Email: tvernon@stateraenergy.co.uk

cusc.team@nationalgrid.com

10th August 2016

Statera Energy response to CUSC Workgroup Consultation CMP264 ‘Embedded Generation Triad Avoidance Standstill’ and CMP265 ‘Gross charging of TNUoS for HH demand where Embedded Generation is in the Capacity Market’

Dear CUSC Workgroup Members,

Thank you for the opportunity to respond to this consultation. This response is on behalf of Statera Energy Limited.

We believe that both options being presented are drastic, substantial, and unjustified changes that would cause irreversible damage to existing and future Embedded Generators, Demand Side Response market participants and investors who have committed substantial investment in the Great Britain Electricity Market. That said, we acknowledge the substantial rise in the benefit is also unjustified (an unintended consequence of the €2.5/MWh European Regulation passing cost onto the Demand Residual and spiralling costs offshore) and requires addressing, however the entire removal of the embedded benefit is not fully justified. Considering the complexity of the various issues and the need for a thorough review it is not acceptable to rush a modification through in such short timescales in the lead up to capacity auctions.

We would like to draw National Grid and Ofgem’s attention to the ever-increasing cost of being a distributed connected market participant, and encourage a full review of the comparative costs and benefits of being either Transmission connected or Distribution connected in the UK. Again, we would turn to recent National Grid evidence supporting the removal of the Small Generator Discount (see Embedded Benefit Open Letter, April 2014) that showed the average 132kV transmission connectee paid £1.19kW compared with an average of £15.03/kVA for a 132kV distribution connectee. Considering the substantial fall in transmission Generation Residual (i.e. the amount paid by Generation) since this 2014 National Grid assessment it is clear that Distributed Connected Generators were not only at a substantial dis-advantage previously, but are in a much worse position today. According to page 14 of the consultation this continuous decrease in monies paid by Transmission Generators will result in the consumer paying transmission connectees £671.4m a year (Generation residual) by 2020/21, an amount which dwarfs that being paid via the embedded benefit. Therefore we do not believe the current market signals incentivise/dis-incentivise generators as to where they should connect/operate on the network appropriately. We suggest the existing signals are so heavily diluted they are not giving Transmission connected parties appropriate indication as to where they should locate projects. Furthermore Page 21 of the consultation discusses some of the access to market issues faced by distributed generation, further highlighting the un-level playing field. We urge Ofgem to review the market signals being given to market participants to ensure cost-reflectivity (particularly at a regional level), but in a way that considers the fundamental issues such as charging structures, which these modifications do not attempt to address.

There are clearly a number of regulatory issues which are linked via various methodologies, and to adjust just one factor without the others would be deliberately un-competitive and irresponsible in the run up to the Government auctions. Particularly when there is already an un-level playing field between transmission and distribution, continuously reducing transmission charges, and CMP261 demonstrated Ofgem’s willingness to provide regulatory certainty/security to current and future transmission connectees in this area. We therefore urge Ofgem to undergo a fuller, holistic review that



aims to level the playing field and give the appropriate signals to generators as to where they should connect to the network.

We do not believe the changes raised by these modifications would benefit the consumer, as discussed in paragraph 3.8.8 of the consultation. The removal of embedded benefits would reduce competition and increase capacity market clearing prices and wholesale peaking prices. They may also result in material investment being required in the transmission networks. None of these market wide impacts are considered in the modification consultation, but would arguably have more material impact on customers than reducing TNUoS charges.

There are also some wider points Ofgem must consider:

- Parties with multiple year agreements from 2014/15 t-4 auctions risk losing their embedded benefits if P265 is approved, so the economic response must be to find a way to terminate their agreements (leaving the market short in 2018/19/20);
- Going into T-4 2016 all embedded generators will now have to assume that the embedded benefits are worth less than expected by investors, who acted in good faith, which undermines their future plans and therefore may reduce competition in the auction;
- While signals can advantage embedded or transmission connected plant, both are having significant problems getting connection capacity and this problem sits with Ofgem; and
- Without grandfathering, investment for T-4 2016 will be undermined as investors in longer term contracts will no longer trust the regulator.

In order to dis-connect the calculation of the embedded benefit from being increased by European regulation (that is increasing the Demand residual) we support the WACM put forward by Green Frog et al. as it seems fair until a wider review is conducted, whilst also giving certainty for upcoming auctions. We note that National Grid's April 2014 Embedded Benefit review did not support any changes to the Demand Residual, and therefore believe the Green Frog modification could be better justified by using the Demand Residual at the time of this National Grid review (£35/kW, in April 2014) in addition to the locational tariff.

Please do not hesitate to contact myself should you have any questions,

Yours faithfully,

Tom Vernon
Director,
Statera Energy Limited

CUSC Workgroup Consultation Response Proforma

CMP264 'Embedded Generation Triad Avoidance Standstill' and **CMP265** 'Gross charging of TNUoS for HH demand where Embedded Generation is in the Capacity Market'

Industry parties are invited to respond to this consultation expressing their views and supplying the rationale for those views, particularly in respect of any specific questions detailed below.

Please send your responses by **24th August 2016** to cusc.team@nationalgrid.com Please note that any responses received after the deadline or sent to a different email address may not receive due consideration by the Workgroup.

Any queries on the content of the consultation should be addressed to Caroline Wright at caroline.wright@nationalgrid.com

These responses will be considered by the Workgroup at its next meeting at which members will also consider any Workgroup Consultation Alternative Requests. Where appropriate, the Workgroup will record your response and its consideration of it within the final Workgroup Report which is submitted to the CUSC Modifications Panel.

Respondent:	<i>Matthew Bacon, matthew.bacon@vattenfall.com, 0203 301 9103</i>
Company Name:	<i>Vattenfall</i>
Please express your views regarding the Workgroup Consultation, including rationale. (Please include any issues, suggestions or queries)	<p>Vattenfall is the Swedish state-owned utility and one of Europe's largest generators of electricity and heat and the second largest player in the global offshore sector.</p> <p>Vattenfall has invested nearly £3bn in the UK since 2008. We will operate nearly 1GW of onshore and offshore wind capacity by 2017 connected at both a transmission and distribution level. Some of our projects receive 'embedded benefits' and others do not. As we have significant ambitions to invest in low-carbon generation over the coming years, Vattenfall is keen to see the effective development of a stable, predictable, and fit-for-purpose grid charging regime which provides efficient signals to us about where and when to invest.</p> <p>Vattenfall is currently working towards a full response to Ofgem on CMP264/265 following their open letter of 29 July 2016. Given the short timescales set as part of the 'expedited' CUSC modification process, we have not yet been able to form an evidenced and detailed view about the impacts of these proposals on either our portfolio or the broader energy system and so are unable to comment as yet to whether 'embedded benefit' reform is in the overall interests of grid users and end-consumers in our view.</p> <p>However, we would like to note that reform of 'embedded benefits' in the manner proposed represents a major change to exemptible embedded generators with the potential for significant financial impact on existing sites and planned projects, including wind generators, and unintended discrimination between users.</p>

As a result, we think a change of this scale would benefit from more detailed analysis conducted to a longer timetable by an impartial third party (i.e. Ofgem) which allows industry more time to provide evidence, consider the potential for unintended consequences, and take a longer term outlook.

Despite the potential need for urgency, if embedded benefits are leading to market distortions, we think a more considered process will produce a better understanding on which to base long-term change.

In particular, a longer timetable for analysis and phased implementation of change is likely to benefit investor certainty in the regime. Investor uncertainty is not in the consumer interest and may detract from any positive impact of change. This is a principle that Ofgem have recognised in recent decisions, such as CMP255 regarding the generation/demand split in TNUOS charges as well as the decision not to reopen the RIIO methodology as part of the Mid-point Review.¹

On the modifications themselves, we note that both are likely to have considerable impact on existing and future exemptible embedded generators. However, of the two proposals it is evident that CMP 265 will have a more targeted impact with less scope for discrimination and other unintended consequences.

¹ Ofgem, *Decision on a mid-point review for RIIO-T1 and GD1*, p.56 (May 2016) and Ofgem, *Decision Letter – CMP255*, p.3 (August 2016).



Date 24th August 2016

CUSC Workgroup Consultation Response Proforma
cusc.team@nationalgrid.com

Dear Sir / Madam

Veolia Response to CMP264 'Embedded Generation Triad Avoidance Standstill' and CMP265 'Gross charging of TNUoS for HH demand where Embedded Generation is in the Capacity Market'

Veolia welcomes the opportunity to contribute to the above named consultation and as a licensed exempt generator with facilities operating ~400MWe of embedded generation on our customer premises or exporting facilities connected to the DNO network.

We are writing a response to the consultation as an overall summary of our concerns to the proposed modifications under the CUSC process and we would state:

- 1) We feel that the timeline of the reform has failed to recognize the benefits of embedded generation in terms of safety and security of supply and fails to consider the implications of what is potentially a very rapid change to a methodology (that has been in place for several years).
 - a. We urge the CUSC panel and OFGEM to review the entire TNUoS charging methodology in order to treat transmission connected and embedded generation in a fair and equitable manner rather than a simple modification which will likely favor the transmission connected generators.
- 2) As a licensed exempt generator we are a price taker for the sale of any exported electricity and therefore extremely sensitive to movements of the wholesale electricity price. We are unable to influence the wholesale price and therefore would be unable to recover on a direct basis through sales of electricity any revenue lost as a result of the change to embedded benefit. We feel that the proposals within CMP264 and CMP265 represents a significant change to the competitive market place due to the change of network charges and these it appears these changes are seemingly being 'fast-tracked' due to OFGEM wanting to reform network charges and embedded benefits.
 - a. Rules for embedded benefits should be simple and consistent for all generators as opposed to assessments of embedded generation on a case by case basis, which may lead to administrative errors and increased costs.
- 3) In the case of Capacity Market and the removal of the TNUoS benefit under modification CMP265. We would urge a more thorough analysis of the full cost-reflective benefit of embedded generation and positive consequences through its participation in both the Capacity Market and the current TNUoS charging methodology.
 - a. Historically TNUoS charges have not been formally agreed until just prior to the charging year (ie T-1), however certainty of capacity market involvement would only be via participation of the four years ahead "T-4" auction.
 - b. At present the future value of TNUoS to embedded generators is not clear, nor is the final clearing price for existing generators within the Capacity Market until the auction takes place.
 - c. TNUoS charges need to provide very clear price signals to generators and need to be fixed and remain unchanged over long time-period (ie T-4), we cannot see how a fair assessment of participating in the CM or retaining some element of TNUoS embedded benefit would otherwise be a workable approach.

Regards

Robert Hunt
Chief Corporate Officer and External Affairs Director

Veolia UK Limited

8th Floor, 210 Pentonville Road
London N1 9JY
Tel: +44 (0)20 3567 6600

www.veolia.co.uk

Registered Office:

210 Pentonville Road, London N1 9JY
Registered in England & Wales: 2664833

A group company of
Veolia UK Limited





Bringing Energy
Together

Consultation Response | CMP264 and CMP265 24 August 2016

Context

The Association for Decentralised Energy (ADE) welcomes the opportunity to respond to the consultation for CMP264 and CMP265 under the CUSC process.

The ADE is the UK's leading decentralised energy advocate, focused on a more cost-effective, efficient and user-led energy system. The ADE has over 100 members active across a range of technologies, and they include both the providers and the users of energy. Our members have particular expertise in combined heat and power, district heating networks and demand side energy services, including demand response and storage.

The Association's membership includes substantial amounts of CHP generation assets, of which more than 3 GW is connected to the distribution networks. These assets provide essential services by delivering heat to fuel poor households through heat networks, or to industrial manufacturers to support their industrial competitiveness. Our members, which include all of the major DSR aggregators, also support the delivery of on-site generation and storage through demand-side response.

Executive summary

The ADE's views on CMP264 and CMP265 are:

- CMP264 and CMP265 are attempts to make the costs of using the network comparable between different types of generators. It is no more relevant to promote competition by equalising all or some components of network charges than by equalising fuel costs between different types of generation. A generator or demand user's position in the electricity market should reflect the costs and charges, including network charges, required to provide or receive their service. We highlight that the proposer of CMP264, Scottish Power, agreed with these views when responding to the informal National Grid consultation on embedded benefits in February 2014, stating "We believe that the charging methodology should be based upon the net flows onto and off the transmission system and therefore we do not believe that there is any justification for basing any element of the transmission charge upon gross demand¹."
- The claimed defect sought to be addressed by CMP264 and CMP265 would result in a significant shift in the competitive nature of the electricity generation marketplace. These proposals have been made without any robust analysis or quantitative investigation. Due to the accelerated timetable required by the Regulator for this work group, no analysis was performed and no evidence was provided on the cost reflectivity of the embedded benefit by the proposers. The work group was not permitted to investigate either the cost-reflective value of the embedded benefit, nor

¹ <http://www2.nationalgrid.com/workarea/downloadasset.aspx?id=32671>

was it permitted to investigate the costs which are included within the TNUoS demand residual. As a result the proposals are made in the absence of justifying evidence of how they are more cost reflective.

- The concept of net charging, and subsequently the embedded benefit, has been a transmission network principle from before 2001. The proposal to remove this principle and implement an entirely different charging regime within nine months is unrealistic and likely to result in significant harm to generators and consumers.
- The implementation of CMP264 and CMP265 will create new distortions in the electricity market, treating the cost of increasing flows on the transmission network (the triad charge) differently from the value of reducing flows from it (the triad benefit). The proposals will also treat the reduction of net demand differently depending on whether a distributed generator is existing or new (in the case of CMP264); and whether the reduction is the result of exported distributed generation, on site generation, or demand reduction. These distortions are the result of approaching this issue in a piecemeal fashion and addressing the incorrect defect.
- We see the optimal approach to address this issue in a fair and equitable manner, across all users, is to review the triad charge itself – both the triad methodology and its use of peak charging, as well as the size of the residual. To meet the Applicable CUSC Objectives, the CUSC Panel and the Regulator should take a careful, considered, holistic and system approach to this issue.

Responses to consultation questions

Standard work group questions for CMP264

1. *Do you believe that CMP264 Original proposal or either of the associated potential options for change better facilitates the Applicable CUSC Objectives?*

No, neither CMP264 nor CMP265 better facilitate the Applicable CUSC Objectives.

The Applicable CUSC Objectives are to “facilitate effective competition in the generation and supply of electricity” and for the use of system charging methodology to result “in charges which reflect, as far as is reasonably practicable, the costs ... incurred by transmission licensees in their transmission businesses.”

Increasing cost reflectivity must lead to the most cost effective and competitive system. Charges for connection to the transmission system should be based upon the net power flows modelled onto and off the system as it these net flows that drive incremental transmission investment. CMP264 and CMP265 are attempts to make the costs of using the network comparable between different types of generators. However, equalising all or some components of network charges to promote competition is no more relevant than by equalising fuel costs between different types of generation. A generator or demand user’s position in the electricity market should reflect the costs and charges, including network charges, required to provide or receive their service.

We feel it is necessary to highlight that the proposer of CMP264, Scottish Power, agreed with the net charging approach when responding to the informal National Grid consultation on embedded benefits in February 2014, stating “We believe that the charging methodology should be based upon the net flows onto and off the transmission system and therefore we do not believe that there is any justification for basing any element of the transmission charge

upon gross demand².” We agree with Scottish Power’s previous assessment, especially since February 2014 no new evidence has been provided to change the recognition that net charging is the most effective and cost reflective charging methodology.

The defect identified in in CMP264 and CMP265 would represent a significant shift in the competitive nature of the electricity generation marketplace, without the support of any robust analysis or quantitative investigation on the part of the proposers and despite the presence of robust quantitative analysis to the contrary. The accelerated timetable required by the Regulator for this work group, the CUSC group neither sought nor performed any analysis or evidence to establish the cost reflectivity or otherwise of the embedded benefit. The work group was not permitted to investigate either the cost-reflective value of the embedded benefit, nor was it permitted to investigate the costs which are included within the TNUoS demand residual.

The proposer has noted that National Grid has estimated the cost reflective value for the embedded benefit at approximately £1.58/kW. In contrast, recent analysis by Cornwall Energy commissioned by the Association for Decentralised Energy found that embedded generation offset the cost of new transmission network assets required for new generation and that this value was the equivalent of £32.0/kW. However the work group did not discuss the methodology behind these figures, allowing for a consensus to be found.

The concept of net charging, and subsequently the embedded benefit, has been a transmission network principle since before 2001. The proposal to remove this principle and implement an entirely different charging regime within nine months is unrealistic and likely to result in significant harm to generators and consumers.

The appropriate way to meet the Applicable CUSC Objectives is to be take a careful, considered, holistic and system approach, starting with a Significant Code Review. National Grid’s Charging Seminar Summary, published in August 2016, found that stakeholders advised the key attributes of any charging review should be to:

- *Balance delivering review as soon as possible while maintaining a process including open and transparent consultation*
- *Clear responsibilities for parties*
- *Use clear objectives for the review in order to focus on proactively driving alignment between the long term vision and policy*
- *Use evidenced based/objective methodologies to determine the most appropriate options to progress*
- *Deliver an efficient change process – limiting re-work and reusing/building on previous analysis (and Modifications) wherever possible to ensure that participants’ time is used effectively*
- *Initiate a progressive transition to the future, taking into account changing technologies/behaviour whilst recognising the journey to date and implementing changes in appropriate timescales*

None of these attributes is being delivered on this issue through the current CUSC process for CMP264 and CMP265.

² <http://www2.nationalgrid.com/workarea/downloadasset.aspx?id=32671>

The triad charge is the methodology by which the transmission system estimates a consumer or a generator's use of the network in order to apply appropriate costs. The triad avoidance benefit, whether received by exporting distributed generation, on site generation or demand reduction, is the value of avoiding the use of the network, as determined by the triad methodology. The cost of using a network, and the value of not using a network, should be mirror images of one other.

The implementation of CMP264 and CMP265 would create new distortions in the electricity market, treating the cost of increasing flows on the transmission network (the triad charge) differently from the value of reducing flows from it (the triad benefit). In the case of CMP264 the proposals treat the reduction of net demand differently depending on whether a distributed generator is existing or new. Both proposals seek to create disparate treatment of net demand reduction dependent on whether that reduction is delivered by exported distributed generation, on site generation or demand reduction. These distortions are the result of approaching this issue in a piecemeal fashion and addressing the incorrect defect.

An appropriate approach to address this complex issue in a fair and equitable manner, across all users, would be to review the triad charge itself – both the triad methodology, as well as the size of the residual. However, we would note that as most of the Association for Decentralised Energy's members are not CUSC parties, they are unable to propose CUSC modifications to address this defect, and due to the limited nature of the defect identified by the proposers of CMP264 and CMP265, alternatives addressing this defect are unlikely to be accepted within the working group process.

While CMP264 and CMP265 have identified the avoided triad charge as a distortion for exported distributed generation, on site generation and demand reduction, they have only proposed a solution that attempts to fix one of those three i.e. exported distributed generation. There are no indications that their proposals could be extended to the other two types of avoidance, on site generation and demand reduction. In fact, it is our view that extending gross charging to on site generation and demand reduction will be extremely difficult to implement in practice, and the result will be that the new distortions created would exist for significant periods of time. If gross charging were to be extended:

- The charge for using the transmission network, as determined by the triad charge, will be set at a different level than the value of reducing the use of the transmission network.
- The cost of reducing net demand on the transmission network will be different depending on the type of action – exported distributed generation, on-site generation, or demand reduction – taken to reduce net demand.
- The total cost placed on DG for claimed use of the TN could be higher than the cost of Transmission connected generation as a result of them having the €2.50 MWh limit which is clearly not cost reflective.

The types of harm identified by the proposer do not stand up to scrutiny, and identify the embedded benefit as the cause of the distortion when it would be more appropriate to identify other defects:

- **Claim of harm from inefficient investment/closure:** No evidence was provided that plant are closing as a result of the embedded benefit. No evidence was provided on the impact of reduced net demand to long-run marginal costs of the transmission network.

- **Claim of harm from inefficient dispatch:** The proposer states that the size of the demand residual is so large that it creates inefficient dispatch signals. This distortion does not reflect a problem with the embedded benefit, but may instead indicate a problem with the cost recovery methodology for demand, which is based on peak demand and creates a signal to operate or reduce demand during the triad periods. CMP264 does not directly address the appropriate defect.
- **Claim of harm from discriminatory redistribution of transmission costs between customers and generators:** The proposer states that the “total sunk cost of the Transmission network still has to be collected from customer bills”. However, the work group was not permitted to explore the value of the residual and what elements of the residual should be identified as ‘sunk costs’. Furthermore, the reduction of net demand on the transmission network reduces long run marginal costs by reducing the need for future infrastructure investment.
- **Claim of harm from discriminatory redistribution of transmission costs between generators:** The proposer states that the payment represents discrimination between types of generators. This is incorrect. A generator or demand user’s position in the electricity market should reflect the costs and charges, including network charges, required to provide or receive their service. The current method for measuring use of the transmission network by demand users, including distributed generation, is through the triad methodology.

From the perspective of the transmission network, embedded generators are negative demand and they reduce overall transmission network demand. The difference in value between the embedded and transmission-connected generator reflects:

- (a) The difference in charging between generation – based on capacity – and demand – based on peak demand
- (b) The European cap on generation transmission network charges, which increases the share of the demand residual relative to generation
- (c) A share of the demand residual not being demand related, leading to less cost-reflective recognition for net demand reduction

If the proposer does not believe the current triad methodology accurately reflects use of the transmission network, then they have identified the incorrect distortion in the embedded benefit. In fact, both CMP264 and CMP265 would increase discrimination in the marketplace. CMP264 will reward transmission network net demand reduction via exported embedded generation, on-site embedded generation and embedded demand reduction in different ways, creating new charging distortions. CMP265 will treat Capacity Market generators differently from other generators.

Finally, CMP264 was proposed as a temporary measure and that position helped guide the working group process, based on the expectation that Ofgem would announce a formal review process. The proposer repeatedly emphasised the temporary nature of CMP264, and stated that it was not necessary to undergo more quantitative analysis of the correct value of the embedded benefit, as this value would be determined following the Ofgem review. The proposal specifically notes that “it is not aimed at solving the bigger question of what should be the appropriate methodology for allocating supplier contributions towards TNUoS costs.” However, Ofgem’s Open Letter, published in August 2016, indicates that Ofgem does not

intend to launch a full review. As CMP264 was not intended as an enduring solution, it would not be appropriate to look to implement it as an enduring solution.

2. *Do you support the proposed implementation approach for CMP264? Are the suggested implementation timescales suggested for CMP264 appropriate / achievable?*

The proposed implementation approach raises significant risks to gaming as a result of the rushed timetable. If suppliers do not have automated systems in place by June 2017, the proposal will require manual intervention, significantly increasing risks of errors.

We do not agree with the proposer's assessment that 13 months from becoming aware of the proposal is sufficient to complete construction and commission "given the smaller nature of embedded plant". This statement is not accurate. Embedded plant can reach sizes of up to 100 MW, and include highly complex gas CCGT and biomass generation assets. These assets have build times of at least two years, and engineering complications can extend this build time for several additional years. For example, the most recent 50 MW biomass CHP plant in Scotland took five years to complete construction.

The proposal would put plant currently in development at risk by removing value for plant which have already received either CfD contracts or Capacity Market contracts for delivery in 2017, 2018 and 2019. This raises significant concern that the implementation timetable will harm market certainty, increasing costs for consumers.

The proposer recognises the distortion resulting from generators serving load behind the meter in paragraph 3.3.17, but does not recognise the remaining distortion where behind the meter generation will be treated differently from demand reduction, despite both reducing transmission network net demand in the identical way.

The proposer's identification of the embedded benefit as the defect, instead of either the demand residual or the triad methodology, means that the proposer's modification adds new distortions to the charging methodology while not addressing the correct defect.

3. *Do you have any other comments for CMP264?*

No.

4. *Do you wish to raise a Workgroup Consultation Alternative request for the Workgroup to consider for CMP264? Please see 6.3*

Yes.

Standard work group questions for CMP265

5. *Do you believe that CMP265 Original proposal or either of the associated potential options for change better facilitates the Applicable CUSC Objectives?*

Please see our response to Question 1.

6. *Do you support the proposed implementation approach for CMP265? Are the suggested implementation timescales suggested for CMP265 appropriate / achievable?*

We do not think sufficient consideration has been given to how suppliers will be able to manage the case of mixed sites, especially those which have CM embedded generation and other generation assets which can operate during triad periods. The need for manual consideration for these hundreds of sites is likely to lead to significant complications and cost impacts for both suppliers and customers.

7. *Do you have any other comments for CMP265?*

No.

8. *Do you wish to raise a Workgroup Consultation Alternative request for the Workgroup to consider for CMP265? Please see 6.3.*

Yes.

Specific questions for CMP264

10. i) *Do you think a cut-off date for "new embedded generation" of 30 June 2017 is appropriate? What other date would you propose?*

No. We would recommend a cut-off date of May 2018, as this would reflect a two year period from the original notification of the modification. Two to three years is a standard build time for many decentralised energy projects, including gas and renewable CHP plant, which can reach sizes of up to 100 MW.

ii) *Do you have any views on how mixed sites are being addressed in CMP264 Original?*

The ADE has no comment.

iii) *Do you think new-build embedded generation capacity that has entered into long term financial and performance commitment obligations via 2014 and 2015 capacity market or contracts for difference auctions (prior to this modification proposal) should be given exceptions to this cut-off date?*

Yes. In addition, there are gas and renewable CHP projects which are under construction and which have neither capacity market nor CfD contracts, such as those which are proceeding without subsidy and those which are proceeding under the Renewables Obligation. We believe that CMP264 should not be implemented and would create regrettable distortions if it were implemented. Given that implementation is a possibility the following proposals are made to minimise the harm caused by its implementation. If CMP 264 were implemented, any CHP plant already under construction as of May 2016 should be given exceptions to the proposed cut-off date. We would propose the way to provide evidence that a site was under construction is that the CHP site would have to provide a CHP Quality Assurance F3 certificate, provided to pre-commissioned CHP plants, dated before May 2016. The number of projects to which this would apply would be small, and it would be the responsibility of the CHP site to provide the certificate to suppliers in order for their meter to be recognised as eligible for the embedded benefit.

iv) Do you agree that ignoring demand behind the meter is unlikely to create a significant "loophole" or material discrimination risk in relation to the CMP264 arrangements in the short term.

No. The reduction of transmission network net demand is the same, whether that net demand is caused by exported generation on the distribution network, on-site generation or demand reduction. The proposer has suggested that charges could be applied to these other users at a later date, but has not provided any practical solutions to repair this discrimination. The likely effect will be that the distortion between different users remains over a long term period, or new distortions will have to be introduced to prevent the identified 'loopholes'.

v) Question to suppliers: Do you consider that the wording of your existing contracts allow you to reflect the changes provided by these modifications in a cost reflective manner. For example, these changes will apply to existing PPAs and generators who significantly alter their output (EREC 59).

The ADE has no comment.

vi) Do you agree with the definition of commissioned and do you agree that it is appropriate? If you do not agree with the definition or that it is appropriate please provide alternative definitions and rationale for this definition.

No. We do not believe the proposer's method will be sufficiently accurate and will likely create new distortions. By linking the definition to the registration of exporting MSIDs, there is a significant risk of users registering exporting MSIDs ahead of the cut-off date. Furthermore, it is unclear if suppliers will be able to implement the necessary changes to incorporate these changes in time for the proposed June 2017 cut-off date.

13. Do you have a view of whether implementation for the 2017/18 Triad season is sufficient to allow changes for:

i) supplier contracts and billing system; and

The ADE has no comment.

ii) for other stakeholders?

The implementation timetable is too short for such a significant change to the charging regime. The concept of net charging, and subsequently the embedded benefit, has been a transmission network principle since before 2001. The proposal to remove this principle and implement an entirely different charging regime within nine months is unrealistic and likely to result in significant harm to generators and consumers.

The proposer's assessment is that 13 months from becoming aware of the proposal is sufficient to complete construction and commission "given the smaller nature of embedded plant". This statement is not accurate as demonstrated by the proposer's own project repowering [Carland Cross Windfarm near Newquay in Cornwall](#). Embedded plant can reach sizes of up to 100 MW, and include highly complex gas CCGT and biomass generation assets. These assets have build times of at least two years, and engineering complexities or

complications can extend this build time for additional years. For example, the most recent 50 MW biomass CHP plant in Scotland took five years to complete.

The proposal would put plant currently in development at risk by removing value for plant which have already received CfD contracts, undermining earlier auctions, or Capacity Market contracts for delivery in 2017, 2018 and 2019. This raises significant concern that the implementation timetable will harm market certainty, increasing costs for consumers.

18. Do you have a view if embedded benefits are frozen at a non-zero value, what should that value be as a £/kW tariff (2016/17 value is £45.33 / kW)?

We strongly agree that the appropriate approach to this issue is to freeze the embedded benefit at an appropriate level, pending a full review that considers both the triad methodology and the demand residual.

We would note that no analysis was undertaken in the working group, and that working group requests for new analysis were rejected due to accelerated timescales. This has prevented the working group from fully considering evidence on what the cost-reflective level of the embedded benefit should be. There is a need to undertake a proper review of the cost-reflectivity of the triad charging arrangement for demand users and distributed generators.

Network charging is a complicated and integrated area, with knock-on effects across the energy system. A rushed decision to remove the TNUoS embedded benefit will have significant real world impacts on Government policy which cannot be reversed.

Pending such a full and proper review, we would recommend freezing the residual at the level of £32.30/kW, which reflects the total capital and operating costs of new network assets required to deliver transmission generation assets which are displaced by embedded generation as found by Cornwall Energy. This is the minimum fair value possible for the Embedded Benefit.

- Cornwall Energy's analysis assessed the capital cost of a number of National Grid schemes under consideration with a total potential spend of £8.8bn. The average annuitised cost across all the schemes is £18.5/kW on a 2015-16 price basis. The minimum embedded benefit attributable to embedded generation is £18.5/kW, as this is the 'replacement' cost of embedded generation if it were to be removed and replaced with transmission generation.
- However, this estimated cost does not include the ongoing costs associated with these schemes such as operations and maintenance or the non-quantifiable impacts such as visual amenity. As the investment in embedded generation is a long term decision and they offset demand over the life of their connection, it is appropriate that embedded generation should benefit from offsetting long term costs in addition to short term costs. Cornwall Energy estimated these elements to equate to c£13.8/kW in 2016-17.

Therefore, Cornwall Energy assessed the total capital and operating cost of new network assets required to deliver transmission generation assets which are displaced by embedded generation at £32.30/kW. We would note that no other analysis or estimate was offered to the working group on the value of the embedded benefit to transmission network long run marginal costs. Both proposers referred to a previous National Grid estimate of £1.58, but no detailed discussion or debate was had about the methodology behind that approach.

We would recommend the embedded benefit should be frozen at £32.30/kW while a full review is undertaken. To remove the embedded benefit based on proposals that are not backed up with quantitative evidence and in a process in which additional evidence could not be sought would be a very poor piece of policy making. Finally it would have substantial impact on a number of market players who are competitors to the proposer so the adoption of such proposals without evidence would rightly raise questions about the appropriateness of the process used.

Specific questions for CMP265

11. i) Views are sought on the implication for mixed sites discussed in 3.4.10.

We do not agree with the proposals for mixed sites and do not agree that mixed sites with combinations of Capacity Market generation and non-Capacity Market generation are 'rare'.

There are almost 3 GW of CHP assets in the UK connected at the distribution level, with nearly 90% of those assets located on more than 300 industrial sites. These industrial sites regularly include gas CHP assets (which may be in the Capacity Market), renewable generation assets (largely excluded from the Capacity Market) and back-up generators for emergencies and which may, or may not, be used to reduce net demand during triad periods. For example, there are approximately 100 sewage works in the UK, and in 2012 75% of sewage sludge was processed using renewable anaerobic digestion and are likely ineligible for the Capacity Market. All of these sewage work sites would also have back up fossil fuel generation which is likely to participate in the Capacity Market. There are other types of industries and users with similarly complex arrangements which would be similarly impacted.

Based on this evidence, we expect that the number of sites for which suppliers are going to be expected to manage bespoke arrangements are likely to be significantly higher than expected by the proposer and the working group, adding to complications, costs and delays. The lack of understanding of mixed site arrangements indicates a lack of thorough review necessary to implement such a significant change as proposed in CMP265.

ii) Views are sought on the preference of categories of capacity Market CMU captured by this proposal, please indicate your preference from the following list and reasons:

- All existing and new distribution generation CMUs
- All existing and new distribution generation CMUs and DSR CMUs (proven and unproven)
- All price maker CMUs
- All new build/prospective distribution generation CMUs only (defined as >1year contracts)

As we do not agree with the proposer's defect, our preference is for an approach which is aimed at the smallest number of market participants i.e. 'all price maker CMUs'.

The proposal to apply this change to all existing distribution generation CMUs will result in the removal of embedded benefits from legacy industrial CHP assets, which operate in response to a heat demand and were designed to have limited flexibility to react to market signals, including triad events. As these assets largely operate as baseload generators, they reduce net demand on transmission networks consistently over the course of the year.

There are more than 3 GW of distribution-connected CHP assets in the UK, located on more than 300 industrial sites. These assets are particularly focussed in the chemicals, paper, and food and drink sectors, and these CHP assets help support tens of thousands of jobs by helping these sites control their energy costs. Changes to these sites' energy costs will result in reduced profitability and, in some cases, job losses as site production is reduced. In allowing a proposal such as this to go forward, the proposer, National Grid and the regulator must be sure that any resulting loss of jobs was justified on a clear case backed up by compelling evidence. The absence of evidence produced by the proposer or during the CUSC process makes such a conclusion impossible to reach.

14. *Do you have a view of whether implementation for the 2020/21 Triad season is sufficient to allow changes for i) supplier contracts and billing system, and ii) for other stakeholders?*

The ADE has no comment.

Specific questions for both CMP264 and CMP265

9. *i) Suppliers: In setting charges for your demand customers, do you charge them at the same tariff as National Grid charges you (i.e. gross), to enable you to pay the embedded benefit to embedded generators, or please explain the way in which it is funded?*

The ADE has no comment.

ii) Suppliers: Does the estimate that 7.58GW of embedded generation output and 2.5GW of demand side reduction at the time of Triad for 2016/17 seem reasonable based on your knowledge of the UK market? If not what is your estimate of embedded generator output and DSR at time of Triad?

The ADE has no comment.

12. *Can you identify – either quantitatively or qualitatively - the impact of the demand TNUoS embedded benefit on your decisions made in making capacity market decisions?*

The current uncertainty in the marketplace, as a result of both the CMP264 and CMP265 proposals, is that ADE members would not rely on embedded benefit value when making future Capacity Market investment decisions. Members have advised us they will not bank embedded benefit value when making future investment decisions, and lenders and investors will not invest against embedded benefit value.

Analysis by Cornwall Energy found that the removal of the TNUoS and BSUoS embedded benefit would increase Capacity Market prices in the 2016 auction by £2/kW. This difference would add more than £100m to Capacity Market costs. However, the analysis found that the increase in Capacity Market price was insufficient to make any significant difference to whether new transmission-connected generation assets were successful in the market.

We are concerned that the proposal put forward was aimed at raising the price of the Capacity Market to benefit the businesses of the proposers. While this an understandable aim, it is not the role of the charging regime to support a given business model and making such changes to achieve these ends would be a poor decision not in the interests of energy consumers.

15. i) *What are your views on the 2 broad options to enable the reporting of gross export metered data?*

The ADE has no comment.

ii) *Would you have the data available required for Option B (both CMP264 and CMP265) for both new contracts and existing contracts where a customer may be partially exempt?*

The ADE has no comment.

iii) *Do you believe you can implement the proposed changes by the respective implementation dates?*

The ADE has no comment.

iv) *What are the pros and cons of the 2 proposals that ELEXON are considering to implement this (P348 for CMP265/ P349 for CMP264)?*

The ADE has no comment.

16. *Do you have any further evidence / comments on the consumer impact of changing the demand TNUoS embedded benefit in either the short-run or long-run?*

The following short-term impacts are likely to occur as a result of removing the demand TNUoS embedded benefit:

- Distributed generators are likely to decrease export during triad periods, resulting in higher net demand. As more than 7.5 GW of distributed generation operates at peak, even a reduction of 15% would result in a 1 GW shortfall in coming winters, during a period of significantly tight security of supply margins. Legacy, large-scale industrial CHP plant are largely operated as baseload generators, but are able to reduce on-site demand and have some flexibility to increase generation during system peak. As these operators are industrial manufacturers with limited engagement in the electricity market, they often struggle to respond directly to market signals and are likely to operate less flexibly during periods of peak demand if the triad charge is removed.
- Reports by both Cornwall Energy and KPMG have highlighted that approximately 2 GW of existing distributed generation has received Capacity Market contracts. The removal of the embedded benefit could result in those plant under construction not being completed and existing plant shutting down, resulting in further capacity shortfalls in 2018 and 2019.
- Industrial sites which use CHP to improve their efficiency and control their energy costs would see significant cost rises. Some industrial sites would see their costs rise by £5m a year during a time of economic uncertainty, putting manufacturing jobs at risk. Some industrial sites have indicated they will shut down their CHP assets in response to the removal of embedded benefits.

- District heating sites which use combined heat and power will see their revenue decrease, in the case of one large scheme by 15%, requiring these networks to increase their heat prices to householders. District heating schemes often serve council houses and the fuel poor.
- Higher wholesale prices, reflecting an increase in the marginal cost of embedded generation and the potential closure of embedded generation in response to the removal of triad benefits.
- An increase in the cost of ancillary services as embedded generators need to make up for a shortfall in their revenue through higher contract prices.

Over a longer-term, we would expect:

- Higher levels of reinforcement and other costs at the transmission network level as embedded generation is replaced by transmission connected generation.
- Higher levels of reinforcement and other costs at the distribution network level as the export from embedded generation is reduced.
- A higher cost of capital for all generation due to the increased risk associated with industry change.

17. Do you feel that both the locational and residual component of the demand TNUoS should be removed as an embedded benefit (as CMP264 Original) or just the residual component (as CMP265 Original) or some other method?

No. All forms of transmission network net demand reduction should be treated equally. The locational element of the TNUoS demand charge was not reviewed as part of the Project TransmiT process, and it may not be as cost-reflective as it could be. We would recommend a review of the TNUoS demand charge to consider whether the balance of the charge between locational and residual is appropriate before implementing any changes to the embedded benefit regime.

19. Regarding the proposed alternatives what are your views on the suggested implementation dates? Are these achievable? Please give reasons for your view.

The ADE has no additional comment.

For further information please contact:

Jonathan Graham
Head of Policy

Association for Decentralised Energy
Tel: +44 (0) 20 3031 8740
Jonathan.graham@theade.co.uk

CUSC Workgroup Consultation Response Proforma

CMP264 'Embedded Generation Triad Avoidance Standstill' and **CMP265** 'Gross charging of TNUoS for HH demand where Embedded Generation is in the Capacity Market'

Industry parties are invited to respond to this consultation expressing their views and supplying the rationale for those views, particularly in respect of any specific questions detailed below.

Please send your responses by **24th August 2016** to cusc.team@nationalgrid.com Please note that any responses received after the deadline or sent to a different email address may not receive due consideration by the Workgroup.

Any queries on the content of the consultation should be addressed to Caroline Wright at caroline.wright@nationalgrid.com

These responses will be considered by the Workgroup at its next meeting at which members will also consider any Workgroup Consultation Alternative Requests. Where appropriate, the Workgroup will record your response and its consideration of it within the final Workgroup Report which is submitted to the CUSC Modifications Panel.

Respondent:	Paul Jenkinson/John Harmer
Company Name:	Alkane Energy Limited
Please express your views regarding the Workgroup Consultation, including rationale. (Please include any issues, suggestions or queries)	<p>For reference, the Applicable CUSC objectives are:</p> <p>Use of System Charging Methodology</p> <p>(a) that compliance with the use of system charging methodology facilitates effective competition in the generation and supply of electricity and (so far as is consistent therewith) facilitates competition in the sale, distribution and purchase of electricity;</p> <p>(b) that compliance with the use of system charging methodology results in charges which reflect, as far as is reasonably practicable, the costs (excluding any payments between transmission licensees which are made under and in accordance with the STC) incurred by transmission licensees in their transmission businesses and which are compatible with standard condition C26 (Requirements of a connect and manage connection);</p> <p>(c) that, so far as is consistent with sub-paragraphs (a) and (b), the use of system charging methodology, as far as is reasonably practicable, properly takes account of the developments in transmission licensees' transmission businesses.</p> <p>(d) Compliance with the Electricity Regulation and any relevant legally binding decision of the European Commission and/or the Agency.</p>

Background

At the outset we want to stress that for a small business like Alkane to be able to fully comprehend all the issues, including related historic analysis and reviews, takes considerable time and resources. Issues such as industry IT settlement and metering processes are subject areas with which we are not fully conversant. We have until now had no need to understand these areas as they are handled by our supplier/power purchaser; we now find them critical to give sensible answers to questions in this consultation.

In that context we find it difficult to comprehend how these proposals which have such significant repercussions for consumers, businesses, lenders and investors could be made without companies like us, the market participants most affected, having the time to procure evidence within an objective framework and appropriate timescale. The recent analysis from Cornwall Energy/KPMG has been given scant review within the rushed timescales imposed upon the Working Group, let alone been developed and expanded. Therefore whilst we appreciate the opportunity exceptionally to be part of the CUSC Working Group considering these proposals, we feel the whole CUSC structure and process to be weighted heavily against us. We and representatives of our peer companies are working alongside those representing transmission connected generators who are vastly more experienced of the CUSC process, have considered this issue in detail before over many years, and many of whom are directly represented on the CUSC panel that will make the final recommendation.

We also feel that the CUSC process is by definition narrowly focused on the value of the Triad element of embedded benefit in isolation and has almost entirely neglected the consumer benefits that arise from reduced transmission and capacity market charges, and the implications for security of supply.

We will be making these points directly to Ofgem in response to its open letter of 29 July 2016 but feel also these need to be conveyed to the CUSC Panel directly as it decides on what modification should be taken forward.

Triad charges have been a key component of the market since before privatisation and create a signal to operate or reduce demand during the Triad periods. The net charging principle has been used for many years and has been subject to numerous reviews but on each previous occasion the principle has been retained. The most recent review appears to have been the National Grid informal review in 2013/14 and, after lengthy and detailed consideration of all the issues and recognition of different points of view on many of them, this appears to have concluded with no change being made. Therefore we feel strongly that any move away from this net charging principle must not be done without appropriate process supported by fully detailed and holistic analysis or industry consensus on an alternative agreed methodology.

During Workgroup meetings it has been highlighted that the regulatory uncertainty associated with this CMP264 and 265 process, and most specifically Ofgem's open letter implying that this process should deliver an

enduring outcome, makes decision making in respect of investment in new embedded generation extremely difficult. This applies not simply to bidding in the forthcoming Capacity Market auctions but also to decisions about whether the cost of terminating existing CM contracts is commercially better than building out what could be loss making capacity following what could be ultimately settled on as the enduring changes to Triads. At a time of tight capacity margins this seems to us a difficult decision for Ofgem to defend if the intent is to keep the lights on for consumers.

We are disappointed that the impact on customer bills from potentially higher peak prices, increased capacity market costs, and increased transmission capacity requirements are not explored in more depth. Without the participation of embedded generation, it is clear the capacity market auction clearing prices would have been higher than would otherwise be the case and this would be the case going forward. This consumer benefit significantly outweighs the increase costs associated with the new embedded generation receiving Triad benefits. The simplest maths shows that new build EG of 2GW that reduced capacity clearing price on 50GW by £2/kW would exactly match a Triad benefit of £50/kW received by that 2GW of embedded plant. The Capacity Market results show an impact greater than £2/kW.

Standard Workgroup consultation questions – CMP264

Q	Question	Response
---	----------	----------

<p>1 Do you believe that the CMP264 Original Proposal better facilitates the Applicable CUSC Objectives?</p>	<p>We note that the Proposer (ScottishPower) was involved in the National Grid 2013/14 process. In referring to the consultation document in footnote 1 of its original proposal form, the Proposer is offering no new evidence to change the outcome which was the recognition that net charging is the most appropriate charging methodology.</p> <p>It appears the Workgroup has reached some consensus that the increasing size of the Triad benefit is driven by a combination of (i) recovery of stranded costs of the existing transmission network, which has been sized for the historic flows of power that no longer take place (ii) the significant costs of new transmission needed to support offshore wind and (iii) the EU cap of EUR2.50/MWh on all transmission connected generation. These result in the “demand residual” increasing dramatically <u>AND a net benefit being received by almost ALL E&W transmission connected generation by 2020/21.</u></p> <p>There is also a recognition that EG in locations of generation deficit does avoid transmission investment and so should benefit from long term transmission costs avoided.</p> <p>While we recognise that the Triad benefit is set to increase, the CMP264 proposal does not set out to provide an enduring solution and therefore does not offer investor stability, nor does it attempt to address the system benefit of new EG investment. In Workgroup meetings the Proposer has merely asserted that zero is closer than existing Triad payments to the genuine EG benefit in his view. He has backed up by a single datapoint from one historic data source, but in meetings has acknowledged that the reality is almost certainly greater than the £1.62/kW/year. The most recent analysis presented by Cornwall Energy quotes a value of £32.30/kW. No one has to date refuted the basis of this analysis and undermined the value it delivers.</p> <p>The Proposal does not address whether the reduction is the result of exported distributed generation, on site generation or demand reduction. The analysis in section 7.7 of the consultation document shows that the same net effect on the transmission system occurs whichever of these actions takes place. In setting out that the current system of charging does not reflect this, the analysis also clearly shows that the Proposer is dealing with only one of the three potential actions that give rise to this. This is self evidently discriminatory and therefore cannot be seen as “facilitating effective competition in the generation and supply...sale, distribution and purchase of electricity”. It should be noted that the analysis in 7.7 muddies the waters by suggesting that the delta cost of transmission is much higher if an embedded generator connects, rather than on site generation or demand reduction. Put simply the £0.63m additional paid for by consumers occurs in every case of 100MW reduced transmission demand and in every case the £4.55m benefit is shared between those putting or facilitating the 100MW onto the system. The three cases affect consumers and unassociated EG equally.</p> <p>This analysis is helpful in showing the flaw in the current methodology: that increasing embedded generation or reducing demand anywhere on the transmission system increases the Triad benefit for all embedded</p>
---	--

<p>2 Do you support the proposed implementation approach? Or are there any further implementation implications that need to be considered?</p>	<p>The proposal would require investors with CM contracts secured in the 2014 & 2015 auctions with a requirement to build plant earlier than required under those contracts.</p> <p>It is unreasonable to suggest that 13 months from becoming aware of the proposal is sufficient to complete construction and commission the embedded plant that has capacity market contracts. We are subject to a number of constraints including the raising of finance, supply chain capacity, gas and power distribution network capacity upgrades etc. Some of these (notably the last) are outside our control.</p> <p>Both forecast Triad revenue and capacity market income are required to support the economics of our embedded plant. Without either of these streams the revenue from other sources, which is more uncertain, becomes critical. As the project economics become less certain this raises cost of capital and means that revenue streams from other sources need to be that much greater to justify investment.</p> <p>As of today we face a choice whether to build out our capacity market commitments or terminate the contracts. Our capacity market bids were based in good faith on the outcome of reviews of Triads that concluded the status quo was acceptable. We accepted the risk that the forecasts may change because of changed assumptions, but not the risk of a wholesale change to Triad calculation in isolation, nor what is proposed by CMP264 i.e. the removal of Triad benefits completely.</p> <p>If this proposal went through it is doubtful whether we would be able to justify building to meet our existing contracts. This would place increased costs on consumers today and in the medium term future as more capacity would need to be procured at higher prices, in part driven by increasing investor nervousness over the regulatory risk faced by investing in the UK, as well as risking medium term security of supply.</p>
---	---

3	Do you have any other comments?	<p>CMP264 was framed as a stop gap until Ofgem undertook a comprehensive review of all the issues. Through Workgroup discussion and the release of the Ofgem open letter it has, midway through the process, morphed into a proposal for an enduring solution. We believe this to be a totally inadequate approach and as a consequence, we do not consider the original modification and its implementation to be supportable.</p> <p>The Proposer now invites a future change via the CUSC process to be brought forward with indeterminate outcome and timescale. For an EG like Alkane who is not a CUSC member this is a totally inappropriate route. It also prolongs regulatory uncertainty that increases consumer costs and puts in jeopardy investments that help secure supplies, keep power prices low and so help enhance industry competitiveness.</p> <p>The EG community is a wide ranging group all of whom will be impacted by the proposed modifications. This investment community need clear medium to long term signals. We have received clear feedback that implementation of the Original CMP264 will ensure capacity not already built is not financeable.</p>
4	Do you wish to raise a WG Consultation Alternative Request for the Workgroup to consider?	<p>Yes. Please see attached.</p> <p><i>If yes, please complete a WG Consultation Alternative Request form, available on National Grid's website¹, and return to the CUSC inbox at cusc.team@nationalgrid.com</i></p>

Standard Workgroup consultation questions – CMP265

Q	Question	Response
---	----------	----------

¹ http://www.nationalgrid.com/uk/Electricity/Codes/systemcode/amendments/forms_guidance/

Q	Question	Response
5	<p>Do you believe that the CMP265 Original Proposal better facilitates the Applicable CUSC Objectives?</p>	<p>We view this Proposal as blatantly discriminatory and in the Proposer's corporate self-interest. It is recognised by the Proposer as only a partial solution to something that has been through many previous reviews, and throughout the Workgroup discussions has been demonstrated to have much wider impact and implications than simply impact with the Capacity Market. The reason for the narrow definition is purported to be to achieve a specific aim of removing distortion from the coming Capacity Market auction, yet it is proposed as an enduring not temporary solution. It would provide extremely limited cost savings to consumers through removing the Triad benefit from capacity contracted embedded generators in the capacity market; however the choice of an embedded generator to opt for Triads would remove it from the capacity market stack and so incrementally increase the price in the capacity market for over 50GW of capacity. It seems extraordinary to claim that this would benefit consumers.</p> <p>EDF has about 400MW of distribution connected onshore windfarms in the UK. To the extent these are generating at time of Triad they would receive the Triad payment. Statistically they would receive 100-150MW worth of Triad payments, but they do not provide firm capacity. This capacity is equivalent to Alkane's existing portfolio of firm capacity. To deprive Alkane of equivalent Triad revenue because Alkane can provide firm capacity and can contribute that to the Capacity Market seems self evidently anti competitive.</p> <p>Accordingly we cannot support this proposal. We believe a modification to the CMP264 Proposal is a much more appropriate basis for a way forward.</p>
6	<p>Do you support the proposed implementation approach? Or are there any further implementation implications that need to be considered?</p>	<p>We note the comment of the Elexon representative at the Working group that implementation of CMP264 or a variant of it would be easier in system terms.</p> <p>We have received feedback from our funders that this change would mean the capacity that has been built is at risk of default. Contrary to assertions that the capacity would be there anyway and certain to generate, albeit with other owners, a more likely outcome would be an international sale of the generators with capacity leaving the UK within months of a default.</p> <p>Also, we have been advised that this will be seen by investors/lenders as retrospective regulatory change, in what is perceived as a relatively mature UK environment. Ultimately this will cause investor capital to move to more stable regulatory environments.</p>
7	<p>Do you have any other comments?</p>	

Q	Question	Response
8	Do you wish to raise a WG Consultation Alternative Request for the Workgroup to consider?	<i>If yes, please complete a WG Consultation Alternative Request form, available on National Grid's website², and return to the CUSC inbox at cusc.team@nationalgrid.com</i>

Specific questions for CMP264

Q	Question	Response
---	----------	----------

² http://www.nationalgrid.com/uk/Electricity/Codes/systemcode/amendments/forms_guidance/

i) Do you think a cut-off date for “new embedded generation” of 30 June 2017 is appropriate? What other date would you propose?

A 13 month period is not appropriate. We would propose a date that is reflective of capacity market contract commitments, namely October 2018 and October 2019 for 2014 and 2015 CM contracted capacity respectively.

If this is considered unreasonable the earliest we could anticipate as a reasonable timeframe to apply to both years is October 2018.

We are unable to comply with 30 June 2017 for all our capacity market contract obligations and feel it is unreasonable for our investors to be penalised for working to a date set out in the capacity market rules.

ii) Do you have any views on how mixed sites are being addressed in CMP264 Original?

We think all embedded generation, behind the meter onsite generation and demand reduction should be treated the same since all have the same impact on the transmission system.

iii) Do you think new-build embedded generation capacity that has entered into long term financial and performance commitment obligations via 2014 and 2015 capacity market or contracts for difference auctions (prior to this modification proposal) should be given exceptions to this cut-off date?

Yes we think the cut-off date should be set based on the timetable to meet 2014 and 2015 CM and CfD capacity obligations.

We do not consider it likely that there will be significant new-build embedded generation built outside these initiatives. If any such investment were to take place such as CHP and projects under the Renewables Obligation they should be given exceptions to any cut-off date but provide evidence that a site was under construction prior to the end of 2016.

iv) Do you agree that ignoring demand behind the meter is unlikely to create a significant “loophole” or material discrimination risk in relation to the CMP264 arrangements in the short term

This is a significant loophole and very likely will continue to remain a distortion between embedded generators and to other parties that reduce net demand on the transmission network such as demand reduction. We as an embedded generator would be incentivised to “re-locate” our generation activities behind the meter and would actively seek to do so wherever possible.

v) Question to suppliers: Do you consider that the wording of your existing contracts allow you to reflect the changes provided by these modifications in a cost reflective manner. For example, these changes will apply to existing PPAs and generators who significantly alter their output (EREC 59).

N/A

vi) Do you agree with the definition of commissioned and do you agree that it is appropriate? If you do not agree with the

We support the definition of commissioned and that this should be used provided the dates set take account of CM/CfD contractual commitments.

13	<p>Do you have a view of whether implementation for the 2017/18 Triad season is sufficient to allow changes for:</p> <ul style="list-style-type: none">i) supplier contracts and billing system; andii) for other stakeholders?	<p>A significant change to the charging regime which has been established for so many years should be done with due consideration and full assessment of the impacts.</p> <p>Based on our participation in the discussions to date we consider it is very unlikely to be able to address all the issues including Elexon IT system changes and agree relevant proposals in time to be able to introduce a change prior to 2018/19 Triad season.</p>
----	---	---

18	<p>Do you have a view if embedded benefits are frozen at a non-zero value, what should that value be as a £/kW tariff (2016/17 value is £45.33 / kW)?</p>	<p>We agree that embedded benefits could be frozen at a non-zero value. It is important to give investors certainty to allow for investment in new and existing generation. Any value should be frozen for a period that enables businesses and their investors to make investment decisions.</p> <p>We consider existing embedded generators and new generators with 2014 & 2015 CM and CfD contracts should continue to receive Triads at the 2016/17 rate throughout the period of their contracts. In terms of costs to consumers, cost reflectivity and competitive positioning this is an improvement on the CMP 264 Original Proposal which would allow forecast increases in Triad payments to flow through to all existing generators. However it does provide investors who have made past investment decisions across all technologies a reasonable level of revenue in line with likely forecasts they would have made at the time of making the investment decisions.</p> <p>New embedded generators should receive a payment that is set at a level that can be supported by the limited evidence available on what the cost reflective level of the embedded benefit should be. For example the Cornwall Energy analysis that shows that total capital and operating costs of new network assets to deliver TG assets displaced by embedded generation at £32.30/kW. We have seen no counter evidence to dispute this very recent analysis. As we have stated we think all parties need time to acquire and present further analysis in evidence to support a value that can be viewed as certain for a period of time sufficient to support investment decisions.</p> <p>Investors need this clear long term signal to make investment decisions. Any uncertainty creates regulatory risk which is not conducive to competition or likely to benefit consumers.</p> <p>Absent a more rigorously defined number that has been through comprehensive peer group scrutiny and review we would recommend that the embedded benefit be frozen for new embedded generators at a national average of £20-30/kW for a minimum five-year period. A new generator would be a party that has undertaken a G59 and does not have a 2014 & 2015 capacity market or CfD contract.</p>
----	--	---

Specific questions for CMP265

Q	Question	Response
---	----------	----------

11	<p>i) Views are sought on the implication for mixed sites discussed in 3.4.10.</p> <p>ii) Views are sought on the preference of categories of capacity Market CMU captured by this proposal, please indicate your preference from the following list and reasons:</p> <ul style="list-style-type: none"> • All existing and new distribution generation CMUs • All existing and new distribution generation CMUs and DSR CMUs (proven and unproven) • All price maker CMUs • All newbuild/prospective distribution generation CMUs only (defined as >1year contracts) 	<p>Whilst we appreciate that to attempt to capture generation assets at mixed sites differently will be fraught with difficulty, we consider any on site generation should be treated no differently to demand reduction or other discrete embedded generation since all have the same impact on the transmission network.</p> <p>The complexity involved here demonstrates how discriminatory the proposal of CMP265 is. We therefore think it is a question that should not be asked since it gives spurious credibility around deliverability to the original proposal.</p>
14	<p>Do you have a view of whether implementation for the 2020/21 Triad season is sufficient to allow changes for i) supplier contracts and billing system, and ii) for other stakeholders?</p>	<p>(i) No view</p> <p>(ii) We believe a change for the 2020/21 Triad season is an appropriate time since it allows for change to be priced into the coming CM auctions for new plant. From discussions at the Workgroups involving Elexon we believe this should be sufficient time to make central system changes, but we have no other experience of this.</p>

Specific questions for BOTH CMP264 & CMP265

Q	Question	Response
---	----------	----------

Q	Question	Response
9	<p>i) Suppliers: In setting charges for your demand customers, do you charge them at the same tariff as National Grid charges you (i.e. gross), to enable you to pay the embedded benefit to embedded generators, or please explain the way in which it is funded?</p> <p>ii) Suppliers: Does the estimate that 7.58GW of embedded generation output and 2.5GW of demand side reduction at the time of Triad for 2016/17 seem reasonable based on your knowledge of the UK market? If not what is your estimate of embedded generator output and DSR at time of Triad?</p>	N/A
12	<p>Can you identify – either quantitatively or qualitatively - the impact of the demand TNUoS embedded benefit on your decisions made in making capacity market decisions?</p>	<p>The removal of the Triad benefit will have a significant negative impact on the economics of both existing and new embedded generation. If Triad revenues were to fall below the 2016/17 level and there to be continued regulatory uncertainty, we do not expect to meet our 2014 & 2015 Capacity Market contract obligations due to a lack of investor/lender appetite.</p> <p>The stability of future Triad benefit is crucial to allow generators to accurately forecast revenue and provide investor/lender confidence.</p> <p>The uncertainty that now arises will have a significant impact on our decisions in the 2016 capacity market auction. We will only be an investor if the auction price is materially higher than in the previous auctions. The pricing in of risk and uncertainty of outcome is almost certainly going to deliver a price that is higher than it would otherwise have been.</p>

Q	Question	Response
15	<p>i) What are your views on the 2 broad options to enable the reporting of gross export metered data?</p> <p>ii) Would you have the data available required for Option B (both CMP264 and CMP265) for both new contracts and existing contracts where a customer may be partially exempt?</p> <p>iii) Do you believe you can implement the proposed changes by the respective implementation dates?</p> <p>iv) What are the pros and cons of the 2 proposals that ELEXON are considering to implement this (P348 for CMP265/ P349 for CMP264)?</p>	<p>We have no comment as this is handled by our supplier/PPA provider.</p>

Q	Question	Response
16	<p>Do you have any further evidence / comments on the consumer impact of changing the demand TNUoS embedded benefit in either the short-run or long-run?</p>	<p>We understand from analysis shared within the Workgroup that some 2GW of new build embedded generation secured contracts in the 2014 & 15 Capacity Market auctions. This resulted in significant benefits to consumers as the auction clearing prices were lower than almost all earlier forecasts.</p> <p>We expect the removal of the embedded benefit as proposed by CMP265 and by CMP264 unless delivery timescales are extended or an exemption given to those holding CM contracts to result in some of this plant not being built. This could result in capacity shortfalls in 2018 and 2019 and will require higher cost capacity to be procured to fill the gap.</p> <p>In addition to the new build embedded generation that secured capacity market contracts there is well in excess of 10GW of embedded generation. Much of this (we would suggest well in excess of 30% but have not yet had time to refine this number) is onshore wind which does not contribute towards firm capacity but does nonetheless benefit in exactly the same way as firm capacity at time of Triad. We would question whether this capacity which also receives a direct subsidy via ROCs should continue to benefit from unadjusted rising Triad prices as forecast, while that EG which is a major contributor to the security of supply and the provision of balancing services has the benefit removed in a discriminatory way.</p> <p>Over the longer term we would expect distribution network costs to rise especially at the EHV voltage levels as the export from embedded generation is reduced. We also expect transmission network costs to be higher over the long term if embedded generation is replaced with transmission connected generation.</p> <p>Our ability to gather evidence to support our analysis is limited by both the time made available to us to comment (given resources) and the time it takes to tender for and procure third party support to conduct appropriate analysis.</p>

Q	Question	Response
17	<p>Do you feel that both the locational and residual component of the demand TNUoS should be removed as an embedded benefit (as CMP264 Original) or just the residual component (as CMP265 Original) or some other method?</p>	<p>We believe a further thorough review of the TNUoS charging regime must be undertaken given the demand residual outcomes now being forecast. Retaining the locational benefit for EG is preferable to removal of the total benefit including residual, but still is we believe not fully cost reflective of the benefit delivered by EG.</p> <p>There is an increasing conflict between cost reflectivity and “fair” competition. The group behind the December 2013 consultation on embedded benefits issued by NG felt cost reflectivity was most important. <i>“There was a general agreement within the focus group that the following two remits were areas for consideration when discussing potential defects.</i></p> <ul style="list-style-type: none"> • <i>Cost reflectivity of transmission charges on distribution connected generation.</i> • <i>Impact of transmissions charges on competition between transmission and distribution connected generation.</i> <p><i>These were primarily based on the charging objectives of cost reflectivity and facilitating competition. These were presented to the focus group by the Chair for their views on whether the remits should be classed as defects themselves. Most of the focus group felt that there was no clear defect or impact on the embedded benefit within the two apparent defects presented and preferred the term ‘remit’ over ‘apparent defect’. Some members believed that cost reflectivity should take priority over competition and that by addressing cost reflectivity it should in turn address competition. A view was expressed that applicable CUSC objective b (cost reflectivity) should always be considered first as competition can only be considered in a broader sense. Therefore the review should focus on cost reflectivity. There was general support that, even if there were no apparent defect, that cost reflectivity of the embedded benefit could be improved.”</i></p> <p>In practice it is however the desire of a “level playing field” for competition that is actually causing the issue and driving both Proposers to define the defect. The EU Directive imposing the EUR2.50/MWh cap on transmission costs passed to generators was largely driven by improving the fairness of competition between member states. However as already noted, the implementation of this in the UK will drive payments to be made to almost all onshore transmission connected generators by 2020/21. This cannot be considered cost reflective and could paradoxically put the UK transmission generators at a competitive advantage from this date when it comes to exports across interconnectors.</p> <p>It is this cap which is driving demand residual up so high – demand residual is (in the current charging regime) the only place to allocate costs. Ultimately the consumer is obliged to pay the costs – in question is the route through to the consumer and what distortions this may deliver along the way.</p> <p>For example, to deliver fair competition between transmission and distribution connected generators and avoid this specific distortion, it follows that this negative generation residual payment to TC should at</p>

Q	Question	Response
19	<p>Regarding the proposed alternatives what are your views on the suggested implementation dates? Are these achievable? Please give reasons for your view.</p>	<p>Based on Workgroup discussions to date and the complexity of the issues involved and interaction with industry systems including suppliers and Elexon, we do not think implementation by the 2017/8 season is credible (we recollect it has been variously described as “challenging” and “impossible”). An earliest implementation date of 2018/9 seems more reasonable and deliverable. Although this means the existing Triad regime would influence the Early Capacity Auction of 2017/8, this is a one year auction and it would be extremely difficult at this stage to build more capacity on sites without existing contracts in place and guarantee those would be able to deliver by October 2017. It would however ensure that capacity bidding into the T-4 auction for delivery in 2020/21 would certainly be affected as would non CM plants built to deliver after October 2018.</p> <p>Early certainty would be welcomed therefore consistent with not undermining past investment decisions we would support the earliest possible credible implementation date.</p>

CUSC Workgroup Consultation Response Proforma

CMP264 'Embedded Generation Triad Avoidance Standstill' and **CMP265** 'Gross charging of TNUoS for HH demand where Embedded Generation is in the Capacity Market'

Industry parties are invited to respond to this consultation expressing their views and supplying the rationale for those views, particularly in respect of any specific questions detailed below.

Please send your responses by **24th August 2016** to cusc.team@nationalgrid.com Please note that any responses received after the deadline or sent to a different email address may not receive due consideration by the Workgroup.

Any queries on the content of the consultation should be addressed to Caroline Wright at caroline.wright@nationalgrid.com

These responses will be considered by the Workgroup at its next meeting at which members will also consider any Workgroup Consultation Alternative Requests. Where appropriate, the Workgroup will record your response and its consideration of it within the final Workgroup Report which is submitted to the CUSC Modifications Panel.

Respondent:	<i>Phil Robinson</i> <i>phil.robinson@calonenergy.com</i>
Company Name:	<i>Calon Energy</i>
Please express your views regarding the Workgroup Consultation, including rationale. (Please include any issues, suggestions or queries)	<p>For reference, the Applicable CUSC objectives are:</p> <p>Use of System Charging Methodology</p> <p>(a) that compliance with the use of system charging methodology facilitates effective competition in the generation and supply of electricity and (so far as is consistent therewith) facilitates competition in the sale, distribution and purchase of electricity;</p> <p>(b) that compliance with the use of system charging methodology results in charges which reflect, as far as is reasonably practicable, the costs (excluding any payments between transmission licensees which are made under and in accordance with the STC) incurred by transmission licensees in their transmission businesses and which are compatible with standard condition C26 (Requirements of a connect and manage connection);</p> <p>(c) that, so far as is consistent with sub-paragraphs (a) and (b), the use of system charging methodology, as far as is reasonably practicable, properly takes account of</p>

	<p>the developments in transmission licensees' transmission businesses.</p> <p>(d) Compliance with the Electricity Regulation and any relevant legally binding decision of the European Commission and/or the Agency.</p>
--	---

Standard Workgroup consultation questions – CMP264

Q	Question	Response
1	Do you believe that the CMP264 Original Proposal better facilitates the Applicable CUSC Objectives?	Yes. Calon believes that the modification will create a more level playing field between generators and thus remove market distortions and enhance competition, in line with objective a. It will also better reflect the costs associated with transmission, which should not reward third parties, and thus meet objective b.
2	Do you support the proposed implementation approach? Or are there any further implementation implications that need to be considered?	Yes. However, we note that there remains an incentive for embedded generators to move behind the meter, so would propose that Ofgem modify the CM rules to allow EMR Settlements to provide details of all CM meters for the purposes of TNUoS charging. These meters could then be incorporated into an expanded solution.
3	Do you have any other comments?	No.
4	Do you wish to raise a WG Consultation Alternative Request for the Workgroup to consider?	Yes.

Standard Workgroup consultation questions – CMP265

Q	Question	Response
5	Do you believe that the CMP265 Original Proposal better facilitates the Applicable CUSC Objectives?	Yes, as with CMP264 it does reduce the distortions in competition in line with objective a and improves the cost reflexivity of the charging structure, in line with objective b.

Q	Question	Response
6	Do you support the proposed implementation approach? Or are there any further implementation implications that need to be considered?	Yes. The timing seems to be a sensible approach given the issues associated with systems.
7	Do you have any other comments?	No.
8	Do you wish to raise a WG Consultation Alternative Request for the Workgroup to consider?	Yes

Specific questions for CMP264

Q	Question	Response
---	----------	----------

Q	Question	Response
10	<p>i) Do you think a cut-off date for “new embedded generation” of 30 June 2017 is appropriate? What other date would you propose?</p> <p>ii) Do you have any views on how mixed sites are being addressed in CMP264 Original?</p> <p>iii) Do you think new-build embedded generation capacity that has entered into long term financial and performance commitment obligations via 2014 and 2015 capacity market or contracts for difference auctions (prior to this modification proposal) should be given exceptions to this cut-off date?</p> <p>iv) Do you agree that ignoring demand behind the meter is unlikely to create a significant “loophole” or material discrimination risk in relation to the CMP264 arrangements in the short term</p> <p>v) Question to suppliers: Do you consider that the wording of your existing contracts allow you to reflect the changes provided by these modifications in a cost reflective manner. For example, these changes will apply to existing PPAs and generators who significantly alter their output (EREC 59).</p> <p>vi) Do you agree with the definition of commissioned and do you agree that it is appropriate? If you do not agree with the definition or that it is appropriate please provide alternative definitions and rationale for this definition.</p>	<p>i) Yes, that seems long enough for all T-4 capacity to finish building.</p> <p>ii) In an ideal world it would be easy to capture on-site generation in the general principles of the modification, but that may prove difficult in practice. We therefore suspect a pragmatic solution is to ignore these sites.</p> <p>iii) All plant economics are subject to regulatory changes and all should be treated equally. However, we recognise that the changes could undermine the economics of these plants, which investors have built in good faith, so we think there is a good case for some form of grandfathering. However, that should be at the current level of benefits and should not go on escalating over time.</p> <p>iv) This is clearly a loophole, but it is one of many that exist for on-site generation. If the proposal can ensure it picks up exporting meter that would be better than nothing, but otherwise we may have to accept that do nothing is the pragmatic solution.</p> <p>v) N/A</p> <p>vi) using the G59 statement for commissioning seems appropriate.</p>

Q	Question	Response
13	<p>Do you have a view of whether implementation for the 2017/18 Triad season is sufficient to allow changes for:</p> <p>i) supplier contracts and billing system; and</p> <p>ii) for other stakeholders?</p>	<p>We would be surprised if the BSC systems could be altered that fast. While in principle we support the date, we would suggest that the implementation fits with the timetable for system changes, allowing for a full test of any changes. Recent experience with IT projects suggests that rushed implementation results in unforeseen consequences that would best be avoided.</p>
18	<p>Do you have a view if embedded benefits are frozen at a non-zero value, what should that value be as a £/kW tariff (2016/17 value is £45.33 / kW)?</p>	<p>Were benefits to be frozen we would suggest that around the 2014/15 levels (£30.05/kW) would be acceptable as that aligns with the last embedded benefits review when NG seemed to conclude that there was no material issues that needed resolving. Since then the growth in both embedded generation and TO costs has probably been far beyond what the review envisaged.</p>

Specific questions for CMP265

Q	Question	Response
11	<p>i) Views are sought on the implication for mixed sites discussed in 3.4.10.</p> <p>ii) Views are sought on the preference of categories of capacity Market CMU captured by this proposal, please indicate your preference from the following list and reasons:</p> <ul style="list-style-type: none"> • All existing and new distribution generation CMUs • All existing and new distribution generation CMUs and DSR CMUs (proven and unproven) • All price maker CMUs • All newbuild/prospective distribution generation CMUs only (defined as >1year contracts) 	<p>i) As noted above, mixed site are treated in a different way on a number of fronts, so it may be pragmatic ignore them for now. While this creates some incentives to go "behind the meter" we suspect the impact in terms of volume will be limited.</p> <p>ii) We believe that all CMUs, both DSR and generation, should be covered by the proposal. What we are not sure about is why it is only CM parties and not all embedded generation.</p> <p>As noted under P264, there may be a case for grandfathering embedded benefits to sites that had signed longer term agreements in the 2014/15 T-4 auctions on the basis of the benefits at that time. All CMUs in auctions after those dates should have rationally been aware of the risk of changes to embedded benefits and have factored those into their CM bids.</p>

14	<p>Do you have a view of whether implementation for the 2020/21 Triad season is sufficient to allow changes for i) supplier contracts and billing system, and ii) for other stakeholders?</p>	<p>This seems like a perfectly acceptable timetable to allow for changes to contracts and systems. If anything we believe that the modification should be implemented by 2019/20 which is in line with Ofgem's letter of 29/7/16.</p>
----	--	---

Specific questions for BOTH CMP264 & CMP265

Q	Question	Response
9	<p>i) Suppliers: In setting charges for your demand customers, do you charge them at the same tariff as National Grid charges you (i.e. gross), to enable you to pay the embedded benefit to embedded generators, or please explain the way in which it is funded?</p> <p>ii) Suppliers: Does the estimate that 7.58GW of embedded generation output and 2.5GW of demand side reduction at the time of Triad for 2016/17 seem reasonable based on your knowledge of the UK market? If not what is your estimate of embedded generator output and DSR at time of Triad?</p>	<p>No comment as we are not suppliers.</p>
12	<p>Can you identify – either quantitatively or qualitatively - the impact of the demand TNUoS embedded benefit on your decisions made in making capacity market decisions?</p>	<p>As a company we have been very concerned by the growth in embedded benefits, but as the owners of TO connected plant there has been little we can do. The TNUoS embedded benefit is distorting peak pricing economics meaning that price signals are not reflective of marginal economics or scarcity pricing. This is not efficient and we do not believe the situation to be sustainable. This in turn makes CM decisions highly problematic as they are subject to considerable regulatory uncertainty.</p>

Q	Question	Response
15	<p>i) What are your views on the 2 broad options to enable the reporting of gross export metered data?</p> <p>ii) Would you have the data available required for Option B (both CMP264 and CMP265) for both new contracts and existing contracts where a customer may be partially exempt?</p> <p>iii) Do you believe you can implement the proposed changes by the respective implementation dates?</p> <p>iv) What are the pros and cons of the 2 proposals that ELEXON are considering to implement this (P348 for CMP265/ P349 for CMP264)?</p>	<p>i) We would prefer that settlement data is managed centrally and provided by Elexon to NG. The industry should have one set of robustly remained settlement data and not rely on their parties more than they have to.</p> <p>ii) no comments.</p> <p>iii) No comments.</p> <p>iv) No comments.</p>
16	<p>Do you have any further evidence / comments on the consumer impact of changing the demand TNUoS embedded benefit in either the short-run or long-run?</p>	<p>We note that there have been concerns about the impact of the proposals on peak prices were the embedded generation to no longer despatch at peak for Triad payments. However, these parties should be able to find different routes to market, either directly or via a supplier. We note that some companies are now BSC parties, so we are not convinced that market access is the problem. However, setting that aside, there is a problem that the longer term prices are not creating signals to build new plant without substantial CM payments. We believe that the energy price signals should not only be telling parties when to generate, but also sending strong signals on demand to load shed.</p> <p>For a given peak half hour, the TNUOS embedded benefit is high and the predictability is decreasing as there is greater embedded generation. As a result, half hourly prices no longer reflect marginal economics or scarcity but instead reflect the desire to reduce annual charges. We believe this leads to an inefficiency to an extent that was not envisaged when the current market mechanisms were established.</p>

Q	Question	Response
17	<p>Do you feel that both the locational and residual component of the demand TNUoS should be removed as an embedded benefit (as CMP264 Original) or just the residual component (as CMP265 Original) or some other method?</p>	<p>Yes. We can see no case for any embedded benefits unless they are truly reflective of all externalities and do not create distortions in either short-run or long-run pricing.</p>
19	<p>Regarding the proposed alternatives what are your views on the suggested implementation dates? Are these achievable? Please give reasons for your view.</p>	<p>We are not experts in the IT systems, but we would urge implementation be aligned with the timing for altering the systems and testing them to make sure that the changes are robust.</p>

CUSC Workgroup Consultation Response Proforma

CMP264 'Embedded Generation Triad Avoidance Standstill' and **CMP265** 'Gross charging of TNUoS for HH demand where Embedded Generation is in the Capacity Market'

Industry parties are invited to respond to this consultation expressing their views and supplying the rationale for those views, particularly in respect of any specific questions detailed below.

Please send your responses by **24th August 2016** to cusc.team@nationalgrid.com Please note that any responses received after the deadline or sent to a different email address may not receive due consideration by the Workgroup.

Any queries on the content of the consultation should be addressed to Caroline Wright at caroline.wright@nationalgrid.com

These responses will be considered by the Workgroup at its next meeting at which members will also consider any Workgroup Consultation Alternative Requests. Where appropriate, the Workgroup will record your response and its consideration of it within the final Workgroup Report which is submitted to the CUSC Modifications Panel.

Respondent:	<i>Tim Collins, tim.collins1@centrica.com</i>
Company Name:	<i>Centrica</i>
<p>Please express your views regarding the Workgroup Consultation, including rationale.</p> <p>(Please include any issues, suggestions or queries)</p>	<p>For reference, the Applicable CUSC objectives are:</p> <p>Use of System Charging Methodology</p> <p>(a) that compliance with the use of system charging methodology facilitates effective competition in the generation and supply of electricity and (so far as is consistent therewith) facilitates competition in the sale, distribution and purchase of electricity;</p> <p>(b) that compliance with the use of system charging methodology results in charges which reflect, as far as is reasonably practicable, the costs (excluding any payments between transmission licensees which are made under and in accordance with the STC) incurred by transmission licensees in their transmission businesses and which are compatible with standard condition C26 (Requirements of a connect and manage connection);</p> <p>(c) that, so far as is consistent with sub-paragraphs (a) and (b), the use of system charging methodology, as far as is reasonably practicable, properly takes account of the developments in transmission licensees' transmission</p>

	<p>businesses.</p> <p>(d) Compliance with the Electricity Regulation and any relevant legally binding decision of the European Commission and/or the Agency.</p>
--	--

Standard Workgroup consultation questions – CMP264

Q	Question	Response
1	Do you believe that the CMP264 Original Proposal better facilitates the Applicable CUSC Objectives?	<p>No.</p> <p>On applicable objective (a), we recognise the status quo is not conducive to effective competition in generation. However, we are concerned that CMP264 would create further distortions between new and existing embedded generation. There would also be distortions to competition between new embedded generators in different geographical locations, because all new embedded generators would face a zero tariff despite their different effects on transmission network flows (and therefore transmission investment needs). Finally, we note that the effective continuation of status quo embedded TNUoS benefits for existing embedded generation would leave a significant competitive distortion between transmission connected and existing embedded generation unaddressed.</p> <p>On applicable objective (b), we have concerns about the non-cost reflectivity of CMP264, because it will result in generators having similar effects on transmission network flows (and therefore transmission investment needs) facing materially different charges (according to whether they are transmission connected, existing embedded or new embedded). Whilst we accept that the status quo is not cost reflective, we do not believe CMP264 enhances cost reflectivity.</p>
2	Do you support the proposed implementation approach? Or are there any further implementation implications that need to be considered?	<p>We believe there is significant implementation risk associated with CMP264, notably in ensuring that “new” embedded generation is captured, reported and charged as intended. We also believe the proposed 30 June 2017 cut-off date for being deemed an “existing” embedded generator could put pressure on system / process delivery timelines. It seems to us that a good deal of system / process work needs to be undertaken before June 2017 to give effect to CMP264 and we question whether this is practicable.</p>
3	Do you have any other comments?	No.

Q	Question	Response
4	<p>Do you wish to raise a WG Consultation Alternative Request for the Workgroup to consider?</p>	<p><i>If yes, please complete a WG Consultation Alternative Request form, available on National Grid's website¹, and return to the CUSC inbox at cusc.team@nationalgrid.com</i></p> <p>We do not wish to raise a WG Consultation Alternative Request given the potential alternatives already mooted by Centrica in the Workgroup Consultation report.</p>

Standard Workgroup consultation questions – CMP265

Q	Question	Response
---	----------	----------

¹ http://www.nationalgrid.com/uk/Electricity/Codes/systemcode/amendments/forms_guidance/

Q	Question	Response
5	<p>Do you believe that the CMP265 Original Proposal better facilitates the Applicable CUSC Objectives?</p>	<p>No.</p> <p>On applicable objective (a), we recognise the status quo is not conducive to effective competition in generation. However, we have concerns that CMP265 may not facilitate effective competition either. CMP265 effectively gives embedded generators a choice between status quo transmission embedded benefits and Capacity Market (CM) payments. This will likely result in embedded generators opting out of future CM auctions in order to retain non-cost reflective transmission embedded benefits. The projected increases in (status quo) transmission embedded benefits are such that we would likely see continued roll out of new embedded generation, even with the loss of CM payments. The level of roll out would likely exceed the economic and efficient level, because embedded generation would continue to be over-remunerated by the status quo transmission embedded benefit. Because expected contributions from non-CM capacity are taken into account when CM auction demand is calculated, we believe the continued roll out of embedded generation would result in a corresponding reduction in CM target demand in future CM auctions, with a growing subset of the total market sustained by alternative (and higher) payments outside the CM (i.e. status quo embedded benefits). We therefore believe that status quo embedded benefits will continue to have adverse competitive impacts on the Capacity Market / generation mix and electricity market more broadly, even if embedded generation does not participate in the CM directly.</p> <p>On applicable objective (b), we have concerns about the non-cost reflectivity of CMP265, because it will result in generators having similar effects on transmission network flows (and therefore forward looking transmission costs) facing materially different charges (according to whether they are transmission connected, embedded and in the CM or embedded and outside the CM). Whilst we agree that the status quo is not cost reflective, we are unconvinced that CMP265 enhances cost reflectivity.</p>

Q	Question	Response
6	Do you support the proposed implementation approach? Or are there any further implementation implications that need to be considered?	We support the principle of reasonable lead times prior to major industry change being implemented. In this instance, we believe change should be sympathetic to the Capacity Market bidding cycle, which requires price commitments to be made four years ahead, based in part on assumptions about transmission charges. However, we recognise that cost reflective transmission charges can (and should) change over time and do not support grandfathering of transmission tariffs. An implementation date of April 2020 strikes the right balance between cost reflectivity, effective competition and certainty/risk mitigation for existing embedded generators.
7	Do you have any other comments?	No.
8	Do you wish to raise a WG Consultation Alternative Request for the Workgroup to consider?	<p><i>If yes, please complete a WG Consultation Alternative Request form, available on National Grid's website², and return to the CUSC inbox at cusc.team@nationalgrid.com</i></p> <p>We do not wish to raise a WG Consultation Alternative Request given the potential alternatives already mooted by Centrica in the Workgroup Consultation report.</p>

Specific questions for CMP264

Q	Question	Response
---	----------	----------

² http://www.nationalgrid.com/uk/Electricity/Codes/systemcode/amendments/forms_guidance/

Q	Question	Response
10	<p>i) Do you think a cut-off date for “new embedded generation” of 30 June 2017 is appropriate? What other date would you propose?</p> <p>ii) Do you have any views on how mixed sites are being addressed in CMP264 Original?</p> <p>iii) Do you think new-build embedded generation capacity that has entered into long term financial and performance commitment obligations via 2014 and 2015 capacity market or contracts for difference auctions (prior to this modification proposal) should be given exceptions to this cut-off date?</p> <p>iv) Do you agree that ignoring demand behind the meter is unlikely to create a significant “loophole” or material discrimination risk in relation to the CMP264 arrangements in the short term</p> <p>v) Question to suppliers: Do you consider that the wording of your existing contracts allow you to reflect the changes provided by these modifications in a cost reflective manner. For example, these changes will apply to existing PPAs and generators who significantly alter their output (EREC 59).</p> <p>vi) Do you agree with the definition of commissioned and do you agree that it is appropriate? If you do not agree with the definition or that it is appropriate please provide alternative definitions and rationale for this definition.</p>	<p>We have overarching concerns about the administrative complexity and impracticality of CMP264.</p> <p>We believe it is unnecessary and undesirable to create sub categories of embedded generation, with some sub categories being eligible for transmission embedded benefits and others not.</p> <p>A more straightforward and cost reflective approach is to treat all exports from embedded generation equivalently for transmission charging purposes, irrespective of whether they are “new” or “existing”.</p>

Q	Question	Response
13	<p>Do you have a view of whether implementation for the 2017/18 Triad season is sufficient to allow changes for:</p> <p>i) supplier contracts and billing system; and</p> <p>ii) ii) for other stakeholders?</p>	<p>We have concerns about the timeline associated with CMP264. We would favour a simpler implementation approach and a longer lead time, as per the potential alternatives mooted by Centrica in the Workgroup Consultation report.</p>
18	<p>Do you have a view if embedded benefits are frozen at a non-zero value, what should that value be as a £/kW tariff (2016/17 value is £45.33 / kW)?</p>	<p>We do not believe that transmission tariffs for embedded generation (whether new or existing) should be frozen. We believe embedded generation tariffs should be broadly equivalent in value to the tariffs applying to transmission connected generators in similar locations. Because transmission connected generator tariffs can (and should) change over time, freezing tariffs for any embedded generation at any level would work against cost reflectivity and effective competition in generation.</p>

Specific questions for CMP265

Q	Question	Response
---	----------	----------

11	<p>i) Views are sought on the implication for mixed sites discussed in 3.4.10.</p> <p>ii) Views are sought on the preference of categories of capacity Market CMU captured by this proposal, please indicate your preference from the following list and reasons:</p> <ul style="list-style-type: none"> • All existing and new distribution generation CMUs • All existing and new distribution generation CMUs and DSR CMUs (proven and unproven) • All price maker CMUs • All newbuild/prospective distribution generation CMUs only (defined as >1year contracts) 	<p>We believe it is unnecessary and undesirable to create sub-categories of embedded generation, with some sub-categories being eligible for transmission embedded benefits and others not.</p> <p>A more straightforward and cost reflective approach is to treat all exports from embedded generation equivalently for transmission charging purposes, irrespective of their status in the CM.</p>
14	<p>Do you have a view of whether implementation for the 2020/21 Triad season is sufficient to allow changes for i) supplier contracts and billing system, and ii) for other stakeholders?</p>	<p>Whilst we have sympathy with an April 2020 implementation date, implementation risk could be reduced further if all exports from embedded generation were treated equivalently for transmission charging purposes, irrespective of their status in the CM.</p>

Specific questions for BOTH CMP264 & CMP265

Q	Question	Response
---	----------	----------

Q	Question	Response
9	<p>i) Suppliers: In setting charges for your demand customers, do you charge them at the same tariff as National Grid charges you (i.e. gross), to enable you to pay the embedded benefit to embedded generators, or please explain the way in which it is funded?</p> <p>ii) Suppliers: Does the estimate that 7.58GW of embedded generation output and 2.5GW of demand side reduction at the time of Triad for 2016/17 seem reasonable based on your knowledge of the UK market? If not what is your estimate of embedded generator output and DSR at time of Triad?</p>	
12	<p>Can you identify – either quantitatively or qualitatively - the impact of the demand TNUoS embedded benefit on your decisions made in making capacity market decisions?</p>	

Q	Question	Response
15	<p>i) What are your views on the 2 broad options to enable the reporting of gross export metered data?</p> <p>ii) Would you have the data available required for Option B (both CMP264 and CMP265) for both new contracts and existing contracts where a customer may be partially exempt?</p> <p>iii) Do you believe you can implement the proposed changes by the respective implementation dates?</p> <p>iv) What are the pros and cons of the 2 proposals that ELEXON are considering to implement this (P348 for CMP265/ P349 for CMP264)?</p>	<p>We have concerns about the implementation of both CMP264 and CMP265 because they introduce subcategories of embedded generation (e.g. new/existing and CM/non-CM) that may prove difficult to capture in industry codes. We favour a CUSC modification based around identifying embedded generation “exports” and establishing corresponding export tariffs for each GSP group that ensure effective competition between embedded and transmission connected generation. This has been mooted by Centrica as a potential alternative in the Workgroup Consultation report) and may also simplify the BSC modification requirements.</p>
16	<p>Do you have any further evidence / comments on the consumer impact of changing the demand TNUoS embedded benefit in either the short-run or long-run?</p>	
17	<p>Do you feel that both the locational and residual component of the demand TNUoS should be removed as an embedded benefit (as CMP264 Original) or just the residual component (as CMP265 Original) or some other method?</p>	<p>We believe embedded generation exports should face a cost reflective locational signal and their overall tariff should be broadly equivalent in value to that of transmission connected generators in similar locations.</p>
19	<p>Regarding the proposed alternatives what are your views on the suggested implementation dates? Are these achievable? Please give reasons for your view.</p>	<p>In general, the April 2017 implementation dates appear challenging and the April 2020 implementation dates appear feasible.</p>

CUSC Workgroup Consultation Response Proforma

CMP264 'Embedded Generation Triad Avoidance Standstill' and **CMP265** 'Gross charging of TNUoS for HH demand where Embedded Generation is in the Capacity Market'

Industry parties are invited to respond to this consultation expressing their views and supplying the rationale for those views, particularly in respect of any specific questions detailed below.

Please send your responses by **24th August 2016** to cusc.team@nationalgrid.com Please note that any responses received after the deadline or sent to a different email address may not receive due consideration by the Workgroup.

Any queries on the content of the consultation should be addressed to Caroline Wright at caroline.wright@nationalgrid.com

These responses will be considered by the Workgroup at its next meeting at which members will also consider any Workgroup Consultation Alternative Requests. Where appropriate, the Workgroup will record your response and its consideration of it within the final Workgroup Report which is submitted to the CUSC Modifications Panel.

Respondent:	<i>Eddie Wilkinson</i> <i>CEO - CLP Envirogas</i> <i>ewilkinson@clpenvirogas.com</i>
Company Name:	<i>CLP Envirogas Limited</i>
Please express your views regarding the Workgroup Consultation, including rationale. (Please include any issues, suggestions or queries)	<p>For reference, the Applicable CUSC objectives are:</p> <p>Use of System Charging Methodology</p> <p>(a) that compliance with the use of system charging methodology facilitates effective competition in the generation and supply of electricity and (so far as is consistent therewith) facilitates competition in the sale, distribution and purchase of electricity;</p> <p>(b) that compliance with the use of system charging methodology results in charges which reflect, as far as is reasonably practicable, the costs (excluding any payments between transmission licensees which are made under and in accordance with the STC) incurred by transmission licensees in their transmission businesses and which are compatible with standard condition C26 (Requirements of a connect and manage connection);</p> <p>(c) that, so far as is consistent with sub-paragraphs (a)</p>

	<p>and (b), the use of system charging methodology, as far as is reasonably practicable, properly takes account of the developments in transmission licensees' transmission businesses.</p> <p>(d) Compliance with the Electricity Regulation and any relevant legally binding decision of the European Commission and/or the Agency.</p>
--	---

Standard Workgroup consultation questions – CMP264

Q	Question	Response
1	Do you believe that the CMP264 Original Proposal better facilitates the Applicable CUSC Objectives?	No. Given the rules around allocating transmission system costs between Generation and Demand, embedded generation is effectively negative demand at GSP and should be treated as such.
2	Do you support the proposed implementation approach? Or are there any further implementation implications that need to be considered?	No. The proposal sits outside the CUSC objectives, does not address the fundamental issue of increasing transmission system costs and their allocation, and unfairly targets new embedded generators, some of whom may have included this revenue when designing their projects.
3	Do you have any other comments?	No.
4	Do you wish to raise a WG Consultation Alternative Request for the Workgroup to consider?	<i>If yes, please complete a WG Consultation Alternative Request form, available on National Grid's website¹, and return to the CUSC inbox at cusc.team@nationalgrid.com</i>

Standard Workgroup consultation questions – CMP265

Q	Question	Response
5	Do you believe that the CMP265 Original Proposal better facilitates the Applicable CUSC Objectives?	No. Given the rules around allocating transmission system costs between Generation and Demand, embedded generation is effectively negative demand at GSP and should be treated as such.

¹ http://www.nationalgrid.com/uk/Electricity/Codes/systemcode/amendments/forms_guidance/

Q	Question	Response
6	Do you support the proposed implementation approach? Or are there any further implementation implications that need to be considered?	No. The proposal sits outside the CUSC objectives, does not address the fundamental issue of increasing transmission system costs and their allocation, and unfairly targets CM embedded generators, who are likely to have included this ongoing revenue when designing their projects.
7	Do you have any other comments?	If such an amendment is appropriate in respect of CM embedded generators, it should not be applied retrospectively. it should be clear at the time of future Capacity Market auctions, it can then be reflected in the bid price.
8	Do you wish to raise a WG Consultation Alternative Request for the Workgroup to consider?	<i>If yes, please complete a WG Consultation Alternative Request form, available on National Grid's website², and return to the CUSC inbox at cusc.team@nationalgrid.com</i>

Specific questions for CMP264

Q	Question	Response
---	----------	----------

² http://www.nationalgrid.com/uk/Electricity/Codes/systemcode/amendments/forms_guidance/

Q	Question	Response
10	<p>i) Do you think a cut-off date for “new embedded generation” of 30 June 2017 is appropriate? What other date would you propose?</p> <p>ii) Do you have any views on how mixed sites are being addressed in CMP264 Original?</p> <p>iii) Do you think new-build embedded generation capacity that has entered into long term financial and performance commitment obligations via 2014 and 2015 capacity market or contracts for difference auctions (prior to this modification proposal) should be given exceptions to this cut-off date?</p> <p>iv) Do you agree that ignoring demand behind the meter is unlikely to create a significant “loophole” or material discrimination risk in relation to the CMP264 arrangements in the short term</p> <p>v) Question to suppliers: Do you consider that the wording of your existing contracts allow you to reflect the changes provided by these modifications in a cost reflective manner. For example, these changes will apply to existing PPAs and generators who significantly alter their output (EREC 59).</p> <p>vi) Do you agree with the definition of commissioned and do you agree that it is appropriate? If you do not agree with the definition or that it is appropriate please provide alternative definitions and rationale for this definition.</p>	<p>We do not agree with the change so do not comment on the selected date.</p> <p>No comment</p> <p>Yes, we do not agree with retrospective change to revenue and support mechanisms.</p> <p>No, to not include a specific category of embedded generators is discriminatory.</p> <p>No comment</p> <p>No comment</p>

Q	Question	Response
13	<p>Do you have a view of whether implementation for the 2017/18 Triad season is sufficient to allow changes for:</p> <p>i) supplier contracts and billing system; and</p> <p>ii) ii) for other stakeholders?</p>	<p>No comment, we do not agree with the change.</p>
18	<p>Do you have a view if embedded benefits are frozen at a non-zero value, what should that value be as a £/kW tariff (2016/17 value is £45.33 / kW)?</p>	<p>We do not believe that the embedded benefit should be frozen. However, if the tariffs are frozen, the value should be no less than the 2016/17 value (£45.33 per kW) as this would result in least damage to investor confidence.</p>

Specific questions for CMP265

Q	Question	Response
11	<p>i) Views are sought on the implication for mixed sites discussed in 3.4.10.</p> <p>ii) Views are sought on the preference of categories of capacity Market CMU captured by this proposal, please indicate your preference from the following list and reasons:</p> <ul style="list-style-type: none"> • All existing and new distribution generation CMUs • All existing and new distribution generation CMUs and DSR CMUs (proven and unproven) • All price maker CMUs • All newbuild/prospective distribution generation CMUs only (defined as >1year contracts) 	<p>No comment.</p> <p>No comment.</p>

14	<p>Do you have a view of whether implementation for the 2020/21 Triad season is sufficient to allow changes for i) supplier contracts and billing system, and ii) for other stakeholders?</p>	No comment.
----	--	-------------

Specific questions for BOTH CMP264 & CMP265

Q	Question	Response
9	<p>i) Suppliers: In setting charges for your demand customers, do you charge them at the same tariff as National Grid charges you (i.e. gross), to enable you to pay the embedded benefit to embedded generators, or please explain the way in which it is funded?</p> <p>ii) Suppliers: Does the estimate that 7.58GW of embedded generation output and 2.5GW of demand side reduction at the time of Triad for 2016/17 seem reasonable based on your knowledge of the UK market? If not what is your estimate of embedded generator output and DSR at time of Triad?</p>	<p>No comment.</p> <p>No comment.</p>
12	<p>Can you identify – either quantitatively or qualitatively - the impact of the demand TNUoS embedded benefit on your decisions made in making capacity market decisions?</p>	No comment.

Q	Question	Response
15	<p>i) What are your views on the 2 broad options to enable the reporting of gross export metered data?</p> <p>ii) Would you have the data available required for Option B (both CMP264 and CMP265) for both new contracts and existing contracts where a customer may be partially exempt?</p> <p>iii) Do you believe you can implement the proposed changes by the respective implementation dates?</p> <p>iv) What are the pros and cons of the 2 proposals that ELEXON are considering to implement this (P348 for CMP265/ P349 for CMP264)?</p>	<p>No comment.</p> <p>No comment.</p> <p>No comment.</p> <p>No comment.</p>
16	<p>Do you have any further evidence / comments on the consumer impact of changing the demand TNUoS embedded benefit in either the short-run or long-run?</p>	<p>No comment.</p>
17	<p>Do you feel that both the locational and residual component of the demand TNUoS should be removed as an embedded benefit (as CMP264 Original) or just the residual component (as CMP265 Original) or some other method?</p>	<p>Neither should be removed.</p>
19	<p>Regarding the proposed alternatives what are your views on the suggested implementation dates? Are these achievable? Please give reasons for your view.</p>	<p>No comment.</p>

CUSC Workgroup Consultation Response Proforma

CMP264 'Embedded Generation Triad Avoidance Standstill' and **CMP265** 'Gross charging of TNUoS for HH demand where Embedded Generation is in the Capacity Market'

Industry parties are invited to respond to this consultation expressing their views and supplying the rationale for those views, particularly in respect of any specific questions detailed below.

Please send your responses by **24th August 2016** to cusc.team@nationalgrid.com Please note that any responses received after the deadline or sent to a different email address may not receive due consideration by the Workgroup.

Any queries on the content of the consultation should be addressed to Caroline Wright at caroline.wright@nationalgrid.com

These responses will be considered by the Workgroup at its next meeting at which members will also consider any Workgroup Consultation Alternative Requests. Where appropriate, the Workgroup will record your response and its consideration of it within the final Workgroup Report which is submitted to the CUSC Modifications Panel.

Respondent:	<i>Joe Underwood</i> – Joseph.Underwood@drax.com
Company Name:	<i>Drax</i>
<p>Please express your views regarding the Workgroup Consultation, including rationale.</p> <p>(Please include any issues, suggestions or queries)</p>	<p>For reference, the Applicable CUSC objectives are:</p> <p>Use of System Charging Methodology</p> <p>(a) that compliance with the use of system charging methodology facilitates effective competition in the generation and supply of electricity and (so far as is consistent therewith) facilitates competition in the sale, distribution and purchase of electricity;</p> <p>(b) that compliance with the use of system charging methodology results in charges which reflect, as far as is reasonably practicable, the costs (excluding any payments between transmission licensees which are made under and in accordance with the STC) incurred by transmission licensees in their transmission businesses and which are compatible with standard condition C26 (Requirements of a connect and manage connection);</p> <p>(c) that, so far as is consistent with sub-paragraphs (a) and (b), the use of system charging methodology, as far as is reasonably practicable, properly takes account of the developments in transmission licensees' transmission</p>

	<p>businesses.</p> <p>(d) Compliance with the Electricity Regulation and any relevant legally binding decision of the European Commission and/or the Agency.</p>
--	--

Standard Workgroup consultation questions – CMP264

Q	Question	Response
----------	-----------------	-----------------

Q	Question	Response
1	<p>Do you believe that the CMP264 Original Proposal better facilitates the Applicable CUSC Objectives?</p>	<p>Yes.</p> <p>CMP264 addresses the disparity in competition between sub 100MW embedded generators and other generators caused by the excessive benefit arising from Embedded Benefits (EBs) based on the increasing and non-cost reflective demand residual tariff. The modification will put all generators on a more level playing field better facilitating competition.</p> <p>We believe that the true benefit that Embedded Generation (EG) brings the system is far less than the c.£45/kW they receive currently (and rising excessively in future). With respect to ACO (b), CMP264 will ensure a better reflection of actual costs (benefits).</p> <p>A rough approximation for the EB, mentioned in paragraph 2.3.14 in the workgroup report is the Total Allowable Revenue divided by Net Demand. The increasing amount of EG (effectively negative demand) on the distribution network has resulted in a decrease in the Net Demand (the denominator) thereby increasing the value of the EB. This artificially increases the profitability of building EG resulting in a positive feedback mechanism that encourages new EG to be built. This discernible increase in EG is impacting the ways in which the system is developed and operated therefore CMP264 will better facilitate ACO (c) with respect to the baseline.</p> <p>We would note that CMP264 has a number of shortfalls and that the potential option for change, denoted as Centrica 1 in the workgroup report, will better facilitate the ACOs. Firstly, while we agree with the principle of grandfathering in some circumstances, given these circumstances we do not agree that it is appropriate in this instance. This is because the charging arrangements have never been subject to any form of grandfathering meaning that a prudent investor will not have expected any form of grandfathering when making investment decisions. To apply grandfathering to the charging arrangements will create moral hazard, rewarding inefficient investment decisions and entrenching ineffective competition. Secondly, CMP264 removes any reference to the wider tariff in the EB. Under Centrica 1, all EGs will be subject to the modification and would receive the locational TNUoS tariff element as an EB. From the evidence provided and the time we have had to review, we believe that the locational TNUoS tariff element reflects a better approximation of the EB.</p>

Q	Question	Response
		<p>Centrica 1 however has a proposed implementation date of 1st April 2020 which we see as being excessive. The precedence set for charging changes (such as those seen in CMP213) was one full charging year.</p>
2	<p>Do you support the proposed implementation approach? Or are there any further implementation implications that need to be considered?</p>	<p>We see the benefit of swift action being taken to address the inappropriateness of the current and future EBs. We agree with the implementation date of CMP264 but for any EGs not subject to grandfathering, a more pragmatic approach should be taken such as the one mentioned in the answer to question 1 above i.e. One full charging year from Authority decision.</p>
3	<p>Do you have any other comments?</p>	<p>The temporary nature of CMP264 has been addressed a number of times in workgroup meetings. The modification proposal assumes a level of Ofgem intervention after its approval. However, the recent Ofgem letter on their minded-to position on charging arrangements for EB suggested that the CMP264/CMP265 work stream may be sufficient to address the defect. Given this it was suggested that CMP264 was no longer fit for purpose.</p> <p>We would highlight that the CUSC is not permanent in nature and that modifications can be raised by any party to the CUSC or any materially affected party. Therefore CMP264 can quickly address the defect in the short term and can be followed up by a modification that could take a more detailed holistic view of EBs as a whole or not if no further change is required. As such we believe CMP264 is still fit for purpose.</p>
4	<p>Do you wish to raise a WG Consultation Alternative Request for the Workgroup to consider?</p>	<p>If we decide to do so it will be in my capacity as a workgroup member.</p>

Standard Workgroup consultation questions – CMP265

Q	Question	Response
---	----------	----------

Q	Question	Response
5	<p>Do you believe that the CMP265 Original Proposal better facilitates the Applicable CUSC Objectives?</p>	<p>Yes for the same reasons seen in our answer to question 1</p> <p>Both CMP264 and CMP265 have drawbacks: CMP264 gets rid of the wider tariff as an EB and grandfathers current EGs, and CMP265 only applies to Capacity Market Units (CMUs). We believe that the wider tariff should be used to calculate the EB and that this should be applied to <u>all</u> embedded plant sub 100MW. The defect exists in the CUSC and relates to the demand residual being not cost reflective and thus distorting effective competition. Whether an EG is a CMU is irrelevant. We believe that the Centrica 1 potential option for change can address the issues described under CMP264 and CMP265.</p> <p>Centrica 1 however has a proposed implementation date of 1st April 2020 which we see as being excessive. The precedence set for charging changes (such as those seen in CMP213) was one full charging year.</p>
6	<p>Do you support the proposed implementation approach? Or are there any further implementation implications that need to be considered?</p>	<p>Please see the answer to question 2 above.</p>
7	<p>Do you have any other comments?</p>	<p>Not at this time.</p>
8	<p>Do you wish to raise a WG Consultation Alternative Request for the Workgroup to consider?</p>	<p>If we decide to do so it will be in my capacity as a workgroup member.</p>

Specific questions for CMP264

Q	Question	Response
10	<p>i) Do you think a cut-off date for “new embedded generation” of 30 June 2017 is appropriate? What other date would you propose?</p> <p>ii) Do you have any views on how mixed sites are being addressed in CMP264 Original?</p> <p>iii) Do you think new-build embedded generation capacity that has entered into long term financial and performance commitment obligations via 2014 and 2015 capacity market or contracts for difference auctions (prior to this modification proposal) should be given exceptions to this cut-off date?</p> <p>iv) Do you agree that ignoring demand behind the meter is unlikely to create a significant “loophole” or material discrimination risk in relation to the CMP264 arrangements in the short term</p> <p>v) Question to suppliers: Do you consider that the wording of your existing contracts allow you to reflect the changes provided by these modifications in a cost reflective manner. For example, these changes will apply to existing PPAs and generators who significantly alter their output (EREC 59).</p> <p>vi) Do you agree with the definition of commissioned and do you agree that it is appropriate? If you do not agree with the definition or that it is appropriate please provide alternative definitions and rationale for this definition.</p>	<p>i) We agree that if CMP264 were to be implemented this date is acceptable provided a timely decision by The Authority. However, while we agree with the principle of grandfathering, we do not agree that it is appropriate in this instance.</p> <p>ii) We believe that this should be applied to export from mixed sites.</p> <p>iii) No. It has never been an expectation that grandfathering will be applied to the charging arrangements. To make an exception rewards reckless behaviour and represents moral hazard that could set a damaging precedence. It is inherent to the CUSC that the charging methodology is subject to change and insulating generators that have held the view that the charging arrangements will remain unchanged in perpetuity only rewards inefficient investments and entrenches ineffective competition.</p> <p>iv) If it becomes an issue it can be addressed with a follow up modification. CMP264 is designed to address a much bigger defect quickly and an issue such as this should not frustrate the process. We believe that any EG who invests in utilising the “loophole” will do so at the risk of the “loophole” being closed at a later date.</p> <p>v) No response.</p> <p>vi) Notwithstanding our issues with grandfathering we agree with the wording of commissioned.</p>

Q	Question	Response
13	<p>Do you have a view of whether implementation for the 2017/18 Triad season is sufficient to allow changes for:</p> <p>i) supplier contracts and billing system; and</p> <p>ii) ii) for other stakeholders?</p>	<p>i) We understand that supplier billing systems are generally complex and therefore making changes can often be time-consuming.</p> <p>ii) We agree that this is sufficient to allow appropriate changes. If other respondents are keen for a longer implementation there needs to be robust justification.</p>
18	<p>Do you have a view if embedded benefits are frozen at a non-zero value, what should that value be as a £/kW tariff (2016/17 value is £45.33 / kW)?</p>	<p>We are unsure about a frozen value but given the evidence the wider demand tariff seems to be an appropriate approximation of the true value of the EB.</p>

Specific questions for CMP265

Q	Question	Response
11	<p>i) Views are sought on the implication for mixed sites discussed in 3.4.10.</p> <p>ii) Views are sought on the preference of categories of capacity Market CMU captured by this proposal, please indicate your preference from the following list and reasons:</p> <ul style="list-style-type: none"> • All existing and new distribution generation CMUs • All existing and new distribution generation CMUs and DSR CMUs (proven and unproven) • All price maker CMUs • All newbuild/prospective distribution generation CMUs only (defined as >1year contracts) 	<p>i) We believe that this should be applied to export from mixed sites.</p> <p>ii) If CMP265 were to be implemented then our preference would be the second option <i>All existing and new distribution generation CMUs and DSR CMUs (proven and unproven)</i>. While all the options better facilitate against the ACOs, the second option best limits the current distortions in the market as it applies to the widest category of EG.</p> <p>We fundamentally believe that the residual demand tariff is not an appropriate measurement of the EB. The wider tariff better reflects the 'true' EB.</p>

14	<p>Do you have a view of whether implementation for the 2020/21 Triad season is sufficient to allow changes for i) supplier contracts and billing system, and ii) for other stakeholders?</p>	<p>We believe that this is too long. As previously stated, the precedence set for implementation of charging changes (under CMP213) is 1 full charging year.</p>
----	--	--

Specific questions for BOTH CMP264 & CMP265

Q	Question	Response
9	<p>i) Suppliers: In setting charges for your demand customers, do you charge them at the same tariff as National Grid charges you (i.e. gross), to enable you to pay the embedded benefit to embedded generators, or please explain the way in which it is funded?</p> <p>ii) Suppliers: Does the estimate that 7.58GW of embedded generation output and 2.5GW of demand side reduction at the time of Triad for 2016/17 seem reasonable based on your knowledge of the UK market? If not what is your estimate of embedded generator output and DSR at time of Triad?</p>	<p>i) Confidential repose given.</p> <p>ii) No response</p>
12	<p>Can you identify – either quantitatively or qualitatively - the impact of the demand TNUoS embedded benefit on your decisions made in making capacity market decisions?</p>	<p>Assuming rational market behaviour, we believe the current system makes EG artificially more competitive compared to other generators. This lowers their exit price, directly lowering the clearing price of the Capacity Market. This stifles the build of potential new transmission connected generators and lowers the profitability of older conventional generators that are needed to maintain an effective system. More economic generation is disadvantaged, resulting in a reduction of allocative efficiency and ultimately increasing costs for customers.</p>

Q	Question	Response
15	<p>i) What are your views on the 2 broad options to enable the reporting of gross export metered data?</p> <p>ii) Would you have the data available required for Option B (both CMP264 and CMP265) for both new contracts and existing contracts where a customer may be partially exempt?</p> <p>iii) Do you believe you can implement the proposed changes by the respective implementation dates?</p> <p>iv) What are the pros and cons of the 2 proposals that ELEXON are considering to implement this (P348 for CMP265/ P349 for CMP264)?</p>	No response.
16	Do you have any further evidence / comments on the consumer impact of changing the demand TNUoS embedded benefit in either the short-run or long-run?	Currently the consumer is paying too much. Therefore if the issue is not addressed in a timely manner the customer will be paying more. Therefore a pragmatic timescale should be used. For all EGs not subject to grandfathering, the implementation period should not be longer than one full charging year from an Authority decision.
17	Do you feel that both the locational and residual component of the demand TNUoS should be removed as an embedded benefit (as CMP264 Original) or just the residual component (as CMP265 Original) or some other method?	We believe that the residual element of the demand TNUoS should be removed. Please see answer to question 1 above.
19	Regarding the proposed alternatives what are your views on the suggested implementation dates? Are these achievable? Please give reasons for your view.	See answers above.

CUSC Workgroup Consultation Response Proforma

CMP264 'Embedded Generation Triad Avoidance Standstill' and **CMP265** 'Gross charging of TNUoS for HH demand where Embedded Generation is in the Capacity Market'

Industry parties are invited to respond to this consultation expressing their views and supplying the rationale for those views, particularly in respect of any specific questions detailed below.

Please send your responses by **24th August 2016** to cusc.team@nationalgrid.com Please note that any responses received after the deadline or sent to a different email address may not receive due consideration by the Workgroup.

Any queries on the content of the consultation should be addressed to Caroline Wright at caroline.wright@nationalgrid.com

These responses will be considered by the Workgroup at its next meeting at which members will also consider any Workgroup Consultation Alternative Requests. Where appropriate, the Workgroup will record your response and its consideration of it within the final Workgroup Report which is submitted to the CUSC Modifications Panel.

Respondent:	<i>Steve Davies</i> stephen.davies@eon-uk.com
Company Name:	<i>E.ON</i>
Please express your views regarding the Workgroup Consultation, including rationale. (Please include any issues, suggestions or queries)	<p><u>Summary of E.ON's views</u></p> <p>We recognise that the forecasted level of triad avoidance benefit may over-state the transmission costs avoided by using embedded generation in future. However, given the time available, the workgroup process and consultation document have not made any attempt to quantify the true value of embedded generation in this context. Without thorough analysis which addresses this point we do not believe either of the proposed modifications can be justified as better meeting the CUSC objectives. Were independent analysis to justify some level of benefit (albeit lower than the forecasted levels), it may be that CMP 264 and CMP 265 are further from this level and therefore more distorting than the current level of triad benefit.</p> <p>Paragraph 3.8.57 of the consultation document states that: "...in the absence of significant quantitative analysis, it is not possible to definitely state whether the consumer will be better or worse off as a result of these proposals." Without such analysis and a view of any benefit to consumers we do not see how the proposals can be justified.</p> <p>Neither of the proposed modifications fully addresses the underlying defect (to the extent one exists): that the current triad benefit may not reflect the true value of avoided transmission costs. CMP 264 treats new generators differently to existing, but</p>

	<p>leaves the current benefit unchanged for existing generators; CMP 265 treats embedded generators with a Capacity Market Agreement differently to those without, leaving the current benefit unchanged for those without.</p> <p>The uncertainty surrounding the TNUOS embedded benefit, and therefore any impact on CM offer prices, exists in the market already and is unlikely to change as a result of approving (or not) either of the proposed modifications. We do not, therefore, believe that decisions should be rushed in order to meet the 2016 Capacity Auction timescale. A rushed decision, without the necessary supporting analysis, is likely to be challenged or changed by further modifications therefore gives no more certainty (and arguably less certainty) than already exists today.</p> <p>CMP 264 and a number of alternates involve changes to suppliers' processes as early as June 2017. Meeting these timescales will be extremely challenging.</p>
--	---

Standard Workgroup consultation questions – CMP264

Q	Question	Response
1	<p>Do you believe that the CMP264 Original Proposal better facilitates the Applicable CUSC Objectives?</p>	<p>We do not believe sufficient analysis has been carried out to assess whether or not CMP264 (or associated alternatives) better facilitates the applicable CUSC objectives.</p> <p>We understand the proposer's view that the forecasted level of triad avoidance benefit under the current methodology may over-estimate the value of the avoided transmission costs and may distort the market. However, without thorough analysis of the true value of these avoided costs, the extent of any defect is not clear and we cannot agree that CMP264 better meets the applicable CUSC objectives.</p> <p>If independent analysis were to demonstrate that the current level of benefit was excessive, but a lower value of avoided cost was appropriate, it may be that a move to £0/kW benefit as proposed by CMP264 is further away from this justified value than the current level. Therefore CMP264 could be more distorting than the current level.</p> <p>We would highlight that CMP264 was originally envisaged as a temporary change in the context of a more substantial review and as such it affects only new embedded generation. This highlights the importance of a thorough and substantial review to ensure an enduring solution can be found. Ofgem's open letter on charging arrangements for embedded generation states that it may be difficult to justify grandfathering of the current arrangements for existing plant, CMP 264 appears to</p>

Q	Question	Response
		<p>conflict with this view.</p> <p>As a permanent change therefore, CMP264 appears to be less effective in meeting the CUSC objectives than the status quo.</p>
2	<p>Do you support the proposed implementation approach? Or are there any further implementation implications that need to be considered?</p>	<p>Notwithstanding our belief that CMP 264 cannot be justified without further analysis, we support the proposed implementation approach (see response to Q10(i) for comments on the 30th June 2017 cut-off date).</p> <p>However, we note that implementing changes by June 2017 is likely to require a number of changes in suppliers' processes and billing systems in a short period of time. It has not been possible for us to assess the impacts and quantify the associated costs in the time available but we would highlight that, in the context of a number of major changes to industry rules in recent months (not least as a result of the CMA investigation), IT change plans of suppliers are likely to be highly stretched already. More time is required to explore more thorough the impacts on suppliers' processes and systems before any proposal is approved.</p>
3	<p>Do you have any other comments?</p>	<p>As an enduring change, the Centrica 2 alternative provides a sensible framework to reflect the locational charge in the triad benefit plus any additional, justifiable costs avoided that are currently recovered through the residual charge (the additional £X/kW). However, we disagree that £X/kW should be set equal to the generation residual as proposed. This level is arbitrary as it is not based on analysis of the transmission costs avoided; it also further embeds the impact of the EU's non-cost reflective €2.50/MWh cap on generation charges.</p> <p>As we highlight throughout this response, more detailed analysis of the transmission costs that can be avoided by the use of embedded generation is needed in order to determine a cost reflective value of £X/kW.</p>
4	<p>Do you wish to raise a WG Consultation Alternative Request for the Workgroup to consider?</p>	<p>No.</p>

Standard Workgroup consultation questions – CMP265

Q	Question	Response
---	----------	----------

Q	Question	Response
5	Do you believe that the CMP265 Original Proposal better facilitates the Applicable CUSC Objectives?	<p>As outlined in our views on CMP264, whilst we accept that the current methodology may overstate the value of embedded generation in future, we do not believe sufficient analysis has been carried out to demonstrate that CMP265 better meets the CUSC objectives.</p> <p>Were independent analysis to show that some level of embedded benefit beyond the current locational element was appropriate (albeit lower than today's level), it may be that CMP265 is further from this justified level than today's embedded benefit. Therefore CMP265 could be more distorting.</p> <p>Without thorough, independent analysis of the overall value of avoided transmission costs as a result of embedded generation we do not believe an assessment of whether or not CMP265 better meets the CUSC objectives can be made.</p>
6	Do you support the proposed implementation approach? Or are there any further implementation implications that need to be considered?	<p>Notwithstanding our belief that CMP 265 cannot be justified without further analysis, we support the proposed implementation approach.</p> <p>The implementation date of April 2020 gives sufficient time for suppliers and other stakeholders to make the necessary changes in their billing and administration systems.</p>
7	Do you have any other comments?	<p>CMP 265 highlights the defect as "<i>unwarranted distortion of capacity market tenders</i>". If this is true, it is as a result of the charging methodology (specifically the triad avoidance arrangements) not being cost reflective. By focussing only on generators with Capacity Market Agreements, CMP265 does not address the underlying cause of the potential defect identified in the CUSC.</p>
8	Do you wish to raise a WG Consultation Alternative Request for the Workgroup to consider?	No.

Specific questions for CMP264

Q	Question	Response
---	----------	----------

10	<p>i) Do you think a cut-off date for “new embedded generation” of 30 June 2017 is appropriate? What other date would you propose?</p> <p>ii) Do you have any views on how mixed sites are being addressed in CMP264 Original?</p> <p>iii) Do you think new-build embedded generation capacity that has entered into long term financial and performance commitment obligations via 2014 and 2015 capacity market or contracts for difference auctions (prior to this modification proposal) should be given exceptions to this cut-off date?</p>	<p>(i) We believe this date is too soon. New embedded generators who entered the Capacity Market in good faith have an expectation of a 4 year lead time to commission their projects. New generators from the 2015 Capacity Auction have a reasonable expectation that they have until October 2019 to commission their plant (the CM Rules actually allow for a further 12 months beyond this).</p> <p>We note that the alternative proposal UKPR1 proposes that plant that currently holds CM Agreements or CfD Contracts should be excluded from the definition of “new embedded generator”. We are concerned that embedded generators not covered by this exclusion, who do not participate in the Capacity Market, work to similar timescales and are likely to be just as committed financially to a project.</p> <p>Under CMP264 or its alternates, the cut-off date for all new embedded generation should be the same, and should not be any earlier than 1st October 2019.</p> <p>(ii) In general we agree with the approach to mixed sites in CMP264.</p> <p>Where a mixed site sees an increase in generation capacity behind an export meter it should be made clear that CMP264 only applies to the additional generation capacity. To remain consistent with the intent of CMP264 and its treatment of equivalent sites, the original generation capacity at the site should remain unaffected.</p> <p>(iii) As highlighted above, we believe this cut-off date should be extended for all embedded generators. Addressing this issue for CM or CfD plant alone introduces new distortions between CM or CfD plant and other new embedded generators who may have entered long term financial obligations or contracts outside of the Capacity Market or CfD schemes.</p>
----	--	--

	<p>iv) Do you agree that ignoring demand behind the meter is unlikely to create a significant “loophole” or material discrimination risk in relation to the CMP264 arrangements in the short term</p> <p>v) Question to suppliers: Do you consider that the wording of your existing contracts allow you to reflect the changes provided by these modifications in a cost reflective manner. For example, these changes will apply to existing PPAs and generators who significantly alter their output (EREC 59).</p> <p>vi) Do you agree with the definition of commissioned and do you agree that it is appropriate? If you do not agree with the definition or that it is appropriate please provide alternative definitions and rationale for this definition.</p>	<p>(iv) As a temporary solution whilst a more thorough review is carried out, as CMP264 was originally presented, we agree that any distortion from ignoring behind the meter generation is minimal.</p> <p>However, over the longer term and without further change we believe developers are likely to seek opportunities to develop generation projects behind the meter to avoid being captured. This means any possible defect will not be addressed and the proposal will not better meet the CUSC objectives.</p> <p>(v) No comment.</p> <p>(vi) We agree with the definition of commissioned.</p>
--	--	---

13	<p>Do you have a view of whether implementation for the 2017/18 Triad season is sufficient to allow changes for:</p> <p>i) supplier contracts and billing system; and</p> <p>ii) for other stakeholders?</p>	<p>As noted in the consultation document, it is unlikely that many suppliers will be able to implement changes to billing systems and contracts in time for the 2017/18 Triad season. Manual workarounds are therefore likely to be required which increase administrative costs and risks of error.</p> <p>As highlighted above, should this proposal be taken forward we believe the cut-off for new embedded generators should be pushed back to October 2019 at the earliest; this is likely to give sufficient time to implement any necessary changes.</p>
18	<p>Do you have a view if embedded benefits are frozen at a non-zero value, what should that value be as a £/kW tariff (2016/17 value is £45.33 / kW)?</p>	<p>Understanding the true value of embedded generation in terms of the avoided cost of the transmission network is central to CMP264, CMP265 and the various alternatives proposed.</p> <p>There have been various attempts to calculate a true value with results ranging from very high (in some cases above the current level of triad benefit) down to £0/kW.</p> <p>Without thorough, independent analysis we do not believe any of these values can be justified as a permanent change. It is not clear to us that freezing the value at £0/kW as proposed in CMP264 better meets the CUSC objectives than a freeze at any other level (including the current level).</p>

Specific questions for CMP265

Q	Question	Response
---	----------	----------

11	<p>i) Views are sought on the implication for mixed sites discussed in 3.4.10.</p> <p>ii) Views are sought on the preference of categories of capacity Market CMU captured by this proposal, please indicate your preference from the following list and reasons:</p> <ul style="list-style-type: none"> • All existing and new distribution generation CMUs • All existing and new distribution generation CMUs and DSR CMUs (proven and unproven) • All price maker CMUs • All newbuild/prospective distribution generation CMUs only (defined as >1year contracts) 	<p>(i) Under CMP265 we agree that a process should be established to allow for sites with a mixture of CM and non-CM embedded generation. In principle the proposal put forward in 3.4.10(a) seems sensible for a limited number of cases.</p> <p>However, this process would require a number of manual inputs and would be extremely difficult to audit to ensure the triad benefit was only paid on the applicable generation.</p> <p>(ii) We do not believe an approach which targets a particular category of generator is appropriate (in the case of CMP265 those generators with CM agreements versus those without).</p>
14	<p>Do you have a view of whether implementation for the 2020/21 Triad season is sufficient to allow changes for i) supplier contracts and billing system, and ii) for other stakeholders?</p>	<p>Depending on the final scope of CMP265, implementation for the 2020/21 Triad season does seem plausible. This is likely to give sufficient time for suppliers and other stakeholders to update their systems as appropriate.</p>

Specific questions for BOTH CMP264 & CMP265

Q	Question	Response
---	----------	----------

Q	Question	Response
9	<p>i) Suppliers: In setting charges for your demand customers, do you charge them at the same tariff as National Grid charges you (i.e. gross), to enable you to pay the embedded benefit to embedded generators, or please explain the way in which it is funded?</p> <p>ii) Suppliers: Does the estimate that 7.58GW of embedded generation output and 2.5GW of demand side reduction at the time of Triad for 2016/17 seem reasonable based on your knowledge of the UK market? If not what is your estimate of embedded generator output and DSR at time of Triad?</p>	Confidential, response sent separately.

Q	Question	Response
12	<p>Can you identify – either quantitatively or qualitatively - the impact of the demand TNUoS embedded benefit on your decisions made in making capacity market decisions?</p>	<p>The demand TNUOS embedded benefit is an income stream for embedded generators. The Capacity Market (CM) has been designed as a competitive auction which encourages participants to offer prices as low as possible. Therefore participants will account for all other sources of income when calculating their CM offer prices (taking account of the likelihood of receiving that income).</p> <p>If CM participants who previously assumed they would receive some or all of the TNUOS embedded benefit now assume they will not receive it (or perceive a higher risk of not receiving it) – in other words those generators affected by these proposals – other things being equal you would expect the income they need from the CM to either justify investment or to remain open (i.e. their offer price) to increase as a result. This means that some new build projects may no longer be viable and some existing plants may close if their required capacity price in the absence of the TNUOS benefit is too high and they are unsuccessful in the Capacity Auction.</p> <p>Both proposers highlight distortions in the Capacity Market as a result of a TNUOS embedded benefit which they judge is too high. We would add that a TNUOS embedded benefit that is too low may be equally distorting. A TNUOS embedded benefit that undervalues any transmission cost savings as a result of embedded generation will result in a less than efficient number of embedded generators being successful, increasing costs for customers overall. Therefore, without thorough analysis of the value of the avoided transmission costs from embedded generation, it is not possible to quantify the extent of any current distortion or to suggest a level of embedded benefit which reduces that distortion.</p> <p>The uncertainty surrounding the TNUOS embedded benefit, and therefore any impact on CM offer prices, exists in the market already. Any impact on the 2016 CM auction is unlikely to be different as a result of approving (or not) either of the proposed modifications or alternatives. We do not, therefore, believe there is any value in rushing decisions, without thorough analysis, in order to meet the 2016 Capacity Auction timescale. On the contrary, a rushed decision is likely</p>

Q	Question	Response
		<p>to be challenged or changed by further modifications, and therefore gives no more certainty (and arguably less certainty) than already exists today.</p> <p>Without thorough, independent analysis of the true value of embedded generation in terms of avoided transmission costs we believe this uncertainty will continue. In other words, embedded generators who are unaffected by any approved modification (for example existing generators in the case of CMP264) are unlikely to assume the TNUOS benefit will remain unchanged indefinitely given the limited scope of the modifications.</p> <p>To remove this uncertainty it is crucial that this issue is explored and addressed thoroughly and robustly; we do not believe the modifications proposed and the timescales within which to assess and analyse them have been sufficient to develop proposals that can be demonstrated to better meet the CUSC objectives.</p>
15	<p>i) What are your views on the 2 broad options to enable the reporting of gross export metered data?</p>	<p>i) Of the two options we prefer option (a). It is important that a thorough and robust process is developed to ensure gross metered export data is recorded and reported accurately.</p> <p>We are concerned that option (b), while simpler and easier to implement, could result in different standards of data from different suppliers. This is likely to be less effective in the long run.</p> <p>Whichever option is implemented it is crucial that aggregated data reflecting any changes as a result of CMP264 or CMP265 is published regularly and transparently (for example as part of the SO142 report).</p> <p>Similarly, any changes to the calculation of triad demand itself should be made clear (presumably the demand in each triad period</p>

Q	Question	Response
	<p>ii) Would you have the data available required for Option B (both CMP264 and CMP265) for both new contracts and existing contracts where a customer may be partially exempt?</p> <p>iii) Do you believe you can implement the proposed changes by the respective implementation dates?</p> <p>iv) What are the pros and cons of the 2 proposals that ELEXON are considering to implement this (P348 for CMP265/ P349 for CMP264)?</p>	<p>would reflect any change from net to gross demand for the categories of plant affected by CMP264 or CMP265).</p> <p>ii) In principle the data required is available. Similarly the data required to identify the different categories of embedded generator (new generators or those with Capacity Market Agreements) is available to suppliers, either through their agreements with those generators or through external sources such as the Capacity Market Register.</p> <p>However, referencing between different systems (for example meter level data in a supplier's systems with CMU level data in the Capacity Market Register) could be complex. These processes need to be explored more thoroughly.</p> <p>iii) As highlighted above, implementing changes by June 2017 will be extremely challenging.</p> <p>iv) No comment. This is a matter for the workgroups and associated processes reviewing these proposals.</p>
16	<p>Do you have any further evidence / comments on the consumer impact of changing the demand TNUoS embedded benefit in either the short-run or long-run?</p>	<p>The consultation document highlights a number of areas where consumers may see impacts, positive or negative, as a result of changes to the demand TNUoS embedded benefit.</p> <p>The overall impact on consumers is very complex and has many interactions and dependencies on other schemes. As stated in the consultation document itself (paragraph 3.8.57), based on the analysis carried out so far it is not possible to state whether consumers will be better or worse off as a result of these proposals. Until a robust view of the overall benefit (or not) to consumers can be established, or even a view of whether customers are better or worse off as a result of the changes, we do not believe it appropriate to</p>

Q	Question	Response
		<p>implement permanent changes to the CUSC.</p> <p>The consultation document references a view of one workgroup member that, as a general principle, if price signals are cost reflective then the decisions which users make in response to these price signals will be aligned with the interest of society. We fully support this principle but are concerned that:</p> <ul style="list-style-type: none"> (i) CMP264 and 265 assume the cost reflective signal is either very low (the locational element for CMP265) or £0/kW (CMP264). There has not been sufficient analysis or evidence to justify this view. Implementing CMP264 or 265 risks undervaluing embedded generation which could lead to investment decisions which are not in the best interests of society. (ii) Changing one price signal (the TNUOS embedded benefit in this case) in isolation from others which may be equally or even more distorting could simply move distortions from one market or one technology to another. <p>We would also highlight that industrial or business energy customers could be affected by the proposals in a number of ways. For example, these customers could well be benefitting from the current demand TNUOS embedded benefit either through on site generation or demand shifting. The overall impact on such customers should also be captured.</p> <p>As we have highlighted throughout this response, it is crucial that a thorough and independent review of the value of embedded generation is carried out before any changes are adopted. This will ensure any remaining benefit is truly cost reflective.</p>

Q	Question	Response
17	<p>Do you feel that both the locational and residual component of the demand TNUoS should be removed as an embedded benefit (as CMP264 Original) or just the residual component (as CMP265 Original) or some other method?</p>	<p>We believe there is a clear case that a locational element of the demand TNUoS embedded benefit should be retained. However, whether the current locational element represents the total value of the transmission costs avoided as a result of embedded generation is not clear based on the analysis conducted so far.</p> <p>The residual component, whilst not cost reflective in the sense that it is not built up of a series of separate, explicit costs, nevertheless covers a number of costs associated with running and investing in the transmission network. Some of these may well be avoided if embedded generation is used.</p> <p>Understanding the components of the demand residual is crucial in order to determine how much of it should be reflected in any embedded benefit. We note that a number of bodies have attempted to draw conclusions about elements of the demand residual which should be reflected in a benefit, with conclusions ranging from very low numbers in the case of the proposers of CMP 264 & 265 but much higher numbers from other analysis such as Cornwall Energy's recent review of embedded benefits.</p> <p>Until a robust, independent and thorough review is carried out we do not believe it is possible to conclude how much of the current residual component should be reflected in an embedded benefit.</p> <p>Implementing CMP 264 or 265 moves to an extreme position where the benefit of embedded generation in terms of transmission costs is valued either at zero or very low. Without concrete analysis to support this view we do not believe such a position is justified.</p>

Q	Question	Response
19	<p>Regarding the proposed alternatives what are your views on the suggested implementation dates? Are these achievable? Please give reasons for your view.</p>	<p>Centrica 1, Centrica 2 and UKPR2 all have implementation dates of April 2020. We believe this does give sufficient time to implement any necessary changes should any of these proposals or a variation of them be approved (although we note that Centrica's proposals are likely to require more change than others given the wider scope of plant affected).</p> <p>As highlighted in response to Q2, implementing changes as early as April 2017 is likely to require costly manual workarounds and risks undermining investment decisions that have already been made (although we note that the impact of this is limited in Green Frog et al's proposal)</p>

CUSC Workgroup Consultation Response Proforma

CMP264 'Embedded Generation Triad Avoidance Standstill' and **CMP265** 'Gross charging of TNUoS for HH demand where Embedded Generation is in the Capacity Market'

Industry parties are invited to respond to this consultation expressing their views and supplying the rationale for those views, particularly in respect of any specific questions detailed below.

Please send your responses by **24th August 2016** to cusc.team@nationalgrid.com Please note that any responses received after the deadline or sent to a different email address may not receive due consideration by the Workgroup.

Any queries on the content of the consultation should be addressed to Caroline Wright at caroline.wright@nationalgrid.com

These responses will be considered by the Workgroup at its next meeting at which members will also consider any Workgroup Consultation Alternative Requests. Where appropriate, the Workgroup will record your response and its consideration of it within the final Workgroup Report which is submitted to the CUSC Modifications Panel.

Respondent:	<i>Please insert your name and contact details (phone number or email address)</i>
Company Name:	<i>Please insert Company Name</i>
<p>Please express your views regarding the Workgroup Consultation, including rationale.</p> <p>(Please include any issues, suggestions or queries)</p>	<p>For reference, the Applicable CUSC objectives are:</p> <p>Use of System Charging Methodology</p> <p>(a) that compliance with the use of system charging methodology facilitates effective competition in the generation and supply of electricity and (so far as is consistent therewith) facilitates competition in the sale, distribution and purchase of electricity;</p> <p>(b) that compliance with the use of system charging methodology results in charges which reflect, as far as is reasonably practicable, the costs (excluding any payments between transmission licensees which are made under and in accordance with the STC) incurred by transmission licensees in their transmission businesses and which are compatible with standard condition C26 (Requirements of a connect and manage connection);</p> <p>(c) that, so far as is consistent with sub-paragraphs (a) and (b), the use of system charging methodology, as far as is reasonably practicable, properly takes account of</p>

	<p>the developments in transmission licensees' transmission businesses.</p> <p>(d) Compliance with the Electricity Regulation and any relevant legally binding decision of the European Commission and/or the Agency.</p>
--	---

Standard Workgroup consultation questions – CMP264

Q	Question	Response
1	Do you believe that the CMP264 Original Proposal better facilitates the Applicable CUSC Objectives?	We believe that this does not better facilitate the applicable CUSC objectives.
2	Do you support the proposed implementation approach? Or are there any further implementation implications that need to be considered?	We believe that the proposed implementation is too soon to allow industry parties to be ready for the implementation of CMP264.
3	Do you have any other comments?	<p>-We believe these benefits should vary by GSP group or at least a fractional benefit, as opposed to a suspension of benefit.</p> <p>-Ideally, we would like the current stance on these embedded benefits to remain the same or to charge on gross demand then have a separate benefit. This benefit shall reflect what you are putting into the system.</p> <p>-</p>
4	Do you wish to raise a WG Consultation Alternative Request for the Workgroup to consider?	<i>If yes, please complete a WG Consultation Alternative Request form, available on National Grid's website¹, and return to the CUSC inbox at cusc.team@nationalgrid.com</i>

Standard Workgroup consultation questions – CMP265

Q	Question	Response
5	Do you believe that the CMP265 Original Proposal better facilitates the Applicable CUSC Objectives?	N/A

¹ http://www.nationalgrid.com/uk/Electricity/Codes/systemcode/amendments/forms_guidance/

Q	Question	Response
6	Do you support the proposed implementation approach? Or are there any further implementation implications that need to be considered?	N/A
7	Do you have any other comments?	N/A
8	Do you wish to raise a WG Consultation Alternative Request for the Workgroup to consider?	<i>If yes, please complete a WG Consultation Alternative Request form, available on National Grid's website², and return to the CUSC inbox at cusc.team@nationalgrid.com</i>

Specific questions for CMP264

Q	Question	Response
---	----------	----------

² http://www.nationalgrid.com/uk/Electricity/Codes/systemcode/amendments/forms_guidance/

Q	Question	Response
10	<p>i) Do you think a cut-off date for “new embedded generation” of 30 June 2017 is appropriate? What other date would you propose?</p> <p>ii) Do you have any views on how mixed sites are being addressed in CMP264 Original?</p> <p>iii) Do you think new-build embedded generation capacity that has entered into long term financial and performance commitment obligations via 2014 and 2015 capacity market or contracts for difference auctions (prior to this modification proposal) should be given exceptions to this cut-off date?</p> <p>iv) Do you agree that ignoring demand behind the meter is unlikely to create a significant “loophole” or material discrimination risk in relation to the CMP264 arrangements in the short term</p> <p>v) Question to suppliers: Do you consider that the wording of your existing contracts allow you to reflect the changes provided by these modifications in a cost reflective manner. For example, these changes will apply to existing PPAs and generators who significantly alter their output (EREC 59).</p> <p>vi) Do you agree with the definition of commissioned and do you agree that it is appropriate? If you do not agree with the definition or that it is appropriate please provide alternative definitions and rationale for this definition.</p>	<p>i) We believe that the industry deserves a few more years before the cut-off date is introduced, as generation commissioned after this date may have been based on investment decisions made with this embedded benefit in mind and it would be unfair to penalise those parties.</p> <p>ii) In the whole, we do agree with the views on mixed sites. We do however seek clarification on the scenario where additional generating capacity is connected behind an existing exporting meter. We believe it will be hard to calculate this and seek clarification if sub-metering will be introduced or if it will be calculated by estimates. We also seek clarification in the scenario where there isn't an existing export meter and there is no increase in capacity, what would this be classed as?</p> <p>iii) We believe that they should not have an exception to the cut-off date, but instead be given a longer notice period for their cut-off date. This is due to the fact that they bid for this on the assumption they would have this benefit.</p> <p>iv) We agree that it is unlikely.</p> <p>v) We believe that this shouldn't be an issue and could be resolved at contract renewals.</p> <p>vi) We believe the definition of commissioned is appropriate.</p>

Q	Question	Response
13	<p>Do you have a view of whether implementation for the 2017/18 Triad season is sufficient to allow changes for:</p> <p>i) supplier contracts and billing system; and</p> <p>ii) ii) for other stakeholders?</p>	<p>We believe that this isn't sufficient. Parties are already quoting beyond this period and other stakeholders have already made financial investments. We believe a further year should be provided to make it fairer.</p>
18	<p>Do you have a view if embedded benefits are frozen at a non-zero value, what should that value be as a £/kW tariff (2016/17 value is £45.33 / kW)?</p>	<p>We believe that it should depends on the benefits to the system. A generational calculation to the benefit will be more cost-reflective.</p>

Specific questions for CMP265

Q	Question	Response
11	<p>i) Views are sought on the implication for mixed sites discussed in 3.4.10.</p> <p>ii) Views are sought on the preference of categories of capacity Market CMU captured by this proposal, please indicate your preference from the following list and reasons:</p> <ul style="list-style-type: none"> • All existing and new distribution generation CMUs • All existing and new distribution generation CMUs and DSR CMUs (proven and unproven) • All price maker CMUs • All newbuild/prospective distribution generation CMUs only (defined as >1year contracts) 	<p>N/A</p>

14	Do you have a view of whether implementation for the 2020/21 Triad season is sufficient to allow changes for i) supplier contracts and billing system, and ii) for other stakeholders?	N/A
----	--	-----

Specific questions for BOTH CMP264 & CMP265

Q	Question	Response
9	<p>i) Suppliers: In setting charges for your demand customers, do you charge them at the same tariff as National Grid charges you (i.e. gross), to enable you to pay the embedded benefit to embedded generators, or please explain the way in which it is funded?</p> <p>ii) Suppliers: Does the estimate that 7.58GW of embedded generation output and 2.5GW of demand side reduction at the time of Triad for 2016/17 seem reasonable based on your knowledge of the UK market? If not what is your estimate of embedded generator output and DSR at time of Triad?</p>	N/A
12	Can you identify – either quantitatively or qualitatively - the impact of the demand TNUoS embedded benefit on your decisions made in making capacity market decisions?	N/A

Q	Question	Response
15	<p>i) What are your views on the 2 broad options to enable the reporting of gross export metered data?</p> <p>ii) Would you have the data available required for Option B (both CMP264 and CMP265) for both new contracts and existing contracts where a customer may be partially exempt?</p> <p>iii) Do you believe you can implement the proposed changes by the respective implementation dates?</p> <p>iv) What are the pros and cons of the 2 proposals that ELEXON are considering to implement this (P348 for CMP265/ P349 for CMP264)?</p>	N/A
16	Do you have any further evidence / comments on the consumer impact of changing the demand TNUoS embedded benefit in either the short-run or long-run?	N/A
17	Do you feel that both the locational and residual component of the demand TNUoS should be removed as an embedded benefit (as CMP264 Original) or just the residual component (as CMP265 Original) or some other method?	N/A
19	Regarding the proposed alternatives what are your views on the suggested implementation dates? Are these achievable? Please give reasons for your view.	N/A

CUSC Workgroup Consultation Response Proforma

CMP264 'Embedded Generation Triad Avoidance Standstill' and **CMP265** 'Gross charging of TNUoS for HH demand where Embedded Generation is in the Capacity Market'

Industry parties are invited to respond to this consultation expressing their views and supplying the rationale for those views, particularly in respect of any specific questions detailed below.

Please send your responses by **24th August 2016** to cusc.team@nationalgrid.com Please note that any responses received after the deadline or sent to a different email address may not receive due consideration by the Workgroup.

Any queries on the content of the consultation should be addressed to Caroline Wright at caroline.wright@nationalgrid.com

These responses will be considered by the Workgroup at its next meeting at which members will also consider any Workgroup Consultation Alternative Requests. Where appropriate, the Workgroup will record your response and its consideration of it within the final Workgroup Report which is submitted to the CUSC Modifications Panel.

Respondent:	Paul Mott
Company Name:	EDF Energy
<p>Please express your views regarding the Workgroup Consultation, including rationale.</p> <p>(Please include any issues, suggestions or queries)</p>	<p>For reference, the Applicable CUSC objectives are:</p> <p>Use of System Charging Methodology</p> <p>(a) that compliance with the use of system charging methodology facilitates effective competition in the generation and supply of electricity and (so far as is consistent therewith) facilitates competition in the sale, distribution and purchase of electricity;</p> <p>(b) that compliance with the use of system charging methodology results in charges which reflect, as far as is reasonably practicable, the costs (excluding any payments between transmission licensees which are made under and in accordance with the STC) incurred by transmission licensees in their transmission businesses and which are compatible with standard condition C26 (Requirements of a connect and manage connection);</p> <p>(c) that, so far as is consistent with sub-paragraphs (a) and (b), the use of system charging methodology, as far as is reasonably practicable, properly takes account of the developments in transmission licensees' transmission</p>

	<p>businesses.</p> <p>(d) Compliance with the Electricity Regulation and any relevant legally binding decision of the European Commission and/or the Agency.</p>
--	--

Standard Workgroup consultation questions – CMP264

Q	Question	Response
----------	-----------------	-----------------

Q	Question	Response
1	<p>Do you believe that the CMP264 Original Proposal better facilitates the Applicable CUSC Objectives?</p>	<p>Yes. CMP264 better facilitates charging objective a, effective competition – but only to a small extent. CMP264 also slightly better facilitates charging objective b, cost-reflectivity. CMP264 also slightly better facilitates charging objective c, because as to developments in transmission licensees' transmission businesses, there has been a marked growth in the amount of embedded generation impacting the ways the system is developed and operated – the charging distortion to which both CMP264 and CMP265 relate, may have been a contributory factor to that.</p> <p>CMP264 is neutral as to the remaining charging objective d, on Europe.</p> <p>Within this overall judgement, we are counter-balancing competing considerations :</p> <ol style="list-style-type: none"> 1. we believe that the “grandfathering” that is inherent in CMP264, as between plant that commissioned before and after June 2017, is probably distortive of competition and hard to justify in this case 2. the unjustified crediting to relevant embedded generation of the demand HH residual charge element, which is an artifice to ensure correct overall revenue recovery and not a cost-reflective charge (unlike locational charge elements), is distortive across the patch, and CMP264 addresses this (but see (3) below); there is no logic to netting-off the output of embedded generators from HH demand as far as the demand residual charge element is concerned. Note that this distortion has its most marked effect within the capacity mechanism. 3. CMP264 original as proposed, removes not only the demand HH residual charge element, but also the locational charge signals from embedded generation. This, if passed, would be distortive of competition as between these (<100 MW embedded) generators and others (those which are bigger than 100 MW, or those which are transmission-connected). We know that the proposer has acceded to the possibility of altering this aspect of CMP264 Original so that the locational charge signals are not removed; such a change would improve CMP264 Original.

Q	Question	Response
2	Do you support the proposed implementation approach? Or are there any further implementation implications that need to be considered?	Yes. We do have concerns about whether implementation by June 2017 can be achieved in terms of BSC system releases, but this is not an objection on our part, and might be overcome.
3	Do you have any other comments?	No
4	Do you wish to raise a WG Consultation Alternative Request for the Workgroup to consider?	No

Standard Workgroup consultation questions – CMP265

Q	Question	Response
---	----------	----------

Q	Question	Response
5	<p>Do you believe that the CMP265 Original Proposal better facilitates the Applicable CUSC Objectives?</p>	<p>Yes. CMP265 better facilitates charging objective a, effective competition. It also better facilitates charging objective b, cost-reflectivity, and it better facilitates charging objective c, because as to developments in transmission licensees' transmission businesses, there has been a marked growth in the amount of embedded generation impacting the ways the system is developed and operated – the charging distortion may have been a contributory factor to that. CMP265 is neutral as to the remaining charging objective d, on Europe.</p> <p>We believe it is beneficial that CMP265 entails no “grandfathering”. We recognise the importance of investment decisions but in this case reform of embedded benefits has been clear to the market for some time and therefore given grandfathering could be distortive of competition between different, otherwise-identical, generators, and could take away some consumer benefit we do not support it in this case.</p> <p>A key benefit of CMP265 is removing the unjustified crediting to relevant embedded generation of the demand HH residual charge element, which is an artifice to ensure correct overall revenue recovery and not a cost-reflective charge (unlike locational charge elements). This is distortive across the patch, and CMP264 addresses this; there is no logic to netting-off the output of embedded generators from HH demand as far as the demand residual charge element is concerned. Addressing this distortion explains how CMP264 better facilitates charging objective b. Note that this distortion has its most marked effect within the capacity mechanism.</p>
6	<p>Do you support the proposed implementation approach? Or are there any further implementation implications that need to be considered?</p>	<p>Yes, the proposed implementation approach is appropriate</p>
7	<p>Do you have any other comments?</p>	<p>No</p>
8	<p>Do you wish to raise a WG Consultation Alternative Request for the Workgroup to consider?</p>	<p>No</p>

Specific questions for CMP264

Q	Question	Response
----------	-----------------	-----------------

Q	Question	Response
10	<p>i) Do you think a cut-off date for “new embedded generation” of 30 June 2017 is appropriate? What other date would you propose?</p> <p>ii) Do you have any views on how mixed sites are being addressed in CMP264 Original?</p> <p>iii) Do you think new-build embedded generation capacity that has entered into long term financial and performance commitment obligations via 2014 and 2015 capacity market or contracts for difference auctions (prior to this modification proposal) should be given exceptions to this cut-off date?</p> <p>iv) Do you agree that ignoring generation behind the meter is unlikely to create a significant “loophole” or material discrimination risk in relation to the CMP264 arrangements in the short term</p> <p>v) Question to suppliers: Do you consider that the wording of your existing contracts allow you to reflect the changes provided by these modifications in a cost reflective manner. For example, these changes will apply to existing PPAs and generators who significantly alter their output (EREC 59).</p> <p>vi) Do you agree with the definition of commissioned and do you agree that it is appropriate? If you do not agree with the definition or that it is appropriate please provide alternative definitions and rationale for this definition.</p>	<p>(i) The cut off date appears to be a difficult date for Elexon to meet in terms of its part in creating a necessary new data flow under BSC P349. A date in 2018, perhaps just after the 2017/18 triad season via the February 2018 Elexon systems release, would certainly be achievable for Elexon.</p> <p>(ii) As to mixed sites, the solutions in 3.3.15 and 3.3.16 of the consultation appear reasonable, pragmatic and workable.</p> <p>(iii) We do not see merit in exceptions to CMP264 of this nature (see comments on grandfathering in replies to questions 4 and 5)</p> <p>(iv) We do agree that ignoring generation behind the meter is unlikely to create a significant “loophole” or material discrimination risk in relation to CMP264; indeed, attempting to encompass difficult cases in this mod, could slow the mod’s progress down and prevent its main benefit being realised through the mod being approved in a reasonable timeframe. If there are loopholes, if the arrangements seem to lead to embedded generation being developed in particular/novel configurations, these can be addressed via a further future modification receiving specific detailed consideration on this matter.</p> <p>(v) As a Supplier: we consider that the wording of our existing contracts allow us to reflect the changes provided by these modifications in a competitive manner</p> <p>(vi) We agree with the definition of commissioned. The focus on the G59/2 commissioning process does exclude single phase embedded generators of up to 80 amps (up to 19 kW), which might tend to be domestic and other (e.g. schools, churches) solar PV, even when these are half hourly metered. Such installations are presently only rarely half hourly metered anyway. If they do become half hourly metered, it is arguable whether or not they <i>should</i> be caught by CMP264; we are uncertain on this point as there are good arguments both for and against.</p>

Q	Question	Response
13	<p>Do you have a view of whether implementation for the 2017/18 Triad season is sufficient to allow changes for:</p> <p>i) supplier contracts and billing system; and</p> <p>ii) ii) for other stakeholders?</p>	<p>Yes, there is sufficient time for these matters if any decision to approve were made by The Authority late in 2016 or very early in 2017. It is the time needed for Elexon systems development that is the critical potential stumbling block, albeit it might just about be able to be circumvented by a manual workaround for the first year, if reliable data could be obtained to bill against, given the relatively small number of units forecast to be captured in the first year.</p>
18	<p>Do you have a view if embedded benefits are frozen at a non-zero value, what should that value be as a £/kW tariff (2016/17 value is £45.33 / kW)?</p>	<p>We do not favour this concept of freezing at what we would see as an arbitrary value that destroys potential consumer benefit, at all.</p>

Specific questions for CMP265

Q	Question	Response
---	----------	----------

11	<p>i) Views are sought on the implication for mixed sites discussed in 3.4.10.</p> <p>ii) Views are sought on the preference of categories of capacity Market CMU captured by this proposal, please indicate your preference from the following list and reasons:</p> <ul style="list-style-type: none"> • All existing and new distribution generation CMUs • All existing and new distribution generation CMUs and DSR CMUs (proven and unproven) • All price maker CMUs • All newbuild/prospective distribution generation CMUs only (defined as >1year contracts) 	<p>i) Regarding 3.4.10, we do not believe that it would necessarily matter if these mixed sites were not addressed at all in this modification proposal. For if they were not, and the omission began to prove problematic, a later modification could allow detailed attention to be directed to this very matter; yet, the risk of attempting to address it now might be that the mod itself could be delayed, resulting in delay to the consumer benefits, because of seeking perfection in the treatment of a minority amongst embedded generators in the CM. If the approach in 3.4.10 were to be taken, it is our view that there needn't be a requirement (or obligation), whether via the CUSC or BSC, on the Supplier to do or declare anything; merely the possibility to declare this data if the embedded generator in the CM on a mixed site with non-BSC-accessible embedded generation in the CM, was being disadvantaged due to other, non-CM embedded generation contributing to net site export as seen at the BSC-accessible site boundary meter – or due to another, import, meter to that site in a novel configuration. There would be every incentive for the customers and its supplier to co-operate in identifying the requisite data. It is perfectly acceptable for mod 265 to give no treatment to mixed sites, though, as it only has to be better than baseline; it doesn't have to be agreed by all as "perfect". Perfection is rarely arrived at in one mod.</p>
14	<p>Do you have a view of whether implementation for the 2020/21 Triad season is sufficient to allow changes for i) supplier contracts and billing system, and ii) for other stakeholders?</p>	<p>Yes, the 2020/21 triad season is a long time away and affords more than ample time for these matters</p>

Q	Question	Response
---	----------	----------

Q	Question	Response
9	<p>i) Suppliers: In setting charges for your demand customers, do you charge them at the same tariff as National Grid charges you (i.e. gross), to enable you to pay the embedded benefit to embedded generators, or please explain the way in which it is funded?</p> <p>ii) Suppliers: Does the estimate that 7.58GW of embedded generation output and 2.5GW of demand side reduction at the time of Triad for 2016/17 seem reasonable based on your knowledge of the UK market? If not what is your estimate of embedded generator output and DSR at time of Triad?</p>	<p>i) Customer tariffs are set independent of contracts with embedded generators. The manner in which we determine what charges to offer to demand customers in the competitive market will take good account of all actual Supply costs, including charges to us, as a result of having that customer's volume on our books (in our chargeable TNUoS volume in that GSP group as a Supplier), from Grid; for if this were not so, we would either be over-charging the customer, who would find his quotes from other, rival Suppliers to be preferable – or we would be under-pricing, and supplying at a loss, or failing to supply at the expected profit margin. Insofar as embedded generation. The purpose of this consultation question is of course to discern whether Suppliers give most of the embedded benefit in relation to embedded generators with whom they contract, to those embedded generators, or to other customers as a discount. Any Supplier, including us, will give most of the embedded benefit in relation to embedded generators with whom they contract, as otherwise those embedded generators would use their leverage to negotiate with a different Supplier. Also, if Suppliers gave the benefit of any embedded generation with whom they might contract to their other HH (or NHH) customers that are not associated with embedded generation, the prices quoted to those other customers would vary randomly with how much embedded generation that supplier happened to have contracted with, in comparison to its total volumes; this would not be the characteristic of a normal competitive market.</p> <p>ii) Yes, those seem like reasonable estimates, which were explained by Grid as underlying Future Energy Scenarios (FES) (in the FES dataset, it is estimated that there will be 7.58GW of distributed generation output at the time of Triads</p>

Q	Question	Response
12	<p>Can you identify – either quantitatively or qualitatively - the impact of the demand TNUoS embedded benefit on your decisions made in making capacity market decisions?</p>	<p>As our CM-participating assets do not earn embedded benefits, our CM bids are not ‘subsidised’ by the embedded benefits relating to the HH demand residual TNUoS charge element, and our bids therefore reflect the fundamental economic value of our plant. The effect of the likely participation of a class of generation that, through being lower voltage-connected and of less than 100 MW capacity per site, will benefit from the non-cost-reflective credit from its partner Supplier, in relation to its output at triads, of the HH demand TNUoS residual charge element, there being no rational for this, is that it is much less likely that more efficient larger generation plant will be constructed. This is probably why little or no such new efficient larger plant is being realised.</p> <p>(DELIBERATE PAGE BREAK BEFORE next question PTO</p>

15	<p>i) What are your views on the 2 broad options to enable the reporting of gross export metered data?</p> <p>ii) Would you have the data available required for Option B (both CMP264 and CMP265) for both new contracts and existing contracts where a customer may be partially exempt?</p> <p>iii) Do you believe you can implement the proposed changes by the respective implementation dates?</p> <p>iv) Please list the pros and cons of the 2 proposals that ELEXON are considering to implement this (P348 for CMP265/ P349 for CMP264)?</p>	<p>(i) The first of these two broad options for enabling the reporting of gross export metered data is to develop a more detailed set of BSC requirements and processes that describe specifically how Suppliers, their Party Agents and the SVAA collaborate to collect, aggregate and report data to National Grid (e.g. using the existing TUOS Report). This seems as though it should work, details being worked up at the BSC P348/349 workgroups. The second of these two broad options, option B, for enabling the reporting of gross export metered data, would lie in a simple set of BSC requirements that simply require Suppliers to provide metered data (at triads) for individual Metering Systems to National Grid – this second option provides the Supplier flexibility to decide how to report but places greater pressure on National Grid to aggregate the metered data from individual Metering Systems for its purposes. We prefer this second approach, although both are to the same net effect.</p> <p>(ii) Yes. Note that it is our view that there needn't be a requirement (or obligation), whether via the CUSC or BSC, on the Supplier to do or declare anything; merely the possibility to declare this data. The customer could only gain from co-operating with its Supplier in this matter.</p> <p>(iii) Yes</p> <p>(iv) We are responding separately in parallel to detailed consultation on BSC P348 and BSC P349 on a comparable timeframe. Our responses will not be marked confidential.</p>
----	--	---

16	<p>Do you have any further evidence / comments on the consumer impact of changing the demand TNUoS embedded benefit in either the short-run or long-run?</p>	<p>The first order detriment to consumers that arises as a result of demand TNUoS residual being paid out to embedded generators, is that charges to consumers from suppliers to recover transmission costs are greater than the cost of the transmission system (the difference is the embedded benefit). Under the current TNUoS arrangement this first order detriment could grow quite significantly a) if substantial incremental new build EG comes forward under the CM and b) will grow anyway as TNUoS tariffs increase. In addition to this first order effect there is the wider negative impact of the resulting distortions. We do foresee consumer benefit from addressing distortions, as if price signals are cost-reflective, then the decisions which users make in response to those price signals will be aligned with the interest of society – they will make efficient decisions that minimise whole-system costs, which ultimately fall on consumers. The costs of non-cost-reflective embedded benefits will tend to fall on consumers.</p>
17	<p>Do you feel that both the locational and residual component of the demand TNUoS should be removed as an embedded benefit (as CMP264 Original) or just the residual component (as CMP265 Original) or some other method?</p>	<p>Only the residual component of the demand TNUoS should be removed, as is the case in CMP 265 Original. The approach in calculating demand and generation TNUoS is to compute forward-looking locational signals for application via their tariffs to these network users. The signals are designed to promote efficient use of the network by providing a signal to generators of the impact that their location decision has on the estimated need for transmission network investment. This currently applies also to embedded generation, because a consequence of the fact that EG is charged the negative of the demand raw locational charge, is that it is exposed to roughly the same signal as the generation raw locational charge for transmission-connected, and >100 MW embedded, generators – as it should be.</p>

<p>19</p>	<p>Regarding the proposed alternatives what are your views on the suggested implementation dates? Are these achievable? Please give reasons for your view.</p>	<p>Centrica's alternative features an implementation date of 1st April 2020 which matches CMP265 original, giving a generous amount of time for all parties to prepare for this change.</p> <p>Green Frog's alternative to CMP264 has a nominal implementation date of 1st April 2017, and an actual implementation date of 30th June 2017. This is so soon as to be potentially problematic in systems terms. In terms of notice to parties, since it grandfathers today's embedded residual-charge-related embedded benefit of £45/kW plus RPI, it does not represent a step change, and so may have less need of notice; although this is shorter notice of change that is generally preferred.</p> <p>UKPR's alternative to CMP264 also has a nominal implementation date of 1st April 2017, and an actual implementation date of 30th June 2017. It mirrors CMP264, yet making the application of the 30th June 2017 threshold date more lenient such that more generation can qualify for "grandfathering", since qualification under this alternative is no longer G59/2 commissioning, but the award of a CM or CFD contract much earlier in the project's life. Our comment on UKPR's alternative to CMP264 would be the same as for CMP264 original : the date is rather early, and hard for BSC systems changes to accommodate. It may need a workaround. It represents a little less notice that is normally preferable for such a change.</p> <p>UKPR's alternative to CMP265 matches CMP265 original in its implementation date in 2020. The timeframe is workable, it is other features of UKPR's alternative to CMP265 that are not desirable.</p>
-----------	---	--

CUSC Workgroup Consultation Response Proforma

CMP264 'Embedded Generation Triad Avoidance Standstill' and **CMP265** 'Gross charging of TNUoS for HH demand where Embedded Generation is in the Capacity Market'

Industry parties are invited to respond to this consultation expressing their views and supplying the rationale for those views, particularly in respect of any specific questions detailed below.

Please send your responses by **24th August 2016** to cusc.team@nationalgrid.com Please note that any responses received after the deadline or sent to a different email address may not receive due consideration by the Workgroup.

Any queries on the content of the consultation should be addressed to Caroline Wright at caroline.wright@nationalgrid.com

These responses will be considered by the Workgroup at its next meeting at which members will also consider any Workgroup Consultation Alternative Requests. Where appropriate, the Workgroup will record your response and its consideration of it within the final Workgroup Report which is submitted to the CUSC Modifications Panel.

Respondent:	Michael Davies Mike.Davies@EiderReservePower.co.uk
Company Name:	Eider Reserve Power Limited
Please express your views regarding the Workgroup Consultation, including rationale. (Please include any issues, suggestions or queries)	<p>We consider that the Workgroup Consultation fails to demonstrate any credible evidence supporting the existence of a defect in the manner and to the extent suggested by either the proposers of CMP264 or CMP265 and hence neither can be considered to be objectively better than the base line. Whilst we are of the view that the Triad structure in its current form does not correctly reflect the value of embedded benefits, we consider it to be a fundamental point that the residual component of TNUoS costs is a direct cost to the consumer resulting from transmission connected generation and to suggest it should be ignored when considering the economics of embedded generation is flawed.</p> <p>The Workgroup Consultation process is running to an accelerated time line for good commercial reasons in view of the considerable undermining of investor confidence which these self-serving amendment proposals have achieved. This is not helpful to a full and detailed review in this area and hence we consider that it should be a firm conclusion of this exercise that a Significant Code Review should be undertaken by Ofgem as soon as possible with any Amendment Proposal which may be adopted to be seen as a stop-gap only until the implementation of SCR recommendations in due course.</p>

Standard Workgroup consultation questions – CMP264

Q	Question	Response
1	Do you believe that the CMP264 Original Proposal better facilitates the Applicable CUSC Objectives?	No we do not as changes to Triad payments as suggested suggested would strongly favour transmission connected projects in a manner we consider to be anti-competitive, self-serving on the part of the proposer, damaging to long term consider cost savings and not reflective of the level of embedded benefits brought to the market by embedded generation.
2	Do you support the proposed implementation approach? Or are there any further implementation implications that need to be considered?	No. Aside from our view that the proposal has no merit we note that the regulator has sought in the past not to undermine investment decisions already made. This proposal, if implemented in the manner suggested, would cause new embedded generation with capacity market agreements and committed arrangements for grid and other expenditure to have to cancel with losses to all concerned and a reduction in much needed generation capacity in the market at a time of short supply, increasing the risk of damaging wide area power outages.
3	Do you have any other comments?	We consider that there are elements of transmission costs, principally those related to offshore generation, that cannot be avoided by building more embedded generation as they are policy objectives of the UK Government with fixed price arrangements through the Contract for Difference structure. These offshore generation costs are the principal driver of TNUoS growth in the years to come and have not been addressed by any of the amendment proposals to date. We would support and are submitting an alternative to address this obvious issue. Note that in our view this still does not mean that the adjusted Triad benefits or indeed other charging is fully fit for purpose so we would continue to argue for an SCR.
4	Do you wish to raise a WG Consultation Alternative Request for the Workgroup to consider?	Yes – see alternative.

Standard Workgroup consultation questions – CMP265

Q	Question	Response
---	----------	----------

Q	Question	Response
5	Do you believe that the CMP265 Original Proposal better facilitates the Applicable CUSC Objectives?	No we do not as changes to Triad payments in the manner suggested would strongly favour transmission connected projects in a manner we consider to be anti-competitive, self-serving on the part of the proposer and not reflective of the level of embedded benefits brought to the market by embedded generation.
6	Do you support the proposed implementation approach? Or are there any further implementation implications that need to be considered?	No. Aside from our view that the proposal has no merit we note that the regulator has sought in the past not to undermine investment decisions already made. This proposal, if implemented in the manner suggested, would cause new embedded generation with capacity market agreements and committed arrangements for grid and other expenditure to have to cancel with losses to all concerned and a reduction in much needed generation capacity in the market at a time of short supply.
7	Do you have any other comments?	We consider that there are elements of transmission costs, principally those related to offshore generation, that cannot be avoided by building more embedded generation as they are policy objectives of the UK Government with fixed price arrangements through the Contract for Difference structure. These offshore generation costs are the principal driver of TNUoS growth in the years to come and have not been addressed by any of the amendment proposals to date. We would support and are submitting an alternative to address this obvious issue. Note that in our view this still does not mean that the adjusted Triad benefits or indeed other charging is fully fit for purpose so we would continue to argue for an SCR.
8	Do you wish to raise a WG Consultation Alternative Request for the Workgroup to consider?	Yes – see alternative.

Specific questions for CMP264

Q	Question	Response
----------	-----------------	-----------------

Q	Question	Response
10	<p>i) Do you think a cut-off date for “new embedded generation” of 30 June 2017 is appropriate? What other date would you propose?</p> <p>ii) Do you have any views on how mixed sites are being addressed in CMP264 Original?</p> <p>iii) Do you think new-build embedded generation capacity that has entered into long term financial and performance commitment obligations via 2014 and 2015 capacity market or contracts for difference auctions (prior to this modification proposal) should be given exceptions to this cut-off date?</p> <p>iv) Do you agree that ignoring demand behind the meter is unlikely to create a significant “loophole” or material discrimination risk in relation to the CMP264 arrangements in the short term</p> <p>v) Question to suppliers: Do you consider that the wording of your existing contracts allow you to reflect the changes provided by these modifications in a cost reflective manner. For example, these changes will apply to existing PPAs and generators who significantly alter their output (EREC 59).</p> <p>vi) Do you agree with the definition of commissioned and do you agree that it is appropriate? If you do not agree with the definition or that it is appropriate please provide alternative definitions and rationale for this definition.</p>	<p>No because we have embedded generation in course of construction with expenditure made on grid, engines etc which would be uneconomic if this date was to be adopted. We would support a date of 31 December 2018 but no earlier.</p> <p>No</p> <p>Yes unless the cut-off date is set late enough to allow such projects to not be impacted. It would be very damaging to long term investor confidence in the UK power market to do otherwise,</p> <p>Yes. It will create a clear way to structure around the concept and is discriminatory.</p> <p>N/A</p> <p>No view</p>

Q	Question	Response
13	<p>Do you have a view of whether implementation for the 2017/18 Triad season is sufficient to allow changes for:</p> <p>i) supplier contracts and billing system; and</p> <p>ii) ii) for other stakeholders?</p>	<p>This is a supplier question rather than one for us as a generator.</p>
18	<p>Do you have a view if embedded benefits are frozen at a non-zero value, what should that value be as a £/kW tariff (2016/17 value is £45.33 / kW)?</p>	<p>£45.33, i.e. current value but only as a temporary measure pending an SCR.</p>

Specific questions for CMP265

Q	Question	Response
11	<p>i) Views are sought on the implication for mixed sites discussed in 3.4.10.</p> <p>ii) Views are sought on the preference of categories of capacity Market CMU captured by this proposal, please indicate your preference from the following list and reasons:</p> <ul style="list-style-type: none"> • All existing and new distribution generation CMUs • All existing and new distribution generation CMUs and DSR CMUs (proven and unproven) • All price maker CMUs • All newbuild/prospective distribution generation CMUs only (defined as >1year contracts) 	<p>No view</p> <p>It is our view that the CUSC should not discriminate in this manner between generators in receipt of revenues external to the CUSC. It is inappropriate and hence we consider all the following to be unacceptable.</p>

14	<p>Do you have a view of whether implementation for the 2020/21 Triad season is sufficient to allow changes for i) supplier contracts and billing system, and ii) for other stakeholders?</p>	<p>From our position as a generator the time line appears viable for changes but as we have expressed a strong preference for an SCR, we consider that one argument among the many for rejection of this Modification Proposal is the required time for implementation of something that should be superseded within that time by new regulations introduced following an SCR.</p>
----	--	--

Specific questions for BOTH CMP264 & CMP265

Q	Question	Response
9	<p>i) Suppliers: In setting charges for your demand customers, do you charge them at the same tariff as National Grid charges you (i.e. gross), to enable you to pay the embedded benefit to embedded generators, or please explain the way in which it is funded?</p> <p>ii) Suppliers: Does the estimate that 7.58GW of embedded generation output and 2.5GW of demand side reduction at the time of Triad for 2016/17 seem reasonable based on your knowledge of the UK market? If not what is your estimate of embedded generator output and DSR at time of Triad?</p>	<p>Not applicable to us – we are not a supplier.</p> <p>Not applicable to us – we are not a supplier.</p>
12	<p>Can you identify – either quantitatively or qualitatively - the impact of the demand TNUoS embedded benefit on your decisions made in making capacity market decisions?</p>	<p>Yes. The existence of this benefit has been key to our investment decisions to date. Whilst it is possible that Capacity Market payments in the future could be received at a level sufficient to compensate for any reduction in the embedded benefit, we are not presently convinced that this will happen.</p>

Q	Question	Response
15	<p>i) What are your views on the 2 broad options to enable the reporting of gross export metered data?</p> <p>ii) Would you have the data available required for Option B (both CMP264 and CMP265) for both new contracts and existing contracts where a customer may be partially exempt?</p> <p>iii) Do you believe you can implement the proposed changes by the respective implementation dates?</p> <p>iv) What are the pros and cons of the 2 proposals that ELEXON are considering to implement this (P348 for CMP265/ P349 for CMP264)?</p>	<p>This is a question for suppliers only to answer</p> <p>A supplier question.</p> <p>Supplier question</p> <p>Supplier question</p>
16	<p>Do you have any further evidence / comments on the consumer impact of changing the demand TNUoS embedded benefit in either the short-run or long-run?</p>	<p>We are prepared to work with industry appointed consultants to develop robust economic material to demonstrate the adverse impact of the proposed changes on consumers.</p>
17	<p>Do you feel that both the locational and residual component of the demand TNUoS should be removed as an embedded benefit (as CMP264 Original) or just the residual component (as CMP265 Original) or some other method?</p>	<p>Absolutely not in either case. These are both fundamentally incorrect approaches.</p>
19	<p>Regarding the proposed alternatives what are your views on the suggested implementation dates? Are these achievable? Please give reasons for your view.</p>	<p>We consider that any change pending an SCR should be both minimal in impact, be supportable and be capable of rapid and easy implementation to make any difference within the time line of an SCR. We consider that all of the alternatives fail to achieve this goal.</p>

CUSC Workgroup Consultation Response Proforma

CMP264 'Embedded Generation Triad Avoidance Standstill' and **CMP265** 'Gross charging of TNUoS for HH demand where Embedded Generation is in the Capacity Market'

Industry parties are invited to respond to this consultation expressing their views and supplying the rationale for those views, particularly in respect of any specific questions detailed below.

Please send your responses by **24th August 2016** to cusc.team@nationalgrid.com Please note that any responses received after the deadline or sent to a different email address may not receive due consideration by the Workgroup.

Any queries on the content of the consultation should be addressed to Caroline Wright at caroline.wright@nationalgrid.com

These responses will be considered by the Workgroup at its next meeting at which members will also consider any Workgroup Consultation Alternative Requests. Where appropriate, the Workgroup will record your response and its consideration of it within the final Workgroup Report which is submitted to the CUSC Modifications Panel.

Respondent:	<i>Please insert your name and contact details (phone number or email address)</i>
Company Name:	<i>Please insert Company Name</i>
<p>Please express your views regarding the Workgroup Consultation, including rationale.</p> <p>(Please include any issues, suggestions or queries)</p>	<p>For reference, the Applicable CUSC objectives are:</p> <p>Use of System Charging Methodology</p> <p>(a) that compliance with the use of system charging methodology facilitates effective competition in the generation and supply of electricity and (so far as is consistent therewith) facilitates competition in the sale, distribution and purchase of electricity;</p> <p>(b) that compliance with the use of system charging methodology results in charges which reflect, as far as is reasonably practicable, the costs (excluding any payments between transmission licensees which are made under and in accordance with the STC) incurred by transmission licensees in their transmission businesses and which are compatible with standard condition C26 (Requirements of a connect and manage connection);</p> <p>(c) that, so far as is consistent with sub-paragraphs (a) and (b), the use of system charging methodology, as far as is reasonably practicable, properly takes account of</p>

	<p>the developments in transmission licensees' transmission businesses.</p> <p>(d) Compliance with the Electricity Regulation and any relevant legally binding decision of the European Commission and/or the Agency.</p>
--	---

Standard Workgroup consultation questions – CMP264

Q	Question	Response
1	<p>Do you believe that the CMP264 Original Proposal better facilitates the Applicable CUSC Objectives?</p>	

Q	Question	Response
2	<p>Do you support the proposed implementation approach? Or are there any further implementation implications that need to be considered?</p>	<p>ELEXON is the Balancing and Settlement Code Company (BSCCo). ELEXON fulfils the role of the BSC's code administrator. As such we have focused our responses to this consultation on the implications of CMP264 and 265 for the BSC and the interdependencies between CMP264 and 265, and BSC Modifications P348 and P349¹. Our responses do not represent the views of the BSC Panel or of BSC Parties.</p> <p>ELEXON is in the process of consulting the industry and completing an impact assessment of P348 and P349. Consequently we cannot say what the implications of CMP264 and 265 might be for the BSC. Any conclusions drawn from P348/349 consultation responses and the IA will help us to better understand the timescales, costs and feasibility of achieving the proposed implementation timetables.</p> <p>Nevertheless ELEXON has highlighted to the CMP264/265 and P348/349 workgroups, and at BSC Panel meetings that BSC Scheduled Releases over the next 12-18 months already pose a challenge to implement. Including additional changes to BSC Systems in forthcoming Scheduled Releases is likely to be expensive and possibly at the cost of other competing changes. This risk is particularly relevant to CMP264 and P349 because the proposer would like these changes implemented in 2017. It may be appropriate to consider an interim solution that avoids or minimises changes to BSC Systems in order to achieve an implementation date in 2017.</p> <p>ELEXON has also highlighted the need for careful coordination between the principal CUSC modifications and supporting industry code modifications. We believe that overall the proposed CUSC requirements are driving all changes. Therefore we recommend that primary requirements and definitions should originate in the CUSC which supporting industry codes can refer to or draw their vires from. In addition, as CMP264 and 265 are principal modifications that rely on changes to other industry codes we believe that the Code Administrators' Joint Working Practices should be more clearly employed and that in this case National Grid is the lead Code Administrator. Therefore National Grid should take a clearer role in ensuring that any consequential changes, e.g. to the BSC or the DTC, are co-ordinated effectively (e.g. where appropriate through joint workgroup meetings and consultations).</p> <p>With co-ordination in mind, the consultation document correctly recognises that the implementation of the technical solutions proposed by P348 and P349 may require changes to the Data Transfer Catalogue (DTC). That is, changes may be required to modify existing or introduce new data flows used by Suppliers, their agents and Supplier Volume Allocation Agent (SVAA) to facilitate the collection and reporting of metered data necessary to support CMP264 and 265. However, ELEXON nor any Party has raised a corresponding DTC Change Proposal (in part because the workgroups have not finalised the technical solutions yet) and we note that this process can take several months to progress through design, assessment, decision and implementation.</p> <p>Finally, BSC changes tend to be implemented as part of a Scheduled Release in February, June and November each year, whereas CUSC changes are implemented on an ad hoc basis. At the moment the proposed implementation date for CMP264 is 1 April 2017 whereas for P349 it is 29 June 2017 (as part of the June 2017 Release), and the implementation date for CMP265 is 1 April 2020 whereas it is 7 November 2019 (as part of the November 2019 Release) for P348. We encourage the CMP264/265 and P348/349 workgroups to consider the implications of not implementing these changes on the same day.</p>

Q	Question	Response
3	Do you have any other comments?	
4	Do you wish to raise a WG Consultation Alternative Request for the Workgroup to consider?	<i>If yes, please complete a WG Consultation Alternative Request form, available on National Grid's website², and return to the CUSC inbox at cusc.team@nationalgrid.com</i>

Standard Workgroup consultation questions – CMP265

Q	Question	Response
5	Do you believe that the CMP265 Original Proposal better facilitates the Applicable CUSC Objectives?	
6	Do you support the proposed implementation approach? Or are there any further implementation implications that need to be considered?	Please see our responses to Q2, 13 and 14.
7	Do you have any other comments?	
8	Do you wish to raise a WG Consultation Alternative Request for the Workgroup to consider?	<i>If yes, please complete a WG Consultation Alternative Request form, available on National Grid's website³, and return to the CUSC inbox at cusc.team@nationalgrid.com</i>

Specific questions for CMP264

Q	Question	Response
---	----------	----------

¹ In order to support CMP264 and 265, EDF and SP raised BSC Modifications P348 and P349 to introduce BSC-based solutions for reporting metered data to National Grid.

² http://www.nationalgrid.com/uk/Electricity/Codes/systemcode/amendments/forms_guidance/

³ http://www.nationalgrid.com/uk/Electricity/Codes/systemcode/amendments/forms_guidance/

Q	Question	Response
10	<p>i) Do you think a cut-off date for “new embedded generation” of 30 June 2017 is appropriate? What other date would you propose?</p> <p>ii) Do you have any views on how mixed sites are being addressed in CMP264 Original?</p> <p>iii) Do you think new-build embedded generation capacity that has entered into long term financial and performance commitment obligations via 2014 and 2015 capacity market or contracts for difference auctions (prior to this modification proposal) should be given exceptions to this cut-off date?</p> <p>iv) Do you agree that ignoring demand behind the meter is unlikely to create a significant “loophole” or material discrimination risk in relation to the CMP264 arrangements in the short term</p> <p>v) Question to suppliers: Do you consider that the wording of your existing contracts allow you to reflect the changes provided by these modifications in a cost reflective manner. For example, these changes will apply to existing PPAs and generators who significantly alter their output (EREC 59).</p> <p>vi) Do you agree with the definition of commissioned and do you agree that it is appropriate? If you do not agree with the definition or that it is appropriate please provide alternative definitions and rationale for this definition.</p>	<p>In keeping with our role as the BSCCo, we have only responded to sub-questions ii) and vi).</p> <p>In general, because of the interdependency between the CUSC and other industry codes to deliver CMP264 and 265, and the potential complexity of these arrangements, we believe that the clarity of any requirements and definitions is vitally important. It was clear at the CMP264/265 Workgroup meeting on 11 August that the CMP Workgroup had not thoroughly explored the detail and the implications of a technical solution previously considered by the P348/349 workgroup. Nevertheless we are encouraged that the CMP workgroup’s meeting on 11 August began to consider in more detail what is necessary to ensure a robust solution. We look forward to the focused CMP264/265 sub-group and the coordinated drafting of legal texts.</p> <p>As part of the P348/349 workgroup meeting it was apparent that the activity at a New Embedded Generator (NEG) site may be more complicated than first thought. That is, in reality any generating site is metered for any on-site demand as well as any generation it exports to the system. Furthermore, the site may be a combination of generating units, some of which the developer may have commissioned after the ‘cut-off’ date proposed (therefore qualifying as NEG) and some may not. The P348/349 workgroup recognised that the ‘mixed site’ nature of generating sites may require special attention.</p> <p>In terms of CMP264 and P349, these modifications propose that Suppliers only report gross metered data from export metering systems that measure energy at sites consisting NEGs. This is irrespective of whether the site consists of generating units that are non-NEG. The proposer was not convinced the workgroup had made a strong case for a more complicated set of arrangements for mixed sites. Therefore we believe CMP264 and P349 propose a technical solution which is simpler than CMP265 and P348 because it avoids the challenges of identifying complicated mixed site configurations and determining rules for netting import from export volumes. However, we also note that the consultation considers whether suppliers could provide additional evidence to National Grid (over and above what is reported in accordance with the BSC solution). The means of collecting and providing this additional data has not been specified under P349 and the CMP workgroup should give consideration to how this process would work in practice.</p> <p>ELEXON does not have a view whether the definition of ‘commissioned’ is appropriate. However, as noted above, we believe definitions need to be clear so parties are able to effectively discharge their obligations and because other industry code requirements will rely on those set out in the CUSC.</p> <p>For example, in addition to relying on suppliers determining whether a site has received EREC G59 certification, the definition of NEG and ‘commissioned’ relies on a handful of exceptional circumstances (see paragraph 3.3.15) and the site being a ‘sufficient size’. It is clear the definitions will require precise drafting to ensure the definitions are clear and unambiguous.</p> <p>Finally, in light of the reliance on suppliers to self-certify a site and to provide metered data, the CMP264/265 workgroup should consider how compliance will be monitored and assured.</p> <p>In keeping with our comments relating to primacy, we believe the CUSC should take the primary role in any assurance requirements.</p>

Q	Question	Response
13	<p>Do you have a view of whether implementation for the 2017/18 Triad season is sufficient to allow changes for:</p> <p>i) supplier contracts and billing system; and</p> <p>ii) for other stakeholders?</p>	<p>This response is in addition to our more general response to Q2.</p> <p>We have assumed that implementation for the 2017/18 Triad season means by the proposed implementation date, i.e. 1 April 2017.</p> <p>ELEXON is still waiting for responses to the P349 Assessment Consultation and Impact Assessment. Until ELEXON receives these responses and the P349 workgroup has considered them, we cannot say whether implementation of CMP264 in time for the 2017/18 Triad is achievable.</p> <p>ELEXON note that the Scheduled BSC Releases over the next 12-18 months are already expected to be challenging to implement because of the volume and complexity of changes required. Additional changes to BSC Systems, such as P349, are likely to make these Releases more of a challenge.</p> <p>We note that National Grid may be considering its own temporary manual workaround to enable the implementation of CMP264 in time for the 2017/18 Triad. We'd welcome more detail on National Grid's plans to ensure compatibility with any BSC solution.</p>

Q	Question	Response
18	Do you have a view if embedded benefits are frozen at a non-zero value, what should that value be as a £/kW tariff (2016/17 value is £45.33 / kW)?	

Specific questions for CMP265

Q	Question	Response
11	<p>i) Views are sought on the implication for mixed sites discussed in 3.4.10.</p> <p>ii) Views are sought on the preference of categories of capacity Market CMU captured by this proposal, please indicate your preference from the following list and reasons:</p> <ul style="list-style-type: none"> • All existing and new distribution generation CMUs • All existing and new distribution generation CMUs and DSR CMUs (proven and unproven) • All price maker CMUs • All newbuild/prospective distribution generation CMUs only (defined as >1year contracts) 	<p>In keeping with our role as the BSCCo, we have only responded to sub-question i). Furthermore, our response to this question should be read in conjunction with our response to Q10 – particularly in relation to the need for clear requirements and definitions.</p> <p>As originally drawn out during the P348 workgroup discussion and summarised above in our response to Q10, CMP265 and P348 propose that a net value of export metered data should be reported for qualifying CMU sites. The process for calculating a net value is potentially complicated in terms of i) identifying all related metering systems (some of which may not be registered to the supplier responsible for the CMU metering system), ii) determining and sharing an appropriate method for calculating a net export volume for each CMU site, iii) performing individual site net calculations, iv) aggregating the data and v) reporting the results to National Grid.</p> <p>P348 would require BSC Systems to handle data and perform calculations that it is unfamiliar with. That is BSC Systems don't currently receive and process metered data for individual SVA metering systems. Nor do they execute SVA site specific netting rules. BSC Systems may require considerable changes to facilitate P348.</p> <p>In light of this complexity it is important that the requirements and definitions are clearly specified within the CUSC and BSC. This is so the arrangements are robust and that parties involved in these processes are clear of what their responsibilities are.</p> <p>Furthermore, the CMP265 workgroup should pay particular attention to how they expect the CUSC to monitor compliance with these requirements and provide assurance.</p>

14	<p>Do you have a view of whether implementation for the 2020/21 Triad season is sufficient to allow changes for i) supplier contracts and billing system, and ii) for other stakeholders?</p>	<p>This response is in addition to our more general response to Q2.</p> <p>We have assumed that implementation for the 2020/21 Triad season means by the proposed implementation date, i.e. 1 April 2020.</p> <p>ELEXON is still waiting for responses to the P348 Assessment Consultation and Impact Assessment. Until ELEXON receives these responses and the P348 workgroup has considered them, we cannot say whether implementation of CMP264 in time for the 2020/21 Triad is achievable.</p> <p>Whilst we must wait for consultation and IA responses, on the one hand it is reasonable to expect the challenges of implementing CMP265 in four years' time are fewer than we are likely to face for CMP264 because CMP265 and P348 have longer lead times before implementing any solution. However, whilst there may be more time in which to implement a solution, CMP265 and P348 propose more complicated solutions which may pose more of a challenge to design and implement for Suppliers and ELEXON.</p>
----	--	--

Specific questions for BOTH CMP264 & CMP265

Q	Question	Response
9	<p>i) Suppliers: In setting charges for your demand customers, do you charge them at the same tariff as National Grid charges you (i.e. gross), to enable you to pay the embedded benefit to embedded generators, or please explain the way in which it is funded?</p> <p>ii) Suppliers: Does the estimate that 7.58GW of embedded generation output and 2.5GW of demand side reduction at the time of Triad for 2016/17 seem reasonable based on your knowledge of the UK market? If not what is your estimate of embedded generator output and DSR at time of Triad?</p>	

Q	Question	Response
12	<p>Can you identify – either quantitatively or qualitatively - the impact of the demand TNUoS embedded benefit on your decisions made in making capacity market decisions?</p>	
15	<p>i) What are your views on the 2 broad options to enable the reporting of gross export metered data?</p> <p>ii) Would you have the data available required for Option B (both CMP264 and CMP265) for both new contracts and existing contracts where a customer may be partially exempt?</p> <p>iii) Do you believe you can implement the proposed changes by the respective implementation dates?</p> <p>iv) What are the pros and cons of the 2 proposals that ELEXON are considering to implement this (P348 for CMP265/ P349 for CMP264)?</p>	<p>We have already provided thoughts on the two primary solutions (i.e. 'Option A') proposed by P348 and P349 for reporting data in our responses to Q13 and 14.</p> <p>The P348 and P349 workgroup considered alternative solutions to both P348 and P349 (i.e. 'Option B'). Put simply the main proposals of each modification specify solutions that require Suppliers, their Data Aggregators and the Supplier Volume Allocation Agent to collect, correct for line losses and aggregate (which may require following netting rules provided by Suppliers) metered data to Supplier BMU level before reporting these values to National Grid (i.e. Option A). The alternative solutions considered for each of P348 and P349 propose simpler solutions in terms of the BSC. That is, they would only specify in the BSC that Suppliers and their Data Collectors report HH metered data for individual metering systems to National Grid. This approach would avoid the need for any changes to BSC Systems. Instead it would be National Grid's responsibility to aggregate the individual metering system metered data (which may include import metered data and require following netting rules provided by Suppliers) to determine export volumes for each Supplier BMU. At present P348 and P349 do not envisage specifying the additional steps National Grid would need to follow in the BSC. These would need to be specified in the CUSC.</p> <p>Please note that the P348/349 Workgroup has not yet formally raised these options as Alternative Modifications.</p>
16	<p>Do you have any further evidence / comments on the consumer impact of changing the demand TNUoS embedded benefit in either the short-run or long-run?</p>	
17	<p>Do you feel that both the locational and residual component of the demand TNUoS should be removed as an embedded benefit (as CMP264 Original) or just the residual component (as CMP265 Original) or some other method?</p>	

Q	Question	Response
19	Regarding the proposed alternatives what are your views on the suggested implementation dates? Are these achievable? Please give reasons for your view.	<p>We note that the CMP264/265 workgroup has considered several Workgroup Alternative CUSC Modifications (WACMs). As we have raised at workgroup meetings, based on what we know about the potential WACMs, we are concerned that defects identified by P348 and P349 are narrow (i.e. they specifically relate to NEG's or CMUs) and may not accommodate the proposed WACMs. The CMP264/265 workgroup will need to urgently consider whether any WACM requires a new BSC Modification Proposal to be raised – particularly if the intention is for the WACM to be implemented over the next 12-18 months.</p>

CUSC Workgroup Consultation Response Proforma

CMP264 'Embedded Generation Triad Avoidance Standstill' and **CMP265** 'Gross charging of TNUoS for HH demand where Embedded Generation is in the Capacity Market'

Industry parties are invited to respond to this consultation expressing their views and supplying the rationale for those views, particularly in respect of any specific questions detailed below.

Please send your responses by **24th August 2016** to cusc.team@nationalgrid.com Please note that any responses received after the deadline or sent to a different email address may not receive due consideration by the Workgroup.

Any queries on the content of the consultation should be addressed to Caroline Wright at caroline.wright@nationalgrid.com

These responses will be considered by the Workgroup at its next meeting at which members will also consider any Workgroup Consultation Alternative Requests. Where appropriate, the Workgroup will record your response and its consideration of it within the final Workgroup Report which is submitted to the CUSC Modifications Panel.

Respondent:	<i>Tony Mortimer</i> <i>Ely Power Station Manager</i> <i>tony.mortimer@epri.co.uk</i>
Company Name:	<i>EPR Ely Limited</i>
Please express your views regarding the Workgroup Consultation, including rationale. (Please include any issues, suggestions or queries)	<p>For reference, the Applicable CUSC objectives are:</p> <p>Use of System Charging Methodology</p> <p>(a) that compliance with the use of system charging methodology facilitates effective competition in the generation and supply of electricity and (so far as is consistent therewith) facilitates competition in the sale, distribution and purchase of electricity;</p> <p>(b) that compliance with the use of system charging methodology results in charges which reflect, as far as is reasonably practicable, the costs (excluding any payments between transmission licensees which are made under and in accordance with the STC) incurred by transmission licensees in their transmission businesses and which are compatible with standard condition C26 (Requirements of a connect and manage connection);</p> <p>(c) that, so far as is consistent with sub-paragraphs (a)</p>

	<p>and (b), the use of system charging methodology, as far as is reasonably practicable, properly takes account of the developments in transmission licensees' transmission businesses.</p> <p>(d) Compliance with the Electricity Regulation and any relevant legally binding decision of the European Commission and/or the Agency.</p>
--	---

Standard Workgroup consultation questions – CMP264

Q	Question	Response
1	Do you believe that the CMP264 Original Proposal better facilitates the Applicable CUSC Objectives?	No. Given the rules around allocating transmission system costs between Generation and Demand, embedded generation is effectively negative demand at GSP and should be treated as such.
2	Do you support the proposed implementation approach? Or are there any further implementation implications that need to be considered?	No. The proposal sits outside the CUSC objectives, does not address the fundamental issue of increasing transmission system costs and their allocation, and unfairly targets new embedded generators, some of whom may have included this revenue when designing their projects.
3	Do you have any other comments?	No.
4	Do you wish to raise a WG Consultation Alternative Request for the Workgroup to consider?	<i>If yes, please complete a WG Consultation Alternative Request form, available on National Grid's website¹, and return to the CUSC inbox at cusc.team@nationalgrid.com</i>

Standard Workgroup consultation questions – CMP265

Q	Question	Response
5	Do you believe that the CMP265 Original Proposal better facilitates the Applicable CUSC Objectives?	No. Given the rules around allocating transmission system costs between Generation and Demand, embedded generation is effectively negative demand at GSP and should be treated as such.

¹ http://www.nationalgrid.com/uk/Electricity/Codes/systemcode/amendments/forms_guidance/

Q	Question	Response
6	Do you support the proposed implementation approach? Or are there any further implementation implications that need to be considered?	No. The proposal sits outside the CUSC objectives, does not address the fundamental issue of increasing transmission system costs and their allocation, and unfairly targets CM embedded generators, who are likely to have included this ongoing revenue when designing their projects.
7	Do you have any other comments?	If such an amendment is appropriate in respect of CM embedded generators, it should not be applied retrospectively. it should be clear at the time of future Capacity Market auctions, it can then be reflected in the bid price.
8	Do you wish to raise a WG Consultation Alternative Request for the Workgroup to consider?	<i>If yes, please complete a WG Consultation Alternative Request form, available on National Grid's website², and return to the CUSC inbox at cusc.team@nationalgrid.com</i>

Specific questions for CMP264

Q	Question	Response
---	----------	----------

² http://www.nationalgrid.com/uk/Electricity/Codes/systemcode/amendments/forms_guidance/

Q	Question	Response
10	<p>i) Do you think a cut-off date for “new embedded generation” of 30 June 2017 is appropriate? What other date would you propose?</p> <p>ii) Do you have any views on how mixed sites are being addressed in CMP264 Original?</p> <p>iii) Do you think new-build embedded generation capacity that has entered into long term financial and performance commitment obligations via 2014 and 2015 capacity market or contracts for difference auctions (prior to this modification proposal) should be given exceptions to this cut-off date?</p> <p>iv) Do you agree that ignoring demand behind the meter is unlikely to create a significant “loophole” or material discrimination risk in relation to the CMP264 arrangements in the short term</p> <p>v) Question to suppliers: Do you consider that the wording of your existing contracts allow you to reflect the changes provided by these modifications in a cost reflective manner. For example, these changes will apply to existing PPAs and generators who significantly alter their output (EREC 59).</p> <p>vi) Do you agree with the definition of commissioned and do you agree that it is appropriate? If you do not agree with the definition or that it is appropriate please provide alternative definitions and rationale for this definition.</p>	<p>We do not agree with the change so do not comment on the selected date.</p> <p>No comment</p> <p>Yes, we do not agree with retrospective change to revenue and support mechanisms.</p> <p>No, to not include a specific category of embedded generators is discriminatory.</p> <p>No comment</p> <p>No comment</p>

Q	Question	Response
13	<p>Do you have a view of whether implementation for the 2017/18 Triad season is sufficient to allow changes for:</p> <p>i) supplier contracts and billing system; and</p> <p>ii) ii) for other stakeholders?</p>	<p>No comment, we do not agree with the change.</p>
18	<p>Do you have a view if embedded benefits are frozen at a non-zero value, what should that value be as a £/kW tariff (2016/17 value is £45.33 / kW)?</p>	<p>We do not believe that the embedded benefit should be frozen. However, if the tariffs are frozen, the value should be no less than the 2016/17 value (£45.33 per kW) as this would result in least damage to investor confidence.</p>

Specific questions for CMP265

Q	Question	Response
11	<p>i) Views are sought on the implication for mixed sites discussed in 3.4.10.</p> <p>ii) Views are sought on the preference of categories of capacity Market CMU captured by this proposal, please indicate your preference from the following list and reasons:</p> <ul style="list-style-type: none"> • All existing and new distribution generation CMUs • All existing and new distribution generation CMUs and DSR CMUs (proven and unproven) • All price maker CMUs • All newbuild/prospective distribution generation CMUs only (defined as >1year contracts) 	<p>No comment.</p> <p>No comment.</p>

14	<p>Do you have a view of whether implementation for the 2020/21 Triad season is sufficient to allow changes for i) supplier contracts and billing system, and ii) for other stakeholders?</p>	No comment.
----	--	-------------

Specific questions for BOTH CMP264 & CMP265

Q	Question	Response
9	<p>i) Suppliers: In setting charges for your demand customers, do you charge them at the same tariff as National Grid charges you (i.e. gross), to enable you to pay the embedded benefit to embedded generators, or please explain the way in which it is funded?</p> <p>ii) Suppliers: Does the estimate that 7.58GW of embedded generation output and 2.5GW of demand side reduction at the time of Triad for 2016/17 seem reasonable based on your knowledge of the UK market? If not what is your estimate of embedded generator output and DSR at time of Triad?</p>	<p>No comment.</p> <p>No comment.</p>
12	<p>Can you identify – either quantitatively or qualitatively - the impact of the demand TNUoS embedded benefit on your decisions made in making capacity market decisions?</p>	No comment.

Q	Question	Response
15	<p>i) What are your views on the 2 broad options to enable the reporting of gross export metered data?</p> <p>ii) Would you have the data available required for Option B (both CMP264 and CMP265) for both new contracts and existing contracts where a customer may be partially exempt?</p> <p>iii) Do you believe you can implement the proposed changes by the respective implementation dates?</p> <p>iv) What are the pros and cons of the 2 proposals that ELEXON are considering to implement this (P348 for CMP265/ P349 for CMP264)?</p>	<p>No comment.</p> <p>No comment.</p> <p>No comment.</p> <p>No comment.</p>
16	<p>Do you have any further evidence / comments on the consumer impact of changing the demand TNUoS embedded benefit in either the short-run or long-run?</p>	<p>No comment.</p>
17	<p>Do you feel that both the locational and residual component of the demand TNUoS should be removed as an embedded benefit (as CMP264 Original) or just the residual component (as CMP265 Original) or some other method?</p>	<p>Neither should be removed.</p>
19	<p>Regarding the proposed alternatives what are your views on the suggested implementation dates? Are these achievable? Please give reasons for your view.</p>	<p>No comment.</p>

CUSC Workgroup Consultation Response Proforma

CMP264 'Embedded Generation Triad Avoidance Standstill' and **CMP265** 'Gross charging of TNUoS for HH demand where Embedded Generation is in the Capacity Market'

Industry parties are invited to respond to this consultation expressing their views and supplying the rationale for those views, particularly in respect of any specific questions detailed below.

Please send your responses by **24th August 2016** to cusc.team@nationalgrid.com Please note that any responses received after the deadline or sent to a different email address may not receive due consideration by the Workgroup.

Any queries on the content of the consultation should be addressed to Caroline Wright at caroline.wright@nationalgrid.com

These responses will be considered by the Workgroup at its next meeting at which members will also consider any Workgroup Consultation Alternative Requests. Where appropriate, the Workgroup will record your response and its consideration of it within the final Workgroup Report which is submitted to the CUSC Modifications Panel.

Respondent:	<i>Simon Lord, Transmission Services Director, ENGIE UK</i> simon.lord@engie.com
Company Name:	ENGIE UK 
Please express your views regarding the Workgroup Consultation, including rationale. (Please include any issues, suggestions or queries)	For reference, the Applicable CUSC objectives are: Use of System Charging Methodology (a) that (b) that.... (c) that..., (d) Compliance...

Standard Workgroup consultation questions – CMP264

Q	Question	Response
1	Do you believe that the CMP264 Original Proposal better facilitates the Applicable CUSC Objectives?	We do not support this proposal as presently crafted. It discriminates between existing and new users based on date of construction/first running. We believe that embedded generators should see an appropriate locational signal and an embedded substation benefit relating to avoided substation cost.
2	Do you support the proposed implementation approach? Or are there any further implementation implications that need to be considered?	See 1
3	Do you have any other comments?	Please see Technical Appendices for detailed analysis
4	Do you wish to raise a WG Consultation Alternative Request for the Workgroup to consider?	No: This may be raised via the working group and would be based on the Centrica (2) proposal with an embedded substation benefit of £3-4/kW applied in addition to the locational tariff in accordance with CUSC 14.15.119. Practically, setting the lowest location tariff to zero may achieve both objectives. Implementation would be the next following 1 st April after an Authority decision i.e. a decision in March 17 would result in implementation 1 st April 18. This will give the maximum benefit to consumers

Standard Workgroup consultation questions – CMP265

Q	Question	Response
5	Do you believe that the CMP265 Original Proposal better facilitates the Applicable CUSC Objectives?	We are minded to support this proposal as being an improvement on the baseline CUSC; although we have concerns that as presently drafted it discriminates between classes of users and we would like to see an earlier implementation date. We would prefer this proposal to apply to all embedded generators with an implementation date set by the Authority.
6	Do you support the proposed implementation approach? Or are there any further implementation implications that need to be considered?	We would prefer the implementation date to be linked to an Ofgem decision with implementation the “next following 1 st April after an Authority decision” i.e. a decision in March 17 would result in implementation 1 st April 18. This would see a consumer benefit in a timely fashion whilst always giving a minimum 12 months prior to implementation.

Q	Question	Response
7	Do you have any other comments?	<p>Whereas passing through a smaller benefit is relatively easy, adding a charge (negative locational charge) may be more troublesome. So we would prefer the lowest locational charge to be zero.</p> <p>Please see Technical Appendices for other information</p>
8	Do you wish to raise a WG Consultation Alternative Request for the Workgroup to consider?	<p>No :- this may be raised via the working group and would be based on the Centrica (2) proposal with an embedded substation benefit of £3-4/kW applied in addition to the locational tariff in accordance with CUSC 14.15. Practically setting the lowest location tariff to zero may achieve both objectives. Implementation would be the next following 1st April after an Authority decision. This will give the maximum benefit to consumers.</p>

Specific questions for CMP264

Q	Question	Response
10	<p>i) Do you think a cut-off date for “new embedded generation” of 30 June 2017 is appropriate? What other date would you propose?</p> <p>ii) Do you have any views on how mixed sites are being addressed in CMP264 Original?</p> <p>iii) Do you think new-build embedded generation capacity that has entered into long term financial and performance commitment obligations via 2014 and 2015 capacity market or contracts for difference auctions (prior to this modification proposal) should be given exceptions to this cut-off date?</p> <p>iv) Do you agree that ignoring demand behind the meter is unlikely to create a significant “loophole” or material discrimination risk in relation to the CMP264 arrangements in the short term</p> <p>v) Question to suppliers: Do you consider that the wording of your existing contracts allow you to reflect the changes provided by these modifications in a cost reflective manner. For example, these changes will apply to existing PPAs and generators who significantly alter their output (EREC 59).</p> <p>vi) Do you agree with the definition of commissioned and do you agree that it is appropriate? If you do not agree with the definition or that it is appropriate please provide alternative definitions and rationale for this definition.</p>	<p>The date (if there is one) should be the date the modification was raised as this is normal practice for changes of this nature.</p> <p>All export meters should be covered by the proposal set at the maximum size prior to the cut-off date.</p> <p>Charging arrangements are and have consistently been subject to change. The Ofgem- led Transmit project clearly indicated to the industry that all charging arrangements could be changed and parties entering auctions or other commercial arrangements would have been able to take account of potential changes in any commercial arrangements. There should be no exemptions.</p> <p>This proposal deals with the supplier netting arrangements; behind the meter onsite/ DSR will need to be tackled with a different arrangement, e.g. by “spreading the triad”</p> <p>From a supplier perspective contracts are flexible enough to pass through increases or reductions in embedded benefits from the various sources and this would not be barrier to implementation as long as sufficient (12 months) notice was given. Whereas passing through a smaller benefit is relatively easy, adding a charge (negative locational charge) may be more troublesome</p> <p>We think all embedded generation should be treated the same. The date (if there is one) should be the date the modification was raised as this is normal practice for changes of this nature otherwise individual parties can select against the scheme.</p>

Q	Question	Response
13	<p>Do you have a view of whether implementation for the 2017/18 Triad season is sufficient to allow changes for:</p> <p>i) supplier contracts and billing system; and</p> <p>ii) for other stakeholders?</p>	<p>We believe that implementation should be the next following 1st April after an Authority decision. This will give 12 months to implement the change.</p>
18	<p>Do you have a view if embedded benefits are frozen at a non-zero value, what should that value be as a £/kW tariff (2016/17 value is £45.33 / kW)?</p>	<p>We believe this is an embedded substation benefit of £3-4/kW applied in addition to the locational tariff in accordance with CUSC 14.15.119. Practically setting the lowest location tariff to zero may achieve both objectives -see the Technical appendices to this response.</p>

Specific questions for CMP265

Q	Question	Response
11	<p>i) Views are sought on the implication for mixed sites discussed in 3.4.10.</p> <p>ii) Views are sought on the preference of categories of capacity Market CMU captured by this proposal, please indicate your preference from the following list and reasons:</p> <ul style="list-style-type: none"> • All existing and new distribution generation CMUs • All existing and new distribution generation CMUs and DSR CMUs (proven and unproven) • All price maker CMUs • All newbuild/prospective distribution generation CMUs only (defined as >1year contracts) 	<p>We believe that this level of complexity (to try to unpick sites with some capacity in the CM and some not) is fraught with challenges. For this reason we believe that this modification should apply to all site exports on an equal basis.</p> <p>We believe that all embedded generation should be included in this modification not just those with CM agreements.</p>

14	<p>Do you have a view of whether implementation for the 2020/21 Triad season is sufficient to allow changes for i) supplier contracts and billing system, and ii) for other stakeholders?</p>	<p>We believe that implementation should be the next following 1st April after an Authority decision this give sufficient time for change.</p> <p>Whereas passing through a smaller benefit is relatively easy, adding a charge (negative locational charge) may be more troublesome so we would prefer the lowest locational charge to be zero.</p>
----	--	---

Specific questions for BOTH CMP264 & CMP265

Q	Question	Response
9	<p>i) Suppliers: In setting charges for your demand customers, do you charge them at the same tariff as National Grid charges you (i.e. gross), to enable you to pay the embedded benefit to embedded generators, or please explain the way in which it is funded?</p> <p>ii) Suppliers: Does the estimate that 7.58GW of embedded generation output and 2.5GW of demand side reduction at the time of Triad for 2016/17 seem reasonable based on your knowledge of the UK market? If not what is your estimate of embedded generator output and DSR at time of Triad?</p>	<p>It is standard industry practice to change gross demand at the tariff rate (£/kw) set by National Grid.</p> <p>Yes, it is reasonable based on our knowledge</p>
12	<p>Can you identify – either quantitatively or qualitatively - the impact of the demand TNUoS embedded benefit on your decisions made in making capacity market decisions?</p>	<p>All sources of income and cost (including the risk that income and costs may change) would be considered.</p>

Q	Question	Response
15	<p>i) What are your views on the 2 broad options to enable the reporting of gross export metered data?</p> <p>ii) Would you have the data available required for Option B (both CMP264 and CMP265) for both new contracts and existing contracts where a customer may be partially exempt?</p> <p>iii) Do you believe you can implement the proposed changes by the respective implementation dates?</p> <p>iv) What are the pros and cons of the 2 proposals that ELEXON are considering to implement this (P348 for CMP265/ P349 for CMP264)?</p>	<p>We would expect Elexon to determine appropriate sites to include/exclude from the netting arrangements. A verification report should be available to the Supplier from Elexon that shows which meters are excluded from netting. The final TNUoS bill from National Grid should include a breakdown netted/not-netted by volume. The process should be seamless without Supplier interactions.</p> <p>We believe that implementation should be the next following 1st April after an Authority decision. This should give sufficient time for change.</p> <p>We have not been involved in these proposals and we may respond directly to them.</p>
16	<p>Do you have any further evidence / comments on the consumer impact of changing the demand TNUoS embedded benefit in either the short-run or long-run?</p>	<p>Yes, please see analysis in Appendices. We consider that embedded benefits at the current level are not cost reflective and overstate the benefit by a factor of 10.</p>
17	<p>Do you feel that both the locational and residual component of the demand TNUoS should be removed as an embedded benefit (as CMP264 Original) or just the residual component (as CMP265 Original) or some other method?</p>	<p>We believe that the locational element should remain plus an embedded substation benefit of £3-4/kW applied in addition to the locational tariff in accordance with CUSC 14.15.119 possibly added to the demand locational tariff for simplicity. Please see analysis in the Appendices.</p>

Q	Question	Response
19	<p>Regarding the proposed alternatives what are your views on the suggested implementation dates? Are these achievable? Please give reasons for your view.</p>	<p>Please see Appendix F for further comments on the Green Frog and UK Power Reserve proposals:</p> <p>Green Frog:- We do not support this proposal. The level of residual proposed exceeds the cost reflective value by a factor of 10 and there is no evidence to support the proposed value.</p> <p>UK Power Reserve (1 and 2): We do not support these modifications, it protects existing/nearly built embedded generators with CM/CFD contracts with grandfathering. As such they are discriminatory and the level of residual (even at the current level) exceeds by a factor of 10 the cost reflective value. There is no evidence to support the proposed value.</p> <p>Centrica (1): We support this proposal as being an improvement over the current CUSC arrangements</p> <p>Centrica (2): We support this proposal as being an improvement over the current CUSC arrangements. We think an embedded substation benefit of £3-4/kW applied in addition to the locational tariff in set in accordance with CUSC 14.15.119. Practically, setting the lowest location tariff to zero may achieve both objectives. Implementation should be next following 1st April after an Authority decision. This gives sufficient time for change and the maximum benefit to consumers. See the Technical Appendices for detailed analysis.</p>

Technical Appendices Executive Summary

The analysis in the appendices is presented to support working group discussion.

The first appendix addresses **the money flows for different type of generation/reduction in demand**, including transmission-connection generation, embedded generation sold to a supplier, on-site generation and demand side reduction. The conclusion is that although the flows on the transmission system associated with a particular action are the same (in this example a reduction of 100MW) the **TNUoS costs to the end consumer is different**. For transmission-connection generation there is no additional cost to the consumer. For **embedded generation all consumers see an increased cost**. For on-site generation and DSR, the host demand sees a reduced cost but all other consumers see an increase in costs.

The second appendix (Appendix B) is a load flow analysis of the **effect on the transmission system of distribution connected generation**. It uses the current version of National Grid's transport model. This shows that identical load flows result from connecting generation at either the transmission or the distribution level. The **increase or reduction in the size of the transmission system is only affected by the location of Grid Supply Point (GSP) relative** to other demand and generation connections and the network parameters. **Distribution and transmission connected generation have the same effect on system flows** and hence the size of the transmission system.

The third piece of analysis (Appendix C) shows the effect of connecting multiple generators on the transmission system either with an **equal level of MW in each generation zone** compared with a **pro-rata increase in line with the generation locational tariff**. This shows that without a locational tariff the size of the transmission system (MWkm) is around 6% larger than it would be with the locational tariff. This shows that the result of applying the current embedded benefit across all embedded generators (with negligible locational signal) is likely to result in a **larger, more costly transmission system** than would otherwise be the case.

Appendix D shows that if the generator connection saving (£1.44/kw/year) is added to the cost estimated by National Grid of avoided demand connection (£1.62/kw) ([Embedded Benefit Review | National Grid](#) 15th January 14, section 4.6 below) the combined embedded benefit is around £3-4/kw/year the value. It suggest adding a new charge (benefit) to the substation cost relating to connection generation via a demand connection. The embedded substation benefit of £3-4/kW would be calculated by National Grid using the same methodology as substation cost CUSC 14.15.119 and would be avoid substation cost resulting from generation connecting via a demand circuit. A new line would be added to the table.

Appendix E is a high level overview of the DCLF model used in this analysis as well of the CUSC link to obtain the model. Appendix F contains Consumer impacts and further thoughts on Green Frog and UK Power Reserve proposals.

Appendix A The impact of embedded generation, onsite generation and demand side response on customer costs.

This note details the incremental impact on **transmission costs** (as collected by suppliers and National Grid) resulting from the connection of 100MW of various types of distributed generation. The diagram shows the system used for the presentation with the main transmission system demand, generation and embedded generation represented by F_m , T_m and E_m respectively.

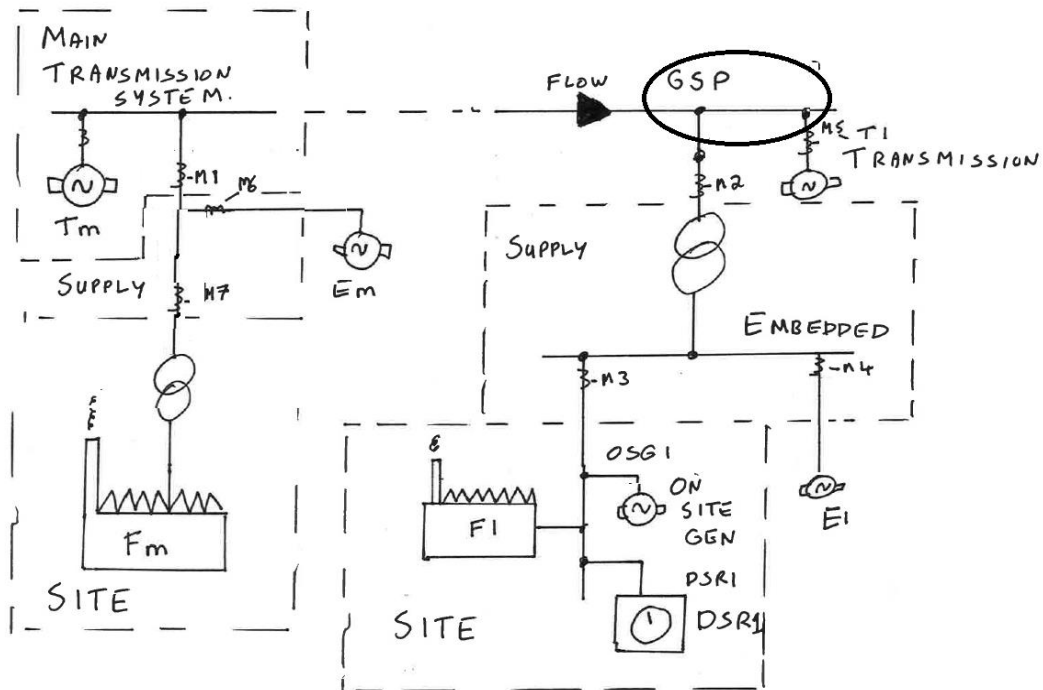

A small node (GSP) on the system was then examined that contains a 1000MW of demand (F1). 100MW of generation/demand reduction is placed at four locations below the GSP to replicate, supplier connected embedded generation (E1), on site generation (OSG1), demand side response (DRS1) and transmission connected generation (T1) at the same GSP.

The MW assumptions for each load/generator is shown below. Meters are allocated as required but principally at boundaries to the supplier zones. The numbers used are representative of the actual demand /supply and costs at peak.

Base assumptions			Base	Transmission	Embedded	DSR	OSG
Demand	Demand	F_m (M7)	56000	56000	56000	56000	56000
		F1	1000	1000	1000	1000	1000
Generation	Transmission	T_m (slack Bus)	-50100	-50000	-50000	-50000	-50000
		T1 (M5)	0	-100			
	Embedded	E_m (M6)	-6900	-6900	-6900	-6900	-6900
		E1 (M4)			-100		
	DSR	DSR1				-100	
On site gen	OSG1					-100	
	=Fixed	Changes					

The output from the model for the four scenarios are shown below based on increment 100 MW.

			Base	Transmission	Embedded	DSR	OSG
Transmission Demand (M1 + M2)		MW	50100	50100	50000	50000	50000
Supplier Demand (M7 + M2)		MW	57000	57000	57000	56900	56900
Transmission Cost		£m	2275	2275	2275	2275	2275
Rate		£/kw	45.41	45.41	45.50	45.50	45.50

			Base	Transmission	Embedded	DSR	OSG
Flow (MW)			1000	900	900	900	900
Transmission Customer Cost(Fm+F1)		£m	2588.32	2588.32	2593.50	2588.95	2588.95
F1 cost		£m	45.41	45.41	45.50	40.95	40.95
E1+Em Cost		£m	-313.32	-313.32	-318.50	-313.95	-313.95
Delta Transmission Cost (100MW)		£m	NA	0.00	5.18	0.63	0.63
Delta F1 Cost		£m	NA	0.00	0.09	-4.46	-4.46
DSR/onsite payment [50/90%] of benefit		£m				2.23	4.01
Customer cost + DSR/onsite payment		£m	2588.32	2588.32	2593.50	2591.18	2592.96
Delta cost		£m		0.00	5.18	2.86	4.64

The key points from this analysis are:

1. For all four options the flows on the **transmission are the same at 900 MW import**. So the effect on the transmission system of connecting embedded, on site generating, DSR or transmission connected generation via the same GSP is the same
2. Funding for supplier embedded benefits is collected from the difference between the supplier and the transmission demand changing base multiplied by rate (TNUoS tariff); this funding is shared across all demand customers in equal share.
3. The **incremental transmission cost** to consumers resulting from connecting additional 100MW of embedded generation via the supply embedded route is £5.18m this results from a reduction in the transmission demand charging base (creating a higher tariff) that is then collected over the larger supplier charging base this is more than £4.55m that might be expected as the higher tariff is collected over all embedded generation and not just the additional 100 MW this creates an addition £0.63m of cost.
4. The **incremental transmission cost** to consumers resulting from connecting additional on Site/DSR is £0.63m, the tariff is the same as the supplier embedded generation but the supplier charging base is 100MW smaller. The reduction in the cost borne by the demand that hosts the DSR/OSG can be used to pay for DSR [50% assumption] or own generation or a private wire to external provider [90% assumption]. The money comes from the **demand host** as opposed to all customers.
5. If the **additional payment made by the demand host to (DSR/OSG) is included as transmission cost [arguable]** then the cost of onsite generation approaches the cost of the supplier embedded generation option.
6. The lowest **incremental transmission cost** to consumers is 100 MW of transmission connected generation at the GSP. This results in no change to costs faced by consumers and does not change the supplier or the transmission demand charging base.
7. On site generation and DSR are different in character to supply embedded generation. With onsite generation/DSR the lower supplier transmission cost was seen directly by the **demand host**. The benefit could be used to reduce demands as long as the cost of reduction did not exceed the benefit of reduction. With supply embedded generation there is an increased transmission cost that is seen by all consumers without exception.

Appendix B: DC Load flow analysis of effect on the transmission system of distribution connected generation

The 2016/17 National Grid Transport and Tariff Model was used to examine the difference in network flows and the size of the transmission system of connecting 450 MW of generation via demand (embedded) or transmission at Norwich 400kV substation (as shown in the diagram and table below). Norwich substation was chosen as it includes both demand and generation at the same Grid Supply Point.

Methodology - The 2016/17 Transport and Tariff Model was set up using tariff generation and demand data but forced to run an identical load flow by re-categorising all generation as CCGT (this allows all generation appeared in the Peak and Year round load flows), this simplified the analysis as only one generator scaling factor needed to be dealt with. Generation was scaled to meet demand as is required for a load flow model (~72% scaling factor) and the load flow run to determine the size (MWkm) of the network and the power flows on all transmission circuits (Base scenario). The MWkm represents the length of 400 kV transmission lines (cables and lower voltage lines are converted in to 400 kV equivalents) multiplied by the power flow. It does not include historic costs, the cost of non-locational items (substations transformers etc) or other RIIO costs eg. SO costs. Then 450 MW of transmission connected generation was added at one substation Norwich 400kV (NORM40) and the load flow was re-run (Option A). This was repeated by simulating the connection of 450 MW of embedded generating by reducing demand at the Norwich 400kV substation by 450 MW (Option B). As expected the power flows on all transmission system circuits produced identical results for Option A and B. These power flows are shown in the diagram below.

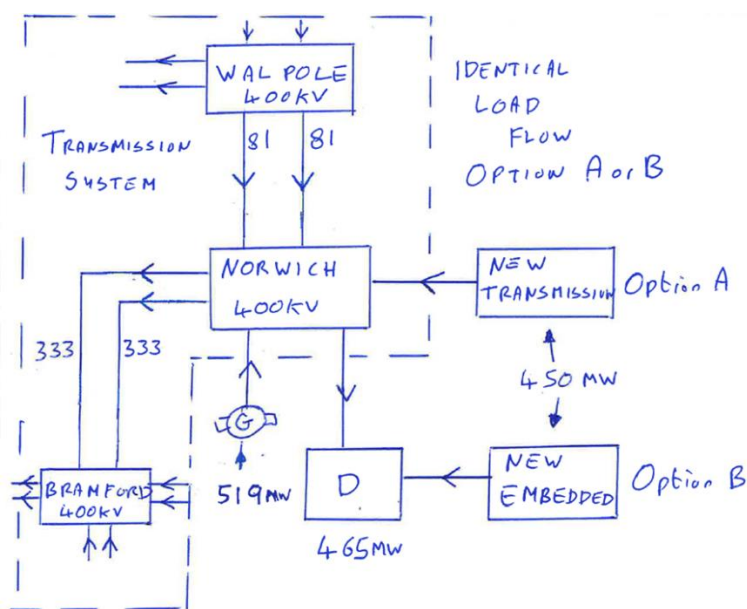

Overall the size of the transmission system (MWkm) reduced by 0.56% as a result of the connection of 450 MW of embedded/transmission generation as can be seen in the table below.

Scenario NG 16/17 tariff all plant type set to CCGT force one load flow (Year round)	Bus Name	Demand MW	Generation MW	Toatal load flow MWkm	% Network size change
Norwich 400 kV substation base load flow	NORM40	465	519	7,751,081	0.00%
Option A transmission + 450 MW generation	NORM40	465	969	7,707,548	-0.56%
Option B embeded generation - 450 MW demand lower	NORM40	15	519	7,707,549	-0.56%

Key Observations

1. The network flows on the transmission system as a result of connecting a similar volume of transmission generation or embeded generation at the same point **are identical**.
2. The change in the size of the transmission system as a result of connecting embeded or transmissions generation at the same Grid Supply point is identical. The increase or reduction in the size of the transmission system is only affected by the location of the GSP relative to other demand and generation connections and the network parameters.

Appendix C: Effect on the size (MWkm) of Transmission system of connecting generation (distribution or transmission) evenly or according to a locational signal.

Following on from the Appendix B analysis that looked at the effect of connecting embedded/transmission generation at the same Grid Supply Point further analysis was undertaken to establish the effect on the size of the network of connecting generation evenly across the network (i.e. no locational signal) or in proportion to a locational signal. As previously noted the MWkm represents the length of 400 kV transmission lines (cables and lower voltage lines are converted in to 400 kV equivalents) multiplied by the power flow. It does not include historic costs, the cost of non-locational items (substations transformers etc) or other RIIO costs e.g. SO costs.

Methodology - The 2016/17 Transport and Tariff Model was set up using tariff generation and demand data, the model was used without modification. The initial run established size of the network (Peak plus Year round MWkm) as used in the tariff calculation. Scenarios (1-6) were then performed to establish the effect on the size of the transmission system resulting from connecting 5000MW of conventional (CCGT type) generation in various generation tariff zones. Scenarios 7-9 were then performed that added different amounts of generation to each of the generation tariff zones based on even distribution (7), in proportion to the generation locational tariff (8) or the reverse generation locational tariff (9) the actual MW added to each zone are shown in the second table below.

Transport and tariff model 16/17 with additional MW showing change in size of			Peak MWkm	Year Round	Peak + Year Round	Annuitized cost **	% from base
Scenario	Zone	Change applied to zone	MWkm	MWkm	MWkm	£m	%
0	Base case tariff model		4,907,755	4,457,111	9,364,866	£224.87	0.00%
1	North Scotland (z1)	+5000 MW generation	7,677,102	5,453,463	13,130,565	£315.29	40.21%
2	Stirlingshire and Fife (z9)	+5000 MW generation	5,615,063	5,545,066	11,160,129	£267.98	19.17%
3	West Devon and Cornwall (Z27)	+5000 MW generation	5,042,423	5,131,648	10,174,071	£244.30	8.64%
4	West Midlands (z13-z18)	+5000 MW generation	4,857,261	4,751,375	9,608,636	£230.72	2.60%
5	Mid Wales and The Midlands (z18)	+5000 MW generation	4,705,604	4,567,725	9,273,329	£222.67	-0.98%
6	Central London (Z23)	+5000 MW generation	4,538,888	4,200,420	8,739,308	£209.85	-6.68%
7	All zones	185.1MW all zones *	4,702,668	5,601,791	10,304,459	£247.43	10.03%
8	All Zones	locational see table*	4,460,641	5,245,271	9,705,912	£233.06	3.64%
9	All Zones	Reverse locational*	5,179,169	5,943,590	11,122,759	£267.08	18.77%

** Expansion constant £13.34/MWkm and Security Factor 1.8 * see table of MW per zone below

Table of MW applied to each zone		Even all zones	Locational	Reverse locational
Name	Zone	MW	MW	MW
North Scotland	1	185.2	56.3	342.6
East Aberdeenshire	2	185.2	123.2	260.8
Western Highlands	3	185.2	88.6	303.2
Skye and Lochalsh	4	185.2	120.6	264.1
Eastern Grampian and Tayside	5	185.2	103.3	285.2
Central Grampian	6	185.2	63.6	333.7
Argyll	7	185.2	0.0	411.4
The Trossachs	8	185.2	119.2	265.8
Stirlingshire and Fife	9	185.2	189.4	180.1
South West Scotlands	10	185.2	144.0	235.5
Lothian and Borders	11	185.2	159.0	217.2
Solway and Cheviot	12	185.2	198.9	168.5
North East England	13	185.2	225.1	136.4
North Lancashire and The Lakes	14	185.2	197.9	169.6
South Lancashire, Yorkshire and Humber	15	185.2	191.7	177.2
North Midlands and North Wales	16	185.2	206.9	158.7
South Lincolnshire and North Norfolk	17	185.2	225.8	135.6
Mid Wales and The Midlands	18	185.2	237.1	121.7
Anglesey and Snowdon	19	185.2	186.1	184.1
Pembrokeshire	20	185.2	180.5	190.9
South Wales & Gloucester	21	185.2	216.2	147.2
Cotswold	22	185.2	254.5	100.5
Central London	23	185.2	336.8	0.0
Essex and Kent	24	185.2	266.4	86.0
Oxfordshire, Surrey and Sussex	25	185.2	293.1	53.3
Somerset and Wessex	26	185.2	307.7	35.6
West Devon and Cornwall	27	185.2	308.1	35.0
Total		5000.0	5000.0	5000.0

Key observations:-

1. As expected locating generation remote from demand centres (e.g. North Scotland) increases the size of the network whilst connecting generation close to demand centres (Central London) reduces the size of the network.
2. The increase in size of the network between generation located evenly over each tariff zone (scenario 7) as opposed to pro-rated to a locational signal (scenario 8) is around 6% larger.
3. The locational cost of the transmission network (MWkm multiplied by the expansion factor and the security factor) represents around 10% of the network cost with the remainder being made up of historic and non-locational items. The non-location related costs are included in the residual.
4. There is no difference between the size of the transmission system resulting from connection of distribution or transmission connected generation.

Appendix D: Benefits to Transmission users of generation connecting via the distribution system

Typical funding arrangement for connection of transmission and distribution connected generation. This is represented in the diagram below. Transmission connected generators typically own and fund all equipment (1) including the 400kV switch. A skeletal 400 kV bay (6) is typically provided by the TO (included in TNUoS) to connect to the transmission system at £10/kW for a 500 MW connection. As this connection is funded by TNUoS it is not directly paid for by the generator but funded by all customers.

Distribution connected generators face similar charges they pay for their own works (2) fund sole user works (3) and a share of reinforcement (4), (5). In general no works are required to the distribution connection (7) to the 400 kV system except in the case of exporting GSPs connection when funding is typically included in TNUoS.

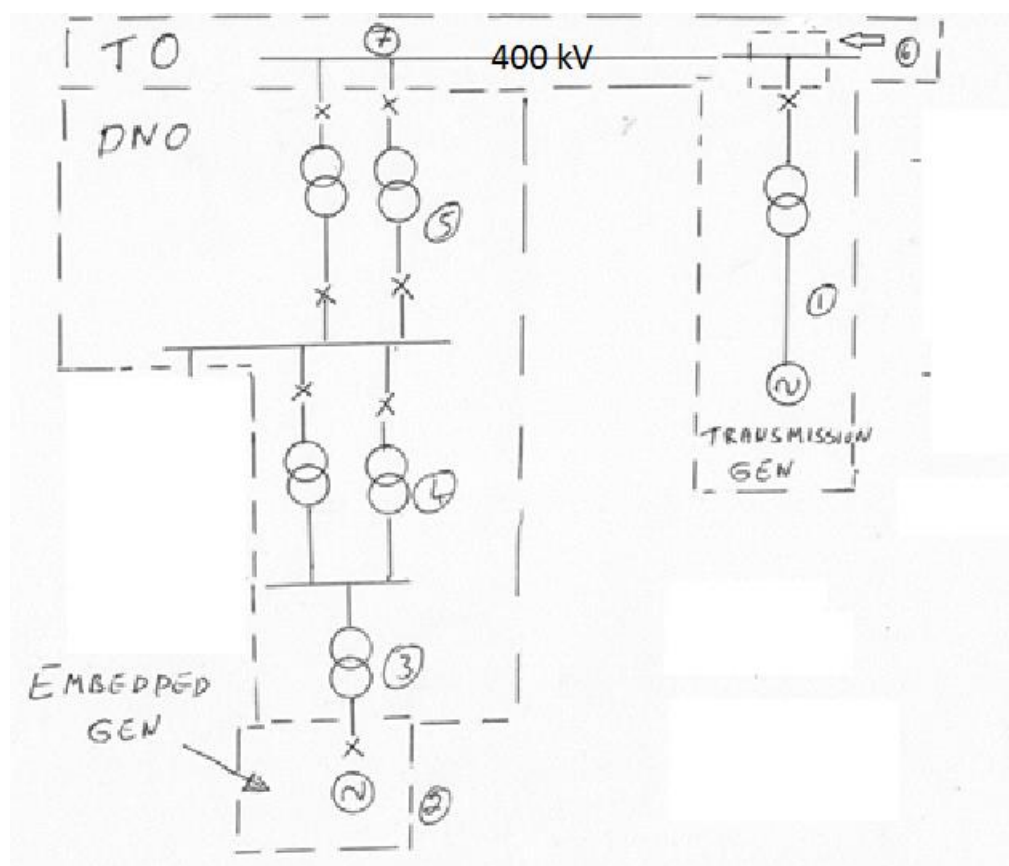

Key

Key	Typical funding arrangements for connections
1	Transmission generator owner
6	TO owned securitised by Transmission generator
2	Embedded generator owned
3	Sole works funded by embedded generator
4	Reinforcement funded by embedded generator
5	Reinforcement funded by embedded generator
7	Exporting GSP's no embedded generator funding

RIIO sets the baseline revenue that can be collected via TNUoS on an annual basis. This includes allowances for capital projects as well as some volume related drivers.

For generator connections for 16/17 an allowance of £220m for 3553 MW of connection has been made. This covers all generator connection work: some of this is classified as connection (sole user works) and some related to shared works such as the skeletal bay described above. Different years have different costs depending on the business plan with an average of £30/kW/new connection.

Part A: Baseline Generation Connections and Allowed Expenditure

6F.5 Table 1 in this condition sets out the baseline forecast of Generation Connections (BGCO) and overhead line (BLOHL) for each Relevant Year in the Price Control Period and the baseline expenditure (BGCE), in 2009/10 prices, associated with those baseline outputs as at 1 April 2013.

Table 1: Baseline Generation Connections and Allowed Expenditure

	Relevant Year							
	2013/14	2014/15	2015/16	2016/17	2017/18	2018/19	2019/20	2020/21
BGCO (MW)	504.0	1597.0	3264.0	3553.0	1540.0	3797.0	5649.5	13819.0
BLOHL (circuit km)	5.4	0.0	0.0	100.0	0.0	70.0	40.0	0.0
BGCE (£m)	130.524	185.228	184.112	220.710	117.364	95.965	42.494	20.662

6F.6 The baseline expenditure set out in Table 1 in this condition has been reflected in:

- (a) the licensee’s Opening Base Revenue Allowance, set against the licensee’s name in Appendix 1 to Special Condition 3A; and
- (b) GCE values contained in the PCFM Variable Values Table for the Licensee contained in the ET1 Price Control Financial Model as at 1 April 2013.

The table below shows the indicative annual cost (£/kW) for generator connection from 15/16 to 20/21 derived from the RIIO data. The average cost is around £2/kw/year.

Indicative Cost		2015/16	2016/17	2017/18	2016/18	2017/19	2018/20
Total Circuit Capital Cost	£m	184.1	220.7	117.4	96.0	42.5	20.7
Capacity	MW	3264	3553	1540	3797	5650	13819
Unit Cost	£/kw	56.41	62.12	76.21	25.27	7.52	1.50
Depreciation	years	45	45	45	45	45	45
Rate	WACC	4.55%	4.55%	4.55%	4.55%	4.55%	4.55%
Annuity	rate	0.053	0.053	0.053	0.053	0.053	0.053
Annual Cost	£/kw/year	2.967	3.268	4.009	1.329	0.396	0.079

If the generator connection saving is added to the cost estimated by National Grid of avoided demand connection (£1.62/kW) ([Embedded Benefit Review | National Grid](#) 15th January 14, section 4.6 below) the combined embedded benefit is around £3-4/kw/year. Embedded generation connecting via exporting GSPs do not result in a demand infrastructure saving and actually cause a cost, so this saving should be removed from sites exporting via an exporting GSP. The avoided demand connection cost is also possibly overstated depending on the nature of generation: high load factor generation would lead to reduced infrastructure at the GSP but low load factor or intermittent generation is unlikely to lead to reduced demand GSP infrastructure. Therefore, the benefit may be overstated for this class of generation.

We suggest the Embedded Substation benefit would be calculated as per other substation cost and be the “Avoided cost of connection generation via a demand circuit”. National Grid would set the initial value and would there after update it in line with RPI with a full review after each price control. An example table is shown below.

14.15.118 Using the above factors, the corresponding £/kW tariffs (quoted to 3dp) that will be applied during 2010/11 are:

Substation Rating (b)	Connection Type (c)	Substation Voltage (a)		
		132kV	275kV	400kV
<1320MW	No redundancy	0.133	0.081	0.065
<1320MW	Redundancy	0.301	0.192	0.155
>=1320MW	No redundancy	n/a	0.257	0.208
>=1320MW	Redundancy	n/a	0.417	0.336
Embedded substation benefit		- 3.500		

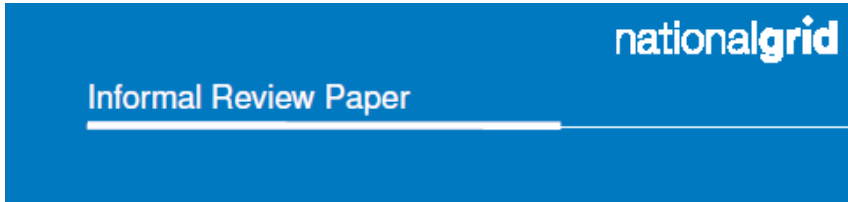

Review of the Embedded (Distributed) Generation Benefit arising from transmission charges

A total of eighteen NGET schemes were assessed from their RIIO-T1 price control submission and the spread of infrastructure costs can be seen in Figure 10 below.

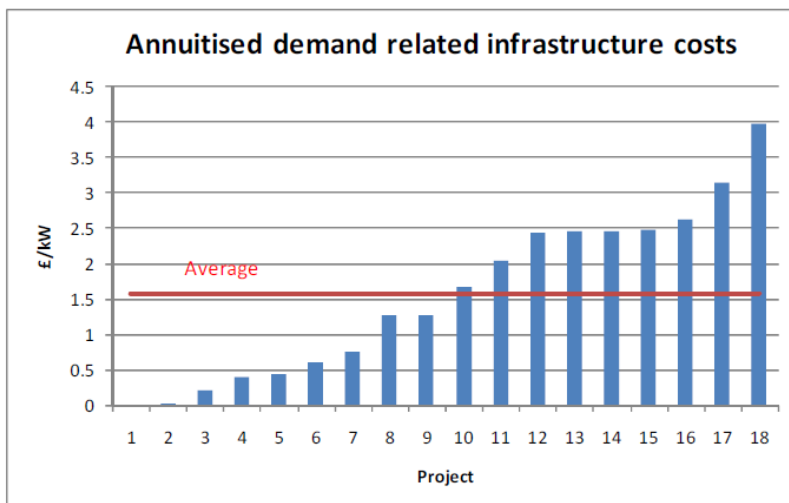

Figure 10

The average annuitized cost was determined as £1.58/kW in 2012/13 prices (£1.62 in 2013/14 prices). This is comparable with previous analysis in 2009/10 where the equivalent price was £1.47/kW.

Appendix E Brief Explanation of DCLF ICRP GB Transport Model Methodology

The 2016/17 Transport and Tariff Model is freely available to all CUSC parties from National Grid and is a useful tool to export network interactions. The model is populated with data from the 10 Years Statement, TEC register and latest demand forecast as used in tariff setting. The current version runs two load flows (Peak and Years round) with different generation backgrounds and then allocates each transmission circuit to one or other background for tariff setting. For network analysis (Appendix B) one load flow was used by forcing all plant to be one type (CCGT) for the locational effect on the transmission system (Appendix D) the full dual load flow was used.

The DCLF ICRP GB Transport Model is a representation of the transmission network and derives power flows in line with standard DC electrical theory. Ten Year statement, nodal and network data are used given background, the DCLF ICRP GB Transport Model scales nodal generation as appropriate to ensure national generation matches national peak demand. It then derives two power flows for the prescribed network with different generation backgrounds but common demand pattern, based on the impedance values of the lines in the network. This means that;

- (i) the prescribed network linking nodes consist of actual circuits and their electrical characteristics as seen on the actual transmission network
- (ii) the electrical characteristics determine power flows which are reflective of those that would be seen on the actual transmission network
- (iii) the pattern of power flows leads reflect those that are seen on the actual transmission network at peak

Network segments are then binned into Peak and Year round components depending on which has the larger flow. This split is used in subsequent tariff setting.

The total MWkm figure for the transport solution is derived from these power flows and the effective lengths of circuits over which they travel. The MWkm represents the length of 400 kV transmission lines (cables and lower voltage lines are converted into 400 kV equivalents) multiplied by the power flow. It does not include historic costs, the cost of non-locational items (substations, transformers etc) or other RIIO costs eg. SO costs.

The link below is to the DCLF page.

<http://www2.nationalgrid.com/UK/Industry-information/System-charges/Electricity-transmission/Transmission-Network-Use-of-System-Charges/Tools-and-Data/>

Appendix F

Consumer impacts

TNUoS.

In the short term there is likely to be no significant effect on the TNUoS allowable revenue as this is stable over a price control period. In the medium and long term the required size of the transmission system will determine the level of TO investment required and ultimately cost to the consumer. Embedded and transmission connected generation have the same effect on the transmission system when located at the same grid supply point. For example, 1000 MW of generation located in Scotland will drive the same reinforcement need irrespective whether it is embedded or transmission connected. The main difference between the two classes of generation is the locational tariff that is applied. Transmission connected generation has a relatively strong locational tariff with high price signals in the North of the UK and low/negative prices in Southern England near the major demand centres. This has been a factor in the closure of some transmission connected power stations. Embedded generation sees a large negative price signal at all locations, the signal has only a small locational element applied (driven principally by the large demand zones uses in its calculation). Given the difference in locational price signals, from a TNUoS perspective, embedded generation (weak locational signal) is likely to result in a larger transmission system compared to transmission connected generation (strong locational signal). Thus a higher level of embedded generation is likely to drive a larger, more costly transmission system compared to transmission connected generation.

Capacity Market Prices

In the short term there is likely to be an increase in the cleared price of future capacity auctions driven by the removal of the embedded benefit from a number of market participants. In the medium and long term it is likely that cleared auction prices would be lower than they would otherwise be driven by increased volume of supply as a consequence of the closures of fewer transmission connected power stations than would otherwise be the case.

Transmission connected generation currently receives the majority of their income from energy margin, this income is relatively small compared to previous years and is negative for many such power stations. A contributing factor to the lower level of power prices is the running of embedded generation for Triad capture over much of the winter peak period. Lower capacity prices will potential lead to the further closure of transmission connected power stations in the near term. Embedded power station receive an addition source of income (the embedded benefit compared to transmission connected power station) that is around £45/kw.

The volume of embedded generation that have capacity contracts but may not be built as a consequence of the removal of TNUoS embedded benefits needs to be considered in the connected of the continued closure of transmission connected power stations.

The new generation that will be needed to replace these closed stations is likely to come from small embedded stations as these can be built relatively quickly. Thus if further closures of transmission connected power station occur in the near term (driven by low auction prices) customers will need to fund not only an increase in capacity payments in

future capacity auctions (as a result of reduced supply) but an increased level of embedded benefits paid to new embedded power stations.

Thus from a customer's perspective one scenario is that the removal of embedded benefits will lead to an overall reduction in cost to the consumer.

Further comments the potential working group alternatives

(Submitted but not included in the working group report)

Green Frog Proposal

We consider that this option would do little to correct the market distortion that the current level of embedded benefits brings. It simply continues with benefits to new and existing embedded generators at the current rate; it is effectively a "do nothing" proposal. There is no evidence to support the proposed value of benefits. If the proposed rate were to be set on a cost reflective principle around £1-5/kWh then we consider that the proposal may have merit. However, at the current level there will continue to be a significant over payment of benefits.

UK Power Reserve potential working group alternatives

We believe that the charging arrangements are, and have consistently been, subject to change. The Ofgem-led Transmit project clearly indicated to the industry that all charging arrangements could be changed. Parties entering to auctions, or other commercial arrangements, would have been able to take account of potential changes in any commercial arrangements. We believe that this option would do little to correct the market distortion that the current level of embedded benefits creates. There is no evidence to support the proposed value of benefits. The proposal would add a further distortion of grandfathering to the current embedded benefit mechanism for existing and near completion projects at an ever increasing rate. It would disadvantage new embedded generators who would not be treated on the same basis. We also consider that the continued closure of transmission connected generation (caused in part by the market distortion created by the high level of embedded benefits) would have greater Security of Supply implications than the failure to build a quantity of embedded generation due to the removal of all or most of the TNUoS embedded benefit.

CUSC Workgroup Consultation Response Proforma

CMP264 'Embedded Generation Triad Avoidance Standstill' and **CMP265** 'Gross charging of TNUoS for HH demand where Embedded Generation is in the Capacity Market'

Industry parties are invited to respond to this consultation expressing their views and supplying the rationale for those views, particularly in respect of any specific questions detailed below.

Please send your responses by **24th August 2016** to cusc.team@nationalgrid.com Please note that any responses received after the deadline or sent to a different email address may not receive due consideration by the Workgroup.

Any queries on the content of the consultation should be addressed to Caroline Wright at caroline.wright@nationalgrid.com

These responses will be considered by the Workgroup at its next meeting at which members will also consider any Workgroup Consultation Alternative Requests. Where appropriate, the Workgroup will record your response and its consideration of it within the final Workgroup Report which is submitted to the CUSC Modifications Panel.

Respondent:	<i>Myles Wallace</i> <i>Westfield Power Station Manager</i> <i>myles.wallace@epri.co.uk</i>
Company Name:	<i>EPR Scotland Limited</i>
Please express your views regarding the Workgroup Consultation, including rationale. (Please include any issues, suggestions or queries)	<p>For reference, the Applicable CUSC objectives are:</p> <p>Use of System Charging Methodology</p> <p>(a) that compliance with the use of system charging methodology facilitates effective competition in the generation and supply of electricity and (so far as is consistent therewith) facilitates competition in the sale, distribution and purchase of electricity;</p> <p>(b) that compliance with the use of system charging methodology results in charges which reflect, as far as is reasonably practicable, the costs (excluding any payments between transmission licensees which are made under and in accordance with the STC) incurred by transmission licensees in their transmission businesses and which are compatible with standard condition C26 (Requirements of a connect and manage connection);</p> <p>(c) that, so far as is consistent with sub-paragraphs (a)</p>

	<p>and (b), the use of system charging methodology, as far as is reasonably practicable, properly takes account of the developments in transmission licensees' transmission businesses.</p> <p>(d) Compliance with the Electricity Regulation and any relevant legally binding decision of the European Commission and/or the Agency.</p>
--	---

Standard Workgroup consultation questions – CMP264

Q	Question	Response
1	Do you believe that the CMP264 Original Proposal better facilitates the Applicable CUSC Objectives?	No. Given the rules around allocating transmission system costs between Generation and Demand, embedded generation is effectively negative demand at GSP and should be treated as such.
2	Do you support the proposed implementation approach? Or are there any further implementation implications that need to be considered?	No. The proposal sits outside the CUSC objectives, does not address the fundamental issue of increasing transmission system costs and their allocation, and unfairly targets new embedded generators, some of whom may have included this revenue when designing their projects.
3	Do you have any other comments?	No.
4	Do you wish to raise a WG Consultation Alternative Request for the Workgroup to consider?	<i>If yes, please complete a WG Consultation Alternative Request form, available on National Grid's website¹, and return to the CUSC inbox at cusc.team@nationalgrid.com</i>

Standard Workgroup consultation questions – CMP265

Q	Question	Response
5	Do you believe that the CMP265 Original Proposal better facilitates the Applicable CUSC Objectives?	No. Given the rules around allocating transmission system costs between Generation and Demand, embedded generation is effectively negative demand at GSP and should be treated as such.

¹ http://www.nationalgrid.com/uk/Electricity/Codes/systemcode/amendments/forms_guidance/

Q	Question	Response
6	Do you support the proposed implementation approach? Or are there any further implementation implications that need to be considered?	No. The proposal sits outside the CUSC objectives, does not address the fundamental issue of increasing transmission system costs and their allocation, and unfairly targets CM embedded generators, who are likely to have included this ongoing revenue when designing their projects.
7	Do you have any other comments?	If such an amendment is appropriate in respect of CM embedded generators, it should not be applied retrospectively. It should be clear at the time of future Capacity Market auctions, it can then be reflected in the bid price.
8	Do you wish to raise a WG Consultation Alternative Request for the Workgroup to consider?	<i>If yes, please complete a WG Consultation Alternative Request form, available on National Grid's website², and return to the CUSC inbox at cusc.team@nationalgrid.com</i>

Specific questions for CMP264

Q	Question	Response
---	----------	----------

² http://www.nationalgrid.com/uk/Electricity/Codes/systemcode/amendments/forms_guidance/

Q	Question	Response
10	<p>i) Do you think a cut-off date for “new embedded generation” of 30 June 2017 is appropriate? What other date would you propose?</p> <p>ii) Do you have any views on how mixed sites are being addressed in CMP264 Original?</p> <p>iii) Do you think new-build embedded generation capacity that has entered into long term financial and performance commitment obligations via 2014 and 2015 capacity market or contracts for difference auctions (prior to this modification proposal) should be given exceptions to this cut-off date?</p> <p>iv) Do you agree that ignoring demand behind the meter is unlikely to create a significant “loophole” or material discrimination risk in relation to the CMP264 arrangements in the short term</p> <p>v) Question to suppliers: Do you consider that the wording of your existing contracts allow you to reflect the changes provided by these modifications in a cost reflective manner. For example, these changes will apply to existing PPAs and generators who significantly alter their output (EREC 59).</p> <p>vi) Do you agree with the definition of commissioned and do you agree that it is appropriate? If you do not agree with the definition or that it is appropriate please provide alternative definitions and rationale for this definition.</p>	<p>We do not agree with the change so do not comment on the selected date.</p> <p>No comment</p> <p>Yes, we do not agree with retrospective change to revenue and support mechanisms.</p> <p>No, to not include a specific category of embedded generators is discriminatory.</p> <p>No comment</p> <p>No comment</p>

Q	Question	Response
13	<p>Do you have a view of whether implementation for the 2017/18 Triad season is sufficient to allow changes for:</p> <p>i) supplier contracts and billing system; and</p> <p>ii) ii) for other stakeholders?</p>	<p>No comment, we do not agree with the change.</p>
18	<p>Do you have a view if embedded benefits are frozen at a non-zero value, what should that value be as a £/kW tariff (2016/17 value is £45.33 / kW)?</p>	<p>We do not believe that the embedded benefit should be frozen. However, if the tariffs are frozen, the value should be no less than the 2016/17 value (£45.33 per kW) as this would result in least damage to investor confidence.</p>

Specific questions for CMP265

Q	Question	Response
11	<p>i) Views are sought on the implication for mixed sites discussed in 3.4.10.</p> <p>ii) Views are sought on the preference of categories of capacity Market CMU captured by this proposal, please indicate your preference from the following list and reasons:</p> <ul style="list-style-type: none"> • All existing and new distribution generation CMUs • All existing and new distribution generation CMUs and DSR CMUs (proven and unproven) • All price maker CMUs • All newbuild/prospective distribution generation CMUs only (defined as >1year contracts) 	<p>No comment.</p> <p>No comment.</p>

14	<p>Do you have a view of whether implementation for the 2020/21 Triad season is sufficient to allow changes for i) supplier contracts and billing system, and ii) for other stakeholders?</p>	No comment.
----	--	-------------

Specific questions for BOTH CMP264 & CMP265

Q	Question	Response
9	<p>i) Suppliers: In setting charges for your demand customers, do you charge them at the same tariff as National Grid charges you (i.e. gross), to enable you to pay the embedded benefit to embedded generators, or please explain the way in which it is funded?</p> <p>ii) Suppliers: Does the estimate that 7.58GW of embedded generation output and 2.5GW of demand side reduction at the time of Triad for 2016/17 seem reasonable based on your knowledge of the UK market? If not what is your estimate of embedded generator output and DSR at time of Triad?</p>	<p>No comment.</p> <p>No comment.</p>
12	<p>Can you identify – either quantitatively or qualitatively - the impact of the demand TNUoS embedded benefit on your decisions made in making capacity market decisions?</p>	No comment.

Q	Question	Response
15	<p>i) What are your views on the 2 broad options to enable the reporting of gross export metered data?</p> <p>ii) Would you have the data available required for Option B (both CMP264 and CMP265) for both new contracts and existing contracts where a customer may be partially exempt?</p> <p>iii) Do you believe you can implement the proposed changes by the respective implementation dates?</p> <p>iv) What are the pros and cons of the 2 proposals that ELEXON are considering to implement this (P348 for CMP265/ P349 for CMP264)?</p>	<p>No comment.</p> <p>No comment.</p> <p>No comment.</p> <p>No comment.</p>
16	<p>Do you have any further evidence / comments on the consumer impact of changing the demand TNUoS embedded benefit in either the short-run or long-run?</p>	<p>No comment.</p>
17	<p>Do you feel that both the locational and residual component of the demand TNUoS should be removed as an embedded benefit (as CMP264 Original) or just the residual component (as CMP265 Original) or some other method?</p>	<p>Neither should be removed.</p>
19	<p>Regarding the proposed alternatives what are your views on the suggested implementation dates? Are these achievable? Please give reasons for your view.</p>	<p>No comment.</p>

CUSC Workgroup Consultation Response Proforma

CMP264 'Embedded Generation Triad Avoidance Standstill' and **CMP265** 'Gross charging of TNUoS for HH demand where Embedded Generation is in the Capacity Market'

Industry parties are invited to respond to this consultation expressing their views and supplying the rationale for those views, particularly in respect of any specific questions detailed below.

Please send your responses by **24th August 2016** to cusc.team@nationalgrid.com Please note that any responses received after the deadline or sent to a different email address may not receive due consideration by the Workgroup.

Any queries on the content of the consultation should be addressed to Caroline Wright at caroline.wright@nationalgrid.com

These responses will be considered by the Workgroup at its next meeting at which members will also consider any Workgroup Consultation Alternative Requests. Where appropriate, the Workgroup will record your response and its consideration of it within the final Workgroup Report which is submitted to the CUSC Modifications Panel.

Respondent:	<i>Andrew Corbyn Thetford Power Station Manager andrew.corbyn@epri.co.uk</i>
Company Name:	<i>EPR Thetford Limited</i>
Please express your views regarding the Workgroup Consultation, including rationale. (Please include any issues, suggestions or queries)	<p>For reference, the Applicable CUSC objectives are:</p> <p>Use of System Charging Methodology</p> <p>(a) that compliance with the use of system charging methodology facilitates effective competition in the generation and supply of electricity and (so far as is consistent therewith) facilitates competition in the sale, distribution and purchase of electricity;</p> <p>(b) that compliance with the use of system charging methodology results in charges which reflect, as far as is reasonably practicable, the costs (excluding any payments between transmission licensees which are made under and in accordance with the STC) incurred by transmission licensees in their transmission businesses and which are compatible with standard condition C26 (Requirements of a connect and manage connection);</p> <p>(c) that, so far as is consistent with sub-paragraphs (a)</p>

	<p>and (b), the use of system charging methodology, as far as is reasonably practicable, properly takes account of the developments in transmission licensees' transmission businesses.</p> <p>(d) Compliance with the Electricity Regulation and any relevant legally binding decision of the European Commission and/or the Agency.</p>
--	---

Standard Workgroup consultation questions – CMP264

Q	Question	Response
1	Do you believe that the CMP264 Original Proposal better facilitates the Applicable CUSC Objectives?	No. Given the rules around allocating transmission system costs between Generation and Demand, embedded generation is effectively negative demand at GSP and should be treated as such.
2	Do you support the proposed implementation approach? Or are there any further implementation implications that need to be considered?	No. The proposal sits outside the CUSC objectives, does not address the fundamental issue of increasing transmission system costs and their allocation, and unfairly targets new embedded generators, some of whom may have included this revenue when designing their projects.
3	Do you have any other comments?	No.
4	Do you wish to raise a WG Consultation Alternative Request for the Workgroup to consider?	<i>If yes, please complete a WG Consultation Alternative Request form, available on National Grid's website¹, and return to the CUSC inbox at cusc.team@nationalgrid.com</i>

Standard Workgroup consultation questions – CMP265

Q	Question	Response
5	Do you believe that the CMP265 Original Proposal better facilitates the Applicable CUSC Objectives?	No. Given the rules around allocating transmission system costs between Generation and Demand, embedded generation is effectively negative demand at GSP and should be treated as such.

¹ http://www.nationalgrid.com/uk/Electricity/Codes/systemcode/amendments/forms_guidance/

Q	Question	Response
6	Do you support the proposed implementation approach? Or are there any further implementation implications that need to be considered?	No. The proposal sits outside the CUSC objectives, does not address the fundamental issue of increasing transmission system costs and their allocation, and unfairly targets CM embedded generators, who are likely to have included this ongoing revenue when designing their projects.
7	Do you have any other comments?	If such an amendment is appropriate in respect of CM embedded generators, it should not be applied retrospectively. it should be clear at the time of future Capacity Market auctions, it can then be reflected in the bid price.
8	Do you wish to raise a WG Consultation Alternative Request for the Workgroup to consider?	<i>If yes, please complete a WG Consultation Alternative Request form, available on National Grid's website², and return to the CUSC inbox at cusc.team@nationalgrid.com</i>

Specific questions for CMP264

Q	Question	Response
---	----------	----------

² http://www.nationalgrid.com/uk/Electricity/Codes/systemcode/amendments/forms_guidance/

Q	Question	Response
10	<p>i) Do you think a cut-off date for “new embedded generation” of 30 June 2017 is appropriate? What other date would you propose?</p> <p>ii) Do you have any views on how mixed sites are being addressed in CMP264 Original?</p> <p>iii) Do you think new-build embedded generation capacity that has entered into long term financial and performance commitment obligations via 2014 and 2015 capacity market or contracts for difference auctions (prior to this modification proposal) should be given exceptions to this cut-off date?</p> <p>iv) Do you agree that ignoring demand behind the meter is unlikely to create a significant “loophole” or material discrimination risk in relation to the CMP264 arrangements in the short term</p> <p>v) Question to suppliers: Do you consider that the wording of your existing contracts allow you to reflect the changes provided by these modifications in a cost reflective manner. For example, these changes will apply to existing PPAs and generators who significantly alter their output (EREC 59).</p> <p>vi) Do you agree with the definition of commissioned and do you agree that it is appropriate? If you do not agree with the definition or that it is appropriate please provide alternative definitions and rationale for this definition.</p>	<p>We do not agree with the change so do not comment on the selected date.</p> <p>No comment</p> <p>Yes, we do not agree with retrospective change to revenue and support mechanisms.</p> <p>No, to not include a specific category of embedded generators is discriminatory.</p> <p>No comment</p> <p>No comment</p>

Q	Question	Response
13	<p>Do you have a view of whether implementation for the 2017/18 Triad season is sufficient to allow changes for:</p> <p>i) supplier contracts and billing system; and</p> <p>ii) ii) for other stakeholders?</p>	<p>No comment, we do not agree with the change.</p>
18	<p>Do you have a view if embedded benefits are frozen at a non-zero value, what should that value be as a £/kW tariff (2016/17 value is £45.33 / kW)?</p>	<p>We do not believe that the embedded benefit should be frozen. However, if the tariffs are frozen, the value should be no less than the 2016/17 value (£45.33 per kW) as this would result in least damage to investor confidence.</p>

Specific questions for CMP265

Q	Question	Response
11	<p>i) Views are sought on the implication for mixed sites discussed in 3.4.10.</p> <p>ii) Views are sought on the preference of categories of capacity Market CMU captured by this proposal, please indicate your preference from the following list and reasons:</p> <ul style="list-style-type: none"> • All existing and new distribution generation CMUs • All existing and new distribution generation CMUs and DSR CMUs (proven and unproven) • All price maker CMUs • All newbuild/prospective distribution generation CMUs only (defined as >1year contracts) 	<p>No comment.</p> <p>No comment.</p>

14	<p>Do you have a view of whether implementation for the 2020/21 Triad season is sufficient to allow changes for i) supplier contracts and billing system, and ii) for other stakeholders?</p>	No comment.
----	--	-------------

Specific questions for BOTH CMP264 & CMP265

Q	Question	Response
9	<p>i) Suppliers: In setting charges for your demand customers, do you charge them at the same tariff as National Grid charges you (i.e. gross), to enable you to pay the embedded benefit to embedded generators, or please explain the way in which it is funded?</p> <p>ii) Suppliers: Does the estimate that 7.58GW of embedded generation output and 2.5GW of demand side reduction at the time of Triad for 2016/17 seem reasonable based on your knowledge of the UK market? If not what is your estimate of embedded generator output and DSR at time of Triad?</p>	<p>No comment.</p> <p>No comment.</p>
12	<p>Can you identify – either quantitatively or qualitatively - the impact of the demand TNUoS embedded benefit on your decisions made in making capacity market decisions?</p>	No comment.

Q	Question	Response
15	<p>i) What are your views on the 2 broad options to enable the reporting of gross export metered data?</p> <p>ii) Would you have the data available required for Option B (both CMP264 and CMP265) for both new contracts and existing contracts where a customer may be partially exempt?</p> <p>iii) Do you believe you can implement the proposed changes by the respective implementation dates?</p> <p>iv) What are the pros and cons of the 2 proposals that ELEXON are considering to implement this (P348 for CMP265/ P349 for CMP264)?</p>	<p>No comment.</p> <p>No comment.</p> <p>No comment.</p> <p>No comment.</p>
16	<p>Do you have any further evidence / comments on the consumer impact of changing the demand TNUoS embedded benefit in either the short-run or long-run?</p>	<p>No comment.</p>
17	<p>Do you feel that both the locational and residual component of the demand TNUoS should be removed as an embedded benefit (as CMP264 Original) or just the residual component (as CMP265 Original) or some other method?</p>	<p>Neither should be removed.</p>
19	<p>Regarding the proposed alternatives what are your views on the suggested implementation dates? Are these achievable? Please give reasons for your view.</p>	<p>No comment.</p>

CUSC Workgroup Consultation Response Proforma

CMP264 'Embedded Generation Triad Avoidance Standstill' and **CMP265** 'Gross charging of TNUoS for HH demand where Embedded Generation is in the Capacity Market'

Industry parties are invited to respond to this consultation expressing their views and supplying the rationale for those views, particularly in respect of any specific questions detailed below.

Please send your responses by **24th August 2016** to cusc.team@nationalgrid.com Please note that any responses received after the deadline or sent to a different email address may not receive due consideration by the Workgroup.

Any queries on the content of the consultation should be addressed to Caroline Wright at caroline.wright@nationalgrid.com

These responses will be considered by the Workgroup at its next meeting at which members will also consider any Workgroup Consultation Alternative Requests. Where appropriate, the Workgroup will record your response and its consideration of it within the final Workgroup Report which is submitted to the CUSC Modifications Panel.

Respondent:	<i>David Brewer</i> <i>Eye Power Station Manager</i> <i>david.brewer@epri.co.uk</i>
Company Name:	<i>EPR Eye Limited</i>
Please express your views regarding the Workgroup Consultation, including rationale. (Please include any issues, suggestions or queries)	<p>For reference, the Applicable CUSC objectives are:</p> <p>Use of System Charging Methodology</p> <p>(a) that compliance with the use of system charging methodology facilitates effective competition in the generation and supply of electricity and (so far as is consistent therewith) facilitates competition in the sale, distribution and purchase of electricity;</p> <p>(b) that compliance with the use of system charging methodology results in charges which reflect, as far as is reasonably practicable, the costs (excluding any payments between transmission licensees which are made under and in accordance with the STC) incurred by transmission licensees in their transmission businesses and which are compatible with standard condition C26 (Requirements of a connect and manage connection);</p> <p>(c) that, so far as is consistent with sub-paragraphs (a)</p>

	<p>and (b), the use of system charging methodology, as far as is reasonably practicable, properly takes account of the developments in transmission licensees' transmission businesses.</p> <p>(d) Compliance with the Electricity Regulation and any relevant legally binding decision of the European Commission and/or the Agency.</p>
--	---

Standard Workgroup consultation questions – CMP264

Q	Question	Response
1	Do you believe that the CMP264 Original Proposal better facilitates the Applicable CUSC Objectives?	No. Given the rules around allocating transmission system costs between Generation and Demand, embedded generation is effectively negative demand at GSP and should be treated as such.
2	Do you support the proposed implementation approach? Or are there any further implementation implications that need to be considered?	No. The proposal sits outside the CUSC objectives, does not address the fundamental issue of increasing transmission system costs and their allocation, and unfairly targets new embedded generators, some of whom may have included this revenue when designing their projects.
3	Do you have any other comments?	No.
4	Do you wish to raise a WG Consultation Alternative Request for the Workgroup to consider?	<i>If yes, please complete a WG Consultation Alternative Request form, available on National Grid's website¹, and return to the CUSC inbox at cusc.team@nationalgrid.com</i>

Standard Workgroup consultation questions – CMP265

Q	Question	Response
5	Do you believe that the CMP265 Original Proposal better facilitates the Applicable CUSC Objectives?	No. Given the rules around allocating transmission system costs between Generation and Demand, embedded generation is effectively negative demand at GSP and should be treated as such.

¹ http://www.nationalgrid.com/uk/Electricity/Codes/systemcode/amendments/forms_guidance/

Q	Question	Response
6	Do you support the proposed implementation approach? Or are there any further implementation implications that need to be considered?	No. The proposal sits outside the CUSC objectives, does not address the fundamental issue of increasing transmission system costs and their allocation, and unfairly targets CM embedded generators, who are likely to have included this ongoing revenue when designing their projects.
7	Do you have any other comments?	If such an amendment is appropriate in respect of CM embedded generators, it should not be applied retrospectively. it should be clear at the time of future Capacity Market auctions, it can then be reflected in the bid price.
8	Do you wish to raise a WG Consultation Alternative Request for the Workgroup to consider?	<i>If yes, please complete a WG Consultation Alternative Request form, available on National Grid's website², and return to the CUSC inbox at cusc.team@nationalgrid.com</i>

Specific questions for CMP264

Q	Question	Response
---	----------	----------

² http://www.nationalgrid.com/uk/Electricity/Codes/systemcode/amendments/forms_guidance/

Q	Question	Response
10	<p>i) Do you think a cut-off date for “new embedded generation” of 30 June 2017 is appropriate? What other date would you propose?</p> <p>ii) Do you have any views on how mixed sites are being addressed in CMP264 Original?</p> <p>iii) Do you think new-build embedded generation capacity that has entered into long term financial and performance commitment obligations via 2014 and 2015 capacity market or contracts for difference auctions (prior to this modification proposal) should be given exceptions to this cut-off date?</p> <p>iv) Do you agree that ignoring demand behind the meter is unlikely to create a significant “loophole” or material discrimination risk in relation to the CMP264 arrangements in the short term</p> <p>v) Question to suppliers: Do you consider that the wording of your existing contracts allow you to reflect the changes provided by these modifications in a cost reflective manner. For example, these changes will apply to existing PPAs and generators who significantly alter their output (EREC 59).</p> <p>vi) Do you agree with the definition of commissioned and do you agree that it is appropriate? If you do not agree with the definition or that it is appropriate please provide alternative definitions and rationale for this definition.</p>	<p>We do not agree with the change so do not comment on the selected date.</p> <p>No comment</p> <p>Yes, we do not agree with retrospective change to revenue and support mechanisms.</p> <p>No, to not include a specific category of embedded generators is discriminatory.</p> <p>No comment</p> <p>No comment</p>

Q	Question	Response
13	<p>Do you have a view of whether implementation for the 2017/18 Triad season is sufficient to allow changes for:</p> <p>i) supplier contracts and billing system; and</p> <p>ii) ii) for other stakeholders?</p>	<p>No comment, we do not agree with the change.</p>
18	<p>Do you have a view if embedded benefits are frozen at a non-zero value, what should that value be as a £/kW tariff (2016/17 value is £45.33 / kW)?</p>	<p>We do not believe that the embedded benefit should be frozen. However, if the tariffs are frozen, the value should be no less than the 2016/17 value (£45.33 per kW) as this would result in least damage to investor confidence.</p>

Specific questions for CMP265

Q	Question	Response
11	<p>i) Views are sought on the implication for mixed sites discussed in 3.4.10.</p> <p>ii) Views are sought on the preference of categories of capacity Market CMU captured by this proposal, please indicate your preference from the following list and reasons:</p> <ul style="list-style-type: none"> • All existing and new distribution generation CMUs • All existing and new distribution generation CMUs and DSR CMUs (proven and unproven) • All price maker CMUs • All newbuild/prospective distribution generation CMUs only (defined as >1year contracts) 	<p>No comment.</p> <p>No comment.</p>

14	<p>Do you have a view of whether implementation for the 2020/21 Triad season is sufficient to allow changes for i) supplier contracts and billing system, and ii) for other stakeholders?</p>	No comment.
----	--	-------------

Specific questions for BOTH CMP264 & CMP265

Q	Question	Response
9	<p>i) Suppliers: In setting charges for your demand customers, do you charge them at the same tariff as National Grid charges you (i.e. gross), to enable you to pay the embedded benefit to embedded generators, or please explain the way in which it is funded?</p> <p>ii) Suppliers: Does the estimate that 7.58GW of embedded generation output and 2.5GW of demand side reduction at the time of Triad for 2016/17 seem reasonable based on your knowledge of the UK market? If not what is your estimate of embedded generator output and DSR at time of Triad?</p>	<p>No comment.</p> <p>No comment.</p>
12	<p>Can you identify – either quantitatively or qualitatively - the impact of the demand TNUoS embedded benefit on your decisions made in making capacity market decisions?</p>	No comment.

Q	Question	Response
15	<p>i) What are your views on the 2 broad options to enable the reporting of gross export metered data?</p> <p>ii) Would you have the data available required for Option B (both CMP264 and CMP265) for both new contracts and existing contracts where a customer may be partially exempt?</p> <p>iii) Do you believe you can implement the proposed changes by the respective implementation dates?</p> <p>iv) What are the pros and cons of the 2 proposals that ELEXON are considering to implement this (P348 for CMP265/ P349 for CMP264)?</p>	<p>No comment.</p> <p>No comment.</p> <p>No comment.</p> <p>No comment.</p>
16	<p>Do you have any further evidence / comments on the consumer impact of changing the demand TNUoS embedded benefit in either the short-run or long-run?</p>	<p>No comment.</p>
17	<p>Do you feel that both the locational and residual component of the demand TNUoS should be removed as an embedded benefit (as CMP264 Original) or just the residual component (as CMP265 Original) or some other method?</p>	<p>Neither should be removed.</p>
19	<p>Regarding the proposed alternatives what are your views on the suggested implementation dates? Are these achievable? Please give reasons for your view.</p>	<p>No comment.</p>

CUSC Workgroup Consultation Response Proforma

CMP264 'Embedded Generation Triad Avoidance Standstill' and **CMP265** 'Gross charging of TNUoS for HH demand where Embedded Generation is in the Capacity Market'

Industry parties are invited to respond to this consultation expressing their views and supplying the rationale for those views, particularly in respect of any specific questions detailed below.

Please send your responses by **24th August 2016** to cusc.team@nationalgrid.com Please note that any responses received after the deadline or sent to a different email address may not receive due consideration by the Workgroup.

Any queries on the content of the consultation should be addressed to Caroline Wright at caroline.wright@nationalgrid.com

These responses will be considered by the Workgroup at its next meeting at which members will also consider any Workgroup Consultation Alternative Requests. Where appropriate, the Workgroup will record your response and its consideration of it within the final Workgroup Report which is submitted to the CUSC Modifications Panel.

Respondent:	<i>Barry Cowen Glanford Power Station Manager barry.cowen@epri.co.uk</i>
Company Name:	<i>EPR Glanford Limited</i>
Please express your views regarding the Workgroup Consultation, including rationale. (Please include any issues, suggestions or queries)	<p>For reference, the Applicable CUSC objectives are:</p> <p>Use of System Charging Methodology</p> <p>(a) that compliance with the use of system charging methodology facilitates effective competition in the generation and supply of electricity and (so far as is consistent therewith) facilitates competition in the sale, distribution and purchase of electricity;</p> <p>(b) that compliance with the use of system charging methodology results in charges which reflect, as far as is reasonably practicable, the costs (excluding any payments between transmission licensees which are made under and in accordance with the STC) incurred by transmission licensees in their transmission businesses and which are compatible with standard condition C26 (Requirements of a connect and manage connection);</p> <p>(c) that, so far as is consistent with sub-paragraphs (a)</p>

	<p>and (b), the use of system charging methodology, as far as is reasonably practicable, properly takes account of the developments in transmission licensees' transmission businesses.</p> <p>(d) Compliance with the Electricity Regulation and any relevant legally binding decision of the European Commission and/or the Agency.</p>
--	---

Standard Workgroup consultation questions – CMP264

Q	Question	Response
1	Do you believe that the CMP264 Original Proposal better facilitates the Applicable CUSC Objectives?	No. Given the rules around allocating transmission system costs between Generation and Demand, embedded generation is effectively negative demand at GSP and should be treated as such.
2	Do you support the proposed implementation approach? Or are there any further implementation implications that need to be considered?	No. The proposal sits outside the CUSC objectives, does not address the fundamental issue of increasing transmission system costs and their allocation, and unfairly targets new embedded generators, some of whom may have included this revenue when designing their projects.
3	Do you have any other comments?	No.
4	Do you wish to raise a WG Consultation Alternative Request for the Workgroup to consider?	<i>If yes, please complete a WG Consultation Alternative Request form, available on National Grid's website¹, and return to the CUSC inbox at cusc.team@nationalgrid.com</i>

Standard Workgroup consultation questions – CMP265

Q	Question	Response
5	Do you believe that the CMP265 Original Proposal better facilitates the Applicable CUSC Objectives?	No. Given the rules around allocating transmission system costs between Generation and Demand, embedded generation is effectively negative demand at GSP and should be treated as such.

¹ http://www.nationalgrid.com/uk/Electricity/Codes/systemcode/amendments/forms_guidance/

Q	Question	Response
6	Do you support the proposed implementation approach? Or are there any further implementation implications that need to be considered?	No. The proposal sits outside the CUSC objectives, does not address the fundamental issue of increasing transmission system costs and their allocation, and unfairly targets CM embedded generators, who are likely to have included this ongoing revenue when designing their projects.
7	Do you have any other comments?	If such an amendment is appropriate in respect of CM embedded generators, it should not be applied retrospectively. it should be clear at the time of future Capacity Market auctions, it can then be reflected in the bid price.
8	Do you wish to raise a WG Consultation Alternative Request for the Workgroup to consider?	<i>If yes, please complete a WG Consultation Alternative Request form, available on National Grid's website², and return to the CUSC inbox at cusc.team@nationalgrid.com</i>

Specific questions for CMP264

Q	Question	Response
---	----------	----------

² http://www.nationalgrid.com/uk/Electricity/Codes/systemcode/amendments/forms_guidance/

Q	Question	Response
10	<p>i) Do you think a cut-off date for “new embedded generation” of 30 June 2017 is appropriate? What other date would you propose?</p> <p>ii) Do you have any views on how mixed sites are being addressed in CMP264 Original?</p> <p>iii) Do you think new-build embedded generation capacity that has entered into long term financial and performance commitment obligations via 2014 and 2015 capacity market or contracts for difference auctions (prior to this modification proposal) should be given exceptions to this cut-off date?</p> <p>iv) Do you agree that ignoring demand behind the meter is unlikely to create a significant “loophole” or material discrimination risk in relation to the CMP264 arrangements in the short term</p> <p>v) Question to suppliers: Do you consider that the wording of your existing contracts allow you to reflect the changes provided by these modifications in a cost reflective manner. For example, these changes will apply to existing PPAs and generators who significantly alter their output (EREC 59).</p> <p>vi) Do you agree with the definition of commissioned and do you agree that it is appropriate? If you do not agree with the definition or that it is appropriate please provide alternative definitions and rationale for this definition.</p>	<p>We do not agree with the change so do not comment on the selected date.</p> <p>No comment</p> <p>Yes, we do not agree with retrospective change to revenue and support mechanisms.</p> <p>No, to not include a specific category of embedded generators is discriminatory.</p> <p>No comment</p> <p>No comment</p>

Q	Question	Response
13	<p>Do you have a view of whether implementation for the 2017/18 Triad season is sufficient to allow changes for:</p> <p>i) supplier contracts and billing system; and</p> <p>ii) ii) for other stakeholders?</p>	No comment, we do not agree with the change.
18	<p>Do you have a view if embedded benefits are frozen at a non-zero value, what should that value be as a £/kW tariff (2016/17 value is £45.33 / kW)?</p>	We do not believe that the embedded benefit should be frozen. However, if the tariffs are frozen, the value should be no less than the 2016/17 value (£45.33 per kW) as this would result in least damage to investor confidence.

Specific questions for CMP265

Q	Question	Response
11	<p>i) Views are sought on the implication for mixed sites discussed in 3.4.10.</p> <p>ii) Views are sought on the preference of categories of capacity Market CMU captured by this proposal, please indicate your preference from the following list and reasons:</p> <ul style="list-style-type: none"> • All existing and new distribution generation CMUs • All existing and new distribution generation CMUs and DSR CMUs (proven and unproven) • All price maker CMUs • All newbuild/prospective distribution generation CMUs only (defined as >1year contracts) 	<p>No comment.</p> <p>No comment.</p>

14	<p>Do you have a view of whether implementation for the 2020/21 Triad season is sufficient to allow changes for i) supplier contracts and billing system, and ii) for other stakeholders?</p>	No comment.
----	--	-------------

Specific questions for BOTH CMP264 & CMP265

Q	Question	Response
9	<p>i) Suppliers: In setting charges for your demand customers, do you charge them at the same tariff as National Grid charges you (i.e. gross), to enable you to pay the embedded benefit to embedded generators, or please explain the way in which it is funded?</p> <p>ii) Suppliers: Does the estimate that 7.58GW of embedded generation output and 2.5GW of demand side reduction at the time of Triad for 2016/17 seem reasonable based on your knowledge of the UK market? If not what is your estimate of embedded generator output and DSR at time of Triad?</p>	<p>No comment.</p> <p>No comment.</p>
12	<p>Can you identify – either quantitatively or qualitatively - the impact of the demand TNUoS embedded benefit on your decisions made in making capacity market decisions?</p>	No comment.

Q	Question	Response
15	<p>i) What are your views on the 2 broad options to enable the reporting of gross export metered data?</p> <p>ii) Would you have the data available required for Option B (both CMP264 and CMP265) for both new contracts and existing contracts where a customer may be partially exempt?</p> <p>iii) Do you believe you can implement the proposed changes by the respective implementation dates?</p> <p>iv) What are the pros and cons of the 2 proposals that ELEXON are considering to implement this (P348 for CMP265/ P349 for CMP264)?</p>	<p>No comment.</p> <p>No comment.</p> <p>No comment.</p> <p>No comment.</p>
16	<p>Do you have any further evidence / comments on the consumer impact of changing the demand TNUoS embedded benefit in either the short-run or long-run?</p>	<p>No comment.</p>
17	<p>Do you feel that both the locational and residual component of the demand TNUoS should be removed as an embedded benefit (as CMP264 Original) or just the residual component (as CMP265 Original) or some other method?</p>	<p>Neither should be removed.</p>
19	<p>Regarding the proposed alternatives what are your views on the suggested implementation dates? Are these achievable? Please give reasons for your view.</p>	<p>No comment.</p>

CUSC Workgroup Consultation Response Proforma

CMP264 'Embedded Generation Triad Avoidance Standstill' and **CMP265** 'Gross charging of TNUoS for HH demand where Embedded Generation is in the Capacity Market'

Industry parties are invited to respond to this consultation expressing their views and supplying the rationale for those views, particularly in respect of any specific questions detailed below.

Please send your responses by **24th August 2016** to cusc.team@nationalgrid.com Please note that any responses received after the deadline or sent to a different email address may not receive due consideration by the Workgroup.

Any queries on the content of the consultation should be addressed to Caroline Wright at caroline.wright@nationalgrid.com

These responses will be considered by the Workgroup at its next meeting at which members will also consider any Workgroup Consultation Alternative Requests. Where appropriate, the Workgroup will record your response and its consideration of it within the final Workgroup Report which is submitted to the CUSC Modifications Panel.

Respondent:	Tom Steward, Wholesale Regulatory Officer Tom.Steward@goodenergy.co.uk
Company Name:	Good Energy
Please express your views regarding the Workgroup Consultation, including rationale. (Please include any issues, suggestions or queries)	<p>For reference, the Applicable CUSC objectives are:</p> <p>Use of System Charging Methodology</p> <p>(a) that compliance with the use of system charging methodology facilitates effective competition in the generation and supply of electricity and (so far as is consistent therewith) facilitates competition in the sale, distribution and purchase of electricity;</p> <p>(b) that compliance with the use of system charging methodology results in charges which reflect, as far as is reasonably practicable, the costs (excluding any payments between transmission licensees which are made under and in accordance with the STC) incurred by transmission licensees in their transmission businesses and which are compatible with standard condition C26 (Requirements of a connect and manage connection);</p> <p>(c) that, so far as is consistent with sub-paragraphs (a) and (b), the use of system charging methodology, as far as is reasonably practicable, properly takes account of</p>

	<p>the developments in transmission licensees' transmission businesses.</p> <p>(d) Compliance with the Electricity Regulation and any relevant legally binding decision of the European Commission and/or the Agency.</p>
--	---

Standard Workgroup consultation questions – CMP264

Q	Question	Response
1	<p>Do you believe that the CMP264 Original Proposal better facilitates the Applicable CUSC Objectives?</p>	<p>A – It is evident that CMP264 undermines objective A of the CUSC.</p> <ul style="list-style-type: none"> - It is clear that CMP264 risks undermining investor confidence, leading to decreased competition in the generation market in addition to increasing cost of capital for investors. - CMP264 also introduces perverse incentives encouraging economically inefficient investment in private distribution networks to create behind-the-meter arrangements. Such generators generally do not participate in the wholesale market. This could lead to reduced numbers of participants in the wholesale market, leading to a reduction in both competition and market liquidity. - This is also likely to significantly increase barriers to entry to the smaller generation market, again reducing competition going forward. <p>(B) It is evident that CMP264 undermines objective B of the CUSC.</p> <ul style="list-style-type: none"> - The commissioning date of a generation facility has little or no impact on the costs or benefits it brings to the transmission system. It is therefore inappropriate to discriminate by commissioning date in the way set out in CMP264. - CMP264 also frames new embedded generation as offering no benefit in terms of cost saving to the transmission network – this is clearly not the case. <p>(C) It is clear that CMP264 is not supportive of objective C of the CUSC.</p> <ul style="list-style-type: none"> - As outlined in the proposal documentation this change may lead to significant systems and procedural change for National Grid. Should Ofgem's final decision on the future of the TNUoS charging regime not align with CMP264, there are likely then to be significant abortive costs to be borne by the industry.

Q	Question	Response
2	Do you support the proposed implementation approach? Or are there any further implementation implications that need to be considered?	<p>The short timescale proposed for implementation of CMP264 would be highly disruptive for PPA negotiations which are already in progress. The timescale could also introduce significant risk to any projects for which significant investment commitment has already been made, but which may not be commissioned by 30th June 2017.</p> <p>Implementation of CMP264 is also likely to lead to significant administrative and cost burdens relating to mixed sites, both in the immediate and longer term.</p>
3	Do you have any other comments?	<p>Introduction of a modification such as CMP264, ahead of OFGEM's final decision on the future of embedded benefits, could lead to the introduction of changes which are not consistent with OFGEM's final viewpoint. This risks leading industry participants to incur significant abortive costs. Additionally, introduction of interim measures such as CMP264 risks reducing the pressure on OFGEM to implement a lasting solution in a timely fashion.</p>
4	Do you wish to raise a WG Consultation Alternative Request for the Workgroup to consider?	<p>We do not wish to introduce an alternative modification at this time.</p>

Standard Workgroup consultation questions – CMP265

Q	Question	Response
---	----------	----------

Q	Question	Response
5	<p>Do you believe that the CMP265 Original Proposal better facilitates the Applicable CUSC Objectives?</p>	<p>(A) It is evident that CMP265 undermines objective A of the CUSC.</p> <ul style="list-style-type: none"> - It is clear that CMP265 risks undermining investor confidence, leading to decreased competition in the generation market in addition to increasing cost of capital for investors. - Removal of embedded benefits for Capacity Market participants is likely to lead to a number of generators not participating in the Capacity Market auction – leading to a reduced level of competition in the auction. <p>(B) It is clear that CMP265 undermines objective B of the CUSC.</p> <ul style="list-style-type: none"> - The holding of a Capacity Market (CM) contract has no impact on the costs or benefits that a generator brings to the transmission system. It is therefore inappropriate to discriminate between generators in this way. - CMP265 also frames embedded generation with CM contracts as offering no benefit in terms of cost saving to the transmission network – this is clearly not the case, and therefore such a modification would not be cost reflective. <p>(C) It is evident that CMP265 is not supportive of objective C of the CUSC.</p> <ul style="list-style-type: none"> - Any changes that are made which are not consistent with OFGEM's final decision on the future of the TNUoS charging regime risk leading to industry participants facing significant abortive costs.
6	<p>Do you support the proposed implementation approach? Or are there any further implementation implications that need to be considered?</p>	<p>As a 100% renewable energy supplier, none of our generators currently participate in the Capacity Market. We therefore have no view on implementation of CMP265 at this time.</p>
7	<p>Do you have any other comments?</p>	<p>Introduction of a modification such as CMP265, ahead of OFGEM's final decision on the future of embedded benefits, could lead to the introduction of changes which are not consistent with OFGEM's final viewpoint. This risks leading industry participants to incur significant abortive costs. Additionally, introduction of interim measures such as CMP265 risks reducing the pressure on OFGEM to implement a lasting solution in a timely fashion.</p>

Q	Question	Response
8	<p>Do you wish to raise a WG Consultation Alternative Request for the Workgroup to consider?</p>	<p>We do not wish to introduce an alternative modification at this time.</p>

Specific questions for CMP264

Q	Question	Response
---	----------	----------

Q	Question	Response
10	<p>i) Do you think a cut-off date for “new embedded generation” of 30 June 2017 is appropriate? What other date would you propose?</p> <p>ii) Do you have any views on how mixed sites are being addressed in CMP264 Original?</p> <p>iii) Do you think new-build embedded generation capacity that has entered into long term financial and performance commitment obligations via 2014 and 2015 capacity market or contracts for difference auctions (prior to this modification proposal) should be given exceptions to this cut-off date?</p> <p>iv) Do you agree that ignoring demand behind the meter is unlikely to create a significant “loophole” or material discrimination risk in relation to the CMP264 arrangements in the short term</p> <p>v) Question to suppliers: Do you consider that the wording of your existing contracts allow you to reflect the changes provided by these modifications in a cost reflective manner. For example, these changes will apply to existing PPAs and generators who significantly alter their output (EREC 59).</p>	<p>i) The short timescale proposed for implementation would be highly disruptive for PPA negotiations which are already in progress. The timescale could also introduce significant risk to any projects for which significant investment commitment has already been made, but which may not be commissioned by 30th June 2017.</p> <p>ii) CMP264 is also likely to lead to significant administrative and cost burdens relating to mixed sites, both in the immediate and longer term.</p> <p>iii) Whilst generators with capacity market or CfD contracts should be exempted from any modification proposal changes, it is important to note that these are not the only forms of long-term contract that generators may have entered into which would be affected by CMP264. Therefore any changes to embedded benefits must take consideration of the long timescales over which contracts are set.</p> <p>iv) It is not viable to use the CUSC to affect changes on behind-the-meter generation.</p> <p>v) No - A number of our generators are locked into contracts whose value was set on the assumption that triad would remain at current levels.</p>

Q	Question	Response
10	<p>vi) Do you agree with the definition of commissioned and do you agree that it is appropriate? If you do not agree with the definition or that it is appropriate please provide alternative definitions and rationale for this definition.</p>	<p>vi) We have concerns regarding the current definition of commissioning. It is not clear that there are absolutely no circumstances under which a new G59 could be required for an already operating site, incorrectly classifying it as a new site.</p>
13	<p>Do you have a view of whether implementation for the 2017/18 Triad season is sufficient to allow changes for:</p> <p>i) supplier contracts and billing system; and</p> <p>ii) ii) for other stakeholders?</p>	<p>i) This time period is not sufficient to allow changes to take place - a number of our generators are locked into contracts whose value was set on the assumption that triad would remain at current levels.</p> <p>ii) We are not in a position to comment on impacts for other stakeholders.</p>
18	<p>Do you have a view if embedded benefits are frozen at a non-zero value, what should that value be as a £/kW tariff (2016/17 value is £45.33 / kW)?</p>	<p>Embedded benefits should be frozen at current levels of £45.33 in order to protect investor confidence in the sector. Any revenue shortfall from future years could be reversed through a kWh charge, levied over the 4-7pm period across the entire year – as with Non-half hourly customers.</p>

Specific questions for CMP265

Q	Question	Response
---	----------	----------

11	<p>i) Views are sought on the implication for mixed sites discussed in 3.4.10.</p> <p>ii) Views are sought on the preference of categories of capacity Market CMU captured by this proposal, please indicate your preference from the following list and reasons:</p> <ul style="list-style-type: none"> • All existing and new distribution generation CMUs • All existing and new distribution generation CMUs and DSR CMUs (proven and unproven) • All price maker CMUs • All newbuild/prospective distribution generation CMUs only (defined as >1year contracts) 	<p>As a 100% renewable energy supplier, none of our generators currently participate in the Capacity Market. We therefore have no view on these issues at this time.</p>
14	<p>Do you have a view of whether implementation for the 2020/21 Triad season is sufficient to allow changes for i) supplier contracts and billing system, and ii) for other stakeholders?</p>	<p>i) As a 100% renewable energy supplier, none of our generators currently participate in the Capacity Market. We therefore have no view on implementation of CMP265 at this time</p> <p>ii) We are not in a position to comment on impacts for other stakeholders.</p>

Specific questions for BOTH CMP264 & CMP265

Q	Question	Response
---	----------	----------

Q	Question	Response
9	<p>i) Suppliers: In setting charges for your demand customers, do you charge them at the same tariff as National Grid charges you (i.e. gross), to enable you to pay the embedded benefit to embedded generators, or please explain the way in which it is funded?</p> <p>ii) Suppliers: Does the estimate that 7.58GW of embedded generation output and 2.5GW of demand side reduction at the time of Triad for 2016/17 seem reasonable based on your knowledge of the UK market? If not what is your estimate of embedded generator output and DSR at time of Triad?</p>	<p>i) Yes, in setting charges for our demand customers we recover transmission use of system charges at the same level as National Grid charges.</p> <p>ii) We do not have access to the relevant data to assess the accuracy of these estimates.</p>
12	<p>Can you identify – either quantitatively or qualitatively - the impact of the demand TNUoS embedded benefit on your decisions made in making capacity market decisions?</p>	<p>As a supplier of 100% renewable electricity, none of the generators with whom we are contracted, or have any other commercial interest, are currently eligible to participate in the Capacity Market.</p>

Q	Question	Response
15	<p>i) What are your views on the 2 broad options to enable the reporting of gross export metered data?</p> <p>ii) Would you have the data available required for Option B (both CMP264 and CMP265) for both new contracts and existing contracts where a customer may be partially exempt?</p> <p>iii) Do you believe you can implement the proposed changes by the respective implementation dates?</p> <p>iv) What are the pros and cons of the 2 proposals that ELEXON are considering to implement this (P348 for CMP265/ P349 for CMP264)?</p>	<p>i) Of the two proposed options, we strongly favour option A. This is because option B places significant onus on suppliers to obtain and collate the data – this burden is likely to be significant for small suppliers, particularly those which contract with large numbers of embedded generators.</p> <p>ii) No – under present arrangements we would not have access to the data required for Option B. Obtaining this data for each site would be likely to come at a significant cost relative to the value of the triad.</p> <p>iii) No – given the short timescale of implementation, it is unlikely we could make all the required changes for CMP264. This is particularly the case for mixed sites.</p> <p>iv) We will be reviewing P348 and P349 in time, and will engage with the modifications directly as appropriate.</p>
16	<p>Do you have any further evidence / comments on the consumer impact of changing the demand TNUoS embedded benefit in either the short-run or long-run?</p>	<p>The recent report from Cornwall Energy on embedded benefits estimates the appropriate level of Triad benefit as £32.30/kW for 2015/16, taking account of both short term and long term cost benefits. It is essential that any changes to embedded benefits do not undermine investor confidence in the industry – this is particularly important given the energy security implications of falling levels of de-rated margin.</p>
17	<p>Do you feel that both the locational and residual component of the demand TNUoS should be removed as an embedded benefit (as CMP264 Original) or just the residual component (as CMP265 Original) or some other method?</p>	<p>For reasons set out above, it would not be appropriate to remove either the locational or residual elements of TNUoS benefit. However, it should be highlighted that there is absolutely no sound economic justification for the removal of the locational element.</p>

Q	Question	Response
19	Regarding the proposed alternatives what are your views on the suggested implementation dates? Are these achievable? Please give reasons for your view.	As set out above, implementing any significant changes as set out here by June 2017 would be highly disruptive for PPA negotiations which are already in progress. This timescale could also introduce substantial risk to any projects for which significant investment commitment has already been made, but which may not be commissioned by 30th June 2017.

CUSC Workgroup Consultation Response Proforma

CMP264 'Embedded Generation Triad Avoidance Standstill' and **CMP265** 'Gross charging of TNUoS for HH demand where Embedded Generation is in the Capacity Market'

Industry parties are invited to respond to this consultation expressing their views and supplying the rationale for those views, particularly in respect of any specific questions detailed below.

Please send your responses by **24th August 2016** to cusc.team@nationalgrid.com Please note that any responses received after the deadline or sent to a different email address may not receive due consideration by the Workgroup.

Any queries on the content of the consultation should be addressed to Caroline Wright at caroline.wright@nationalgrid.com

These responses will be considered by the Workgroup at its next meeting at which members will also consider any Workgroup Consultation Alternative Requests. Where appropriate, the Workgroup will record your response and its consideration of it within the final Workgroup Report which is submitted to the CUSC Modifications Panel.

Respondent:	<i>Graz Macdonald</i>
Company Name:	<i>Green Frog Power</i>
<p>Please express your views regarding the Workgroup Consultation, including rationale.</p> <p>(Please include any issues, suggestions or queries)</p>	<p>For reference, the Applicable CUSC objectives are:</p> <p style="text-align: center;">Use of System Charging Methodology</p> <p>(a) that compliance with the use of system charging methodology facilitates effective competition in the generation and supply of electricity and (so far as is consistent therewith) facilitates competition in the sale, distribution and purchase of electricity;</p> <p>(b) that compliance with the use of system charging methodology results in charges which reflect, as far as is reasonably practicable, the costs (excluding any payments between transmission licensees which are made under and in accordance with the STC) incurred by transmission licensees in their transmission businesses and which are compatible with standard condition C26 (Requirements of a connect and manage connection);</p> <p>(c) that, so far as is consistent with sub-paragraphs (a) and (b), the use of system charging methodology, as far as is reasonably practicable, properly takes account of the developments in transmission licensees' transmission businesses.</p> <p>(d) Compliance with the Electricity Regulation and any relevant legally binding decision of the European Commission and/or the Agency.</p>

Q	Question	Response
---	----------	----------

Q	Question	Response
1	<p>Do you believe that the CM P264 Original Proposal better facilitates the Application of CUSC Objectives?</p>	<p>Green Frog Power do not believe that the current system charging methodology properly takes account of the developments in transmission licensees' transmission businesses. There have been vast sums of money invested in transmission assets far removed from demand, despite the application of locational price signals, indicating that the locational signals are not sufficient to dissuade generation from locating far from demand. This is, of course, largely due to renewables projects located in offshore and/or in Scotland. Because the locational signals are not sufficiently high to dissuade these generation investments, the cost of the resulting transmission investment is being smeared across all transmission network users.</p> <p>Whereas this has always been an underlying issue in charging methodology, it is the excessive costs of connecting these faraway generation assets that brings the matter into the stark light.</p> <p>To the extent that this underlying problem results by a chain reaction into ever increasing payments to embedded generators, we agree that this is problematic. We think that the current methodology should be changed to reflect better the impacts of these spiralling costs.</p> <p>We do not believe that CMP264 or CMP265 better facilitates the remaining CUSC objectives. The original intent of embedded "benefits" was to excluded embedded parties from exposure to the costs of a system that they do not use. CMP264 and CMP265 each propose to charge some, but not others, recipients of embedded benefits for the cost of the transmission system that they do not use.</p> <p>Some parties who use the transmission system would be charged and others would not. Some generators who do not use the transmission system would be charged at the same rate as generators that do use the system. Amongst generators that do not use the system, they'd be distinguished between each other on the basis of an arbitrary cut-off date for first commissioning, or by virtue of having specific contractual arrangements (Capacity Market agreements). This is very clear discrimination.</p> <p>Either of these proposals would clearly create distortions that wou grow in significance if the underlying size of the residual TNUoS were not addressed in the first instance. We fail to see that an arbitrary distinction and discrimination against certain parties better facilitates the CUSC objectives and, in fact, both proposals, as they stand would cause a worsening situation compared to the CUSC objectives.</p> <p>Moreover, the attempt to increase the costs of competitors' generation through charging them for the use of assets they do not in fact use is, at its heart, fundamentally absurd. A better approach would be to address the issue of spiralling residual costs through a full, top-to-bottom SCR.</p> <p>There has been a notable lack of evidence provided to support the proposers' claims that the current system leads to inefficient dispatch or to the inefficient closure of transmission connected generators, so we are unable to comment on whether the proposal better facilitates CUSC objectives in these regards.</p>

Q	Question	Response
2	<p>Do you support the proposed implementation approach? Or are there any further implementation implications that need to be considered?</p>	<p>Green Frog Power believe that the proposed implementation is overly complicated, discriminatory, and does not address the underlying issue of spiralling transmission costs and the consequent spiralling embedded benefits.</p> <p>We are also concerned that the Mods fail to address effectively behind-the-meter generation and DSR providers. If the fundamental way in which the transmission residual is collected is not addressed, the spiralling value will cause increasing distortions. This will result in yet another review and further dragging out of the uncertainty in an already inhospitable investment environment created by the proposed change.</p> <p>Serious consideration needs to be given as to how the system will react to a relatively sudden change to triads and to the ensuing adjustments to embedded generators' behaviour. Triads enable the provision of a valuable service – reduction of peak transmitted demand. If triads are reduced or eliminated (as proposed), consideration must be taken of the impact on security of supply and on peak prices for consumers.</p> <p>Though these issues have been raised regularly through the workgroup meetings, the timetable did not permit a thorough impact study. Triads have been an integral part of the power system for decades – changing them without thoroughly reviewing the impact on consumers would be short-sighted.</p> <p>As well as a lack of analysis of the impact on security of supply and on consumers' costs, there has not been sufficient time to conduct a thorough system-wide study of the value of embedded generation to the system –in other words, what the cost-reflective value should be that embedded generators receive. Scottish Power have honed in on a number of ~£1.60/kW, identified in a cursory study by National Grid some years ago. In contrast, Cornwall Energy have identified, in their own more recent study, that ~£32/kW was the appropriate cost-reflective level. The workgroup had no time to consider the methodology underpinning these studies nor to propose or conduct additional studies. Nonetheless, we note that £32 is the level closest to that which has endured over recent history and which has had the desired impact on security of supply (i.e. keeping the lights on during winter peaks).</p>

Q	Question	Response
3	<p>Do you have any other comments?</p>	<p>CMP264 was proposed as a temporary, interim solution, as it was envisioned that Ofgem would be conducting a full SCR. Ofgem has since announced that they will not be doing so.</p> <p>We reiterate our view that an SCR is required to address the issue of the TNUoS residual and embedded benefits appropriately and in a manner that will ensure we are not all back together in a similar workgroup in six or twelve months.</p> <p>Since CMP264 was intended to be a temporary fix, we do not feel it remains a valid proposal. The cut-off date (1 June 2017) and the impact on generators that have gained a CM agreement for 2018/19 or 2019/20 in previous CM auctions needs to be very carefully considered.</p> <p>The best approach would be to apply a fixed or capped level of triads, at this winter's level for example, to all embedded generators. This would be a compromise solution that would endure through an SCR process, or indeed without one, providing stability and consistency to the market and to investors. This would still leave the significant issue of distortions between the rewards for different types of parties whose actions, in different ways, both reduce transmission demand. Nonetheless it would be acceptable for an interim solution.</p>
4	<p>Do you wish to raise a WG Consultation Alternative Request for the Workgroup to consider?</p>	<p><i>If yes, please complete a WG Consultation Alternative Request form, available on National Grid's website¹, and return to the CUSC inbox at cusc.team@nationalgrid.com</i></p>

¹ http://www.nationalgrid.com/uk/Electricity/Codes/systemcode/amendments/forms_guidance/

Standard Workgroup consultation questions – CMP265

Q	Question	Response
5	Do you believe that the CMP265 Original Proposal better facilitates the Applicable CUSC Objectives?	No. Our response to the same question for CMP264 holds for CMP265, except that this proposal runs the significantly increased risk of causing embedded generators with long-term capacity agreements to have to walk away from their CM agreements with their assets unbuilt. With a significant income stream removed for 13-14 years of a 15-year agreement, many (new) market participants already feel that they have been let down by the Regulator for even entertaining the notion.
6	Do you support the proposed implementation approach? Or are there any further implementation implications that need to be considered?	No. Green Frog Power believe that CMP265 has the same issues as CMP264 in terms of maintaining spiralling embedded benefits for a select group of market participants, in addition to the issues of potential distortion caused by largely ignoring the issue of behind-the-meter generation and DSR continuing to receive those spiralling benefits.
7	Do you have any other comments?	N/A
8	Do you wish to raise a WG Consultation Alternative Request for the Workgroup to consider?	<i>If yes, please complete a WG Consultation Alternative Request form, available on National Grid's website², and return to the CUSC inbox at cusc.team@nationalgrid.com</i>

Specific questions for CMP264

Q	Question	Response
---	----------	----------

² http://www.nationalgrid.com/uk/Electricity/Codes/systemcode/amendments/forms_guidance/

Q	Question	Response
10	<p>i) Do you think a cut-off date for “new embedded generation” of 30 June 2017 is appropriate? What other date would you propose?</p> <p>ii) Do you have any views on how mixed sites are being addressed in CMP264 Original?</p> <p>iii) Do you think new-build embedded generation capacity that has entered into long term financial and performance commitment obligations via 2014 and 2015 capacity market or contracts for difference auctions (prior to this modification proposal) should be given exceptions to this cut-off date?</p> <p>iv) Do you agree that ignoring demand behind the meter is unlikely to create a significant “loophole” or material discrimination risk in relation to the CMP264 arrangements in the short term</p> <p>v) Question to suppliers: Do you consider that the wording of your existing contracts allow you to reflect the changes provided by these modifications in a cost reflective manner. For example, these changes will apply to existing PPAs and generators who significantly alter their output (EREC 59).</p> <p>vi) Do you agree with the definition of commissioned and do you agree that it is appropriate? If you do not agree with the definition or that it is appropriate please provide alternative definitions and rationale for this definition.</p>	<p>i) Subject to concerns noted above, we think that the June 2017 cut-off date is as random and inappropriate as any other. It is likely to result in significant financial harm to some parties, all of them smaller market participants, and will, overall, benefit larger market players with a proportionately larger market presence. Choosing a later date would mitigate some of the obvious damage this Mod will cause.</p> <p>ii) No comment</p> <p>iii) We agree that embedded generation capacity that has already been awarded a capacity market contract should be provided exceptions to this cut-off date. They have invested in good faith on the basis of trust in the policy makers, the regulator and trust in the broad endurance of a sensible long-term system.</p> <p>iv) We do believe that ignoring the effects of spiralling benefits to other market participants will provide an obvious loophole and clear and financially material discrimination, in addition to the discrimination between those who hit the deadline and those who do not.</p> <p>v) N/A</p> <p>vi) The definition is fine although the idea is not.</p>

Q	Question	Response
13	<p>Do you have a view of whether implementation for the 2017/18 Triad season is sufficient to allow changes for:</p> <p>i) supplier contracts and billing system; and</p> <p>ii) ii) for other stakeholders?</p>	Please see response to question 16.
18	<p>Do you have a view if embedded benefits are frozen at a non-zero value, what should that value be as a £/kW tariff (2016/17 value is £45.33 / kW)?</p>	<p>We think that the triad value should be frozen at current levels while Ofgem conducts a thorough top-to-bottom SCR. For the reasons outlined in question 1, we believe that there are some flaws underpinning the charging methodology and the current proposed solutions are merely a plaster on a gaping wound. If the underlying issue of how to charge for those spiralling transmission costs is not effectively addressed in the reasonably near term, then we shall be back having these same discussions, but about other new distortions. If the wound is not adequately attended to, we shall have failed to have taken the opportunity to have created a sustained and healthy investment climate. This applies to all market participants, not just embedded generators.</p>

Q	Question	Response
11	<p>i) Views are sought on the implication for mixed sites discussed in 3.4.10.</p> <p>ii) Views are sought on the preference of categories of capacity Market CMU captured by this proposal, please indicate your preference from the following list and reasons:</p> <ul style="list-style-type: none"> • All existing and new distribution generation CMUs • All existing and new distribution generation CMUs and DSR CMUs (proven and unproven) • All price maker CMUs • All newbuild/prospective distribution generation CMUs only (defined as >1year contracts) 	<p>i) N/A</p> <p>ii) CMP265 is unacceptably discriminatory. It is specifically designed to undermine the income of the proposers' competition in the Capacity Market, but conveniently maintains the income stream for embedded generation interests within its own renewables portfolio.</p> <p>Keeping in mind the desire to reduce the discrimination caused by this proposal, we feel that this mod is totally inappropriate, but if it is implemented, it should be applied to all existing and new embedded generation and DSR CMUs.</p>
14	<p>Do you have a view of whether implementation for the 2020/21 Triad season is sufficient to allow changes for i) supplier contracts and billing system, and ii) for other stakeholders?</p>	N/A

Q	Question	Response
---	----------	----------

Q	Question	Response
9	<p data-bbox="201 170 408 1653">i) Suppliers: In setting charges for your demand customers, do you charge them at the same tariff as National Grid charges you (i.e. gross), to enable you to pay the embedded benefit to embedded generators, or please explain the way in which it is funded ?</p> <p data-bbox="201 1675 408 2237">ii) Suppliers: Does the estimate that 7.58GW of embedded generation output and 2.5GW of demand</p>	N/A

Q	Question	Response
12	Can you identify – either quantitatively or qualitatively - the impact of the demand TNUoS embedded benefit on your decisions made in making capacity market decisions?	The most important factor is a fair and stable regime. If financiers and investors do not feel that the regime is reliable then it is not fit for purpose. It is therefore important to ensure that a thorough review of the charging regime is undertaken.

Q	Question	Response
15	<p data-bbox="204 174 405 779">i) What are your views on the 2 broad options to enable the reporting of gross export metered data?</p> <p data-bbox="204 835 405 1973">ii) Would you have the data available required for Option B (both CMP26 4 and CMP26 5) for both new contracts and existing contracts where a customer may be partially exempt?</p> <p data-bbox="204 2000 405 2228">iii) Do you believe you can implement the</p>	N/A

Q	Question	Response
16	<p>Do you have any further evidence / comments on the consumer impact of changing the demand TNUoS embedded benefit in either the short-run or long-run?</p>	<p>In the short-term we believe there will be significant problems with security of supply and ensuing price increases in level and volatility. We provide a report published by the highly respected energy-market analysts Enappsys, in which they calculate the extent of the impact on system costs in the event of a reduction or removal of triads. If just 10-20 per cent of embedded generation chooses to remain idle through peaks, there will be a very significant impact on security of supply. Very likely the proportion will be higher.</p> <p>It is not in the interest of the consumer to eliminate triads. Though not perfect, it has been effective for many years. If the spiralling of pricing is mitigated, the system could successfully endure for another four decades.</p> <p>In the absence of triads, the market access to small generators would need to improve significantly. Brave souls can of course operate in the BM or day-ahead market, and they can hope to monetise the value of their fast and flexible peaks in those limited sectors. But removing triads takes a very important risk-management tool away from the market. Suppliers and small generators are able to hedge winter peaks well in advance of delivery using triads as the tool to engage with each other and, in effect, lock in value. These products are not (yet) tradable otherwise, and removing triads increases the risk exposure for any parties who are unable to forward hedge because they are not large enough or not vertically integrated. This provides an unfair advantage to larger players (generators and suppliers) and increases the overall risk profile of the electricity market and impacts competition – which will have an adverse impact on consumers.</p> <p>Secure and Promote is not ready to address these issues, as the focus is not yet on the appropriate products. We think Ofgem should reconsider the scope of Secure and Promote when making a decision about undertaking an SCR and approving the final CUSC-modification proposal.</p> <p>There have not been any studies of the additional network costs at both the transmission and distribution levels if embedded generation does not generate at peaks. This is clearly a fundamental question that must be addressed before any full and enduring solution is decided upon, ideally in an SCR.</p>

Q	Question	Response
17	<p>Do you feel that both the locational and residual component of the demand TNUoS should be removed as an embedded benefit (as CMP264 Original) or just the residual component (as CMP265 Original) or some other method?</p>	<p>A full SCR is required to address this question in a way that will truly offer long-term stability. In the meantime, we think that the level of TNUoS residual should be frozen or capped at a level that will enable appropriate levels of investment across the industry while a full review is undertaken.</p> <p>As noted in our response to earlier questions, we think that the locational signal needs to be sharpened rather than removed.</p>
19	<p>Regarding the proposed alternatives what are your views on the suggested implementation dates? Are these achievable? Please give reasons for your view.</p>	N/A



Impact of Removal of Embedded Generator Triad Benefits on the GB Power System

Quantitative Analysis

Contents

1	Executive Summary	1
2	Background & Scope	5
2.1	Introduction	5
3	State of System in Winter 2015/16	7
3.1	Embedded Generator Activity (Best View)	7
3.2	State of Main Market	8
3.3	Closures/New-Builds Prior To Winter 2015/16	9
3.4	November to February versus October and March	9
3.5	Winter 2015/16 Margin Analysis	12
3.6	Relationship Between Margin and Price	14
4	State of Market Ahead of Winter 2016/17	16
4.1	Recent Closures/New-Builds	16
4.2	Supplemental Balancing Reserve (SBR) Winter 2016/17	17
4.3	Winter 2016/17 Margin Analysis	17
4.4	Modelling Potential Price Increases	19
5	Impact of Removal of Triad Income	22
5.1	Low Case	22
5.2	High Case	24
5.3	Cost of TNUoS to the System	25
5.4	Summary of TNUoS Cost Impact	25

1 Executive Summary

Winter 2015/16 saw levels of margin within the GB power market remain just above what was sufficient for secure operation. The difference between supply and demand fell below 2GW on two occasions across the winter.

The UK's embedded generation fleet's peak output was approximately 9GW in the winter of 2015-16. EnAppSys estimates are that there is approximately 2GW of baseload capacity, 4-5GW of solar generation from HH meters at the peak, 3-4GW of wind solar generation from HH meters at the peak and 1-2GW of peaking generation capacity¹

Strong levels of renewable generation and low demand from consumers resulted in minimum daily thermal generation averaging 18.7GW, with a lower quartile of 15.9GW and an upper quartile of 21.7GW. Peak daily thermal generation reached 30.4GW on low-wind high-demand days.

Some large power stations had low utilization levels, which reduced their income and put pressure on their ability to cover fixed costs, resulting in mothballing and closures. Much of the UK's fleet doesn't have the flexibility and speed to fill in around renewable generation and to target peaks in demand.

As a result, there have been numerous closures since last winter, despite margins having been tight, as evidenced by National Grid's purchase of ~3.5GW of strategic reserve.

The large number of closures within the main market (particularly in 2016) have arisen as a result of power stations being reduced to insufficient running hours at insufficient prices, and therefore insufficient operating profits.

If new large power stations are to be built, then existing plants that sit on the margins of the market will see their running hours reduced and so will be in a similar situation to the plants that are already closing.

In order to avoid constructing new plants while inefficiently closing identical levels of existing capacity, power prices need to rise via a scarcity premium, or non-power market income must rise.

An extra source of non-power income could come from a higher Capacity Mechanism (CM) price. To have a significant impact upon the income levels of large power stations

¹ Source embedded generation analysis from SVAA P0276 data and <http://www2.nationalgrid.com/WorkArea/DownloadAsset.aspx?id=36393>, 1GW estimate based on STOR flexible contract tendered volumes 15/16.

and to encourage the building of new CCGTs would probably require at least a £7/kW CM price increase up to at least £25/kW. Estimates of the trigger CM price vary; the price might need to rise to £45-50/kW, but we provide a conservative analysis in this report.

With 46.9GW of capacity targeted at £0/kW in the 2015 auction, the implied net cost to the system of a £25/kW CM price would be £328m. This is the same cost as constructing 4.7GW of new embedded generators earning triad income at £70/kW alongside current CM prices.

Without intervention and following recent closures, EnAppSys notes that the hours when the margin drops below 2GW are likely to increase from 2 hours in winter 2015/16 to an expected 49.5 hours in winter 2016/17.

A conservative approach has been taken with our modeling: we assume that 1.5GW of additional capacity will become available across winter 2016/17, provided by large thermal power stations. This is a rough estimate of the maximum extra capacity that was cut for cost-saving purposes but could be expected to become available in response to higher prices.

At the moment, there are no indications of plants increasing their TEC to benefit from tight margins for the winter of 2016/17. The increased availability at Keadby and Carrington is already included in the modelling ahead of this 1.5GW increase.

These tight margins and the slow response from large generators provide the backdrop for any changes to the embedded benefits regime.

Modelling carried out by EnAppSys and detailed in this report shows that in winter 2016/17 the system will see **an increase in costs of £507million-£764million due to the scarcity premium that will result from the increased periods with tight margins, if triads are removed.** This modelling involves the use of a scarcity price curve that is detailed further below.

In the Capacity Mechanism there are just under 2GW of embedded projects coming online that will in the future mean a cost of approximately £140m/annum at future higher TNUoS values. Overall these costs will be distributed via the common charging methodology but the rationale is that it is a neutral transaction as there would be lower requirement to build transmission infrastructure and the presence of embedded generation and its benefits result in lower transmission losses that would be passed to the consumer. Modelling of winter 2016/17 shows that the 2GW increase in margin offered by these plants could turn the modelled increase of £507m-£764m from increased market prices in a tight system

into potential savings of £52m-£90m, by consistently boosting margins within the system and thereby reducing market prices.²

This places a net benefit to the system of £457m-£676m per annum as a result of the construction of the embedded plants with CM obligations. Their value to the system increases the sooner they come online. It is worth noting that transmitted generation would provide the same value to the system (all else held equal) were it able to show up to the market in time.

Should embedded benefits be removed from the system, EnAppSys forecast that

- 1GW of generation that operates via flexible STOR, and
- 1GW of generation that earns income from other ancillary services

might be insufficiently remunerated in the absence of triads to justify continued operations so could potentially exit the market.

If this exit were coupled with the cancelled construction of the 2GW of new embedded CM plants that are currently expected, modelling of winter 2016/17 shows a 2GW decrease in margin from that which existed in 2015/16, putting the system under serious stress.

Under such a scenario there would be an expectation that margins would drop below 2GW for 193 hours across the winter period and below zero for 49.5 hours. A drop below zero would not necessarily mean the lights going out, but would force the system to rely heavily on last-resort services such as Supplemental Balancing Reserve (SBR) and STOR (typically provided by embedded generators that are at least partially supported by triad income).

With the system under such stress, the scarcity of supply would have a considerable impact upon power prices: we estimate an increase in power costs of about £1.75bn – £3.33bn over the winter period. At the same time the system would need to source 4GW of capacity specifically to generate on peak days without impacting upon the viability of generators already in the market.

From a purely quantitative perspective there would appear to be a justification for the continuation of triads. Further, consumers put a value on security of supply – this soft benefit is not considered in this analysis. The focus of Triad generators on peak days ensures that embedded generators do not compete directly with existing plants, which

² With these plants normally supplementing triad income with operation in reserve markets such as STOR or FFR

sometimes have higher efficiencies and therefore lower energy costs, particularly over longer running periods.

This implies that in contrast to large new-build CCGTs, existing embedded plants don't need additional income to ensure that they are not forced out the market by new-build plant – there is a pressing need for new plant and old.

In this analysis we consider only the embedded generation that runs during evening peaks. We have not considered demand response nor embedded generation operating at baseload (waste-to-energy plants, anaerobic digesters etc) which might have triad income as a significant component of its revenue stream. For such plants Triad removal could put their viability at risk and therefore cause withdrawal from the market. Our exclusion of this scenario, which would serve to magnify the impact of the removal of triads, is in keeping with the conservative approach we have taken across this whole modelling exercise.

It is important to note that removing embedded generators' triad income will incentivise a shift towards behind-the-meter running. With higher power prices resulting from the removal of triads there will be a negative overall impact for consumers, including for those half-hour metered customers who are practicing triad avoidance. That might in the long run create more demand destruction or self-supply at a higher overall net cost to the system.

2 Background & Scope

2.1 Introduction

The transmission network is set up so that locally-connected distribution generators in England and Wales are treated as negative demand for the purposes of transmission charging.

By generating power during the three peak 'triad' periods each year, such 'embedded' generators reduce a retail power supplier's peak use of the transmission system and therefore the associated charges. Suppliers compensate embedded generators for providing this service – compensation often referred to as "embedded benefits". The triad periods are the three half hours of the year when the system is most likely to be under severe stress and are defined by National Grid as follows:

The Triads are the three half-hour settlement periods with highest system demand and are used by National Grid to determine charges for demand customers with half-hour metering and payments to licence exempt distributed generation. They can occur in any half-hour on any day between November to February inclusive but are separated from each other by at least ten full days.

This means that embedded generators within the GB market can currently receive payments equivalent to the half-hourly demand TNUoS tariffs in a given charging year. TNUoS costs are paid for by suppliers and form part of their overall costs to supply. Overall the rationale is that it is a neutral transaction as the presence of embedded generation and its benefits result in lower transmission losses (that would be passed to the consumer) and low requirement to build transmission. Embedded generation has to pay in full its connection costs as opposed to centralised generation where the costs are spread across the market generators and consumers

These TNUoS charges vary from region to region, encouraging the construction of embedded generation and reduction of demand in regions where there is the greatest imbalance between supply and demand, and the greatest shortage of local power stations relative to local demand.

In April 2013 National Grid commenced a review that encompassed embedded benefits and TNUoS benefits. The review was concluded in 2014 and resulted in no changes to the system. The key reasons for not making changes were given as (1) greater transparency on embedded generation was in progress and it was felt prudent to wait for the results, (2) the volume of industry reform with the EMR coming in, (3) discriminatory treatment of generation over demand-side response if changes were implemented.

More recently Ofgem has raised a potential review of embedded benefits:

We are aware that small scale generators bring a range of benefits, including for security of supply, as they can help to meet peak demand by producing electricity when it is most needed. However, we are aware that small distribution connected generators receive an increasing level of benefits, which includes avoiding the generator transmission network charges and receiving payments from suppliers for helping them to avoid transmission charges for customers. We have previously expressed concerns that these arrangements are not fully cost reflective and continue to hold this view. Given the increasing scale of embedded generation and the increasing impact of distribution network flows on the transmission network, we are concerned that the lack of cost reflectivity of these arrangements could be having an increasing impact. However, we need to consider the wider implications for consumers of making any changes to these arrangements, taking account of wider benefits provided by embedded generators.

We are currently considering the impact on consumers of changing the charging arrangements for distribution connected generators, whether there is a case for us to initiate any changes to the charging methodologies and how and when any such changes should occur. This includes whether any transitional arrangements are required. We have not yet reached a decision on this, but expect to set out a way forward on this matter in the summer.

Ofgem Forward Work Program – March 2016

This has come on a backdrop of TNUoS prices that have risen in England from £14-26/kW in 2010/11 to £33-46/kW in 2015/16. These values are currently forecasted to reach £61-80/kW in 2019/20.

This report looks into the landscape in which any potential changes might be made and goes on to consider what impact any changes to the embedded benefits regime might have, specifically relating to the implications upon security of supply - raised by Ofgem as a potential consequence of any changes.

3 State of System in Winter 2015/16

The past decade has seen significant changes within the GB power market. In 2005 things were relatively stable, with 75% of power generation coming from coal- or gas-fired power stations that could be relied upon to deliver power across winter periods. A further 22% of power came from nuclear plant; only 6% of power generation come from interconnectors or renewable plants.

By 2015 the levels of generation from coal- or gas-fired plants had fallen to 51%, while recent closures at nuclear plants along with concerns over cracks found in graphite bricks at EDF's plants resulted in a nuclear fleet providing a slightly reduced percentage of power generation. The remaining 29% of power was sourced from renewables (21% of total) and electricity imports (7% of total).

3.1 Embedded Generator Activity (Best View)

A typical embedded generation shape in the market is shown below. This chart uses P0276 data from Elexon and shows the sum of metered volume at a HH level for export meters in HH metering nationally for February 2016.

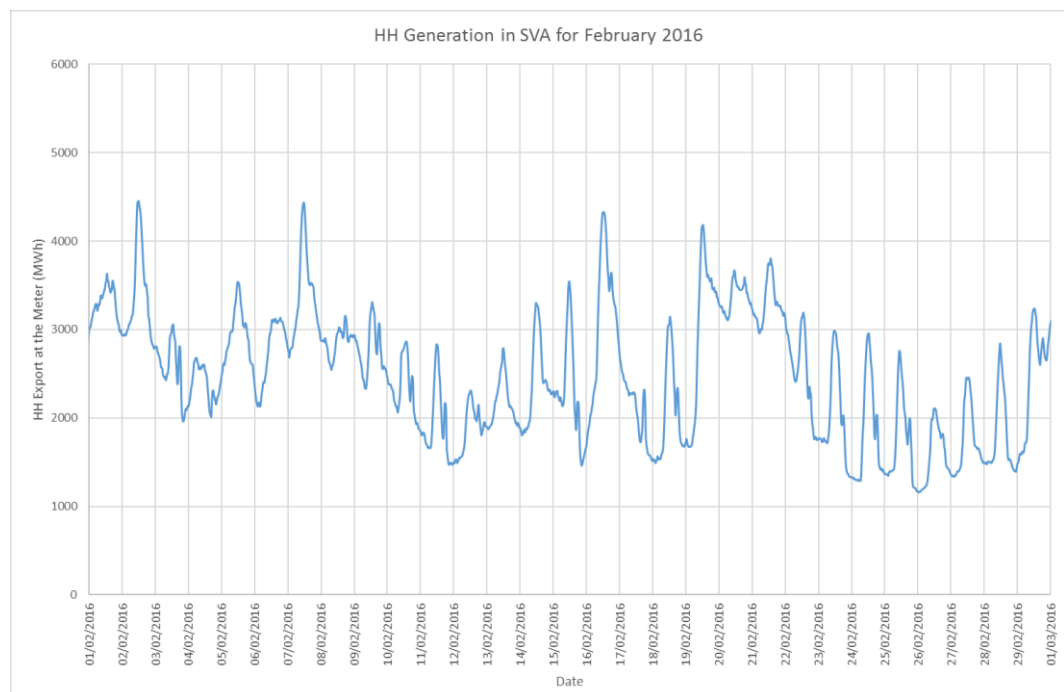

The chart shows that peak output was approximately 9GW (2 x HH metered volume) in February 2016. EnAppSys estimates are that there is approximately 2GW of baseload capacity, 4-5GW of solar generation from HH meters at the peak, 3-4GW of wind solar

generation from HH meters at the peak and 1-2GW of peaking generation capacity. In terms of Capacity Mechanism new builds, the following table documents activity at all operators with successful new builds in the past two CM auctions.

Table 1

OPERATOR	FUTURE CAPACITY (MW)	EXITING (MW)	EXISTING (MW)	NEW BUILD With CM contract (MW)	Plants Without CM Contract (MW)
Carlton Power	1,656.2	0.0	0.0	1,656.2	569.6
ESB	809.9	362.2	0.0	809.9	0.0
UKPR	607.6	0.0	96.2	511.5	347.9
Green Frog Power	298.2	197.7	3.3	294.9	87.6
Peak Gen	244.7	0.0	0.0	244.7	207.1
Prime Energy	138.0	0.0	0.0	138.0	132.4
Eider	79.3	0.0	0.0	79.3	0.0
Noriker Power	75.6	0.0	0.0	75.6	18.9
Welsh Power	84.9	0.0	9.5	75.5	226.0
Alkane Energy	130.8	0.0	56.3	74.6	22.7
Sterling Power	70.0	0.0	0.0	70.0	40.0
Ferrybridge MFE	63.6	0.0	0.0	63.6	67.7
Plutus Energy	56.7	0.0	0.0	56.7	104.0
GDF Suez	3,089.1	1,521.5	3,042.6	46.5	0.0
FCC Environment	88.4	0.0	42.6	45.9	0.0
Power Balancing Services	45.2	0.0	0.0	45.2	0.0
First Renewable	35.9	0.0	0.0	35.9	47.3
Viridor Waste	22.8	0.0	0.0	22.8	30.7
TP Leaseco	19.8	0.0	0.0	19.8	0.0
Cadoxton Power	15.1	0.0	0.0	15.1	0.0

Of these operators, Carlton Power represent Trafford Power and ESB owns Carrington, but the remaining 1.92GW of de-rated capacity is all expected to come from small embedded generators.

These generators, designed to provide peak power on high-demand days, are a key source of new-build capacity within the GB power market.

3.2 State of Main Market

In general, the growth of wind capacity has meant that much of the winter period has seen ample levels of margin - strong wind output across winter months ensuring that there is a large excess of potential supply from thermal generators.

The challenge for the system is in dealing with high-demand days when levels of wind generation are low so capacity margins become very tight. Wind generation was fairly consistent last winter but dropped away on a small number of days. A low-wind high-demand day is the greatest challenge to the system in terms of ensuring security of supply. The danger is greatest when there is high atmospheric pressure over the UK – on cold still winter nights.

3.3 Closures/New-Builds Prior To Winter 2015/16

A number of power stations have closed in recent years:

- Barking (1.0GW; closed 2014),
- Cockenzie (1.2GW; closed 2013),
- Didcot A (2.0GW; closed 2013),
- Grain (1.3GW; closed 2012),
- King's Lynn (0.3GW; closed 2012),
- Kingsnorth (1.9GW; closed 2012),
- Littlebrook (1.1GW; 2015GW),
- Teesside (1.9GW; closed 2013)
- Tilbury B (0.8GW; closed 2013).

Much of this plant was due to close anyway before the end of 2015, having opted out of the Large Combustion Plant Directive, but their running for limited hours in the face of increasingly difficult economics has resulted in early closure. In many cases these plants have already been demolished.

Since 2010 a number of new power stations have been constructed including:

- Marchwood (0.8GW),
- Staythorpe (1.7GW),
- Langage (0.9GW),
- Grain CHP (1.3GW),
- Pembroke (2.0GW)
- West Burton B (1.3GW).

These new builds total 8.0GW, the last being commissioned in 2013.

3.4 November to February versus October and March

An interesting development in the past couple of years is that the shoulder periods are becoming tighter relative to the triad periods.

In winter 2015/16, the overall levels of margin within the system were generally lower outside of the triad months of November to February, which are usually considered to be the core winter months and are the only time during which triad periods apply.

The following chart plots the average demand from November to February and during March and October:

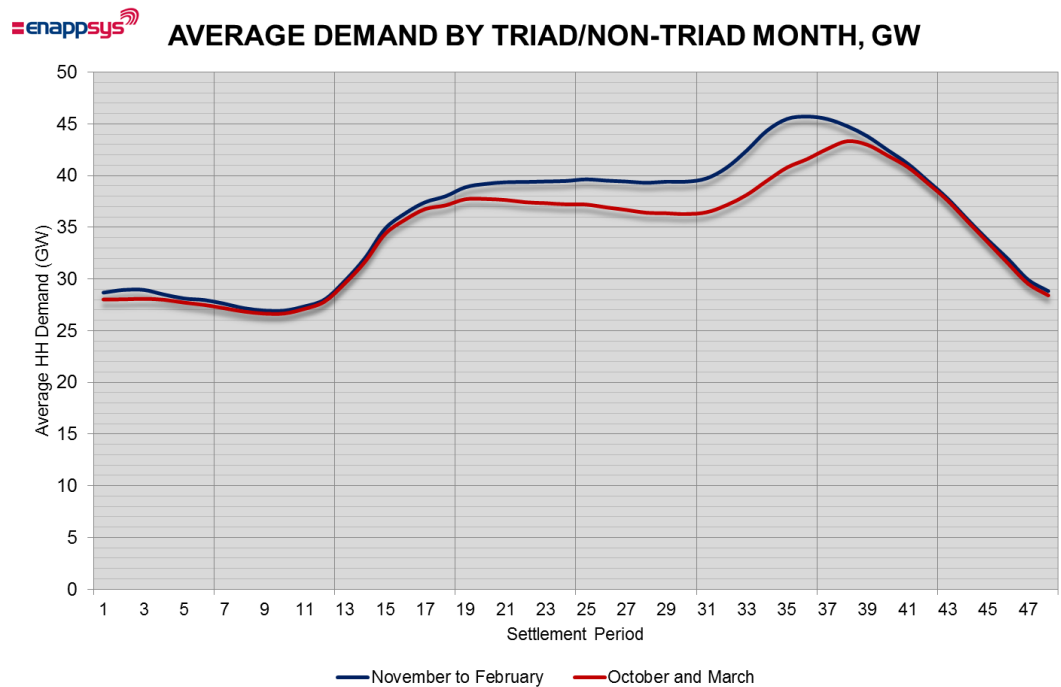

From November to February, embedded generators seek to increase their output and electricity consumers to decrease their requirement around peak periods.

The difference between margins during the two periods shown is unlikely to be solely down to the impact of TNUoS payments, but the reduction of peak demand in these months will contribute to the reduced demand for thermal generation and hence increased margins within the system.

These reduced margins impact system prices. The impact can be seen in the following chart:

enappsys AVERAGE SYSTEM PRICE BY TRIAD/NON-TRIAD MONTH, £/MWh

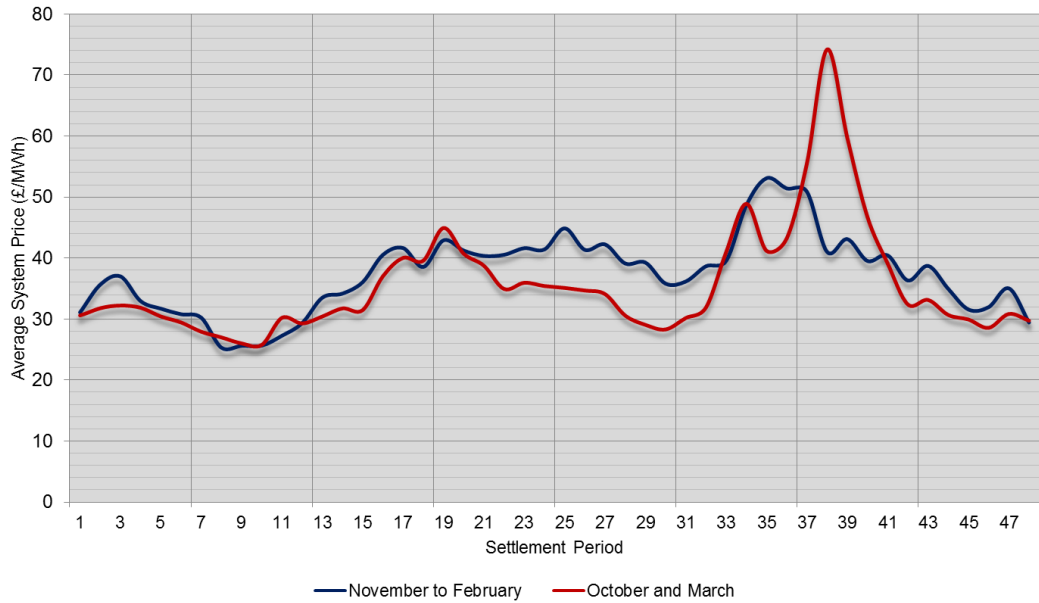

This in turn translates into higher within-day power prices in October and March:

enappsys AVERAGE WITHIN DAY POWER PRICE BY TRIAD/ NON-TRIAD MONTH, £/MWh

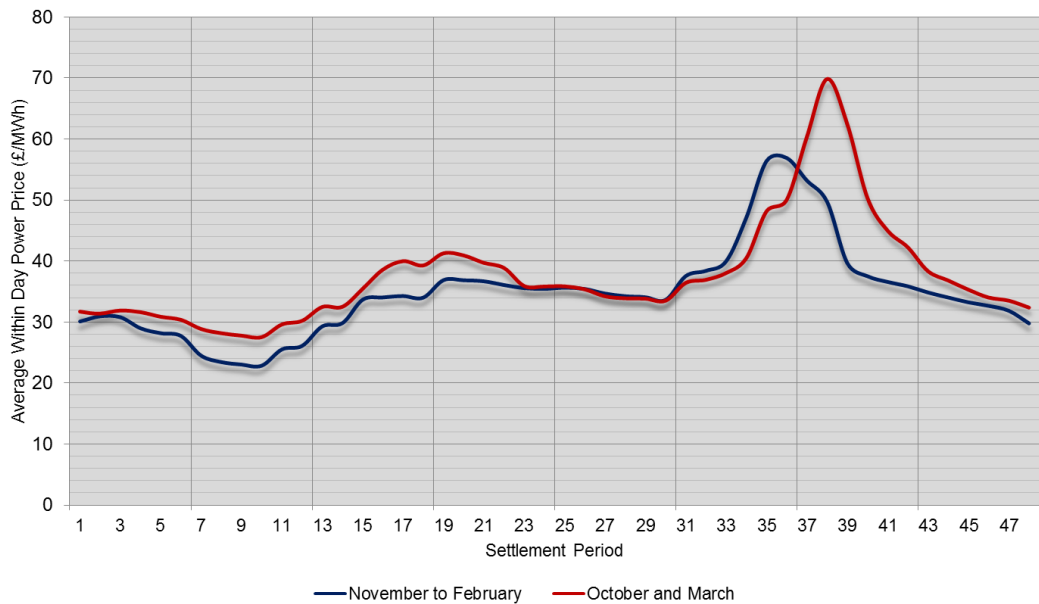

The fact that November to February are triad months will not be the only driver of activity as wind generation is also higher then; but triad avoidance will be contributing towards the overall trend: there is a clear reduction in winter prices when embedded generation is

chasing triads and benefitting from TNUoS, compared with the shoulder months where it is either in STOR or else responding only to strong price signals.

The same trend does not exist if one looks at day-ahead data, shown in the following chart:

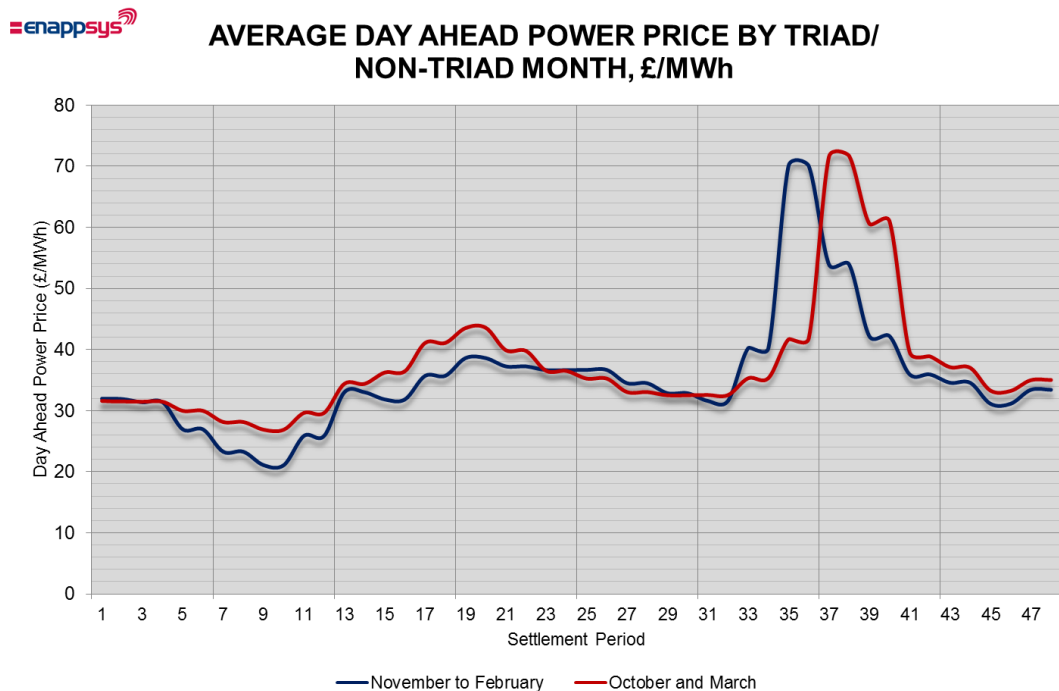

The day-ahead market price reflects the risk-weighted assumption that planned generation will operate to schedule and that demand will follow forecasts. The interaction of embedded generation in 'chasing Triads' is factored into the market: it is notable that when demand is at its highest in winter peaks, day-ahead prices do not show commensurate spikes, indicating that embedded generation is likely to be contributing to keeping winter day-ahead peak prices stable - the market assumes embedded generators will run during the peaks.

The movement in the demand peak is influenced by the change in sunset timing, as seen by the peak's shift between winter and the shoulder months.

3.5 Winter 2015/16 Margin Analysis

Across the full winter period of 2015/16 margins were 5GW or more on 85% of the days. Levels only dropped below 2GW on two days across the period (2nd November 2015 to 1.5GW and 10th March 2016 to just under 2.0GW).

A plot of the levels of minimum margins and average daily generation across the winter period can be seen in the following chart, alongside levels of non-thermal generation:

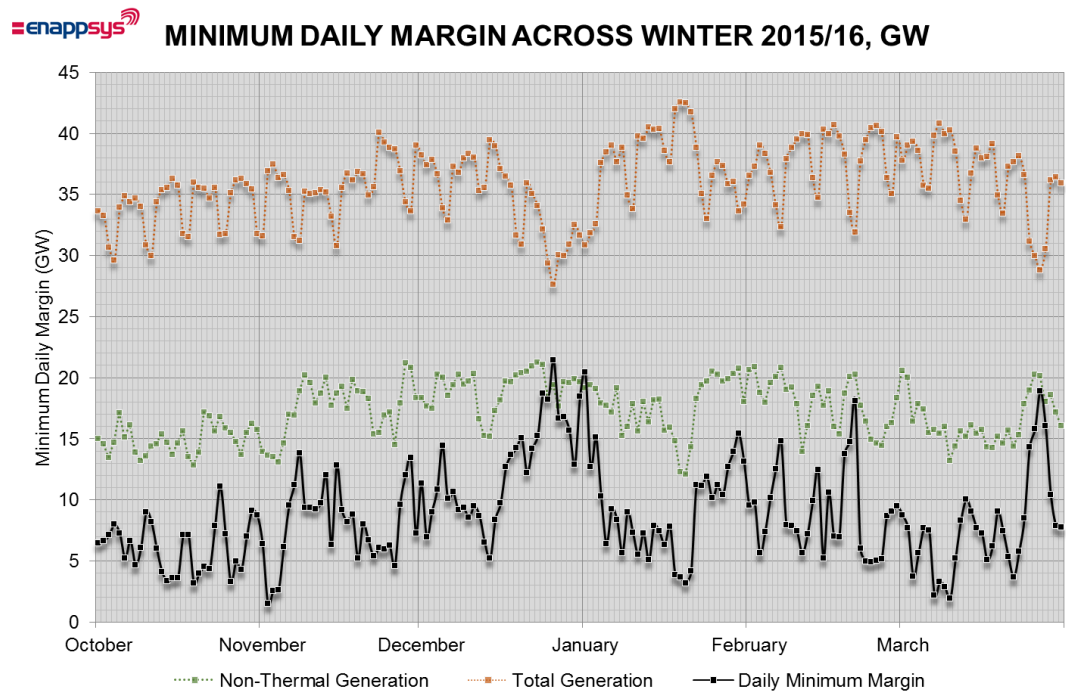

The periods of short margin generally occurred when levels of total generation were high and when levels of non-thermal generation were low. Across December and February, the system was particularly well supplied with wind power, which was a large contributor to healthy margins across much of the winter period.

These strong levels of renewable generation, coupled with high levels of nuclear generation meant that generation across the thermal fleet was relatively low.

Across winter 2015/16 levels of daily thermal generation averaged 18.7GW, upper and lower quartiles at 15.9GW and 21.7GW (a range of 5.7GW). Minimum and maximum levels of daily thermal generation were at much higher extremes, with a maximum daily generation at 30.4GW and minimum daily generation at 8.3GW (a range of 22.1GW).

This meant that whereas the requirements for peak thermal generation in winter 2015/16 were very high, the typical running hours for coal and gas plants were relatively low across the whole winter period.

These totals only account for large power stations. Embedded generators were reducing the amount of total generation required on the peak days. The loss of this embedded generation output from the system would increase the requirements for output from large coal and gas power stations on peak days.

Low thermal running hours were a key factor contributing to the high number of closures ahead of winter 2016/17. Since the winter of 2015/16 was mild, the requirements for 2016/17 could be much higher on peak days.

There are three key challenges posed in terms of ensuring security of supply within the GB power market:

1. Ensuring that levels of power supply are high enough to keep the lights on.
2. Ensuring that plants on the margins of the market are sufficiently rewarded to continue to participate in the market and continue to keep the lights on.
3. Ensuring that plants are available at the right time.

In the winter of 2015/16, levels of margin remained above what appear to be acceptable levels, despite the issue of two NISMs (Notice of Insufficient Margins). Recent closures will, however, place a larger stress upon the system in winter 2016/17 as large marginal plants were unable to ensure sufficient income to remain active in the market.

This second point is more challenging, since any new-build capacity will act to push existing plant down the merit order and further towards the margins of the market, reducing the operating hours of the more marginal plants. This in turn could put existing generators' futures in doubt, when they might have continued operations without the construction of the new plant. If the capacity of existing plant were sufficient to meet demand the newer more efficient plant would squeeze out the older plant.

The third point is key in maximising the value able to be derived from relatively low levels of overall market capacity available on peak days. The Capacity Mechanism has been designed around ensuring that generators maximise their ability to generate on days where there is a risk of forced lost load.

All this creates a requirement to build new plants at sufficient scale in a manner that does not reduce the operating income of existing marginal plants to a degree that they close down, and that these plants are available to the system when required.

3.6 Relationship Between Margin and Price

The relationship between the historic margin and day-ahead price can be seen in the following chart, along with a curve fit produced by EnAppSys:

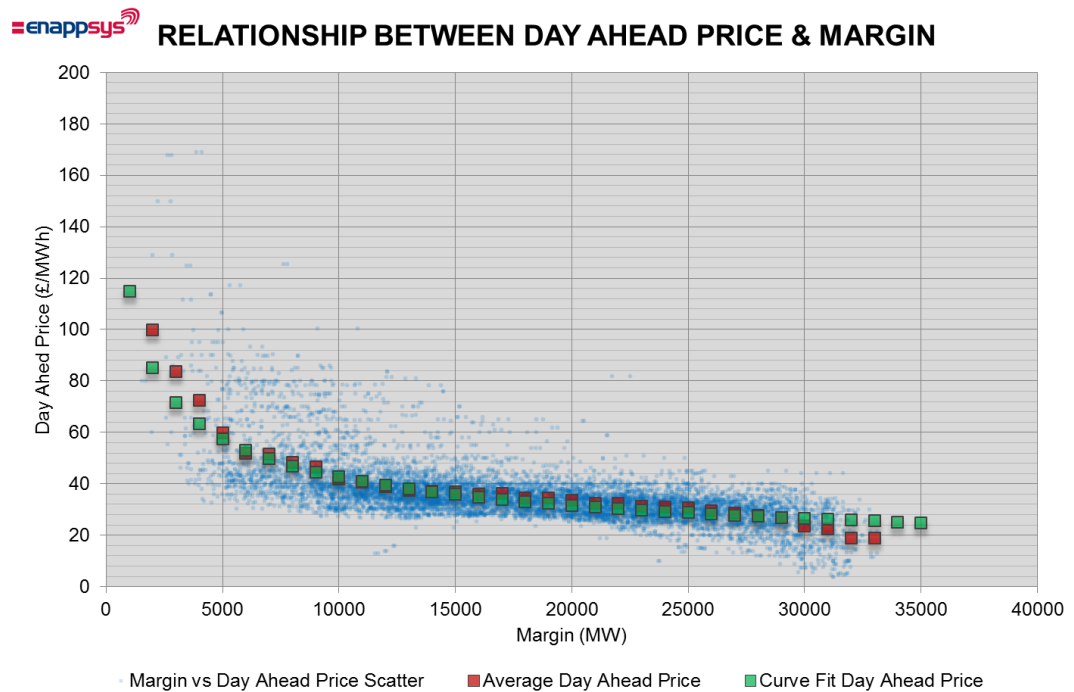

The chart above represents a scarcity pricing function, which as demand exceeds supply and takes margins to zero, will tend towards infinity. However, the function can also be adjusted if a price cap is introduced by the government, deemed here to be either £300/MWh or 1,000/MWh, based upon 10%-33% of the £3,000/MWh price that will result if SBR is utilised. In our modelling from this analysis these two price cap values have been used.

Since £3,000/MWh will be the cost that generators incur for any failed generation, prices should be pushed up towards that level.

4 State of Market Ahead of Winter 2016/17

Since the start of 2016, falling gas prices have meant that coal stations have been struggling to operate profitably. Furthermore, the government has been highlighting their intention to cease unabated coal-fired generation by 2025, in addition to the effect of Industrial Emissions Directive (IED). Many of these plants have therefore taken the decision to close.

4.1 Recent Closures/New-Builds

In 2016 final plant closures have occurred at:

- Eggborough (2.0GW; partial close 2016),
- Ferrybridge C (2.0GW; fully closed 2016),
- Ironbridge (1.0GW; fully closed 2016),
- Killingholme 1 (0.7GW; closed 2016),
- Killingholme 2 (0.9GW; closed 2016),
- Longannet (2.4GW; closed 2016),
- Rugeley B (1.0GW; closed 2016)

These power stations have now either closed down their last operating units or closed down all but a small share of their capacity, which will move into SBR (Supplemental Balancing Reserve – a service of last resort whereby generators are paid to remain out of the market but provide power when required to ensure that the lights remain on).

The total capacity of these stations amounts to 10GW, although some of this capacity was already lost to the system prior to last winter, as single units closed ahead of any full plant closures. The actual closures occurring during 2016 total around 5GW.

Drax's coal units and Fiddler's Ferry were also very close to closure before being awarded "black start" contracts from National Grid with a reported value of £113m over two years.

The total capacity that has closed since 2012 is 21.5GW.

A 0.9GW power station (Carrington) is currently into final commissioning. Trafford Power is the only large new-build power station to have won in the Capacity Mechanism, with a capacity of 1.9GW. Doubts about the owners' ability to finance their project have been worsening.

If Trafford Power fails then the largest new source of power procured via the Capacity Mechanism will have been obligated to small embedded stations, which amount to a total de-rated capacity of 1.9GW, due to be built by 18 separate developers.

4.2 Supplemental Balancing Reserve (SBR) Winter 2016/17

To offset the amount of capacity being lost ahead of expectations, National Grid brought in Supplemental Balancing Reserve (SBR), paying a fee to plant that was committed to shutting down for still providing power if needed as a last resort (ie as peaking plant).

Ahead of winter 2016/17 an increased amount of capacity has exited the markets and shifted into SBR:

	Unit	Owner	De-Rated Capacity (MW)*
New Contracts	Eggborough Coal (775MW)	Eggborough	681
	South Humber CCGT (750MW)	Centrica	654
	Peterhead CCGT (additional 2 x 375MW)	SSE	646
	Killingholme CCGT (600MW)	Uniper	523
	Fiddlers Ferry Coal (480MW)	SSE	422
	Deeside CCGT (additional 250MW)	Engie	218
15/16 Rollovers	Corby CCGT (353MW)	ESBi	308
	Fiddlers Ferry GTs (2 x 17MW)	SSE	32
	Keadby GT (23MW)	SSE	22
	South Humber CCGT (20MW headroom)	Centrica	17
	MW Total		3523

The following generators have terminated their 2015/16 SBR contracts:

Unit	Owner	De-Rated Capacity (MW)*
Ferrybridge GTs (2 x 16MW)	SSE	30
Barry CCGT (227MW)	Centrica	198
Killingholme CCGT (660MW)	Centrica	576
MW Total		804

The loss of capacity to this service of last resort comes following a winter in which margins were on occasions relatively tight, system prices rising as high as £518/MWh on 10th March 2016 and with two NISMs (Notices of Insufficient Margins) called.

4.3 Winter 2016/17 Margin Analysis

To assess the market next winter, EnAppSys has taken the levels of availability, generation and demand across winter 2015/16 and modelled what winter 2016/17 might look like based upon identical levels, but removing power stations that have closed or gone into SBR. The modelling also accounts for Keadby returning to full availability and Carrington becoming available at full capacity. Embedded generation is assumed to be undertaking its 'normal' triad avoidance.

The impact of capacity closing or moving into SBR shows much tighter margins, with frequent periods where margins will drop below 0MW unless extra availability can be found:

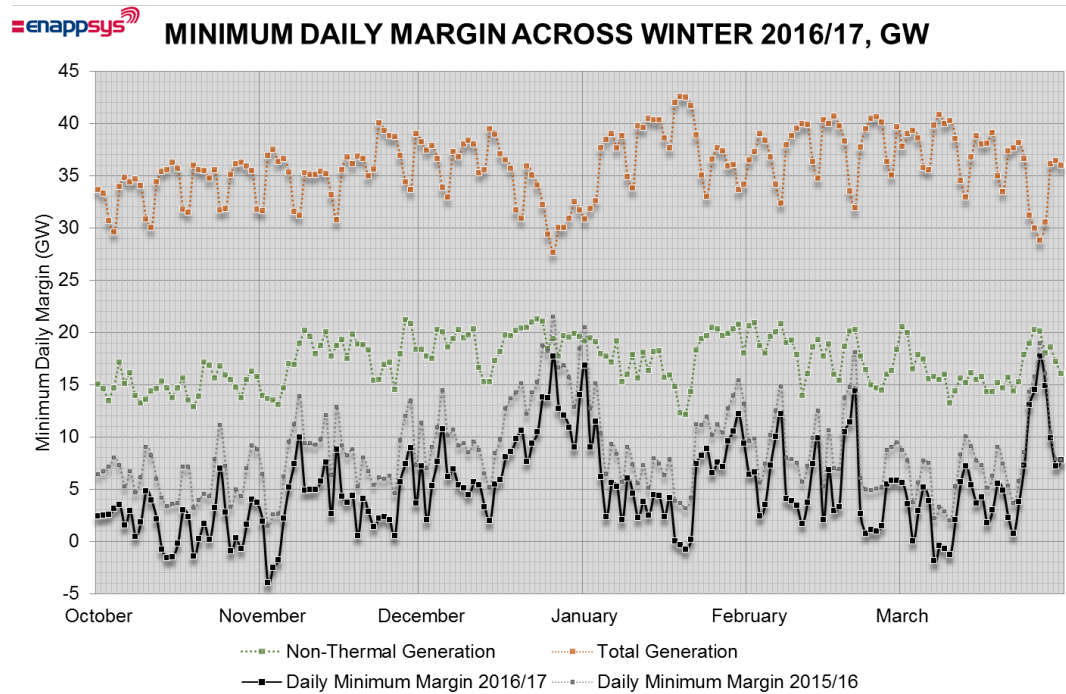

The analysis excludes units that will be in SBR so does not imply that the lights will go out, but when SBR is used the system price will go up to £3,000/MWh, as it must only be used as a last resort and when there is an expectation of forced lost load unless it is activated.

This will potentially translate into power prices peaking as high as £3,000/MWh in winter 2016/17.

Without the use of SBR the following chart shows the number of periods where the margin is expected to drop below 2GW, unless generators that were unavailable in winter 2015/16 increase their levels of availability in the coming winter:



POTENTIAL PERIODS OF LOW MARGIN IN WINTER 2016/17

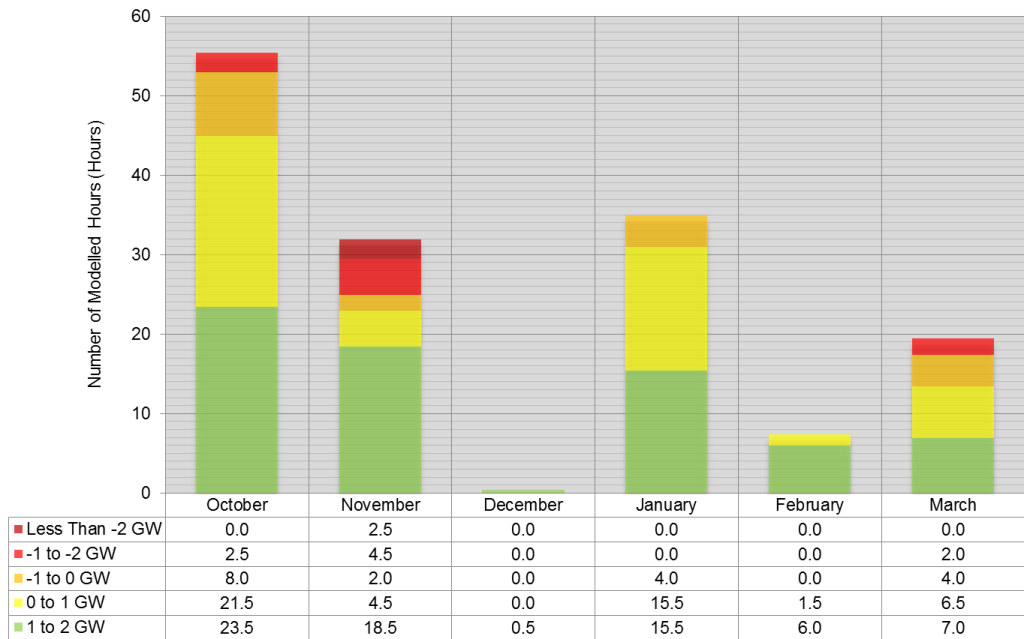

Such a frequency of low margins suggests a system on the very edge of having appropriate capacity and suggests that the system could see major price spikes through the winter as 'scarcity pricing' comes into play. Offsetting this will be any newly built embedded generators that have come online ahead of their 15-year Capacity Mechanism contracts.

Carrington has already been accounted for as an early new build, so the only other new builds available to improve the margin will be new embedded generators.

4.4 Modelling Potential Price Increases

The relationship between the historic margin and the day-ahead price can be used to estimate the expected overall cost to the system of the tighter margin in winter 2016/17 (as measured by the difference in expected power price multiplied by the total generation over the winter period).

This relationship has already been established in an earlier section of this report and is shown in the following chart:

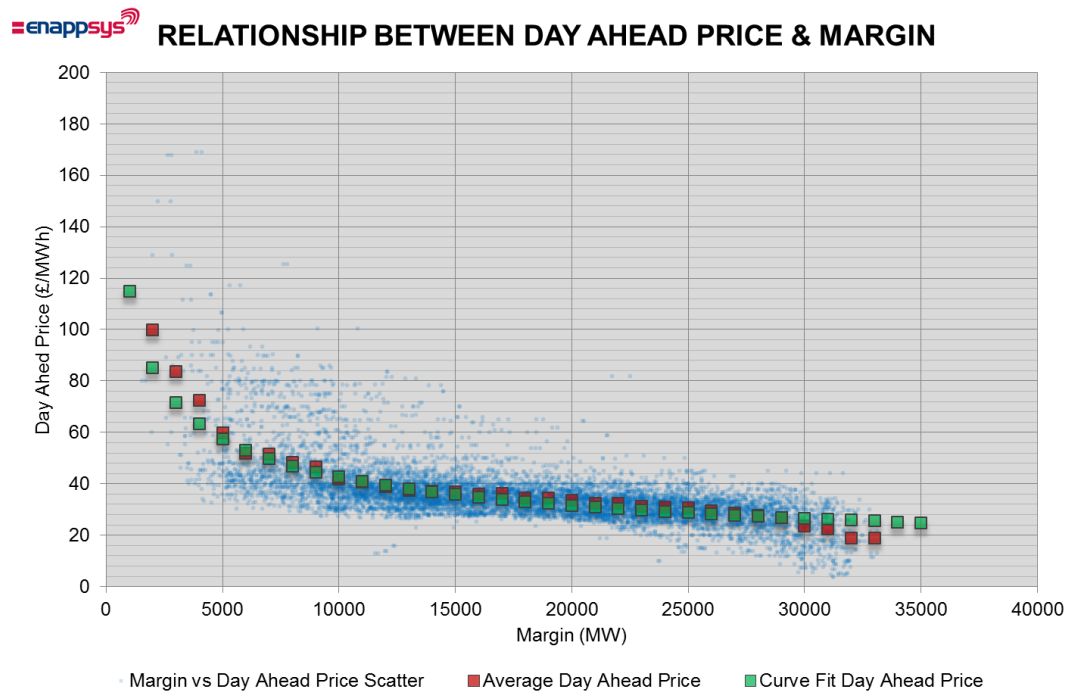

This curve fit has been modified to apply a price cap of £300/MWh or 1,000/MWh which represents 10%-33% of the value of lost load (£3,000/MWh) and the expected system price if SBR is called. Since this value of lost load will be the price that generators will incur for any failed generation, prices should head towards £3,000/MWh.

This cap is arguably a very conservative assumption as a pure market would tend to deliver prices at or close to the next alternative action i.e. £3,000/MWh. In the GB market however, past history would suggest there would be intervention via legislative or regulatory change if prices consistently get to these levels. The industry has therefore been reluctant to drive prices to very high levels on a consistent basis. This could of course change in a very stressed market or with convincing signals from the government or regulator that price spikes are acceptable.

Ofgem's calculation of the value of lost load to consumers is in fact £17,000 per MWh; and current legislation proscribes a doubling of the £3,000 rate to £6,000 in October 2018.

Using the relationship between price and margin, the expected increase in price resulting from the changes in margin documented in the previous section can be calculated and used to identify the increased cost to the system resulting from scarcity of supply within the system.

Using the above approach, the cost of wholesale power is expected to increase by £1.33bn-£2.30bn, with mean prices increasing by £8.83-15.27/MWh, the two values based upon the price caps of £300/MWh and £1,000/MWh respectively. This growth is expected

to be primarily be driven by very high prices around times of severe shortage. Median prices are expected to reach a more modest increment of £2.66/MWh in both cases.

This cost calculation is based upon multiplying the prices by demand over the winter period, with overall winter demand totaling 150.4TWh in all calculations.

In winter 2015/16 there were generators that had reduced levels of availability but which might be induced to increase their availability if market prices rise. It is possible that such an effect will occur next winter with tighter margins and higher prices.

The potential impact of this is limited by the fact that many such generators have moved into SBR, but EnAppSys estimate that there could still be up to a 1.5GW increase in availability across the winter period in response to stronger price signals.

Incorporating this into the analysis reduces the cost increase from the previous winter to an uplift of £0.51bn-£0.76bn, with mean prices increasing by £3.37-5.08/MWh. This 1.5GW increase is incorporated into all future and headline analyses within this report.

Based upon a simple trend fit combined with a simple cap, the figures do suggest that if the system margin does tighten, there could be considerable increases in the cost of supplying electricity due to shortages in the system.

5 Impact of Removal of Triad Income

If Triads are removed, there are a number of ways the market could be impacted. These include

- (1) those assets that have been awarded 2018/2019 15-year Capacity Mechanism agreement or a CfD might not be built or might be delayed,
- (2) existing embedded plant will be setting prices on the scarcity price model and hence will hold back generation (via mothballing) until a significant premium is available, or it might even exit the market entirely,
- (3) Projects without a CM agreement or a CfD - new embedded projects, demand-side response (DSR) and renewables projects might not get developed, or are developed but with higher CM or CfD prices due to the impact of regulatory uncertainty on investor confidence

Conversely the continued growth in embedded generation which is not impacted by the removal of triads, which is typically renewable generation, should offset some of the costs arising from the impact of reduced margins as its capacity reduces the number of periods when margins are tight.

One of the key consequences of embedded benefits is that a large number of small, flexible and distributed generators (and demand-side units) provide a net demand reduction in peak periods without being centrally dispatched or dispatched by market price signals and in the remaining periods are available as reserve power, under contract to National Grid or to a supplier.

To model the consequence of the loss of embedded generation, EnAppSys has replicated the effect by increasing margins in line with the changing levels of embedded generation. This is consistent with the assumption that generators will target triads during evening peaks and then operate via STOR or main markets to boost overall margins during other hours.

5.1 Low Case

The low case follows the most conservative approach of a £300/MWh price cap and assumes that the system is still able to avoid a loss of load despite the loss of margin.

In this table the increases are compared with winter 2015/16 and the increase in power cost is the increase in price multiplied by demand for each half-hourly period. The reduction in power costs are then compared with the power cost if there is no change in embedded generation. The net benefit values account for an HH demand tariff at £70/kWh and offsets this from any cost reductions.

Impact of Removal of Triad Income

The changes in net benefit to the system at different levels of embedded generation are as follows:

Increase In Embedded Generation (MW)	Effect on Median Power Price (£/MWh) (+ve prices rise)	Effect on Mean Power Price (£/MWh) (+ve prices rise)	Effect on Overall Power Cost (£m p.a.)	Reduction in Power Cost from No Change (£m p.a.)	Net Embedded Generation Benefit (£m p.a.)
5,000	-£2.86	-£4.11	-£617.8	£1,124.5	£774.5
4,800	-£2.73	-£3.92	-£589.5	£1,096.2	£760.2
4,600	-£2.60	-£3.73	-£560.4	£1,067.1	£745.1
4,400	-£2.46	-£3.53	-£530.7	£1,037.4	£729.4
4,200	-£2.33	-£3.33	-£500.2	£1,006.9	£712.9
4,000	-£2.19	-£3.12	-£468.9	£975.6	£695.6
3,800	-£2.05	-£2.90	-£436.8	£943.5	£677.5
3,600	-£1.90	-£2.68	-£403.7	£910.5	£658.5
3,400	-£1.76	-£2.46	-£369.7	£876.4	£638.4
3,200	-£1.61	-£2.22	-£334.6	£841.3	£617.3
3,000	-£1.46	-£1.98	-£298.2	£804.9	£594.9
2,800	-£1.31	-£1.73	-£260.2	£767.0	£571.0
2,600	-£1.15	-£1.46	-£220.0	£726.7	£544.7
2,400	-£1.00	-£1.18	-£177.5	£684.2	£516.2
2,200	-£0.84	-£0.89	-£134.0	£640.7	£486.7
2,000	-£0.68	-£0.60	-£90.0	£596.8	£456.8
1,800	-£0.51	-£0.31	-£46.1	£552.8	£426.8
1,600	-£0.35	-£0.00	-£0.1	£506.8	£394.8
1,400	-£0.18	£0.32	£48.7	£458.0	£360.0
1,200	£0.00	£0.68	£101.7	£405.0	£321.0
1,000	£0.17	£1.04	£156.6	£350.1	£280.1
800	£0.35	£1.42	£213.3	£293.4	£237.4
600	£0.53	£1.84	£276.4	£230.3	£188.3
400	£0.72	£2.32	£349.3	£157.5	£129.5
200	£0.91	£2.85	£429.2	£77.6	£63.6
0	£1.10	£3.37	£506.7	£0.0	£0.0
-200	£1.29	£3.90	£586.4	-£79.7	-£65.7
-400	£1.49	£4.46	£670.7	-£164.0	-£136.0
-600	£1.70	£5.11	£768.6	-£261.9	-£219.9
-800	£1.90	£5.83	£877.6	-£370.9	-£314.9
-1,000	£2.11	£6.62	£996.0	-£489.2	-£419.2
-1,200	£2.33	£7.43	£1,117.0	-£610.3	-£526.3
-1,400	£2.55	£8.32	£1,252.0	-£745.3	-£647.3
-1,600	£2.77	£9.36	£1,407.3	-£900.5	-£788.5
-1,800	£3.00	£10.41	£1,565.4	-£1,058.7	-£932.7
-2,000	£3.23	£11.61	£1,747.0	-£1,240.3	-£1,100.3
-2,200	£3.47	£12.84	£1,931.5	-£1,424.8	-£1,270.8
-2,400	£3.71	£14.10	£2,120.5	-£1,613.8	-£1,445.8
-2,600	£3.96	£15.49	£2,329.4	-£1,822.7	-£1,640.7
-2,800	£4.22	£16.82	£2,529.6	-£2,022.9	-£1,826.9
-3,000	£4.48	£18.20	£2,738.2	-£2,231.5	-£2,021.5
-3,200	£4.74	£19.62	£2,951.6	-£2,444.9	-£2,220.9
-3,400	£5.01	£21.02	£3,162.3	-£2,655.6	-£2,417.6
-3,600	£5.29	£22.60	£3,399.0	-£2,892.3	-£2,640.3
-3,800	£5.58	£24.27	£3,650.7	-£3,144.0	-£2,878.0
-4,000	£5.87	£25.89	£3,894.2	-£3,387.5	-£3,107.5
-4,200	£6.17	£27.55	£4,144.0	-£3,637.3	-£3,343.3

Impact of Removal of Triad Income

Increase In Embedded Generation (MW)	Effect on Median Power Price (£/MWh) (+ve prices rise)	Effect on Mean Power Price (£/MWh) (+ve prices rise)	Effect on Overall Power Cost (£m p.a.)	Reduction in Power Cost from No Change (£m p.a.)	Net Embedded Generation Benefit (£m p.a.)
-4,400	£6.48	£29.22	£4,395.3	-£3,888.5	-£3,580.5
-4,600	£6.79	£31.00	£4,662.2	-£4,155.5	-£3,833.5
-4,800	£7.11	£32.81	£4,935.3	-£4,428.5	-£4,092.5
-5,000	£7.45	£34.65	£5,211.1	-£4,704.4	-£4,354.4

5.2 High Case

The high case uses the less conservative £1,000/MWh price cap and assumes that the system is still able to avoid a loss of load, despite the loss of margin involved.

In this table the increases are compared with winter 2015/16 and the increase in power cost is the increase in price multiplied by demand during each half-hourly period. The reduction in power cost then compares to the cost if there is no change in embedded generation.

The net benefit values account for an HH demand tariff at £70/kWh and offsets this from any cost reductions.

The changes in net benefit to the system at different levels of embedded generation are as follows:

Increase In Embedded Generation (MW)	Effect on Median Power Price (£/MWh) (+ve prices rise)	Effect on Mean Power Price (£/MWh) (+ve prices rise)	Effect on Overall Power Cost (£m p.a.)	Reduction in Power Cost from No Change (£m p.a.)	Net Embedded Generation Benefit (£m p.a.)
5,000	-£2.86	-£4.11	-£617.8	£1,381.9	£1,031.9
4,800	-£2.73	-£3.92	-£589.4	£1,353.5	£1,017.5
4,600	-£2.60	-£3.73	-£560.4	£1,324.5	£1,002.5
4,400	-£2.46	-£3.53	-£530.7	£1,294.8	£986.8
4,200	-£2.33	-£3.33	-£500.2	£1,264.3	£970.3
4,000	-£2.19	-£3.12	-£468.9	£1,233.0	£953.0
3,800	-£2.05	-£2.90	-£436.8	£1,200.9	£934.9
3,600	-£1.90	-£2.68	-£403.7	£1,167.8	£915.8
3,400	-£1.76	-£2.46	-£369.7	£1,133.8	£895.8
3,200	-£1.61	-£2.22	-£334.6	£1,098.7	£874.7
3,000	-£1.46	-£1.98	-£298.2	£1,062.3	£852.3
2,800	-£1.31	-£1.73	-£260.2	£1,024.3	£828.3
2,600	-£1.15	-£1.46	-£220.0	£984.1	£802.1
2,400	-£1.00	-£1.07	-£161.4	£925.5	£757.5
2,200	-£0.84	-£0.70	-£105.9	£870.0	£716.0
2,000	-£0.68	-£0.34	-£51.8	£815.9	£675.9
1,800	-£0.51	£0.01	£2.1	£762.0	£636.0
1,600	-£0.35	£0.32	£48.1	£716.0	£604.0
1,400	-£0.18	£0.64	£96.9	£667.2	£569.2
1,200	-£0.00	£1.00	£151.1	£613.0	£529.0
1,000	£0.17	£1.48	£222.9	£541.2	£471.2
800	£0.35	£1.95	£293.2	£470.9	£414.9

Impact of Removal of Triad Income

Increase In Embedded Generation (MW)	Effect on Median Power Price (£/MWh) (+ve prices rise)	Effect on Mean Power Price (£/MWh) (+ve prices rise)	Effect on Overall Power Cost (£m p.a.)	Reduction in Power Cost from No Change (£m p.a.)	Net Embedded Generation Benefit (£m p.a.)
600	£0.53	£2.37	£356.3	£407.8	£365.8
400	£0.72	£2.98	£448.1	£316.0	£288.0
200	£0.91	£3.84	£577.5	£186.6	£172.6
0	£1.10	£5.08	£764.1	£0.0	£0.0
-200	£1.29	£6.04	£908.9	-£144.8	-£130.8
-400	£1.49	£6.81	£1,024.0	-£259.9	-£231.9
-600	£1.70	£7.77	£1,168.4	-£404.3	-£362.3
-800	£1.90	£9.03	£1,358.4	-£594.3	-£538.3
-1,000	£2.11	£10.61	£1,595.3	-£831.2	-£761.2
-1,200	£2.33	£12.58	£1,892.2	-£1,128.1	-£1,044.1
-1,400	£2.55	£14.28	£2,147.2	-£1,383.1	-£1,285.1
-1,600	£2.77	£16.54	£2,487.5	-£1,723.4	-£1,611.4
-1,800	£3.00	£19.52	£2,935.3	-£2,171.2	-£2,045.2
-2,000	£3.23	£22.14	£3,330.8	-£2,566.7	-£2,426.7
-2,200	£3.47	£25.88	£3,892.8	-£3,128.7	-£2,974.7
-2,400	£3.71	£29.72	£4,470.2	-£3,706.1	-£3,538.1
-2,600	£3.96	£33.34	£5,014.0	-£4,249.9	-£4,067.9
-2,800	£4.22	£37.94	£5,706.6	-£4,942.5	-£4,746.5
-3,000	£4.48	£42.13	£6,337.5	-£5,573.4	-£5,363.4
-3,200	£4.74	£46.70	£7,024.3	-£6,260.2	-£6,036.2
-3,400	£5.01	£50.48	£7,592.9	-£6,828.8	-£6,590.8
-3,600	£5.29	£54.70	£8,226.9	-£7,462.8	-£7,210.8
-3,800	£5.58	£59.99	£9,022.5	-£8,258.4	-£7,992.4
-4,000	£5.87	£65.48	£9,849.7	-£9,085.6	-£8,805.6
-4,200	£6.17	£70.68	£10,630.7	-£9,866.6	-£9,572.6
-4,400	£6.48	£76.05	£11,438.7	-£10,674.6	-£10,366.6
-4,600	£6.79	£81.13	£12,202.8	-£11,438.7	-£11,116.7
-4,800	£7.11	£87.28	£13,128.2	-£12,364.1	-£12,028.1
-5,000	£7.45	£93.03	£13,993.2	-£13,229.1	-£12,879.1

5.3 Cost of TNUoS to the System

TNUoS costs are forecasted for most regions to rise to around £70/kW, with some regions seeing higher values and others seeing lower values.

This gives a rough cost to the system for embedded benefits for triads of £70m/GW, which can be used to identify a rough net cost to the system of any changes in levels of embedded generation.

From this it is possible to evaluate the impact on embedded generation resulting from legislative or regulatory change.

5.4 Summary of TNUoS Cost Impact

In the Capacity Mechanism there are just under 2GW of embedded projects coming online. Modelling of winter 2016/17 shows that the 2GW increase in margin offered by

these plants could turn the modelled £507m-£764m cost increase into a potential £52m-£90m cost decrease by consistently boosting margins within the system.³

This places a net benefit to the system of £457m-£676m per annum as a result of the construction of these plants, the value to the system of these generators increasing the sooner they come online.

If embedded benefits were removed from the system, EnAppSys forecast that 1GW of generation that operates via flexible STOR, plus another 1GW of additional generation that earns income from other markets might be insufficiently remunerated to justify continued operation, in the absence of triads, and might potentially exit the market.

If this exit were coupled with the cancelled construction of the 2GW of new plants currently expected, modelling of winter 2016/17 shows that the net 2GW decrease in margin from the position in winter 2015/16 would put the system under serious stress.

Under such a scenario there is an expectation that margins would drop below 2GW for 193 hours across the winter period, while margins in the main market would drop below zero for 49.5 hours. This drop below zero would not necessarily mean the lights going out, but would force the system to rely heavily on last-resort services such as Supplemental Balancing Reserve (SBR) and STOR (typically provided by embedded generators that are at least partly supported by triad income).

With the system under such stress, the scarcity of supply would have a considerable impact upon power prices: an increase of £1.75bn-£3.33bn increase in prices. This would result in a £1.47bn-£3.05bn net cost increase. At the same time the system would need to source 4GW of capacity specifically to generate on peak days without impacting upon the viability of current generators, this additional transmission-connected capacity (likely to be CCGTs) would act to drive out lower-merit-order plant and would be compromised in the long run by increasing renewable generation penetration.

³ With these plants normally supplementing triad income with operation in reserve markets such as STOR or FFR

CUSC Workgroup Consultation Response Proforma

CMP264 'Embedded Generation Triad Avoidance Standstill' and **CMP265** 'Gross charging of TNUoS for HH demand where Embedded Generation is in the Capacity Market'

Industry parties are invited to respond to this consultation expressing their views and supplying the rationale for those views, particularly in respect of any specific questions detailed below.

Please send your responses by **24th August 2016** to cusc.team@nationalgrid.com Please note that any responses received after the deadline or sent to a different email address may not receive due consideration by the Workgroup.

Any queries on the content of the consultation should be addressed to Caroline Wright at caroline.wright@nationalgrid.com

These responses will be considered by the Workgroup at its next meeting at which members will also consider any Workgroup Consultation Alternative Requests. Where appropriate, the Workgroup will record your response and its consideration of it within the final Workgroup Report which is submitted to the CUSC Modifications Panel.

Respondent:	Graham Meeks Director of Policy Tel: 0330 1232137 Mob: 07802 242498 Email: graham.meeks@greeninvestmentbank.com
Company Name:	UK Green Investment Bank plc
Confidentiality:	Private & Confidential
Please express your views regarding the Workgroup Consultation, including rationale. (Please include any issues, suggestions or queries)	For reference, the Applicable CUSC objectives are: Use of System Charging Methodology (a) that compliance with the use of system charging methodology facilitates effective competition in the generation and supply of electricity and (so far as is consistent therewith) facilitates competition in the sale, distribution and purchase of electricity; (b) that compliance with the use of system charging methodology results in charges which reflect, as far as is reasonably practicable, the costs (excluding any payments between transmission licensees which are made under and in accordance with the STC) incurred by transmission licensees in their transmission businesses and which are compatible with standard condition C26

	<p>(Requirements of a connect and manage connection);</p> <p>(c) that, so far as is consistent with sub-paragraphs (a) and (b), the use of system charging methodology, as far as is reasonably practicable, properly takes account of the developments in transmission licensees' transmission businesses.</p> <p>(d) Compliance with the Electricity Regulation and any relevant legally binding decision of the European Commission and/or the Agency.</p>
--	---

Standard Workgroup consultation questions – CMP264

Q	Question	Response
1	Do you believe that the CMP264 Original Proposal better facilitates the Applicable CUSC Objectives?	No comment
2	Do you support the proposed implementation approach? Or are there any further implementation implications that need to be considered?	No comment
3	Do you have any other comments?	No comment
4	Do you wish to raise a WG Consultation Alternative Request for the Workgroup to consider?	No

Standard Workgroup consultation questions – CMP265

Q	Question	Response
5	Do you believe that the CMP265 Original Proposal better facilitates the Applicable CUSC Objectives?	No comment

Q	Question	Response
6	Do you support the proposed implementation approach? Or are there any further implementation implications that need to be considered?	No comment
7	Do you have any other comments?	No comment
8	Do you wish to raise a WG Consultation Alternative Request for the Workgroup to consider?	No

Specific questions for CMP264

Q	Question	Response
---	----------	----------

Q	Question	Response
10	<p>i) Do you think a cut-off date for “new embedded generation” of 30 June 2017 is appropriate? What other date would you propose?</p> <p>ii) Do you have any views on how mixed sites are being addressed in CMP264 Original?</p> <p>iii) Do you think new-build embedded generation capacity that has entered into long term financial and performance commitment obligations via 2014 and 2015 capacity market or contracts for difference auctions (prior to this modification proposal) should be given exceptions to this cut-off date?</p> <p>iv) Do you agree that ignoring demand behind the meter is unlikely to create a significant “loophole” or material discrimination risk in relation to the CMP264 arrangements in the short term</p> <p>v) Question to suppliers: Do you consider that the wording of your existing contracts allow you to reflect the changes provided by these modifications in a cost reflective manner. For example, these changes will apply to existing PPAs and generators who significantly alter their output (EREC 59).</p> <p>vi) Do you agree with the definition of commissioned and do you agree that it is appropriate? If you do not agree with the definition or that it is appropriate please provide alternative definitions and rationale for this definition.</p>	<p>i) A cut-off date for new embedded generation of 30 June 2017 is not appropriate. Our experience in the financing of larger embedded generators utilising steam turbines indicates that a typical period from financial close to commissioning will be in the region of 24 to 28 months. Allowing for a reasonable contingency period to allow for overruns in construction or commissioning suggests that allowing for a 3 year construction and commissioning period would be more appropriate in setting a cut off date.</p> <p>ii) No comment.</p> <p>iii) New build plant that has entered into these long-term financial and performance obligations should certainly be given exceptions to this cut-off date. This would recognise that the basis upon which investment and wider commercial decisions have been made will include a reasonable assumption over the future level of embedded benefits. Similarly any plant that is expected to accredit under the Renewables Obligation and which has satisfied relevant eligibility criteria for applicable grace period should be given an exception. Consideration should also be given to the circumstances of plant that may be subject to a municipal waste contract that has been entered into prior to the development of these proposals: whilst some contracts may contain strong Change In Law protections this should not be assumed.</p> <p>iv) or any plant that is contracted under a municipal waste PFI contract prior to this date</p> <p>v) It is agreed that demand behind the meter is unlikely to create a significant loophole or material discrimination risk in relation to CMP264 arrangements in the short term.</p> <p>vi) No comment.</p> <p>vii) No comment.</p>

Q	Question	Response
13	<p>Do you have a view of whether implementation for the 2017/18 Triad season is sufficient to allow changes for:</p> <p>i) supplier contracts and billing system; and</p> <p>ii) ii) for other stakeholders?</p>	
18	<p>Do you have a view if embedded benefits are frozen at a non-zero value, what should that value be as a £/kW tariff (2016/17 value is £45.33 / kW)?</p>	<p>It would be appropriate to freeze benefits at the 2016/17 value of £45.33/kW.</p>

Specific questions for CMP265

Q	Question	Response
11	<p>i) Views are sought on the implication for mixed sites discussed in 3.4.10.</p> <p>ii) Views are sought on the preference of categories of capacity Market CMU captured by this proposal, please indicate your preference from the following list and reasons:</p> <ul style="list-style-type: none"> • All existing and new distribution generation CMUs • All existing and new distribution generation CMUs and DSR CMUs (proven and unproven) • All price maker CMUs • All newbuild/prospective distribution generation CMUs only (defined as >1year contracts) 	<p>No comment.</p>

14	<p>Do you have a view of whether implementation for the 2020/21 Triad season is sufficient to allow changes for i) supplier contracts and billing system, and ii) for other stakeholders?</p>	No comment.
----	--	-------------

Specific questions for BOTH CMP264 & CMP265

Q	Question	Response
9	<p>i) Suppliers: In setting charges for your demand customers, do you charge them at the same tariff as National Grid charges you (i.e. gross), to enable you to pay the embedded benefit to embedded generators, or please explain the way in which it is funded?</p> <p>ii) Suppliers: Does the estimate that 7.58GW of embedded generation output and 2.5GW of demand side reduction at the time of Triad for 2016/17 seem reasonable based on your knowledge of the UK market? If not what is your estimate of embedded generator output and DSR at time of Triad?</p>	No comment.
12	<p>Can you identify – either quantitatively or qualitatively - the impact of the demand TNUoS embedded benefit on your decisions made in making capacity market decisions?</p>	No comment.

Q	Question	Response
15	<p>i) What are your views on the 2 broad options to enable the reporting of gross export metered data?</p> <p>ii) Would you have the data available required for Option B (both CMP264 and CMP265) for both new contracts and existing contracts where a customer may be partially exempt?</p> <p>iii) Do you believe you can implement the proposed changes by the respective implementation dates?</p> <p>iv) What are the pros and cons of the 2 proposals that ELEXON are considering to implement this (P348 for CMP265/ P349 for CMP264)?</p>	No comment.
16	Do you have any further evidence / comments on the consumer impact of changing the demand TNUoS embedded benefit in either the short-run or long-run?	No comment.
17	Do you feel that both the locational and residual component of the demand TNUoS should be removed as an embedded benefit (as CMP264 Original) or just the residual component (as CMP265 Original) or some other method?	In present circumstances it is inappropriate to address removal of either the locational or residual component of demand TNUoS in isolation. A preferred approach would be to consider all aspects of demand TNUoS and related embedded benefits as part of a comprehensive review of network system charging, taking full account of expected developments in system operation, future generation mix and behaviour of demand-side participants. This would best be undertaken as a Significant Code Review.
19	Regarding the proposed alternatives what are your views on the suggested implementation dates? Are these achievable? Please give reasons for your view.	No comment.

CUSC Workgroup Consultation Response Proforma

CMP264 'Embedded Generation Triad Avoidance Standstill' and **CMP265** 'Gross charging of TNUoS for HH demand where Embedded Generation is in the Capacity Market'

Industry parties are invited to respond to this consultation expressing their views and supplying the rationale for those views, particularly in respect of any specific questions detailed below.

Please send your responses by **24th August 2016** to cusc.team@nationalgrid.com Please note that any responses received after the deadline or sent to a different email address may not receive due consideration by the Workgroup.

Any queries on the content of the consultation should be addressed to Caroline Wright at caroline.wright@nationalgrid.com

These responses will be considered by the Workgroup at its next meeting at which members will also consider any Workgroup Consultation Alternative Requests. Where appropriate, the Workgroup will record your response and its consideration of it within the final Workgroup Report which is submitted to the CUSC Modifications Panel.

Respondent:	Martyn Bentley, Planning Manager 0131 514 4445 martyn@greenspanenergy.com
Company Name:	The Greenspan Agency Limited
Please express your views regarding the Workgroup Consultation, including rationale. (Please include any issues, suggestions or queries)	<p>For reference, the Applicable CUSC objectives are:</p> <p>Use of System Charging Methodology</p> <p>(a) that compliance with the use of system charging methodology facilitates effective competition in the generation and supply of electricity and (so far as is consistent therewith) facilitates competition in the sale, distribution and purchase of electricity;</p> <p>(b) that compliance with the use of system charging methodology results in charges which reflect, as far as is reasonably practicable, the costs (excluding any payments between transmission licensees which are made under and in accordance with the STC) incurred by transmission licensees in their transmission businesses and which are compatible with standard condition C26 (Requirements of a connect and manage connection);</p> <p>(c) that, so far as is consistent with sub-paragraphs (a)</p>

	<p>and (b), the use of system charging methodology, as far as is reasonably practicable, properly takes account of the developments in transmission licensees' transmission businesses.</p> <p>(d) Compliance with the Electricity Regulation and any relevant legally binding decision of the European Commission and/or the Agency.</p>
--	---

Standard Workgroup consultation questions – CMP264

Q	Question	Response
1	Do you believe that the CMP264 Original Proposal better facilitates the Applicable CUSC Objectives?	Unsure.
2	Do you support the proposed implementation approach? Or are there any further implementation implications that need to be considered?	No.

3

Do you have any other comments?

We have endeavoured to consider this consultation as best we can before writing our response. However the volume of documents relating to this modification is extremely large and presents a challenge for any interested parties within the time allowed. Therefore, although our comments are general in nature and do not address more technical aspects of the modification and the CUSC, by participating we wish to make all parties aware that we are interested in, and affected by, the process and its outcome.

DECC (now BEIS) published a consultation on a review to the Capacity Market on 1st March year. It is widely considered that the Capacity Market is not providing a sufficiently high auction price for new build transmission generation to be built. This may be the case however we are concerned that the blame is unfairly being squared on embedded generation and the 'embedded benefits' that DECC considers are preventing a 'level playing field' with transmission generation. It appears this has led to efforts being concentrated on issues such as the one in question, Triad benefit, at the expense of other matters that may be of more pressing concern to the CM.

For example, the IPPR published a report in March 2016 titled 'Incapacitated' which shows that the vast majority of the winners in the 2014 and 2015 Capacity Market auctions were existing transmission generators, the majority of whom do not require CM payments to generate. This raises important questions about the extent to which the CM clearing price was reduced by *proposed* embedded generation versus *existing* transmission generation.

Therefore we are concerned that embedded generation is being singled out for scrutiny despite it providing extremely valuable benefits to the electricity system and society as a whole. More energy is being delivered closer to the point of use than ever before. This has reduced energy losses from long-distance transmission. It has reduced GB's dependency on larger, often fossil-fuelled power stations. The increasing proportion of 'fuel-free' renewables such as wind, solar and hydro has reduced the wholesale price of electricity.

A carefully considered review of TNUoS – but more importantly the electricity system as a whole – is sorely needed. It is widely understood in the Industry that TNUoS and the method by which TOs recover their revenue is overdue for a proper review. However, despite being labelled a temporary measure, we are concerned that this modification proposal would endure for too long. It is also poorly timed – the GB electricity system requires new-build supply to come forward as soon as possible.

3	(continued)	<p>Non-intermittent embedded generating capacity such as gas engines are relatively quick to consent, build and commission and so should not be discouraged.</p> <p>Should it be deemed that the Triad benefit must be amended in the short term, we would argue that the reduction should be: temporary, and; shared across all distribution connected generation, rather than being removed solely for new embedded generation.</p> <p>Further general thoughts include the following:</p> <ul style="list-style-type: none"> • Has COMMISSION REGULATION (EU) No 838/2010 been reviewed yet, in accordance with Annex Part B Section 5? Is the 2.5 EURO cap still appropriate? Or is this arbitrary measure undervaluing the contribution transmission generation should be making towards overall transmission system costs? (Instead of the 27:73 split). • The Triad signals between demand and generation should be equal. <p>These modifications should be considered in the context of the wider review of the electricity system proposed by Ofgem in their recent letter. We intend to respond to this also.</p>
---	--------------------	---

4	Do you wish to raise a WG Consultation Alternative Request for the Workgroup to consider?	<i>If yes, please complete a WG Consultation Alternative Request form, available on National Grid's website¹, and return to the CUSC inbox at cusc.team@nationalgrid.com</i>
---	--	---

Standard Workgroup consultation questions – CMP265

Q	Question	Response
5	Do you believe that the CMP265 Original Proposal better facilitates the Applicable CUSC Objectives?	Unsure.

¹ http://www.nationalgrid.com/uk/Electricity/Codes/systemcode/amendments/forms_guidance/

Q	Question	Response
6	Do you support the proposed implementation approach? Or are there any further implementation implications that need to be considered?	No.
7	Do you have any other comments?	Please refer to general comments made under CMP264.
8	Do you wish to raise a WG Consultation Alternative Request for the Workgroup to consider?	<i>If yes, please complete a WG Consultation Alternative Request form, available on National Grid's website², and return to the CUSC inbox at cusc.team@nationalgrid.com</i>

Specific questions for CMP264

Q	Question	Response
---	----------	----------

² http://www.nationalgrid.com/uk/Electricity/Codes/systemcode/amendments/forms_guidance/

Q	Question	Response
10	<p>i) Do you think a cut-off date for “new embedded generation” of 30 June 2017 is appropriate? What other date would you propose?</p> <p>ii) Do you have any views on how mixed sites are being addressed in CMP264 Original?</p> <p>iii) Do you think new-build embedded generation capacity that has entered into long term financial and performance commitment obligations via 2014 and 2015 capacity market or contracts for difference auctions (prior to this modification proposal) should be given exceptions to this cut-off date?</p> <p>iv) Do you agree that ignoring demand behind the meter is unlikely to create a significant “loophole” or material discrimination risk in relation to the CMP264 arrangements in the short term</p> <p>v) Question to suppliers: Do you consider that the wording of your existing contracts allow you to reflect the changes provided by these modifications in a cost reflective manner. For example, these changes will apply to existing PPAs and generators who significantly alter their output (EREC 59).</p> <p>vi) Do you agree with the definition of commissioned and do you agree that it is appropriate? If you do not agree with the definition or that it is appropriate please provide alternative definitions and rationale for this definition.</p>	

Q	Question	Response
13	<p>Do you have a view of whether implementation for the 2017/18 Triad season is sufficient to allow changes for:</p> <p>i) supplier contracts and billing system; and</p> <p>ii) ii) for other stakeholders?</p>	
18	<p>Do you have a view if embedded benefits are frozen at a non-zero value, what should that value be as a £/kW tariff (2016/17 value is £45.33 / kW)?</p>	

Specific questions for CMP265

Q	Question	Response
11	<p>i) Views are sought on the implication for mixed sites discussed in 3.4.10.</p> <p>ii) Views are sought on the preference of categories of capacity Market CMU captured by this proposal, please indicate your preference from the following list and reasons:</p> <ul style="list-style-type: none"> • All existing and new distribution generation CMUs • All existing and new distribution generation CMUs and DSR CMUs (proven and unproven) • All price maker CMUs • All newbuild/prospective distribution generation CMUs only (defined as >1year contracts) 	

14	<p>Do you have a view of whether implementation for the 2020/21 Triad season is sufficient to allow changes for i) supplier contracts and billing system, and ii) for other stakeholders?</p>	
----	--	--

Specific questions for BOTH CMP264 & CMP265

Q	Question	Response
9	<p>i) Suppliers: In setting charges for your demand customers, do you charge them at the same tariff as National Grid charges you (i.e. gross), to enable you to pay the embedded benefit to embedded generators, or please explain the way in which it is funded?</p> <p>ii) Suppliers: Does the estimate that 7.58GW of embedded generation output and 2.5GW of demand side reduction at the time of Triad for 2016/17 seem reasonable based on your knowledge of the UK market? If not what is your estimate of embedded generator output and DSR at time of Triad?</p>	
12	<p>Can you identify – either quantitatively or qualitatively - the impact of the demand TNUoS embedded benefit on your decisions made in making capacity market decisions?</p>	

Q	Question	Response
15	<p>i) What are your views on the 2 broad options to enable the reporting of gross export metered data?</p> <p>ii) Would you have the data available required for Option B (both CMP264 and CMP265) for both new contracts and existing contracts where a customer may be partially exempt?</p> <p>iii) Do you believe you can implement the proposed changes by the respective implementation dates?</p> <p>iv) What are the pros and cons of the 2 proposals that ELEXON are considering to implement this (P348 for CMP265/ P349 for CMP264)?</p>	
16	<p>Do you have any further evidence / comments on the consumer impact of changing the demand TNUoS embedded benefit in either the short-run or long-run?</p>	
17	<p>Do you feel that both the locational and residual component of the demand TNUoS should be removed as an embedded benefit (as CMP264 Original) or just the residual component (as CMP265 Original) or some other method?</p>	
19	<p>Regarding the proposed alternatives what are your views on the suggested implementation dates? Are these achievable? Please give reasons for your view.</p>	

CUSC Workgroup Consultation Response Proforma

CMP264 'Embedded Generation Triad Avoidance Standstill' and **CMP265** 'Gross charging of TNUoS for HH demand where Embedded Generation is in the Capacity Market'

Industry parties are invited to respond to this consultation expressing their views and supplying the rationale for those views, particularly in respect of any specific questions detailed below.

Please send your responses by **24th August 2016** to cusc.team@nationalgrid.com Please note that any responses received after the deadline or sent to a different email address may not receive due consideration by the Workgroup.

Any queries on the content of the consultation should be addressed to Caroline Wright at caroline.wright@nationalgrid.com

These responses will be considered by the Workgroup at its next meeting at which members will also consider any Workgroup Consultation Alternative Requests. Where appropriate, the Workgroup will record your response and its consideration of it within the final Workgroup Report which is submitted to the CUSC Modifications Panel.

Respondent:	Christopher Granby Christopher.Granby@INFINIS.COM Direct dial: 01604 662450
Company Name:	Infinis Energy
Please express your views regarding the Workgroup Consultation, including rationale. (Please include any issues, suggestions or queries)	<p>For reference, the Applicable CUSC objectives are:</p> <p>Use of System Charging Methodology</p> <p>(a) that compliance with the use of system charging methodology facilitates effective competition in the generation and supply of electricity and (so far as is consistent therewith) facilitates competition in the sale, distribution and purchase of electricity;</p> <p>(b) that compliance with the use of system charging methodology results in charges which reflect, as far as is reasonably practicable, the costs (excluding any payments between transmission licensees which are made under and in accordance with the STC) incurred by transmission licensees in their transmission businesses and which are compatible with standard condition C26 (Requirements of a connect and manage connection);</p> <p>(c) that, so far as is consistent with sub-paragraphs (a) and (b), the use of system charging methodology, as far as is reasonably practicable, properly takes account of</p>

	<p>the developments in transmission licensees' transmission businesses.</p> <p>(d) Compliance with the Electricity Regulation and any relevant legally binding decision of the European Commission and/or the Agency.</p>
--	---

Standard Workgroup consultation questions – CMP264

Q	Question	Response
1	Do you believe that the CMP264 Original Proposal better facilitates the Applicable CUSC Objectives?	No – the proposal as is creates a clearly distortive effect between existing and new build embedded generation, therefore impacting objective 1. Exempting all new embedded generation also adversely impacts objective 2 – there are avoided transmission-related costs for embedded generation to connect behind the majority of grid supply points and these are not being reflected by removing all triad embedded benefit.
2	Do you support the proposed implementation approach? Or are there any further implementation implications that need to be considered?	No – we feel the proposed implementation approach significantly distorts the market environment for a number of plant including: <ul style="list-style-type: none"> ▪ a number of plant awarded a capacity market contract ▪ a number of plant awarded a contract-for-difference over the past two years ▪ new build embedded generators at a time of concerns over system security.
3	Do you have any other comments?	Infinis Energy disagrees with the principle of altering the market landscape in order to drive through market signals for a policy tool. While the current level of triads have never been a certainty, removing them altogether for a select number of plant will reduce investor confidence in the market.
4	Do you wish to raise a WG Consultation Alternative Request for the Workgroup to consider?	Yes we have raised two alternatives seeking to implement a more enduring solution to the triad embedded benefit calculation including its current over-valuation. These are attached.

Standard Workgroup consultation questions – CMP265

Q	Question	Response
---	----------	----------

Q	Question	Response
5	Do you believe that the CMP265 Original Proposal better facilitates the Applicable CUSC Objectives?	No – the proposal as is creates a clearly distortive effect between embedded generation awarded a capacity market contract and those without, therefore impacting objective 1. Exempting all plant with a capacity market contract also adversely impacts objective 2 – successful capacity market bidders are not costing transmission owners more in terms of transmission system investment; indeed they are helping manage peak demand.
6	Do you support the proposed implementation approach? Or are there any further implementation implications that need to be considered?	No – we feel the proposed implementation approach massively distorts the market rules within which capacity market providers made their investment decisions and bids into the capacity market. This proposal could affect system security during peak periods.
7	Do you have any other comments?	We disagree with the principle of altering the market landscape in order to drive through market signals for a policy tool. While the current level of triad benefit has been questioned by some market participants for some time, removing them altogether for a select number of plant will reduce investor confidence in the market.
8	Do you wish to raise a WG Consultation Alternative Request for the Workgroup to consider?	See response to question 4.

Specific questions for CMP264

Q	Question	Response
----------	-----------------	-----------------

Q	Question	Response
10	<p>i) Do you think a cut-off date for “new embedded generation” of 30 June 2017 is appropriate? What other date would you propose?</p> <p>ii) Do you have any views on how mixed sites are being addressed in CMP264 Original?</p> <p>iii) Do you think new-build embedded generation capacity that has entered into long term financial and performance commitment obligations via 2014 and 2015 capacity market or contracts for difference auctions (prior to this modification proposal) should be given exceptions to this cut-off date?</p> <p>iv) Do you agree that ignoring demand behind the meter is unlikely to create a significant “loophole” or material discrimination risk in relation to the CMP264 arrangements in the short term</p> <p>v) Question to suppliers: Do you consider that the wording of your existing contracts allow you to reflect the changes provided by these modifications in a cost reflective manner. For example, these changes will apply to existing PPAs and generators who significantly alter their output (EREC 59).</p> <p>vi) Do you agree with the definition of commissioned and do you agree that it is appropriate? If you do not agree with the definition or that it is appropriate please provide alternative definitions and rationale for this definition.</p>	<p>Yes considering the timeframes within which Ofgem is looking to place a solution. However we would recommend some carve out for plant that reached a final investment decision under the current market arrangements (for example plant awarded contracts under the CfD or CM).</p> <p>No views.</p> <p>Yes as outlined in our WACMs to this proposal. Existing CM and CfD contract holders tendered and won contracts based on the existing transmission charging rules. We propose to grandfather the current arrangements for these contract holders to avoid unforeseen losses. The grandfathering period would be a minimum of ten years.</p> <p>Current market conditions incentivise private wire or behind the meter solutions as these can avoid a very significant proportion of a consumer’s costs. However this solution can result in significant investment in network assets in order to deliver electricity between generator and consumer, and this increases with distance between the two. By removing the triad benefit for all new generators, this modification is consequently further pushing embedded generators to locate “behind the meter” or under a private wire solution because it further increases the potential revenue differential between supply over a public network and a private network.</p> <p>N/A</p> <p>Yes.</p>

Q	Question	Response
13	<p>Do you have a view of whether implementation for the 2017/18 Triad season is sufficient to allow changes for:</p> <p>i) supplier contracts and billing system; and</p> <p>ii) ii) for other stakeholders?</p>	<p>As the modification only seeks to remove the triad benefit from new plant, we would expect this to have very little impact on suppliers' systems. The exception being whether they have agreed a PPA or offtake arrangement with a generator ahead of plant commissioning, in which case the supplier would need to have the processes and technology in place to flag said generation as "new" and to exempt them from triad benefits.</p>
18	<p>Do you have a view if embedded benefits are frozen at a non-zero value, what should that value be as a £/kW tariff (2016/17 value is £45.33 / kW)?</p>	<p>If they are to be frozen, triad embedded benefit should be set at a level that is reflective of the avoided costs for the transmission network. We believe that, as a minimum, the value of embedded benefits should be set at:</p> <p>1) the Locational Charge: The existing locational charge as derived each year using ICRP.</p> <p>2) an Avoided Local Reinforcement Charge: An additional credit will be added to the locational element to reflect the saving to the transmission company on infrastructure costs around the GSP.</p> <p>3) an Avoided Wider Reinforcement Charge: A further credit will be added to represent wider network savings. The rationale for the inclusion of this element is contained below and further relevant information is set out in the supporting paper attached to this document.</p> <p>4) TNUoS Generation Residual: The generation residual applied to transmission has reduced substantially and is forecast to become negative in the future. This is likely to lead to further distortions between transmission and distribution connected generation within the energy and capacity markets in the future. To remove this potential distortion, the TNUoS generation residual should be applied to the charge for embedded generation with a negative value treated as an additional credit for embedded generation.</p> <p>We have brought forward two WACMs to this effect.</p>

Q	Question	Response
11	<p>i) Views are sought on the implication for mixed sites discussed in 3.4.10.</p> <p>ii) Views are sought on the preference of categories of capacity Market CMU captured by this proposal, please indicate your preference from the following list and reasons:</p> <ul style="list-style-type: none"> • All existing and new distribution generation CMUs • All existing and new distribution generation CMUs and DSR CMUs (proven and unproven) • All price maker CMUs • All newbuild/prospective distribution generation CMUs only (defined as >1year contracts) 	<p>No views.</p> <p>Not material to Infinis.</p>
14	<p>Do you have a view of whether implementation for the 2020/21 Triad season is sufficient to allow changes for i) supplier contracts and billing system, and ii) for other stakeholders?</p>	<p>Depending on potential date of approval, implementation in 2020-21 provides generators with a reasonable three year grace period. Plant that have already bid into capacity auctions will have factored the triad residual into their bid prices. Without this value these plant may not be constructed, affecting future security of supply.</p>

Specific questions for BOTH CMP264 & CMP265

Q	Question	Response
---	----------	----------

Q	Question	Response
9	<p>i) Suppliers: In setting charges for your demand customers, do you charge them at the same tariff as National Grid charges you (i.e. gross), to enable you to pay the embedded benefit to embedded generators, or please explain the way in which it is funded?</p> <p>ii) Suppliers: Does the estimate that 7.58GW of embedded generation output and 2.5GW of demand side reduction at the time of Triad for 2016/17 seem reasonable based on your knowledge of the UK market? If not what is your estimate of embedded generator output and DSR at time of Triad?</p>	<p>N/A.</p> <p>N/A</p>
12	<p>Can you identify – either quantitatively or qualitatively - the impact of the demand TNUoS embedded benefit on your decisions made in making capacity market decisions?</p>	<p>They are key to our investment decisions, but the schemes we develop do not qualify for the capacity market.</p>

Q	Question	Response
15	<p>i) What are your views on the 2 broad options to enable the reporting of gross export metered data?</p> <p>ii) Would you have the data available required for Option B (both CMP264 and CMP265) for both new contracts and existing contracts where a customer may be partially exempt?</p> <p>iii) Do you believe you can implement the proposed changes by the respective implementation dates?</p> <p>iv) What are the pros and cons of the 2 proposals that ELEXON are considering to implement this (P348 for CMP265/ P349 for CMP264)?</p>	<p>N/A</p> <p>N/A</p>
16	<p>Do you have any further evidence / comments on the consumer impact of changing the demand TNUoS embedded benefit in either the short-run or long-run?</p>	<p>As noted previously, if the suggested modifications were to remove triad benefit for new plant and/ or those with a CM contract, this would further incentivise investors to construct on-site or private wire generation. We believe there are potentially significant impacts from simply removing the triad benefit without wider consideration of the costs currently dealt with by the residual.</p>
17	<p>Do you feel that both the locational and residual component of the demand TNUoS should be removed as an embedded benefit (as CMP264 Original) or just the residual component (as CMP265 Original) or some other method?</p>	<p>The locational aspect should be maintained in order to drive a locational signal to generators. In addition embedded generators should receive an additional amount reflecting their support for the wider system. This might include: an Avoided Local Reinforcement Charge to reflect the saving to the transmission company on infrastructure costs around the GSP; an Avoided Wider Reinforcement Charge to represent wider network savings; and the TNUoS Generation Residual where negative to prevent further market distortion between embedded and transmission-connected plant.</p>
19	<p>Regarding the proposed alternatives what are your views on the suggested implementation dates? Are these achievable? Please give reasons for your view.</p>	<p>No views.</p>

CUSC Workgroup Consultation Response Proforma

CMP264 'Embedded Generation Triad Avoidance Standstill' and **CMP265** 'Gross charging of TNUoS for HH demand where Embedded Generation is in the Capacity Market'

Industry parties are invited to respond to this consultation expressing their views and supplying the rationale for those views, particularly in respect of any specific questions detailed below.

Please send your responses by **24th August 2016** to cusc.team@nationalgrid.com Please note that any responses received after the deadline or sent to a different email address may not receive due consideration by the Workgroup.

Any queries on the content of the consultation should be addressed to Caroline Wright at caroline.wright@nationalgrid.com

These responses will be considered by the Workgroup at its next meeting at which members will also consider any Workgroup Consultation Alternative Requests. Where appropriate, the Workgroup will record your response and its consideration of it within the final Workgroup Report which is submitted to the CUSC Modifications Panel.

Respondent:	<i>James Kendall, LondonWaste Ltd , EcoPark, Advent Way, London N18 3AG email James.Kendall@londonwaste.co.uk, Telephone: 020 8884 5530</i>
Company Name:	<i>LondonWaste Ltd</i>
Please express your views regarding the Workgroup Consultation, including rationale. (Please include any issues, suggestions or queries)	<p>For reference, the Applicable CUSC objectives are:</p> <p>Use of System Charging Methodology</p> <p>(a) that compliance with the use of system charging methodology facilitates effective competition in the generation and supply of electricity and (so far as is consistent therewith) facilitates competition in the sale, distribution and purchase of electricity;</p> <p>(b) that compliance with the use of system charging methodology results in charges which reflect, as far as is reasonably practicable, the costs (excluding any payments between transmission licensees which are made under and in accordance with the STC) incurred by transmission licensees in their transmission businesses and which are compatible with standard condition C26 (Requirements of a connect and manage connection);</p> <p>(c) that, so far as is consistent with sub-paragraphs (a) and (b), the use of system charging methodology, as far</p>

	<p>as is reasonably practicable, properly takes account of the developments in transmission licensees' transmission businesses.</p> <p>(d) Compliance with the Electricity Regulation and any relevant legally binding decision of the European Commission and/or the Agency.</p>
--	---

Standard Workgroup consultation questions – CMP264

Q	Question	Response
1	Do you believe that the CMP264 Original Proposal better facilitates the Applicable CUSC Objectives?	<p>No we do not and we argue that it would do the opposite by reducing competition in generation by creating a barrier to new entry into the generation market in the form of regulatory risk.</p> <p>This proposal seems to be based on the flawed premise that embedded generators (and the demand they offset) are 'using' the transmission system. What was the lowest level of total embedded generation during a triad Settlement Period? As a collective they provide a significant generation base which is "always there" at triad times in the same way the demand they offset is "always there" and so the transmission system has never had to cater for that demand. It cannot be argued that anything more than a minority of such generators are using the transmission system. It might be argued that the embedded generators have stolen this load away – but that is competition which is to be encouraged. The proposal claims that it seeks to "level playing field between new embedded generators and other generation <u>plant</u>", but in fact the effective competition in the long term arises between <u>companies</u> and results from the investment decisions they make. The playing field is already level, because the proposer of CMP264 is quite free to build embedded plants as well as any other company. CMP264 would significantly stifle the building of new embedded plant and thus stifle competition in generation.</p>
2	Do you support the proposed implementation approach? Or are there any further implementation implications that need to be considered?	<p>We do not support this form of approach at all and we believe that the status quo should remain.</p> <p>Clearly when the current arrangements were set up people considered generation and demand reduction to equivalent with respect to the Triad charge. Since then, nothing has fundamentally changed other than the volumes and the price. It would be inappropriate change these long established principle in the rushed manner that has been proposed.</p>

Q	Question	Response
3	Do you have any other comments?	The contorted nature of the proposal is revealed by the proposal that generators commissioned after June 2017 should not be able to avoid paying for NGC's sunk costs while those built before then could.
4	Do you wish to raise a WG Consultation Alternative Request for the Workgroup to consider?	<i>If yes, please complete a WG Consultation Alternative Request form, available on National Grid's website¹, and return to the CUSC inbox at cusc.team@nationalgrid.com</i> No

Standard Workgroup consultation questions – CMP265

Q	Question	Response
5	Do you believe that the CMP265 Original Proposal better facilitates the Applicable CUSC Objectives?	<p>No we do not and we argue that it would do the opposite by reducing competition in generation by creating a barrier to new entry into the generation market in the form of regulatory risk.</p> <p>This proposal seems to be based on the flawed premise that embedded generators (and the demand they offset) are 'using' the transmission system. What was the lowest level of total embedded generation during a triad Settlement Period? As a collective they provide a significant generation base which is "always there" at triad times in the same way the demand they offset is "always there" and so the transmission system has never had to cater for that demand. It cannot be argued that anything more than a minority of such generators are using the transmission system. It might be argued that the embedded generators have stolen this load away – but that is competition which is to be encouraged. The proposal claims that it seeks to "level playing field between new embedded generators and other generation <u>plant</u>", but in fact the effective competition in the long term arises between <u>companies</u> and results from the investment decisions they make. The playing field is already level, because the proposer of CMP265 is quite free to build embedded plants as well as any other company. CMP265 would significantly stifle the building of new embedded plant and thus stifle competition in generation.</p>

¹ http://www.nationalgrid.com/uk/Electricity/Codes/systemcode/amendments/forms_guidance/

Q	Question	Response
6	Do you support the proposed implementation approach? Or are there any further implementation implications that need to be considered?	We do not support this form of approach at all and we believe that the status quo should remain or the transmission charging regime should be overhauled in its entirety. The approach adopted seems to be to address the symptom rather than the cause which is the ever increasing projected triad demand charge in turn at part at least driven by the €2.50 /MWh limit (which of course benefits the class of generators which support these two proposals).
7	Do you have any other comments?	This issue supposedly was triggered by a concern over air quality issues arising from diesel generating plants bidding into the Capacity Market and being over rewarded. However, somehow, that has been taken as an excuse to remove the benefit for all new embedded generators?
8	Do you wish to raise a WG Consultation Alternative Request for the Workgroup to consider?	<i>If yes, please complete a WG Consultation Alternative Request form, available on National Grid's website², and return to the CUSC inbox at cusc.team@nationalgrid.com</i> No

Specific questions for CMP264

Q	Question	Response
---	----------	----------

² http://www.nationalgrid.com/uk/Electricity/Codes/systemcode/amendments/forms_guidance/

Q	Question	Response
10	<p>i) Do you think a cut-off date for “new embedded generation” of 30 June 2017 is appropriate? What other date would you propose?</p> <p>ii) Do you have any views on how mixed sites are being addressed in CMP264 Original?</p> <p>iii) Do you think new-build embedded generation capacity that has entered into long term financial and performance commitment obligations via 2014 and 2015 capacity market or contracts for difference auctions (prior to this modification proposal) should be given exceptions to this cut-off date?</p> <p>iv) Do you agree that ignoring demand behind the meter is unlikely to create a significant “loophole” or material discrimination risk in relation to the CMP264 arrangements in the short term</p> <p>v) Question to suppliers: Do you consider that the wording of your existing contracts allow you to reflect the changes provided by these modifications in a cost reflective manner. For example, these changes will apply to existing PPAs and generators who significantly alter their output (EREC 59).</p> <p>vi) Do you agree with the definition of commissioned and do you agree that it is appropriate? If you do not agree with the definition or that it is appropriate please provide alternative definitions and rationale for this definition</p>	<p>This date would be wholly inappropriate.</p> <p>No, we see the national aggregate embedded generation and national aggregate demand reduction at times of triad as being equivalent from the point of view of the transmission system. A large proportion of the offset is constant (that is at triad times year to year).</p> <p>Yes. Some new build plants will complete after that date and cannot now back out of their projects, including some which will have 15 year Capacity Market obligations to deliver. There will undoubtedly be some plants which would not have entered into 15 year contracts with the Delivery Body had they not also had the benefit of the Embedded Benefit. Such plants could not simply “tear up” their CM contracts as suggested in 3.4.9 as it would not be (and should not be) possible to ‘escape’ the CM contract by simply breaching it. This suggestion must really call into question the seriousness of whoever put forward this comment and their understanding of the situation for CM providers.</p> <p>Yes. For the same reasons we disagree with the proposals we disagree with driving it now to start examining the on-site and private wire arrangements. We see no distinction between reduction of demand and generation.</p> <p>Neutral.</p>

Q	Question	Response
13	<p>Do you have a view of whether implementation for the 2017/18 Triad season is sufficient to allow changes for:</p> <p>i) supplier contracts and billing system; and</p> <p>ii) ii) for other stakeholders?</p>	<p>Neutral</p> <p>This would be a wholly inappropriate timescale for parties to adjust their business plans and risks rushing the consultation process.</p>
18	<p>Do you have a view if embedded benefits are frozen at a non-zero value, what should that value be as a £/kW tariff (2016/17 value is £45.33 / kW)?</p>	<p>This would be the 'least bad' option and might be considered as means of buying time for more thorough consideration of solutions to the perceived problems.</p>

Specific questions for CMP265

Q	Question	Response
11	<p>i) Views are sought on the implication for mixed sites discussed in 3.4.10.</p> <p>ii) Views are sought on the preference of categories of capacity Market CMU captured by this proposal, please indicate your preference from the following list and reasons:</p> <ul style="list-style-type: none"> • All existing and new distribution generation CMUs • All existing and new distribution generation CMUs and DSR CMUs (proven and unproven) • All price maker CMUs • All newbuild/prospective distribution generation CMUs only (defined as >1year contracts) 	<p>This is overly complex and impossible to police.</p> <p>We do not agree to the discrimination against any CM provider. CM providers have in good faith entered into contracts of up to 15 years to provide a service to the total system. They should not now lose a benefit far in excess of the CM payment, just because they are providing e CM service. This proposal is outrageous.</p>

14	<p>Do you have a view of whether implementation for the 2020/21 Triad season is sufficient to allow changes for i) supplier contracts and billing system, and ii) for other stakeholders?</p>	<p>The proposals are not at all acceptable.</p>
----	--	---

Specific questions for BOTH CMP264 & CMP265

Q	Question	Response
9	<p>i) Suppliers: In setting charges for your demand customers, do you charge them at the same tariff as National Grid charges you (i.e. gross), to enable you to pay the embedded benefit to embedded generators, or please explain the way in which it is funded?</p> <p>ii) Suppliers: Does the estimate that 7.58GW of embedded generation output and 2.5GW of demand side reduction at the time of Triad for 2016/17 seem reasonable based on your knowledge of the UK market? If not what is your estimate of embedded generator output and DSR at time of Triad?</p>	
12	<p>Can you identify – either quantitatively or qualitatively - the impact of the demand TNUoS embedded benefit on your decisions made in making capacity market decisions?</p>	<p>Since the embedded benefit to be removed would most likely greatly exceed the TNUoS benefits the TNUoS benefits would always be the dominant consideration.</p>

Q	Question	Response
15	<p>i) What are your views on the 2 broad options to enable the reporting of gross export metered data?</p> <p>ii) Would you have the data available required for Option B (both CMP264 and CMP265) for both new contracts and existing contracts where a customer may be partially exempt?</p> <p>iii) Do you believe you can implement the proposed changes by the respective implementation dates?</p> <p>iv) What are the pros and cons of the 2 proposals that ELEXON are considering to implement this (P348 for CMP265/ P349 for CMP264)?</p>	Neutral
16	Do you have any further evidence / comments on the consumer impact of changing the demand TNUoS embedded benefit in either the short-run or long-run?	Reducing the triad benefit can only serve to reduce embedded generation at triad times and therefore increase net demand on the system and reduce system security. This would ultimately increase total system costs.
17	Do you feel that both the locational and residual component of the demand TNUoS should be removed as an embedded benefit (as CMP264 Original) or just the residual component (as CMP265 Original) or some other method?	Neither should be removed.
19	Regarding the proposed alternatives what are your views on the suggested implementation dates? Are these achievable? Please give reasons for your view.	Neutral

CUSC Workgroup Consultation Response Proforma

CMP264 'Embedded Generation Triad Avoidance Standstill' and **CMP265** 'Gross charging of TNUoS for HH demand where Embedded Generation is in the Capacity Market'

Industry parties are invited to respond to this consultation expressing their views and supplying the rationale for those views, particularly in respect of any specific questions detailed below.

Please send your responses by **24th August 2016** to cusc.team@nationalgrid.com Please note that any responses received after the deadline or sent to a different email address may not receive due consideration by the Workgroup.

Any queries on the content of the consultation should be addressed to Caroline Wright at caroline.wright@nationalgrid.com

These responses will be considered by the Workgroup at its next meeting at which members will also consider any Workgroup Consultation Alternative Requests. Where appropriate, the Workgroup will record your response and its consideration of it within the final Workgroup Report which is submitted to the CUSC Modifications Panel.

Respondent:	Dr Tim Senior, tSenior@octopusinvestments.com
Company Name:	Octopus Investments
<p>Please express your views regarding the Workgroup Consultation, including rationale.</p> <p>(Please include any issues, suggestions or queries)</p>	<p>For reference, the Applicable CUSC objectives are:</p> <p>Use of System Charging Methodology</p> <p>(a) that compliance with the use of system charging methodology facilitates effective competition in the generation and supply of electricity and (so far as is consistent therewith) facilitates competition in the sale, distribution and purchase of electricity;</p> <p>(b) that compliance with the use of system charging methodology results in charges which reflect, as far as is reasonably practicable, the costs (excluding any payments between transmission licensees which are made under and in accordance with the STC) incurred by transmission licensees in their transmission businesses and which are compatible with standard condition C26 (Requirements of a connect and manage connection);</p> <p>(c) that, so far as is consistent with sub-paragraphs (a) and (b), the use of system charging methodology, as far as is reasonably practicable, properly takes account of the developments in transmission licensees' transmission</p>

	<p>businesses.</p> <p>(d) Compliance with the Electricity Regulation and any relevant legally binding decision of the European Commission and/or the Agency.</p>
--	--

Standard Workgroup consultation questions – CMP264

Q	Question	Response
1	<p>Do you believe that the CMP264 Original Proposal better facilitates the Applicable CUSC Objectives?</p>	<p>No. OI considers that this proposal is discriminatory between those generators that are already generating and new entrants. Depending on where the CM closes in future auctions (including December 2016), CMP264 is likely to favour existing embedded generators taking one-year CM contracts that will benefit from continued TRIADs as well as higher CM prices. This would lead to identical capital cost units having different variable costs against which they dispatch. In our view this proposal runs counter to objective (a) above by distorting competition between embedded generators and results in greater costs to consumers overall.</p> <p>This proposal would also have an impact wider than small flexible generators that are the supposed target in order to increase the CM clearing price. Any new generation would be impacted and this particularly includes new renewable generation which is central to the government's efforts to meet the climate change and decarbonisation targets. It would seem perverse that Ofgem would approve a measure that penalises such an important element of the government's energy policy and we believe this should be reflected in the Panel's consideration of this proposed amendment.</p> <p>Further, as stated in the recent Ofgem letter, this measure is designed to specifically disincentivise new embedded generation in favour of large gas turbines. However we do not believe that it is possible to reach a conclusion regarding the composition of the future energy mix without a detailed review. See below for further comment on this point.</p>
2	<p>Do you support the proposed implementation approach? Or are there any further implementation implications that need to be considered?</p>	<p>No, we do not think it is appropriate to simply halt TRIADs during the review or indeed permanently with grandfathering as this proposal would imply absent a review. We consider freezing TRIADs at the current level and undertaking the full planned review is the most appropriate approach.</p>

Q	Question	Response
3	<p>Do you have any other comments?</p>	<p>We believe that Ofgem’s approach of not undertaking its intended Significant Code Review (SCR) is a significant abrogation of its responsibilities. The energy industry has been subject to substantial change in the last few years and innovation is likely to have further material impact over the next 5-10 years, for instance from increased renewables, development of storage, smart grid applications and decarbonisation of transport infrastructure. As such it is not at all clear that promoting one form of generation (CCGT) over others as is indicated in Ofgem’s letter without a full review is tenable.</p> <p>As a result of the absence of an SCR it is not clear how the panel or Ofgem can consider this option as it is predicated as a stop gap pending that review. If the review is no longer occurring we believe that this is no longer a valid modification proposal.</p> <p>We would encourage the panel to consider not just the cost of TRIADs and the claimed negative impact on contracting new large gas generation but also the benefits to the UK system. The current structure of TRIAD regime incentivises 6-10GW of additional capacity to generate during the Winter darkness peak which significantly enhances security of supply and reduces costs for consumers. If TRIADs are removed or limited a substantial proportion of this capacity is likely not to generate as baseload and enter the STOR market instead, causing greater volatility in system prices and higher costs of balancing which will overall be to the detriment of consumers as the higher costs feed through to their bills.</p> <p>The crucial role that embedded generators, incentivised through TRIADs, play in delivering security of supply over the Winter should be considered in the context of DEFRA’s proposals for implementation for the MCPD which would substantially reduce the volume of diesel generation. Without diesel it is even more critical to provide appropriate incentives for gas-fired embedded generators to deliver supply in the peaks. In reviewing all the proposed code modifications related to TRIADs Ofgem should be mindful of the full energy policy landscape rather than making piecemeal changes based on lobbying from interested parties.</p>

Q	Question	Response
		<p>There has been a suggestion from Ofgem that TRIADs cause embedded plants to dispatch out of merit (ie generate when it is not economic for them to do so) as a result of chasing TRIADs. It is not clear where the consumer detriment arises in this behaviour as dampening peak prices offsets the additional cost of TRIADs.</p> <p>Outside of the Winter peak conventional embedded plants have no incentive to dispatch out of merit which limits any negative market impact. Of considerably greater impact on prices and running hours for large conventional plant is the volume of renewable energy that is effectively dispatching out of merit due to its subsidies. Therefore it cannot be suggested that amending the TRIAD regime will create a perfect energy market with all players competing on equal terms nor are conventional embedded generators the primary factor inhibiting the commissioning of new transmission connected plant.</p> <p>This proposal by contrast would deliver significant windfall gains to existing generation, particularly large transmission connected plant that would benefit from higher annual CM clearing prices and higher peak prices, all to the consumer's detriment.</p> <p>All responses below are caveated that we do not believe this proposal is valid in the absence of an SCR and therefore should be struck down or put on hold until Ofgem commits to undertake such a review.</p>
4	<p>Do you wish to raise a WG Consultation Alternative Request for the Workgroup to consider?</p>	<p>No – we support the proposed Greenfrog amendment with a requirement for Ofgem to undertake its intended SCR</p>

Standard Workgroup consultation questions – CMP265

Q	Question	Response
5	<p>Do you believe that the CMP265 Original Proposal better facilitates the Applicable CUSC Objectives?</p>	<p>No. OI considers that this proposal is designed to specifically disincentivise new embedded generation in favour of large gas turbines and therefore is contrary to objective (a) above. However we do not believe that it is possible to reach a conclusion regarding the composition of the future energy mix without a detailed review. The only alternative is to leave it to the market to determine which plants enter. See below for further comment on this point.</p>

Q	Question	Response
6	Do you support the proposed implementation approach? Or are there any further implementation implications that need to be considered?	<p>No. This proposal takes no account of the impact on Winter peak energy supply needs. In the absence of TRIADs 6-10 GW of supply is likely to cease supplying in the Winter evening peak and instead enter STOR. The resulting impact is potentially substantially higher peak pricing plus materially greater costs of balancing services, increasing costs for consumers.</p> <p>Overall this proposal is detrimental to consumers by aiming to increase the cost of the CM and resulting in higher costs of meeting the Winter peak demand.</p>
7	Do you have any other comments?	<p>Our general comments in relation to CMP264 (Q3) also apply here.</p> <p>In addition the impact of this proposal is that even plant that took CM contracts in the 2014 and 2015 auctions may struggle to be constructed. Financing banks have taken comfort from TRIADs as a contracted revenue stream in support of new embedded generation loan facilities. Without TRIADs the plants are reliant on uncertain merchant of balancing services income and financing is substantially harder, if not impossible, to achieve. This will deprive the UK market of the only new dispatchable generation being constructed at a time when supply margins are extremely tight and the growing supply of intermittent renewable generation necessitates increased flexible capacity.</p> <p>This appears to be an entirely self-serving amendment put forward by a large generator so that their large plant(s) are able to clear in the CM. As noted in our comments in relation to CMP264 OI considers that the industry is best served by an SCR undertaken by Ofgem and the freezing of TRIADs in the meantime. CCGTs may well be required but unless and until a full review is undertaken it is not possible to be determinative on this and measures to promote one technology above another should not be implemented.</p>
8	Do you wish to raise a WG Consultation Alternative Request for the Workgroup to consider?	No

Specific questions for CMP264

Q	Question	Response
---	----------	----------

Q	Question	Response
10	<p>i) Do you think a cut-off date for “new embedded generation” of 30 June 2017 is appropriate? What other date would you propose?</p> <p>ii) Do you have any views on how mixed sites are being addressed in CMP264 Original?</p> <p>iii) Do you think new-build embedded generation capacity that has entered into long term financial and performance commitment obligations via 2014 and 2015 capacity market or contracts for difference auctions (prior to this modification proposal) should be given exceptions to this cut-off date?</p> <p>iv) Do you agree that ignoring demand behind the meter is unlikely to create a significant “loophole” or material discrimination risk in relation to the CMP264 arrangements in the short term</p> <p>v) Question to suppliers: Do you consider that the wording of your existing contracts allow you to reflect the changes provided by these modifications in a cost reflective manner. For example, these changes will apply to existing PPAs and generators who significantly alter their output (EREC 59).</p> <p>vi) Do you agree with the definition of commissioned and do you agree that it is appropriate? If you do not agree with the definition or that it is appropriate please provide alternative definitions and rationale for this definition.</p>	<p>No, we support freezing the TRIADs at the current rate during an SCR</p> <p>No</p> <p>No, see answer to (i). Exempting certain CMUs from this measure is entirely random and does not support the objective of facilitating effective competition as there will have been no systematic approach to determining which plants should and should not receive TRIADs</p> <p>Yes, we consider this will create a loophole and do not understand the basis for any discrimination</p> <p>N/A</p> <p>Yes</p>

Q	Question	Response
13	<p>Do you have a view of whether implementation for the 2017/18 Triad season is sufficient to allow changes for:</p> <p>i) supplier contracts and billing system; and</p> <p>ii) ii) for other stakeholders?</p>	<p>We consider that to avoid retrospectively impacting investment the cut-off date should be delayed to allow projects that have reached financial close at the implementation date (ie the date on which Ofgem announces any implementation of this proposal) should be allowed to continue to receive TRIADs. This would give a cut-off date of say 15 months after implementation. Alternatively the financial commitment milestone definition from the CM could be used – all projects meeting the FCM by the cut-off date would retain TRIADs</p>
18	<p>Do you have a view if embedded benefits are frozen at a non-zero value, what should that value be as a £/kW tariff (2016/17 value is £45.33 / kW)?</p>	<p>We believe TRIADs should be frozen at the 2016/17 for all generators, existing and future new build</p>

Specific questions for CMP265

Q	Question	Response
---	----------	----------

11	<p>i) Views are sought on the implication for mixed sites discussed in 3.4.10.</p> <p>ii) Views are sought on the preference of categories of capacity Market CMU captured by this proposal, please indicate your preference from the following list and reasons:</p> <ul style="list-style-type: none"> • All existing and new distribution generation CMUs • All existing and new distribution generation CMUs and DSR CMUs (proven and unproven) • All price maker CMUs • All newbuild/prospective distribution generation CMUs only (defined as >1year contracts) 	<p>We do not have a particular views but consider that all embedded generation should be treated consistently</p> <p>Our first preference is that this proposal is not implemented. However if it is taken forward it should apply equally to all CMUs</p>
14	<p>Do you have a view of whether implementation for the 2020/21 Triad season is sufficient to allow changes for i) supplier contracts and billing system, and ii) for other stakeholders?</p>	<p>We do not have any view on the practicability of implementing changes but consider that a delay until 20/21 for implementation would be sufficient time for market participants to determine the impact and address issues such as bank financing.</p>

Specific questions for BOTH CMP264 & CMP265

Q	Question	Response
---	----------	----------

Q	Question	Response
9	<p>i) Suppliers: In setting charges for your demand customers, do you charge them at the same tariff as National Grid charges you (i.e. gross), to enable you to pay the embedded benefit to embedded generators, or please explain the way in which it is funded?</p> <p>ii) Suppliers: Does the estimate that 7.58GW of embedded generation output and 2.5GW of demand side reduction at the time of Triad for 2016/17 seem reasonable based on your knowledge of the UK market? If not what is your estimate of embedded generator output and DSR at time of Triad?</p>	<p>N/A</p> <p>N/A</p>
12	<p>Can you identify – either quantitatively or qualitatively - the impact of the demand TNUoS embedded benefit on your decisions made in making capacity market decisions?</p>	<p>TRIADs are one revenue stream available to embedded plants which contribute to their overall economics. CM bidding decisions are taken on the basis of the expected total profitability of the plant, so if TRIADs are changed this will be taken into account along with countervailing market impacts which will result from the withdrawal of 6-10GW of embedded capacity from the energy market in the Winter peak and other times of the year</p>

Q	Question	Response
15	<p>i) What are your views on the 2 broad options to enable the reporting of gross export metered data?</p> <p>ii) Would you have the data available required for Option B (both CMP264 and CMP265) for both new contracts and existing contracts where a customer may be partially exempt?</p> <p>iii) Do you believe you can implement the proposed changes by the respective implementation dates?</p> <p>iv) What are the pros and cons of the 2 proposals that ELEXON are considering to implement this (P348 for CMP265/ P349 for CMP264)?</p>	No view on this
16	Do you have any further evidence / comments on the consumer impact of changing the demand TNUoS embedded benefit in either the short-run or long-run?	As detailed in response to Q3 we believe that changing TRIADs will increase the clearing price of the CM and drive much greater volatility and an overall uplift in system prices in the Winter peak. Overall we believe this will be a substantially negative impact on consumers by increasing the costs of power supply. It will also increase the risks of a supply shortfall in the Winter peaks.
17	Do you feel that both the locational and residual component of the demand TNUoS should be removed as an embedded benefit (as CMP264 Original) or just the residual component (as CMP265 Original) or some other method?	We feel that neither should be removed

Q	Question	Response
19	<p>Regarding the proposed alternatives what are your views on the suggested implementation dates? Are these achievable? Please give reasons for your view.</p>	<p>We do not support the Centrica or UKPR proposals and believe that the Greenfrog proposal is the best approach. The implementation dates are achievable on all the proposals except the UKPR option which is not deliverable due to the complexities of its implementation. A consolidated register of CMU that took contracts in the 2014 and 2015 auctions does not currently exist and suppliers and National Grid would need to undertake significant adjustments to their payment/billing systems in order to differentiate between embedded generators based on their CM contract position. We do not believe that this could be achieved by April 2017.</p>

CUSC Workgroup Consultation Response Proforma

CMP264 'Embedded Generation Triad Avoidance Standstill' and **CMP265** 'Gross charging of TNUoS for HH demand where Embedded Generation is in the Capacity Market'

Industry parties are invited to respond to this consultation expressing their views and supplying the rationale for those views, particularly in respect of any specific questions detailed below.

Please send your responses by **24th August 2016** to cusc.team@nationalgrid.com Please note that any responses received after the deadline or sent to a different email address may not receive due consideration by the Workgroup.

Any queries on the content of the consultation should be addressed to Caroline Wright at caroline.wright@nationalgrid.com

These responses will be considered by the Workgroup at its next meeting at which members will also consider any Workgroup Consultation Alternative Requests. Where appropriate, the Workgroup will record your response and its consideration of it within the final Workgroup Report which is submitted to the CUSC Modifications Panel.

Respondent:	Mark Draper, mdraper@peakgen.com , 01926 336 127
Company Name:	Peak Gen Power Ltd
Please express your views regarding the Workgroup Consultation, including rationale. (Please include any issues, suggestions or queries)	<p>The summary of our response is as follows:</p> <ol style="list-style-type: none"> i. Whilst there are defects in the current transmission charging regime it is our view that CMP 264 and CMP 265 have not properly identified them. Given both the complexity and materiality it is appropriate that Ofgem runs a <i>significant code review</i> rather than attempting to patch the symptoms of defecting in the methodology; ii. CMP 265 asserts that there is a defect because embedded benefit distorts power despatch and the capacity market, regardless of the validity of this argument our view is the same issues would exist after CMP 265 and for this reason it should be rejected; iii. Our view is that the CMP 264 would introduce further market distortions. However, the alternate where the residual benefit to embedded generation is frozen at current levels could provide a stop gap solution whilst Ofgem conducts a significant code review; and iv. We are concerned that gross transmission charging would result in users being forced to pay for the costs of the transmission system regardless of if they use it or not (gross charging would result in a GSP with perfectly matched generation and demand which and

therefore did not use the transmission system still being required to pay for this). This would become a tax on users of electricity and as such is a matter for parliament, not the CUSC panel and Ofgem. We assume that a tax to fund the transmission operator would require EU state aid approval. By forcing demand not supplied via the transmission system to pay for it and the use of a revenue cap rather than a price for a volume of service delivered (like most other price controls) appears to be protecting the transmission system from competition.

We set out more general comments and respond to the specific questions below.

Rising residual charge

The residual charge corresponds to the revenue that National Grid is allowed to collect for using (but not operating) its transmission system less the actual income recovered via the locational charge. The locational charge is calculated by working out the distance that an extra MW of power injected at each node (relative to a change in demand on the reference node) on each circuit in the national grid causes. By multiplying the change in load on the circuit by its length the MWkm (Megawatt kilometre) impact can be calculated – this is how many additional MW are carried and by how far. This MWkm figure is then converted to nodal prices by multiplying it by the *expansion constant*, which is the assessed value of the annual cost of enough transmission system to transmit 1MW by 1 kilometre.

We understand that if the reference node is changed, the locational charge changes although the relative difference between nodes remains the same. For this reason, the split between locational and residual element of the charge is arbitrary and difficult to justify charging (or paying) some users only the locational or residual element.

The residual charge is rising because the locational charge is insufficient to recover National Grid's allowed income, and this is partly driven by the falling use of the transmission system. Peak demand has fallen by 9 GW since 2007 (59.5 GW, Dec 2007 to 50.5 GW, Jan 2016)

The expansion constant is calculated based on the cost of overhead line installed by National Grid. Basically the annualised cost of the overhead line divided by the capacity installed and the length of line installed. The expansion constant assumes that overhead line of exactly the right capacity is installed and it is

fully utilised for a 40-year life. Both of these assumptions appear wrong – it is very rare that overhead line capacity is fully utilised (it is natural to install the highest capacity available because the marginal cost is low and the cost of a later upgrade is significant) and changing generation patterns mean that it is highly unlikely that the full capacity of an overhead line will be required year on year. The expansion constant also excludes the cost of transformers (GSP transformers are included in connection charges) and the cost of switchgear. Before adopting one of the proposed modifications we would suggest that the method of assessing the expansion constant is reviewed. A higher expansion constant may increase the location charge and reduce the residual charge; this may correct the defect that Ofgem refers to in its open letter to industry.

We note that the value of embedded benefit is currently around £350 million (figure 8, baseline 2016/17) out of a total residual cost of £2,289 million (table 3, 2016/17, demand residual £2,257.6 million + generation residual £31.8 million). 85% of the residual charge is not related to embedded generation.

Paying demand to reduce in exporting areas gives the wrong pricing signal

Some GSPs export power onto the system, this can be a benefit (if they are in a part of the system that is short of generation) or a disbenefit (if they are in a part of the transmission system that is export constrained). Even if a GSP is importing, reducing the amount that it imports by can make transmission congestion worse if it is in an exporting part of the system.

The transmission charging regime creates an incentive to reduce net demand from a GSP at time of peak even if reducing demand creates higher levels of congestion on the transmission system or precipitates transmission reinforcement. Whilst charging the residual element on a gross basis would reduce the incentive for embedded generation to operate at peak, the incentive for demand to reduce at time of peak remains (and highlights one of the unintended consequences of crating different incentives for demand management and embedded generation despite their impact on the transmission system being the same).

Our initial view is that strengthening the locational signals (and reducing the residual element) would better target this defect. This might be delivered by reviewing the expansion constant.

The residual charge is a “tax” on demand

This view was stated in the consultation report (3.2.18, 3.2.44)

and that the embedded benefit was tax avoidance (3.2.26). TNUoS is the charge made for using the transmission system (*transmission network use of system*), and the amount that a user uses the system is based on the flow that they put on the system. Where a grid supply point contains both generation and demand the amount of flow that the grid supply point imposes on the system is the net of generation and demand. So for a GSP with 500 MW of demand and 200 MW of generation, 300 MW of the transmission system is used, and it is appropriate that the total charges for users in that group should total up to the same charge as 300 MW of demand would incur (because both scenarios use exactly the same amount of transmission). Charging the group for more than 300 MW of flow on the system would result in the group's users paying for more of the transmission system than they are using.

An analogy to gross charging exists in the rail network. The rail network is partially funded by the sale of train tickets, but in addition the government subsidises the rail network funded via general taxation. This means that all tax payers fund the rail system, even if they don't take train. Funding the transmission system from a charge on gross demand (rather than only charging use of system to energy flowing on the transmission network) is the same effect (demand that is supplied without using the transmission system still has to pay for the network). For the rail network, the decisions on subsidies are taken by parliament, not the rail regulator, and are subject to state aid approval (see State aid No N 356/2002

http://ec.europa.eu/competition/state_aid/cases/137131/137131_453400_5_2).

If Ofgem considers that some of the costs of National Grid should be levied as a tax on all power users then we assume that they will make this recommendation to parliament who will decide, and the government will seek the appropriate state aid approval.

Avoidance of Discrimination

Normally when someone stops using a service, they stop paying for it, although there may be a termination period or minimum contract period to allow for the fact that certain investments have been made specific to meeting those customers' needs. This period could be significant if the asset has a significant life and cannot readily be redeployed (as is often the case with transmission infrastructure).

There are three broad ways that transmission system users can cease to use the transmission system:

- i. Demand reduction (a demand customer ceases to or

reducers their take of demand from the system);

- ii. Generation mothball or closure; and
- iii. Demand being met from locally supplied generation rather than through the transmission system.

Under current charging arrangements, each of the three scenarios are treated approximately equally (effectively a year's notice is given and the user stops paying to use the system charge). Introducing gross demand charging appears to introduce a massive discrimination where demand reduction (i) and generation closure (ii) can still cease to pay for the transmission system with a year's notice, but where it is economic to supply demand from local generation rather than use the transmission system (iii) then the demand still has to pay for the transmission system in perpetuity.

Such a change would protect the transmission system and the generation connected to it from competition from locally generated power.

Embedded Generation is causing transmission connected plant to close

Over recent years a significant volume of transmission connected plant has or is closing or has threatened to close. There is a theory that this is because the capacity market cleared at too low a price to either bring forward new build or to invest in coal plant so it can remain operational up to the government's deadline for coal closure in 2025.

If we assume that a key factor driving this was the 2018/19 capacity market, there are three factors more significant than the level of new build embedded generation awarded agreements:

- i. Scottish Power stating that they were going to keep Longannet open outside the capacity market, such that the secretary of state reduced the volume of capacity purchased and then closing the plant following the auction.
- ii. The government deciding to withhold 2,500 MW of capacity from the T-4 auction for potential demand side providers who couldn't guarantee 4 years ahead that they would be able to deliver
- iii. The Trafford CCGT that took on an obligation for a new build transmission connected plant. Again reducing the capacity from existing transmission connected plant with agreements and reducing the clearing price. Carlton Power has stated that it has received a termination notice for its capacity agreement for this

	<p style="text-align: center;">plant¹</p> <p>Small embedded plant fulfils a different role on the system compared to base load coal, gas and nuclear plant. It can be used to provide short notice balancing services such as STOR, Fast Reserve and response as well as support local networks. The CEGB invested in plant for these services (eg Taylors Lane, Cowes). Whilst small scale embedded plant is not the total solution to delivers the countries energy, they form part of an appropriate mix.</p> <p><u>Competition Issues</u></p> <p>Because there is only one transmission licence per area, the transmission system is not exposed to competition from other transmission systems. However, under the current charging regime, it is partially exposed to competition from other technologies (for example, generating electricity locally).</p> <p>Normally when an industry faces competition from a disruptive technology that is undercutting the prices it charges, it responds by cutting prices supported by cost cutting, lower rates of return and write downs on stranded assets. However, for the transmission system the current situation is that use of the transmission system (measured as peak demand) is falling whilst total revenue is rising leading to rapidly rising prices to use the transmission system.</p> <p>In the long term, this appears unsustainable (the incentive to source generation locally rather than pay to use the transmission system continues to rise).</p> <p>The solutions proposed of allowing gross demand charging (so charging for the transmission system regardless of your use of it) combined with the current revenue control, seems designed to protect the transmission system (and the generators connected to it) from competition from locally produced energy, rather than take the harsh decisions that would normally be faced by a company with a rising cost base and a falling demand for its product.</p> <p>Most other regulated industries have a price rather than a revenue control such that if customers use less of their product / service, their revenue falls. A revenue control means that as the use of a company's service falls, its price rises.</p>
--	---

Standard Workgroup consultation questions – CMP264

¹ <http://www.newpower.info/2016/07/trafford-ccgt-faces-capacity-market-contract-termination/>

Q	Question	Response
1	<p>Do you believe that the CMP264 Original Proposal better facilitates the Applicable CUSC Objectives?</p>	<p>No.</p> <p>Given the CUSC objective “that compliance with the charging methodology [for the transmission system] facilitates effective competition in the sale distribution and purchase of electricity”, it would seem reasonable that where a supplier takes energy from a local generator, rather than use the transmission system, the supplier should avoid having to pay the cost of the transmission system.</p> <p>Given the competitive nature of the market, it is also reasonable that the local generator ought to be able to realize a price consistent with the marginal provider (who does have to pay the transmission cost). The current method of charging delivers this principle without creating issues of market power where supply of generation within a GSP is dominated by either a limited number of suppliers or generators.</p> <p>For clarity, this situation is analogous with the provision of fresh vegetables where a local provider competes with international providers. At the supermarket both the locally provided vegetables and the imported providers achieve the same price (assuming an identical product), however the local producer does not incur the cost of international shipping and therefore, if other costs are identical, achieve a higher margin. This modification appears to be suggesting that the local supplier should pay a part of his competitor’s transport fees.</p> <p>We also note that by not using the international shipper, the local supplier is able to avoid the shippers full cost (which includes overheads, return on capital etc.) rather than the shippers marginal cost.</p>
2	<p>Do you support the proposed implementation approach? Or are there any further implementation implications that need to be considered?</p>	<p>If the proposal were to be approved, the suggested implementation approach appears reasonable.</p>
3	<p>Do you have any other comments?</p>	<p>We note that there appear to be defects in the current charging regime and it is appropriate to solve these. Given the complexity of this issues we think that a significant code review should be undertaken and note that an interim solution could have a benefit. Please refer to our general comments to the consultation for details.</p>

Q	Question	Response
4	Do you wish to raise a WG Consultation Alternative Request for the Workgroup to consider?	<p>No.</p> <p><i>It is our view that a Significant Code Review should take place with appropriate modifications raised once a proper overview has been taken.</i></p> <p><i>As an interim solution to allow time to undertake an SCR maintaining embedded benefit at current levels seems most appropriate – we have supported the draft WACM produced by Green Frog et al on this basis.</i></p>

Standard Workgroup consultation questions – CMP265

Q	Question	Response
5	Do you believe that the CMP265 Original Proposal better facilitates the Applicable CUSC Objectives?	<p>No.</p> <p>Under the proposed modification, the “modification is limited to only embedded generation with capacity market contracts”, whilst the defect identified by the proposer relates to the “netting-off of the output of embedded generation ...is causing a distortion to the generation market; to the extent that they run at times of triad, embedded generators are given an artificial advantage over others, which among other effects, distorts the outcome of capacity market tenders”</p> <p>This modification proposal, if approved, would apply from 2020, where the residual tariff is forecast to have risen to around 65 £/kW (stage 02, workgroup consultations, page 17, figure 4). At this level, embedded benefit would be three times the highest price that a capacity market auction has cleared at, and is clearly high enough to justify ongoing investment in new embedded plant without any capacity market payment.</p> <p>We therefore conclude that if this modification were applied, and the forecast level of embedded benefit were correct, embedded plant would simply opt out of the capacity market and continue to run at peak. We assume the volume targeted in the capacity market would be reduced by the level of opted out embedded generation and the capacity market would clear at the same level as if the modification had not been raised.</p> <p>Hence if you accept the defect as specified by the proposer (and please see our initial comments as to why we think this is not correct) the proposed modification would not solve them.</p>

Q	Question	Response
6	Do you support the proposed implementation approach? Or are there any further implementation implications that need to be considered?	If the modification were to be adopted, the proposed solution appears reasonable
7	Do you have any other comments?	Please refer to our opening comments for a full discussion.
8	Do you wish to raise a WG Consultation Alternative Request for the Workgroup to consider?	<p><i>No.</i></p> <p><i>It is our view that a Significant Code Review should take place with appropriate modifications raised once a proper overview has been taken.</i></p> <p><i>As an interim solution to allow time to undertake an SCR maintaining embedded benefit at current levels seems most appropriate.</i></p>

Specific questions for CMP264

Q	Question	Response
---	----------	----------

Q	Question	Response
10	<p>i) Do you think a cut-off date for “new embedded generation” of 30 June 2017 is appropriate? What other date would you propose?</p> <p>ii) Do you have any views on how mixed sites are being addressed in CMP264 Original?</p> <p>iii) Do you think new-build embedded generation capacity that has entered into long term financial and performance commitment obligations via 2014 and 2015 capacity market or contracts for difference auctions (prior to this modification proposal) should be given exceptions to this cut-off date?</p> <p>iv) Do you agree that ignoring demand behind the meter is unlikely to create a significant “loophole” or material discrimination risk in relation to the CMP264 arrangements in the short term</p> <p>v) Question to suppliers: Do you consider that the wording of your existing contracts allow you to reflect the changes provided by these modifications in a cost reflective manner. For example, these changes will apply to existing PPAs and generators who significantly alter their output (EREC 59).</p> <p>vi) Do you agree with the definition of commissioned and do you agree that it is appropriate? If you do not agree with the definition or that it is appropriate please provide alternative definitions and rationale for this definition.</p>	<p>i. Given commitments already entered into and lead times, 1 January 2018 appears more reasonable.</p> <p>ii. We note that most sites considered as generation have ancillary load and therefore are formally mixed sites. We therefore think that it is important that mixed sites are properly addressed.</p> <p>iii. To ensure investor confidence and to deliver security of supply, yes.</p> <p>iv. Provided that this is an interim solution and a short and achievable timetable is set out and followed for a more permanent solution, the loophole will be small.</p> <p>v. NA.</p> <p>vi. Yes – the proposed definition is appropriate</p>

Q	Question	Response
13	<p>Do you have a view of whether implementation for the 2017/18 Triad season is sufficient to allow changes for:</p> <p>i) supplier contracts and billing system; and</p> <p>ii) ii) for other stakeholders?</p>	<p>Given our experience of other changes, this timeline looks challenging.</p>
18	<p>Do you have a view if embedded benefits are frozen at a non-zero value, what should that value be as a £/kW tariff (2016/17 value is £45.33 / kW)?</p>	<p>As an interim solution, this seems appropriate as it reflects the current level that will have been built into most investment and open/close decisions. This level should provide the stability to allow investments to deliver security of supply to be delivered whilst a proper investigation takes place, and to be consistent with investors expectation to date. Therefore, a freeze at the current level of £45.33/kW seems logical.</p>

Specific questions for CMP265

Q	Question	Response
---	----------	----------

11	<p>i) Views are sought on the implication for mixed sites discussed in 3.4.10.</p> <p>ii) Views are sought on the preference of categories of capacity Market CMU captured by this proposal, please indicate your preference from the following list and reasons:</p> <ul style="list-style-type: none"> • All existing and new distribution generation CMUs • All existing and new distribution generation CMUs and DSR CMUs (proven and unproven) • All price maker CMUs • All newbuild/prospective distribution generation CMUs only (defined as >1year contracts) 	<p>i. The proposed solution seems over complex. Given that metering schemes have to be registered for all CMU, then identification of output from capacity market units at time of a triad should be trivial.</p> <p>ii. These definitions seem flawed, and they should presumably relate to a capacity market unit with a capacity market obligation and exclude units that either opted out or were unsuccessful in the auction. Given the capacity market allows for secondary trading of obligations it is unclear how a unit should be treated that only held an obligation for half the winter (and perhaps a single triad day). Again it is difficult to see how this would work if a unit traded part of its obligation. For example, if the unit had a capacity of 20 MW but only held an obligation for 5 MW how would the rest of its capacity be treated? How would such a unit be treated if during a stress event it over delivered and either received an over delivery payment from the capacity market or used an over delivery volume reallocation?</p>
14	<p>Do you have a view of whether implementation for the 2020/21 Triad season is sufficient to allow changes for i) supplier contracts and billing system, and ii) for other stakeholders?</p>	<p>i. No view</p> <p>ii. Such a change could delay/deter investment in new plant in anticipation of the rise of triad benefit in later years, and trigger a capacity crisis.</p>

Specific questions for BOTH CMP264 & CMP265

Q	Question	Response
---	----------	----------

Q	Question	Response
9	<p>i) Suppliers: In setting charges for your demand customers, do you charge them at the same tariff as National Grid charges you (i.e. gross), to enable you to pay the embedded benefit to embedded generators, or please explain the way in which it is funded?</p> <p>ii) Suppliers: Does the estimate that 7.58GW of embedded generation output and 2.5GW of demand side reduction at the time of Triad for 2016/17 seem reasonable based on your knowledge of the UK market? If not what is your estimate of embedded generator output and DSR at time of Triad?</p>	<p>i. NA</p> <p>ii. NA</p>
12	<p>Can you identify – either quantitatively or qualitatively - the impact of the demand TNUoS embedded benefit on your decisions made in making capacity market decisions?</p>	<p>Yes. Capacity market pricing reflects the ranges of income and costs we expect to receive.</p> <p>If different rules had been in place, we would have priced differently. Lower income streams would lead to higher CM pricing.</p> <p>We would assume that transmission connected generation would price higher if generation TNUoS was to rise.</p>

Q	Question	Response
15	<p>i) What are your views on the 2 broad options to enable the reporting of gross export metered data?</p> <p>ii) Would you have the data available required for Option B (both CMP264 and CMP265) for both new contracts and existing contracts where a customer may be partially exempt?</p> <p>iii) Do you believe you can implement the proposed changes by the respective implementation dates?</p> <p>iv) What are the pros and cons of the 2 proposals that ELEXON are considering to implement this (P348 for CMP265/ P349 for CMP264)?</p>	<p>i. Not our area of expertise</p> <p>ii. NA</p> <p>iii. NA</p> <p>iv. Not our area of expertise</p>

Q	Question	Response
16	<p>Do you have any further evidence / comments on the consumer impact of changing the demand TNUoS embedded benefit in either the short-run or long-run?</p>	<p>Changes to transmission charging can and will cause loss of investor confidence resulting in delays and/or cancellations of committed contracts. This could lead to a potential shortage of capacity and again further expensive actions (such as SBR) having to be undertaken by the SO to deliver security of supply</p> <p>If economic embedded generation is removed from the capacity market, then the clearing price will increase (increasing the price paid to existing generators). Inspection of the reports published by National Grid suggests, very approximately, then a 1 GW adjustment of the clearing volume would increase the clearing price by 5 £/kW, assuming that 50 GW of capacity is held the extra cost to the customer would be £250 million per annum. This should be compared to the presented saving in embedded benefit (Stage 2, workgroup consultations, page 43, figure 8) which shows the impact of CMP264 as a saving of £78 million in 2018/19 (465-387).</p> <p>If embedded plant is not running at peak, this might lead to higher peak power prices. However, these are difficult to forecast (and unhedgable, therefore unlikely to appear in lower capacity market bids from generators).</p>
17	<p>Do you feel that both the locational and residual component of the demand TNUoS should be removed as an embedded benefit (as CMP264 Original) or just the residual component (as CMP265 Original) or some other method?</p>	<p>We believe that the removal of the location and / or residual element is incorrect. We have detailed out thinking on other methods in our introduction. We support a review of the value of the locational element of the TNUoS charge which could lead to sharper locational pricing and reduced residual charges.</p>
19	<p>Regarding the proposed alternatives what are your views on the suggested implementation dates? Are these achievable? Please give reasons for your view.</p>	<p>We would suggest that adoption of the Green Frog alternate proposal as an interim solution would provide the appropriate stability that the industry needs to deliver security of supply in the short term, and allow a significant code review to be undertaken.</p>

CUSC Workgroup Consultation Response Proforma

CMP264 'Embedded Generation Triad Avoidance Standstill' and **CMP265** 'Gross charging of TNUoS for HH demand where Embedded Generation is in the Capacity Market'

Industry parties are invited to respond to this consultation expressing their views and supplying the rationale for those views, particularly in respect of any specific questions detailed below.

Please send your responses by **24th August 2016** to cusc.team@nationalgrid.com Please note that any responses received after the deadline or sent to a different email address may not receive due consideration by the Workgroup.

Any queries on the content of the consultation should be addressed to Caroline Wright at caroline.wright@nationalgrid.com

These responses will be considered by the Workgroup at its next meeting at which members will also consider any Workgroup Consultation Alternative Requests. Where appropriate, the Workgroup will record your response and its consideration of it within the final Workgroup Report which is submitted to the CUSC Modifications Panel.

Respondent:	<i>Phil Stephens</i> <i>Direct dial: 07738 026550</i>
Company Name:	<i>Plutus PowerGen ("Plutus")</i>
Please express your views regarding the Workgroup Consultation, including rationale. (Please include any issues, suggestions or queries)	<p>For reference, the Applicable CUSC objectives are:</p> <p>Use of System Charging Methodology</p> <p>(a) that compliance with the use of system charging methodology facilitates effective competition in the generation and supply of electricity and (so far as is consistent therewith) facilitates competition in the sale, distribution and purchase of electricity;</p> <p>(b) that compliance with the use of system charging methodology results in charges which reflect, as far as is reasonably practicable, the costs (excluding any payments between transmission licensees which are made under and in accordance with the STC) incurred by transmission licensees in their transmission businesses and which are compatible with standard condition C26 (Requirements of a connect and manage connection);</p> <p>(c) that, so far as is consistent with sub-paragraphs (a) and (b), the use of system charging methodology, as far as is reasonably practicable, properly takes account of</p>

	<p>the developments in transmission licensees' transmission businesses.</p> <p>(d) Compliance with the Electricity Regulation and any relevant legally binding decision of the European Commission and/or the Agency.</p>
--	---

Standard Workgroup consultation questions – CMP264

Q	Question	Response
1	Do you believe that the CMP264 Original Proposal better facilitates the Applicable CUSC Objectives?	No – the proposal as is creates a clearly distortive effect between existing and new build embedded generation, therefore impacting objective 1. Exempting all new embedded generation also adversely impacts objective 2 – there are avoided transmission-related costs for embedded generation to connect behind the majority of grid supply points and these are not being reflected by removing all of the demand residual embedded benefit.
2	Do you support the proposed implementation approach? Or are there any further implementation implications that need to be considered?	No – we feel the proposed implementation approach significantly distorts the market environment for a number of plant including: <ul style="list-style-type: none"> ▪ a number of plant awarded a capacity market contract ▪ a number of plant awarded a contract-for-difference over the past two years ▪ new build embedded generators at a time of concerns over system security.
3	Do you have any other comments?	<p>Plutus is a developer of standby generation, and an active bidder in the recent CM and forthcoming auctions.</p> <p>We strongly disagree with the principle of altering the market landscape in order to drive through market signals for a policy tool. While the current level of triads have never been a certainty, removing them altogether for a select number of plant will reduce investor confidence in the market.</p> <p>We would also note that the consultation does not address the problems that will arise as and when the generator residual charge turns negative.</p>
4	Do you wish to raise a WG Consultation Alternative Request for the Workgroup to consider?	No but we will support the two alternatives being raised by Infinis seeking to implement a more enduring solution to the triad embedded benefit calculation including its current over-valuation. A much more considered approach than that being pursued on CMP264 and CMP265 is needed with wider impacts taken into account.

Standard Workgroup consultation questions – CMP265

Q	Question	Response
5	Do you believe that the CMP265 Original Proposal better facilitates the Applicable CUSC Objectives?	No – the proposal as is creates a clearly distortive effect between embedded generation awarded a capacity market contract and those without, therefore impacting objective 1. Exempting all plant with a capacity market contract also adversely impacts objective 2 – successful capacity market bidders are not costing transmission owners more in terms of transmission system investment; indeed they are helping manage peak demand.
6	Do you support the proposed implementation approach? Or are there any further implementation implications that need to be considered?	No – we feel the proposed implementation approach massively distorts the market rules within which capacity market providers made their investment decisions and bids into the capacity market. This proposal could affect system security during peak periods.
7	Do you have any other comments?	We disagree with the principle of altering the market landscape in order to drive through market signals for a policy tool. While the current level of triad benefit has been questioned by some market participants for some time, removing them altogether for a select number of plant will reduce investor confidence in the market.
8	Do you wish to raise a WG Consultation Alternative Request for the Workgroup to consider?	See response to question 4.

Specific questions for CMP264

Q	Question	Response
----------	-----------------	-----------------

Q	Question	Response
10	<p>i) Do you think a cut-off date for “new embedded generation” of 30 June 2017 is appropriate? What other date would you propose?</p> <p>ii) Do you have any views on how mixed sites are being addressed in CMP264 Original?</p> <p>iii) Do you think new-build embedded generation capacity that has entered into long term financial and performance commitment obligations via 2014 and 2015 capacity market or contracts for difference auctions (prior to this modification proposal) should be given exceptions to this cut-off date?</p> <p>iv) Do you agree that ignoring demand behind the meter is unlikely to create a significant “loophole” or material discrimination risk in relation to the CMP264 arrangements in the short term</p> <p>v) Question to suppliers: Do you consider that the wording of your existing contracts allow you to reflect the changes provided by these modifications in a cost reflective manner. For example, these changes will apply to existing PPAs and generators who significantly alter their output (EREC 59).</p> <p>vi) Do you agree with the definition of commissioned and do you agree that it is</p>	<p>Any implementation of this proposal should carve plant that reached a final investment decision under the current market arrangements (for example plant awarded contracts under the CfD or CM).</p> <p>No views.</p> <p>Yes, see response to 10 (i) . Existing CM and CfD contract holders tendered and won contracts based on the existing transmission charging rules. We propose to grandfather the current arrangements for these contract holders to avoid unforeseen losses. The grandfathering period would be a minimum of ten years.</p> <p>Current market conditions incentivise private wire or behind the meter solutions as these can avoid a very significant proportion of a consumer’s costs. However this solution can result in significant investment in network assets in order to deliver electricity between generator and consumer, and this increases with distance between the two.</p> <p>By removing the triad benefit for all new generators, this modification is consequently further pushing embedded generators to locate “behind the meter” or under a private wire solution because it further increases the potential revenue differential between supply over a public network and a private network.</p> <p>N/A</p> <p>Yes.</p>

Q	Question	Response
13	<p>Do you have a view of whether implementation for the 2017/18 Triad season is sufficient to allow changes for:</p> <p>i) supplier contracts and billing system; and</p> <p>ii) ii) for other stakeholders?</p>	<p>This is much too quick as all commercial arrangements would need to be reconsidered with supplier offtakers.</p>
18	<p>Do you have a view if embedded benefits are frozen at a non-zero value, what should that value be as a £/kW tariff (2016/17 value is £45.33 / kW)?</p>	<p>If they are to be frozen, triad embedded benefit should be set at a level that is reflective of the avoided costs for the transmission network. We believe that, as a minimum, the value of embedded benefits should be set at:</p> <p>1) the Locational Charge: The existing locational charge as derived each year using ICRP.</p> <p>2) an Avoided Local Reinforcement Charge: An additional credit will be added to the locational element to reflect the saving to the transmission company on infrastructure costs around the GSP.</p> <p>3) an Avoided Wider Reinforcement Charge: A further credit will be added to represent wider network savings.</p> <p>4) TNUoS Generation Residual: The generation residual applied to transmission has reduced substantially and is forecast to become negative in the future. This is likely to lead to further distortions between transmission and distribution connected generation within the energy and capacity markets in the future.</p>

Specific questions for CMP265

Q	Question	Response
---	----------	----------

11	<p>i) Views are sought on the implication for mixed sites discussed in 3.4.10.</p> <p>ii) Views are sought on the preference of categories of capacity Market CMU captured by this proposal, please indicate your preference from the following list and reasons:</p> <ul style="list-style-type: none"> • All existing and new distribution generation CMUs • All existing and new distribution generation CMUs and DSR CMUs (proven and unproven) • All price maker CMUs • All newbuild/prospective distribution generation CMUs only (defined as >1year contracts) 	<p>No views.</p> <p>Price maker CMUs only. They can price their capacity value into their bid. Price takers if they were successful in the auction would simply be rewarded for capacity value they bring to the system (which is not reflected in the triad benefit anyway).</p>
14	<p>Do you have a view of whether implementation for the 2020/21 Triad season is sufficient to allow changes for i) supplier contracts and billing system, and ii) for other stakeholders?</p>	<p>Four years would allow us to adapt our behaviour in future capacity auction rounds. We nevertheless oppose this change.</p>

Specific questions for BOTH CMP264 & CMP265

Q	Question	Response
---	----------	----------

Q	Question	Response
9	<p>i) Suppliers: In setting charges for your demand customers, do you charge them at the same tariff as National Grid charges you (i.e. gross), to enable you to pay the embedded benefit to embedded generators, or please explain the way in which it is funded?</p> <p>ii) Suppliers: Does the estimate that 7.58GW of embedded generation output and 2.5GW of demand side reduction at the time of Triad for 2016/17 seem reasonable based on your knowledge of the UK market? If not what is your estimate of embedded generator output and DSR at time of Triad?</p>	<p>N/A.</p> <p>N/A</p>
12	<p>Can you identify – either quantitatively or qualitatively - the impact of the demand TNUoS embedded benefit on your decisions made in making capacity market decisions?</p>	<p>They are key to our investment decisions. If there is to be change to the current regime, the impact on security of supply needs to be fully considered.</p>

Q	Question	Response
15	<p>i) What are your views on the 2 broad options to enable the reporting of gross export metered data?</p> <p>ii) Would you have the data available required for Option B (both CMP264 and CMP265) for both new contracts and existing contracts where a customer may be partially exempt?</p> <p>iii) Do you believe you can implement the proposed changes by the respective implementation dates?</p> <p>iv) What are the pros and cons of the 2 proposals that ELEXON are considering to implement this (P348 for CMP265/ P349 for CMP264)?</p>	<p>N/A</p> <p>N/A</p>
16	<p>Do you have any further evidence / comments on the consumer impact of changing the demand TNUoS embedded benefit in either the short-run or long-run?</p>	<p>As noted previously, if the suggested modifications were to remove triad benefit for new plant and/ or those with a CM contract, this would further incentivise investors to construct on-site or private wire generation. We believe there are potentially significant impacts from simply removing the triad benefit without wider consideration of the costs currently dealt with by the residual.</p> <p>We also believe that depending on the extent of the cut in the residual, there could be a significant impact on existing and proposed generation. We believe the Working Group should specifically consider the impact on distribution-connected plant economics. If this is out of scope, Ofgem needs to pick this up in its Regulatory Impact Assessment.</p>

Q	Question	Response
17	<p>Do you feel that both the locational and residual component of the demand TNUoS should be removed as an embedded benefit (as CMP264 Original) or just the residual component (as CMP265 Original) or some other method?</p>	<p>The locational aspect should be maintained in order to drive a locational signal to generators.</p> <p>In addition embedded generators should receive an additional amount reflecting their support for the wider system. This might include (as noted in response to question 18): an Avoided Local Reinforcement Charge to reflect the saving to the transmission company on infrastructure costs around the GSP; an Avoided Wider Reinforcement Charge to represent wider network savings; and the TNUoS Generation Residual where negative to prevent further market distortion between embedded and transmission-connected plant.</p>
19	<p>Regarding the proposed alternatives what are your views on the suggested implementation dates? Are these achievable? Please give reasons for your view.</p>	<p>No views.</p>

CUSC Workgroup Consultation Response Proforma

CMP264 'Embedded Generation Triad Avoidance Standstill' and **CMP265** 'Gross charging of TNUoS for HH demand where Embedded Generation is in the Capacity Market'

Industry parties are invited to respond to this consultation expressing their views and supplying the rationale for those views, particularly in respect of any specific questions detailed below.

Please send your responses by **24th August 2016** to cusc.team@nationalgrid.com Please note that any responses received after the deadline or sent to a different email address may not receive due consideration by the Workgroup.

Any queries on the content of the consultation should be addressed to Caroline Wright at caroline.wright@nationalgrid.com

These responses will be considered by the Workgroup at its next meeting at which members will also consider any Workgroup Consultation Alternative Requests. Where appropriate, the Workgroup will record your response and its consideration of it within the final Workgroup Report which is submitted to the CUSC Modifications Panel.

Respondent:	<i>Neil Drake</i> <i>Mob : 07422 677242</i>
Company Name:	<i>Reliance Energy Limited</i>
Please express your views regarding the Workgroup Consultation, including rationale. (Please include any issues, suggestions or queries)	<p>For reference, the Applicable CUSC objectives are:</p> <p>Use of System Charging Methodology</p> <p>(a) that compliance with the use of system charging methodology facilitates effective competition in the generation and supply of electricity and (so far as is consistent therewith) facilitates competition in the sale, distribution and purchase of electricity;</p> <p>(b) that compliance with the use of system charging methodology results in charges which reflect, as far as is reasonably practicable, the costs (excluding any payments between transmission licensees which are made under and in accordance with the STC) incurred by transmission licensees in their transmission businesses and which are compatible with standard condition C26 (Requirements of a connect and manage connection);</p> <p>(c) that, so far as is consistent with sub-paragraphs (a) and (b), the use of system charging methodology, as far as is reasonably practicable, properly takes account of</p>

	<p>the developments in transmission licensees' transmission businesses.</p> <p>(d) Compliance with the Electricity Regulation and any relevant legally binding decision of the European Commission and/or the Agency.</p>
--	---

Standard Workgroup consultation questions – CMP264

Q	Question	Response
1	Do you believe that the CMP264 Original Proposal better facilitates the Applicable CUSC Objectives?	No – the proposal as is creates a clearly distortive effect between existing and new build embedded generation, therefore impacting objective 1. Exempting all new embedded generation also adversely impacts objective 2 – there are avoided transmission-related costs for embedded generation to connect behind the majority of grid supply points and these are not being reflected by removing all of the demand residual embedded benefit.
2	Do you support the proposed implementation approach? Or are there any further implementation implications that need to be considered?	No – we feel the proposed implementation approach significantly distorts the market environment for a number of plant including: <ul style="list-style-type: none"> ▪ a number of plant awarded a capacity market contract ▪ a number of plant awarded a contract-for-difference over the past two years ▪ new build embedded generators at a time of concerns over system security.
3	Do you have any other comments?	REL is a professional services company who work with active developers of low-carbon generation schemes in GB. We strongly disagree with the principle of altering the market landscape in order to drive through market signals for a policy tool. While the current level of triads have never been a certainty, removing them altogether for a select number of plant will reduce investor confidence in the market. We would also note that the consultation does not address the problems that will arise as and when the generator residual charge turns negative.
4	Do you wish to raise a WG Consultation Alternative Request for the Workgroup to consider?	No but we will support the two alternatives being raised by Infinis seeking to implement a more enduring solution to the triad embedded benefit calculation including its current over-valuation. A much more considered approach than that being pursued on CMP264 and CMP265 is needed with wider impacts taken into account.

Standard Workgroup consultation questions – CMP265

Q	Question	Response
5	Do you believe that the CMP265 Original Proposal better facilitates the Applicable CUSC Objectives?	No – the proposal as is creates a clearly distortive effect between embedded generation awarded a capacity market contract and those without, therefore impacting objective 1. Exempting all plant with a capacity market contract also adversely impacts objective 2 – successful capacity market bidders are not costing transmission owners more in terms of transmission system investment; indeed they are helping manage peak demand.
6	Do you support the proposed implementation approach? Or are there any further implementation implications that need to be considered?	No – we feel the proposed implementation approach massively distorts the market rules within which capacity market providers made their investment decisions and bids into the capacity market. This proposal could affect system security during peak periods.
7	Do you have any other comments?	We disagree with the principle of altering the market landscape in order to drive through market signals for a policy tool. While the current level of triad benefit has been questioned by some market participants for some time, removing them altogether for a select number of plant will reduce investor confidence in the market.
8	Do you wish to raise a WG Consultation Alternative Request for the Workgroup to consider?	See response to question 4.

Specific questions for CMP264

Q	Question	Response
----------	-----------------	-----------------

Q	Question	Response
10	<p>i) Do you think a cut-off date for “new embedded generation” of 30 June 2017 is appropriate? What other date would you propose?</p> <p>ii) Do you have any views on how mixed sites are being addressed in CMP264 Original?</p> <p>iii) Do you think new-build embedded generation capacity that has entered into long term financial and performance commitment obligations via 2014 and 2015 capacity market or contracts for difference auctions (prior to this modification proposal) should be given exceptions to this cut-off date?</p> <p>iv) Do you agree that ignoring demand behind the meter is unlikely to create a significant “loophole” or material discrimination risk in relation to the CMP264 arrangements in the short term</p> <p>v) Question to suppliers: Do you consider that the wording of your existing contracts allow you to reflect the changes provided by these modifications in a cost reflective manner. For example, these changes will apply to existing PPAs and generators who significantly alter their output (EREC 59).</p> <p>vi) Do you agree with the definition of commissioned and do you agree that it is</p>	<p>Any implementation of this proposal should carve plant that reached a final investment decision under the current market arrangements (for example plant awarded contracts under the CfD or CM).</p> <p>No views.</p> <p>Yes, see response to 10 (i) . Existing CM and CfD contract holders tendered and won contracts based on the existing transmission charging rules. We propose to grandfather the current arrangements for these contract holders to avoid unforeseen losses. The grandfathering period would be a minimum of ten years.</p> <p>Current market conditions incentivise private wire or behind the meter solutions as these can avoid a very significant proportion of a consumer’s costs. However this solution can result in significant investment in network assets in order to deliver electricity between generator and consumer, and this increases with distance between the two.</p> <p>By removing the triad benefit for all new generators, this modification is consequently further pushing embedded generators to locate “behind the meter” or under a private wire solution because it further increases the potential revenue differential between supply over a public network and a private network.</p> <p>N/A</p> <p>Yes.</p>

Q	Question	Response
13	<p>Do you have a view of whether implementation for the 2017/18 Triad season is sufficient to allow changes for:</p> <p>i) supplier contracts and billing system; and</p> <p>ii) ii) for other stakeholders?</p>	<p>This is much too quick as all commercial arrangements would need to be reconsidered with supplier offtakers.</p>
18	<p>Do you have a view if embedded benefits are frozen at a non-zero value, what should that value be as a £/kW tariff (2016/17 value is £45.33 / kW)?</p>	<p>If they are to be frozen, triad embedded benefit should be set at a level that is reflective of the avoided costs for the transmission network. We believe that, as a minimum, the value of embedded benefits should be set at:</p> <p>1) the Locational Charge: The existing locational charge as derived each year using ICRP.</p> <p>2) an Avoided Local Reinforcement Charge: An additional credit will be added to the locational element to reflect the saving to the transmission company on infrastructure costs around the GSP.</p> <p>3) an Avoided Wider Reinforcement Charge: A further credit will be added to represent wider network savings.</p> <p>4) TNUoS Generation Residual: The generation residual applied to transmission has reduced substantially and is forecast to become negative in the future. This is likely to lead to further distortions between transmission and distribution connected generation within the energy and capacity markets in the future.</p>

Specific questions for CMP265

Q	Question	Response
---	----------	----------

11	<p>i) Views are sought on the implication for mixed sites discussed in 3.4.10.</p> <p>ii) Views are sought on the preference of categories of capacity Market CMU captured by this proposal, please indicate your preference from the following list and reasons:</p> <ul style="list-style-type: none"> • All existing and new distribution generation CMUs • All existing and new distribution generation CMUs and DSR CMUs (proven and unproven) • All price maker CMUs • All newbuild/prospective distribution generation CMUs only (defined as >1year contracts) 	<p>No views.</p> <p>Price maker CMUs only. They can price their capacity value into their bid. Price takers if they were successful in the auction would simply be rewarded for capacity value they bring to the system (which is not reflected in the triad benefit anyway).</p>
14	<p>Do you have a view of whether implementation for the 2020/21 Triad season is sufficient to allow changes for i) supplier contracts and billing system, and ii) for other stakeholders?</p>	<p>Four years would allow us to adapt our behaviour in future capacity auction rounds. We nevertheless oppose this change.</p>

Specific questions for BOTH CMP264 & CMP265

Q	Question	Response
---	----------	----------

Q	Question	Response
9	<p>i) Suppliers: In setting charges for your demand customers, do you charge them at the same tariff as National Grid charges you (i.e. gross), to enable you to pay the embedded benefit to embedded generators, or please explain the way in which it is funded?</p> <p>ii) Suppliers: Does the estimate that 7.58GW of embedded generation output and 2.5GW of demand side reduction at the time of Triad for 2016/17 seem reasonable based on your knowledge of the UK market? If not what is your estimate of embedded generator output and DSR at time of Triad?</p>	<p>N/A.</p> <p>N/A</p>
12	<p>Can you identify – either quantitatively or qualitatively - the impact of the demand TNUoS embedded benefit on your decisions made in making capacity market decisions?</p>	<p>They are key to our investment decisions. If there is to be change to the current regime, the impact on security of supply needs to be fully considered.</p>

Q	Question	Response
15	<p>i) What are your views on the 2 broad options to enable the reporting of gross export metered data?</p> <p>ii) Would you have the data available required for Option B (both CMP264 and CMP265) for both new contracts and existing contracts where a customer may be partially exempt?</p> <p>iii) Do you believe you can implement the proposed changes by the respective implementation dates?</p> <p>iv) What are the pros and cons of the 2 proposals that ELEXON are considering to implement this (P348 for CMP265/ P349 for CMP264)?</p>	<p>N/A</p> <p>N/A</p>
16	<p>Do you have any further evidence / comments on the consumer impact of changing the demand TNUoS embedded benefit in either the short-run or long-run?</p>	<p>As noted previously, if the suggested modifications were to remove triad benefit for new plant and/ or those with a CM contract, this would further incentivise investors to construct on-site or private wire generation. We believe there are potentially significant impacts from simply removing the triad benefit without wider consideration of the costs currently dealt with by the residual.</p> <p>We also believe that depending on the extent of the cut in the residual, there could be a significant impact on existing and proposed generation. We believe the Working Group should specifically consider the impact on distribution-connected plant economics. If this is out of scope, Ofgem needs to pick this up in its Regulatory Impact Assessment.</p>

Q	Question	Response
17	<p>Do you feel that both the locational and residual component of the demand TNUoS should be removed as an embedded benefit (as CMP264 Original) or just the residual component (as CMP265 Original) or some other method?</p>	<p>The locational aspect should be maintained in order to drive a locational signal to generators.</p> <p>In addition embedded generators should receive an additional amount reflecting their support for the wider system. This might include (as noted in response to question 18): an Avoided Local Reinforcement Charge to reflect the saving to the transmission company on infrastructure costs around the GSP; an Avoided Wider Reinforcement Charge to represent wider network savings; and the TNUoS Generation Residual where negative to prevent further market distortion between embedded and transmission-connected plant.</p>
19	<p>Regarding the proposed alternatives what are your views on the suggested implementation dates? Are these achievable? Please give reasons for your view.</p>	<p>No views.</p>

Response: CUSC Workgroup on modifications

CMP 264 & CMP 265

RenewableUK is the UK's leading trade body for the renewable energy sector, representing over 430 organisations across the value chain of the wind, wave, and marine energy industries. Many of our members own and operate renewable energy sources which are connected to the Distribution Networks.

The CUSC Modifications CMP 264 and CMP 265 seek to remove the embedded benefits which many of our members currently receive. RenewableUK believes that a holistic review of both the triad charging process and the embedded benefits methodologies should be carried out in place of either of CMP 264 or CMP 265, and that such a review would best inform all parties as to the best allocation of charges and benefits.

Summary

RenewableUK takes the following general views of CMP 264 & CMP 265:

- Call for a holistic review:
RenewableUK believes that the need for CMP 264 and CMP 265 would be obviated by a thorough and holistic review of the triad system and embedded benefits.
- Revenue issues:
 - Many RenewableUK members who operate variable embedded generation assets report that embedded benefits are a small but significant component of their revenues – being of the order of 5%. The loss of embedded benefits will have an impact on the profitability of many projects.
 - We hold that the CMP 264 proposal to deny embedded benefits to new embedded generators to be an arbitrary and discriminatory decision, introducing an unnecessary asymmetry to the market. The Workgroup, in Paragraph 3.2.10, has noted that: *“it is discriminatory to treat like cases differently”*.
 - CMP 265 also introduces an asymmetry of treatment to the market, which would have to be addressed in the future with a further modification.
 - Both CUSC Mods will, we believe, damage wider investor confidence due to the alterations which they will make to both current and future investors' expected returns from a project, and in particular since the removal of the climate change levy exemption.
- Cost reflectivity:

- We believe that the principle of *cost reflectivity* is inadequately applied by both proposals, as discussed below.
 - It is clear from Table 3 on page 14 of the CUSC Workgroup report that the vast bulk of the demand TNUoS revenues are collected by National Grid via the demand residual component. Paragraph 3.2.18 likens the demand residual amount to a tax: *"The demand residual is therefore a non-locational, non-cost reflective balancing item and may be considered equivalent to a form of taxation with the purpose of raising revenue from demand for sunken costs. In this sense, it is not cost reflective..."*.
 - Were only the locational component of the demand TNUoS revenues to be made available to embedded generation it is clear that these amounts would not represent a fair reflection of the costs to the consumer – from whom the demand TNUoS revenues are collected – of operating the transmission network. The locational element is, by effect if not by design, a redistributive charge. The net costs faced by National Grid in operating the transmission system are recovered from consumers almost entirely by the residual element.
 - RenewableUK believes that it is unfair to restrict embedded generators to only the locational element of embedded benefits as this clearly does not reflect the benefit embedded generators deliver by reducing flows on the transmission network.
 - We are aware, however, of the effects which exporting Grid Supply Points have upon the transmission network, and that such effects are caused when the output from embedded generation exceeds the demand within a particular GSP Group. We do not mean to suggest that in all cases embedded generation acts to improve the flows on the transmission system, however we do suggest that if the system tariff structure is to be used to efficiently place both generation and demand, then that tariff system should be reviewed to properly reflect the costs imposed upon the system at all points.
 - We are supportive of a properly cost reflective system that rewards the efficient placing of distributed generation. This system should be properly evidenced and supported by wide ranging studies which examine, amongst other things, the value which embedded generation brings to the transmission system. Such a study should look at the impacts/benefits of different types of generation and load connecting at all levels of the total electricity system, with a view to identifying charging and benefit signals that encourage the most economic and efficient long term overall outcome for the consumer. Such a study must therefore take into account the cost of electricity generation and system operation in order to be truly holistic.
 - We support the suggestions made in the CUSC Workgroup report from paragraph 3.2.14 onwards that the Project TransmiT methodologies for recalculating both the locational and residual elements should be applied to the demand TNUoS charge.
- Insufficient modeling has been conducted:
 - We believe that an insufficient level of modelling has been conducted by the proposers of these two modifications as well as by the CUSC Workgroup with regards to the true value of embedded generation to the system as a whole. In the rush to push through these modifications to fix a problem with the Capacity Market (implicit in CMP 264 and explicit in CMP 265) an inadequate level of evidence has been presented. Because of the accelerated timetable granted to both CMP 264

and CMP 265 no new analysis has been possible, and, given the significant nature of the changes, this means that the evidence base is insufficient.

- RenewableUK objects to the introduction of gross charging via either CMP 264 or CMP 265, which would create a strong, and, as per the point above, inadequately justified precedent in the market before Ofgem conducts any substantial reviews on embedded benefits or triad charging.
- Asymmetrical treatment of parties:
 - RenewableUK believes that net charging at the distribution level will lead to the most efficient outcomes for the electricity system as a whole, if the network charges are well enough designed to manage the process.
 - We contest the clear restriction of the application of changes to the receipt of embedded benefits to particular classes of embedded generation, whilst not considering the ultimately identical effects of demand side reduction actions or behind-the-meter onsite generation on net demand.
 - Paragraph 2.3.36 notes that: “[a] 1MW reduction in demand or a 1MW increase in embedded generation has the same effect on the net flow observed at the GSP”. Paragraph 3.2.10 acknowledges that this “...is selective discrimination against embedded generators as a subset of demand”. Whilst an accountable financial transaction takes place between a supplier and an embedded generator when embedded production is netted off against demand, it is also the case that the demand TNUoS cost of every reduced MW of consumption must be paid for by the neighbours of the party who reduces their consumption. This is also a form of cost transfer from one demand customer to another, which increases the cost to each remaining demand TNUoS payer in an identical way to the actions of an embedded generator.
 - CMP 264 and CMP 265 are focused, implicitly and explicitly respectively, on fixing a perceived defect in the Capacity Market, and not on tackling the issue of the costs to the consumer for the use of the transmission network. We hold that both mods introduce asymmetries in the treatment of different methods of reducing peak demand which cannot be justified if the rationale for their application is in terms of the reduction of costs to the consumer. As per paragraph 2.3.36, the consumer cannot distinguish between actions which reduce net demand, and in both cases is charged an identical extra amount.
 - We also note that both CMP 264 and CMP 265 apply an asymmetrical treatment of the cost impacts of an increase or decrease in the volume of power drawn from the transmission network. If a demand customer who increases their consumption at peak by 1MW is expected to pay the full TNUoS charge related to that increase, then an embedded generator who reduces the same GSP Group’s net consumption by 1MW during the same peak should get exactly the opposite value as a payment. As noted above, in paragraph 2.3.36, the Workgroup is aware of this asymmetry, and we believe that more justification than has been presented so far is needed to support the rational of these CUSC modifications.

Standard work group questions for CMP264

1. Do you believe that CMP264 Original proposal or either of the associated potential options for change better facilitates the Applicable CUSC Objectives?

- RenewableUK does not believe that the CMP 264 Original proposal facilitates the Applicable CUSC Objectives.
- Nor does RUK believe that either of the Alternative CMP 264 proposals meet these objectives either.
- The objective of enabling “*effective competition*” is undermined with the introduction of an arbitrary distinction between the access to embedded benefits for established and new distributed generators.
- This arbitrary asymmetry does not remedy any misallocation of “*the costs incurred by the transmission licensees*”. Indeed, the open ended nature of CMP 264, with its lack of sunset clause, and considering Ofgem’s apparent disinclination, expressed in its recent letter on the matter, to engage in a full and detailed review of embedded benefits, means that it would bring much uncertainty to the market.
- CMP 264 therefore introduces a further defect to the market, rather than fixing an existing defect, through the arbitrary establishment of a distinction between new and existing generation.
- With regards to the Alternative proposals, both of the suggestions of offering the locational element of the demand TNUoS benefit and either a frozen residual component or an as-yet-to-be defined sum are arbitrary in nature if there is no detailed study of the value of embedded benefits to the system and the nature of the triad system against which to judge them. We restate our view that a holistic review of embedded benefits should be carried out to support any action taken.
- Many of our members object to the lack of grandfathering in any of these proposals, as financial commitments have been made against the existing set of charging arrangements. Were grandfathering to be brought in for the purposes of fairly treating existing parties, it would count against the Centrica alternative modifications, which apply to all generators.

RenewableUK believes that neither CMP 264 nor the several Alternatives proposed in this consultation facilitates the Applicable CUSC Objectives:

- a) CMP 264 does not facilitate effective competition in the generation and supply of electricity because it arbitrarily divides embedded generation into new and existing plant, which will be treated differently even though they may have exactly the same impact on the network.
- b) It is not cost reflective as it creates an uneven playing field for embedded generation.
- c) It does not take account of the developments in the transmission licensees’ transmission businesses.
- d) It has no impact on EU law

2. Do you support the proposed implementation approach for CMP264? Are the suggested implementation timescales suggested for CMP264 appropriate / achievable?

- No, we do not support the implementation approach of CMP 264.

- The Proposal makes no effort to address directly the defects which it lists, namely:
 - uncertainty over the correctly cost-reflective value of embedded benefits to distributed generation which is producing during triad periods;
 - the nature of the triad structure itself;
 - distorted investment decisions, which favour smaller, distribution connected generation over larger, transmission connected generation.
- We disagree with the proposition that CMP 264 is a “proportionate response”.

3. Do you have any other comments for CMP264?

- We believe that CMP 264 was proposed in a rush, without adequate analysis of the effects which halting the provision of embedded benefits would have on the majority of new Distributed Generation projects, many of which may be relying upon embedded benefit income as a key revenue component in order to attain financial close.
- The lack of a sunset clause will deliver only uncertainty to the market, rather than certainty, given Ofgem’s clear disinclination to undertake a full response.
- The arbitrary difference in treatment between new and existing embedded generation, both of which classes, howsoever they are delimited, will have identical impacts on the network, creates another defect which CMP 264 does not solve.

4. Do you wish to raise a Workgroup Consultation Alternative request for the Workgroup to consider for CMP264?

No

Standard work group questions for CMP265

5. Do you believe that CMP265 Original proposal or either of the associated potential options for change better facilitates the Applicable CUSC Objectives?

- No, We do not believe that either the CMP 265 Original proposal or the alternatives facilitate the Applicable CUSC objectives
- RenewableUK does not believe that problems with the Capacity Market, which this modification expressly intends to solve, are best resolved with CUSC modifications absent a broad and holistic review of all related issues, such as the nature of the triad system, the relationship between the locational and residual components of the demand TNUoS charge, and the nature of embedded benefits themselves.

- This CUSC modification does not “*properly [take] account of the developments in transmission licensees’ transmission businesses*”, in that it does not aim to solve any of the underlying problems which it purports to say are causing harm to the outcomes of the Capacity Market.

RenewableUK believes that neither CMP 265 nor the several Alternatives proposed in this consultation facilitates the Applicable CUSC Objectives:

- a) CMP 265 does not facilitate effective competition in the generation and supply of electricity because it arbitrarily divides embedded generation into those with CM contracts and those without, which will be treated differently even though they may have exactly the same impact on the network.
- b) It is not cost reflective as its remedies purport to solve issues with the Capacity Market and not issues arising because of the current shape and scale of the residual component of the demand TNUoS element of embedded benefits. Penalising a participant in one market because of the perceived failures to achieve certain desired outcomes in another market is discriminatory.
- c) It does not take account of the developments in the transmission licensees’ transmission businesses.
- d) It has no impact on EU law

6. Do you support the proposed implementation approach for CMP265? Are the suggested implementation timescales suggested for CMP265 appropriate / achievable?

RenewableUK is concerned with the potential problems which would be faced by mixed sites when renewables and storage – which may seek a Capacity Market contract – are co-located. We believe that this could be many sites in the future. Detailed and careful work will have to be carried out to ensure that equitable treatment is ensured.

7. Do you have any other comments for CMP265?

- We have concerns about the seemingly widely accepted view that the Capacity Market is not achieving certain desired outcomes largely because of the effects of embedded benefits. We are not convinced that this is the case, and no solid evidence has been put forth to justify this point.
- The Government may be concerned about the impact of small gas and diesel generators distorting the Capacity Market auctions, but it is distinctly possible that these technologies’ previous access to various favourable tax schemes have contributed to the distortion to a greater extent.
- We also point out that as “[t]he CM is technology neutral”, according to DECC’s March 2016 Capacity Market consultation, then the technologies which can deliver capacity at the lowest cost to consumers should be winning the auctions. CMP 265 presupposes that the Capacity Market is delivering the ‘wrong’ outcome and needs to be amended to deliver ‘correctly’. There has been no analysis presented which examines the benefits of having

smaller generation units focused on generation mainly at times of system peak, which, were they to be transplanted to the transmission network would need to be larger, and which would impose more costs on the system.

- We raise this to illustrate the lack of evidence presented in the modifications for the demonstration of the whole-system benefits of embedded generation, in terms of the reduction in peak demand, the flattening of demand, or for the reduction in transmission network reinforcement costs.
- We would like to see an analysis of the counterfactual case of delivering the same peak generation capacity from transmission connected plant as is currently supplied over the distribution networks, acting as negative demand.

8. Do you wish to raise a Workgroup Consultation Alternative request for the Workgroup to consider for CMP265?

No

10. CMP 265 standard workgroup questions – components of question 10:

- i) Do you think a cut-off date for “new embedded generation” of 30 June 2017 is appropriate? What other date would you propose?**

RenewableUK is not in a position to comment on this matter.

- ii) Do you have any views on how mixed sites are being addressed in CMP264 Original?**

RenewableUK believes that the issue of mixed sites has not been considered adequately by this Modification proposal. There is neither a remedy applicable to co-located technology types nor to sites with ‘behind the meter’ generation in this proposal.

Both of these forms of site make-up have the potential to have exactly the same net effect on the network as single technology generation sites. RenewableUK is concerned that, as the number of mixed sites increases on the system, the processes will not be in place to deal fairly with their network effects. We encourage greater consideration of the impacts of the various types of mixed sites.

- iii) Do you think new-build embedded generation capacity that has entered into long term financial and performance commitment obligations via 2014 and 2015 capacity market or contracts for difference auctions (prior to this modification proposal) should be given exceptions to this cut-off date?**

RenewableUK is not in a position to comment on this matter.

- iv) Do you agree that ignoring demand behind the meter is unlikely to create a significant “loophole” or material discrimination risk in relation to the CMP264 arrangements in the short term.**

It is a question of fairness. Were CMP 264 to be effected as-is, then there would clearly and automatically be discriminatory treatment between generators connected directly to the distribution network and those connected behind the meter of a demand location. As the physical effects on the network from these two locations would be indistinguishable, it is clear that a defect would have been introduced to the system.

It is not clear, however, whether or not a “loophole” would be introduced in the short term, nor whether indeed it would be exploited. There are no studies against which to assess the possible impacts, so, beyond highlighting the inherent potential conflicts, RenewableUK cannot take anything other than a principled position in this matter.

- v) Question to suppliers: Do you consider that the wording of your existing contracts allow you to reflect the changes provided by these modifications in a cost reflective manner. For example, these changes will apply to existing PPAs and generators who significantly alter their output (EREC 59).**

RenewableUK is not in a position to comment on this matter.

- vi) Do you agree with the definition of commissioned and do you agree that it is appropriate? If you do not agree with the definition or that it is appropriate please provide alternative definitions and rationale for this definition.**

RenewableUK is not in a position to comment on this matter.

- 13. Do you have a view of whether implementation for the 2017/18 Triad season is sufficient to allow changes for:**
- a. supplier contracts and billing system; and**
 - b. for other stakeholders?**

RenewableUK is not in a position to comment on this matter.

18. Do you have a view if embedded benefits are frozen at a non-zero value, what should that value be as a £/kW tariff (2016/17 value is £45.33 / kW)?

RenewableUK is not in a position to comment on this matter.

Specific questions for CMP265

11. Specific questions for CMP265

a. Views are sought on the implication for mixed sites discussed in 3.4.10.

Please see our answer to question 10.ii

b. Views are sought on the preference of categories of capacity Market CMU captured by this proposal, please indicate your preference from the following list and reasons:

i. All existing and new distribution generation CMUs

RenewableUK is not in a position to comment on this matter.

ii. All existing and new distribution generation CMUs and DSR CMUs (proven and unproven)

RenewableUK is not in a position to comment on this matter.

iii. All price maker CMUs

RenewableUK is not in a position to comment on this matter.

iv. All newbuild/prospective distribution generation CMUs only (defined as >1year contracts)

RenewableUK is not in a position to comment on this matter.

14. Do you have a view of whether implementation for the 2020/21 Triad season is sufficient to allow changes for:

a. supplier contracts and billing system, and

RenewableUK is not in a position to comment on this matter.

b. for other stakeholders?

RenewableUK is not in a position to comment on this matter.

Specific questions for both CMP264 and CMP265

9. Specific questions for both CMP264 and CMP265:

- a. Suppliers: In setting charges for your demand customers, do you charge them at the same tariff as National Grid charges you (i.e. gross), to enable you to pay the embedded benefit to embedded generators, or please explain the way in which it is funded?**

RenewableUK is not in a position to comment on this matter.

- b. Suppliers: Does the estimate that 7.58GW of embedded generation output and 2.5GW of demand side reduction at the time of Triad for 2016/17 seem reasonable based on your knowledge of the UK market? If not what is your estimate of embedded generator output and DSR at time of Triad?**

RenewableUK is not in a position to comment on this matter.

12. Can you identify – either quantitatively or qualitatively - the impact of the demand TNUoS embedded benefit on your decisions made in making capacity market decisions?

RenewableUK is not in a position to comment on this matter.

15. Specific questions for both CMP264 and CMP265:

- a. What are your views on the 2 broad options to enable the reporting of gross export metered data?**

RenewableUK is not in a position to comment on this matter.

- b. Would you have the data available required for Option B (both CMP264 and CMP265) for both new contracts and existing contracts where a customer may be partially exempt?**

RenewableUK is not in a position to comment on this matter.

- c. Do you believe you can implement the proposed changes by the respective implementation dates?**

RenewableUK is not in a position to comment on this matter.

- d. What are the pros and cons of the 2 proposals that ELEXON are considering to implement this (P348 for CMP265/ P349 for CMP264)?**

RenewableUK is not in a position to comment on this matter.

16. Do you have any further evidence / comments on the consumer impact of changing the demand TNUoS embedded benefit in either the short-run or long-run?

We refer the reader to RenewableUK's Principles section above, and add here only that the Workgroup has not been permitted to consider in enough detail either the long term or the short term impacts of these CUSC Mods. It is inappropriate to make such material changes to the charging regime on such little evidence and analysis. Paragraph 2.3.37 indicates that the Workgroup has been operating on the assumption that embedded generation contributes 7.5GW of generation (or, via the netting of SVA accounts, reduction in demand) at time of system peak. Too little consideration has been given to the impacts of the loss of portions of this supply in the absence of embedded benefits. We strongly encourage both the Workgroup and Ofgem to conduct in-depth analysis of the impacts/benefits of embedded generation on the system, and to begin a holistic review of the embedded benefits system and all the attendant and associated issues around it.

17. Do you feel that both the locational and residual component of the demand TNUoS should be removed as an embedded benefit (as CMP264 Original) or just the residual component (as CMP265 Original) or some other method?

RenewableUK believes that both the locational and residual components of the demand TNUoS tariff should continue to be paid to embedded generators until such times as the elements of the demand TNUoS tariff are brought into line with the generator TNUoS tariffs via the Project TransmiT methodologies, and until a holistic review of the impacts/benefits of embedded generation is conducted by Ofgem. This way, an assessment of cost reflectivity can be conducted in an evidence-based manner.

19. Regarding the proposed alternatives what are your views on the suggested implementation dates? Are these achievable? Please give reasons for your view.

RenewableUK is not in a position to comment on this matter.

For further information please contact:

Eamonn Bell
RenewableUK policy Manager for Networks & Systems
[E: eamonn.bell@renewableuk.com](mailto:eamonn.bell@renewableuk.com)
T: 020 7901 3029

CUSC Workgroup Consultation Response Proforma

CMP264 'Embedded Generation Triad Avoidance Standstill' and **CMP265** 'Gross charging of TNUoS for HH demand where Embedded Generation is in the Capacity Market'

Industry parties are invited to respond to this consultation expressing their views and supplying the rationale for those views, particularly in respect of any specific questions detailed below.

Please send your responses by **24th August 2016** to cusc.team@nationalgrid.com Please note that any responses received after the deadline or sent to a different email address may not receive due consideration by the Workgroup.

Any queries on the content of the consultation should be addressed to Caroline Wright at caroline.wright@nationalgrid.com

These responses will be considered by the Workgroup at its next meeting at which members will also consider any Workgroup Consultation Alternative Requests. Where appropriate, the Workgroup will record your response and its consideration of it within the final Workgroup Report which is submitted to the CUSC Modifications Panel.

Respondent:	<i>Romain Benquey – Regulatory affairs manager</i> <i>+33658388175</i> <i>romain.benquey@restore.eu</i>
Company Name:	<i>REstore</i>
Please express your views regarding the Workgroup Consultation, including rationale. (Please include any issues, suggestions or queries)	<p>REstore welcomes the opportunity to respond to the consultation for CMP264 and CMP265 under the CUSC process.</p> <p>REstore is a demand-response aggregator active on the whole spectre of reserves, from short term frequency reserves to capacity market.</p> <p>REstore believes that CMP 264 and 265 (would they be implemented) would come with important consequences for the whole market which have not been fully evaluated.</p> <p>REstore supports the fact that a deep revision of the methodology used to recover network charges and on the incentives that are sent to market players should be undertaken. The growing part of residual demand charges is indeed leading to an increasing incentive to develop distribution connected generation assets, and that incentive may be well beyond the real value those capacities bring to the network.</p> <p>REstore therefore supports a revision based on cost-reflectivity and avoidance of any market distortion or discrimination. Market players should receive benefits according to the value they bring to the system. But such a revision can't be done in a rush and will have to involve network charges as a whole.</p> <p>Embedded benefit has been part of the electric system since a</p>

	<p>long time, and reached a level that makes it a significant element of the landscape. Given the importance of the incentives and their impact on the market, REstore also supports the fact that any revision should be deeply analysed and consulted, in order to assess the full consequences of any changes in the way network charges are recovered.</p> <p>Therefore, REstore does not support the two proposals submitted to consultation, given the heavy consequences they will bring, without them being fully known. No element is available to fully understand what all the changes would be if one the two proposal consulted would be implemented.</p> <p>Looking separately at CMP264 and CMP265, the first one at least will not affect existing capacities and could be acceptable for a limited time, while CMP265 is obviously only oriented towards the benefits of transmission generators in CM auctions and does not attempt to bring a solution to the issue.</p> <p>Instead, REstore support a heavy code revision.</p>
--	--

Standard Workgroup consultation questions – CMP264

Q	Question	Response
1	Do you believe that the CMP264 Original Proposal better facilitates the Applicable CUSC Objectives?	No, see introduction.
2	Do you support the proposed implementation approach? Or are there any further implementation implications that need to be considered?	No, see introduction.
3	Do you have any other comments?	While concerning only new built generation assets from 2017, CMP264 would probably have less impacts for the whole market, and in particular would not bring and retroactive change for market players that have already developed capacities based on the existing framework. Still, this could only be a temporary “freeze” of the embedded benefit system, in order to avoid an uncontrolled increase of those capacities, while a deep revision of network charges is undertaken.
4	Do you wish to raise a WG Consultation Alternative Request for the Workgroup to consider?	

Standard Workgroup consultation questions – CMP265

Q	Question	Response
5	Do you believe that the CMP265 Original Proposal better facilitates the Applicable CUSC Objectives?	No, see introduction.
6	Do you support the proposed implementation approach? Or are there any further implementation implications that need to be considered?	No, see introduction.
7	Do you have any other comments?	<p>On the contrary to CMP264, this proposal clearly intends to exclude capacities that benefit from embedded benefit from CM auctions, in order to create more space and value for the transmission connected generators.</p> <p>While embedded benefit may indeed send incentives and revenues that overstep the actual value for the system, and therefore favour some capacities that participate to the CM auctions, REstore does not believe that freezing the embedded benefit for all capacities that participate to CM is a rational and fair solution.</p> <p>Indeed, it will not solve at all the situation from distributed generators that would not participate to CM auctions, since they would still be able to keep the embedded benefit.</p> <p>CMP265 only addresses the distortion created on CM auctions, and not the core of the issue.</p>
8	Do you wish to raise a WG Consultation Alternative Request for the Workgroup to consider?	

Specific questions for CMP264

Q	Question	Response
---	----------	----------

Q	Question	Response
10	<p>i) Do you think a cut-off date for “new embedded generation” of 30 June 2017 is appropriate? What other date would you propose?</p> <p>ii) Do you have any views on how mixed sites are being addressed in CMP264 Original?</p> <p>iii) Do you think new-build embedded generation capacity that has entered into long term financial and performance commitment obligations via 2014 and 2015 capacity market or contracts for difference auctions (prior to this modification proposal) should be given exceptions to this cut-off date?</p> <p>iv) Do you agree that ignoring demand behind the meter is unlikely to create a significant “loophole” or material discrimination risk in relation to the CMP264 arrangements in the short term</p> <p>v) Question to suppliers: Do you consider that the wording of your existing contracts allow you to reflect the changes provided by these modifications in a cost reflective manner. For example, these changes will apply to existing PPAs and generators who significantly alter their output (EREC 59).</p> <p>vi) Do you agree with the definition of commissioned and do you agree that it is appropriate? If you do not agree with the definition or that it is appropriate please provide alternative definitions and rationale for this definition.</p>	

Q	Question	Response
13	<p>Do you have a view of whether implementation for the 2017/18 Triad season is sufficient to allow changes for:</p> <p>i) supplier contracts and billing system; and</p> <p>ii) ii) for other stakeholders?</p>	
18	<p>Do you have a view if embedded benefits are frozen at a non-zero value, what should that value be as a £/kW tariff (2016/17 value is £45.33 / kW)?</p>	

Specific questions for CMP265

Q	Question	Response
11	<p>i) Views are sought on the implication for mixed sites discussed in 3.4.10.</p> <p>ii) Views are sought on the preference of categories of capacity Market CMU captured by this proposal, please indicate your preference from the following list and reasons:</p> <ul style="list-style-type: none"> • All existing and new distribution generation CMUs • All existing and new distribution generation CMUs and DSR CMUs (proven and unproven) • All price maker CMUs • All newbuild/prospective distribution generation CMUs only (defined as >1year contracts) 	

14	<p>Do you have a view of whether implementation for the 2020/21 Triad season is sufficient to allow changes for i) supplier contracts and billing system, and ii) for other stakeholders?</p>	
----	--	--

Specific questions for BOTH CMP264 & CMP265

Q	Question	Response
9	<p>i) Suppliers: In setting charges for your demand customers, do you charge them at the same tariff as National Grid charges you (i.e. gross), to enable you to pay the embedded benefit to embedded generators, or please explain the way in which it is funded?</p> <p>ii) Suppliers: Does the estimate that 7.58GW of embedded generation output and 2.5GW of demand side reduction at the time of Triad for 2016/17 seem reasonable based on your knowledge of the UK market? If not what is your estimate of embedded generator output and DSR at time of Triad?</p>	
12	<p>Can you identify – either quantitatively or qualitatively - the impact of the demand TNUoS embedded benefit on your decisions made in making capacity market decisions?</p>	

Q	Question	Response
15	<p>i) What are your views on the 2 broad options to enable the reporting of gross export metered data?</p> <p>ii) Would you have the data available required for Option B (both CMP264 and CMP265) for both new contracts and existing contracts where a customer may be partially exempt?</p> <p>iii) Do you believe you can implement the proposed changes by the respective implementation dates?</p> <p>iv) What are the pros and cons of the 2 proposals that ELEXON are considering to implement this (P348 for CMP265/ P349 for CMP264)?</p>	
16	<p>Do you have any further evidence / comments on the consumer impact of changing the demand TNUoS embedded benefit in either the short-run or long-run?</p>	
17	<p>Do you feel that both the locational and residual component of the demand TNUoS should be removed as an embedded benefit (as CMP264 Original) or just the residual component (as CMP265 Original) or some other method?</p>	
19	<p>Regarding the proposed alternatives what are your views on the suggested implementation dates? Are these achievable? Please give reasons for your view.</p>	

CUSC Workgroup Consultation Response Proforma

CMP264 'Embedded Generation Triad Avoidance Standstill' and **CMP265** 'Gross charging of TNUoS for HH demand where Embedded Generation is in the Capacity Market'

Industry parties are invited to respond to this consultation expressing their views and supplying the rationale for those views, particularly in respect of any specific questions detailed below.

Please send your responses by **24th August 2016** to cusc.team@nationalgrid.com Please note that any responses received after the deadline or sent to a different email address may not receive due consideration by the Workgroup.

Any queries on the content of the consultation should be addressed to Caroline Wright at caroline.wright@nationalgrid.com

These responses will be considered by the Workgroup at its next meeting at which members will also consider any Workgroup Consultation Alternative Requests. Where appropriate, the Workgroup will record your response and its consideration of it within the final Workgroup Report which is submitted to the CUSC Modifications Panel.

Respondent:	<i>Andrew Green/ Tristan Evans</i> 0207 015 2158
Company Name:	<i>Rockpool Investments ("Rockpool")</i>
Please express your views regarding the Workgroup Consultation, including rationale. (Please include any issues, suggestions or queries)	<p>For reference, the Applicable CUSC objectives are:</p> <p>Use of System Charging Methodology</p> <p>(a) that compliance with the use of system charging methodology facilitates effective competition in the generation and supply of electricity and (so far as is consistent therewith) facilitates competition in the sale, distribution and purchase of electricity;</p> <p>(b) that compliance with the use of system charging methodology results in charges which reflect, as far as is reasonably practicable, the costs (excluding any payments between transmission licensees which are made under and in accordance with the STC) incurred by transmission licensees in their transmission businesses and which are compatible with standard condition C26 (Requirements of a connect and manage connection);</p> <p>(c) that, so far as is consistent with sub-paragraphs (a) and (b), the use of system charging methodology, as far as is reasonably practicable, properly takes account of</p>

	<p>the developments in transmission licensees' transmission businesses.</p> <p>(d) Compliance with the Electricity Regulation and any relevant legally binding decision of the European Commission and/or the Agency.</p>
--	---

Standard Workgroup consultation questions – CMP264

Q	Question	Response
1	Do you believe that the CMP264 Original Proposal better facilitates the Applicable CUSC Objectives?	No – the proposal as is creates a clearly distortive effect between existing and new build embedded generation, therefore impacting objective 1. Exempting all new embedded generation also adversely impacts objective 2 – there are avoided transmission-related costs for embedded generation to connect behind the majority of grid supply points and these are not being reflected by removing all of the demand residual embedded benefit.
2	Do you support the proposed implementation approach? Or are there any further implementation implications that need to be considered?	No – we feel the proposed implementation approach significantly distorts the market environment for a number of plant including: <ul style="list-style-type: none"> ▪ a number of plant awarded a capacity market contract ▪ a number of plant awarded a contract-for-difference over the past two years ▪ new build embedded generators at a time of concerns over system security.
3	Do you have any other comments?	<p>Rockpool is an independent investment firm dedicated to creating direct private company investment opportunities for individuals. We are actively investing in a portfolio of companies that are designed to provide standby power to the GB electricity system, and the current projects will all be distribution-connected. Their viability will be directly impacted by the outcome of the process for considering these modifications and their respective alternatives.</p> <p>We strongly disagree with the principle of altering the market landscape in order to drive through market signals for a policy tool. While the current level of triads have never been a certainty, removing them altogether for a select number of plant will reduce investor confidence in the market.</p> <p>We would also note that the consultation does not address the problems that will arise as and when the generator residual charge turns negative.</p>

Q	Question	Response
4	Do you wish to raise a WG Consultation Alternative Request for the Workgroup to consider?	No but we will support the two alternatives being raised by Infinis seeking to implement a more enduring solution to the triad embedded benefit calculation including its current over-valuation. A much more considered approach than that being pursued on CMP264 and CMP265 is needed with wider impacts taken into account.

Standard Workgroup consultation questions – CMP265

Q	Question	Response
5	Do you believe that the CMP265 Original Proposal better facilitates the Applicable CUSC Objectives?	No – the proposal as is creates a clearly distortive effect between embedded generation awarded a capacity market contract and those without, therefore impacting objective 1. Exempting all plant with a capacity market contract also adversely impacts objective 2 – successful capacity market bidders are not costing transmission owners more in terms of transmission system investment; indeed they are helping manage peak demand.
6	Do you support the proposed implementation approach? Or are there any further implementation implications that need to be considered?	No – we feel the proposed implementation approach massively distorts the market rules within which capacity market providers made their investment decisions and bids into the capacity market. This proposal could affect system security during peak periods.
7	Do you have any other comments?	We disagree with the principle of altering the market landscape in order to drive through market signals for a policy tool. While the current level of triad benefit has been questioned by some market participants for some time, removing them altogether for a select number of plant will reduce investor confidence in the market.
8	Do you wish to raise a WG Consultation Alternative Request for the Workgroup to consider?	See response to question 4.

Specific questions for CMP264

Q	Question	Response
----------	-----------------	-----------------

Q	Question	Response
10	<p>i) Do you think a cut-off date for “new embedded generation” of 30 June 2017 is appropriate? What other date would you propose?</p> <p>ii) Do you have any views on how mixed sites are being addressed in CMP264 Original?</p> <p>iii) Do you think new-build embedded generation capacity that has entered into long term financial and performance commitment obligations via 2014 and 2015 capacity market or contracts for difference auctions (prior to this modification proposal) should be given exceptions to this cut-off date?</p> <p>iv) Do you agree that ignoring demand behind the meter is unlikely to create a significant “loophole” or material discrimination risk in relation to the CMP264 arrangements in the short term</p> <p>v) Question to suppliers: Do you consider that the wording of your existing contracts allow you to reflect the changes provided by these modifications in a cost reflective manner. For example, these changes will apply to existing PPAs and generators who significantly alter their output (EREC 59).</p> <p>vi) Do you agree with the definition of commissioned and do you agree that it is</p>	<p>Any implementation of this proposal should carve plant that reached a final investment decision under the current market arrangements (for example plant awarded contracts under the CfD or CM).</p> <p>No views.</p> <p>Yes, see response to 10 (i) . Existing CM and CfD contract holders tendered and won contracts based on the existing transmission charging rules. We propose to grandfather the current arrangements for these contract holders to avoid unforeseen losses. The grandfathering period would be a minimum of ten years.</p> <p>Current market conditions incentivise private wire or behind the meter solutions as these can avoid a very significant proportion of a consumer’s costs. However this solution can result in significant investment in network assets in order to deliver electricity between generator and consumer, and this increases with distance between the two.</p> <p>By removing the triad benefit for all new generators, this modification is consequently further pushing embedded generators to locate “behind the meter” or under a private wire solution because it further increases the potential revenue differential between supply over a public network and a private network.</p> <p>N/A</p> <p>Yes.</p>

Q	Question	Response
13	<p>Do you have a view of whether implementation for the 2017/18 Triad season is sufficient to allow changes for:</p> <p>i) supplier contracts and billing system; and</p> <p>ii) ii) for other stakeholders?</p>	<p>This is much too quick as all commercial arrangements would need to be reconsidered with supplier offtakers.</p>
18	<p>Do you have a view if embedded benefits are frozen at a non-zero value, what should that value be as a £/kW tariff (2016/17 value is £45.33 / kW)?</p>	<p>If they are to be frozen, triad embedded benefit should be set at a level that is reflective of the avoided costs for the transmission network. We believe that, as a minimum, the value of embedded benefits should be set at:</p> <p>1) the Locational Charge: The existing locational charge as derived each year using ICRP.</p> <p>2) an Avoided Local Reinforcement Charge: An additional credit will be added to the locational element to reflect the saving to the transmission company on infrastructure costs around the GSP.</p> <p>3) an Avoided Wider Reinforcement Charge: A further credit will be added to represent wider network savings.</p> <p>4) TNUoS Generation Residual: The generation residual applied to transmission has reduced substantially and is forecast to become negative in the future. This is likely to lead to further distortions between transmission and distribution connected generation within the energy and capacity markets in the future.</p>

Specific questions for CMP265

Q	Question	Response
---	----------	----------

11	<p>i) Views are sought on the implication for mixed sites discussed in 3.4.10.</p> <p>ii) Views are sought on the preference of categories of capacity Market CMU captured by this proposal, please indicate your preference from the following list and reasons:</p> <ul style="list-style-type: none"> • All existing and new distribution generation CMUs • All existing and new distribution generation CMUs and DSR CMUs (proven and unproven) • All price maker CMUs • All newbuild/prospective distribution generation CMUs only (defined as >1year contracts) 	<p>No views.</p> <p>Price maker CMUs only. They can price their capacity value into their bid. Price takers if they were successful in the auction would simply be rewarded for capacity value they bring to the system (which is not reflected in the triad benefit anyway).</p>
14	<p>Do you have a view of whether implementation for the 2020/21 Triad season is sufficient to allow changes for i) supplier contracts and billing system, and ii) for other stakeholders?</p>	<p>Four years would allow us to adapt our behaviour in future capacity auction rounds. We nevertheless oppose this change.</p>

Specific questions for BOTH CMP264 & CMP265

Q	Question	Response
---	----------	----------

Q	Question	Response
9	<p>i) Suppliers: In setting charges for your demand customers, do you charge them at the same tariff as National Grid charges you (i.e. gross), to enable you to pay the embedded benefit to embedded generators, or please explain the way in which it is funded?</p> <p>ii) Suppliers: Does the estimate that 7.58GW of embedded generation output and 2.5GW of demand side reduction at the time of Triad for 2016/17 seem reasonable based on your knowledge of the UK market? If not what is your estimate of embedded generator output and DSR at time of Triad?</p>	<p>N/A.</p> <p>N/A</p>
12	<p>Can you identify – either quantitatively or qualitatively - the impact of the demand TNUoS embedded benefit on your decisions made in making capacity market decisions?</p>	<p>They are key to our investment decisions. If there is to be change to the current regime, the impact on security of supply needs to be fully considered.</p>

Q	Question	Response
15	<p>i) What are your views on the 2 broad options to enable the reporting of gross export metered data?</p> <p>ii) Would you have the data available required for Option B (both CMP264 and CMP265) for both new contracts and existing contracts where a customer may be partially exempt?</p> <p>iii) Do you believe you can implement the proposed changes by the respective implementation dates?</p> <p>iv) What are the pros and cons of the 2 proposals that ELEXON are considering to implement this (P348 for CMP265/ P349 for CMP264)?</p>	<p>N/A</p> <p>N/A</p>
16	<p>Do you have any further evidence / comments on the consumer impact of changing the demand TNUoS embedded benefit in either the short-run or long-run?</p>	<p>As noted previously, if the suggested modifications were to remove triad benefit for new plant and/ or those with a CM contract, this would further incentivise investors to construct on-site or private wire generation. We believe there are potentially significant impacts from simply removing the triad benefit without wider consideration of the costs currently dealt with by the residual.</p> <p>We also believe that depending on the extent of the cut in the residual, there could be a significant impact on existing and proposed generation. We believe the Working Group should specifically consider the impact on distribution-connected plant economics. If this is out of scope, Ofgem needs to pick this up in its Regulatory Impact Assessment.</p>

Q	Question	Response
17	<p>Do you feel that both the locational and residual component of the demand TNUoS should be removed as an embedded benefit (as CMP264 Original) or just the residual component (as CMP265 Original) or some other method?</p>	<p>The locational aspect should be maintained in order to drive a locational signal to generators.</p> <p>In addition embedded generators should receive an additional amount reflecting their support for the wider system. This might include (as noted in response to question 18): an Avoided Local Reinforcement Charge to reflect the saving to the transmission company on infrastructure costs around the GSP; an Avoided Wider Reinforcement Charge to represent wider network savings; and the TNUoS Generation Residual where negative to prevent further market distortion between embedded and transmission-connected plant.</p>
19	<p>Regarding the proposed alternatives what are your views on the suggested implementation dates? Are these achievable? Please give reasons for your view.</p>	<p>No views.</p>

CMP264 ‘Embedded Generation Triad Avoidance Standstill’ and **CMP265** ‘Gross charging of TNUoS for HH demand where Embedded Generation is in the Capacity Market’

Industry parties are invited to respond to this consultation expressing their views and supplying the rationale for those views, particularly in respect of any specific questions detailed below.

Please send your responses by **24th August 2016** to cusc.team@nationalgrid.com Please note that any responses received after the deadline or sent to a different email address may not receive due consideration by the Workgroup.

Any queries on the content of the consultation should be addressed to Caroline Wright at caroline.wright@nationalgrid.com

These responses will be considered by the Workgroup at its next meeting at which members will also consider any Workgroup Consultation Alternative Requests. Where appropriate, the Workgroup will record your response and its consideration of it within the final Workgroup Report which is submitted to the CUSC Modifications Panel.

<p>Respondent:</p>	<p><i>Fruzsina Kemenes</i> <i>Fruzsina.kemenes@rwe.com</i></p>
<p>Company Name:</p>	<p><i>RWE Innogy UK- RWE npower joint submission</i></p>
<p>Please express your views regarding the Workgroup Consultation, including rationale. (Please include any issues, suggestions or queries)</p>	<p>For reference, the Applicable CUSC objectives are:</p> <p>Use of System Charging Methodology</p> <p>(a) that compliance with the use of system charging methodology facilitates effective competition in the generation and supply of electricity and (so far as is consistent therewith) facilitates competition in the sale, distribution and purchase of electricity;</p> <p>(b) that compliance with the use of system charging methodology results in charges which reflect, as far as is reasonably practicable, the costs (excluding any payments between transmission licensees which are made under and in accordance with the STC) incurred by transmission licensees in their transmission businesses and which are compatible with standard condition C26 (Requirements of a connect and manage connection);</p> <p>(c) that, so far as is consistent with sub-paragraphs (a) and (b), the use of system charging methodology, as far as is reasonably practicable, properly takes account of the developments in transmission licensees' transmission businesses.</p>

	(d) Compliance with the Electricity Regulation and any relevant legally binding decision of the European Commission and/or the Agency.
--	--

Standard Workgroup consultation questions – CMP264

Q	Question	Response
1	<p>Do you believe that the CMP264 Original Proposal better facilitates the Applicable CUSC Objectives?</p>	<p>No, on balance it does not better facilitate the CUSC Objectives.</p> <p>CMP 264 could prevent any new directly DNO connected embedded CM party factoring in the benefit of net metering into their bids in future auction rounds. However, the overall impact of CMP264 is that it is detrimental to competition in the energy market. CMP264 introduces a new Defect. It introduces undue discrimination in the treatment of ‘new’ and ‘old’ generation. The network impact of both new and old embedded generation is the same, differential charging treatment is unjustified and discriminatory.</p> <p>Also, CMP264 does not actually propose a solution that reflects the costs/benefits of embedded generation on the network. The Proposer established that the defect is that the level of Triad Avoidance signals are too high because the Triad Avoidance signal is not cost reflective in terms of the transmission reinforcement avoided by reducing flows from the transmission system to meet demand. The Modification has very limited impact on the Triad Avoidance signal for ‘old’ embedded generation and does not actually put forward a cost reflective methodology for ‘new’ embedded generation either.</p> <p>CMP264 has the following impact on the CUSC objectives:</p> <ul style="list-style-type: none"> a) Does not facilitate better competition, as different rules for different Embedded Generators. (old vs new) b) Not cost reflective as the defect raised has not been addressed c) Neutral on developments in the transmission licensees' transmission businesses d) Neutral on EU <p>Overall CMP264 fails to address the defect that the Proposer identifies and it introduces a New Defect of discrimination.</p>

Q	Question	Response
2	<p>Do you support the proposed implementation approach? Or are there any further implementation implications that need to be considered?</p>	<p>No we do not support the suggested implementation approach.</p> <p>The proposed date of introduction: April 2017 is unacceptable for the following reasons:</p> <ul style="list-style-type: none"> - this is a highly significant charging methodology change switching from net metering to gross metering. - Elexon, NGET billing system changes need to be accommodated in the timeline - Supplier system changes need to be accommodated in the timeline. <p>Internal pricing and billing systems would require changes along with customer contractual arrangements.</p> <p>While we are against the implementation of CMP264, we want to make the point that any Mod that makes such significant changes to the demand charging principles should allow 3 years from the date of the Ofgem decision to implementation. The Ofgem decision itself will provide the correct signal to CM (the date of implementation is less critical).</p> <p>This delay is necessary for suppliers and consumers because it will enable systems and processes to be updated to accommodate the changes required. In addition it will enable current contractual agreements to unwind which will facilitate required changes to be factored into future contracts. There could be a Negative Impact on suppliers who are contracted with embedded generators.</p> <p>Customers typically will sign a 1, 2 or 3 year contract with their suppliers. It is only at the point of contract renewal that the supplier can incorporate these additional charges into customer contracts.</p> <p>Longer term contracts covering 25 years plus also exist . These highlight the increased risks around changing industry rules / charging methodologies.</p>

Q	Question	Response
2 Cont	<p>Do you support the proposed implementation approach? Or are there any further implementation implications that need to be considered?</p>	<p>Regarding impact on embedded generation investor certainty: This proposal does avoid step changes in charging for existing projects. Avoiding sharp charging changes in general is important for UK generation investor confidence. Investors in generation have in good faith made investments based on locational signals established by NGET and approved by Ofgem – this Modification proposal recognises that this is the case and only applies a solution to new generators.</p> <p>CMP264 aims to provide due time for the implementation of a new comprehensive charging arrangement. It is suggested that CMP264 is intended as a “stop-gap” solution with a sunset clause anticipating a SCR that Ofgem’s Letter suggests is not forthcoming. Since the SCR is not forthcoming we would say that a stop gap solution is inappropriate. For a proposal that presents a partial, temporary solution it is associated with very high disruption. A comprehensive, enduring solution would be preferable.</p> <p>We feel that the development of systems and data flows to support such a change are prohibitively expensive and disproportionate in terms of the terms of the temporary and partial nature of the solution suggested.</p> <p>There are additional loopholes (behind the meter generation) that cannot be covered.</p> <p>In addition the expectation that suppliers can obtain appropriate information from Embedded Generators without supporting central data flows when quoting for an Embedded Generator that is not part of their current portfolio is unrealistic.</p> <p>It is unclear whether the associated BSc change is perceived as a prerequisite to this change or an option.</p> <p>This proposal opens up wider questions on the governance framework required on the data quality in addition to the resource implications this would have across the industry. Appropriate SLAs would need to be put in place to ensure suppliers can readily access the required information for their tendering process.</p>

Q	Question	Response
3	<p>Do you have any other comments?</p>	<p>A) The Working Group should bear in mind that new hydro, wind and biomass generators will be detrimentally impacted by these proposals- the arrangements are not exclusive to fossil fuelled peaking plant. Providing sufficient lead time for any changes to current charging arrangements is very important for the economics of such projects too – they will be losing a significant annual income stream.</p> <p>B) The proposed ‘CMP264 potential WACMs’ all fail to present a new cost reflective charging solution and some introduce new layers of discrimination and complexities for suppliers. This all lends itself to introducing considerable uncertainty in the electricity market.</p> <p>C) We have a question regarding implementation:</p> <ul style="list-style-type: none"> - What are the implications of switching suppliers? How can it be ensured that existing sites and new sites continue to be correctly categorised between switches? Suppliers would require industry supporting data held centrally by Elexon to manage this. Will this be available? <p>D) When an embedded generator changes supplier we don’t understand how a potential new supplier would have access to their EREC 59 data and therefore we feel this is unrealistic .This would present one of the following challenges:</p> <ul style="list-style-type: none"> i) Relying on suppliers for information (data quality / governance) ii) Cost and time for implementing robust data flows for a temporary solution <p>It is unclear whether the associated BSc change is perceived as a prerequisite to this change or an option.</p>
4	<p>Do you wish to raise a WG Consultation Alternative Request for the Workgroup to consider?</p>	<p><i>If yes, please complete a WG Consultation Alternative Request form, available on National Grid's website¹, and return to the CUSC inbox at cusc.team@nationalgrid.com</i></p> <p>No</p>

¹ http://www.nationalgrid.com/uk/Electricity/Codes/systemcode/amendments/forms_guidance/

5	<p>Do you believe that the CMP265 Original Proposal better facilitates the Applicable CUSC Objectives?</p>	<p>No, on balance it does not better facilitate the CUSC Objectives.</p> <p>CMP265 could prevent any directly DNO connected embedded CM party factoring in the benefit of net metering and residual tariff into their bids. However, to the detriment of energy market competition CMP265 introduces a new Defect. It introduces undue discrimination in the treatment of 'CM' and 'non-CM' generation. The network impact of both types of embedded generation is the same, differential charging treatment appears as discriminatory.</p> <p>Additionally, gross charging for the Demand Residual element and applying the net charging for the current locational element of Demand TNUoS does not create a correct cost reflective signal for 'CM embedded generators'. The current locational signal is not aligned with SQSS. It is our view that the current demand charging methodology should as a first step be updated in line with SQSS in the way that generation charging was under Transmit. Demand charging should appropriately represent the peak and year round backgrounds and address issues associated with the half hourly and non-half hourly demand charging base.</p> <p>CMP265 has the following impact on the CUSC objectives:</p> <ul style="list-style-type: none"> a) Does not improve competition, as different rules for different Embedded Generators. (CM vs non CM) b) Not cost reflective as the defect raised has not been addressed c) Neutral on developments in the transmission licensees' transmission businesses d) Neutral on EU <p>Overall CMP265 introduces a New Defect of discrimination and does not introduce a more cost reflective charging arrangement than the baseline.</p>
---	---	---

6	<p>Do you support the proposed implementation approach? Or are there any further implementation implications that need to be considered?</p>	<p>While we are unsupportive of the implementation of CMP265, we want to make the point that any Mod that makes such significant changes to the demand charging principles should allow a minimum of 3 years from the date of the Ofgem decision to implementation. This delay is necessary for suppliers and consumers because it will enable systems and processes to be updated to accommodate the changes required. In addition it will enable current contractual agreements to unwind which will facilitate required changes to be factored into future contracts.</p> <p>Assuming that Ofgem make a decision on the proposal and approve it between now and April 2017 the proposed timeline of April 2020 for implementation is acceptable since this will fulfil our requirement of receiving 3 years notice from the point of a decision to implementation.</p> <p>- Supplier system changes need to be accommodated in the timeline. Internal pricing and billing systems would require changes along with customer contractual arrangements.</p> <p>Without this notice there could be a negative Impact on suppliers Customers typically will sign a 1, 2 or 3 year contract with their suppliers. It is only at the point of contract renewal that the supplier can incorporate these additional charges into customer contracts.</p> <p>Should the locational element of TNUoS remain for these embedded generators but the residual removed, some will have negative TNUoS charges and some positive. Where pass through benefits have been specified explicitly and exclusively for TNUoS within a contract with an embedded generator there will not be scope to pass on charges.</p> <p>Should the industry not receive 3 years notice from the point of a decision to implementation then future TNUoS rates charged by suppliers will need to factor in appropriate additional risk premia for potential future methodology changes</p> <p>Longer term contracts covering 25 years plus also exist . These highlight the increased risks around changing industry rules / charging methodologies.</p>
---	---	--

<p>6 Con t</p>	<p>Do you support the proposed implementation approach? Or are there any further implementation implications that need to be considered?</p>	<p>In practical terms CMP265 seems impossible to achieve. It anticipates that suppliers must identify sites with CM contracts. This is challenging as the proposal does not establish a means for suppliers to have visibility of CM contracts. Also, CM contracts are temporary- how would suppliers deal with detecting and dealing with customers entering and leaving CM agreements?</p> <p>CMP265 is practically impossible to implement for behind the meter embedded generation, thereby creating another dimension of discrimination.</p> <p>We feel that the development of systems and data flows to support such a change are prohibitively expensive and disproportionate in terms of the partial nature of the solution suggested.</p> <p>There are additional loopholes (behind the meter generation) that cannot be covered.</p> <p>In addition the expectation that suppliers can obtain appropriate information from Embedded Generators without supporting central data flows when quoting for an Embedded Generator that is not part of their current portfolio is unrealistic.</p> <p>We are unclear whether the associated BSc change is perceived as a prerequisite to this change or an option.</p> <p>This opens up wider questions on the governance framework required on the data quality in addition to the resource implications this would have across the industry. Appropriate SLAs would need to be put in place to ensure suppliers can readily access the required information for their tendering process.</p>
------------------------	---	--

7	<p>Do you have any other comments?</p>	<p>A) The Working Group should bear in mind that hydro, wind and biomass generators will be detrimentally impacted by these proposals- the arrangements are not exclusive to fossil fuelled peaking plant. Providing sufficient lead time for any change to current charging arrangements is very important for the economics of such projects too – they will be losing a significant annual income stream.</p> <p>B) In addition to considering the impact of tariff changes on embedded generation the Working Group should also consider what signal is the set value going to deliver for Demand Side Response and storage.</p> <p>C) The proposed ‘CMP265 potential WACMs’ all fail to present a new cost reflective charging solution and some introduce new layers of discrimination and complexity for suppliers.</p> <p>D) We have a question regarding implementation: How would we find the relevant CM contract information? Suppliers would require industry supporting data held centrally by Elexon to manage this. This would present one of the following challenges:</p> <ul style="list-style-type: none"> I. Relying on customers/suppliers for information (data quality / governance) II. Cost and time for implementing robust data flows for a temporary solution <p>We are unclear whether the associated BSc change is perceived as a prerequisite to this change or an option.</p>
8	<p>Do you wish to raise a WG Consultation Alternative Request for the Workgroup to consider?</p>	<p><i>If yes, please complete a WG Consultation Alternative Request form, available on National Grid's website², and return to the CUSC inbox at cusc.team@nationalgrid.com</i></p> <p>No</p>

² http://www.nationalgrid.com/uk/Electricity/Codes/systemcode/amendments/forms_guidance/

Specific questions for CMP264

Q	Question	Response
----------	-----------------	-----------------

Q	Question	Response
10	<p>i) Do you think a cut-off date for “new embedded generation” of 30 June 2017 is appropriate? What other date would you propose?</p> <p>ii) Do you have any views on how mixed sites are being addressed in CMP264 Original?</p> <p>iii) Do you think new-build embedded generation capacity that has entered into long term financial and performance commitment obligations via 2014 and 2015 capacity market or contracts for difference auctions (prior to this modification proposal) should be given exceptions to this cut-off date?</p> <p>iv) Do you agree that ignoring demand behind the meter is unlikely to create a significant “loophole” or material discrimination risk in relation to the CMP264 arrangements in the short term</p> <p>v) Question to suppliers: Do you consider that the wording of your existing contracts allow you to reflect the changes provided by these modifications in a cost reflective manner. For example, these changes will apply to existing PPAs and generators who significantly alter their output (EREC 59).</p> <p>vi) Do you agree with the definition of commissioned and do you agree that it is appropriate? If you do not agree with the definition or that it is appropriate please provide alternative definitions and rationale for this definition.</p>	<p>i) Although this date has a clear link to the upcoming Capacity Mechanism Auction in network charging terms the impact of an embedded generator connecting before or after this date could be the same and therefore it is difficult to justify this cut-off. In network charging terms it is arbitrary. There is also a practical problem with this cut-off: it does not allow the due time for Elexon, NGET and supplier metering and billing systems to adapt.</p> <p>ii) Mixed sites and DSR are hard to capture under this proposal even though their network impact is the same as that of embedded generation.</p> <p>iii) This seems like a proposal that would add a further level of undue discrimination. The network impact of such parties could be the same as that of other embedded generators old and new, with or without CM/CfD contracts.</p> <p>iv) This does create a loophole. There has not been any assessment of the materiality so we cannot comment on this. We feel that the costs and complexity of a solution to address this is disproportionate with the temporary and unsustainable nature of this proposal.</p> <p>v) As discussed in question 2, existing wording of some contracts with embedded generators may not easily allow us to reflect the changes provided by these modifications in a cost reflective manner. Some contracts could be addressed via a contract variation or upon renewal / acquisition, others would require contracts to be reopened with Embedded Generator who may not be open to large reductions in their income. Long term PPAs will usually have provisions for legal industry changes e.g. BSC changes.</p> <p>vi) G59 testing is a standard test for confirming that a commercial site is commissioned under regulated schemes that generators are familiar with. From a generators perspective it is therefore a logical definition to be used. This would capture all sites that have embedded benefit arrangements with suppliers.</p>

Q	Question	Response
13	<p>Do you have a view of whether implementation for the 2017/18 Triad season is sufficient to allow changes for:</p> <p>i) supplier contracts and billing system; and</p> <p>ii) for other stakeholders?</p>	<p>No this implementation for the 17/18 Triad season is insufficient to allow for supplier contracts and pricing / billing system changes.</p> <p>Receiving 3 years notice from the point of a Ofgem decision is important for suppliers and consumers because it will enable systems and processes to be updated to accommodate the changes required. In addition it will enable current contractual agreements to unwind which will allow changes to be factored into future contracts.</p> <p>In general it is only acceptable for generation projects to be provided with completely new investment signals, if they have sufficient time to model and adapt investment decisions.</p> <p>From the perspective of the owner operator of existing and new non-peaking embedded generation plants: CMP264 has the advantage over CMP265 of avoiding step changes in charging for existing projects. Investors in wind and hydro generation have in good faith made investments based on locational signals established in the current charging methodology by NGET and approved by Ofgem – CMP264 proposal does recognise that this is the case and only applies a solution to new generators.</p>

Q	Question	Response
18	<p>Do you have a view if embedded benefits are frozen at a non-zero value, what should that value be as a £/kW tariff (2016/17 value is £45.33 / kW)?</p>	<p>There is no clear justification for freezing the embedded benefit tariff at 2016/17 value is £45.33 / kW nor is there evidence that it should be set at zero. There has not been an assessment of the appropriate value by the workgroup of the cost reflective value to the network from embedded generators.</p> <p><i>If</i> embedded benefits are frozen they should be frozen at a level that is a best estimate of cost reflective impact.</p> <p>There are a number of reports that have set out their assessment of what these cost reflective charges would be: E.g. Cornwall Energy-ADE have conducted an in-depth assessment of the impact of embedded generation on network flows and suggest a value of £32.3/kW is appropriate for the 2015/16 charging year.</p> <p>Alternatively, the 2014/15 tariff could be justified given that this is when NGET's last review assessed the appropriateness of the embedded benefit.</p> <p>Our preference is that an enduring solution is developed and implemented that can ensure that a more cost reflective tariff is applied to embedded generators. There is a valid and varied locational benefit to the networks from embedded generation that should be recognised. We also contest the conclusion that transmission and distribution connection charges are on par with one another. The embedded benefit does currently help offset some of the distortion in connection charges.</p> <p>In addition to considering the impact of tariff changes on embedded generation the Working Group should also consider what signal is the set value going to deliver for Demand Side Response and storage.</p>

Specific questions for CMP265

Q	Question	Response
11	<p>i) Views are sought on the implication for mixed sites discussed in 3.4.10.</p> <p>ii) Views are sought on the preference of categories of capacity Market CMU captured by this proposal, please indicate your preference from the following list and reasons:</p> <ul style="list-style-type: none"> • All existing and new distribution generation CMUs • All existing and new distribution generation CMUs and DSR CMUs (proven and unproven) • All price maker CMUs • All newbuild/prospective distribution generation CMUs only (defined as >1year contracts) 	<p>The problems identified for mixed sites demonstrate that the solution is unworkable. While it may be possible to develop a more costly solution to address some of the issues, there is no way of capturing all the sites.</p> <p>We feel that time and effort would be better spent on developing an enduring solution that addresses the underlying problem, which does not lead to such complexities and provides something simple and, workable.</p>
14	<p>Do you have a view of whether implementation for the 2020/21 Triad season is sufficient to allow changes for i) supplier contracts and billing system, and ii) for other stakeholders?</p>	<p>Essentially we do not see how the arrangements can be practically implementable at all. Suppliers do not have visibility of CM contract status of their customers.</p> <p>Regarding whether 2020/21 is acceptable this is dependent upon when a solution is approved, since we require 3 years clear notice of changes from the point of a decision to the implementation of changes to the charging methodology in order to address our pricing and billing systems.</p>

Specific questions for BOTH CMP264 & CMP265

Q	Question	Response
9	<p>i) Suppliers: In setting charges for your demand customers, do you charge them at the same tariff as National Grid charges you (i.e. gross), to enable you to pay the embedded benefit to embedded generators, or please explain the way in which it is funded?</p> <p>ii) Suppliers: Does the estimate that 7.58GW of embedded generation output and 2.5GW of demand side reduction at the time of Triad for 2016/17 seem reasonable based on your knowledge of the UK market? If not what is your estimate of embedded generator output and DSR at time of Triad?</p>	<p>i) If tariffs have been published, we will charge our customers this rate. Customers who are exporting at the time of triads will have this rate applied to a negative demand, and so will receive a credit i.e. net</p> <p>ii) No comment. The National Grid Future Energy scenarios should consider industry input.</p>
12	<p>Can you identify – either quantitatively or qualitatively - the impact of the demand TNUoS embedded benefit on your decisions made in making capacity market decisions?</p>	<p>No. RWE Innogy does not participate in the CM.</p>

Q	Question	Response
15	<p>i) What are your views on the 2 broad options to enable the reporting of gross export metered data?</p> <p>ii) Would you have the data available required for Option B (both CMP264 and CMP265) for both new contracts and existing contracts where a customer may be partially exempt?</p> <p>iii) Do you believe you can implement the proposed changes by the respective implementation dates?</p> <p>iv) What are the pros and cons of the 2 proposals that ELEXON are considering to implement this (P348 for CMP265/ P349 for CMP264)?</p>	<p>i) We do not support the 2 broad options to enable the reporting of gross export metered data as outlined below:</p> <ul style="list-style-type: none"> A. Cost and time for implementing robust data flows for a temporary solution B. Relying on customers/suppliers for information (data quality / governance) <p>We are unclear whether the associated BSc change is perceived as a prerequisite to this change or an option. The terminology “broad” sounds vague and costs are already being incurred through the BSc change request.</p> <p>We feel that the development of systems and data flows to support such a change are prohibitively expensive and disproportionate in terms of the temporary and partial nature of the solution suggested.</p> <p>There are additional loopholes (behind the meter generation) that cannot be covered.</p> <p>In addition the expectation that suppliers can obtain appropriate information from Embedded Generators without supporting central data flows when quoting for an Embedded Generator that is not part of their current portfolio is unrealistic.</p> <p>This opens up wider questions on the governance framework required on the data quality in addition to the resource implications this would have across the industry. Appropriate SLAs would need to be put in place to ensure suppliers can readily access the required information for their tendering process.</p> <p>ii) We would not have this information available for either new or existing contracts.</p> <p>iii) We would require at least 3 years notice from the point of formal decision to implementation date.</p> <p>iv) We feel that the development of systems and data flows to support such a change are prohibitively expensive and disproportionate in terms of the temporary and partial nature of the solution suggested. We do not feel there are any pros associated with P348 / P349 due to the temporary and partial nature of the solutions.</p>

Q	Question	Response
16	<p>Do you have any further evidence / comments on the consumer impact of changing the demand TNUoS embedded benefit in either the short-run or long-run?</p>	<p>This is a complex area that needs Ofgem’s thorough scrutiny. There will be impacts on the wholesale price, security of supply etc. from changes that need to be considered in addition to simply how much suppliers pay generators under the status quo and alternatives. A neutral quantitative impact assessment should be conducted by Ofgem.</p> <p>As a supplier we can only comment that embedded benefits are a direct result of the signals being given by the current TNUoS charging methodology. Bearing in mind that in 5 years’ time following smart metering roll-out all customers should be charged based on their triad demands. It is up to National Grid to say whether the demand reductions seen are cost effective in terms of managing the system. We believe that the current demand charging methodology is not cost reflective, since the system peaks do not necessarily coincide with problem times. In the short term, the Triad signal will increase costs to consumers because as more and more customers will load manage to avoid and simultaneously self-perpetuate these spiralling costs, it will be the customers who cannot respond who will pick up the bill. The proposals do nothing to address this underlying problem.</p>
17	<p>Do you feel that both the locational and residual component of the demand TNUoS should be removed as an embedded benefit (as CMP264 Original) or just the residual component (as CMP265 Original) or some other method?</p>	<p>Some other method is required, we do not support either CMP264, CMP265 or any of the associated WACM proposals.</p> <p>We feel that some form of locational element of the charge should remain. We also feel that there needs to be sufficient residual such that no demand tariff becomes negative. Negative demand tariffs could lead to escalating demands during system peak which would utilise all available generation, push up energy costs and threaten security of supply.</p> <p>We also believe a certain amount of the residual should remain in addition to the locational signal to reward any load management which is beneficial to the SO. Total removal of the residual component would be detrimental to the overall cost of maintaining the transmission network.</p>

Q	Question	Response
19	<p>Regarding the proposed alternatives what are your views on the suggested implementation dates? Are these achievable? Please give reasons for your view.</p>	<p>We do not support either CMP264, CMP265 or any of the associated WACM proposals.</p> <p>Clearly this is a complex charging problem that needs to be addressed in a timely manner in the interest of the consumer and generator competition. Given its complexity we anticipate any viable solution would be a significant change to the charging methodology. It is important that any such solution is implemented minimum 3 years after the Authority Decision. The Ofgem decision itself will provide the correct signal to CM (the date of implementation is less critical).</p> <p>A robust enduring solution is required to address the defect identified. Further consideration is also required on the future of TNUoS charging so as to ensure stability.</p>

CUSC Workgroup Consultation Response Proforma

CMP264 'Embedded Generation Triad Avoidance Standstill' and **CMP265** 'Gross charging of TNUoS for HH demand where Embedded Generation is in the Capacity Market'

Industry parties are invited to respond to this consultation expressing their views and supplying the rationale for those views, particularly in respect of any specific questions detailed below.

Please send your responses by **24th August 2016** to cusc.team@nationalgrid.com Please note that any responses received after the deadline or sent to a different email address may not receive due consideration by the Workgroup.

Any queries on the content of the consultation should be addressed to Caroline Wright at caroline.wright@nationalgrid.com

These responses will be considered by the Workgroup at its next meeting at which members will also consider any Workgroup Consultation Alternative Requests. Where appropriate, the Workgroup will record your response and its consideration of it within the final Workgroup Report which is submitted to the CUSC Modifications Panel.

Respondent:	<i>Please insert your name and contact details (phone number or email address) Bill Reed</i> Bill.reed@rwe.com 07795 355310
Company Name:	RWE Generation UK plc, RWE Supply & Trading GmbH
<p>Please express your views regarding the Workgroup Consultation, including rationale.</p> <p>(Please include any issues, suggestions or queries)</p>	<p>For reference, the Applicable CUSC objectives are:</p> <p style="text-align: center;">Use of System Charging Methodology</p> <p>(a) that compliance with the use of system charging methodology facilitates effective competition in the generation and supply of electricity and (so far as is consistent therewith) facilitates competition in the sale, distribution and purchase of electricity;</p> <p>(b) that compliance with the use of system charging methodology results in charges which reflect, as far as is reasonably practicable, the costs (excluding any payments between transmission licensees which are made under and in accordance with the STC) incurred by transmission licensees in their transmission businesses and which are compatible with standard condition C26 (Requirements of a connect and manage connection);</p> <p>(c) that, so far as is consistent with sub-paragraphs (a) and (b), the use of system charging methodology, as far</p>

	<p>as is reasonably practicable, properly takes account of the developments in transmission licensees' transmission businesses.</p> <p>(d) Compliance with the Electricity Regulation and any relevant legally binding decision of the European Commission and/or the Agency.</p>
--	---

Standard Workgroup consultation questions – CMP264

Q	Question	Response
1	<p>Do you believe that the CMP264 Original Proposal better facilitates the Applicable CUSC Objectives?</p>	<p>CMP264 Original proposal may better meet the CUSC objectives, particularly with regard to Objective (a). The proposal will ensure that investment decisions for new embedded generation are not distorted by the residual component of the demand TNUoS tariffs.</p> <p>However, the proposal fails to address the wider issues associated with the defect for existing generators and also introduces discriminatory treatment between new and existing generation (which continue to receive the growing Triad benefit).</p> <p>In addition, we have concerns that under the proposal the locational element of the demand tariffs, as applied to new embedded generation, is not cost reflective since it does not appropriately represent the peak and year round backgrounds and also does not address issues associated with the demand charging base (half hourly and non half hourly). As a consequence, the original proposal can only be described as a temporary solution until such time that a comprehensive and enduring approach towards demand transmission charging is developed.</p>

Q	Question	Response
2	<p>Do you support the proposed implementation approach? Or are there any further implementation implications that need to be considered?</p>	<p>The scale and extent of the distortions associated with the residual component of the demand TNUoS tariffs as identified under the modification proposal (and in Ofgem’s Open Letter¹) suggests that it is appropriate that the defect is addressed as soon as practicable. However, we have concerns about the feasibility of the proposed solution and its impact on suppliers if implemented with effect from 30th June 2017. In particular it may be difficult to develop and deliver efficient central reporting mechanisms and supplier billing systems in the required timescale. These are required to ensure the identification of relevant embedded generation and the introduction of gross charging for such parties.</p> <p>1. Ofgem “Open letter: Charging arrangements for embedded generation”, : 29th July at https://www.ofgem.gov.uk/system/files/docs/2016/07/open_letter_-_charging_arrangments_for_embedded_generation.pdf</p>
3	<p>Do you have any other comments?</p>	<p>We are concerned about the accelerated timescales required for consideration of the issues identified under this modification proposal. As can be seen from the scale and materiality of the impact together with the complexity of the proposed solutions detailed consideration is required to determine whether this proposal or its alternatives can address the defects identified and lead to an enduring solution.</p> <p>The proposed modification is at best a partial solution and further change will be required to develop enduring arrangements. In particular the nature of the locational component of the demand tariff and the appropriate charging bases for these tariffs require careful assessment. We believe that a partial and potentially discriminatory solution, as proposed, carries the risk of creating more harm than good, and introducing considerable uncertainty in the electricity market.</p>

Q	Question	Response
4	<p>Do you wish to raise a WG Consultation Alternative Request for the Workgroup to consider?</p>	<p><i>If yes, please complete a WG Consultation Alternative Request form, available on National Grid's website¹, and return to the CUSC inbox at cusc.team@nationalgrid.com</i></p> <p>We have considered the potential development of an alternative based on improving the cost reflectivity of the locational component of demand tariffs and the relevant charging base and addressing the issues associated with the cost recovery through the residual component of the tariff. However, we believe that these issues are potentially outside the limited scope of the defects identified in the modification proposals. We believe that further consideration is required by the Workgroup to determine whether the proposed solution or alternatives are capable of the addressing the issues identified by the workgroup in its consultation and Ofgem in its Open Letter.</p>

¹ http://www.nationalgrid.com/uk/Electricity/Codes/systemcode/amendments/forms_guidance/

Standard Workgroup consultation questions – CMP265

Q	Question	Response
5	<p>Do you believe that the CMP265 Original Proposal better facilitates the Applicable CUSC Objectives?</p>	<p>CMP264 Original proposal may better meet the CUSC objectives, particularly with regard to Objective (a). The proposal will ensure that investment decisions for new embedded generation with a capacity market agreement are not distorted by the residual component of the demand TNUoS tariffs.</p> <p>However, the proposal fails to address the wider issues associated with the defect for existing generators and also introduces discriminatory treatment between new embedded generation with a capacity market and remaining embedded generators which do not have a capacity market agreement but continue to receive the growing Triad benefit).</p> <p>In addition, we have concerns that under the proposal that the locational element of the demand TNUoS tariffs for new generation is not cost reflective since it does not appropriately represent the peak and year round backgrounds and does not address issues associated with the demand charging base (half hourly and non half hourly). As a consequence the modification can only be described as a temporary solution until such time that a comprehensive and enduring approach towards demand transmission charging is developed.</p>
6	<p>Do you support the proposed implementation approach? Or are there any further implementation implications that need to be considered?</p>	<p>The scale and extent of the distortions associated with the residual component of the demand TNUoS tariffs as identified under the modification proposal (and in Ofgem’s Open Letter¹) suggests that it is appropriate that the defect is addressed as soon as practicable. However, we have concerns about the feasibility of the proposed solution and its impact on suppliers. In particular it may be difficult to develop and deliver efficient central reporting mechanisms and supplier billing systems. These are required to ensure the identification of relevant embedded generators and the introduction of gross charging for such parties.</p> <p>1. Ofgem “Open letter: Charging arrangements for embedded generation”, : 29th July at https://www.ofgem.gov.uk/system/files/docs/2016/07/open_letter_-_charging_arrangments_for_embedded_generation.pdf</p>

Q	Question	Response
7	Do you have any other comments?	<p>We are concerned about the accelerated timescales required for consideration of the issues identified under this modification proposal. As can be seen from the scale and materiality of the impact together with the complexity of the proposed solutions that detailed consideration is required to determine whether this proposal or its alternatives can adequately address the defects identified and provide an enduring solution. The proposed solution is at best a partial solution and further change will be required to develop enduring arrangements. In particular the nature of the locational component of the demand TNUoS tariffs and the appropriate charging bases for these tariffs require careful assessment. We believe that a partial and potentially discriminatory solution, as proposed, carries the risk of creating more harm than good, and introducing considerable uncertainty into the electricity market.</p>
8	Do you wish to raise a WG Consultation Alternative Request for the Workgroup to consider?	<p><i>If yes, please complete a WG Consultation Alternative Request form, available on National Grid's website², and return to the CUSC inbox at cusc.team@nationalgrid.com</i></p> <p>We have considered the potential development of an alternative based on improving the cost reflectivity of the locational component of demand TNUoS tariffs and the relevant charging base and also addressing the issues associated with the cost recovery through the residual component of the tariff. However, these issues are potentially outside the scope of the defects identified in the modification proposal. We believe that more discussion is required to determine whether the proposed modifications or alternatives are capable of the addressing the issues identified by workgroup in its consultation and Ofgem in its Open Letter.</p>

² http://www.nationalgrid.com/uk/Electricity/Codes/systemcode/amendments/forms_guidance/

Specific questions for CMP264

Q	Question	Response
10	<p>i) Do you think a cut-off date for “new embedded generation” of 30 June 2017 is appropriate? What other date would you propose?</p> <p>ii) Do you have any views on how mixed sites are being addressed in CMP264 Original?</p> <p>iii) Do you think new-build embedded generation capacity that has entered into long term financial and performance commitment obligations via 2014 and 2015 capacity market or contracts for difference auctions (prior to this modification proposal) should be given exceptions to this cut-off date?</p> <p>iv) Do you agree that ignoring demand behind the meter is unlikely to create a significant “loophole” or material discrimination risk in relation to the CMP264 arrangements in the short term</p> <p>v) Question to suppliers: Do you consider that the wording of your existing contracts allow you to reflect the changes provided by these modifications in a cost reflective manner. For example, these changes will apply to existing PPAs and generators who significantly alter their output (EREC 59).</p> <p>vi) Do you agree with the definition of commissioned and do you agree that it is appropriate? If you do not agree with the definition or that it is appropriate please provide alternative definitions and rationale for this definition.</p>	<p>i) Given the nature of the issue identified in the modification proposal (i.e. in relation to the capacity market) it is appropriate to define a specific implementation date in the proposed solution. The date of 30th June 2017 represents a cut off point with respect to a potential 2017/18 capacity market auction process and as such is appropriately justified. However we have concerns about the practicality of this implementation date (see answer to Q2).</p> <p>ii) It is essential that the incentives on new generation are consistent and enduring. We do not believe that the modification should create potential loopholes in relation to mixed sites (where new embedded generation could continue to enjoy the embedded benefit). Therefore we support an approach that addresses mixed sites. However, we note that this increases the complexity of the potential solution and its costs. Furthermore it may not be practical to deliver such a solution.</p> <p>iii) Since the modification proposal itself introduces discrimination (between new and old generation), the potential for further discrimination such as between new-build embedded generation capacity that has entered into long term financial and performance commitment obligations via 2014 and 2015 capacity market and generation that has entered into contracts for difference auctions prior to this modification proposal requires detailed consideration. Evidence is required to justify such discrimination, and further work is required to provide such justification. Given the nature of the defect identified with respect to the residual component of the demand TNUoS tariffs it may be challenging to demonstrate that the discrimination of the nature identified in the question would be justified.</p>

Q	Question	Response
		<p>iv) The modification should not introduce potential loopholes such as encouraging “behind the meter generation” in order to continue receipt of the embedded benefit. Therefore we support an approach that addresses “behind the meter generation”. However, we note that this approach would increase the complexity of the potential solution and costs.</p> <p>v) No Comment</p> <p>vi) The modification proposal requires an appropriate definition of commissioned and the process outlined appears an appropriate basis for determining whether an embedded generator is capable of operation.</p>
13	<p>Do you have a view of whether implementation for the 2017/18 Triad season is sufficient to allow changes for:</p> <p>i) supplier contracts and billing system; and</p> <p>ii) ii) for other stakeholders?</p>	<p>We are concerned about whether efficient central reporting mechanisms and supplier billing systems can be developed and delivered in the required timescale to capture the relevant embedded generators and the introduction of gross charging for such parties.</p>
18	<p>Do you have a view if embedded benefits are frozen at a non-zero value, what should that value be as a £/kW tariff (2016/17 value is £45.33 / kW)?</p>	<p>The embedded benefit should not be frozen at any level. We are concerned that freezing the embedded benefit at an arbitrary level merely creates other issues associated with discrimination and cost reflectivity of charges.</p>

Specific questions for CMP265

Q	Question	Response
11	<p>i) Views are sought on the implication for mixed sites discussed in 3.4.10.</p> <p>ii) Views are sought on the preference of categories of capacity Market CMU captured by this proposal, please indicate your preference from the following list and reasons:</p> <ul style="list-style-type: none"> • All existing and new distribution generation CMUs • All existing and new distribution generation CMUs and DSR CMUs (proven and unproven) • All price maker CMUs • All newbuild/prospective distribution generation CMUs only (defined as >1year contracts) 	<p>i) It is essential that the incentives on new generators are consistent with existing generators and are enduring. We do not believe that the solution should create potential loopholes in relation to mixed sites (where new embedded generation could also enjoy the embedded benefit). Therefore we support an approach that addresses mixed sites. However, we note that this approach would increase the complexity of the potential solution and its costs.</p> <p>ii) In our view all embedded CMUs with a capacity market agreement should be considered in scope for the modification proposal (both generation and DSR). A proposal based on selective capacity market CMUs carries with it the risk of distorting the capacity market clearing prices and creating perverse incentives for certain categories of CMU.</p>
14	<p>Do you have a view of whether implementation for the 2020/21 Triad season is sufficient to allow changes for i) supplier contracts and billing system, and ii) for other stakeholders?</p>	<p>We are concerned about whether efficient central reporting mechanisms and supplier billing systems can be developed and delivered in the required timescale to allow for the capture of relevant embedded generators and the introduction of gross charging for such parties.</p>

Specific questions for BOTH CMP264 & CMP265

Q	Question	Response
9	<p>i) Suppliers: In setting charges for your demand customers, do you charge them at the same tariff as National Grid charges you (i.e. gross), to enable you to pay the embedded benefit to embedded generators, or please explain the way in which it is funded?</p> <p>ii) Suppliers: Does the estimate that 7.58GW of embedded generation output and 2.5GW of demand side reduction at the time of Triad for 2016/17 seem reasonable based on your knowledge of the UK market? If not what is your estimate of embedded generator output and DSR at time of Triad?</p>	<p>i) We note that the Ofgem Open Letter states that “<i>the payments to EG are an extra cost to suppliers over and above the payment of transmission charges to National Grid, and therefore an additional cost to consumers to the extent that this cost of passed on the consumers</i>” (Ofgem “Open letter: Charging arrangements for embedded generation”, : 29th July page 4)</p> <p>ii) No comment</p>
12	<p>Can you identify – either quantitatively or qualitatively - the impact of the demand TNUoS embedded benefit on your decisions made in making capacity market decisions?</p>	<p>No comment</p>

Q	Question	Response
15	<p>i) What are your views on the 2 broad options to enable the reporting of gross export metered data?</p> <p>ii) Would you have the data available required for Option B (both CMP264 and CMP265) for both new contracts and existing contracts where a customer may be partially exempt?</p> <p>iii) Do you believe you can implement the proposed changes by the respective implementation dates?</p> <p>iv) What are the pros and cons of the 2 proposals that ELEXON are considering to implement this (P348 for CMP265/ P349 for CMP264)?</p>	<p>i) We favour a fair and equitable approach towards the reporting of gross export metered data. We believe that suppliers are best placed to provide the required information, given the direct physical and contractual relationship with relevant embedded generator. However we have concerns about the practicality of this solution.</p> <p>ii) We believe that the relevant information should be available from suppliers, given the introduction of an obligation to report such information for the purpose of demand transmission charging. However we have concerns about the practicality of this solution.</p> <p>iii) The scale and extent of the distortions associated with the residual component of the demand TNUoS tariffs as identified in the modification proposal and in Ofgem's Open Letter suggests that it is appropriate that the defect is addressed as soon as practicable. However, we have concerns about the feasibility of the solution and its potential impact on suppliers. In particular, the requirement for economic and efficient central reporting mechanisms and supplier billing systems enable the identification of relevant embedded generators and the introduction of gross charging for such parties may be difficult to deliver.</p> <p>iv) We believe that the relevant information should be available from suppliers, given an obligation to report such information for the purpose of charging. However we have concerns about the practicality of this solution.</p>
16	<p>Do you have any further evidence / comments on the consumer impact of changing the demand TNUoS embedded benefit in either the short-run or long-run?</p>	<p>No comment</p>

Q	Question	Response
17	<p>Do you feel that both the locational and residual component of the demand TNUoS should be removed as an embedded benefit (as CMP264 Original) or just the residual component (as CMP265 Original) or some other method?</p>	<p>We do not believe that the locational component of the demand TNUoS tariff should be removed as an embedded benefit. In this context we note that Ofgem state that “<i>We support the current approach of “forward looking locational signals being provided that network users” and that “We think that this should continue to apply to EG in relation to its impact on the transmission system”</i> (Ofgem “Open letter: Charging arrangements for embedded generation”, 29th July page 4). We endorse this approach. However further work is required to explore the cost reflectivity of the locational component of the tariff and the relevant charging base.</p> <p>We agree with Ofgem that the residual component of the demand TNUoS tariffs relates to cost recovery and this element of the tariff may result in market distortions that “<i>will continue and will likely increase</i>” Ofgem “Open letter: Charging arrangements for embedded generation”, 29th July page 5). Therefore it is essential that any modification proposal addresses the underlying issues associated with this element of the tariff.</p>
19	<p>Regarding the proposed alternatives what are your views on the suggested implementation dates? Are these achievable? Please give reasons for your view.</p>	<p>The workgroup report and Ofgem’s Open letter highlight the issues associated with the cost reflectivity of demand TNUoS charges and potential market distortions. A comprehensive and enduring solution is required. The modification proposals and possible alternatives proposed in the workgroup consultation do not represent such a solution. Therefore further work is required to identify and develop appropriate cost reflective enduring arrangements for demand TNUoS charging.</p>

CUSC Workgroup Consultation Response Proforma

CMP264 'Embedded Generation Triad Avoidance Standstill' and **CMP265** 'Gross charging of TNUoS for HH demand where Embedded Generation is in the Capacity Market'

Industry parties are invited to respond to this consultation expressing their views and supplying the rationale for those views, particularly in respect of any specific questions detailed below.

Please send your responses by **24th August 2016** to cusc.team@nationalgrid.com Please note that any responses received after the deadline or sent to a different email address may not receive due consideration by the Workgroup.

Any queries on the content of the consultation should be addressed to Caroline Wright at caroline.wright@nationalgrid.com

These responses will be considered by the Workgroup at its next meeting at which members will also consider any Workgroup Consultation Alternative Requests. Where appropriate, the Workgroup will record your response and its consideration of it within the final Workgroup Report which is submitted to the CUSC Modifications Panel.

Respondent:	<i>Please insert your name and contact details (phone number or email address)</i>
Company Name:	<i>Please insert Company Name</i>
<p>Please express your views regarding the Workgroup Consultation, including rationale.</p> <p>(Please include any issues, suggestions or queries)</p>	<p>For reference, the Applicable CUSC objectives are:</p> <p>Use of System Charging Methodology</p> <p>(a) that compliance with the use of system charging methodology facilitates effective competition in the generation and supply of electricity and (so far as is consistent therewith) facilitates competition in the sale, distribution and purchase of electricity;</p> <p>(b) that compliance with the use of system charging methodology results in charges which reflect, as far as is reasonably practicable, the costs (excluding any payments between transmission licensees which are made under and in accordance with the STC) incurred by transmission licensees in their transmission businesses and which are compatible with standard condition C26 (Requirements of a connect and manage connection);</p> <p>(c) that, so far as is consistent with sub-paragraphs (a) and (b), the use of system charging methodology, as far as is reasonably practicable, properly takes account of</p>

	<p>the developments in transmission licensees' transmission businesses.</p> <p>(d) Compliance with the Electricity Regulation and any relevant legally binding decision of the European Commission and/or the Agency.</p>
--	---

Standard Workgroup consultation questions – CMP264

Q	Question	Response
1	Do you believe that the CMP264 Original Proposal better facilitates the Applicable CUSC Objectives?	No
2	Do you support the proposed implementation approach? Or are there any further implementation implications that need to be considered?	
3	Do you have any other comments?	<p>Until the real underlying benefits of embedded generation are independently reviewed, in conjunction with a wider review of the TNUoS charging arrangements both CMP264 and CMP265 are premature.</p> <p>The impact of the removal of the triad revenue stream on new renewable energy projects should be reviewed.</p> <p>Renewable energy projects are often distribution connected due to their size. Although Triad revenues are less relevant for solar the impact will be large for potential Hydro projects and will be a significant for wind farms, especially in the context of reduced subsidy, removal of the LEC and lower wholesale prices (which will be partly driven by the capacity market). This will have an environmental impact.</p>
4	Do you wish to raise a WG Consultation Alternative Request for the Workgroup to consider?	<i>If yes, please complete a WG Consultation Alternative Request form, available on National Grid's website¹, and return to the CUSC inbox at cusc.team@nationalgrid.com</i>

Standard Workgroup consultation questions – CMP265

Q	Question	Response
---	----------	----------

¹ http://www.nationalgrid.com/uk/Electricity/Codes/systemcode/amendments/forms_guidance/

Q	Question	Response
5	Do you believe that the CMP265 Original Proposal better facilitates the Applicable CUSC Objectives?	No
6	Do you support the proposed implementation approach? Or are there any further implementation implications that need to be considered?	
7	Do you have any other comments?	<p>Until the real underlying benefits of embedded generation are independently reviewed, in conjunction with a wider review of the demand TNUoS charging arrangements both CMP264 and CMP265 are premature.</p> <p>If the building of a particular technology/connection is the desired outcome of the capacity market, there are more direct changes that can be made to the CM auction process than amending Triad Avoidance payments.</p> <p>In many ways the change is not necessary, an enduring solution at this stage will be a missed opportunity to review the logic of the wider EB and TNUoS charging methodology holistically – ofgem’s open letter stating its intention to review embedded benefits, in particular the demand residual is enough to ensure EG bidders in the next CM auction are unlikely to include significant triads receipts in their financial modelling.</p>
8	Do you wish to raise a WG Consultation Alternative Request for the Workgroup to consider?	<i>If yes, please complete a WG Consultation Alternative Request form, available on National Grid's website², and return to the CUSC inbox at cusc.team@nationalgrid.com</i>

Specific questions for CMP264

Q	Question	Response
---	----------	----------

² http://www.nationalgrid.com/uk/Electricity/Codes/systemcode/amendments/forms_guidance/

Q	Question	Response
10	<p>i) Do you think a cut-off date for “new embedded generation” of 30 June 2017 is appropriate? What other date would you propose?</p> <p>ii) Do you have any views on how mixed sites are being addressed in CMP264 Original?</p> <p>iii) Do you think new-build embedded generation capacity that has entered into long term financial and performance commitment obligations via 2014 and 2015 capacity market or contracts for difference auctions (prior to this modification proposal) should be given exceptions to this cut-off date?</p> <p>iv) Do you agree that ignoring demand behind the meter is unlikely to create a significant “loophole” or material discrimination risk in relation to the CMP264 arrangements in the short term</p> <p>v) Question to suppliers: Do you consider that the wording of your existing contracts allow you to reflect the changes provided by these modifications in a cost reflective manner. For example, these changes will apply to existing PPAs and generators who significantly alter their output (EREC 59).</p> <p>vi) Do you agree with the definition of commissioned and do you agree that it is appropriate? If you do not agree with the definition or that it is appropriate please provide alternative definitions and rationale for this definition.</p>	<p>If implemented the proposed date would be appropriate – it is an interim solution, ofgem have indicated they would look to implement changes by 2019/20 so any later date would remove the impact of the interim solution (it could be hard to argue the modification would be worth making if it only applied to a single triad season).</p> <p>No</p> <p>Yes, there is a real threat that industry regulation constantly changing value streams after auction events (such as the removal of the LEC from renewable generation after CfD bids) undermine investor confidence in the wider industry. There is neither an industry consensus or a robust independent (unbiased by vested interests) calculation of the true long and short term benefits EG brings, hopefully this will be done as part of the ofgem investigation, however a change at this stage would be premature.</p> <p>Yes – demand reduction via onsite generation should not be considered a loophole anymore/less than shifting use or energy or using less energy over the triad periods is a loophole. If the current demand charging methodology gives non cost reflective time based signals, these should be amended as part of a wider review – onsite generation should not be singled out and amended piecemeal.</p>

Q	Question	Response
13	<p>Do you have a view of whether implementation for the 2017/18 Triad season is sufficient to allow changes for:</p> <p>i) supplier contracts and billing system; and</p> <p>ii) ii) for other stakeholders?</p>	No view
18	<p>Do you have a view if embedded benefits are frozen at a non-zero value, what should that value be as a £/kW tariff (2016/17 value is £45.33 / kW)?</p>	Any value would be arbitrary as a robust in depth analysis of the true value of embedded generation has not been determined.

Specific questions for CMP265

Q	Question	Response
11	<p>i) Views are sought on the implication for mixed sites discussed in 3.4.10.</p> <p>ii) Views are sought on the preference of categories of capacity Market CMU captured by this proposal, please indicate your preference from the following list and reasons:</p> <ul style="list-style-type: none"> • All existing and new distribution generation CMUs • All existing and new distribution generation CMUs and DSR CMUs (proven and unproven) • All price maker CMUs • All newbuild/prospective distribution generation CMUs only (defined as >1year contracts) 	

14	<p>Do you have a view of whether implementation for the 2020/21 Triad season is sufficient to allow changes for i) supplier contracts and billing system, and ii) for other stakeholders?</p>	
----	--	--

Specific questions for BOTH CMP264 & CMP265

Q	Question	Response
9	<p>i) Suppliers: In setting charges for your demand customers, do you charge them at the same tariff as National Grid charges you (i.e. gross), to enable you to pay the embedded benefit to embedded generators, or please explain the way in which it is funded?</p> <p>ii) Suppliers: Does the estimate that 7.58GW of embedded generation output and 2.5GW of demand side reduction at the time of Triad for 2016/17 seem reasonable based on your knowledge of the UK market? If not what is your estimate of embedded generator output and DSR at time of Triad?</p>	

Q	Question	Response
12	<p>Can you identify – either quantitatively or qualitatively - the impact of the demand TNUoS embedded benefit on your decisions made in making capacity market decisions?</p>	
15	<p>i) What are your views on the 2 broad options to enable the reporting of gross export metered data?</p> <p>ii) Would you have the data available required for Option B (both CMP264 and CMP265) for both new contracts and existing contracts where a customer may be partially exempt?</p> <p>iii) Do you believe you can implement the proposed changes by the respective implementation dates?</p> <p>iv) What are the pros and cons of the 2 proposals that ELEXON are considering to implement this (P348 for CMP265/ P349 for CMP264)?</p>	

Q	Question	Response
16	<p>Do you have any further evidence / comments on the consumer impact of changing the demand TNUoS embedded benefit in either the short-run or long-run?</p>	<p>There are two perspectives to consider - practical and ideological.</p> <p>Ideological:</p> <ol style="list-style-type: none"> (1) Cost reflective can be taken to mean the marginal cost to the existing transmission system, although a logical approach it cannot really be fully adhered to, as sunk/fixed costs are also need to be assigned. If a truly marginal approach was taken new build generation which did not cause those costs would not be charged. (2) It is the opinion of some that TNUoS charging should be a treated as a tax on generation paying for the greater good of the transmission network (consultation document 3.2.24), if EG pays even when it doesn't use the transmission network does this imply all onsite/off grid users also pay? Decisions regarding tax should be decided by the government, cost recovery is fundamentally different in nature. (3) A tax like approach on generation to fund TNUoS would be a strong pull to the status quo, and bar any real long term potential for a more distributed network (even if it were to become more cost effective in the long run), sites paying for a system they do not use also has a monopolistic aspect, and could be seen as anti-competitive. (4) Cost reflective could also be taken to mean the cost of a system should be borne by its users, so arguably electricity produced by EG (if used in same GSP)/onsite generation/Off grid should not bear any cost. EG in importing GSPs could argue they do not use the transmission networks, but this would be more difficult for EG in exporting GSPs as some of the electricity produced by EG does use the transmission system. <p>Practical:</p> <ol style="list-style-type: none"> (1) The current system not system does not facilitate effective competition between TG/EG/Demand response. (2) It is very hard for most parties to the debate to be unbiased as there are potentially large financial implications to most asset owners. Modelling needs to be completed by a genuinely independent party. (3) The strong time related price signal given to demand and EG currently is a result of increasing transmission network costs and EU legislation, it has not been calculated for the optimal response and is likely not to be cost reflective of its impact on transmission charges. This does not mean that a complete absence of time based signal is optimal: a combination of volume used, time based element and maximum capacity may all be a better reflection. (4) It is important any solution does not discriminate between demand reduction/generation, as this is the bigger distortion, none of the current proposals / alternatives address this. (5) Thought should be given to monetising the less tangible benefits: smaller more numerous distributed generators are less vulnerable to large outages caused by a major plant going offline or intentional attacks on the system. As the cost of such an outage is very high, the reduced risk/impact can be small, but still have a significant value. (6) It is unclear from the information available the extent to which TNUoS costs are incurred by: <ol style="list-style-type: none"> a) Transporting electricity between GSPs b) Transporting TG to the local DNO c) Overheads d) How peak capacity effects these costs in long/short run <p>It is also unclear the extent to which Transmission connection charges are recovered via TNUoS (compared to the distribution charges, which are to be more expensive upfront).</p> <p>Without the above calculations and in the absence of the context of a wider TNUoS demand/supply charging review it is not possible to conclude whether the proposed modifications would be better aligned to the charging objectives.</p>

Q	Question	Response
17	<p>Do you feel that both the locational and residual component of the demand TNUoS should be removed as an embedded benefit (as CMP264 Original) or just the residual component (as CMP265 Original) or some other method?</p>	<p>There should never be a locational signal that causes a negative Triad Charge. If any EG were subject to this, they would have to switch off over any period they that might be a triad. Any time there is an expectation of high demand, EG switching off would exacerbate the demand. In reality, it would bar EG from Triads <u>and</u> generating over any winter peak price periods -this would be of particular impact to onshore wind in Scotland. Affected windfarms would have to switch off whenever demand looked high, distorting the merit order, reducing system stability and increasing balancing costs.</p>
19	<p>Regarding the proposed alternatives what are your views on the suggested implementation dates? Are these achievable? Please give reasons for your view.</p>	

CUSC Workgroup Consultation Response Proforma

CMP264 'Embedded Generation Triad Avoidance Standstill' and **CMP265** 'Gross charging of TNUoS for HH demand where Embedded Generation is in the Capacity Market'

Industry parties are invited to respond to this consultation expressing their views and supplying the rationale for those views, particularly in respect of any specific questions detailed below.

Please send your responses by **24th August 2016** to cusc.team@nationalgrid.com Please note that any responses received after the deadline or sent to a different email address may not receive due consideration by the Workgroup.

Any queries on the content of the consultation should be addressed to Caroline Wright at caroline.wright@nationalgrid.com

These responses will be considered by the Workgroup at its next meeting at which members will also consider any Workgroup Consultation Alternative Requests. Where appropriate, the Workgroup will record your response and its consideration of it within the final Workgroup Report which is submitted to the CUSC Modifications Panel.

Respondent:	<i>Philip Heasman</i> pheasman@silvarenewable.com <i>Direct dial: (0) 7808 293864</i>
Company Name:	<i>Silva Renewable Energy Limited – Bilateral Connection Contract holder</i>
Please express your views regarding the Workgroup Consultation, including rationale. (Please include any issues, suggestions or queries)	<p>For reference, the Applicable CUSC objectives are:</p> <p style="text-align: center;">Use of System Charging Methodology</p> <p>(a) that compliance with the use of system charging methodology facilitates effective competition in the generation and supply of electricity and (so far as is consistent therewith) facilitates competition in the sale, distribution and purchase of electricity;</p> <p>(b) that compliance with the use of system charging methodology results in charges which reflect, as far as is reasonably practicable, the costs (excluding any payments between transmission licensees which are made under and in accordance with the STC) incurred by transmission licensees in their transmission businesses and which are compatible with standard condition C26 (Requirements of a connect and manage connection);</p>

	<p>(c) that, so far as is consistent with sub-paragraphs (a) and (b), the use of system charging methodology, as far as is reasonably practicable, properly takes account of the developments in transmission licensees' transmission businesses.</p> <p>(d) Compliance with the Electricity Regulation and any relevant legally binding decision of the European Commission and/or the Agency.</p>
--	---

Standard Workgroup consultation questions – CMP264

Q	Question	Response
1	<p>Do you believe that the CMP264 Original Proposal better facilitates the Applicable CUSC Objectives?</p>	<p>No</p> <p>We do not support either of the proposed two modifications because we believe they do not provide an enduring solution to the distortions their sponsors seek to address or the defects identified subsequently by Ofgem. Indeed neither improves on the current CUSC baseline, and could be argued to be regressive under charging objectives a), b) and c).</p> <p>Indeed, we are strongly opposed to the standstill proposal for embedded benefits (CMP264) which discriminates against developers like us and would not support competition under the CUSC charging objectives. By design it does not provide an enduring solution, and hence the stability, which is what the market requires.</p> <p>It is also relevant that Ofgem has raised concerns over the cost-reflectivity of the triad benefit and wishes to see change. We do not believe either of the two tabled solutions address this problem, and they would simply introduce further distortions and discriminations into the current CUSC baseline. They do not bring charges in line with costs nor reflect developments in the transmission system. It is clear that for a robust solution to be identified considerable further work is needed, and the key is coming forward with a revised charging methodology that captures the true benefits of distribution-connected to the system, and not just National Grid's avoided reinforcement costs.</p>

Q	Question	Response
2	<p>Do you support the proposed implementation approach? Or are there any further implementation implications that need to be considered?</p>	<p>No</p> <p>This situation – especially the prospect of no early resolution - gives rise to considerable risks to us and other developers. It is virtually impossible at this stage to call what enduring solution might emerge. Whilst some reduction in the triad benefit may be one outcome, we estimate that in our case, any such result could add materially to the required CfD strike price. We would expect other developers in similar circumstances to encounter a similar issue. This is contrary to HM Government’s key objective for CfD, namely that any subsidy for renewable energy must achieve value for money to the energy consumer.</p> <p>There needs to be a clear implementation path way for addressing the defect and the Ofgem issues communicated to the industry well ahead of CFD auction processes.</p> <p>We would be happy to share with the code administrator our confidential estimates on the size of the potential impact.</p>

Q	Question	Response
3	<p>Do you have any other comments?</p>	<p>Silva is the developer behind the Grangemouth renewable energy scheme, a s36 consented 120MWe biomass CHP in the strategically important Grangemouth petrochemical and industrial processing zone. Grangemouth CHP is being prepared for the second CfD allocation round which is expected imminently.</p> <p>Grangemouth CHP already has a transmission connection agreement in place, but is also advancing the option of a distribution connection which is now at offer stage. Assuming a successful outcome at CfD, Grangemouth CHP would be constructed and commissioned in time for the 2021 delivery year. It is a project that has immense economic benefit for the Grangemouth industrial area and broader Falkirk community, and is being closely followed at all levels of local and national government.</p> <p>Against this background we have been preparing our bid in the forthcoming CfD auction using the transmission charging baseline as it stands, but following closely the recent developments with regard to the embedded benefit review and the Consultation and how these may impact our distribution connection offer. This is particularly important to Grangemouth CHP as, in unchanged circumstances unaffected by the embedded benefit review and Consultation, a distribution connection would help greatly the project economics and enhance the deliverability of Grangemouth CHP under the CfD regime with the commensurate benefits to the local community and wider national interest.</p> <p>Given the huge uncertainty surrounding the transmission charging regime, the significant regulatory risk that has been introduced into the process and the probability this will not be resolved by the two modifications in process, the Working Group should consider the interactions of these change proposals (and alternatives) with the CfD regime.</p> <p>The only obvious solution we can see at this stage is to respect the assumptions made by developers in making their CfD bids, in effect “grandfathering” them, and the next stage of the assessment process should explicitly address this. Some accommodation to address other potential material changes to the regulatory regime in the future also needs consideration as regulatory risk has significantly increased in the eyes of the financial community.</p> <p>As a separate comment we believe the Working Group has failed to consider the implications of the generator residual turning negative in the near time and the further distorting effect this would have on the competitive process for CFDs.</p>

Q	Question	Response
4	Do you wish to raise a WG Consultation Alternative Request for the Workgroup to consider?	No but I support Infinis Energy's proposed WACMs

Standard Workgroup consultation questions – CMP265

Q	Question	Response
5	Do you believe that the CMP265 Original Proposal better facilitates the Applicable CUSC Objectives?	<p>No</p> <p>We do not support either of the proposed two modifications because we believe they do not provide an enduring solution to the distortions their sponsors seek to address.</p> <p>We believe this proposal is discriminatory. If it transpired we were not successful in the CFD auction, one alternative way forward under consideration is for us to seek a long-term capacity market contract rewarding the firm availability we bring. In the event it made more sense to pursue the distribution connection, it would be distortive to deny equivalent access to the triad benefit as past and future investors given the beneficial impact we would bring to the regional system.</p> <p>It is also relevant that Ofgem has raised concerns over the cost-reflectivity of the triad benefit and wishes to see change. We do not believe either of the two tabled solutions address this problem, and they would simply introduce further distortions and discriminations into the current CUSC baseline. They do not bring charges in line with costs nor reflect developments in the transmission system. It is clear that for a robust solution to be identified considerable further work is needed, and the key is coming forward with a revised charging methodology that captures the true benefits of distribution-connected to the system, and not just National Grid's avoided reinforcement costs.</p>

Q	Question	Response
6	<p>Do you support the proposed implementation approach? Or are there any further implementation implications that need to be considered?</p>	<p>No. But the Working Group urgently needs to consider the interactions and implications for the imminent CFD award process.</p> <p>This situation – especially the prospect of no early resolution - gives rise to considerable risks to us and other developers. It is virtually impossible at this stage to call what enduring solution might emerge. Whilst some reduction in the triad benefit may be one outcome, we estimate that there could be a material impact on the required CfD strike price. We would expect other developers in similar circumstances to encounter a similar issue. This is contrary to HM Government’s key objective for CfD, namely that any subsidy for renewable energy must achieve value for money to the energy consumer.</p> <p>There needs to be a clear implementation path way for addressing the defect and the Ofgem issues communicated to the industry well ahead of CFD auction processes.</p> <p>We would be happy to share with the code administrator our confidential estimates on the size of the potential impact.</p>
7	<p>Do you have any other comments?</p>	<p>Given the huge uncertainty surrounding the charging regime, the significant regulatory risk that has been introduced into the process and the probability this will not be resolved by the two modifications in process, I believe the Working Group should explicitly consider the interactions of these change proposals (and alternatives) with the CfD regime. The only obvious solution we can see at this stage is to respect the assumptions made by developers in making their CfD bids, in effect “grandfathering” them, and the next stage of the assessment process should explicitly address this. Some accommodation to address other potential material changes to the regulatory regime in the future also needs consideration as regulatory risk has significantly increased in the eyes of the developer and financial community.</p>
8	<p>Do you wish to raise a WG Consultation Alternative Request for the Workgroup to consider?</p>	<p>No but I support Infinis Energy’s proposed WACMs</p>

Specific questions for CMP264

Q	Question	Response
---	----------	----------

Q	Question	Response
10	<p>i) Do you think a cut-off date for “new embedded generation” of 30 June 2017 is appropriate? What other date would you propose?</p> <p>ii) Do you have any views on how mixed sites are being addressed in CMP264 Original?</p> <p>iii) Do you think new-build embedded generation capacity that has entered into long term financial and performance commitment obligations via 2014 and 2015 capacity market or contracts for difference auctions (prior to this modification proposal) should be given exceptions to this cut-off date?</p> <p>iv) Do you agree that ignoring demand behind the meter is unlikely to create a significant “loophole” or material discrimination risk in relation to the CMP264 arrangements in the short term</p> <p>v) Question to suppliers: Do you consider that the wording of your existing contracts allow you to reflect the changes provided by these modifications in a cost reflective manner. For example, these changes will apply to existing PPAs and generators who significantly alter their output (EREC 59).</p> <p>vi) Do you agree with the definition of commissioned and do you agree that it is appropriate? If you do not agree with the definition or that it is appropriate please provide alternative definitions and rationale for this definition.</p>	<p>Not appropriate.</p> <p>No</p> <p>They should be grandfathered at prevailing rates.</p> <p>Yes</p>

Q	Question	Response
13	<p>Do you have a view of whether implementation for the 2017/18 Triad season is sufficient to allow changes for:</p> <p>i) supplier contracts and billing system; and</p> <p>ii) ii) for other stakeholders?</p>	No view
18	<p>Do you have a view if embedded benefits are frozen at a non-zero value, what should that value be as a £/kW tariff (2016/17 value is £45.33 / kW)?</p>	The values should reflect the value to the grid in investment and operational terms. Interaction with distribution charges also needs to be assessed before firm reform proposals are committed to.

Specific questions for CMP265

Q	Question	Response
11	<p>i) Views are sought on the implication for mixed sites discussed in 3.4.10.</p> <p>ii) Views are sought on the preference of categories of capacity Market CMU captured by this proposal, please indicate your preference from the following list and reasons:</p> <ul style="list-style-type: none"> • All existing and new distribution generation CMUs • All existing and new distribution generation CMUs and DSR CMUs (proven and unproven) • All price maker CMUs • All newbuild/prospective distribution generation CMUs only (defined as >1year contracts) 	No view on these matters.

14	<p>Do you have a view of whether implementation for the 2020/21 Triad season is sufficient to allow changes for i) supplier contracts and billing system, and ii) for other stakeholders?</p>	<p>The key will be communicating to the industry a clear implementation pathway in good time ahead of next CFD auction.</p> <p>Given the huge uncertainty surrounding the transmission charging regime, the significant regulatory risk that has been introduced into the process and the probability this will not be resolved by the two modifications in process, the Working Group should consider the interactions of these change proposals (and alternatives) with the CfD regime.</p> <p>The only obvious solution we can see at this stage is to respect the assumptions made by developers in making their CfD bids, in effect “grandfathering” them, and the next stage of the assessment process should explicitly address this. Some accommodation to address other potential material changes to the regulatory regime in the future also needs consideration as regulatory risk has significantly increased in the eyes of the financial community.</p>
----	--	--

Specific questions for BOTH CMP264 & CMP265

Q	Question	Response
---	----------	----------

Q	Question	Response
9	<p>i) Suppliers: In setting charges for your demand customers, do you charge them at the same tariff as National Grid charges you (i.e. gross), to enable you to pay the embedded benefit to embedded generators, or please explain the way in which it is funded?</p> <p>ii) Suppliers: Does the estimate that 7.58GW of embedded generation output and 2.5GW of demand side reduction at the time of Triad for 2016/17 seem reasonable based on your knowledge of the UK market? If not what is your estimate of embedded generator output and DSR at time of Triad?</p>	
12	<p>Can you identify – either quantitatively or qualitatively - the impact of the demand TNUoS embedded benefit on your decisions made in making capacity market decisions?</p>	<p>We estimate that in our case, any reduction in triad revenue could materially impact on our required CfD strike price. We would expect other developers in similar circumstances to encounter a similar issue. This is contrary to HM Government's key objective for CfD, namely that any subsidy for renewable energy must achieve value for money to the energy consumer.</p> <p>We would be happy to share with the code administrator our estimates on the size of the potential impact.</p>

Q	Question	Response
15	<p>i) What are your views on the 2 broad options to enable the reporting of gross export metered data?</p> <p>ii) Would you have the data available required for Option B (both CMP264 and CMP265) for both new contracts and existing contracts where a customer may be partially exempt?</p> <p>iii) Do you believe you can implement the proposed changes by the respective implementation dates?</p> <p>iv) What are the pros and cons of the 2 proposals that ELEXON are considering to implement this (P348 for CMP265/ P349 for CMP264)?</p>	No opinion
16	Do you have any further evidence / comments on the consumer impact of changing the demand TNUoS embedded benefit in either the short-run or long-run?	No
17	Do you feel that both the locational and residual component of the demand TNUoS should be removed as an embedded benefit (as CMP264 Original) or just the residual component (as CMP265 Original) or some other method?	<p>No at the very least the locational should remain in order to drive a locational signal to generators and therefore better meet CUSC charging objectives.</p> <p>Further work is required to understand what part of the residual charge is sensitive to local netting.</p>
19	Regarding the proposed alternatives what are your views on the suggested implementation dates? Are these achievable? Please give reasons for your view.	No view.

CUSC Workgroup Consultation Response Proforma

CMP264 'Embedded Generation Triad Avoidance Standstill' and **CMP265** 'Gross charging of TNUoS for HH demand where Embedded Generation is in the Capacity Market'

Industry parties are invited to respond to this consultation expressing their views and supplying the rationale for those views, particularly in respect of any specific questions detailed below.

Please send your responses by **24th August 2016** to cusc.team@nationalgrid.com Please note that any responses received after the deadline or sent to a different email address may not receive due consideration by the Workgroup.

Any queries on the content of the consultation should be addressed to Caroline Wright at caroline.wright@nationalgrid.com

These responses will be considered by the Workgroup at its next meeting at which members will also consider any Workgroup Consultation Alternative Requests. Where appropriate, the Workgroup will record your response and its consideration of it within the final Workgroup Report which is submitted to the CUSC Modifications Panel.

Respondent:	<i>James Anderson</i> <i>james.anderson@scottishpower.com</i>
Company Name:	<i>ScottishPower Energy Management Limited</i>
Please express your views regarding the Workgroup Consultation, including rationale. (Please include any issues, suggestions or queries)	<p>For reference, the Applicable CUSC objectives are:</p> <p>Use of System Charging Methodology</p> <p>(a) that compliance with the use of system charging methodology facilitates effective competition in the generation and supply of electricity and (so far as is consistent therewith) facilitates competition in the sale, distribution and purchase of electricity;</p> <p>(b) that compliance with the use of system charging methodology results in charges which reflect, as far as is reasonably practicable, the costs (excluding any payments between transmission licensees which are made under and in accordance with the STC) incurred by transmission licensees in their transmission businesses and which are compatible with standard condition C26 (Requirements of a connect and manage connection);</p> <p>(c) that, so far as is consistent with sub-paragraphs (a) and (b), the use of system charging methodology, as far as is reasonably practicable, properly takes account of</p>

	<p>the developments in transmission licensees' transmission businesses.</p> <p>(d) Compliance with the Electricity Regulation and any relevant legally binding decision of the European Commission and/or the Agency.</p>
--	---

Standard Workgroup consultation questions – CMP264

Q	Question	Response
1	Do you believe that the CMP264 Original Proposal better facilitates the Applicable CUSC Objectives?	<p>Yes. Overall, CMP264 will better meet the Applicable Charging Objectives (ACOs) than the current baseline.</p> <p>CMP264 will remove a distortion in competition between investing in embedded and transmission connected generation by removing a non-cost reflective payment from embedded generation. This better facilitates ACO (a).</p> <p>CMP264 will better facilitate ACO (b) by removing a non-cost reflective payment realised by embedded generators.</p> <p>Developments in the transmission system have resulted in a significant increase in the demand residual TNUoS tariff which is significantly in excess of any savings in transmission investment resulting from connecting generation at a distribution level. By addressing which generators can access the demand residual TNUoS charge as an embedded benefit, CMP264 better facilitates ACO (c).</p>
2	Do you support the proposed implementation approach? Or are there any further implementation implications that need to be considered?	<p>Parties participating in the Capacity Mechanism auction process require certainty over future costs and revenues in order to bid efficiently. The implementation approach for CMP264 can provide that certainty by allowing for an Authority determination before the December 2016 CM auction and a cut-off date for entitlement to embedded benefits of June 2017. In line with when Triad periods can occur, the actual implementation of the system changes needs to be no later than 1 November 2017.</p>
3	Do you have any other comments?	No.
4	Do you wish to raise a WG Consultation Alternative Request for the Workgroup to consider?	No.

Standard Workgroup consultation questions – CMP265

Q	Question	Response
5	<p>Do you believe that the CMP265 Original Proposal better facilitates the Applicable CUSC Objectives?</p>	<p>Yes. Overall, CMP265 will better meet the Applicable Charging Objectives (ACOs) than the current baseline.</p> <p>CMP265 will remove a distortion in competition between investing in embedded and transmission connected generation, in particular in connection with the Capacity Market, by removing a non-cost reflective payment from embedded generation. This better facilitates Applicable Charging Objective (ACO) (a).</p> <p>CMP265 will better facilitate ACO (b) by removing a non-cost reflective payment realised by embedded generators.</p> <p>Developments in the transmission system, in particular the increase in the amount of embedded generation connected and a significant increase in the demand residual TNUoS tariff have resulted in payments to embedded generators which are significantly in excess of any savings in transmission investment resulting from connecting generation at a distribution level. By addressing which generators can access the demand residual TNUoS charge as an embedded benefit, CMP265 better facilitates ACO (c).</p>
6	<p>Do you support the proposed implementation approach? Or are there any further implementation implications that need to be considered?</p>	<p>No. By delaying implementation until 2020 (and assuming CMP264 is not also adopted) there is the opportunity for embedded generators to bid into the capacity market on the basis of receipt of escalating embedded benefits in the period between construction and CMP265 implementation. The NPV of these benefits could amount to as much as £17/kWⁱ which could represent a significant distortion in the CM auction. An earlier implementation date would prevent this potential distortion. Alternatively, if CMP264 were also to be adopted, we would support the proposed implementation approach.</p>
7	<p>Do you have any other comments?</p>	<p>No.</p>
8	<p>Do you wish to raise a WG Consultation Alternative Request for the Workgroup to consider?</p>	<p>No.</p>

Specific questions for CMP264

Q	Question	Response
10	<p>i) Do you think a cut-off date for “new embedded generation” of 30 June 2017 is appropriate? What other date would you propose?</p> <p>ii) Do you have any views on how mixed sites are being addressed in CMP264 Original?</p> <p>iii) Do you think new-build embedded generation capacity that has entered into long term financial and performance commitment obligations via 2014 and 2015 capacity market or contracts for difference auctions (prior to this modification proposal) should be given exceptions to this cut-off date?</p> <p>iv) Do you agree that ignoring demand behind the meter is unlikely to create a significant “loophole” or material discrimination risk in relation to the CMP264 arrangements in the short term</p>	<p>i) Yes. The cut-off date should be early enough to prevent distortion of future investment decisions but late enough to allow Parties who have already made such a decision sufficient time to construct and commission the new plant. As most of the new plant will be smaller scale in nature, 30 June 2017 is appropriate.</p> <p>ii) Under the current baseline there is an issue with being able to capture generation behind the meter as only boundary metering enters the settlement process. CMP264 does not attempt to address this separate issue and will only capture exporting half-hourly settlement metering. We consider that mixed sites should be addressed as part of Ofgem’s further review of charging or via a separate modification.</p> <p>iii) No. As outlined in our answer to (i) above, we believe that projects which were sufficiently advanced to be eligible to secure contracts in the Capacity Mechanism or CFD auctions should be able to construct and commission before the cut-off date. However, if firm evidence to the contrary is provided, it may also be appropriate to offer additional carve outs to those who have already won CM agreements or CFDs, until such time as CMP265 is implemented</p> <p>iv) We do not believe that capturing only exporting boundary metering will present a significant “loophole” in the short term and in particular with respect to the forthcoming capacity auction. As outlined in our response to (ii), we consider that it would be appropriate for mixed sites to be addressed as part of Ofgem’s further review of charging or via a separate modification.</p>

Q	Question	Response
10	<p>v) Question to suppliers: Do you consider that the wording of your existing contracts allow you to reflect the changes provided by these modifications in a cost reflective manner. For example, these changes will apply to existing PPAs and generators who significantly alter their output (EREC 59).</p> <p>vi) Do you agree with the definition of commissioned and do you agree that it is appropriate? If you do not agree with the definition or that it is appropriate please provide alternative definitions and rationale for this definition.</p>	<p>v) In most cases, PPAs with existing generators will not be caught by the definition of New Embedded Generator. Wording will be required in future PPA agreements to ensure that commission dates can be verified by reference to the EREC59 commissioning certificate and to allow the metering data to be provided to National Grid for billing purposes if required.</p> <p>vi) Yes. We believe that EREC G59 process provides a consistent, conclusive and verifiable record of the date of commissioning of new embedded generation.</p>
13	<p>Do you have a view of whether implementation for the 2017/18 Triad season is sufficient to allow changes for:</p> <p>i) supplier contracts and billing system; and</p> <p>ii) for other stakeholders?</p>	<p>As CMP264 only affects embedded generation commissioned after the cut-off date, there is no need for retrospective registration of existing plant. As the commissioning of new embedded plant after the cut-off date is expected to reduce after the removal of the distortion to investment decisions as a result of the implementation of CMP264 and the remaining new plant would be expected to register with many individual suppliers due to competition, the burden on each supplier, registering a small number of New Embedded generators should not be onerous. Table 8 in the Workgroup report indicates that the number of affected sites (assuming CMP264 does not reduce the number of new embedded generators that come forward) would be between 12 and 122 per annum in the period 2017/18 to 2020/21. In practice, we believe that implementation of CMP264 would lead to lower volumes than this, especially in later years. As a supplier, we do not foresee any issues.</p>

Q	Question	Response
18	<p>Do you have a view if embedded benefits are frozen at a non-zero value, what should that value be as a £/kW tariff (2016/17 value is £45.33 / kW)?</p>	<p>If embedded benefits were to be frozen at a non-zero value this should be based upon the £1.62/kW/year identified in NGET's Review of the Embedded (Distributed) Generation Benefit, December 2013.</p> <p>Further analysis would require to be undertaken by NGET to re-validate and update this figure. However it is clear that with the current Triad avoidance benefit in 2018/19 estimated at around £52.91/kW/yearⁱⁱ, adopting a zero value would be closer to cost reflectivity than the current baseline.</p>

Specific questions for CMP265

Q	Question	Response
11	<p>i) Views are sought on the implication for mixed sites discussed in 3.4.10.</p> <p>ii) Views are sought on the preference of categories of capacity Market CMU captured by this proposal, please indicate your preference from the following list and reasons:</p> <ul style="list-style-type: none"> • All existing and new distribution generation CMUs • All existing and new distribution generation CMUs and DSR CMUs (proven and unproven) • All price maker CMUs • All newbuild/prospective distribution generation CMUs only (defined as >1year contracts) 	<p>i) Given the scale of potential Triad avoidance benefits available to non-CM embedded plant post 1 April 2020 (£72.03/kW Demand Residual per NGET forecast of TNUoS tariffs from 2017/18 to 2020/21ⁱⁱⁱ) there would be a strong commercial incentive on mixed sites to assign separate settlement metering on all generation plant not covered by the CMEG definition. We would therefore not advocate complex alternative arrangement within the CUSC and BSC to cater for these sites.</p> <p>ii) We believe that CMP265 should apply to all existing and new distribution-connected generation CMUs. Given that CMP 265 is intended to be an enduring solution, this prevents potential discrimination between those CMUs connected before the CMP265 implementation date (1 April 2020), and those connected after.</p> <p>Ofgem acknowledges in its open letter of 29 July 2016 that a consequence of not fully addressing all market defects could be to push more generation to connect behind the meter or via private wires, which is likely to lead to inefficient outcomes. We believe that similar considerations could also apply to DSR investments. We consider that these aspects are likely to be addressed by reviewing the whole concept of charging according to triad demand – whether as a result of work initiated by Ofgem or following a further code modification proposal.</p>

14	<p>Do you have a view of whether implementation for the 2020/21 Triad season is sufficient to allow changes for i) supplier contracts and billing system, and ii) for other stakeholders?</p>	<p>Yes. Implementation for the 2020/21 Triad season provides around 4 years for suppliers to amend PPA contracts with embedded generators and for National Grid to amend its billing systems. Even allowing for the fact that CMP265 affects existing plant (unlike CMP264) this should be more than adequate.</p>
----	--	--

Specific questions for BOTH CMP264 & CMP265

Q	Question	Response
9	<p>i) Suppliers: In setting charges for your demand customers, do you charge them at the same tariff as National Grid charges you (i.e. gross), to enable you to pay the embedded benefit to embedded generators, or please explain the way in which it is funded?</p> <p>ii) Suppliers: Does the estimate that 7.58GW of embedded generation output and 2.5GW of demand side reduction at the time of Triad for 2016/17 seem reasonable based on your knowledge of the UK market? If not what is your estimate of embedded generator output and DSR at time of Triad?</p>	<p>i) Suppliers require to recover both the demand TNUoS charges levied on them by National Grid and payments for Triad Avoidance benefit (made to embedded generation under the terms of power purchase agreements) from consumers. A supplier which fails to recover both of these costs (plus an appropriate profit) from its customer portfolio over time will be unable to cover its cost of capital.</p> <p>ii) We do not have an independent view of the volume of embedded generation output and DSR at Triad but the Future Energy Scenarios document would appear to be an acceptable source for the estimates.</p>
12	<p>Can you identify – either quantitatively or qualitatively - the impact of the demand TNUoS embedded benefit on your decisions made in making capacity market decisions?</p>	<p>TNUoS embedded benefit is one of a number of potential income streams to be considered when considering an investment in embedded generation plant; others include power prices and Capacity Mechanism or CFD income. Being able to assume an additional income stream from Triad avoidance benefit enables embedded generation to reflect lower costs into Capacity Mechanism bids.</p>

Q	Question	Response
15	<p>i) What are your views on the 2 broad options to enable the reporting of gross export metered data?</p> <p>ii) Would you have the data available required for Option B (both CMP264 and CMP265) for both new contracts and existing contracts where a customer may be partially exempt?</p> <p>iii) Do you believe you can implement the proposed changes by the respective implementation dates?</p> <p>iv) What are the pros and cons of the 2 proposals that ELEXON are considering to implement this (P348 for CMP265/ P349 for CMP264)?</p>	<p>i) We believe that the simpler requirement to require Suppliers to provide the appropriate meter data for individual metering systems to National Grid is the most efficient solution given the limited number of sites potentially affected (see our response to Q13). Such a solution is also more easily implemented as a manual workaround to achieve implementation in time for the 2017/18 Triad season.</p> <p>ii) For SVA Generation sites that have MPANs associated to them, we are not always the Supplier for both the Import and Export and therefore netting could be a problem. We do hold line loss factor information and GCF values, so if we had to adjust data and send this to NG, potentially this could be done, albeit the rules/criteria to apply would have to be explicit and applied consistently across all Suppliers. For CVA sites we may also hold the information if these sites were within the Manweb and SP GSP Group areas.</p> <p>iii) Yes. Due to the limited number of sites affected we believe that initial manual and later enduring systems can be put in place to deliver the required data.</p> <p>iv) Option (a) with detailed BSC requirements and processes would provide a robust enduring solution. However, it may require considerable development and would require more resource both during development and on an enduring basis. Option (b) could be more easily deliverable given the implementation date for CMP264 and may be delivered at a cost and effort more appropriate to the number of embedded generation sites potentially affected.</p>
16	<p>Do you have any further evidence / comments on the consumer impact of changing the demand TNUoS embedded benefit in either the short-run or long-run?</p>	<p>We believe that Table 5 and Figure 6 provide a reasonable estimation of the cost of Triad Avoidance benefit borne by consumers.</p>

Q	Question	Response
17	<p>Do you feel that both the locational and residual component of the demand TNUoS should be removed as an embedded benefit (as CMP264 Original) or just the residual component (as CMP265 Original) or some other method?</p>	<p>The locational component of the demand TNUoS tariff provides a signal to embedded generation which is analogous to the locational components of the Generation. However, there is a risk that retention of the demand location component could result in perverse incentives on embedded generation in demand zones with a negative locational component to avoid generating over the Triad period. This would not assist the System Operator or DSOs to manage the system at times of high demand and could result in additional costs to consumers through the requirement to dispatch additional transmission connected plant. We would recommend that, should the demand locational component be retained, this should be “floored” at zero. Retention of the demand locational component may also require more complex TNUoS billing systems.</p>
19	<p>Regarding the proposed alternatives what are your views on the suggested implementation dates? Are these achievable? Please give reasons for your view.</p>	<p>While we do not support the “Green Frog et al” Alternative, their implementation dates appear achievable. We do not support the implementation date for “UKPR2” and “Centrica 1 &2” of 1 April 2020 as we believe that the ability to secure embedded benefits in the period until 1 April 2020 has the potential to distort Capacity Mechanism auction in the intervening period.</p>

ⁱ Please see attached estimate of the equivalent CM contract value (£/kW) of securing Triad Avoidance benefit in the Charging Years 2017/18 to 2019/20

ⁱⁱ Table 23, NGET forecast of TNUoS tariffs from 2017/18 to 2020/21, 11 February 2016

ⁱⁱⁱ Table 23, NGET forecast of TNUoS tariffs from 2017/18 to 2020/21, 11 February 2016

Estimate of the equivalent CM contract value (£/kW) of securing Triad Avoidance benefit in the Charging Years 2017/18 to 2019/20

**TNUoS Demand Residual Charge
per National Grid Forecast from 2017/18 to 2020/21**

Table 23

	<u>£/kW</u>
2017/18	46.34
2018/19	52.91
2019/20	58.13
2020/21	72.03

Assume 1MW project commissioned before winter 2017/18 and receiving Triad avoidance benefit until removed by CMP265 in 2020/21	
Assume new build plant securing a 15 year CM contract	
Assume project cost of capital	10%
Assume embedded generator secures	90% of the embedded benefit from the Supplier
Assume inflation	2%

	<u>NPV</u>	<u>2016/17</u>	<u>2017/18</u>	<u>2018/19</u>	<u>2019/20</u>	<u>2020/21</u>	<u>2021/22</u>	<u>2022/23</u>	<u>2023/24</u>	<u>2024/25</u>	<u>2025/26</u>	<u>2026/27</u>	<u>2027/28</u>	<u>2028/29</u>	<u>2029/30</u>	<u>2030/31</u>	<u>2031/32</u>	<u>2032/33</u>	<u>2033/34</u>	<u>2034/35</u>	<u>2035/36</u>	
Inflation Factor		1.00	1.02	1.04	1.06	1.08	1.10	1.13	1.15	1.17	1.20	1.22	1.24	1.27	1.29	1.32	1.35	1.37	1.40	1.43		
Triad Avoidance Income	£105,978	0	41,706	47,619	52,317	0	0	0	0	0	0	0	0	0	0	0	0	0	0	0	0	141,642
CM Payment equivalent	£105,978	0	0	0	0	18,313	18,680	19,053	19,434	19,823	20,219	20,624	21,036	21,457	21,886	22,324	22,770	23,226	23,690	24,164	0	316,701

CM equivalent to Triad revenue (£/kW/year) 16.92

Equivalent to CM Contract of £16.92 /kW from 2020/21

**ScottishPower
August 2016**

CUSC Workgroup Consultation Response Proforma

CMP264 'Embedded Generation Triad Avoidance Standstill' and **CMP265** 'Gross charging of TNUoS for HH demand where Embedded Generation is in the Capacity Market'

Industry parties are invited to respond to this consultation expressing their views and supplying the rationale for those views, particularly in respect of any specific questions detailed below.

Please send your responses by **24th August 2016** to cusc.team@nationalgrid.com Please note that any responses received after the deadline or sent to a different email address may not receive due consideration by the Workgroup.

Any queries on the content of the consultation should be addressed to Caroline Wright at caroline.wright@nationalgrid.com

These responses will be considered by the Workgroup at its next meeting at which members will also consider any Workgroup Consultation Alternative Requests. Where appropriate, the Workgroup will record your response and its consideration of it within the final Workgroup Report which is submitted to the CUSC Modifications Panel.

<p>Respondent:</p>	<p>Scott Taylor AVP Business Development</p> <p>Sembcorp Utilities (UK) Limited Sembcorp UK Headquarters Wilton International Middlesbrough TS90 8WS</p> <p>DID: +44 (0)1642 212798 Mob: +44 (0)7773 812021 Email: scott.taylor@sembcorp.com www.sembcorp.com</p>
<p>Company Name:</p>	<p>Sembcorp Utilities (UK) Limited</p>
<p>Please express your views regarding the Workgroup Consultation, including rationale.</p> <p>(Please include any issues, suggestions or queries)</p>	<p>Sembcorp believes that transmission charges applied directly, and avoided indirectly by generators, should be fair and reflective of the generators location and the locational demand. Furthermore generation, irrespective of its connection point, should have the efficiency and flexibility to deliver reliable, affordable, electricity to the consumer and not just deliver selective generation to secure specific “windfalls” such as capacity agreements and triad avoidance payments.</p> <p>To that end Sembcorp welcome Ofgem’s open letter on Charging arrangements for embedded benefits, and the opportunity to respond to CMP 264 and CMP265.</p>

	Sembcorp believes in a level playing-field for transmission charges such that no one particular generator in the same location is, all things considered, financially over-compensated for being connected to the distribution network compared to a comparable station being transmission connected. However Sembcorp also believe in the concept of grandfathering with respect to energy policy amendments.
--	--

Standard Workgroup consultation questions – CMP264

Q	Question	Response
1	Do you believe that the CMP264 Original Proposal better facilitates the Applicable CUSC Objectives?	Please see our opinion in Q2 below
2	Do you support the proposed implementation approach? Or are there any further implementation implications that need to be considered?	We support the review of charging arrangements for embedded generation however CMP264's proposal to remove triad avoidance revenue, even temporarily, for existing and sanctioned new-build generation would send the wrong signal to investors.
3	Do you have any other comments?	No
4	Do you wish to raise a WG Consultation Alternative Request for the Workgroup to consider?	No

Standard Workgroup consultation questions – CMP265

Q	Question	Response
5	Do you believe that the CMP265 Original Proposal better facilitates the Applicable CUSC Objectives?	Please see our opinion in Q6 below

6	Do you support the proposed implementation approach? Or are there any further implementation implications that need to be considered?	We support the review of charging arrangements for embedded generation and the proposed CMP265 gives a fair opportunity for developers and investors to assess the viability of distribution connection generation without the over-compensation of the current triad avoidance arrangements, thus moving towards a more level playing-field for all generation.
7	Do you have any other comments?	No
8	Do you wish to raise a WG Consultation Alternative Request for the Workgroup to consider?	No

End of Comments

CUSC Workgroup Consultation Response Proforma

CMP264 'Embedded Generation Triad Avoidance Standstill' and **CMP265** 'Gross charging of TNUoS for HH demand where Embedded Generation is in the Capacity Market'

Industry parties are invited to respond to this consultation expressing their views and supplying the rationale for those views, particularly in respect of any specific questions detailed below.

Please send your responses by **24th August 2016** to cusc.team@nationalgrid.com Please note that any responses received after the deadline or sent to a different email address may not receive due consideration by the Workgroup.

Any queries on the content of the consultation should be addressed to Caroline Wright at caroline.wright@nationalgrid.com

These responses will be considered by the Workgroup at its next meeting at which members will also consider any Workgroup Consultation Alternative Requests. Where appropriate, the Workgroup will record your response and its consideration of it within the final Workgroup Report which is submitted to the CUSC Modifications Panel.

Respondent:	<i>Colin Prestwich</i>
Company Name:	<i>SmartestEnergy</i>
<p>Please express your views regarding the Workgroup Consultation, including rationale.</p> <p>(Please include any issues, suggestions or queries)</p>	<p>For reference, the Applicable CUSC objectives are:</p> <p>Use of System Charging Methodology</p> <p>(a) that compliance with the use of system charging methodology facilitates effective competition in the generation and supply of electricity and (so far as is consistent therewith) facilitates competition in the sale, distribution and purchase of electricity;</p> <p>(b) that compliance with the use of system charging methodology results in charges which reflect, as far as is reasonably practicable, the costs (excluding any payments between transmission licensees which are made under and in accordance with the STC) incurred by transmission licensees in their transmission businesses and which are compatible with standard condition C26 (Requirements of a connect and manage connection);</p> <p>(c) that, so far as is consistent with sub-paragraphs (a) and (b), the use of system charging methodology, as far as is reasonably practicable, properly takes account of the developments in transmission licensees' transmission</p>

	<p>businesses.</p> <p>(d) Compliance with the Electricity Regulation and any relevant legally binding decision of the European Commission and/or the Agency.</p>
--	--

Standard Workgroup consultation questions – CMP264

Q	Question	Response
1	<p>Do you believe that the CMP264 Original Proposal better facilitates the Applicable CUSC Objectives?</p>	<p>No. The charging methodology is meant to result in charges which reflect the costs incurred by transmission licensees. The recipients of these charges are suppliers. Embedded generators are not “Users” as captured in the requirements to be cost reflective. As far as NGT are concerned there is no difference between a MW of reduced demand or a MW of increased embedded generation. It is therefore not more cost reflective in the CUSC environment to change the charging from net demand to gross demand. There may be a differential between the charges seen by transmission connected generators and embedded generators but the focus should be on NGT’s residual and apportioning this in a more sophisticated manner.</p> <p>What is really at odds here is the fact that the residual is increasing because of the €2.50 cap and the aforementioned differential. However, the €2.50 cap is a massive benefit to transmission connected generation in itself and it is this that creates much of the differential.</p> <p>Charging embedded generation differently from behind the meter would introduce an artificial distinction that does not currently exist because the net charging of suppliers is consistent with the regulatory arrangements.</p> <p>Given that the greater concern, expressed both by the proposer and Ofgem, is the projected increase of the residual, coupled with the fact that removing the embedded benefit would adversely affect the economics of existing plant it is essential that if there is to be any change made along the currently proposed lines, it is to new plant only.</p>

Q	Question	Response
2	Do you support the proposed implementation approach? Or are there any further implementation implications that need to be considered?	No
3	Do you have any other comments?	No
4	Do you wish to raise a WG Consultation Alternative Request for the Workgroup to consider?	Yes. Please see accompanying attachment.

Standard Workgroup consultation questions – CMP265

Q	Question	Response
5	Do you believe that the CMP265 Original Proposal better facilitates the Applicable CUSC Objectives?	No. The CUSC and EMR arrangements are two separate things, as are Triad payments and capacity payments. It is wrong to discriminate within the CUSC for impacts within the EMR arrangements.
6	Do you support the proposed implementation approach? Or are there any further implementation implications that need to be considered?	No
7	Do you have any other comments?	No
8	Do you wish to raise a WG Consultation Alternative Request for the Workgroup to consider?	No

Specific questions for CMP264

Q	Question	Response
----------	-----------------	-----------------

Q	Question	Response
10	<p>i) Do you think a cut-off date for “new embedded generation” of 30 June 2017 is appropriate? What other date would you propose?</p> <p>ii) Do you have any views on how mixed sites are being addressed in CMP264 Original?</p> <p>iii) Do you think new-build embedded generation capacity that has entered into long term financial and performance commitment obligations via 2014 and 2015 capacity market or contracts for difference auctions (prior to this modification proposal) should be given exceptions to this cut-off date?</p> <p>iv) Do you agree that ignoring demand behind the meter is unlikely to create a significant “loophole” or material discrimination risk in relation to the CMP264 arrangements in the short term</p> <p>v) Question to suppliers: Do you consider that the wording of your existing contracts allow you to reflect the changes provided by these modifications in a cost reflective manner. For example, these changes will apply to existing PPAs and generators who significantly alter their output (EREC 59).</p> <p>vi) Do you agree with the definition of commissioned and do you agree that it is appropriate? If you do not agree with the definition or that it is appropriate please provide alternative definitions and rationale for this definition.</p>	<p>i) It’s as good a date as any that is not retrospective.</p> <p>ii) If the supplier net model is retained then the issue of random boundaries in localised netting falls away.</p> <p>iii) No. It is generally not desirable to create exceptions for interactions with other codes/arrangements. If necessary, changes should be proposed under EMR governance.</p> <p>iv) We would have agreed with this if the proposal were a stop-gap arrangement. However, as it would now appear that the result of this modification would be for an enduring solution, as per the Ofgem open letter and alternatives on the table, building in an arbitrary boundary will lead to material discrimination. In short we do not agree with the assertion behind this question.</p> <p>v) Yes, the proposed changes would constitute a material change which would allow us to invoke a Change in Law clause.</p> <p>vi) No comment</p>

Q	Question	Response
13	<p>Do you have a view of whether implementation for the 2017/18 Triad season is sufficient to allow changes for:</p> <p>i) supplier contracts and billing system; and</p> <p>ii) ii) for other stakeholders?</p>	<p>i) No. We believe that the processes required for aggregating affected sites would mean that implementation for the 2017/18 Triad season would not be feasible.</p> <p>ii) No comment</p>
18	<p>Do you have a view if embedded benefits are frozen at a non-zero value, what should that value be as a £/kW tariff (2016/17 value is £45.33 / kW)?</p>	<p>If industry insists on hitting on a number which may or may not be reflective of the “embedded benefit” then we believe that a value of £35/kW would not be unreasonable. But this value will change over time and should not be fixed in this way. The level of the embedded benefit is a function of the TNUoS pricing methodology. If NGT apportioned the residual in a more sophisticated manner the “embedded benefit” would not be an issue.</p>

Specific questions for CMP265

Q	Question	Response
---	----------	----------

11	<p>i) Views are sought on the implication for mixed sites discussed in 3.4.10.</p> <p>ii) Views are sought on the preference of categories of capacity Market CMU captured by this proposal, please indicate your preference from the following list and reasons:</p> <ul style="list-style-type: none"> • All existing and new distribution generation CMUs • All existing and new distribution generation CMUs and DSR CMUs (proven and unproven) • All price maker CMUs • All newbuild/prospective distribution generation CMUs only (defined as >1year contracts) 	<p>i) No comment</p> <p>ii) Our preference in descending order of desirability would be:</p> <ol style="list-style-type: none"> 1) All new build/prospective distribution generation CMUs only (defined as >1year contracts) 2) All price maker CMUs 3) All existing and new distribution generation CMUs 4) All existing and new distribution generation CMUs and DSR CMUs (proven and unproven)
14	<p>Do you have a view of whether implementation for the 2020/21 Triad season is sufficient to allow changes for i) supplier contracts and billing system, and ii) for other stakeholders?</p>	<p>This is probably feasible.</p>

Specific questions for BOTH CMP264 & CMP265

Q	Question	Response
---	----------	----------

Q	Question	Response
9	<p>i) Suppliers: In setting charges for your demand customers, do you charge them at the same tariff as National Grid charges you (i.e. gross), to enable you to pay the embedded benefit to embedded generators, or please explain the way in which it is funded?</p> <p>ii) Suppliers: Does the estimate that 7.58GW of embedded generation output and 2.5GW of demand side reduction at the time of Triad for 2016/17 seem reasonable based on your knowledge of the UK market? If not what is your estimate of embedded generator output and DSR at time of Triad?</p>	<p>i) We pass through (or price in) at the NGT tariff for both demand and embedded generation. This means that we can reconcile our net bill from NGT to a fair degree of accuracy (i.e. aside from forecasting issues on fixed contracts) payments to generators netted off receipts from customers equal our TNUoS bill.</p> <p>ii) This estimate seems sensible.</p>
12	<p>Can you identify – either quantitatively or qualitatively - the impact of the demand TNUoS embedded benefit on your decisions made in making capacity market decisions?</p>	<p>No comment.</p>

Q	Question	Response
15	<p>i) What are your views on the 2 broad options to enable the reporting of gross export metered data?</p> <p>ii) Would you have the data available required for Option B (both CMP264 and CMP265) for both new contracts and existing contracts where a customer may be partially exempt?</p> <p>iii) Do you believe you can implement the proposed changes by the respective implementation dates?</p> <p>iv) What are the pros and cons of the 2 proposals that ELEXON are considering to implement this (P348 for CMP265/ P349 for CMP264)?</p>	<p>i) Reporting gross data is inappropriate. The triad charge is on suppliers and should be net. As far as NGT are concerned there is no difference between a MW of reduced demand or a MW of increased embedded generation.</p> <p>ii) We do not hold this data.</p> <p>iii) No. We would require another year.</p> <p>iv) No comment</p>
16	<p>Do you have any further evidence / comments on the consumer impact of changing the demand TNUoS embedded benefit in either the short-run or long-run?</p>	<p>No</p>
17	<p>Do you feel that both the locational and residual component of the demand TNUoS should be removed as an embedded benefit (as CMP264 Original) or just the residual component (as CMP265 Original) or some other method?</p>	<p>Some other method. We do not believe that the residual needs to be removed. Some of the costs within it need to be moved into the locational element or recovered in some other way.</p>
19	<p>Regarding the proposed alternatives what are your views on the suggested implementation dates? Are these achievable? Please give reasons for your view.</p>	<p>Centrica's proposals (2020) are achievable). Greenfrog's et al.'s and UKPR 1 proposals (2017) are not achievable. UKPR 2 (2020) is achievable</p>

CUSC Workgroup Consultation Response Proforma

CMP264 'Embedded Generation Triad Avoidance Standstill' and **CMP265** 'Gross charging of TNUoS for HH demand where Embedded Generation is in the Capacity Market'

Industry parties are invited to respond to this consultation expressing their views and supplying the rationale for those views, particularly in respect of any specific questions detailed below.

Please send your responses by **24th August 2016** to cusc.team@nationalgrid.com Please note that any responses received after the deadline or sent to a different email address may not receive due consideration by the Workgroup.

Any queries on the content of the consultation should be addressed to Caroline Wright at caroline.wright@nationalgrid.com

These responses will be considered by the Workgroup at its next meeting at which members will also consider any Workgroup Consultation Alternative Requests. Where appropriate, the Workgroup will record your response and its consideration of it within the final Workgroup Report which is submitted to the CUSC Modifications Panel.

Respondent:	John Tindal, 01738 457308, john.tindal@sse.com
Company Name:	SSE
<p>Please express your views regarding the Workgroup Consultation, including rationale.</p> <p>(Please include any issues, suggestions or queries)</p>	<p>For reference, the Applicable CUSC objectives are:</p> <p>Use of System Charging Methodology</p> <p>(a) that compliance with the use of system charging methodology facilitates effective competition in the generation and supply of electricity and (so far as is consistent therewith) facilitates competition in the sale, distribution and purchase of electricity;</p> <p>(b) that compliance with the use of system charging methodology results in charges which reflect, as far as is reasonably practicable, the costs (excluding any payments between transmission licensees which are made under and in accordance with the STC) incurred by transmission licensees in their transmission businesses and which are compatible with standard condition C26 (Requirements of a connect and manage connection);</p> <p>(c) that, so far as is consistent with sub-paragraphs (a) and (b), the use of system charging methodology, as far as is reasonably practicable, properly takes account of the developments in transmission licensees' transmission</p>

	<p>businesses.</p> <p>(d) Compliance with the Electricity Regulation and any relevant legally binding decision of the European Commission and/or the Agency.</p>
--	--

Standard Workgroup consultation questions – CMP264

Q	Question	Response
----------	-----------------	-----------------

Q	Question	Response
1	<p>Do you believe that the CMP264 Original Proposal better facilitates the Applicable CUSC Objectives?</p>	<p>Yes, we believe that the Original CMP264 better facilitates the competition and cost reflectivity objectives but we consider that some of the alternatives would facilitate these even more effectively (e.g. the approached suggested by proposed alternative Centrica 1 & Centrica 2 with some additional further changes). Our reasoning is outlined below.</p> <p>a) <u>CUSC Objective “a” - Better facilitates effective competition</u> – Yes, CMP264 Original does better facilitate effective competition as compared with the Baseline with regard to “New Embedded Generators”. There are other aspects of effective competition where the Original does not improve upon the Baseline and these shortcomings may be better addressed through an alternative such that proposed by Centrica option 1, or Centrica option 2, or a future modification. These shortcomings regarding the CMP264 Original in include:</p> <p><u>With regard to Network Connected Embedded generators</u></p> <ul style="list-style-type: none"> i. <u>Would Discriminate between : Existing Embedded vs Transmission Connected and New Embedded</u> – Although the Original successfully removes one element of discrimination (between New Embedded vs Transmission Connected), it leaves in place existing Baseline discrimination between Existing Embedded vs Transmission Connected (and also New Embedded). ii. <u>Would not correct Baseline distortion regarding investment/closure decisions for existing stations</u> – CMP264 Original would not represent an improvement compared with the Baseline with regard to non cost reflective charges/benefits for existing embedded generators. This would continue to distort their investment or closure decisions which in turn would continue to distort the Capacity and Wholesale Power markets. iii. <u>Would not correct Baseline distortion regarding dispatch decisions for existing stations</u> – CMP264 Original would not represent an improvement compared with Baseline of the defect regarding the dispatch decisions made by existing Embedded generators. The resulting dispatch decisions will continue to distort wholesale prices and therefore continue to distort competition in new investment and the capacity market. iv. <u>Would not correct Baseline distortion regarding discrimination: Customers Vs Existing Embedded Generators</u> – CMP264 Original would not improve the defect, compared with Baseline, regarding the discriminatory nature of the additional cost collected from customers to be used to pay the Embedded Benefit to <u>existing</u> Embedded generators.

Q	Question	Response
		<p><u>With regard to behind a demand meter</u></p> <p>The following behind the meter defects may be out of scope of CMP264, however, the fact that CMP264 may not have a wide enough scope to correct all of these existing Baseline defects should not prevent or delay the implementation of a modification which does implement some elements better than the Baseline. If a number of defects remain, then these can be left to be addressed by a future modification with a wider scope.</p> <ul style="list-style-type: none"> <li data-bbox="715 495 1530 792">i. Does not address Baseline distortion of investment/closure decisions for Existing and New <u>Embedded generators</u> behind a demand meter - It is not able to address the Baseline defect with regard to New Embedded generation behind a demand meter. This type of user will continue to be able to receive a benefit equivalent to continued net charging even though the justification for receipt of such a benefit is absent. <li data-bbox="715 831 1530 1061">ii. Does not address Baseline distortion of investment/closure and dispatch decisions for existing and new <u>DSR</u> - It is not able to correct the defect with regard to DSR since this will continue to benefit from the non cost reflective value of avoiding the Triad demand charge and this will continue to distort the market for new investment. <li data-bbox="715 1099 1530 1330">iii. Does not address Baseline discriminatory distribution Customers vs Customers - It fails to correct the discriminatory nature of the additional cost to some groups of customers which is collected to pay for the reduced cost of other groups of customers who are still able to avoid paying the “tax” element of TNUoS charges i.e. the Demand Residual. <p>b) <u>CUSC Objective “b” - Better facilitates cost reflectivity of charges</u> – Yes with regard “New Embedded Generators”, CMP264 Original does better facilitate cost reflectivity of charges as compared with the Baseline. However CMP264 Original is no better than the baseline with regard to the cost reflectivity of charges for 1) Existing embedded generators, or 2) Behind a demand meter. This would result in the CMP264 Original not correcting the selection of existing Baseline defects as already described above.</p>

Q	Question	Response
2	<p>Do you support the proposed implementation approach? Or are there any further implementation implications that need to be considered?</p>	<p>We support the proposed implementation approach, but we think that the following aspects need to be taken into account in the final implementation.</p> <p>1) How much of the Demand Residual should be charged gross ?</p> <ul style="list-style-type: none"> i. Support the implementation principle that the Demand Residual is charged Gross. ii. Gross on <u>all</u> embedded generation - Agree that the “Centrica 1” or “Centrica 2” proposed alternatives are likely to improve cost reflectivity and facilitate effective competition better than CMP264 Original. If the Centrica 2 alternative used a value of “x £/kW” set <u>equal to the Generator TNUoS Residual</u> this would contribute to maintain a level playing field between transmission connected generation and embedded generation. <p>2) Short transition period with stepped down cap to the net element</p> <p>If the Start date were to be delayed beyond 2017/18, then it would be better to also include a short transition period with does have a start date as early as practicable. The transition arrangements should take the form of a cap on the element of the Demand Residual charged net which should step down in straight line annual increments towards the enduring level. The starting level for the calculation of the transitional cap should be the level of the 2016/17 Demand Residual. This transition period would better enable the market to adjust to the new charging arrangements.</p> <p>3) Peak Security tariff element should be charged net</p> <ul style="list-style-type: none"> • Support the Centrica 1&2 proposed alternatives which apply the Peak Security Tariff element on a net basis. This is more cost reflective than applying the Peak Security tariff element gross.

Q	Question	Response
	(Q2 continued)	<p>4) Support the CMP264 Original proposal for the <u>Year Round tariff element to also be charged gross</u> - Until a future more comprehensive solution is implemented to change the definition of the Demand TNUoS charging base.</p> <p>i. A more comprehensive solution would apply the Year Round tariff on a net basis <u>but only on a different definition of charging base such as using an ALF, or a commoditised £/MWh basis (definitely not peak, and not Triad)</u>. Project TransmiT identified that the Year Round tariff reflects year round network conditions (not just at peak), which is why the Generator TNUoS Year Round element is effectively commoditised via each station's "ALF". However, if it is out of scope for CMP264 to change the definition of the Triad charging base, then the Year Round tariff element is not useful for providing an economic price signal because it is not cost reflective when it is applied to the Triad charging base.</p> <p>ii. As an interim solution until the charging base can be improved, we would support the CMP264 Original proposal of continuing to charge the Year Round tariff element on a <u>gross</u> basis in order to avoid causing additional harm. If the Year Round tariff element were to be charged net on Triad demand charging base, then the Year Round tariff element of the Triad price signal would be spurious, discriminatory and not cost reflective. This would tend to distort investment and dispatch decisions and cause a reduction in social welfare:</p> <ul style="list-style-type: none"> • E.g. For embedded generators in <u>positive</u> Year Round charging zones – They would face a dispatch signal to generate at Triad peaks in order to earn a Year Round tariff element benefit, the value of which does not reflect the value to the network of their generation at Triad periods.

Q	Question	Response
	(Q2 continued)	<ul style="list-style-type: none"> • E.g. For embedded generators in <u>negative Year Round tariff zones</u> - Net charging of Year Round tariff on Triad demand would result in perverse dispatch behaviour because the embedded generator would face the incentive to generate up to an expected Triad period, then switch off and not generate at all during the expected Triad period, only to switch back on again once the Triad period had ended. This incentive to change dispatch behaviour at peak would not change the year round network cost caused by that embedded generator, so their response to the price signal, corresponding to the Year Round tariff element, would fail to achieve the intended purpose of that price signal. Therefore the Year Round tariff element charged net on Triad demand would fail to provide a useful price signal.

Q	Question	Response
3	Do you have any other comments?	<p><u>Cost reflectivity vs Revenue collection</u></p> <p>It is essential that each charging element should be clearly identified as having one out of two purposes (never both). The two types of classification of purpose could be described as either: 1) Economic Price Signal or 2) Revenue Collection as described below:</p> <p>1) Economic Price Signal - E.g. TNUoS Locational tariff elements. These charging elements should be consistent with the CUSC objectives of being <u>cost reflective</u> and <u>facilitating effective competition</u> (among Transmission connected generators, among Distribution connected generators, among demand and between all of these groups). These are the price signals which society wants parties to respond to. However, for these charging elements to be appropriate, it is a prerequisite that the tariff elements are applied to an appropriate definition of charging base so that the decisions which parties make in response to the price signals do actually cause a corresponding change in the cost of the network. If these economic price signals are not applied in a cost reflective way (either in terms of the charging base they are applied to, their magnitude, whether they are positive/negative, or locational distribution), then they may be no longer useful as economic price signals. This is because when parties respond to an economic price signal which is not cost reflective, then their resulting behaviour will tend to cause an economically inefficient outcome, discrimination and higher cost to customers. Therefore when applying charges which have the purpose of being cost reflective, it is important to be aware of the risk of unintended consequences which may be detrimental to social welfare.</p> <p>2) Revenue Collection - Effectively a form of tax. E.g. TNUoS Demand Residual. Economic theory regarding <u>optimal tax theory</u> indicates these types of charges should be <u>equitable</u> and <u>difficult to avoid</u>. This is because these charges do not reflect an avoidable cost, so these should not be used as an economic price signal for behaviour, but instead they should be applied in a way which is fair and explicitly attempts to avoid causing distortions to market behaviour. Society does not want parties to even try to avoid these “taxes” because avoidance behaviour is economically inefficient so would result in a less socially efficient result, higher cost to society and higher cost to customers. Economic resources which society expends on avoiding these “taxes” is not economically useful for society (although it can be rational for each individual taking the action).</p> <p>It is important to note that there can be circumstances where there may be a trade-off between the various CUSC objectives and Ofgem further objectives of: cost reflectivity, effective competition, transparency, accuracy, stability and practicality. If there are circumstances where for a particular charging element, this trade-off can't be adequately resolved, then a better solution can be to discard the (failed) attempt to be cost reflective and instead use an approach based on socialised revenue collection.</p>

Q	Question	Response
	(Q 3 continued)	<p><u>Implications for system security</u></p> <p>The concerns which the consultation raises regarding capacity adequacy and system security appear overblown. The proposed changes should not detrimentally affect system security for the following reasons:</p> <ol style="list-style-type: none"> 1) Removal of the benefit does not change the system margin. As long as embedded generators remain available, then they will dispatch in merit due to wholesale price signals if they are needed by the system.. 2) Only if the loss of the Triad benefit makes some generators unable to recover their short-run operating costs, then some may close or not build so they may not be available. Only then would this tend to reduce the system margin. 3) It is the purpose of the Capacity Mechanism to source sufficient capacity to maintain adequate system margin. Capacity adequacy and system security is not and should not be the purpose of transmission network charging. Also noting a system stress even can happen any time (not necessarily at a Triad) so the Capacity Mechanism provides the right incentives to address this, but the Triad signal does not. 4) A short transitional period may be helpful – Ofgem should consider how best to manage any transition to a new charging arrangement. Any concern regarding the risk of short-term system security issues should be considered in the context of how best to implement the change, but this does not have any bearing on the question of if the change should take place.
4	Do you wish to raise a WG Consultation Alternative Request for the Workgroup to consider?	<p><i>If yes, please complete a WG Consultation Alternative Request form, available on National Grid's website¹, and return to the CUSC inbox at cusc.team@nationalgrid.com</i></p> <p>Yes – Alternative Request form to follow.</p>

Standard Workgroup consultation questions – CMP265

Q	Question	Response
---	----------	----------

¹ http://www.nationalgrid.com/uk/Electricity/Codes/systemcode/amendments/forms_guidance/

Q	Question	Response
5	<p>Do you believe that the CMP265 Original Proposal better facilitates the Applicable CUSC Objectives?</p>	<p>Yes, we believe that the Original CMP265 better facilitates the competition and cost reflectivity Objectives but we consider that some of the alternatives would facilitate these even more effectively (e.g. the approached suggested by proposed alternative Centrica 1 & Centrica 2 with some additional further changes). Our reasoning is outlined below.</p> <p>a) <u>CUSC Objective “A”</u> - Better facilitates effective competition – Yes with regard to the specific sub group classed as having a Capacity Mechanism contract, CMP265 Original does better facilitate effective competition as compared with the Baseline. However there are many aspects of effective competition where the Original is not better than the Baseline, including:</p> <ul style="list-style-type: none"> <li data-bbox="730 674 1528 1346">i. It would likely fail to address the identified defect with regard to the distortion to the capacity market clearing price. This is because the Triad avoidance benefit appears to be of much greater value than the recent capacity market clearing price which means that embedded generation given the choice may be expected to choose to continue to receive the TNUoS Triad benefit and forego the capacity mechanism revenue. However, it is likely that when BEIS decide how much capacity to procure in the Capacity Market, then they will take this embedded generation into account as being available whether that embedded generation chooses to participate in the capacity mechanism or not. Therefore even if these generators do not participate in the Capacity Market, it is likely to result in the capacity market clearing with roughly the same marginal plant at roughly the same clearing price as it otherwise would have done. This will therefore fail to correct the defect with regard to competition within the capacity market and fail to correct the defect with regard to new investment. <li data-bbox="730 1379 1528 2051">ii. It creates a new defect regarding further distorting and reducing competition in the Capacity Market. The purpose of the capacity market is to provide a competitive market where suppliers of capacity can compete with each other so that society can procure the level of capacity it requires at an efficient price. However, if a select group of market participants, namely embedded generators, face the economic incentive to avoid participating in this competitive market Capacity Market, then this reduces the effectiveness of the capacity market. Unless the defect is corrected with regard to the cost reflectivity of the Triad avoidance benefit, Triad avoiding embedded generators may to continue to invest and build in new capacity (based on the Triad benefit incentive instead of the Capacity Mechanism incentive), which would continue to crowd out other potentially lower cost generators and progressively reduce the capacity which BEIS are required to source competitively from the Capacity Market.

Q	Question	Response
		<p>i. Discrimination between generators and customers - Fails to correct the existing Baseline discriminatory nature of the additional cost to customers collected to pay for the embedded benefit for embedded generators without capacity mechanism contracts.</p> <p>b) CUSC Objective “B” - Better facilitates cost reflectivity of charges – Yes with regard to the specific sub group classed as Embedded Generators with a Capacity Mechanism contract, CMP265 Original does better facilitate cost reflectivity of charges as compared with the Baseline. However CMP265 Original is no better, than the Baseline with regard to the cost reflectivity of charges for embedded generators who do not have a capacity contract.</p>
6	Do you support the proposed implementation approach? Or are there any further implementation implications that need to be considered?	See answer to question 2
7	Do you have any other comments?	See above answer to question 3
8	Do you wish to raise a WG Consultation Alternative Request for the Workgroup to consider?	<p><i>If yes, please complete a WG Consultation Alternative Request form, available on National Grid's website², and return to the CUSC inbox at cusc.team@nationalgrid.com</i></p> <p>Yes – Alternative request form to follow</p>

Specific questions for CMP264

Q	Question	Response
---	----------	----------

² http://www.nationalgrid.com/uk/Electricity/Codes/systemcode/amendments/forms_guidance/

Q	Question	Response
10	<p>i) Do you think a cut-off date for “new embedded generation” of 30 June 2017 is appropriate? What other date would you propose?</p> <p>ii) Do you have any views on how mixed sites are being addressed in CMP264 Original?</p> <p>iii) Do you think new-build embedded generation capacity that has entered into long term financial and performance commitment obligations via 2014 and 2015 capacity market or contracts for difference auctions (prior to this modification proposal) should be given exceptions to this cut-off date?</p> <p>iv) Do you agree that ignoring demand behind the meter is unlikely to create a significant “loophole” or material discrimination risk in relation to the CMP264 arrangements in the short term</p> <p>v) Question to suppliers: Do you consider that the wording of your existing contracts allow you to reflect the changes provided by these modifications in a cost reflective manner. For example, these changes will apply to existing PPAs and generators who significantly alter their output (EREC 59).</p> <p>vi) Do you agree with the definition of commissioned and do you agree that it is appropriate? If you do not agree with the definition or that it is appropriate please provide alternative definitions and rationale for this definition.</p>	<p>i. We would propose there should be no cut-off date such that any element of the Demand TNUoS tariff charged gross applies to <u>all embedded generators</u> irrespective of whether they are new or existing. However, if a cut-off date is used for “new embedded generation”, then any cut-off date should be as early as practicable, in which case the proposed date of 30th June 2017 would appear reasonable.</p> <p>ii. A better all encompassing solution for dealing with mixed sites would be to change the definition of the Triad charging base such that each of the TNUoS tariff elements (Peak Security, Year Round and Residual) are applied to a different and more appropriate definition of charging base, therefore applied to Demand and affect embedded generation in a way which is consistent and cost reflective. However if this type of all encompassing solution is out of scope for CMP264, then it is reasonable that the modifications should affect as much embedded generation as is reasonably practicable giving the limitations of the scope. In this context, the proposed treatment of mixed site by CMP264 Original would appear to be reasonable.</p> <p>iii. No, there should be no exceptions to the cut-off date. It would be worse for cost reflectivity and worse for effective competition to allow any group of embedded generators to be treated differently from any other group of embedded generators. The same argument applies that there should be no cut-off date at all. The possibility of the charging methodology being varied to take into account new situations or new thinking has been well understood since the methodology was first introduced and therefore the possibility of substantial change should have been accepted by all parties entering into long term financial obligations.</p>

Q	Question	Response
		<p>iv. Whilst we agree that CMP264 is unlikely to create a significant “loophole”, or discrimination for behind the meter situations in the short term, this is partly because these loopholes already exist within the Baseline, so they are not new. However, it is essential to address the outstanding defects that are responsible for the “loophole” that exists in the Baseline quickly (within the next 2 years) through a subsequent future modification proposal. Importantly regarding generation, or demand behind the meter, these loopholes and discrimination already exist within the Baseline as compared with transmission connected generation. Therefore CMP264 does not create these defects, but instead it appears to be limited by its scope from implementing a modification which is wide enough in scope to include the correction of these defects.</p> <p>v. Yes, the wording of PPA contracts does allow these changes to be reflected.</p> <p>vi. It would be a better solution to apply the change to all embedded generators instead of using a cut-off. However, if a cut-off is to be used, then the proposed definition of “commissioned” appears to be reasonable.</p>
13	<p>Do you have a view of whether implementation for the 2017/18 Triad season is sufficient to allow changes for:</p> <p>i) supplier contracts and billing system; and</p> <p>ii) for other stakeholders?</p>	<p>i. Suppliers-customer supply contracts - Regarding supply contracts and billing system between the supplier and customers, this timescale would be sufficient. Supply contracts are already based on the gross supply volume and the TNUoS tariffs published by National Grid.</p> <p>ii. Supplier-Embedded generator PPA offtake contracts - Regarding supplier PPA offtaker contracts with embedded generators, this may take some time to implement. However, the proposed timescale should enable sufficient time.</p>

Q	Question	Response
18	<p>Do you have a view if embedded benefits are frozen at a non-zero value, what should that value be as a £/kW tariff (2016/17 value is £45.33 / kW)?</p>	<p>The embedded benefit should not be frozen in its entirety at any non-zero value. However, there may be a case for charging a part of the value of the Demand Residual on a net basis and linking the value of this element to another number as outlined in 1 to 2 below. We further consider that the fixing of the benefits with reference to Cost of avoided transmission infrastructure investment at GSPs (see 3 below) or cost savings identified by Cornwall Energy (see 4 below) are not justified.</p> <p>1) Link to generator TNUoS Residual – If a part of the Demand Residual remained net, then it would better facilitate effective competition between transmission connected generators and embedded generators if this remaining net element was linked to the value of the TNUoS Generator Residual in each year. This aspect is consistent with the “Centrica 2” proposed alternative.</p> <p>2) Step reduction during a transition period - If the Start date were to be delayed beyond 2017/18, then it would be better to also include a short transition period which does have a start date as early as practicable. The transition arrangements should take the form of a cap on the element of the Demand Residual charged net which should step down in straight line annual increments towards enduring level. The starting level for the calculation of the transitional cap should be the level of the 2016/17 Demand Residual.</p>

Q	Question	Response
	(18 continued)	<p>3) Cost of avoided transmission infrastructure investment at GSPs - Previous evidence from National Grid is out of date following CMP213 decision, so would be best considered as part of the wider review of charging as indicated in Ofgem’s open letter and not considered within this modification. This is because it is not cost reflective to apply the <u>average</u> number identified by National Grid when in practice, the value at a particular GSP may be substantially smaller, or even negative. The National grid published average embedded benefit of £1.62 (Review of the Embedded (Distributed) Generation Benefit arising from transmission charges, December 2013). This should not be used of evidence of a non zero value for “x” without further analysis. Reasons why this can not be relied upon include:</p> <ul style="list-style-type: none"> i. Demand Security vs. Economy Criterion of the SQSS - As is the case with the wider network, the cost of transmission infrastructure investment at GSP will be driven by the maximum flow, which may be either during “peak” conditions, or “year round” conditions. In order to apply any associated benefit in a cost reflective way, it would be essential to first identify what are the conditions which drive the cost at each GSP, then identify whether a particular embedded generator either contributed to higher cost, or avoided cost. ii. Exporting GSPs may result in additional embedded generation further <u>increasing</u> transmission infrastructure investment cost at GSPs – Depending on the circumstances at a particular GSP and the performance characteristics of the particular embedded generator, the embedded generator may contribute to additional cost at the GSP instead of reduced cost. Therefore applying an “average benefit” to all embedded generators would not be cost reflective.

Q	Question	Response
	(18 continued)	<p data-bbox="847 159 1519 757">4) Evidence from Cornwall Energy for the Association of Decentralised Energy uses flawed assumptions so the analysis can not be relied upon (<i>A Review of the Embedded Benefits accruing to Distribution Connected Generation in GB</i>). Contrary to Cornwall's analysis, the existing locational elements of the TNUoS tariff already provide the appropriate cost reflective economic price signal on a locational basis, so the potential costs which Cornwall identify are already taken into account in the existing locational price signals. The existing charging methodology already takes this into account through the application of "expansion constant" and "expansion factors" to the MWkm derived from the ICRP Transport model:</p> <ul data-bbox="847 801 1519 1877" style="list-style-type: none"> <li data-bbox="847 801 1519 1104">• Long-term capital cost – "The expansion constant, expressed in £/MWkm, represents the annuitized value of the transmission infrastructure capital investment required to transport 1 MW over 1 km. Its magnitude is derived from the projected cost of 400kV overhead line, including an estimate of the cost of capital, to provide for future system expansion." (CUSC v1.12, 14.15.59) <li data-bbox="847 1137 1519 1440">• Overhead costs - "The final step in calculating the expansion constant is to add a share of the annual transmission overheads (maintenance, rates etc.). This is done by multiplying the average weighted cost (J) by an 'overhead factor'. The factors are then derived by dividing the calculated expansion constant by the 400kV overhead line expansion constant." (CUSC v1.12, 14.15.66) <li data-bbox="847 1473 1519 1877">• Different cost of different types of network reinforcement – "Base onshore expansion factors are calculated by deriving individual expansion constants for the various types of circuit, following the same principles used to calculate the 400kV overhead line expansion constant." (CUSC v1.12, 14.15.70). "AC sub-sea cable and HVDC circuit expansion factors are calculated on a case by case basis using actual project costs (Specific Circuit Expansion Factors)." (CUSC v1.12, 14.15.75).

Q	Question	Response
	(Q18 continued)	<p>The Cornwall Report builds up a sum of different components, all of which used flawed assumptions, as described below:</p> <p>i. £18.5/kW for average cost of <u>new</u> network reinforcement – Cornwall calculated this from the capital cost of a number of National Grid network reinforcement schemes currently under construction (£8.8bn), divided by the total GW of additional generation made possible by that reinforcement (35.56GW) to calculate an annualised average network cost per kW of generation capacity. However, there are logical flaws in Cornwall's next steps because it is not a valid conclusion to draw that this can be used as a generalised value of embedded benefits:</p> <ul style="list-style-type: none"> • Capital, operations and maintenance costs <u>already included</u> in locational tariff elements - Cornwall suggest existing locational tariff elements do not take account of operations and maintenance costs, but to the contrary, as described above, the TNUoS locational tariff elements <u>do already</u> take these operational and maintenance costs into account.. • Location matters (national average price is not cost reflective) – Cost and benefit of embedded generation is dependent on its location, so it would be contrary to both cost reflectivity and effective competition to apply a flat average embedded benefit irrespective of location. Only if an embedded generator was built in a location on the transmission network which reduced flows on the network could there be a cost saving, but Cornwall fail to take this locational effect into account. This cost of this locational effect is already reflected by the TNUoS locational tariff elements such as the Peak Security tariff which is positive in some locations and negative in other locations.

Q	Question	Response
	(Q18 continued)	<ul style="list-style-type: none"> • Technology and operating characteristics matter (national average price is not cost reflective) – Project TransmiT recognised that different types of plant cause a different cost/benefit to the transmission network, whether they are intermittent, low carbon, high or low load factor. The locational elements of the TNUoS generation tariff is applied to different definitions of charging base to take this into account, but a flat national average value for embedded benefit would fail to reflect this difference in cost.. • Inconsistent methodology for calculating the average cost of the network – For a great many good reasons, the TNUoS charging methodology uses a measure of the <u>average cost of the existing network</u> to calculate TNUoS tariffs, not the cost of a small number of current, or possible specific future network investment decisions. Therefore Cornwall's approach of using current network investment is not consistent with the recognised practice of the TNUoS charging methodology. <p>ii. £13.8/kW Long-term cost of <u>existing</u> network – Cornwall calculate this as the long-term cost which they claim embedded generation can avoid, but their methodology and conclusions are not valid:</p> <ul style="list-style-type: none"> • Location matters – As above, location matters, so if an embedded generator does not cause any avoided new investment cost of the transmission network, then it clearly does not cause any avoided long-term cost of the existing transmission network either. As described above, with regard to avoided long-term cost, these locational differences are already reflected by the locational elements of the TNUoS tariff. • Long-term costs are already accounted for – As described above, the TNUoS charging methodology already takes the long-term cost of network either caused, or avoided into account when calculating the Peak Security and Year Round locational tariff elements.

Q	Question	Response
	(Q18 continued)	<p>3) Cornwall argues “Use of peak demand over states the value of the triad benefit by approximately £9.2/kW” – However, the existing TNUoS tariff elements already provide the answer to this question on a locational basis through providing separate Peak Security and Year Round tariff elements which vary by location. A more appropriate solution to this defect would be to change the definition of the charging base so that the Peak Security and Year Round tariff price signals can operate independently of each other on different charging bases, but if this change is beyond the scope of these modifications, then a change to the charging base should be considered as part of Ofgem’s wider review.</p>

Q	Question	Response
	(Q18 continued)	<p>The costs associated with building and maintaining a transmission network and would still be needed even if embedded generation entirely displaced transmission connected generation</p> <p>A further flaw in Cornwall's logic is the fallacy that if the total volume of electricity demand in a year could be matched by generation from embedded generators, then there would be no need for a transmission network. This is false because in both the short-term and long-term, as described by National Grid in their 2010 NETS Seven Year Statement: Chapter 6 – The Transmission System p8. In this, National Grid clearly explain why the transmission network does exist for more than simply carrying the flow of power from transmission connected generators, but by contrast, the transmission system exists to carry the flow of power from <u>all generators including embedded generators</u>:</p> <p>“Until the 1930's electricity supply in Great Britain was the responsibility of a multiplicity of private and municipally owned utilities, each operating largely in isolation. The Electricity Supply Act (1926) recognised that this was a wasteful duplication of resources. In particular, each authority had to install enough generating plant to cover the breakdown and maintenance of its generation. Once installed, it was necessary to run more plant than the expected demand to allow for possible sudden plant failure.</p> <p>By interconnecting separate utilities with the high voltage transmission system, it is possible to pool both generation and demand, providing a number of economic and other benefits, including:</p> <ul style="list-style-type: none"> • An interconnected transmission system providing a more efficient bulk transfer of power from generation to demand centres. • The interconnected transmission system, by linking together all participants across the transmission system, makes it is possible to select the cheapest generation available. • Transmission circuits tend to be far more reliable than individual generating units, and enhanced security of supply is achieved because the transmission system is better able to exploit the diversity between individual generation sources and demand.

Q	Question	Response
	(Q18 continued)	<ul style="list-style-type: none">• An interconnected transmission system enables surplus generation capacity in one area to be used to cover shortfalls elsewhere on the system, resulting in lower requirements for additional installed generation capacity, to provide sufficient generation security for the whole system.• Without transmission interconnection, each separate system would need to carry its own frequency response to meet demand variations, but with interconnection the net response requirement only needs to match the highest of the individual system requirements to cover for the largest potential loss of power (generation) rather than the sum of them all.”

Specific questions for CMP265

Q	Question	Response
11	<p>i) Views are sought on the implication for mixed sites discussed in 3.4.10.</p> <p>ii) Views are sought on the preference of categories of capacity Market CMU captured by this proposal, please indicate your preference from the following list and reasons:</p> <ul style="list-style-type: none"> i. All existing and new distribution generation CMUs ii. All existing and new distribution generation CMUs and DSR CMUs (proven and unproven) iii. All price maker CMUs iv. All newbuild/prospective distribution generation CMUs only (defined as >1year contracts) 	<p>i. It would be better address the defect if the element of the TNUoS tariff applied on a gross basis applied to all embedded generation irrespective of whether or not they had a capacity mechanism contract. However, if embedded generators without a capacity contract are to receive an exemption from gross charging, then the approach described appears to be reasonable.</p> <p>ii. From the list provided, the preference would be “All existing and new distribution generation CMUs and DSR CMUs (proven and unproven)” The reasoning is that this appears to be the widest definition of CMUs to be captured by the proposal. Any attempt to narrow the scope of CMUs captured would result in a less effective solution to the defect. It would result in more CMUs continuing to be exposed to non-cost reflective price signals, which would continue to be detrimental for facilitating effective competition and it would increase the level of discrimination. The only reason to exclude specific CMU groups from being captured by the proposal would be if it was not practicable for this modification to include them.</p>
14	<p>Do you have a view of whether implementation for the 2020/21 Triad season is sufficient to allow changes for i) supplier contracts and billing system, and ii) for other stakeholders?</p>	<p>Yes, an implementation for the 2020/21 Triad season would be more than sufficient time to allow changes for supplier contracts, billing systems and other stakeholders. It would be possible to implement the required changes in a much shorter time scale.</p> <p>However, it would be better if there was a transitional cap on the value of the demand Residual charged net implemented as soon as practicable. Any delay to this would delay the cost savings received by customers of reduced embedded benefit payments.</p>

Specific questions for BOTH CMP264 & CMP265

Q	Question	Response
---	----------	----------

Q	Question	Response
9	<p>i) Suppliers: In setting charges for your demand customers, do you charge them at the same tariff as National Grid charges you (i.e. gross), to enable you to pay the embedded benefit to embedded generators, or please explain the way in which it is funded?</p> <p>ii) Suppliers: Does the estimate that 7.58GW of embedded generation output and 2.5GW of demand side reduction at the time of Triad for 2016/17 seem reasonable based on your knowledge of the UK market? If not what is your estimate of embedded generator output and DSR at time of Triad?</p>	<p>i. To the first question: Yes, as a supplier, we do charge customers on their <u>gross</u> demand at the same published Final TNUoS tariff rate as National Grid charges the supply business. To the second question: Yes, any resulting surplus between the TNUoS revenue collected from customers (based on gross demand) and the TNUoS charge paid to National Grid (based on net demand) is used by the supply business to pay the value of the embedded benefit to the embedded generator. This has an important implication:</p> <ul style="list-style-type: none"> • Any reduction in the published £/kW unit rate of TNUoS tariffs (following an increase in the TNUoS demand charging base) would result in a corresponding reduction in the total TNUoS cost paid by customers <p>ii. Yes, the estimates provided appear to be reasonable.</p>
12	<p>Can you identify – either quantitatively or qualitatively - the impact of the demand TNUoS embedded benefit on your decisions made in making capacity market decisions?</p>	<p>For embedded generation assets – A reduction in the value of the TNUoS embedded benefit would result in a corresponding increase in required price within the Capacity Mechanism.</p> <p>For Transmission connected generation assets – If the Baseline embedded benefit persisted, then this would result in the “playing field” continuing to become further progressively stacked against transmission connected generators in a way which is discriminatory and not cost reflective. A continuation of the Baseline would cause a progressively worsening investment environment with an increasingly high risk associated with developing a transmission connected generation asset. Economic theory would suggest this higher risk environment would tend to require higher risk margins, therefore higher bid prices in the capacity market, so a higher cost to customers.</p>

Q	Question	Response
15	<p>i) What are your views on the 2 broad options to enable the reporting of gross export metered data?</p> <p>ii) Would you have the data available required for Option B (both CMP264 and CMP265) for both new contracts and existing contracts where a customer may be partially exempt?</p> <p>iii) Do you believe you can implement the proposed changes by the respective implementation dates?</p> <p>iv) What are the pros and cons of the 2 proposals that ELEXON are considering to implement this (P348 for CMP265/ P349 for CMP264)?</p>	<p>i. It is our view that option “A” would be a better solution because it leverages existing systems and agents in a robust way which better enables the collection and transfer of data with strong assurance and auditability. By contrast, option “B” could also deliver the desired result, however it would require new direct interfaces between suppliers and National Grid which may not as easily provide as strong data assurance and auditability.</p> <p>ii. Yes.</p> <p>iii. Yes</p> <p>iv. We support the approaches proposed for both modifications. The solutions present challenges of complexity and additional administrative burden, although they both appear to provide reasonable solutions given the inherent challenges they are designed to address.</p>

Q	Question	Response
16	<p>Do you have any further evidence / comments on the consumer impact of changing the demand TNUoS embedded benefit in either the short-run or long-run?</p>	<p>1) <u>Embedded benefit</u> - The benefit to customers from reduced customer cost which is clearest and most important is the reduction in the cost which customers are currently paying for the embedded benefits. The National Grid analysis in Figure 8 shows the cost to customers of paying for the TNUoS Demand Residual embedded benefit to embedded generators is £343m per year in 2016/17, increasing to £650m per year by 2020/21 (real 2016/17 prices). Further analysis by National Grid indicated that if the Baseline was permitted to continue, then this cost to customers could be expected to reach £1Bn per year by 2030, or using the National Grid Consumer Power scenario, increasing to <u>£2Bn per year by 2032</u>, which would equal 70% of the entire cost of the Transmission network in 2016/17 (12 August 2016, p4, Charging Seminar - Case for change: National Grid Analysis of a Do Nothing Scenario, http://www2.nationalgrid.com/UK/Industry-information/System-charges/Electricity-transmission/charging_review/).</p> <p>2) <u>Capacity Mechanism</u> - Potential offsetting increase in Capacity Mechanism cost to customers is relatively small. The Cornwall report indicated a corresponding increase in the Capacity Mechanism clearing price of £4.7/kW equating to an increase in cost to customers of £214m per year (2019/20), or up to £282m (2020/21). It should not be surprising that the removal of a subsidy from a group of participants in a market may result in a higher clearing price for that market, however:</p> <ol style="list-style-type: none"> i. The purpose of TNUoS charging is not and should not be to provide a subsidy to the Capacity Market to achieve a lower clearing price. ii. Even if it was accepted in principle that TNUoS could be used to subsidise the Capacity Mechanism clearing price, then it is a very inefficient tool since the embedded benefit paid to reduce the Capacity Market clearing price results in a much higher cost to customers than the benefit to customers obtain from the lower clearing price. iii. The use of a non cost reflective policy tool to subsidise a different policy tool would result in an outcome which is progressively less economically efficient and results in a progressively higher cost to customers.

Q	Question	Response
		<p>3) Wholesale power price – Cornwall carried out analysis and estimated that the removal of the Triad incentive could result in an increase in wholesale power price which equated to an increase in cost to customers of between £10m and £45m. This is a relatively small value compared to the customer benefit of not having to pay for the value of the embedded benefit. It is important to note:</p> <p>i. Feedback to lower Capacity Market price - Cornwall failed to take account of the fact that a higher peak power price will increase the profit (infra marginal rent) of generators operating during peak times, so will tend to cause a corresponding <u>reduction</u> in the capacity mechanism clearing price. Therefore the net impact on of the increase in wholesale price on customers, may be close to zero.</p> <p>Better economic efficiency should result in even lower cost to customers over the long-term – A more towards more cost reflective price signals will tend to result in competitive markets delivering a more economically efficient result at a lower total system cost, therefore lower cost to society (regarding both network cost and generation cost). It is reasonable to expect that this lower total system cost would result in even greater reductions in cost to customers over the longer term.</p> <p>The net customer benefit for CMP264 Original and CMP265 Original are not as large. 100% gross charging of the Demand Residual (as per Centrica alternative) would deliver the highest cost saving for customers</p> <p>The analysis provided in the Workgroup Consultation Fig. 8 and Fig. 9 show that the benefit to customers by 2020/21 would be much larger if 100% of the Demand residual was applied gross.</p> <ul style="list-style-type: none"> •CMP264 Original – Avoided embedded benefit saving is £155 (£650m minus £495m), compared with the 100% gross charging which would save the full £650m.

Q	Question	Response
		<ul style="list-style-type: none">• CMP265 Original - Avoided embedded benefit saving is £204 (£650m minus £446m), compared with the 100% gross charging which would save the full £650m. Although some of this saving may never materialise if embedded generators choose to cancel Capacity Mechanism contracts to continue to earn Triad benefits instead.

Q	Question	Response
17	<p>Do you feel that both the locational and residual component of the demand TNUoS should be removed as an embedded benefit (as CMP264 Original) or just the residual component (as CMP265 Original) or some other method?</p>	<p>We agree that the Demand Residual should be removed as an embedded benefit, although it would also be beneficial to maintain a part of the Demand Residual embedded benefit for a short transitional period and also to enable a level playing field with transmission connected generators by including a net element equal to the generation TNUoS residual. The Year Round tariff element should also be removed as an embedded benefit on the Triad demand charging base, because it would only be cost reflective to provide a Year Round embedded benefit if this was applied to a year round charging base (not a peak charging base such as Triad). The Peak Security tariff embedded benefit should be maintained. The reasoning is provided below:</p> <p>Demand Residual tariff element (gross) – Yes, agree with both CMP264 and CMP265 Original that this should be <u>removed</u> as an embedded benefit i.e. charged on a gross basis.</p> <p>Year Round tariff element (gross) – Agree with CMP264 that this should be <u>removed</u> as an embedded benefit i.e. charged on a gross basis. As per the reasoning provided in answer to question 2 of this consultation response - the Year Round tariff element does not provide a cost reflective price signal when it is applied to the Triad charging base. However, there is an opportunity for a future modification to change the definition of the charging base used for the Year Round tariff element such as to a commoditised £/MWh basis. Only after the charging base has been appropriately changed would it be appropriate to reinstate the Year Round tariff element on a net basis to be re-included in the price signal provided to embedded generators by the value of the embedded benefit.</p> <p>Peak Security tariff element (net) – Agree with CMP265 that this tariff element should be <u>maintained</u> charged on a net basis, so the embedded benefit with regard to this tariff element is maintained.</p>

Q	Question	Response
		<p>New interim element of Demand Residual (net) – Support the approach used in the Centrica 2 proposed alternative which would set a value of “£x/MWh” equal to the value of the Generator TNUoS Residual. This may not be justified by cost reflectivity, but could be a good interim solution to address the issues of “level playing field” and effective competition until a wider review of charging can be carried out.</p> <p>New Transitional element of the Demand Residual (net) – If the date of the removal of the Demand Residual embedded benefit is relatively late (such as 2020/21), then a transitional step change descending cap should be applied to the net element of the Demand Residual as soon as practicable (ideally 2017/18). This would limit the cost to customers during the intervening time. This approach is described in the answer to question 2.</p>
19	<p>Regarding the proposed alternatives what are your views on the suggested implementation dates? Are these achievable? Please give reasons for your view.</p>	<p>It is easily achievable for implementation to begin 2020/21.</p> <p>As described above, a transitional cap to the net element of the Demand Residual should be implemented as early as practicable – ideally 2017/18.</p>

CUSC Workgroup Consultation Response Proforma

CMP264 'Embedded Generation Triad Avoidance Standstill' and **CMP265** 'Gross charging of TNUoS for HH demand where Embedded Generation is in the Capacity Market'

Industry parties are invited to respond to this consultation expressing their views and supplying the rationale for those views, particularly in respect of any specific questions detailed below.

Please send your responses by **24th August 2016** to cusc.team@nationalgrid.com Please note that any responses received after the deadline or sent to a different email address may not receive due consideration by the Workgroup.

Any queries on the content of the consultation should be addressed to Caroline Wright at caroline.wright@nationalgrid.com

These responses will be considered by the Workgroup at its next meeting at which members will also consider any Workgroup Consultation Alternative Requests. Where appropriate, the Workgroup will record your response and its consideration of it within the final Workgroup Report which is submitted to the CUSC Modifications Panel.

Respondent:	<i>Tom Vernon</i> <i>Director</i>
Company Name:	<i>Statera Energy</i>
Please express your views regarding the Workgroup Consultation, including rationale. (Please include any issues, suggestions or queries)	<p>For reference, the Applicable CUSC objectives are:</p> <p>Use of System Charging Methodology</p> <p>(a) that compliance with the use of system charging methodology facilitates effective competition in the generation and supply of electricity and (so far as is consistent therewith) facilitates competition in the sale, distribution and purchase of electricity;</p> <p>(b) that compliance with the use of system charging methodology results in charges which reflect, as far as is reasonably practicable, the costs (excluding any payments between transmission licensees which are made under and in accordance with the STC) incurred by transmission licensees in their transmission businesses and which are compatible with standard condition C26 (Requirements of a connect and manage connection);</p> <p>(c) that, so far as is consistent with sub-paragraphs (a) and (b), the use of system charging methodology, as far as is reasonably practicable, properly takes account of</p>

	<p>the developments in transmission licensees' transmission businesses.</p> <p>(d) Compliance with the Electricity Regulation and any relevant legally binding decision of the European Commission and/or the Agency.</p>
--	---

Standard Workgroup consultation questions – CMP264

Q	Question	Response
1	Do you believe that the CMP264 Original Proposal better facilitates the Applicable CUSC Objectives?	<p>a) No, this modification distorts competition between old and new generation and transmission and distribution generation.</p> <p>b) No, not enough evidence has been demonstrated that this modification results in a more cost-reflective system. A more holistic review of all the economics of different plant types is required, not just TNUoS at Triad. It is not the fault of embedded plant that there is an EU cap on generators, nor that the cost of transmission is increasing. An ill considered change will not address the fundamental problems.</p>
2	Do you support the proposed implementation approach? Or are there any further implementation implications that need to be considered?	<p>No, this implementation approach is not justified and will severely damage investor confidence.</p> <p>The modifications do not fully consider the following issues:</p> <ul style="list-style-type: none"> i. The incentives for existing plant to default on CM agreements signed in good faith due to the changes in plant economics; ii. The impact on the CM clearing prices, and thus customer bills; iii. The impact on supply security if plant stops running during Triad periods and no new plant is forthcoming on the transmission network; iv. The impact on the TO costs of reinforcement to meet peak demand; v. The impact on longer term security if new, flexible generation is not built to support the intermittent plant; vi. The impact on wholesale prices, notably at peak, as embedded plant have little market access except via the Triad signal; and vii. The unduly discriminatory nature of any change that targets only one group of generators - if embedded plant is over rewarded then it is all over rewarded.
3	Do you have any other comments?	See cover letter attached.

Q	Question	Response
4	Do you wish to raise a WG Consultation Alternative Request for the Workgroup to consider?	<p>The working group should consider the Green Frog alternative, but conditional on a proper Ofgem review.</p> <p>We think there is merit in considering different ways to address the residual issue Ofgem raises, such as a fixed charge on all demand meters, more cost recovery via the locational charges, and difference in the structure of the Triad system.</p> <p>However, it is not obvious that these sit as alternatives in this case, and hence we would ask Ofgem to undertake a proper, well considered and researched review before accepting any modifications along the lines raised in CMP264/5.</p>

Standard Workgroup consultation questions – CMP265

Q	Question	Response
5	Do you believe that the CMP265 Original Proposal better facilitates the Applicable CUSC Objectives?	<p>a) No, the proposal discriminates against embedded generation only in the capacity market without justification.</p> <p>b) Again, no justification why this would be cost-reflective.</p>
6	Do you support the proposed implementation approach? Or are there any further implementation implications that need to be considered?	No. See above.
7	Do you have any other comments?	See cover letter.
8	Do you wish to raise a WG Consultation Alternative Request for the Workgroup to consider?	<i>If yes, please complete a WG Consultation Alternative Request form, available on National Grid's website¹, and return to the CUSC inbox at cusc.team@nationalgrid.com</i>

Specific questions for CMP264

Q	Question	Response
---	----------	----------

¹ http://www.nationalgrid.com/uk/Electricity/Codes/systemcode/amendments/forms_guidance/

Q	Question	Response
10	<p>i) Do you think a cut-off date for “new embedded generation” of 30 June 2017 is appropriate? What other date would you propose?</p> <p>ii) Do you have any views on how mixed sites are being addressed in CMP264 Original?</p> <p>iii) Do you think new-build embedded generation capacity that has entered into long term financial and performance commitment obligations via 2014 and 2015 capacity market or contracts for difference auctions (prior to this modification proposal) should be given exceptions to this cut-off date?</p> <p>iv) Do you agree that ignoring demand behind the meter is unlikely to create a significant “loophole” or material discrimination risk in relation to the CMP264 arrangements in the short term</p> <p>v) Question to suppliers: Do you consider that the wording of your existing contracts allow you to reflect the changes provided by these modifications in a cost reflective manner. For example, these changes will apply to existing PPAs and generators who significantly alter their output (EREC 59).</p> <p>vi) Do you agree with the definition of commissioned and do you agree that it is appropriate? If you do not agree with the definition or that it is appropriate please provide alternative definitions and rationale for this definition.</p>	<p>i) No. what happens if plant is delayed for no fault of their own, such as DNO issues? In particular it discriminates against participants in the T-4 auctions for 2014 and 2015, and also those planning to participate in 2016.</p> <p>ii) If embedded plant is to be excluded from Traids then so should on-site generation. This may mean a change to the CM rules, but it would be less distortionary.</p> <p>iii) Yes, but who and how you police that is difficult to see.</p> <p>iv) No. It clearly sends a signal to go behind meters and for many new plant that is an option.</p> <p>v) No comment.</p> <p>vi) how does this address plants on private wires?</p>

Q	Question	Response
13	<p>Do you have a view of whether implementation for the 2017/18 Triad season is sufficient to allow changes for:</p> <p>i) supplier contracts and billing system; and</p> <p>ii) for other stakeholders?</p>	<p>No, this is an extremely short time period to allow stakeholders to make changes.</p>
18	<p>Do you have a view if embedded benefits are frozen at a non-zero value, what should that value be as a £/kW tariff (2016/17 value is £45.33 / kW)?</p>	<p>We believe the value should be at the value set in April 2014 charging year (valued at £35/kW) as National Grid's embedded benefit review did not identify a reason to remove the benefit at this time.</p>

Specific questions for CMP265

Q	Question	Response
11	<p>i) Views are sought on the implication for mixed sites discussed in 3.4.10.</p> <p>ii) Views are sought on the preference of categories of capacity Market CMU captured by this proposal, please indicate your preference from the following list and reasons:</p> <ul style="list-style-type: none"> • All existing and new distribution generation CMUs • All existing and new distribution generation CMUs and DSR CMUs (proven and unproven) • All price maker CMUs • All newbuild/prospective distribution generation CMUs only (defined as >1year contracts) 	<p>No comments</p>

14	<p>Do you have a view of whether implementation for the 2020/21 Triad season is sufficient to allow changes for i) supplier contracts and billing system, and ii) for other stakeholders?</p>	No comments
----	--	-------------

Specific questions for BOTH CMP264 & CMP265

Q	Question	Response
9	<p>i) Suppliers: In setting charges for your demand customers, do you charge them at the same tariff as National Grid charges you (i.e. gross), to enable you to pay the embedded benefit to embedded generators, or please explain the way in which it is funded?</p> <p>ii) Suppliers: Does the estimate that 7.58GW of embedded generation output and 2.5GW of demand side reduction at the time of Triad for 2016/17 seem reasonable based on your knowledge of the UK market? If not what is your estimate of embedded generator output and DSR at time of Triad?</p>	No comments.
12	<p>Can you identify – either quantitatively or qualitatively - the impact of the demand TNUoS embedded benefit on your decisions made in making capacity market decisions?</p>	<p>While not commenting on a company strategy we would expect that parties will increase their bids and thus the clearing price will be higher, to the detriment of consumers. This we assume was the intent of these proposed modifications.</p> <p>However, we are concerned about all of the wider impacts that the changes will have on the market and believe they need a better considered solution.</p>

Q	Question	Response
15	<p>i) What are your views on the 2 broad options to enable the reporting of gross export metered data?</p> <p>ii) Would you have the data available required for Option B (both CMP264 and CMP265) for both new contracts and existing contracts where a customer may be partially exempt?</p> <p>iii) Do you believe you can implement the proposed changes by the respective implementation dates?</p> <p>iv) What are the pros and cons of the 2 proposals that ELEXON are considering to implement this (P348 for CMP265/ P349 for CMP264)?</p>	No comments.
16	Do you have any further evidence / comments on the consumer impact of changing the demand TNUoS embedded benefit in either the short-run or long-run?	Please refer to our attached cover letter.
17	Do you feel that both the locational and residual component of the demand TNUoS should be removed as an embedded benefit (as CMP264 Original) or just the residual component (as CMP265 Original) or some other method?	<p>We believe the locational element should be retained (and possibly enhanced). We also believe a review of whether the Demand zones are appropriate for netting embedded output (i.e. there are 2 demand zones in Scotland so the embedded generation might not be local to it's actual demand – and may use substantial amounts of the network).</p> <p>We believe it is not justified to completely remove the residual element as there is clearly dispute as to the actual benefit embedded generation provides. Until a holistic review is completed to ensure a level-playing field, a sudden removal of the residual element would cause severe damage to the embedded industry. Instead fixing it at £35/kW + RPI would resolve the concerns around being linked to the Demand Residual and would allow more thorough review of all connection and use of system charging.</p>

Q	Question	Response
19	Regarding the proposed alternatives what are your views on the suggested implementation dates? Are these achievable? Please give reasons for your view.	No comments.

CUSC Workgroup Consultation Response Proforma

CMP264 'Embedded Generation Triad Avoidance Standstill' and **CMP265** 'Gross charging of TNUoS for HH demand where Embedded Generation is in the Capacity Market'

Industry parties are invited to respond to this consultation expressing their views and supplying the rationale for those views, particularly in respect of any specific questions detailed below.

Please send your responses by **24th August 2016** to cusc.team@nationalgrid.com Please note that any responses received after the deadline or sent to a different email address may not receive due consideration by the Workgroup.

Any queries on the content of the consultation should be addressed to Caroline Wright at caroline.wright@nationalgrid.com

These responses will be considered by the Workgroup at its next meeting at which members will also consider any Workgroup Consultation Alternative Requests. Where appropriate, the Workgroup will record your response and its consideration of it within the final Workgroup Report which is submitted to the CUSC Modifications Panel.

Respondent:	<i>Torkel Sjoner</i> torsj@statoil.com
Company Name:	<i>Statoil ASA</i>
Please express your views regarding the Workgroup Consultation, including rationale. (Please include any issues, suggestions or queries)	<p>Statoil's response is related to <u>CMP 264</u>.</p> <p>Our principal position is that we do not support CMP 264. We recommend that any changes to embedded benefits and the triad system is done through a holistic review, as initiated through Ofgem's open letter on charging arrangements for embedded generation dated 29 July 2016.</p> <p>CMP 264 would mean unfair treatment of projects that are under construction through its definition of New Embedded Generators as any project commissioned after 30 June 2017. Projects that have made their investment decision based on receiving embedded benefits should be protected through grandfathering arrangements. Hence our secondary position is that if CMP 264 is implemented, the definition of New Embedded Generators would need to be changed. We would propose that this should only apply to generators commissioned after 30 September 2018 which is the latest date any generator can qualify under the Renewables Obligation (including grace periods).</p>

Standard Workgroup consultation questions – CMP264

Q	Question	Response
1	Do you believe that the CMP264 Original Proposal better facilitates the Applicable CUSC Objectives?	No, we believe that CMP 264 should be rejected and that any changes to embedded benefits and the triad system is done through a holistic review, as initiated through Ofgem's open letter on charging arrangements for embedded generation dated 29 July 2016.
2	Do you support the proposed implementation approach? Or are there any further implementation implications that need to be considered?	We do not support CMP 264 as proposed. However, if CMP 264 is implemented, the cut of date for New Embedded Generators" should be delayed to 30 September 2018, ref our response to question 10.
3	Do you have any other comments?	Any changes to embedded benefits would need to have sufficient grandfathering protection for projects that have made investment protection based on receiving embedded benefits.
4	Do you wish to raise a WG Consultation Alternative Request for the Workgroup to consider?	

Standard Workgroup consultation questions – CMP265

Q	Question	Response
5	Do you believe that the CMP265 Original Proposal better facilitates the Applicable CUSC Objectives?	
6	Do you support the proposed implementation approach? Or are there any further implementation implications that need to be considered?	
7	Do you have any other comments?	
8	Do you wish to raise a WG Consultation Alternative Request for the Workgroup to consider?	

Specific questions for CMP264

Q	Question	Response
10	<p>i) Do you think a cut-off date for “new embedded generation” of 30 June 2017 is appropriate? What other date would you propose?</p> <p>ii) Do you have any views on how mixed sites are being addressed in CMP264 Original?</p> <p>iii) Do you think new-build embedded generation capacity that has entered into long term financial and performance commitment obligations via 2014 and 2015 capacity market or contracts for difference auctions (prior to this modification proposal) should be given exceptions to this cut-off date?</p> <p>iv) Do you agree that ignoring demand behind the meter is unlikely to create a significant “loophole” or material discrimination risk in relation to the CMP264 arrangements in the short term</p> <p>v) Question to suppliers: Do you consider that the wording of your existing contracts allow you to reflect the changes provided by these modifications in a cost reflective manner. For example, these changes will apply to existing PPAs and generators who significantly alter their output (EREC 59).</p> <p>vi) Do you agree with the definition of commissioned and do you agree that it is appropriate? If you do not agree with the definition or that it is appropriate please provide alternative definitions and rationale for this definition.</p>	<p>i)</p> <p>We do not believe that the proposed cut-off date of 30 June 2017 is appropriate. Any change to embedded benefits would need to have sufficient grandfathering protection of projects that have made their investments decisions based on receiving embedded benefits. We disagree with the proposer’s assessment that the proposed cut-off date would be sufficient as it in our view will negatively affect projects currently under construction. In our view the cut-off date would need to be later to protect projects under construction. We would propose that the cut-off date is after 30 September 2018 which is similar to the deadline for accrediting under the Renewables Obligation (including graced periods).</p>

Q	Question	Response
13	<p>Do you have a view of whether implementation for the 2017/18 Triad season is sufficient to allow changes for:</p> <p>i) supplier contracts and billing system; and</p> <p>ii) ii) for other stakeholders?</p>	Please see our response to Q10.
18	<p>Do you have a view if embedded benefits are frozen at a non-zero value, what should that value be as a £/kW tariff (2016/17 value is £45.33 / kW)?</p>	

Specific questions for CMP265

Q	Question	Response
11	<p>i) Views are sought on the implication for mixed sites discussed in 3.4.10.</p> <p>ii) Views are sought on the preference of categories of capacity Market CMU captured by this proposal, please indicate your preference from the following list and reasons:</p> <ul style="list-style-type: none"> • All existing and new distribution generation CMUs • All existing and new distribution generation CMUs and DSR CMUs (proven and unproven) • All price maker CMUs • All newbuild/prospective distribution generation CMUs only (defined as >1year contracts) 	

14	<p>Do you have a view of whether implementation for the 2020/21 Triad season is sufficient to allow changes for i) supplier contracts and billing system, and ii) for other stakeholders?</p>	
----	--	--

Specific questions for BOTH CMP264 & CMP265

Q	Question	Response
9	<p>i) Suppliers: In setting charges for your demand customers, do you charge them at the same tariff as National Grid charges you (i.e. gross), to enable you to pay the embedded benefit to embedded generators, or please explain the way in which it is funded?</p> <p>ii) Suppliers: Does the estimate that 7.58GW of embedded generation output and 2.5GW of demand side reduction at the time of Triad for 2016/17 seem reasonable based on your knowledge of the UK market? If not what is your estimate of embedded generator output and DSR at time of Triad?</p>	
12	<p>Can you identify – either quantitatively or qualitatively - the impact of the demand TNUoS embedded benefit on your decisions made in making capacity market decisions?</p>	

Q	Question	Response
15	<p>i) What are your views on the 2 broad options to enable the reporting of gross export metered data?</p> <p>ii) Would you have the data available required for Option B (both CMP264 and CMP265) for both new contracts and existing contracts where a customer may be partially exempt?</p> <p>iii) Do you believe you can implement the proposed changes by the respective implementation dates?</p> <p>iv) What are the pros and cons of the 2 proposals that ELEXON are considering to implement this (P348 for CMP265/ P349 for CMP264)?</p>	
16	<p>Do you have any further evidence / comments on the consumer impact of changing the demand TNUoS embedded benefit in either the short-run or long-run?</p>	
17	<p>Do you feel that both the locational and residual component of the demand TNUoS should be removed as an embedded benefit (as CMP264 Original) or just the residual component (as CMP265 Original) or some other method?</p>	
19	<p>Regarding the proposed alternatives what are your views on the suggested implementation dates? Are these achievable? Please give reasons for your view.</p>	

CUSC Workgroup Consultation Response Proforma

CMP264 'Embedded Generation Triad Avoidance Standstill' and **CMP265** 'Gross charging of TNUoS for HH demand where Embedded Generation is in the Capacity Market'

Industry parties are invited to respond to this consultation expressing their views and supplying the rationale for those views, particularly in respect of any specific questions detailed below.

Please send your responses by **24th August 2016** to cusc.team@nationalgrid.com Please note that any responses received after the deadline or sent to a different email address may not receive due consideration by the Workgroup.

Any queries on the content of the consultation should be addressed to Caroline Wright at caroline.wright@nationalgrid.com

These responses will be considered by the Workgroup at its next meeting at which members will also consider any Workgroup Consultation Alternative Requests. Where appropriate, the Workgroup will record your response and its consideration of it within the final Workgroup Report which is submitted to the CUSC Modifications Panel.

Respondent:	Sarah Tennison, Tees Valley Combined Authority, Cavendish House, Teesdale Business Park, Stockton-on-Tees, Tees Valley, TS17 6QY. Email Sarah.Tennison@teesvalley-ca.gov.uk, Telephone 01642 524400
Company Name:	Tees Valley Combined Authority
<p>Please express your views regarding the Workgroup Consultation, including rationale.</p> <p>(Please include any issues, suggestions or queries)</p>	<p>For reference, the Applicable CUSC objectives are:</p> <p>Use of System Charging Methodology</p> <p>(a) that compliance with the use of system charging methodology facilitates effective competition in the generation and supply of electricity and (so far as is consistent therewith) facilitates competition in the sale, distribution and purchase of electricity;</p> <p>(b) that compliance with the use of system charging methodology results in charges which reflect, as far as is reasonably practicable, the costs (excluding any payments between transmission licensees which are made under and in accordance with the STC) incurred by transmission licensees in their transmission businesses and which are compatible with standard condition C26 (Requirements of a connect and manage connection);</p> <p>(c) that, so far as is consistent with sub-paragraphs (a)</p>

	<p>and (b), the use of system charging methodology, as far as is reasonably practicable, properly takes account of the developments in transmission licensees' transmission businesses.</p> <p>(d) Compliance with the Electricity Regulation and any relevant legally binding decision of the European Commission and/or the Agency.</p>
--	---

Standard Workgroup consultation questions – CMP264

Q	Question	Response
1	Do you believe that the CMP264 Original Proposal better facilitates the Applicable CUSC Objectives?	<p>We believe that the proposals may run counter to the objective of the CUSC. The proposals have the potential to reduce competition, by increasing uncertainty (due to regulatory risk) as to the impact of new investment in the local provision of generating plant.</p> <p>Evidence from the local market would assert that a large proportion of embedded generators do not 'use' the transmission system at all. That is because, during Settlement Periods when the TNUOS charges are determined (the Triads), there is a consistency of offset between embedded generation and demand. It may be the case that the size of this offset has grown over the years, taking load off the transmission system and stranding NGC assets, but that is a separate issue which needs to be addresses in a more holistic manner.</p>
2	Do you support the proposed implementation approach? Or are there any further implementation implications that need to be considered?	<p>At this present time, we are not in a position to be able to assess the full implications of the proposed implementation approach and would strongly recommend an extension of the consultation period. Only after such a consultation period would we be in a position to provide a robust response.</p>

Q	Question	Response
3	Do you have any other comments?	While the CMP264 proposal to grandfather existing generators will protect existing embedded generators in our region, the proposed date of June 2017 does not provide a sufficient investment window for a region such as the Tees Valley, which is currently undertaking significant industrial restructuring following recent closures.
4	Do you wish to raise a WG Consultation Alternative Request for the Workgroup to consider?	<i>If yes, please complete a WG Consultation Alternative Request form, available on National Grid's website¹, and return to the CUSC inbox at cusc.team@nationalgrid.com</i> No

Standard Workgroup consultation questions – CMP265

Q	Question	Response
5	Do you believe that the CMP265 Original Proposal better facilitates the Applicable CUSC Objectives?	We believe that the proposals may run counter to the objective of the CUSC. The proposals have the potential to reduce competition, by increasing uncertainty (due to regulatory risk) as to the impact of new investment in the local provision of generating plant. Evidence from the local market would assert that a large proportion of embedded generators do not 'use' the transmission system at all. That is because, during Settlement Periods when the TNUOS charges are determined (the Triads), there is a consistency of offset between embedded generation and demand. It may be the case that the size of this offset has grown over the years, taking load off the transmission system and stranding NGC assets, but that is a separate issue which needs to be addresses in a more holistic manner.
6	Do you support the proposed implementation approach? Or are there any further implementation implications that need to be considered?	At this present time, we are not in a position to be able to assess the full implications of the proposed implementation approach and would strongly recommend an extension of the consultation period. Only after such a consultation period would we be in a position to provide a robust response.

¹ http://www.nationalgrid.com/uk/Electricity/Codes/systemcode/amendments/forms_guidance/

Q	Question	Response
7	Do you have any other comments?	The proposal to backdate the changes and to discriminate against plants in the CM is completely unacceptable. (It is as if CMP 265 is there to make 264 look less bad.). Companies who have entered into Capacity Market contracts in good faith would find themselves singled out to take a hit much bigger than the benefit of the CM payments, but they would still have the CM obligation. It was suggested in the consultation that companies would simply tear up their CM contracts, but this suggestion is misguided and irresponsible as there is no mechanism in the CM for them to walk away.
8	Do you wish to raise a WG Consultation Alternative Request for the Workgroup to consider?	<i>If yes, please complete a WG Consultation Alternative Request form, available on National Grid's website², and return to the CUSC inbox at cusc.team@nationalgrid.com</i> No

Specific questions for CMP264

Q	Question	Response
---	----------	----------

² http://www.nationalgrid.com/uk/Electricity/Codes/systemcode/amendments/forms_guidance/

Q	Question	Response
10	<p>i) Do you think a cut-off date for “new embedded generation” of 30 June 2017 is appropriate? What other date would you propose?</p> <p>ii) Do you have any views on how mixed sites are being addressed in CMP264 Original?</p> <p>iii) Do you think new-build embedded generation capacity that has entered into long term financial and performance commitment obligations via 2014 and 2015 capacity market or contracts for difference auctions (prior to this modification proposal) should be given exceptions to this cut-off date?</p> <p>iv) Do you agree that ignoring demand behind the meter is unlikely to create a significant “loophole” or material discrimination risk in relation to the CMP264 arrangements in the short term</p> <p>v) Question to suppliers: Do you consider that the wording of your existing contracts allow you to reflect the changes provided by these modifications in a cost reflective manner. For example, these changes will apply to existing PPAs and generators who significantly alter their output (EREC 59).</p> <p>vi) Do you agree with the definition of commissioned and do you agree that it is appropriate? If you do not agree with the definition or that it is appropriate please provide alternative definitions and rationale for this definition.</p>	<p>This date is much too soon, there are plants under construction now which will not be online for several years.</p> <p>We see the embedded generation and demand reduction as being entirely equivalent and disagree with the treatment at the DNO level, let alone the site level.</p> <p>Yes and especially so for those plants which have met the CM Extended Years Criteria.</p> <p>Yes. The electricity industry should not be attempting to interfere with what happens at a site level.</p> <p>We have no comments on this.</p>

Q	Question	Response
13	<p>Do you have a view of whether implementation for the 2017/18 Triad season is sufficient to allow changes for:</p> <p>i) supplier contracts and billing system; and</p> <p>ii) ii) for other stakeholders?</p>	<p>We have no comments on this.</p> <p>This would be a wholly inappropriate when the timescale for the build of some embedded plants is 3 years.</p>
18	<p>Do you have a view if embedded benefits are frozen at a non-zero value, what should that value be as a £/kW tariff (2016/17 value is £45.33 / kW)?</p>	<p>This might be used as a stop-gap to allow a more considered approach to be taken.</p>

Specific questions for CMP265

Q	Question	Response
11	<p>i) Views are sought on the implication for mixed sites discussed in 3.4.10.</p> <p>ii) Views are sought on the preference of categories of capacity Market CMU captured by this proposal, please indicate your preference from the following list and reasons:</p> <ul style="list-style-type: none"> • All existing and new distribution generation CMUs • All existing and new distribution generation CMUs and DSR CMUs (proven and unproven) • All price maker CMUs • All newbuild/prospective distribution generation CMUs only (defined as >1year contracts) 	<p>We do not see these proposals as workable.</p> <p>We do not agree that CM providers should be targeted. Since the TNUoS benefit to be lost would be much greater than the CM benefit to be earned, this would instantly kill off all CM driven investment in the embedded generation. We wish to see all investment encouraged.</p>

14	<p>Do you have a view of whether implementation for the 2020/21 Triad season is sufficient to allow changes for i) supplier contracts and billing system, and ii) for other stakeholders?</p>	<p>We do not consider to proposals to be acceptable on any timescale.</p>
----	--	---

Specific questions for BOTH CMP264 & CMP265

Q	Question	Response
9	<p>i) Suppliers: In setting charges for your demand customers, do you charge them at the same tariff as National Grid charges you (i.e. gross), to enable you to pay the embedded benefit to embedded generators, or please explain the way in which it is funded?</p> <p>ii) Suppliers: Does the estimate that 7.58GW of embedded generation output and 2.5GW of demand side reduction at the time of Triad for 2016/17 seem reasonable based on your knowledge of the UK market? If not what is your estimate of embedded generator output and DSR at time of Triad?</p>	
12	<p>Can you identify – either quantitatively or qualitatively - the impact of the demand TNUoS embedded benefit on your decisions made in making capacity market decisions?</p>	<p>It should be fairly clear that the larger benefit (so far), which is the TNUoS saving will dominate people's decision making.</p>

Q	Question	Response
15	<p>i) What are your views on the 2 broad options to enable the reporting of gross export metered data?</p> <p>ii) Would you have the data available required for Option B (both CMP264 and CMP265) for both new contracts and existing contracts where a customer may be partially exempt?</p> <p>iii) Do you believe you can implement the proposed changes by the respective implementation dates?</p> <p>iv) What are the pros and cons of the 2 proposals that ELEXON are considering to implement this (P348 for CMP265/ P349 for CMP264)?</p>	Neutral
16	Do you have any further evidence / comments on the consumer impact of changing the demand TNUoS embedded benefit in either the short-run or long-run?	Reducing the triad benefit can only serve to reduce embedded generation at triad times and therefore increase net demand on the system and reduce system security. This would ultimately increase total system costs.
17	Do you feel that both the locational and residual component of the demand TNUoS should be removed as an embedded benefit (as CMP264 Original) or just the residual component (as CMP265 Original) or some other method?	We disagree with the removal of either. We do however note the irony that CMP264 would leave new plants supporting sunk transmission costs and old plant not doing so – this reveals the false premise of the proposals.
19	Regarding the proposed alternatives what are your views on the suggested implementation dates? Are these achievable? Please give reasons for your view.	We have no comments on this.

CUSC Workgroup Consultation Response

Respondent:	<i>Sam Wither, Commercial Director, UK Power Reserve</i> <u>Sam.wither@ukpowerreserve.com</u>
Company Name:	<i>UK Power Reserve</i>

Please express your views regarding the Workgroup Consultation, including rationale.

UKPR Executive summary

UKPR has submitted a variety of alternatives to the proposed modifications. This is to ensure that we, together with the working group, present the widest range of scenarios to the CUSC panel and later Ofgem for their consideration. Our position is as follows:

We agree that the current embedded charging system is unsustainable and we support changes which enable **certainty, good visibility** and above all a **level playing field for the full range of uncommitted future new build generation (UNDG¹)**.

However, we firmly believe that the 1.7GW of committed new build distributed generation (CNDG²) procured in the 2014 and 2015 capacity market (CM) auctions needs proper protection to avoid:

- **stranding assets**
- **impacting security of supply from 2018 onward**
- **raising the cost of electricity for the end consumer**

The UK's energy system is increasingly decentralized and complex meaning **distributed or embedded generation (DG or EG) is a key part of the future mix. It is fast build, inexpensive and able to turn up and down quickly and flexibly when and where it is most needed.** The right proportion in the overall mix must be supported to ensure it can continue to play its critical role over the next couple of decades as the UK continues to decarbonize and embrace innovative technologies and processes including new storage and progressive demand side response behaviors.

Ofgem's consultation and the Scottish Power and EDF mods have sent a clear signal to the market going forward – from the 2016 CM auction and onward – that triad revenues paid cannot be relied upon and that this should be factored into the CM 2016 bidding price by all parties which levels the playing field. We accept this, but urge the working group, CUSC panel and Ofgem to look extremely careful at the outcomes for security of supply and value for the consumer of stranding committed assets without understanding what the unintended consequences could be.

To that end we have presented a variety of alternatives which are designed to help the system transition away from the current embedded charging regime to a more sustainable one.

1 Uncommitted New Build Distributed Generation: Capacity which has not yet been awarded capacity market contracts or similar / pre Ofgem's Open Letter regarding embedded benefits

2 Committed New Build Distributed Generation: capacity which has reached a significant investment commitment prior to the 29/7/2016 (Ofgem Open Letter regarding embedded benefits).

- **We propose a level of protection for the committed investment made in '14 and '15 CM auction EG to give it the certainty to move forward through to construction and delivery**
- UKPR's WACMs analyse the **value to the end consumer** over time of investment in DG versus transmission generation, and a range of price outcomes in the CM auction
- They consider the impact and cost of changing the calculation of the triad volumes by time and length to better reflect cost and competition.
- We support a longer-term holistic review by Ofgem of broader charging arrangements but believe it **imperative to give short-term certainty** around committed investment to allow construction to proceed this year and next
- We believe EG gas reciprocating technology is a clean, efficient and sustainable way to help the UK decarbonize and are mindful of Defra's forthcoming consultation which aims to address the emissions from new build diesel DG
- It is proper that innovation and early adoption of technologies be awarded some form of protection to recognize the high risk new developments represent and high cost of capital required to deliver new forms of market critical capacity

Context

DG plays a critical role in the UK's generation mix and Capacity Market (CM) auctions. It helps safeguard security of supply, enables the decarbonisation of the broader power sector by complementing intermittent renewable generation and also represents excellent value for consumers in an increasingly decentralized energy world.

UK Power Reserve has a 700MW portfolio of thermal generation assets, 65MW is existing diesel, 120MW is operating gas fired and the remainder mains-gas fired of just over 500MW of committed investment under development due to be installed between now and 2018 to meet secured obligations as per the capacity market. These power stations service the capacity, wholesale and ancillary markets, enabling efficient and effective management of the UK's electricity supply and demand.

UKPR was involved in the development and design consultations for Electricity Market Reform (EMR) specifically the CM. UKPR participated into the newly established 2014 and 2015 CM auctions and the more recent Transitional Arrangements CM auctions and successfully secured capacity obligations for its existing DG assets and its newbuild DG assets.

The CM was designed and implemented to secure supply for UK plc at the lowest possible cost to the end consumer. It complements existing electricity market revenues and opportunities at the same time as introducing a framework to incentivize new-build capacity on a technology neutral basis by offering long-term obligations for those who need to invest significant capital into assets to service those obligations for up to 15 years and beyond.

The award of several gigawatts of newbuild capacity to DG via the CM auctions has increased industry focus on the role of DG in the overall generation mix and the perceived distortions within the embedded distribution charging regime. CNDG comprises a mixture of lean burn gas engines and diesel engines. The increase in newbuild diesel capacity – which is cheap to develop but highly polluting – has created concern and is subject to two consultations. One by Ofgem into overcompensation and another by DEFRA into environmental impacts.

These consultations have triggered two CUSC modifications (mod/s), CMP264 and CMP265, and the setup of a working group. In addition, Ofgem has published an Open Letter providing its intended 'direction of travel' on embedded charging in which it says it is minded to adopt one of the mod process outcomes. Defra is due to publish and launch a consultation in the near future placing new restrictions on emissions to clean up diesel generation and divert new investment into cleaner technologies. It recently published its current thinking which can be read [here](#).

We are concerned that the mods and Ofgem's review processes are creating significant uncertainty for the more than two gigawatts of CNDG secured in the 2014 and 2015 CM auctions. The decision to invest in this capacity was made on the basis of long-standing charging arrangements and benefits. This capacity now faces an uncertain future because of the potential removal of a significant revenue stream, paid to pioneers of DG to help secure the UK's electricity future. UKPR has both existing and CNDG. We are extremely concerned that **this 2014 and 2015 committed capacity strongly risks being stranded** if proper arrangements are not put in place to protect it, protect security of supply and most importantly, protect the end consumer.

The type of lean gas-reciprocating engines built by UKPR represent excellent value for the consumer. The participation by DG in the CMs has been blamed for lowering the outturn price which has in turn made it unviable for the auction to attract larger scale, more expensive generation like CCGTs. Regardless, the auctions attracted sufficient capacity to address supply requirements. In the meantime, having committed to build generation against the existing and affirmed charging framework, which clearly influenced the price at which we were able to bid into the auction, we now find that Ofgem is considering pulling the rug out from under our feet by radically altering that charging framework. There is a high risk that we will no longer be able to viably deliver that 500MW if that happens without some form of protection via grandfathering or carefully implemented transitional arrangements. The UK generation mix needs this kind of DG in near, medium and longer term. Stranding committed 2014 and 2015 investments – which are relatively quick and economic to build and flexible and clean to generate – through Ofgem's review or implementation of the proposed mods may drastically affect its ability to keep the lights on in an affordable way that delivers a cleaner energy mix.

UKPR recognizes the current embedded charging system is unsustainable in the longer-term. It recognizes that there is a need for a review and for changes to be implemented. The cost to the consumer of paying for the TRIAD system is forecast to continue to grow significantly as indicated recently through National Grid (NG's) Charging Seminar presentation. Left unchecked, this escalation could result in significant distortions in the UK electricity market through to 2040 that ultimately are at the expense of the end consumer. Below is the current forecast for transmission charges in NG's Future Energy Scenarios (FES).

The first diagram shows transmission connected generation charges (typically sites >100MW connection) split between onshore and offshore out to 2040. Onshore charges move on average from positive to negative – a fundamental change to average historical charges which have always been positive. Offshore charges are very high and decline over the period.

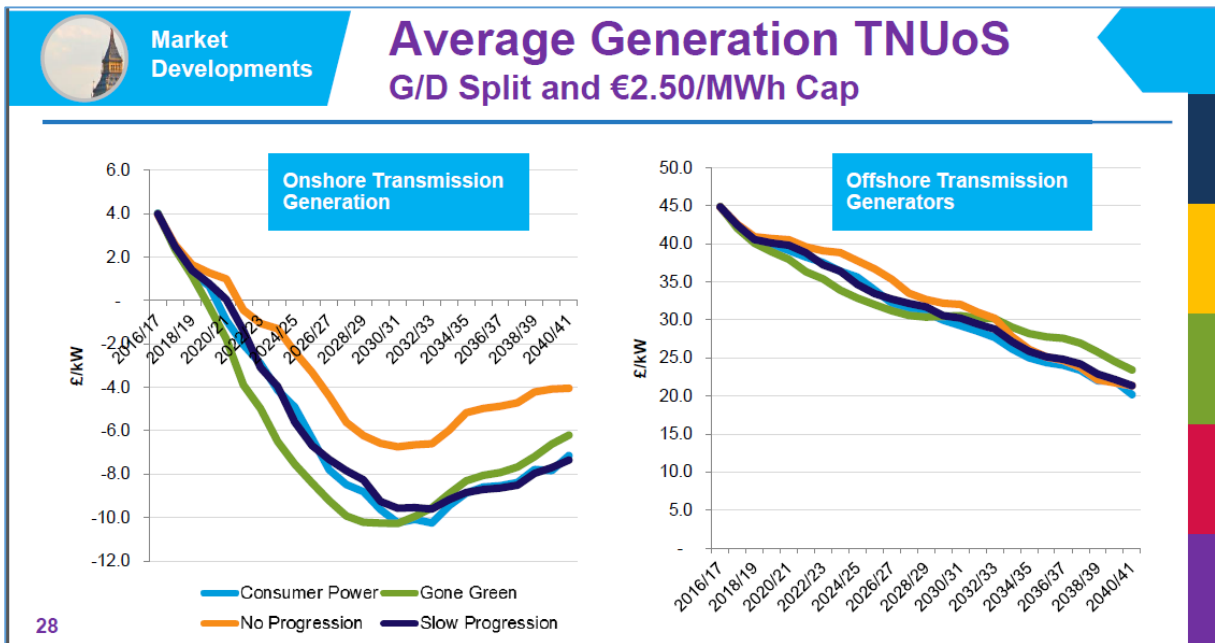

Source: NG

Below is NG's forecast of the cost of the EB over the period though to 2040 using the FES scenarios. The cost of EBs increases significantly over the period driven by both rates and volume increases which compound the costs.

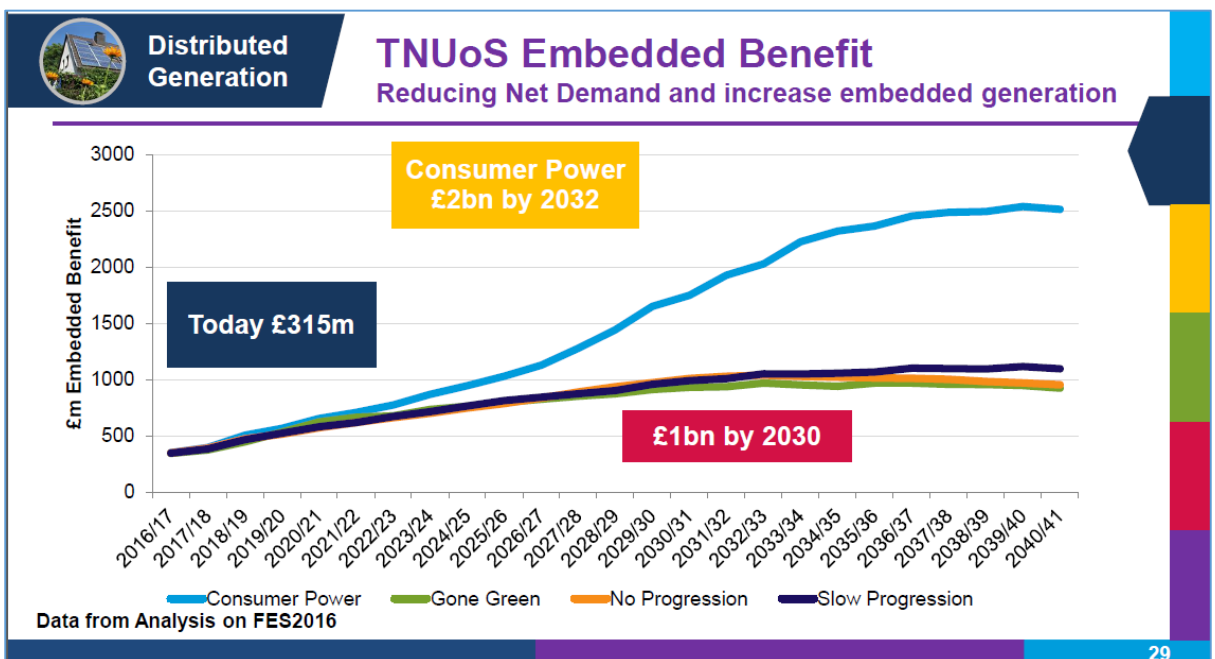

Source: NG

Both the charging forecasts demonstrate that current charging frameworks are unsustainable if left unchecked. It has yet to be determined whether the appropriate change is to pursue fundamental reform or progressive adjustments to even the keel.

A key deliverable of the CUSC working group and of the industry charging structures are that they are fit for purpose in that they promote competition and are cost reflective. The indicative costs shown need proper scrutiny and analysis to determine the appropriate way forward for the whole market. UKPR recognize that changes need to be made to the charging system going forward and we believe these should be made holistically and with consideration for other areas of the UK charging system to avoid simply moving costs around – and ultimately landing them with the consumer. We therefore believe that it is appropriate that EB should continue to be paid to CNDG which entered into long-term financial and performance commitment obligations in 2014 and 2015 and other similar committed projects such as Combined Heat and Power units (CHPs) and Contracts for Difference (CfD).

We also strongly believe, having recently been given due warning of the charging review that any future investment decisions via industry auctions no longer be eligible for elements of EBs (such as triad) until such time that Ofgem provides certainty and clarity. We need a set of charging arrangements which encourage the right investment in the right locations to create an energy mix which meets the UK's ambitions for energy supply through to 2030's and looking beyond this out to 2050.

Our view is based on the simple position that future investment in newbuilds can operate on a level playing field in auctions such as the CM and CfD and adjust their bid prices to account for these recent developments. Protecting CNDG while levelling the playing field for all capacity going forward represents a pragmatic short-term solution prior to any longer term charging review which may also take place. It removes uncertainty, avoids stranding assets and protects security of supply and reduces costs levied to the end consumer.

We therefore support elements of each of the original mods but believe certain provisions are needed to avoid further unintended consequences which would raise costs for consumers.

The energy sector has entered an extremely unstable and uncertain time, made all the more challenging by Brexit and the government shakeup, and by political decisions around flagship, largescale infrastructure like Hinkley Point. Investment in a declining market (by demand) is inherently risky and Ofgem must do everything it can to protect what investment there is by conducting a proper impact assessment into embedded charging, its place within the broader charging frameworks and the role of DG going forward. It strongly risks undermining investor confidence and security of supply in the UK by being minded to adopt mods put forward by Big Six incumbents and further skewing the playing field in the direction of the status quo.

We will be calling on Ofgem to demonstrate evidence for the various assumptions it has made in its direction of travel letter, including around investor confidence and the impact on future infrastructure, the value to consumer of transmission versus DG and the perceived difficulties in grandfathering existing assets.

We are concerned that an incomplete and unbalanced assessment and outcome could result in significantly prolonged uncertainty for investors and consumers alike, for example because of the high risk to Ofgem of Judicial Review or calls for an SCR. We therefore continue to seek reassurance that there will be an appropriately timely conclusion to the ongoing process, at the very least relating to CNDG, so we can proceed as planned with our portfolio, avoid the stranding of assets, and enter the

2016 and future CM and CfD auctions on a level and visible playing field with all generators. We believe this would be the most efficient way to avoid paralyzing the industry for two or more years and deeply damaging investor confidence, diversity and innovation in smaller corporates and security of supply.

Responses to consultation questions Standard work group questions for CMP264

Question 1: Do you believe that CMP264 Original proposal or either of the associated potential options for change better facilitates the Applicable CUSC Objectives?

Yes, we believe that certain principles presented in the original mods better facilitates the Applicable CUSC objectives. However, the following considerations or alternatives would improve objectives (a) & (b).

We have presented a **UKPR alternative** that protects projects that are yet to commission, beyond the original proposer's cut-off date, as long as these projects have already made significant commitments and investment decisions such as securing newbuild CM contracts in the 2014 and 2015 auctions. Below is an overview of the impact assessment of this proposal, as presented in the draft working group consultation:

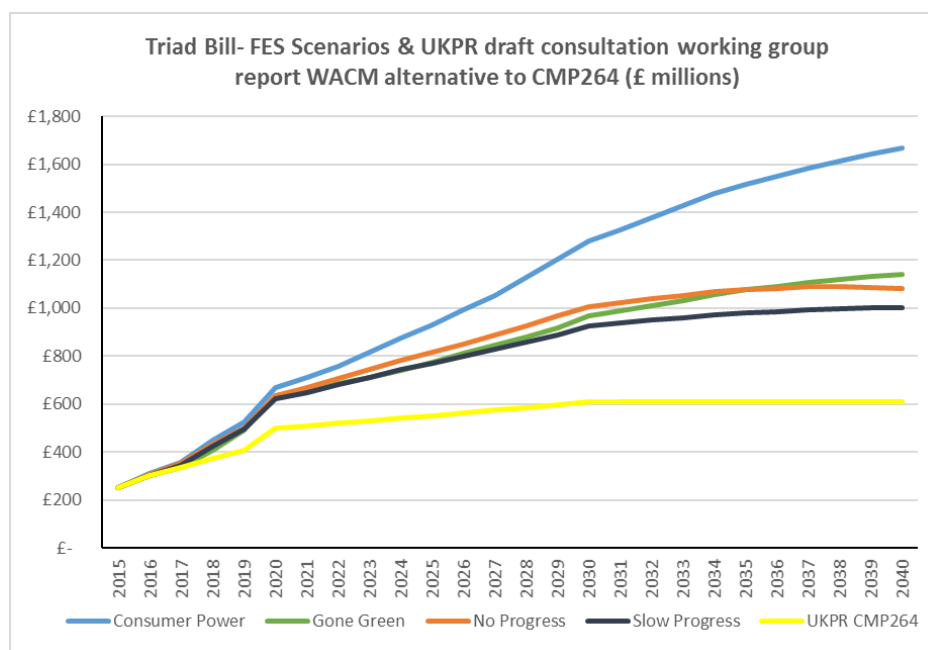

Source: UKPR

This alternative acts as a temporary measure to ensure all CNDG and existing capacity continues to provide embedded services such as triad whilst a more enduring review is undertaken. The above high-level impact assessment indicates that compared to the status quo under NG's FES scenarios this

alternative would cap the total triad bill for EBs to approximately £600 million per annum from the mid-2020s. This represents a 25%-45% reduction over the same period if this alternative is taken forward. We have assessed **Greenfrog's alternative proposal** for comparison:

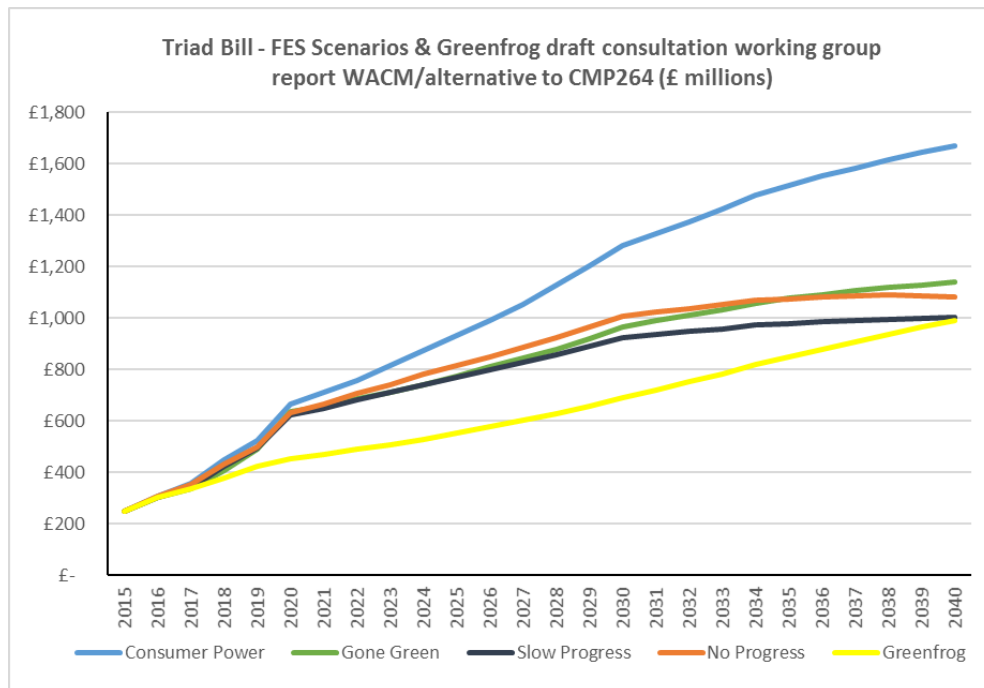

Source: UKPR

This alternative proposes maintaining but discounting the EB triad rate for all embedded capacity including future newbuild. In the first few years of implementation this alternative has a reasonable reduction in costs but the increase in embedded generation in future bolsters the total triad bill significantly through the '20s-'40s to similar levels as those in NG forecasts. This alternative may also be challenged on whether it actually addresses the distortion raised by the original proposer.

We have assessed **Centrica's 1 & 2 alternative proposal** for comparison. Centrica 1 essentially reduces the triad bill to £0 from 2020 onwards whereas Centrica 2 proposes the same as Greenfrog although the alternative is silent on the rate proposed. Therefore, we have modelled a range of potential rates below that proposed by Greenfrog to present the potential impact on the triad bill:

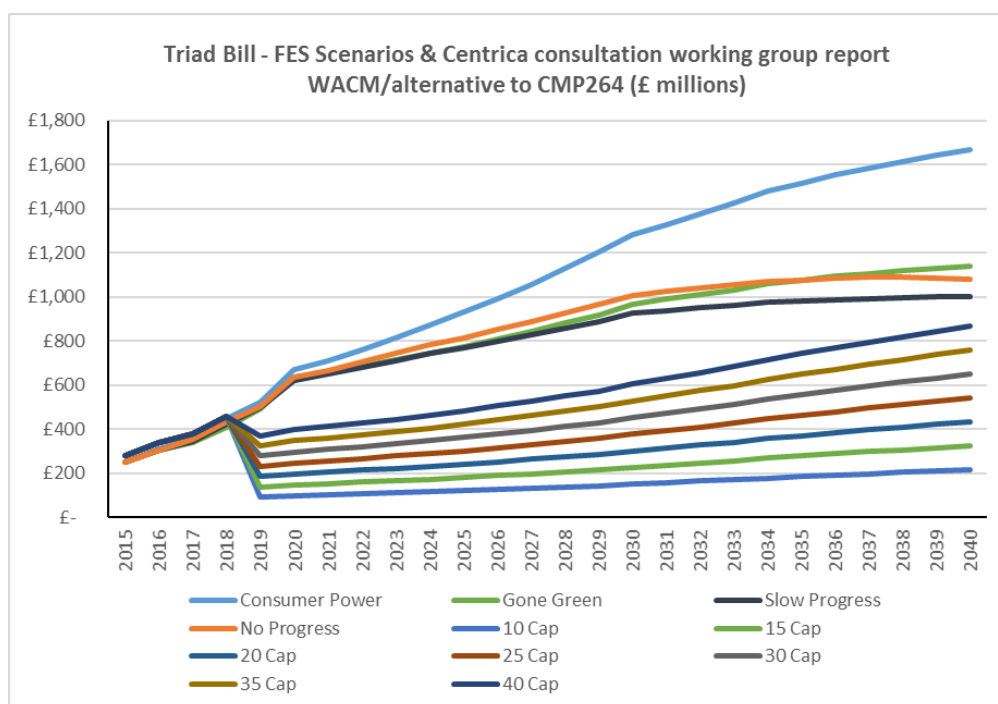

Source: UKPR

Centrica 1 alternative effectively reduces the triad bill to zero and therefore presents a significant difference to the status quo. We view this proposal as discriminatory and anti-competitive, nor cost reflective for reasons that we will explain later in this response and therefore believe this mod does not offer an improvement to the CUSC objectives.

Centrica 2 alternative presents a range of triad bill discounts but similarly to the Greenfrog alternative, these discounts are made at the expense of existing and CNDG to create headroom in the triad bill for UNDG. Applied uniformly to all embedded generators, these discounts would discriminate against those who have made long-term investment commitments against non-discounted triad rates. These discounted rates would strand assets and result in the end consumer picking up the tab for more expensive or carbon intensive generation.

This alternative may also be challenged on whether it actually addresses the distortion raised by the original proposer.

Conclusion to Question 1

The original mods and the alternatives can be viewed on their merits using the above analysis but it does not provide the level of detail and potential cost/volume impacts that could be influenced such as the cost of the CM auctions or influence that changes on the EBs may have on future auction clearing prices. The next figure shows known EG CM market costs/volumes from the all '14 and '15 CM auctions plus the forecast of future newbuild distribution generation capacity as per National Grids FES 2016. The 2014 CM Impact Assessment auction clearing price estimate is used for future auction results to indicate approximate costs of CM payments for embedded generators.

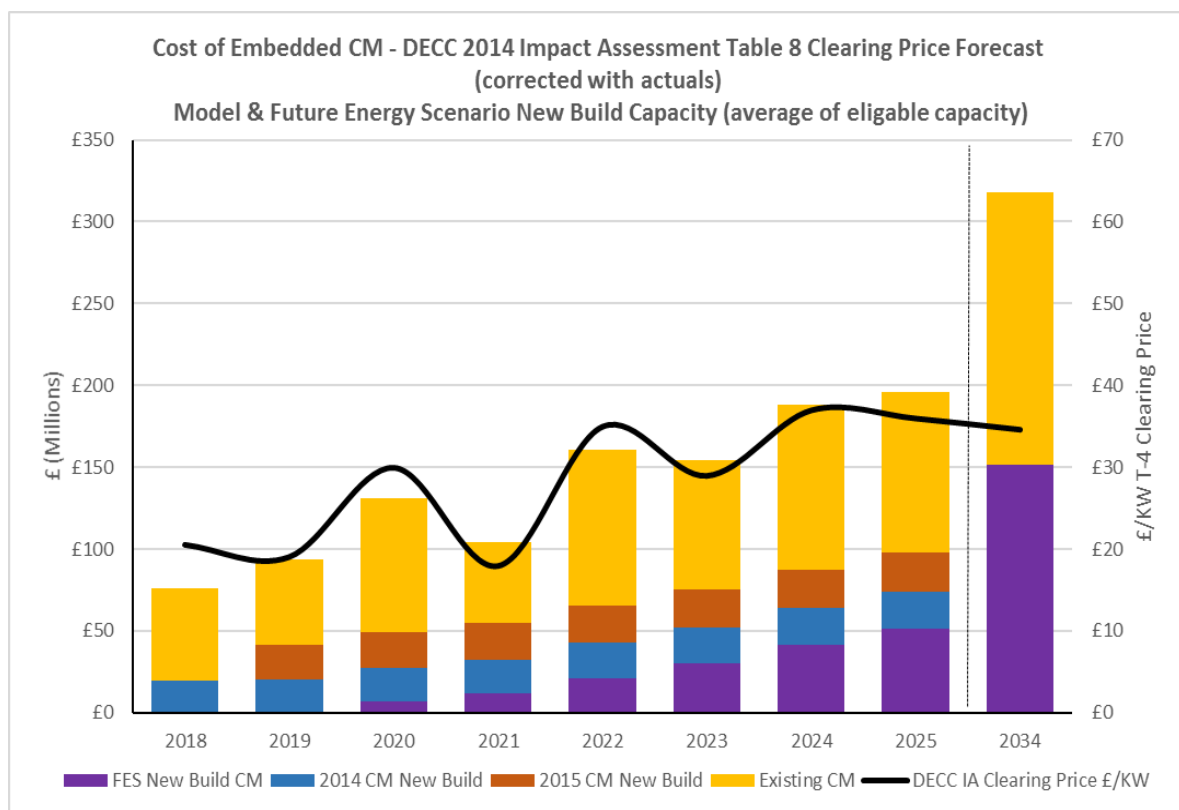

Source: UKPR

The interplay of future CM results and enduring costs levied on the end consumer when considered with EBs and changes that could be brought about through these mods is significant.

When considering these mods the working group must consider the wider impacts and the timing and implementation, while maintaining due process and focusing on the distortion raised in the original mods to better facilitate the CUSC objectives.

Please see further analysis presented throughout this response and *notably to Q10* on potential impacts on alternative costs to the end consumer.

Question 2: Do you support the proposed implementation approach for CMP264? Are the suggested implementation timescales suggested for CMP264 appropriate / achievable?

We believe the principles supporting the proposed implementation approach are sensible but have concerns on a number of areas including:

- The proposed cut-off date is likely to discriminate against CNDG which are passing financial commitment milestones and/or under development;
- The proposed cut-off date could see a rush of 2016 CM and CfD newbuild CMUs looking to build and connect which would favour the lowest-capital, quickest build technologies such as liquid fuels (diesel) but penalise more capital intensive technologies such as gas, anaerobic digestion or combined heat and power (CHP);
- And, the proposed cut-off date is challenging in terms of implementation for subsequent mods changes to the BSC and for associated system changes.

Question 3: Do you have any other comments for CMP264?

CMP264 is presented as a temporary solution subject to further industry/regulatory review therefore we see a number of further subsequent mods, analysis and consultation will be required to deliver appropriate transitional and enduring arrangements that better facilitates the CUSC objectives.

CMP264 could look at the alternative definition/principle to a cut-off date to target a certain sub set of new distribution generation capacity to enable easier implementation in the timescales required in order to address the potential distortion(s) in the short-term.

Question 4: Do you wish to raise a Workgroup Consultation Alternative request for the Workgroup to consider for CMP264?

Yes. Please refer to separately submitted Workgroup Consultation Alternatives. A summary of each is listed below:

Alternative 1

Multifaceted option for discussion of the workgroup introducing a cap on TNUoS demand rates for embedded generators on either a regional or uniform basis whilst moving the calculation methodology over to gross charging by 2019 with appropriate time limited exemptions for certain classifications/owners of distributed generation assets. This alternative also proposes changes to the Triad methodology to move from the Triad 3 peaks to a baseline calculation that determine the demand TNUoS charge based on the average export/import between November – January of 16:30-19:30 and for February 17:00-20:00. Time limited exemptions introduced for all committed investments (2014, 2015 CM/CfD and committed CHP projects) from gross TNUoS demand treatment until 2033/34. Additionally, time limited exemptions for existing distributed generation capacity through to 2024/25. All uncommitted newbuild distributed generation capacity received no exemptions from gross charging treatment for TNUoS Demand.

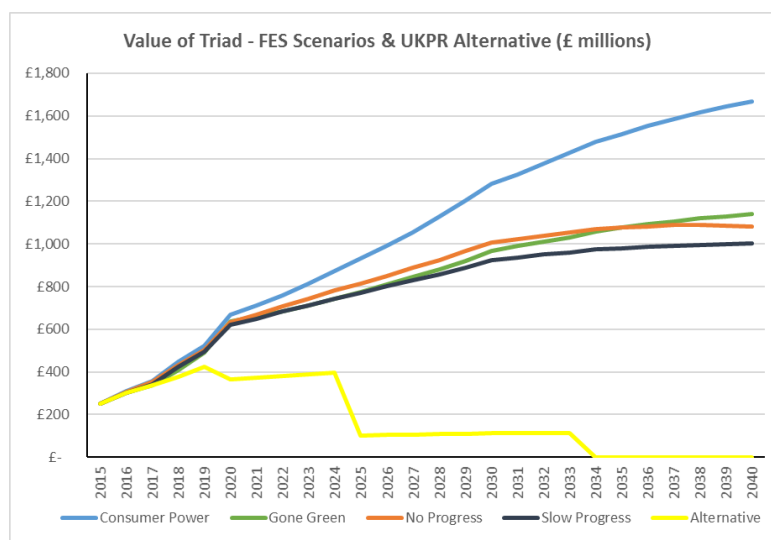

Alternative 2 - please see UKPR Alternative presented to Q4 (as per draft WG consultation)

Do not deduct new Embedded Generation from a suppliers charging volumes (i.e. move to gross TNUoS charging), for the purposes of demand TNUoS. Thereby, removing demand TNUoS embedded benefit for those new embedded generators for future embedded generation. New embedded

generation that is committed investments in CHPs as well as 2014 and 2015 CM/CfD commitments will not be impacted by this proposal. Similar to CMP264 with some exceptions introduced into the Cut-Off date definition to protect committed new builds.

Alternative 3

Do not deduct new Embedded Generation from a suppliers charging volumes, for the purposes of demand TNUoS (i.e. move to gross TNUoS charging). Thereby, removing demand TNUoS embedded benefit for those new embedded generators for future embedded generation. New embedded generation that is committed investments in CHPs as well as 2014 and 2015 CM/CfD commitments will not be impacted by this proposal. Additionally, TNUoS rates will be capped at the final rates applicable to 2017/18 charging period with the cap increasing with RPI;

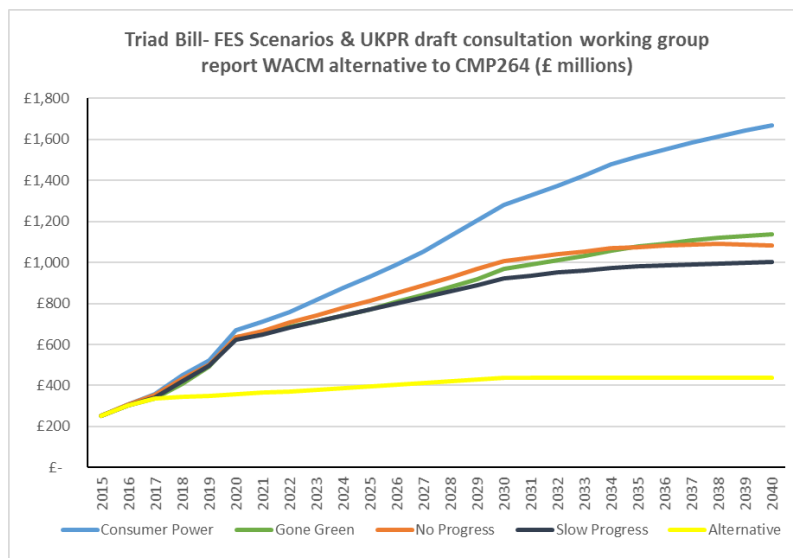

Alternative 4

Do not deduct new Embedded Generation from a suppliers charging volumes (i.e. move to gross TNUoS charging), for the purposes of demand TNUoS. Thereby, removing demand TNUoS embedded benefit for those new embedded generators for future embedded generation. New embedded generation that is committed investments in CHPs as well as 2014 and 2015 CM/CfD commitments will not be impacted by this proposal as a time limited exemption introduced for all committed investments (2014, 2015 CM/CfD and committed CHP projects) from gross TNUoS demand treatment until 2034/35. This leaves the treatment of existing distributed generation untouched under this proposal on the assumption further consultation will be required at a later date;

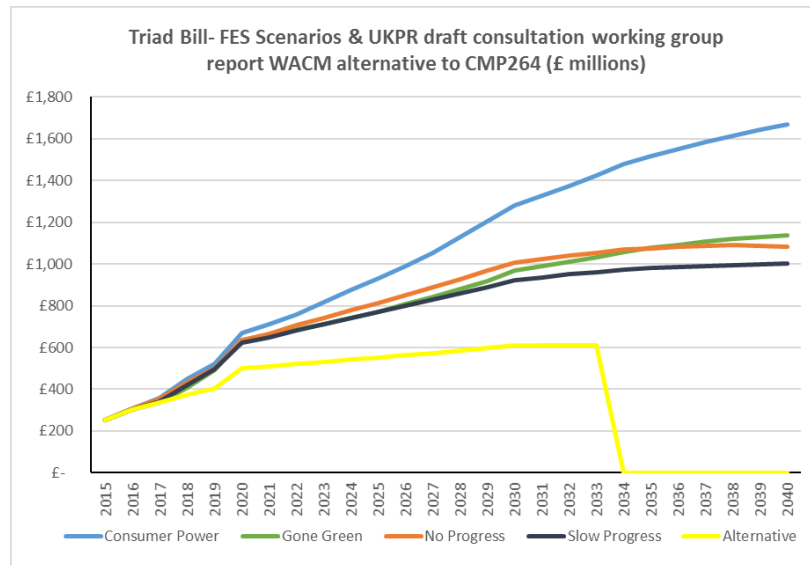

Alternative 5 – please see UKPR Alternative presented to Q5 (as per draft WG consultation)

Do not deduct certain embedded generation (those with Capacity Market agreements) from a suppliers charging volumes, for the purposes of demand TNUoS. Thereby, removing demand TNUoS embedded benefit for those embedded generators. This means all existing and already committed CM distribution generators will continue to be treated on a net basis for TNUoS demand embedded benefit. All future new build embedded generators that successfully secure a 2016 CM agreement >1year will move to gross TNUoS demand charging i.e. not be able to net off from a suppliers charging volumes.

Alternative 6 – This does not change the cost of embedded benefit but increases the cost reflectivity

Change to the Triad methodology to move from the Triad 3 peaks to a baseline calculation that determine the demand TNUoS charge based on the average export/import every winter week night between November – January of 16:30-19:30 and for February 17:00-20:00 implemented from the April 2019/20 charging year.

Alternative 7 – please see UKPR Alternative presented to Q4 (as per draft WG consultation)

Do not deduct new Embedded Generation from a suppliers charging volumes, for the purposes of residual demand TNUoS. Thereby, removing the residual demand TNUoS embedded benefit for those new embedded generators for future embedded generation. Existing and New embedded generation (that is committed investments in CHPs as well as 2014 and 2015 CM/CfD commitments) will not be impacted by this proposal. The locational element of the Triad rate will be unaffected by this process and still apply on a net basis for new build embedded generation after the Cut Off point. Similar to original CMP264 and alternative 2 as listed above;

Alternative 8

Amends the CUSC to mandate all new build exportable embedded generation – defined as commissioning after 01 April 2017 (that is not already subject to a significant commitment such as CM/CfD long term agreement or CHPs) to enter into a BEGA with National Grid. These BEGAs should be revised to stipulate the Demand Residual element of TNUoS will be calculated on a gross basis and centrally administered by National Grid;

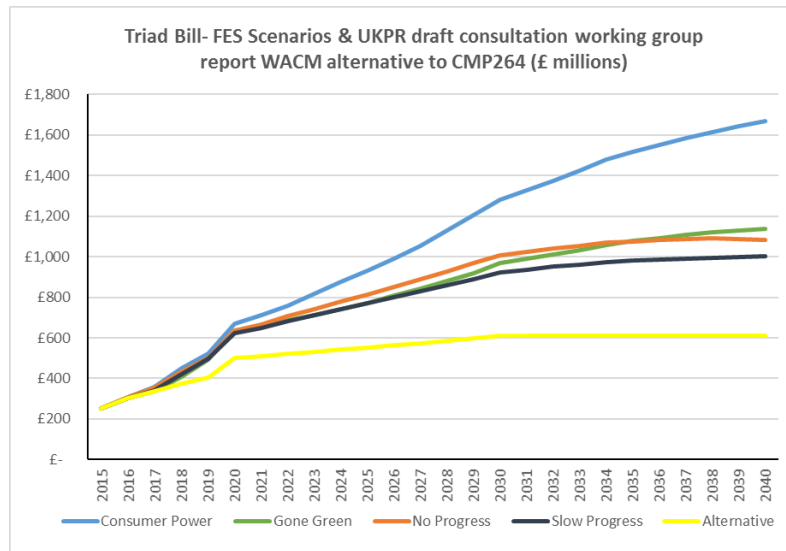

Alternative 9

This modification proposes a steady degradation of the current Triad demand residual rates from the 2017/18 charging year for all existing and future plant. This will be implemented as a 25% annual reduction on the 2017/18 Triad rate year on year, resulting in the complete removal of Triad for the 2025/26 charging year. The locational element of the Triad rate will be unaffected by this reduction process. New embedded generation that is committed investments in CHPs as well as 2014 and 2015 CM/CfD commitments will not be impacted by this proposal for a time limited period expiring in 2033/34 as TNUoS rates for these users will be capped at the 2017/18 charging period only increasing with RPI;

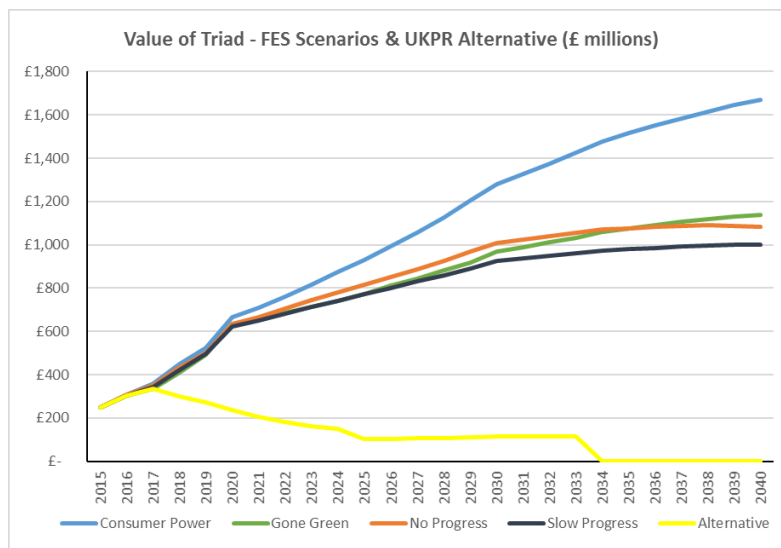

Alternative 10

This modification proposes a steady degradation of the current Triad demand residual rates from the 2017/18 charging year for all existing and future plant. This will be implemented as a 15% annual reduction on the 2017/18 Triad rate year on year, resulting in the complete removal of Triad for the 2030/31 charging year. The locational element of the Triad rate will be unaffected by this reduction

process. New embedded generation that is committed investments in CHPs as well as 2014 and 2015 CM/CfD commitments will not be impacted by this proposal for a time limited period expiring in 2033/34 as TNUoS rates for these users will be capped at the 2017/18 charging period only increasing with RPI;

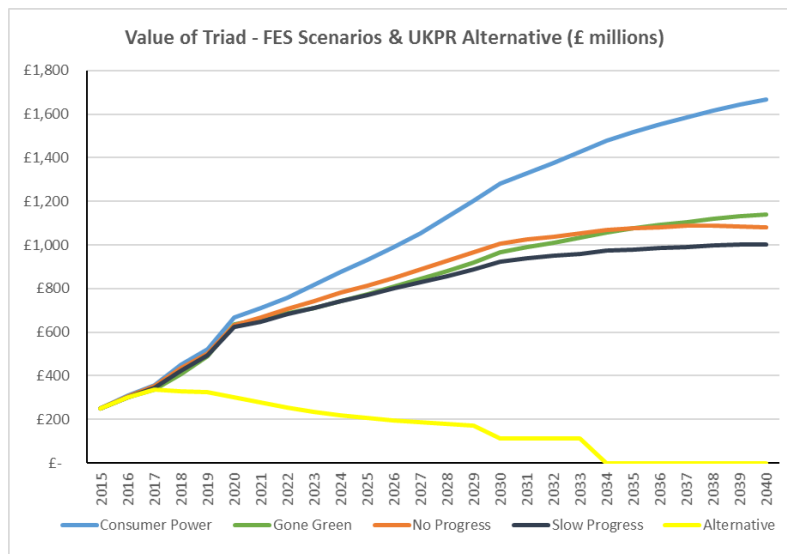

Standard work group questions for CMP265

Question 5: Do you believe that CMP265 Original proposal or either of the associated potential options for change better facilitates the Applicable CUSC Objectives?

We believe that as it stands the original mod does not better facilitate the applicable CUSC objectives. However, certain principles within the mod, combined with further alternatives would better facilitate the Applicable CUSC objectives. Our primary concern is that CMP265 as proposed under the original introduces more severe distortions than those the mod is proposing to remedy, notably discrimination of existing distributed-connected capacity that would have to choose between EBs and the CM. This could remove a significant volume from the CM auction, reduce liquidity and substantially increase costs on the end consumer. The CM was intentionally designed to enable all eligible existing capacity to participate and receive CM revenue in addition to other revenue streams as set out [here](#).

To mitigate gaming, the auction was designed to place price threshold restrictions on all existing capacity to prohibit distortions or portfolio gaming of large capacity owners when bidding and influencing the clearing price. This is known as price-take status and capacity with this status can only bid up to £25/kW. This means that the distortions cited in the original proposal are unfounded and inaccurate as the CM has already built in provisions to mitigate such distortions.

Furthermore, the original mod would discriminate against CNDG in the 2014 and 2015 CM auctions where up to 1.7GW of newbuild DG capacity has secured obligations commencing in 2018/19 for 15 years. These units have already bid into the auction assuming the revenue to be in addition to other revenue streams such as EBs. It would be discriminatory to then subsequently remove an anticipated

and well-reviewed revenue stream from this capacity. To do so risks stranding the assets, at significant additional cost to the end consumer (please see our response and supporting analysis to Q10 in this response).

We have presented an alternative to CMP265 that introduces a mutual exclusivity between securing future newbuild CM agreements and the triad EB. Under this alternative, any future capacity entering in to the T-4 or T-1 CM (that is new or that has price-maker status) can still participate but if successful in securing CM obligations this capacity will not be eligible to receive the triad benefit for the corresponding delivery year. This does not restrict new capacity being developed and establishing itself as existing capacity and entering into the T-1 CM auctions in future. We believe this alternative will better address the distortion that has been raised by the proposer.

Below is an overview of the impact assessment of **the UKPR alternative proposal** to CMP265 as presented in the draft working group consultation;

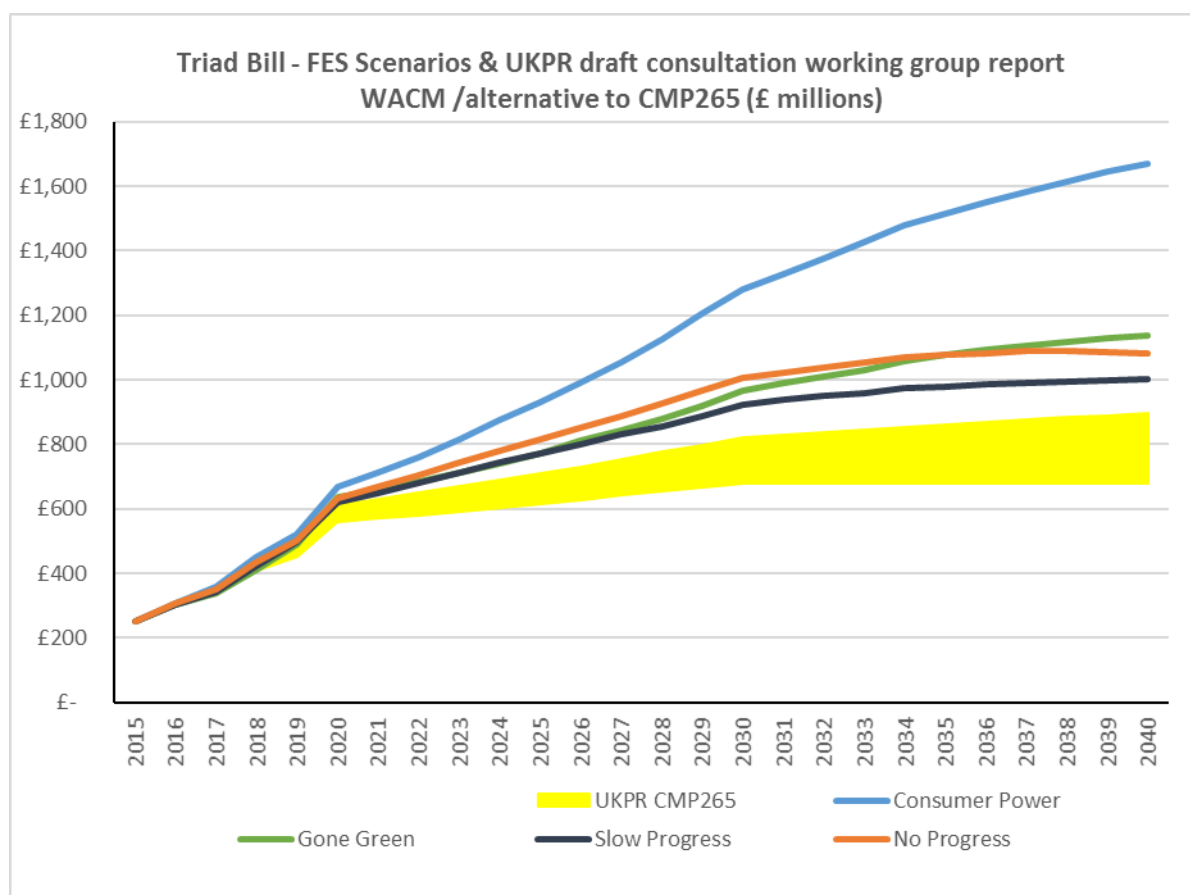

Source:UKPR

The impact assessment is similar to that presented in UKPR's alternative to CMP264 with the addition of the range showing an upper and lower potential triad cost. The upper end of this range assumes newbuild embedded generation still develops over the period albeit at a slower rate than it would under the status quo due. The original proposer and the defect presented was one that requested

urgent attention due to the perceived distortions possible in the up and coming 2016 CM auction. UKPRs alternative is designed to address the proposer's key concerns without introducing the potential for significant unintended consequences in the short-term by discriminating against a large volume of existing and CNDG.

We believe some of the principles referenced in CMP265 have grounds for further consideration given the economics and speed at which certain controllable distribution generation capacity can be developed and built coupled with compounding increases being forecast in the TNUoS demand tariffs for EBs. The factors can contribute to distortions in the CM auctions alongside other factors such as:

- a) The target volume for procurement is going up not down as expected putting upward pressure on clearing prices. This will result in less dependency on EBs and higher levels of cheap capital can be raised to fund building these assets. This is set out in the following document from [DECC](#).
- b) Newbuild controllable DG capacity with low capex or complexity such as diesel generation can be built very quickly and take advantage of earlier T-1 CM auctions and potentially secure the equivalent of 18-year CM revenues. This is something a newbuild CCGT cannot do given the size and scale of projects.
- c) The Demand TNUoS tariff five-year forecast as published in 2016 is increasing rapidly due to macro factors that were not foreseen. This could result in newbuild distribution capacity discounting CM bid prices more significantly than previous CM auctions, distorting the auction outcome to the detriment of existing transmission connected capacity.

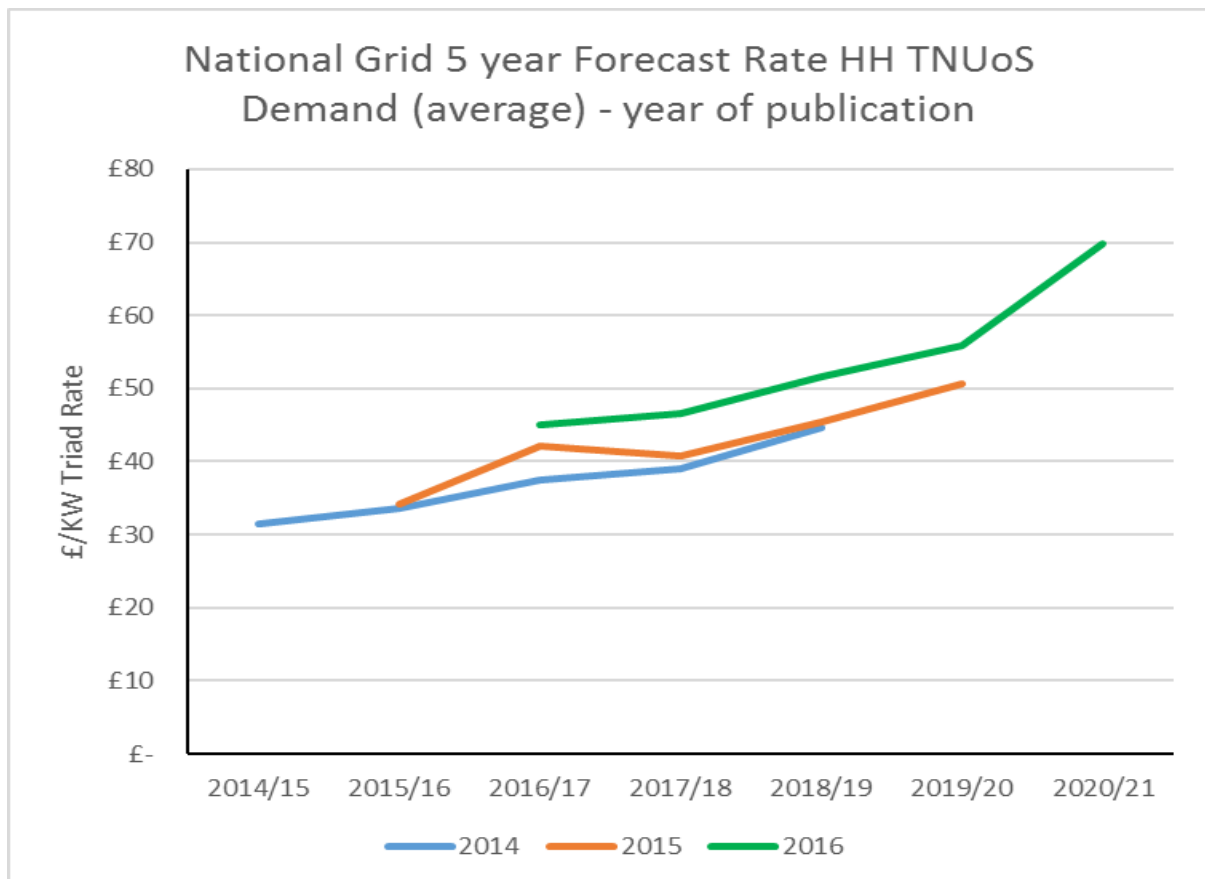

Source: NG

- d) Newbuild controllable DG in the 2016 CM and beyond are adopting proven business models and supply chain economies of scale that have been proven and delivered by the pioneers (or innovators) of the 2014 auction and subsequently the early adopters in the 2015 CM auctions.

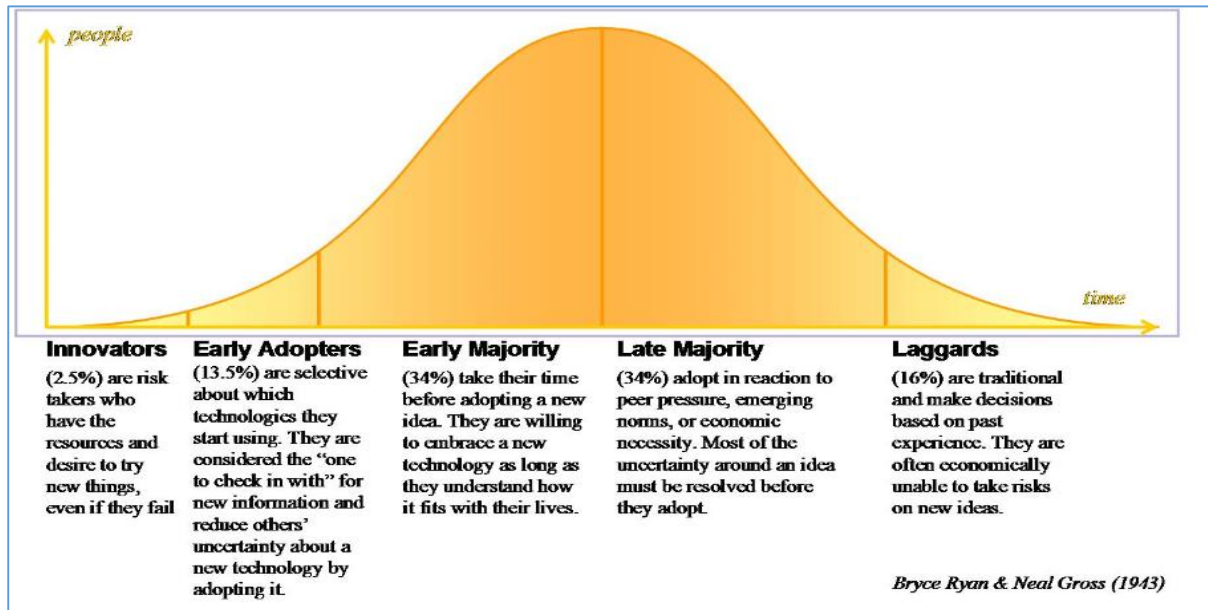

- These pioneers (innovators) have 'done the hard yards' and taken higher risks at greater costs in order to develop
- They have developed and proven concepts through 100% equity investments without CM incomes
- Encouraged lenders/investors into these markets to make the opportunity lendable/bankable
- Set up supply chains and manufacturers

It therefore stands to reason that the early majority entering into the 2016 CM auction and beyond wanting to secure >1year CM agreements are less dependent upon EBs than capacity committed prior to the 2016 CM auction especially when considering the other factors aforementioned.

We believe that a more appropriate mod would be to make future newbuild capacity (any capacity seeking to secure >1year CM obligations or with price maker status) and Demand TNUoS Embedded Benefit mutually exclusive which would (in the short-term) better address the perceived distortion and facilitate the CUSC objectives.

We believe this alternative would make implementation simpler and more accurately address the proposers concerns in the short-term whilst the industry consults further on enduring charging changes.

Question 6: Do you support the proposed implementation approach for CMP265? Are the suggested implementation timescales suggested for CMP265 appropriate / achievable?

We believe the implementation date of 2020 is achievable and appropriately aligned given the up and coming T-4 CM auction secures capacity for the year 2020/21. As per our response to question 5 we believe an alternative proposal better serves the implementation approach as it better facilitates the CUSC objectives.

Question 7: Do you have any other comments for CMP265?

We believe CMP265 original as proposed could significantly increase the CM clearing prices and costs to the end consumer if all embedded generation that wishes to receive EBs is excluded. The timetable for CMP265 for decision ahead of the CM auction is very challenging especially as the majority of existing capacity potentially impacted by this mod’s proposal will have already prequalified with price-taker status. Therefore, this proposal would need to be decided at least 15 working days prior to the auction to enable any price-taker status CMUs to opt out of the auction.

Whilst it is feasible the target volume of the auction could be adjusted by the Secretary of State to account for the embedded capacity that has opted out of the auction there are no obligations or assurances for this specific capacity to remain operational in the delivery year and therefore there is a high risk of under- or over- procurement for the delivery year and the associated impacts this has on the CM clearing price and economics of all participating capacity.

Below is the T-4 2014 & 2015 CM Auction Results summary of all bids/volumes exited in order to determine the clearing price at the target volume:

2014 CM Results

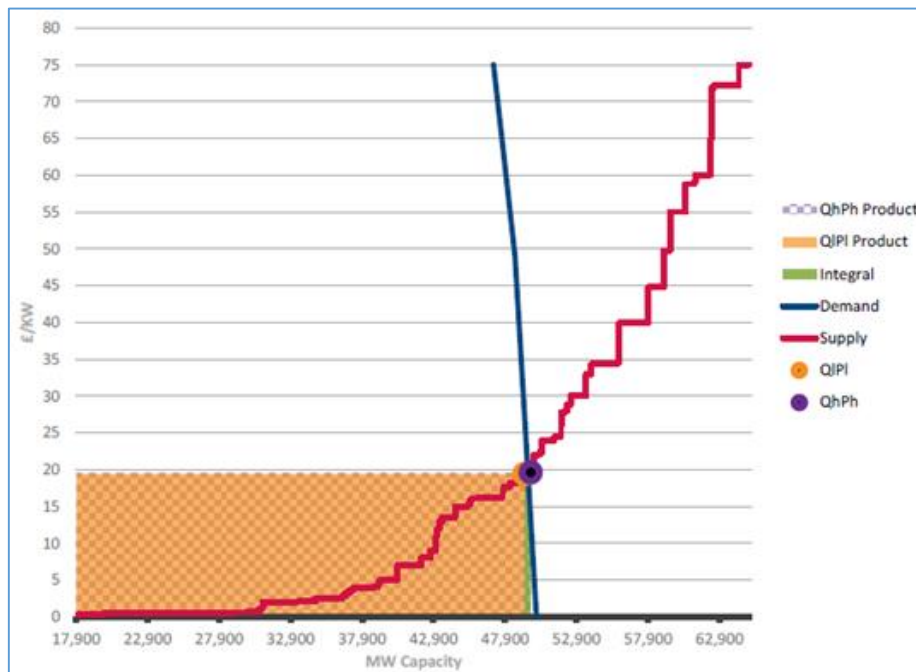

Source: NG

2015 CM Results

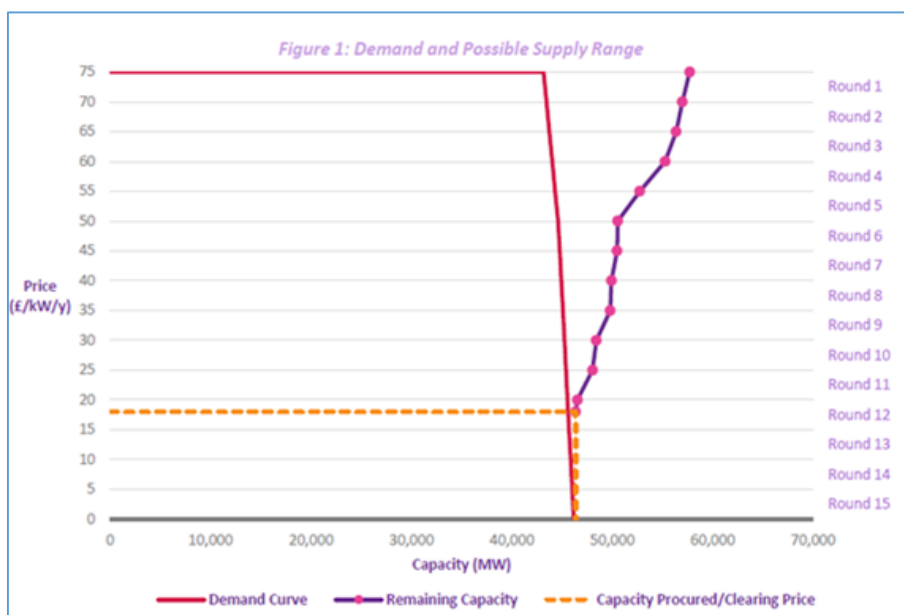

Source: NG

If, for example, removing or increasing the target volume by approximately 7GW (comprising of existing and newbuild embedded capacity impacted by the mod/s) it is possible to see a range of clearing price outcomes of between £9/kW to £55/kW. The low end of the range saves the end consumer some £500m in CM costs (assuming all existing capacity could survive on this outcome which is questionable and therefore this range would likely narrow based on a view taken by participants on likely future results of the T-1 CM auctions). The high end of the range would result in costing the end consumer billions in additional CM costs (please see our analysis in response to Q10 to quantify this assumption when considering the potential cost of replacing the 2014 and 2015 newbuild DG capacity).

In the up and coming 2016 and 2017 CM auctions, an increase in the target volume of 6GW to 53GW has already been set by the government ahead of the 2016 T-4 CM auction to cater for shortfalls from obligations made in previous auctions by transmission connected generation (Trafford Power, West Burton and Cottam), which each took on CM obligations >1year in duration and have since failed to reach their financial commitment milestones. resulting in major distortions in the CM results to date (and arguably already distorting the generation mix landscape out to 2035).

In order to procure an additional several GW of capacity to replace the distribution capacity the auction has a high potential to clear above £65/kW, a price set by the most expensive of newbuild projects which would otherwise not be successful in the auction. A clearing price at this level would likely secure significant volumes of newbuild capacity whilst gifting a windfall to all existing Transmission connected generators with the cost to the end consumer being significantly increased in the delivery year 2020/21 at £3.5bn compared to the previous auction cost of approximately £1bn, a £2.5bn increase.

Furthermore, the end consumer would be landed with a subsequent cost over a further 14 years (through to 2035) for the newbuild capacity awarded in this year's T-4 CM auction (inefficiently set at

the highest priced newbuild project) that would likely equate to approximately £4.9bn over the duration (adjusted for inflation).

On this basis alone we believe the original mod fails to better facilitate the CUSC objectives due to the high level of sensitivity and risk of cost increases levied on the end consumer in the up and coming CM auction.

Question 8: Do you wish to raise a Workgroup Consultation Alternative request for the Workgroup to consider for CMP265? Please see 6.3.

Yes, please refer to separately submitted Workgroup Consultation Alternatives. A summary of each is listed in our response to Q4.

Specific questions for CMP264

Question 10 (i): Do you think a cut-off date for “new embedded generation” of 30 June 2017 is appropriate? What other date would you propose?

We think a cut-off date of the 30th June is a simple concept and aligns to previous cut-off dates made when charging changes have been made as the connection date typically lands close to the commissioning date of new plant coming online. However, the original mod and definition of ‘commissioning’ introduces new consequences and discriminations that need to be addressed, notably the following:

- Newbuild obligations awarded to CNDG are not mandated to commission prior to the proposed cut-off date and therefore relevant exceptions should be made to ensure these assets do not become stranded. This cut-off date does not restrict a certain subset of technology for UNDG as described in our response to question 5 taking advantage of this proposed cut-off date and developing between the 2016 CM prequalification window and 30 June 2017. This would result in projects potentially securing a 15-year CM agreement in the T-4 2016 CM auction and then also being eligible to subsequently qualify for the T-1 for the 2017/18, 2018/19 and 2019/20 delivery years, benefitting from an effective 18-year CM revenue stream whilst also qualifying for continuation of full EBs. Whilst this is a challenge it is surmountable predominantly for diesel fuelled generation capacity due to the lower capex and lower complexity for implementing and commissioning this technology. This cut-off date offers a loop hole for certain technologies that can deploy quickly such as diesel-fired generation given the relatively low lead times to secure this technology from the factory to the site as well as identifying and deploying electricity grid infrastructure or using pre-existing infrastructure such as a pre-existing solar farm distribution grid connection.
- We would advocate an earlier cut-off date to mitigate loop holes being exploited and also ask that the definition of “commissioning” be extended to provide exemptions to Committed Capacity.

Question 10 (ii): Do you have any views on how mixed sites are being addressed in CMP264 Original?

This is a complex area that will undoubtedly require further consideration. Our view is that under this original mod any UNDG as defined under the mod proposal that exports onto the distribution grid at the settlement meter will not receive the ‘net’ EB and therefore certain mixed sites will be captured. There will likely be exceptions to the rule but we would expect further consultation and further mods to be raised to address any outstanding concerns.

Question 10 (iii): Do you think new-build embedded generation capacity that has entered into long-term financial and performance commitment obligations via 2014 and 2015 CM or CfD auctions (prior to this mod's proposal) should be given exceptions to this cut-off date?

Yes. We are the largest newbuild developer of distributed gas generation assets in the UK and have Committed Newbuild Capacity in both the 2014 and 2015 CM auctions. The obligations we secured were at low CM clearing prices as a result of our approach to the CM and EBs being:

- Complementary to core markets/tariffs including EBs, wholesale and ancillary market revenues;
- Certainty of revenues to attract investment and lower overall cost of capital by securing debt to fund the investment case;
- Good value to the end consumer through security of supply and lowering costs of maintaining and operating the transmission system;
- And best Available Technology (BAT) and fit for purpose as we are building efficient, flexible gas fired capacity to support a renewable future. This technology can compete with alternatives such as open and combined cycle gas turbines and pumped storage and will offer an attractive alternative to these mature technologies in meeting the energy trilemma.

The above is important as it should be recognised that the newbuild CM capacity already secured during the 2014 and 2015 CM auctions is the right technology to service the generation mix for the duration of the CM agreements.

UKPR is investing heavily in lean burn gas reciprocating engines that offer robust and sustainable efficiency in a future world where thermal generation will be expected to ramp quickly and frequently to meet the volatility a renewable generation mix brings – especially in the cold dark winter evenings when wind and sunshine either cannot or does not turn up.

When comparing gas technologies, the lean burn gas engine is at least as efficient than a combined cycle gas turbine and outperforms most if not all open cycle gas turbines for frequent ramping and idling operations. NG produced some analysis looking at the carbon intensity of procuring the Short-term Operating Reserve (STOR) service compared to the alternative of keeping CCGTs on standby and this found keeping flexible capacity in reserve lowers the carbon footprint than keeping CCGTs warm or part loaded for system balancing.

The analysis presented by Wartsila highlights the attributes of operating a flexible lean burn gas reciprocating versus a larger CCGT for managing intermittency and clearly shows the benefits of rapid response high efficiency reciprocating units versus larger plant that has longer and slower ramps and therefore inefficiencies for managing intermittency.

Around 1.7GW of newbuild DG capacity has already secured long-term CM obligations as a result of the 2014 and 2015 auctions and this capacity has contributed to lowering the CM clearing price delivering a benefit and cost saving to the end consumer for the duration of these obligations through to 2034. This capacity has achieved this as a result of banking on the EBs value which has been in place since before 2001 and had recently been reviewed as part of Project Transmit by NG. This review was well consulted and concluded in 2014 with no changes proposed. Both KPMG and ADE's recent reports on embedded outline the brief history of the reviews.

Ahead of both the 2014 and 2015 auctions a number of forecasts of the demand TNUoS tariff were published by NG showing upward pressure on rates through to 2018/19 (**2014 5yr forecast**) and 2019/20 (**2015 5yr forecast**) respectively.

Given the expenditure required on the NG Transmission system to connect renewables and meet decarbonisation targets through to the 2030s it was not unreasonable to suggest these forecasts would see further upward pressure. Take for example the **Eastern bootstraps subsea cabling interconnector project** that has been deferred to post 2020 for investment decisions but will likely be required and costs levied through the demand TNUoS methodology.

It is therefore reasonable for Committed Capacity providers to have taken a view that EBs would continue for the lifetime of CM agreements due to value provided to the end consumer and complementary design of the CM framework as cited in the State decision document published by the European Commission.

It is also worth noting that Electricity Market Reform (EMR) was to be the enduring framework to deliver the generation mix fit for the future. The pillars were the CM, CfD, Carbon Price Support (CPS) and the Emissions Performance Standard (EPS) and the period of 2013-2015 saw these pillars move from design to implementation. However, in the short time since the implementation many developments have occurred that arguably change the short – long-term horizon and potential developments in the generation mix, potentially changing the investment risk profile for commitments already made in the previous CM auctions. Examples of significant change are:

New/revised Capacity Products

- Extension of Contingency Balancing Reserve (Supplemental Balancing Reserve and Demand Side Balancing Reserve (DSBR) for 2016/17. Ofgem's announcement is **here**.
- Introduction of new T-1 CM auction for 2017/18 delivery year per **this announcement**.

While demonstrated by the government and Ofgem as being good for the end consumer, these decisions have also changed the generation mix envisaged by the market when it bid into the 2014 and 2015 CM auctions. Through introducing additional frameworks and revenues, capacity that would otherwise have closed may now remain online, potentially undermining anticipated returns from the wholesale market or CMs that would otherwise been realised by newbuild investments.

- Increased 2016 T-4 target volume of 6GW
For a variety of reasons unforeseen at the time of the 2014 and 2015 CM auctions the target volume has been set by the secretary of state to account for undelivered transmission committed capacity that has failed to meet its obligations to date. This has arguably already introduced significant market distortions in the generation mix through to the 2030s.
- T-4 CM Price Duration Curve abandoned

It was widely expected that a price duration curve would be introduced alongside introduction of interconnectors ahead of the 2015 CM auction. The expectation of this introduction will have been factored into 2014 newbuild bid assessments when considering whether to wait and bid into the 2015 or future CM auctions where the longer term element of the clearing price would have been discounted over time. This concept was quickly abandoned during 2015 due to complexity of design and implementation.

- Developing interconnectors framework as set out **here**.

The cap and floor principle and eligibility for new interconnector projects was known in advance of the 2014 CM auction however this was for phase 1 eligibility projects only and since this time

the frameworks and maturity of interconnector projects has developed significantly. There is still uncertainty on the optimal requirement for interconnector capacity and the long-term impacts on the UK home grown generation mix.

New Ancillary Services

- 200MW Enhanced Frequency Response (EFR) Tender for energy storage, as set out [here](#).
- 200MW+ Bilateral Firm Frequency Response (FFR) **bridging contracts**
- Power Responsive Campaign targeting 40% - 50% of ancillary services procurement from Demand Side Response (DSR) by 2020 <http://www.powerresponsive.com/>

These initiatives are all welcomed by the industry in general and some developments such as DSR and increased FFR participation were to be expected. However, NG offering four- year duration EFR auctions/contracts specifically for energy storage was not foreseen for technology investors in the 2014 CM auction. Bringing online flexible capacity outside the EMR frameworks for this technology by 2018 will potentially reduce expected returns from ancillary services and wholesale markets would otherwise been realised by Committed newbuild investments.

Wholesale Market volatility

- Gas and oil prices have experienced historic highs and lows in the space of the last several years through to current day. This level of uncertainty makes forecasting wholesale price returns and spreads very difficult when considering the potential returns for a T-4 newbuild committing to 15 years of commitments.
- The solar industry has grown significantly, especially over the 2014 – 2016 period due to certain subsidy deadlines for >5MW and <5MW ground mounted solar arrays. This incentivised a rush to build and beat deadlines ahead of 31st March 2014, 2015 and 2016. This has seen the UK develop significantly more solar capacity than anticipated. There is now in excess of 10GW of installed solar in the UK and this new capacity is displacing other forms of generation all year round and contributing to downward pressure on the wholesale price as the market adjusts for more generation than was expected in the short-term coming from this technology.

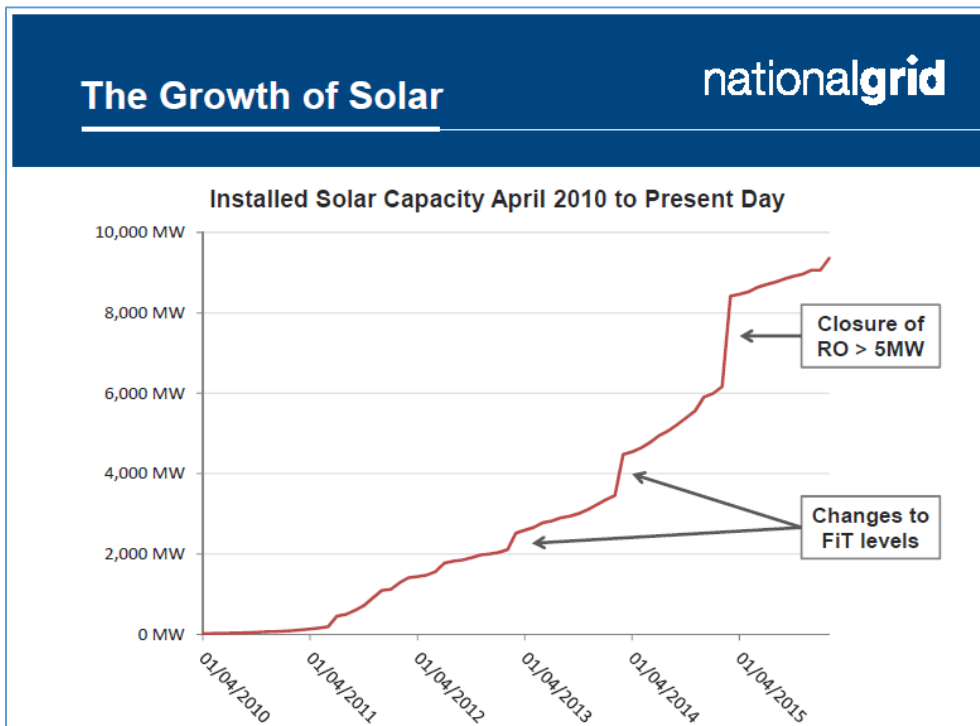

Source: NG

- Cashout Reform is less than one-year old from implementation and has changed the imbalance risks associated with not delivering accurate contracted positions. The introduction of cashout reform presents both an opportunity but also a risk for CM providers as it is fundamentally designed to incentivise more accurate contracting and actions to self-balance, meaning less volatility in the wholesale markets over time. Over the 2015/16 winter the market was predominantly long due to average mild weather and lower commodity costs enabling more gas fired generation. This contributed to the winter peak price being lower than expected.

The above developments highlight additional downward pressure on merchant revenues and contribute to the 'missing money' issue prevailing longer than otherwise would as prices in the wholesale market are continually dampened by new initiatives and schemes that are introduced resulting in scarcity rents not being realised by generators as they otherwise would have been. Cost Reflectivity, Competition and Value to the End Consumer.

Newbuild DG capacity provides a range of EBs and the new capacity/technology providing these benefits are valuable to the end consumer and the wider energy industry participants. We would draw parallels with EBs received for newbuild thermal flexible capacity and renewable subsidy schemes.

These scheme have seen many recent changes but forms of protection through grandfathering and transitional arrangements have always been sought and implemented to protect investment decisions and deliver the value of these investments to the end consumer. We see many parallels in this consultation and Ofgem's review of EBs in that there are many factors that should indicate investment decisions already made should be protected and future investment decisions yet to make significant commitments may be subject to different tariffs/charges.



Most importantly we believe not providing sufficient protection and exemption will cost the end consumer significantly more in the long run. KPMG's report identified the potential impacts of neglecting 2014 and 2015 newbuild CM assets by ensuring appropriate grandfathering or transitional arrangements and avoiding asset stranding.

We have revisited the baseline analysis in KPMG's report in light of recent decisions and developments ahead of the 2016 T-4 CM auction and the launch of a new T-1 CM delivery year to secure supplies for 2017/18 period against the back drop of tighter margins and failure of new and refurbishing transmission connected plant to meet their 2014 and 2015 CM obligations. Below is analysis we have undertaken to build upon the work already published by KPMG to demonstrate the potential cost to the end consumer should appropriate grandfathering or transitional arrangements not be forthcoming for 2014 and 2015 newbuild commitments already undertaken.

This analysis takes two volume scenarios (low & high) with two different clearing prices (low & high) associated in the following CM auctions:

T-1 2018/19

T-1 2019/20

T-1 2020/21

T-4 2021/22 (one-year CM cost impacts and subsequent 14-year for replacement newbuild CM costs)

The low to high clearing prices used were derived from the Supplemental Balancing Reserve tender results as published for the 2016/17 year as this was deemed the most likely capacity to form the replacement capacity and the reflected prices that would be paid to the T-1 clearing volumes.

The low to high target volumes were derived using the replacement capacity required being a calculation of the original T-1 target + replacement capacity for newbuilds (distributed CMUs) – Transitional Arrangements capacity participating (+ replacement capacity for the newbuild (transmission CMU)). The lower T-1 volume requirement presented a lower clearing price whereas the compounding nature of procuring a higher volume would mean a higher clearing price.

The additional comparison is to look at the net savings of the newbuild 2014 and 2015 embedded capacity when aggregating the CM cost and the gross EBs potentially achieved over the duration of the CM obligations.

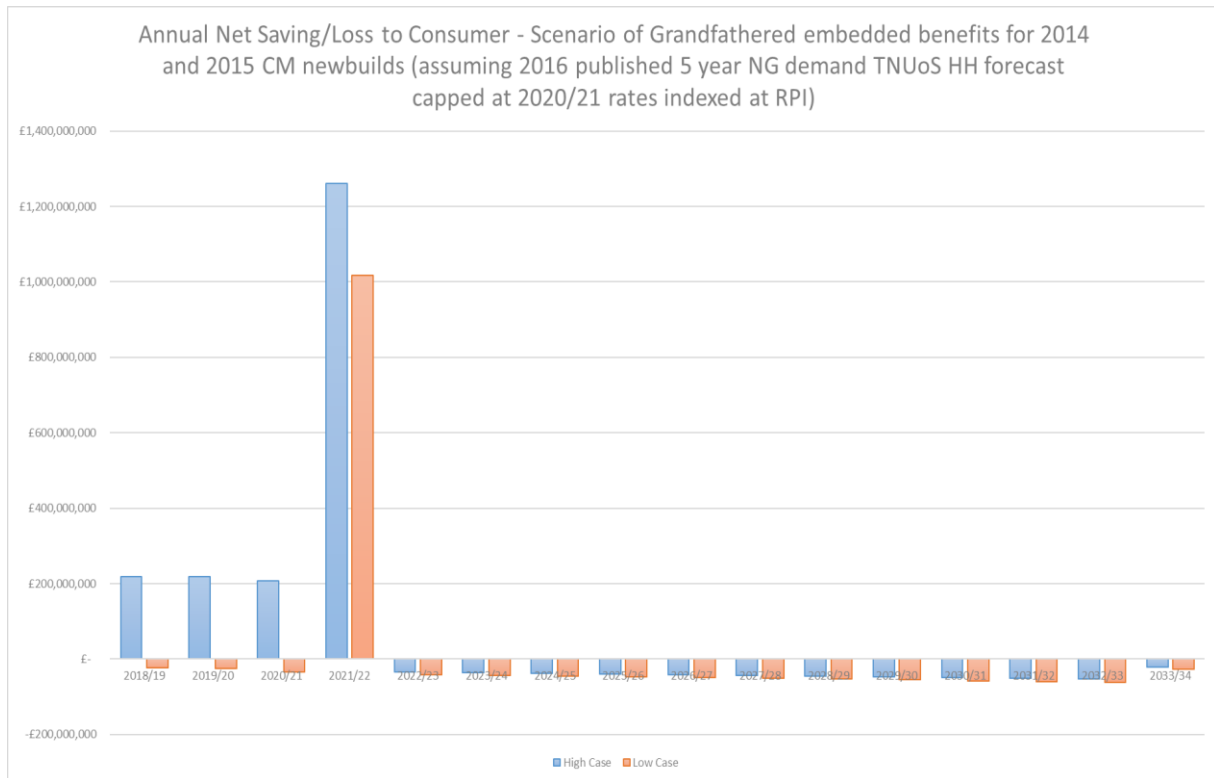

Index Year		
2014 and 2015 Triad rates as is (2020/21 + CPI)		
High Delta (Saving)	£	1,404,349,734
Low Delta (Saving)	£	340,163,408

This analysis shows the range of total saving from low to high is £0.34bn - £1.4bn compared to the costs of the 2014 and 2015 embedded newbuilds when aggregating the CM payments and triad EB over the lifetime of the CM commitments.

The replacement costs could be significantly higher in the short-term due to the lack of supply to meet demand for capacity in the run up to 2021/22 when it is assumed the newbuild replacement capacity from the increased target volume being procured through the T-4 2017 CM auction. This is an important consideration as it frontloads significant replacement expenditure and risks on the end consumer.

If the same analysis is run but caps 2014 and 2015 newbuilds at TNUoS demand rates at 2017/18 levels over the period indexed to RPI (2017/18 rates would be representative of the NG 5 year TNUoS forecast as published at the time of entering into the respective CM auctions) we see the following results:

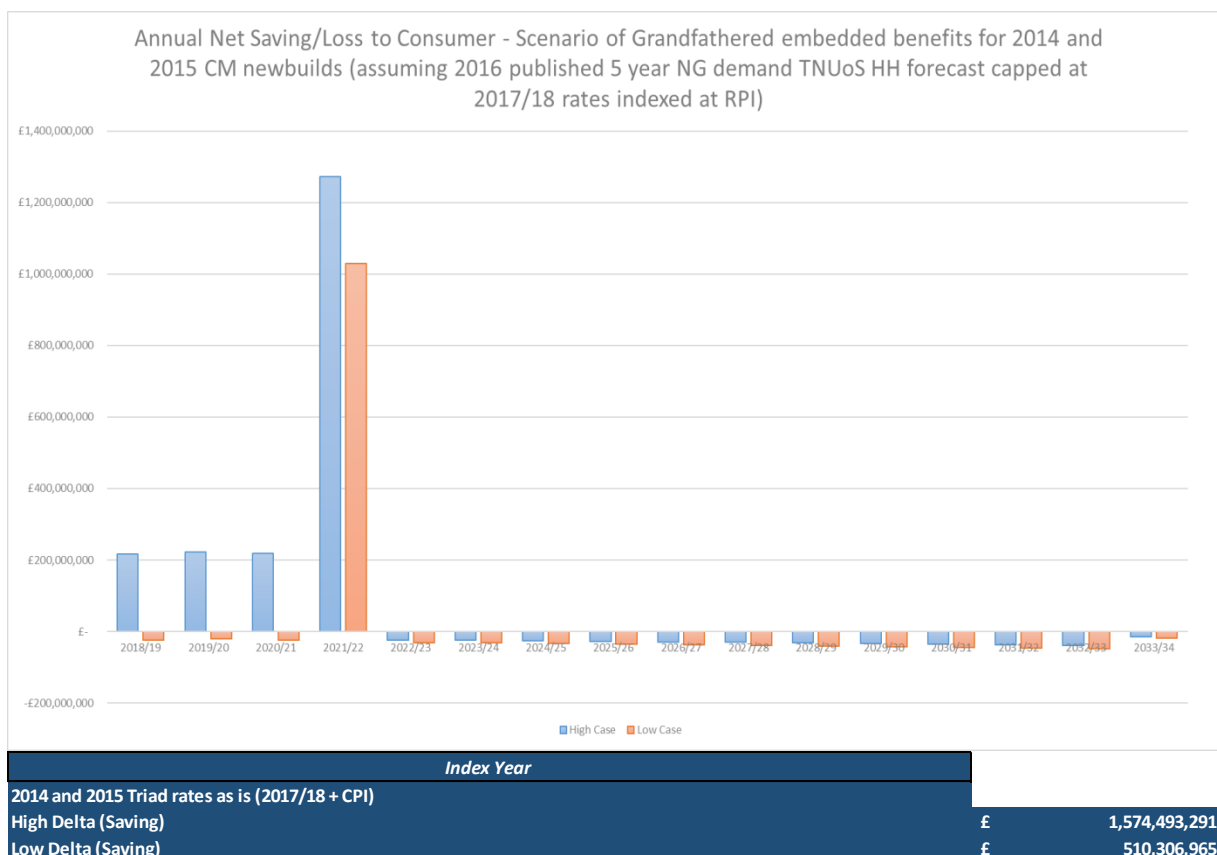

This analysis shows the range of total saving from low to high is £0.51bn-£1.57bn. Again it is important to recognise that high and low case replacement cost frontloads significant replacement expenditure and risks on the end consumer which is not the case when this capacity is delivered from the 2014 and 2015 newbuilds as this cost is evenly spread over the term of the obligations.

Another viewpoint is that the scenario of replacing the newbuilds places much higher risk on the end consumer and less risk on the replacement capacity providers as they enter into firm capacity market arrangements whereas the 2014 and 2015 newbuilds still have to deliver a service to receive the triad benefits through to the 2030s and this is by no means guaranteed to be achieved even with the certainty of rates being available. This puts more risks on the newbuild 2014 and 2015 capacity providers and less risks on the end consumer than in either replacement scenario.

Question 10 (iv): Do you agree that ignoring demand behind the meter is unlikely to create a significant “loophole” or material discrimination risk in relation to the CMP264 arrangements in the short-term.

We do not agree. There is a material amount of capacity that participates in the ancillary service market and CMs that could potentially exploit a significant loophole and therefore risk material discrimination in relation to the CMP264 arrangements. This can be assessed in two categories;

Existing CM and Ancillary Services behind the meter capacity

By measuring the secured categories of CMUs across the auction results to date provides an indicative volume of existing capacity that could inform whether or not this is significant;

T-4 2015 proven DSR = 7.96 MW (2 CMU)
T-4 2015 unproven DSR = 448.5MW (21 CMU)
TA 2015 proven DSR (New & Existing) = 327.9 MW (21 CMU)
(TA 2015 Proven DSR New Build Only) = 12.8 MW (2 CMU)
(TA 2015 Proven DSR Existing Generating Only) = 315.2 MW (19 CMU)
TA 2015 unproven DSR = 551.5 MW (36 CMU)
Total = 1336 MW (80 CMU)

Newbuild CM and Ancillary Services behind the meter capacity

There are a number of large utilities and smaller aggregators now specialising in developing, selling, installing and operating standby generation specifically designed to sit behind the meter and operate for wholesale, capacity and ancillary market revenues. This type of generation can still scale quickly and participate in the up and coming CM auctions. This capacity can prequalify as either unproven DSR or newbuild generation CMUs and only once CM prequalification results are published in the coming month will we have a better idea of its materiality.

A further source of information is **NG's document** on non-balancing services volumes and expenditure covering the 2015 contracting period which totals contracted DSR volumes at 2634MW with a total cost of £32m for the nine-month reporting period. It should be noted that the report includes generation that is both in front of and behind the meter and therefore the exact breakdown requires further consideration in terms of its materiality.

Question 10 (v): Question to suppliers: Do you consider that the wording of your existing contracts allow you to reflect the changes provided by these mods in a cost reflective manner. For example, these changes will apply to existing PPAs and generators who significantly alter their output (EREC 59).

NA

Question 10 (vi): Do you agree with the definition of commissioned and do you agree that it is appropriate? If you do not agree with the definition or that it is appropriate, please provide alternative definitions and rationale for this definition.

We do not believe the current definition of "commissioned" is appropriate for the reasons set out in our response to 10 (i). The definition should exempt all assets that have already made significant commitments and undertaken obligations such as CM, CfD and CHPs but are likely to commission after the cut-off date. Additionally, any loop hole that can be exploited by a 'oil rush' to secure up and coming CM 2016 T-4 long-term contracts and commission before the cut-off date should be examined closely and considered in either the concept of the cut-off.

Question 13: Do you have a view of whether implementation for the 2017/18 triad season is sufficient to allow changes for:

Question 13 (i): supplier contracts and billing system; and

NA

Question 13 (ii): for other stakeholders?

It depends on the complexity of the mods and the identify/quantity of sites impacted.

Question 18: Do you have a view if EBs are frozen at a non-zero value, what should that value be as a £/kW tariff (2016/17 value is £45.33 / kW)?

We do have a view. It differs for different circumstances. It also depends on whether considerations will be given the triad methodology to determine charges for embedded generators. Firstly, we do not believe any rates should be frozen but instead should be treated as caps that are index linked to RPI.

As the TNUoS rates can increase and decrease a cap is more appropriate should rates decrease in future. We also think there is justification to amend the baseline calculation for determining the EB from triad to average output over the winter weekday peak for 16:30 to 19:30 November to January and 17:00 – 20:00 in February. We believe a combination of the rate and the baseline will address concerns about cost reflectivity, competition and provide better overall value to the end consumer whilst levelling the playing field between technologies to ensure the net triad benefit is levelled.

We believe the current forecasts of demand HH tariffs as published in NG's most recent five- year forecast are unsustainable and will create distortions in the generation mix driven in part by the CM. We also believe adopting a single value tariff erodes that value of the locational signal many investment decisions have been based upon when investing in newbuild capacity, for example distribution generation assets being built in the south of the UK will pay higher costs for land and grid connections than in the north and the current and historic Demand TNUoS tariffs reflect this.

However, when considering adopting a single tariff we recognise there is a trade-off between simplicity and equity. We believe if EBs are frozen at a non-zero value then the following rates and justifications should be considered alongside time limited extensions for sub categories of capacity:

Newbuild committed 2014 and 2015 CM DG capacity (including other newbuild capacity with significant investment commitments) capped at £48.76/kW from 2017/18. This is the average 2018/19 HH TNUoS rate (removing Scottish regions as no newbuild CM newbuilds are listed as being in Scotland) as **was forecast and published by NG** ahead of the 2014 CM Auction. We also firmly believe this cap and the EBs value for this capacity be retained for the duration of the CM agreement to enable a reasonable return on the investment.

Existing DG Capacity (pre 2015 connected) capped at £33.67/kW from 2017/18. This is the average 2014/15 HH TNUoS rate (removing Scottish regions as majority of DG assets are sited in England and Wales) as per link [here](#). We also firmly expect this cap and the EBs value for this capacity be retained until 2025 to allow to enable a reasonable period of transition and to preserve the value of EBs for a period of transition where old coal coming offline and new nuclear and CCGT coming online are yet to materialise.

Newbuild uncommitted DG Capacity (post 2016 connected) We believe the value should be capped closer to £0/kW for UNDG, e.g. capacity entering into this year's T-4 2016 CM auction for delivery years 2020/21 onwards.

- a) Capped demand locational TNUoS at 100% from 2017/18
- b) Capped demand residual TNUoS at 0% from 2017/18

Time Limited Extension for Special Licence Condition C13 generators

We would expect this time limited extension to Scottish generators to expire as per Ofgem's recent decision to extend the C13 Special Condition time limited extension to 2019.

Specific questions for CMP265

Question 11 (i): Views are sought on the implication for mixed sites discussed in 3.4.10.

NA

Question 11 (ii): Views are sought on the preference of categories of CMUs captured by this proposal, please indicate your preference from the following list and reasons:

- All existing and new distribution generation CMUs
- All existing and new distribution generation CMUs and DSR CMUs (proven and unproven)
- All price-maker CMUs
- All newbuild/prospective distribution generation CMUs only (defined as >1year contracts)

We believe all CMUs who are price-taker status are capped at bidding in the CM auction at £25/kW as per the current price taker threshold and therefore are unable to influence the clearing price or distort the CM outcome less so than if this capacity was effectively mandated to opt out as would be the case under the original CMP265 mod. We have provided analysis and reasons as to why we believe CMP265 in its current form would create significantly more distortions and significant cost increases on the end consumer should price taker CMUs be mandated to opt out of the up and coming T-4 CM auction.

Question 14: Do you have a view of whether implementation for the 2020/21 triad season is sufficient to allow changes for i) supplier contracts and billing system, and ii) for other stakeholders?

This should allow adequate time for implementation.

Specific questions for both CMP264 and CMP265

Question 9 (i) Suppliers: In setting charges for your demand customers, do you charge them at the same tariff as NG charges you (i.e. gross), to enable you to pay the EB to embedded generators, or please explain the way in which it is funded?

NA

Question 9 (ii): Suppliers: Does the estimate that 7.58GW of embedded generation output and 2.5GW of demand side reduction at the time of triad for 2016/17 seem reasonable based on your knowledge of the UK market? If not what is your estimate of embedded generator output and DSR at time of triad?

Yes. We believe the analysis undertaken in the Cornwall and KPMG reports provides a robust estimate of the total derated DG capacity that reduces Transmission demand, estimates of demand side reduction are harder to ascertain however NG's estimates of Customer Demand Management (CDM) as published in their electricity operations forum (extract below) reviewing the most recent winter indicates a similar level of participation.

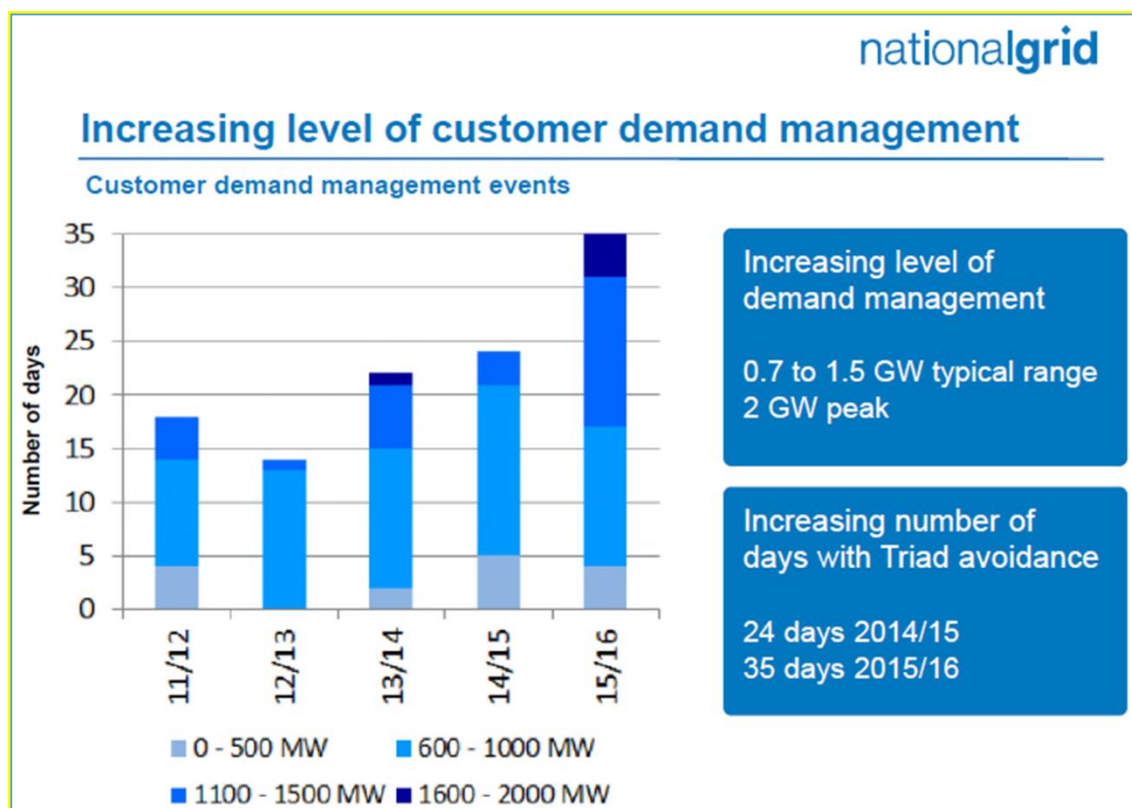

Source: NG

The above analysis shows capacity that operates for triad most infrequently to minimise cost avoidance, such as standby diesels or large expensive turn down management such as steel mills. It is difficult to split out what is embedded generation and customer demand management during the triad season due to much of the capacity operating on different baselines with some operating from 16:00 – 20:00 and running over 300hrs to others operating for 50hrs for example a standby diesel generator as the cost to operate for diesel is higher.

Question 12: Can you identify – either quantitatively or qualitatively - the impact of the demand TNUoS EB on your decisions made in making CM decisions?

Newbuilds

We assumed the 5year NG demand TNUoS regional forecast applicable to each newbuild project as published at that time then escalated rates over the duration of the CM newbuild agreements at RPI. This was factored into our revenue requirements and formed a significant element of bankable revenue to complement the CM agreement and enabled bid pricing to be competitive in securing newbuild obligations and durations. This rates informed our decisions to secure planning, and grid and gas connections and the material expense that goes with each. Our response to Q18 sets out our qualitative views.

Existing and pre refurbishment

As these units are price takers the impact of TNUoS EBs did not feature in our bid price assessment during the 2014 and 2015 CM auctions.

Post refurbishment

Similar to our newbuild assessment as we did take account of the demand TNUoS element over the duration of the investment case when determining our submitted bids into the auction.

Question 15 (i): What are your views on the 2 broad options to enable the reporting of gross export metered data?

NA

Question 15 (ii) Would you have the data available required for Option B (both CMP264 and CMP265) for both new contracts and existing contracts where a customer may be partially exempt?

UKPR as a party would be capable of providing the required data although we have identified as part of the BSC working group that for complex sites the availability of this data might be lacking and that it would additionally potentially create scope for loop holes that would need to be identified and addressed prior to implementation.

Question 15 (iii) Do you believe you can implement the proposed changes by the respective implementation dates?

Yes.

Question 15 (iv) What are the pros and cons of the 2 proposals that ELEXON are considering to implement this (P348 for CMP265/ P349 for CMP264)?

We believe that the earlier implementation dates that the BSC work groups has identified may be more difficult, however it should be considered that the payments associated for CMP264 will not be due or calculated until June 2018 despite a June 2017 cut-off date and therefore thoughtful consideration is required on each modifications to determine what is realistically achievable given the issue at identified.

Question 16: Do you have any further evidence / comments on the consumer impact of changing the demand TNUoS EB in either the short-run or long-run?

Security of Supply

Yes, we believe that there is a high risk to continuity of supply in the short, medium and long-term should appropriate confirmation/commitment on transitional arrangements/grandfathering for newbuild distribution assets that have undertaken significant financial commitments to date. Further to the evidence and impacts already presented as part of this response we believe that an increase in Transmission Net Demand may result in energy unserved from Transmission connected generation and lead to a loss of continuity of supply.

The cost of this to UK Plc could be significant, especially if this is not a one-off. We are entering a period of tightening margins and embedded generation plays a vital role in keeping the lights on – something we in the UK have all enjoyed in having a first class robust energy supply with well-maintained networks providing best in class security of supply. Below is a recently published graph of Winter historic NISMs as published by NG.

Winter NISM breakdown

	Nov	Dec	Jan	Feb	Mar	Total
2016						
2015	1					1
2014						
2013						
2012				1		1
2011						
2010						
2009			1			1
2008	1	1			1	3
2007	3					3
2006					1	1
2005	2	1		2	2	7
2004						
No. of NISM	6	2	1	3	4	17

Source: NG

Shortly after the **November 2015 NISM NG** were called in by the Environment and Climate Change Select Committee (ECCC) to provide oral evidence on security of supply following the 05th November NISM which saw some parties commanding £2,500/MWh in the balancing markets. The reality is this price was actually on a very small volume but it is perhaps a sign of things to come in the short-term. **In the oral evidence NG** stated that should the winter present an average cold spell then NG expected a further 10 NISMs during the 2015/16 winter.

As it stands no further NISMs were issued, partly as a result of the mildest winter on record and partly because on the odd few days there were cold snaps, there was high wind generation meaning margins were not as tight as they could have been.

It is estimated that there is around 7.5GW of embedded generation output at the time of system peak, and 2.5GW of demand side reduction (either onsite generation or demand reduction; both seen as a reduction at the consumer's meter). Without embedded generation and demand side reduction the system peak would be higher at around 59GW. Although the system has previously operated at a peak around this level (only seen in 2005/06), it would place an increasing constraint on the transmission plant margin if the embedded generation and DSR did not operate at peak. Below is a chart showing average historic UK demand peak over the triad since 1990/91 to current day.

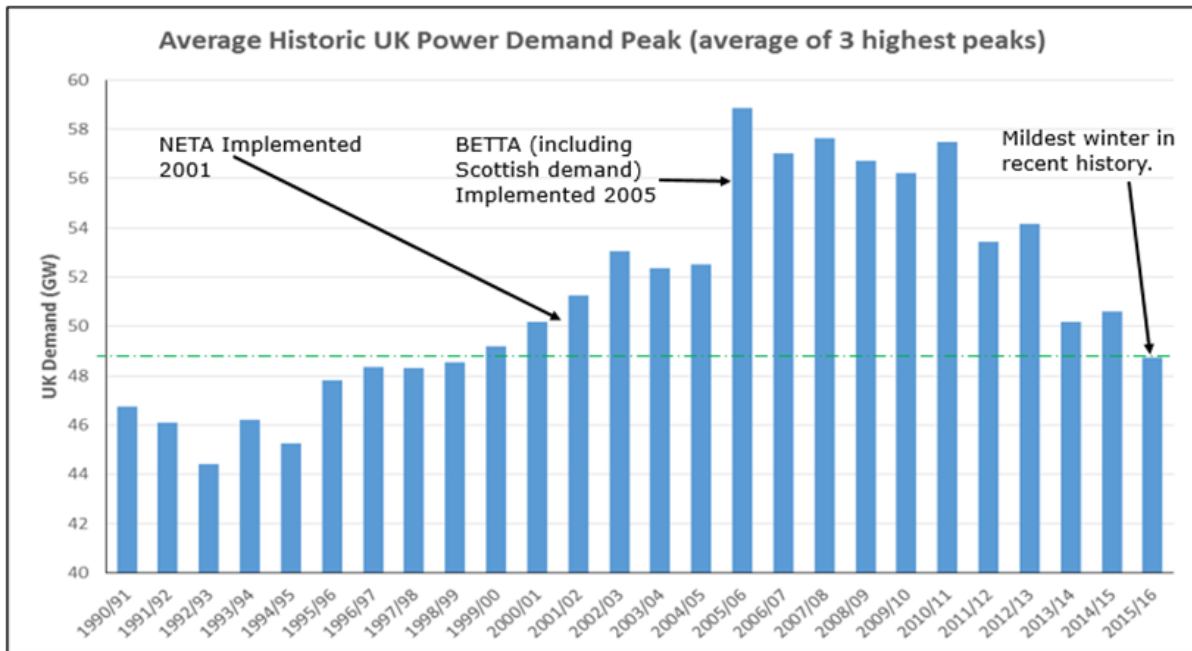

Source: KPMG Report, May 2016: 'The effects of changes to EB on the Energy Trilemma'

The highest number of winter NISMs (7) recorded was in 2005 which was also when Transmission net demand was much higher, this is 3 less than what could be expected in the current market conditions if the UK experiences an average cold spell winter. Given the current state of the large thermal generation fleet and margins are getting very tight, the contribution to security of supply of the 10.5GW of DG and DSR is significant. With an additional 1.7GW of newbuild capacity secured and due to be delivered in the 2016-2018 period, this capacity could be invaluable to ensuring the UK maintains its gold standard in reliability at a reasonable cost to the end consumer.

Should EBs be removed quickly for existing distribution generation capacity we could see Transmission net demand increase significantly as well as the potential use of NISMs. It is a risk that requires proper assessment when determining whether the Transmission network and the Transmission generation fleet as it stands can deliver the reliability the end consumer has become accustomed to. Below is a graph adjusted to show the potential impact on Transmission net demand should EBs be removed from existing the newbuild DG by 2020:

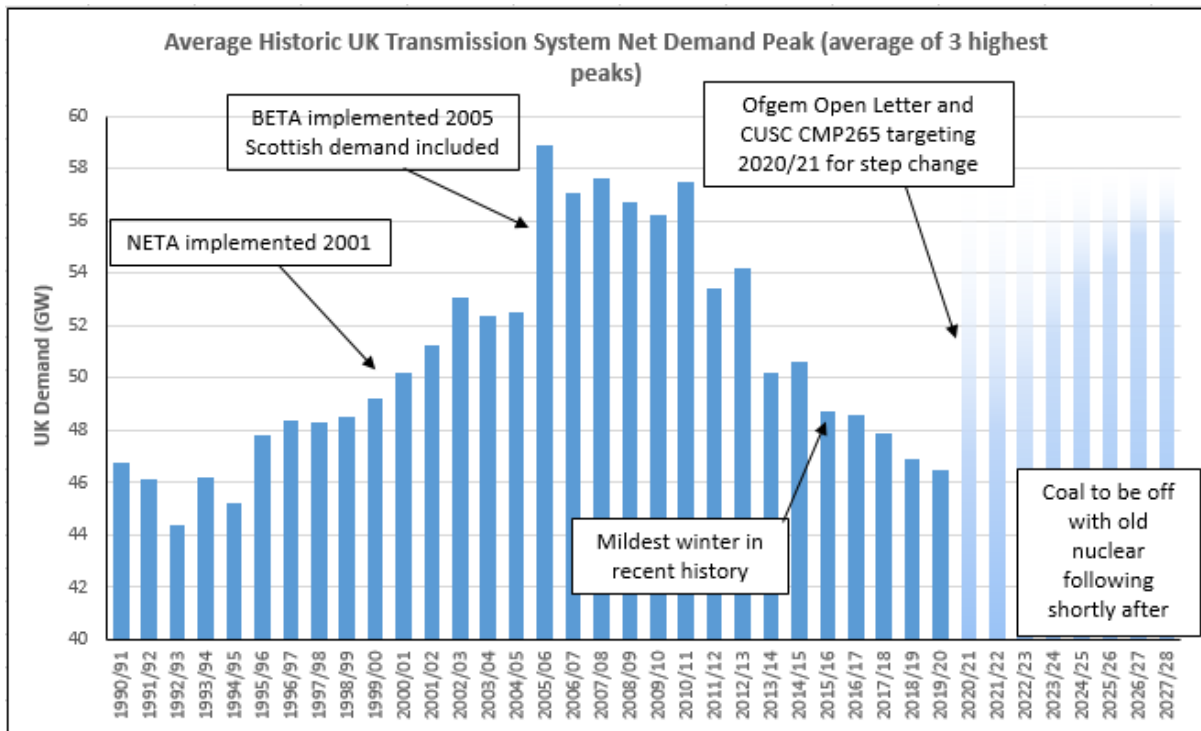

Source: UKPR forecast range of Transmission System Net Demand Peak

The stark reality is NISMs and CM stress events could become a very frequent occurrence and this notification/warning to the market will incentivise a subset of the embedded generation to generate and counteract increasing transmission system demand. The forecast above should not see the high end of the range but it does however demonstrate that the market has to function very well and also have the right type of capacity to deliver security of supply.

Any removal of EBs for near term committed capacity has to be considered carefully and we believe a gradual transition is better for all rather than a cliff edge with potential for significant unintended consequences. Our view is that a transitional arrangement for existing DG over the 2020s represents better overall value for the end consumer than the direction given recently in Ofgem’s open letter that references 2019/20 as a potential cut-off point.

Cost reflectivity and level playing field for the consumer and embedded generators

Part of the distortions and focus of the CUSC mods CMP264 and CMP265 is due to the recent increase in newbuild capacity at distribution level. The majority of this capacity is diesel- or gas- fired generation. The underlying business model in both these technologies is reliant upon the Triad benefit, however it is not fair to say both receive the same net triad benefit nor that both need the same level of triad to make the investment case work.

Diesel generation is much cheaper and quicker to build and the idle operational costs are far lower, however the fuel is expensive when compared to mains gas. Gas fired generation is more capital intensive for the generation equipment and the gas connections plus the idling costs are much higher coupled with the gas pipe availability charges (transportation charges) however the variable costs for fuel are lower. Diesel generation tends to lean heavily on capacity based products and rent returns

plus triad income whereas Gas generation needs to earn scarcity rents from the energy markets in order to make a return in addition to triad.

Below is analysis published recently by Aurora Energy Research on the potential returns of these technologies based on their view of the business models deployed:

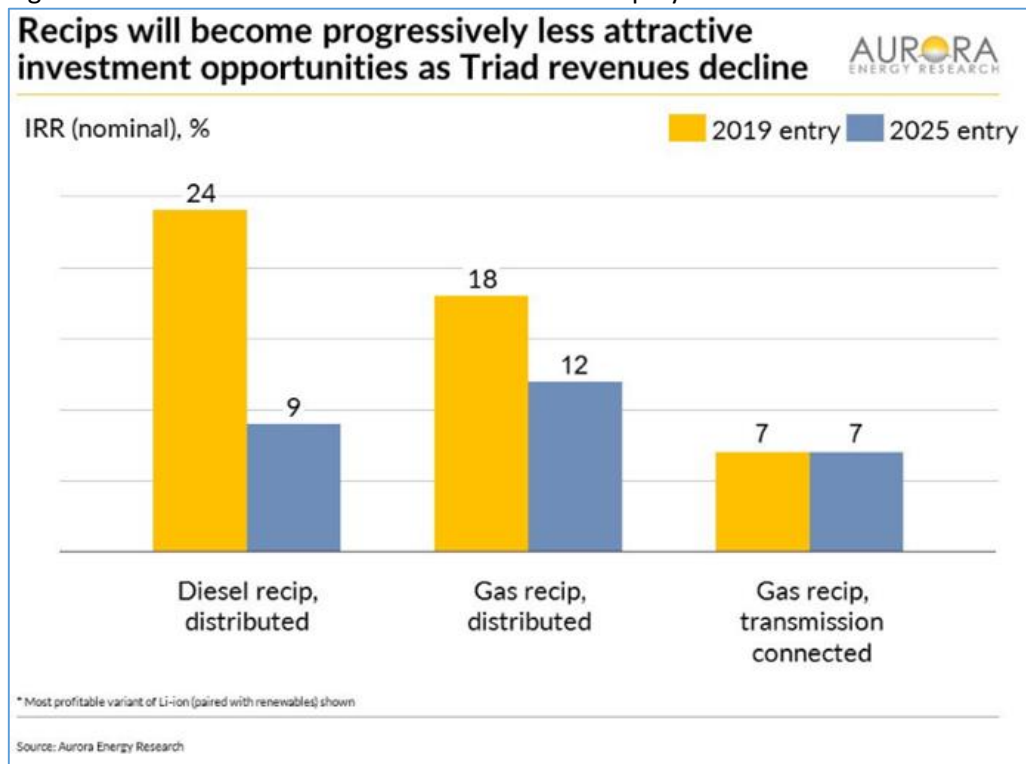

Source: Aurora Energy Research

This analysis predicts triads will become more expensive to target for diesel technologies when entering in 2025 compared to 2019 due to the triad moving away from the traditional 5pm – 6pm evening peak period. This results in higher variable costs on both gas and diesel embedded generators and reduces the net triad benefit and lowers returns from this EB.

Below is analysis showing the net triad benefit across these technologies when taking into consideration the variable run costs (= fuel + O&M + Carbon – sales of energy) of securing the triad year on year, this analysis has been run on four types of embedded technology, gas recip, diesel recip, diesel recip (non EUETS) and gas CHP recip. We have taken the outturn half hourly wholesale peak prices from winter 2015/16 as reasonable proxy for the sales of energy).

The reason we have included a diesel recip and a variant of diesel recip (non EUETS) is due to the rise of merchant diesel plants funded through long-term contracts such as the CM newbuilds and through Demand Side Response (or behind the meter diesel) or the large embedded diesel arrays, both types use small individual diesel generators (below 3MW thermal rated) aggregated however due to the low thermal rating of each generator are not mandated under Greenhouse Gas emissions (GHG) regulations and EUETS to hold a permit nor report carbon emissions. This presents an economic advantage as these facilities are exposed to lower carbon costs than EUETS permitted facilities. Please

see the analysis of net Triad benefit mapped against three different run hour assumptions to operate for all three triad peaks in each year:

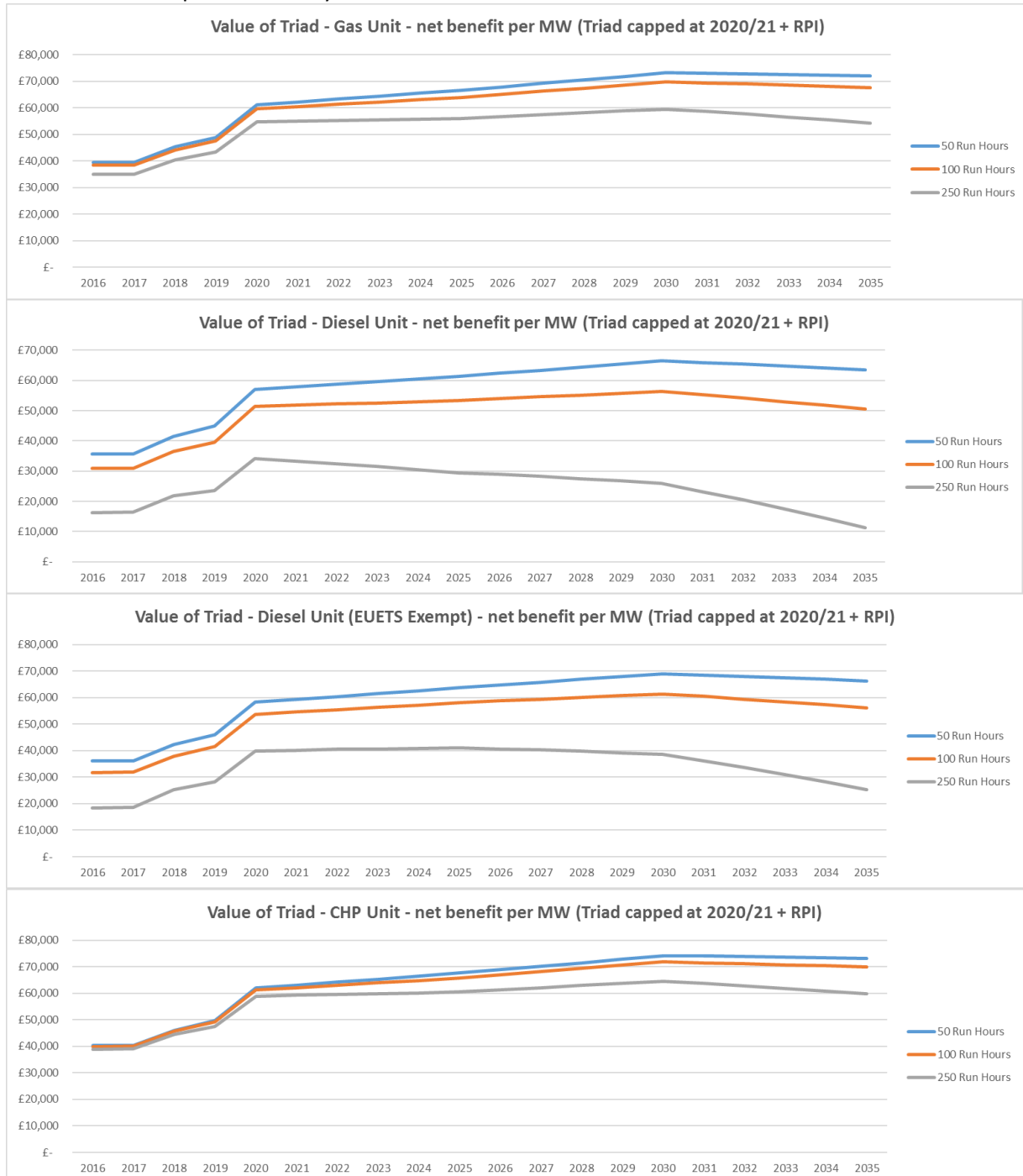

Source: UKPR

As you can see from the analysis, when operating for between 50 – 100 run hours the net triad benefit retention is high across all technologies due to lower overall running costs and higher than average energy sales covering the core peaks. The most recent winter indicated that the number of Triad warnings has increased to equate to between 40 – 60 hours of operation to triad manage (please see

our response to Q9(ii)) with NG indicating approximately 35 triad management events during winter 2015/16 (up from 24 events in 2014/15). Due to the Demand TNUoS five-year forecast increasing significantly by 2020/21 the net triad benefit also increases significantly.

All technologies see a lower net benefit over the 250 hours of operation due to the lower average wholesale price achieved eroding the spread against a baseline of increasing costs (carbon). Diesel's net benefit is impacted most out of the technologies when considering the number of triad management events increases significantly to require 250 hours of operations whereas CHP is impacted the least due to the ability of CHP to command a higher premium for its output than other technologies (additional sales/use of heat/CO2/steam). For example, in order to equate to 250 hours of operation, a unit would need to run between 16:30 – 19:30 every winter weekday between November and February (within the traditional triad season).

We have run the same analysis but assuming the demand TNUoS rate is capped at the forecast 2017/18 rates as currently published in NGs latest 5year forecast (index linked to RPI):

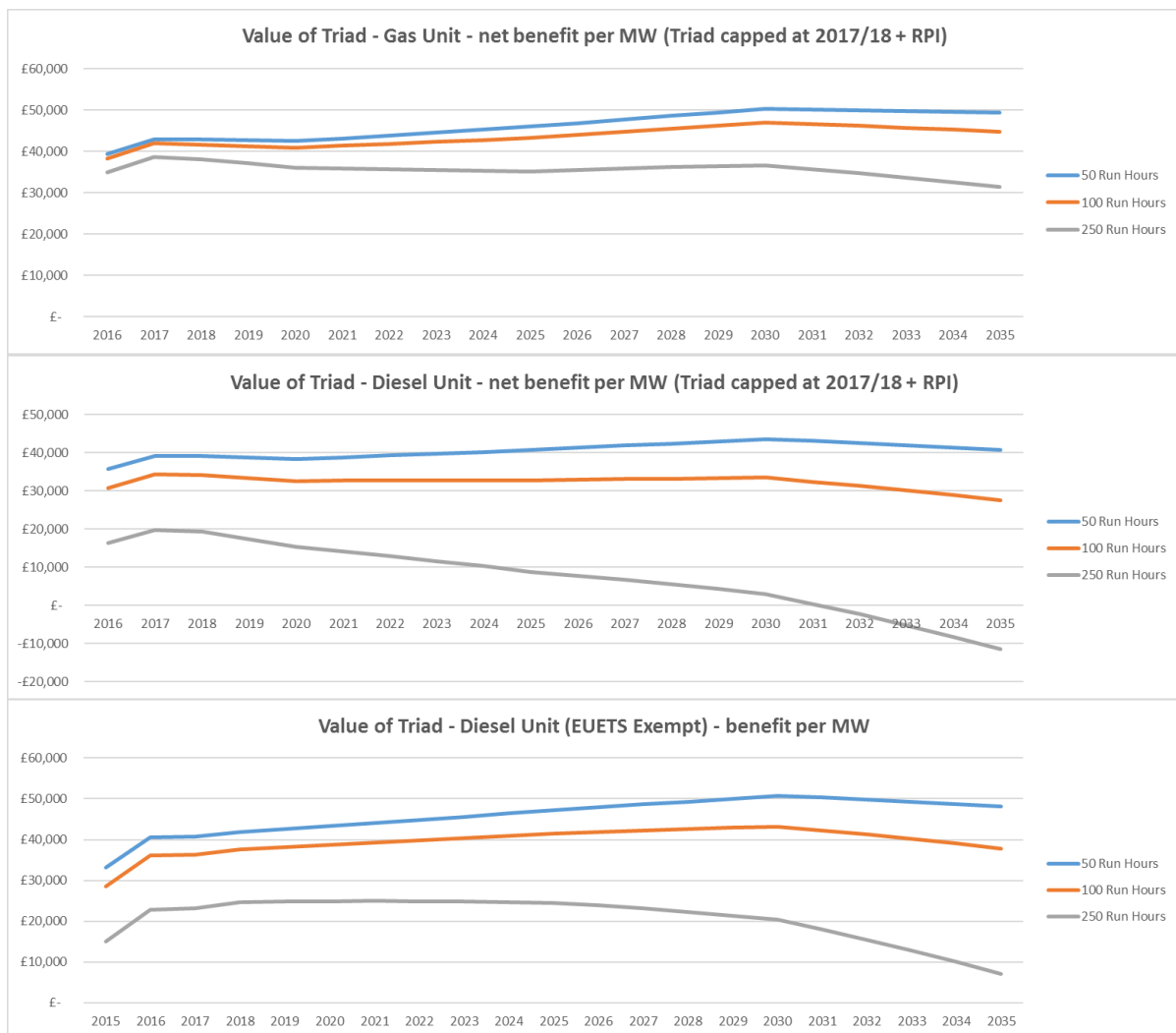

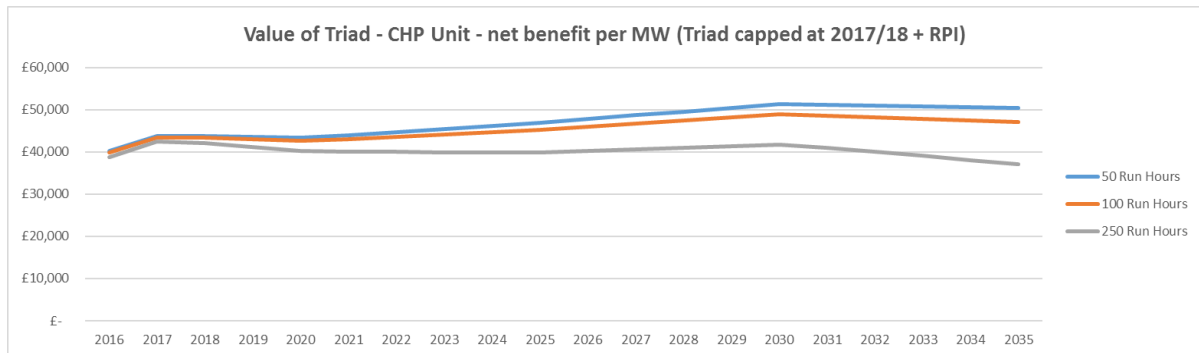

Source: UKPR

As can be seen from this analysis the new Triad rate cap combined with high run hours and associated costs reduces the net Triad benefit sooner and over the period with higher carbon costs gradually eroding the net margin. Again diesel sees the largest net benefit decrease due to higher fuel and carbon costs to maintain the Triad benefit. The analysis presented above is likely over optimistic on the forecast wholesale energy price. With offshore wind, new nuclear, new CCGT, energy storage and other renewable technologies entering the market over the period coupled with a recognition from government that capacity market prices need to increase it is more likely to result in downward pressure on the wholesale electricity price that counters any increases seen through Carbon Price Support being passed through the wholesale prices. In this scenario we reduce the wholesale peak energy price by RPI which results in the following net Triad benefit;

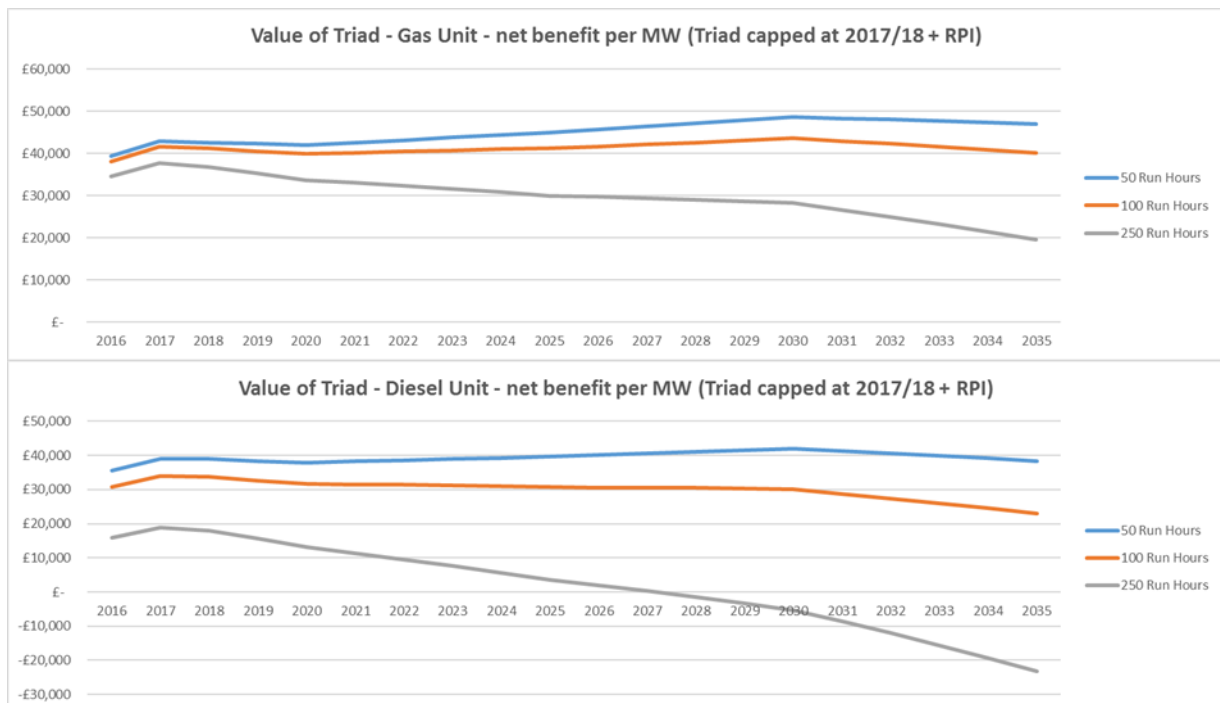

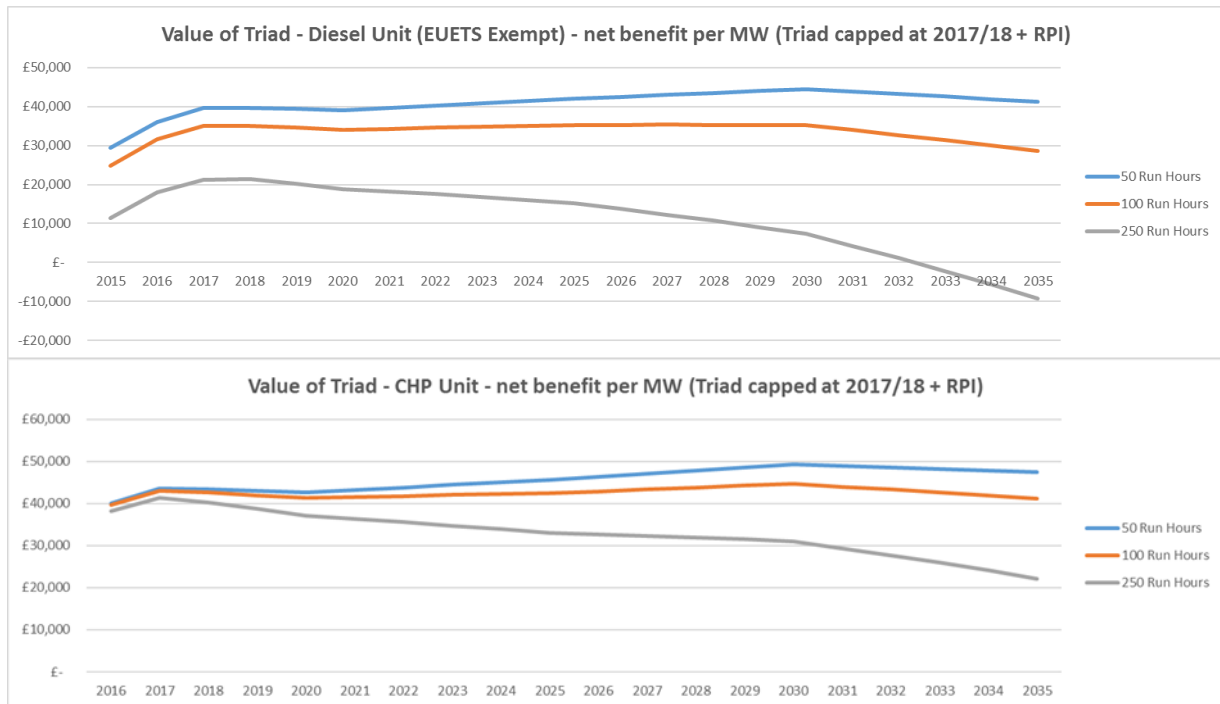

Source:UKPR

This analysis is useful when considering both the cost reflective nature of charging and the playing field for technologies within the Triad framework. The CUSC working group has already seen a number of different proposals on alternative caps and/or TNUoS demand rates. The reality is the Demand TNUoS rate is only one aspect of the framework and other considerations are required including the volume methodology and the technology operating for the EB and also the locational signal (regional rates v single uniform rates as some have proposed).

This analysis supports the Aurora Energy Research assumption that diesel recip investments enjoy higher Internal Rate of Return (IRR) than other technologies when assuming capacity payments and EBs such as triad in a low run hours operating world. More recently as indicated in by NG in ancillary service market reports for Firm Frequency Response, modern diesel technologies can be configured to ramp very quickly (within 30 seconds) and can also qualify for static FFR services that are paid an availability/rental fee 24/7/365 and are expected to only be called into action between 6 – 12 hours per annum. Diesel has lower capital and operational expenditure in almost all respects with the exception of fuel cost. This investment model means the vast majority of revenues are capacity/availability based and therefore favour this technology and present strong IRRs over other technologies such as gas, making the diesel investment case very hard to ignore.

We recognise this is an area that will be further analysed in Ofgem’s review of EBs to consider whether overcompensation is an issue, and with a view to promoting competition. We also recognise DEFRA is about to launch a consultation looking at emissions standards for sub 50MW thermal generation (mainly targeted at liquid fuels) to reduce the potential for investors to “pollute for profit” in future at the expense of the end consumer.

We also recognise that diesel generation does and always has played an important and strategic role in the UK generation mix. This technology is effectively cheap energy storage and is used very little but importantly it does provide for the 1 in 365 event over the coldest winter night to ensure security of supply. This does present benefits for the end consumer as it cheap, reliable and effective. There is however a limit on the volume of this type of capacity before it tips the balance in the overall generation mix and displaces more suitable or economic technologies that present best available technology for operating over longer periods.

The 2014 and 2015 CM auctions have secured upward of 1GW of newbuild liquid- fuelled embedded generation and this technology will bring significant benefits to the end consumer in the short-term in the form of security of supply. We believe a change to the baseline methodology to revise the triad to a 4:30pm – 7:30pm winter baseline to determine the Triad EB for embedded generators should be considered as this better reflects costs and levels the playing field when considering the net triad benefit across different embedded technologies. It will also help security of supply and potentially avoid NISMs as was experienced on 4th November 2015 (as this period would have been covered by the new baseline triad meaning higher margins and far less chance of NISMs). When determining the most appropriate winter baseline other impacts have to be considered and balanced against the objective of cost reflectivity, one consideration is the export of solar over the winter peaks. Below is the estimated output of solar embedded generation over the winter 2015/16 triad season:

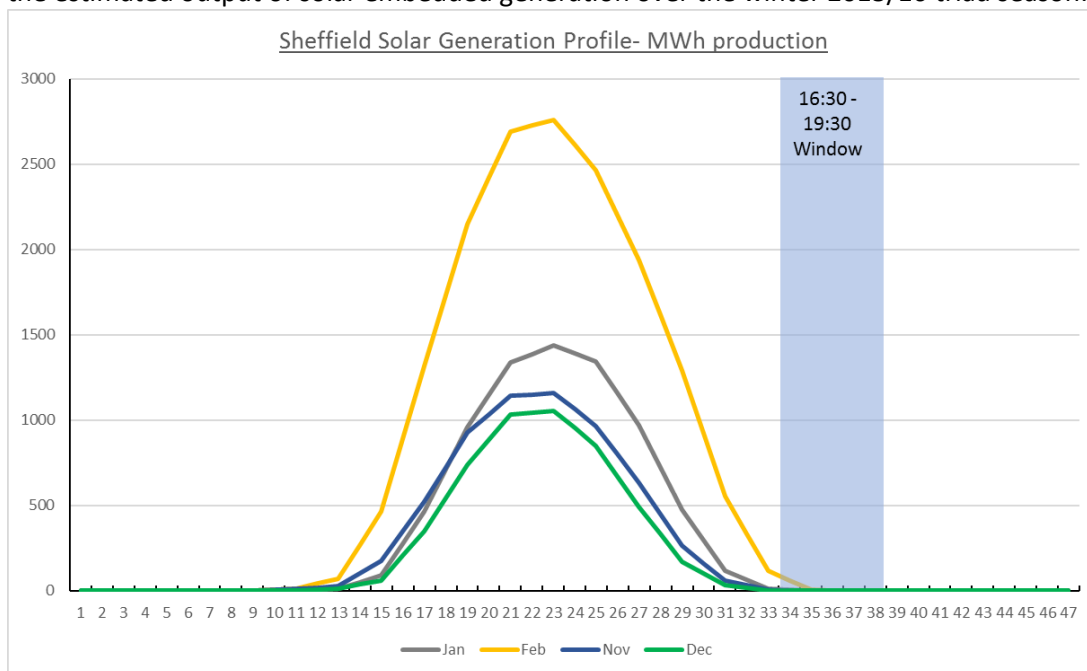

Source: Sheffield Solar/NG

As can be seen from the above solar does deliver some export volume over the 16:30 – 19:30 peak during the winter months. Should a change in the baseline methodology to calculate the Demand TNUoS allocation to avoid compensating solar embedded generation (which currently does not operate over the triad as its usually at the darkness peak) then the following times would be required:

- November 16:30 – 19:30
- December 16:30 – 19:30
- January 16:30 – 19:30
- February 17:00 – 20:00

Principles of investor confidence and lowering cost of capital to the benefit of the end consumer

Changes to the regime for EB will have a detrimental effect on investors already holding obligations under the CM and have made significant commitments to meet these obligations. Any changes that negatively impact the newbuild CM obligations clearly have the ability to raise uncertainty, reducing the appetite for investment in the sector with an associated increase in the cost of capital and a reduction in competition – costs that will, in the end, be passed on to the consumer.

There are many parallels that can be made between EBs for CM embedded generators and principles adopted and implemented through renewable subsidy schemes such as Feed in Tariffs (FiTs). Where significant commitments to investments have been made, any subsequent changes associated with rates or bandings have been offered some form of grandfathering or transitional arrangements in order to maintain investor confidence and protect competition for the benefit of the end consumer.

Whilst we recognise this concern may sit outside the objectives of the CUSC when considering the mods, this aspect is something Ofgem should consider.

Question 17: Do you feel that both the locational and residual component of the demand TNUoS should be removed as an EB (as CMP264 Original) or just the residual component (as CMP265 Original) or some other method?

We do not believe either should be removed for existing or CNDG. We believe for UNDG the residual component of the demand TNUoS should be removed, therefore preserving a locational signal for future investment in capacity. *Please see our response to Q18.*

Question 19: Regarding the proposed alternatives what are your views on the suggested implementation dates? Are these achievable? Please give reasons for your view.

We believe that if the alternatives adopt an approach where UNDG does not receive the demand residual or indeed any demand TNUoS EB going forward but no later than 2020/21 then time can be afforded to consult and implement over the coming period to ensure the CUSC objectives are met whilst also enabling Ofgem to fulfil their wider obligations and commitments to the energy sector.

CUSC Workgroup Consultation Response Proforma

CMP264 'Embedded Generation Triad Avoidance Standstill' and **CMP265** 'Gross charging of TNUoS for HH demand where Embedded Generation is in the Capacity Market'

Industry parties are invited to respond to this consultation expressing their views and supplying the rationale for those views, particularly in respect of any specific questions detailed below.

Please send your responses by **24th August 2016** to cusc.team@nationalgrid.com Please note that any responses received after the deadline or sent to a different email address may not receive due consideration by the Workgroup.

Any queries on the content of the consultation should be addressed to Caroline Wright at caroline.wright@nationalgrid.com

These responses will be considered by the Workgroup at its next meeting at which members will also consider any Workgroup Consultation Alternative Requests. Where appropriate, the Workgroup will record your response and its consideration of it within the final Workgroup Report which is submitted to the CUSC Modifications Panel.

Respondent:	<i>Guy Phillips</i>
Company Name:	<i>Uniper UK</i>
<p>Please express your views regarding the Workgroup Consultation, including rationale.</p> <p>(Please include any issues, suggestions or queries)</p>	<p>For reference, the Applicable CUSC objectives are:</p> <p>Use of System Charging Methodology</p> <p>(a) that compliance with the use of system charging methodology facilitates effective competition in the generation and supply of electricity and (so far as is consistent therewith) facilitates competition in the sale, distribution and purchase of electricity;</p> <p>(b) that compliance with the use of system charging methodology results in charges which reflect, as far as is reasonably practicable, the costs (excluding any payments between transmission licensees which are made under and in accordance with the STC) incurred by transmission licensees in their transmission businesses and which are compatible with standard condition C26 (Requirements of a connect and manage connection);</p> <p>(c) that, so far as is consistent with sub-paragraphs (a) and (b), the use of system charging methodology, as far as is reasonably practicable, properly takes account of the developments in transmission licensees' transmission</p>

	<p>businesses.</p> <p>(d) Compliance with the Electricity Regulation and any relevant legally binding decision of the European Commission and/or the Agency.</p>
--	--

Standard Workgroup consultation questions – CMP264

Q	Question	Response
1	Do you believe that the CMP264 Original Proposal better facilitates the Applicable CUSC Objectives?	Although it is not a perfect solution, on balance yes, as it sets out to avoid further distortion from present high and increasing levels of embedded benefit arising from the Demand Residual component of the TNUoS tariff for the forthcoming Capacity Market auctions. It is therefore an incremental improvement against Objectives a), b) and c).
2	Do you support the proposed implementation approach? Or are there any further implementation implications that need to be considered?	CMP264 aims to be implemented in April 2017. This seems ambitious, particularly in terms of getting the necessary data to enable National Grid to bill accordingly. However, it needs to be implemented by then in order to provide charging for the early year 2017/18 capacity market auction.
3	Do you have any other comments?	No.
4	Do you wish to raise a WG Consultation Alternative Request for the Workgroup to consider?	<p><i>If yes, please complete a WG Consultation Alternative Request form, available on National Grid's website¹, and return to the CUSC inbox at cusc.team@nationalgrid.com</i></p> <p>Yes. Please see separate WG Consultation Alternative Request form attachment.</p>

Standard Workgroup consultation questions – CMP265

Q	Question	Response
5	Do you believe that the CMP265 Original Proposal better facilitates the Applicable CUSC Objectives?	Although it is not a perfect solution, on balance yes, as, although it does not address the payments received by eligible embedded generators before the end of the decade and is limited to only those eligible generators in the Capacity Market; it sets out to remove the distortion from present high and increasing levels of embedded benefit arising from the Demand Residual component of the TNUoS tariff for the forthcoming Capacity Market auctions. It is therefore an incremental improvement against Objectives a), b) and c).

¹ http://www.nationalgrid.com/uk/Electricity/Codes/systemcode/amendments/forms_guidance/

Q	Question	Response
6	Do you support the proposed implementation approach? Or are there any further implementation implications that need to be considered?	This would seem less challenging to implement given the proposed implementation date is further out. However, there would be a significant potential benefit for embedded plant which could be connected well before the Capacity Market delivery date that continue to receive the large TNUoS embedded benefit in the interim period, at the expense of the consumer.
7	Do you have any other comments?	No.
8	Do you wish to raise a WG Consultation Alternative Request for the Workgroup to consider?	<p><i>If yes, please complete a WG Consultation Alternative Request form, available on National Grid's website², and return to the CUSC inbox at cusc.team@nationalgrid.com</i></p> <p>Yes. Please see separate WG Consultation Alternative Request form attachment.</p>

Specific questions for CMP264

Q	Question	Response
---	----------	----------

² http://www.nationalgrid.com/uk/Electricity/Codes/systemcode/amendments/forms_guidance/

Q	Question	Response
10	<p>i) Do you think a cut-off date for “new embedded generation” of 30 June 2017 is appropriate? What other date would you propose?</p> <p>ii) Do you have any views on how mixed sites are being addressed in CMP264 Original?</p> <p>iii) Do you think new-build embedded generation capacity that has entered into long term financial and performance commitment obligations via 2014 and 2015 capacity market or contracts for difference auctions (prior to this modification proposal) should be given exceptions to this cut-off date?</p> <p>iv) Do you agree that ignoring demand behind the meter is unlikely to create a significant “loophole” or material discrimination risk in relation to the CMP264 arrangements in the short term</p> <p>v) Question to suppliers: Do you consider that the wording of your existing contracts allow you to reflect the changes provided by these modifications in a cost reflective manner. For example, these changes will apply to existing PPAs and generators who significantly alter their output (EREC 59).</p> <p>vi) Do you agree with the definition of commissioned and do you agree that it is appropriate? If you do not agree with the definition or that it is appropriate please provide alternative definitions and rationale for this definition.</p>	<p>i) This appears to be the earliest potential cut-off date, although it grandfathers the benefit for those embedded generators prior to the cut-off date. This would create a further distortion in the market between new and existing embedded generation and transmission connected generation. Ofgem’s letter of 29 July 2016 questions whether the cost of continuing with the embedded benefit for existing embedded generators and continuing with a distortion between the different categories can be justified or is fair. As the Original Proposal, if approved, would be an enduring arrangement, until such time as a replacement arrangement was to be introduced; there would be a clear and continuing non-cost reflective distortion that would still need to be addressed.</p> <p>ii) In so far as the Original Proposal is only intended to capture new embedded export meters after the cut-off date, we note the scenarios presented in the consultation and agree that providing the G59 commissioning process certificate would be a method to validate whether an export was new or not. This does however add additional administrative burden and complexity to identify how a particular metered volume should be treated for charging purposes.</p> <p>iii) No. There is no justification for continuing with a non-cost reflective revenue stream at the consumers’ expense.</p> <p>iv) In our view, no. The volume is most likely much smaller compared to the volume of embedded generation connected to the Total System. Reducing a Demand TNUoS liability with behind the meter generation is arguably the right signal to provide as opposed to making additional benefits to netted volume where no clear benefit has been demonstrated.</p> <p>v) We have no comments in response to this question.</p> <p>vi) The G59 process seems sensible.</p>

Q	Question	Response
13	<p>Do you have a view of whether implementation for the 2017/18 Triad season is sufficient to allow changes for:</p> <p>i) supplier contracts and billing system; and</p> <p>ii) for other stakeholders?</p>	<p>There appears to be some doubt as to whether a robust billing system could be introduced in time for the 2017/18 Triad season, particularly if the onus is on Suppliers to provide the necessary information to enable National Grid to issue its invoices, as opposed to a central systems led approach. However, as noted by Ofgem in its letter of 29 July 2016, we would agree that it is challenging to identify any benefit from continuing with the present arrangements and that these should be revised at the earliest possible opportunity and certainly no later than April 2019.</p>
18	<p>Do you have a view if embedded benefits are frozen at a non-zero value, what should that value be as a £/kW tariff (2016/17 value is £45.33 / kW)?</p>	<p>The benefit should be at a level which is a reasonable estimate of the actual benefit provided to the system. We would observe that, whilst estimates of the total value of the embedded benefit have been presented under certain scenarios, to date the workgroup has not presented any evidence as to what the true avoided cost of transmission investment arising from connecting 1kW to a distribution network is and therefore what the correct value should be. This makes it difficult to justify any value above zero, at this point, on the basis that the TNUoS Demand Residual element is simply a non-cost reflective component of the TNUoS tariff to enable National Grid to recover the correct amount of allowed revenue in a given year.</p>

Specific questions for CMP265

Q	Question	Response
---	----------	----------

11	<p>i) Views are sought on the implication for mixed sites discussed in 3.4.10.</p> <p>ii) Views are sought on the preference of categories of capacity Market CMU captured by this proposal, please indicate your preference from the following list and reasons:</p> <ul style="list-style-type: none"> • All existing and new distribution generation CMUs • All existing and new distribution generation CMUs and DSR CMUs (proven and unproven) • All price maker CMUs • All newbuild/prospective distribution generation CMUs only (defined as >1year contracts) 	<p>i) Mixed sites should be very rare. It does highlight the complexity of a solution which seeks to apply this to a subset of distributed generation.</p> <p>ii) It would be appropriate to limit the impact to existing and new distribution generation CMU's.</p>
14	<p>Do you have a view of whether implementation for the 2020/21 Triad season is sufficient to allow changes for i) supplier contracts and billing system, and ii) for other stakeholders?</p>	<p>We would anticipate that it should be reasonable for industry to implement changes in this time. We would note however that implementation for the 2020/21 Triad season is one year later than the latest date set out in Ofgem's letter of 29 July 2016, which suggests that in its view it will be challenging to demonstrate that consumers would benefit from any delay in its implementation beyond 2019/20.</p>

Specific questions for BOTH CMP264 & CMP265

Q	Question	Response
---	----------	----------

Q	Question	Response
9	<p>i) Suppliers: In setting charges for your demand customers, do you charge them at the same tariff as National Grid charges you (i.e. gross), to enable you to pay the embedded benefit to embedded generators, or please explain the way in which it is funded?</p> <p>ii) Suppliers: Does the estimate that 7.58GW of embedded generation output and 2.5GW of demand side reduction at the time of Triad for 2016/17 seem reasonable based on your knowledge of the UK market? If not what is your estimate of embedded generator output and DSR at time of Triad?</p>	<p>i) We have no comments in response to this question.</p> <p>ii) We have no comments in response to this question.</p>
12	<p>Can you identify – either quantitatively or qualitatively - the impact of the demand TNUoS embedded benefit on your decisions made in making capacity market decisions?</p>	<p>In our view the removal of the Demand Residual component of the TNUoS embedded benefit will remove a distortion from the CM and better enable a true price of generation capacity to be discovered. It may result in marginally higher clearing prices in some years by avoiding artificially lower clearing prices as a result of removing this source of revenue from some embedded generation. It may also still result in new embedded generation displacing some transmission connected generation where this is truly cost competitive.</p>

Q	Question	Response
15	<p>i) What are your views on the 2 broad options to enable the reporting of gross export metered data?</p> <p>ii) Would you have the data available required for Option B (both CMP264 and CMP265) for both new contracts and existing contracts where a customer may be partially exempt?</p> <p>iii) Do you believe you can implement the proposed changes by the respective implementation dates?</p> <p>iv) What are the pros and cons of the 2 proposals that ELEXON are considering to implement this (P348 for CMP265/ P349 for CMP264)?</p>	<p>i) The issues demonstrate why a simpler, more generic option should be adopted which would use the general Supplier Gross Demand data file, which already exists, benefits from existing assurance arrangements and is robust for billing purposes.</p> <p>ii) We have no comments in response to this question.</p> <p>iii) We have no comments in response to this question.</p> <p>iv) This is a matter for the P348 and P349 Assessment Procedure Consultation, however we would refer you to our response to question 15(i) above.</p>
16	<p>Do you have any further evidence / comments on the consumer impact of changing the demand TNUoS embedded benefit in either the short-run or long-run?</p>	<p>No.</p>
17	<p>Do you feel that both the locational and residual component of the demand TNUoS should be removed as an embedded benefit (as CMP264 Original) or just the residual component (as CMP265 Original) or some other method?</p>	<p>The locational signal is not an issue, as it provides a cost reflective forward looking signal. We agree that the issue lies with non-cost reflective distortion arising from the Demand TNUoS Residual component of the tariff.</p>
19	<p>Regarding the proposed alternatives what are your views on the suggested implementation dates? Are these achievable? Please give reasons for your view.</p>	<p>Whilst they seem achievable, they do not remove the distortion early enough.</p>

CUSC Workgroup Consultation Response Proforma

CMP264 'Embedded Generation Triad Avoidance Standstill' and **CMP265** 'Gross charging of TNUoS for HH demand where Embedded Generation is in the Capacity Market'

Industry parties are invited to respond to this consultation expressing their views and supplying the rationale for those views, particularly in respect of any specific questions detailed below.

Please send your responses by **24th August 2016** to cusc.team@nationalgrid.com Please note that any responses received after the deadline or sent to a different email address may not receive due consideration by the Workgroup.

Any queries on the content of the consultation should be addressed to Caroline Wright at caroline.wright@nationalgrid.com

These responses will be considered by the Workgroup at its next meeting at which members will also consider any Workgroup Consultation Alternative Requests. Where appropriate, the Workgroup will record your response and its consideration of it within the final Workgroup Report which is submitted to the CUSC Modifications Panel.

Respondent:	<i>Kirstin Gardner; kgardner@stagenenergy.com</i>
Company Name:	<i>Watt Power Ltd</i>
<p>Please express your views regarding the Workgroup Consultation, including rationale.</p> <p>(Please include any issues, suggestions or queries)</p>	<p>For reference, the Applicable CUSC objectives are:</p> <p>Use of System Charging Methodology</p> <p>(a) that compliance with the use of system charging methodology facilitates effective competition in the generation and supply of electricity and (so far as is consistent therewith) facilitates competition in the sale, distribution and purchase of electricity;</p> <p>(b) that compliance with the use of system charging methodology results in charges which reflect, as far as is reasonably practicable, the costs (excluding any payments between transmission licensees which are made under and in accordance with the STC) incurred by transmission licensees in their transmission businesses and which are compatible with standard condition C26 (Requirements of a connect and manage connection);</p> <p>(c) that, so far as is consistent with sub-paragraphs (a) and (b), the use of system charging methodology, as far as is reasonably practicable, properly takes account of the developments in transmission licensees' transmission</p>

	<p>businesses.</p> <p>(d) Compliance with the Electricity Regulation and any relevant legally binding decision of the European Commission and/or the Agency.</p>
--	--

Standard Workgroup consultation questions – CMP264

Q	Question	Response
1	<p>Do you believe that the CMP264 Original Proposal or either of the associated potential options for change better facilitates the Applicable CUSC Objectives?</p>	<p>Firstly, we assert that we are not supportive of the CMP264 proposal as the scope of the defect is too narrow and overemphasises the link between Triad avoidance payments available to distribution connected generators and the lack of investment in alternative forms of new generation. The issues surrounding current investment in the UK generation mix are far greater than those described by CMP264 and should be addressed by Ofgem through a SCR or via a more suitable modification proposal.</p> <p>Secondly, the proposed solution creates a defect, since all parties appear to accept that embedded generation provides some grid cost reduction, which would not be reflected in the payments to generators affected by the modification. There is no firm evidence that this defect is less significant than the defect that the modification seeks to address.</p> <p>Notwithstanding the above, we are of the opinion that the potential WACM raised by Green Frog et al best addresses the defect defined by CMP264.</p>
2	<p>Do you support the proposed implementation approach? Or are there any further implementation implications that need to be considered?</p>	<p>As stated above, we are not supportive of proposal CMP264. Regardless, it appears that the implementation approach for the original CMP264 proposal raised by Scottish Power is not appropriate or achievable. The post June 30th 2017 cut-off date for “new” embedded generation would require complementary changes to a number of billing and charging systems. It is highly unlikely that the tight timeframe would allow sufficient time for these changes to be brought forward. Further, the timeframe for implementation does not allow sufficient time for parties to bring forward plants which are already under development (i.e. planning consent granted, connections secured and where relevant capacity contracts are in place) though the plant is not yet constructed or commissioned.</p>

Q	Question	Response
3	Do you have any other comments?	The “temporary nature” implied by the CMP264, though the proposal is no longer accompanied by a disapplication date, is made void by the recent Ofgem Open Letter on embedded benefits. If Ofgem are not minded to undertake a Significant Code Review and undertake a holistic review of charging arrangements in order to examine the cost-reflectivity of embedded benefits and instead have chosen to focus on bringing forward change through the CUSC modification proposals currently under consideration, CMP264 would be no more temporary than any other CUSC modification. In effect, CMP264 would introduce an indefinite freeze of Triad payments to any ‘new’ embedded generator (‘new’ defined by the proposal as any embedded generator commissioned on or after 1 st July 2017). This could endanger security of supply by sparking the termination of existing Capacity Market contracts, and result in higher costs to consumers as significantly less small-scale flexible and affordable generation is brought forward following the implementation date.
4	Do you wish to raise a WG Consultation Alternative Request for the Workgroup to consider?	<i>If yes, please complete a WG Consultation Alternative Request form, available on National Grid's website¹, and return to the CUSC inbox at cusc.team@nationalgrid.com</i>

Standard Workgroup consultation questions – CMP265

Q	Question	Response
5	Do you believe that the CMP265 Original Proposal or either of the associated potential options for change better facilitates the Applicable CUSC Objectives?	We are not supportive of the CMP265 proposal as the scope of the defect is too narrow and unjustly targets distribution connected generators as a cause for distorted capacity market outcomes. The issues surrounding charging arrangements and transmission network costs are far more complex than set out in the defect described by CMP264 and should be addressed by Ofgem through a SCR or via a more suitable modification proposal. The proposed solution creates a defect, since all parties appear to accept that embedded generation provides some grid cost reduction, which would not be reflected in the payments to generators affected by the modification. There is no firm evidence that this defect is less significant than the defect that the modification seeks to address.

¹ http://www.nationalgrid.com/uk/Electricity/Codes/systemcode/amendments/forms_guidance/

Q	Question	Response
6	Do you support the proposed implementation approach? Or are there any further implementation implications that need to be considered?	No comment.
7	Do you have any other comments?	No comment.
8	Do you wish to raise a WG Consultation Alternative Request for the Workgroup to consider?	<i>If yes, please complete a WG Consultation Alternative Request form, available on National Grid's website², and return to the CUSC inbox at cusc.team@nationalgrid.com</i>

Specific questions for CMP264

Q	Question	Response
---	----------	----------

² http://www.nationalgrid.com/uk/Electricity/Codes/systemcode/amendments/forms_guidance/

Q	Question	Response
10	<p>i) Do you think a cut-off date for “new embedded generation” of 30 June 2017 is appropriate? What other date would you propose?</p> <p>ii) Do you have any views on how mixed sites are being addressed in CMP264 Original?</p> <p>iii) Do you think new-build embedded generation capacity that has entered into long term financial and performance commitment obligations via 2014 and 2015 capacity market or contracts for difference auctions (prior to this modification proposal) should be given exceptions to this cut-off date?</p> <p>iv) Do you agree that ignoring demand behind the meter is unlikely to create a significant “loophole” or material discrimination risk in relation to the CMP264 arrangements in the short term</p> <p>v) Question to suppliers: Do you consider that the wording of your existing contracts allow you to reflect the changes provided by these modifications in a cost reflective manner. For example, these changes will apply to existing PPAs and generators who significantly alter their output (EREC 59).</p> <p>vi) Do you agree with the definition of commissioned and do you agree that it is appropriate? If you do not agree with the definition or that it is appropriate please provide alternative definitions and rationale for this definition.</p>	<p>i) In the first instance, we are opposed to proposal CMP264. Further, the proposed cut-off date is wholly inappropriate as it does not allow time for any complementary system changes to be brought forward.</p> <p>ii) No comment.</p> <p>iii) As above, we are not in support of proposal CMP264, however, we support the notion that new-build generation capacity that has entered into long term obligations via the capacity market or similar auctions prior to this modification proposal should continue to have access to some form of Triad payment if they are providing the relevant services. Prices taken in the capacity market auction, and subsequent financial deals and decisions made by the affected developers have been informed on the basis of access to Triad avoidance payments – the indefinite suspension of Triad payments may impact the viability of existing contracts and result in the termination of contracts. This would force the procurement of additional capacity as a replacement, most likely at much inflated prices, resulting in both security of supply problems and unnecessarily inflated costs to consumers.</p> <p>iv) We believe that ignoring demand behind the meter would create a loophole that allows for parties to circumvent the arrangements of proposal CMP264. The different treatment would not be cost reflective and is not consistent with the CUSC objectives.</p> <p>v) N/A</p> <p>vi) As above, we are opposed to proposal CMP264. Further, we do not support the definition of “commissioned” and believe that relying on certification produced by the DNO in advance of any “cut-off” date will result in undue strain on DNOs, create backlogs and delays. A plant that has an MPAN and has been constructed before the cut-off date should qualify as commissioned and be eligible for Triad payments.</p>

Q	Question	Response
13	<p>Do you have a view of whether implementation for the 2017/18 Triad season is sufficient to allow changes for:</p> <p>i) supplier contracts and billing system; and</p> <p>ii) for other stakeholders?</p>	<p>As stated above, we are not supportive of proposal CMP264. Regardless, it appears that the implementation approach for the original CMP264 proposal raised by Scottish Power is not appropriate or achievable. The post June 30th 2017 cut-off date for “new” embedded generation would require complementary changes to a number of billing and charging systems. It is highly unlikely that the tight timeframe would allow sufficient time for these changes to be brought forward. Further, the timeframe for implementation does not allow sufficient time for parties to bring forward plants which are already under development (i.e. planning consent granted, connections secured and where relevant capacity contracts are in place) though the plant is not yet constructed or commissioned.</p>
18	<p>Do you have a view if embedded benefits are frozen at a non-zero value, what should that value be as a £/kW tariff (2016/17 value is £45.33 / kW)?</p>	<p>If embedded benefits are frozen at a non-zero value, we suggest that they are frozen at the forecast 2016/2017 tariff values. The 2016/17 residual is a reasonable starting point for temporary solutions such as those proposed in CMP264 and CMP265. This is a known value and will have been built into the calculations of many generators planning to build embedded plant. The 2016/17 tariff values have a locational element and therefore there should not be frozen at a blanket rate of £45.33 / kW for all embedded generators as the question seems to suggest. In some areas the value is higher, in others it is lower, and the locational element should vary from year to year so that it remains cost reflective.</p>

Specific questions for CMP265

Q	Question	Response
---	----------	----------

11	<p>i) Views are sought on the implication for mixed sites discussed in 3.4.10.</p> <p>ii) Views are sought on the preference of categories of capacity Market CMU captured by this proposal, please indicate your preference from the following list and reasons:</p> <ul style="list-style-type: none"> • All existing and new distribution generation CMUs • All existing and new distribution generation CMUs and DSR CMUs (proven and unproven) • All price maker CMUs • All newbuild/prospective distribution generation CMUs only (defined as >1year contracts) 	<p>i) No comment.</p> <p>ii) To avoid discrimination, this should apply to all embedded generation and demand reduction.</p>
14	<p>Do you have a view of whether implementation for the 2020/21 Triad season is sufficient to allow changes for i) supplier contracts and billing system, and ii) for other stakeholders?</p>	<p>Implementing the necessary changes by 2020/21 should be possible.</p>

Specific questions for BOTH CMP264 & CMP265

Q	Question	Response
---	----------	----------

Q	Question	Response
9	<p data-bbox="279 174 758 548">i) Suppliers: In setting charges for your demand customers, do you charge them at the same tariff as National Grid charges you (i.e. gross), to enable you to pay the embedded benefit to embedded generators, or please explain the way in which it is funded?</p> <p data-bbox="279 571 758 996">ii) Suppliers: Does the estimate that 7.58GW of embedded generation output and 2.5GW of demand side reduction at the time of Triad for 2016/17 seem reasonable based on your knowledge of the UK market? If not what is your estimate of embedded generator output and DSR at time of Triad?</p>	N/A

Q	Question	Response
12	<p>Can you identify – either quantitatively or qualitatively - the impact of the demand TNUoS embedded benefit on your decisions made in making capacity market decisions?</p>	<p>TRIAD revenues are not long term contracts/agreements and are therefore not 'guaranteed', but they are part of a stable charging mechanism and it has been possible to take a reasonable view about the level of these revenues over the next few years. Further, Ofgem reviewed embedded benefits in 2014 and found no reason to make extensive changes, so generators would have received some assurance as to the continuation of the TNUoS charging methodology.</p> <p>Different lenders treat Triad revenues in different ways, and the exact treatment will vary over time. Triad revenues are not viewed as being as certain as a Capacity Agreement or PPA/Tolling Deal. The impact on any financing of having access to this income stream is difficult to quantify.</p> <p>Triad revenues are at risk from a number of operational and commercial factors and each bidder in the Capacity Market will take a different view about the impact of these revenues on their exit price in the auction. However, these revenues are a substantial element in the income of plant generating mainly at peak or to cover for intermittent generation. It is clear that the clearing price in the capacity market would have been significantly higher had embedded benefits not been available.</p>

Q	Question	Response
15	<p>i) What are your views on the 2 broad options to enable the reporting of gross export metered data?</p> <p>ii) Would you have the data available required for Option B (both CMP264 and CMP265) for both new contracts and existing contracts where a customer may be partially exempt?</p> <p>iii) Do you believe you can implement the proposed changes by the respective implementation dates?</p> <p>iv) What are the pros and cons of the 2 proposals that ELEXON are considering to implement this (P348 for CMP265/ P349 for CMP264)?</p>	<p>i) If metering is to be gross it needs to look at all metering systems as suggested in option 2. It should not simply add back the output of embedded generators.</p> <p>ii) N/A</p> <p>iii) N/A</p> <p>iv) We have not been party to the Elexon discussions</p>
16	<p>Do you have any further evidence / comments on the consumer impact of changing the demand TNUoS embedded benefit in either the short-run or long-run?</p>	<p>It is impossible to predict with any precision the impact on consumers, since it will depend on a host of market factors. However, it is certain that, in both the short and long run, the Capacity Market clearing price would need to be significantly increased and that the wholesale electricity price at peak will be higher. These factors mean that there will be a large and unequivocal windfall transfer from consumers to grid connected generators that will dwarf any reduction in embedded benefits.</p>
17	<p>Do you feel that both the locational and residual component of the demand TNUoS should be removed as an embedded benefit (as CMP264 Original) or just the residual component (as CMP265 Original) or some other method?</p>	<p>As stated previously, we are not in support of either proposal and feel that changes to the charging arrangements should be brought about through a more holistic review under an Ofgem SCR. Alternatively, a wider reaching CUSC modification proposal should be raised, which could better address current concerns.</p> <p>However, focusing on the assessment of the two proposals currently under review, we strongly oppose the removal of both the locational and residual component of the demand TNUoS (as proposed by CMP264 Original). We would suggest an embedded benefit of the demand TNUoS locational component + 2016/2017 residual.</p>

Q	Question	Response
19	Regarding the proposed alternatives what are your views on the suggested implementation dates? Are these achievable? Please give reasons for your view.	It is highly unlikely that the necessary changes could be implemented by April 2017. Implementing changes by April 2020 should be possible.

CUSC Workgroup Consultation Response Proforma

CMP264 'Embedded Generation Triad Avoidance Standstill' and **CMP265** 'Gross charging of TNUoS for HH demand where Embedded Generation is in the Capacity Market'

Industry parties are invited to respond to this consultation expressing their views and supplying the rationale for those views, particularly in respect of any specific questions detailed below.

Please send your responses by **24th August 2016** to cusc.team@nationalgrid.com Please note that any responses received after the deadline or sent to a different email address may not receive due consideration by the Workgroup.

Any queries on the content of the consultation should be addressed to Caroline Wright at caroline.wright@nationalgrid.com

These responses will be considered by the Workgroup at its next meeting at which members will also consider any Workgroup Consultation Alternative Requests. Where appropriate, the Workgroup will record your response and its consideration of it within the final Workgroup Report which is submitted to the CUSC Modifications Panel.

Respondent:	<i>Kirstin Gardner; kgardner@stagenenergy.com</i>
Company Name:	<i>Watt Power Ltd</i>
<p>Please express your views regarding the Workgroup Consultation, including rationale.</p> <p>(Please include any issues, suggestions or queries)</p>	<p>For reference, the Applicable CUSC objectives are:</p> <p>Use of System Charging Methodology</p> <p>(a) that compliance with the use of system charging methodology facilitates effective competition in the generation and supply of electricity and (so far as is consistent therewith) facilitates competition in the sale, distribution and purchase of electricity;</p> <p>(b) that compliance with the use of system charging methodology results in charges which reflect, as far as is reasonably practicable, the costs (excluding any payments between transmission licensees which are made under and in accordance with the STC) incurred by transmission licensees in their transmission businesses and which are compatible with standard condition C26 (Requirements of a connect and manage connection);</p> <p>(c) that, so far as is consistent with sub-paragraphs (a) and (b), the use of system charging methodology, as far as is reasonably practicable, properly takes account of the developments in transmission licensees' transmission</p>

	<p>businesses.</p> <p>(d) Compliance with the Electricity Regulation and any relevant legally binding decision of the European Commission and/or the Agency.</p>
--	--

Standard Workgroup consultation questions – CMP264

Q	Question	Response
1	<p>Do you believe that the CMP264 Original Proposal or either of the associated potential options for change better facilitates the Applicable CUSC Objectives?</p>	<p>Firstly, we assert that we are not supportive of the CMP264 proposal as the scope of the defect is too narrow and overemphasises the link between Triad avoidance payments available to distribution connected generators and the lack of investment in alternative forms of new generation. The issues surrounding current investment in the UK generation mix are far greater than those described by CMP264 and should be addressed by Ofgem through a SCR or via a more suitable modification proposal.</p> <p>Secondly, the proposed solution creates a defect, since all parties appear to accept that embedded generation provides some grid cost reduction, which would not be reflected in the payments to generators affected by the modification. There is no firm evidence that this defect is less significant than the defect that the modification seeks to address.</p> <p>Notwithstanding the above, we are of the opinion that the potential WACM raised by Green Frog et al best addresses the defect defined by CMP264.</p>
2	<p>Do you support the proposed implementation approach? Or are there any further implementation implications that need to be considered?</p>	<p>As stated above, we are not supportive of proposal CMP264. Regardless, it appears that the implementation approach for the original CMP264 proposal raised by Scottish Power is not appropriate or achievable. The post June 30th 2017 cut-off date for “new” embedded generation would require complementary changes to a number of billing and charging systems. It is highly unlikely that the tight timeframe would allow sufficient time for these changes to be brought forward. Further, the timeframe for implementation does not allow sufficient time for parties to bring forward plants which are already under development (i.e. planning consent granted, connections secured and where relevant capacity contracts are in place) though the plant is not yet constructed or commissioned.</p>

Q	Question	Response
3	Do you have any other comments?	The “temporary nature” implied by the CMP264, though the proposal is no longer accompanied by a disapplication date, is made void by the recent Ofgem Open Letter on embedded benefits. If Ofgem are not minded to undertake a Significant Code Review and undertake a holistic review of charging arrangements in order to examine the cost-reflectivity of embedded benefits and instead have chosen to focus on bringing forward change through the CUSC modification proposals currently under consideration, CMP264 would be no more temporary than any other CUSC modification. In effect, CMP264 would introduce an indefinite freeze of Triad payments to any ‘new’ embedded generator (‘new’ defined by the proposal as any embedded generator commissioned on or after 1 st July 2017). This could endanger security of supply by sparking the termination of existing Capacity Market contracts, and result in higher costs to consumers as significantly less small-scale flexible and affordable generation is brought forward following the implementation date.
4	Do you wish to raise a WG Consultation Alternative Request for the Workgroup to consider?	<i>If yes, please complete a WG Consultation Alternative Request form, available on National Grid's website¹, and return to the CUSC inbox at cusc.team@nationalgrid.com</i>

Standard Workgroup consultation questions – CMP265

Q	Question	Response
5	Do you believe that the CMP265 Original Proposal or either of the associated potential options for change better facilitates the Applicable CUSC Objectives?	We are not supportive of the CMP265 proposal as the scope of the defect is too narrow and unjustly targets distribution connected generators as a cause for distorted capacity market outcomes. The issues surrounding charging arrangements and transmission network costs are far more complex than set out in the defect described by CMP264 and should be addressed by Ofgem through a SCR or via a more suitable modification proposal. The proposed solution creates a defect, since all parties appear to accept that embedded generation provides some grid cost reduction, which would not be reflected in the payments to generators affected by the modification. There is no firm evidence that this defect is less significant than the defect that the modification seeks to address.

¹ http://www.nationalgrid.com/uk/Electricity/Codes/systemcode/amendments/forms_guidance/

Q	Question	Response
6	Do you support the proposed implementation approach? Or are there any further implementation implications that need to be considered?	No comment.
7	Do you have any other comments?	No comment.
8	Do you wish to raise a WG Consultation Alternative Request for the Workgroup to consider?	<i>If yes, please complete a WG Consultation Alternative Request form, available on National Grid's website², and return to the CUSC inbox at cusc.team@nationalgrid.com</i>

Specific questions for CMP264

Q	Question	Response
---	----------	----------

² http://www.nationalgrid.com/uk/Electricity/Codes/systemcode/amendments/forms_guidance/

Q	Question	Response
10	<p>i) Do you think a cut-off date for “new embedded generation” of 30 June 2017 is appropriate? What other date would you propose?</p> <p>ii) Do you have any views on how mixed sites are being addressed in CMP264 Original?</p> <p>iii) Do you think new-build embedded generation capacity that has entered into long term financial and performance commitment obligations via 2014 and 2015 capacity market or contracts for difference auctions (prior to this modification proposal) should be given exceptions to this cut-off date?</p> <p>iv) Do you agree that ignoring demand behind the meter is unlikely to create a significant “loophole” or material discrimination risk in relation to the CMP264 arrangements in the short term</p> <p>v) Question to suppliers: Do you consider that the wording of your existing contracts allow you to reflect the changes provided by these modifications in a cost reflective manner. For example, these changes will apply to existing PPAs and generators who significantly alter their output (EREC 59).</p> <p>vi) Do you agree with the definition of commissioned and do you agree that it is appropriate? If you do not agree with the definition or that it is appropriate please provide alternative definitions and rationale for this definition.</p>	<p>i) In the first instance, we are opposed to proposal CMP264. Further, the proposed cut-off date is wholly inappropriate as it does not allow time for any complementary system changes to be brought forward.</p> <p>ii) No comment.</p> <p>iii) As above, we are not in support of proposal CMP264, however, we support the notion that new-build generation capacity that has entered into long term obligations via the capacity market or similar auctions prior to this modification proposal should continue to have access to some form of Triad payment if they are providing the relevant services. Prices taken in the capacity market auction, and subsequent financial deals and decisions made by the affected developers have been informed on the basis of access to Triad avoidance payments – the indefinite suspension of Triad payments may impact the viability of existing contracts and result in the termination of contracts. This would force the procurement of additional capacity as a replacement, most likely at much inflated prices, resulting in both security of supply problems and unnecessarily inflated costs to consumers.</p> <p>iv) We believe that ignoring demand behind the meter would create a loophole that allows for parties to circumvent the arrangements of proposal CMP264. The different treatment would not be cost reflective and is not consistent with the CUSC objectives.</p> <p>v) N/A</p> <p>vi) As above, we are opposed to proposal CMP264. Further, we do not support the definition of “commissioned” and believe that relying on certification produced by the DNO in advance of any “cut-off” date will result in undue strain on DNOs, create backlogs and delays. A plant that has an MPAN and has been constructed before the cut-off date should qualify as commissioned and be eligible for Triad payments.</p>

Q	Question	Response
13	<p>Do you have a view of whether implementation for the 2017/18 Triad season is sufficient to allow changes for:</p> <p>i) supplier contracts and billing system; and</p> <p>ii) for other stakeholders?</p>	<p>As stated above, we are not supportive of proposal CMP264. Regardless, it appears that the implementation approach for the original CMP264 proposal raised by Scottish Power is not appropriate or achievable. The post June 30th 2017 cut-off date for “new” embedded generation would require complementary changes to a number of billing and charging systems. It is highly unlikely that the tight timeframe would allow sufficient time for these changes to be brought forward. Further, the timeframe for implementation does not allow sufficient time for parties to bring forward plants which are already under development (i.e. planning consent granted, connections secured and where relevant capacity contracts are in place) though the plant is not yet constructed or commissioned.</p>
18	<p>Do you have a view if embedded benefits are frozen at a non-zero value, what should that value be as a £/kW tariff (2016/17 value is £45.33 / kW)?</p>	<p>If embedded benefits are frozen at a non-zero value, we suggest that they are frozen at the forecast 2016/2017 tariff values. The 2016/17 residual is a reasonable starting point for temporary solutions such as those proposed in CMP264 and CMP265. This is a known value and will have been built into the calculations of many generators planning to build embedded plant. The 2016/17 tariff values have a locational element and therefore there should not be frozen at a blanket rate of £45.33 / kW for all embedded generators as the question seems to suggest. In some areas the value is higher, in others it is lower, and the locational element should vary from year to year so that it remains cost reflective.</p>

Specific questions for CMP265

Q	Question	Response
---	----------	----------

11	<p>i) Views are sought on the implication for mixed sites discussed in 3.4.10.</p> <p>ii) Views are sought on the preference of categories of capacity Market CMU captured by this proposal, please indicate your preference from the following list and reasons:</p> <ul style="list-style-type: none"> • All existing and new distribution generation CMUs • All existing and new distribution generation CMUs and DSR CMUs (proven and unproven) • All price maker CMUs • All newbuild/prospective distribution generation CMUs only (defined as >1year contracts) 	<p>i) No comment.</p> <p>ii) To avoid discrimination, this should apply to all embedded generation and demand reduction.</p>
14	<p>Do you have a view of whether implementation for the 2020/21 Triad season is sufficient to allow changes for i) supplier contracts and billing system, and ii) for other stakeholders?</p>	<p>Implementing the necessary changes by 2020/21 should be possible.</p>

Specific questions for BOTH CMP264 & CMP265

Q	Question	Response
---	----------	----------

Q	Question	Response
9	<p data-bbox="279 174 758 548">i) Suppliers: In setting charges for your demand customers, do you charge them at the same tariff as National Grid charges you (i.e. gross), to enable you to pay the embedded benefit to embedded generators, or please explain the way in which it is funded?</p> <p data-bbox="279 571 758 996">ii) Suppliers: Does the estimate that 7.58GW of embedded generation output and 2.5GW of demand side reduction at the time of Triad for 2016/17 seem reasonable based on your knowledge of the UK market? If not what is your estimate of embedded generator output and DSR at time of Triad?</p>	N/A

Q	Question	Response
12	<p>Can you identify – either quantitatively or qualitatively - the impact of the demand TNUoS embedded benefit on your decisions made in making capacity market decisions?</p>	<p>TRIAD revenues are not long term contracts/agreements and are therefore not 'guaranteed', but they are part of a stable charging mechanism and it has been possible to take a reasonable view about the level of these revenues over the next few years. Further, Ofgem reviewed embedded benefits in 2014 and found no reason to make extensive changes, so generators would have received some assurance as to the continuation of the TNUoS charging methodology.</p> <p>Different lenders treat Triad revenues in different ways, and the exact treatment will vary over time. Triad revenues are not viewed as being as certain as a Capacity Agreement or PPA/Tolling Deal. The impact on any financing of having access to this income stream is difficult to quantify.</p> <p>Triad revenues are at risk from a number of operational and commercial factors and each bidder in the Capacity Market will take a different view about the impact of these revenues on their exit price in the auction. However, these revenues are a substantial element in the income of plant generating mainly at peak or to cover for intermittent generation. It is clear that the clearing price in the capacity market would have been significantly higher had embedded benefits not been available.</p>

Q	Question	Response
15	<p>i) What are your views on the 2 broad options to enable the reporting of gross export metered data?</p> <p>ii) Would you have the data available required for Option B (both CMP264 and CMP265) for both new contracts and existing contracts where a customer may be partially exempt?</p> <p>iii) Do you believe you can implement the proposed changes by the respective implementation dates?</p> <p>iv) What are the pros and cons of the 2 proposals that ELEXON are considering to implement this (P348 for CMP265/ P349 for CMP264)?</p>	<p>i) If metering is to be gross it needs to look at all metering systems as suggested in option 2. It should not simply add back the output of embedded generators.</p> <p>ii) N/A</p> <p>iii) N/A</p> <p>iv) We have not been party to the Elexon discussions</p>
16	<p>Do you have any further evidence / comments on the consumer impact of changing the demand TNUoS embedded benefit in either the short-run or long-run?</p>	<p>It is impossible to predict with any precision the impact on consumers, since it will depend on a host of market factors. However, it is certain that, in both the short and long run, the Capacity Market clearing price would need to be significantly increased and that the wholesale electricity price at peak will be higher. These factors mean that there will be a large and unequivocal windfall transfer from consumers to grid connected generators that will dwarf any reduction in embedded benefits.</p>
17	<p>Do you feel that both the locational and residual component of the demand TNUoS should be removed as an embedded benefit (as CMP264 Original) or just the residual component (as CMP265 Original) or some other method?</p>	<p>As stated previously, we are not in support of either proposal and feel that changes to the charging arrangements should be brought about through a more holistic review under an Ofgem SCR. Alternatively, a wider reaching CUSC modification proposal should be raised, which could better address current concerns.</p> <p>However, focusing on the assessment of the two proposals currently under review, we strongly oppose the removal of both the locational and residual component of the demand TNUoS (as proposed by CMP264 Original). We would suggest an embedded benefit of the demand TNUoS locational component + 2016/2017 residual.</p>

Q	Question	Response
19	Regarding the proposed alternatives what are your views on the suggested implementation dates? Are these achievable? Please give reasons for your view.	It is highly unlikely that the necessary changes could be implemented by April 2017. Implementing changes by April 2020 should be possible.

23 August 2016

National Grid
National Grid House
Warwick Technology Park
Gallows Hill
Warwick
CV346DA

Welsh Power Group Limited

First Floor
18 Park Place
Cardiff
CF10 3DQ
Tel: +44 (0)2920 547200
Fax: +44 (0)2920 398248
info@welshpower.com

cusc.team@nationalgrid.com

Dear Sirs

Please find attached Welsh Power's response to the CUSC Workgroup Consultation.

Background

Welsh Power Group is a privately-owned energy company with a strong track-record in the development, construction and operation of both conventional and renewable power generation projects. The company has owned large thermal generating plant, Uskmouth Power; developed and financed a new build 850MW CCGT, Severn Power; established a successful supply business, Haven Power; and constructed a small 50MW peaking portfolio which it sold to Alkane Energy in July 2014.

Since 2014 Welsh Power has been working in partnership with an investor to bring forward a portfolio of new flexible, efficient gas fired generating capacity to the UK market. Having participated in both the 2014 and 2015 Capacity Market auctions Welsh Power currently has over 250 MW of gas fired embedded generating capacity either operational or actively under construction.

The development, finance and build cycle of these plants is typically three years. The company is part way through the build out programme and is deeply concerned at the proposed changes to the treatment of embedded benefits following proposal CMP264 and CMP265 submitted to the CUSC Panel by Scottish Power and EDF respectively.

We are particularly surprised by the manner in which these fundamental changes to charging arrangements are being rushed through on an accelerated timescale with little time for cross industry engagement and proper analysis of the impact on generators, suppliers and consumers. It is clear that both of the proposed modifications are intended to increase the clearing price in the upcoming capacity market auction and to raise electricity prices. The proposers of CMP264 and CMP265 hypothecate that this will lead to more efficient investment decisions in the future which will lead to lower costs to consumer in the long run. Whilst it was generally accepted by the working group that the immediate impact of the proposals would be a clear increase in consumer costs no evidence was presented to the work group to justify how the anticipated reduction would materialise in the longer term. Purist economic arguments tabled by the proposers about efficient market signals and rational investment decisions ignore the facts of the UK energy market which has over the past decade relied increasingly on subsidy and regulatory intervention to bring forward new build capacity. The Capacity Market is the most recent and obvious example of intervention

in the market to bring forward new capacity and compensate for market failures. It is nonsensical to argue that the removal of Triad benefits would lead to a more efficient investment signal given the evidence of the past years.

Any changes that would lead to an increase in Capacity Market clearing prices, the stated aim of the CUSC proposals, would lead to large windfall gains to owners of existing transmission connected generation. For every £1 increase in the Capacity Market auction clearing price an additional £53.8m will be paid by consumers for securing the targeted capacity in the 2016 auction. In the 2014 and 2015 auctions 94.3% and 90.6% of contracts respectively were awarded to existing generators suggesting that existing generators will receive a windfall gain of approximately £48m for each £1 increase in the Capacity Market clearing price resulting from an acceptance of the proposers modifications.

With over 10.5GW of capacity awarded contracts in the 2015 auction the proposers, Scottish Power and EDF stand to benefit by over £10m for every £1 increase in clearing prices as a direct result of their proposed modifications.

The single largest determinant of the clearing price of the Capacity Market auction is the volume of capacity which the Secretary of State decides to procure. The low clearing prices evident in the past two auctions were the result of setting the demand curve below the current installed capacity and therefore ensuring that the auction would clear below the price taker threshold. The award of Capacity Market contracts to distribution connected generators was little more than a rounding error in this context. It should be noted that much of the new build capacity awarded contracts in the 2014 and 2015 auctions are struggling to raise finance to build out their capacity obligations and also that the largest award of new build capacity was to a large transmission connected plant which felt able to outbid both new build distributed generation and existing transmission connected power plant.

Welsh Power has serious reservations about the governance of the CUSC process when large generators are permitted to use their membership of the CUSC panel to push through changes that are clearly in their own commercial self interest to the apparent detriment of smaller gencos and consumers who are not represented on the CUSC panel.

It is important to note that, without direct membership of the CUSC panel, smaller gencos, the target of these proposed changes, are unable to raise CUSC modifications in their own right and are restricted to suggesting narrow alternatives to the changes proposed by CUSC members. This requires an acceptance of the defect raised by the proposers and only alternatives which address the same proposed defect can be brought forward. Welsh Power does not agree with the defect as identified by either proposer.

Both proposals identify the defect as a distortion to investment signals and both are targeted at generators planning to prequalify and bid into the 2016 Capacity Market auction. In different ways both proposals target a subset of embedded generators and seek to exclude them from receipt of Triad payments. In both cases the vast majority of distribution connected capacity will be unaffected by the changes:

- in the case of Scottish Power's modification, the change is prospective and grandfathers existing capacity;
- In the case of EDF's modification the changes will affect only those embedded generators participating in the Capacity Market.

Welsh Power has sympathy for the view that a continual escalation of the Triad benefit as a result of large annual increases in transmission allowed revenues compounded by a cap on charges to transmission connected power plants which results in a forecast cross subsidy from generation to demand of £670m in 2020/21, is likely to lead to a distortion of investment. However, neither proposal addresses the escalation in Triad payments and, with the exception of the subset of excluded generators, will leave the rise in Triad payments unchecked. It is important that the correct defect is addressed and that appropriate care and diligence is applied to the quantification of the true value of distributed generation. Once this exercise has been completed then appropriate changes to the charging methodology can and should be implemented. Consideration also needs to be given to security of supply, consumer impact, market access and the appropriate generation mix for the UK's future energy requirements.

Much of the discussion within the working group has centered around the value that embedded generators bring to the system and therefore the justification of the ongoing payment of an embedded benefit in the form of Triad payments. The proposers have argued that the true cost reflective benefit is the locational element only of the supplier TNUoS charge and that payment of the residual element of the supplier TNUoS is not justified. The assertion is that the residual element simply recovers the allowed revenues of the TSO's. In 2016/17 the residual element of the supplier TNUoS totalled £2257.6m, 83% of the total allowed revenue. In 2020/21 this is forecast to increase to 90%. Welsh Power believes that the concept of cost reflective charging that recovers only a small percentage of the cost of running the transmission system is a contradiction and that a wider review of the recovery of transmission costs is warranted.

Further, Welsh Power would argue that the growth in embedded generation has resulted in a smaller transmission system and has therefore reduced the total allowed revenue 'pot' that is to be recovered through transmission charging. In the absence of the 21GW of capacity connected to the distribution system the transmission system would be significantly larger and more costly. The benefit of this 21GW of distribution connected capacity is realised over the operating life of the distribution connected asset and is not given appropriate value in the forward looking locational charging model currently used to apportion the costs of the transmission system. This 'sunk' benefit of distribution connected generation needs to be quantified and appropriately valued. In its recently announced consultation on a mid period review to RIIO-T1, OFGEM¹ has proposed reducing the allowed revenue that can be recovered across National Grid's electricity transmission businesses by £38.1. This reduction is due to the lower number of large new generating plants connecting to the transmission system and is largely due to the growth of distribution connected capacity replacing the need to invest and increase the size of the transmission system. This is a clear example of the benefit of embedded generation which will continue to be realised by consumers over the operating life of the distribution connected assets.

Welsh Power's response to the specific consultation questions are detailed below.

Yours faithfully



Matthew Tucker

¹https://www.ofgem.gov.uk/system/files/docs/2016/08/consultation_on_the_mid-period_review_mpr_of_riio-t1.pdf

CUSC Workgroup Consultation Response Proforma

CMP264 'Embedded Generation Triad Avoidance Standstill' and **CMP265** 'Gross charging of TNUoS for HH demand where Embedded Generation is in the Capacity Market'

Industry parties are invited to respond to this consultation expressing their views and supplying the rationale for those views, particularly in respect of any specific questions detailed below.

Please send your responses by **24th August 2016** to cusc.team@nationalgrid.com Please note that any responses received after the deadline or sent to a different email address may not receive due consideration by the Workgroup.

Any queries on the content of the consultation should be addressed to Caroline Wright at caroline.wright@nationalgrid.com

These responses will be considered by the Workgroup at its next meeting at which members will also consider any Workgroup Consultation Alternative Requests. Where appropriate, the Workgroup will record your response and its consideration of it within the final Workgroup Report which is submitted to the CUSC Modifications Panel.

Respondent:	<i>Matthew Tucker, matthew.tucker@welshpower.com, 02920 547206</i>
Company Name:	<i>Welsh Power Group Limited</i>
<p>Please express your views regarding the Workgroup Consultation, including rationale.</p> <p>(Please include any issues, suggestions or queries)</p>	<p>For reference, the Applicable CUSC objectives are:</p> <p>Use of System Charging Methodology</p> <p>(a) that compliance with the use of system charging methodology facilitates effective competition in the generation and supply of electricity and (so far as is consistent therewith) facilitates competition in the sale, distribution and purchase of electricity;</p> <p>(b) that compliance with the use of system charging methodology results in charges which reflect, as far as is reasonably practicable, the costs (excluding any payments between transmission licensees which are made under and in accordance with the STC) incurred by transmission licensees in their transmission businesses and which are compatible with standard condition C26</p>

	<p>(Requirements of a connect and manage connection);</p> <p>(c) that, so far as is consistent with sub-paragraphs (a) and (b), the use of system charging methodology, as far as is reasonably practicable, properly takes account of the developments in transmission licensees' transmission businesses.</p> <p>(d) Compliance with the Electricity Regulation and any relevant legally binding decision of the European Commission and/or the Agency.</p>
--	---

Standard Workgroup consultation questions – CMP264

Q	Question	Response
---	----------	----------

Q	Question	Response
1	<p>Do you believe that the CMP264 Original Proposal better facilitates the Applicable CUSC Objectives?</p>	<p>No we do not believe that CMP264 better facilitates the CUSC objectives. Excluding a subset of embedded generators from a material income stream creates a new distortion in the electricity market. By targeting only those generators connecting after 30 June 2017 the vast majority of embedded generators will be unaffected by the proposal.</p> <p>In addition the proposed modification will introduce differential treatment between embedded generators metered at the boundary of the distribution network and those which are located behind the meter. It is not sufficient to permit this difference in treatment simply because it is a challenging area and the argument that the proposal needs to just be an incremental improvement is an inadequate justification.</p> <p><u>We do not consider a proposal that introduces new discrimination into the market can meet the CUSC objective of better 'facilitating competition in the sale, distribution and purchase of electricity.'</u></p> <p>We consider that the most significant driver of the costs 'incurred by transmission licencees in their transmission businesses' is the absolute size of the transmission system. This total cost is influenced by the amount of capacity connected to and transporting electricity through the transmission system. Embedded generation, over time, reduces the size of the transmission system and as a consequence it is appropriate that embedded generators receive a share of the benefit arising from the reduced size and cost of the transmission system.</p> <p><u>We do not consider that proposal CMP264 would result in charge which better reflect the costs 'incurred by transmission licencees in their transmission businesses'</u></p> <p>The proposer, by its own admission, does not consider that this modification should be the enduring solution and as a result this modification, if it were to be accepted, would likely lead to a series of similar modifications, each of which would lead to a period of uncertainty and a further erosion of investor confidence in the UK electricity market.</p>

Q	Question	Response
2	Do you support the proposed implementation approach? Or are there any further implementation implications that need to be considered?	<p>We do not support the proposed implementation approach. We believe that the required code and system changes, were this proposal to be taken forward, would take significantly longer than the timescales for implementation outlined in the proposal.</p> <p>Insufficient time has been allowed during the working group process to sufficiently investigate the impact on suppliers, systems and consumers of the proposed modification and that any change so fundamental in its approach to charging arrangements should not be rushed into implementation in such short timescales with the potential for requiring manual work arounds and rushed changes to systems and processes.</p>
3	Do you have any other comments?	<p>Noting OFGEM's recent open letter on this matter we would question whether the description of CMP264 as a 'stop-gap' measure is appropriate. Since OFGEM appear to be content for the CUSC modification proposal to run its course the proposal will become an enduring change to the charging arrangements.</p> <p>We believe that the proposal is entirely unsuitable as an enduring solution to the identified defect and appears to be little more than a swift and crude move designed to impact on clearing prices in the 2016 Capacity Market auction. National Grid identifies over 7.5GW of embedded generation operating during the Triad periods all of which would be unaffected by the current proposal.</p>
4	Do you wish to raise a WG Consultation Alternative Request for the Workgroup to consider?	<p>No. We are supportive of the alternative proposed by Green Frog and believe that this is the most appropriate way of mitigating the real defect which we consider to be the rapid rise in supplier TNUoS rates as a result of the large annual increases in transmission allowed revenues compounded by a cap on charges to transmission connected power plants.</p>

Standard Workgroup consultation questions – CMP265

Q	Question	Response
---	----------	----------

Q	Question	Response
5	<p>Do you believe that the CMP265 Original Proposal better facilitates the Applicable CUSC Objectives?</p>	<p>No we do not believe that CMP265 better facilitates the CUSC objectives. Excluding a subset of embedded generators from a material income stream creates a new distortion in the electricity market. There appears to be no rationale for excluding only those embedded generators with CM contracts from receiving Triad payments and the vast majority of embedded generators will be unaffected by the proposal. In addition the proposed modification will introduce differential treatment between embedded generators metered at the boundary of the distribution network and those which are located behind the meter. It is not sufficient to permit this difference in treatment simply because it is a challenging area and the argument that the proposal needs to just be an incremental improvement is an inadequate justification.</p> <p><u>We do not consider a proposal that introduces new discrimination into the market can meet the CUSC objective of better 'facilitating competition in the sale, distribution and purchase of electricity.'</u></p> <p>We consider that the most significant driver of the costs 'incurred by transmission licencees in their transmission businesses' is the absolute size of the transmission system. This total cost is influenced by the amount of capacity connected to and transporting electricity through the transmission system. Embedded generation, over time, reduces the size of the transmission system and as a consequence it is appropriate that embedded generators receive a share of the benefit arising from the reduced size and cost of the transmission system.</p> <p><u>We do not consider that proposal CMP265 would result in charge which better reflect the costs 'incurred by transmission licencees in their transmission businesses'</u></p>
6	<p>Do you support the proposed implementation approach? Or are there any further implementation implications that need to be considered?</p>	<p>We believe that the proposed implementation approach on CMP265 is preferable to CMP264 allowing sufficient time to amend industry documents and systems prior to the effective date of the changes. However, we are not supportive of the proposal and therefore do not support the implementation proposal.</p>

Q	Question	Response
7	Do you have any other comments?	<p>We believe that the proposal is entirely unsuitable as an enduring solution to the identified defect and appears to be little more than a swift and crude move designed to impact on clearing prices in the 2016 Capacity Market auction. National Grid identifies over 7.5GW of embedded generation operating during the Triad periods. A significant majority of this capacity would be unaffected by the current proposal. The proposal is likely to lead to gaming behaviour as embedded generators switch between capacity market and Triad revenue streams depending on which is the most commercially advantageous. We remain unconvinced that this proposal could be administered and fear that the burden placed on suppliers would be unacceptable as generators move between excluded and eligible categories from year to year. This would also make it difficult for National Grid to accurately calculate its charging base..</p>
8	Do you wish to raise a WG Consultation Alternative Request for the Workgroup to consider?	<p>No. We are supportive of the alternative proposed by Green Frog and believe that this is the most appropriate way of mitigating the real defect which we consider to be the rapid rise in supplier TNUoS rates as a result of the large annual increases in transmission allowed revenues compounded by a cap on charges to transmission connected power plants.</p>

Specific questions for CMP264

Q	Question	Response
---	----------	----------

Q	Question	Response
10	<p>i) Do you think a cut-off date for “new embedded generation” of 30 June 2017 is appropriate? What other date would you propose?</p> <p>ii) Do you have any views on how mixed sites are being addressed in CMP264 Original?</p> <p>iii) Do you think new-build embedded generation capacity that has entered into long term financial and performance commitment obligations via 2014 and 2015 capacity market or contracts for difference auctions (prior to this modification proposal) should be given exceptions to this cut-off date?</p> <p>iv) Do you agree that ignoring demand behind the meter is unlikely to create a significant “loophole” or material discrimination risk in relation to the CMP264 arrangements in the short term</p>	<p>i) we believe that the cut-off date is arbitrary and entirely inappropriate . The date appears to be an attempt at grandfathering and at providing some level of protection for investments that have already been made. Since the date falls little more than 6 months after the planned determination date by OFGEM this appears to be too short a period for affected parties to react. If CMP264 were to be progressed we would expect a later cut-off date, perhaps 30 June 2018, or a derogation for plants which have made substantial commitments similar to the concept of Financial Commitment Milestone in the Capacity Market.</p> <p>We believe that there should be consistency in how similar assets are treated. Location behind the meter should not confer an advantage. As currently designed the proposal treats the same asset with different metering configurations in different ways, this approach is discriminatory.</p> <p>We believe that all classes of generation should be treated in the same way. Providing derogations for certain classes of embedded generation risks creating distortions in the market and bestowing windfall gains on certain generators. Whilst this response is potentially contradictory to our answer to (i) above we believe this highlights the inherent deficiencies of CMP264.</p> <p>We believe that ignoring behind the meter generation is discriminatory and given the size of the potential reward presents a significant motivation for generators to alter their metering arrangements.</p>

Q	Question	Response
	<p>v) Question to suppliers: Do you consider that the wording of your existing contracts allow you to reflect the changes provided by these modifications in a cost reflective manner. For example, these changes will apply to existing PPAs and generators who significantly alter their output (EREC 59).</p> <p>vi) Do you agree with the definition of commissioned and do you agree that it is appropriate? If you do not agree with the definition or that it is appropriate please provide alternative definitions and rationale for this definition.</p>	<p>N/A</p> <p>We believe the definition of commissioned will require further development and consideration as CMP264 is further developed. We would comment that there should be consistency of treatment across embedded generators and as we believe the creation of a separate register of excluded embedded generation is likely to be problematic and is unnecessary.</p>
13	<p>Do you have a view of whether implementation for the 2017/18 Triad season is sufficient to allow changes for:</p> <p>i) supplier contracts and billing system; and</p> <p>ii) ii) for other stakeholders?</p>	<p>Were this modification to be implemented we believe it essential that adequate time be given to allow all affected parties to adjust their business models and processes.</p> <p>For those power plants under construction that have raised debt financing a cliff edge commissioning date will create risks of stranded assets and default on debt financing arrangements.</p> <p>Suppliers will need sufficient time to adjust systems, change contracts (if this is possible), recalculate and implement new customer tariffs.</p>

18	<p>Do you have a view if embedded benefits are frozen at a non-zero value, what should that value be as a £/kW tariff (2016/17 value is £45.33 / kW)?</p>	<p>We believe the value of the embedded benefit should be frozen at current rates to alleviate the impact of a rapidly escalating transmission system cost.</p> <p>We believe that a full holistic review of the appropriate value of embedded benefits should be conducted outside of the CUSC process.</p>
----	--	--

Specific questions for CMP265

Q	Question	Response
11	<p>i) Views are sought on the implication for mixed sites discussed in 3.4.10.</p> <p>ii) Views are sought on the preference of categories of capacity Market CMU captured by this proposal, please indicate your preference from the following list and reasons:</p> <ul style="list-style-type: none"> • All existing and new distribution generation CMUs • All existing and new distribution generation CMUs and DSR CMUs (proven and unproven) • All price maker CMUs • All newbuild/prospective distribution generation CMUs only (defined as >1year contracts) 	<p>We are not in favour of implementing changes to the CUSC that differentiate between different customers performing ostensibly the same activity.</p> <p>We do not support the proposal and as such do not wish to comment on which category of CMU will be discriminated against under this proposal.</p>

14	<p>Do you have a view of whether implementation for the 2020/21 Triad season is sufficient to allow changes for i) supplier contracts and billing system, and ii) for other stakeholders?</p>	<p>Were this modification to be implemented then we believe 2020/21 is a realistic timescale.</p>
----	--	---

Specific questions for BOTH CMP264&CMP265

Q	Question	Response
9	<p>i) Suppliers: In setting charges for your demand customers, do you charge them at the same tariff as National Grid charges you (i.e. gross), to enable you to pay the embedded benefit to embedded generators, or please explain the way in which it is funded?</p> <p>ii) Suppliers: Does the estimate that 7.58GW of embedded generation output and 2.5GW of demand side reduction at the time of Triad for 2016/17 seem reasonable based on your knowledge of the UK market? If not what is your estimate of embedded generator output and DSR at time of Triad?</p>	<p>No response</p> <p>No response</p>
12	<p>Can you identify – either quantitatively or qualitatively - the impact of the demand TNUoS embedded benefit on your decisions made in making capacity market decisions?</p>	<p>The Triad revenue stream was an important consideration in formulating bids into the past two CM auctions. As one of the few significant, stable and forecastable revenue streams for an embedded generator it was a key determinant of the bids placed in the CM auctions.</p>

Q	Question	Response
15	<p>i) What are your views on the 2 broad options to enable the reporting of gross export metered data?</p> <p>ii) Would you have the data available required for Option B (both CMP264 and CMP265) for both new contracts and existing contracts where a customer may be partially exempt?</p> <p>iii) Do you believe you can implement the proposed changes by the respective implementation dates?</p> <p>iv) What are the pros and cons of the 2 proposals that ELEXON are considering to implement this (P348 for CMP265/ P349 for CMP264)?</p>	<p>We do not believe sufficient information has been presented in the consultation document to enable informed comment on the question.</p> <p>No comment</p> <p>No comment</p> <p>We do not believe sufficient information has been presented in the consultation document to enable informed comment on the question.</p>

Q	Question	Response
16	<p>Do you have any further evidence / comments on the consumer impact of changing the demand TNUoS embedded benefit in either the short-run or long-run?</p>	<p>Welsh Power has commissioned a study to quantify the value of embedded generation and to quantify the significant cost to consumers which will be a direct and immediate result of proposed changes. The results of this report are not yet available.</p> <p>However It is clear that both of the proposed modifications are intended to increase the clearing price in the upcoming capacity market auction and to raise electricity prices. The proposers of CMP264 and CMP265 hypothecate that this will lead to more efficient investment decisions in the future which will lead to lower costs to consumer in the long run. Whilst it was generally accepted by the working group that the short term impact of the proposals would be a clear increase in consumer costs no evidence was presented to the work group to justify how the anticipated reduction would materialise in the longer term. Purist economic arguments tabled by the proposers about efficient market signals and rational investment decisions ignore the facts of the UK energy market which has over the past decade relied increasingly on subsidy and regulatory intervention to bring forward new build capacity. The Capacity Market is the most recent and obvious example of intervention in the market to bring forward new capacity and compensate for market failures. It is nonsensical to argue that the removal of Triad benefits would lead to a more efficient investment signal given the evidence of the past years and to do so would risk shouldering consumers with significant increased cost in the near term in the hope that lower costs would materialise at some point in the future.</p>
17	<p>Do you feel that both the locational and residual component of the demand TNUoS should be removed as an embedded benefit (as CMP264 Original) or just the residual component (as CMP265 Original) or some other method?</p>	<p>We do not support either proposal and consequently do not believe removal of either element is appropriate</p>

Q	Question	Response
19	Regarding the proposed alternatives what are your views on the suggested implementation dates? Are these achievable? Please give reasons for your view.	We believe any proposed implementation date before 2020/21 is unrealistic. The changes required to business models, charging arrangement, supplier contracts and industry processes require significant lead times. We also consider that the rush to implement a partial solution is unnecessary and unwarranted. Neither proposal adequately addresses the defect and it is unlikely that either will survive as an enduring solution. To rush implementation risks continual changes and flux in market arrangements.