

Assessment of Risks Resulting from the Adjustment of Vector Shift (VS) Based Loss of Mains Protection Settings

Phase II

Authors

Dr Adam Dyśko
Dimitrios Tzelepis
Dr Campbell Booth

This work was commissioned by and prepared for the National Grid
workgroup “Frequency changes during large system disturbances” (GC0079)

July 2017

**Institute for Energy and Environment
Department of Electronic and Electrical Engineering
University of Strathclyde
Glasgow**

Table of Contents

Abbreviations and symbols	3
Executive Summary	4
1 Introduction	7
2 WP1 – Simulation based assessment of NDZ for VS relay	8
2.1 NDZ Evaluation	8
2.2 Network modelling	8
2.3 DG Models and Controls.....	9
2.3.1 Synchronous Generator	9
2.3.2 Doubly fed induction generator	10
2.4 Determining the NDZ.....	11
2.5 NDZ results	11
3 WP2 – Risk level calculation at varying NDZ	18
3.1 Risk Calculation Methodology	18
3.1.1 Expected number of LOM occurrences in a single islanding point	19
3.1.2 Load and generation profile analysis.....	19
3.1.3 Calculation of national LOM probability figures and individual risk	22
3.2 Initial assumptions and available data	24
3.2.1 Potential islanding scenarios and estimated frequency of occurrence	25
3.2.2 DG connection register analysis	26
3.2.3 Load profile data.....	28
3.2.4 DG generation profiles.....	30
3.3 Risk calculation case studies and results	31
3.3.1 Case Study 1 (CS1): No dedicated LOM protection – setting option 9.....	31
3.3.2 Case Study 2 (CS2): ROCOF risk for SG and DFIG only	31
3.3.3 Case Study 3 (CS3): VS related risk assessment	32
4 Conclusions	35
5 References	37
Appendix A: Simulation model parameters	38
Appendix B: Detailed record of NDZ Assessment	40
B.1. Tabular Results.....	40
B.2. NDZ Graphs	42
Appendix C: Detailed VS risk assessment results (CS3).....	46
C.1. Summary Results.....	46
C.1.1. Case Study 3a – VS operation with no fault.....	46
C.1.2. Case Study 3b – VS operation with single phase-to-earth fault	48
C.1.3. Case Study 3c – VS operation with phase-to-phase fault	50
C.1.4. Case Study 3d – VS operation with three-phase fault	52
C.2. Detailed results for different generation mixes and load profiles (VS operation with no fault).....	54
C.2.1. Case Study 3a – VS operation with no fault.....	54
C.2.2. Case Study 3b – VS operation with single phase-to-earth fault	57
C.2.3. Case Study 3c – VS operation with phase-to-phase fault	60
C.2.4. Case Study 3d – VS operation with three-phase fault	63
C.3. Result figures (VS operation with no fault).....	66
C.3.1. Case Study 3a – VS operation with no fault.....	66
C.3.2. Case Study 3b – VS operation with single phase-to-earth fault	68
C.3.3. Case Study 3c – VS operation with phase-to-phase fault	70
C.3.4. Case Study 3d – VS operation with three-phase fault	72

Abbreviations and symbols

NDZ	- Non-Detection Zone
LOM	- Loss-Of-Mains
P_L, Q_L	- active and reactive power of the load
P_{DGG}, Q_{DGG}	- active and reactive power supplied by the group of distributed generators
NDZ_{PE}, NDZ_{QE}	- exporting NDZ (generator output is higher than the local load during LOM)
NDZ_{PI}, NDZ_{QI}	- importing NDZ (generator output is lower than the local load during LOM)
T_{NDZmax}	- maximum permissible duration of undetected islanding operation
n_{NDZ}	- number of detected NDZ periods
T_{load_record}	- total length of recorded load profile
$T_{NDZ(k)}$	- length of k -th NDZ period.
P_2	- probability of non-detection zone for generator group P_{DGG}, Q_{DGG}
P_3	- probability of non-detection zone duration being longer than T_{NDZmax}
$N_{LOG,1IP}$	- expected number of incidents of losing supply to a single islanding point in 1 year
n_{LOG}	- number of Loss-Of-Grid incidents experienced during the period of T_{LOG} in a population of n_{IP} islanding points
$N_{LOM,1DGG}$	- expected annual number of undetected islanding operations longer than the assumed maximum period T_{NDZmax} for a single DG
T_{NDZavr}	- overall average duration of the NDZ
T_{LOMavr}	- overall average duration of the undetected islanded condition
T_{ARmax}	- expected maximum time of auto-reclose scheme operation
$n_{DGG(m)}$	- number of all connected distributed generator groups in a given generation mix m
$p_{ROCOF(m)}$	- proportion of generators with ROCOF protection in a given generation mix m
$LF_{(m)}$	- load factor for a given generation mix m
$N_{LOM(m)}$	- expected number of undetected islanding incidents in 1 year (in generation mix m)
$T_{LOM(m)}$	- total aggregated time of undetected islanding conditions in 1 year (in generation mix m)
$P_{LOM(m)}$	- probability of the occurrence of an undetected island within a period of 1 year (in generation mix m)
N_{LOM}	- expected national number of undetected islanding incidents in 1 year
T_{LOM}	- total aggregated time of undetected islanding conditions in 1 year
P_{LOM}	- overall probability of the occurrence of an undetected island within a period of 1 year
$P_{PER,E}$	- probability of a person in close proximity to an undetected energised islanded part of the system being killed
$P_{PER,G}$	- probability of a person in close proximity of the generator while in operation
IR	- annual probability related to individual risk
IR_E	- annual probability related to individual risk (injury or death of a person) from the energised parts of an undetected islanded network
P_{AR}	- probability of out-of-phase auto-reclosing action following the disconnection of a circuit supplying a primary substation
N_{OA}	- annual rate of occurrence of any generator being subjected to out-of-phase auto-reclosure during the islanding condition not detected by LOM protection
IR_{AR}	- annual probability related to individual risk from the generator destruction following an out-of-phase auto-reclosure.
WPD	- Western Power Distribution
ENW	- Electricity North West
UKPN	- UK Power Networks
SPD	- ScottishPower Distribution
NPG	- Northern Powergrid
SSE	- Scottish and Southern Energy

Executive Summary

This report describes the outcomes of the extension to Phase II of the work conducted at the University of Strathclyde to assess the risks associated with the adjustment of the loss of mains (LOM) protection settings (through increasing or relaxing the settings, and therefore potentially compromising the sensitivity).

The main purpose of this extension is to investigate the risks associated with the considered relaxation of the voltage Vector Shift (VS) protection settings. The assessment has been undertaken to quantify the risks to individuals' safety, as well as the risk of potential generator equipment damage through unintentional out-of-phase auto-reclosing. This not include potential risks to DNO's plant.

The VS risk assessment work reported in this document utilises the models and resources developed during the earlier work on ROCOF risk assessment, in particular Phase II concerning distributed generation with installed capacities less than 5 MW.

The following case studies have been included in this report:

- Case Study 1 (CS1): No dedicated LOM protection – denoted as setting option 9
The purpose of this case study was to estimate the relative risk increase under the assumption that there is no dedicated LOM protection installed, and islanding detection relies purely on the operation of voltage and frequency protection (set according to G59/3 recommendation). As non-detection zone (NDZ) values for G59 protection were known already from the Phase II work [1] the CS1 risk assessment was performed on the whole population of DG with ROCOF as LOM protection.
- Case Study 2 (CS2): ROCOF risk for SG and DFIG only
- Case Study 3 (CS3): VS related risk assessment for SG and DFIG only
In Phase II report [1] it was identified that the majority of LOM related risk (approximately 62%) is linked to islands formed either by Synchronous Generators (SG) or Doubly-Fed Induction Generators (DFIG). For this reason, and in the interest of limiting the otherwise major effort of assessing NDZ for 15 different generating mixes, it was considered appropriate limit the investigation of VS performance to systems incorporating only these two generating technologies. Consequently, the absolute risk values for VS protection correspond to those two technologies only. However, to facilitate direct comparison with the previously obtained results in Phase II [1], a risk assessment for ROCOF has been repeated using SG and DFIG based generation only. This is denoted as Case Study 2 in this report.

The report builds upon previous documents (prepared in Phase I [2] and Phase II [1]) and ascertains whether the risk of non-detection, under the proposed setting changes, is in line with accepted risk assessment and management approaches that are consistent with the Health and Safety at Work Act 1974 [3]. To achieve the objectives of quantifying and assessing risk, detailed dynamic simulation work has been carried out to determine the potential islanding non-detection zone (NDZ) associated with different VS settings (four setting options to be investigated were stipulated by the workgroup members).

The NDZ has been quantified in terms of the surplus/deficit power supplied by the DG prior to islanding and is expressed as a ratio of this power to the rating of the islanded DG (or the combined rating of multiple units when more than one generator is islanded). The dynamic simulation work uses a transient model of the utility network including generation, and a numerical model of a DG interface relay (MiCOM P341) commonly used in the UK. In addition, the methodology makes use of recorded load profiles, and historical statistics relating to customer interruptions and network incidents. The same data was previously used in Phase II ROCOF study [1].

During the NDZ assessment the operation of both VS and G59 protection (Overvoltage - OV, Undervoltage - UV, Overfrequency - OF, Underfrequency - UF) was considered. The combined NDZ values are arrived at through assessment of the region of non-operation of all of these protection functions.

The following key observations related to risk of “no LOM” and VS LOM protection have been established:

- Considering all existing generation technologies and potential islanding mixes (CS1), the effect of disabling ROCOF protection would result in approximately 75% risk increase compared to ROCOF based LOM protection set to 1 Hz/s with 0.5 s delay. To put this figure into perspective the previously assessed risk increase between the existing practice (0.125 Hz/s, with 0 s delay) and the proposed option 4 (1 Hz/s with 0.5 s delay) was approximately 2 orders of magnitude.
- VS protection is generally very ineffective, especially with a setting of 12° or higher. When using those settings, the generator is disconnected by G59 protection (as opposed to VS) in the majority of islanding situations, except for the case when a 3-phase fault occurs at the same time.
- Due to generally low islanding detection sensitivity the difference between the existing practice (VS set to 6°) and the remaining setting options of 12°, 24° and 48° is insignificant, except for the case with a three-phase fault which has a relatively rare occurrence.
- Note that if there is a three phase fault on the network, the generator’s own protection (e.g. overcurrent) would be bound to trip the generator.
- Risk related to accidental electrocution (IR_E) for the LOM option where only G59 voltage and frequency protection are used, is estimated at $6.28 \cdot 10^{-7}$ and lies in the broadly acceptable region according to the Health and Safety at Work Act 1974 [3]. Therefore, it can be viewed as acceptable.
- Similarly to the earlier Phase II study reported in [1], the rate of occurrence of out-of-phase auto-reclosing (N_{OA}) appears to be high with all considered VS setting options (nearly 80 expected incidents per annum under “no LOM” protection option), and therefore, should not be neglected. Further assessment of the anticipated costs and consequences of out-of-phase auto-reclosing to individual generating technologies is required to realistically assess the proportion of those incidents which would cause serious damage to the generator or endanger personnel. The presented final figures make no such distinction and assume that 80% of all out-of-phase re-closures are damaging. Moreover, consideration of the proportion of the network where auto-reclose is not enabled (e.g. underground cables) would reduce the expected number of out-of-phase reclosures further.

- Although the simulated NDZ values and calculated risk levels presented in this document relate specifically to distributed generation with installed capacity of less than 5 MW, the outcomes can be helpful in considering LOM practice on larger generators. Assuming similar performance of all synchronous machine based generation during islanding, the VS related NDZ values presented in this report (and those included in Phase II report [1] for ROCOF protection) could be used to inform the decision on disabling VS in larger generators (>5 MW). The report demonstrates that the VS NDZ under all setting options is the same as NDZ with "no LOM" (i.e. V and f protection only). Therefore, disabling VS does not change the risk. Additionally, it was observed that changing VS to ROCOF with a setting of 1 Hz/s, 0.5s delay, on synchronous generators, would result in a minor risk reduction.
- In all VS case studies (including LOM option) the individual estimated risk of electrocution (denoted as IR_E) is within the limits of broadly acceptable region (i.e. $< 10^{-6}$), and therefore, is consistent with the expectations of the Health and Safety at Work Act 1974 [3].
- Actual observed incidence of unintended islanding operation in UK appears to be lower than the analysis shows which indicates that the absolute risk figures presented in this report are overestimated. This is due to various pessimistic assumptions made in the calculation process. Although some evidence of unintended islanding operation has been reported in Spain [4], in GB system there have not been any documented cases to date. Therefore, the results included in this report should not be interpreted as absolute risk estimates but rather as an indicator of the relative difference between the existing and future risk levels under the considered revision options.

1 Introduction

The VS risk assessment work reported in this document utilises the models and resources developed during the earlier work on ROCOF risk assessment, in particular Phase II [1] concerning distributed generation with installed capacities less than 5 MW. In Phase II report [1] it was identified that the majority of LOM related risk (approximately 62%) is linked to islands formed either by Synchronous Generators (SG) or Doubly-Fed Induction Generators (DFIG). For this reason, it was considered appropriate to limit VS investigation to those two technologies.

The report contains two main sections as outlined in the proposal [5]:

- WP1: Simulation-based assessment of Non Detection Zone (NDZ): in this section, the NDZ is determined experimentally under varying VS settings using transient Matlab-based simulations which include a power network model and a detailed model of an LOM protection relay validated against a commercial device through hardware testing [6].
- WP2: Calculation of probability of specific hazards under “no LOM” and various VS settings: in this section, a generic NDZ/risk characteristic is established based on the obtained NDZ values, available load profiles, and a number of other assumptions which are explained fully in the report.

In order to meet the objectives outlined above, the work adopts a risk assessment methodology applied successfully in Phase II of this work [1] which dealt with ROCOF based LOM protection. In order to facilitate direct comparison with the ROCOF related results of Phase II, the underlying assumptions regarding the network configuration, load representation, generation technology with associated control systems have all been assumed the same. Likewise, the same load profile data and annual fault statistics were utilised to estimate probabilities of islanding incidents and occurrences of balanced (or very-near-balanced) conditions between local load and distributed generation output in the formed island prior to islanding occurring. This arrangement is used collectively to assess the risk of LOM non-detection with the aid of the developed risk tree. The generic outline of the risk assessment methodology is illustrated in Figure 1.

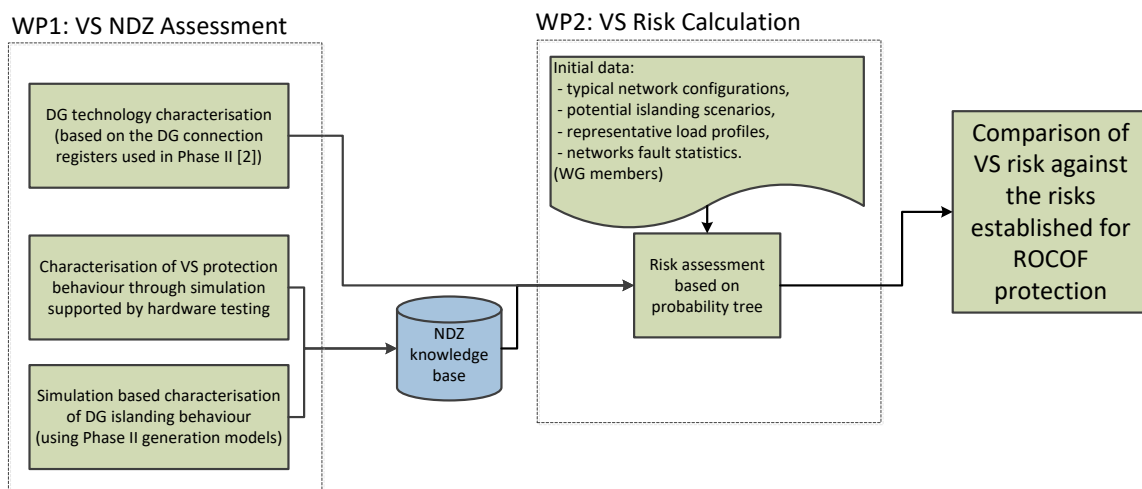

Figure 1. Risk assessment methodology

2 WP1 – Simulation based assessment of NDZ for VS relay

This section describes the results and approach through which the NDZ has been determined experimentally for a range of VS settings, including a configuration with G59 (OF, UF, OV, UV) protection only.

2.1 NDZ Evaluation

The objective of this experimental evaluation is to determine the non-detection zone (NDZ) of the VS and G59 (OV, UV, OF, UF) protection as a percentage of DG MVA rating. The imbalance of active and reactive power through the point of common coupling (PCC) is adjusted independently to determine the NDZ. A dynamic model of a commercially available DG interface relay commonly used in UK practice (MiCOM P341) has been utilised in this test. The NDZ was assessed separately for the following protective functions (outlined in Table 1):

- VS with four different setting options (marked in this report as options 5, 6, 7 and 8 to avoid confusion with the earlier considered ROCOF based LOM protection options 1 to 4).
- G59 only protection including under and over voltage (OV, UV), and under and over frequency (OF, UF), with two stages according to most recent recommendations included in G59/3 [7] (denoted as option 9). The NDZ for this option has been derived directly from the detailed results included in Appendix B of Phase II report [1].

The tripping signal for each protection function is monitored separately to determine which functions (OV/UV/OF/UF/ROCOF) are activated for each test case, and are recorded where appropriate.

Unlike ROCOF protection, VS relay operation is affected by the network fault. Therefore, the NDZ evaluation (and subsequent risk calculation) was performed both with and without the presence of the fault at the onset of the LOM event. All types of faults were considered, i.e. single phase-to-earth, phase-to-phase and three-phase faults.

Table 1: LOM Protection Options

LOM Option	LOM protection type	Setting
5	VS	6°
6	VS	12°
7	VS	24°
8	VS	48°
9	Voltage and frequency protection only	G59/3 recommended settings [7]

2.2 Network modelling

The network and generator models which were used previously in [1] to evaluate the performance and the risk of the ROCOF protection settings relaxation, have also been utilised in this study. The network is based on a reduced section of 11kV distribution network, representing a typical UK network (as illustrated in Figure 2). The potentially-islanded section of the network incorporating the DG is connected through a Point of Common Coupling (PCC) to the main grid. An LOM condition is initiated by opening the circuit breaker at PCC. The measured voltage (from which VS is derived) at busbar 'A' forms an input to the relay model under test. The network is modelled using Matlab/Simulink with SimPowerSystems toolbox. Additionally, a model of a commercially-available

DG interface relay commonly used in UK practice (MiCOM P341) has been utilised in this test. The network parameters are detailed in Table 18, and generator parameters are included in Table 19 and Table 20 for synchronous and DFIG generators respectively (Appendix A).

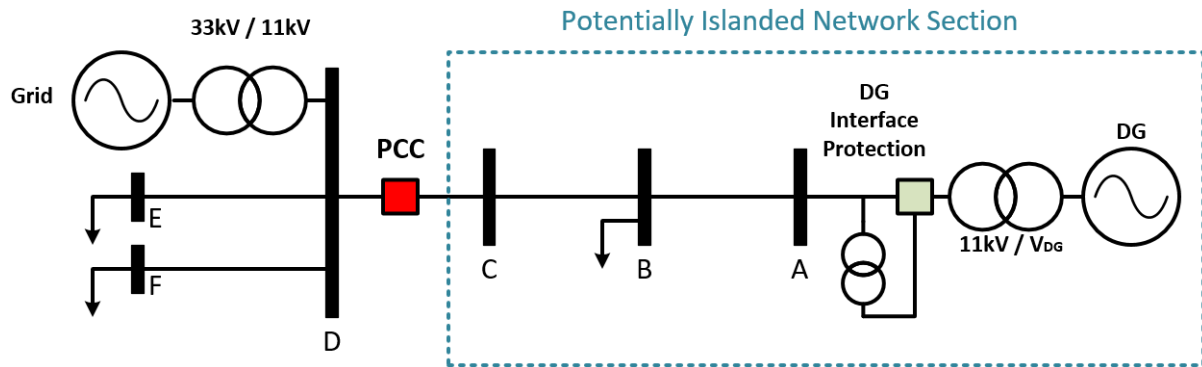

Figure 2. 11kV Test Network

2.3 DG Models and Controls

As previously mentioned, two different generator technologies have been included in the test programme, including SG and DFIG. For the purposes of the NDZ test the total installed capacity of the DG island is fixed at 2 MVA. Each DG is connected to the grid through a step-up transformer with unearthened HV winding to represent the typical DG connection arrangement in the UK.

2.3.1 Synchronous Generator

A synchronous machine with a power rating of 2 MVA is modelled as depicted in Figure 3. An active power and voltage (P-V) control scheme is employed for this machine. A standard IEEE governor/turbine model is also used (available in the SimPowerSystems component library). The block diagram for the excitation control is depicted in Figure 4. The parameters of the machine and the controller are detailed in Appendix A (Table 19).

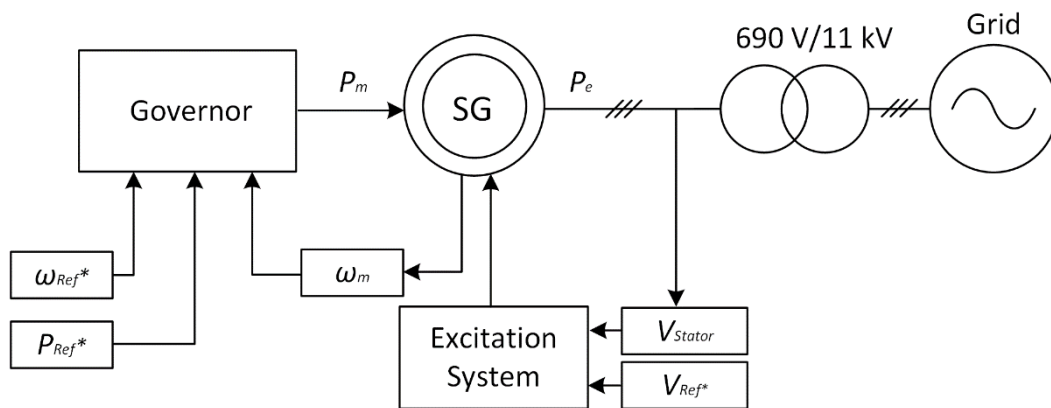

Figure 3. 11kV Synchronous Machine Model

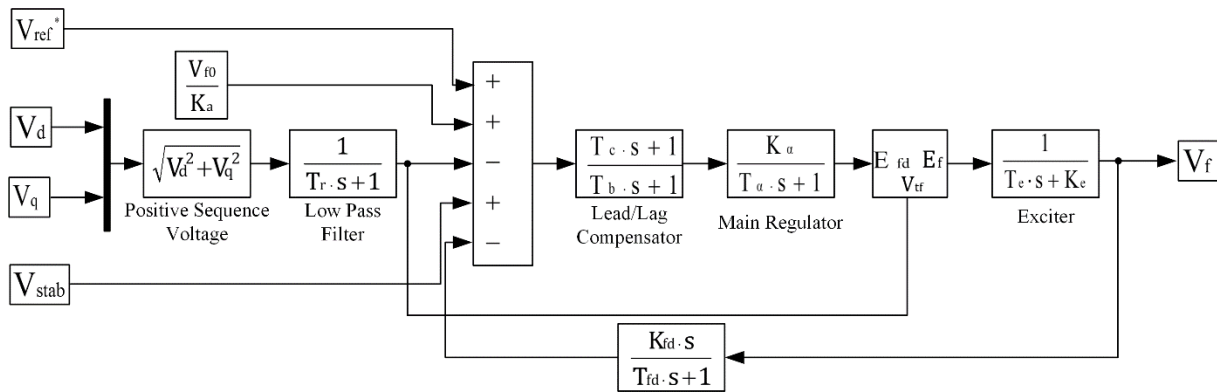

Figure 4. IEEE Type 1 Excitation System Block Diagram

2.3.2 Doubly fed induction generator

A DFIG with a maximum capacity of 2 MVA is modelled as shown in Figure 5. The DFIG consists of a wound-rotor induction generator, driven by a wind turbine and an AC/DC/AC IGBT-based PWM converter. The stator winding is connected through a transformer to the 11 kV 50 Hz grid, while the rotor is fed at variable frequency through the AC/DC/AC converter. The power converter offers the capability for variable speed operation while decoupled control of active and reactive power can be achieved.

Two controllers are utilised within the model. The Grid Side Converter (GSC) controller consists of an inner and outer control loop. The inner loop regulates the currents while the outer loop regulates the DC link voltage. The GSC operates at a fixed frequency (equal to the grid frequency) as it is connected directly to the grid. The main objective of the Rotor Side Converter (RSC) is to control the rotor currents which will define the torque produced by the DFIG. This is achieved by supplying the rotor with a voltage which corresponds to these currents. In order to control the output power of the DFIG, the GSC can use either a torque, a speed, or an active power controller. The parameters of the DFIG model are detailed in Appendix A (Table 20).

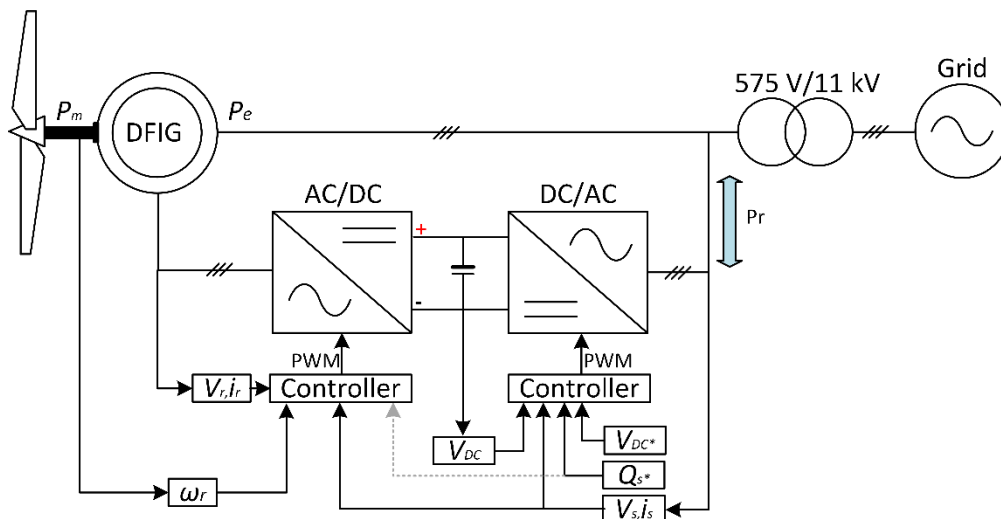

Figure 5. DFIG Model connected to 11kV Network

2.4 Determining the NDZ

The NDZ was determined for both levels of pre-island active and reactive power imports and exports across the PCC. The imbalance of one type of power (e.g. active) is changed while holding the other type of power imbalance (e.g. reactive) at 0% by adjusting the local demand (and generator reactive power output if necessary). The power imbalance is expressed as a percentage of the DG rating. An automatic search routine developed specifically for this study was employed to iteratively change the power imbalances and monitor the relay trip response. With each incremental change in power imbalance across the PCC, the numerical relay model was injected with the simulated bus 'A' 3-phase voltages. The reported values of NDZ (considering separately power import and export) for active and reactive power are expressed according to the following equations (1).

$$\begin{aligned} NDZ_{PI} &= \frac{P_{PCCI}}{S_{DG}} \times 100\%, & NDZ_{PE} &= \frac{P_{PCCE}}{S_{DG}} \times 100\% \\ NDZ_{QI} &= \frac{Q_{PCCI}}{S_{DG}} \times 100\%, & NDZ_{QE} &= \frac{Q_{PCCE}}{S_{DG}} \times 100\% \end{aligned} \quad (1)$$

Where:

NDZ_{PI}, NDZ_{PE} - Real power NDZ assessed for import and export respectively

NDZ_{QI}, NDZ_{QE} - Reactive power NDZ assessed for import and export respectively

P_{PCCI}, P_{PCCE} - Active power across the PCC defined separately for import and export

Q_{PCCI}, Q_{PCCE} - Reactive power across the PCC defined separately for import and export

S_{DG} - DG MVA Rating

The main reason behind the formation of LOM events is the occurrence of faults. In order to assess the performance of VS under fault occurrence, fault scenarios have been considered. These include single phase-to-earth faults (most common), phase-to-phase faults and three-phase faults. As illustrated in Figure 6, faults have been applied at the PCC on the DG side. The fault clearance time is assumed to be 100 ms which is considered the fastest achievable distribution fault clearance. From the stability (and island non-detection risk) standpoint it is a pessimistic assumption, and therefore, appropriate for ensuring that the risk is not underestimated.

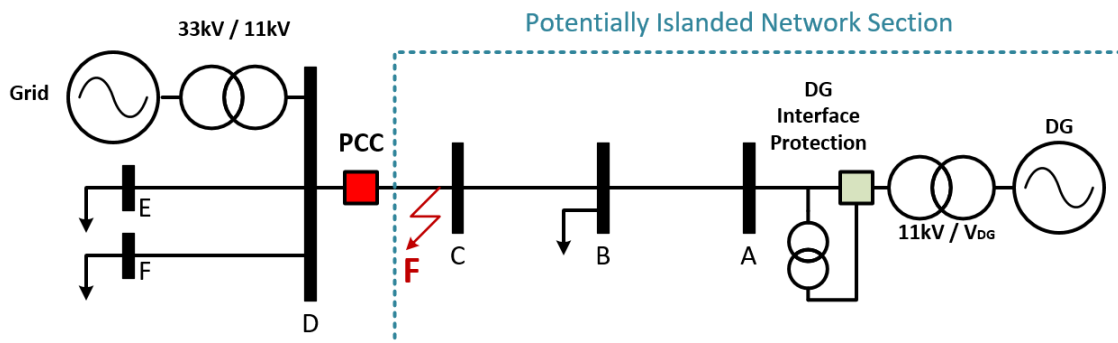

Figure 6: 11 kV Distribution network incorporating faults.

2.5 NDZ results

The combined NDZ results (with both VS and G59 protection enabled) for SG and DFIG based generating technologies are summarised in Tables 2 to 9. Values denoted by * indicate that G59 protection (combined operation of OF, UF, OV, and UF protection) has a narrower NDZ than the VS

protection (considering 3 s as a maximum operation time). The results in full detail are presented in Appendix B in Tables 21 to 30.

Table 2. Combined VS/G59 NDZ results for SG – No fault

Setting Option	VS setting [°]	NDZ_{PI} Import [%]	NDZ_{PE} Export [%]	NDZ_{QI} Import [%]	NDZ_{QE} Export [%]
5	6°	6.92*	3.14*	12.16*	23.67*
6	12°	6.92*	3.14*	12.16*	23.67*
7	24°	6.92*	3.14*	12.16*	23.67*
8	48°	6.92*	3.14*	12.16*	23.67*

Table 3. Combined VS/G59 NDZ results for SG – Single phase-to-earth fault

Setting Option	VS setting [°]	NDZ_{PI} Import [%]	NDZ_{PE} Export [%]	NDZ_{QI} Import [%]	NDZ_{QE} Export [%]
5	6°	6.92*	3.14*	12.16*	23.67*
6	12°	6.92*	3.14*	12.16*	23.67*
7	24°	6.92*	3.14*	12.16*	23.67*
8	48°	6.92*	3.14*	12.16*	23.67*

Table 4. Combined VS/G59 NDZ results for SG – Phase-to-phase fault

Setting Option	VS setting [°]	NDZ_{PI} Import [%]	NDZ_{PE} Export [%]	NDZ_{QI} Import [%]	NDZ_{QE} Export [%]
5	6°	6.92*	3.14*	5.46	23.67*
6	12°	6.92*	3.14*	12.16*	23.67*
7	24°	6.92*	3.14*	12.16*	23.67*
8	48°	6.92*	3.14*	12.16*	23.67*

Table 5. Combined VS/G59 NDZ results for SG – Three-phase fault

Setting Option	VS setting [°]	NDZ_{PI} Import [%]	NDZ_{PE} Export [%]	NDZ_{QI} Import [%]	NDZ_{QE} Export [%]
5	6°	6.92*	3.14*	7.241	23.67*
6	12°	6.92*	3.14*	9.515	23.67*
7	24°	6.92*	3.14*	12.16*	23.67*
8	48°	6.92*	3.14*	12.16*	23.67*

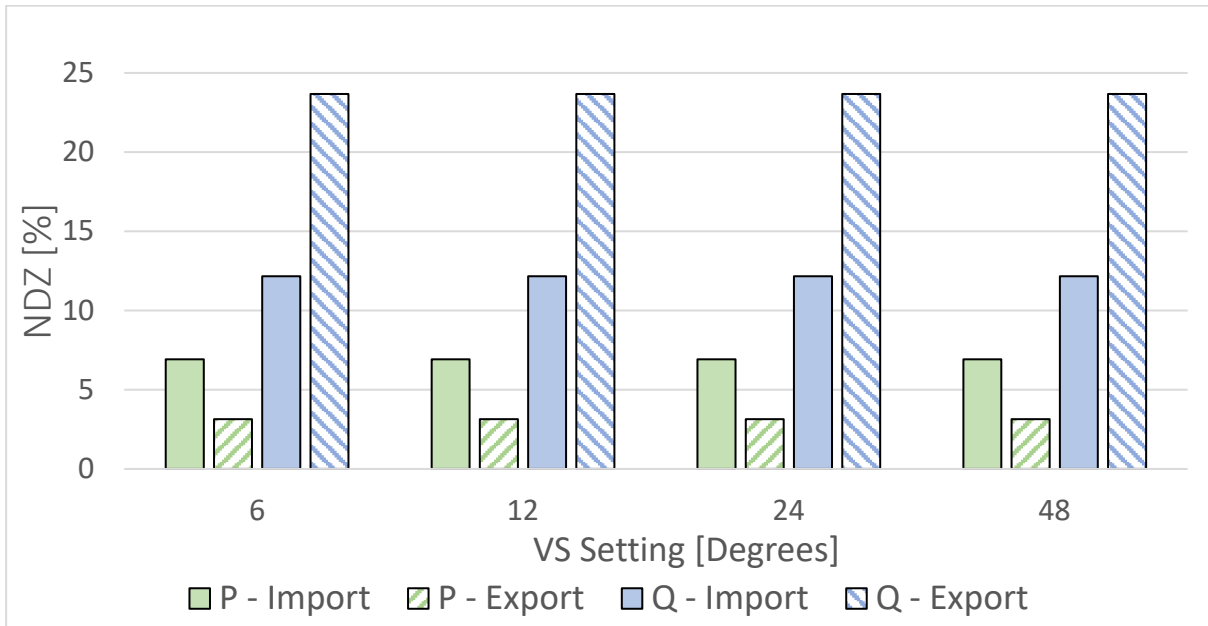

Figure 7: NDZ representation for combined VS/G59 results - SG (No fault)

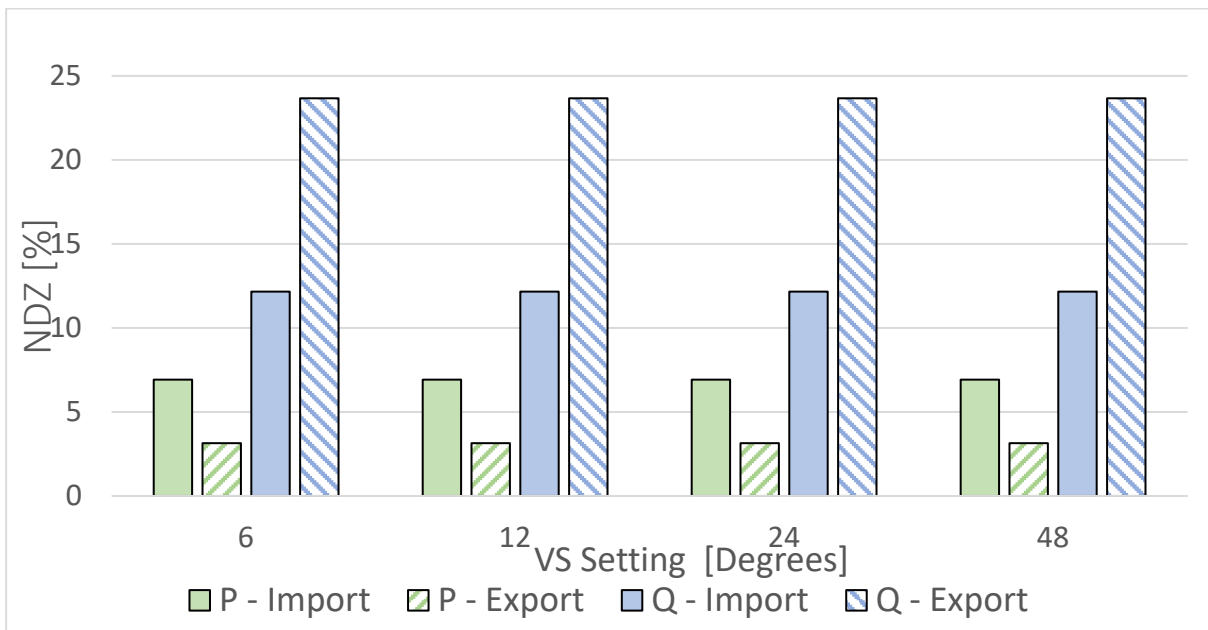

Figure 8: NDZ representation for combined VS/G59 results - SG (Single phase-to-earth)

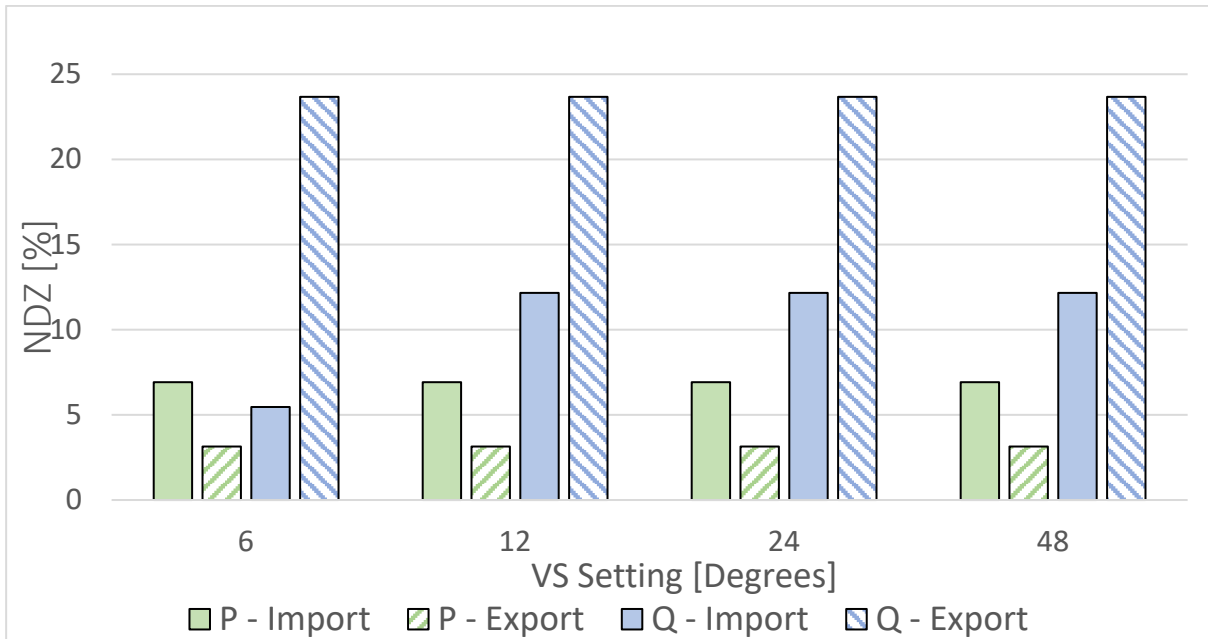

Figure 9: NDZ representation for combined VS/G59 results - SG (Phase-to-phase fault)

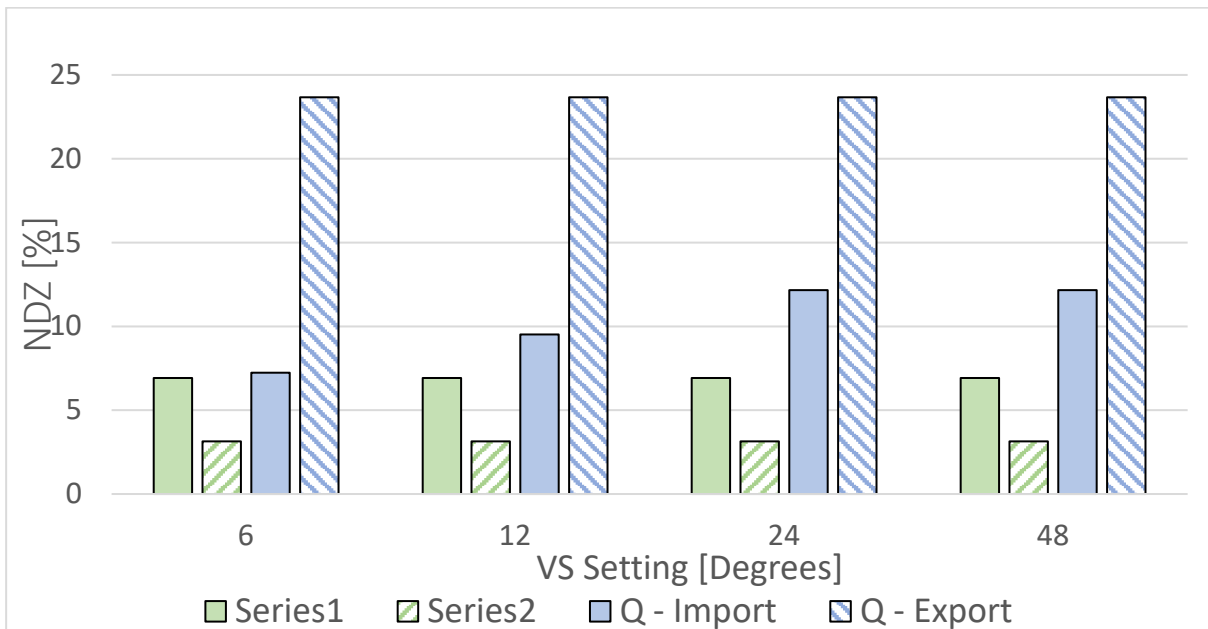

Figure 10: NDZ representation for combined VS/G59 results - SG (Three-phase fault)

Table 6. Combined VS/G59 NDZ results for DFIG – No fault

Setting Option	VS setting	NDZ_{PI}	NDZ_{PE}	NDZ_{QI}	NDZ_{QE}
	[°]	Import [%]	Export [%]	Import [%]	Export [%]
5	6°	3.97*	2.69*	8.69*	9.98*
6	12°	3.97*	2.69*	8.69*	9.98*
7	24°	3.97*	2.69*	8.69*	9.98*
8	48°	3.97*	2.69*	8.69*	9.98*

Table 7. Combined VS/G59 NDZ results for DFIG – Single phase-to-earth fault

Setting Option	VS setting	NDZ_{PI}	NDZ_{PE}	NDZ_{QI}	NDZ_{QE}
	[°]	Import [%]	Export [%]	Import [%]	Export [%]
5	6°	0	0	0	0
6	12°	3.97*	2.69*	8.69*	9.98*
7	24°	3.97*	2.69*	8.69*	9.98*
8	48°	3.97*	2.69*	8.69*	9.98*

Table 8. Combined VS/G59 NDZ results for DFIG – Phase-to-phase fault

Setting Option	VS setting	NDZ_{PI}	NDZ_{PE}	NDZ_{QI}	NDZ_{QE}
	[°]	Import [%]	Export [%]	Import [%]	Export [%]
5	6°	3.97*	2.69*	8.69*	9.98*
6	12°	3.97*	2.69*	8.69*	9.98*
7	24°	3.97*	2.69*	8.69*	9.98*
8	48°	3.97*	2.69*	8.69*	9.98*

Table 9. Combined VS/G59 NDZ results for DFIG – Three-phase fault

Setting Option	VS setting	NDZ_{PI}	NDZ_{PE}	NDZ_{QI}	NDZ_{QE}
	[°]	Import [%]	Export [%]	Import [%]	Export [%]
5	6°	0	0	0	0
6	12°	0	0	0	0
7	24°	0	0	0	0
8	48°	3.97*	2.69*	8.69*	9.98*

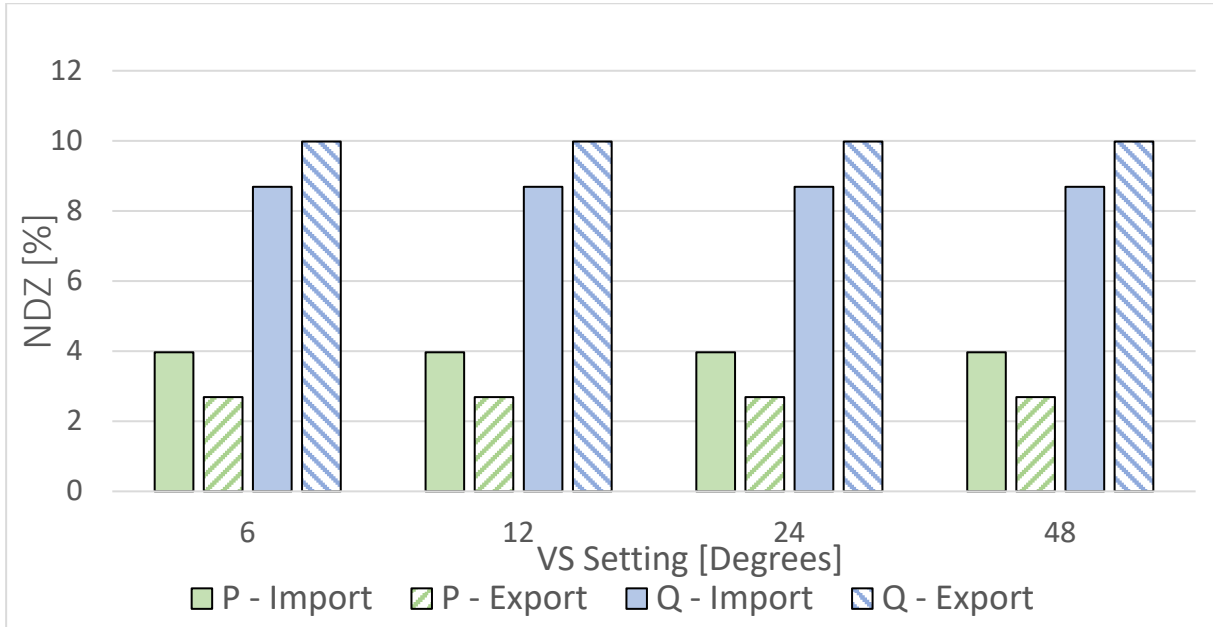

Figure 11: NDZ representation for combined VS/G59 results - DFIG (No fault)

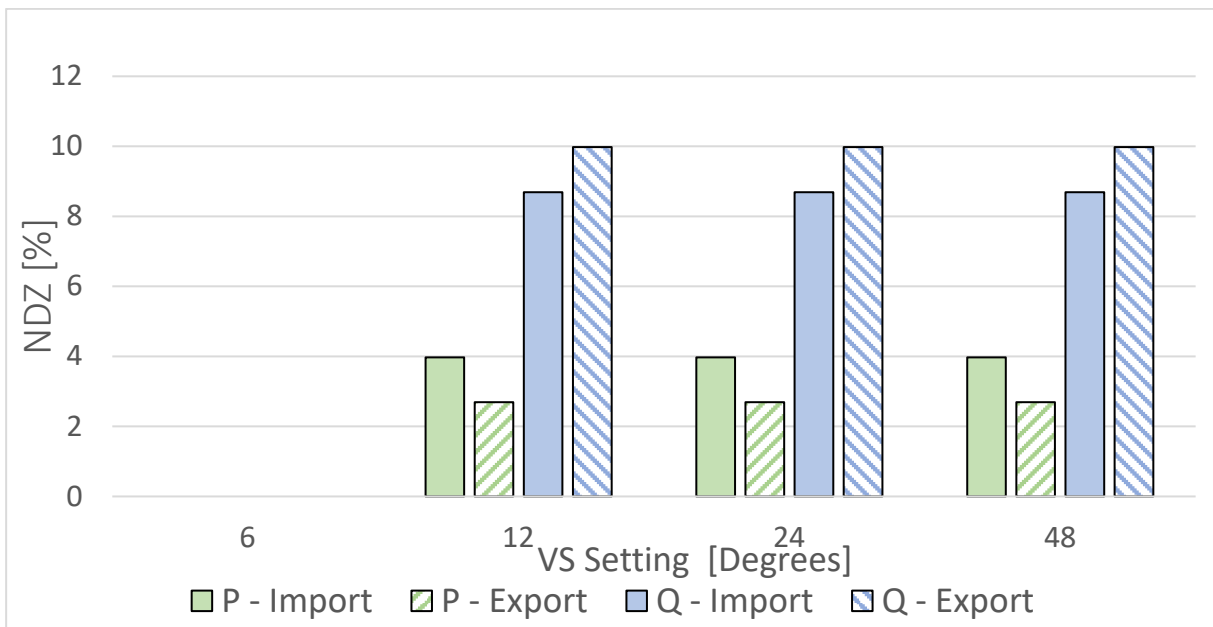

Figure 12: NDZ representation for combined VS/G59 results - DFIG (Single phase-to-earth)

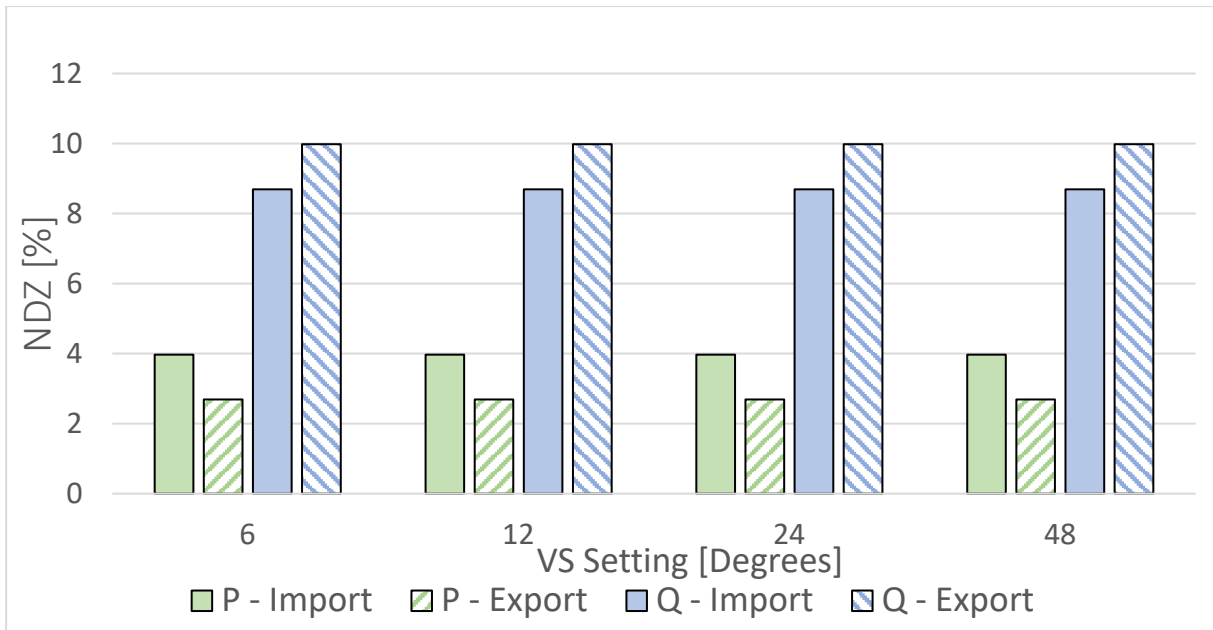

Figure 13: NDZ representation for combined VS/G59 results - DFIG (Phase-to-phase fault)

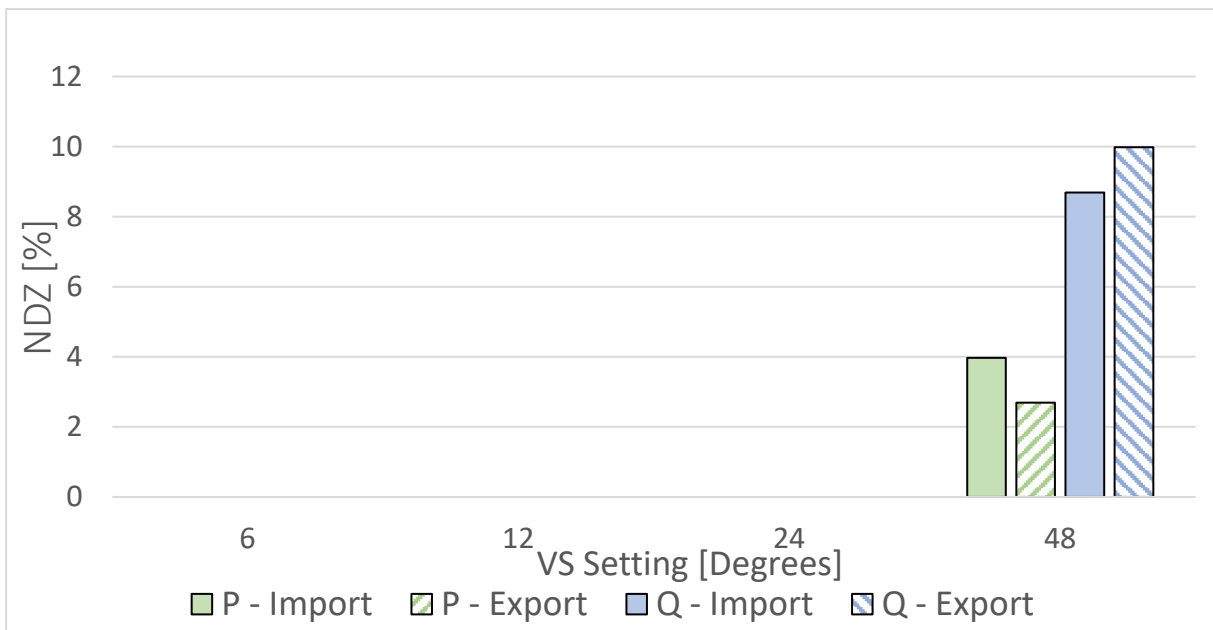

Figure 14: NDZ representation for combined VS/G59 results - DFIG (Three-phase fault)

3 WP2 – Risk level calculation at varying NDZ

3.1 Risk Calculation Methodology

The risk calculation methodology adopted in this report is essentially the same as the method previously applied in Phase II of the work [1]. The approach is based on a statistical analysis of a probability tree depicting perceived probability of specific hazards (including safety of people or damage to equipment).

The methodology makes a number of assumptions regarding the type of utility network, type and size of the distributed generators and generation technology (refer to section 3.2 for details). It utilises the width of the Non Detection Zone (NDZ) established through detailed dynamic simulation described earlier in section 2 of this document (WP1). Recorded typical utility load profiles, generation profiles, as well as statistics of utility network incidents including loss of supply to primary substations and short term interruptions are also utilised to estimate probabilities of islanding incidents and load-generation matching.

Additionally, detailed DG connection registers (provided by a number of DNOs for the purposes of Phase II assessment [2]) were utilised also here. With the use of a fault tree as presented in Figure 15, the calculations described in the following sub-sections, are performed to assess:

- a) personal safety hazard (the term Individual Risk IR_E is used in this report to denote the annual probability of death resulting from electrocution during an undetected LOM condition), and
- b) damage to generator occurring as a result of sustained undetected islanded operation of DG combined with likely out-of-phase auto-reclosure (the annual rate of occurrence of out-of-phase auto-reclosure N_{OA} is used in this report).

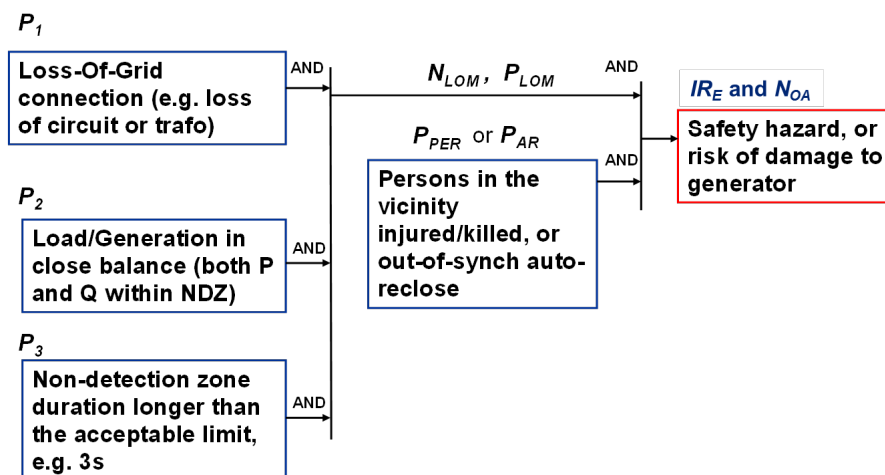

Figure 15. LOM Safety Hazard Probability Tree [1]

Due to the variety of islanding scenarios (section 3.2.1), in conjunction with the range of possible different generation mixes (section 3.2.1), the risk tree calculation is systematically repeated through all combinations of islanding situations and the final probability figures are obtained as a sum or weighted average of the individual results. The following subsections explain this process in detail. Although the methodology has been previously described in detail in Phase II report [2], it is also included here for completeness (with small adjustments to reflect the specifics of the VS study).

3.1.1 Expected number of LOM occurrences in a single islanding point

For a single islanding point (whether an entire substation or an individual circuit), the possibility of an undetected islanding situation arises from the loss of grid supply. Accordingly, the expected number of incidents of losing supply to an individual islanding point ($N_{LOG,1IP}$) during the period of one year can be estimated as follows:

$$N_{LOG,1IP} = \frac{n_{LOG}}{n_{IP} \cdot T_{LOG}} \quad (2)$$

where n_{LOG} is the total number of loss of supply incidents experienced during the period of T_{LOG} in a population of n_{IP} islanding points. The assumed values of n_{LOG} and n_{IP} for each islanding scenario have been derived from the network incident statistics, as described in section 3.2.1.

3.1.2 Load and generation profile analysis

For each generation mix and each islanding scenario $m = 1, 2, \dots, 4$ (in VS study only 2 mixes, i.e. SG and DFIG, were considered in each scenario) the probabilities $P_{2(m)}$ and $P_{3(m)}$ (refer to Figure 15) are calculated jointly by systematic analysis of the example recorded load and generation profiles recorded over a period of 1 week with 1 s resolution. This is performed iteratively in two nested loops. The inner loop (iteration i) progresses through the whole duration of the given record, while the outer loop (iteration j) covers the range of generation mix capacities according to the histogram characteristic of the given mix of technologies. The histograms for all predominant generation mixes are derived from the available DG connection registers as described in section 3.2.1. In each capacity band j there is a certain number of islanding points $n_{IP(m,j)}$. It should be noted that generator maximum output and generator rating are synonymous in the context of this calculation.

Within the inner loop at each time step (iteration i), the instantaneous load values $P_{L(i)}$ and $Q_{L(i)}$ are compared with the scaled version of the generation profile ($P_{DGG(m,j,i)}$ and $Q_{DGG(m,j,i)}$) to check if the difference falls within the NDZ established for the specific generation mix. This condition is described by (3).

$$\begin{aligned} -NDZ_{PE(m)} < P_{L(i)} - P_{DGG(m,j,i)} < NDZ_{PI(m)} \\ \wedge \\ -NDZ_{QE(m)} < Q_{L(i)} - Q_{DGG(m,j,i)} < NDZ_{QI(m)} \end{aligned} \quad (3)$$

Where:

- $P_{L(i)}, Q_{L(i)}$ - recorded samples of active and reactive load power
- $P_{DGG(m,j,i)}, Q_{DGG(m,j,i)}$ - scaled active and reactive generation profile for the generation mix m and capacity band j
- $NDZ_{PE(m)}, NDZ_{QE(m)}$ - NDZ when generator output is higher than the local load (export) for generation mix m
- $NDZ_{PI(m)}, NDZ_{QI(m)}$ - NDZ when generator output is lower than the local load (import) for generation mix m

When consecutive samples conform to the conditions specified in equation (3), the time is accumulated until the local load exits the NDZ. After all NDZ instances (i.e. their durations) are recorded, the NDZ duration cumulative distribution function (CDF) is derived, an example of which is

presented in Figure 16. As illustrated in the figure, the probability $P_{3(m,j)}$ that the NDZ is longer than T_{NDZmax} can easily be obtained from the CDF.

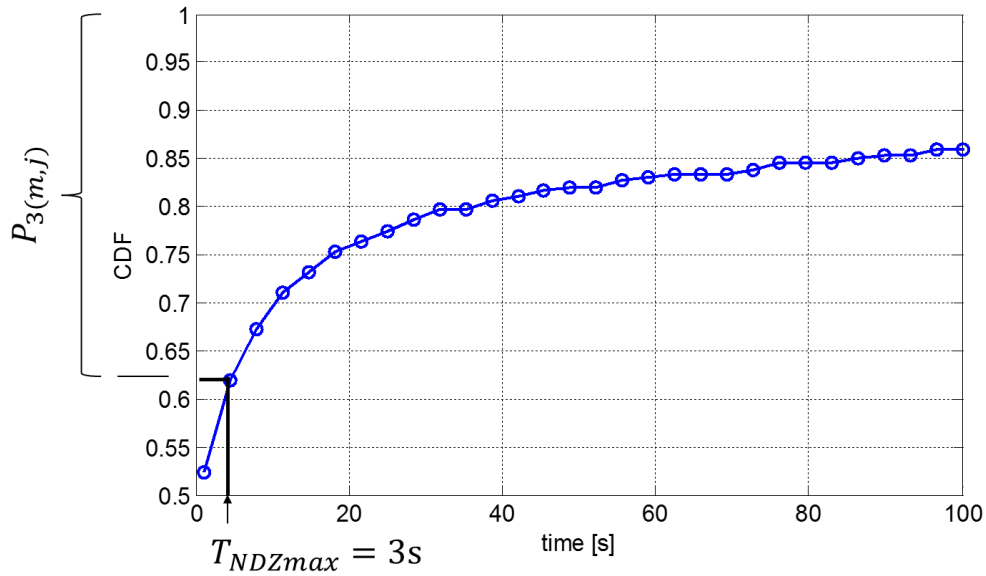

Figure 16. CDF of an example NDZ duration time

At the same time, the probability $P_{2(m,j)}$ of both P and Q being within the NDZ is also calculated as a sum of all recorded NDZ periods with respect to the total length of the recorded load profile (4).

$$P_{2(j)} = \sum_{k=1}^{n_{NDZ(m,j)}} \frac{T_{NDZ(m,j,k)}}{T_{load_record}} \quad (4)$$

Where:

- $n_{NDZ(m,j)}$ - number of detected NDZ periods within the capacity band j
- T_{load_record} - total length of the recorded load profile
- $T_{NDZ(m,j,k)}$ - length of k -th NDZ period.

Finally, the joint probability $P_{23(m,j)}$ for each capacity band j can be calculated as (5) which leads to the development of the probability density as shown in Figure 17.

$$P_{23(m,j)} = \frac{n_{DGG(m,j)}}{n_{DGG(m)}} P_{2(m,j)} \cdot P_{3(m,j)} \quad (5)$$

where:

- $n_{DGG(m,j)}$ - number of DG islanding groups in the mix m and the capacity band j
- $n_{DGG(m)}$ - total number of DG groups in the generation mix m

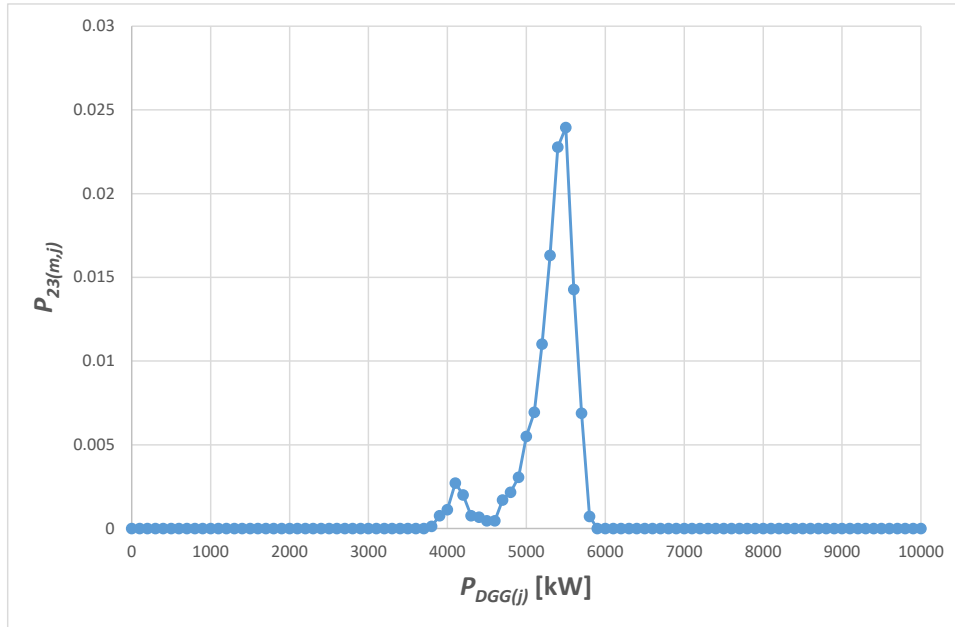

Figure 17. Non-detection zone probability at varying DG group capacity

Consequently, according to the principle of marginal probability [8], the combined probability $P_{23(m)}$, considering all DG groups of certain mix, is calculated using a simple summation as shown in (6).

$$P_{23(m)} = \sum_{j=1}^{n_{CB(m)}} P_{23(m,j)} \quad (6)$$

Where $n_{CB(m)}$ is the number of capacity bands.

The expected annual number of undetected islanding operations longer than the assumed maximum period T_{NDZmax} for an individual DG mix can be calculated as (7).

$$N_{LOM,1DGG(m)} = N_{LOG,1IP} \cdot P_{23(m)} \quad (7)$$

Additionally, the overall average duration of the NDZ for a given mix ($T_{NDZavr(m)}$) is calculated by adding all NDZ durations longer than T_{NDZmax} from all generator groups and dividing the sum by the total number of NDZ occurrences.

The above process described by equations (3)-(7) is repeated for all considered 4 islanding cases. The final figures of T_{NDZavr} are calculated as a weighted average (8) from all different generation mixes and islanding scenarios ($m = 1,2$ for scenarios 1 and $m = 3,4$ for scenario 2).

$$T_{NDZavr,s1} = \frac{\sum_{m=1}^2 n_{DGG(m)} \cdot T_{NDZavr(m)}}{\sum_{m=1}^2 n_{DGG(m)}}$$

$$T_{NDZavr,s2} = \frac{\sum_{m=3}^4 n_{DGG(m)} \cdot T_{NDZavr(m)}}{\sum_{m=3}^4 n_{DGG(m)}} \quad (8)$$

$$T_{NDZavr} = \frac{\sum_{m=1}^4 n_{DGG(m)} \cdot T_{NDZavr(m)}}{\sum_{m=1}^4 n_{DGG(m)}}$$

3.1.3 Calculation of national LOM probability figures and individual risk

In each case of generation mix m the expected annual number of undetected LOM events $N_{LOM(m)}$ and the probability of an undetected islanded system at any given time $P_{LOM(m)}$ are established. Firstly, using the known total number of connected DG groups ($n_{DGG(m)}$) with an assumed proportion of VS based LOM protection ($p_{VS(m)}$) and load factor ($LF_{(m)}$), the expected annual number of undetected islanding incidents (within mainland UK) can be estimated from:

$$N_{LOM(m)} = N_{LOM,1DG(m)} \cdot n_{DGG(m)} \cdot p_{VS(m)} \cdot LF_{(m)} \quad (9)$$

The expected cumulative time of undetected islanding conditions for all considered DG groups $n_{DGG(m)}$ in mix m can be estimated using:

$$T_{LOM(m)} = N_{LOM(m)} \cdot (T_{LOMavr(m)} - T_{NDZmax}) \quad (10)$$

where $T_{LOMavr(m)}$ is the average time that an undetected island can be sustained in mix m . This time is selected as the minimum value between $T_{NDZavr(m)}$ and assumed maximum operation time of the auto-reclosing scheme (T_{ARmax}). It is assumed that sustained islanded operation following an auto-reclose operation is not possible.

Finally, the overall probability in mix m of an undetected islanded system at any given time and at specific assumed VS settings is calculated as:

$$P_{LOM(m)} = \frac{T_{LOM(m)}}{T_a} \quad (11)$$

Where:

T_a – period of 1 year

The final figures of P_{LOM} are calculated as a direct sum of probabilities obtained for individual generation mixes ($m = 1,2$ for scenarios 1 and $m = 3,4$ for scenario 2).

$$P_{LOM,s1} = \sum_{m=1}^2 P_{LOM(m)}$$

$$P_{LOM,s2} = \sum_{m=3}^4 P_{LOM(m)} \quad (12)$$

$$P_{LOM} = \sum_{m=1}^4 P_{LOM(m)}$$

For a single DG group with VS protection in mix m , the probability can be calculated as:

$$P_{LOM,1DGG(m)} = \frac{P_{LOM(m)}}{n_{DGG(m)} \cdot p_{VS(m)}} \quad (13)$$

In this case the final figures of $P_{LOM,DGG}$ are calculated as a weighted average (proportional to the number of DG groups) from all different generation mixes and islanding scenarios ($m = 1,2$ for scenarios 1 and $m = 3,4$ for scenario 2).

$$P_{LOM,1DGG,s1} = \frac{\sum_{m=1}^2 n_{DGG(m)} \cdot P_{LOM,1DGG(m)}}{\sum_{m=1}^2 n_{DGG(m)}}$$

$$P_{LOM,1DGG,s2} = \frac{\sum_{m=3}^4 n_{DGG(m)} \cdot P_{LOM,1DGG(m)}}{\sum_{m=3}^4 n_{DGG(m)}} \quad (14)$$

$$P_{LOM,1DGG} = \frac{\sum_{m=1}^4 n_{DGG(m)} \cdot P_{LOM,1DGG(m)}}{\sum_{m=1}^4 n_{DGG(m)}}$$

In order to ascertain whether the risk resulting from the proposed adjustment to the VS settings is acceptable, the analysis and interpretation of the calculated N_{LOM} and P_{LOM} values is performed in two steps:

1. Firstly, the annual expected number of out-of-phase auto-reclosures (N_{OA}) during the islanding condition (undetected by LOM protection) is calculated as follows:

$$N_{OA} = N_{LOM} \cdot P_{AR} \quad (15)$$

where P_{AR} is the probability of an out-of-phase auto-reclosing action following the disconnection of a circuit supplying a primary substation. Considering that auto-reclosing action would occur in the vast majority of cases of losing supply to a primary substation (unless the system is wholly underground) and also considering the fact that reclosure with small angle differences may be safe, a value of $P_{AR} = 0.8$ was assumed.

2. Secondly, the annual probability values are calculated related to perceived Individual Risk (IR). Two sources of IR are considered: (a) the risk of a fatality due to accidental contact with any elements of the energised undetected island (IR_E), and (b) risk of physical injury or death resulting from the generator destruction following an out-of-phase auto-reclosure (IR_{AR}). These two indices are calculated as follows:

$$IR_E = P_{LOM} \cdot P_{PER,E} \quad (16)$$

$$IR_{AR} = N_{OA} \cdot P_{PER,G} \quad (17)$$

where $P_{PER,E}$ is the probability of a person in close proximity to an undetected islanded part of the system being killed, and $P_{PER,G}$ is the probability of a person being in close proximity of the generator while in operation and suffering fatal injury as a result of the generator being destroyed by an out-of-phase auto-reclosure. The resulting IR can be then compared with the general criteria for risk tolerability included in the Health and Safety at Work Act 1974 which adopts the risk management principle often referred to as the 'ALARP' or 'As Low as Reasonably Practicable' principle. The ALARP region applies for IR levels between 10^{-6} and 10^{-4} . Risks with probabilities below 10^{-6} can generally be deemed as tolerable. The same approach was used in the risk assessment of ROCOF protection [1][2] where the value of

$P_{PER,E} = 10^{-2}$ was used. However, the probability $P_{PER,G}$ will depend on specific circumstances, generator location and regime of operation, and therefore, it is beyond the scope of this report to quantify such probabilities.

The relative difference in the probability of undetected islanding condition under the existing recommended settings and the new proposed settings provides further guidance as to the acceptability of the proposed setting options.

3.2 Initial assumptions and available data

The following assumptions and initial values were made in this study:

- Generation range considered 0-5MW.
- Only synchronous and DFIG generating technologies were considered in this study.
- DFIG generation output is represented by an example measured wind generation profile provided by SSE (recorded with 5s sampling resolution), and synchronous generator was represented by constant output equal to the rated power of the machine, with the output assumed to be generated at a power factor of $pf = 0.99$ (*lagging*).
- Similarly to Phase I and II of the work, the load factor (LF) was assumed to be $2/3$ for synchronous generation, and for DFIG it was assumed that $LF = 1$.
- In order to provide the result which can be directly compared with the previously performed assessment of ROCOF protection in Phase II [1], the VS study was performed on the same population of generators, i.e. it was assumed that the VS relays are installed on the same generators. The percentage usage of VS protection was 80% for Synchronous, and 50% for DFIG based generation.
- Detailed distribution of DG sizes and numbers in the UK (also used previously in [1]) were obtained from available DG connection registers for the following DNOs: WPD, ENW, UKPN, SPD and NPG.
- Six different load scenarios recorded on typical 11kV and LV feeders in the UK were used as described in section 3.2.3.
- A period of $T_{NDZmax} = 3$ s was assumed as the maximum permissible duration of undetected islanding condition (i.e. no auto-reclosing faster than T_{NDZmax} is expected to occur).
- A period of $T_{ARmax} = 20$ s was assumed as the maximum expected time of operation of the auto-reclosing scheme (in other words, regardless of load/generation balance, undetected stable island will not continue to operate longer than T_{ARmax} due to the impact of out-of-phase reclosure).
- It is assumed that the generator (or a group of generators) does not continue to supply the system after an out-of-phase auto-reclosing operation.
- As VS relay operation is significantly affected by network faults, the LOM events were simulated both, as a simple opening of a circuit breaker at the point of common coupling, and by applying a fault prior to islanding. Single phase-to-earth, phase-to-phase and three-phase faults were considered.

3.2.1 Potential islanding scenarios and estimated frequency of occurrence

Generation below 5MW can be connected either at LV (0.4kV) or HV (11kV) voltage level. There are a few different scenarios which can lead to power islanding of one or more generating units. For the purposes of this study (similarly to Phase II ROCOF assessment [1]), two different scenarios were considered as illustrated in Figure 18.

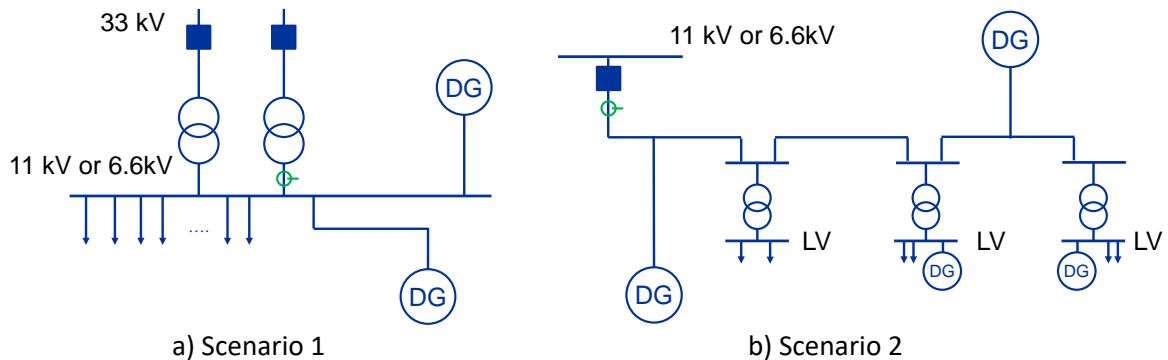

Figure 18. Islanding scenarios

Scenario 1 considers the loss of grid supply to primary substation or supply point. In this case, to assess the expected annual number of LOM occurrences the following primary substation incident records (including short duration interruptions) were used:

- ENW – in a population of 440 substations there were 96 loss of supply incidents over a period of 7 years,
- Northern Powergrid – in a population of 613 substations (including supply point sites) there were 258 loss of supply incidents over a period of 10 years.

The combined figures were used to calculate expected annual number of LOM occurrences in a single substation according to equation (2) ($N_{LOG,1IP,s1} = 0.0375$).

Scenario 2 considers the disconnection of an individual 11kV feeder, usually due to a short-circuit fault. As a result, an islanding of DG (connected to the same feeder) can occur. In particular, single phase to earth faults, after being cleared from the substation side, will no longer be seen by the generator which typically connects to the HV system through a star/delta step-up transformer. In such cases G59 or LOM protection will be responsible for de-energising the islanded part of the network. It is assumed, therefore, that only single phase to earth faults pose a potential hazard related to islanding condition. The majority of other types of faults should be detected by the generator overcurrent protection. In order to establish the expected number of network incidents which may potentially lead to islanding various network statistics provided by individual DNOs have been used. The relevant data have been extracted from the individual DNO's records and summarised in Table 10. As a complete set of statistics was not available, the number of HV feeders as well as data relating to short-term interruptions for some of the DNOs had to be estimated (indicated by the shaded cells in the table) assuming that these figures were proportional to the number of primary substations in a given DNO area.

Table 10. Distribution network data and incident statistics

DNO	No of Primary Subs	No of 11kV feeders	HV incidents p.a. (2012/13)	Short interruptions p.a. (2013/14)	All incidents p.a.
WPD_WMID	240	2870	2840	3564	6404
WPD_EMID	493	3480	2089	7321	9410
ENWL	415	2905	2269	6163	8432
NPG_N	191	1337	1868	3468	5336
NPG_Y	422	2954	1727	5635	7362
WPD_SWales	262	1840	1752	3891	5643
WPD_SWest	478	2380	2765	7098	9863
UKPN_LPN	66	462	718	980	1698
UKPN_SPN	367	2569	2208	5450	7658
UKPN_EPN	532	3724	3236	7900	11136
SP_SPD	399	2793	2269	5925	8194
SP_SPM	674	4718	2513	10009	12522
SSE_SHEPD	476	3332	2319	7069	9388
SSE_SEPD	548	3836	2738	8138	10876
Total:	5563	39200	31311	82610	113921

Assuming that single phase to earth faults cause 90% of all network interruptions the expected annual number of incidents leading to islanded situation in a single feeder can be calculated from (2)

$$\text{as: } N_{LOG,1IP,s2} = \frac{n_{LOG}}{n_{IP} \cdot T_{LOG}} = \frac{0.9 \times 113921}{39200 \times 1} = 2.6155$$

For the purposes of scenario 2 it was estimated (based on the numbers of HV circuit breakers provided for WPD, refer to Table 10) that on average there are 7 feeders supplied from a single primary substation, i.e. $\frac{2870+3480+1840+2380}{240+493+262+478} = 7.18$.

3.2.2 DG connection register analysis

Available registers of the UK-installed DG with capacities of less than 5MW have been utilised to ascertain the most dominant generation mixes in the UK for both assumed islanding scenarios 1 and 2. The registers were available (provided directly by the workgroup members) for the following DNOs: WPD, ENW, NPG, UKPN and SPD. For WPD the DG capacity register is available online [9].

All generation types included in the available registers were mapped into 5 main generating technologies as outlined in Table 11 and pre-processed as described in section 3.2.2 of the report [1]. In this study only Synchronous and DFIG generation were included in the analysis. Refer to Executive Summary on page 4 for reasoning on the choice of generating technologies in this study.

Table 11. Generation technology mapping [1]

Generation type reported in the register	Assumed generating technology
Hydro	Asynchronous
HY	
Hydro run-of-river and poundage	
Hydro water reservoir	
Onshore Wind	DFIG
WD	
HV GEN INTERMITTENT POST APR05	
HV GEN NON-INT PRE APR 05	
Onshore wind	
Wind onshore	
Wind Onshore	Inverter Connected
Photovoltaic	
PV	
LV GEN INTERMITTENT POST APR05	
PV & WIND	
Solar	Permanent Magnet SG
Offshore Wind	
Wind offshore	Synchronous
Biomass & Energy Crops (not CHP)	
Landfill Gas Sewage Gas Biogas (not CHP)	
Large CHP (>=50mw)	
Medium CHP (>5MW <50MW)	
Micro CHP (Domestic)	
Mini CHP (<1MW)	
Other Generation	
Small CHP (>1MW <5MW)	
Waste Incineration (not CHP)	
Not known	
Micro CHP	
CHP	
CiC	
Diesel	
Gas	
STOR	
Storage	
Waste	
Biomass & energy crops (not CHP)	
Landfill gas, sewage gas, biogas (not CHP)	
Small CHP (>=1MW, <5MW)	
Micro CHP (domestic)	
Other generation	
Waste incineration (not CHP)	
Biomass	
Fossil coal-derived gas	
Fossil gas	
Fossil hard coal	
Fossil oil	
Other	
Other renewable	
Steam	

3.2.3 Load profile data

In order to cover a wide range of possible loading scenarios and capacities, six different active and reactive (P and Q) load profiles have been included in this study. These profiles were recorded by the DNOs at various primary and secondary distribution substations. This section includes a brief description of each record including a graphical illustration of the P and Q traces. All records have been time aligned to start at 00:00:00hs in order to properly coincide with time-of-day-dependent variation of PV generation. Additionally, all records were resampled (if necessary) to 1s resolution and trimmed (or extended) to a fixed duration of one week. The same load profile data was used previously in Phase II risk assessment [1], and is also included in the following subsections for ease of reference.

3.2.3.1 Load Profile LP1 (WPD)

This record (provided by WPD) has been measured on one of the two parallel-connected 33/11kV 24MVA transformers supplying an 11kV busbar at a primary substation which feeds a mixture of domestic, commercial and industrial load. The time adjusted trace is presented in Figure 19. Two variants of the record were used in the risk assessment calculations: LP1a – original values as recorded from a single transformer (used in scenario 2), and LP1b where all the values were doubled to obtain the full load of the primary substation (used in scenario 1) assuming equal load sharing between both transformers at the primary substation.

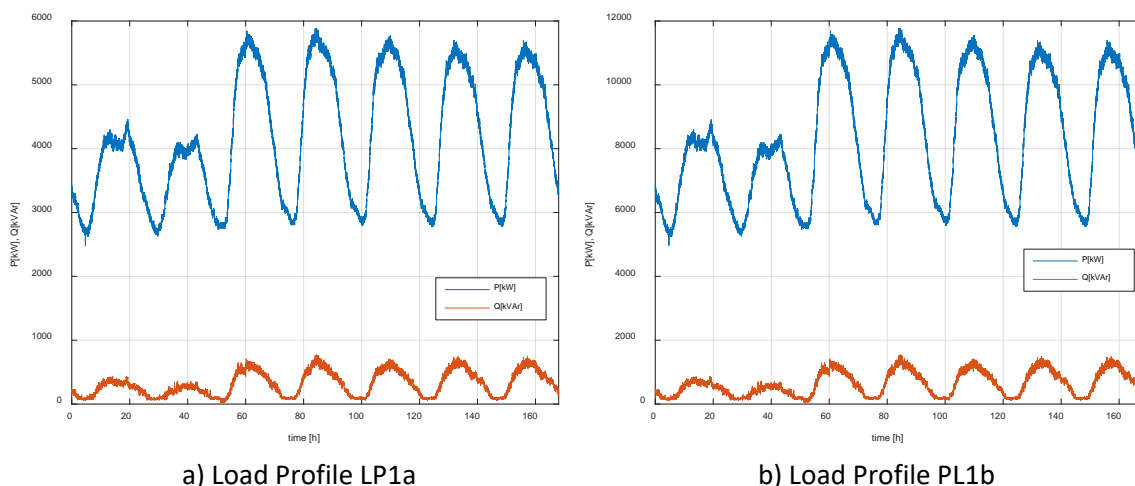

Figure 19. 11kV Load Monitoring Data – WPD – October 2014

3.2.3.2 Load Profile LP2 (ENW)

This load trace was recorded during Phase I of the work in a rural primary substation supplied by a single transformer, and is presented in Figure 20. The week-long record was synthesised using available 3 days' worth of monitoring data – one week day plus Saturday and Sunday. This record was used in risk assessment of islanding scenario 1.

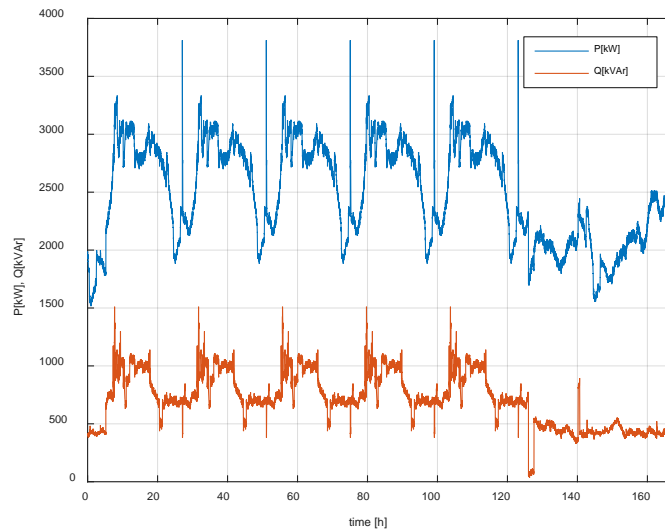
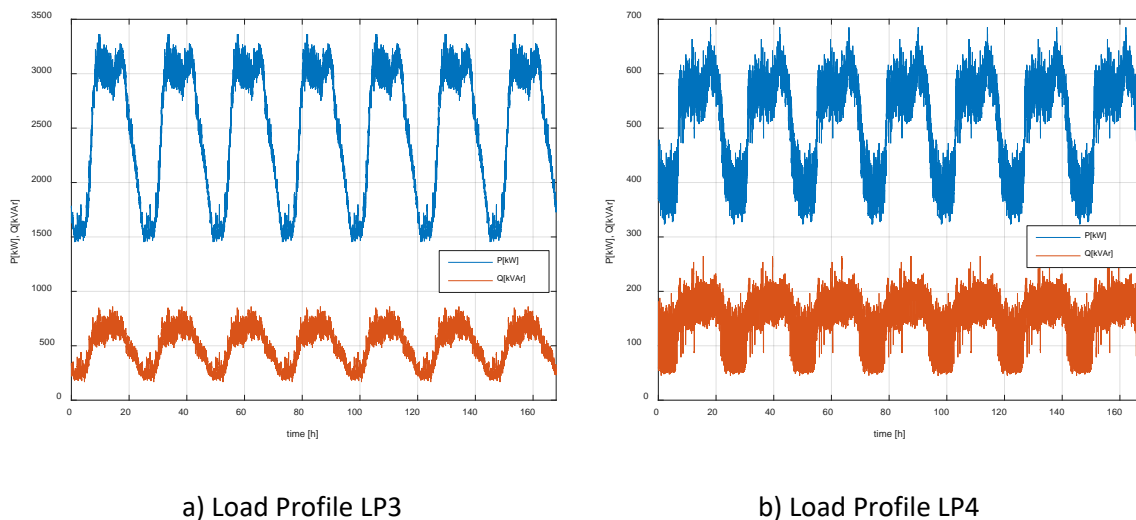

Figure 20. Load Monitoring Data captured in Phase I – April 2013

3.2.3.3 Load Profiles LP3 and LP4 (ENW)

These two load profiles (termed as LP3 and LP4) were recorded by ENW in 2008 and previously used in the risk assessment of NVD protection [9][10]. Both records were captured with 1s resolution and contain a good daily spread of demand as well as a number of short-term variations. As the data was recorded over a 24h period only, a week-long record was synthesised by repeating the daily profile 7 times as illustrated in Figure 21. The records were used in both islanding scenarios 1 and 2.



a) Load Profile LP3

b) Load Profile LP4

Figure 21. Two 1s records (over 24h) – 23 October 2008

3.2.3.4 Load Profile LP5 and LP6 (ENW)

These two records (termed as LP5 and LP6) were recorded by ENW at the supply point to an LV board, i.e. the secondary side of a distribution transformer. As the peak demand reaches 400kW only both records were used in scenario 2 while LP5 was also used in scenario 1 as an example of very low demand on a primary substation.

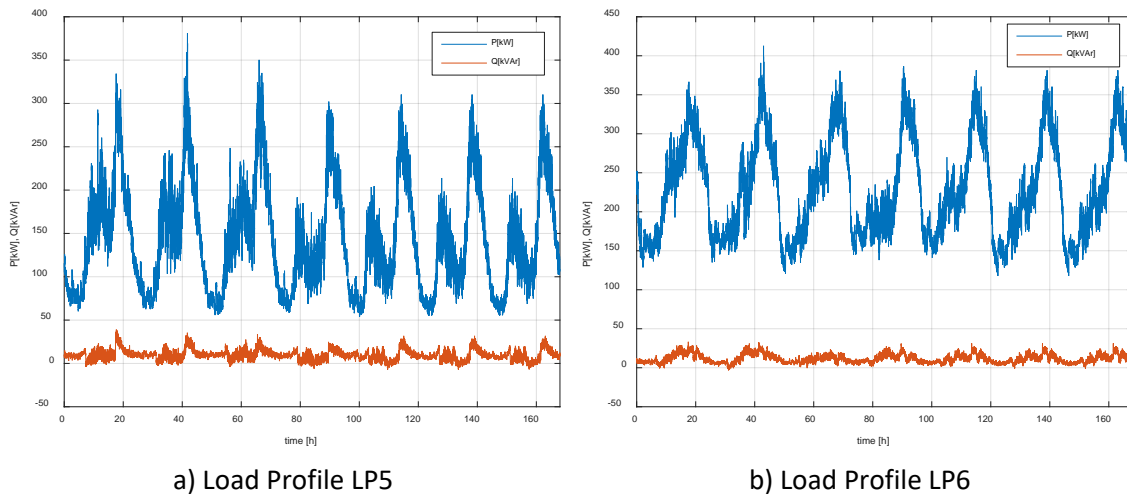

Figure 22. Two LV switchboard recorded profiles (ENW) – February 2015

3.2.4 DG generation profiles

In order to match detailed load profiles with realistic generation outputs, example profiles of different technologies were utilised in this work. In this study two categories of generating outputs were considered, namely: synchronous and wind generation.

- For synchronous generation a fixed output profile was synthesised at the assumed $pf=0.995$ (lagging). This is illustrated in Figure 23a.
- For wind generation two example days were used to create a week-long profile as illustrated in Figure 23b.

All profiles were normalised to have a maximum real power at 5MW. This value, however, has no bearing on the results, as the profiles are rescaled again when the calculations step through the capacity bands of the generation distribution histograms.

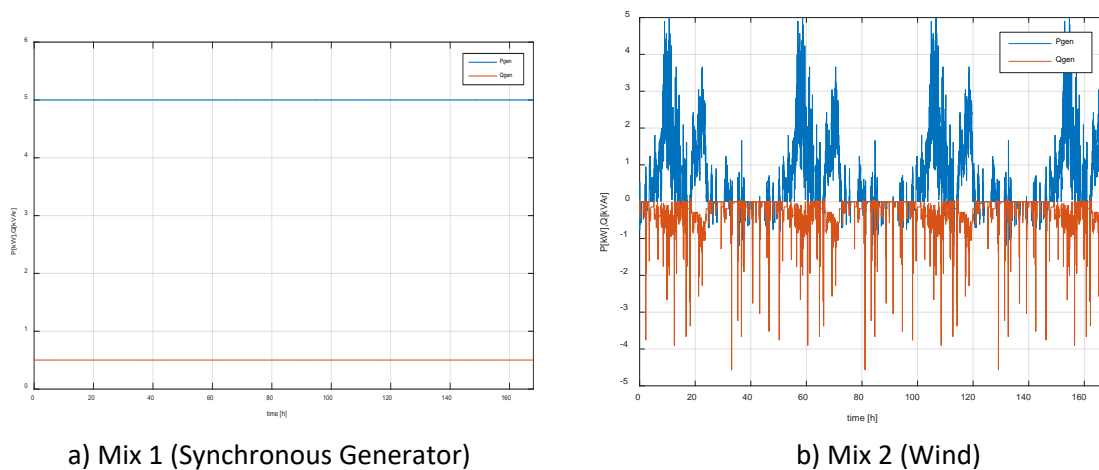

Figure 23. Example load profiles from individual DG technologies

3.3 Risk calculation case studies and results

3.3.1 Case Study 1 (CS1): No dedicated LOM protection – setting option 9

The purpose of this case study was to estimate the relative risk increase under the assumption that there is no dedicated LOM protection installed, and islanding detection relies purely on the operation of voltage and frequency protection (set according to G59/3 recommendation [7]) – referred to in this report as LOM option 9. The risk indices have been calculated using the NDZ values established earlier for G59 protection (refer to Appendix B in Phase II report [2]). For ease of comparison Table 12 includes both the original results obtained for ROCOF setting options 1 to 4, and the risk calculated for the “no LOM” setting option 9. It can be seen that additional 75% risk increase can be expected compared to the ROCOF setting option 4 (1 Hz/s with 0.5 s time delay). This can be considered relatively minor compared to the 2-3 orders of magnitude difference between the existing setting option 1 and the proposed option 4 for ROCOF based LOM protection.

Table 12. P_{LOM} , IR_E and N_{OA} obtained through load profile averaging – Case Study 1

Setting Option	ROCOF [Hz/s]	Time Delay [s]	N_{LOM}	P_{LOM}	IR_E	N_{OA}
1	0.13	0	1.66E-01	8.06E-08	8.06E-10	1.33E-01
2	0.2	0	3.29E-01	1.95E-07	1.95E-09	2.64E-01
3	0.5	0.5	2.96E+01	1.87E-05	1.87E-07	2.37E+01
4	1.0	0.5	5.66E+01	3.57E-05	3.57E-07	4.53E+01
9	No LOM protection UV/OV, UF/OF according to G59/3		9.91E+01	6.28E-05	6.28E-07	7.93E+01
	Percentage risk increase compared to setting option 4		+75.09%	+75.91%	+75.91%	+75.06%

3.3.2 Case Study 2 (CS2): ROCOF risk for SG and DFIG only

To facilitate direct comparison of the VS results (which are evaluated for SG and DFIG technologies only) the Phase II ROCOF risk assessment was repeated with those two technologies only. The results are included in Table 13 and form a benchmark case study for comparison with VS protection results included in Case study 3.

Table 13. P_{LOM} , IR_E and N_{OA} obtained through load profile averaging – SG and DFIG islands only

Setting Option	ROCOF [Hz/s]	Time Delay [s]	N_{LOM}	P_{LOM}	IR_E	N_{OA}
1	0.13	0	1.42E-01	7.27E-08	7.27E-10	1.13E-01
2	0.2	0	2.99E-01	1.85E-07	1.85E-09	2.39E-01
3	0.5	0.5	8.24E+00	5.10E-06	5.10E-08	6.59E+00
4	1.0	0.5	3.51E+01	2.21E-05	2.21E-07	2.81E+01
9	G59/3 (UV/OV, UF/OF)		7.76E+01	4.92E-05	4.92E-07	6.21E+01

3.3.3 Case Study 3 (CS3): VS related risk assessment

This case study assesses the risk of four VS setting options (referred to as options 5 to 8). This was achieved by performing the risk calculations under the same conditions as Case Study 2 except for the NDZ values which had been evaluated for VS protection in section 2 of this report. As all other assumptions were the same, CS3 results are based on the same population of generators as CS2, which is equivalent of replacing all ROCOF relays with VS relays. Although such scenario is not practical, it can be used as a direct risk comparison between various LOM setting options. The following four sub-cases were calculated:

- Case Study 3a: No fault applied
- Case Study 3b: Single phase-to-earth fault applied prior to islanding
- Case Study 3c: Phase-to-phase fault applied prior to islanding
- Case Study 3d: Three-phase fault applied prior to islanding

The full numerical record of probability calculations performed for CS3 is included in Appendix C. The results take into account the fact that G59 protection is always enabled and trips the generator in situations where VS relay sensitivity is poor. Additionally, for ease of analysis, the values of P_{LOM} are also presented graphically in Appendix C.3. It should be noted that in some cases where the final probability result was zero, in order to represent this on the graph using a logarithmic scale, a small value of 10^{-11} was used rather than zero. All other non-zero results were always higher than 10^{-11} , so this value can be used as an unambiguous indicator of a zero result.

Considering all load cases, generation mixes and islanding scenarios, the overall probability figures N_{LOM} and P_{LOM} have been obtained (based on results in Appendix C). Moreover, both probability of Individual Risk (IR_E) and expected annual rate of occurrence of out-of-phase auto-reclosure (N_{OA}) were calculated using the formulae (16) and (17). The values presented in Tables 14 to 17 were obtained by averaging the probability figures across all the load profiles.

Table 14. P_{LOM} , IR_E and N_{OA} obtained through load profile averaging – VS (CS3a, no fault)

Setting Option	ROCOF [Hz/s]	N_{LOM}	P_{LOM}	IR_E	N_{OA}
5	6	7.76E+01	4.92E-05	4.92E-07	6.21E+01
6	12	7.76E+01	4.92E-05	4.92E-07	6.21E+01
7	24	7.76E+01	4.92E-05	4.92E-07	6.21E+01
8	48	7.76E+01	4.92E-05	4.92E-07	6.21E+01

Table 15. P_{LOM} , IR_E and N_{OA} obtained through load profile averaging – VS (CS3b, single phase-to-earth fault)

Setting Option	ROCOF [Hz/s]	N_{LOM}	P_{LOM}	IR_E	N_{OA}
5	6	2.04E+01	1.29E-05	1.29E-07	1.63E+01
6	12	7.76E+01	4.92E-05	4.92E-07	6.21E+01
7	24	7.76E+01	4.92E-05	4.92E-07	6.21E+01
8	48	7.76E+01	4.92E-05	4.92E-07	6.21E+01

Table 16. P_{LOM} , IR_E and N_{OA} obtained through load profile averaging – VS (CS3c, phase-to-phase fault)

Setting Option	ROCOF [Hz/s]	N_{LOM}	P_{LOM}	IR_E	N_{OA}
5	6	7.07E+01	4.48E-05	4.48E-07	5.65E+01
6	12	7.76E+01	4.92E-05	4.92E-07	6.21E+01
7	24	7.76E+01	4.92E-05	4.92E-07	6.21E+01
8	48	7.76E+01	4.92E-05	4.92E-07	6.21E+01

Table 17. P_{LOM} , IR_E and N_{OA} obtained through load profile averaging – VS (CS3d, three-phase fault)

Setting Option	ROCOF [Hz/s]	N_{LOM}	P_{LOM}	IR_E	N_{OA}
5	6	1.36E+01	8.65E-06	8.65E-08	1.09E+01
6	12	1.56E+01	9.89E-06	9.89E-08	1.25E+01
7	24	2.01E+01	1.27E-05	1.27E-07	1.60E+01
8	48	7.76E+01	4.92E-05	4.92E-07	6.21E+01

The above figures represent the probabilities of the perceived hazards (IR and OA) under four different VS protection setting options when applied to the existing generators in UK with ratings below 5MW. It is important to bear in mind the following points when using these results to inform decision-making processes:

- The presented probability figures are based on the same connections registers as the earlier Phase II ROCOF study, which is somewhat out of date due to the rapidly growing number of DG installations (and changes in DG types) in the UK.
- The probabilities will increase in proportion to the total number of separate islanding points as well as being dependent on the usage of dedicated ROCOF-based protection. However, due to generation grouping, the number of islanding points is growing more slowly than the absolute number of individual DG connections.
- Wherever exact data was not available, pessimistic assumptions were always made so that the final probability values will ideally never be lower than reality, but this also means that the final figures are potentially higher than reality.
- The results are expressed as probabilities of specific events or occurrences happening over a period of one year. By inverting these values, the average expected times between such occurrences can be calculated.

The analysis of VS results is aided by two figures as follows:

- Figure 24 illustrates the relative difference in risk between various VS protection setting options and ROCOF protection set to 1 Hz/s with 0.5 s time delay (option 4). The ratio above one indicates higher risk of VS compared to ROCOF. It can be seen that the risk related to VS is higher in the majority of cases, except when there is a three-phase fault occurring prior to islanding, or a single phase-to-earth fault with VS set to 6°.

- Figure 25 shows the relative difference in risk between various VS protection setting options and “no LOM” protection option 9. The ratio of one indicates that LOM detection fully relies on G59 voltage or frequency protection. The results indicate that only when there is a three-phase fault occurring prior to islanding or a single phase-to-earth fault with VS set to 6°, there is a benefit of VS installation.

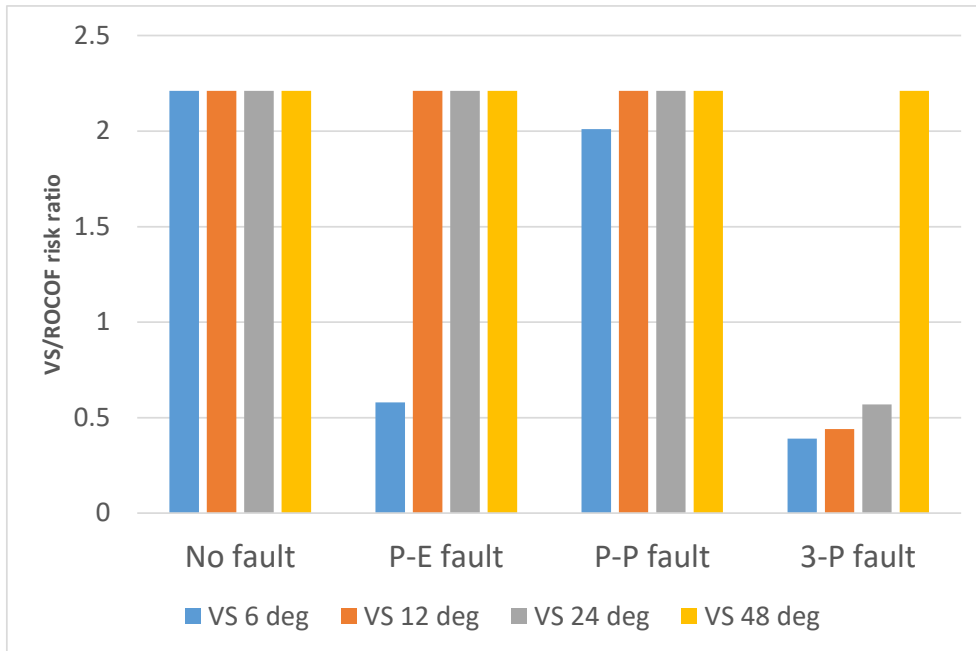

Figure 24. Relative risk of various VS setting options compared to ROCOF (Option 4)

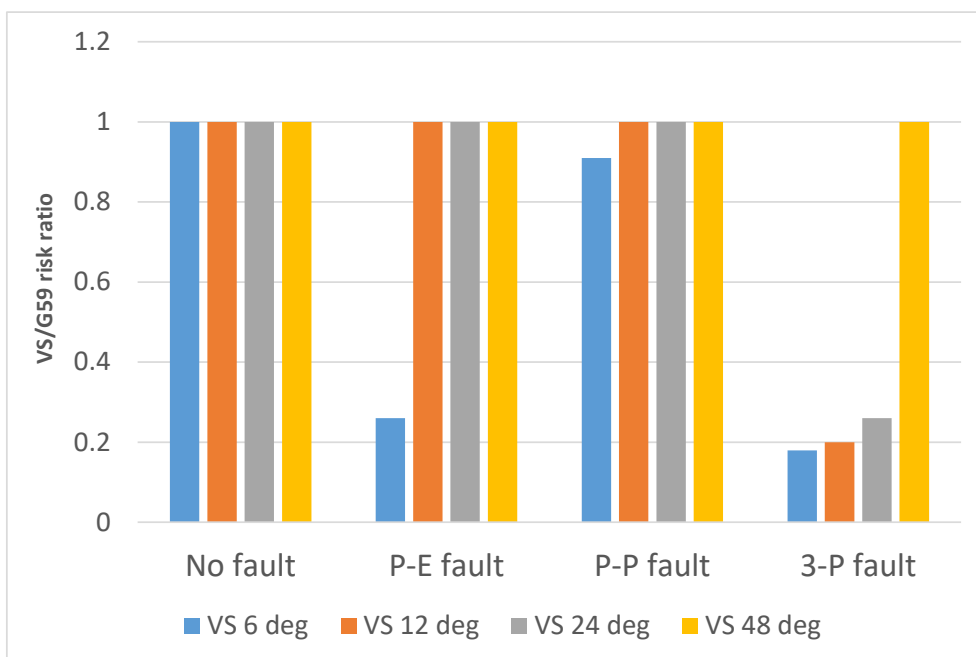

Figure 25. Relative risk of various VS setting options compared to G59 protection only (option 9)

4 Conclusions

When analysing the results the following observations can be made:

- Considering all generation mixes the effect of disabling ROCOF protection would result in approximately 75% risk increase compared to LOM setting option 4 (ROCOF set to 1 Hz/s with 0.5 s delay). To put this figure into perspective the previously assessed risk increase between the existing practice (0.125 Hz/s, with 0 s delay) and the proposed option 4 (1 Hz/s with 0.5 s delay) was approximately 2 orders of magnitude.
- VS protection is generally very ineffective, especially with a setting of 12° or higher. When using those settings, the generator is disconnected by G59 protection (as opposed to VS) in the majority of islanding situations, except for the case with a 3-phase fault initiating the island.
- The difference between the existing practice (VS set to 6°) and the remaining setting options 6, 7 and 8 (i.e. 12°, 24° and 48°) is insignificant, except when there is a three-phase fault prior to islanding. In this case, the risk is increased approximately by a factor of 5.7 when changing the setting from 6° to 48°. Under the typical scenario with a single phase-to-earth fault the risk between option 5 and 8 would increase by a factor of 3.8 only, with no observed difference between options 6, 7 and 8.
- Note that if there is a three phase fault on the network, the generator's own protection (e.g. overcurrent) would be bound to trip the generator.
- In the worst case scenario of "no LOM" (where only G59 voltage and frequency protection are used) risk related to accidental electrocution (IR_E) is estimated at $6.28 \cdot 10^{-7}$ which lies within the limits of broadly acceptable region (i.e. $< 10^{-6}$), and therefore, is consistent with the expectations of the Health and Safety at Work Act 1974 [3].
- Similarly to the earlier Phase II study reported in [1], the rate of occurrence of out-of-phase auto-reclosing (N_{OA}) appears to be high with all considered VS setting options (nearly 80 expected incidents p.a. under "no LOM" option 9), and therefore, should not be neglected. Further assessment of the anticipated costs and consequences of out-of-phase auto-reclosing to individual generating technologies is required to realistically assess the proportion of those incidents which would cause serious damage to the generator or endanger personnel. The presented final figures make no such distinction and assume that 80% of all out-of-phase reclosures are damaging. Moreover, consideration of the proportion of the network where auto-reclose is not enabled (e.g. underground cables) would reduce the expected number of out-of-phase reclosures further.
- Although the simulated NDZ values and calculated risk levels presented in this document relate specifically to distributed generation with installed capacity of less than 5 MW, the outcomes under certain assumptions can be helpful in considering LOM practice on larger generators. For example, assuming similar performance of all synchronous machine based generation during islanding, the VS related NDZ values presented in this report, and those included in Phase II report [1] for ROCOF protection, could be used to inform the decision on disabling VS in larger synchronous generators (>5MW). In Figure 26 the NDZ values for all considered LOM options 1 to 9 (including ROCOF, VS and "no LOM") are presented. VS results are included for the most typical islanding case of single phase-to-ground fault followed by

LOM. It can be observed that VS NDZ under all setting options is the same as "No LOM" NDZ. Therefore, disabling VS does not affect the risk. Additionally, changing VS to ROCOF with the setting of 1 Hz/s, and 0.5s delay, results in a minor risk reduction (as *P Import* element of NDZ is slightly narrower for ROCOF compared to VS or "no LOM" NDZ).

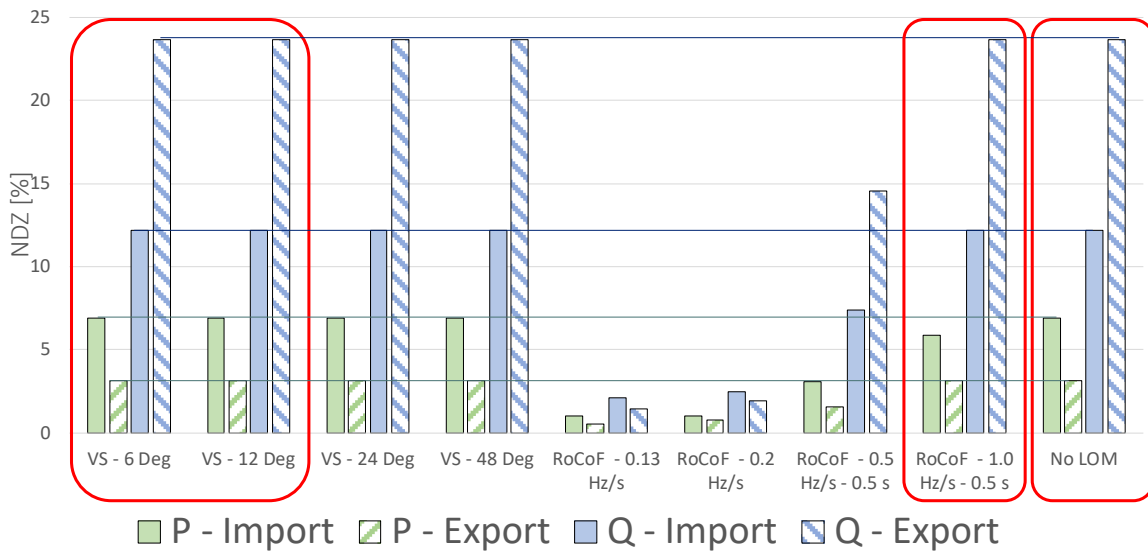

Figure 26. Combined RoCoF-VS-G59 NDZ results - SG (Single phase to ground fault)

- Actual observed incidence of unintended islanding operation in UK appears to be lower than the analysis shows which indicates that the absolute risk figures presented in this report are overestimated. This is due to various pessimistic assumptions made in the calculation process. Although some evidence of unintended islanding operation has been reported in Spain [4], in UK there have not been any documented cases to date. Therefore, the results included in this report should not be interpreted as absolute risk estimates but rather as an indicator of the relative difference between the existing and future risk levels under the considered revision options.

5 References

- [1] A. Dyśko, D. Tzelepis, and C. Booth, 'Assessment of Risks Resulting from the Adjustment of ROCOF Based Loss of Mains Protection Settings - Phase II', University of Strathclyde, ENA/LOM/TR/2015-001, Oct. 2015.
- [2] A. Dyśko, I. Abdulhadi, X. Li, and C. Booth, 'Assessment of Risks Resulting from the Adjustment of ROCOF Based Loss of Mains Protection Settings - Phase I', University of Strathclyde, NGC/LOM/TR/2013-001b, Jun. 2013.
- [3] 'Health and Safety at Work etc. Act 1974'. [Online]. Available: <http://www.legislation.gov.uk/ukpga/1974/37/contents>. [Accessed: 21-Jun-2016].
- [4] Francisco José PAZOS, 'Operational experience and field tests on islanding events caused', in *21st CIREC conference on Electricity distribution*, Frankfurt, 2011.
- [5] A. Dyśko, 'Assessment of the Risks Associated with Adjustment of Voltage Vector Shift (VS) based Loss-Of-Mains Protection Settings - Research Proposal', University of Strathclyde, NGC/LOM/RP/2016-002, Dec. 2016.
- [6] Bugdal, R., Dysko, A., Burt, G.M., and McDonald, J.R., 'Performance analysis of the ROCOF and vector shift methods using a dynamic protection modeling approach', presented at the 15th International Conference on Power System Protection, Bled, Slovenia, 2006, pp. 139–144.
- [7] Electricity Networks Association, 'Engineering Recommendation G59/3: Recommendations for the Connection of Generating Plant to the Distribution Systems of Licensed Distribution Network Operators'. Issue 3, Aug-2014.
- [8] 'Marginal distribution', *Wikipedia, the free encyclopedia*, 02-Jun-2016. [Online]. Available: https://en.wikipedia.org/w/index.php?title=Marginal_distribution&oldid=723297349. [Accessed: 21-Jun-2016].
- [9] 'Generation capacity register', *Western Power Distribution*. [Online]. Available: <http://www.westernpower.co.uk/Connections/Generation/Generation-Capacity-Map/Generation-capacity-register.aspx>.
- [10] A. Dyśko, A. MacKay, and G. Burt, 'Neutral Voltage Displacement Protection Requirement for DG'. DTI Centre for Sustainable Electricity and Distributed Generation, 2009.
- [11] Distribution Code Review Panel G59 NVD Working Group, 'Embedded generation interface protection: Assessment of risks arising from relaxation in the application of neutral voltage displacement (NVD) interface protection'. Energy Networks Association, 31-Dec-2009.

Appendix A: Simulation model parameters

Table 18. Line parameters used in the 11kV network

11kV Distribution Lines		
Line Section	Resistance (Ω)	Inductance (mH)
A-B	0.169	0.17
B-C	0.169	0.17
D-E	0.67	0.56
D-F	0.613	0.45

Table 19. Synchronous machine parameters

Power Rating [MVA]		2
Nominal Voltage [V]		440
Nominal Frequency [Hz]		50
Pole Pairs		2
Inertia Constant [s]		1.3
Reactances [p.u.]		
X_d		2.24
X_d'		0.17
X_d''		0.12
X_q		1.02
X_q''		0.13
X_l		0.18
Excitation System / Governor		
T_r		0.02
K_a		465
T_a		0.002
K_e		1
T_e		0.27
T_b		0
T_c		0
K_f		0.003
T_f		0.2
E_{fmin}		-8
E_{fmax}		8
K_p		0

Table 20. DFIG parameters

Power Rating [MVA]	2
Nominal Voltage [V]	690
Nominal Frequency [Hz]	50
Pole Pairs	2
Inertia Constant [s]	4
Windings	
Stator Resistance [p.u.]	0.00488
Stator Inductance [p.u.]	0.09241
Rotor Resistance [p.u.]	0.00549
Rotor Inductance [p.u.]	0.0997
Mutual Inductance [p.u.]	4
Rotor Side Converter	
Torque Controller Kp	20
Torque Controller Ki	19
Current Regulator Kp	0.08
Current Regulator Ki	8
Reactive Power Controller Kp	5
Reactive Power Controller Ki	100
Grid Side Converter	
V_{DC} Regulator Kp	3
V_{DC} Regulator Ki	60
Current Regulator Kp	10
Current Regulator Ki	15

Appendix B: Detailed record of NDZ Assessment

B.1. Tabular Results

Table 21. VS results for SG – No fault

Setting Option	VS Setting [°]	NDZ_{PI} Import [%]	NDZ_{PE} Export [%]	NDZ_{QI} Import [%]	NDZ_{QE} Export [%]
5	6°	>50	>50	>50	>50
6	12°	>50	>50	>50	>50
7	24°	>50	>50	>50	>50
8	48°	>50	>50	>50	>50

Table 22. VS NDZ results for SG – Single phase-to-earth fault

Setting Option	VS Setting [°]	NDZ_{PI} Import [%]	NDZ_{PE} Export [%]	NDZ_{QI} Import [%]	NDZ_{QE} Export [%]
5	6°	>50	>50	>50	>50
6	12°	>50	>50	>50	>50
7	24°	>50	>50	>50	>50
8	48°	>50	>50	>50	>50

Table 23. VS NDZ results for SG – Phase-to-phase fault

Setting Option	VS Setting [°]	NDZ_{PI} Import [%]	NDZ_{PE} Export [%]	NDZ_{QI} Import [%]	NDZ_{QE} Export [%]
5	6°	32.09	48.908	5.46	25.52
6	12°	>50	>50	>50	>50
7	24°	>50	>50	>50	>50
8	48°	>50	>50	>50	>50

Table 24. VS NDZ results for SG – Three-phase fault

Setting Option	VS Setting [°]	NDZ_{PI} Import [%]	NDZ_{PE} Export [%]	NDZ_{QI} Import [%]	NDZ_{QE} Export [%]
5	6°	>50	>50	7.241	26.884
6	12°	>50	>50	9.515	26.884
7	24°	>50	>50	>50	26.884
8	48°	>50	>50	>50	>50

Table 25: G59 NDZ results for SG

Setting Option	NDZ_{PI} Import [%]	NDZ_{PE} Export [%]	NDZ_{QI} Import [%]	NDZ_{QE} Export [%]
UF,OF	6.92	3.14	12.16	23.67
UV,OV	>50	>50	>50	>50

Table 26. VS results for DFIG – No fault

Setting Option	VS Setting [°]	NDZ_{PI} Import [%]	NDZ_{PE} Export [%]	NDZ_{QI} Import [%]	NDZ_{QE} Export [%]
5	6°	10.709	9.699	>50	21.274
6	12°	10.709	10.979	>50	21.375
7	24°	>50	11.768	>50	23.197
8	48°	>50	>50	>50	>50

Table 27. VS NDZ results for DFIG – Single phase-to-earth fault

Setting Option	VS Setting [°]	NDZ_{PI} Import [%]	NDZ_{PE} Export [%]	NDZ_{QI} Import [%]	NDZ_{QE} Export [%]
5	6°	0	0	0	0
6	12°	>50	31.041	>50	>50
7	24°	>50	33.323	>50	>50
8	48°	>50	>50	>50	>50

Table 28. VS NDZ results for DFIG – Phase-to-phase fault

Setting Option	VS Setting [°]	NDZ_{PI} Import [%]	NDZ_{PE} Export [%]	NDZ_{QI} Import [%]	NDZ_{QE} Export [%]
5	6°	>50	27.374	>50	25.433
6	12°	>50	>50	>50	>50
7	24°	>50	>50	>50	>50
8	48°	>50	>50	>50	>50

Table 29. VS NDZ results for DFIG – Three-phase fault

Setting Option	VS Setting [°]	NDZ_{PI} Import [%]	NDZ_{PE} Export [%]	NDZ_{QI} Import [%]	NDZ_{QE} Export [%]
5	6°	0	0	0	0
6	12°	0	0	0	0
7	24°	0	0	0	0
8	48°	>50	>50	>50	>50

Table 30: G59 NDZ results for DFIG

Setting Option	NDZ_{PI} Import [%]	NDZ_{PE} Export [%]	NDZ_{QI} Import [%]	NDZ_{QE} Export [%]
UF,OF	3.97	2.69	8.69	9.98
UV,OV	8.18	12.02	>50	17.92

B.2. NDZ Graphs

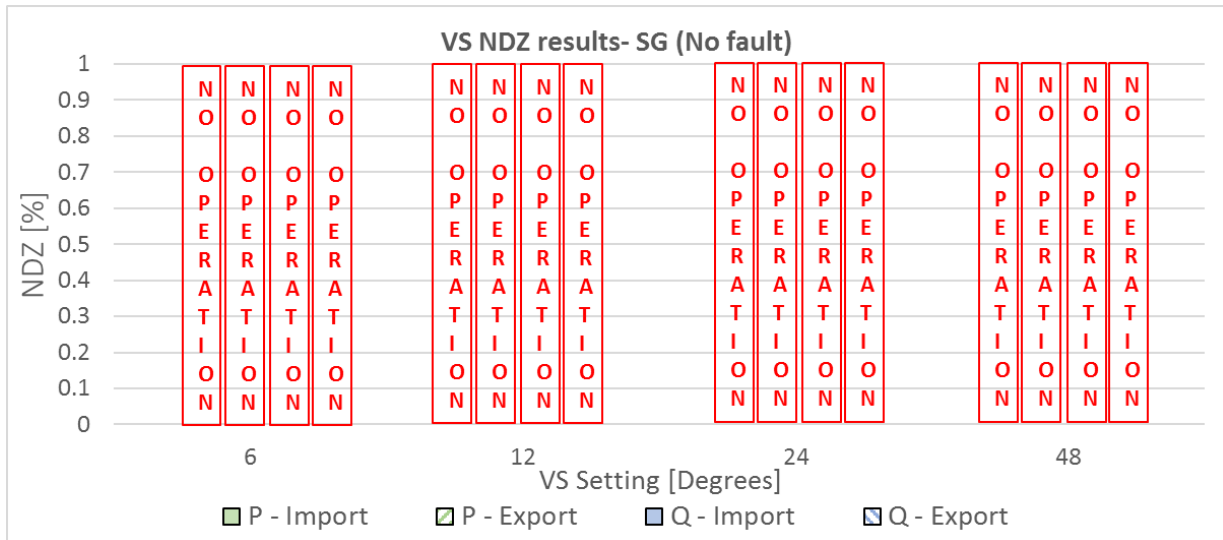

Figure 27: NDZ representation for VS - SG (No fault)

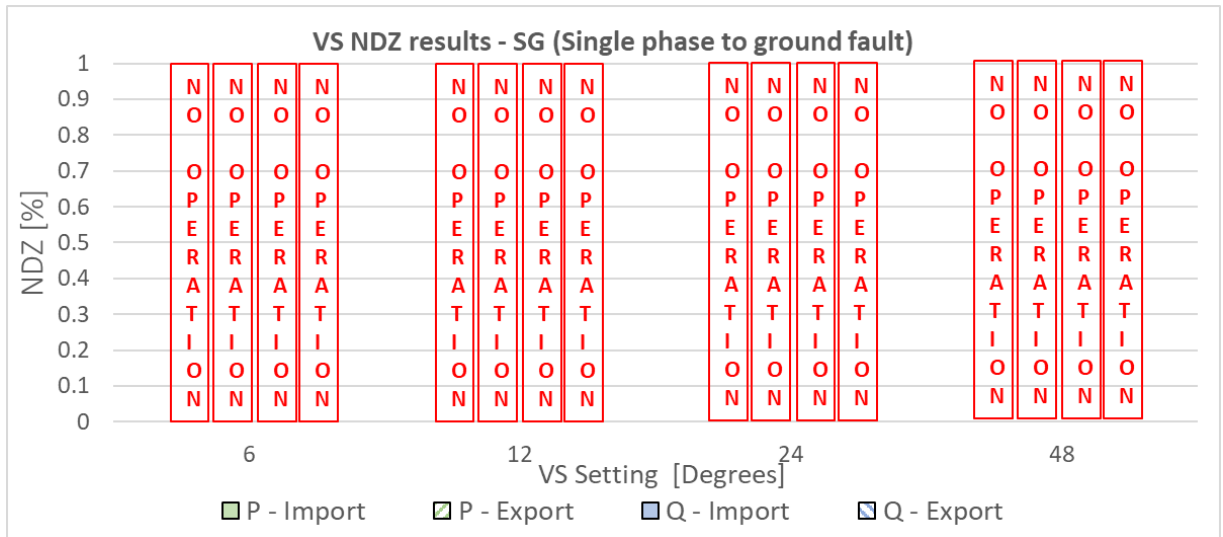

Figure 28: NDZ representation for VS results - SG (Single phase-to-earth fault)

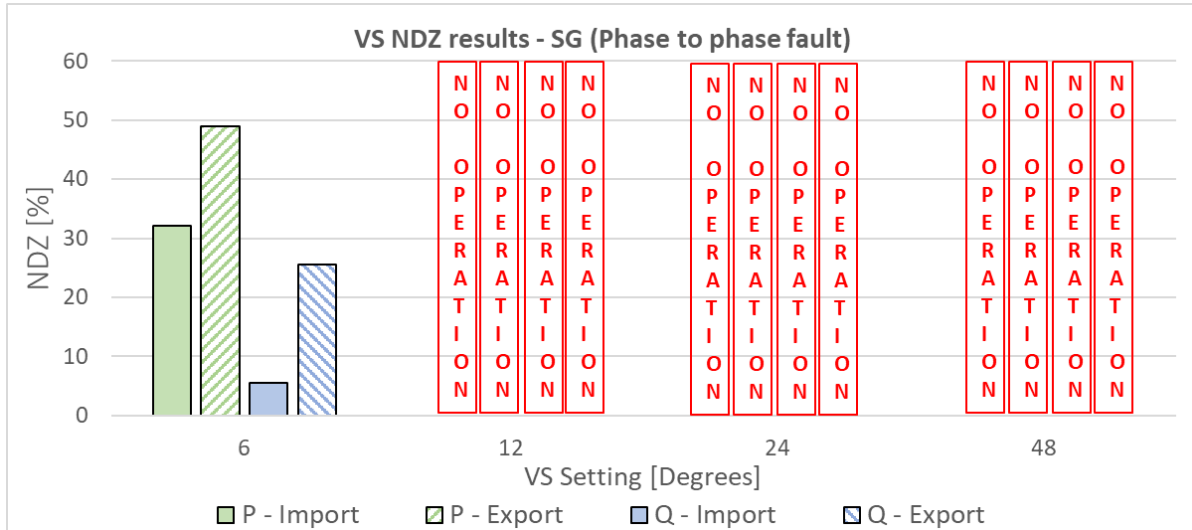

Figure 29: NDZ representation for VS results -SG (Phase-to-phase fault)

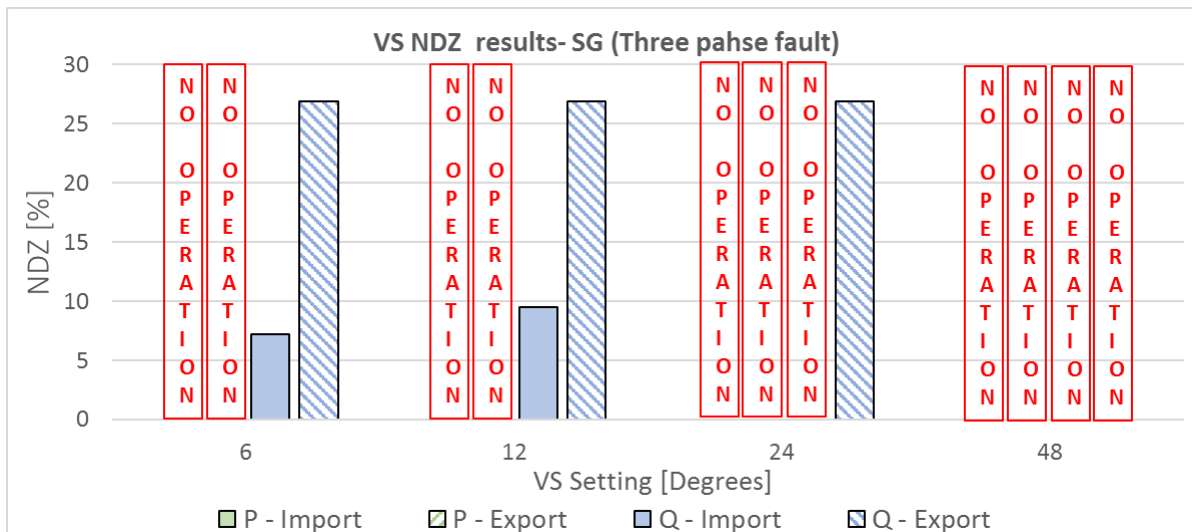

Figure 30: NDZ representation for VS results - SG (Three-phase fault)

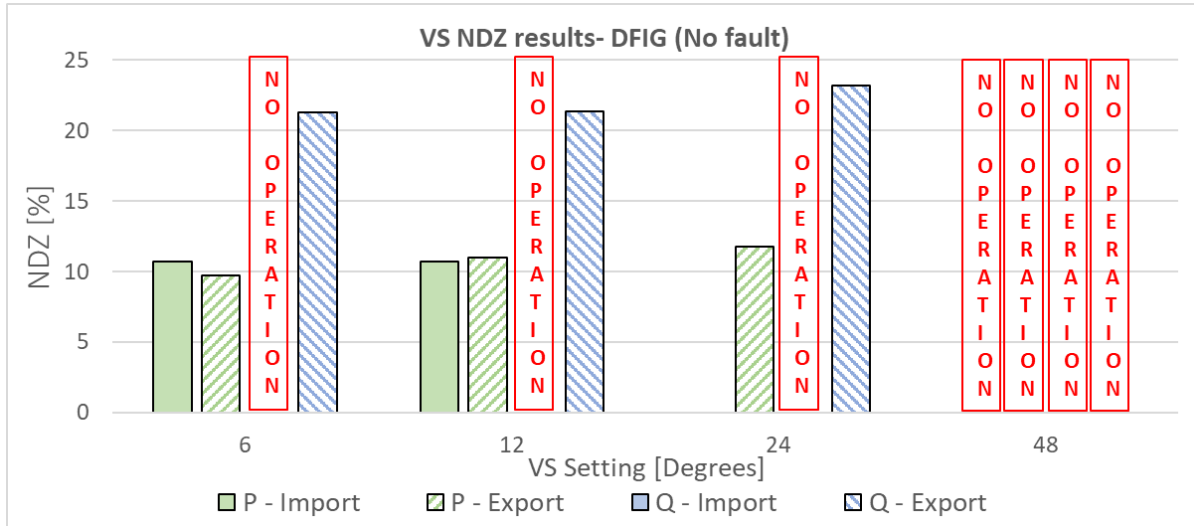

Figure 31: NDZ representation for VS results - DFIG (No fault)

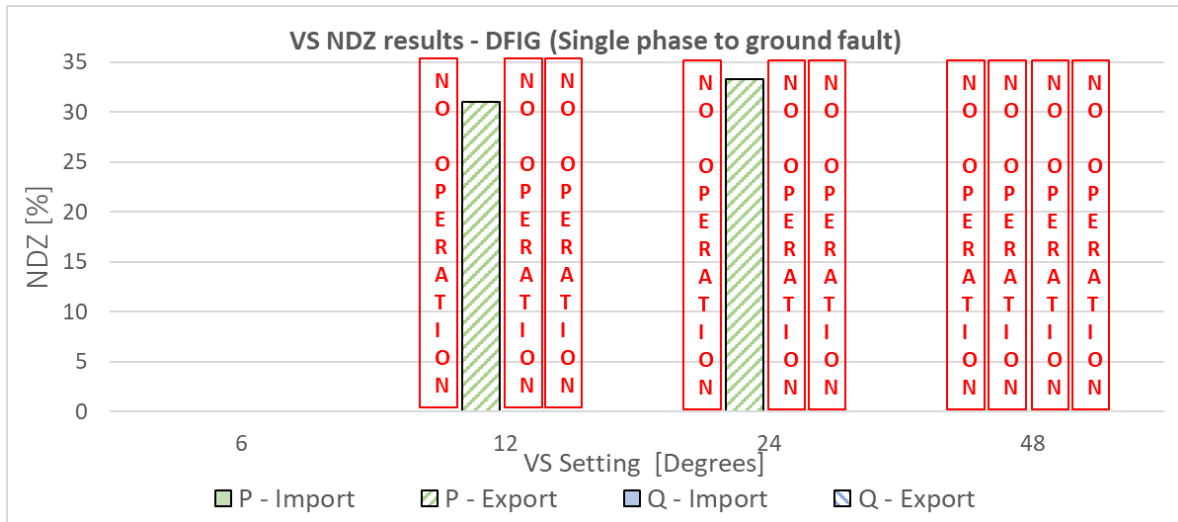

Figure 32: NDZ representation for VS results - DFIG (Single phase-to-earth fault)

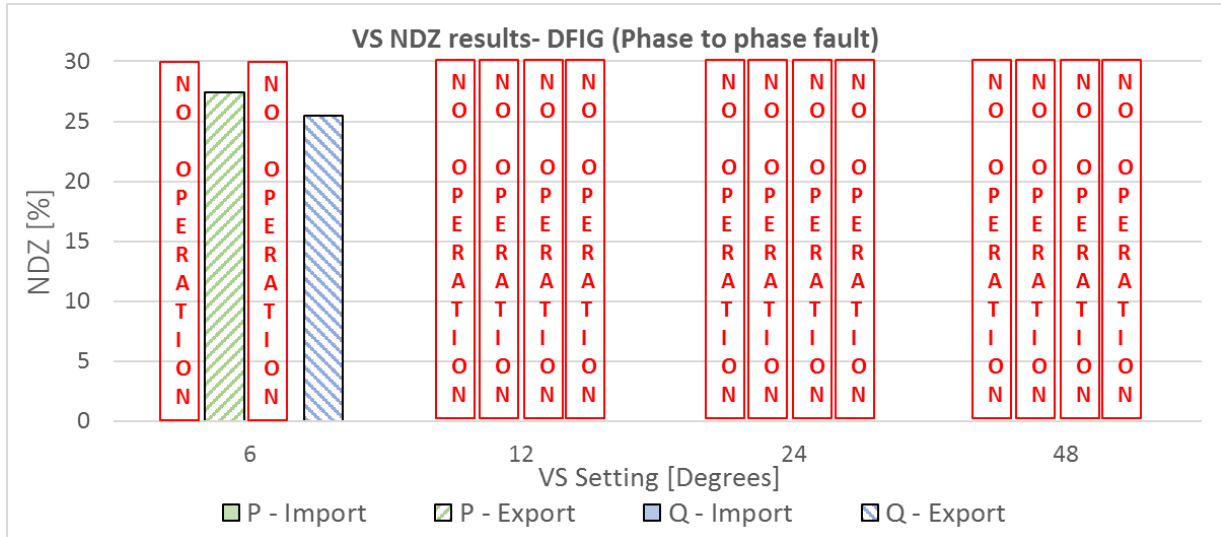

Figure 33: NDZ representation for VS results -DFIG (Phase-to-phase fault)

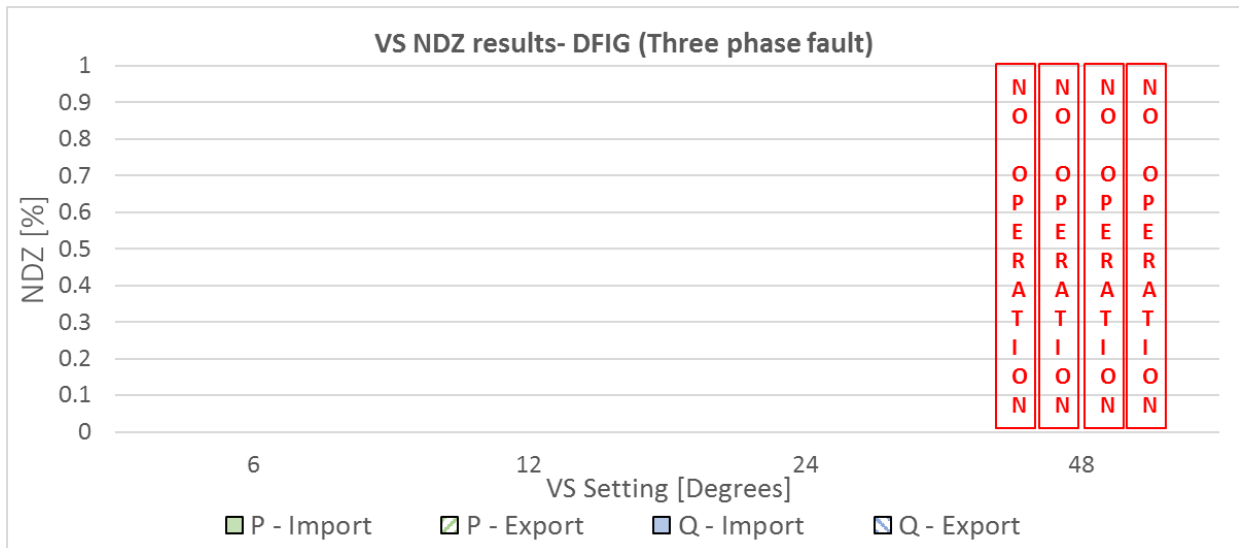

Figure 34: NDZ representation for VS results -DFIG (Three-phase fault)

Appendix C: Detailed VS risk assessment results (CS3)

C.1. Summary Results

C.1.1. Case Study 3a – VS operation with no fault

Table 31. LOM risk assessment results for islanding scenario 1 (loss of supply to primary substation)

Load Profile	Setting Option	$T_{NDZavr,s1}$ [min]	$N_{LOM,1DGG,s1}$	$P_{LOM,1DGG,s1}$	$P_{LOM,s1}$
LP1b	5	35.36	1.13E-04	4.98E-11	8.41E-08
	6	35.36	1.13E-04	4.98E-11	8.41E-08
	7	35.36	1.13E-04	4.98E-11	8.41E-08
	8	35.36	1.13E-04	4.98E-11	8.41E-08
LP2	5	27.28	6.08E-05	3.49E-11	4.51E-08
	6	27.28	6.08E-05	3.49E-11	4.51E-08
	7	27.28	6.08E-05	3.49E-11	4.51E-08
	8	27.28	6.08E-05	3.49E-11	4.51E-08
LP3	5	13.65	1.38E-04	6.99E-11	1.02E-07
	6	13.65	1.38E-04	6.99E-11	1.02E-07
	7	13.65	1.38E-04	6.99E-11	1.02E-07
	8	13.65	1.38E-04	6.99E-11	1.02E-07
LP4	5	17.38	5.76E-04	3.65E-10	4.27E-07
	6	17.38	5.76E-04	3.65E-10	4.27E-07
	7	17.38	5.76E-04	3.65E-10	4.27E-07
	8	17.38	5.76E-04	3.65E-10	4.27E-07
LP5	5	21.14	9.04E-04	5.71E-10	6.70E-07
	6	21.14	9.04E-04	5.71E-10	6.70E-07
	7	21.14	9.04E-04	5.71E-10	6.70E-07
	8	21.14	9.04E-04	5.71E-10	6.70E-07

Table 32. LOM risk assessment results for islanding scenario 2 (loss of individual HV circuit)

Load Profile	Setting Option	$T_{NDZavr,s2}$ [min]	$N_{LOM,1DGG,s2}$	$P_{LOM,1DGG,s2}$	$P_{LOM,s2}$
LP5	5	18.20	6.28E-02	3.97E-08	1.26E-04
	6	18.20	6.28E-02	3.97E-08	1.26E-04
	7	18.20	6.28E-02	3.97E-08	1.26E-04
	8	18.20	6.28E-02	3.97E-08	1.26E-04
LP6	5	18.27	2.28E-02	1.42E-08	4.57E-05
	6	18.27	2.28E-02	1.42E-08	4.57E-05
	7	18.27	2.28E-02	1.42E-08	4.57E-05
	8	18.27	2.28E-02	1.42E-08	4.57E-05
LP3	5	13.63	1.14E-02	4.81E-09	2.28E-05
	6	13.63	1.14E-02	4.81E-09	2.28E-05
	7	13.63	1.14E-02	4.81E-09	2.28E-05
	8	13.63	1.14E-02	4.81E-09	2.28E-05
LP4	5	8.07	6.24E-03	3.95E-09	1.25E-05
	6	8.07	6.24E-03	3.95E-09	1.25E-05
	7	8.07	6.24E-03	3.95E-09	1.25E-05
	8	8.07	6.24E-03	3.95E-09	1.25E-05
LP1a	5	32.30	1.88E-02	7.95E-09	3.77E-05
	6	32.30	1.88E-02	7.95E-09	3.77E-05
	7	32.30	1.88E-02	7.95E-09	3.77E-05
	8	32.30	1.88E-02	7.95E-09	3.77E-05

Table 33. Summary LOM risk assessment results – based on maximum load profile figures

LOM Scenario	Setting Option	T_{NDZavr} [min]	$N_{LOM,1DGG}$	$P_{LOM,1DGG}$	P_{LOM}
S1	5	35.4	9.04E-04	5.71E-10	6.70E-07
	6	35.4	9.04E-04	5.71E-10	6.70E-07
	7	35.4	9.04E-04	5.71E-10	6.70E-07
	8	35.4	9.04E-04	5.71E-10	6.70E-07
S2	5	32.30	6.28E-02	3.97E-08	1.26E-04
	6	32.30	6.28E-02	3.97E-08	1.26E-04
	7	32.30	6.28E-02	3.97E-08	1.26E-04
	8	32.30	6.28E-02	3.97E-08	1.26E-04
Combined S1 & S2	5	33.13	4.61E-02	2.92E-08	1.27E-04
	6	33.13	4.61E-02	2.92E-08	1.27E-04
	7	33.13	4.61E-02	2.92E-08	1.27E-04
	8	33.13	4.61E-02	2.92E-08	1.27E-04

Table 34. Summary LOM risk assessment results – based on average load profile figures

LOM Scenario	Setting Option	T_{NDZavr} [min]	$N_{LOM,1DGG}$	$P_{LOM,1DGG}$	P_{LOM}
S1	5	22.96	3.58E-04	2.18E-10	2.66E-07
	6	22.96	3.58E-04	2.18E-10	2.66E-07
	7	22.96	3.58E-04	2.18E-10	2.66E-07
	8	22.96	3.58E-04	2.18E-10	2.66E-07
S2	5	18.10	2.44E-02	1.41E-08	4.89E-05
	6	18.10	2.44E-02	1.41E-08	4.89E-05
	7	18.10	2.44E-02	1.41E-08	4.89E-05
	8	18.10	2.44E-02	1.41E-08	4.89E-05
Combined S1 & S2	5	19.41	1.79E-02	1.04E-08	4.92E-05
	6	19.41	1.79E-02	1.04E-08	4.92E-05
	7	19.41	1.79E-02	1.04E-08	4.92E-05
	8	19.41	1.79E-02	1.04E-08	4.92E-05

C.1.2. Case Study 3b – VS operation with single phase-to-earth fault

Table 35. LOM risk assessment results for islanding scenario 1 (loss of supply to primary substation)

Load Profile	Setting Option	$T_{NDZavr,s1}$ [min]	$N_{LOM,1DGG,s1}$	$P_{LOM,1DGG,s1}$	$P_{LOM,s1}$
LP1b	5	12.56	4.05E-05	1.90E-11	3.01E-08
	6	35.36	1.13E-04	4.98E-11	8.41E-08
	7	35.36	1.13E-04	4.98E-11	8.41E-08
	8	35.36	1.13E-04	4.98E-11	8.41E-08
LP2	5	10.77	4.37E-05	2.77E-11	3.24E-08
	6	27.28	6.08E-05	3.49E-11	4.51E-08
	7	27.28	6.08E-05	3.49E-11	4.51E-08
	8	27.28	6.08E-05	3.49E-11	4.51E-08
LP3	5	7.26	5.66E-05	3.54E-11	4.20E-08
	6	13.65	1.38E-04	6.99E-11	1.02E-07
	7	13.65	1.38E-04	6.99E-11	1.02E-07
	8	13.65	1.38E-04	6.99E-11	1.02E-07
LP4	5	14.37	5.74E-04	3.64E-10	4.26E-07
	6	17.38	5.76E-04	3.65E-10	4.27E-07
	7	17.38	5.76E-04	3.65E-10	4.27E-07
	8	17.38	5.76E-04	3.65E-10	4.27E-07
LP5	5	17.88	8.96E-04	5.67E-10	6.63E-07
	6	21.14	9.04E-04	5.71E-10	6.70E-07
	7	21.14	9.04E-04	5.71E-10	6.70E-07
	8	21.14	9.04E-04	5.71E-10	6.70E-07

Table 36. LOM risk assessment results for islanding scenario 2 (loss of individual HV circuit)

Load Profile	Setting Option	$T_{NDZavr,s2}$ [min]	$N_{LOM,1DGG,s2}$	$P_{LOM,1DGG,s2}$	$P_{LOM,s2}$
LP5	5	4.43	3.61E-04	1.53E-10	7.25E-07
	6	18.20	6.28E-02	3.97E-08	1.26E-04
	7	18.20	6.28E-02	3.97E-08	1.26E-04
	8	18.20	6.28E-02	3.97E-08	1.26E-04
LP6	5	7.41	1.05E-03	4.43E-10	2.10E-06
	6	18.27	2.28E-02	1.42E-08	4.57E-05
	7	18.27	2.28E-02	1.42E-08	4.57E-05
	8	18.27	2.28E-02	1.42E-08	4.57E-05
LP3	5	10.21	1.14E-02	4.81E-09	2.28E-05
	6	13.63	1.14E-02	4.81E-09	2.28E-05
	7	13.63	1.14E-02	4.81E-09	2.28E-05
	8	13.63	1.14E-02	4.81E-09	2.28E-05
LP4	5	4.51	4.62E-05	1.95E-11	9.26E-08
	6	8.07	6.24E-03	3.95E-09	1.25E-05
	7	8.07	6.24E-03	3.95E-09	1.25E-05
	8	8.07	6.24E-03	3.95E-09	1.25E-05
LP1a	5	30.44	1.88E-02	7.95E-09	3.77E-05
	6	32.30	1.88E-02	7.95E-09	3.77E-05
	7	32.30	1.88E-02	7.95E-09	3.77E-05
	8	32.30	1.88E-02	7.95E-09	3.77E-05

Table 37. Summary LOM risk assessment results – based on maximum load profile figures

LOM Scenario	Setting Option	T_{NDZavr} [min]	$N_{LOM,1DGG}$	$P_{LOM,1DGG}$	P_{LOM}
S1	5	17.9	8.96E-04	5.67E-10	6.63E-07
	6	35.4	9.04E-04	5.71E-10	6.70E-07
	7	35.4	9.04E-04	5.71E-10	6.70E-07
	8	35.4	9.04E-04	5.71E-10	6.70E-07
S2	5	30.44	1.88E-02	7.95E-09	3.77E-05
	6	32.30	6.28E-02	3.97E-08	1.26E-04
	7	32.30	6.28E-02	3.97E-08	1.26E-04
	8	32.30	6.28E-02	3.97E-08	1.26E-04
Combined S1 & S2	5	27.05	1.40E-02	5.96E-09	3.84E-05
	6	33.13	4.61E-02	2.92E-08	1.27E-04
	7	33.13	4.61E-02	2.92E-08	1.27E-04
	8	33.13	4.61E-02	2.92E-08	1.27E-04

Table 38. Summary LOM risk assessment results – based on average load profile figures

LOM Scenario	Setting Option	T_{NDZavr} [min]	$N_{LOM,1DGG}$	$P_{LOM,1DGG}$	P_{LOM}
S1	5	12.57	3.22E-04	2.03E-10	2.39E-07
	6	22.96	3.58E-04	2.18E-10	2.66E-07
	7	22.96	3.58E-04	2.18E-10	2.66E-07
	8	22.96	3.58E-04	2.18E-10	2.66E-07
S2	5	11.40	6.33E-03	2.68E-09	1.27E-05
	6	18.10	2.44E-02	1.41E-08	4.89E-05
	7	18.10	2.44E-02	1.41E-08	4.89E-05
	8	18.10	2.44E-02	1.41E-08	4.89E-05
Combined S1 & S2	5	11.71	4.71E-03	2.01E-09	1.29E-05
	6	19.41	1.79E-02	1.04E-08	4.92E-05
	7	19.41	1.79E-02	1.04E-08	4.92E-05
	8	19.41	1.79E-02	1.04E-08	4.92E-05

C.1.3. Case Study 3c – VS operation with phase-to-phase fault

Table 39. LOM risk assessment results for islanding scenario 1 (loss of supply to primary substation)

Load Profile	Setting Option	$T_{NDZavr,s1}$ [min]	$N_{LOM,1DGG,s1}$	$P_{LOM,1DGG,s1}$	$P_{LOM,s1}$
LP1b	5	35.36	1.13E-04	4.98E-11	8.41E-08
	6	35.36	1.13E-04	4.98E-11	8.41E-08
	7	35.36	1.13E-04	4.98E-11	8.41E-08
	8	35.36	1.13E-04	4.98E-11	8.41E-08
LP2	5	17.96	4.42E-05	2.79E-11	3.27E-08
	6	27.28	6.08E-05	3.49E-11	4.51E-08
	7	27.28	6.08E-05	3.49E-11	4.51E-08
	8	27.28	6.08E-05	3.49E-11	4.51E-08
LP3	5	8.74	5.90E-05	3.64E-11	4.37E-08
	6	13.65	1.38E-04	6.99E-11	1.02E-07
	7	13.65	1.38E-04	6.99E-11	1.02E-07
	8	13.65	1.38E-04	6.99E-11	1.02E-07
LP4	5	14.26	5.75E-04	3.64E-10	4.26E-07
	6	17.38	5.76E-04	3.65E-10	4.27E-07
	7	17.38	5.76E-04	3.65E-10	4.27E-07
	8	17.38	5.76E-04	3.65E-10	4.27E-07
LP5	5	21.14	9.04E-04	5.71E-10	6.70E-07
	6	21.14	9.04E-04	5.71E-10	6.70E-07
	7	21.14	9.04E-04	5.71E-10	6.70E-07
	8	21.14	9.04E-04	5.71E-10	6.70E-07

Table 40. LOM risk assessment results for islanding scenario 2 (loss of individual HV circuit)

Load Profile	Setting Option	$T_{NDZavr,s2}$ [min]	$N_{LOM,1DGG,s2}$	$P_{LOM,1DGG,s2}$	$P_{LOM,s2}$
LP5	5	18.16	6.28E-02	3.97E-08	1.26E-04
	6	18.20	6.28E-02	3.97E-08	1.26E-04
	7	18.20	6.28E-02	3.97E-08	1.26E-04
	8	18.20	6.28E-02	3.97E-08	1.26E-04
LP6	5	18.27	2.28E-02	1.42E-08	4.57E-05
	6	18.27	2.28E-02	1.42E-08	4.57E-05
	7	18.27	2.28E-02	1.42E-08	4.57E-05
	8	18.27	2.28E-02	1.42E-08	4.57E-05
LP3	5	10.67	5.68E-04	2.40E-10	1.14E-06
	6	13.63	1.14E-02	4.81E-09	2.28E-05
	7	13.63	1.14E-02	4.81E-09	2.28E-05
	8	13.63	1.14E-02	4.81E-09	2.28E-05
LP4	5	5.19	6.20E-03	3.93E-09	1.24E-05
	6	8.07	6.24E-03	3.95E-09	1.25E-05
	7	8.07	6.24E-03	3.95E-09	1.25E-05
	8	8.07	6.24E-03	3.95E-09	1.25E-05
LP1a	5	32.30	1.88E-02	7.95E-09	3.77E-05
	6	32.30	1.88E-02	7.95E-09	3.77E-05
	7	32.30	1.88E-02	7.95E-09	3.77E-05
	8	32.30	1.88E-02	7.95E-09	3.77E-05

Table 41. Summary LOM risk assessment results – based on maximum load profile figures

LOM Scenario	Setting Option	T_{NDZavr} [min]	$N_{LOM,1DGG}$	$P_{LOM,1DGG}$	P_{LOM}
S1	5	35.4	9.04E-04	5.71E-10	6.70E-07
	6	35.4	9.04E-04	5.71E-10	6.70E-07
	7	35.4	9.04E-04	5.71E-10	6.70E-07
	8	35.4	9.04E-04	5.71E-10	6.70E-07
S2	5	32.30	6.28E-02	3.97E-08	1.26E-04
	6	32.30	6.28E-02	3.97E-08	1.26E-04
	7	32.30	6.28E-02	3.97E-08	1.26E-04
	8	32.30	6.28E-02	3.97E-08	1.26E-04
Combined S1 & S2	5	33.13	4.61E-02	2.92E-08	1.27E-04
	6	33.13	4.61E-02	2.92E-08	1.27E-04
	7	33.13	4.61E-02	2.92E-08	1.27E-04
	8	33.13	4.61E-02	2.92E-08	1.27E-04

Table 42. Summary LOM risk assessment results – based on average load profile figures

LOM Scenario	Setting Option	T_{NDZavr} [min]	$N_{LOM,1DGG}$	$P_{LOM,1DGG}$	P_{LOM}
S1	5	19.49	3.39E-04	2.10E-10	2.51E-07
	6	22.96	3.58E-04	2.18E-10	2.66E-07
	7	22.96	3.58E-04	2.18E-10	2.66E-07
	8	22.96	3.58E-04	2.18E-10	2.66E-07
S2	5	16.92	2.22E-02	1.32E-08	4.46E-05
	6	18.10	2.44E-02	1.41E-08	4.89E-05
	7	18.10	2.44E-02	1.41E-08	4.89E-05
	8	18.10	2.44E-02	1.41E-08	4.89E-05
Combined S1 & S2	5	17.61	1.63E-02	9.71E-09	4.48E-05
	6	19.41	1.79E-02	1.04E-08	4.92E-05
	7	19.41	1.79E-02	1.04E-08	4.92E-05
	8	19.41	1.79E-02	1.04E-08	4.92E-05

C.1.4. Case Study 3d – VS operation with three-phase fault

Table 43. LOM risk assessment results for islanding scenario 1 (loss of supply to primary substation)

Load Profile	Setting Option	$T_{NDZavr,s1}$ [min]	$N_{LOM,1DGG,s1}$	$P_{LOM,1DGG,s1}$	$P_{LOM,s1}$
LP1b	5	33.06	1.04E-04	4.42E-11	7.74E-08
	6	33.06	1.04E-04	4.42E-11	7.74E-08
	7	33.06	1.04E-04	4.42E-11	7.74E-08
	8	35.36	1.13E-04	4.98E-11	8.41E-08
LP2	5	9.42	1.89E-06	8.01E-13	1.40E-09
	6	19.19	7.92E-06	3.35E-12	5.87E-09
	7	24.51	1.74E-05	7.37E-12	1.29E-08
	8	27.28	6.08E-05	3.49E-11	4.51E-08
LP3	5	6.80	1.36E-05	5.75E-12	1.01E-08
	6	10.06	3.80E-05	1.61E-11	2.82E-08
	7	10.86	8.39E-05	3.55E-11	6.22E-08
	8	13.65	1.38E-04	6.99E-11	1.02E-07
LP4	5	3.22	5.65E-07	1.37E-13	2.40E-10
	6	3.29	1.05E-06	2.60E-13	4.56E-10
	7	4.88	1.70E-06	7.20E-13	1.26E-09
	8	17.38	5.76E-04	3.65E-10	4.27E-07
LP5	5	5.13	1.02E-05	4.29E-12	7.53E-09
	6	5.13	1.02E-05	4.29E-12	7.53E-09
	7	5.13	1.02E-05	4.29E-12	7.53E-09
	8	21.14	9.04E-04	5.71E-10	6.70E-07

Table 44. LOM risk assessment results for islanding scenario 2 (loss of individual HV circuit)

Load Profile	Setting Option	$T_{NDZavr,s2}$ [min]	$N_{LOM,1DGG,s2}$	$P_{LOM,1DGG,s2}$	$P_{LOM,s2}$
LP5	5	4.41	3.61E-04	1.53E-10	7.24E-07
	6	4.42	3.61E-04	1.53E-10	7.25E-07
	7	4.43	3.61E-04	1.53E-10	7.25E-07
	8	18.20	6.28E-02	3.97E-08	1.26E-04
LP6	5	7.41	1.05E-03	4.43E-10	2.10E-06
	6	7.41	1.05E-03	4.43E-10	2.10E-06
	7	7.41	1.05E-03	4.43E-10	2.10E-06
	8	18.27	2.28E-02	1.42E-08	4.57E-05
LP3	5	8.74	1.30E-03	5.48E-10	2.60E-06
	6	10.04	4.37E-03	1.85E-09	8.76E-06
	7	10.21	1.14E-02	4.81E-09	2.28E-05
	8	13.63	1.14E-02	4.81E-09	2.28E-05
LP4	5	2.71	1.11E-05	2.41E-12	1.14E-08
	6	3.33	3.31E-05	9.24E-12	4.38E-08
	7	4.51	4.62E-05	1.95E-11	9.26E-08
	8	8.07	6.24E-03	3.95E-09	1.25E-05
LP1a	5	30.44	1.88E-02	7.95E-09	3.77E-05
	6	30.44	1.88E-02	7.95E-09	3.77E-05
	7	30.44	1.88E-02	7.95E-09	3.77E-05
	8	32.30	1.88E-02	7.95E-09	3.77E-05

Table 45. Summary LOM risk assessment results – based on maximum load profile figures

LOM Scenario	Setting Option	T_{NDZavr} [min]	$N_{LOM,1DGG}$	$P_{LOM,1DGG}$	P_{LOM}
S1	5	33.1	1.04E-04	4.42E-11	7.74E-08
	6	33.1	1.04E-04	4.42E-11	7.74E-08
	7	33.1	1.04E-04	4.42E-11	7.74E-08
	8	35.4	9.04E-04	5.71E-10	6.70E-07
S2	5	30.44	1.88E-02	7.95E-09	3.77E-05
	6	30.44	1.88E-02	7.95E-09	3.77E-05
	7	30.44	1.88E-02	7.95E-09	3.77E-05
	8	32.30	6.28E-02	3.97E-08	1.26E-04
Combined S1 & S2	5	31.14	1.38E-02	5.81E-09	3.78E-05
	6	31.14	1.38E-02	5.81E-09	3.78E-05
	7	31.14	1.38E-02	5.81E-09	3.78E-05
	8	33.13	4.61E-02	2.92E-08	1.27E-04

Table 46. Summary LOM risk assessment results – based on average load profile figures

LOM Scenario	Setting Option	T_{NDZavr} [min]	$N_{LOM,1DGG}$	$P_{LOM,1DGG}$	P_{LOM}
S1	5	11.52	2.61E-05	1.10E-11	1.93E-08
	6	14.14	3.23E-05	1.36E-11	2.39E-08
	7	15.69	4.35E-05	1.84E-11	3.23E-08
	8	22.96	3.58E-04	2.18E-10	2.66E-07
S2	5	10.74	4.30E-03	1.82E-09	8.63E-06
	6	11.13	4.92E-03	2.08E-09	9.87E-06
	7	11.40	6.33E-03	2.68E-09	1.27E-05
	8	18.10	2.44E-02	1.41E-08	4.89E-05
Combined S1 & S2	5	10.95	3.15E-03	1.33E-09	8.65E-06
	6	11.94	3.60E-03	1.52E-09	9.89E-06
	7	12.56	4.63E-03	1.96E-09	1.27E-05
	8	19.41	1.79E-02	1.04E-08	4.92E-05

C.2. Detailed results for different generation mixes and load profiles (VS operation with no fault)

C.2.1. Case Study 3a – VS operation with no fault

Table 47. LOM risk assessment results (islanding scenario 1, load profile LP1b)

Generation Mix (<i>m</i>)	Setting Option	$T_{NDZavr(m)}$ [min]	$N_{LOM,1DGG(m)}$	$P_{LOM,1DGG(m)}$	$N_{LOM(m)}$	$P_{LOM(m)}$
1	5	148.42	4.69E-04	1.98E-10	1.22E-01	7.74E-08
	6	148.42	4.69E-04	1.98E-10	1.22E-01	7.74E-08
	7	148.42	4.69E-04	1.98E-10	1.22E-01	7.74E-08
	8	148.42	4.69E-04	1.98E-10	1.22E-01	7.74E-08
2	5	22.32	8.69E-05	5.51E-11	1.05E-02	6.64E-09
	6	22.32	8.69E-05	5.51E-11	1.05E-02	6.64E-09
	7	22.32	8.69E-05	5.51E-11	1.05E-02	6.64E-09
	8	22.32	8.69E-05	5.51E-11	1.05E-02	6.64E-09

Table 48. LOM risk assessment results (islanding scenario 1, load profile LP2)

Generation Mix (<i>m</i>)	Setting Option	$T_{NDZavr(m)}$ [min]	$N_{LOM,1DGG(m)}$	$P_{LOM,1DGG(m)}$	$N_{LOM(m)}$	$P_{LOM(m)}$
1	5	110.07	7.83E-05	3.31E-11	2.04E-02	1.29E-08
	6	110.07	7.83E-05	3.31E-11	2.04E-02	1.29E-08
	7	110.07	7.83E-05	3.31E-11	2.04E-02	1.29E-08
	8	110.07	7.83E-05	3.31E-11	2.04E-02	1.29E-08
2	5	26.81	4.21E-04	2.67E-10	5.07E-02	3.22E-08
	6	26.81	4.21E-04	2.67E-10	5.07E-02	3.22E-08
	7	26.81	4.21E-04	2.67E-10	5.07E-02	3.22E-08
	8	26.81	4.21E-04	2.67E-10	5.07E-02	3.22E-08

Table 49. LOM risk assessment results (islanding scenario 1, load profile LP3)

Generation Mix (<i>m</i>)	Setting Option	$T_{NDZavr(m)}$ [min]	$N_{LOM,1DGG(m)}$	$P_{LOM,1DGG(m)}$	$N_{LOM(m)}$	$P_{LOM(m)}$
1	5	48.78	3.77E-04	1.59E-10	9.80E-02	6.22E-08
	6	48.78	3.77E-04	1.59E-10	9.80E-02	6.22E-08
	7	48.78	3.77E-04	1.59E-10	9.80E-02	6.22E-08
	8	48.78	3.77E-04	1.59E-10	9.80E-02	6.22E-08
2	5	27.00	5.26E-04	3.34E-10	6.34E-02	4.02E-08
	6	27.00	5.26E-04	3.34E-10	6.34E-02	4.02E-08
	7	27.00	5.26E-04	3.34E-10	6.34E-02	4.02E-08
	8	27.00	5.26E-04	3.34E-10	6.34E-02	4.02E-08

Table 50. LOM risk assessment results (islanding scenario 1, load profile LP4)

Generation Mix (<i>m</i>)	Setting Option	$T_{NDZavr(m)}$ [min]	$N_{LOM,1DGG(m)}$	$P_{LOM,1DGG(m)}$	$N_{LOM(m)}$	$P_{LOM(m)}$
1	5	21.90	7.64E-06	3.23E-12	1.99E-03	1.26E-09
	6	21.90	7.64E-06	3.23E-12	1.99E-03	1.26E-09
	7	21.90	7.64E-06	3.23E-12	1.99E-03	1.26E-09
	8	21.90	7.64E-06	3.23E-12	1.99E-03	1.26E-09
2	5	121.24	5.57E-03	3.53E-09	6.71E-01	4.26E-07
	6	121.24	5.57E-03	3.53E-09	6.71E-01	4.26E-07
	7	121.24	5.57E-03	3.53E-09	6.71E-01	4.26E-07
	8	121.24	5.57E-03	3.53E-09	6.71E-01	4.26E-07

Table 51. LOM risk assessment results (islanding scenario 1, load profile LP5)

Generation Mix (<i>m</i>)	Setting Option	$T_{NDZavr(m)}$ [min]	$N_{LOM,1DGG(m)}$	$P_{LOM,1DGG(m)}$	$N_{LOM(m)}$	$P_{LOM(m)}$
1	5	23.02	4.56E-05	1.93E-11	1.19E-02	7.53E-09
	6	23.02	4.56E-05	1.93E-11	1.19E-02	7.53E-09
	7	23.02	4.56E-05	1.93E-11	1.19E-02	7.53E-09
	8	23.02	4.56E-05	1.93E-11	1.19E-02	7.53E-09
2	5	155.27	8.67E-03	5.50E-09	1.04E+00	6.62E-07
	6	155.27	8.67E-03	5.50E-09	1.04E+00	6.62E-07
	7	155.27	8.67E-03	5.50E-09	1.04E+00	6.62E-07
	8	155.27	8.67E-03	5.50E-09	1.04E+00	6.62E-07

Table 52. LOM risk assessment results (islanding scenario 2, load profile LP5)

Generation Mix (<i>m</i>)	Setting Option	$T_{NDZavr(m)}$ [min]	$N_{LOM,1DGG(m)}$	$P_{LOM,1DGG(m)}$	$N_{LOM(m)}$	$P_{LOM(m)}$
1	5	21.58	1.76E-03	7.45E-10	1.14E+00	7.25E-07
	6	21.58	1.76E-03	7.45E-10	1.14E+00	7.25E-07
	7	21.58	1.76E-03	7.45E-10	1.14E+00	7.25E-07
	8	21.58	1.76E-03	7.45E-10	1.14E+00	7.25E-07
2	5	116.35	5.27E-01	3.34E-07	1.97E+02	1.25E-04
	6	116.35	5.27E-01	3.34E-07	1.97E+02	1.25E-04
	7	116.35	5.27E-01	3.34E-07	1.97E+02	1.25E-04
	8	116.35	5.27E-01	3.34E-07	1.97E+02	1.25E-04

Table 53. LOM risk assessment results (islanding scenario 2, load profile LP6)

Generation Mix (<i>m</i>)	Setting Option	$T_{NDZavr(m)}$ [min]	$N_{LOM,1DGG(m)}$	$P_{LOM,1DGG(m)}$	$N_{LOM(m)}$	$P_{LOM(m)}$
1	5	36.14	5.11E-03	2.16E-09	3.31E+00	2.10E-06
	6	36.14	5.11E-03	2.16E-09	3.31E+00	2.10E-06
	7	36.14	5.11E-03	2.16E-09	3.31E+00	2.10E-06
	8	36.14	5.11E-03	2.16E-09	3.31E+00	2.10E-06
2	5	91.73	1.84E-01	1.17E-07	6.88E+01	4.36E-05
	6	91.73	1.84E-01	1.17E-07	6.88E+01	4.36E-05
	7	91.73	1.84E-01	1.17E-07	6.88E+01	4.36E-05
	8	91.73	1.84E-01	1.17E-07	6.88E+01	4.36E-05

Table 54. LOM risk assessment results (islanding scenario 2, load profile LP3)

Generation Mix (<i>m</i>)	Setting Option	$T_{NDZavr(m)}$ [min]	$N_{LOM,1DGG(m)}$	$P_{LOM,1DGG(m)}$	$N_{LOM(m)}$	$P_{LOM(m)}$
1	5	49.77	5.55E-02	2.35E-08	3.60E+01	2.28E-05
	6	49.77	5.55E-02	2.35E-08	3.60E+01	2.28E-05
	7	49.77	5.55E-02	2.35E-08	3.60E+01	2.28E-05
	8	49.77	5.55E-02	2.35E-08	3.60E+01	2.28E-05
2	5	28.89	0.00E+00	0.00E+00	0.00E+00	0.00E+00
	6	28.89	0.00E+00	0.00E+00	0.00E+00	0.00E+00
	7	28.89	0.00E+00	0.00E+00	0.00E+00	0.00E+00
	8	28.89	0.00E+00	0.00E+00	0.00E+00	0.00E+00

Table 55. LOM risk assessment results (islanding scenario 2, load profile LP4)

Generation Mix (<i>m</i>)	Setting Option	$T_{NDZavr(m)}$ [min]	$N_{LOM,1DGG(m)}$	$P_{LOM,1DGG(m)}$	$N_{LOM(m)}$	$P_{LOM(m)}$
1	5	21.98	2.25E-04	9.52E-11	1.46E-01	9.26E-08
	6	21.98	2.25E-04	9.52E-11	1.46E-01	9.26E-08
	7	21.98	2.25E-04	9.52E-11	1.46E-01	9.26E-08
	8	21.98	2.25E-04	9.52E-11	1.46E-01	9.26E-08
2	5	30.12	5.23E-02	3.32E-08	1.96E+01	1.24E-05
	6	30.12	5.23E-02	3.32E-08	1.96E+01	1.24E-05
	7	30.12	5.23E-02	3.32E-08	1.96E+01	1.24E-05
	8	30.12	5.23E-02	3.32E-08	1.96E+01	1.24E-05

Table 56. LOM risk assessment results (islanding scenario 2, load profile LP1a)

Generation Mix (<i>m</i>)	Setting Option	$T_{NDZavr(m)}$ [min]	$N_{LOM,1DGG(m)}$	$P_{LOM,1DGG(m)}$	$N_{LOM(m)}$	$P_{LOM(m)}$
1	5	148.42	9.17E-02	3.88E-08	5.94E+01	3.77E-05
	6	148.42	9.17E-02	3.88E-08	5.94E+01	3.77E-05
	7	148.42	9.17E-02	3.88E-08	5.94E+01	3.77E-05
	8	148.42	9.17E-02	3.88E-08	5.94E+01	3.77E-05
2	5	15.73	0.00E+00	0.00E+00	0.00E+00	0.00E+00
	6	15.73	0.00E+00	0.00E+00	0.00E+00	0.00E+00
	7	15.73	0.00E+00	0.00E+00	0.00E+00	0.00E+00
	8	15.73	0.00E+00	0.00E+00	0.00E+00	0.00E+00

C.2.2. Case Study 3b – VS operation with single phase-to-earth fault

Table 57. LOM risk assessment results (islanding scenario 1, load profile LP1b)

Generation Mix (m)	Setting Option	$T_{NDZavr(m)}$ [min]	$N_{LOM,1DGG(m)}$	$P_{LOM,1DGG(m)}$	$N_{LOM(m)}$	$P_{LOM(m)}$
1	5	46.05	1.42E-04	6.00E-11	3.69E-02	2.34E-08
	6	148.42	4.69E-04	1.98E-10	1.22E-01	7.74E-08
	7	148.42	4.69E-04	1.98E-10	1.22E-01	7.74E-08
	8	148.42	4.69E-04	1.98E-10	1.22E-01	7.74E-08
2	5	22.32	8.69E-05	5.51E-11	1.05E-02	6.64E-09
	6	22.32	8.69E-05	5.51E-11	1.05E-02	6.64E-09
	7	22.32	8.69E-05	5.51E-11	1.05E-02	6.64E-09
	8	22.32	8.69E-05	5.51E-11	1.05E-02	6.64E-09

Table 58. LOM risk assessment results (islanding scenario 1, load profile LP2)

Generation Mix (m)	Setting Option	$T_{NDZavr(m)}$ [min]	$N_{LOM,1DGG(m)}$	$P_{LOM,1DGG(m)}$	$N_{LOM(m)}$	$P_{LOM(m)}$
1	5	35.96	1.29E-06	5.45E-13	3.35E-04	2.13E-10
	6	110.07	7.83E-05	3.31E-11	2.04E-02	1.29E-08
	7	110.07	7.83E-05	3.31E-11	2.04E-02	1.29E-08
	8	110.07	7.83E-05	3.31E-11	2.04E-02	1.29E-08
2	5	26.81	4.21E-04	2.67E-10	5.07E-02	3.22E-08
	6	26.81	4.21E-04	2.67E-10	5.07E-02	3.22E-08
	7	26.81	4.21E-04	2.67E-10	5.07E-02	3.22E-08
	8	26.81	4.21E-04	2.67E-10	5.07E-02	3.22E-08

Table 59. LOM risk assessment results (islanding scenario 1, load profile LP3)

Generation Mix (m)	Setting Option	$T_{NDZavr(m)}$ [min]	$N_{LOM,1DGG(m)}$	$P_{LOM,1DGG(m)}$	$N_{LOM(m)}$	$P_{LOM(m)}$
1	5	20.09	1.05E-05	4.45E-12	2.74E-03	1.74E-09
	6	48.78	3.77E-04	1.59E-10	9.80E-02	6.22E-08
	7	48.78	3.77E-04	1.59E-10	9.80E-02	6.22E-08
	8	48.78	3.77E-04	1.59E-10	9.80E-02	6.22E-08
2	5	27.00	5.26E-04	3.34E-10	6.34E-02	4.02E-08
	6	27.00	5.26E-04	3.34E-10	6.34E-02	4.02E-08
	7	27.00	5.26E-04	3.34E-10	6.34E-02	4.02E-08
	8	27.00	5.26E-04	3.34E-10	6.34E-02	4.02E-08

Table 60. LOM risk assessment results (islanding scenario 1, load profile LP4)

Generation Mix (<i>m</i>)	Setting Option	$T_{NDZavr(m)}$ [min]	$N_{LOM,1DGG(m)}$	$P_{LOM,1DGG(m)}$	$N_{LOM(m)}$	$P_{LOM(m)}$
1	5	8.38	6.91E-07	7.85E-14	1.80E-04	3.07E-11
	6	21.90	7.64E-06	3.23E-12	1.99E-03	1.26E-09
	7	21.90	7.64E-06	3.23E-12	1.99E-03	1.26E-09
	8	21.90	7.64E-06	3.23E-12	1.99E-03	1.26E-09
2	5	121.24	5.57E-03	3.53E-09	6.71E-01	4.26E-07
	6	121.24	5.57E-03	3.53E-09	6.71E-01	4.26E-07
	7	121.24	5.57E-03	3.53E-09	6.71E-01	4.26E-07
	8	121.24	5.57E-03	3.53E-09	6.71E-01	4.26E-07

Table 61. LOM risk assessment results (islanding scenario 1, load profile LP5)

Generation Mix (<i>m</i>)	Setting Option	$T_{NDZavr(m)}$ [min]	$N_{LOM,1DGG(m)}$	$P_{LOM,1DGG(m)}$	$N_{LOM(m)}$	$P_{LOM(m)}$
1	5	8.40	9.92E-06	1.13E-12	2.58E-03	4.42E-10
	6	23.02	4.56E-05	1.93E-11	1.19E-02	7.53E-09
	7	23.02	4.56E-05	1.93E-11	1.19E-02	7.53E-09
	8	23.02	4.56E-05	1.93E-11	1.19E-02	7.53E-09
2	5	155.27	8.67E-03	5.50E-09	1.04E+00	6.62E-07
	6	155.27	8.67E-03	5.50E-09	1.04E+00	6.62E-07
	7	155.27	8.67E-03	5.50E-09	1.04E+00	6.62E-07
	8	155.27	8.67E-03	5.50E-09	1.04E+00	6.62E-07

Table 62. LOM risk assessment results (islanding scenario 2, load profile LP5)

Generation Mix (<i>m</i>)	Setting Option	$T_{NDZavr(m)}$ [min]	$N_{LOM,1DGG(m)}$	$P_{LOM,1DGG(m)}$	$N_{LOM(m)}$	$P_{LOM(m)}$
1	5	21.58	1.76E-03	7.45E-10	1.14E+00	7.25E-07
	6	21.58	1.76E-03	7.45E-10	1.14E+00	7.25E-07
	7	21.58	1.76E-03	7.45E-10	1.14E+00	7.25E-07
	8	21.58	1.76E-03	7.45E-10	1.14E+00	7.25E-07
2	5	0.00	0.00E+00	-0.00E+00	0.00E+00	-0.00E+00
	6	116.35	5.27E-01	3.34E-07	1.97E+02	1.25E-04
	7	116.35	5.27E-01	3.34E-07	1.97E+02	1.25E-04
	8	116.35	5.27E-01	3.34E-07	1.97E+02	1.25E-04

Table 63. LOM risk assessment results (islanding scenario 2, load profile LP6)

Generation Mix (<i>m</i>)	Setting Option	$T_{NDZavr(m)}$ [min]	$N_{LOM,1DGG(m)}$	$P_{LOM,1DGG(m)}$	$N_{LOM(m)}$	$P_{LOM(m)}$
1	5	36.14	5.11E-03	2.16E-09	3.31E+00	2.10E-06
	6	36.14	5.11E-03	2.16E-09	3.31E+00	2.10E-06
	7	36.14	5.11E-03	2.16E-09	3.31E+00	2.10E-06
	8	36.14	5.11E-03	2.16E-09	3.31E+00	2.10E-06
2	5	0.00	0.00E+00	-0.00E+00	0.00E+00	-0.00E+00
	6	91.73	1.84E-01	1.17E-07	6.88E+01	4.36E-05
	7	91.73	1.84E-01	1.17E-07	6.88E+01	4.36E-05
	8	91.73	1.84E-01	1.17E-07	6.88E+01	4.36E-05

Table 64. LOM risk assessment results (islanding scenario 2, load profile LP3)

Generation Mix (<i>m</i>)	Setting Option	$T_{NDZavr(m)}$ [min]	$N_{LOM,1DGG(m)}$	$P_{LOM,1DGG(m)}$	$N_{LOM(m)}$	$P_{LOM(m)}$
1	5	49.77	5.55E-02	2.35E-08	3.60E+01	2.28E-05
	6	49.77	5.55E-02	2.35E-08	3.60E+01	2.28E-05
	7	49.77	5.55E-02	2.35E-08	3.60E+01	2.28E-05
	8	49.77	5.55E-02	2.35E-08	3.60E+01	2.28E-05
2	5	0.00	0.00E+00	-0.00E+00	0.00E+00	-0.00E+00
	6	28.89	0.00E+00	0.00E+00	0.00E+00	0.00E+00
	7	28.89	0.00E+00	0.00E+00	0.00E+00	0.00E+00
	8	28.89	0.00E+00	0.00E+00	0.00E+00	0.00E+00

Table 65. LOM risk assessment results (islanding scenario 2, load profile LP4)

Generation Mix (<i>m</i>)	Setting Option	$T_{NDZavr(m)}$ [min]	$N_{LOM,1DGG(m)}$	$P_{LOM,1DGG(m)}$	$N_{LOM(m)}$	$P_{LOM(m)}$
1	5	21.98	2.25E-04	9.52E-11	1.46E-01	9.26E-08
	6	21.98	2.25E-04	9.52E-11	1.46E-01	9.26E-08
	7	21.98	2.25E-04	9.52E-11	1.46E-01	9.26E-08
	8	21.98	2.25E-04	9.52E-11	1.46E-01	9.26E-08
2	5	0.00	0.00E+00	-0.00E+00	0.00E+00	-0.00E+00
	6	30.12	5.23E-02	3.32E-08	1.96E+01	1.24E-05
	7	30.12	5.23E-02	3.32E-08	1.96E+01	1.24E-05
	8	30.12	5.23E-02	3.32E-08	1.96E+01	1.24E-05

Table 66. LOM risk assessment results (islanding scenario 2, load profile LP1a)

Generation Mix (<i>m</i>)	Setting Option	$T_{NDZavr(m)}$ [min]	$N_{LOM,1DGG(m)}$	$P_{LOM,1DGG(m)}$	$N_{LOM(m)}$	$P_{LOM(m)}$
1	5	148.42	9.17E-02	3.88E-08	5.94E+01	3.77E-05
	6	148.42	9.17E-02	3.88E-08	5.94E+01	3.77E-05
	7	148.42	9.17E-02	3.88E-08	5.94E+01	3.77E-05
	8	148.42	9.17E-02	3.88E-08	5.94E+01	3.77E-05
2	5	0.00	0.00E+00	-0.00E+00	0.00E+00	-0.00E+00
	6	15.73	0.00E+00	0.00E+00	0.00E+00	0.00E+00
	7	15.73	0.00E+00	0.00E+00	0.00E+00	0.00E+00
	8	15.73	0.00E+00	0.00E+00	0.00E+00	0.00E+00

C.2.3. Case Study 3c – VS operation with phase-to-phase fault

Table 67. LOM risk assessment results (islanding scenario 1, load profile LP1b)

Generation Mix (<i>m</i>)	Setting Option	$T_{NDZavr(m)}$ [min]	$N_{LOM,1DGG(m)}$	$P_{LOM,1DGG(m)}$	$N_{LOM(m)}$	$P_{LOM(m)}$
1	5	148.42	4.69E-04	1.98E-10	1.22E-01	7.74E-08
	6	148.42	4.69E-04	1.98E-10	1.22E-01	7.74E-08
	7	148.42	4.69E-04	1.98E-10	1.22E-01	7.74E-08
	8	148.42	4.69E-04	1.98E-10	1.22E-01	7.74E-08
2	5	22.32	8.69E-05	5.51E-11	1.05E-02	6.64E-09
	6	22.32	8.69E-05	5.51E-11	1.05E-02	6.64E-09
	7	22.32	8.69E-05	5.51E-11	1.05E-02	6.64E-09
	8	22.32	8.69E-05	5.51E-11	1.05E-02	6.64E-09

Table 68. LOM risk assessment results (islanding scenario 1, load profile LP2)

Generation Mix (<i>m</i>)	Setting Option	$T_{NDZavr(m)}$ [min]	$N_{LOM,1DGG(m)}$	$P_{LOM,1DGG(m)}$	$N_{LOM(m)}$	$P_{LOM(m)}$
1	5	68.25	3.46E-06	1.46E-12	9.01E-04	5.72E-10
	6	110.07	7.83E-05	3.31E-11	2.04E-02	1.29E-08
	7	110.07	7.83E-05	3.31E-11	2.04E-02	1.29E-08
	8	110.07	7.83E-05	3.31E-11	2.04E-02	1.29E-08
2	5	26.81	4.21E-04	2.67E-10	5.07E-02	3.22E-08
	6	26.81	4.21E-04	2.67E-10	5.07E-02	3.22E-08
	7	26.81	4.21E-04	2.67E-10	5.07E-02	3.22E-08
	8	26.81	4.21E-04	2.67E-10	5.07E-02	3.22E-08

Table 69. LOM risk assessment results (islanding scenario 1, load profile LP3)

Generation Mix (<i>m</i>)	Setting Option	$T_{NDZavr(m)}$ [min]	$N_{LOM,1DGG(m)}$	$P_{LOM,1DGG(m)}$	$N_{LOM(m)}$	$P_{LOM(m)}$
1	5	26.75	2.11E-05	8.92E-12	5.49E-03	3.48E-09
	6	48.78	3.77E-04	1.59E-10	9.80E-02	6.22E-08
	7	48.78	3.77E-04	1.59E-10	9.80E-02	6.22E-08
	8	48.78	3.77E-04	1.59E-10	9.80E-02	6.22E-08
2	5	27.00	5.26E-04	3.34E-10	6.34E-02	4.02E-08
	6	27.00	5.26E-04	3.34E-10	6.34E-02	4.02E-08
	7	27.00	5.26E-04	3.34E-10	6.34E-02	4.02E-08
	8	27.00	5.26E-04	3.34E-10	6.34E-02	4.02E-08

Table 70. LOM risk assessment results (islanding scenario 1, load profile LP4)

Generation Mix (m)	Setting Option	$T_{NDZavr(m)}$ [min]	$N_{LOM,1DGG(m)}$	$P_{LOM,1DGG(m)}$	$N_{LOM(m)}$	$P_{LOM(m)}$
1	5	7.89	7.54E-07	7.79E-14	1.96E-04	3.04E-11
	6	21.90	7.64E-06	3.23E-12	1.99E-03	1.26E-09
	7	21.90	7.64E-06	3.23E-12	1.99E-03	1.26E-09
	8	21.90	7.64E-06	3.23E-12	1.99E-03	1.26E-09
2	5	121.24	5.57E-03	3.53E-09	6.71E-01	4.26E-07
	6	121.24	5.57E-03	3.53E-09	6.71E-01	4.26E-07
	7	121.24	5.57E-03	3.53E-09	6.71E-01	4.26E-07
	8	121.24	5.57E-03	3.53E-09	6.71E-01	4.26E-07

Table 71. LOM risk assessment results (islanding scenario 1, load profile LP5)

Generation Mix (m)	Setting Option	$T_{NDZavr(m)}$ [min]	$N_{LOM,1DGG(m)}$	$P_{LOM,1DGG(m)}$	$N_{LOM(m)}$	$P_{LOM(m)}$
1	5	23.02	4.56E-05	1.93E-11	1.19E-02	7.53E-09
	6	23.02	4.56E-05	1.93E-11	1.19E-02	7.53E-09
	7	23.02	4.56E-05	1.93E-11	1.19E-02	7.53E-09
	8	23.02	4.56E-05	1.93E-11	1.19E-02	7.53E-09
2	1	155.27	8.67E-03	5.50E-09	1.04E+00	6.62E-07
	2	155.27	8.67E-03	5.50E-09	1.04E+00	6.62E-07
	3	155.27	8.67E-03	5.50E-09	1.04E+00	6.62E-07
	11	155.27	8.67E-03	5.50E-09	1.04E+00	6.62E-07

Table 72. LOM risk assessment results (islanding scenario 2, load profile LP5)

Generation Mix (m)	Setting Option	$T_{NDZavr(m)}$ [min]	$N_{LOM,1DGG(m)}$	$P_{LOM,1DGG(m)}$	$N_{LOM(m)}$	$P_{LOM(m)}$
1	5	21.34	1.76E-03	7.42E-10	1.14E+00	7.22E-07
	6	21.58	1.76E-03	7.45E-10	1.14E+00	7.25E-07
	7	21.58	1.76E-03	7.45E-10	1.14E+00	7.25E-07
	8	21.58	1.76E-03	7.45E-10	1.14E+00	7.25E-07
2	5	116.35	5.27E-01	3.34E-07	1.97E+02	1.25E-04
	6	116.35	5.27E-01	3.34E-07	1.97E+02	1.25E-04
	7	116.35	5.27E-01	3.34E-07	1.97E+02	1.25E-04
	8	116.35	5.27E-01	3.34E-07	1.97E+02	1.25E-04

Table 73. LOM risk assessment results (islanding scenario 2, load profile LP6)

Generation Mix (m)	Setting Option	$T_{NDZavr(m)}$ [min]	$N_{LOM,1DGG(m)}$	$P_{LOM,1DGG(m)}$	$N_{LOM(m)}$	$P_{LOM(m)}$
1	5	36.14	5.11E-03	2.16E-09	3.31E+00	2.10E-06
	6	36.14	5.11E-03	2.16E-09	3.31E+00	2.10E-06
	7	36.14	5.11E-03	2.16E-09	3.31E+00	2.10E-06
	8	36.14	5.11E-03	2.16E-09	3.31E+00	2.10E-06
2	5	91.73	1.84E-01	1.17E-07	6.88E+01	4.36E-05
	6	91.73	1.84E-01	1.17E-07	6.88E+01	4.36E-05
	7	91.73	1.84E-01	1.17E-07	6.88E+01	4.36E-05
	8	91.73	1.84E-01	1.17E-07	6.88E+01	4.36E-05

Table 74. LOM risk assessment results (islanding scenario 2, load profile LP3)

Generation Mix (<i>m</i>)	Setting Option	$T_{NDZavr(m)}$ [min]	$N_{LOM,1DGG(m)}$	$P_{LOM,1DGG(m)}$	$N_{LOM(m)}$	$P_{LOM(m)}$
1	5	35.37	2.77E-03	1.17E-09	1.79E+00	1.14E-06
	6	49.77	5.55E-02	2.35E-08	3.60E+01	2.28E-05
	7	49.77	5.55E-02	2.35E-08	3.60E+01	2.28E-05
	8	49.77	5.55E-02	2.35E-08	3.60E+01	2.28E-05
2	5	28.89	0.00E+00	0.00E+00	0.00E+00	0.00E+00
	6	28.89	0.00E+00	0.00E+00	0.00E+00	0.00E+00
	7	28.89	0.00E+00	0.00E+00	0.00E+00	0.00E+00
	8	28.89	0.00E+00	0.00E+00	0.00E+00	0.00E+00

Table 75. LOM risk assessment results (islanding scenario 2, load profile LP4)

Generation Mix (<i>m</i>)	Setting Option	$T_{NDZavr(m)}$ [min]	$N_{LOM,1DGG(m)}$	$P_{LOM,1DGG(m)}$	$N_{LOM(m)}$	$P_{LOM(m)}$
1	5	7.89	1.41E-05	1.45E-12	9.11E-03	1.41E-09
	6	21.98	2.25E-04	9.52E-11	1.46E-01	9.26E-08
	7	21.98	2.25E-04	9.52E-11	1.46E-01	9.26E-08
	8	21.98	2.25E-04	9.52E-11	1.46E-01	9.26E-08
2	5	30.12	5.23E-02	3.32E-08	1.96E+01	1.24E-05
	6	30.12	5.23E-02	3.32E-08	1.96E+01	1.24E-05
	7	30.12	5.23E-02	3.32E-08	1.96E+01	1.24E-05
	8	30.12	5.23E-02	3.32E-08	1.96E+01	1.24E-05

Table 76. LOM risk assessment results (islanding scenario 2, load profile LP1a)

Generation Mix (<i>m</i>)	Setting Option	$T_{NDZavr(m)}$ [min]	$N_{LOM,1DGG(m)}$	$P_{LOM,1DGG(m)}$	$N_{LOM(m)}$	$P_{LOM(m)}$
1	5	148.42	9.17E-02	3.88E-08	5.94E+01	3.77E-05
	6	148.42	9.17E-02	3.88E-08	5.94E+01	3.77E-05
	7	148.42	9.17E-02	3.88E-08	5.94E+01	3.77E-05
	8	148.42	9.17E-02	3.88E-08	5.94E+01	3.77E-05
2	5	15.73	0.00E+00	0.00E+00	0.00E+00	0.00E+00
	6	15.73	0.00E+00	0.00E+00	0.00E+00	0.00E+00
	7	15.73	0.00E+00	0.00E+00	0.00E+00	0.00E+00
	8	15.73	0.00E+00	0.00E+00	0.00E+00	0.00E+00

C.2.4. Case Study 3d – VS operation with three-phase fault

Table 77. LOM risk assessment results (islanding scenario 1, load profile LP1b)

Generation Mix (m)	Setting Option	$T_{NDZavr(m)}$ [min]	$N_{LOM,1DGG(m)}$	$P_{LOM,1DGG(m)}$	$N_{LOM(m)}$	$P_{LOM(m)}$
1	5	148.42	4.69E-04	1.98E-10	1.22E-01	7.74E-08
	6	148.42	4.69E-04	1.98E-10	1.22E-01	7.74E-08
	7	148.42	4.69E-04	1.98E-10	1.22E-01	7.74E-08
	8	148.42	4.69E-04	1.98E-10	1.22E-01	7.74E-08
2	5	0.00	0.00E+00	-0.00E+00	0.00E+00	-0.00E+00
	6	0.00	0.00E+00	-0.00E+00	0.00E+00	-0.00E+00
	7	0.00	0.00E+00	-0.00E+00	0.00E+00	-0.00E+00
	8	22.32	8.69E-05	5.51E-11	1.05E-02	6.64E-09

Table 78. LOM risk assessment results (islanding scenario 1, load profile LP2)

Generation Mix (m)	Setting Option	$T_{NDZavr(m)}$ [min]	$N_{LOM,1DGG(m)}$	$P_{LOM,1DGG(m)}$	$N_{LOM(m)}$	$P_{LOM(m)}$
1	5	42.29	8.51E-06	3.60E-12	2.21E-03	1.40E-09
	6	86.18	3.56E-05	1.50E-11	9.25E-03	5.87E-09
	7	110.07	7.83E-05	3.31E-11	2.04E-02	1.29E-08
	8	110.07	7.83E-05	3.31E-11	2.04E-02	1.29E-08
2	5	0.00	0.00E+00	-0.00E+00	0.00E+00	-0.00E+00
	6	0.00	0.00E+00	-0.00E+00	0.00E+00	-0.00E+00
	7	0.00	0.00E+00	-0.00E+00	0.00E+00	-0.00E+00
	8	26.81	4.21E-04	2.67E-10	5.07E-02	3.22E-08

Table 79. LOM risk assessment results (islanding scenario 1, load profile LP3)

Generation Mix (m)	Setting Option	$T_{NDZavr(m)}$ [min]	$N_{LOM,1DGG(m)}$	$P_{LOM,1DGG(m)}$	$N_{LOM(m)}$	$P_{LOM(m)}$
1	5	30.54	6.11E-05	2.58E-11	1.59E-02	1.01E-08
	6	45.17	1.71E-04	7.21E-11	4.44E-02	2.82E-08
	7	48.78	3.77E-04	1.59E-10	9.80E-02	6.22E-08
	8	48.78	3.77E-04	1.59E-10	9.80E-02	6.22E-08
2	5	0.00	0.00E+00	-0.00E+00	0.00E+00	-0.00E+00
	6	0.00	0.00E+00	-0.00E+00	0.00E+00	-0.00E+00
	7	0.00	0.00E+00	-0.00E+00	0.00E+00	-0.00E+00
	8	27.00	5.26E-04	3.34E-10	6.34E-02	4.02E-08

Table 80. LOM risk assessment results (islanding scenario 1, load profile LP4)

Generation Mix (<i>m</i>)	Setting Option	$T_{NDZavr(m)}$ [min]	$N_{LOM,1DGG(m)}$	$P_{LOM,1DGG(m)}$	$N_{LOM(m)}$	$P_{LOM(m)}$
1	5	14.44	2.54E-06	6.14E-13	6.60E-04	2.40E-10
	6	14.75	4.70E-06	1.17E-12	1.22E-03	4.56E-10
	7	21.90	7.64E-06	3.23E-12	1.99E-03	1.26E-09
	8	21.90	7.64E-06	3.23E-12	1.99E-03	1.26E-09
2	5	0.00	0.00E+00	-0.00E+00	0.00E+00	-0.00E+00
	6	0.00	0.00E+00	-0.00E+00	0.00E+00	-0.00E+00
	7	0.00	0.00E+00	-0.00E+00	0.00E+00	-0.00E+00
	8	121.24	5.57E-03	3.53E-09	6.71E-01	4.26E-07

Table 81. LOM risk assessment results (islanding scenario 1, load profile LP5)

Generation Mix (<i>m</i>)	Setting Option	$T_{NDZavr(m)}$ [min]	$N_{LOM,1DGG(m)}$	$P_{LOM,1DGG(m)}$	$N_{LOM(m)}$	$P_{LOM(m)}$
1	5	23.02	4.56E-05	1.93E-11	1.19E-02	7.53E-09
	6	23.02	4.56E-05	1.93E-11	1.19E-02	7.53E-09
	7	23.02	4.56E-05	1.93E-11	1.19E-02	7.53E-09
	8	23.02	4.56E-05	1.93E-11	1.19E-02	7.53E-09
2	5	0.00	0.00E+00	-0.00E+00	0.00E+00	-0.00E+00
	6	0.00	0.00E+00	-0.00E+00	0.00E+00	-0.00E+00
	7	0.00	0.00E+00	-0.00E+00	0.00E+00	-0.00E+00
	8	155.27	8.67E-03	5.50E-09	1.04E+00	6.62E-07

Table 82. LOM risk assessment results (islanding scenario 2, load profile LP5)

Generation Mix (<i>m</i>)	Setting Option	$T_{NDZavr(m)}$ [min]	$N_{LOM,1DGG(m)}$	$P_{LOM,1DGG(m)}$	$N_{LOM(m)}$	$P_{LOM(m)}$
1	5	21.50	1.76E-03	7.45E-10	1.14E+00	7.24E-07
	6	21.58	1.76E-03	7.45E-10	1.14E+00	7.25E-07
	7	21.58	1.76E-03	7.45E-10	1.14E+00	7.25E-07
	8	21.58	1.76E-03	7.45E-10	1.14E+00	7.25E-07
2	5	0.00	0.00E+00	-0.00E+00	0.00E+00	-0.00E+00
	6	0.00	0.00E+00	-0.00E+00	0.00E+00	-0.00E+00
	7	0.00	0.00E+00	-0.00E+00	0.00E+00	-0.00E+00
	8	116.35	5.27E-01	3.34E-07	1.97E+02	1.25E-04

Table 83. LOM risk assessment results (islanding scenario 2, load profile LP6)

Generation Mix (<i>m</i>)	Setting Option	$T_{NDZavr(m)}$ [min]	$N_{LOM,1DGG(m)}$	$P_{LOM,1DGG(m)}$	$N_{LOM(m)}$	$P_{LOM(m)}$
1	5	36.14	5.11E-03	2.16E-09	3.31E+00	2.10E-06
	6	36.14	5.11E-03	2.16E-09	3.31E+00	2.10E-06
	7	36.14	5.11E-03	2.16E-09	3.31E+00	2.10E-06
	8	36.14	5.11E-03	2.16E-09	3.31E+00	2.10E-06
2	5	0.00	0.00E+00	-0.00E+00	0.00E+00	-0.00E+00
	6	0.00	0.00E+00	-0.00E+00	0.00E+00	-0.00E+00
	7	0.00	0.00E+00	-0.00E+00	0.00E+00	-0.00E+00
	8	91.73	1.84E-01	1.17E-07	6.88E+01	4.36E-05

Table 84. LOM risk assessment results (islanding scenario 2, load profile LP3)

Generation Mix (<i>m</i>)	Setting Option	$T_{NDZavr(m)}$ [min]	$N_{LOM,1DGG(m)}$	$P_{LOM,1DGG(m)}$	$N_{LOM(m)}$	$P_{LOM(m)}$
1	5	42.62	6.31E-03	2.67E-09	4.10E+00	2.60E-06
	6	48.94	2.13E-02	9.00E-09	1.38E+01	8.76E-06
	7	49.77	5.55E-02	2.35E-08	3.60E+01	2.28E-05
	8	49.77	5.55E-02	2.35E-08	3.60E+01	2.28E-05
2	5	0.00	0.00E+00	-0.00E+00	0.00E+00	-0.00E+00
	6	0.00	0.00E+00	-0.00E+00	0.00E+00	-0.00E+00
	7	0.00	0.00E+00	-0.00E+00	0.00E+00	-0.00E+00
	8	28.89	0.00E+00	0.00E+00	0.00E+00	0.00E+00

Table 85. LOM risk assessment results (islanding scenario 2, load profile LP4)

Generation Mix (<i>m</i>)	Setting Option	$T_{NDZavr(m)}$ [min]	$N_{LOM,1DGG(m)}$	$P_{LOM,1DGG(m)}$	$N_{LOM(m)}$	$P_{LOM(m)}$
1	5	13.23	5.42E-05	1.17E-11	3.52E-02	1.14E-08
	6	16.23	1.61E-04	4.51E-11	1.05E-01	4.38E-08
	7	21.98	2.25E-04	9.52E-11	1.46E-01	9.26E-08
	8	21.98	2.25E-04	9.52E-11	1.46E-01	9.26E-08
2	5	0.00	0.00E+00	-0.00E+00	0.00E+00	-0.00E+00
	6	0.00	0.00E+00	-0.00E+00	0.00E+00	-0.00E+00
	7	0.00	0.00E+00	-0.00E+00	0.00E+00	-0.00E+00
	8	30.12	5.23E-02	3.32E-08	1.96E+01	1.24E-05

Table 86. LOM risk assessment results (islanding scenario 2, load profile LP1a)

Generation Mix (<i>m</i>)	Setting Option	$T_{NDZavr(m)}$ [min]	$N_{LOM,1DGG(m)}$	$P_{LOM,1DGG(m)}$	$N_{LOM(m)}$	$P_{LOM(m)}$
1	5	148.42	9.17E-02	3.88E-08	5.94E+01	3.77E-05
	6	148.42	9.17E-02	3.88E-08	5.94E+01	3.77E-05
	7	148.42	9.17E-02	3.88E-08	5.94E+01	3.77E-05
	8	148.42	9.17E-02	3.88E-08	5.94E+01	3.77E-05
2	5	0.00	0.00E+00	-0.00E+00	0.00E+00	-0.00E+00
	6	0.00	0.00E+00	-0.00E+00	0.00E+00	-0.00E+00
	7	0.00	0.00E+00	-0.00E+00	0.00E+00	-0.00E+00
	8	15.73	0.00E+00	0.00E+00	0.00E+00	0.00E+00

C.3. Result figures (VS operation with no fault)

C.3.1. Case Study 3a – VS operation with no fault

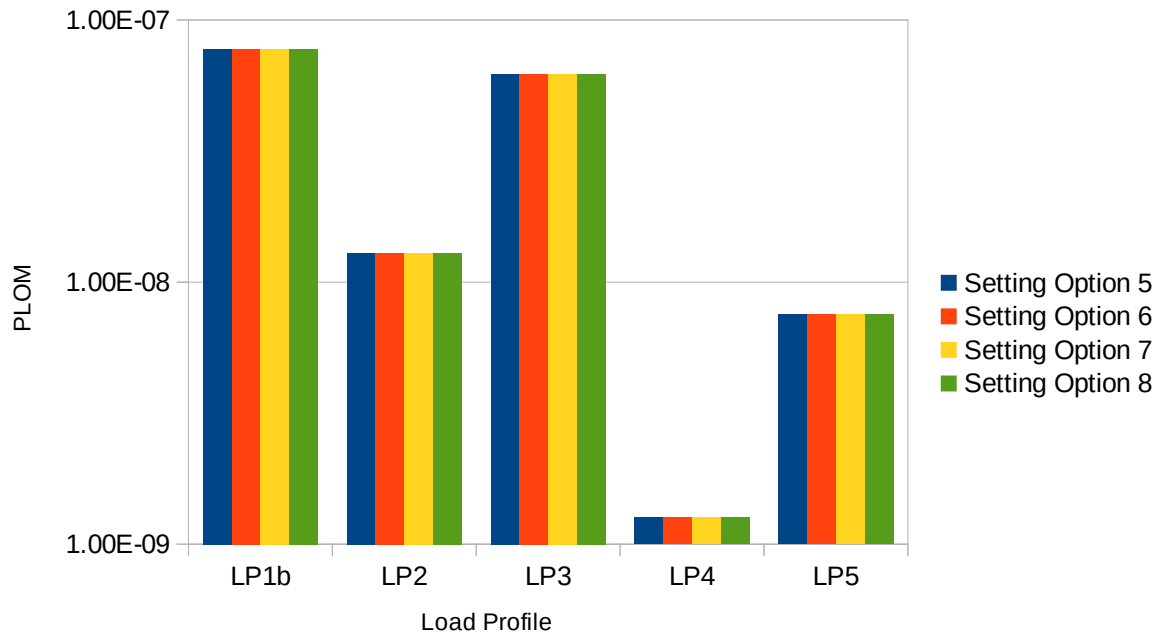

Figure 35. Probability of undetected islanding operation – Scenario 1, Synchronous Generator

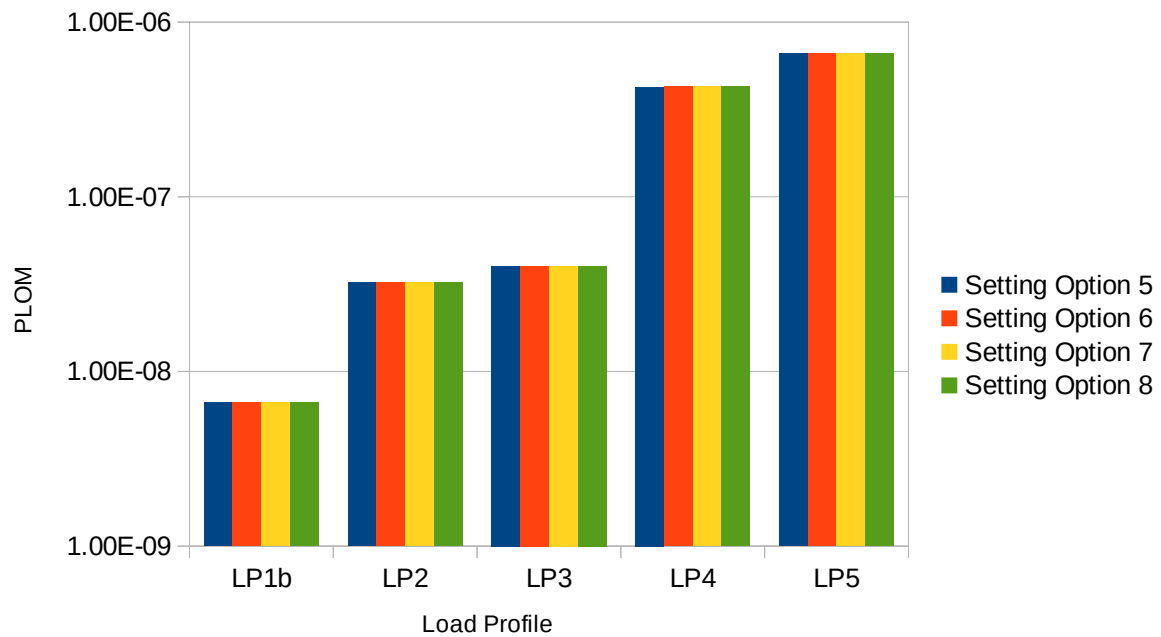

Figure 36. Probability of undetected islanding operation – Scenario 1, DFIG

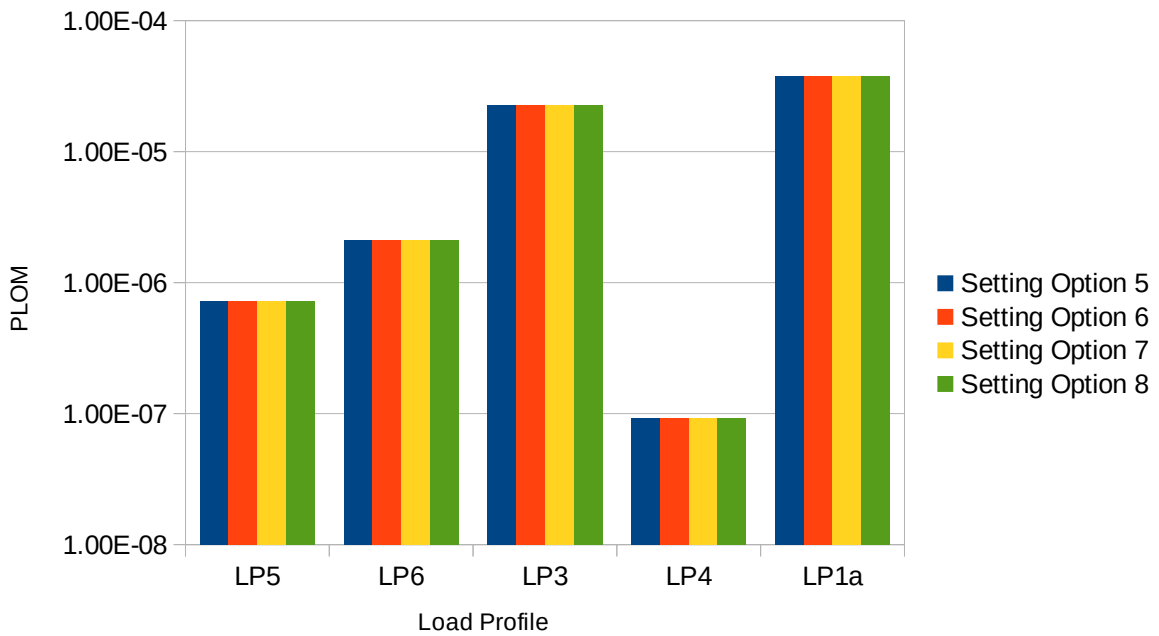

Figure 37. Probability of undetected islanding operation – Scenario 2, Synchronous Generator

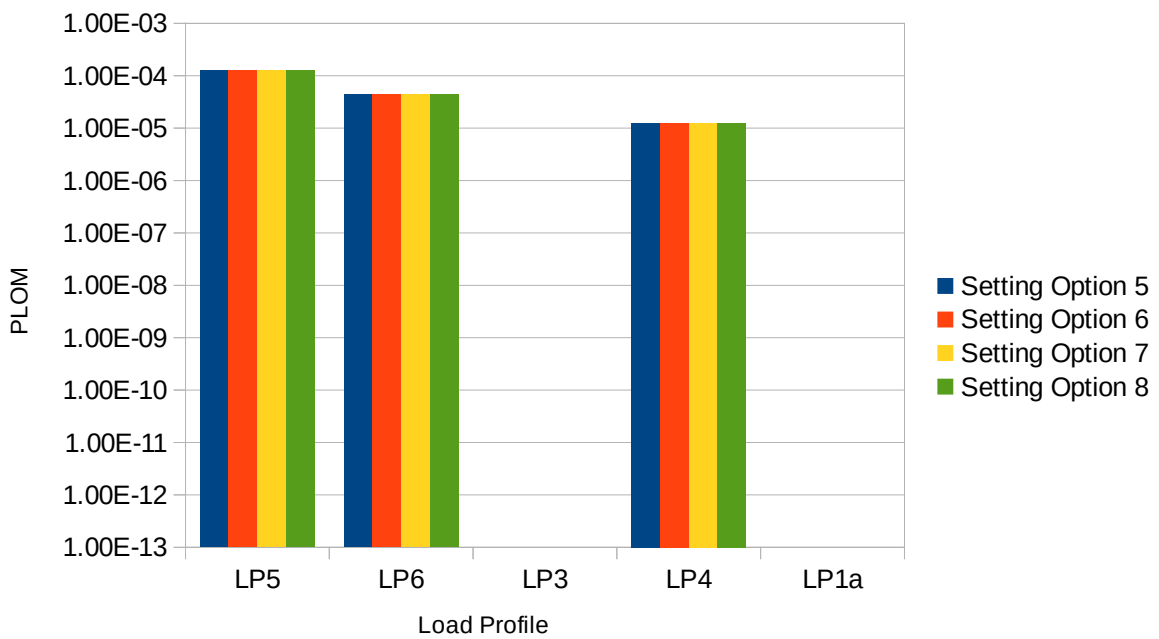

Figure 38. Probability of undetected islanding operation – Scenario 2, DFIG

C.3.2. Case Study 3b – VS operation with single phase-to-earth fault

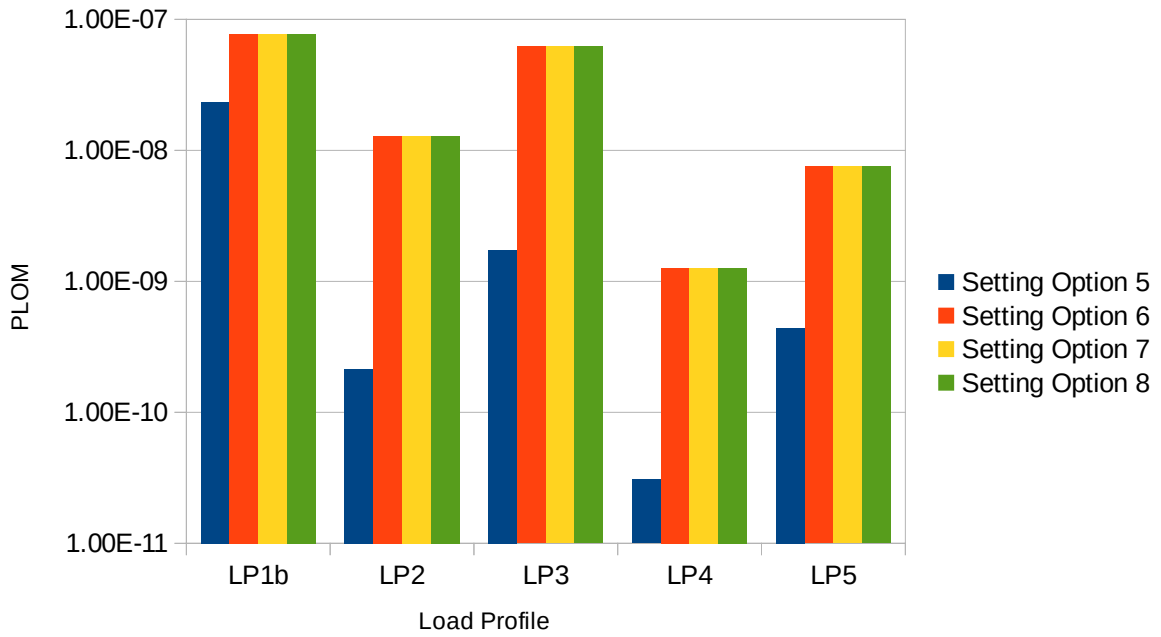

Figure 39. Probability of undetected islanding operation – Scenario 1, Synchronous Generator

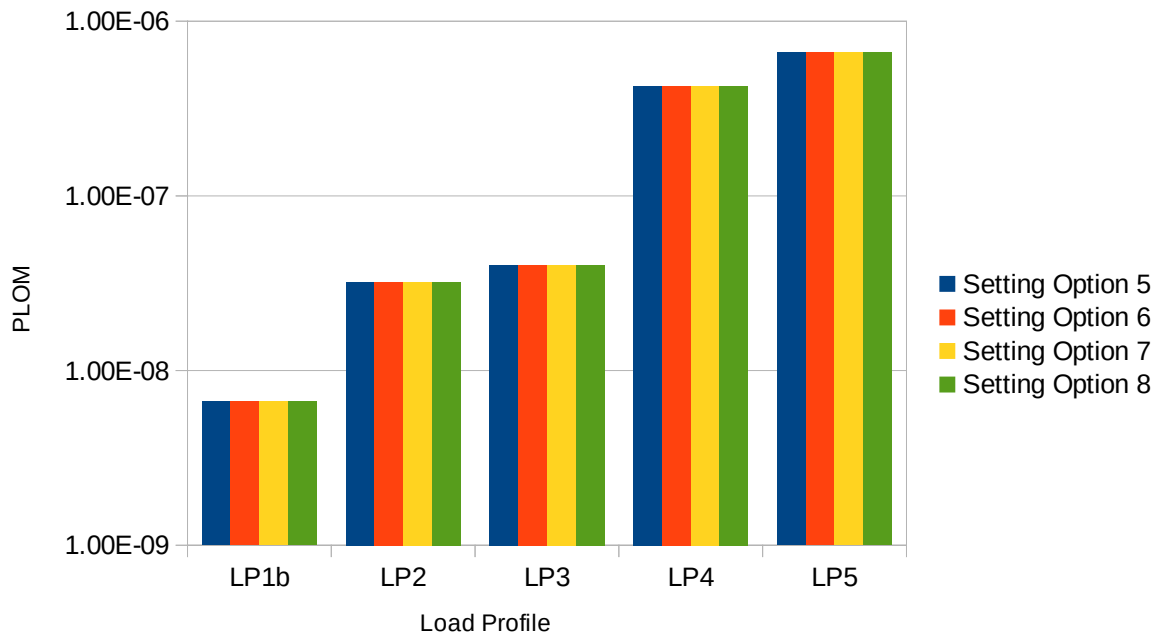

Figure 40. Probability of undetected islanding operation – Scenario 1, DFIG

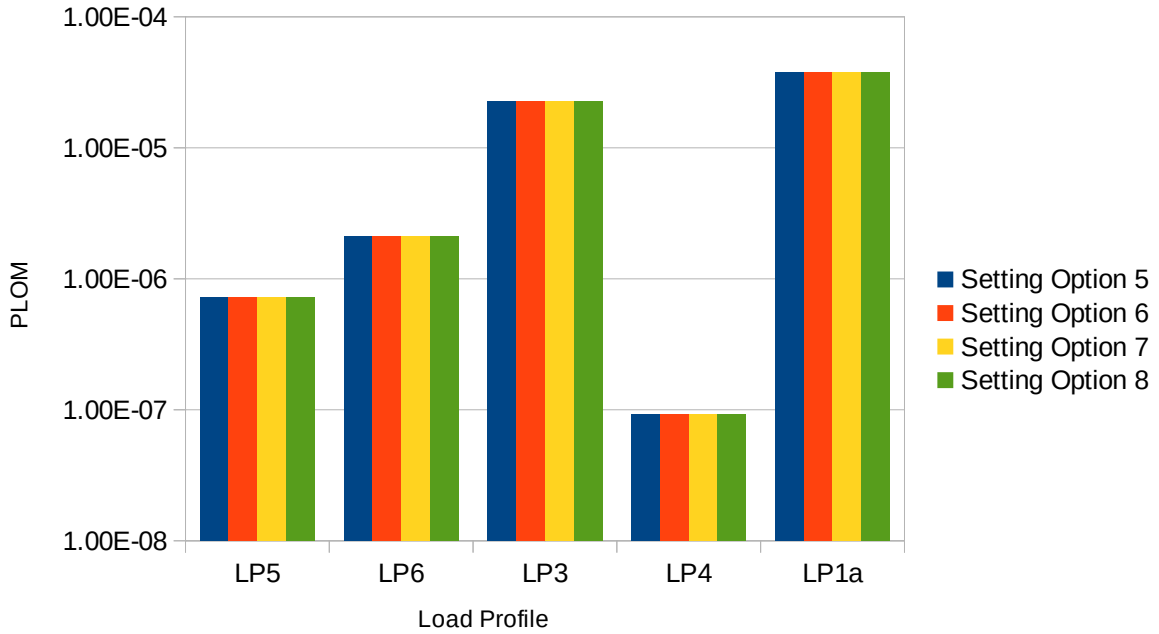

Figure 41. Probability of undetected islanding operation – Scenario 2, Synchronous Generator

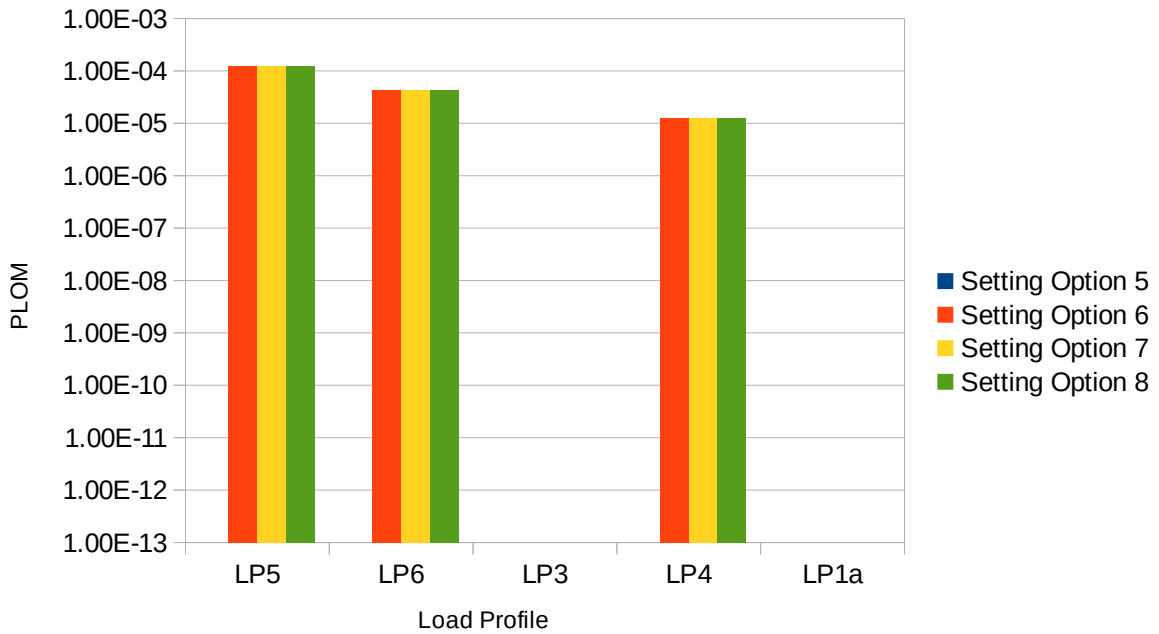

Figure 42. Probability of undetected islanding operation – Scenario 2, DFIG

C.3.3. Case Study 3c – VS operation with phase-to-phase fault

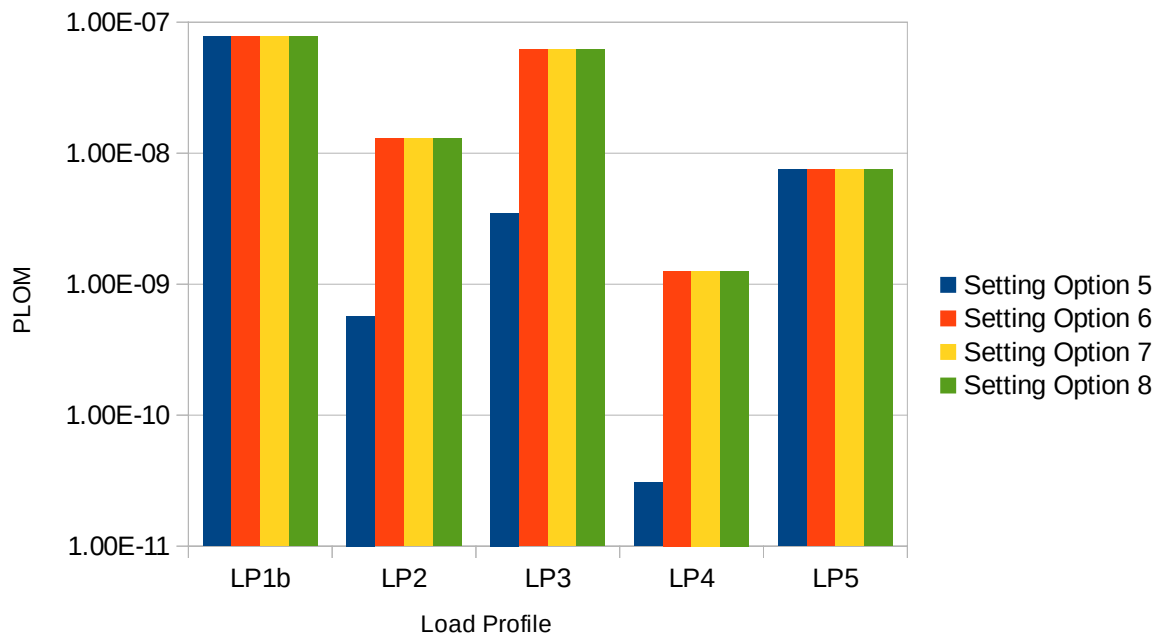

Figure 43. Probability of undetected islanding operation – Scenario 1, Synchronous Generator

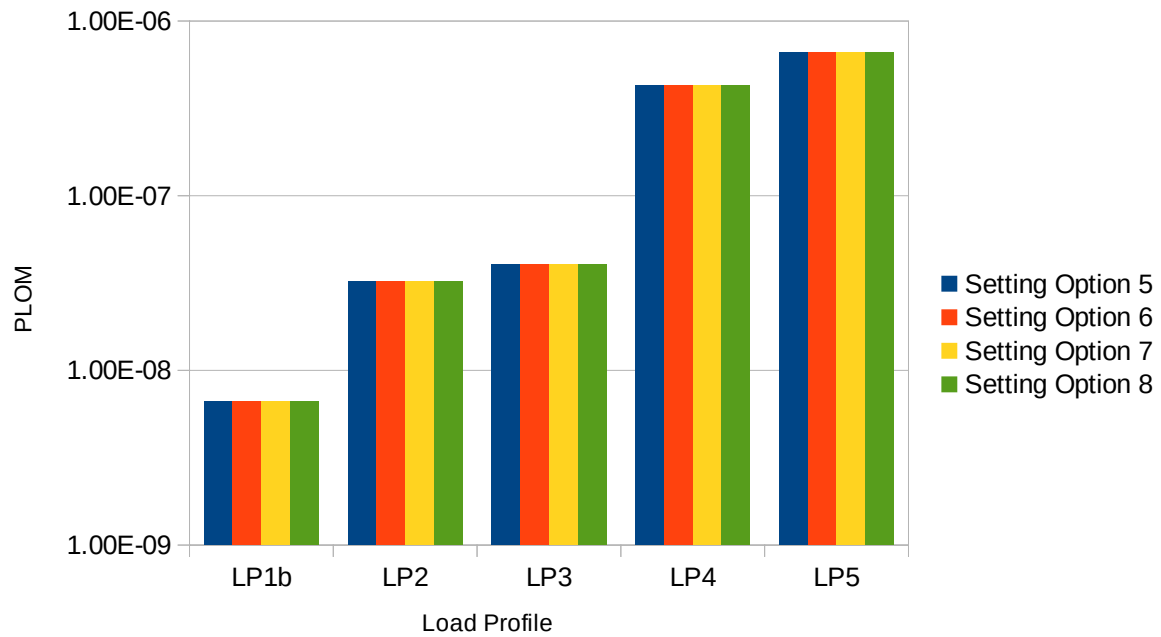

Figure 44. Probability of undetected islanding operation – Scenario 1, DFIG

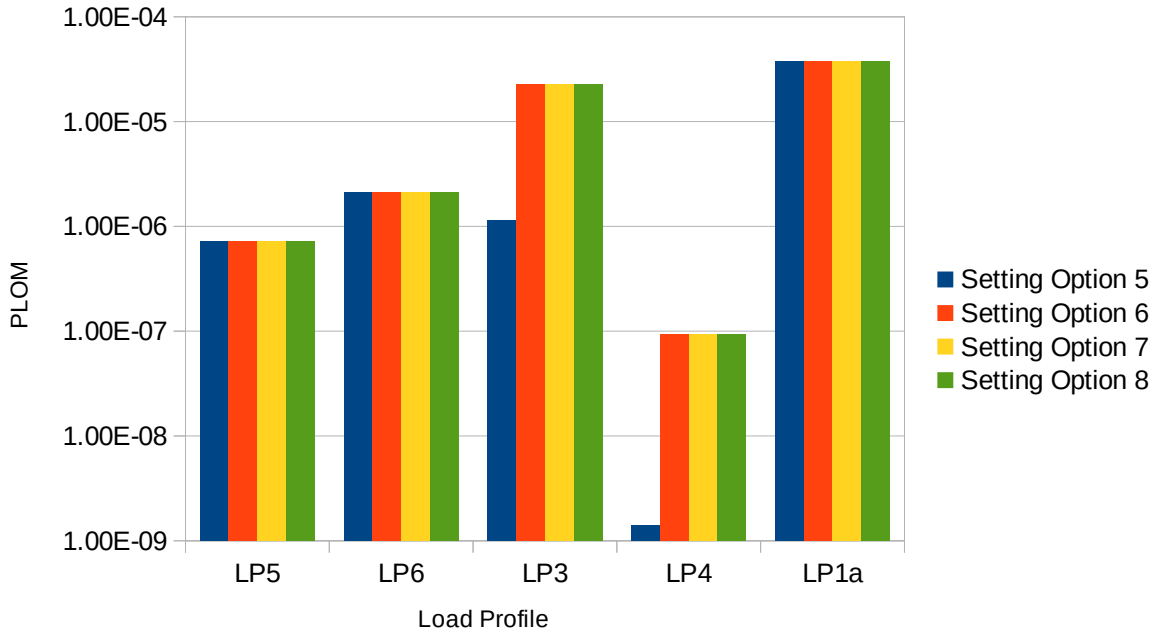

Figure 45. Probability of undetected islanding operation – Scenario 2, Synchronous Generator

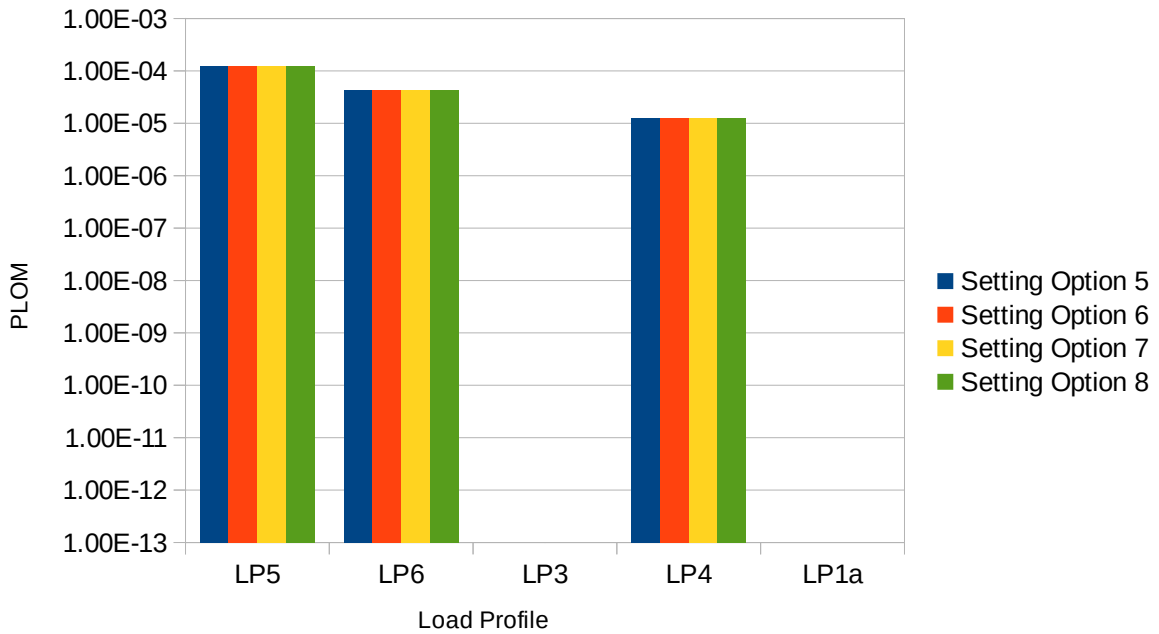

Figure 46. Probability of undetected islanding operation – Scenario 2, DFIG

C.3.4. Case Study 3d – VS operation with three-phase fault

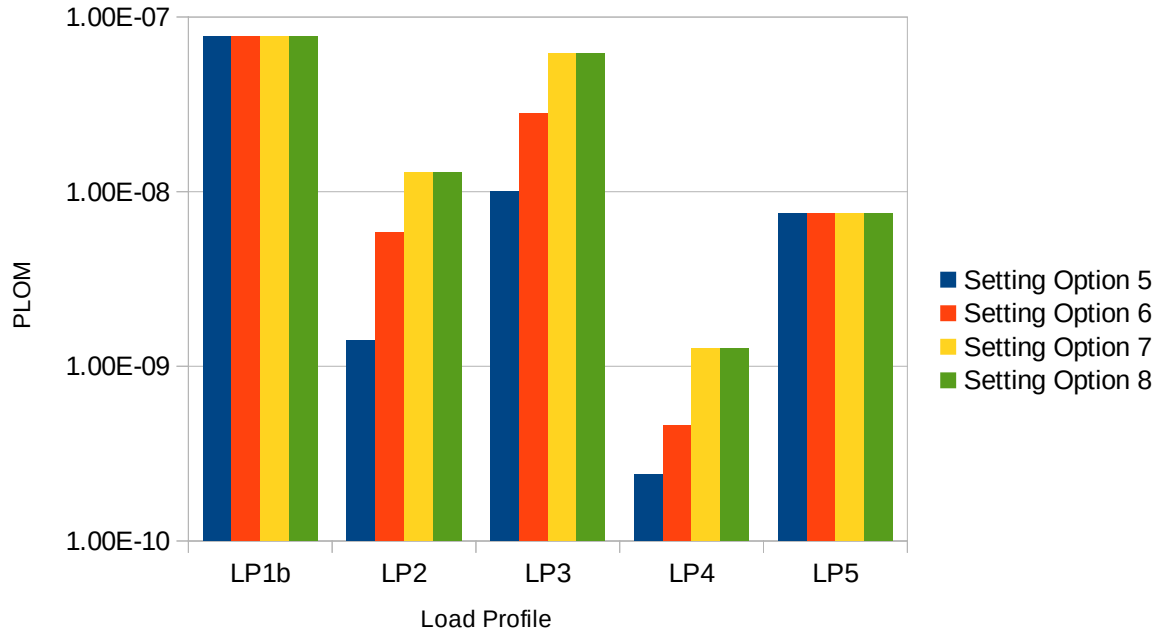

Figure 47. Probability of undetected islanding operation – Scenario 1, Synchronous Generator

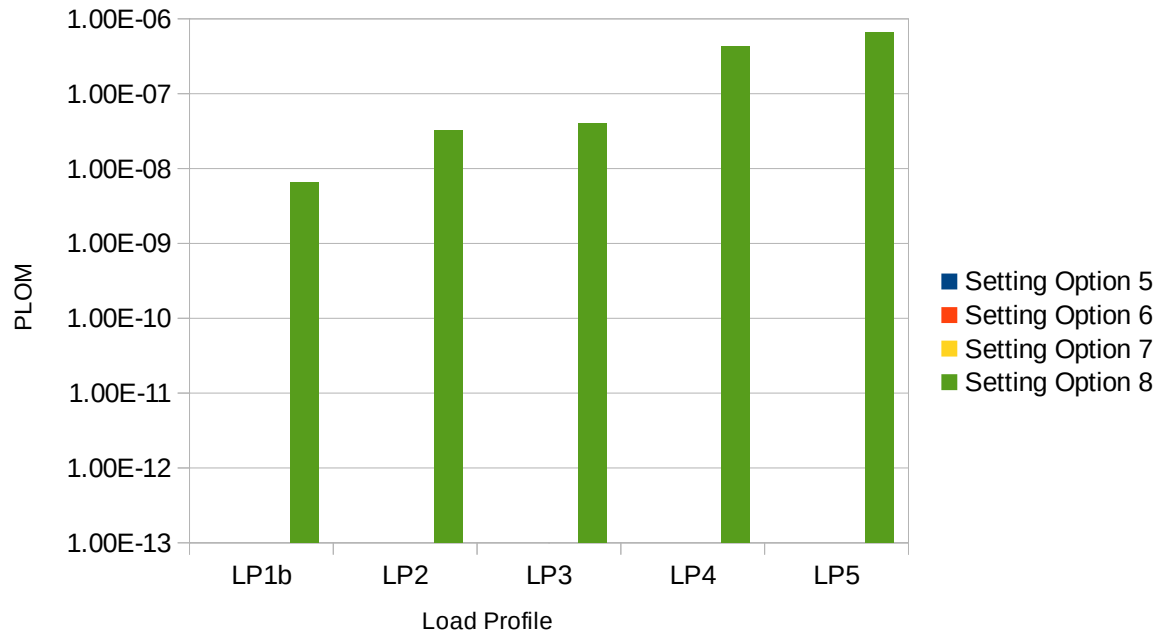

Figure 48. Probability of undetected islanding operation – Scenario 1, DFIG

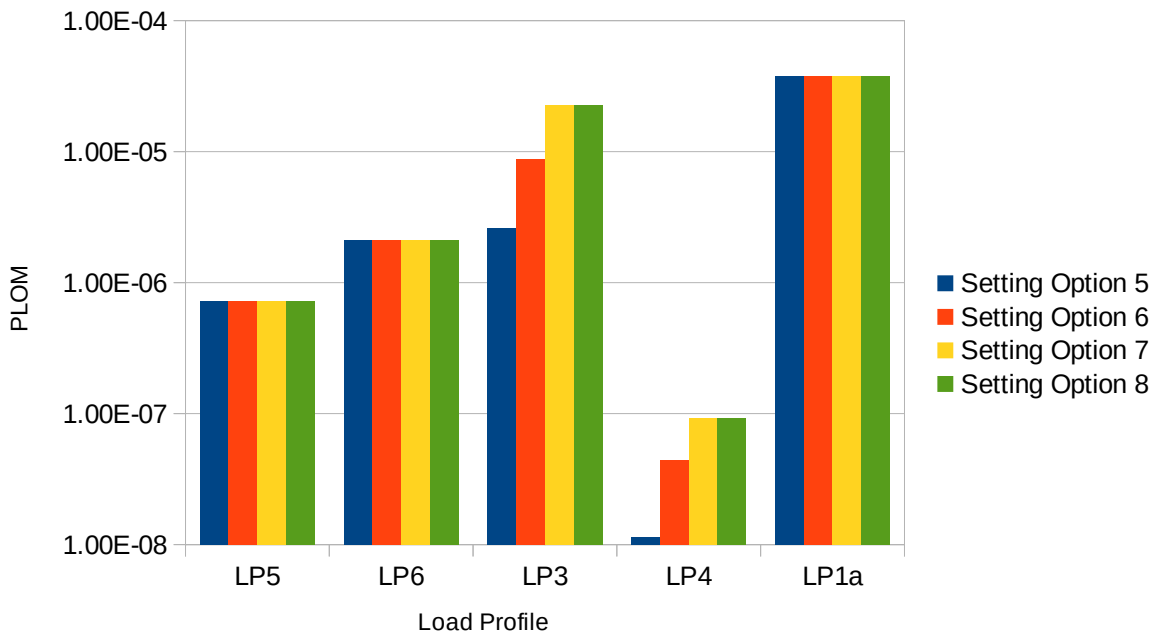

Figure 49. Probability of undetected islanding operation – Scenario 2, Synchronous Generator

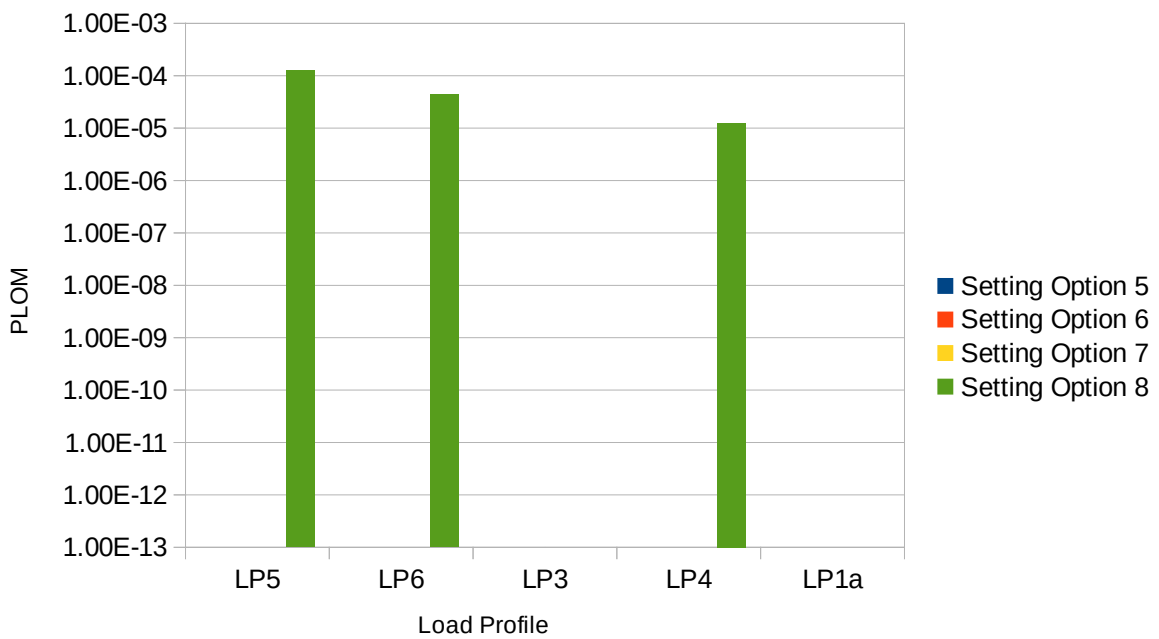

Figure 50. Probability of undetected islanding operation – Scenario 2, DFIG