

System Operation: “Anatomy of a Day”

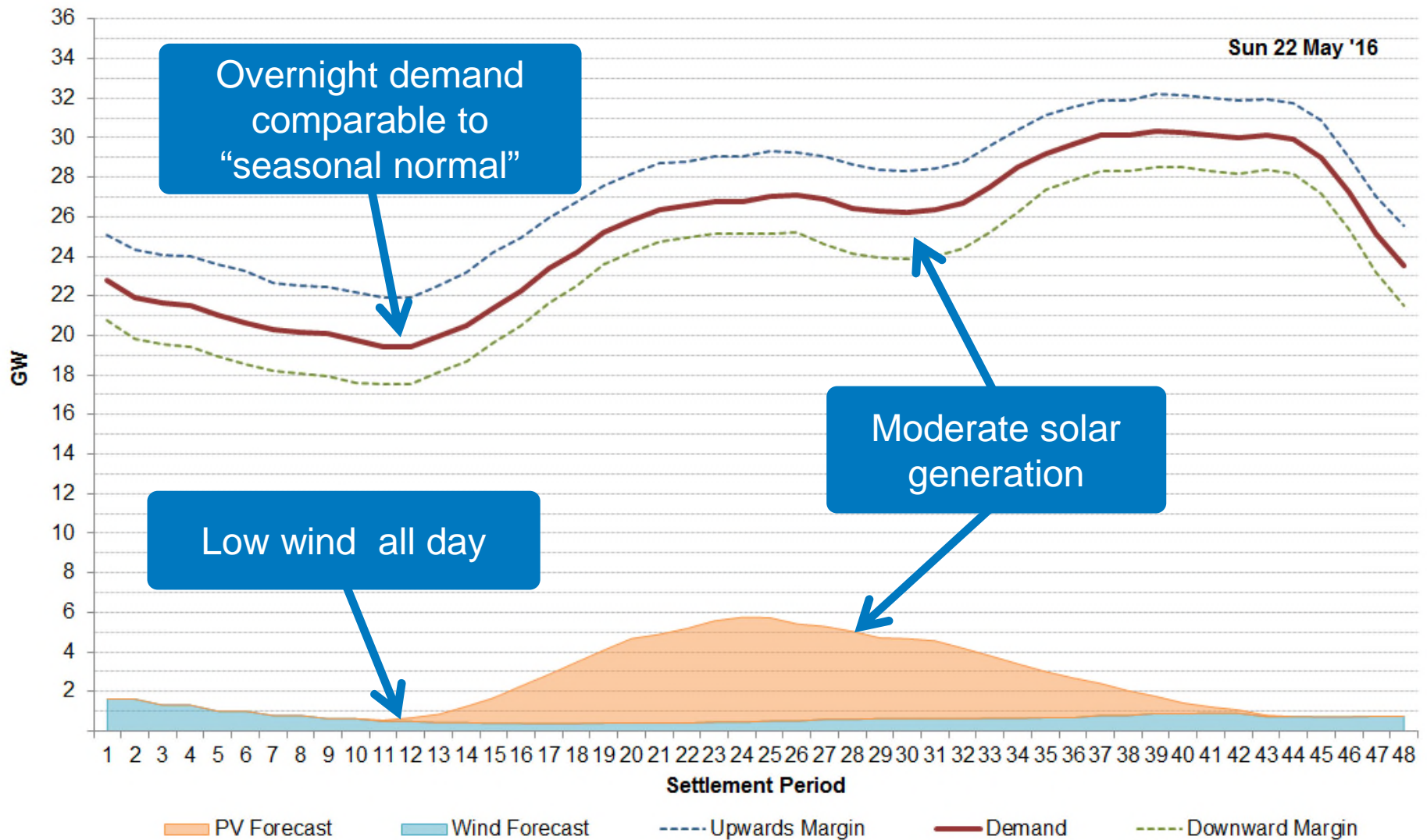

Sunday 22 May 2016: Overview of conditions



Sunday 29 May 2016: Overview of conditions

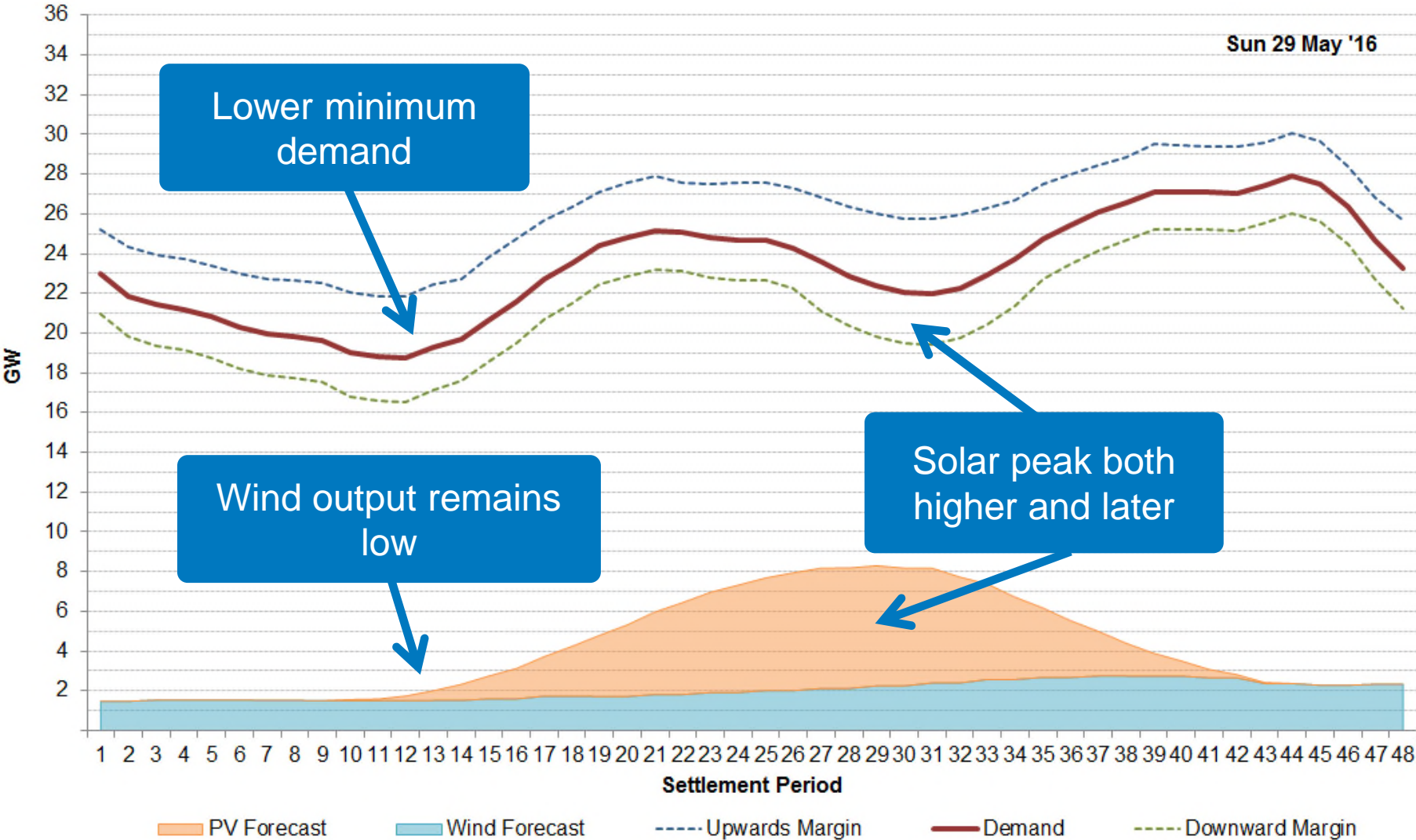

Sunday 22 May 2016: Balancing Actions

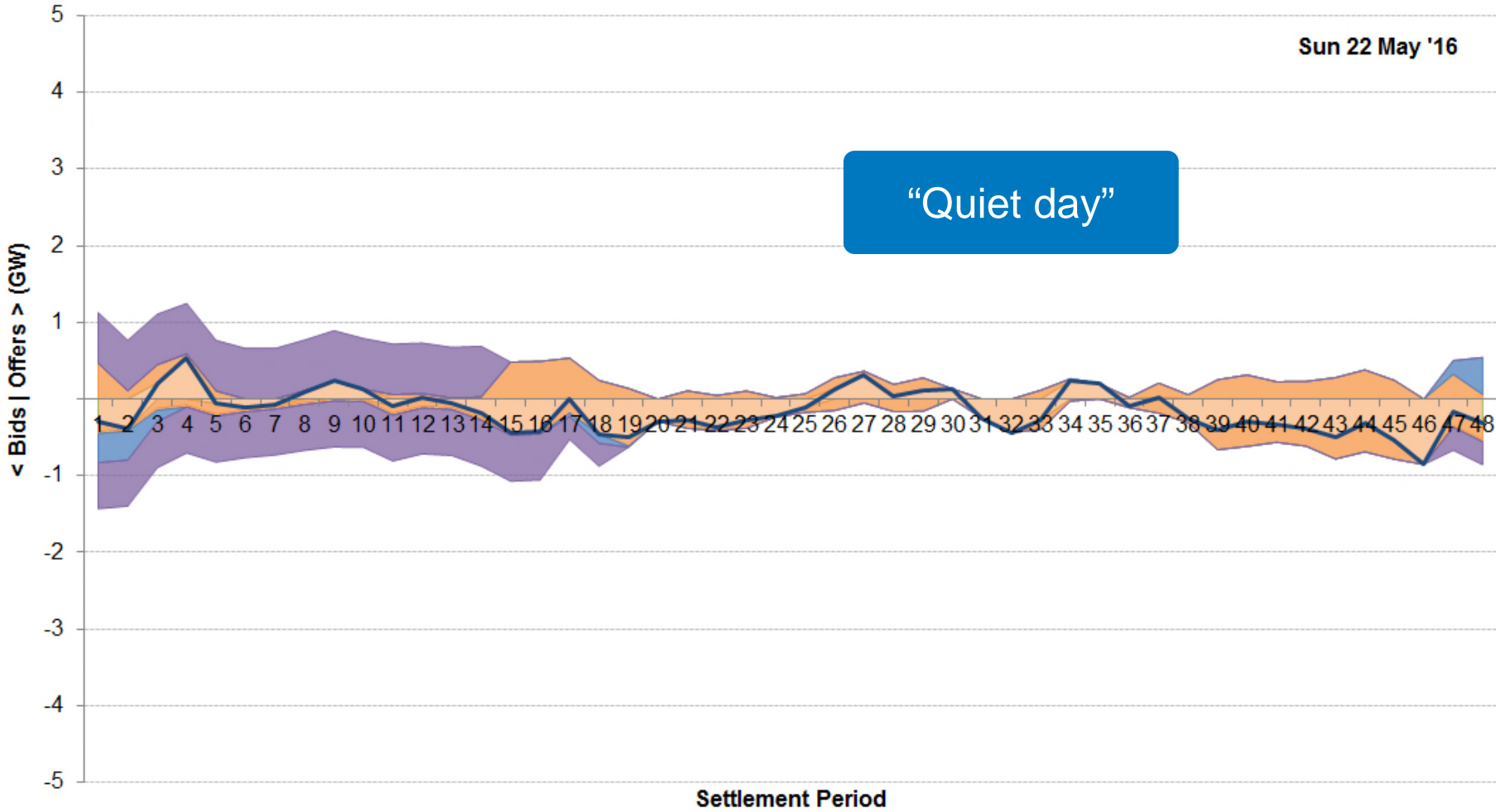

- TRADE_SYSTEM_OFFERS_MW
- BM_SYSTEM_OFFERS_MW
- TRADE_ENERGY_OFFERS_MW
- BM_ENERGY_OFFERS_MW
- TRADE_SYSTEM_BIDS_MW
- BM_SYSTEM_BIDS_MW
- TRADE_ENERGY_BIDS_MW
- BM_ENERGY_BIDS_MW

Sunday 29 May 2016: Balancing Actions

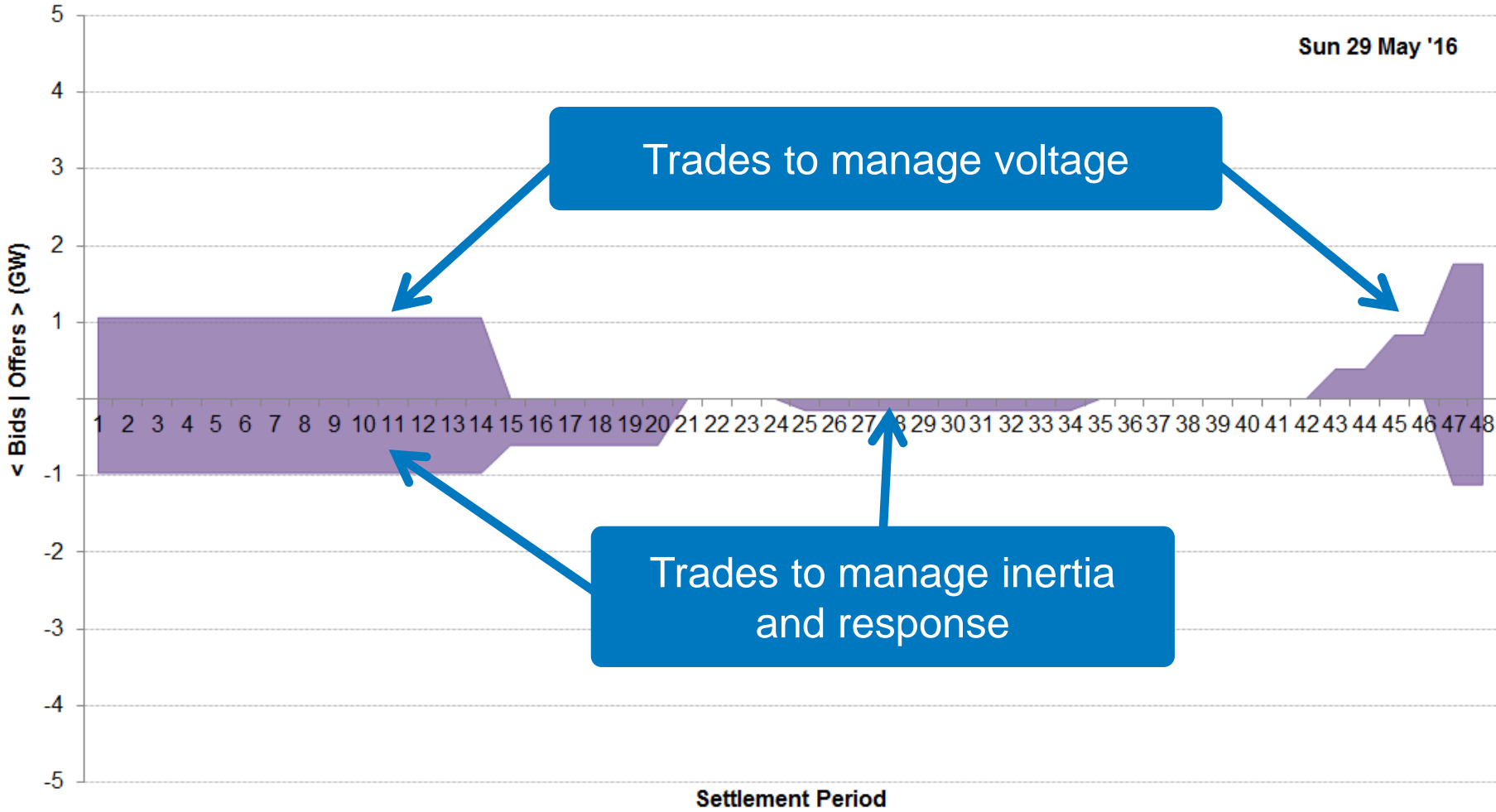

- TRADE_SYSTEM_OFFERS_MW
- BM_SYSTEM_OFFERS_MW
- TRADE_ENERGY_OFFERS_MW
- BM_ENERGY_OFFERS_MW
- TRADE_SYSTEM_BIDS_MW
- BM_SYSTEM_BIDS_MW
- TRADE_ENERGY_BIDS_MW
- BM_ENERGY_BIDS_MW

Sunday 29 May 2016: Balancing Actions

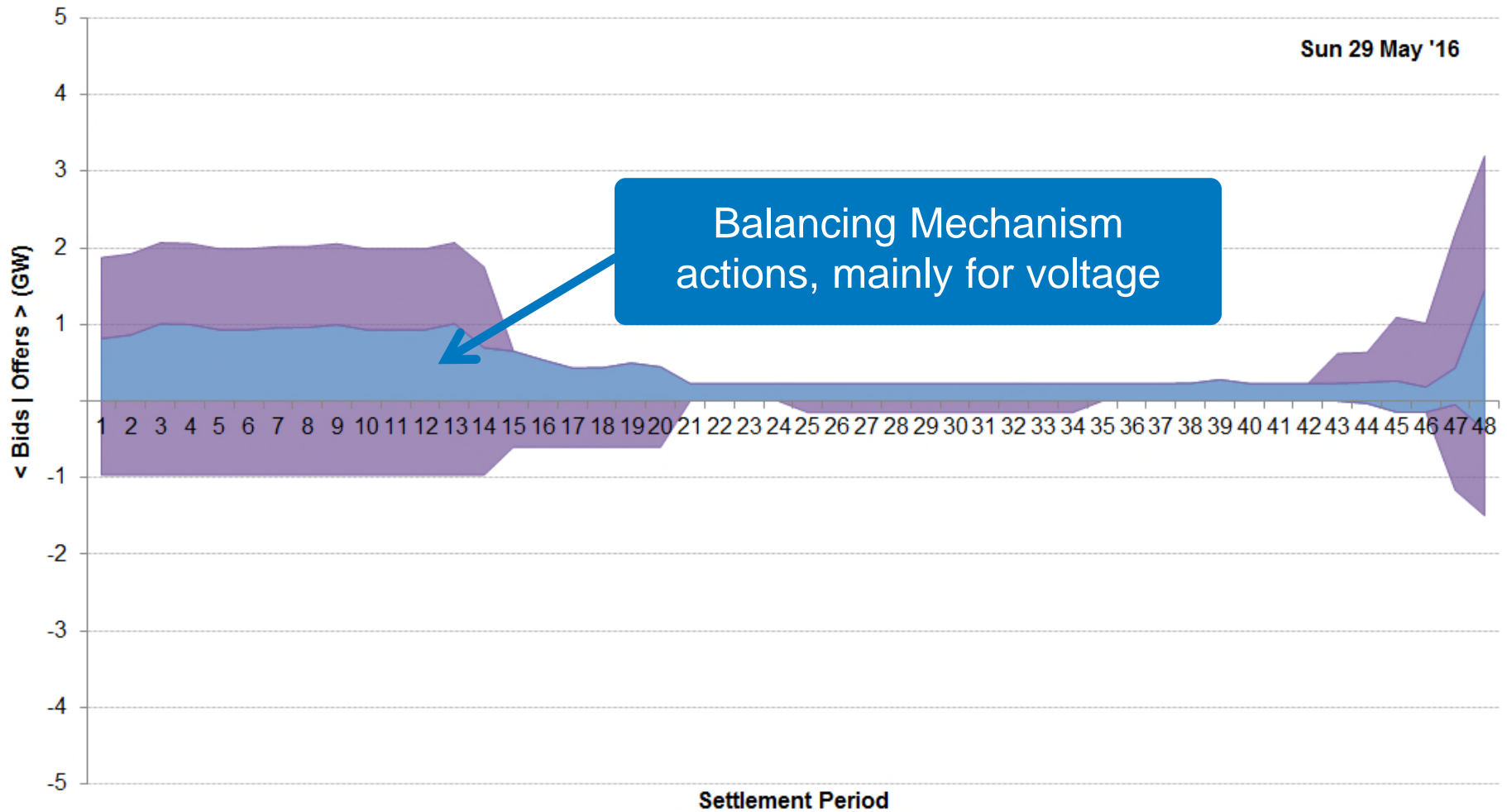

- TRADE_SYSTEM_OFFERS_MW ■ BM_SYSTEM_OFFERS_MW ■ TRADE_ENERGY_OFFERS_MW ■ BM_ENERGY_OFFERS_MW
- TRADE_SYSTEM_BIDS_MW ■ BM_SYSTEM_BIDS_MW ■ TRADE_ENERGY_BIDS_MW ■ BM_ENERGY_BIDS_MW

Sunday 29 May 2016: Balancing Actions

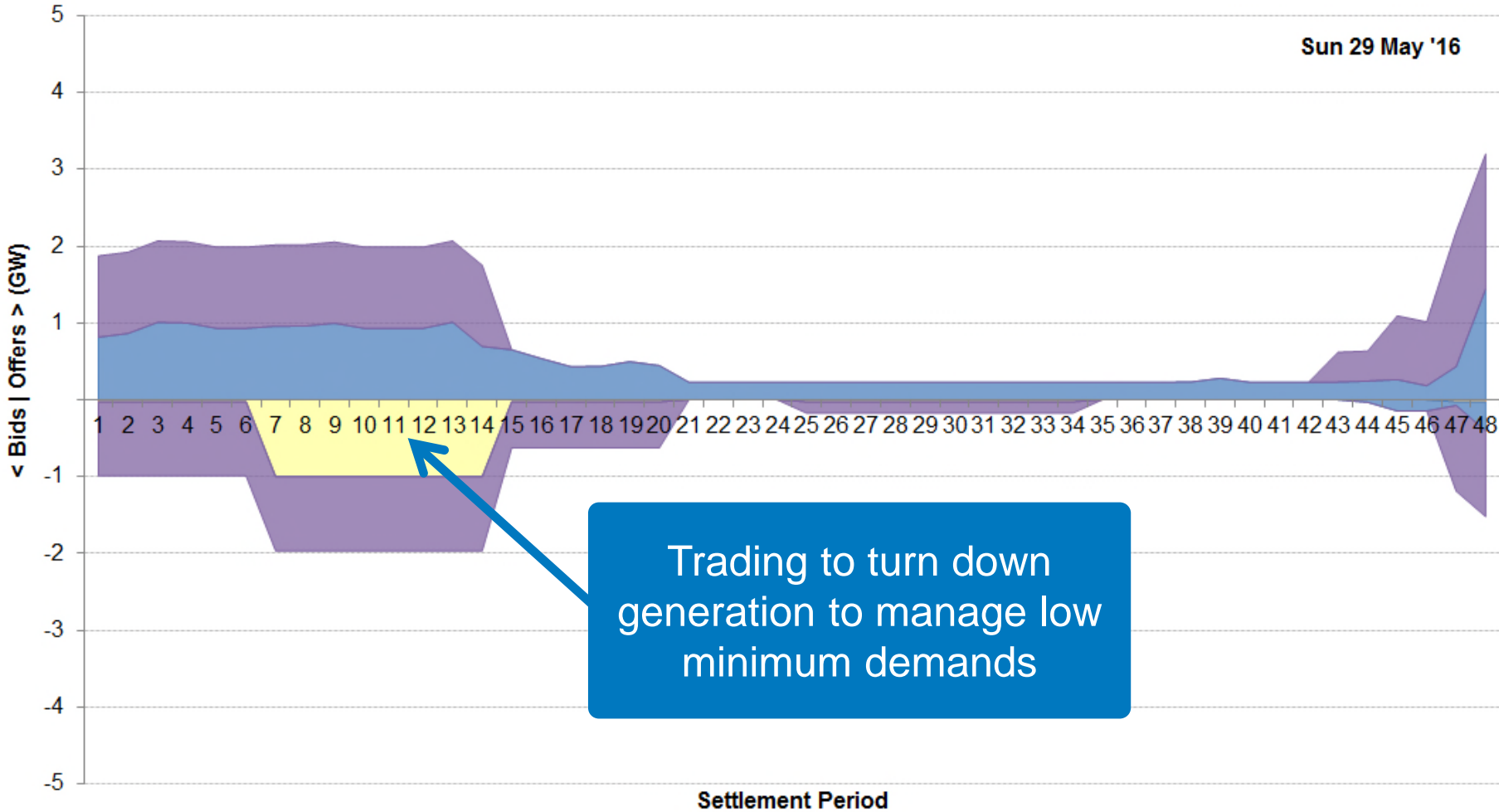

- TRADE_SYSTEM_OFFERS_MW
- BM_SYSTEM_OFFERS_MW
- TRADE_ENERGY_OFFERS_MW
- BM_ENERGY_OFFERS_MW
- TRADE_SYSTEM_BIDS_MW
- BM_SYSTEM_BIDS_MW
- TRADE_ENERGY_BIDS_MW
- BM_ENERGY_BIDS_MW

Sunday 29 May 2016: Balancing Actions

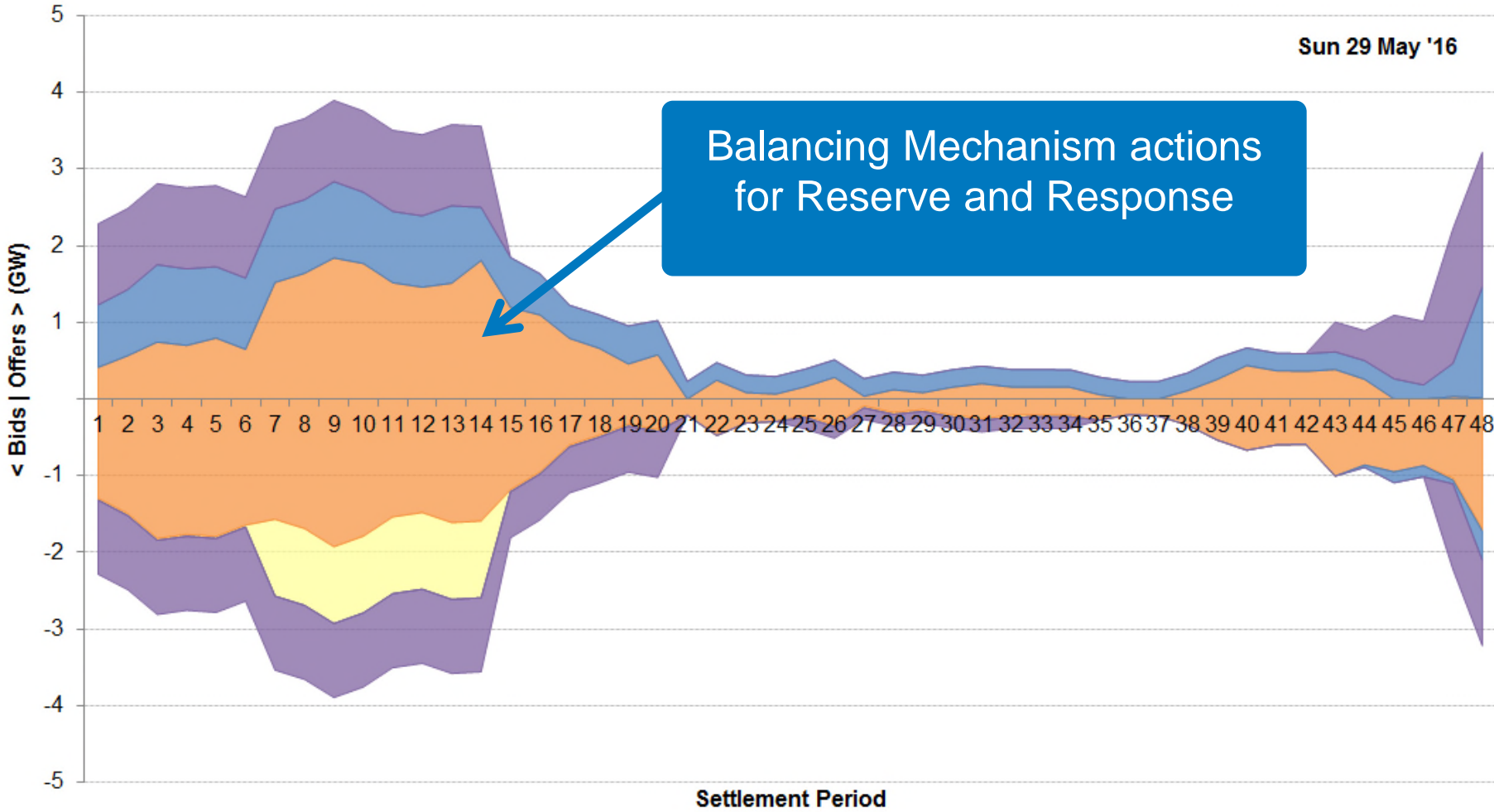

- TRADE_SYSTEM_OFFERS_MW
- BM_SYSTEM_OFFERS_MW
- TRADE_ENERGY_OFFERS_MW
- BM_ENERGY_OFFERS_MW
- TRADE_SYSTEM_BIDS_MW
- BM_SYSTEM_BIDS_MW
- TRADE_ENERGY_BIDS_MW
- BM_ENERGY_BIDS_MW

Sunday 29 May 2016: Balancing Actions

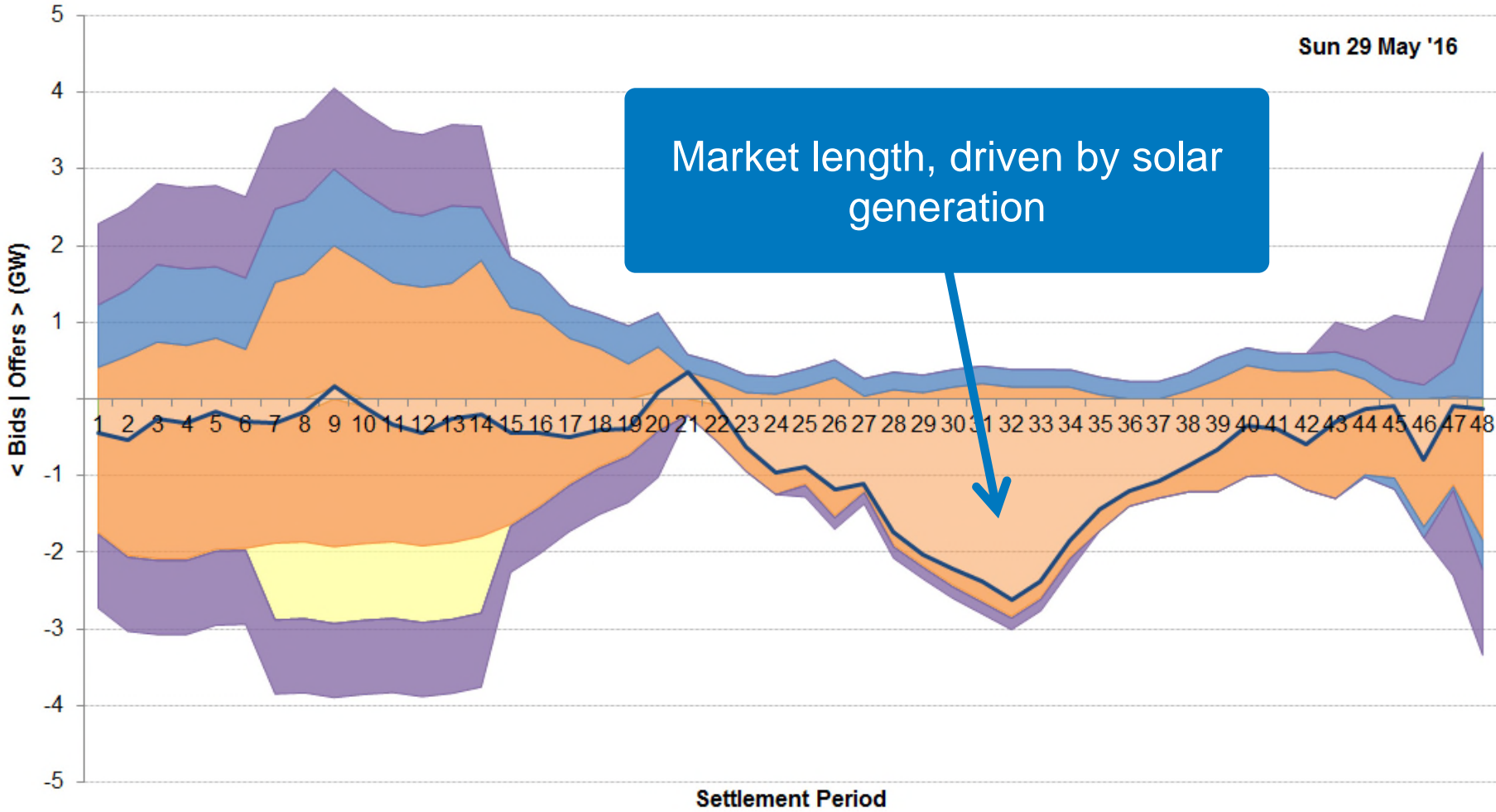

TRADE_SYSTEM_OFFERS_MW BM_SYSTEM_OFFERS_MW TRADE_ENERGY_OFFERS_MW BM_ENERGY_OFFERS_MW
TRADE_SYSTEM_BIDS_MW BM_SYSTEM_BIDS_MW TRADE_ENERGY_BIDS_MW BM_ENERGY_BIDS_MW

System Operation: “Between a *RoCoF* and a hard place”

Examples of large credible losses



DINO-PENT: where is it?

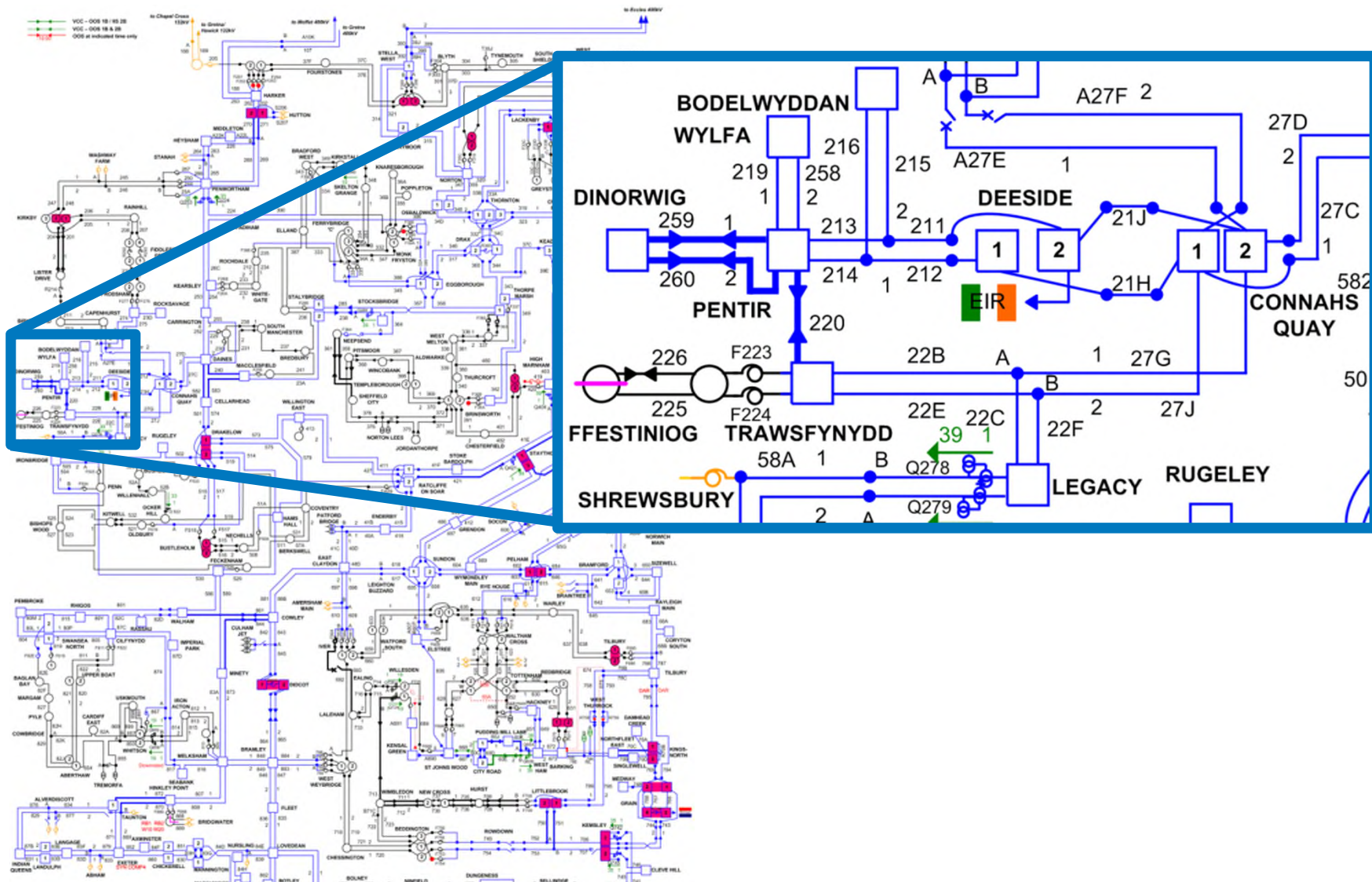

DINO-PENT: where is it?



DINO-PENT: “Electric Mountain”

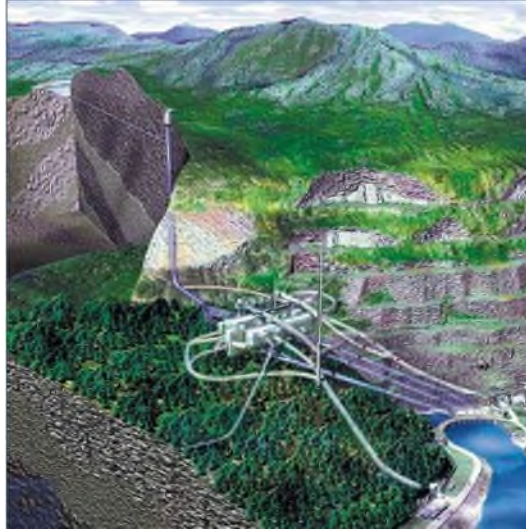

DINO-PENT: credible faults

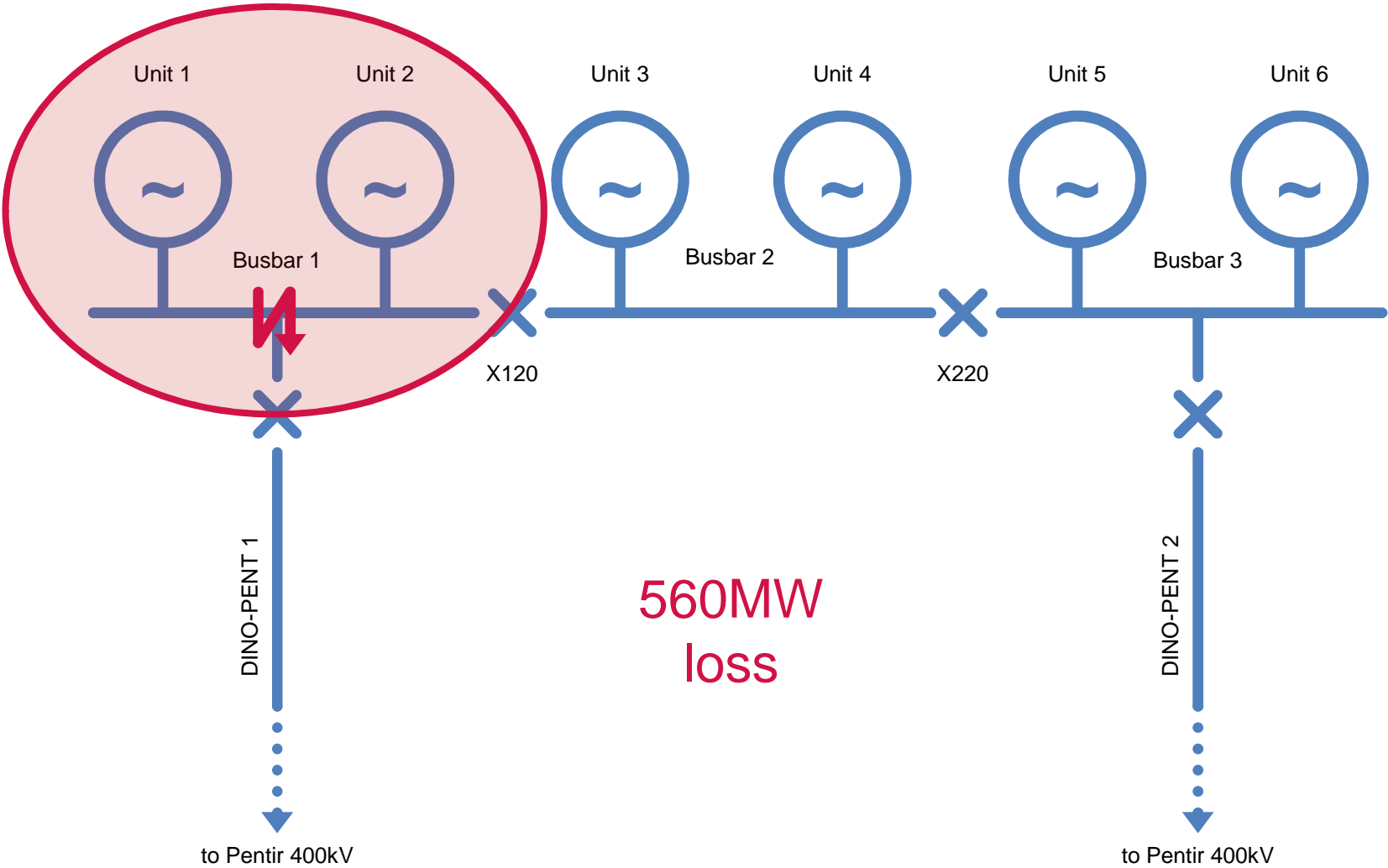

DINO-PENT: credible faults

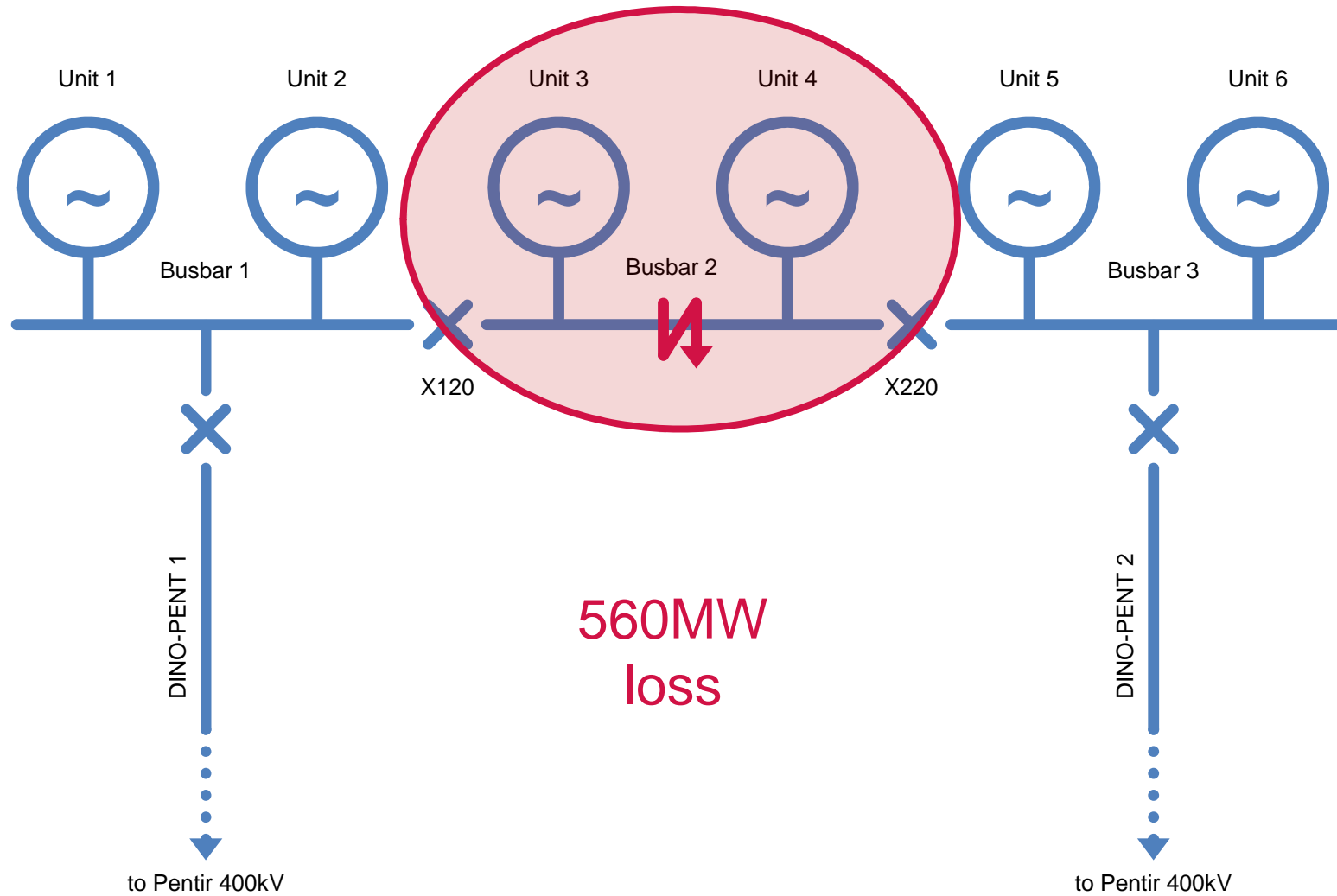

DINO-PENT: credible faults

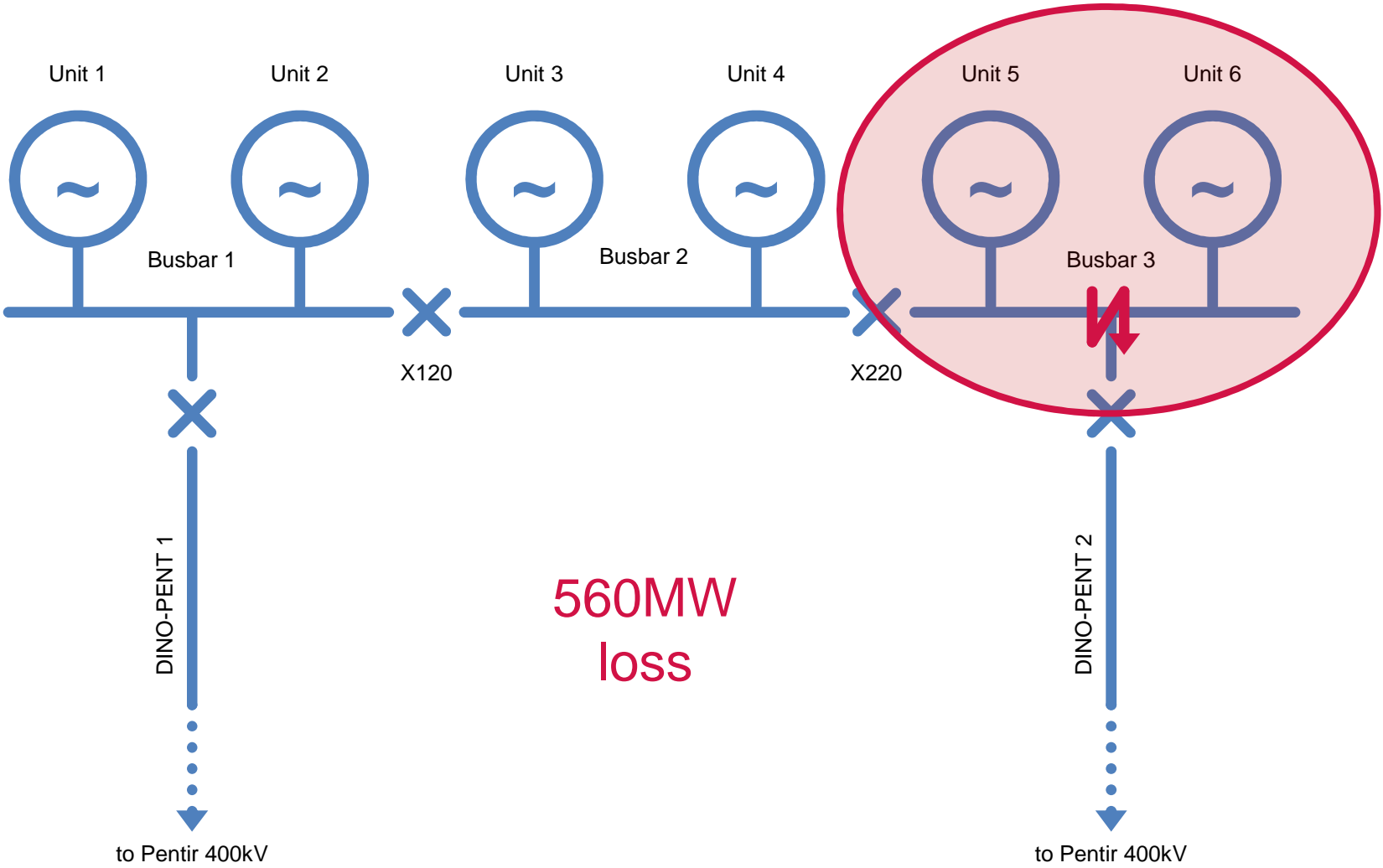

DINO-PENT: credible faults

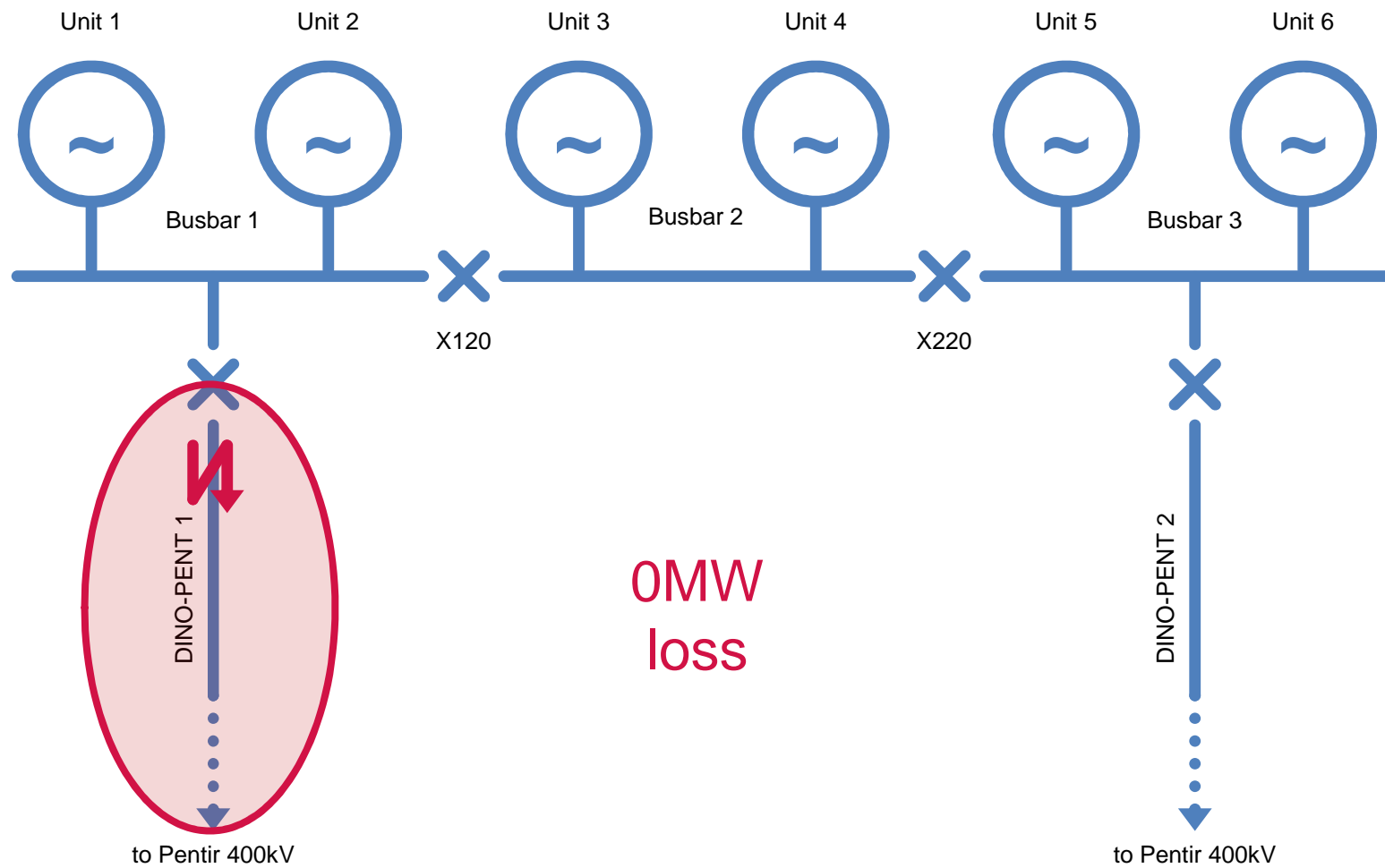

DINO-PENT: credible faults

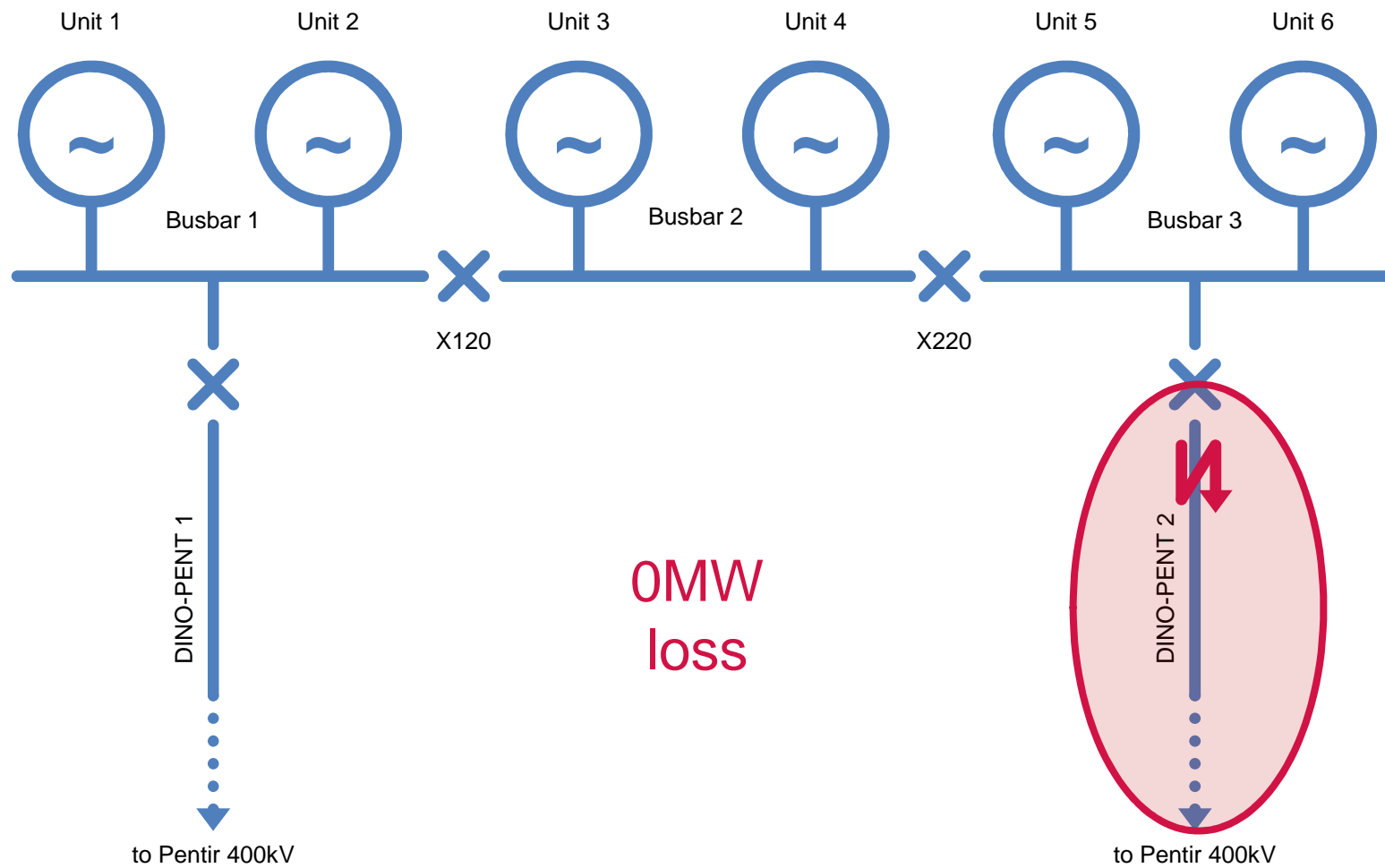

DINO-PENT: impact of an outage

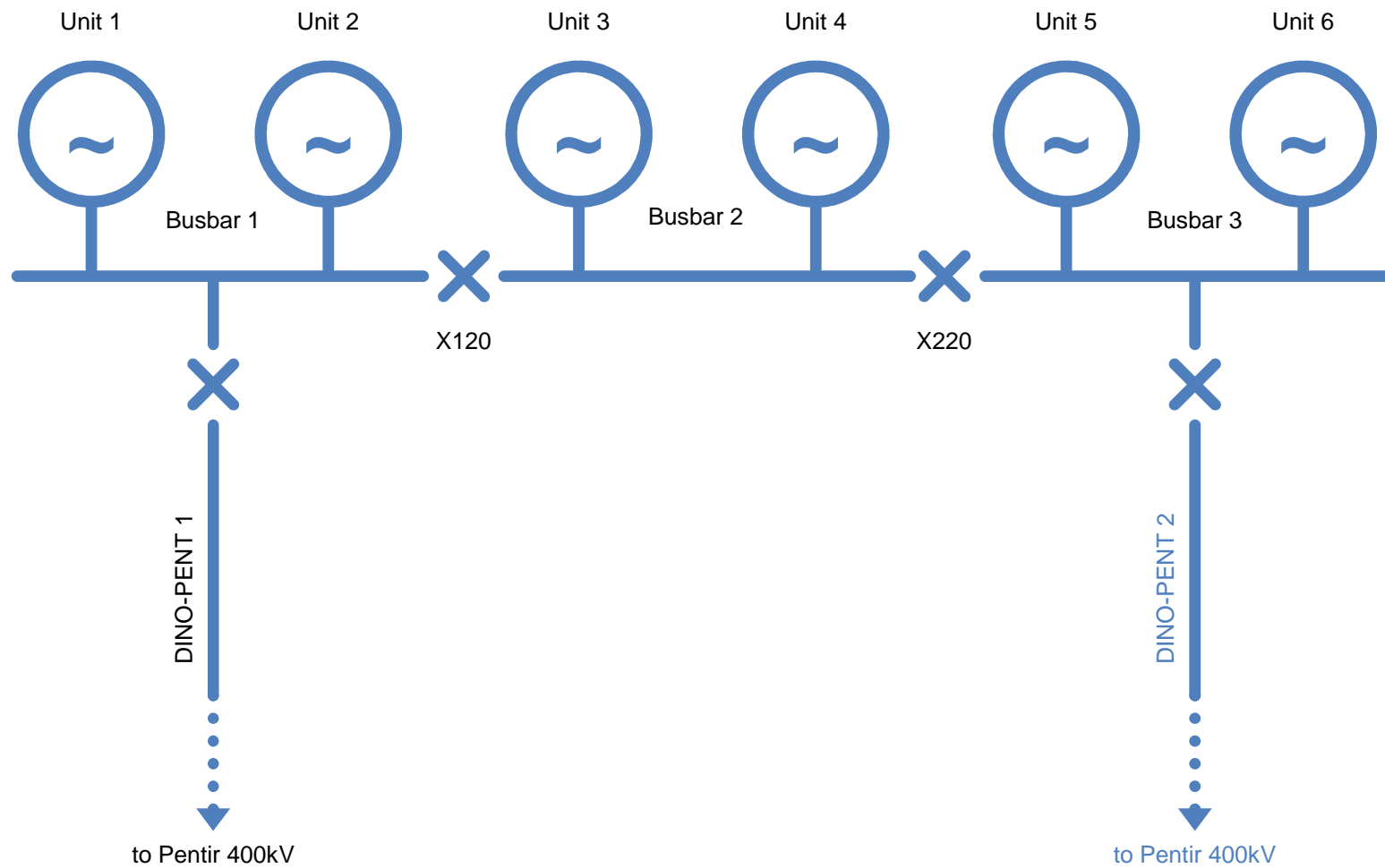

DINO-PENT: impact of an outage

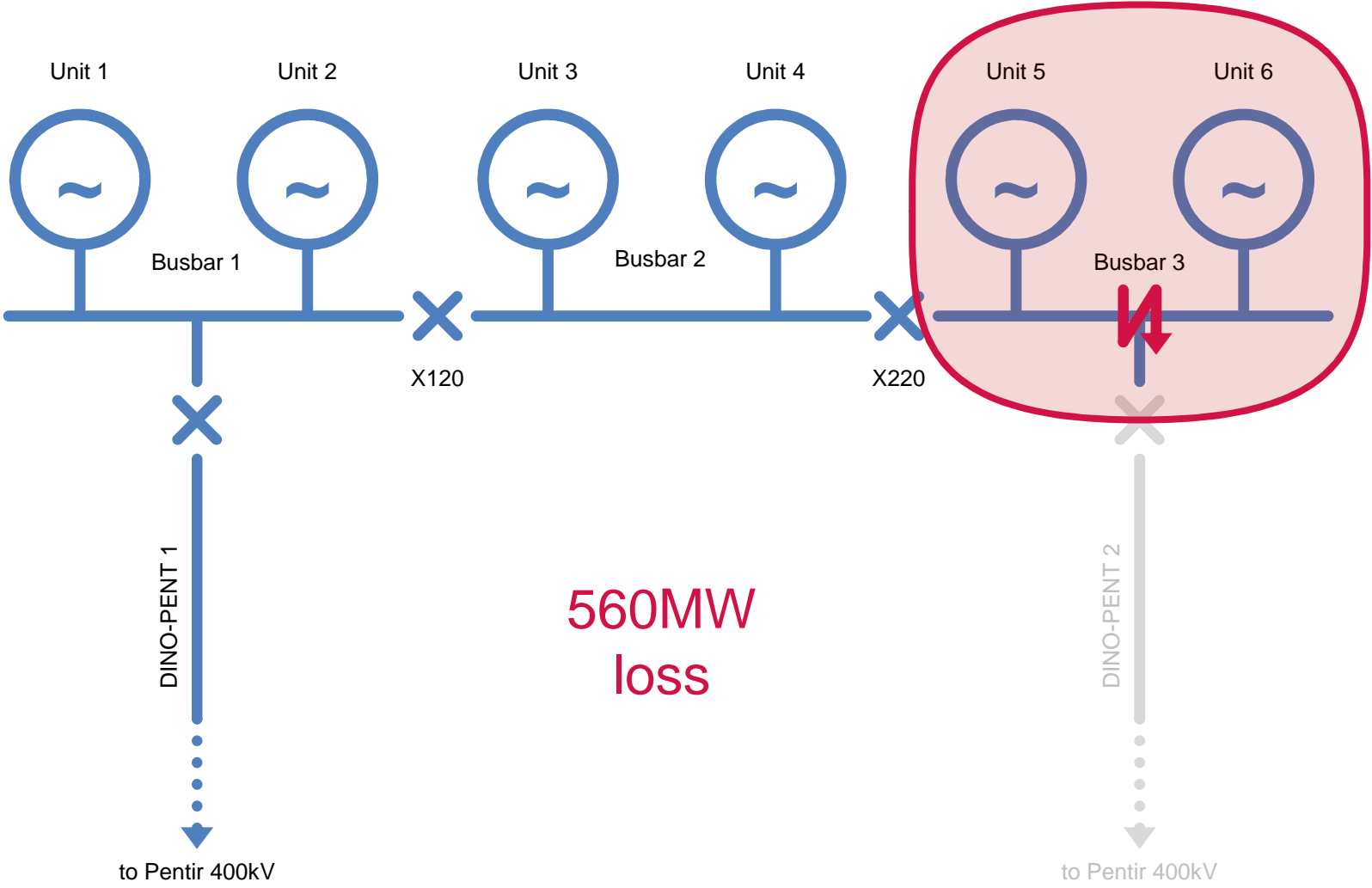

DINO-PENT: impact of an outage

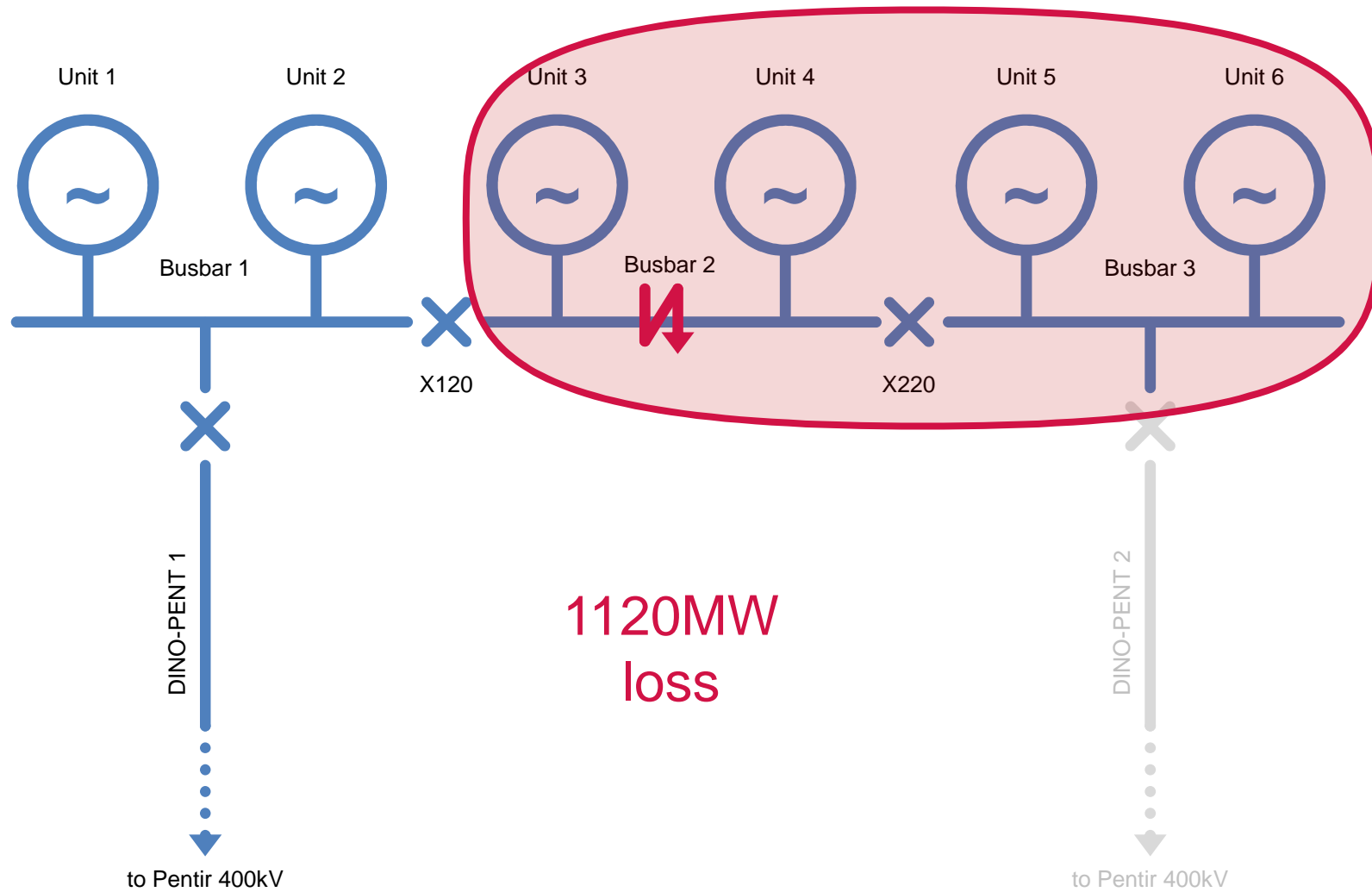

DINO-PENT: impact of an outage

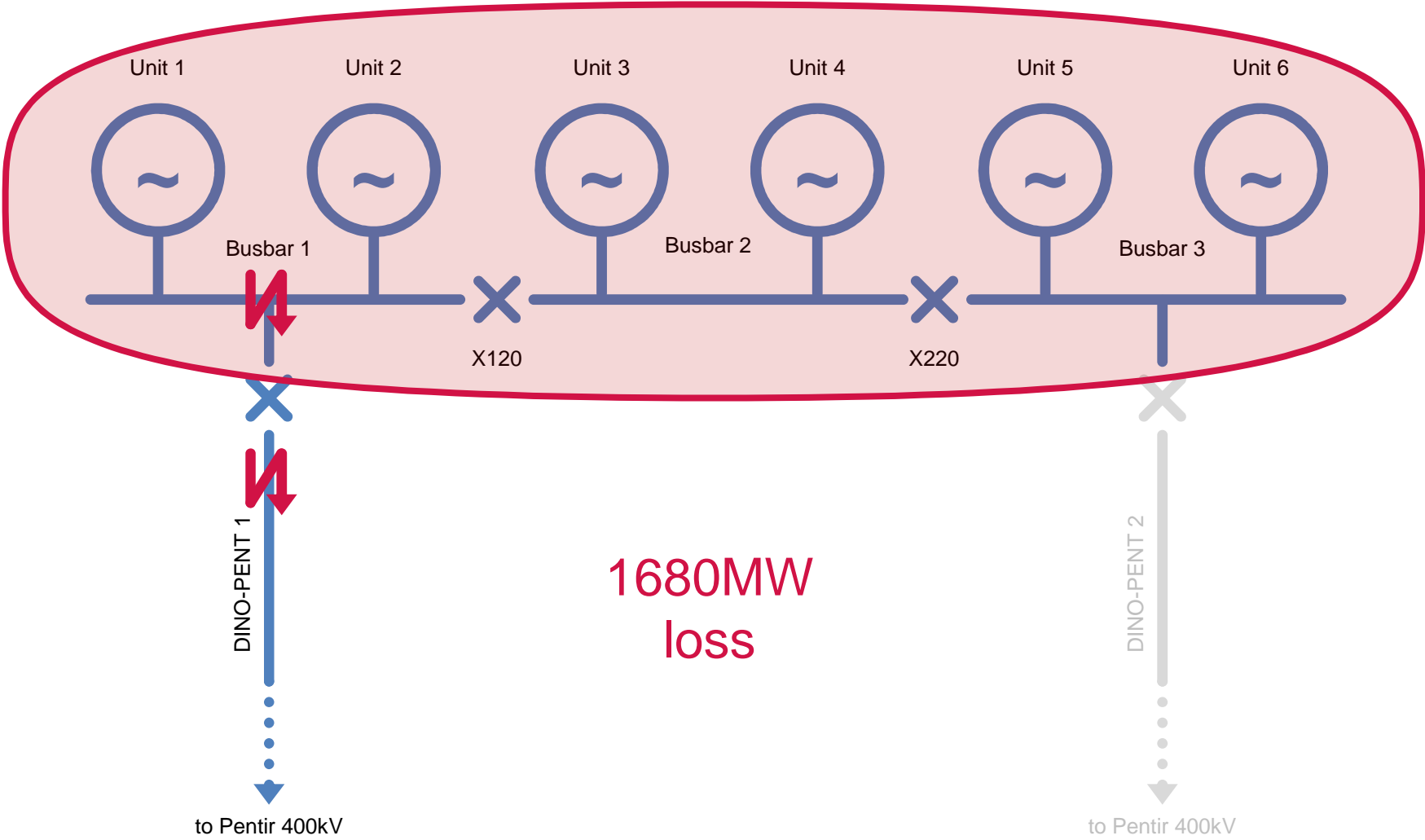

DINO-PENT: what's the big deal?

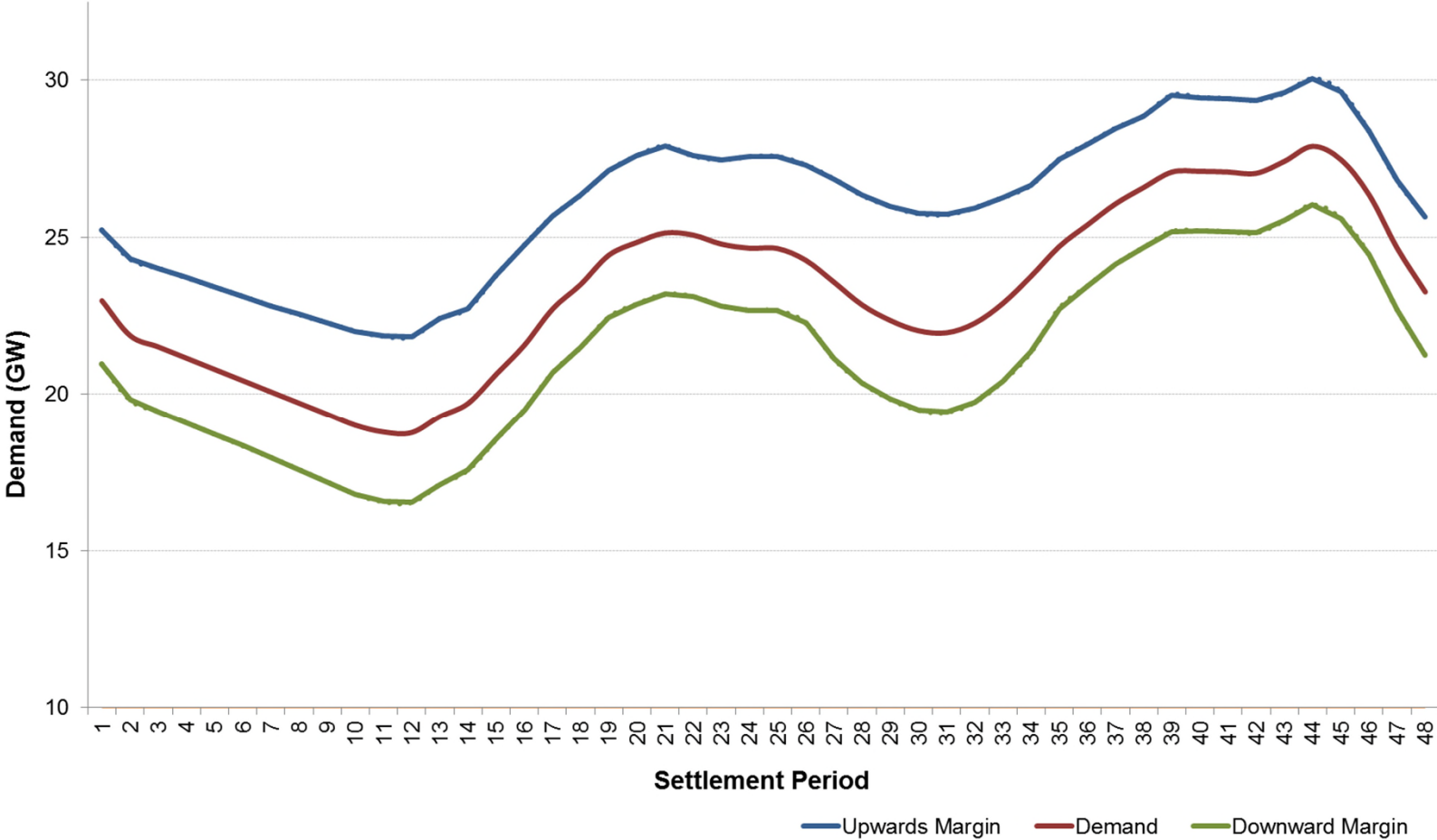

DINO-PENT: what's the big deal?

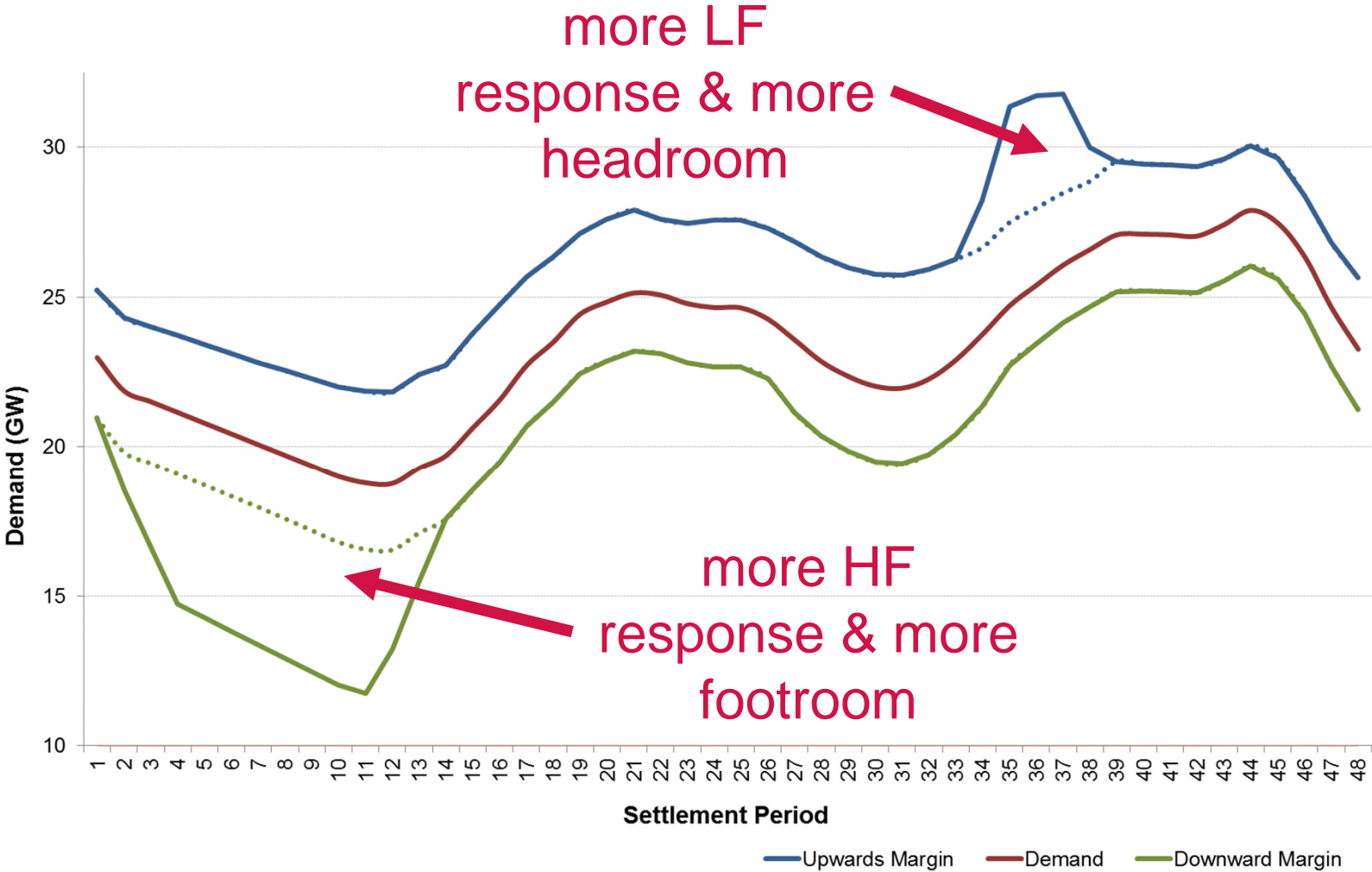

DINO-PENT: what's the big deal?

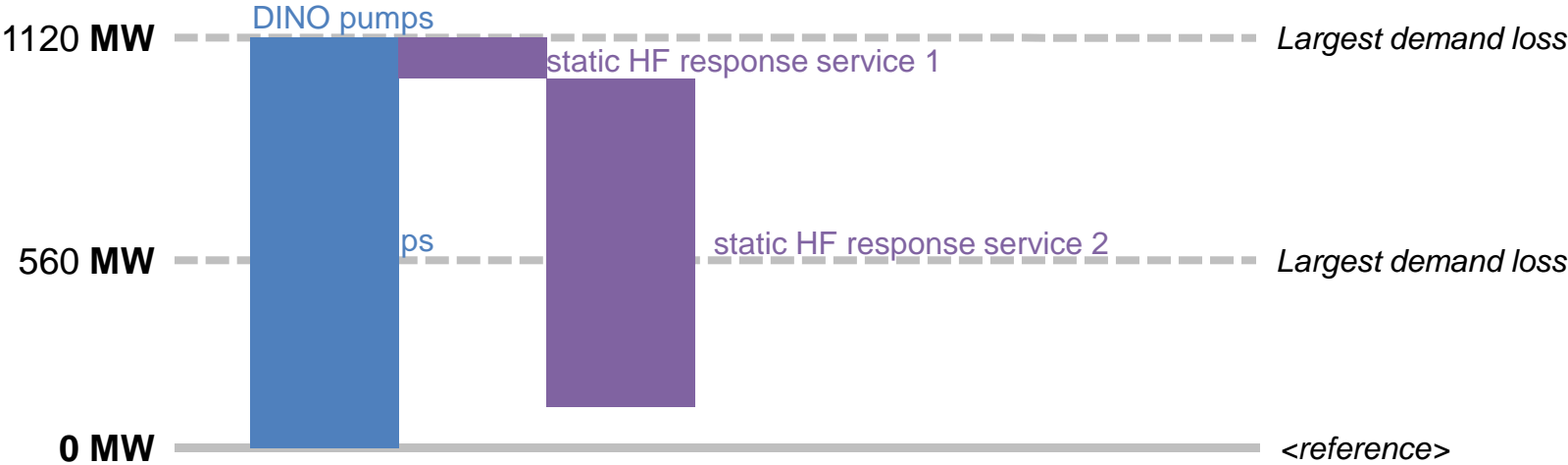

DINO-PENT: what's the big deal?

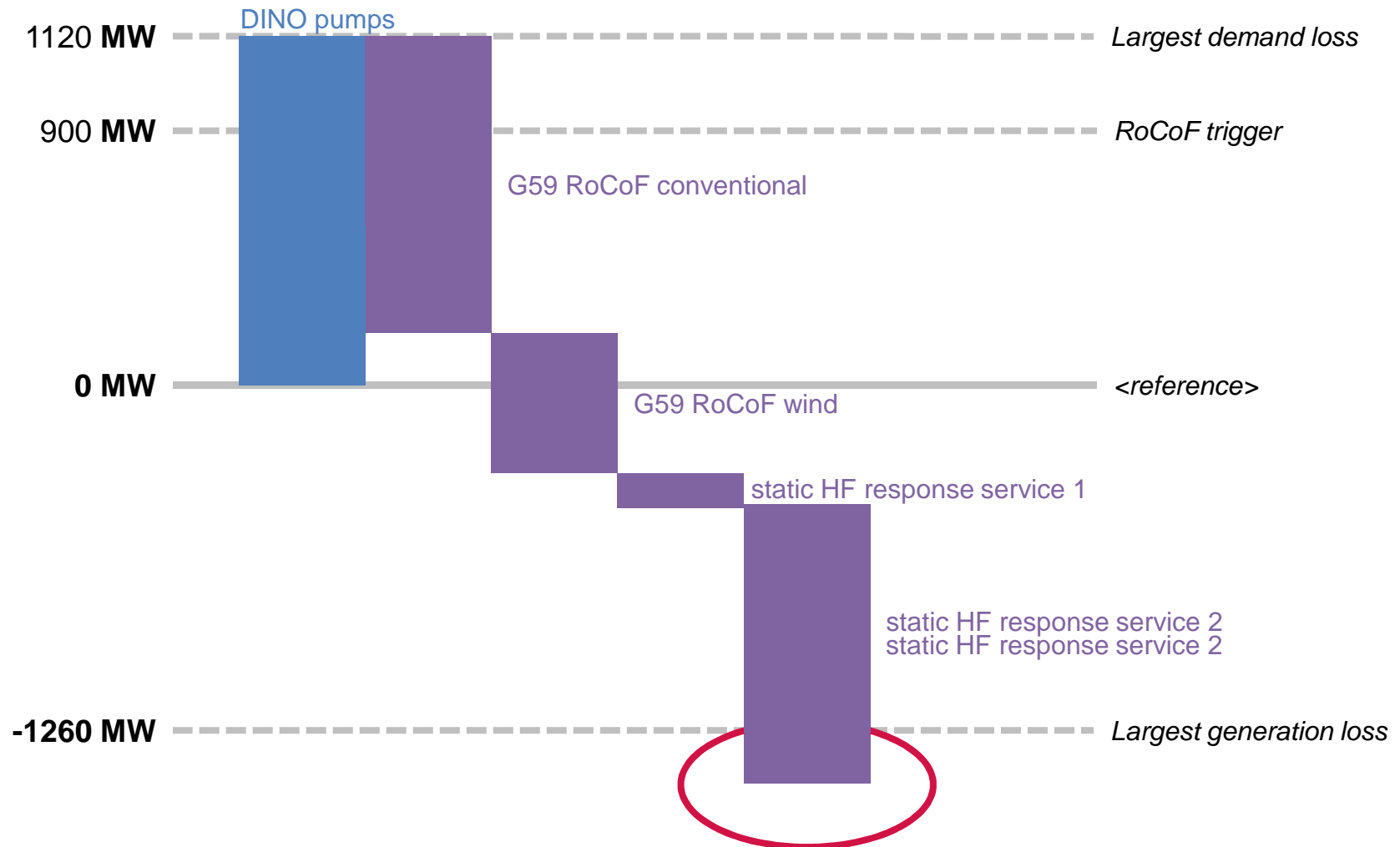

DINO-PENT: why the bigger deal now?

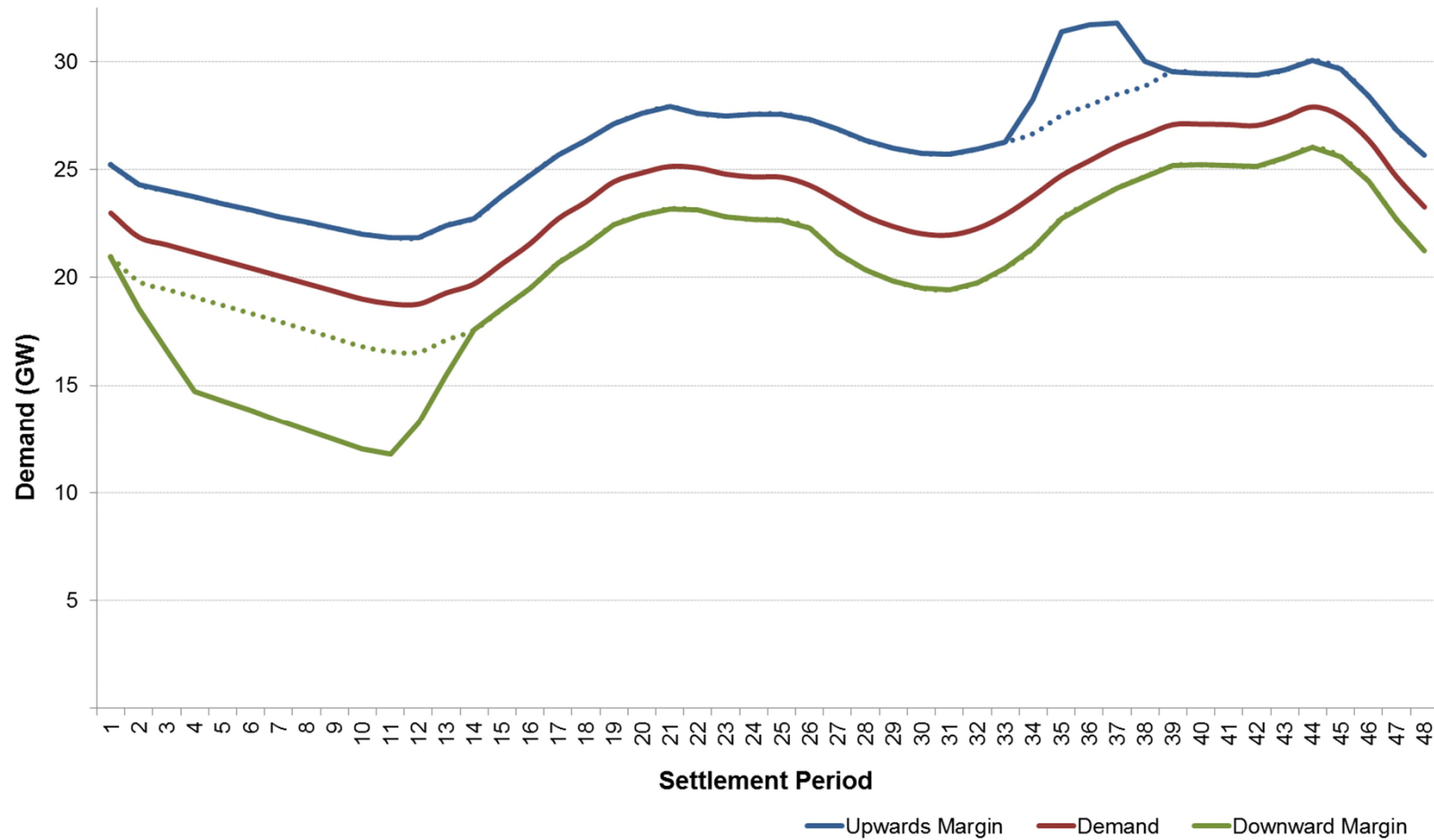

DINO-PENT: why the bigger deal now?

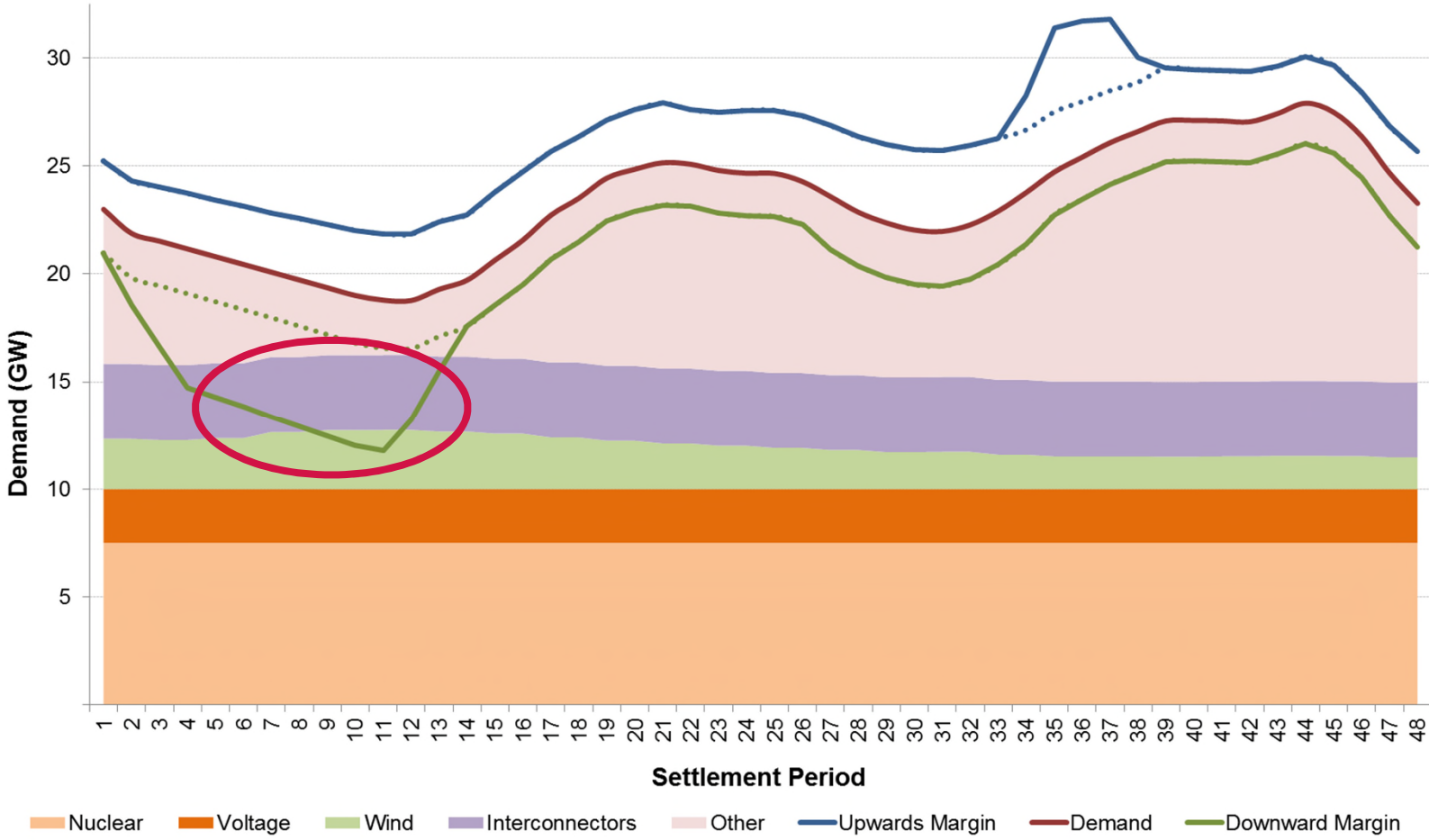

DINO-PENT: why the bigger deal now?

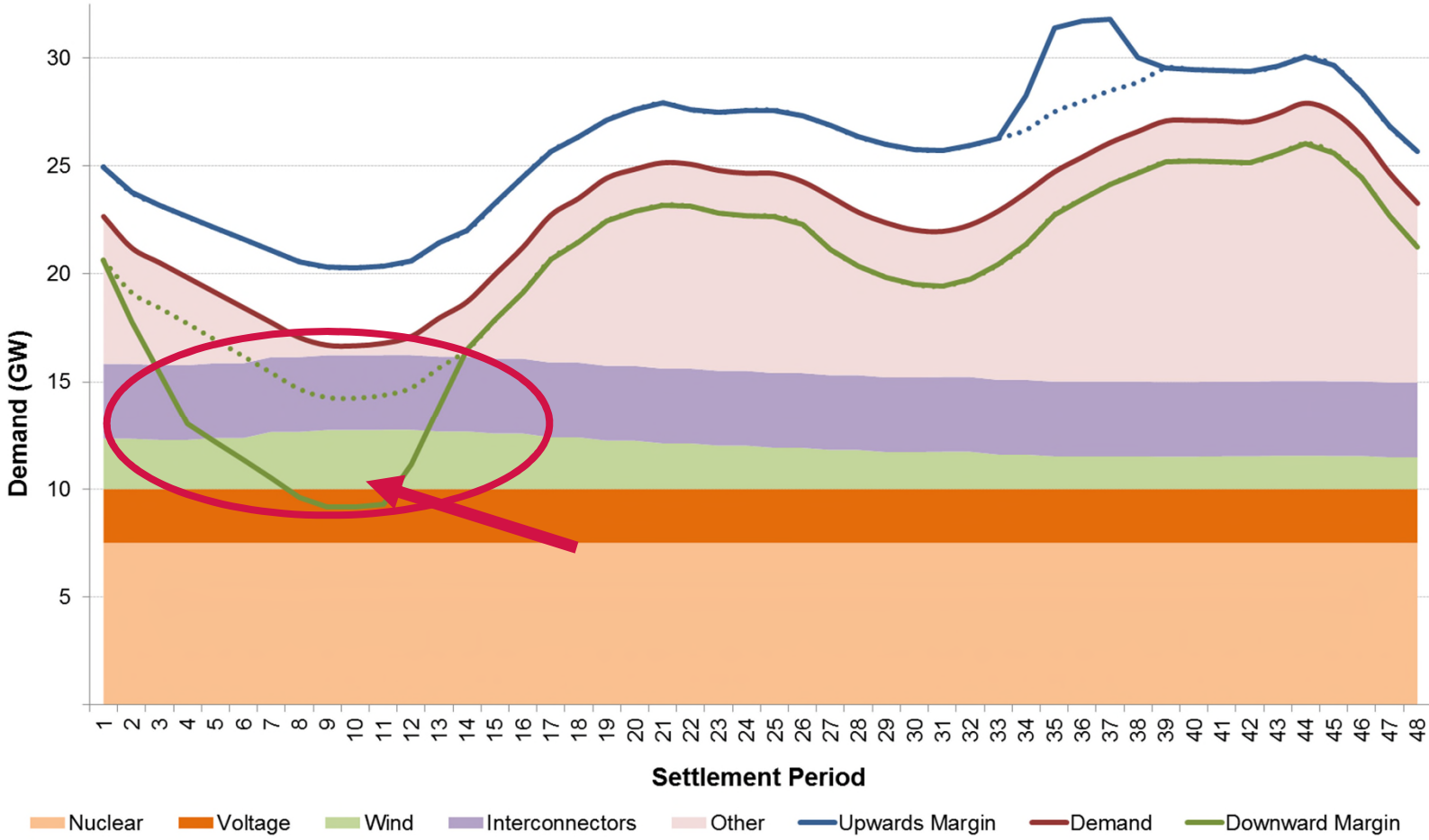

“So What?”



Evolution of trading activity

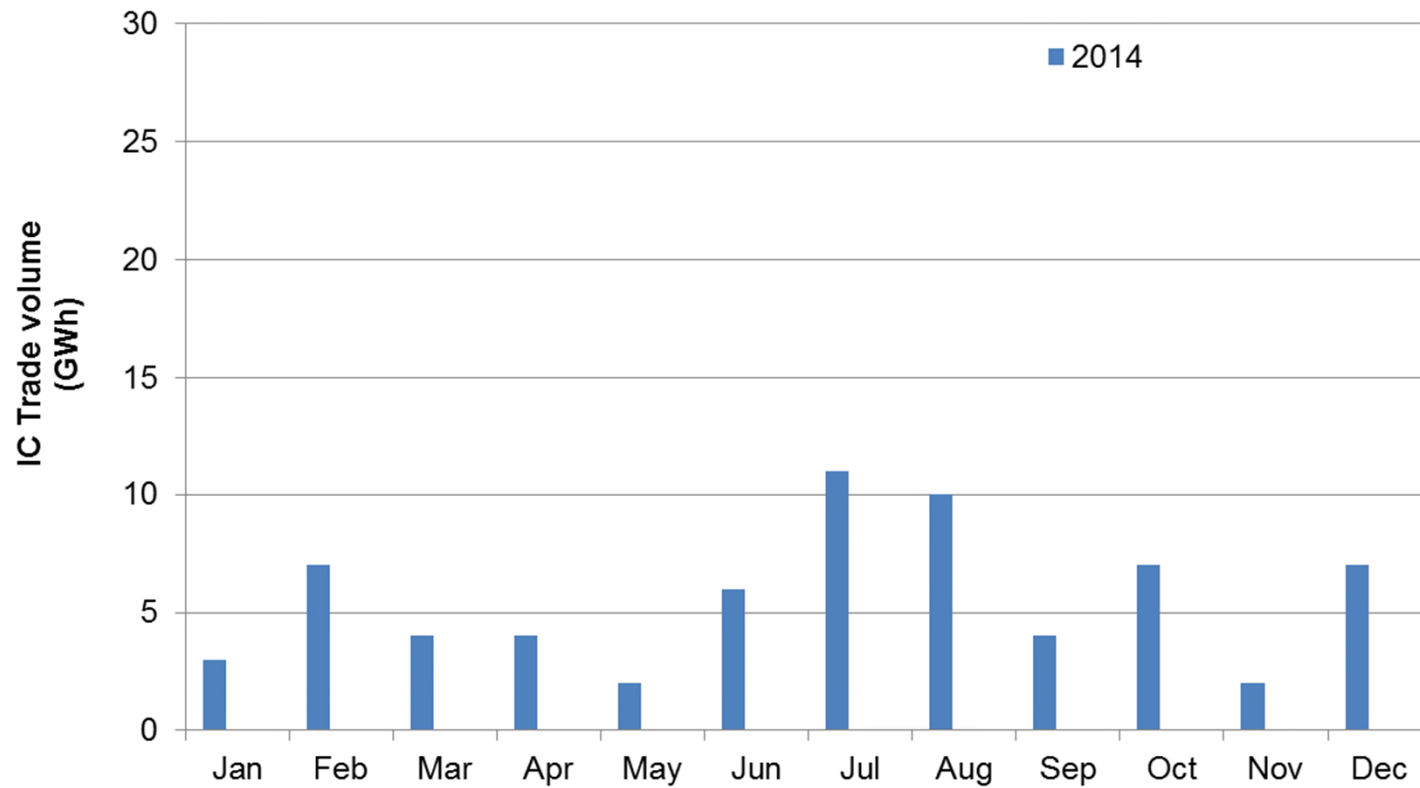

Evolution of trading activity

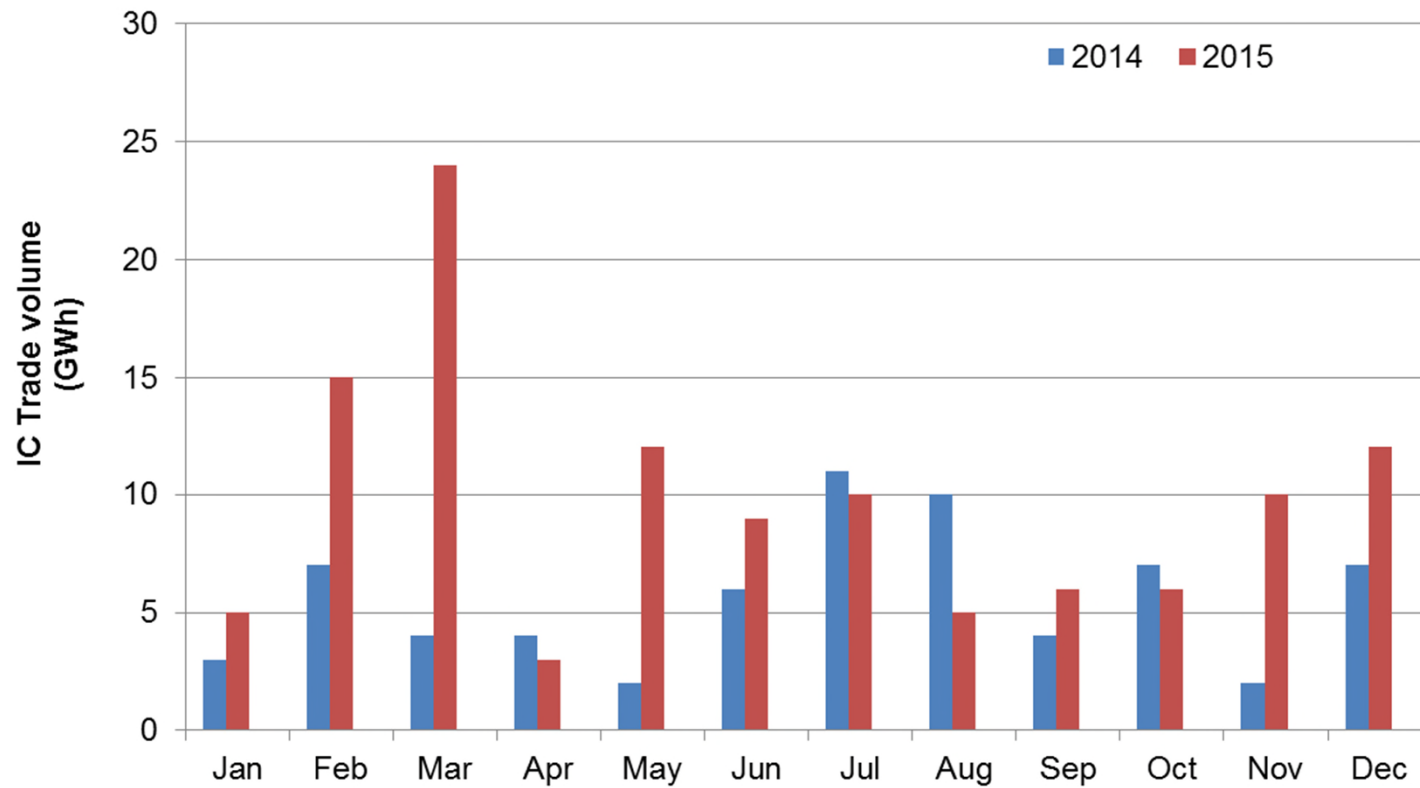

Evolution of trading activity

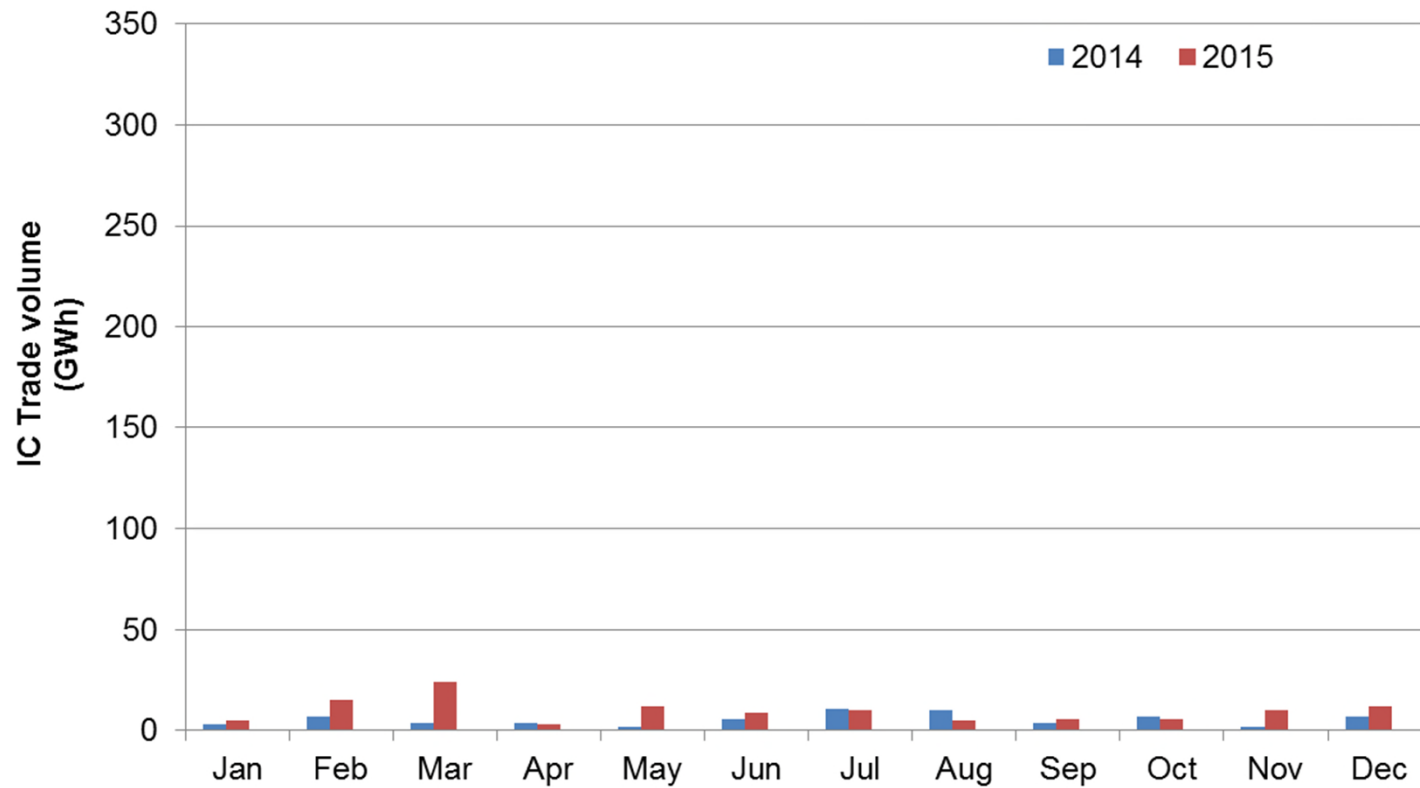

Evolution of trading activity

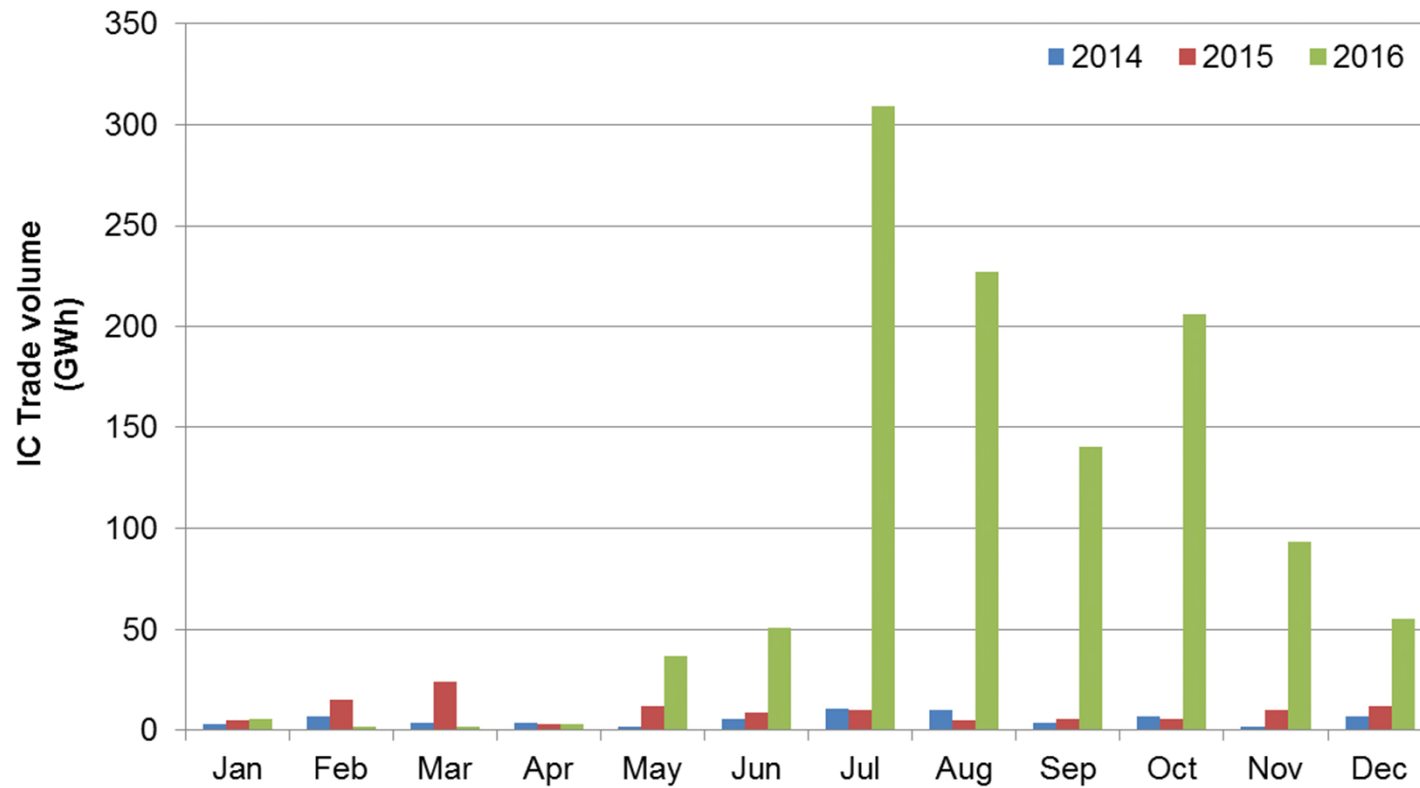

Where are we heading?

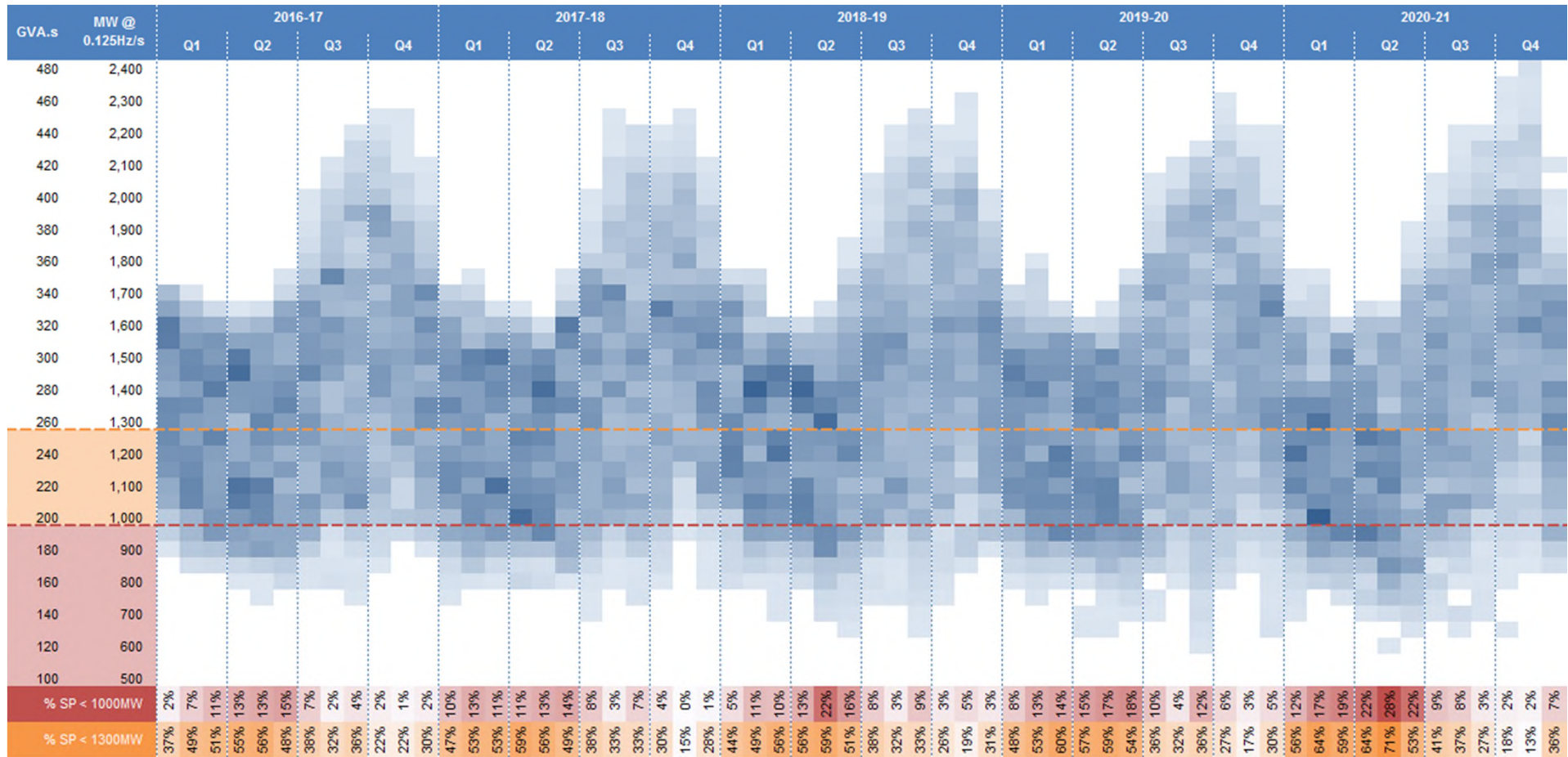

“So What?” are we doing now



DEMAND **TURN UP**

Response Requirements

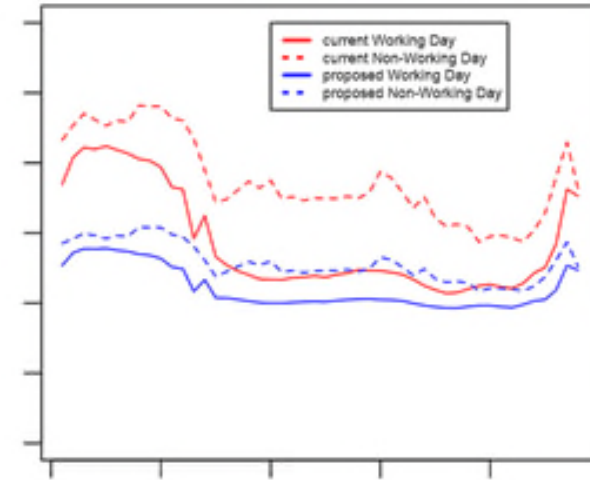

Enhanced Frequency Response

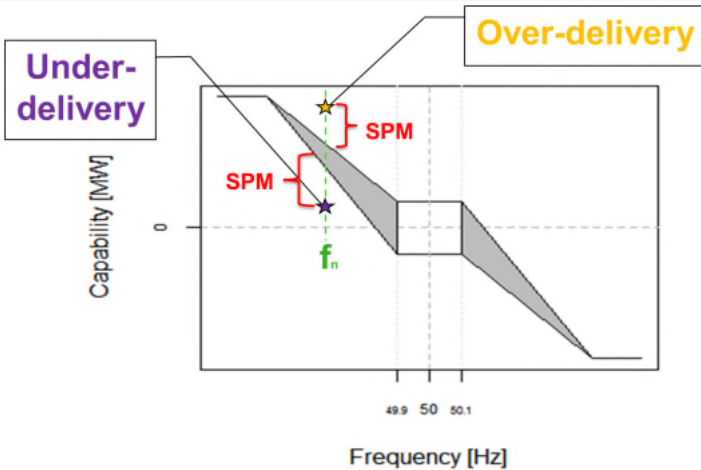

“So What?” will be doing in future

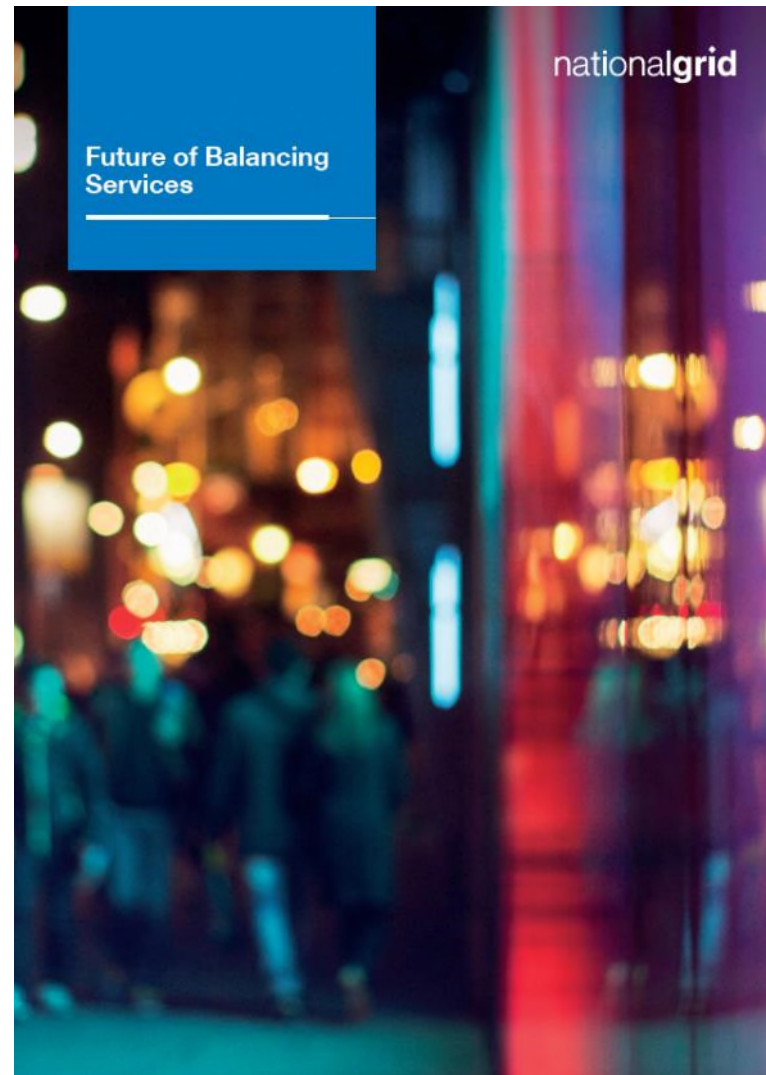

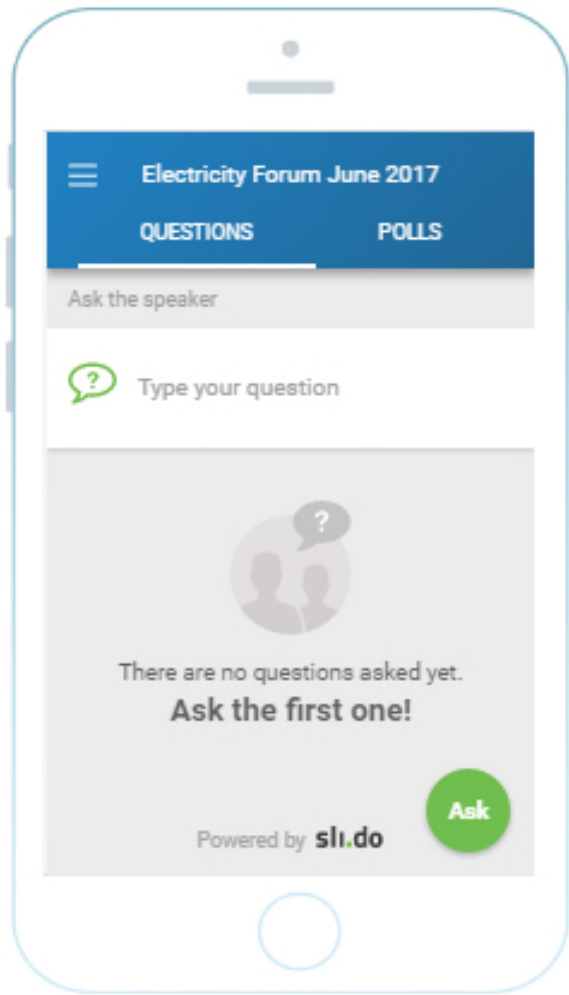

Q&A

*Please provide
feedback
via www.sli.do
#C021*

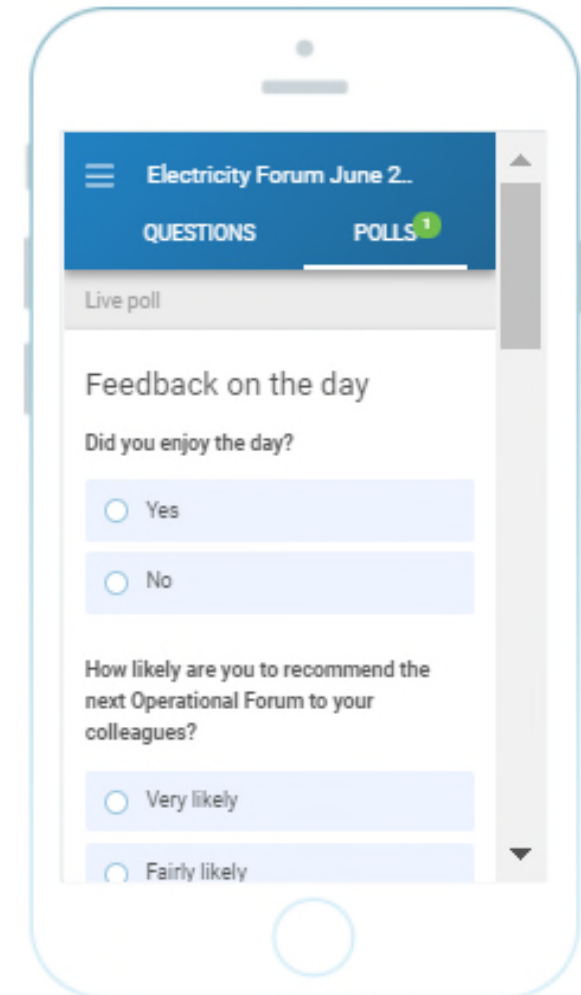

box.futureofbalancingservices@nationalgrid.com