

2013 Electricity  
Ten Year Statement

---

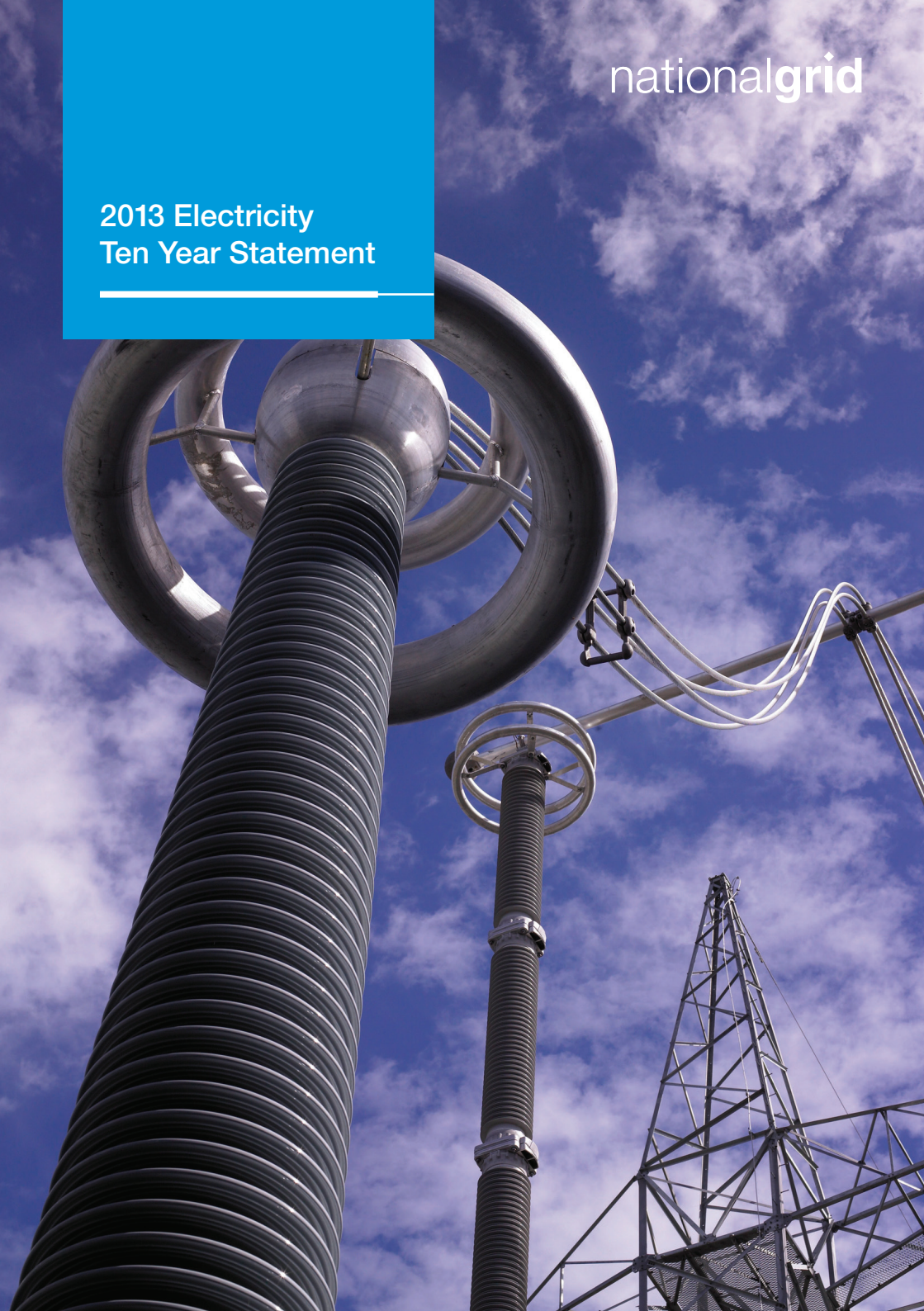

---

Welcome to our 2013 edition of the GB Electricity Ten Year Statement (ETYS). This annual publication describes the GB National Electricity Transmission System, the Transmission Operators potential investment plans in the wider network and details of how we manage the uncertainty of future energy scenarios in both planning and operating the system.

---

**ETYS is produced by National Grid with the assistance of the Transmission Owners (TOs), Scottish Power Transmission (SPT) and Scottish Hydro Electric Transmission (SHE Transmission).**

ETYS builds on the output from the Future Energy Scenarios industry consultation, taking the developments in generation and demand backgrounds captured by the Gone Green and Slow Progression Scenarios and the associated four case studies. We describe the impact these energy scenarios have on the transmission system. Through detailed network modelling and design we explain the potential range of reinforcement options that may be needed. Further to this we highlight the operational challenges and technology development affecting both the planning and operating of the future transmission network.

In last year's publication, we outlined our proposed Network Development Policy (NDP). This defines how we will assess the need to progress wider transmission system reinforcements to meet the requirements of our customers economically and efficiently, taking in to account the risk to consumers. In this year's publication we explain the outcome of applying this policy for the England and Wales transmission system.



**Phil Sheppard**  
Head of Network Strategy

In delivering the 2013 ETYS we set ourselves four key objectives based upon your feedback on our 2013 consultation:

- Provide a document with a high level of clarity regarding the future NETS developments incorporating the NDP into the heart of the document.
- Give transparency to the assumptions behind the analysis that we provide, included in Chapter 2, Network Development Inputs.
- Clearly illustrate the development of the transmission system, taking into account the considerable future uncertainties and the interaction between the onshore and offshore networks.
- Focus more on the opportunities available to existing and future connectees by including an opportunities section in both the Network Development and System Operation chapters.

We hope that you will agree that we have met these objectives.

Your input is of great importance to us and I encourage you to read the Way Forward chapter of this document for further information on our 2014 ETYS consultation process. I also encourage you to tell us what you think by writing to us at [transmission.etsys@nationalgrid.com](mailto:transmission.etsys@nationalgrid.com), engaging us at future stakeholder events or meet us at National Grid House.

I hope that you find this an informative and useful document and look forward to receiving your feedback.



# Contents

Foreword.....	2		
Contents .....	3		
Executive Summary.....	4		
<b>Chapter One</b>	<b>Introduction .....</b>	<b>7</b>	
1.1	Background .....	9	
1.2	Methodology .....	10	
1.3	Navigation through the document ...	13	
1.4	Stakeholder Engagement.....	14	
<b>Chapter Two</b>	<b>Network Development Inputs .....</b>	<b>15</b>	
2.1	Introduction .....	16	
2.2	Future Energy Scenarios .....	17	
2.3	ETYS Background and Scenarios .....	18	
2.4	Demand .....	19	
2.5	Generating Capacity .....	22	
2.6	Plant Margins .....	29	
2.7	Renewables .....	30	
2.8	Interconnectors .....	35	
2.9	Embedded Generation .....	36	
2.10	Application of the Future Energy Scenarios .....	38	
2.11	Operational Cost Assessment Inputs .....	39	
2.12	Stakeholder Engagement Summary .....	44	
<b>Chapter Three</b>	<b>Network Capability and Requirements.....</b>	<b>45</b>	
3.1	Introduction .....	46	
3.2	Background .....	47	
3.3	Offshore Transmission .....	48	
3.4	European Interconnection .....	49	
3.5	Boundary Introduction .....	52	
3.6	Scottish Boundaries.....	57	
3.6.1	B0 .....	58	
3.6.2	B1 .....	60	
3.6.3	B2 .....	62	
3.6.4	B4 .....	64	
3.6.5	B5 .....	66	
3.6.6	B6 .....	68	
3.7	Northern Boundaries.....	70	
3.7.1	EC1.....	72	
3.7.7	B7 .....	74	
3.7.7a	B7a.....	76	
3.7.11	B11.....	78	
3.7.16	B16.....	80	
3.8	Eastern Boundaries.....	82	
3.8	EC3.....	83	
3.8	EC5.....	85	
3.9			<b>South Eastern Boundaries .....</b>
3.9.14	B14 .....	88	
3.9.15	B15.....	90	
3.9	SC1.....	92	
3.10			<b>Western Boundaries.....</b>
3.10	NW1 .....	96	
3.10	NW2 .....	98	
3.10	NW3 .....	100	
3.10	NW4 .....	102	
3.10	MW1 .....	104	
3.10	SW1.....	106	
3.10	SW2.....	108	
3.10.8	B8.....	110	
3.10.9	B9.....	112	
3.10.10	B10.....	114	
3.10.12	B12.....	116	
3.10.13	B13.....	118	
3.10.17	B17.....	120	
3.11			<b>Stakeholder Engagement.....</b>
			<b>122</b>
<b>Chapter Four</b>	<b>Network Development and Opportunities .....</b>	<b>123</b>	
4.1	Introduction .....	124	
4.2	Overview of Transmission Solution Options .....	125	
4.3	Non-Build / Commercial Options...	137	
4.4	Asset Reinforcement Options.....	139	
4.5	Network Development Policy .....	155	
4.6	Investment Recommendations..	159	
4.7	Transmission Losses.....	175	
4.8	Network Opportunities .....	176	
4.9	Stakeholder Engagement.....	182	
<b>Chapter Five</b>	<b>System Operation.....</b>	<b>183</b>	
5.1	Introduction .....	184	
5.2	System Strength .....	187	
5.3	System Balancing.....	209	
5.4	Operational Flexibility .....	211	
5.5	Stakeholder Engagement Summary.....	213	
<b>Chapter Six</b>	<b>Way Forward .....</b>	<b>214</b>	
6.1	Introduction .....	215	
6.2	Continuous Development.....	216	
6.3	Feedback from 2013 Stakeholder Engagement .....	217	
6.4	Stakeholder Engagement.....	219	
			<b>Glossary .....</b>
			<b>220</b>

## Executive Summary

---

---

The purpose of The ETYS is to illustrate the future development of the National Electricity Transmission System (NETS) under a range of plausible energy scenarios and to provide information to assist customers in identifying opportunities to connect to the NETS. To meet these aims this document describes the development of the transmission system needed to meet the Future Energy Scenarios and the opportunities this presents in the operation of the system.

---

The UK has legislation in place setting limits on the emissions of greenhouse gases as far ahead as 2050. There is also legislation mandating a minimum level of renewable energy in 2020. A single forecast of an energy mix does not give a sufficiently rich picture of possible future developments. National Grid carries out analysis based on different scenarios that between them cover a wide range of possible energy futures. This Future Energy Scenarios is heavily driven by stakeholder engagement to help ensure the resulting scenarios are holistic, self-consistent and plausible. This ETYS document presents the outcome of this year's Network Development Analysis using the range of FES scenarios and case studies.

In addition to the generation backgrounds for the Gone Green and Slow Progression scenarios, we use the four case studies to give alternative, plausible generation mixes to provide a wider representation of potential system development needs in this document. Analysis of how the sensitivities affect the transmission system is included in this document.

The scenarios used to underpin our network development analysis present significant challenges in planning the transmission network as we transition to a low carbon economy. The development of the NETS is influenced by a number of key factors including:

- the generation and demand outlook
- generation type
- regulatory policy changes (e.g offshore integration review)
- offshore design approaches
- technology development
- management of future uncertainty and investment risk.

The ability of a transmission network to transfer energy from generation to supply can be described in terms of boundary capability. Each boundary in the transmission network is required to securely enable the maximum expected power transfer. More than 25 local and wider boundaries have been analysed in this way to establish this required capability. As many of the solutions to increase boundary capability can affect more than one boundary they have been grouped into regions to better explain the future NETS developments.

The ETYS demonstrates that the transfers across the northern boundaries could potentially grow by up to six times their current capability under certain scenarios, primarily driven by new onshore and offshore wind connections. The southern boundaries see less

pronounced changes in power transfer requirements driven by generation although interconnection projects have a more significant impact on future transmission reinforcements. In general the developments of the NETS is being driven by generation connecting in more remote parts of the transmission system such as North Wales and East Anglia.

Offshore transmission projects and the development of technologies such as High Voltage Direct Current (HVDC) transmission will play a very big part in both the future capacity requirements and delivery of future transmission capability. An integrated approach to the development of the offshore networks helps provide capacity, control and flexibility that are needed for the effective and economic development of the future transmission network across many of the critical system boundaries.

The RIIO price control introduced the Network Development Policy (NDP) for England and Wales where National Grid is the transmission owner. The NDP identifies the requirements for further transmission investment and considers the balance between the risks of investing too early in wider transmission reinforcements and the risks of investing too late, which include incurring inefficient congestion costs. The key output of the NDP is the identification of the appropriate action to take in the current year. This is selected through minimising the investment regrets against the credible range of future energy scenarios and sensitivities. The NDP provides a transparent process for the selection of transmission solutions and is presented in Chapter 4. This will enable stakeholders to understand why decisions to build, and not to build, have been taken. The range of system requirements and NDP outcomes presented in this years ETYS reflect the current slower market conditions and therefore some major projects are now being delivered in later years.

The operation of the transmission system under the range of scenarios is also covered in the ETYS. The key changes to the system are identified and the impact of these are carefully assessed to identify any mitigating measures needed required to ensure continued safe and secure, reliable, and efficient design and operation of the transmission system. One key change to the network is the transition from a relatively predictable and controllable generation portfolio dominated by fossil fuel synchronous plant, to one including a significant level of non-synchronous plant with intermittent output. There are also important changes to consider related to electricity demand, where loads may become more flexible and price sensitive. This with increasing levels of embedded generation, and in the longer term increased levels of



electricity storage, that could lead to less predictable levels of demand being taken from the transmission system. The degree of change will depend on the future energy outlook and economics. The key system design and operational challenges associated with these changes are:

- The falling level of synchronous generation in service, particularly at low demand periods, will reduce system inertia impacting on frequency management
- Falling fault levels on the system requires the functionality of certain protection devices, the commutation of High Voltage Direct Current (HVDC), and impact on a range of quality of supply issues to be understood.
- Rapid changes in renewable output, including wind generation 'cutting out' at high wind speeds, will have to be matched by changes in conventional generation. As this plant is connected at different locations on the network, there could be significant power flow volatility.

We are working with industry stakeholders on these issues and the potential mitigating measures that can be both technical and commercial in nature. We envisage that this will include innovative approaches that will create new opportunities for customers through commercial services such as flexible demand and fast frequency response. These areas are described in Chapter 5.

Finally, one important aspect to consider when reading this document is that the future energy outlook is uncertain and the scenarios presented in this document while plausible are not a forecast. The actual development of the NETS can differ from that included in this document and therefore should not be used as the sole basis for any financial, planning consent, commercial or engineering decision.

---



---

The Electricity Ten Year Statement (ETYS) illustrates the potential future development of the National Electricity Transmission System (NETS). It helps existing and future customers to identify connection opportunities on both the onshore and offshore transmission system. This introductory chapter outlines the approach we have undertaken and sets out the scope of the ETYS.

---



# 1.1

## Background

---

The 2013 ETYS is the second GB Electricity Ten Year Statement to be published. The ETYS is produced for you, our stakeholders, and we want to ensure it develops as a result of what you have told us.

The document forms part of a suite of publications which is underpinned by our Future Energy Scenarios. This enables the analysis in both the ETYS and its sister publication – the Gas Ten Year Statement (GTYS) – to have a consistent base when assessing the potential future development of both the gas and electricity transmission networks.

The ETYS was developed via an engagement programme with you to harmonise a number of our previous publications, including the SYS and ODIS, enabling stakeholders to access relevant and timely information in a single document that captures both the onshore, offshore and interconnected network.

In April 2013 we consulted with you on the development of the ETYS publication. We received significant amounts of feedback, mainly through face to face meetings at the electricity customer seminars and also through our written consultation on how you would like to see the ETYS developed.

The feedback received from our customers and the output from the process in our 'ETYS Consultation 2013' publication can be found on our website and is also included in Chapter 6, Way Forward. The main elements addressed in this year's edition are the form of the document including the integration of the Network Development Policy and the inclusion of a much clearer opportunities section.

Following the publication of this edition of the document we will gather views from you to enable us to continually evolve the document and incorporate your views. Section 1.4 outlines how we aim to embed your views into the development of the document to a greater degree.

# 1.2

## Methodology

The document will focus on the potential development of the NETS using analysis around the energy scenarios: Slow Progression and Gone Green and their associated case studies, while ensuring that the network is developed to meet customer connection dates.

The energy scenarios are detailed in our Future Energy Scenarios (FES) publication, which can also be found on our website. An overview of these scenarios and how we utilise them as inputs for our wider system planning, can also be found in Chapter 2.

*Figure 1.1*  
*Network Development Process*

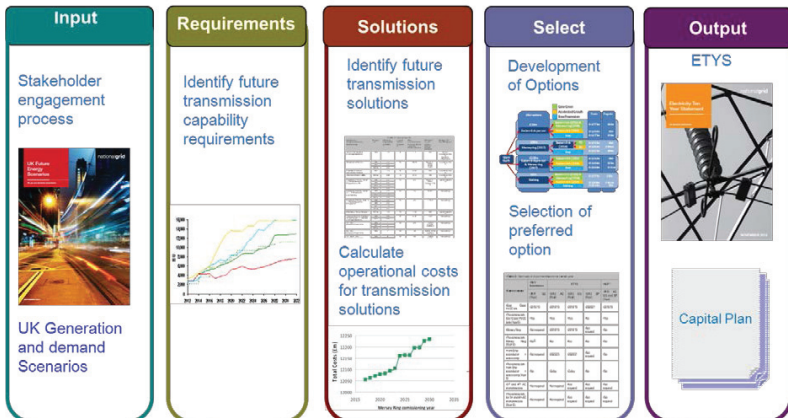

### Network Development Process

The network development process associated with NETS development is shown above. It starts with the inputs to transmission planning, the Future Energy Scenarios, that provide a plausible range of future outcomes. The scenarios are analysed in the different areas of the transmission system to show what they mean for the future system. These requirements are turned into a set of potential network reinforcement solutions. Finally these options are analysed and decisions are made on the preferred course of action to develop the network in the most economic and efficient manner. This process is shown in Figure 1.1 above and is the basis for the structure of the document discussed in section 1.3, Navigation of the document.

### Future Energy Scenarios

In addition to the scenarios and four case studies, further analysis has been produced focusing on the contracted based background, which includes any existing or future project that has a signed connection agreement with us. This ensures that we develop solutions that are consistent

with our wider licence obligations. In developing the network development process we retain the capability of meeting all contracted connection dates.

The use of energy scenarios rather, than focusing purely on the contracted generation background, is one of the key developments of the ETYS. The current contracted position is for 256 projects totalling 102GW of capacity. The use of scenarios allows us to explore a range of more credible outcomes than the use of the contracted background alone. Our scenarios have been developed via a full, wide-ranging industry consultation. They enable an assessment of the development of the transmission network against a range of plausible generation and demand backgrounds.

To help align the ETYS with other National Grid publications and to assist in providing a longer-term view, the analysis contained within the document covers a detailed ten-year study period, with a less detailed analysis considering the period from 2023 to 2033.

### Transmission System Planning

The principle of transmission system planning is common across all Transmission Owners (TO) within GB as we seek to build an economic and efficient level of transmission, to facilitate the connection of new customers and the energy market. However, the approach of TOs will vary across the areas taking into account: each companies own resources; challenges such as volumes of connection, transmission system capacity and age; and their regulatory requirements in the current period.

The National Electricity Transmission System Security and Quality of Supply Standards (NETS SQSS) sets out a coordinated set of criteria and methodologies that Transmission Licensees (both onshore and offshore) shall use in the planning and operation of the National Electricity Transmission System.

The following ETYS document sets out how the TOs expect to plan their network over the coming 20 years. The scenario inputs to Network Planning are analysed utilising the NETS SQSS criterion to determine the future requirements. Based on these requirements options are selected to solve the identified system boundary constraints.

### Network Development Policy

The Network Development Policy (NDP<sup>1</sup>) is a new approach to assessing wider works on the NETS system, in England and Wales only. The analysis and decisions that National Grid has made with respect to NETS reinforcements can be seen in this ETYS document, in Chapter 4. We are keen to engage with industry stakeholders in this key area as we look to build an economic and efficient level of transmission.

The NDP allows NGET to manage one of the most significant uncertainties facing the electricity transmission system that is the quantity, type and location of connected generation and the extent and location of new interconnection to other systems. The lead-time for reinforcement of the wider transmission network can often be longer than the lead-time for the development and construction of new generation projects.

The TOs therefore need to effectively balance the risks of investing too early in wider transmission reinforcements, which includes the risks of inefficient financing costs and an increased stranding risk, with the risks of investing too late, which includes the risks of inefficient congestion costs. Given this significant amount of uncertainty, the decision process with which the preferred combination of

transmission solutions will be chosen needs to be well-structured and transparent. This increased transparency will allow stakeholders to understand our rational to build, or not to build. We believe this allows for greater stakeholder engagement in our process and outputs.

The NDP defines how National Grid will assess the need to progress wider transmission system reinforcements to meet the requirements of our customers in an economic and efficient manner based upon forecast future generation and demand scenarios.

Following their assessment of National Grid's NDP proposals, Ofgem concluded that they "consider the decision-making framework and process in National Grid's proposed NDP to be a proactive, prudent and flexible approach." Ofgem continued "that by applying this approach, National Grid would have a reasonable basis to take decisions on network investment in a manner that is compatible with its overall duty to develop and maintain an efficient, coordinated and economical system of transmission." Therefore "based upon our assessment, and in consideration of our statutory duties, we support the implementation of National Grid's proposed NDP and are minded to not direct any changes to the proposed NDP, subject to stakeholders not raising any significant concerns about it." Ofgem's full response can be read on their website<sup>2</sup>.

The NDP network modelling and analysis contained within the ETYS uses the Future Energy Scenarios (FES). The detailed Cost Benefit Analysis is undertaken using all of the scenarios and case studies equally weighted. The NDP output recommends the projects that will be progressed over the next twelve months.

### Ten Year Network Development Plan (TYNDP)

The TYNDP is a European development plan regarding the investments in electricity transmission systems which are required on a pan-European basis and to support decision-making processes at regional and European level. The ETYS is designed to be more GB focused, giving the readership a clear picture of all GB investments, while complementing the TYNDP in areas of Pan-European interest.

<sup>1</sup> NGET Network Development Policy submission

<sup>2</sup> <https://www.ofgem.gov.uk/ofgem-publications/53478/final-con-letter-nget-ndp-may-2013.pdf>



---

ENTSO-E created the Working Group (WG) TYNDP to lead the development and publication of the TYNDP. The first Pilot TYNDP was published in June 2010, the TYNDP 2012 was published in July 2012. The TYNDP was based on the most up-to-date and accurate information regarding planned or envisaged transmission investment projects of European importance prior to its release.

The next target for the TYNDP WG and the regional groups is the release of the next Ten-Year Network Development Plan in December 2014. The 2014 release will include six Regional Investment Plans and a System Outlook and Adequacy Forecast (SOAF) alongside the Europe-wide development plan which formed the core of the first TYNDP.

---

## 1.3

# Navigation through the document

The form of the document has been changed this year as we have responded directly to what you told us through the ETYS consultation earlier this year. The changes to the document will hopefully allow us to achieve some of our ambitions which are to bring clarity to the development of the NETS and integrate the NDP to the body of the document.

## Stakeholder Engagement

Is this approach suitable for your needs?

**Network Development Inputs** – This chapter describes the key inputs to the development of the network such as the FES and the cost assumptions of generation curtailment. The FES elements in each of the two core scenarios, the case studies for each scenario and an overview of the contracted background are given. It also includes analysis on ‘plant margins’ under the energy scenarios to further assist customers in identifying future market opportunities.

**Network Capability and Future Requirements** – This section builds on the previous chapter and illustrates the impact of the FES inputs on the NETS. It also shows the current capability limits of each NETS boundary for reference. Future network requirements relevant to each of the scenarios are mapped out against all boundaries on the NETS.

In order to assess the potential impact of future requirements on the transmission system it is useful to consider the NETS in terms of specific regions separated by boundaries across which bulk power is transmitted. This section is therefore structured in a way that discusses each of these boundaries, and therefore regions, in turn. For each boundary there is a description of the boundary, detail of the generation background, demand backgrounds and the limiting factors.

**Network Development and Opportunities** – Given the earlier identified future NETS requirements, this chapter moves into assessing the reinforcement solutions available for each region of the network and in turn analyses their merits.

It outlines our NDP methodology. This defines how we will assess the need to progress wider transmission system reinforcements to meet the requirements of our customers, in an economic manner. The chapter looks at the range of network reinforcement options available for example onshore, offshore and commercial.

It discusses the potential development of an integrated offshore network and the impact of increased levels of interconnection on the network.

Potential system reinforcements are analysed across all the energy scenarios analysed and a discussion of the potential

future boundary capability and therefore opportunities are identified. Most importantly this chapter captures the decisions that are being made on the NETS in the next year. This analysis forms the bulk of the document.

This is the section where the illustration of the NETS, including detailed system maps of both the onshore and offshore areas, can be found.

**System Operation** – Following the identification of how the network may look in the future, this chapter focuses on how our operational strategy is evolving. The focus is on how network operation will need to change given the changing generation mix and increase of renewable generation. This section also highlights where there may be opportunities for customers to provide services in support of system operation such as balancing or ancillary services.

**Way Forward** – We are committed to ensuring that the ETYS continues to evolve and that each year our stakeholders have the opportunity to shape the development of this document. This chapter details the engagement process which will run alongside production of the 2013 ETYS.

**Appendices** – In addition to the main ETYS document itself there are also several data appendices to this publication which can be found on our website. The appendices contain all the relevant technical and numerical data in support of the analysis shown in the ETYS.

The appendices include:

- System Schematics – geographical drawings of the existing and potential future NETS.
- Technical Network Data – data tables that include information such as substation data, transmission circuit information, reactive compensation equipment data and indicative switchgear ratings.
- Power Flows – diagrams showing power flows for the full NETS.
- Fault Level Analysis – fault levels calculated for the most onerous system conditions at the time of peak winter demand.
- Generation Data – tables and graphs which will show the fuel type split data for each of the scenarios and also an extract of the contracted background. This appendix will also show a table which will enable linking of study zones to boundaries.
- Technology – in conjunction with key manufacturer suppliers we have produced a series of technology sheets which look at the present and future technologies associated with the development of both the onshore and offshore transmission system.

# 1.4 Stakeholder Engagement

- We are committed to stakeholder engagement and ensuring your views are central to the development of this document. This year we have embedded this stakeholder engagement throughout the document. Within each section we have highlighted the areas where we want to capture your input and views. Please see the Stakeholder Engagement section below that you will find in key areas of the document.

## Stakeholder Engagement

We would very much appreciate the views of the industry on the availability assumptions of these generation types to further enhance our constraint modelling analysis.

Throughout the document you will see key areas we believe further engagement and industry experience could further enhance this statement. However, feedback is not limited to those questions we would be delighted to receive feedback of any nature, by any means appropriate. We are also keen to know how you wish to engage with us on the development of the ETYS.

We will be looking to engage with stakeholders:

- At consultation events as part of the customer seminars
- Through responses to the ETYS email link as below
- Organising bilateral stakeholder meetings depending on the feedback

In preparation for next year's statement a way forward section, Chapter 6, is included at the end of this document that summarises our next steps in the engagement process for the ETYS 2014.

This stakeholder engagement provides an opportunity for us to understand your views. We would very much like to understand how this document is used by the industry and how our work affects others with a view to incorporating these views into our decision making processes.

Should you wish to provide us feedback on any of the content of this document we would ask you to submit it to [transmission.ety@nationalgrid.com](mailto:transmission.ety@nationalgrid.com), catch up with us at one of our consultation events or visit us at National Grid House, Warwick.



# Chapter Two

## Network Development Inputs

---



## 2.1 Introduction

---

This chapter explains how we have used the Future Energy Scenarios and converted them into inputs to identify a credible range of future transmission capacity as described in Chapter 3. It also explains the inputs to our Cost Benefit Analysis approach within the transmission planning activities.

A key driver to future investment requirement is the electricity demand (both active and reactive power) that the generation must meet. This chapter discusses the basis of the future forecasts, utilised in Chapter 3.

In this chapter, we explain the methodology adopted for converting the FES scenarios to generation ranking orders and how these ranking orders, and associated inputs, are utilised to determine the operational costs of a given network. This data is used as inputs into the Network Development Policy, which is further described in Chapter 4.

In presenting this chapter, we seek your views on the input assumptions used in determining future investment requirements.

## 2.2

# Future Energy Scenarios

---

Our energy scenarios are produced annually following an industry consultation process which is designed to encourage debate and help shape the assumptions that underpin the final scenarios. Following completion of this year's stakeholder engagement programme the latest scenarios were published in National Grid's **Future Energy Scenarios** document. As described in the introduction this document uses these scenarios and assumptions as the basis of the analysis with respect to identifying the need for transmission reinforcements. In general the scenarios are also utilised to inform the energy market debate.

To determine the range of future transmission capacity requirements, and the robustness of individual network reinforcement proposals, we have developed a range of both energy scenarios and associated case studies, which are discussed further in this document, in addition to the contracted generation background. The analysis carried out within ETYS is based around the future energy scenarios, which have been developed following extensive stakeholder engagement, which identifies a need for a range of potential reinforcements. Information on Electricity demand and generation within the Future Energy Scenarios document can be found in Chapter 4, sections 4.1 and 4.2.

The 2013 UK Future Energy Scenarios document was published in July 2013 and can be accessed at the following link: **Future Energy Scenarios**.

Appendix 1 of the 2013 Future Energy Scenarios document details a number of government policies that directly impact the development of the electricity and generation demand scenarios, with a summary of Electricity Market Reform being included.

## 2.3

## ETYS Background, Scenarios & Case Studies

**Slow Progression** – Developments in renewable and low carbon energy are comparatively slow and the renewable energy target for 2020 is not met until sometime between 2020 and 2025. The carbon reduction target for 2020 is achieved but not the indicative target for 2030.

**Gone Green** – Assumes a balanced approach with contributions from different generation sectors in order to meet the environmental targets. Gone Green sees the renewable target for 2020 and the emissions targets for 2020 and 2030 all met.

What are the targets?

- UK and EU legislation sets targets for renewable energy and emission of greenhouse gases. Renewables are governed by the 2009 Renewable Energy Directive which sets a target for the UK to achieve 15% of its energy consumption from renewable sources by 2020.
- The Climate Change Act of 2008 introduced a legally binding target to reduce greenhouse gas emissions by at least 80% below the 1990 baseline in 2050, with an interim target to reduce emissions by at least 34% in 2020. The Act also introduced 'carbon budgets', which set the trajectory to ensure the targets in the Act, are met.
- These budgets represent legally binding limits on the total amount of greenhouse gases that can be emitted in the UK for a given five-year period. The fourth carbon budget covers the period up to 2027 and should ensure that emissions will be reduced by around 60% by 2030.

**Case Studies** – In addition to the generation backgrounds for our main two scenarios, we have produced generation backgrounds for four case studies, designed to give alternative, plausible generation mix outcomes for both Gone Green and Slow Progression, and thus ensure a credible range of future transmission capacity requirements are considered. There are two case studies for both Slow Progression and Gone Green. The first Gone Green case study shows a high offshore wind case with the second study showing a high onshore wind scenario. Slow Progression has case studies which show firstly a high CCGT and low coal view with the second study showing an extended coal and low CCGT and biomass scenario. These are described in greater detail in section 2.5.

**Contracted Background** – This refers to all large generation projects that have a signed connection agreement with National Grid. Assumptions regarding generation closures have only been made where we have received notification of a reduction in Transmission Entry Capacity (TEC) or there is a known closure date driven by binding legislation such as the LCPD. The contracted background is only utilised in considering local reinforcement requirements, i.e whilst it's not anticipated that the full contracted background will progress to existing contract timescales, it not unreasonable to assume that the contracted generation in a local given area may connect.

The assessment of transmission reinforcements, discussed in the following chapters, will be decided upon based on a consideration of all of these scenarios. In addition to the main scenarios and case studies, sensitivities will be used to enrich the analysis for particular boundaries/region.

## 2.4

# Demand

This section describes the electricity demand assumptions for both of the scenarios.

### Demand Definitions

For the purposes of the ETYS demand is included at its assumed peak day level. The assessment of electricity network adequacy uses as a base the transmission system peak day demand as this is often the most onerous demand condition the transmission network needs to be able to accommodate and will therefore drive many of the required reinforcements. However, to determine whole year round conditions his demand is scaled as appropriate to give adequacy in the determination of demand security.

The ETYS Transmission Peak Demand is defined including losses, excluding station demand, exports and Demand Side Response (DSR)<sup>1</sup>. As no pumping demand at pumped storage stations is assumed to occur at peak times this is also therefore excluded. Small embedded generation is included as part of the assessment of transmission peak demand and our assumptions on this sector are included in section 2.12.

The electricity transmission peak day demand scenario projection is derived from detailed analysis on annual electricity consumption. The historic relationship between annual electricity consumption and transmission system peak demand is used to form the basis for future relationships between the annual and peak demands, taking into account how future changes may affect this relationship. Our annual electricity demand projections are derived using key drivers by sector, Domestic, Industrial and Commercial. Industrial and Commercial are assessed using econometric methods and Domestic on a bottom up basis.

The key drivers across all sectors are as follows and can be found in more detail in National Grid's 2014 Future Energy Scenarios document.

- Historic annual electricity consumption
- Economic background, including fuel price
- Energy efficiency measures

Peak demand projections for the Gone Green and Slow Progression scenarios against outturn and ACS peak demand are shown in Figure 2.1.

<sup>1</sup> Please note that other related documents may have different definitions of peak demand (e.g. National Grid's 'Winter Outlook Report', 'UK Future Energy Scenarios' and the 'Capacity Assessment' (demand definition details are included in each document). Therefore, care should be exercised when making comparisons between these demand scenarios.

Figure 2.1  
Transmission Peak Demand

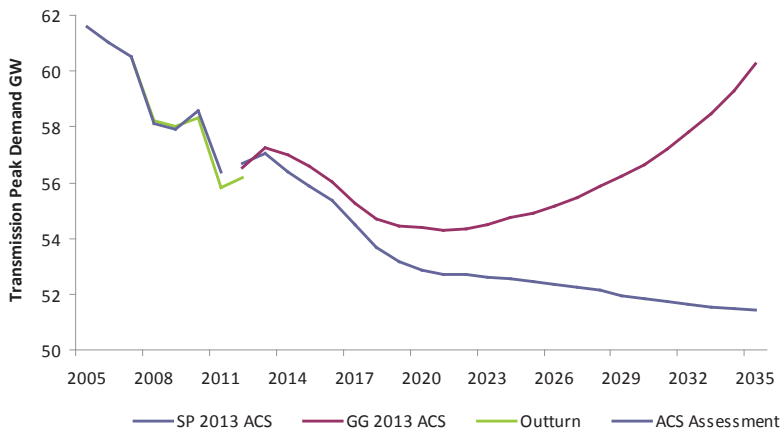

The trend of transmission demand decline over recent years is due to several factors, including the economic downturn and increasing levels of energy efficiency. Near term increases are expected in each scenario as the economy recovers.

In Slow Progression the long term trend is of falling end-users' peak demand, predominantly from industrial and commercial sectors as economic growth is slow. In this scenario, electric vehicles and heat pumps have minimal effects at peak and hence the declining demand in the later years of the scenario compared to Gone Green.

In Gone Green, as in Slow Progression, demand begins to fall on the back of higher levels of energy efficiency and embedded and micro generation. However this

occurs at a slower rate than Slow Progression due to the stronger economy. Demand increases towards 2030 due to continued growth in industrial demand, population and the electrification of heat and transport. The number of electric vehicles increases compared to Slow Progression; however, time-of-use tariffs limit peak charging in this scenario, adding around 1GW to peak towards 2030. Heat pumps limit the increase in peak demand up to the middle of the next decade as the saving from replacing existing resistive heating outweighs the increase from displacement of gas heating.

For the contracted background, the Gone Green demand profile has been applied.

Figure 2.2  
Reactive Power Demand

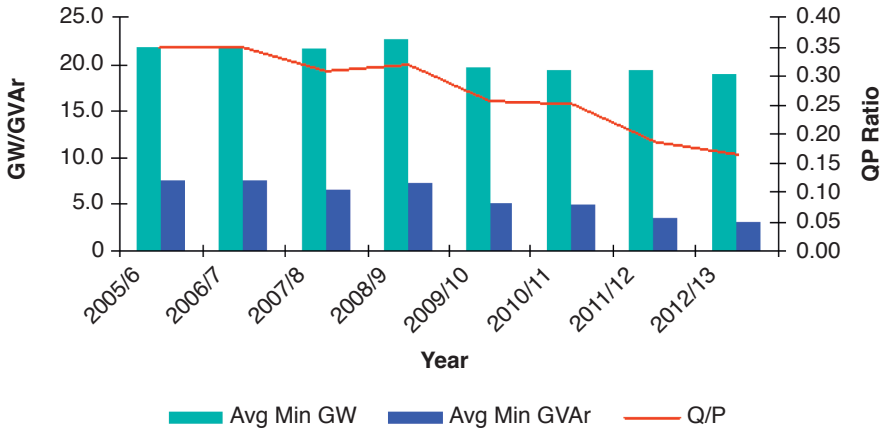

### Reactive Demand

In recent years the reactive demand, independently of the active power demand, has been falling. This can be seen in figure 2.2 above. It is emphasised by the Q/P ratio, which is the ratio of reactive power relative to the active power demand. The perceived reasons for this are associated with change in reactive consumption of many

household items as they become more energy efficient e.g. light bulbs. There is an assumption on consumer behaviour in both Gone Green and to lesser extent Slow Progression that energy efficient appliances become more prevalent. Therefore the anticipation is that this reactive demand will continue to reduce in the medium term in both Gone Green and Slow Progression scenarios.



This section provides some more detail for the generation capacity backgrounds for the scenarios and outlines the key changes over the period to 2035 in each of the cases. For the purposes of the ETYS and associated commentary the start of the analysis period is 2013/14 and the end of the period is 2035/36.

**Generation Capacity Definitions**

The values shown within this section are only for installed capacity that is classed as 'transmission capacity'. This is generally generation capacity that is classified as 'large'<sup>2</sup> Embedded generation not included in these values is accounted for in the assessment of transmission demand and detailed in section 2.9 of this chapter.

The above definition is important to note as the figures utilised within the E-TYS cannot be directly compared with values shown in UK Future Energy Scenarios which are for total capacity, including all embedded and micro-generation generation. For the purposes of the scenarios embedded and micro generation are netted off demand however appropriate allowance is made when determining optimum transmission capacity as discussed in Chapter 3. A section on our embedded generation capacity assumptions is included later in this chapter.

**Slow Progression 2013**

This scenario has a lower emphasis on renewable generation over the period driven by the assumption that the renewable targets will not be met within the 2020 timescales. The key messages for this scenario are shown below;

- Gas/CHP capacity increases over the period to 2020 by 1GW and to a total installed capacity of 44GW by 2035 showing a total increase over the period of 20GW.
- Growth in wind capacity is considerably less in this scenario in comparison to Gone Green and reaches 13GW by 2020 and 29GW by 2035 (21GW being offshore wind), showing a total increase over the full period of approximately 22GW (the vast majority of this falling into the offshore wind category).
- Other renewables excluding wind remain fairly static over the period showing only a 1GW increase.
- Coal capacity shows a slower decline than in the Gone Green scenario showing a 7GW decrease by 2020 leaving 14GW of coal capacity. By 2026 there is no remaining coal capacity on the system resulting in a total decrease to this point of just over 20GW.
- Nuclear capacity remains fairly static over the period showing only a 0.8GW increase out to 2035.

Figure 2.3 illustrates the capacity mix for Slow Progression;

*Figure 2.3  
Slow Progression*

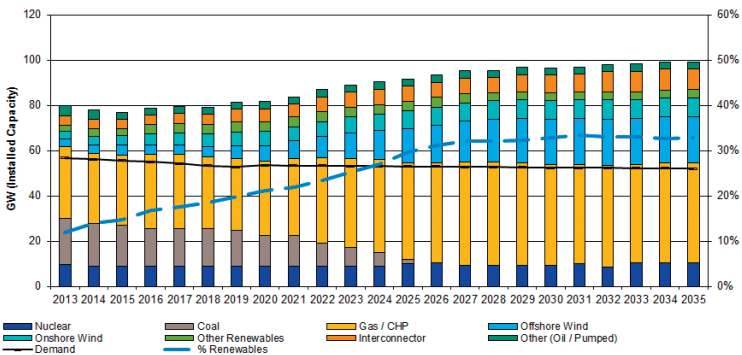

<sup>2</sup> <http://www.nationalgrid.com/uk/Electricity/GettingConnected/FAQs/Question+12.htm>

The level of renewables (as a percentage of installed capacity and not generation output) at the start of the period in this scenario is 12% which will rise to 21% in 2020 and finally increase to 33% in 2035.

#### Slow Progression Case Study 1: (High CCGT, Low Coal)

This case study shows higher levels CCGT capacity and also sees lower levels of coal capacity assuming that IED plant closes more quickly. The key messages for this case study are shown below;

- No Change to renewable generation from the 2013 Slow Progression scenario.
- 3GW less coal plant in 2020 than final Slow Progression and *all* existing coal plant is closed by 2025/26).
- 4.8GW increase in gas capacity compared to 2013 Slow Progression in 2020 and a 2.6GW increase by 2030 (*less of an increase later in the period due to a ramp up of CCGT plant in the Slow Progression final background anyway to fit axioms*).

Figure 2.4 illustrates the capacity mix for Slow Progressions Case Study 1;

Figure 2.4  
Slow Progression Case Study 1

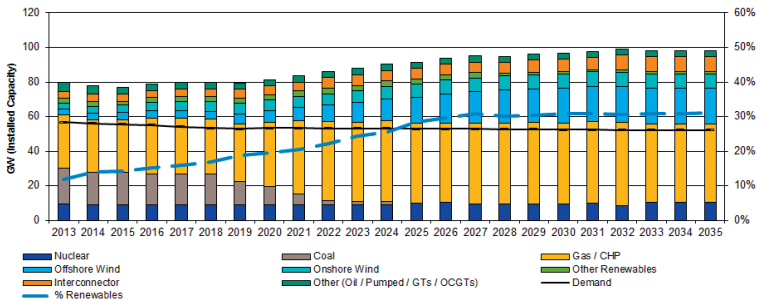

**Slow Progression Case Study 2: (High Coal, Low CCGT/Biomass)**

This case study sees the opposite effect to Slow Progression case study 1 showing less CCGT capacity and a higher coal capacity for longer which assumes that coal plant would retrofit Selective Catalytic Reduction (SCR) systems in order to stay connected thereby complying with IED legislation. The key messages for this case study are shown below;

- No Change to renewable generation from the 2013 Slow Progression scenario.
- 1.4GW increase in coal plant in 2020 over the 2013 Slow Progression figures and 5.9GW of coal still open in 2030 whereas all coal plant is shut in 2013 Slow Progression by 2026/27.
- No change in gas capacity by 2020 but a 1.9GW increase on final Slow Progression levels in 2030.

Figure 2.5 illustrates the capacity mix for Slow Progression Case Study 2;

*Figure 2.5*  
*Slow Progression Case Study 2*

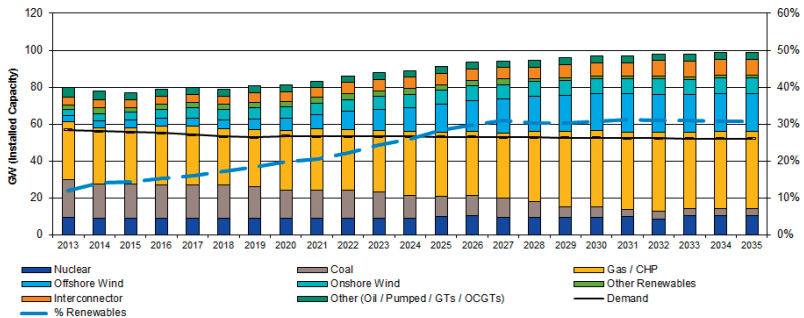

**Gone Green 2013**

As described in section 2.3 the Gone Green scenario assumes a generation mix that will meet the CO<sub>2</sub> and renewable targets. One key change from the 2012 scenarios is that the level of installed capacity for wind by 2020 has decreased by approximately 5GW. This decrease is driven by lower demand and the assumption that there will be an increased number of biomass conversions between now and 2020, therefore lowering the requirement for wind to meet targets. Other key messages from this generation background and how it develops over time are;

- Wind reaches approximately 20GW of capacity by 2020 (just over 11GW of this being offshore) and 51GW by 2035 (37GW of this being offshore).
- Other renewables excluding wind and including hydro, biomass and marine show an increase of 2.6GW (the vast majority of this being biomass conversions) to 2020 and 3.2GW over the full period to 2035.
- Gas/CHP increases over the period and peaks between 2025 and 2030 at 38GW, an increase of 7GW from the start of the analysis period. However from 2030 onwards Gas/CHP capacity decreases showing a total of 31GW in 2035. This decrease is due to the assumed closure of ageing plant with the introduction of CCS post 2030.
- Coal capacity decreases dramatically over the period to 2035, from a starting point of 20GW decreasing to 16GW by 2020 and to 2GW by 2035. This is due to closures through Large Combustion Plant Directive (LCPD) and Industrial Emissions Directive (IED) legislation.
- Carbon Capture & Storage (CCS) assumptions within this scenario show the introduction of this technology into the generation capacity mix from 2025 onwards with a total of 12GW of plant fitted with CCS by the end of the period, this includes Coal, Gas and Biomass CCS.

- Nuclear capacity remains at the same level to 2020 and increases by 2.4GW out to 2035.

Figure 2.6 illustrates the capacity mix for the Gone Green background over the study period.

*Figure 2.6  
Gone Green Capacity Mix*

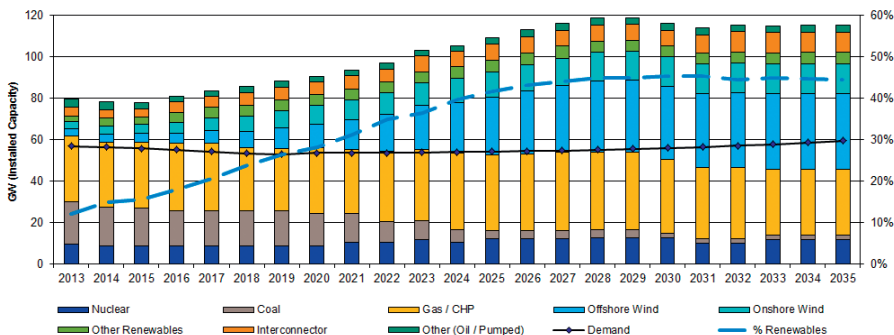

The level of renewables (as a percentage of installed capacity and not generation output) at the start of the period in this scenario is 12% which will rise to 28% in 2020 and finally increase to 44% in 2035.

**Gone Green Case Study 1: (High Offshore Wind)**

This case study has an emphasis on a high level of offshore wind which compensate for a more pessimistic outlook for onshore wind across the whole period, with lower levels of nuclear and CCS towards the end of the period to 2035. The key messages for this case study are shown below;

- Nuclear & CCS plant are generally delayed in this case study and have a slower build rate.
- All onshore wind that did not feature in the 2013 Gone Green background by 2016/17 and does not have consents was removed.
- The above resulted in a 2.6GW decrease in onshore wind levels by 2020 from the final Gone Green scenario and a 4.5GW decrease by 2030.
- Offshore wind levels are increased in this case study, this results in a 1.4GW increase on the 2013 Gone Green levels in 2020 and 7.1GW by 2030.

Figure 2.7 illustrates the capacity mix for Gone Green Case Study 1;

Figure 2.7  
Gone Green Case Study 1

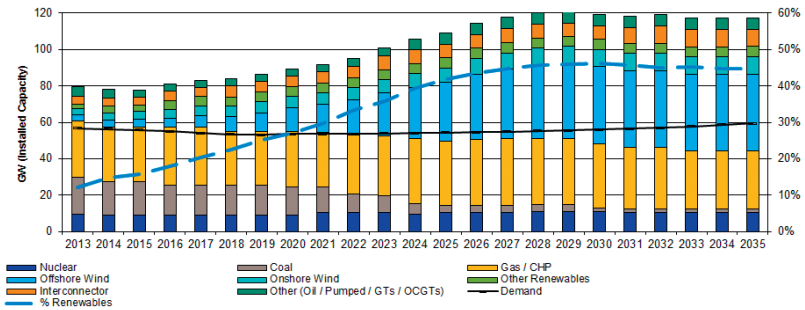

**Gone Green Case Study 2: (High Onshore Wind)**

As a contrast to the first Gone Green case study this iteration contains high onshore wind levels with lower levels of offshore wind, nuclear and CCS. The key messages for this case study are shown below;

- Nuclear & CCS plant are generally delayed in this case study and have a slower build rate.

- Onshore wind increases by 4.8GW on the levels shown in the 2013 Gone Green Background by 2020 and by 9GW in 2030.
- Offshore wind has decreased by 4.7GW in 2020 on Gone Green levels and by 4.9GW in 2030.

Figure 2.8 illustrates the capacity mix for Gone Green Case Study 2;

Figure 2.8  
Gone Green Case Study 2

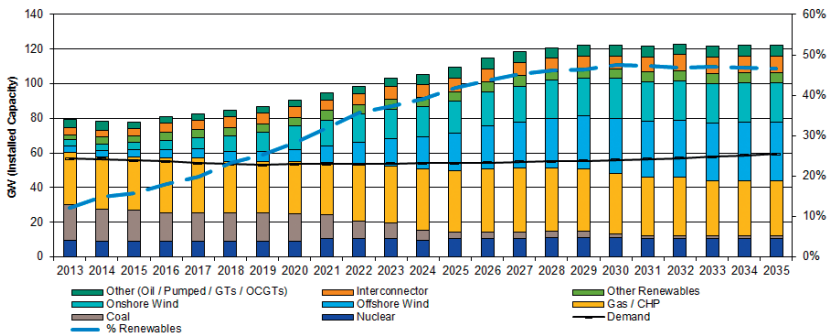

### Contracted Background

The dataset for the contracted background, shown in Figure 2.8, used in this document was taken at the end of May 2013, therefore it should be noted that there will have been updates to the contracted position since this point. For the most recent contracted background analysis please refer to the latest **Transmission Networks Quarterly Connections Update**. It should be noted that when analysing the contracted background the generation mix includes *all* projects that have a signed connection agreement and no assumptions are made about the likelihood of a project reaching completion.

Some of the key messages for the contracted background are;

- A large increase in contracted wind overall but especially offshore wind starting at 7.4GW rising to a total of 58GW of generation that currently has a signed connection agreement.
- A decrease in coal generation amounting to 2.5GW over the full period, this reflects known LCPD closures.
- A rise in nuclear generation capacity which currently has a signed connection agreement results in a total increase over the period to 2035 of 20GW.

Figure 2.9 illustrates the capacity mix for the contracted background;

*Figure 2.9*  
Contracted Background capacity Mix

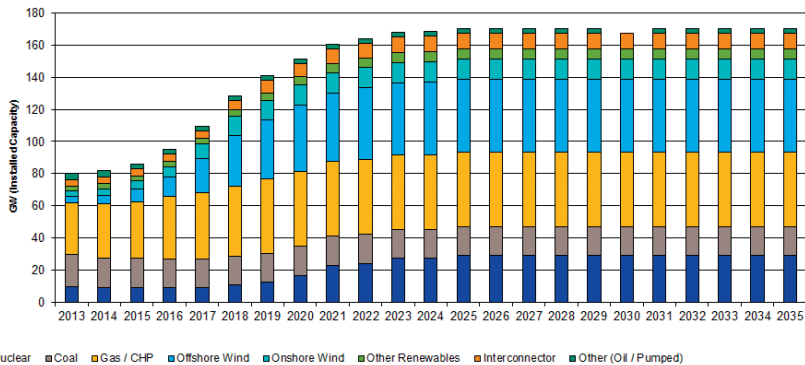

The generation shown in the contracted background is split into categories depending on the particular status of any given project. These categories are;

**Existing** – this is the level of generation capacity already built and commercially generating.

**Under Construction** – the level of generation capacity which is currently being built.

**Consents Approved** – generation projects that have obtained the relevant consents to proceed.

**Awaiting Consents** – these are generation projects that have applied for the relevant consents to proceed but are awaiting a decision.

**Scoping** – these are projects that have a signed connection agreement only but have not yet applied for any consents.

Figure 2.10  
Contracted Background Vs Existing Scenarios

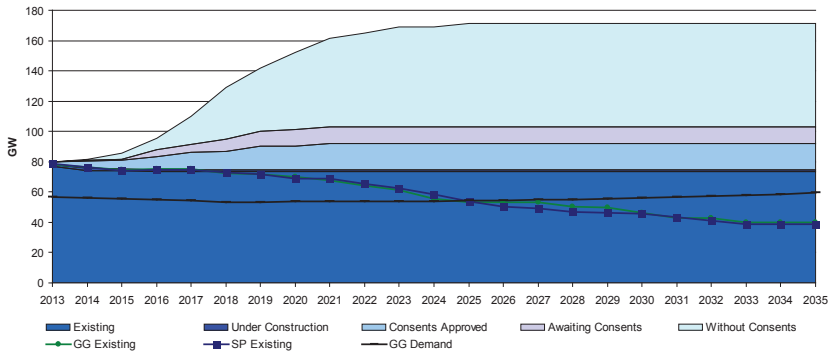

Figure 2.10 shows the level of 'existing' generation assumed in both of the energy scenarios which include assumptions on plant closures within each of the scenarios and highlights when new generation will be required under these scenarios. The graph also compares the scenario data against the contracted background which is split into various status fields as described above.



## 2.6 Plant Margins

---

Plant margin is a key area and brings together the information on demand projections and future generation capacity. Plant margin is defined as the amount of generation capacity available over and above the level of peak demand.

For a detailed view of plant margin calculations please refer to the Future Energy Scenarios document, Section 4.2.4, Figures 38 & 39. As can be seen from this reference there are different ways of calculating plant margin and the figures below are based on the spot de-rated basis which are explained in the Future Energy Scenarios document.

The key points regarding plant margins for the 2013 scenarios are as follows:

- plant margin declines in both Gone Green and Slow Progression from current levels out to 2015/16 due to:
  - mothballing of existing plant
  - recent announcements regarding Transmission Entry Capacity (TEC) reductions
  - closure of plant due to LCPD legislation
  - limited connection of new installed capacity over the next few years
- between 2016/17 and 2020/21 in both scenarios margins start to show an upward trend due to an expectation of greater build capacity reaching a high of 4.1% for Slow Progression and 6.5% for Gone Green in 2020/21, on the spot de-rated basis.

# 2.7 Renewables

One of the key elements for both Gone Green and Slow Progression is the level of renewable generation assumed, both from a network development perspective and an operational perspective.

This section discusses in more detail four of the key transmission renewable generation types. Other renewable generation types that connect principally to the distribution networks are discussed later in this chapter.

- Offshore Wind
- Onshore Wind
- Marine
- Biomass

The analysis shown in Figure 2.11 includes offshore wind, onshore wind, biomass (excluding conversions), hydro and marine generation comparing the contracted background against the scenario backgrounds.

*Figure 2.11  
Renewables contracted background by stage*

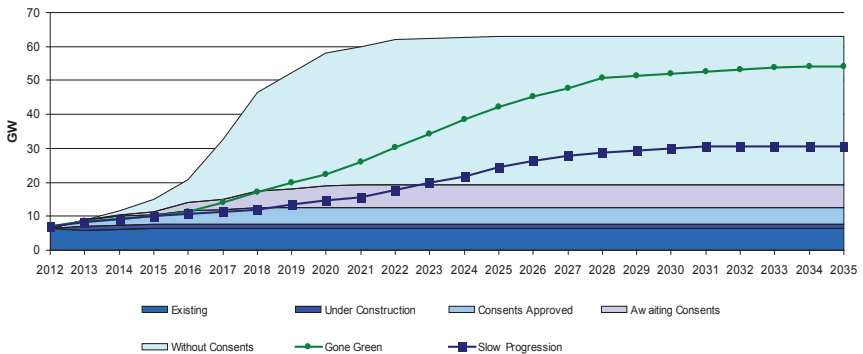

Figure 2.10 shows there is an existing level of around 9GW of renewable generating capacity, with the Gone Green scenario renewable capacity level in 2020 at approximately 22GW. Therefore if the Gone Green scenario is to be met then a further 13GW of renewable generation (out of a total 45GW of renewable contracted future generation with completion dates before 2020), will need to connect to the transmission system by 2020.

Slow Progression shows a level of 15GW of renewable generation capacity connected to the transmission system by 2020, showing an increase of 6GW from the start of the period.

In summary renewable generation plays a large part in all of the scenarios over the period to 2035 and there is enough contracted generation capacity to meet the levels

required under the Slow Progression and Gone Green scenarios, however the majority of these generation projects are without consents or in the scoping phase of development and it is possible that not all of these generation projects may proceed to completion.

### Offshore Wind

Offshore wind has the potential to have a significant impact on the future development of the transmission network and particularly in Gone Green; it plays a significant role in the future energy mix.

Figure 2.12 shows the current contracted position for offshore wind against the requirement for offshore wind generation in the scenarios over the period to 2035.

*Figure 2.12*  
*Offshore Wind Contracted Vs Scenarios*

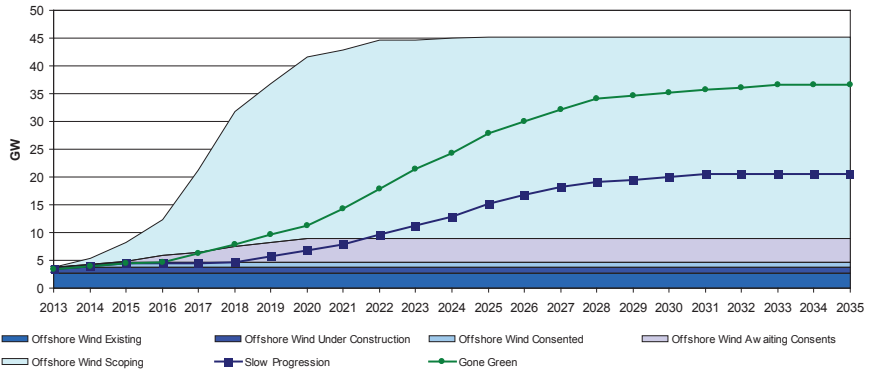

In the Gone Green scenario there is 11GW of offshore wind in 2020. The current level of offshore generation capacity that is either existing or under construction is 4GW, therefore leaving a total of 7GW (of the 42GW that is contracted with a signed connection agreement and completion date before 2020) to be connected to the transmission system by this point. By the end of the period the Gone Green scenario shows an offshore wind generating capacity of 37GW.

There is a large amount of capacity that is in the scoping phase of project development which by definition indicates that at this stage consents have neither been granted or applied for which, based on historical observations, indicates that there is the possibility that some of these generation projects may not progress to completion.

Slow Progression shows that the level of offshore wind in 2020 is 7GW. As mentioned above, 4GW of this generation capacity is either already connected to the transmission system or will be by 2020 and there is enough generation that has either applied for or obtained consents to provide the additional 3GW in this scenario.

#### Onshore Wind

Figure 2.13 shows the current contracted position for onshore wind against the assumption for onshore wind generation under each of the scenarios over the period to 2035.

Figure 2.13  
Onshore Wind Contracted Vs Scenarios

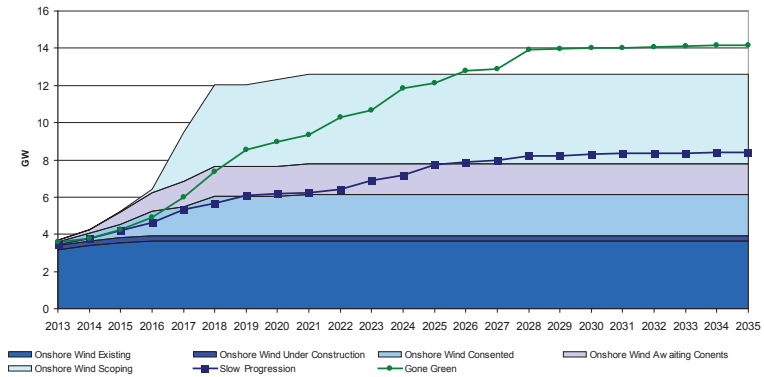

In the Gone Green scenario the level of onshore wind required in 2020 is 9GW. The level of onshore wind generation capacity that is either currently existing or under construction and due to connect to the system before 2020 is 4GW. This therefore leaves a total of 5GW (of the 9GW that is contracted with a signed connection agreement and completion date before 2020) to be connected to the transmission system by this point. By the end of the period the Gone Green scenario shows an onshore wind generating capacity of 14GW.

Slow Progression shows that the level of onshore wind in this scenario at 2020 is 6GW. As mentioned above 4GW of this generation capacity is either already connected

to the transmission system or will be by 2020 and there is currently sufficient generation with the relevant consents to provide the additional 2GW. By the end of the period onshore wind in Slow Progression has increased to a level of 8GW.

#### Marine

Figure 2.14 shows the current contracted position for marine (wave and tidal) against the requirement for marine generation under the scenarios over the period to 2035.

**Figure 2.14**  
*Marine Contracted Vs Scenarios*

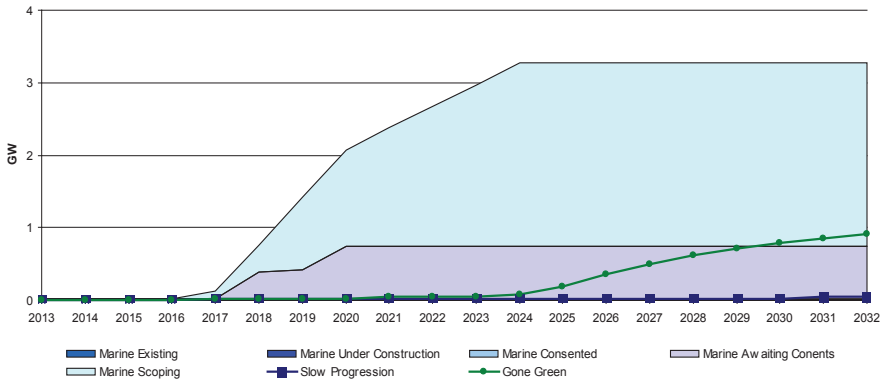

In the Gone Green scenario the level of marine generation capacity required in 2020 is a nominal 20MW. The current level of marine generation capacity that is under construction is 10MW, therefore leaving a total of 10MW (of the 2.1GW that is contracted with a signed connection agreement and completion date before 2020) to be connected to the transmission system by this point. By the end of the period the Gone Green scenario shows a marine generating capacity of around 1.2GW.

In Slow Progression, marine is assumed to develop very slowly due to high costs, with minimal deployment by 2035.

Apart from the 10MW of capacity under construction all marine generation is currently in the scoping phase.

### Biomass

Figure 2.15 shows the current contracted position for biomass capacity generation against the requirement for biomass generation (excluding assumed conversions) under each scenario over the period to 2035.

Figure 2.15  
Biomass Contracted Vs Scenarios

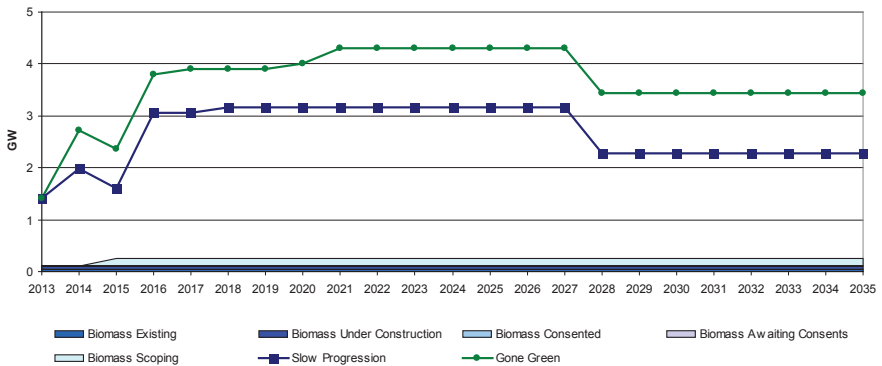

As a contrast and change in underlying assumptions for biomass the Gone Green 2013 scenario include a fairly large amount of biomass conversions by previously dedicated coal or gas plant. This is the reason that Figure 2.15 shows such a high level of biomass required in the scenarios against what is contracted as the conversions are shown in the contracted backgrounds as either coal or gas.

Also as described in the offshore wind section of this chapter it is assumed that there will be a greater level of biomass in 2020 which counteracts against the decreased levels of offshore wind capacity.

Under the Gone Green scenario the level of biomass generation capacity required in 2020 including conversions is 4.3GW. The current level of biomass generation capacity that is either existing or under construction is 1.4GW therefore leaving a total of approximately 2.9GW to be converted by 2020.

In the Slow Progression scenario there is a limited level of biomass growth, with biomass levels reaching 3.2GW in 2020.

## 2.8

# Interconnectors

---

Within the Future Energy Scenarios there are different levels of external interconnection assumed over the period, as described below;

- Slow Progression – approximately 5.2GW of interconnection is assumed at 2020 which increases to a level of 8.6GW in 2035. Broadly consistent with Enstoe vision 1.
- Gone Green – in 2020 external interconnection is assumed to be 6.2GW which rises to a total of 9.6GW in 2035. Broadly consistent with NTSO-e vision 3.

Further information on specific interconnector projects can be found in Chapter 3.



This section describes the small or medium embedded and micro generation capacity mix for the scenarios as the analysis so far in this chapter has focused only on transmission connected or large embedded generation capacity.

In order to meet 2020 renewable targets there is a need for an increased proportion of renewables in the generation mix. In England and Wales, small/medium embedded generation will generally consist of projects that are under 100MW capacity in total. In Scottish Power's transmission area (South Scotland) the small threshold falls to 30MW and in Scottish Hydro's transmission area (North Scotland) it is 10MW.

### Slow Progression

Figure 2.16 shows the embedded and micro generation capacity mix for Slow Progression out to 2035. The levels overall increase over the period by just under 10GW with the largest increases seen in Solar PV and Wind showing increases of 6GW and 3GW respectively over the full period.

Figure 2.16  
Slow Progression Embedded/Micro Generation

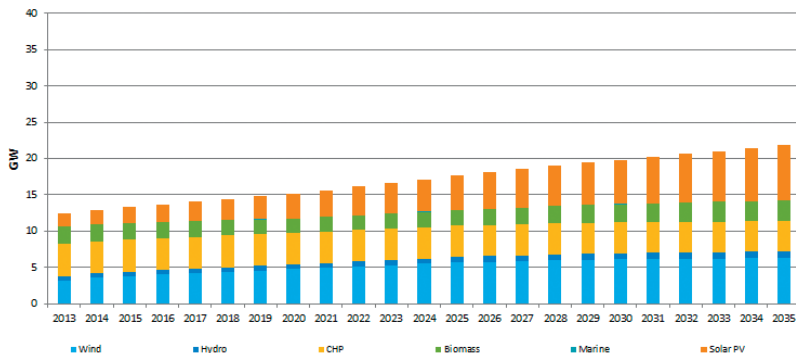

### Gone Green

Figure 2.17 shows the small/medium embedded and micro generation capacity mix for Gone Green which shows more robust levels of growth than Slow Progression which is underpinned by scenario assumptions such as higher carbon prices as well as some technology improvements. Some key messages for this embedded generation scenario are shown below:

- Solar PV shows the largest increase in capacity over the period to 2035, showing a steady increase between 2013 and 2020 from 2GW to 7GW, followed by a steep increase out to the end of the period resulting in a total installed capacity by 2035 of 20GW.
- Wind shows the next largest increase over the period seeing a total increase of approximately 5GW. The vast majority of small/medium embedded wind will continue to be onshore due to the proposed size of the installations.
- Hydro shows a small overall growth over the period resulting in a total increase of 760MW, continuing current installation rates.
- CHP increases modestly over the period to 2035 resulting in a total increase of 690MW on current levels.
- Embedded biomass increases steadily over the period resulting in a 1GW total increase in generation capacity.

Figure 2.17  
Gone Green Small/Medium Embedded/Micro Generation

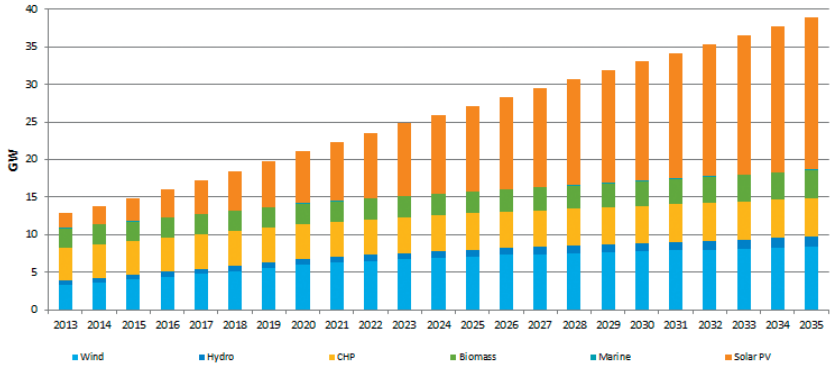

## 2.10

## Application of the Future Energy Scenarios

The earlier section of this chapter discussed the content of the scenarios at a high level, giving summaries in terms of the types, size and timing of generation and level of background demand. To perform network analysis the scenario data must be applied to NETS network models so its performance can be assessed. The FES generation backgrounds are created at an individual generator unit level and demand by zone. The assumptions regarding connection timescales for future plant within the scenarios is carried out against a list of criteria which includes consenting milestones, contractual connection dates and up to date market intelligence gleaned through our stakeholder engagement programme, journals and press releases.

### Ranking Order

Once the generation backgrounds are finalised units are then arranged in order of their perceived likelihood of operation and a ranking order is created, for each scenario. For existing generation this is achieved by inspection of the unit operation experienced over the previous two winter periods, which is taken as being from the beginning of December to the end of January. For future plant the generation is ordered according to fuel type with low carbon plant assumed to be more likely to operate as baseload and new thermal plant higher in the ranking order than existing thermal generation as it is likely to be more efficient. The ranking order used to determine the operation of future plant is shown in table 2.1.

*Table 2.1*  
*Ranking Order*

Rank	Fuel Type
1	Offshore Wind
2	Tidal / Wave
3	Hydro Tranche 1
4	New nuclear
5	Hydro Tranche 2
6	Onshore Wind
7	Hydro Tranche 3
8	Existing nuclear
9	New Coal and Gas with CCS
10	Biomass
11	New Gas
12	Existing plant as per operation calculation & Hydro Tranche 4
13	Pumped Storage
14	GTs

The methodology described for ordering of plant in terms of operation is a general rule and is applied in a pragmatic way and is supported by judgement and market intelligence. For example a plant may have achieved a low ranking based on the previous winter's operational data but it may be recognised that this was due to a unique set of circumstances that are unlikely to be repeated in the future i.e. this particular plant may have been mothballed but market intelligence suggests that it will be returning for future years.

### NETS SQSS

The NETS SQSS standard specifies the output level that should be applied for each generator type for planning the future system requirements. For example, the SQSS Chapter 4 economy standards suggests that at winter peak, wind farm output should be considered at 70% of Capacity, nuclear power stations at 85% and most other thermal plant variably scaled according to the remaining plant margin. Application of the NETS SQSS economy standards allow initial inspection of where a transmission solution may be economic to develop and utilises the ranking order as an initial base, as described above. These transmission requirements are shown in detail for the transmission system in Chapter 3.

### Case Studies and Sensitivities

For each of the Gone Green and Slow Progression scenarios and case studies, continental European interconnector flows have been considered from full import to full export. In addition to these, consideration has been given to the contracted background for the local boundaries. In all, 19 scenario variations have been considered in England and Wales for assessing the NETS in terms of boundary requirements.

## 2.11

# Operational Cost Assessment Inputs

### 2.11.1 Introduction

Operational cost assessment forms one of our key inputs to the transmission investment decision making process, when assessing wider works. The fundamental trade-off is between the risk of undertaking an investment too early and the risk of congestion costs because network capacity has been added too late. The optimum combination of transmission solutions for each of the demand and generation scenarios and sensitivities needs to be established. This will be achieved with the application of detailed cost benefit analysis.

The Electricity Scenario Illustrator (ELSI) is a key tool used to simulate the operation of generation and storage resources to meet consumer requirements. Its output, the forecast costs of network constraints, form a key input to the Cost Benefit Analysis of the NDP. The constraint costs are a key part of the full Cost Benefit Analysis, utilised to determine the optimal course of action for the next year considering all of the Future Energy Scenarios discussed above.

The ELSI model was developed by National Grid to model future constraints on the GB system. It was released to industry to support the stakeholder engagement process for the purposes of our RIIO-T1 submission. Our stakeholders have been presented with the tool and associated information to allow them to perform their own analysis on the possible development of wider works.

The model is a simplification of a complex analysis tool with several limitations on constraint forecasting. There is a user guide and an early version of the program available at the following location – <http://www.talkingnetworkstx.com/consultation-and-engagement.aspx>

The ELSI tool uses various inputs as shown below, in figure 2.18, and later in this section many of these inputs are discussed in more detail.

*Figure 2.18*  
*ELSI Tool Inputs*

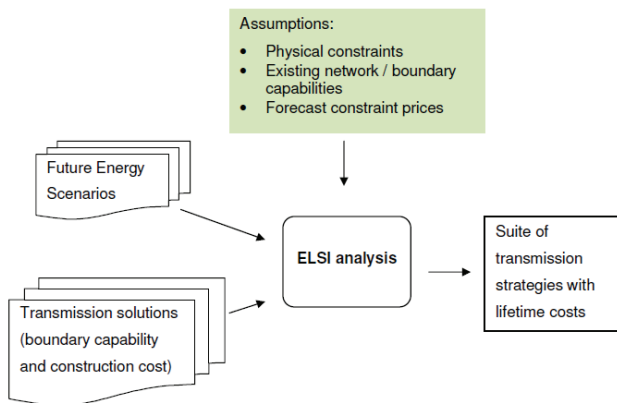

The model requires, as inputs, existing boundary capabilities and their future development. The capabilities are calculated in a separate power system analysis package and neither their dependence on generation and demand nor the power sharing across circuits is modelled in ELSI.

All of the option reinforcements are assessed against each one of the Future Energy Scenarios, discussed in the previous sections of Chapter 2.

ELSI uses the detailed Future Energy Scenarios to complete this analysis out to 2033.

In order to estimate full lifetime costs the values from 2033 are duplicated to give 45 years of data. Lifetime cost analysis will be undertaken against various different transmission strategies, combinations and timings of transmission solutions, until the optimum cost benefit is found for each of the scenarios and sensitivities.

The first stage of this process involves the application of engineering judgement to combinations and timings of transmission solutions based on the capability deficits calculated through the application of the security standards and the capabilities delivered by each of the

transmission solutions. The results from this first stage allow finer adjustments in choice and timing to be made to finalise the selected strategy.

#### 2.11.2 Generation modelling assumptions in ELSI

A key input assumption within ELSI is the availability factors of all generation types and the load factor derivation of wind. In table 2.2 below we have shown the availability factors of the generation types within ELSI. These are the factors that have been used for transmission planning.

*Table 2.2  
Generation Availability Assumptions*

Fuel Type	Fuel Grouping	Winter Availability	Spring Availability	Summer Availability	Autumn Availability
Hydro	Renewables	75%	50%	25%	50%
Offshore Wind	Renewables	100%	100%	100%	100%
Onshore Wind	Renewables	100%	100%	100%	100%
Wave and Tidal	Renewables	100%	100%	100%	100%
Nuclear	Nuclear	70%	60%	50%	60%
Nuclear New	Nuclear	80%	75%	70%	75%
Biomass	Renewables	80%	75%	70%	75%
CHP	Gas	80%	75%	70%	75%
CHP New	Gas	80%	75%	70%	75%
CCGT CCS	Gas	80%	75%	70%	75%
Clean Coal CCS	Coal	80%	75%	70%	75%
Gas Other	Gas	80%	75%	70%	75%
Base Gas	Gas	80%	75%	70%	75%
Mid Gas	Gas	80%	75%	70%	75%
Marg Gas	Gas	80%	75%	70%	75%
Interconnectors	Interconnector	95%	95%	95%	95%
Base Coal	Coal	80%	75%	70%	75%
Mid Coal	Coal	80%	75%	70%	75%
Marg Coal	Coal	80%	75%	70%	75%
Pump Storage Gen	Pump Storage	95%	80%	70%	80%
Pump Storage Pump	Pump Storage	95%	80%	70%	80%
Oil	Peaking plant	90%	80%	70%	80%
CCGT	Peaking plant	100%	100%	100%	100%

### Stakeholder Engagement

We would very much appreciate the views of the industry on the availability assumptions of these generation types to further enhance our constraint modelling analysis.

With respect to the development of a merit order of generation, ELSI uses a layered model approach – a model where classifications of generators have marginal costs based on observed industry behaviours. This is to say that the fuel types above, although they may have the same availability factors, they will have different marginal costs affecting the merit order of the plant.

### Treatment of interconnectors

In undertaking the cost benefit analysis in ELSI, interconnectors are treated via an entry in the merit order, each with two prices quoted. If the GB system price is below the lower price, then it is assumed that the links export power, i.e the receiving country takes advantage of low power prices in GB. Between the lower and upper price, there is assumed to be no power flow (i.e the interconnectors are at float). If the GB system price is above the upper price, the interconnectors import power, i.e the GB benefits from lower power prices abroad. In reality, this treatment is somewhat idealised. We will consider more detailed models of these flows in future developments of ELSI.

We are developing an improved ELSI model to include North Western Europe, in order to better model future Interconnector flows. This work is being carried out in support of our role in the ENTSO-E.

Including utilising the European scenarios developed by ENTSO-E (which are subject to the ENTSO-E stakeholder engagement process) to inform how these interconnectors should be modelled when considering the GB network requirements.

### Wind Modelling in ELSI

Wind output is represented by sampling (Monte Carlo) 10 yrs of historic daily wind speed data gathered from Pöyry data sets. The wind data is for four discrete regions Scotland; England & Wales onshore; offshore east and offshore west & south as depicted in the diagram, figure 2.19. The model is based on historical wind output and will therefore give a seasonal variation. In this year's scenarios given the development of connections in Ireland it has been necessary to assume that the wind outputs in this area are analogous to that of Scotland. Therefore this generation has been linked to the Scottish wind region.

### Stakeholder Engagement

We would welcome engagement on the modelling of wind and future interconnector flow assumptions.



Figure 2.19  
ELSI Wind modelling regions

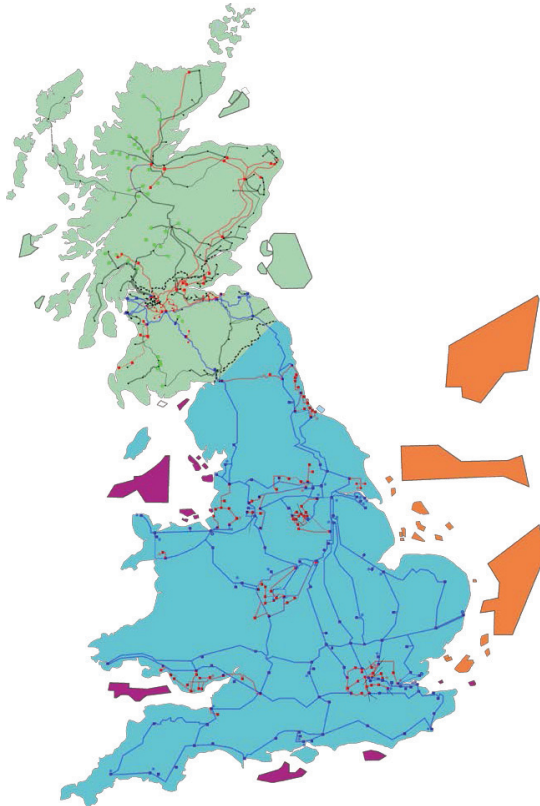

#### Constrain management option costs

In seeking to deliver the optimum investment at the correct time we are seeking to balance investment cost, with operational cost that taking account of those costs that we would occur if investment did not take place, i.e investment costs versus the operational

costs. To allow us to undertake this assessment we need to first calculate constraint volume and then determine costs. The table below is utilised in converting constraint volumes into costs.

Bid/Offer Prices in the BETTA Balancing Mechanism (BM).

The total constraint cost used to solve a transmission congestion issue is associated with a Bid and Offer components within the BM.

The bid is a volume of energy at a £/MWh to reduce generation in an area and the offer is the associated £/MWh to replace the energy, in another area of the system.

The bid prices are technology dependant and are shown for Gone Green (and its case studies) in table 2.3, and for Slow Progression (and its case studies), in table 2.4.

**Table 2.3**  
*Generation Constraint Price Assumptions for Gone Green*

Fuel Type	Fuel Grouping	Bid Prices
Hydro	Renewables	-1xROC
Offshore Wind	Renewables	-2xROC
Onshore Wind	Renewables	-1xROC
Wave and Tidal	Renewables	-1xROC
Nuclear	Nuclear	£0/MWh
Nuclear New	Nuclear	£0/MWh
Biomass	Renewables	£15/MWh
CHP	Gas	£18.22/MWh
CHP New	Gas	£18.22/MWh
CCGT CCS	Gas	£26.89/MWh
Clean Coal CCS	Coal	£21.07/MWh
Gas Other	Gas	£28.27/MWh
Base Gas	Gas	£30.94/MWh
Mid Gas	Gas	£32.80/MWh
Marginal Gas	Gas	£34.89/MWh
Base Coal	Coal	£32.35/MWh
Mid Coal	Coal	£33.80/MWh
Marginal Coal	Coal	£35.95/MWh
Oil	Peaking plant	£78.08/MWh
OCGT	Peaking plant	£102.70/MWh

**Table 2.4**  
*Generation Constraint Prices Assumptions for Slow Progression*

Fuel Type	Fuel Grouping	Bid Prices
Hydro	Renewables	-1xROC
Offshore Wind	Renewables	-2xROC
Onshore Wind	Renewables	-1xROC
Wave and Tidal	Renewables	-1xROC
Nuclear	Nuclear	£0/MWh
Nuclear New	Nuclear	£0/MWh
Biomass	Renewables	£15/MWh
CHP	Gas	£17.43/MWh
CHP New	Gas	£17.43/MWh
CCGT CCS	Gas	£26.89/MWh
Clean Coal CCS	Coal	£21.07/MWh
Gas Other	Gas	£27.05/MWh
Base Gas	Gas	£29.60/MWh
Mid Gas	Gas	£31.37/MWh
Marginal Gas	Gas	£33.38/MWh
Base Coal	Coal	£29.02/MWh
Mid Coal	Coal	£30.32/MWh
Marginal Coal	Coal	£32.24/MWh
Oil	Peaking plant	£75.49/MWh
OCGT	Peaking plant	£99.68/MWh

In areas where there is no generation available to constrain on or off, the only option is to turn down demand; we have assumed the following for a system Value of Lost Load £4000/MWh approximately equal to GDP per unit of electricity consumed.

## 2.12

# Stakeholder Engagement Summary

---

In this chapter we presented the inputs utilised in determining future transmission capacity, these were as of follows; the Future Energy Scenarios and the constraint modelling assumptions. We intend to engage further in these areas via discussions/workshop to discuss in more detail, but if you wish to discuss these prior to the workshop then please contact us via: [transmission.etys@nationalgrid.com](mailto:transmission.etys@nationalgrid.com)

### Stakeholder Engagement

We would very much appreciate the views of the industry on the availability assumptions of these generation types to further enhance our constraint modelling analysis.

### Stakeholder Engagement

We would welcome engagement on the modelling of wind and future interconnector flow assumptions.

---

# Chapter Three

## Network Capability and Requirements

---



# 3.1

## Introduction

This chapter provides detail of the existing National Electricity Transmission System (NETS), its power transmission capabilities and an indication of future system requirements.

In assessing and future requirements, it needs to be considered that there is presently over 100GW of signed contracts for new generation to connect to the NETS. It is unlikely that all this generation will connect, and it will certainly not all connect within the current contracted timescales. There are also significant uncertainties on when existing generation will close. Given this uncertainty we utilise the Future Energy Scenarios discussed in Chapter 2 to determine credible ranges of future transmission requirements.

To provide clarity and transparency on future network requirements, we have represented the NETS capabilities and power transfer requirements using the concept of system boundaries. The transmission system is split by boundaries that cross key power flow paths where it is anticipated additional transmission capacity may be required<sup>1</sup>. The requirements are derived from the application of the NETS SQSS.

The characteristics of each boundary are described in this Chapter. Where appropriate, to describe the characteristics of a given region, a number of interactive boundaries have been grouped together, to allow the reader to easily understand the total requirement within that given region.

Under a fully contracted position, there would be little to no opportunity for further generation development in many of the regions. However, by presenting an estimate of the future requirements of the boundaries against the FES, together with the current system capabilities and opportunities from Chapter 4, judgment can be made to the ease of future connections. This should provide the user with a more realistic assessment of potential future connection options in a given region. A mapping of system areas to affected boundaries is provided in this chapter to aid in interpreting the boundary sections and plots.

In addition to managing the NETS in terms of boundary power flows, other electrical characteristics such as fault levels and power quality/harmonics which can impact customer connections are also provided in this chapter. While specific information suitable for detailed technical settings related to individual connection points is outside the scope of this document an overview of the issues and related indicative data is provided.

Offshore transmission is forming an increasingly integral part of the NETS and this chapter provides an overview of the offshore transmission developments and the potential for future growth. In later chapters, we discuss the potential benefits of developing an integrated network solution which takes requirements of both onshore and offshore users into account in developing the overall economic and efficient solution.

It is also recognised that the growing interconnection capacity with neighbouring European countries provides opportunities and challenge for the NETS<sup>2</sup>, both in terms of planning and operating the transmission system. Details of prospective interconnection projects are provided later in this chapter. Their impact on the NETS is reflected in the boundary commentary and the impact on operating the transmission system is discussed in Chapter 5.

<sup>1</sup> It should be noted that these boundaries will be reviewed annually and updated as appropriate.

<sup>2</sup> [www.entsoe.eu/major-projects/ten-year-network-development-plan/tyndp-2012/](http://www.entsoe.eu/major-projects/ten-year-network-development-plan/tyndp-2012/)

## 3.2

# Background

---

The NETS consists predominantly of 400kV, 275kV and 132kV assets connecting separately owned generation and distribution systems. In Scotland, along with all offshore assets at 132 kV or above are classed as transmission. In comparison, assets at 275kV or above in England and Wales are classed as transmission. The transmission network in Scotland is owned by two separate transmission companies and the offshore transmission systems are also separately owned. National Grid owns the transmission network in England and Wales and is system operator for the NETS.

Presently there are 8 licensed Offshore Transmission Owners (OFTOs) that have been appointed through the transitional tendering process. The licensed OFTOs connect operational offshore wind farms that obtained Crown Estate seabed leases from allocation rounds 1 and 2. Further OFTO appointments will be through the enduring tender process.

Assets at lower voltage levels are part of the six regional distribution companies supplying customers down to domestic level.

The generators and interconnectors are separately owned and operated. The NETS peak demand is approximately 60GW during winter and operates with a generation plant margin as defined in Chapter 2.

Transmission connected generation is dispersed across the country, with large groups of generation clustered around fuel sources such as coal mines, oil and gas terminals, transport corridors and sea access.

With the expected growth in nuclear power and wind as primary sources of energy, generation is moving towards the periphery of the system, away from the demand centres. This results in a requirement to move power over longer distances. Wind power is predominantly being developed to the north and east of the system, particularly within Scotland. This gives rise to increased power transfers from North to South, triggering associated reinforcement requirements.

To manage this challenge we have developed a flexible approach in developing future transmission capacity which allows us to respond to future requirements, whilst minimising the risk of asset stranding.

In dealing with the uncertainty in location and timing of future generation, the NETSO and Transmission Owners (TOs) deal with this uncertainty by considering a number of credible future scenarios, case studies and in areas of the system where the risk is pertinent, a contracted based background. This is described in Chapter 2. From the scenarios a range of system actions and reinforcement options emerge upon which an assessment of the most appropriate options and associated risks are made. These are described in Chapter 4.

Fault level information, including both an explanation of how it is calculated and the fault levels calculated for the most onerous system conditions at the time of peak winter demand, can be found in Appendix D.



## 3.3

## Offshore Transmission

In order to support the connection of new offshore generators, DECC and Ofgem developed a new offshore regulatory regime to offer competitive tender for the development of new offshore transmission. Launched in 2009, the new regime was organised in two parts for tendering, a transitional part for projects already built or in construction, and an enduring part for future projects. Details of the offshore regime are available on the Ofgem website<sup>3</sup>.

With more than 30GW of offshore generation presently being developed; there is a potential associated need for large scale offshore transmission capacity. The offshore transmission is developed as part of the generation connection between the generator developer, OFTO (if appointed), distribution company (if used), the affected onshore Transmission Owner and National Grid as NETSO. During development of offshore transmission a Connection Infrastructure Options Note (CION) is used to record the different options considered to form the connection offer.

The CION process was initially established to facilitate the coordination of design activities between TO's in the case that a developer was located such that connection to different TO owned networks was possible. With the arrival of offshore generation the CION process was adapted to facilitate the optioneering and coordination of design of connections of offshore developments to the onshore transmission network. Through the CION process different connection options are evaluated between all affected TO's and the NETSO and agreement reached on the most efficient option. This process also aims to help identify and facilitate coordination of offshore connections, should there be additional developments in a similar location and there is a potential benefit to be realised.

The CION document can be complex, involving the analysis of a number of different connection options. We are currently undertaking a review of the CION process to ensure we meet the needs of developers, TO's and the NETSO. This review will cover the level of optioneering that is conducted in the pre and post connection offer stages. We are engaging with stakeholders to ensure their views are taken into account.

The System Operator Transmission Owner Code (STC) contains a Procedure detailing the assessment and subsequent provision of a connection offer (STCP18-1). We are aware that the existing STCP18-1 process is not as efficient or clear as it could be in setting obligations for the parties involved. We will be seeking stakeholder views to improve this document. Particular areas of concern

are timescales for communication, data exchange and the clarity of the CION process. Additionally a sub group of the Joint Planning Committee of all the Transmission Operators facilitates interaction on such issues.

The exchange of technical data in a timely manner has been a recurrent issue and obligations could be clarified. One issue is the sharing of full technical details of all generators with offshore developers when analysis of sub-synchronous resonance or control system interaction. The NETSO will be consulting with the industry in order to agree a change to the Grid Code such that provision of such models may be facilitated more readily in the future.

**Figure 3.1**  
*Seabed Lease Zones*

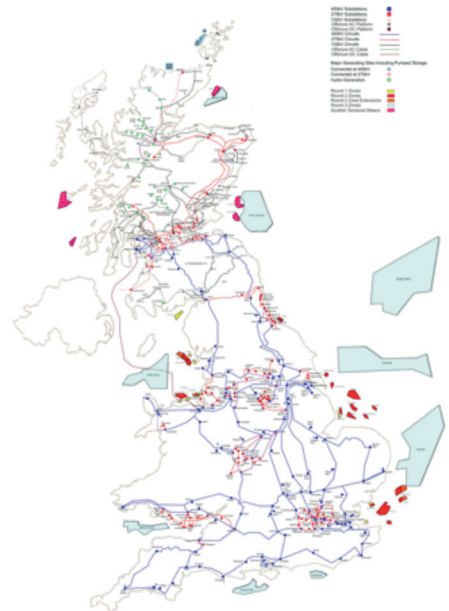

### Stakeholder Engagement

Your views on the representation of offshore and onshore connections are welcome.

<sup>3</sup> [www.ofgem.gov.uk/publications-and-updates/encouraging-investment-offshore-wind](http://www.ofgem.gov.uk/publications-and-updates/encouraging-investment-offshore-wind)



## 3.4 European Interconnection

Increased interconnectivity between European Member States will play a role in the security of the system, facilitating competition and supporting the efficient integration of renewable generation.

### Current and planned interconnection

1. There are four existing interconnectors between GB and other markets:
  - a. **IFA** (1986) – 2000MW interconnector between France and GB jointly owned by National Grid Interconnector Limited (NGIL)<sup>4</sup> and the French transmission company Réseau de Transport d'Electricité (RTE)
  - b. **Moyle**<sup>5</sup> (2002) – 450MW interconnector from Scotland to Northern Ireland owned by Northern Ireland Energy Holdings and operated by the System Operator for Northern Ireland (SONI). 450MW capacity from Scotland and 80MW capacity to Scotland.
  - c. **BritNed** (2011) – 1000MW interconnector between the Netherlands and GB jointly owned by NGIL and the Dutch transmission company TenneT
  - d. **EWIC** (2012) – 500MW interconnector from Ireland to GB owned by the Irish System Operator, EirGrid
2. There are five more interconnectors with signed connection agreements that are contracted to commission before or around 2020:
  - a. **NEMO** (2018) – 1000MW interconnector between Belgium and GB jointly owned by NGIL and the Belgian transmission company Elia
  - b. **ElecLink** – 1000MW interconnector between France and GB owned by ElecLink Ltd.
  - c. **IFA2** (2019) – 1000MW interconnector between France and GB jointly owned by NGIL and RTE
  - d. **NSN** (2019) – 1400MW interconnector between Norway and GB jointly owned by NGIL and the Norwegian transmission company Statnett
  - e. **Northconnect** (2021) – 1400MW interconnector between Norway and GB jointly owned by 5 partners AgderEnergi, E-CO, Lyse, and Vattenfall AB
3. There are further projects which have applied for PCI status (Projects of Common Interest) under the EU's Trans-European Networks (Energy) (TEN-E) regulations, and other projects that are already in the public domain. These are set out in table 3.1. There may be other projects of which we are currently not aware.

<sup>4</sup> A wholly owned subsidiary of National Grid Plc.

<sup>5</sup> Presently operating at part load due to known cable faults but anticipated to return to full load by 2017.

4. The way in which Interconnector requirements are reflected as part of wider network planning is under review. This will be influenced by European processes such as the Ten Year Network Development Plan (TYNDP) as well as Ofgem led projects to review the current regulatory arrangements within GB.
5. We have also initiated a NETS SQSS working group to conclude on the future requirements for interconnectors. It is anticipated that this group will conclude the modification, Grid System Review (GSR) 012 in mid 2014.

### Integrated Transmission Planning and Regulation project

The Integrated Transmission Planning and Regulation (ITPR) project led by Ofgem is considering if and what changes may be required to the planning and regulatory regime. High volumes of renewable generation requires closer co-ordination of transmission system planning to ensure optimum solutions are developed. Additionally there is increasing integration with Europe through interconnection and coordination of TSO activities requiring greater cooperation with European TSOs. This project is considering whether the current regulatory regime is appropriate to deliver an efficient integrated transmission network – onshore, offshore and cross-border given these new challenges.

Emerging thinking was published by Ofgem in June 2013 on the options being considered to facilitate efficient and coordinated planning in electricity transmission and efficient delivery of assets. This emerging thinking considers 4 options for the enduring interconnector regime; Developer led, merchant model, Developer led, cap and floor on returns, developer led, fixed rate of return and centrally identified, cap and floor on returns or fixed regulated return. Ofgem is now developing proposals including an impact assessment with a plan to publish these in early 2014 for consultation.

The project is expected to conclude during 2014/15, with consultation expected in early 2014.

### Ten Year Network Development Plan (TYNDP)

The 2014 Ten Year Network Development Plan will, as part of the wider document, include information on the preferred level of Boundary Transfer Capacity (BTC) and the associated European cost benefit. The required BTC's have been developed using the four demand and generation scenarios (the 'Visions') agreed by ENSTO-E, and are subject to stakeholder engagement.

---

This information will be updated every two years in line with the process to update the TYNDP, but will as a consequence include a 2 year time lag in respect of scenario data given the time required to conduct the necessary analysis and publish the plan. For example, the 2014 TYNDP will be based on 2012 scenario data. The level of interconnected capability identified in the TYNDP will be included in the range of sensitivity studies undertaken within the NDP.

#### **North Seas Countries Offshore Grid Initiative**

It is expected that an increasing amount of intermittent renewable generation across Europe will require stronger interconnection between countries. The extension of the electrical transmission infrastructure into the seas around the European countries to connect the offshore generation adds the opportunity to further extend that infrastructure to join the countries together.

In December 2010, the ten governments of the North Seas countries (Ireland, UK, France, Belgium, Luxembourg, Netherlands, Germany, Denmark, Sweden and Norway) signed a Memorandum of Understanding aimed at providing a co-ordinated, strategic development path for an offshore transmission network in the Northern Seas. The North Seas Countries' Offshore Grid Initiative (NSCOGI) is seeking to establish a strategic and co-operative approach to improve current and future energy infrastructure development. This initiative is now progressing the work that ENTSO-E published in February 2011, which concluded that there are benefits in developing an integrated offshore grid provided there is both a requirement for increased cross border trading capacity, driven by the markets, along with significant and increasing volumes of offshore renewables between the period 2020 to 2030.

*Table 3.1*  
*Interconnectors*

Name	Owner(s)	Connects to	Capacity	Key dates
<b>Operational interconnectors</b>				
IFA	NGIL and RTE	France	2000 MW	Operational 1986
Moyle	NI Energy Holdings	Northern Ireland	450 MW to NI 80 MW from NI	Operational 2002
BritNed	NG and TenneT	The Netherlands	1000 MW	Operational 2011
EWIC	Eirgrid	Ireland	500 MW	Operational 2012
<b>Contracted interconnectors</b>				
ElecLink	Star Capital and Eurotunnel	France	1000 MW	Contracted 2016
Nemo	NGIL and Elia	Belgium	1000 MW	Contracted 2018
NSN	NGIL and Statnett	Norway	1400 MW	Contracted 2019
IFA 2	NGIL and RTE	France	1000 MW	Contracted 2019
Northconnect	Agder Energi, E-CO, Lyse, Scottish and Southern Energy & Vattenfall AB	Norway	1400 MW	Contracted 2021
<b>Others in public domain</b> (applied for PCI status or pre-feasibility studies announced)				
Channel Cable UK	Europagrid	France	1000MW	2016 (PCI)
FAB	Transmission Capital	France	1400MW	2020+
Britlb	Transmission Capital	Spain	1000 MW	2017 (PCI)
Iceland-UK	–	Iceland	–	2019
Denmark-UK	Energinet	–	–	2020+
EWIC2	EirGrid proposal	Ireland	500 MW	2020+ (PCI)
Spain-UK	REE proposal	Spain	1000 MW	2025 (PCI)

# 3.5 Boundary Introduction

## Boundaries

The transmission network is designed to ensure that there is sufficient transmission capacity to send power from areas of generation to those of demand. To provide an overview of existing and future transmission requirements, and report the restrictions, the concept of boundaries has been developed. Boundaries split the system into two contiguous parts, crossing critical circuit paths which carry power between the areas along which power flow limitations may be encountered.

The limiting factor on transmission capacity may be one or more of several different restrictions including thermal circuit rating, voltage constraints and/or dynamic stability, each of which is assessed to determine the network capability. In preparation of this year's ETYS document, analysis has mainly focused on thermal and voltage issues. Where there are known stability issues, these have been reflected in the analysis presented in this report.

The maximum power transfers that can be sustained across a boundary have been determined against existing and future potential network topologies to assess adequacy against a range of future requirements.

The boundaries have developed over many years of operation and planning experience of the transmission system. The NETS and boundaries have developed around major sources of generation, significant route corridors and major demand centres. There are a number of fixed boundaries (B0 to B17) that are regularly reported for consistency and comparison purposes. New boundaries are created and some boundaries are either removed or amended as a consequence of significant transmission system changes (the reason for any amendments will be identified).

In recent years several new boundaries have been added as the future generation seeks to connect to different locations in the country, different to which generation has traditionally connected, resulting in need for transmission reinforcements in areas not previously considered.

As many boundaries cross the same circuits and cover the same parts of the network the boundaries have been grouped into six regions as shown in figure 3.2.

*Figure 3.2  
Region Map*

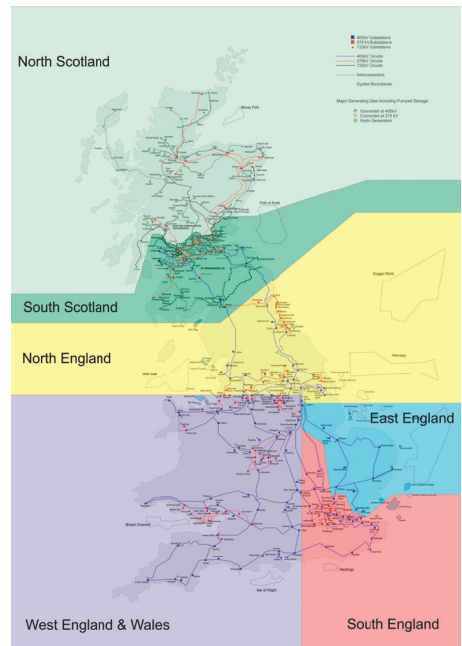

Planning of the systems future needs must also take into account the different conditions that can typically occur during a full year's operation. Many of the technical system operational characteristics have been discussed in the previous chapter. The standard specifies that the NETS must be secure for year round operation during conditions that should be reasonably expected. Some of the differences from peak conditions that can limit the NETS capability include:

- **Seasonal circuit ratings** – The current carrying capability of circuits typically reduces during the warmer seasons as the circuit's capability to dissipate heat is reduced. The rating of a typical 400kV overhead line may be 20% less in the summer than in winter. As mentioned in the previous chapter, the use of dynamic circuit ratings is being considered to actively change circuit ratings based on monitored conditions.

- 
- **Voltage Management** – At times of low demand and particularly low reactive power demand the voltages on the NETS can naturally increase due to capacitive gain. High voltages need to be controlled to avoid equipment damage. Sufficient reactive compensation and switching options must be available to allow effective voltage control.
  - **System Stability** – With reduced power demand and a tendency for higher system voltages during the summer months fewer generators will operate and those that do run could be at reduced power factor output. This condition has a tendency to reduce the dynamic stability of the NETS. Therefore network stability analysis is usually performed for summer minimum demand conditions as this represents the limiting period.
  - **Network Access** – Maintenance and system access is typically undertaken during the spring, summer and autumn seasons. The planning and operation of the system is carefully controlled to ensure system security is maintained.
  - **Generation Profiles** – At winter peak the greatest number of generators will be operational but at other times of the year the number of generators running can be greatly reduced. Variation of generator operation can be much greater in the summer as generators undertake maintenance, demand is reduced and intermittent generation become more sporadic. Care is taken to ensure adequate support is maintained in all regions at all times.

#### **Boundary map**

Figure 3.3 shows the boundaries considered.

---

Figure 3.3  
ETYS GB Boundaries

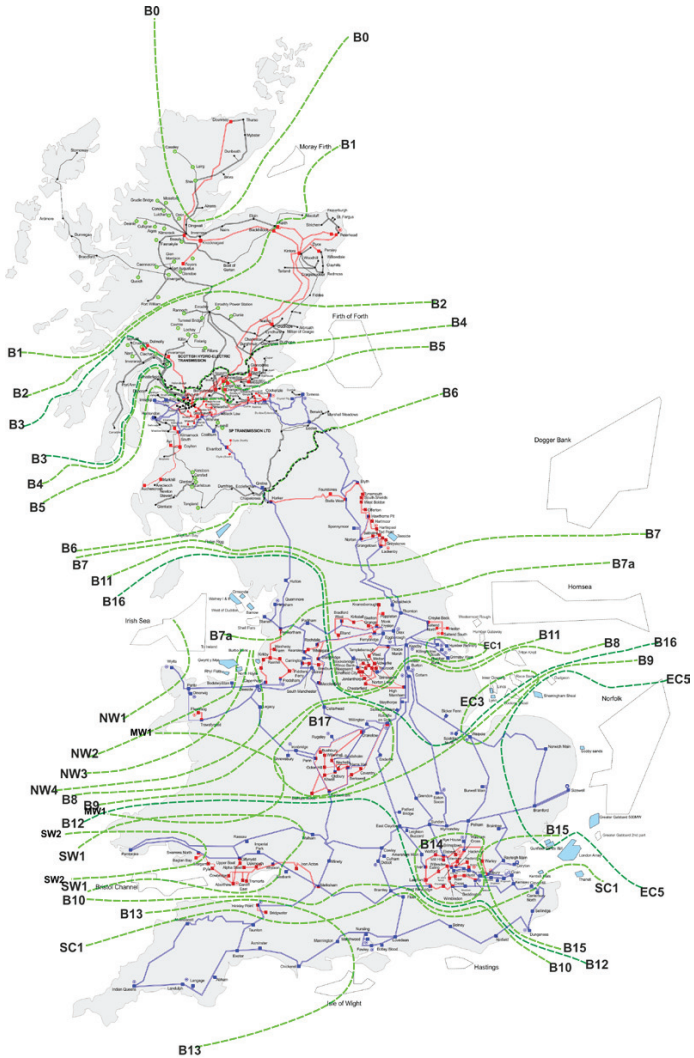

## Security standard requirements and determination of capability

The SQSS specifies methodologies for assessing local generator boundaries and wider system boundaries. The differences lie primarily in the level of generation and demand modelled, which in turn directly affect the level of boundary transfer to be accommodated:

- **Local Boundaries:** For all the local boundaries selected in this statement there is more generation within the group under consideration than demand so they are all net power export boundaries. In such areas, the generation is set at its Transmission Export Capacity (TEC) that may reasonably be expected to arise during the course of a year of operation.
- **Wider Boundaries:** In the case of wider system boundaries the overall generation is selected and scaled according to the Security and Economic criteria described below. The demand level is set at national peak, which results in a 'Planned Transfer' level. Furthermore for each system boundary an extra interconnection or boundary allowance is calculated and added to the Planned Transfer level to give a Required Transfer level. In this way the standard seeks to ensure that peak demand will be met, allowing for generator unavailability and system variations.

For wider boundary studies, the Security and Economy criteria are both applied to the generation background, and in any given year the Required Transfer is the highest value.

### Interpreting the boundary graphs

When presenting the scenarios and sensitivities for the boundaries, it is not possible to show everything at once as there would be extensive overlapping of results and more information than can be clearly displayed. To simplify the information presentation, the boundary graphs are shown in the style of figure 3.4 below.

### Stakeholder Engagement

We would welcome feedback on the use of boundaries as a means of representing transmission network capability and requirements.

**The Security Criterion:** The objective of this criterion is to ensure that demand can be supplied securely, without reliance on either intermittent generators or imports from interconnectors. The background is set by:

- Setting the output from intermittent generators and interconnectors to zero.
- Determining, from a ranking order, the conventional generation required to meet 120% Average Cold Spell (ACS) demand, based on the TEC of the generators.
- Scaling the output of these generators uniformly to meet demand.

**The Economy Criterion:** As increasing volumes of intermittent generation connect to the GB system, the Security criterion will become increasingly unrepresentative of year round operating conditions. The Economy criterion emulates a year round cost benefit analysis. To do this it specifies a single background condition for analysis whereby scaling factors are applied to all classes of generation such that the generation meets the ACS peak demand. The scaling factors used are chosen so as to run plant with the lowest marginal cost, while taking into account that intermittent generation is not likely to operate consistently at 100% output.

Further explanation can be found in Chapter 4 and Appendices C, D & E of the NETS SQSS.

For England and Wales we have shown a maximum and minimum line that represents the highest and lowest requirements of the four case studies for each boundary.

For the local and Scottish boundaries a plot of the contracted background is also shown.

*Figure 3.4*  
*Example of Required transfer and base capability for boundary B16*

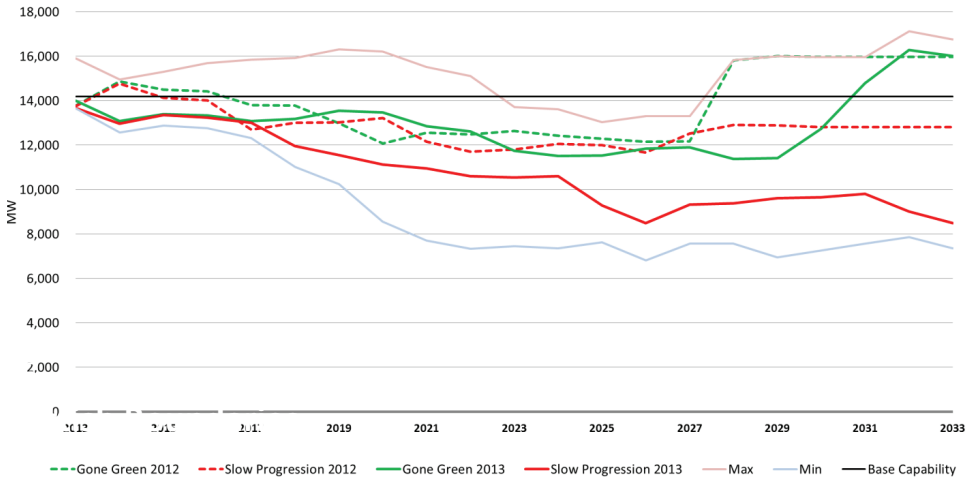



## 3.6

# Scottish Boundaries

### Scottish Boundary Introduction

The following section describes the Scottish transmission networks up to the transmission ownership boundary with the England and Wales transmission network. The onshore transmission network in Scotland is owned by SHE Transmission and SP Transmission but are operated by National Grid as NETSO. The following boundary information has been provided by the two Scottish transmission owners.

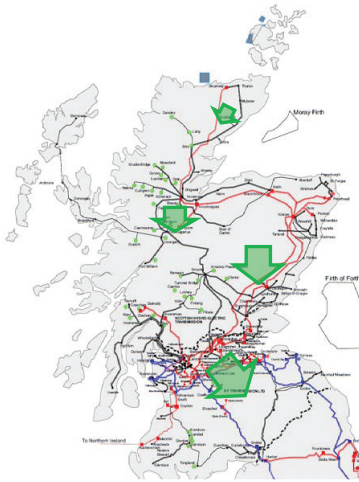

**Primary Challenge Statement:** Significant growth in renewable generation capacity in remote locations connecting to a relatively low capacity and sparse transmission network.

The restrictions of the Scottish Boundaries are often caused by the quickly increasing generation capacity, mostly from renewable sources, connecting within Scotland. The need to transport this generation through the Scottish networks to southerly demand centres in England provides drivers for network development in this region.

### Regional drivers

The forecast increase in generation in Scotland will see:

- Limitation on power transfer from generation in remote locations to the main transmission routes (B0, B1, B2 and B4).
- Limitation on exporting power from Argyll and the Kintyre peninsula (B3).
- Argyll and the Kintyre peninsula area is encompassed by Boundary B3, where the demand at time of the GB system peak is significantly exceeded by the generation in the area. Renewable generation continues to increase in the Kintyre and Argyll area with a significant volume in the consent process with the Argyll and Bute Council prior to application for connection to the grid.
- Assessment of boundary B3 over the ETYS period gives a clear requirement for reinforcement to create extra capacity for exporting power from the Argyll and the Kintyre peninsula area.
- Limitation on power transfer from north to south of Scotland (B0, B1, B2, B4, B5).
- Generation in the north of Scotland is increasing over time due to the high volume of new contracted renewable generation seeking connection in the SHE Transmission area. Consequently, the boundary transfers across B0, B1, B2, B4 and B5 are also increasing with time.
- The current capabilities of some of these boundaries are insufficient to satisfy the boundary transfer requirements for the first few years under the Gone Green and Contracted scenarios, and in some cases even the Slow Progression scenario. This is due to generation being connected ahead of the required reinforcement in accordance with the Connect and Manage access framework. The increase in the required transfer capability of these boundaries over the ETYS period clearly indicates the need to reinforce the transmission system to create the extra capacity for power transfer from north to south of Scotland.
- Limitation on exporting power through Scotland and into England (B2, B4, B5, B6).
- The high volume of new contracted renewable generation seeking connection throughout Scotland is expected to create significance power flows through the Scottish networks to reach demand in England. As there is currently a limitation on power transfer from north to south of Scotland, this implies a restriction to limit the capability of the network to transfer power through the existing Scottish networks for export purposes.
- Since the connection of renewable generation throughout Scotland is expected to increase across all TYS scenarios, the increase in the required transfer capabilities over the ETYS period clearly indicates the need to reinforce the transmission system to create the extra capacity for exporting power from Scotland to England.

### 3.6.1 Boundary B0 – North of Beaully SHE Transmission

*Figure B0.1*  
Geographic representation of boundary B0

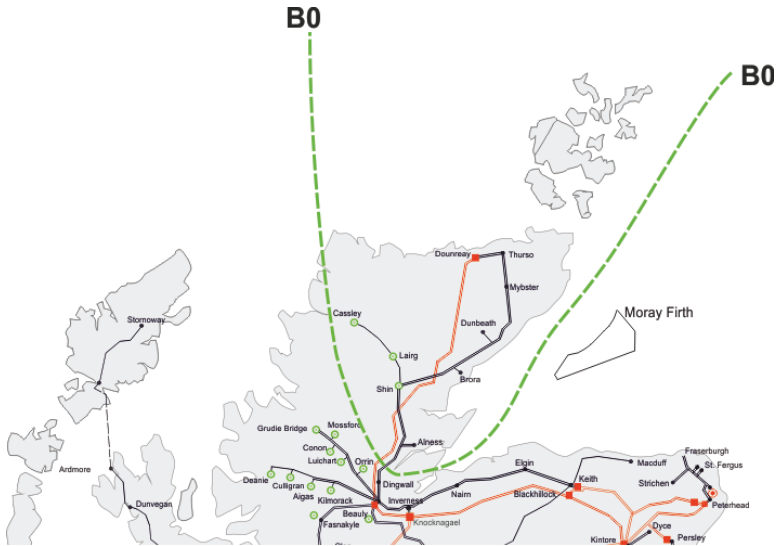

Boundary B0 is a newly created boundary to cover the area north of Beaully, comprising north Highland, Caithness, Sutherland and Orkney. The existing transmission infrastructure north of Beaully is relatively sparse.

The B0 boundary cuts across the existing 275kV double circuit and 132kV double circuits extending north from Beaully. The 275kV overhead line takes a direct route north from Beaully to Dounreay, while the 132kV overhead line takes a longer route along the east coast and serves the local grid supply points at Alness, Shin, Brora, Mybster and Thurso. The Orkney demand is fed via a 33kV subsea link from Thurso.

Reinforcement works in this area, referred to as Beaully-Dounreay Phase 1, were completed in March 2013. These works included the installation of a new second circuit on the 275kV line between Beaully and Dounreay and an upgrade of the Dounreay substation. The base capability for B0 is 245MW.

*Figure B0.2*  
Required transfer and base capability for boundary B0

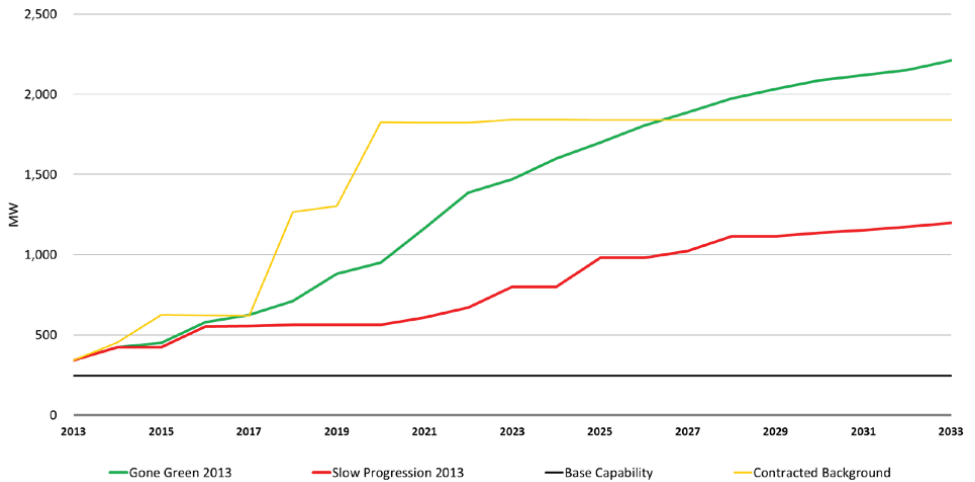

### Boundary requirements and capability

The power transfer through B0 is increasing due to the substantial growth of renewable generation north of the B0 boundary. This generation is primarily onshore wind with the prospect of significant marine generation resource in the Pentland Firth and Orkney waters in the longer term.

Reinforcement of the B0 boundary is required and the Caithness-Moray reinforcement strategy has been proposed to achieve this. The reinforcement comprises an HVDC link between a new substation at Spittal in Caithness and Blackhillock in Moray, along with associated onshore reinforcement works.

The onshore works include the rebuild of the 132kV double circuit line between Dounreay and Spittal at 275kV, a short section of new 132kV line between Spittal and Mybster, and new 275/132kV substations at Fyrish (near Alness), Loch Buidhe (to the east of Shin), Spittal (5km north of Mybster) and Thurso.

3.6.2  
Boundary B1 – North West Export

Figure B1.1  
Geographic representation of boundary B1

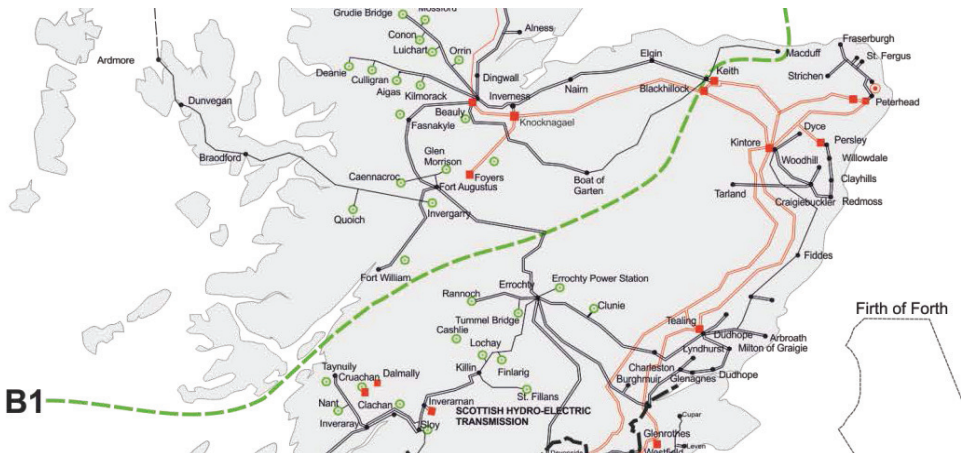

The Boundary B1 runs from the Moray coast near Macduff to the West coast near Oban, separating the north-west of Scotland from the southern and eastern regions. The area to the north and west of Boundary 1 is inclusive of Moray, north Highland, Caithness, Sutherland, Western Isles, Skye, Mull, and Orkney. The boundary crosses the 275kV double circuit running eastwards from Beaulieu, the 275/132kV interface at Keith and the 132kV double circuit running south from Fort Augustus.

Some of the large new generation projects are in places remote from any form of strong transmission infrastructure so new infrastructure is required both for connection and to support power export out of the area.

In all of the generation scenarios there is an increase in the power transfer through B1 due to the large volume of renewable generation connecting to the north of this boundary as can be seen in Figure B1.2. This is primarily onshore wind and hydro. However, there is the prospect of significant additional wind, wave and tidal generation resources being connected in the longer term. The contracted generation behind B1 includes the renewable generation on the Western Isles, Orkney and the Shetland Isles as well as a considerable volume of large and small onshore wind developments. A large new pump storage generator is also planned in the Fort Augustus area. It is also expected that some marine generation will connect in this region during the ETYS time period. This is supplemented by existing generation which comprises around 800MW of Hydro and 300MW of pumped storage at Foyers.

**Figure B1.2**  
Required transfer and base capability for boundary B1

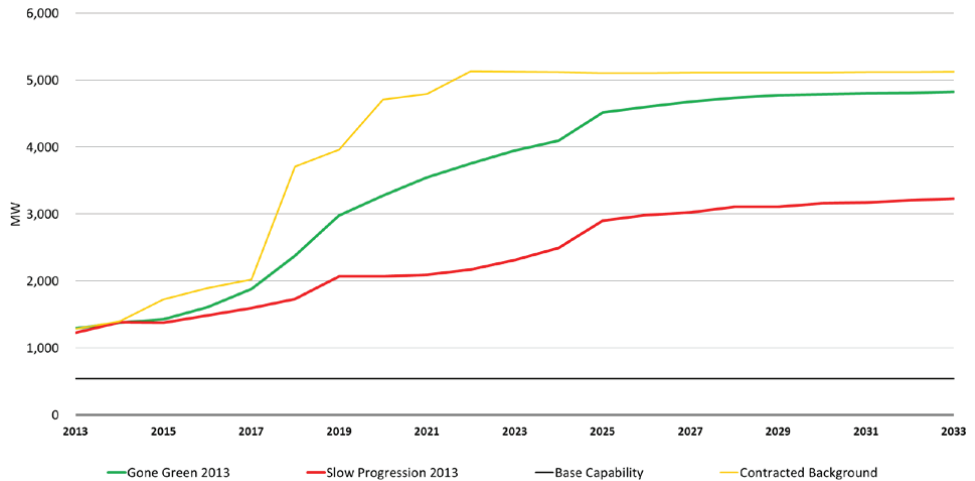

### Boundary requirements and capability

New renewable generation connections north of the boundary are expected to increase the export requirements across the boundary as can be seen in Figure B1.2. All of the generation north of the B0 boundary also lies behind the B1 boundary. The present B1 boundary capability is around 500 MW.

Two key reinforcement projects are currently being constructed to allow for the increasing requirement to export power across boundary B1. The Beauly to Denny reinforcement due for completion in 2015 extends from Beauly in the north to Denny in the south, providing additional capability for boundary B1 as well as boundaries B2 and B4. The second project comprises the replacement of conductors on the 275kV line between Beauly, Blackhilllock and Kintore and also completes in 2015.

In the Gone Green scenario the transfers across B1 indicate the requirement for further reinforcement across this boundary by around 2020. Consideration is therefore being given to other reinforcement works in this area.

There are a number of other transmission projects in the area between boundaries B0 and B1 which are necessary for the connection of generation clusters.

The significant interest from generation developers on the large island groups of the Western Isles, Orkney and Shetland means that new transmission infrastructure will be required to connect these to the mainland transmission network. Current proposals are for the Western Isles to be connected using an HVDC transmission link from Gravir on Lewis to Beauly substation. It is also proposed to use an integrated multi-terminal HVDC link to connect Shetland to the mainland via a DC bussing point at Sinclairs Bay in Caithness. The growth of small onshore renewable generation on mainland Orkney together with the potential significant growth in marine generation around Orkney and the Pentland Firth requires transmission infrastructure to be taken to Orkney. It is currently proposed to install an AC subsea cable from Dounreay to Bay of Skail, on the western side of Orkney. This could be followed at a later date by a 600MW HVDC link from the Bay of Skail to the DC bussing point at Sinclairs Bay in Caithness when the capacity is required.

### 3.6.3 Boundary B2 – North to South SHE Transmission

*Figure B2.1*  
Geographic representation of boundary B2

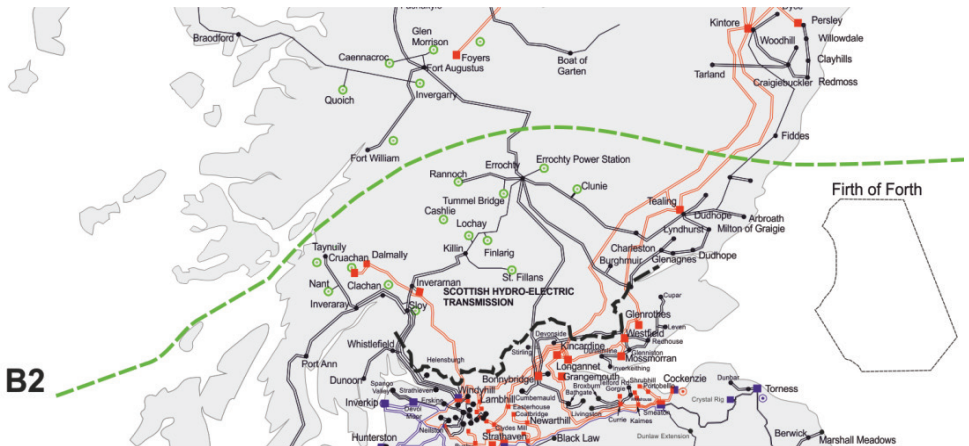

The Boundary B2 cuts across the Scottish mainland from the East coast between Aberdeen and Dundee to near Oban on the West coast. The boundary cuts across the two 275kV double circuit lines and the 132 kV single circuit in the east in addition to the 132kV double circuit running southwards from Fort Augustus. Consequently it crosses all the main North-South transmission routes from the North of Scotland.

As described in boundary B1, the Beauly-Denny project is a key reinforcement which increases the capability across boundaries B1, B2 and B4. This project is currently under construction and is due for completion in 2015.

In all of the generation scenarios, there is an increase in the power transfer through B2 due to the connection of a large volume of renewable generation north of the B2 boundary.

The generation behind the B2 boundary includes both

onshore and offshore wind with the prospect of significant marine generation resource being connected in the longer term. There is also the potential for additional pumped storage plant to be located in the Fort Augustus area. The thermal generation at Peterhead lies between the B1 and B2 boundaries as do the 1GW Beatrice offshore windfarm, the 1.5GW Moray Firth offshore windfarm and the proposed future 1.4GW North Connect Interconnector with Norway. The Beatrice and Moray Firth windfarms are due to connect in 2018 and the North Connect Interconnector in 2021. The present B2 boundary capability is around 1600 MW.

*Figure B2.2*  
Required transfer and base capability for boundary B2

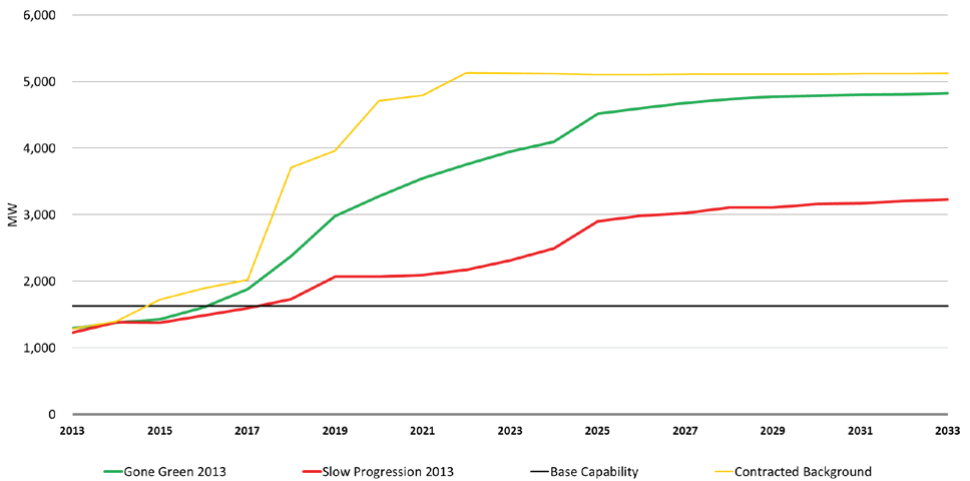

### Boundary requirements and capability

The forecast Boundary transfers for B2 are increasing at a significant rate due to the high volume of contracted renewable generation seeking connection to the north of the boundary.

The increase in the required transfer capability for this boundary across all generation scenarios indicates the need to reinforce the transmission system. The Beauly to Denny reinforcement which is due for completion in 2015, provides significant additional network capacity and increases the B2 North South boundary capability from around 1600 MW today to around 2200 MW.

3.6.4  
Boundary B4 – SHE Transmission to SP Transmission

Figure B4.1  
Geographic representation of boundary B4

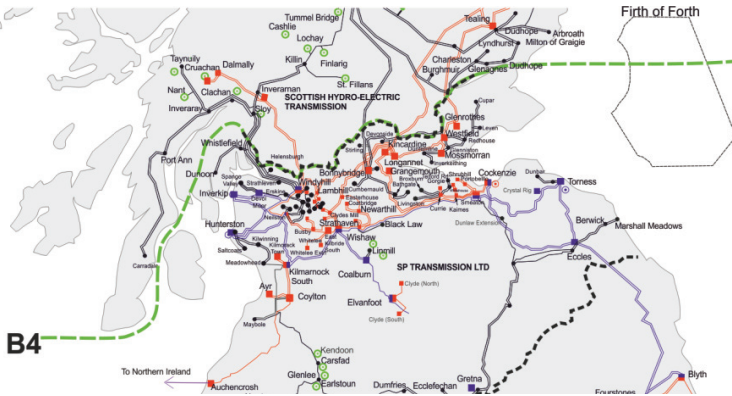

The B4 boundary separates the transmission network at the SP Transmission and SHE Transmission interface running from the Firth of Tay in the east to near the head of Loch Long in the west. With increasing generation in the SHE. Transmission area for all generation scenarios the required transfer across B4 is expected to significantly increase over the period covered by the ETYS.

The boundary is crossed by 275 kV double circuits to Kincardine and Westfield in the east, a 132 kV double circuit to Bonnybridge, near Denny and by two 132 kV double circuits from Sloy to Windyhill in the west. A major reinforcement across B4 is currently under construction. The Beauly to Denny upgrade involves the replacement of the existing 132 kV double circuit route between Beauly and Denny with a new 400 kV tower construction. One circuit on the new route will operate at 400kV and the other at 275kV.

The generation behind the B4 boundary includes around 1 GW from the Round 3 Firth of Forth offshore wind farm in addition to 2.5 GW from the Beatrice and Moray Firth offshore wind farm schemes. The thermal generation at Peterhead is located behind B2 and B4 and is retained under all scenarios.



*Figure B4.2*  
Required transfer and base capability for boundary B4

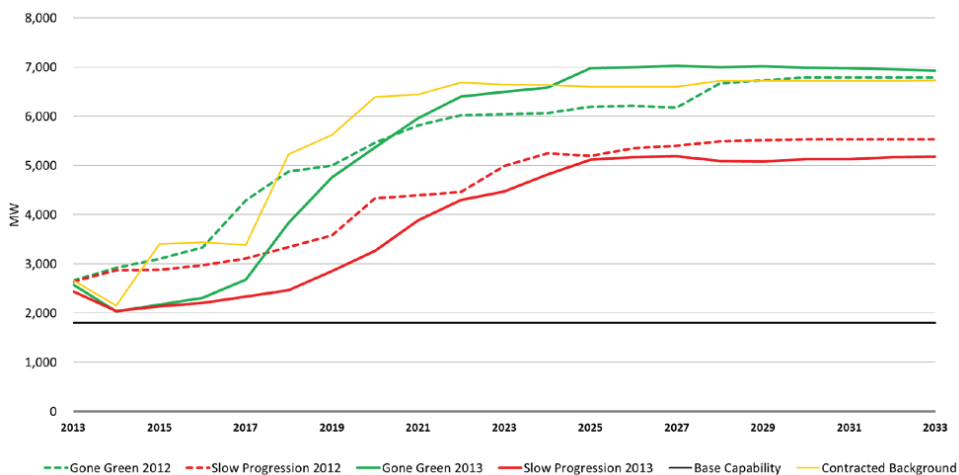

### Boundary requirements and capability

Figure B4.2 above shows required boundary transfers for B4 from 2013 to 2033. In all of the ETYS generation scenarios, the power transfer through B4 increases due to the significant volumes of generation connecting north of the B4 boundary, including all generation above the B0, B1 and B2 boundaries. This is primarily onshore and offshore wind generation with the prospect of significant marine generation resource being connected in the longer term. The contracted generation behind the B4 boundary includes around 3.5GW of offshore and 5.2GW of large onshore wind generation.

The increase in the required transfer capability clearly indicates the need to reinforce the transmission network across the B4 boundary. The current B4 capability is insufficient to satisfy the boundary transfer requirement for the first few years under the Gone Green and Contracted scenarios. This is due to generation being connected ahead of the required reinforcement in accordance with the Connect and Manage access framework.

3.6.5  
Boundary B5 – North to South SPT

*Figure B5.1*  
Geographic representation of boundary B5

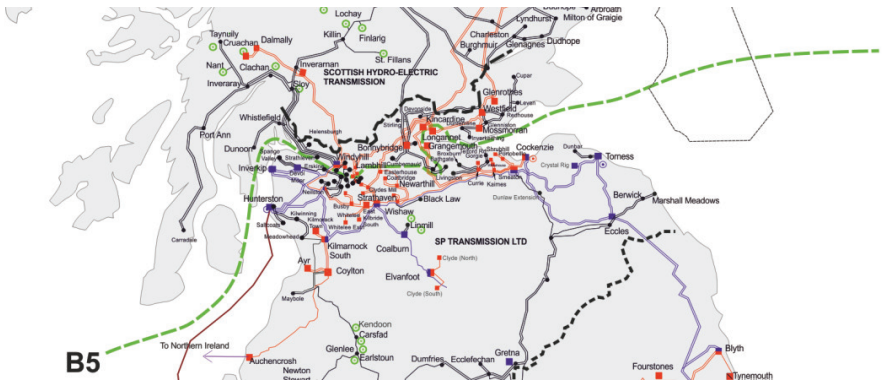

Boundary B5 is internal to the SP Transmission system and runs from the Firth of Clyde in the west to the Firth of Forth in the east. The Generating Stations at Longannet and Cruachan, together with the demand groups served from Windyhill, Lambhill and Bonnybridge 275kV Substations, are located to the north of B5. The existing transmission network across the boundary comprises three 275kV double circuit routes; one from Windyhill 275kV Substation in the west and one from each of Kincardine and Longannet 275kV Substations in the east.

The area to the north of B5 typically contains an excess of generation and the predominant direction of power flow across the boundary is from north to south.

**Figure B5.2**  
Required transfer and base capability for boundary B5

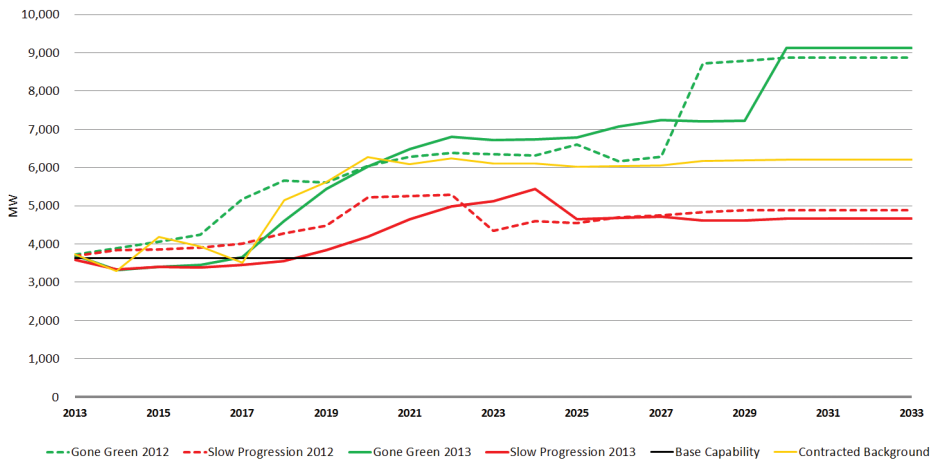

### Boundary requirements and capability

Figure B5.2 above shows required boundary transfers for B5 from 2013 to 2033. In all of the ETYS scenarios, there is an increase in the export requirement across B5. This is due to the connection of a large volume of generation throughout the north of Scotland, primarily on and offshore wind. This includes up to 10GW of wind generation north of B5 over the ETYS period. This large generation increase is supplemented by marine, CCGT and CCS projects and is only partially offset, to varying degrees, by closure of ageing coal and gas plants.

The capability of the boundary is presently limited by thermal considerations to around 3.6 GW. The boundary capability is required to increase, with generation increasing to the north of B5 in all scenarios.

### 3.6.6 Boundary B6 – SPT to NGET

*Figure B6.1  
Geographic representation of boundary B6*

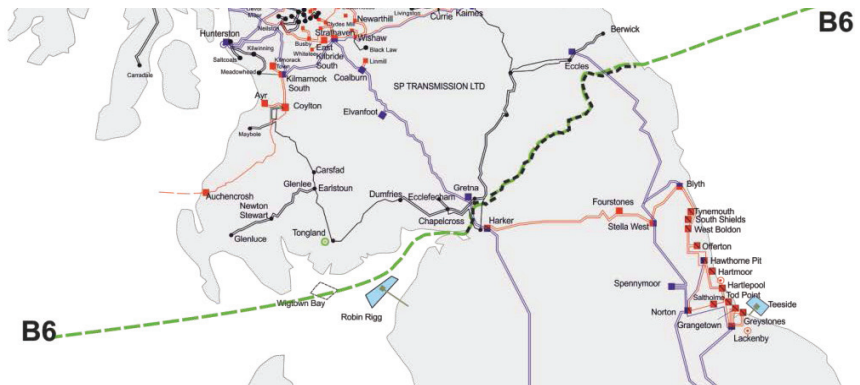

Boundary B6 is the boundary between the SP Transmission and the National Grid Electricity Transmission systems. The existing transmission network across the boundary primarily consists of two double circuit 400kV routes. There are also some 132kV circuits across the boundary, which are of limited capacity. Scotland contains an excess of generation leading to mostly Scottish export conditions, so north-south power flows are considered as the most likely operating condition.

Large thermal and nuclear plants in Scotland still play a vital role in managing Security of Supply issues across Scotland. Presently to secure the peak demand in Scotland at times of low wind generation output, approximately 4GW's of generation will be required in Scotland. This generation could be provided by a variety of sites such as Torness, Hunterston, various Pump Storage and hydro schemes, Longannet and Peterhead. Following the completion of the Western HVDC link in 2016 this requirement is forecast to be reduced down to approximately 2GW's of generation.

In the event of a system condition that includes low availability of the nuclear power stations and the unavailability of Peterhead and Longannet power stations, it will be necessary to install additional reactive compensation equipment to the transmission system, balanced against any other synchronous plant developments in the region, in order to manage the voltage requirements effectively across Scotland. We are already discussing such requirements with the respective Transmission Owners, SP Transmission and Scottish Hydro Electric Transmission.

Small embedded generation within Scotland can make a significant change to the boundary requirements. There is more than 2000 MW of small embedded wind generation capacity that could be installed by 2030. When planning, as per the economy standard this could increase the required boundary capability for B6 by up to 1400MW. The definitions of what is classed as small embedded generation can be found in section 2.4.1.

**Figure B6.2**  
Required transfer and base capability for boundary B6

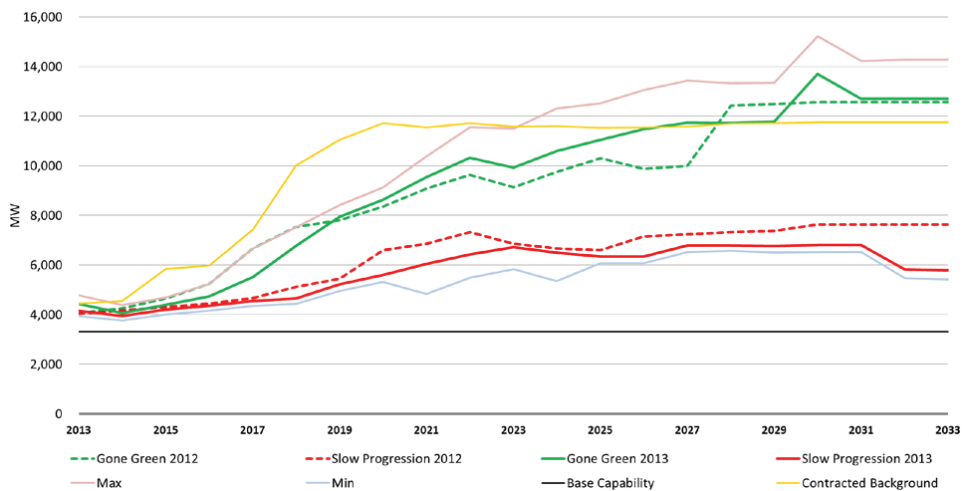

### Boundary requirements and capability

Figure B6.2 above shows required boundary transfers for B6 from 2013 to 2033.

Across all scenarios there is an increase in the export from Scotland to England due to the connection of additional generation in Scotland, primarily onshore and offshore wind. This generation increase is partially offset by the expected closure of between 3 to 7 GW of ageing coal, gas and nuclear plants, which varies in each scenario.

The boundary capability of B6 is currently limited by voltage and stability to around 3.3 GW.

For the situation of power flowing north into Scotland across boundary B6, such as in times of high demand and low generation, output the boundary capability is limited to approximately 2.5GW by circuit loading constraints. This capability is sufficient by current standards. As reinforcements such as the Western HVDC link are completed this capability will increase accordingly.

## Northern Boundaries

### Northern Boundary Introduction

The following section describes the transmission network between Scotland and the north midlands. The boundaries included within Upper North are B7, B7a, B11, B16 and, enclosing the Humber region, EC1.

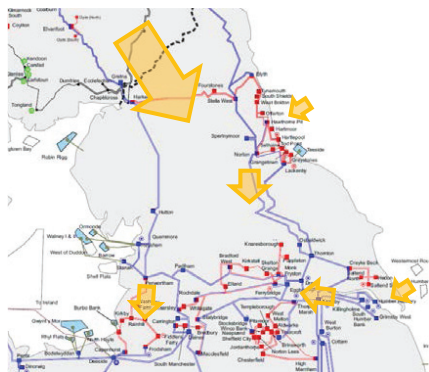

**Primary Challenge Statement:** Rapidly growing North to South power flows, way in excess of existing system capability, driven by renewable generation connections.

The restrictions of the Northern Boundaries are often caused by the fast increasing generation connected to Scotland, Humber and North East England. The needs to transport these generation from Scotland, through North England, to the demand centre located further south in the country provides the drivers for network development in this region.

### Regional drivers

The forecast increase in generation from Scotland and East Coast will see:

- Limitation on power transfer from Scotland to England (B7, B11, B16).
  - The restriction of boundary B6 also limits the capability of the downstream boundaries B7, B11 and B16. Boundary B6 is currently limited by low voltage compliance and system stability at 3.3GW. With the vast amount of renewables that will potentially connect in Scotland over the next ten years, there exists a driver to increase the transfer capability across the Scotland to England boundaries.
- The network in Scotland is connected to England via two sets of 400kV double circuits, Harker-Elvanfoot/ Greta and Stella West-Eccles, which are overhead line routes each over 100km long. There are also some smaller 132kV circuits with limited capacity. These long routes have high impedance nature and results in high reactive power losses. As the power flow increases, the reactive power loss in the circuits also increases. Hence at a high transfer level, the losses, if not compensated, will eventually lead to voltage depression at the receiving end which in this case is the England side of the circuits.
- Furthermore, stability issue arises when fault appears on one of the two double circuit routes – when the fault happens, the Scotland system may be left with only one double circuits connection to the England system; this further increases the impedance in the connection between the two systems significantly and exposes the system to instability at high transfer level.
- Hence previous analysis has led to the construction of the Anglo-Scottish compensation. If the works continue and commission as planned in 2014, voltage and stability capability of Boundary B6 will be improved, and the boundary will instead be limited at 4.4GW by thermal restriction. As generation continues to connect in Scotland, the increasing transfer will see this thermal restriction in the next couple of years.
- As a result, there exists a driver to develop the network to maintaining the voltage at the receiving end on the England side at compliance level, and to increase the thermal capability of the circuits connecting Scotland and England to cope with the forecasted increase in generation connecting in Scotland.
- Limitation on power transfer out of North East England (B7a).
  - Once the power flows through the Scotland to England boundaries, on the east side it enters the network in North East England and continue to flow south via two sets of 400kV double circuits – Norton-Osbaldwick-Thornton and Lackenby-Thornton. As generation forecasted to connect to North East England increases, adding on to the flow through generation from Scotland, the circuits exporting power to the south will be increasingly stressed and will eventually reach their thermal limit.
  - As a result, there exists a driver to develop the network to increase the thermal capability of the circuits exporting power from North East England to the south of the country.

- 
- Limitation on power transfer from North Midlands to West Midlands (B7a).
    - On the west side of the network south to the Scotland to England boundaries, power flows from North Midlands to West Midlands via two branches of circuits - a 400kV branch of Penwortham-Padiham/Daines and a 275kV branch of Penwortham-Kirkby to Deeside. As the power flow increases in the future, the two branches will be stressed to their thermal limit; in particular the 275kV branch may require an upgrade to operate at higher voltage level to enable further increment in its thermal capability.
    - As a result, there exists a driver to develop the network to increase the thermal capability of the circuits exporting power from North Midlands to the south of the country.
  - Limitation on power transfer out of Humber (EC1).
    - There is currently around 4GW of generation connected to the network in Humber. This large group of generation is exported out of Humber via two sets of 400kV double circuits – Keadby-Killingholme/Grimsby West and Keadby/Creyke Beck-Humber Refinery/Killingholme. Further increase in generation in Humber will lead to extra stress on the thermal capability of these exporting circuits.
    - As a result, there exists a driver to develop the network to increase the thermal capability of the circuits exporting power out of Humber.
-

3.7.1  
Boundary EC1 – Humber

Figure EC1.1  
Geographic and single line representation of boundary EC1

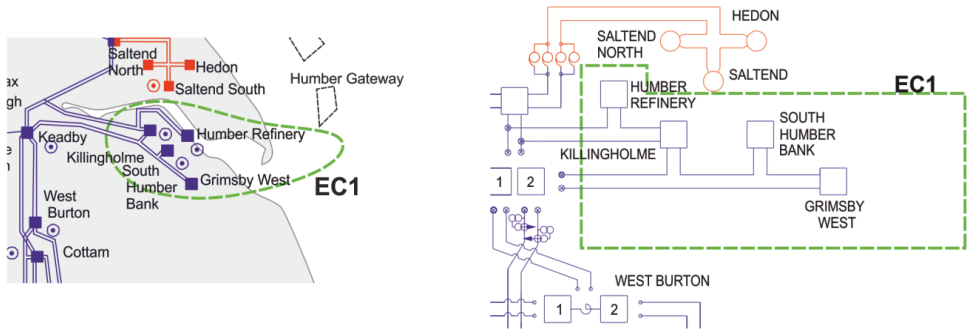

Boundary EC1 is an enclosed local boundary consisting of four 400kV circuits that export power to the Keadby substation. Killingholme is the only substation within the boundary that is connected by more than two transmission circuits.



*Figure EC1.2*  
*Boundary Export and base capability for boundary EC1*

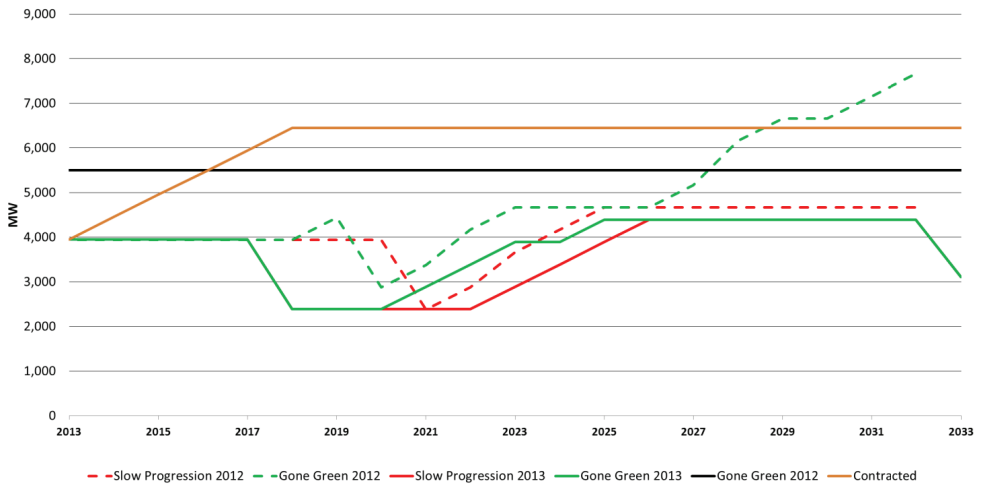

### Boundary requirements and capability

Figure EC1.2 above shows the estimated peak export requirements for EC1 from 2013 to 2033. The plots show that over the next few years the exporting nature of the boundary persists. With the Slow Progression and Gone Green scenarios the boundary requirements do not exceed 4.5GW as despite new generation connections the closure of existing generation keeps the requirements limited. The contracted background does not suggest closures so the boundary requirements increase significantly.

The capability of this boundary is limited by the thermal ratings of the circuits out of Keadby to the South.

### 3.7.7 Boundary B7 – Upper North

*Figure B7.1  
Geographic representation of boundary B7*

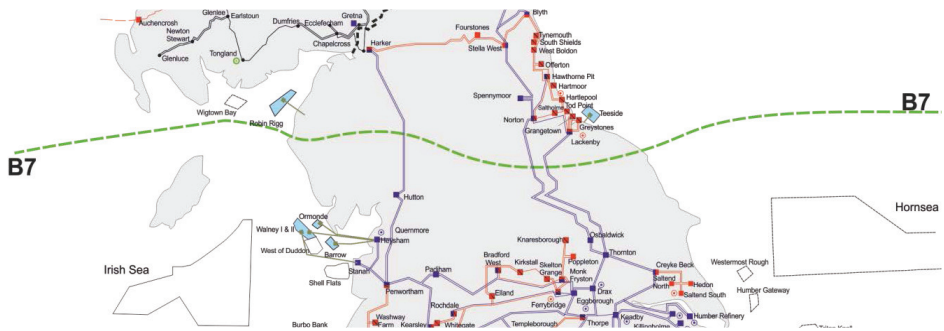

Boundary B7 bisects England south of Teesside. It is characterised by three 400kV double circuits, two in the east and one in the west. The area between B6 and B7 is was traditionally an exporting area with a surplus of generation, added to the exported power from Scotland this put significant requirements on B7. With the recent closure of generation at Teesside the surplus of generation in the area between B6 and B7 has disappeared and the B7 requirement is reduced but is still exposed to large Scottish exports.

*Figure B7.2*  
Required transfer and base capability for boundary B7

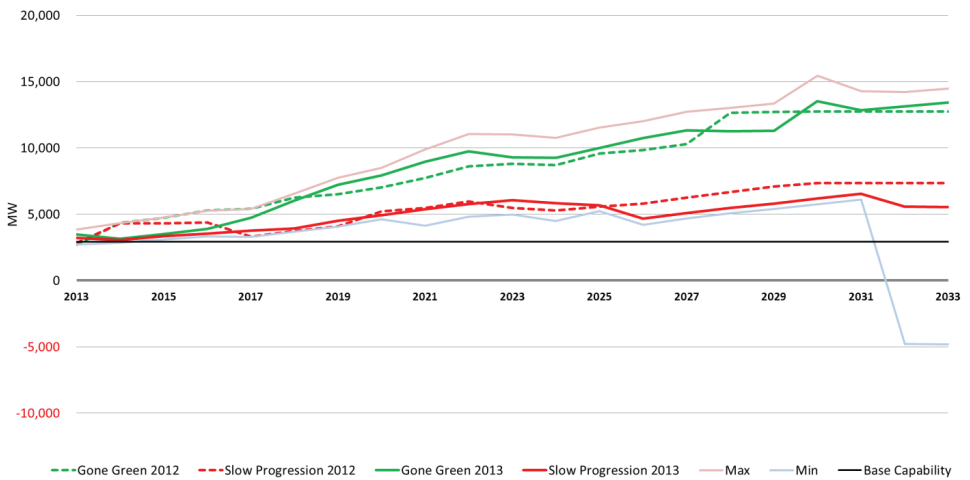

### Boundary requirements and capability

Figure B7.2 above shows the required transfers for B7 from 2013 to 2033. The boundary requirements grow across all the scenarios. The growth looks deceptively shallow but the peak boundary requirement increase from around 4GW to a peak of just over 15GW.

3.7.7a  
Boundary B7a – Upper North

Figure B7a.1  
Geographic representation of boundary B7a

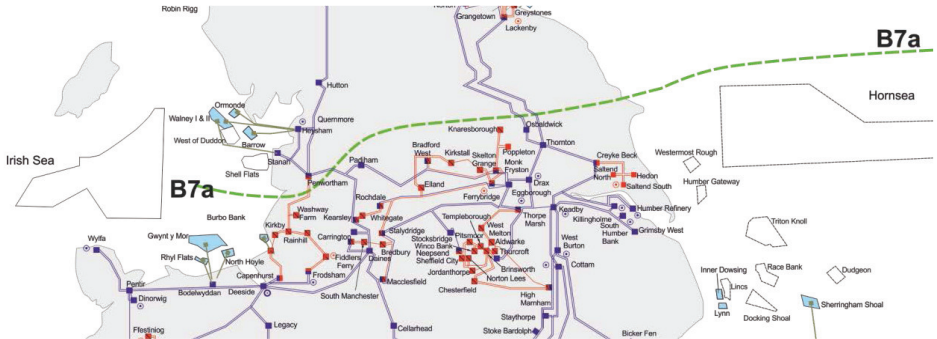

Boundary B7a bisects England south of Teesside and into the Mersey Ring area. It is characterised by three 400kV double circuits, two in the east, one in the west and one 275kV circuit. The area between B6 and B7a was traditionally an exporting area with a surplus of generation, added to the exported power from Scotland this puts significant requirements on B7a. With the recent closure of generation at Teesside the surplus of generation in the area between B6 and B7a has disappeared and the B7a requirement is reduced but is still exposed to large Scottish exports.

**Figure B7a.2**  
Required transfer and base capability for boundary B7a

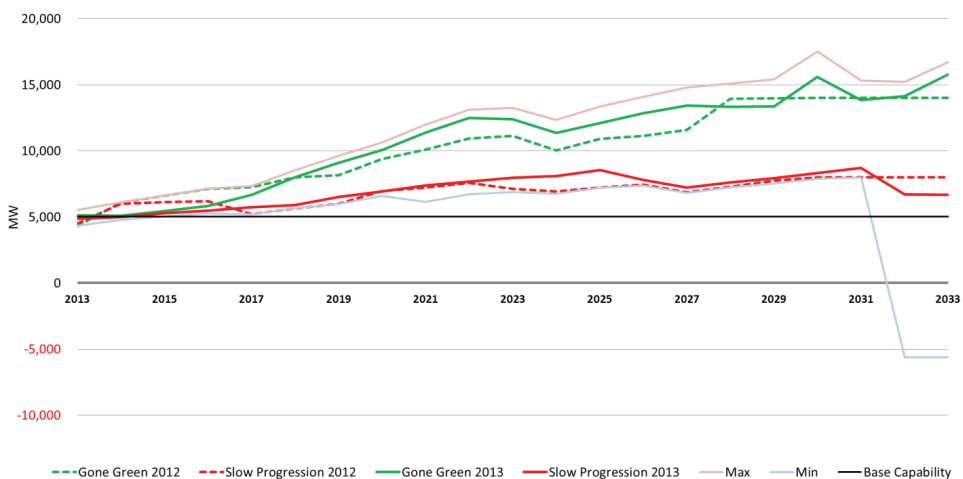

### Boundary requirements and capability

Figure B7a.2 above shows the required transfers for B7a from 2013 to 2033. The required transfers are very similar to those for B7, being driven by renewable generation to the north. The slower progression of renewable is very apparent in the differences between the Slow Progression and Gone Green required transfer plots.

Similarly to B7, the limiting factor to the boundary capability is with the western circuits. For B7a, faults on the 400kV or 27kV circuits south of Penwortham cause heavy loading on the remaining circuits. The pair of parallel double circuits on the east makes that path relatively stronger.

An unusual point appears at 2031 in the plot of minimum values. This comes from the sensitivities as a potential driver appears for the boundary to import power from the south.

3.7.11  
Boundary B11 – North East and Yorkshire

Figure B11.1  
Geographic representation of boundary B11

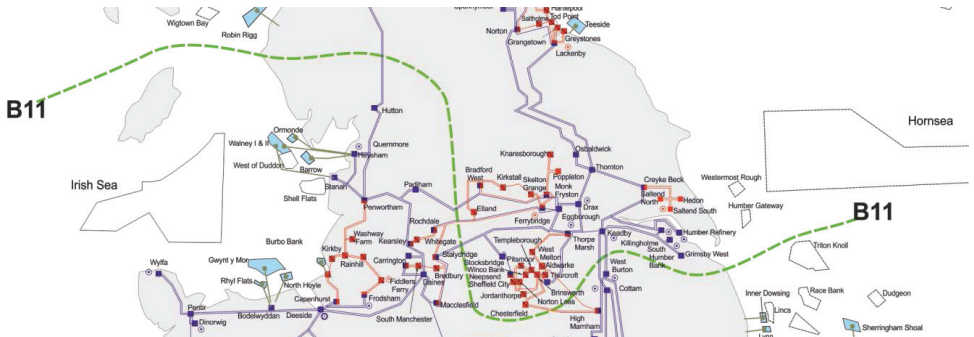

Boundary B11 intersects the north of England. From west to east it crosses through the Harker–Hutton 400kV circuits, before sweeping south across three pairs of circuits between the Yorkshire and Cheshire/Lancashire areas. It then runs east between Nottinghamshire and Lincolnshire south of the Humber area, cutting across the Keadby–Cottam and Keadby–West Burton lines. To the north and east of the boundary are the power exporting regions of Scotland, Yorkshire and the Humber. This boundary is significant to the NETS system, in addition to B7, as it allows us to focus on East-West flows and the effects of the Aire Valley and Humber areas generation.

*Figure B11.2*  
*Required transfer and base capability for boundary B11a*

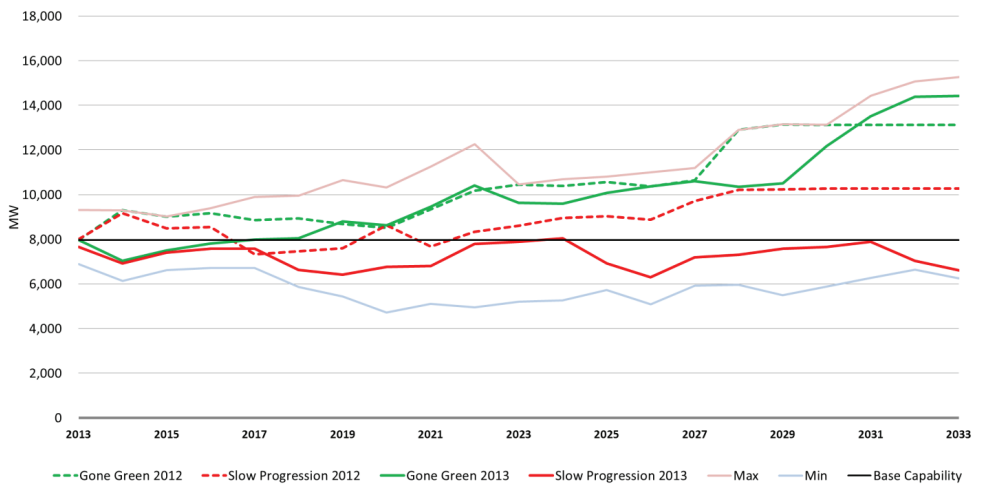

### Boundary requirements and capability

Figure B11.2 above shows the required transfers for B11 from 2013 to 2033. The Slow Progression scenario does not show any significant increase in boundary requirements but the Gone Green scenario suggests increasing requirements beyond 2018. The drive behind this is increasing generation north of the boundary, mostly from renewables.

3.7.16  
Boundary B16 – North East, Trent and Yorkshire

Figure B16.1  
Geographic and single line representation of boundary B16

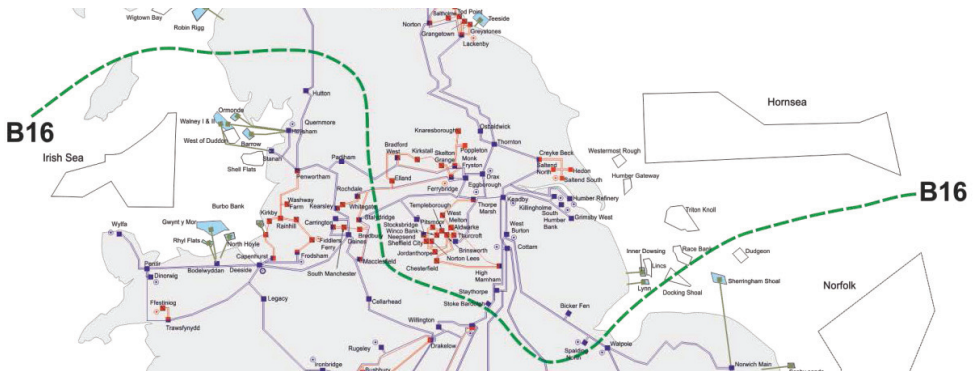

B16 follows the same path of B11 in the west, while in the east it also encompasses the areas of Nottinghamshire and Lincolnshire, thus incorporating additional generation from these regions. The boundary crosses the four double circuits running south from Nottinghamshire (West Burton / Cottam), instead of the two circuit pairs south of Keadby. Similarly to B11, B16 is considered a boundary that carries power from north to south.



*Figure B16.2*

*Required transfer and base capability for boundary B16*

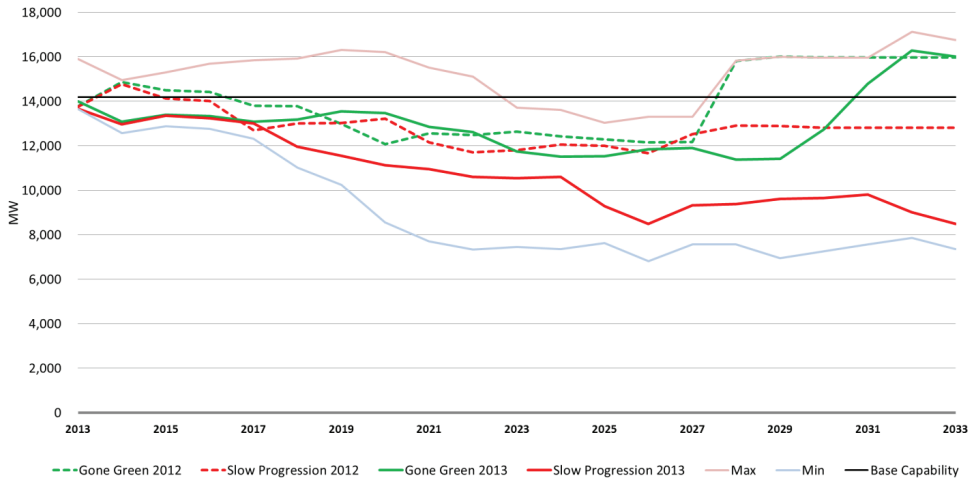

### Boundary requirements and capability

Figure B16.2 above shows the required transfers for B16 from 2013 to 2033. The gradual decay in conventional generation is apparent in this boundary as the required transfer decreases due to the conventional thermal generation closing or reducing output. All of the prospective new nuclear generation lies to the south of this boundary.

## 3.8

## Eastern Boundaries

**Eastern Boundary Introduction**

The East England region includes the counties of Norfolk and Suffolk. The transmission boundaries EC3 and EC5 cover the transmission network in the area. Both boundaries are considered local based on the generation and demand currently connected.

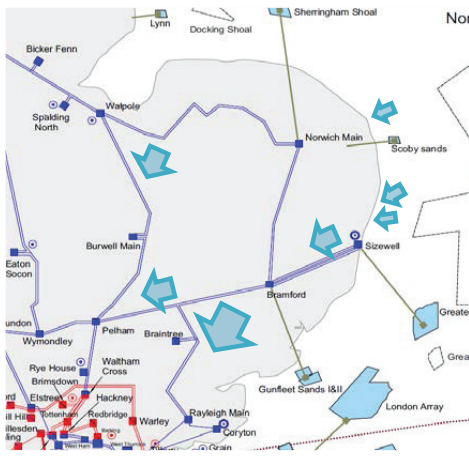

**Primary Challenge Statement:** Large amount of generation to be connected, predominantly offshore wind and nuclear, significantly exceeded the local demand causing heavy circuit loading and voltage depressions.

**Regional drivers**

The forecast increase in generation in East Anglia will see:

- Limitation from East Anglia to Greater London and South East England (EC3, EC5).
- The East England region is connected by several sets of long 400kV double circuits, including Bramford-Pelham/Braintree, Walpole-Spalding North/Bicker Fen and Walpole-Burwell Main. When a fault happens on one set of these circuits, some of the power has to flow a long distance to reach the rest of the network and continue to flow into Greater London and South East England.

□ As the power flow increases due to new generation connection in East Anglia, the reactive power loss in these high impedance routes also increases. Hence at a high transfer level, the losses, if not compensated, will eventually lead to voltage depression at the receiving end of the routes.

□ Furthermore, stability becomes a concern when some of the large generators connect and further increase the size of the generation group in the area. Losing a set of double circuits when a fault happens will lead to significance increases in the impedance of the connection between this large generation group and the remaining of the system. Hence the system may be exposed to risk of instability as transfer increases.

□ It is also important to ensure all the transmission route in the area will have sufficient thermal capacity to cope with the export requirement under post-fault condition.

As a result, there exists a driver to develop the network in the East England region to ensure it has sufficient capability to export the power to the rest of the system securely and safely.

### 3.8.EC3 Boundary EC3 – Wash

*Figure EC3.1*  
Geographic and single line representation of boundary EC3

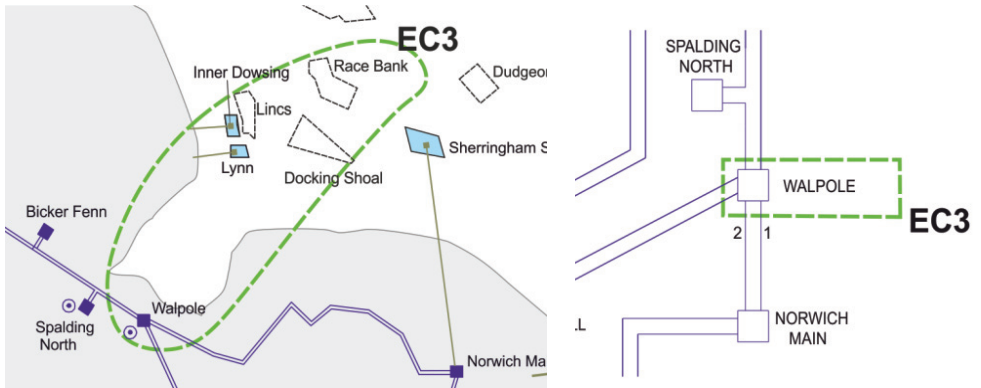

Boundary EC3 is a local boundary surrounding the Walpole substation and includes the six 400kV circuits out of Walpole. These are two single circuits from Walpole to Bicker Fen and Walpole to Spalding North and two double circuits from Walpole to Norwich and Walpole to Burwell Main. Walpole is a critical substation in supporting significant generation connections, high demand and high network power flows along the East Coast network which is why it is selected for local boundary assessment.

*Figure EC3.2*  
*Boundary Export and base capability for boundary EC3*

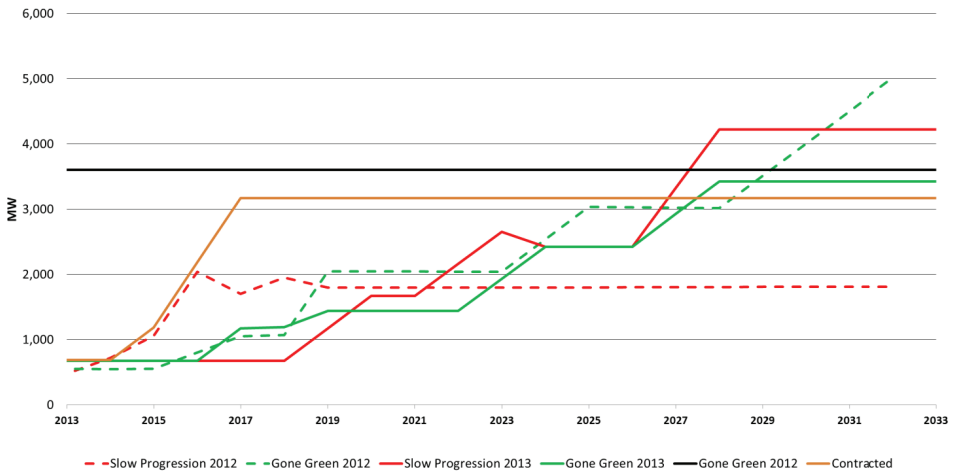

### Boundary requirements and capability

Figure EC3.2 above shows the estimated peak exports for EC3 from 2013 to 2033. The plots show that the export requirements of the boundary increase across all scenarios but the present capability should be sufficient for at least the next ten years.

### 3.8.EC5 Boundary EC5 – East Anglia

*Figure EC5.1*  
Geographic and single line representation of boundary EC5

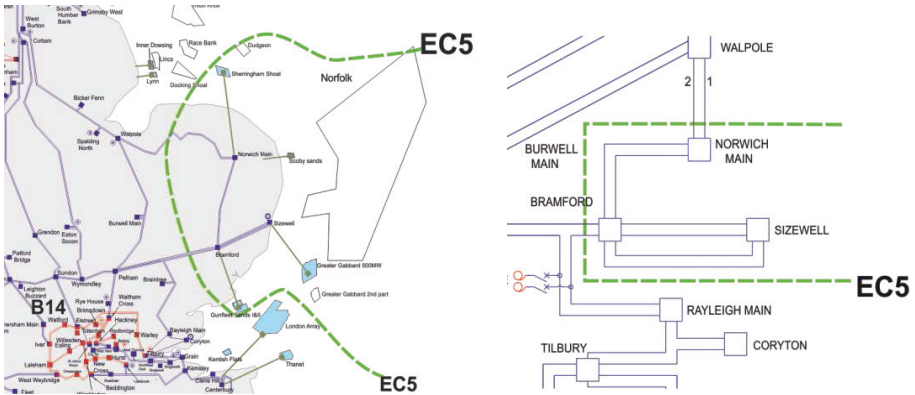

Boundary EC5 encloses most of East Anglia with 400kV substations at Norwich, Sizewell and Bramford. With the generation and demand there today it is classed as a local boundary. The boundary crosses six 400kV circuits that predominantly export power towards London.

The coastline and waters around East Anglia are attractive for the connection of offshore wind projects including the large East Anglia round 3 offshore zone that lies directly to the east. The existing nuclear generation site at Sizewell is one of the approved sites selected for new nuclear generation development.

*Figure EC5.2*  
*Boundary Export and base capability for boundary EC5*

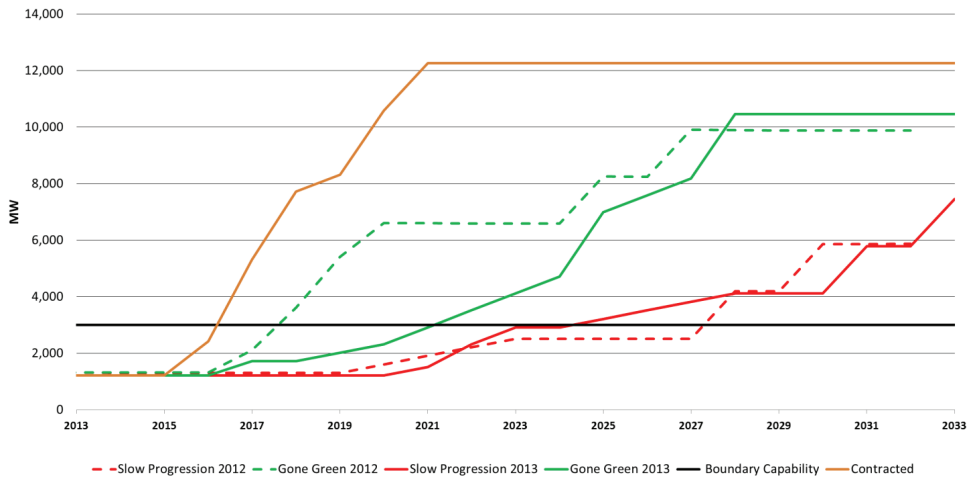

### Boundary requirements and capability

Figure EC5.2 above shows the estimated peak exports for boundary EC5 from 2013 to 2033. The growth in offshore wind and nuclear generation capacities connecting behind this boundary greatly increase the transfer capability requirements. This is particularly prominent with the contracted background.

The present boundary capability is sufficient for today's needs but potentially grossly short of some of the prospective future needs.

### South Eastern Boundary Introduction

The south east region has a high concentration of both power demand and generation with much of the demand to be found in London and generation in the Thames Estuary. Interconnection to central Europe is connected along the south east coast and influences power flows in the region by being able to both import and export power with Europe. The boundaries in the south eastern region are B14, B14E, SC1 and B15.

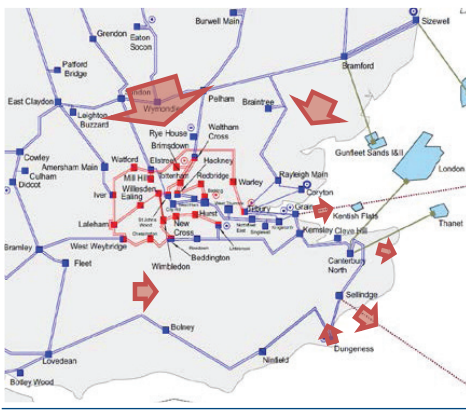

**Primary Challenge Statement:** High demand in London and the possibility coincidental interconnector exports drives power through north London and the Thames Estuary causing heavy circuit loading and voltage depressions.

### Regional drivers

As the generation increases in the north of the country, and the interconnectors in South East England are put onto export operation, the network in South England will see:

- Limitation from Midlands into South England (B14, B14e, B15).
  - High demand in London traditionally drives the heavy north to south flows through the GB network. This big drive has always put the transmission routes connecting Midlands and South England on heavy loading conditions during GB system peak.
  - As more interconnectors plan to connect over the next ten years, an increased draw of power is seen through the major Midlands to South routes and through London when the interconnectors export.
- This will put these major transmission route and the circuits connecting the Greater London area close to the thermal capacity limits.
- The majority of the transmission networks within Greater London are currently operating at 275kV. As the power that flows through London to the interconnector connection points in the south coast continue to increase, requirement to develop the network in order to better utilise the existing transmission capacity or to create new capacity within the area will become unavoidable.
- Limitation in the south coast (SC1).
  - The south coast is connected to the rest of the system by only one set of 400kV double circuits of over 200km long stretching from Kemsley to Lovedean. In the next ten years, the capacity of interconnectors connecting along this long transmission route is forecast to reach 4GW, with a further 1GW capacity connecting near Grain.
  - As a fault happens on one end of this transmission route, power will be forced to flow a very long distance to reach the interconnector connection points. The high demand located in the south coast adds to these interconnector exports to drive a high power flow through this only route in post-fault condition.
  - At a high transfer level, the losses in these long circuits with high impedance, if not compensated, will eventually lead to voltage depression along the route.
  - Furthermore, as the amount of interconnector capacity increases over time, it is important to ensure the transmission route has high enough thermal capability to sustain the growth in requirement.
  - Hence, there exists a driver to develop the network to maintaining the voltage in the south coast at compliance level, and to increase the thermal capability of the circuits connecting the region to cope with the forecasted increase in growth in interconnectors.

3.9.14  
Boundary B14 – London

Figure B14.1  
Geographic and single line representation of boundary B14

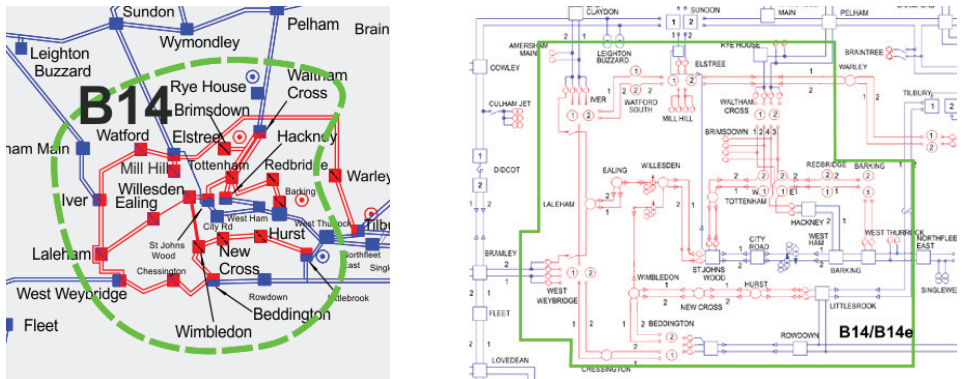

Boundary B14 encloses London and is characterised by containing high local demand and a small amount of generation. London’s energy import relies heavily on surrounding 400kV and 275kV circuits. The circuits entering from the North can be particularly heavily loaded at winter peak conditions. The circuits are further stressed when the European interconnectors export.

The north London circuits can also be a bottleneck for power flow from the East Coast and East Anglia regions as power is down through London North to South.



*Figure B14.2*  
*Required transfer and base capability for boundary B14*

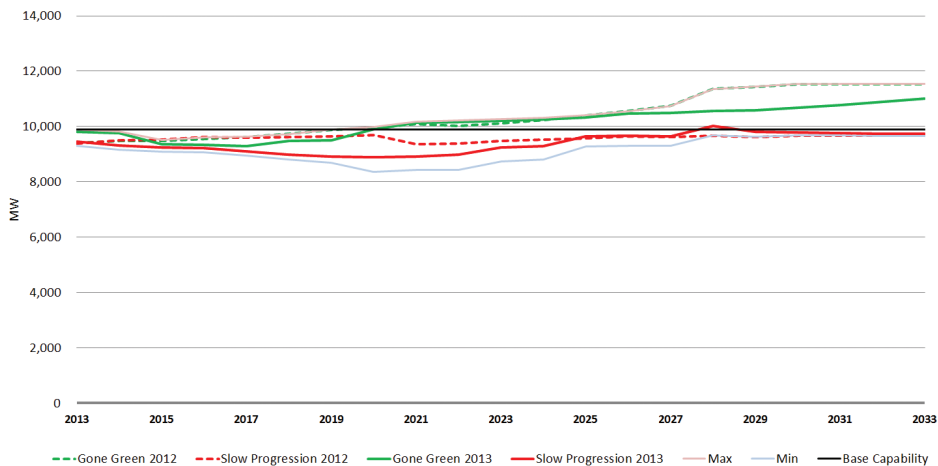

### Boundary requirements and capability

Figure B14.2 above shows the required transfers for B14 from 2013 to 2033. As this boundary's transfer is mostly dictated by the contained demand the future requirements mostly follow the demand in the scenarios with little deviation due to generation changes.

The Slow Progression scenario shows a lower boundary requirement over the Gone Green scenario as the few conventional type generators within the boundary are expected to continue operation in that scenario.

The capability of boundary B14 can be dependent on power flows cutting across London to the Thames Estuary. To account for this a second capability has been produced with the European interconnectors set to export from GB. This removes support for London demand from the Thames Estuary area and puts additional stress on the north London circuits.

This year's capability has increased as a result of the local reactive demand within London falling, and therefore alleviating a previous voltage constraint.

3.9.15  
Boundary B15 – Thames Estuary

Figure B15.1  
Geographic and single line representation of boundary B15

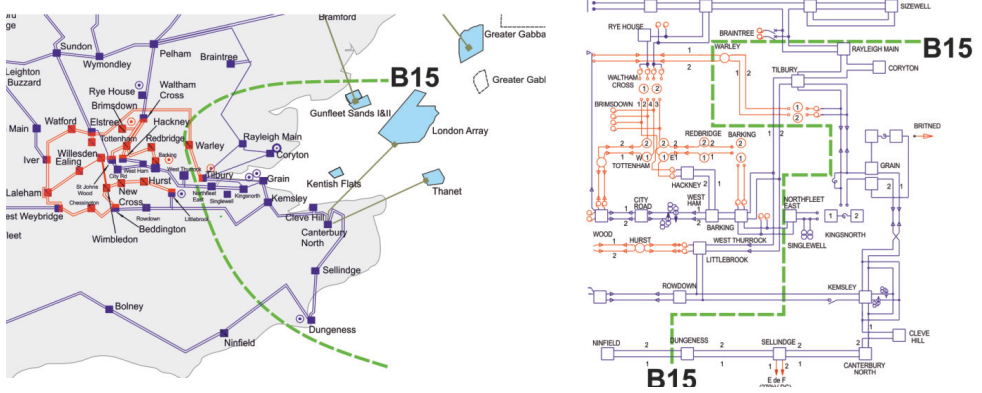

B15 is the Thames Estuary boundary, enclosing the south-east corner of England. It has significant thermal generation capacity and some large offshore wind farms to the east. With its large generation base the boundary normally exports power out to London. With large interconnectors at Sellindge and Grain connecting to France and the Netherlands, the boundary power flow is greatly influenced by their power flows. With agreements in place for new interconnectors to France and Belgium within this boundary the boundary power flows will become dominated by the interconnector activity.

Figure B15.2

Required transfer and base capability for boundary B15

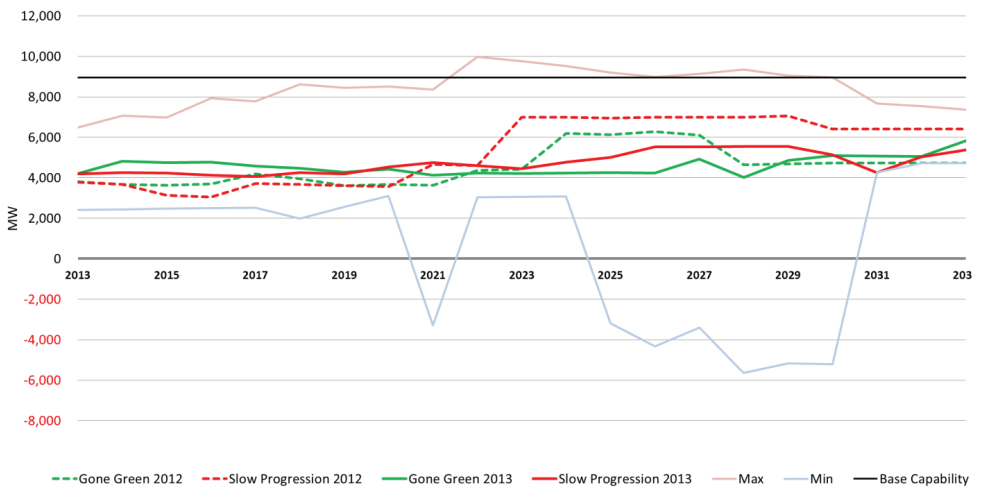

### Boundary requirements and capability

Figure B15.2 above shows the required transfers for B15 from 2013 to 2033. The large differences from the core scenarios to the minimum and maximum requirements are from the sensitivities of interconnectors importing and exporting. The particularly sharp change to boundary import conditions in the minimum requirements are from the sensitivity of GB export conditions pushing the boundary requirement into the NETS SQSS security standard rather than the usually greater economy requirement.

The core scenario view of the Gone Green and Slow Progression scenarios mostly hold the interconnectors at low to no power flow at winter peak, so the boundary requirements not change much from today's requirements. With new generation and interconnectors connecting within the boundary the sensitivities for this boundary become the driving force for future requirements.

Last year's scenarios contained some new generation that connected around 2022, which can be seen by the increase in requirements, but this new generation is not expected in the 2013 scenarios.

The capability of the boundary today is around 9,000MW exporting away from the Thames Estuary area. Limiting factors contributing to this capability are circuit thermal loading capabilities for the circuits out of the boundary into London and voltage depressions at the southern substations if there is a fault on the nearby 400kV double circuit.

3.9.SC1  
Boundary SC1 – South Coast

Figure BSC.1  
Geographic representation of boundary SC1

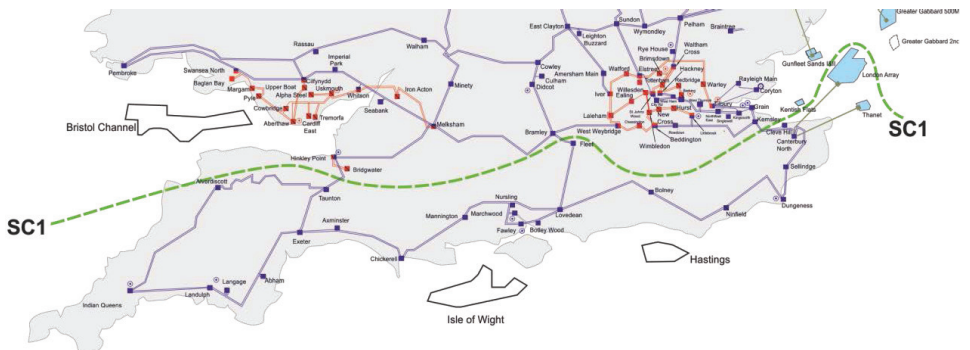

The South Coast boundary SC1 runs parallel with the south coast of England between the Severn and Thames Estuaries. At times of peak winter GB demand the power flow is typically north to south across the boundary with more demand enclosed in the south of the boundary than supporting generation. Interconnector activity can significantly influence the boundary power flow. The current interconnectors to France and to the Netherlands connected at Sellindge and Grain respectively. Crossing the boundary are three 400kV double circuits with one in the east, one west and one in the middle between Fleet and Bramley.

*Figure SC.2  
Required transfer and base capability for boundary SC1*

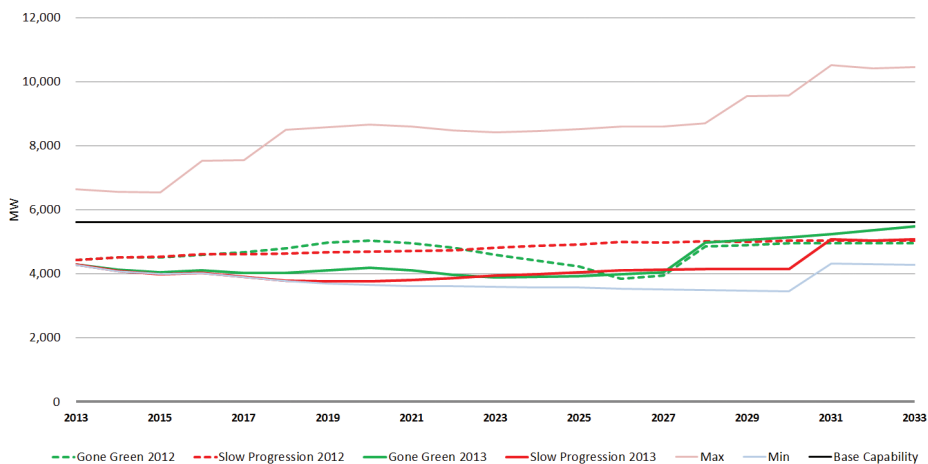

### Boundary requirements and capability

For the base scenarios with default interconnector flows the boundary requirements remain relatively constant with 4 to 5 GW import needs. The large peaks in required transfer seen from the graph above are from the sensitivities cases of the interconnectors set to exporting conditions. The base scenario boundary requirements with the interconnectors not transferring power are relatively benign.

As with other southern boundaries the capability is limited by the south east circuits from Kemsley to Lovedean. If there is a fault along this circuit which disconnects the string from one end the demand (including interconnectors) is fed by the remaining long circuits causing large voltage drops. The situation is fine when the interconnectors import from Europe but under the export conditions and high local demand is the situation of most stress.

## 3.10

## Western Boundaries

**Western Boundary Introduction**

The western region covers the remaining boundaries on the system including Wales, the midlands and the south west. Some of the boundaries are closely related such as those for north Wales but the region also covers large wider boundaries such as B9 and B12.

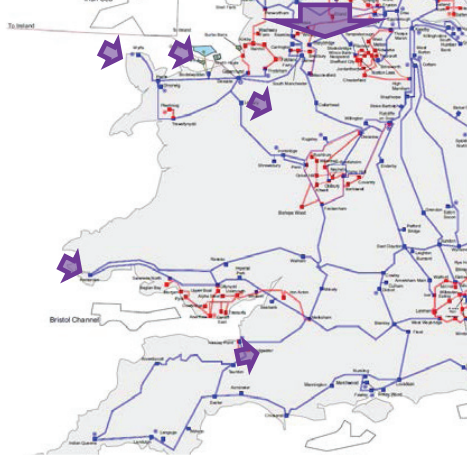
**Primary Challenge Statement:** Rapidly growing North

to South power flows, increasing generation in Wales and new nuclear generation in the South West drives power through Midlands (where various plant closures happen) and the south coast causing heavy circuit loading and voltage depressions.

**Regional drivers**

As the generation continues to increase in the north and wind and nuclear generation connect to the West England and Wales, the network in this region will see:

- Limitation on power transfer through Midlands (B7a, B8, B17).
  - As generation increases in the north, the large demand in Midlands and further south of the country creates the increasingly high north to south power flows through the networks around Midlands. These heavy power flows will stress the transmission routes in the future and may potentially put these routes close to their thermal capability.
- This leads to the need to develop the network around Midlands to ensure there will be sufficient thermal capability to sustain the future increase in power flows through the region.
- Limitation on power export from North Wales (NW1, NW2, NW3, NW4).
  - Large amount of generation, predominantly wind and nuclear, is expected to connect to North Wales. The transmission network in the area is connected by only a few 400kV circuits with limited capacity.
  - Further increase in generation in the area will see need of network development to create new transmission capacity in the area for exporting excess generation to the rest of the system.
- Limitation on power transfer from South West England to South East England (B12, B13).
  - As wind and nuclear generation connects to the South West England, the generation in the area may exceed the amount of demand at time of GB system peak and result in increasing power flows towards the high demand area in South East England.
  - As the two areas are only connected by a few long transmission routes, it is important to ensure future network development in the area will create the thermal capacity required for west to east power flow during interconnectors export operation.

**North Wales – Overview**

The onshore network in North Wales comprises a 400kV circuit ring that connects Pentir, Deeside and Trawsfynydd substations. A 400kV double circuit spur crossing the Menai Strait and running the length of Anglesey connects the nuclear power station at Wylfa to Pentir. A short 275kV double circuit cable spur from Pentir connects Dinorwig pumped storage power station. In addition, a 275kV spur traverses north of Trawsfynydd to Ffestiniog pumped storage power station. The majority of this circuitry is of double circuit tower construction. However, only a single 400kV circuit connects Pentir to Trawsfynydd within the Snowdonia National Park, which is the main limiting factor for capacity in this area.

Figure NW1  
Geographic representation of North Wales boundaries

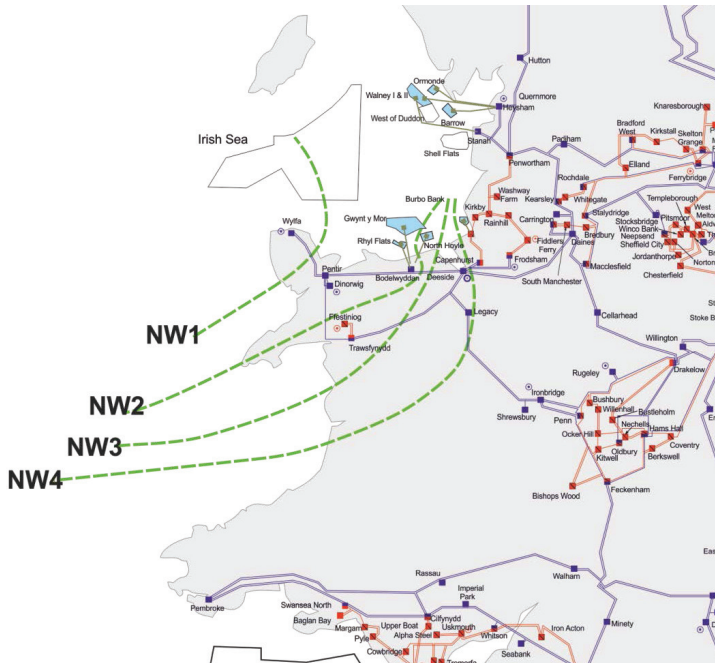

3.10.NW1  
Boundary NW1 – Anglesey

Figure NW1.1  
Geographic and single line representation of boundary NW1

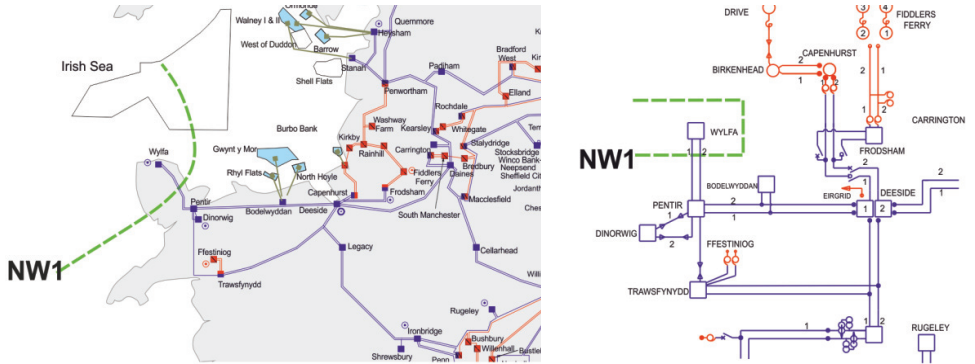

Boundary NW1 is a local boundary crossing the 400kV double circuit that runs along Anglesey between Wylfa and Pentir substations.



Figure NW1.2

Boundary Export and base capability for boundary NW1

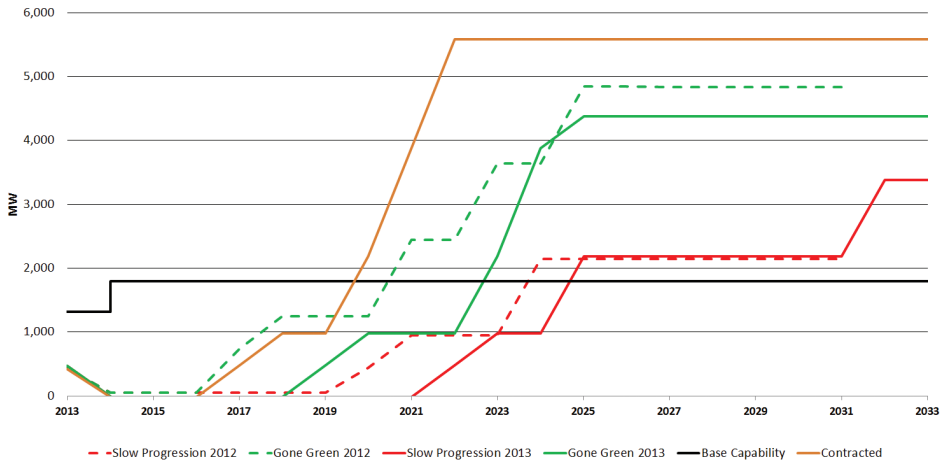

### Boundary requirements and capability

Figure NW1.2 above shows the estimated peak export requirements for boundary NW1 from 2013 to 2033 against the different scenarios. Transfer capability is limited by the infeed loss risk criterion set in the standard which is currently 1,320 MW. From April 2014 this limit will change to 1,800 MW. If the infeed loss risk criterion is exceeded, reinforcement of the boundary will be necessary by means of adding a new transmission route across the boundary.

3.10.NW2  
Boundary NW2 – Anglesey and Caernarvonshire

Figure NW2.1  
Geographic and single line representation of boundary NW2

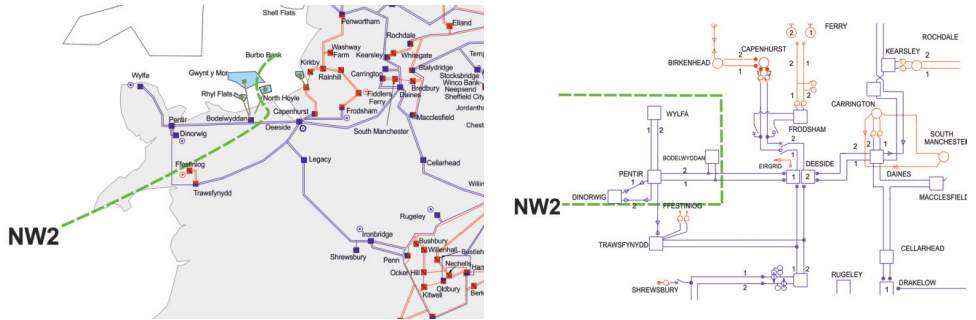

This local boundary bisects the North Wales mainland close to Anglesey and as shown in Figure NW2.1 above, crosses through the Pentir to Deeside 400kV double circuit and Pentir to Trawsfynydd 400kV single circuit.

*Figure NW2.2*  
*Boundary Export and base capability for boundary NW2*

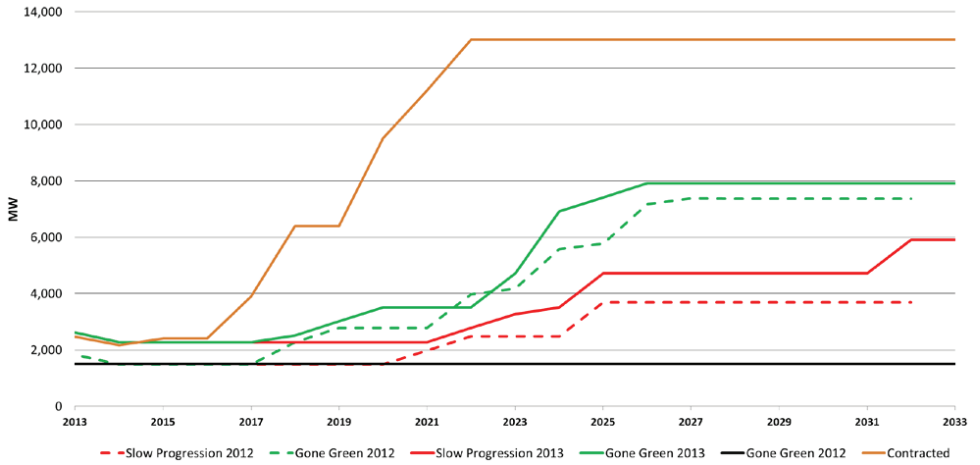

### Boundary requirements and capability

Figure NW2.2 above shows the estimated peak exports for boundary NW2 from 2013 to 2033. The existing boundary capability is 1.5 GW, limited by the single circuit connecting Pentir to Trawsfynydd for a fault outage of the Pentir-Bodelwyddan-Deeside double circuit.

3.10.NW3  
Boundary NW3 – Anglesey and Caernarvonshire and Merionethshire

Figure NW3.1  
Geographic and single line representation of boundary NW3

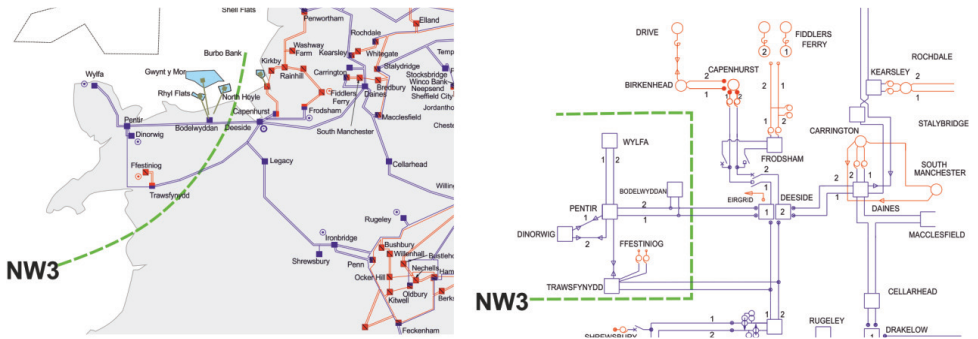

Boundary NW3 provides capacity for further generation connections in addition to those behind NW1 and NW2. The boundary is defined by a pair of 400kV double circuits from Pentir to Deeside and Trawsfynydd to the Treuddyn Tee. Figure NW3.1 above illustrates the boundary NW3.

Figure NW3.2

Boundary Export and base capability for boundary NW3

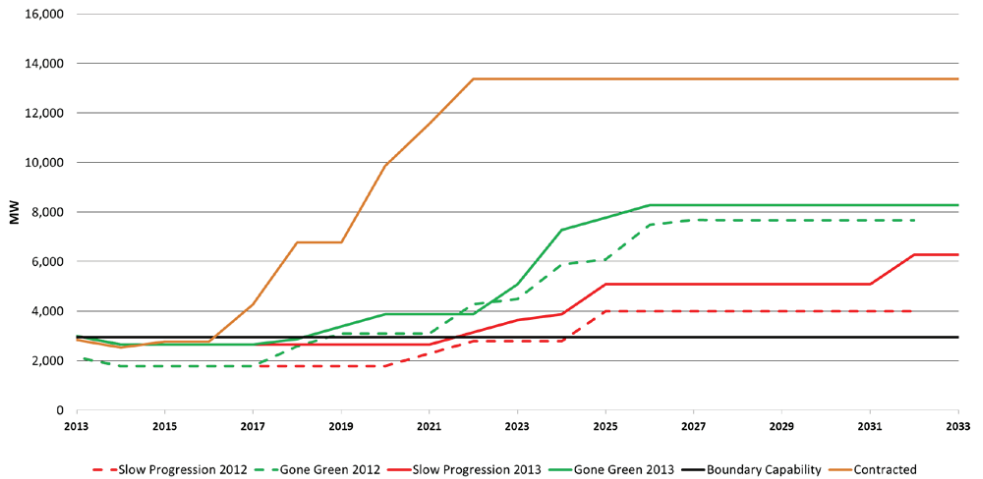

### Boundary requirements and capability

Figure NW3.2 above shows the estimated peak exports for boundary NW3 from 2013 to 2033. The current capability for boundary NW3 is 2.9 GW, limited by the thermal capability across the Trawsfynnd-Treuddynboundary circuits.

3.10.NW4  
Boundary NW4 – North Wales

Figure NW4.1  
Geographic and single line representation of boundary NW4

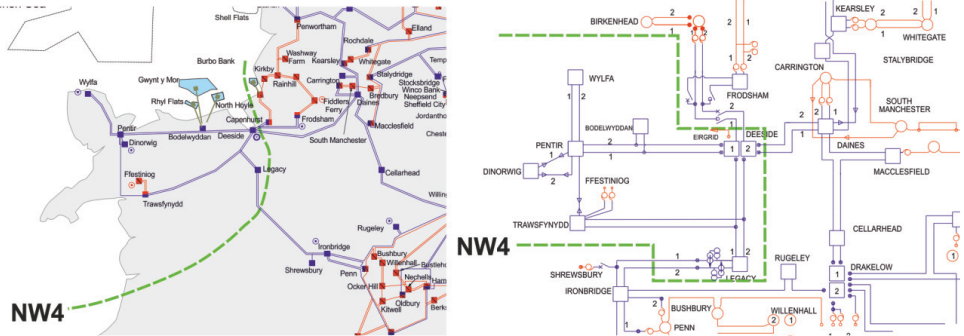

Boundary NW4 cover most of North Wales and close to the limit of being considered as either a local or wider boundary. As there is not much generation and demand enclosed by the boundary now it is currently considered as a local boundary. As the developments in the enclosed area happen the boundary may move to become wider system boundary.

*Figure NW4.2*  
*Boundary Export and base capability for boundary NW4*

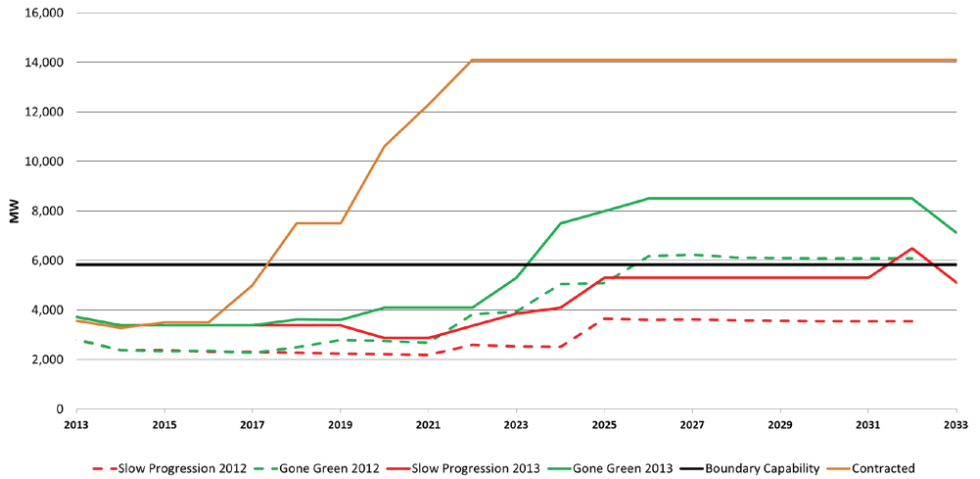

### Boundary requirements and capability

Figure NW4.2 above shows the estimated peak exports for boundary NW4 from 2013 to 2033.

The NW4 boundary is limited thermally by a Cellarhead-Daines and Cellarhead-Macclesfield double circuit fault. The capability is limited to 5.8GW and the overloads are in the South Manchester area.

---

3.10.MW1  
Boundary MW1 – Mid Wales

---

*Figure MW1.1*  
*Geographic representation of boundary MW1*

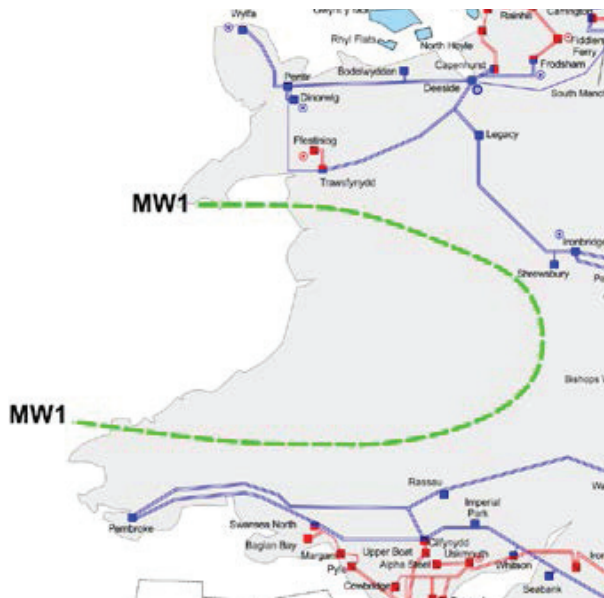

Boundary MW1 is a new local boundary, representing an area in which new wind farm capacity intends to connect to the NETS. Presently there are no transmission circuits crossing central Wales for this new generation to connect to, as there are no large generators or demand points requiring them. The prospective new wind farm capacity is beyond the capability of the current distribution network so will require new circuit capacity to enable its connection.

At this time a preferred substation location and route for the wind farm connections has been identified, although consultation is on-going. Additional details on this project are available on the project website<sup>1</sup>.

---

<sup>1</sup> <http://www.midwalesconnection.com/>



*Figure MW1.2*  
*Boundary Export and base capability for boundary MW1*

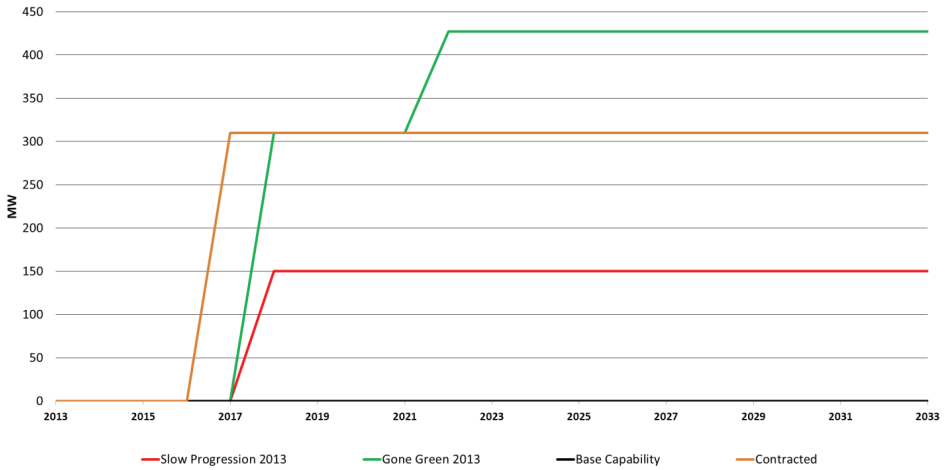

### Boundary requirements and capability

Figure MW1.2 above shows how the mid-Wales wind farm capacity appears in the different scenarios and the resultant export requirement for boundary MW1 from 2013 to 2033. As there is currently no transmission circuits to mid-Wales there is no existing transmission capability out of the area and across the boundary.

---

3.10.SW1  
Boundary SW1 – South Wales

---

*Figure SW1.1*  
Geographic representation of boundary SW1

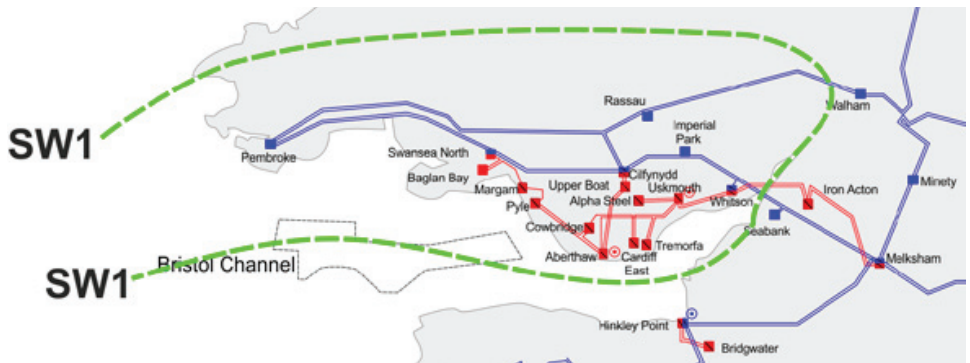

---

Boundary SW1 encloses South Wales and is considered as a local boundary. Within the boundary are a number of thermal generators including Pembroke and Severn Power powered by gas and Aberthaw powered by coal. Some of the older power stations may be expected to close some time in the future but new generation capacity is expected to connect including generators powered by wind and gas.

The South Wales area includes demand consumptions from the major cities including Swansea and Cardiff, and surrounding industry.

---

Figure SW1.2

Boundary Export and base capability for boundary SW1

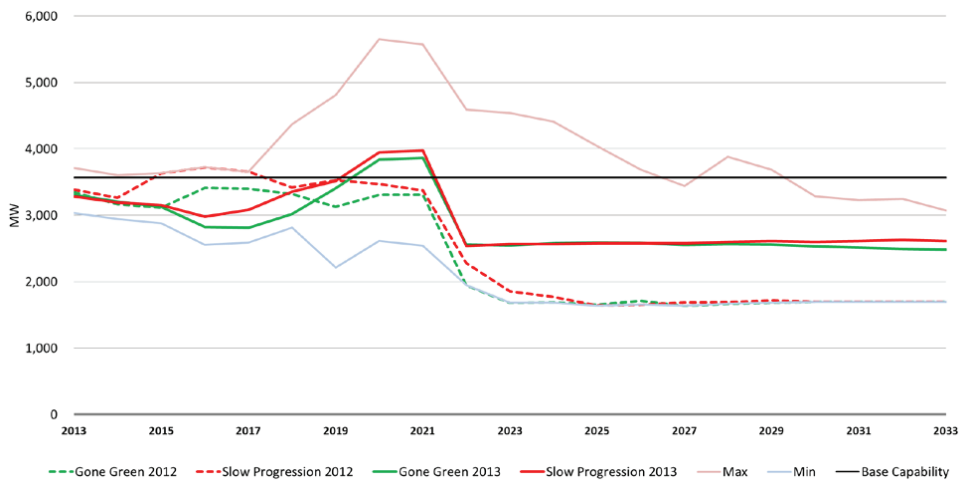

### Boundary requirements and capability

Figure SW1.2 above shows the estimated peak export requirements for boundary SW1 from 2013 to 2033. The high peak in the maximum boundary transfer that can be seen in the graph is from a sensitivity case with high wind power import from Ireland. The decay in boundary requirements beyond 2021 is from a national trend of reducing output and capacity from conventional generators that appears across all scenarios. This is so pronounced in this boundary that the boundary requirements tend to revert to demand security becoming the predominant boundary driver.

The base export capability from this group is around 3.6GW and is limited by the load rating of the 400kV and 275kV circuits crossing the Severn estuary.

3.10.SW2  
Boundary SW2 – Pembrokeshire and Carmarthenshire

Figure SW2.1  
Geographic and single line representation of boundary SW2



Boundary SW2 is considered as a local boundary as it encloses a relatively small part of the NETS.

Figure SW2.2

Boundary Export and base capability for boundary SW2

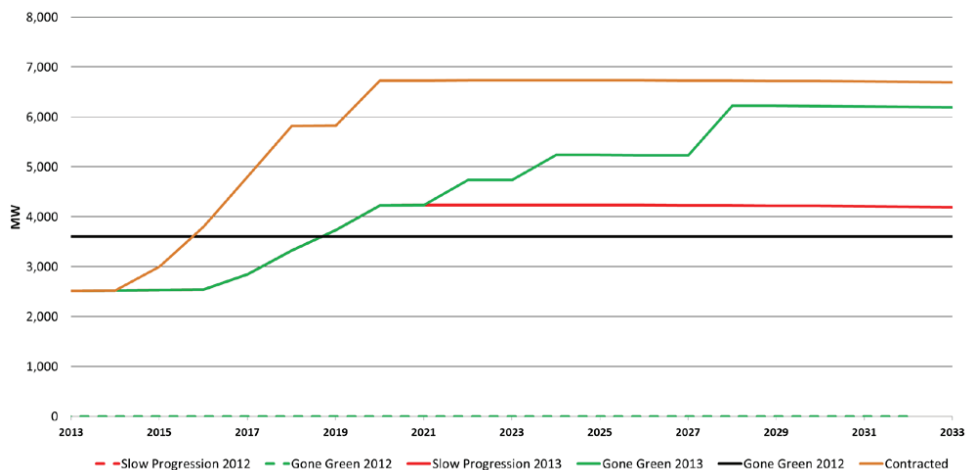

### Boundary requirements and capability

Figure SW2.2 above shows the estimated peak export requirements for boundary SW2 from 2013 to 2033. The capability for this group is 3.6GW and is for a Clyfynnd-Rassau and Rassau-Walham double circuit fault leading to voltage issues at Walham.

The base capability shown is for the whole boundary, and not just the 275kV section in isolation which has a smaller infeed loss-risk and thermal capability.

3.10.8  
Boundary B8 – North to Midlands

Figure B8.1  
Geographic representation of boundary B8

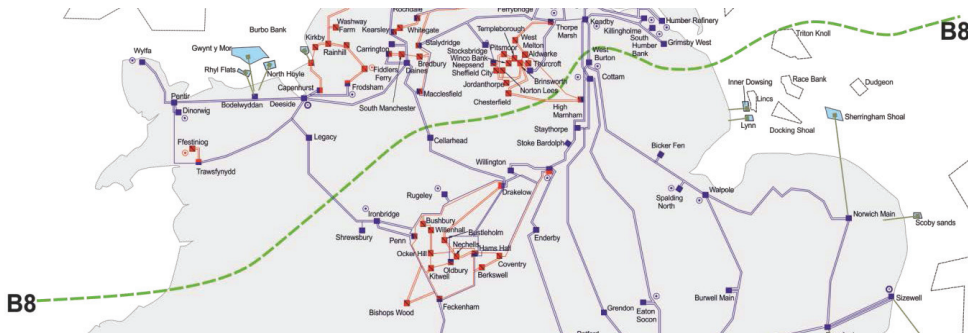

The north to Midlands boundary B8 is one of the wider boundaries that intersects the centre of Great Britain, separating the northern generation zones including Scotland, Northern England and Northern Wales from the Midlands and southern demand centres. The boundary crosses four major 400kV double circuits, with two of those passing through the East Midlands while the other two pass through the West Midlands, and a limited 275kV connection to South Yorkshire.

Generation from Scotland continues to be transported south, leading to the high transfer level across B8. The east of B8 is traditionally a congested area due to the large amount of existing generation in the Humber and Aire valley regions.

The east areas also suffer from high fault levels which constrains the running arrangements of several substations in the area.

**Figure B8.2**  
Required transfer and base capability for boundary B8

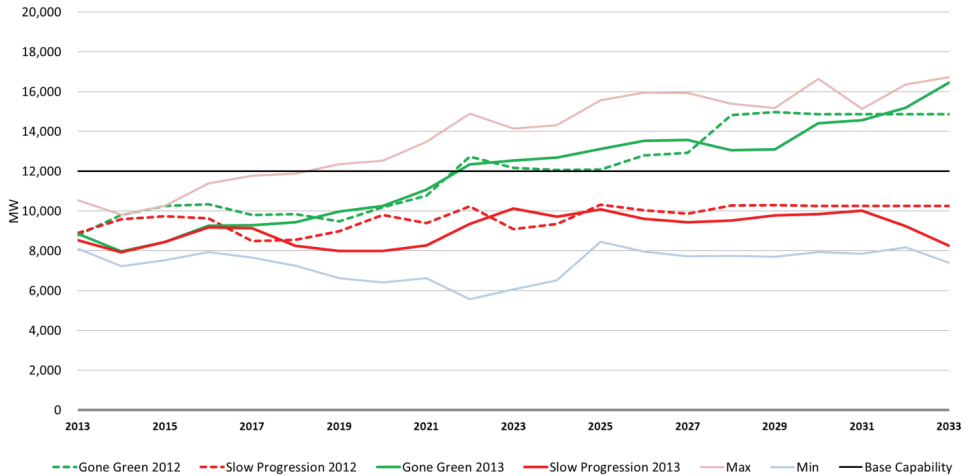

### Boundary requirements and capability

Figure B8.2 above shows the required transfers for B8 from 2013 to 2033. The current boundary capability of 12GW GW and is limited by a thermal constraint. The capability has increased by 700MW from last year as the restriction is no longer voltage related because of the general change in reactive backgrounds. It is now a thermal overload on the Cottam-West Burton circuit for a Keadby-Cottam Double circuit hat removes the Keadby Quadrature boosters from the system.

The future requirements based on the following economy required transfer, only, would suggest that reinforcement is required at earliest between 2019 and 2021.

3.10.9  
Boundary B9 – Midlands to South

Figure B9.1  
Geographic representation of boundary B9

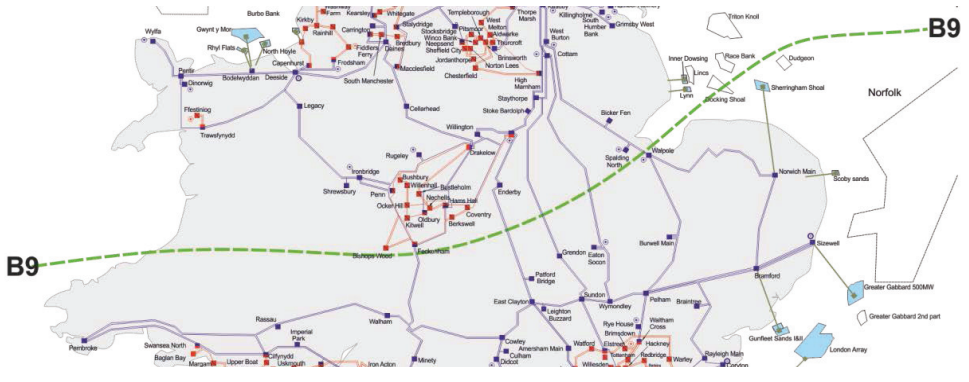

The Midlands to south boundary B9 separates the northern generation zones and the Midlands from the southern demand centres. The boundary crosses five major 400kV double circuits, transporting power from the north over a long distance to the southern demand hubs including London. These long and typically heavily loaded circuits present voltage compliance challenges, which makes delivering reactive compensation support in the right area key for maintaining high transfer capability. Developments in the east coast and the East Anglia regions, such as the locations of offshore wind generation connection and the network infrastructure requirements, will have a significant impact on both the transfer requirement and capability of B9.



*Figure B9.2*  
*Required transfer and base capability for boundary B9*

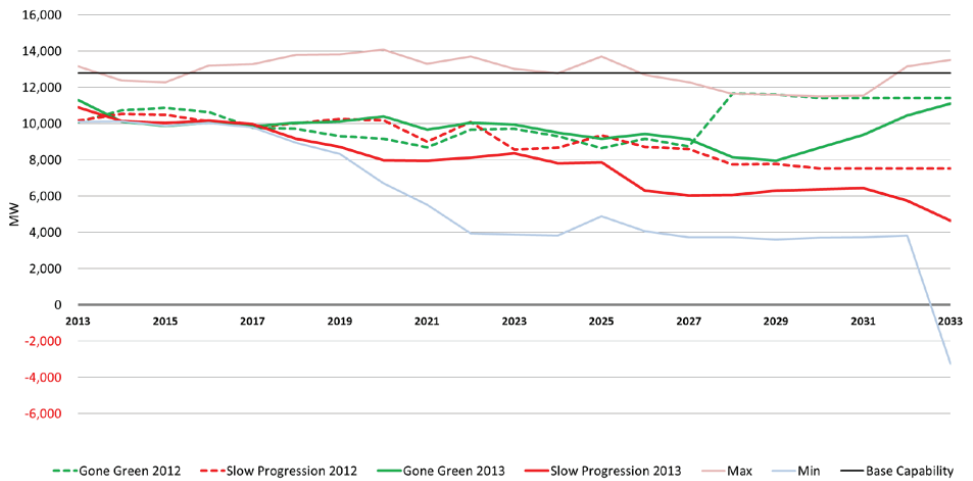

### Boundary requirements and capability

Figure B9.2 above shows the required transfers for B9 from 2013 to 2033. The capability of B9 is limited at 12.8GW for the Pelham-Wymondley and East Claydon-Leighton Buzzard giving rise to a thermal overload of the Sundon-Elstree circuit.

3.10.10  
Boundary B10 – South Coast

Figure B10.1  
Geographic representation of boundary B10

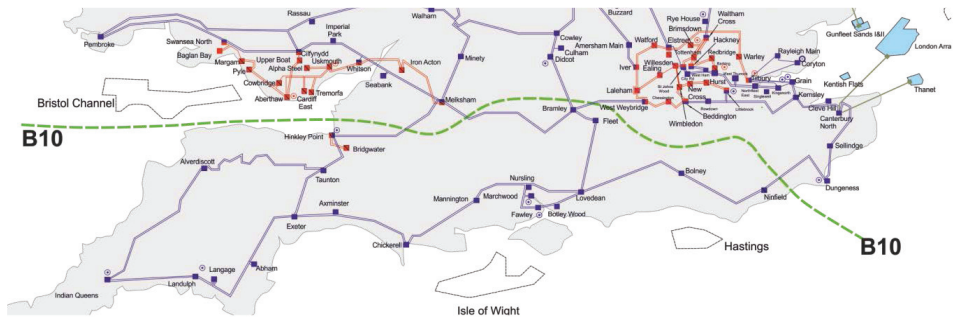

Boundary B10 encompasses the south-west peninsula and the south coast. B10 cuts the four 400kV double circuits from Hinkley Point to Melksham, Ninfield to Dungeness, Bramley to Didcot and Bramley to West Weybridge. B10 is traditionally a heavily importing boundary with higher demand enclosed in the south coast than available generation.

*Figure B10.2*

*Required transfer and base capability for boundary B10*

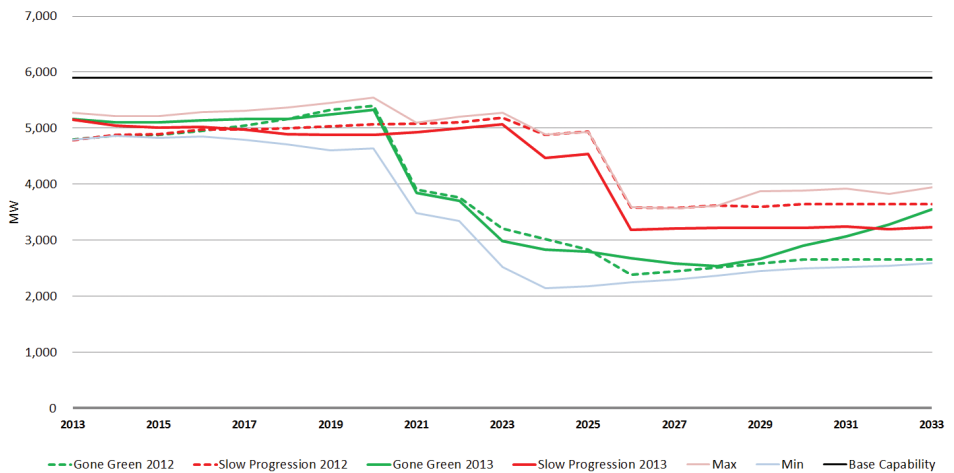

### Boundary requirements and capability

Figure B10.2 above shows the required transfers for B10 from 2013 to 2033. As a predominantly importing boundary with new generation expected to connect, the boundary requirements decrease once the generation connects. There is therefore very little driver from this boundary to change the current network.

This boundary is not effected by interconnector flow as much as the other southern boundaries the cut further east as the French, Belgian and Netherlands interconnectors are outside of this boundary.

3.10.12  
Boundary B12 – South Wales and South West

*Figure B12.1*  
Geographic representation of boundary B12

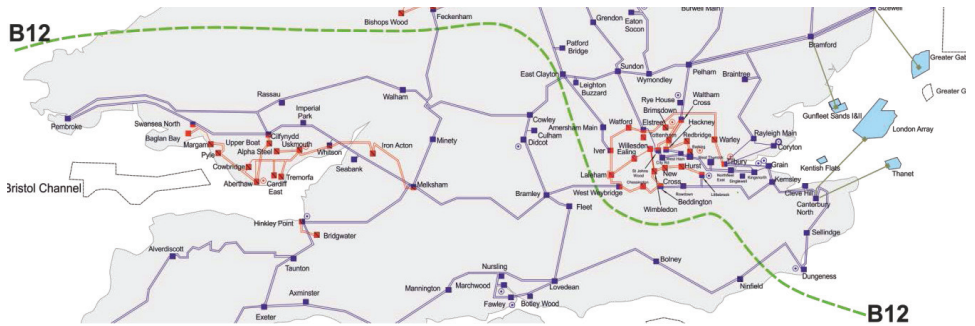

Boundary B12 encompasses South Wales, the south west and a large section of the south coast; with four 400kV double circuits crossing the boundary, Feckenham-Walham, Cowley-Sundon and Cowley-East Claydon, Bramley-West Weybridge and Dungeness-Ninfield circuits. There is a large volume of both demand and generation within the boundary. Existing generation is mostly thermal, at locations such as Pembroke, Fawley and Didcot and large nuclear units at Hinkley Point. The boundary is generally assumed to import in winter peak conditions.

Figure B12.2

Required transfer and base capability for boundary B12

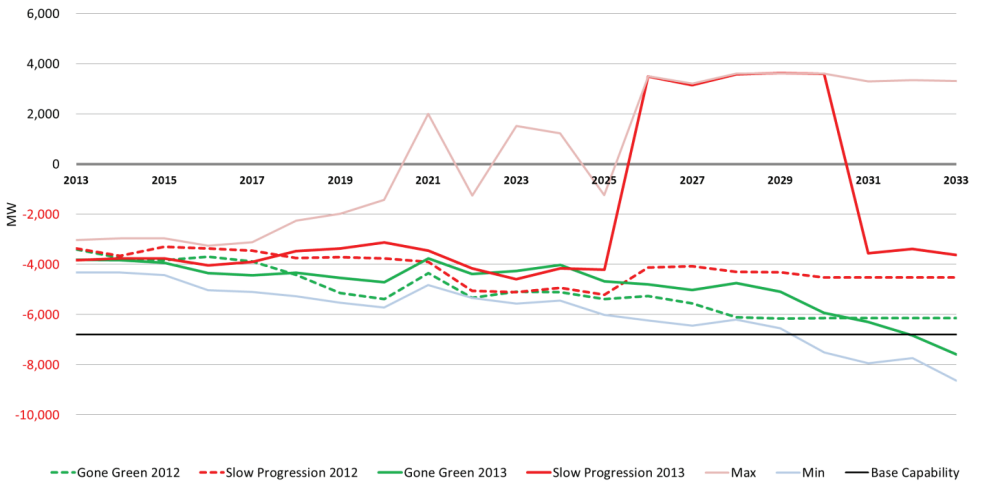

### Boundary requirements and capability

Figure B12.2 above shows the required transfers for B12 from 2013 to 2033. The plots show that over the next few years the importing nature of the boundary persists with very little deviation in requirement across the scenarios and sensitivity cases.

Only a small proportion of the generation currently or proposed to be constructed within this boundary is of renewable nature. This leads to the situation of the NETS SQSS Chapter 4 Security Criteria becoming the dominant driver for some of the later years and scenarios pushing the boundary to see export conditions. This is most obvious for the Slow Progression scenario between 2026 and 2030.

Today's boundary capability of B12 is sufficient to cater for the range of scenarios and sensitivities considered for at least the next ten years. The limiting factor restricting the capability is the maintenance of voltage limit compliance along the Dungeness to Bolney circuits for faults along those circuits. Any significant additional demand along that particular circuit string may reduce the total boundary capability and prove troublesome to accommodate.

3.10.13  
Boundary B13 – South West

Figure B13.1  
Geographic and single line representation of boundary B13

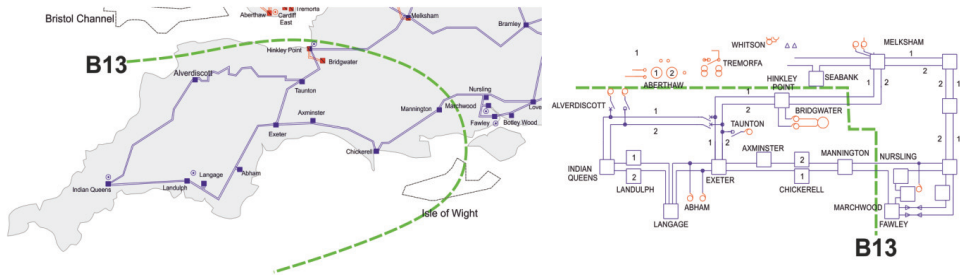

Wider boundary B13 is defined as the southernmost tip of the UK below the Severn estuary, encompassing Hinkley Point in the South West and stretching as far east as Mannington. It is characterised by the Hinkley Point to Melksham double circuit and the Mannington circuits to Nursling and Fawley. It is a region with a high level of localised generation as well as local zone demand. The boundary is currently an importing boundary with the demand being higher than the generation at peak conditions. With the potential connection of new generation connecting to the south west, including new nuclear and wind generation the boundary is expected to change to export more often than import.

*Figure B13.2*

*Required transfer and base capability for boundary B13*

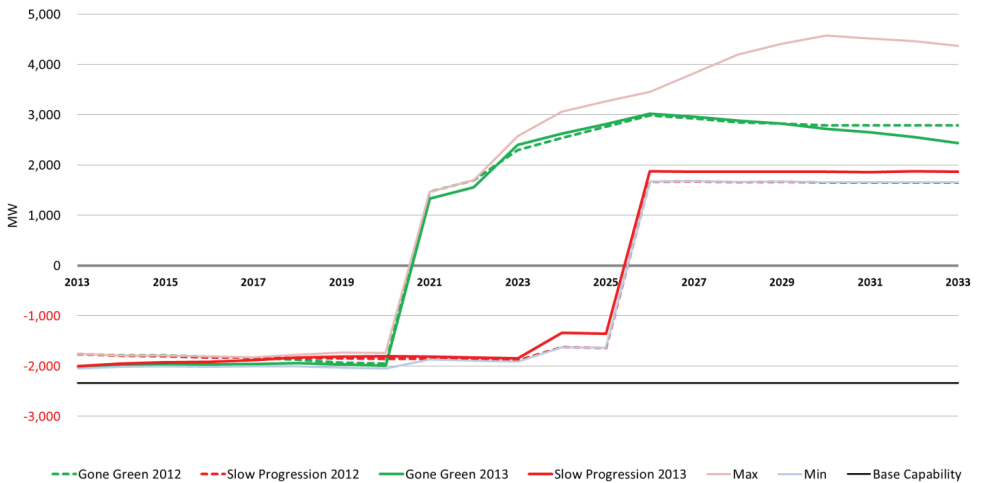

### Boundary requirements and capability

Figure B13.2 above shows the required transfers for B13 from 2013 to 2033. It can be seen that until new generation connects there is very little variation in boundary importing requirements and the current importing boundary capability is sufficient to meet the short-term needs.

With the new generation contracted to connect within this boundary the boundary power flow can be expected to change from importing to export at winter peak. Due to the large size of the potential new generators wishing to connect close to this boundary and the limited rating and distribution of the existing circuits, an additional circuit route is expected to be required crossing this boundary.

3.10.17  
Boundary B17 – West Midlands

Figure B17.1  
Geographic and single line representation of boundary B17

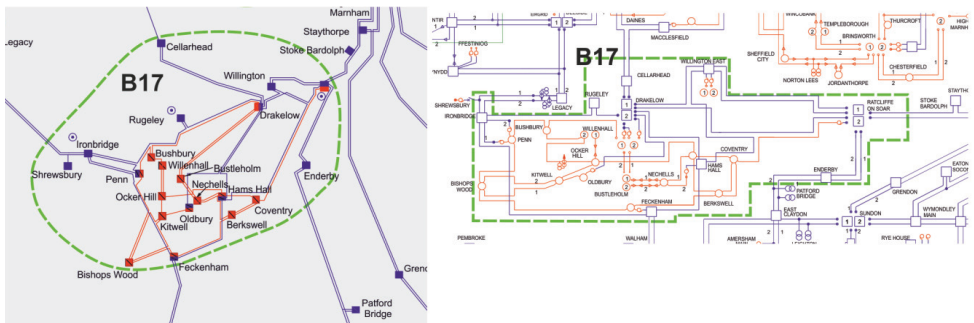

Enclosing the West Midlands, Boundary B17 is heavily dependent on importing power from the north to meet within boundary demand due to a lack of local generation. Boundary B17 is surrounded by five 400kV double circuits but internally the circuits in and around Birmingham are mostly 275kV. Much of the north to south power flows seen by boundaries B8 and B9 also pass straight through B17, putting significant loading on these circuits that is not apparent on this boundaries requirements.



Figure B17.2

Required transfer and base capability for boundary B17

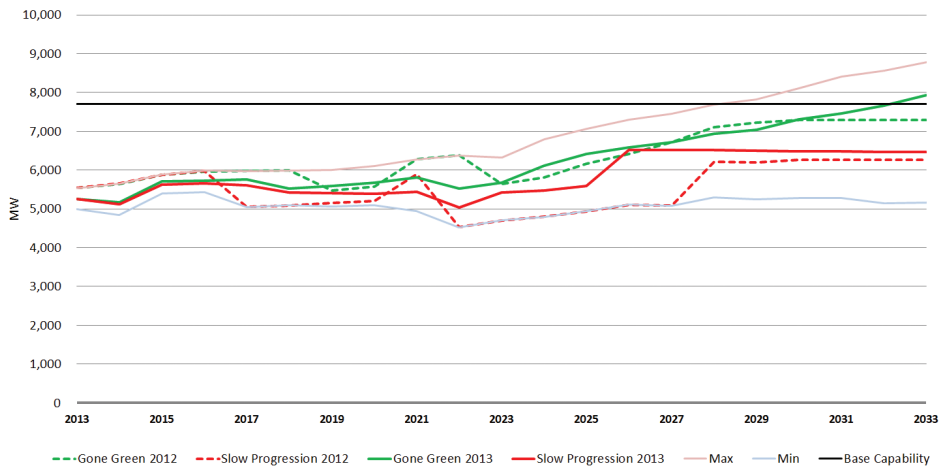

### Boundary requirements and capability

Figure B17.2 above shows the required transfers for B17 from 2013 to 2033. The required transfers resultant from the scenarios suggest a general increase in importing boundary requirements in later years beyond 2021. This can be explained, not by significantly increasing local demand but by reducing output from the enclosed thermal generation.

Reduced availability of local thermal generation causes problems for this boundary in that reactive power support to maintain voltage compliance is also reduced decreasing the boundaries capability so support local demand. Some relief to maintaining voltages at times of high demand is given by the gradually decline in reactive power demands seen by the system as discussed in Chapter 2.

Increasing north to south power flows in the circuits crossing this boundary also work to reduce the boundary capability. Particularly limiting are the circuits entering Cellarhead from the north and the Shrewsbury circuits on the west.

## Stakeholder Engagement

---

In this chapter we presented how the transmission system requirements could develop over the next twenty years against the FES.

If you wish to discuss this further then please contact us at: [transmission.ety@nationalgrid.com](mailto:transmission.ety@nationalgrid.com)

### Stakeholder Engagement

Your views on the representation of offshore and onshore connections are welcome.

### Stakeholder Engagement

We would welcome feedback on the use of boundaries as a means of representing transmission network capability and requirements.

# Network Development and Opportunities

---



## 4.1 Introduction

This chapter brings focus to how the National Electricity Transmission System (NETS) can be developed in response to the drivers presented in the previous chapter. A range of potential solutions are presented and consideration is given to opportunities that may be available for current and future users of the electricity transmission system.

In meeting future transmission requirements, a range of potential asset, operational and commercial solutions have been identified which could fulfil these needs. Opportunities that these present to stakeholders have been highlighted. It is recognised that the practicality of delivering some of these reinforcement solutions can give rise to significant lead-times due to consents, system access and construction coordination.

The responsibility to determine which transmission developments to progress lies with the relevant transmission owner. The decision to invest however is made with input from the many stakeholders including the National Electricity Transmission System Operator (NETSO), customers and government departments.

The decision to progress transmission works that directly relate to individual customer connections are less complex compared to wider works. The single user enabling works must progress to allow that user to connect to the NETS and in time to meet the agreed connection date. When multiple connections are involved, as with wider transmission works, the decision to invest is more complex. The triggering events coinciding become less certain with an increasing number of parties developing projects in a given area. To support investment decisions for wider works, National Grid, as the England and Wales onshore transmission owner has developed the Network Development Policy (NDP). This policy, approved by Ofgem only applies to England and Wales and is described later in this chapter. Similar principles are also applied by the other transmission owners in delivering need and timing for reinforcement in their area.

In this chapter, the potential physical onshore and offshore transmission reinforcements have been split into six regional groups, with related projects grouped into the same region. There are, however, some large reinforcements that span multiple regions. Where this occurs, these reinforcements have been highlighted and the benefits provided to the multiple regions have also been demonstrated. The regions used in this chapter relate to the geographically grouped boundaries from the previous chapter.

A geographical representation, of the six regions (Scotland SHE Transmission, Scotland SP Transmission, North England, West England & Wales, South England and East England) is shown in figure 4.1 below.

The colour codes applied to various regions, as shown in Figure 4.1, are applied throughout this chapter to help identify information relevant to the respective regions.

**Figure 4.1**  
*Region Map*

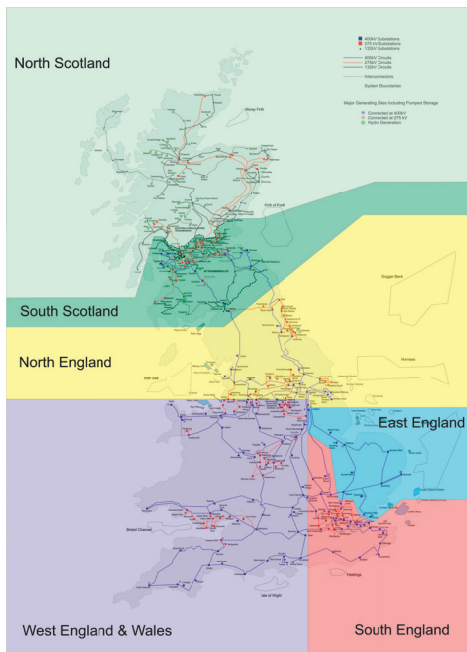

The following sections help describe a number of the important factors considered in making investment decisions. To the end of the chapter, a large summary sheet for each region has been provided.

At the end of this chapter, large summary sheets corresponding to each of the regions above are presented. These bring together the regional drivers, reinforcement options and investment decisions.

## 4.2

## Overview of Transmission Solution Options

### 4.2.1 Transmission Solution Options:

To ensure that economic and efficient investment decisions are made, a range of credible solutions are identified and developed to a stage where the necessary information required to support the investment decision is available in a timely manner.

This first stage of the process is to identify a credible range of potential transmission solutions that provide additional transmission network capability across the transmission boundaries being considered.

In undertaking this review we not only consider new schemes but take the opportunity to review in-flight schemes, to ensure we are always making the most economic and efficient decision at any given time.

Consideration is given to commercial, operational and asset solutions (either onshore, offshore or a combination of both). Individual solutions and a combination of solutions are considered when testing if boundary capability constraints are reduced.

The range of solutions identified should be sufficiently wide, including both small-scale reinforcements with short lead-times as well as large-scale reinforcements that may have longer lead-times. An important factor of the reinforcement considered is the increase in incremental network capability and cost. Transmission solutions are presented in table 4.1 below in order of increasing likely cost.

**Table 4.1**  
*Potential Transmission Solutions*

Category	Transmission Solution	Nature of Constraint			
		Thermal	Voltage	Stability	Fault Levels
Low Cost Investment (Operational)	Coordinated quadrature booster schemes	✓	✓		
	Automatic switching schemes for alternative running arrangements	✓	✓	✓	✓
	Dynamic ratings	✓			
	Enhanced generator reactive range through reactive markets		✓	✓	
	Fast switching reactive compensation		✓	✓	
Commercial	Availability contract	✓	✓	✓	
	Inter-tripping	✓	✓	✓	
	Reactive demand reduction		✓		
	Generation advanced control systems	✓	✓	✓	
Asset Investment (Onshore / Offshore)	Hot-wiring overhead lines	✓			
	Overhead line reconductoring or cable replacement	✓			
	Reactive compensation (MSC, SVC, Reactors)		✓	✓	
	Switchgear replacement	✓	✓	✓	✓
	New build (HVAC / HVDC)	✓	✓	✓	✓

### Operational Options

Changes to operational policies and procedures may provide additional capability to the transmission system. An example would be a move to provide significantly increased Quadrature Booster actions following a fault. This would allow power to be redistributed more effectively following a fault and possibly mitigate circuit overloading. Changes to operational policies and procedures will be developed in response to system requirements.

If you would like to learn more about these potential options, please see Chapter 5 later in this document.

### Commercial Options

In order to provide a more economic and efficient electricity transmission system, National Grid as the NETSO explores commercial, non-build transmission solutions to help resolve potential transmission system issues at any given time.

Examples of non-build transmission solutions include demand side management, inter-trips and reactive power services. It is anticipated that these commercial, non-build options could potentially negate the need for asset investment and construction. As we continue to develop opportunities in this area, further stakeholder discussion will be required.

If you would like to learn more about these potential opportunities, or believe you would be able to offer such a service to National Grid, please see section 4.3 later in this chapter.

### Onshore Options

Increasing the capability of the transmission system by the construction of major new infrastructure could be achieved through different options; such as reinforcing existing routes, use of new technologies or developing new routes. We carry out robust analysis of the options to meet the need case. The analysis is presented to the public and other stakeholders in the local communities.

In carrying out the options analysis, two primary principles set out in the Electricity Act 1989 and the transmission licences are applied:

- To develop an economic, efficient and coordinated transmission system.
- To have due regard to the environment.

With regard to the second of these principles, National Grid maintains a stakeholder, community and amenity policy which defines the commitments when undertaking works. In accordance with this policy, construction of electricity lines along new routes, or above ground installations in new locations, will only be perused as an option where:

- The existing infrastructure cannot be technically or economically upgraded to meet system security standards and regulatory obligations.
- Forecast increases in demand for electricity will not be satisfied by other means.
- New customer connections are required.

All reinforcement needs are assessed using these criteria which lead to the following approach for considering high-level network options.

*Figure 4.2*  
*High-level Network Options Considerations*

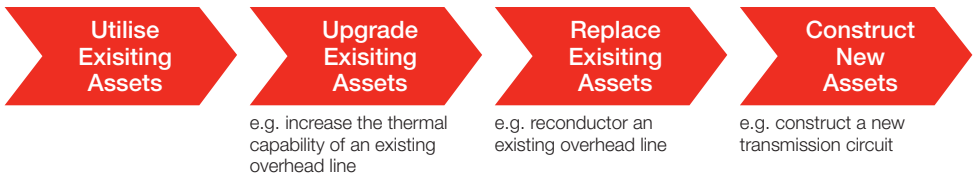

Figure 4.2, which presents our logic chain for selection of network options shows that the use of existing assets to meet the needs of customers is the first considered option. If this is not possible, the upgrade of existing assets, employing techniques such as “hotwiring” circuits or potentially employing SMART technologies to increase utilisation of existing assets will be considered. Beyond that, the replacement of existing assets with assets of a higher capability, such as reconductoring an existing overhead line with higher rated conductor, or replacing a transformer with a higher rated model will be considered. The construction of any major new infrastructure will only be taken forward if, after careful consideration, it remained the only viable option to meet future network requirements.

Where there is a defined need case to improve the transmission system beyond the capability of existing assets such that new assets need to be installed, the various options for resolving the limitation are considered in detail. Stakeholders are consulted widely over what options have been considered as part of the planning process.

In developing these solutions, the replacement priority of any existing transmission assets are considered and aligned wherever possible. If an asset is to be replaced in the relevant timescales, then the marginal cost associated with rating enhancement, rather than the full cost of replacement and enhancement will be calculated.

### Offshore Options

When considering the connection of offshore generation, particularly from the large offshore wind zones, two different design philosophies have been considered.

- **Radial** – A point-to-point connection from the offshore substation to a suitable onshore collector substation, utilising currently available transmission technology.
- **Coordinated** – A coordinated onshore and offshore design approach, with AC cables and HVDC interconnection between offshore platforms and development zones. This is optimised for an economic and efficient holistic design.

Figure 4.3 shows how the different design strategies affect the design of an illustrative 4GW offshore wind farm development. The network design is developed to be delivered in a staged approach to ensure timely investment and minimise stranding risk. Interconnection between the offshore platforms occurs at a later stage (shown as stage two in figure 4.3) of the coordinated design strategy.

**Figure 4.3**  
*Radial and Coordinated Offshore Connection*

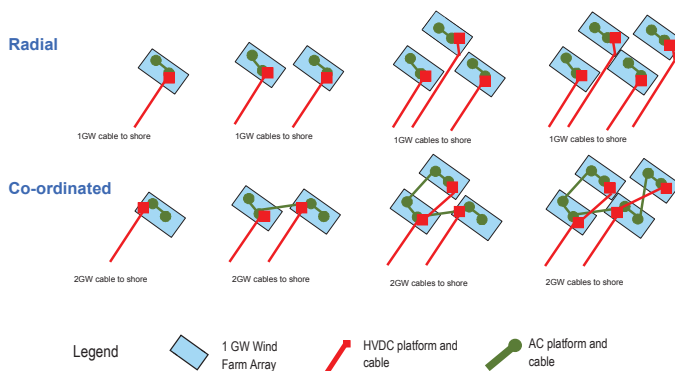



In the event of the loss of any single offshore cable, the coordinated design strategy provides an alternative path for the power to the onshore collector substation. Whilst there may not be sufficient transmission capacity to accommodate the full generation output following an outage, there should be sufficient capacity to cover the majority of the output. If the onshore connection points are separate, then interconnection offshore by the co-ordinated design provides a new transmission path between the two points. If at least one of the circuits is of HVDC construction, which is highly likely for the offshore connections – then the flow of power is directly controllable. This capability is very useful for network operation as both onshore and offshore power flows can be operationally controlled by the influence of the HVDC circuits. Thus providing additional resilience which is not catered for in radial designs.

In addition to local offshore interconnection, the larger offshore generation areas within reasonable distance of each other may offer interconnection opportunities and share onshore collector substation capacity.

HVDC systems, particularly the modern VSC designs, allow for direct active control of the power passing from one end to the other of DC circuits. When combined with offshore interconnection and the parallel operation with the onshore system, the opportunity arises to benefit the onshore power flows. By boosting or restricting power flow along the offshore HVDC circuits, power flow in the AC onshore system may be directed away from areas of electrical constraint. This active power control is a distinct advantage over more traditionally passive AC circuits.

Various Round 3 offshore wind zones present opportunities to develop co-ordinated offshore connection. These opportunities are discussed further in section 4.2.2.

### **General Consideration for Transmission Solution Options**

The process of developing and implementing any transmission strategy will be subject to an inclusive and robust optioneering process in order to evaluate various transmission options and to agree an optimum solution. In this assessment there is a need to balance the conflicting priorities of network benefit, cost and build programme with their associated risks. Co-operative work between all the parties involved is the key to ensuring the timely delivery of an overall economic and efficient network solution for consumers.

### **Strategic Optioneering**

In looking for solutions to develop the NETS we consider both onshore and offshore transmission solutions. We do however recognise there are a number of considerations in taking forward offshore options.

It is recognised that many of the technologies required for wider works are new and developing rapidly. Voltage Sourced Converter (VSC) HVDC technology was introduced in 1997 and since then has been characterised by continuously increasing power transfer capabilities. Significant developments have taken place in the area of DC cables including the introduction of extruded and Mass Impregnated Polypropylene Paper Laminate (MI PPL) insulation technologies. New devices are emerging, such as the HVDC circuit-breaker. The present document aims to anticipate how the capability of the key technology areas for wider works might develop in coming years and provide an indication of technology availability by year in order to inform investment decisions.

Matrices are presented, in Appendix E, for each of the key technology areas we have considered in developing wider work options. These tables show the timelines in which the technology will be available for in service use.

In the “generator connection offer” phase for an offshore connection we will base our design and costs in accordance with the information available in Appendix E. On signature of the agreement we will work with that developer through the CION to further develop these assumptions. We will continue to evaluate the need for the wider works options via the NDP.

Future generation connections, especially in the form of nuclear and renewables, are likely to trigger major network reinforcements in some regions, either onshore or offshore, and the required planning and construction programmes may be extensive. A significant amount of strategic pre-construction work may be required to manage the effective delivery of an overall efficient transmission strategy. It is also important this ability to deliver the overall strategy is not compromised whilst progressing the local connection for individual projects.



Under Connect and Manage (C&M), generation projects are allowed to connect to the transmission system in advance of the completion of the wider transmission reinforcement works. Wherever possible, operational and commercial options will be taken forward to manage the increasing requirements in network capability. This should be consistent with the strategies identified.

As well as identifying the most economic and efficient solution the following factors are also identified for each transmission solution to provide a consistent basis on which to perform the cost benefit analysis.

**Outputs:** The calculated impact of the transmission solution on all affected transmission boundary capabilities, the impact on network security and the forecast impact on transmission losses.

**Lead-Time:** An assessment of the time required to develop and deliver each transmission solution. This comprises an initial consideration of planning and deliverability issues, including dependencies on other projects. An assessment of the opportunity to advance and the risks of delay will also be incorporated. It is recognised that there can be significant lead-time risk for a number of major infrastructure projects (e.g. new overhead lines that require planning consents). In managing these projects, it may be necessary to commit to pre-construction engineering to minimise lead-time when there is sufficient confidence to proceed with a major investment.

**Cost:** The forecast total cost for delivering the project, split to reflect the pre-construction and construction phases. The risk of over spend, for example due to the uncertainty associated with the levels of undergrounding required, will also be quantified to improve the consideration of solutions. A marginally higher mean expected cost may be preferred, if the risk of overspend is significantly reduced.

**Stage:** The progress of a transmission solution through the development and delivery process passes through a number of stages. The stages<sup>1</sup> are as follows:

- **Pre-Construction: Scoping:** The identification of a broad needs case and consideration of a number of design and reinforcement options to solve boundary constraint issues.
- **Pre-Construction: Optioneering:** The needs case is firm and a number of design options have been provided for public consultation so that a preferred design solution can be identified.

- **Pre-Construction: Design:** The preferred solution is designed in greater levels of detail and preparation begins for the planning process.
- **Pre-Construction: Planning:** Continuing with public consultation and adjusting the design as required all the way through the planning application process.
- **Construction:** Planning consent has been granted and the chosen solution is under construction.

In addition, it is possible that some alternative investments will be identified during each investment review. Updates to developments, backgrounds and economics are part of subsequent iterations.

The following sections describe the range of solutions that have been considered for this year's wider system investment review.

<sup>1</sup> Defined as part of the Electricity Network Strategy Group (ENSG) process and published by the Department of Energy and Climate Change (DECC)

#### 4.2.2 Potential Development of a Coordinated Offshore Network

The Round 3 offshore wind programme represents the potential of approximately 37GW of additional offshore generation. A coordinated design approach for these large Round 3 zones, depending upon the timing of volumes of offshore generation could provide alternative transmission solutions to onshore reinforcement. In this section the potential development of a coordinated offshore network in a number of Round 3 zones is discussed.

##### Dogger Bank Zone

There is potential for some 9-12.8GW of offshore wind generation from the Dogger Bank Zone, of which 6GW is presently contracted to connect between 2017 and 2021. Additional offshore generation from the Dogger Bank Zone could be accommodated along the east coast. However, additional transmission capacity across the northern boundaries such as B7 and B7a would be required. The boundaries needing reinforcement would depend upon how far north the connection was to be made. This could be achieved by either onshore or offshore reinforcement. However, by providing an offshore link between distant onshore connection points via the Dogger Bank Zone, it would be possible to provide both transmission capacity to connect the offshore wind and reinforce the main interconnected transmission system. In addition, under onshore or offshore outage conditions, it would be possible to divert power between connection points, thus mitigating the need for further reinforcement in either of these regions. Depending upon the timing of volumes of offshore generation in the Dogger Bank Zone, the integrated offshore network could offer a more economic and environmentally acceptable solution than some of the onshore options described later in this chapter.

##### Hornsea Zone

There is potential for some 4GW of offshore wind generation in the Hornsea Zone, of which 2GW is presently contracted to connect from 2016, south of the Humber region, with the remaining 2GW of capacity contracted to connect in the Wash region by 2023. Additional transmission capacity may be required out of both the EC1 and EC3 group and boundary B8. This could be provided by either onshore or offshore reinforcement. By providing an offshore link between EC1 and EC3 via Hornsea, it would provide transmission capacity to connect the offshore wind to the main interconnected transmission system as well as reinforcing boundary B8. In addition, under outage conditions in either region, EC1 or EC3, it would be possible to divert power to EC3 or EC1 respectively. This would mitigate the need for further reinforcement

in either of these zones. Depending upon the timing and volumes of offshore generation in the Hornsea region, the integrated offshore network could also offer alternative solution and benefits which will be evaluated as part of the ongoing NDP assessments.

##### Dogger Bank and Hornsea Zones

As described above, there is potential for some 13-16.8GW of offshore wind generation in the Round 3 Dogger Bank and Hornsea Zones. Considering these zones in isolation could lead to significantly more investment than if they were considered in an integrated and co-ordinated manner. There is a range of potential solutions available, both onshore and offshore, that can increase the transmission capability across B7, B7a and B8. As this onshore and offshore generation develops, the network solutions will be developed further, ensuring that the proposed solution can be developed incrementally alongside the generators, thus minimising redundancy risk, whilst facilitating future development.

##### East Anglia Zone

The Round 3 East Anglia Zone has the potential for 7.2GW of offshore wind generation capacity. Connection contracts are in place for the full 7.2GW with staged connection dates between 2018 and 2026 to connection points within East Anglia. The connection points are contained within the EC5 boundary. Offshore coordination within the East Anglia Zone can result in increased supply security. The addition of a coordinated connection with Hornsea or Dogger Bank would provide additional boundary capability across the B8 and B9 boundaries. The offshore zone could also be considered for coordination with the Belgian or Dutch projects to provide additional interconnection capacity between the countries.

##### Integrated Offshore Transmission Project (IOTP)

The Integrated Offshore Transmission Project (IOTP) is a joint project between National Grid and the developers of the Dogger Bank, Hornsea and East Anglia projects. This project is considering System Requirements, Technology and Commercial Frameworks.

The benefits of integrated and coordinated offshore designs to help improve transmission boundary capability whilst incorporating flexibility into the existing transmission network, and providing offshore options to avoid potential delays usually associated with onshore reinforcements is being evaluated. This aims to achieve efficient reinforcement of the wider (B7, B7a, B8 and B9) and local system boundaries (EC1, EC3 and EC5) for timely connection of offshore projects.

### South Coast Zone

The two Round 3 projects off of the south coast and south west peninsula of England are Rampion, to the south of Brighton and Navitus Bay, to the south west of the Isle of Wight. There is the potential for some 1.5-1.9GW of offshore wind generation in total from these two zones. As the affected boundaries, B10 and SC1 are generally net importers, it is anticipated that this generation can be accommodated within the zone.

Both of these Round 3 generating zones are close to the coastline. The indicative capacity for each zone is small enough that the use of AC technology is expected to be the most cost effective solution for transmission connection. Connections to existing substations are likely to be the most straightforward option. The low level of existing generation in the area, coupled with local demand requirements, results in only small impacts on load flows and therefore only minor local reinforcements are expected to be required to facilitate these connections.

Due to the large geographic split between these two offshore zones and the pattern of predicted network flows on the south coast circuits, it is unlikely that any offshore links between these zones will be cost effective options to meet any network reinforcement requirements. However, there are other offshore contracted connections from outside these zones that are due to connect to similar regions onshore. However, these further connections will use DC technologies due to the distance from the coast line and it is unlikely that integrating these with the other zones will be economic as it will require combining AC and DC technologies.

### Bristol Channel Zone

There is a single Round 3 zone in the Bristol Channel area, Atlantic Array. There is the potential for some 1.5GW of offshore wind generation in total from this zone.

This Round 3 generating zone is close to the coastline and indicative capacity for the zone is small enough that the use of AC technology is expected to be the most cost effective solution to connect this offshore zone to the onshore network. Although the furthest extent of the zone may be close to the limit of a practical AC circuit connection, the collector network within the zone is unlikely to be such that DC technologies will be necessary. Potential onshore connection points cover both the South Wales peninsula and the south west coast.

Examining boundary requirements for B12 and B13 reveals that connection to the south west coast is preferable as B13 is generally a net importer until the latter years and the generation will help to balance

local demand with a beneficial effect on the required boundary capacity. In addition, the South Wales coastal circuits near Cardiff and Swansea are predominantly 275kV and provide little support for additional generation without replacement or upgrading to 400kV. Adding additional generation to these circuits will increase the B12 transfer requirement.

### Scotland Zone

There are two Round 3 zones in the Scotland area, Moray Firth and Firth of Forth, from which there is the potential for some 4.7-5.2GW of offshore wind generation in total. There are also a number of smaller Scottish territorial water sites with an indicative capacity of some 6.3GW in total, as well as 1.2GW split across a number of sites in the Pentland Firth and Orkney waters strategic marine power development area.

The most significant opportunities for the development of offshore integration lie in the Moray Firth and Firth of Forth zones. These zones may necessitate a requirement for HVDC technology, although the parts of the zones closest to the coastline may only require AC connections. However, a significant requirement for HVDC would present an opportunity for within zone interconnection and thus offset the number of offshore to onshore links, with selected re-optimisation of the rating of some of these links in comparison with the likely radial alternative design.

For the Firth of Forth Zone it is proposed to investigate additional connections offshore to the network in the north east of England. For the Moray Firth zone, a pressing requirement to accommodate renewable generation output from Caithness will be addressed by an HVDC reinforcement planned by SHE Transmission across the Firth between Caithness and Blackhillock in Moray. There may be potential for integration between the offshore windfarms to share their connections to shore but any integration with SHE Transmission's HVDC circuit would be subject to technology compatibility, commercial and timing and considerations for the windfarms and clarification of roles and responsibilities under the evolving transmission licensing arrangements for offshore and onshore transmission.

Initial wave and tidal generation projects in the Pentland Firth and Orkney waters are planned to be connected over AC reinforcements, with the Caithness – Blackhillock HVDC link assumed to have been installed.

Further outline HVDC development options integrating with that circuit, technology permitting, are the basis of accommodating later stages of wave and tidal generation. The widespread nature of the proposed generating sites in the North Scotland Zone gives rise to the possibility of establishing a DC switching station that could connect the mainland network to the Moray Firth, Orkney and Shetland developments, although this would require significant technological innovation and development.

For the west coast of Scotland, the Argyll Array and the Islay developments will both require lengthy HVDC radial circuits to connect to the onshore network. It may be beneficial such that these links interconnect the developments to provide a parallel HVDC offshore transmission route that could provide redundancy to both wind farms and assist in managing the power flow on the onshore AC network, whilst minimising the resultant onshore reinforcement requirements.

#### Irish Sea Zone

There is a single Round 3 zone in the Irish Sea area, off of the north coast of Wales, from which there is the potential for some 4.2GW of offshore wind generation in total. The majority of this zone is within 50km of the shore of Anglesey, so the use of AC technology is considered appropriate. However, the northern parts can be over 60km from the shore, reaching the practical limits of AC cabling and would therefore most likely require a HVDC connection. This northern section is comparatively as close to the Lancashire coast as it is to the North Wales coast, so it is a practical proposition to connect some of the generation to a substation in Lancashire in order to separate the zone across different onshore connection points to help distribute the power infeed from the wind generation thereby reducing the loading impact at specific connection sites. Consideration of the transfer requirements for the North Wales boundaries NW1, NW2, NW3 and NW4 also reveals that alternative connection points away from Anglesey help reduce pressure on these boundaries and mitigate the immediate need for onshore reinforcement.

An integrated design with additional interconnections within the zone could give additional benefits by reducing the number of connections to shore and providing circuit diversity to the offshore generation. Further, it will introduce some additional transfer capability across boundary B7a, either mitigating or deferring the need for additional onshore reinforcement. The use of HVDC technology within this boundary will allow for greater control of power flows which will provide an increased ability to take power from the North Wales area which is traditionally a region of high generation export.

#### Ireland and Irish Territorial Waters

There is interest in connecting significant levels of wind generation both from Irish territorial waters and from the Irish mainland itself. Contractually this totals 10.5 GW from four different developers. The distances involved will require the use of HVDC technology and the indicative capacities will require multiple links to the onshore network, most likely to North Wales, South Wales and possibly beyond into South West England.

There is a range of potential network design solutions, depending on the rate of growth and timing of the generation. A coordinated and integrated design solution is contracted and would allow incremental development, minimising redundancy risk whilst facilitating future development that can incorporate further generation connections. Furthermore, by integrating at the source of these links, it is expected that network transfer can be achieved with the resulting benefit of mitigating major onshore reinforcements compared to a radial approach.

Connection of these network design solutions to the Irish transmission system has also been progressed with EirGrid. The respective TSOs have jointly investigated the benefits of coordinating the infrastructure associated with these renewable wind energy projects and in particular the benefits examined include:

- Increased capacity for cross-border trade.
- Increased sharing of response and reserve.
- Reduction in the total generation capacity required to maintain security of supply.
- Reduction in overall capital costs and environmental impact.
- Future flexibility for network evolution and further integration.

For additional information, please see the joint study conducted with EirGrid that is available on the National Grid website at the following address:

<http://www.nationalgrid.com/uk/Electricity/OffshoreTransmission/Joint+Study+with+EirGrid/>

#### Stakeholder Engagement

We welcome views on the assumptions that we have used for onshore and offshore NETS developments in the ETYS.

### 4.2.3 Technology

This section is National Grid's current view of transmission technology developments and future capability expectations. The shaping of a number of transmission solution options is closely related to these transmission technology developments. For more information on individual technologies please see Appendix E.

#### Technological Solutions

A number of offshore transmission developments that are under consideration, particularly those involving the integration of projects, shall require an increase in the rating of Voltage Source Converters and the size of offshore platforms if multi-lift solutions are to be avoided when higher voltages are used.

#### Developments

Voltage Source Converter (VSC) technology is preferred in offshore applications over the more established Current Source Converter (CSC) alternative due to its ability to function in a network with low system strength as is the case with offshore generation.

From 2016 it is expected that the current ratings for the Insulated Gate Bipolar Transistors (IGBTs) used in VSCs will reach 2000A. Therefore there is a potential for 2.5GW VSC links if these were combined with the highest voltage rated cables available. This would facilitate the full exploitation of VSC technology if compatible offshore platforms are practicable with the increased safety clearances required at a higher operating voltage.

#### Costs

National Grid has engaged manufacturers to obtain costs for:

- HVDC converters, transformers and associated switchgear (both onshore and offshore).
- AC collector stations (offshore).
- AC/DC land and submarine cables.

The EU Consumer Price Index has been applied to values and have been validated against references in Cigre WG B2/B4/C1.17 that provides a formula for scaling the cost of converters. Other complexity factors have been included for platforms and cables based on studies from consultants and on market research.

NGET will continue to engage with developers and manufacturers to comment and provide feedback on cost in order to reduce uncertainty.

#### Stakeholder Engagement

We recognise that the assumptions for technology are a principle input for development of coordinated networks. We would welcome any additional information on these assumptions on cost and availability of technology.

#### Opportunities for Innovation

There is a potential need for reactive power produced by VSCs in excess of minimum requirements located close to the Interface Point with the onshore transmission system. This will be further explored by a Grid Code review group.

#### Onshore Innovations

Series compensation of circuits can enhance transmission capability and system stability. The first installation of series compensation is due on the GB transmission network in 2014/15.

As a result of an international competition organised by the Department of Energy and Climate Change (DECC), the Royal Institute of British Architects and National Grid, the new T-pylon was chosen as a potential alternative to the traditional lattice tower design for overhead circuits. A high temperature, low sag conductor is also available which would facilitate increased power transfers on either tower type.

#### Offshore Innovations

Whilst offshore platforms are used worldwide in the oil and gas industry, their use in electrical transmission, specifically for HVDC is a developing concept in the UK. The main experience in this area has come from the German sector of the North Sea. In the short time they have been used for transmission they have brought about innovative designs such as self-installing platforms.

#### 4.2.4 Planning Consents

The illustrative transmission systems contained in this document do not consider specific requirements for development consent or planning permission. However, such planning permissions will be a key factor in the actual physical development of the NETS. The following section provides a high level overview of the key aspects of the planning process which will be applicable for connecting generation projects to the NETS.

##### England & Wales

In England and Wales, the consenting process for Nationally Significant Infrastructure Projects (NSIPs) is defined in the Planning Act 2008<sup>2</sup>. The Planning Inspectorate<sup>3</sup> is responsible for consideration of development consent applications in respect of NSIP proposals and for making recommendations to the relevant Secretaries of State responsible for deciding whether consent should be granted.

These requirements apply to major energy generation stations (onshore: more than 50MW capacity; offshore: more than 100MW capacity) and electric lines above ground over certain thresholds. UK national policy for NSIPs is set out in a series of National Policy Statements (NPS's)<sup>4</sup>. The Act also imposes requirements on project promoters to consult affected parties and local communities prior to submitting an application and promoters are encouraged to do so early when developing proposals so as to allow projects to be shaped and influenced by consultation feedback.

The Act sets out mandatory pre-application procedures that includes notification, consultation and publicity requirements. NGET will engage and consult affected parties in the development of its projects, demonstrating how local communities' and other stakeholders' views have been taken into consideration. Our commitments in this regard are described in more detail in our Stakeholder Community and Amenity Policy<sup>5</sup> that also outlines how we seek to meet our statutory responsibilities under Schedule 9 of the Electricity Act 1989<sup>6</sup>: to have regard to the preservation of amenity. National Grid has also published a document that seeks to describe in more detail, National Grid's approach to the design and routing of new electricity transmission lines<sup>7</sup>.

Where an offshore renewable energy scheme is a NSIP development (i.e. over 100MW of installed generation capacity) then the developer will apply to the Planning Inspectorate for a Development Consent Order (DCO) for decision by the Secretary of State.

##### Scotland

In Scotland, new major energy infrastructure is consented through the Scottish Government. Applications to construct and operate offshore renewable generation of any capacity are made to Marine Scotland<sup>8</sup> that grants a marine licence for the works under the Marine (Scotland) Act 2010<sup>9</sup>. Marine Scotland makes a recommendation to Scottish Ministers who grant Section 36 consent under the Electricity Act 1989<sup>10</sup>.

##### Marine Planning

The Marine and Coastal Access Act 2009<sup>11</sup> and the Marine (Scotland) Act 2010<sup>12</sup> establish the legislative basis for the marine planning and licensing process in the UK. The Acts aim to provide an integrated approach that brings together marine management decisions and allows for joined-up decision making. The new marine planning framework and marine licensing system came into force in April 2011.

An overarching UK Marine Policy Statement (March 2011)<sup>13</sup> provides a framework for preparing marine plans and taking decisions affecting the marine environment. The Marine Policy Statement supports the UK's high level marine objectives<sup>14</sup> and will be implemented through marine plans in England, Scotland, Wales and Northern Ireland.

<sup>5</sup> [www.nationalgrid.com/NR/rdonlyres/21448661-909B-428D-86F0-2C4B9554C30E/39991/SCADocument6\\_2\\_Final\\_24\\_2\\_13.pdf](http://www.nationalgrid.com/NR/rdonlyres/21448661-909B-428D-86F0-2C4B9554C30E/39991/SCADocument6_2_Final_24_2_13.pdf)

<sup>6</sup> [www.nationalgrid.com/uk/LandandDevelopment/SC/Responsibilities/](http://www.nationalgrid.com/uk/LandandDevelopment/SC/Responsibilities/)

<sup>7</sup> [www.nationalgrid.com/NR/rdonlyres/E9F96A2A-C987-403F-AE7D-BDA07821F2C8/55465/OurApproach.pdf](http://www.nationalgrid.com/NR/rdonlyres/E9F96A2A-C987-403F-AE7D-BDA07821F2C8/55465/OurApproach.pdf)

<sup>8</sup> [scotland.gov.uk/About/Directorates/marinescotland](http://scotland.gov.uk/About/Directorates/marinescotland)

<sup>9</sup> [www.legislation.gov.uk/asp/2010/5/contents](http://www.legislation.gov.uk/asp/2010/5/contents)

<sup>10</sup> [www.legislation.hmso.gov.uk/acts/acts1989/ukpga\\_19890029\\_en\\_2.htm](http://www.legislation.hmso.gov.uk/acts/acts1989/ukpga_19890029_en_2.htm)

[www.legislation.gov.uk/ukpga/1989/29/section/36](http://www.legislation.gov.uk/ukpga/1989/29/section/36)

<sup>11</sup> [www.legislation.gov.uk/ukpga/2009/23/contents](http://www.legislation.gov.uk/ukpga/2009/23/contents)

<sup>12</sup> [www.scotland.gov.uk/Topics/marine/seamanagement/marineact](http://www.scotland.gov.uk/Topics/marine/seamanagement/marineact)

<sup>13</sup> [www.defra.gov.uk/environment/marine/protect/planning/archive.defra.gov.uk/environment/marine/documents/interim2/marine-policy-statement.pdf](http://www.defra.gov.uk/environment/marine/protect/planning/archive.defra.gov.uk/environment/marine/documents/interim2/marine-policy-statement.pdf)

<sup>14</sup> [archive.defra.gov.uk/environment/marine/documents/ourseas-2009update.pdf](http://archive.defra.gov.uk/environment/marine/documents/ourseas-2009update.pdf)

<sup>2</sup> [www.legislation.gov.uk/ukpga/2008/29/contents](http://www.legislation.gov.uk/ukpga/2008/29/contents)

<sup>3</sup> <http://infrastructure.planningportal.gov.uk/>

<sup>4</sup> [infrastructure.independent.gov.uk/legislation-and-advice/national-policy-statements/](http://infrastructure.independent.gov.uk/legislation-and-advice/national-policy-statements/)  
[www.decc.gov.uk/en/content/cms/meeting\\_energy/consents\\_planning/nps\\_en\\_infra/nps\\_en\\_infra.aspx](http://www.decc.gov.uk/en/content/cms/meeting_energy/consents_planning/nps_en_infra/nps_en_infra.aspx)

For marine planning purposes, UK waters will be divided into 'inshore' regions (0-12 nautical miles from the shore) and 'offshore' regions (12-200 nautical miles from the shore). Marine plans will be developed for each marine region. Plans are anticipated to have a life of approximately 20 years and will be kept under regular review during their lifetime.

The Marine Management Organisation (MMO)<sup>15</sup>, Marine Scotland<sup>16</sup>, the Welsh Government<sup>17</sup> and the Department of the Environment for Northern Ireland<sup>18</sup> are responsible for the marine planning systems in their authority areas.

### Marine Licensing

New legislation introduced has changed the system for marine consenting and licensing and has moved from a system where multiple consents were required under multiple Acts to a more streamlined approach where a single 'Marine Licence' is required<sup>19</sup>.

In the past, multiple licensing regimes and authorities regulated marine development and this included consent under the Coast Protection Act 1949<sup>20</sup> (CPA consent) and a licence under the Food and Environment Protection Act 1985<sup>21</sup> (FEPA licence).

Since April 2011, the requirements contained in CPA consents and FEPA licences have been brought together into a single marine licence for which the MMO, Natural Resources Wales (on behalf of the Welsh Government), Marine Scotland and the Department of the Environment for Northern Ireland act as licensing authorities. These bodies determine marine licence applications for offshore generation development projects. In England and Wales the Secretary of State will determine applications for offshore generation development projects greater than 100MW in size. Any associated infrastructure including cabling, collector stations and converter stations would require consent under the Marine and Coastal Access Act 2009<sup>22</sup>, in England, the developer may apply for this to be consented by the Secretary of State as 'associated development' and a marine licence will be issued as part of the (DCO)<sup>23</sup> in consultation with the marine bodies.

---

<sup>15</sup> [www.marinemangement.org.uk/](http://www.marinemangement.org.uk/)

<sup>16</sup> [www.scotland.gov.uk/About/People/Directorates/marinescotland](http://www.scotland.gov.uk/About/People/Directorates/marinescotland)

<sup>17</sup> [wales.gov.uk/?lang=en](http://wales.gov.uk/?lang=en)

<sup>18</sup> [www.doeni.gov.uk/](http://www.doeni.gov.uk/)

<sup>19</sup> [marinemangement.org.uk/licensing/index.htm](http://marinemangement.org.uk/licensing/index.htm)  
[marinemangement.org.uk/licensing/marine.htm](http://marinemangement.org.uk/licensing/marine.htm)

<sup>20</sup> [www.legislation.gov.uk/ukpga/Geo6/12-13-14/74](http://www.legislation.gov.uk/ukpga/Geo6/12-13-14/74)

<sup>21</sup> [www.legislation.gov.uk/ukpga/1985/48](http://www.legislation.gov.uk/ukpga/1985/48)

<sup>22</sup> [www.legislation.gov.uk/ukpga/2009/23/contents](http://www.legislation.gov.uk/ukpga/2009/23/contents)

<sup>23</sup> [www.communities.gov.uk/publications/planningandbuilding/dcosimpactassessment](http://www.communities.gov.uk/publications/planningandbuilding/dcosimpactassessment)

**Table 4.2**

*Indicative timeline for the offshore planning process for an offshore generation project (larger than 100MW of installed generation capacity) connecting to or using the NETS*

Stage	Time	Activity	Consulted / Responsible Party
Project Development	6 months	Strategic Environmental Assessment (SEA) Zones for tender Site identification and selection	DECC Planning Inspectorate The Crown Estate Offshore Developers
		Site awarded	The Crown Estate
		Agreement for lease	The Crown Estate
		Connection application to National Grid Electricity Transmission (NGET)	National Grid Electricity Transmission (NGET)
Pre-Application	1 to 2 years	Options appraisal Environmental Impact Assessment (EIA) Screening / EIA Scoping Statutory stakeholder consultation and public consultation Marine surveys Environmental Statement	Planning Inspectorate Marine Management Organisation (MMO) Scottish Government Marine Scotland Welsh Government Local and Port Authorities Offshore Developer / Offshore Transmission Owner (OFTO)
Consenting	1 year	Development Consent Order under the Planning Act 2008 (England and Wales) Consent under Section 36 Electricity Act 1989 / Marine Licence (Scotland)	Secretary of State (England & Wales) Scottish Government / Marine Scotland
Post-Decision	6 months	Final investment decision (for offshore infrastructure)	Offshore Developer / OFTO
	6 months	Place construction contracts Delivery of offshore infrastructure	Offshore Developer / OFTO
	2+ years	Construction of offshore infrastructure	Offshore Developer / OFTO
	3 months	Connection and commence operation	Offshore Developer / OFTO / TO



## 4.3

## Non-Build / Commercial Options

As an alternative to or complementary with asset solutions “no build” and commercial solutions can also provide boundary capacity. National Grid would like to explore further with stakeholders the possibility and benefits of commercial, non-build solutions to satisfy transmission capacity requirements. In the following section, commercial and non-build solution reinforcement options will be discussed.

At this stage we are keen to learn how our stakeholders would like to be more involved in meeting future network requirements through initiatives such as:

- demand side response.
- generation and demand curtailment (e.g. inter-trips).
- third parties to consider asset investment at specific locations to provide system support (e.g. reactive power services).

### Stakeholder Engagement

We would very much appreciate your views on this new section of the ETYS and also what other commercial opportunities you would like us to explore in the future.

#### 4.3.1 Demand Side Response

There is an opportunity for customers and stakeholders to participate in offering ancillary services such as demand management by curtailing their demand to alleviate constraints. This could be by way of the end energy consumer taking action in reducing the level of energy that they take from the electricity transmission system when required. The demand side response could be of two types: one local to a Grid Supply Point (GSP) and sufficient to reduce constraints at an individual substation; whilst another type would require a larger conglomerate of potential suppliers to reduce demand across a wider region.

An example is illustrated across. The area circled by the red line in figure 4.5 indicates the possibility of reducing demand at a single GSP, such as St.Johns Wood, to reduce constraints at that local substation. In comparison, the area encompassed by the green line indicates the possibility of reducing demand at a number of sites across a region. By way of a

simple example, a number of sites could be identified (arbitrarily shown here by the arrows) whereby if it was possible for them all to collectively reduce their demand at the same time, a positive impact would be experienced on the nearest electricity transmission system boundary.

In both types the specification of the duration of demand side response would have to allow sufficient time for National Grid to re-optimize the transmission system.

**Figure 4.5**  
An example of potential demand side response opportunities in and around London

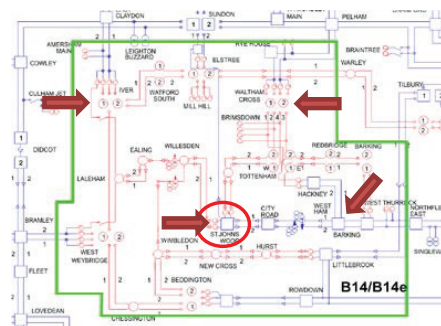

Demand side response services could therefore be contracted out to third parties or suppliers to switch off their highly loaded plants at certain periods of time, such as winter peak, under planned outage conditions, or under fault conditions, in order to reduce the loading on specific GSPs or potentially entire regional areas.

#### 4.3.2 Generation and Demand Curtailment: Inter-trips

An inter-trip will automatically disconnect a generator or demand from the electricity transmission system when a specific event occurs. There are two types of inter-trip service: commercial inter-trips or system to generator operational inter-trips. In this section we shall consider only the commercial inter-trip option<sup>24</sup>.

<sup>24</sup> Where generators are 100% effective against the constraint any necessary operational intertrips are detailed in Appendix F3 of the customer offer and are treated under CAP 076.

The automatic operation of an inter-trip typically requires the monitoring of all transmission circuits within a localised zone that are linked with system protection arrangements. Should a selected circuit trip, the logic process will trigger activation of a scheme to disconnect generation and / or demand.

Inter-trip services may be required as an automatic control arrangement where generation or demand may be reduced or disconnected following a system fault event to relieve localised network overloads, maintain system stability, manage system voltages and / or ensure the quick restoration of the electricity transmission system following its possible collapse.

We are looking to possibly use these commercial inter-trips for planning scenarios on all of the boundaries discussed in Chapter 3. If you believe that you could offer such a service where a current reinforcement is planned please contact us. The opportunities for these areas are highlighted in Chapter 4, Section 8.

#### 4.3.3 Reactive Power Services

Reactive power is a concept to describe the background energy movement in an Alternating Current (AC) system arising from the production of electric and magnetic fields.

National Grid has a requirement to maintain the reactive power balances on the electricity transmission system. As reactive power can only be managed on a local basis, without the appropriate injections of reactive power at the correct locations, the voltage profile of the electricity transmission system could breach statutory planning and operational limits. National Grid controls reactive power through two balancing services: obligatory reactive power services and enhanced reactive power services.

As we look to plan the future transmission system, the need for reactive compensation will be identified in certain areas. Where these areas are identified, rather than looking at only installing assets, we would like to establish if there are any future contracts with local generators that could be explored as a suitable alternative. The reactive service that we would be interested in is a guaranteed obligatory service or an enhanced reactive service provision.

The obligatory reactive power service is the provision of varying reactive power output. At any given output, generators may be requested to produce or absorb reactive power to help manage system voltages close to its point of connection. All generators covered by the Grid Code are required to have the capability to provide reactive power.

The enhanced reactive power service is the provision of voltage support which exceeds the minimum technical requirement of the obligatory reactive power service.

We would expect these opportunities to be available to owners of synchronous compensation or any other plant or apparatus that can generate or absorb reactive power including static compensation equipment.

#### Stakeholder Engagement

We would welcome your view on what would incentivise Users to make more reactive power available to the NETSO.

#### 4.3.4 Further Work and Contact Details

It is hoped that a combination of network investment and the utilisation of commercial or ancillary services such as those previously described could lead to a potential reduction in costs to consumers, enhance security of supply and contribute to sustainable development.

National Grid is currently developing a process to explore the potential for third party suppliers to offer commercial or ancillary services that could potentially negate, or delay, the need for system reinforcement.

We will be sharing the high level work completed to date with stakeholders during 2014. Through this process we shall collaboratively develop potential products with prospective suppliers. This will enable National Grid to take such services in to account in the next NDP and results presented in following ETYS.

#### Stakeholder Engagement

To help deliver our engagement strategy for the development and procurement of non-build reinforcement options, we would like to determine what information, you as third party suppliers would require from National Grid, and in what timescales.

We would very much welcome your input.

Please contact us via:

**[transmission.etys@nationalgrid.com](mailto:transmission.etys@nationalgrid.com)**

## Asset Reinforcement Options

To satisfy the needs for increasing wider NETS capability a number of potential reinforcement options have been developed. This section of the statement presents options that have been considered as part of the network planning. The reinforcement options in England and Wales are considered as part of the NDP.

For each potential reinforcement, an Earliest In-Service Date (EISD) is provided. This is the earliest date to when the project could be delivered and put into service provided investment into the project is started immediately.

Options that reinforce the network across multiple regions are only referenced once in this section. For example, the Western HVDC Link will provide benefits for the regions of Scotland – SHE Transmission, Scotland – SP Transmission and North England; however the Link is only referenced in Section 4.4.2 Scotland – SP Transmission.

Colour codes are used in this section as discussed earlier in the Introduction of this chapter are shown in figure 4.1 to help identify information of the relevant region.

### 4.4.1

#### Scotland – SHE Transmission

##### Beauly to Denny Reinforcement

EISD 2015

Replace the existing Beauly – Fort Augustus – Errochty – Bonnybridge 132kV overhead lines with a new 400kV tower construction which terminates at a new substation near Denny in SP Transmission's area, and carry out associated AC substation works. One of the circuits will be operated at 400kV and the other at 275kV. The Beauly to Denny reinforcement extends from Beauly in the north to Denny in the south, providing additional capability for boundary B1 as well as boundaries B2 and B4.

	Current Status	In construction	Primary boundary capability increase	B4	1,150MW
--	----------------	-----------------	--------------------------------------	----	---------

##### Beauly – Blackhillock – Kintore 275kV Uprate

EISD 2015

Replace the existing conductors on the existing 275kV double circuits between Beauly, Knocknagael, Blackhillock and Kintore with new high capacity conductors.

	Current Status	In construction	Primary boundary capability increase	B1	500MW
--	----------------	-----------------	--------------------------------------	----	-------

##### Beauly – Mossford 132kV Reinforcement

EISD 2015

Replace the existing 132kV overhead line with a new high capacity 132kV overhead line. A new 132kV substation at Corriemoillie near Mossford was completed in October 2013.

	Current Status	In construction	Primary boundary capability increase	Radial	250MW
--	----------------	-----------------	--------------------------------------	--------	-------

##### Kintyre to Hunterston Subsea Link

EISD 2015

Install two 220kV subsea cables from Crossaig, 13km north of Carradale, to Hunterston in Ayrshire, along with reinforcement of the existing 132kV double circuit overhead line from Crossaig to Carradale.

	Current Status	In construction	Primary boundary capability increase	B3	150MW
--	----------------	-----------------	--------------------------------------	----	-------

**Caithness – Moray Reinforcement Strategy****EISD 2018**

Construct an HVDC link between a new substation at Spittal in Caithness and Blackhillock in Moray, along with associated onshore reinforcement works. The onshore works include the rebuild of the 132kV double circuit line between Dounreay and Spittal at 275kV, a short section of new 132kV overhead line between Spittal and Mybster, new 275/132kV substations at Fyrish (near Alness), Loch Buidhe (to the east of Shin), Spittal (5km north of Mybster) and Thurso. This will be designed with a multi-terminal capability to allow a future connection of a second HVDC link from Shetland or Orkney if required.

	Current Status	Planning	Primary boundary capability increase	B1	850MW
--	----------------	----------	--------------------------------------	----	-------

**Gravir on Lewis to Beaully HVDC Link****EISD 2017**

Install a new HVDC transmission link from a new substation at Gravir on Lewis to Beaully substation. The HVDC cable route will be partly subsea and partly overland.

	Current Status	Planning	Primary boundary capability increase	Radial	450MW
--	----------------	----------	--------------------------------------	--------	-------

**Shetland to Mainland HVDC Link****EISD 2018**

Install a subsea HVDC transmission link from a new substation at Kergord on Shetland to a DC bussing point at Sinclair Bay in Caithness to integrate with the main Caithness-Moray HVDC link as described above. This will form a three ended multi-terminal HVDC link arrangement.

	Current Status	Design	Primary boundary capability increase	Radial	600MW
--	----------------	--------	--------------------------------------	--------	-------

**Orkney – Dounreay AC Subsea Connection****EISD 2018**

Construct an AC subsea cable link from Bay of Skall, on the western side of Orkney, to the existing 275kV substation at Dounreay.

	Current Status	Design	Primary boundary capability increase	Radial	200MW
--	----------------	--------	--------------------------------------	--------	-------

**East Coast 400kV Upgrade Blackhillock to Kincardine****EISD 2018**

Joint SHE Transmission and SP Transmission project to upgrade the existing east coast overhead line between Blackhillock and Kincardine to 400kV, using existing infrastructure that is currently operated at 275kV but which was constructed at 400kV. Includes new substations at Rothienorman, Alyth and an extension of the existing substations at Kintore and Kincardine. The existing overhead line between Rothienorman and Peterhead will also be re-insulated to 400kV with associated interface works required at Peterhead substation.

	Current Status	Planning	Primary boundary capability increase	B4	800MW
--	----------------	----------	--------------------------------------	----	-------

**Tealing – Westfield – Longannet 275kV Upgrade****EISD 2019**

Part of East Coast 400kV upgrade strategy. Joint SHE Transmission and SP Transmission project to re-profile the existing double circuit overhead line between Tealing – Westfield – Longannet to 65 deg C and associated works to increase the circuit ratings. This project must follow the East Coast 400kV upgrade to achieve the stated boundary capability increase.

	Current Status	Design	Primary boundary capability increase	B4		300MW
--	----------------	--------	--------------------------------------	----	--	-------

**Eastern HVDC One****EISD 2019**

A new ~2GW subsea HVDC cable link from Peterhead to Hawthorn Pit with associated AC network reinforcement works at both ends. The scope of Eastern HVDC Link 1 shown here is valid at the time of publication. The three TO's will continue to work together during 2014 to determine the most economic and efficient design solution for the Eastern HVDC.

	Current Status	Optioneering	Primary boundary capability increase	B4	B6	2,200MW
--	----------------	--------------	--------------------------------------	----	----	---------

**Eastern HVDC Three****EISD 2025**

A potential new ~2GW subsea HVDC cable link between Peterhead and North East England with associated AC network reinforcement works on both ends.

	Current Status	Scoping	Primary boundary capability increase	B4	B6	2,200MW
--	----------------	---------	--------------------------------------	----	----	---------

**Foyers to Knocknagael 275kV Upgrade****EISD 2015**

Replacement of the existing conductors on the 275kV overhead line between Knocknagael and Foyers with high capacity conductors.

	Current Status	Planning	Primary boundary capability increase	Radial		650MW
--	----------------	----------	--------------------------------------	--------	--	-------

**Lairg to Loch Buidhe 275kV Reinforcement****EISD 2019**

Investigate the installation of a 275kV overhead line between Lairg and a new substation at Loch Buidhe to harvest generation in the Lairg area.

	Current Status	Design	Primary boundary capability increase	Radial		700MW
--	----------------	--------	--------------------------------------	--------	--	-------

**Beauly to Tomatin 275kV Reinforcement****EISD 2018**

Investigate the installation of a 275kV overhead line between Beauly and a new substation at Tomatin to harvest generation in the area.

	Current Status	Design	Primary boundary capability increase	Radial		500MW
--	----------------	--------	--------------------------------------	--------	--	-------

**Beauly to Blackhillock Reinforcement****EISD 2024**

Investigate construction of a new high capacity 400kV or 275kV overhead line between Beauly and Blackhillock to reinforce the B1 boundary.

	Current Status	Scoping	Primary boundary capability increase	B1	1000MW
--	----------------	---------	--------------------------------------	----	--------

**Skye Second 132kV Circuit****EISD 2021**

Investigate the installation of a second 132kV wood pole overhead line between Fort Augustus and the north west of Skye to harvest generation in the area.

	Current Status	Scoping	Primary boundary capability increase	Radial	160MW
--	----------------	---------	--------------------------------------	--------	-------

**4.4.2****Scotland – SP Transmission****B6 Series and Shunt Compensation****EISD 2015**

Series compensation to be installed in the Harker – Hutton, Eccles – Stella West and Strathaven – Harker routes. Two 225MVar MSCs to be installed at Harker, one at Hutton, two at Stella West and one at Cockenzie. Strathaven – Smeaton route to be upgraded to 400kV and the cables at Torness upgraded. Effectively reduces the impedance of the Anglo-Scottish circuits improving the loading capability of the circuits.

	Current Status	In construction	Primary boundary capability increase	B6	1,000MW
--	----------------	-----------------	--------------------------------------	----	---------

**Western HVDC Link****EISD 2016**

A new 2.45 GW (short term rating) submarine HVDC cable route from Deeside to Hunterston with associated AC network reinforcement works on both ends. At the northern end, this will include construction of Hunterston East 400kV GIS Substation. Reconfiguration of the associated 400kV network will facilitate the decommissioning of Inverkip 400kV Substation and the future rationalisation of the local overhead line network.

	Current Status	In construction	Primary boundary capability increase	B6	2,200MW
--	----------------	-----------------	--------------------------------------	----	---------

**Central 400kV Uprate****EISD 2019**

The Central 400kV Uprate utilises existing infrastructure between Denny and Bonnybridge, Wishaw and Newarthill and a portion of an existing double circuit overhead line between Newarthill and Easterhouse. A new section of double circuit overhead line is required from the Bonnybridge area to the existing Newarthill / Easterhouse route. Together with modifications to substation sites, this reinforcement will create two new north to south circuits through the central belt: a 275kV Denny / Wishaw circuit and a 400kV Denny / Wishaw circuit, thereby significantly increasing B5 capability.

	Current Status	Design	Primary boundary capability increase	B5	1,900MW
--	----------------	--------	--------------------------------------	----	---------

**Harker – Strathaven Reconductoring and Series Compensation****EISD 2019**

Reconductor the existing double circuit overhead line which run from Harker to Strathaven with higher rated conductor and additional series compensation.

	Current Status	Scoping	Primary boundary capability increase	B6	500MW
--	----------------	---------	--------------------------------------	----	-------

**Eastern HVDC Two****EISD 2021**

A new second ~2GW submarine HVDC cable route between Torness and North East England with associated AC network reinforcement works on both ends.

	Current Status	Scoping	Primary boundary capability increase	B6	2,200MW
--	----------------	---------	--------------------------------------	----	---------

**South West Scotland Connections Project****EISD 2015**

Extend the 275kV overhead line network in Ayrshire from Coylton 275kV substation to the west of New Cumnock. Construct New Cumnock 275/132kV substation. New Cumnock 132kV substation will form a 'collector' substation for renewable generation in south and east Ayrshire. The 480MW capacity of the initial stage of development will be capable of phased development, as required to accommodate renewable generation development in the area.

	Current Status	In Construction	Primary boundary capability increase	Radial	4.800 MW
--	----------------	-----------------	--------------------------------------	--------	----------

**Kilmarnock South – Coylton 275kV Upgrading****EISD 2016**

Reconductor the existing double circuit overhead line route from Kilmarnock South to Coylton with higher rated conductor and address an existing 275kV cable restriction. This will help ensure the circuits will provide sufficient thermal capacity to transport generation output from South West Scotland, as the amount of wind generation increases over time.

	Current Status	Design	Primary boundary capability increase	Radial	350MW
--	----------------	--------	--------------------------------------	--------	-------

**Coylton – Mark Hill 275kV Upgrading****EISD 2016**

Reconductor the existing single circuit overhead line route from Coylton to Mark Hill with higher rated conductor. This will help ensure the circuit will provide sufficient thermal capacity to transport generation output from the Mark Hill 275kV group as the amount of wind generation increases over time.

	Current Status	Design	Primary boundary capability increase	Radial	350MW
--	----------------	--------	--------------------------------------	--------	-------

**Kilmarnock South 400/275kV Substation Upgrading****EISD 2018**

Replace Kilmarnock South 275kV Substation to increase thermal rating. Install a third 400/275kV 1000MVA transformer and reconfigure Kilmarnock South 400kV Substation. This will help ensure the substation provides sufficient thermal capacity to transport generation output from South West Scotland to the 400kV system, as the amount of wind generation increases over time.

	Current Status	Optioneering	Primary boundary capability increase	Radial	510MW
--	----------------	--------------	--------------------------------------	--------	-------

### Dumfries and Galloway Reinforcement

EISD 2023

The transmission network in the Dumfries and Galloway Region is provided by an interconnected single 132kV between Dumfries and Coylton. This circuit has a summer rating of 106MVA and was constructed in 1936 to connect the Galloway Hydro scheme.

Investigate construction of a new overhead line to serve the main demand blocks, existing generation portfolios and facilitate the connection of new renewable generation in the Dumfries and Galloway area.

	Current Status	Scoping	Primary boundary capability increase		TBC
--	----------------	---------	--------------------------------------	--	-----

#### 4.4.3

##### North England

### Penwortham Quad Boosters

EISD 2014

Install a pair of 2750MVA quadrature boosters (QBs) on the double circuits which run from Penwortham to Padiham and Daines at the Penwortham 400kV substation. The pair of QBs will improve the capability to control the north to south power flows on the circuits connecting the North Midlands and the West Midlands, and hence improve the capability of the network to transport the excess generation from the north to demand centres in the south.

	Current Status	In construction	Primary boundary capability increase	B7a	400MW
--	----------------	-----------------	--------------------------------------	-----	-------

### Kirkby and Rainhill Substation Upgrade

EISD 2016

Replace circuit breakers and equipment at Rainhill so the running arrangements at Kirkby and Rainhill can be changed to a two-way split configuration. This change to the running arrangement will divert more power to flow into the Kirkby – Rainhill – Fiddlers Ferry route from the Kirkby – Lister Drive – Birkenhead route; as a result, loading on the Kirkby to Lister Drive circuits will be better shared and the stress on them will be relieved. Accordingly, the power flows around the 275kV Mersey ring and hence the capability of the network to handle north to south power flows will be improved significantly.

	Current Status	Scoping	Primary boundary capability increase	B7a	1,000MW
--	----------------	---------	--------------------------------------	-----	---------

### Penwortham – Padiham & Penwortham – Carrington Reconductoring and Kirkby – Penwortham Upgrade

EISD 2020

Upgrade Penwortham – Padiham & Penwortham Carrington circuits and upgrade the existing 275kV double circuits from Penwortham to Kirkby to operate at 400kV. Associated work including construction of a new Kirkby 400kV substation and a new Washway Farm 400/132kV substation with two 400/132kV 240MVA SGTs adjacent to the existing site. This work will improve the capability of the network to handle the heavy north to south power flows due to the large amount of expected generation connection in Scotland.

	Current Status	Scoping	Primary boundary capability increase	B7a	1000MW
--	----------------	---------	--------------------------------------	-----	--------



**Yorkshire 400kV Circuits Hotwiring and Reconductoring****EISD 2019**

Reconductor sections of the Lackenby – Norton 400kV circuit with higher rated conductor, and uprate the cross-site cable at Lackenby 400kV substation to a similar or higher rating. Reconductor a small section and hotwire the remainder of the existing 400kV double circuits which run from Norton to Osbaldwick. This will help ensure the circuits will provide sufficient thermal capacity to transport the excess generation from Scotland to southern demand.

	Current Status	Scoping	Primary boundary capability increase	B7	700MW
--	----------------	---------	--------------------------------------	----	-------

**Lister Drive Quad Booster****EISD 2018**

Replace the existing series reactor at Lister Drive with a Quad Booster (QB). The Quad Booster will enable flexibility to control power flows through the circuit south of Lister Drive. The additional control will increase the thermal boundary capability.

	Current Status	Scoping	Primary boundary capability increase	B7a	500MW
--	----------------	---------	--------------------------------------	-----	-------

**Killingholme South – West Burton New Transmission Route****EISD 2022**

Construct a new 400kV substation at Killingholme South and construct a new transmission route between the new Killingholme South substation to West Burton. This extra transmission route will improve the capability of the network to export excess generation from the Humber area in the future.

	Current Status	Scoping	Primary boundary capability increase	EC1	3,900MW
--	----------------	---------	--------------------------------------	-----	---------

**High Marnham – West Burton Reconductor****EISD 2014**

Upgrade the circuits on the High Marnham to West Burton route with higher-rated conductors.

	Current Status	In Construction	Primary boundary capability increase	B9	1,000MW
--	----------------	-----------------	--------------------------------------	----	---------

**Dogger Bank Integration Stage One****EISD 2018**

The integration of project 2 and project 1 via AC technology will provide boundary capability across B7 and B7a due to the connecting onshore locations of the projects situated at the north and south of both boundaries B7 and B7a respectively. This will help to improve the ability of the network to handle the heavy north to south power flows across these boundaries.

	Current Status	Scoping	Primary boundary capability increase	B7	300 – 500 MW
--	----------------	---------	--------------------------------------	----	--------------

**Dogger Bank Integration Stage Two****EISD 2019**

The integration of project 3 and project 4 via AC technology will provide boundary capability across B7 and B7a due to the connecting onshore locations of the projects situated at the north and south of both boundaries B7 and B7a respectively. This will help to improve the ability of the network to handle the heavy north to south power flows across these boundaries.

	Current Status	Scoping	Primary boundary capability increase	B7	300 – 500 MW
--	----------------	---------	--------------------------------------	----	--------------

**Dogger Bank Integration Stage Three****EISD 2020**

Upon completion of project 7 which will connect into the Humber, there is the possibility to integrate project 7 and project 3 via AC technology to provide further capability across B7 and B7a since the onshore connection locations for the projects are situated to the south and north of boundaries B7 and B7a respectively. This will help to improve the ability of the network to handle the heavy north to south power flows across these boundaries.

	Current Status	Scoping	Primary boundary capability increase	B7	300 – 500 MW
--	----------------	---------	--------------------------------------	----	--------------

**Dogger Bank Integration Stage Four****EISD 2021**

Upon completion of project 8 which will connect into the Humber, there is the possibility to integrate project 8 and project 5 via AC technology to provide further capability across B7 and B7a since the onshore connection locations for the projects are situated at the south and north of both boundaries B7 and B7a respectively. This will help to improve the ability of the network to handle the heavy north to south power flows across these boundaries.

	Current Status	Scoping	Primary boundary capability increase	B7	300 – 500 MW
--	----------------	---------	--------------------------------------	----	--------------

**Dogger Bank Integration Stage Five****EISD 2022**

Upon completion of project 9 which will connect into the Wash region, there is the possibility to integrate project 9 and project 6 via AC technology to provide further capability across B7, B7a, B8, B9, B11 and B16 since the onshore connection locations for the respective projects are situated to the south and north of these boundaries. This will help to improve the ability of the network to handle the heavy north to south power flows across these boundaries.

	Current Status	Scoping	Primary boundary capability increase	B7	300 – 500 MW
--	----------------	---------	--------------------------------------	----	--------------

**Dogger Bank Integration Stage Six****EISD 2023**

Upon completion of project 10 which is assumed to connect via project 8 into the Humber region, there is the possibility to integrate project 5 and project 10 via AC technology to provide further capability across B7 and B7a since the onshore connection locations for the projects are situated to the south and north of both boundaries B7 and B7a respectively. This will help to improve the ability of the network to handle the heavy north to south power flows across these boundaries.

	Current Status	Scoping	Primary boundary capability increase	B7	150 – 350 MW
--	----------------	---------	--------------------------------------	----	--------------

## 4.4.4

## East England

**Bramford – Braintree – Rayleigh Main Reconductoring**

EISD 2014

Reconductor the existing circuit which runs between Bramford – Braintree – Rayleigh Main with higher rated conductor. This will help ensure the circuits will provide sufficient thermal capacity to transport the excess generation in the East Anglia area to South East England, as an increasing amount of wind and nuclear generation is expected to connect in the area in the future.

	Current Status	Design	Primary boundary capability increase	EC5	200MW
--	----------------	--------	--------------------------------------	-----	-------

**Bramford – Twinstead New Overhead Lines**

EISD 2017

Reconductor the existing circuit which runs between Pelham – Braintree – Rayleigh Main, and construct a new transmission route from Bramford to the Twinstead tee-point creating double circuits which run between Bramford – Pelham and Bramford – Braintree – Rayleigh Main. These works will result in two transmission routes for power to flow south from the East Anglia area and hence increase the capability of the network to export excess generation from the area significantly.

	Current Status	Planning	Primary boundary capability increase	EC5	2600MW
--	----------------	----------	--------------------------------------	-----	--------

**Norwich – Bramford Reconductoring**

EISD 2018

Reconductor the existing double circuits which run from Norwich to Bramford with higher rated conductor. This will help ensure the circuits will provide sufficient thermal capacity to transport the excess generation in the East Anglia area, as an increasing amount of wind and nuclear generation is expected to connect in the area in the future.

	Current Status	Optioneering	Primary boundary capability increase	EC5	400MW
--	----------------	--------------	--------------------------------------	-----	-------

**Rayleigh – Coryton South – Tilbury Reconductoring**

EISD 2014

Reconductor the existing circuits which run between Rayleigh Main – Coryton South – Tilbury with higher rated conductor. This will help ensure the circuits will provide sufficient thermal capacity to transport the excess generation from the East Anglia area to the south east demand, as an increasing amount of wind and nuclear generation is expected to connect in the area in the future. This reinforcement when taken in conjunction with Bramford-Twinstead above provides in excess of 3GW of capability (depending on the scenario).

	Current Status	In Construction	Primary boundary capability increase	EC5	1000MW
--	----------------	-----------------	--------------------------------------	-----	--------

**East Anglia MSC**

EISD 2017

Install a 225MVar MSC to provide voltage support to the East Anglia area. The MSC will help ensure voltage compliance when there is a fault around the area, leading to diversion of power flowing through a longer transmission route.

	Current Status	Scoping	Primary boundary capability increase	EC5	300MW
--	----------------	---------	--------------------------------------	-----	-------

#### Hornsea Integration Stage One

EISD 2020

Upon completion of platform 3 which is due to connect to the Wash region, there is the possibility to integrate platform 3 with platform 2 via AC technology. This will help to improve the ability of the network to handle the heavy north to south power flows across multiple boundaries including Boundary B8, B9, B11 and B16.

	Current Status	Scoping	Primary boundary capability increase	B8	300 – 500 MW
--	----------------	---------	--------------------------------------	----	--------------

#### Hornsea Integration Stage Two

EISD 2022

Upon completion of platform 4 which is due to connect to the Wash region, there is the possibility to integrate platform 4 with platform 2 via AC technology. This will help to improve the ability of the network to handle the heavy north to south power flows across multiple boundaries including Boundary B8, B9, B11 and B16.

	Current Status	Scoping	Primary boundary capability increase	B8	300 – 500 MW
--	----------------	---------	--------------------------------------	----	--------------

### 4.4.5

#### South England

#### Wymondley Turn-in

EISD 2017

Modify the existing circuit which runs from Pelham to Sundon; turn in the circuit at Wymondley to create two separate circuits which run from Pelham to Wymondley and Wymondley to Sundon. This work will improve the balance of the power flows on the North London circuits, and increase the capability of the network to import power into London from the north transmission routes.

	Current Status	Scoping	Primary boundary capability increase	B14	200MW
--	----------------	---------	--------------------------------------	-----	-------

#### Barking – Lakeside Tee New Double Circuits

EISD 2014

Construct a new 400kV transmission route from Barking to the Lakeside tee-point on the existing transmission route from Tilbury to Littlebrook. This work will divert some of the power flows from the heavily loaded North London circuits into the south east transmission route to supply the London demand; as a result the capability of the network to import power into London will be improved.

	Current Status	Scoping	Primary boundary capability increase	B14	500MW
--	----------------	---------	--------------------------------------	-----	-------

**Hackney – Tottenham – Waltham Cross Uprate****EISD 2017**

Uprate and reconductor the existing 275kV transmission route which runs between Hackney – Tottenham – Brimsdown – Waltham Cross with higher rated conductor to operate at 400kV, and reconductor the existing double circuits which run from Pelham to Rye House with higher rated conductor. Also, carry out the associated work including construction of a new Waltham Cross 400kV substation, modification to the Tottenham substation and installation of two new transformers at the Brimsdown substation. This work will increase the London B14 boundary capability and facilitate future East Anglia, Thames Estuary generation and also interconnectors on the south coast.

	Current Status	Planning	Primary boundary capability increase	B14	200MW
--	----------------	----------	--------------------------------------	-----	-------

**Wymondley QBs****EISD 2018**

Install a pair of 2750MVA quadrature boosters (QBs) on the double circuits which run from Wymondley to Pelham at the Wymondley 400kV substation. The pair of QBs will improve the capability to control the power flows on the North London circuits, and improve the capability of the network to import power into London from the north transmission routes significantly.

	Current Status	Scoping	Primary boundary capability increase	B14	1,600MW
--	----------------	---------	--------------------------------------	-----	---------

**Dungeness – Sellindge – Canterbury North Reconductoring****EISD 2016**

Reconductor the existing double circuits which run between Dungeness – Sellindge – Canterbury North with higher rated conductor. This will help ensure the circuits will provide sufficient thermal capacity to transport the power along the south coast during time with high interconnector flows.

	Current Status	Design	Primary boundary capability increase	B15	200MW
--	----------------	--------	--------------------------------------	-----	-------

**New Transmission Route on South Coast****EISD 2023**

Construct a 400kV transmission route from the south coast to south London and carry out associated work. These works will provide a new transmission route connecting south of London and the south coast circuits between Kemsley and Lovedean, resulting in a strong network connection for the south coast area.

	Current Status	Scoping	Primary boundary capability increase	SC1	Circa 2,200MW
--	----------------	---------	--------------------------------------	-----	---------------

**South Coast Reactive Compensation****EISD 2018**

Install reactive compensation along the south coast for voltage support to the south coast area. The SVC and MSC will help ensure voltage stability when there is a fault around the area during time with high interconnector flows.

	Current Status	Scoping	Primary boundary capability increase	B15	1000MW
--	----------------	---------	--------------------------------------	-----	--------

## 4.4.6

## West England and Wales

**Wylfa – Pembroke HVDC Link****EISD 2022**

Construction of a new subsea HVDC circuit rated at 2-2.5GW connecting from Wylfa to Pembroke. The reinforcement work includes extension of both Wylfa and Pembroke 400kV substations. This link is driven by the new generation at Wylfa and the Irish Sea Round 3 offshore wind farm. It increases the transfer capacity across several boundaries.

	Current Status	Scoping	Primary boundary capability increase	B8	2,500MW
--	----------------	---------	--------------------------------------	----	---------

**Swansea Circuit Turn-in****EISD 2016**

Turn-in the Pembroke to Cilfynydd 400kV double circuit into the existing Swansea 400kV substation.

	Current Status	Scoping	Primary boundary capability increase	SW2	1,000MW
--	----------------	---------	--------------------------------------	-----	---------

**Bramley – Melksham Reconductoring****EISD 2019**

Reconductor the existing double circuits which run from Bramley to Melksham with higher rated conductor. This will help ensure the circuits will provide sufficient thermal capacity to transport the power from west to east in South England during interconnect export operation.

	Current Status	Scoping	Primary boundary capability increase	B13	800MW
--	----------------	---------	--------------------------------------	-----	-------

**Wylfa – Pentir Second Transmission Route****EISD 2022**

Construct a second 400kV transmission route from Wylfa to Pentir and carry out associated work including the modification to the Wylfa400kV substation and extension of Pentir 400kV substation. This extra transmission route will allow the connection of generation at Wylfa beyond the infeed loss risk criterion, which is currently 1320MW and will change to 1800MW from April 2014. As a result, the capability of the network to export power from Wylfa into the main transmission system will be improved significantly.

	Current Status	Optioneering	Primary boundary capability increase	NW1	3,800MW
--	----------------	--------------	--------------------------------------	-----	---------

**Pentir – Trawsfynydd Second Circuit****EISD 2018**

A second circuit is created by using the other side of the route currently occupied by a SP-MANWEB 132kV circuit. A large single core per phase cable section is required across Glaslyn where no overhead line currently exists. A single 400/132kV transformer is teed off the new circuit to provide a connection to SP-MANWEB at Four Crosses to replace its circuit.

	Current Status	Design	Primary boundary capability increase	NW2	1,500MW
--	----------------	--------	--------------------------------------	-----	---------

**Pentir – Deeside and Pentir – Trawsfynydd Reconductoring****EISD 2018**

Reconductor the existing double circuits which run from Pentir to Deeside and Pentir to Trawsfynydd. The boundary capability will improve once both routes are reconducted. This will help ensure the circuits will provide sufficient thermal capacity to export the excess generation from North Wales to the rest of the system, as an increasing amount of wind and nuclear generation is expected to connect in the area in the future.

	Current Status	Scoping	Primary boundary capability increase	NW2	700MW
--	----------------	---------	--------------------------------------	-----	-------

**Trawsfynydd – Treuddyn Tee Reconductoring****EISD 2014**

The route was constructed in 1961 and updated to 400kV in 1976. Reconductor the double circuit to deliver increased transmission capacity to accommodate nuclear and wind farm generation connecting in North Wales.

	Current Status	Construction	Primary boundary capability increase	NW3	2,800MW
--	----------------	--------------	--------------------------------------	-----	---------

**Running Carrington 400kV Substation Solid and Daines 400kV Rationalisation****EISD 2017**

Having both Carrington and Daines 400kV substations split limits the boundary transfer and overloads one of the Carrington to South Manchester circuit due to poor load sharing. This is solved by running Carrington 400kV substation solid and tee-in circuits coming into Daines 400kV substation subsequent decommissioning. The scope of the project also involves extension of the Carrington 400kV that will accommodate new generation connection in the future. This reinforcement shall improve the power transfer from north to south and relaxes the thermal stress on west region boundary circuits.

	Current Status	Scoping	Primary boundary capability increase	B8	800MW
--	----------------	---------	--------------------------------------	----	-------

**Bredbury – South Manchester Reconductoring****EISD 2017**

The work includes replacement of Bredbury substation cables and Bredbury to South Manchester transmission cable with two parallel single core per phase XLPE 2500mm<sup>2</sup>. The busbars, circuit breakers and cable tower termination shall also be replaced.

	Current Status	Scoping	Primary boundary capability increase	B8	1200MW
--	----------------	---------	--------------------------------------	----	--------

**Bredbury – South Manchester Series Reactor****EISD 2017**

Install a series reactor on the Bredbury – South Manchester 275kV circuit (750MVA standard equipment sufficient) at South Manchester 275kV between the existing MC3 connection and the Bredbury – South Manchester line. The reinforcement is an alternative for the Bredbury – South Manchester Reconductoring and similarly enhances the Midlands to South power flows and ultimately, supporting the networks ability to transfer more power from the north to the south.

	Current Status	Scoping	Primary boundary capability increase	B8	900MW
--	----------------	---------	--------------------------------------	----	-------

### Cellarhead – Drakelow Reconductoring

EISD 2017

Reconductor the existing double circuits which runs from Cellarhead to Drakelow with higher rated conductor. Together with the other two West Midlands reinforcements above, this will further increase the thermal capability from Midlands to South, supporting the networks ability to transfer more power from north to south.

	Current Status	Scoping	Primary boundary capability increase	B8	1,100MW
--	----------------	---------	--------------------------------------	----	---------

### Celtic Array Integrated Offshore Stage One

EISD 2019

Upon completion of project 3 which is assumed to connect to the Lancashire coast via HVDC technology given the distances involved, platform 3 can be integrated via AC cables with projects 1 and 2 which connect to North Wales. The use of HVDC technology which will enable the control of power flows and will help to reduce the power flows out of North Wales or across B7a.

	Current Status	Scoping	Primary boundary capability increase	NW4	300 – 500 MW
--	----------------	---------	--------------------------------------	-----	--------------

### Celtic Array Integrated Offshore Stage Two

EISD 2020

Upon completion of project 5 which will connect in North Wales, there is the possibility to integrate project 3 and project 5 via AC technology to provide further capability across B7a.

	Current Status	Scoping	Primary boundary capability increase	B7a	150 – 450 MW
--	----------------	---------	--------------------------------------	-----	--------------

### Celtic Array Integrated Offshore Stage Three

EISD 2021

Upon completion of project 6 which will connect in North Wales, there is the possibility to integrate project 3 and project 6 via AC technology to provide further capability across B7a.

	Current Status	Scoping	Primary boundary capability increase	B7a	150 – 450 MW
--	----------------	---------	--------------------------------------	-----	--------------

### Irish Integration Stage One

EISD 2017

For the levels of Irish wind export generation connecting, the projects will need to be integrated in order to reduce major onshore reinforcements on the GB MITS and to meet the connection dates. As a result boundary capability is provided as a secondary benefit when the wind is generating at less than 100%. This will help improve the ability of the network to handle the heavy north to south power flows across multiple boundaries including Boundary B8, B9, B12 and all the North Wales boundaries.

	Current Status	Scoping	Primary boundary capability increase	NW4	550MW
--	----------------	---------	--------------------------------------	-----	-------



**Irish Integration Stage Two****EISD 2018**

Further transfer capability is provided through an additional link to South Wales which is required to accommodate the increase in wind generation in Ireland. This will provide further capability across multiple boundaries including Boundary B8, B9, B12 and majority of the North Wales boundaries.

	Current Status	Scoping	Primary boundary capability increase	NW4	450MW
--	----------------	---------	--------------------------------------	-----	-------

**Irish Integration Stage Three****EISD 2019**

Additional Irish wind export generation connecting in South Wales and the south west is also required to be integrated in order to reduce major onshore reinforcements on the GB MITS and to meet the connection dates. This will provide further capability across multiple boundaries including Boundary B10, B13 and SC1

	Current Status	Scoping	Primary boundary capability increase	SC1	450MW
--	----------------	---------	--------------------------------------	-----	-------

**Irish Integration Stage Four****EISD 2020**

Further transfer capability is provided through an additional link to south west which is required to accommodate the increase in wind generation in Ireland. This will provide further capability across multiple boundaries including Boundary B10, B13 and SC1.

	Current Status	Scoping	Primary boundary capability increase	SC1	450MW
--	----------------	---------	--------------------------------------	-----	-------

**Pentir – Trawsfynydd 1 Single Core per Phase****EISD 2018**

The existing cable sections of the Pentir – Trawsfynydd 1 are replaced by large single core per phase cable sections.

	Current Status	Scoping	Primary boundary capability increase	NW2	300MW
--	----------------	---------	--------------------------------------	-----	-------

**Pentir – Trawsfynydd 2 Single Core per Phase****EISD 2018**

The cable sections across both existing circuit and new circuit connecting Pentir to Trawsfynydd including the long sections across the Glaslyn estuary are paralleled with additional large single core per phase. The OHL will be the limiting component after this reinforcement is constructed.

	Current Status	Scoping	Primary boundary capability increase	NW2	1,600MW
--	----------------	---------	--------------------------------------	-----	---------

---

### Hinkley-Bridgewater Uprate

EISD 2020

Reconductor of the circuits from Hinkley Point to Bridgewater with higher rated conductor and uprate from 275kV to 400kV operation.

	Current Status	Scoping	Primary boundary capability increase		Local
--	----------------	---------	--------------------------------------	--	-------

### Local Generation Connection Works in the South West

EISD 2019

Local works (substation and transmission capacity) to accommodate local generation prior to the commissioning of the new Hinkley – Seabank circuit.

	Current Status	Scoping	Primary boundary capability increase		Local
--	----------------	---------	--------------------------------------	--	-------

---

## 4.5

# Network Development Policy

### 4.5.1 Identification of schemes for Progression:

The following describes how National Grid applies its NDP in making investment decisions with regard to wider transmission works. Similar principles are applied by the other TOs.

The first stage of the process is to determine future transmission capacity requirements as presented previously in chapter 3. Once requirements have been identified a range of potential solutions are proposed as demonstrated in the previous section.

While identifying potential solutions a high level assessment is made with respect to the benefits provided and the requirements to realise those benefits. An initial ranking of the solutions is formed which takes account of any restrictions in the ability to deliver investments to optimum timescales. For example, outage availability may mean that it is not possible to delay the commissioning of a reinforcement due to other planned outages in the same period.

Following the identification of a range of possible transmission network solutions, the next stage of the NDP is to determine the total lifetime costs, including operational costs against each of the scenarios, case studies and sensitivities considered. Potential reinforcements are considered, both in isolation and in combinations with the other reinforcements, to determine the sequential order is robust. Given the required in service date and lead time of each individual project it can be determined which solution needs to progress to the next stage of NDP analysis.

The Electricity Scenarios Illustrator (ELSI) analysis tool as mentioned in Chapter 2 is used to determine forecast constraint costs and transmission losses for the range of transmission network solutions identified against each of the agreed set of scenarios and sensitivities.

Full lifetime costs are used in the analysis including forecast transmission investment costs and constraint costs. The constraint costs are based on the prices observed in the Balancing Mechanism, and the cost of transmission losses are based on anticipated energy prices. The cost of transmission reinforcements is annuitized at the post-tax weighted average cost of capital. This is then added to the constraint and losses costs in each year, and the totals are discounted at the Treasury's social time preference rate.

### 4.5.2 Progression of Transmission Solution:

In most cases, the commitment required to progress physical network solutions will be in sequential stages from scoping, through optioneering and pre-construction to construction works. With more detailed information revealed and more expenditure at risk of being stranded as they progress.

This allows regret minimising options based on particular stages to be developed. For example, the option to complete pre-construction maintains the ability to complete the project to the earliest commissioning date for any scenario for which the reinforcement is required. It also allows work to cease with minimal regret against a scenario for which it is not required.

### 4.5.3 Selection of Preferred Option – Least Regret Analysis:

Given the range of uncertainty we face, the NDP has been developed to ensure that we take forward the preferred option at any given time.

The regret associated with any potential reinforcement which needs to be progressed is calculated against each of the scenarios and case studies determined appropriate for that region. The regret is defined as the difference in cost (which includes both investment and operational costs) between the option being considered and the best possible transmission option for that scenario, i.e we consider all options against a scenario, the option which provides minimum cost solution (investment and operational costs) is treated as base (zero costs and all other options compared against the base option).

This analysis is then repeated for all scenarios and case studies, it should be noted that different options could be selected as base in different scenarios and case studies. The worst regret for each option is then identified against the range of scenarios and case studies considered.

The preferred option is then selected based on the least regret approach. This is illustrated in table 4.4 below, where Option 1 is selected as the preferred solution for the following year.

**Table 4.4**  
*Least Regret Analysis Example*

Scenario	Option 1	Option 2	Option 3	Option 4
Scenario A	£40m	£0m	£5m	£40m
Scenario B	£0m	£185m	£40m	£160m
Scenario C	£30m	£100m	£80m	£0m
Worst Regret	£40m	£185m	£80m	£160m

For the example above Option 1 is selected as across all of the scenarios it has the lowest worst regret of only £40m when compared to all other options.

#### 4.5.4. Testing Selected Transmission Strategy Against NETS SQSS Security Criterion:

Once a transmission solution has been selected with a delivery date consistent with the "least worst" regret analysis, it will be reviewed against the requirements of the security criterion contained in the NETS SQSS. If the criterion is not met, we will consider the economic implications of a wider range of issues including, but not limited to:

- Safety and reliability.
- Value of lost load and loss of load probability (to the extent that this is not already captured in the ELSI treatment (i.e. ideal curtailment of demand and immediate restoration)).
- Cost of reduced security on the system.

If the economic implications of these considerations outweigh the cost of reinforcement to meet the security criterion then the reinforcement will be taken forward.

#### 4.5.5. Delaying a Transmission Project:

To ensure that the least regret solution is progressed we will annually review the NDP against the latest scenarios and contracted position as updated by the user, it is possible that a transmission reinforcement solution selected in a prior year will no longer be the least regret option identified in the current year. In this event, the transmission strategy will be reviewed in detail

to understand the committed cost to date and the cost of cancellation and progressed in a manner to ensure minimum cost/risk to the consumer. The options available to achieving this outcome will range from continuing a project, delaying and at the extreme may result in cancellation of a project. Where the NDP indicates that a project should be delayed, this means that the project is not required in the original timescales specified in a previous application of the policy.

#### 4.5.6 Strategic Wider Works (SWW) Process:

Some high value future schemes under the Ofgem RII0 regulatory settlement will fall outside of the remit of the Network Development Policy (NDP) and be classified as a Strategic Wider Work (SWW). These schemes follow a separate process as described below. In England and Wales a scheme is classified as SWW, if any of the following criteria are met:

- The project has a forecast cost of more than £500m<sup>25</sup>.
- The project has a forecast cost of less than £100m but consent is required for the project and it is supported by only one customer and is not required under the majority of scenarios.
- The project has a forecast cost between £100m and £500m, is supported by only one customer and is not required under the majority of scenarios.

This is summarised in figure 4.6 across.

For Scotland a different set of criteria with lower expenditure limits are used to determine Strategic Wider Works (SWW) schemes.

In the SP Transmission PLC area three projects were designated as Strategic Wider works in their Final Proposals: Dumfries and Galloway, East Coast (Kincardine to Harburn) and Eastern HVDC. The East Coast (Kincardine to Harburn) project is now defined as the Central 400kV Upgrade (Denny – Wishaw).

Criteria for future SWW projects must satisfy the following materiality criteria:

- (i) total delivery costs will be greater than £100 million
- (ii) the output will deliver cross boundary (or sub boundary) capacity or wider system benefits; and
- (iii) costs cannot be recovered under any other provision of this licence.

SP Transmission PLC are developing each of the above projects in accordance with Ofgem's SWW process.

<sup>25</sup> In 2009/10 prices.

**Figure 4.6**  
*Definition of Strategic Wider Work (SWW) Schemes for England and Wales*

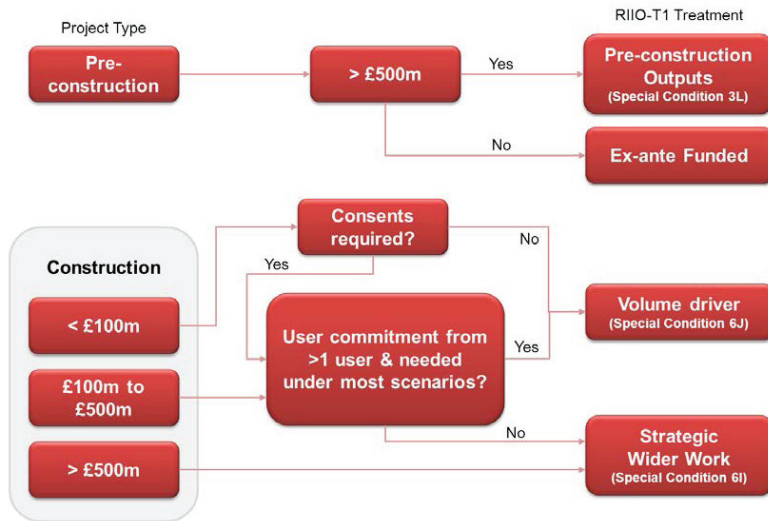

At present, the following projects are treated as Strategic Wider Works, namely:

#### England and Wales

- Western HVDC Link
- Eastern HVDC Link
- Wylfa – Pembroke HVDC Link
- Hinkley – Seabank New Transmission Route
- East Coast Integrated Offshore Transmission Project

#### Scotland

- Eastern HVDC Link
- Kintyre to Hunterston Subsea Link
- Beaulieu – Mossford 132kV OHL Rebuild
- Western Isles HVDC Link
- Caithness – Moray Reinforcement
- Shetland to Mainland HVDC Link

- Orkney – Dounreay AC Link
- East Coast 400kV Reinforcement
- Tealing-Westfield-Longannet Upgrade
- Beaulieu – Blackhilllock 400kV
- Dumfries and Galloway
- Central 400kV upgrade (Denny – Wishaw)

#### Strategic Wider Works Funding Process

A process has been defined to allow the transmission owners to propose new SWW outputs and to be able to request funding to deliver these outputs. The SWW process consists of four main stages: Eligibility Assessment, Needs Case Assessment, Project Assessment and Implementing Decision. This is summarised in figure 4.7.

**Figure 4.7**  
*Strategic Wider Works Assessment Process*

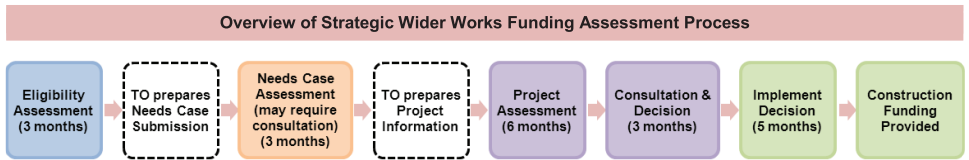

It should be noted that these assessment stages are interactive and can overlap. The timescales defined are indicative only and can be changed to accommodate the need of the project, with agreement from Ofgem.

Table 4.5 below illustrates the responsibilities of the transmission owner and Ofgem at each stage of the Strategic Wider Works process.

**Table 4.5**  
*Strategic Wider Works: Roles and Responsibilities*

Stages	Objective	Transmission Owner (TO)	Ofgem
Eligibility Assessment	Determine eligibility for assessment under SWW mechanism.	Advises Ofgem of its intention to submit a request for SWW and provides evidence of the scheme meeting the pre-defined eligibility criteria.	Assesses whether scheme is eligible. If appropriate, agrees with TO the timetable for assessment.
Needs Case Assessment	Assess needs case for the project including the scope of proposed works and timing.	Submits details of need case including justification of proposed timing and explanation of how proposed project would meet the required need.	Assesses the need case, scope of the project and timing of the project to determine if the project is economically efficient.
Project Assessment	Justify proposals against technical readiness and cost effectiveness; determine funding allowances, outputs and criteria for any future adjustments to costs or outputs.	Submits detailed information about design, costs and risks for project.	Assesses construction costs and deliverables to ensure efficiency and value for money for consumers and consults on initial findings.
Implementing Decision	Provide allowances of delivering the output where needs case is justified.		Publishes decisions. Consults on licence changes. Issues licence changes.

## Investment Recommendations

This section of the chapter takes the potential transmission solutions, which include a variety of offshore, asset, operational and commercial solutions, as input to perform a regional cost benefit analysis. The result gives the best cost benefit strategy for each scenario, and enables the

conclusion to a current year recommendation for works required in a region. Colour codes are used in this section as discussed earlier in the Introduction of this chapter to help identify information of the relevant region.

### 4.6.1

#### Scotland

The table below summarises the regional drivers for Scotland and the corresponding potential transmission solutions suggested for the region.

**Table 4.6**  
*Scottish Investment Options*

Driver	Potential transmission solution		EISD
	Category	Option	
Limitation on power transfer from generation in remote locations to the main transmission routes	Asset	Gravir on Lewis to Beauly HVDC Link	2018
		Shetland to Mainland HVDC Link	2018
		Orkney – Dounreay AC Subsea Connection	2018
		Beauly-Mossford 132kV Reinforcement	2015
		Beauly-Tomatin 275kV Reinforcement	2018
		Foyers-Knocknagael 275kV Upgrade	2015
		Lairg-Loch Buidhe 275kV Reinforcement	2019
		Skye 132kV Second Circuit	2021
		South West Scotland Connections Project	2015
		Kilmarnock South – Coylton 275kV Uprating	2016
		Coylton – Mark Hill 275kV Uprating	2016
		Kilmarnock South 400/275kV Substation Uprating	2018
Dumfries and Galloway Reinforcement	2023		
Limitation on exporting power from Argyll and the Kintyre peninsula	Asset	Kintyre to Hunterston Subsea Link	2015
Limitation on power transfer from north to south of Scotland	Asset	Beauly to Denny Reinforcement	2015
		Beauly – Blackhillock – Kintore Uprate	2015
		Caithness – Moray Reinforcement Strategy	2018
		East Coast 400kV Uprate Blackhillock to Kincardine	2018
		Tealing – Westfield – Longannet Uprate	2019
Limitation on exporting power from Scotland to England	Asset	Central 400kV Uprate	2019
		B6 Series and Shunt Compensation	2015
		Harker – Strathaven Reconductoring and Series Compensation	2019
		Western HVDC Link	2016
		Eastern HVDC One	2019
		Eastern HVDC Two	2021
		Eastern HVDC Three	2025

The timing of the reinforcement projects reflect the later of the required reinforcement year and the earliest possible implementation date.

**Table 4.7**  
*SHE Transmission Investment Recommendation by Scenario*

Transmission Solution	Strategy		
	Scenario Completion date		
	Slow Progression	Gone Green	Local Contracted
Kintyre to Hunterston Subsea Cable	2015	2015	2015
Beauly to Denny Reinforcement	2015	2015	2015
Beauly – Blackhilllock – Kintore Uprate	2015	2015	2015
Gravir on Lewis to Beauly HVDC Link	2017	2017	2017
Shetland to Mainland HVDC Link	2018	2018	2018
Orkney – Dounreay AC Subsea Connection	2018	2018	2018
Caithness – Moray Reinforcement Strategy	2018	2018	2018
East Coast 400kV Uprate Blackhilllock to Kincardine	2020	2018	2018
Tealing – Westfield – Longannet Uprate	2022	2019	2018
Lairg – Lock Buidhe 275kV Uprate	2028	2020	2019
Eastern HVDC Link One	Not required	2023	2023
Eastern HVDC Link Three	Not required		

The Slow Progression, Gone Green and Contracted scenarios predict continual growth in renewable generation that requires reinforcement of the SHE Transmission network.

Three key reinforcement projects are currently being constructed, the – Beauly to Denny reinforcement, the Beauly – Blackhilllock – Kintore Upgrade and the Kintyre to Hunterston subsea link, with all of which are due for completion in 2015.

Against this background of rapidly increasing renewable generation, a number of reinforcement strategies have been proposed and are being investigated to maintain compliance with the NETS SQSS. Examples of these are the proposed Caithness-Moray reinforcement and the East Coast 400kV reinforcement projects. A project to install a subsea HVDC link between Peterhead and Hawthorne Pit, known as Eastern HVDC, is also being investigated to address higher transfer requirements from North Scotland to England.



Additional reinforcement projects that, in the main, are radial extensions of the Main Interconnected Transmission System (MITS) are required to harvest generation in remote areas. An example of these is the Beauly- to Mossford project which is currently under construction and due for completion in 2015. Further proposed projects include Beauly to Tomatin, Knocknagael to Foyers upgrades.

The significant interest from generation developers on the large island groups of the Western Isles, Orkney and Shetland means that new transmission infrastructure will be required to connect these to the mainland transmission network.

Current proposals are for the Western Isles to be connected using an HVDC transmission link from Gravir on Lewis to Beauly substation. It is also proposed to use an integrated multi-terminal HVDC link to connect Shetland to the mainland via a DC bussing point at Sinclairs Bay in Caithness. The growth of small onshore renewable generation on mainland Orkney together with the potential significant growth in marine generation around Orkney and the Pentland Firth requires a transmission connection to Orkney. It is currently proposed to install an AC subsea cable from Orkney to Dounreay.

**Table 4.8**  
*SP Transmission Investment Recommendation by Scenario*

Transmission Solution	Strategy		
	Scenario Completion date		
	Slow Progression	Gone Green	Local Contracted
B6 Series and Shunt Compensation	2015	2015	2015
Western HVDC Link	2016	2016	2016
Central 400kV Upgrade	2021	2019	2019
South West Scotland Connections Project	2015	2015	2015
Kilmarnock South – Coylton 275kV Uprating	2016	2016	2016
Coylton – Mark Hill 275kV Uprating	2016	2016	2016
Kilmarnock South 400/275kV Substation Uprating	2018	2018	2018
Dumfries and Galloway Reinforcement	2023	2023	2023
Harker – Strathaven Reconductoring and Series Compensation	2023	2020	2020
Eastern HVDC Link Two	Not required	2021	2021

A number of schemes have already been delivered to improve the capability of cross Scotland-England power transfer, and two schemes in progress are the insertion of new series and shunt compensation on the existing circuits and the creation of a new Western HVDC link, which are forecast to be delivered at their earliest possible dates of 2015 and 2016 respectively.

Beyond this, taking account of the potential generation in the period up to and beyond 2020, SHE Transmission, SP Transmission and NGET are carrying out pre-construction design and engineering work of an offshore HVDC link between Peterhead, Torness and Hawthorne Pit in the north of England (Eastern HVDC Link One). Undertaking pre-construction design and engineering work positions the delivery of the Eastern HVDC project such that construction can commence at the appropriate time when there is confidence that the reinforcement will be required. For the Gone Green scenario and contracted background this may be around 2020, however under Slow Progression a later delivery date may be more suitable.

SP Transmission is also undertaking pre-construction design and engineering work on prospective upgrades specific to cope with the increasingly high north to south power flows through the Scottish networks. Reinforcement works are programmed for 2019 by SHE Transmission and SP Transmission which involve the upgrade of the existing 275kV tower line between Tealing and Longannet via Westfield and Glenrothes and a new 400kV transmission line between Denny and Wishaw to be constructed by SP Transmission.

The Gone Green scenario may also require further reinforcement around 2029 due to the level of offshore wind generation and assumed CCS generation connecting in the later part of the period.

For Gone Green the reinforcements identified represent a significant challenge if they are to be delivered by the dates specified. In the latter part of the period, the required transfer levels for the Gone Green scenario in some boundaries represent more than three times the current transmission requirement. As a consequence of Connect and Manage the build-up of contracted generation is much faster than in other scenarios. Reinforcement will be delivered at the earliest opportunity once there is sufficient confidence that it is required.

For the contracted background, there is a far greater pace of wind farm connection in the early years, with the required transfer peaking around 2020 after which point it gently decreases, primarily due to the high volume of contracted generation connections in England and Wales.

For Slow Progression, there is little growth in the required transfer after 2025, predominantly due to a reduced amount of generation in the Round 3 and Scottish Territorial Waters windfarm zones, and no assumed CCGT generation connecting in the later part of the period. Accordingly, no further reinforcements are required.

## 4.6.2

## North England

The table below summarises the regional drivers for North England and the corresponding potential transmission solutions suggested for the region.

*Table 4.9*  
*North England Investment Options*

Driver	Potential transmission solution				
	Category	Option	EISD		
Limitation on power transfer from Scotland to England	Asset	B6 Series and Shunt Compensation	2015		
		Western HVDC Link	2016		
		Eastern HVDC Link One	2019		
		Eastern HVDC Link Two	2021		
		Eastern HVDC Link Three	2025		
Limitation on power transfer out of North East England	Asset	Lister Drive Quad Booster	2018		
		Yorkshire 400kV Circuits Hotwiring and Reconductoring	2019		
	Offshore	Dogger Bank Integration Stage One	2018		
		Dogger Bank Integration Stage Two	2019		
		Dogger Bank Integration Stage Three	2020		
		Dogger Bank Integration Stage Four	2021		
		Dogger Bank Integration Stage Five	2022		
		Dogger Bank Integration Stage Six	2023		
		Limitation on power transfer from North Midlands to West Midlands Asset	Asset	Penwortham Quad Boosters	2014
				Kirkby & Rainhill Substation Upgrade	2016
High Marnham – West Burton Reconnector	2014				
Penwortham – Padiham & Penwortham – Carrington	2020				
Limitation on power transfer out of Humber	Asset	Reconductoring and Kirkby – Penwortham Upgrade	2022		
		Killingholme South – West Burton New Transmission Route	2022		

There are a multitude of options for this region that provide significant capability to the boundary. These options include offshore integration that will give onshore boundary capability on the NETS. The current status of these projects vary from initial feasibility scoping through to nearing completion.

Where the time to deliver these projects is relatively short no decision is required within the twelve months.

**Table 4.10**  
*North England Investment Strategies*

Transmission Solution	Strategy		
	Scenario Completion date		
	Slow Progression	Gone Green	Local Contracted
Series and Shunt Compensation	2014	2014	2014
Western HVDC Link	2016	2016	2016
Eastern HVDC Link 1	N/A	2023	2023
Yorkshire Lines reconductoring	2021	2020	2020
Penwortham QBs	2014	2014	2014
High Marnham - West Burton Reconnector	2014	2014	2014
Kirkby-Rainhill 2 Way split	2021	2016	2016
Mersey Ring Stage 1a	2021	2020	2019
Killingholme South – West Burton	N/A	2028	2025
Eastern HVDC Link 2	N/A	2021	2021
Eastern HVDC Link 3	N/A	N/A	N/A
East Offshore Integration	N/A	2024+	2020+
West Offshore Integration	N/A	2023+	2022+
Lister Drive QB	N/A	2020	N/A

The Series compensation, Western HVDC and Penwortham QBs projects show the same year of delivery for all three scenarios. The early years of the scenarios are similar and given the near completion of the projects the recommendation is to continue these projects to completion.

Given the divergence in scenarios in later years we see a difference in required in service dates for the subsequent projects for each scenario.

There are many projects that are only required in Gone Green and local contracted because the Slow Progression transfer volumes would never see a need for this reinforcement. Offshore co-ordination can provide valuable economic capability to the MITS.

#### Reinforcement Selection by Scenario

Cost benefit analysis was completed with for different combinations and timings of transmission solutions until an economic strategy was found for each scenario, as shown in table 4.10 below.

Offshore coordinated development involves the alignment of wider GB transmission needs with the progression of offshore generation connections. The initial dates shown in table 4.10 are based on both boundary need and sufficient offshore transmission through generation connections being available.

#### Development of options

The table above shows that the lowest cost solutions for each of the scenarios.

Taking in to account the lead times and boundary benefit of each of the above reinforcements the key decision for the least regret analysis is the Kirby-Rainhill 2-way split or the Eastern HVDC.

**Selection of the preferred option**

The worst regrets for each of the current year options considered against each of the scenarios are shown in table 4.11. The NDP decisions are shown in table 4.12.

**Table 4.11**  
*North England Investment Options and Regrets*

Scenario	2013 (current year) option			
	Kirby and Rainhill substation reconfiguration	Eastern HVDC	Proceed Both	Do Nothing
Slow Progression	£0m	£12.7m	£4.2m	£8.5m
Slow Progression (High CCGT, low coal)	£0m	£12.6m	£3.3m	£9.3m
Slow Progression (High coal, low CCGT/Biomass)	£0m	£11.3m	£1.2m	£10.1m
Gone Green	£0m	£2.0m	£0.6m	£1.4m
Gone Green (High offshore wind)	£0m	£2.0m	£0.6m	£1.4m
Gone Green (High onshore wind)	£2.2m	£1.4m	£0m	£3.7m
<b>Worst regrets</b>	<b>£2.2m</b>	<b>12.7m</b>	<b>£4.2m</b>	<b>£10.1m</b>

**Table 4.12**  
*North England Investment Decisions*

Option	Decision
B6 NGET Series and Shunt Compensation	Complete construction
Western HVDC Link	Progress construction
Eastern HVDC Link 1	Continue pre-construction scoping
Yorkshire Lines reconductoring	No decision required
Penwortham QBs	Complete construction
Kirkby-Rainhill 2 Way split	Progress pre-construction scoping and design
Mersey Ring Stage 1a	No decision required
Killingholme South – West Burton	No decision required
Eastern HVDC Link 2	No decision required
Eastern HVDC Link 3	No decision required
East Offshore Integration	Evaluation on-going
West Offshore Integration	Evaluation on-going
Lister Drive QB	No decision required

**NDP Recommendations**

The recommendation is to progress the pre-construction of the Kirkby-Rainhill 2 way split and the completion of Series and Shunt compensation, Western HVDC and Penwortham QBs. To maintain the optionality of the Eastern HVDC link it is recommended to continue with the pre-construction scoping phase but do not progress to the pre-construction design phase. The project will be reviewed in next years' NDP.

The decision taken for the Eastern Link 1 is based on minimal spend next year. This spend is based on continuation of scoping studies and considerably less than utilised in NDP analysis, which assumed entry into design phase. The benefits of this approach allow risk mitigation of the project in the construction phase.

**4.6.3****East England**

The table below summarises the regional drivers for East England and the corresponding potential transmission solutions suggested for the region.

*Table 4.13  
East England Investment Options*

Driver	Potential transmission solution		EISD
	Category	Option	
Limitation from East Anglia to Greater London and South East England	Asset	Bramford – Braintree – Rayleigh Main Reconductoring	2014
		Rayleigh – Coryton South – Tilbury Reconductoring	2014
		Bramford – Twinstead New Overhead Lines	2020
		Norwich – Bramford Reconductoring	2018
		East Anglia MSC	2017

**Reinforcement Selection by Scenario**

Cost benefit analysis was completed with consideration of different combinations and timings of transmission solutions until the lowest cost strategies were found for each of the scenarios. These optimised strategies were shown in table 4.14 below.

*Table 4.14  
East England Investment Strategies*

Transmission Solution	Strategy		
	Scenario Completion date		
	Slow Progression	Gone Green	Local Contracted
Bramford to Twinstead Tee	2025	2022	2022
Norwich to Bramford Reconductoring	2025	2022	2021
Rayleigh Main – Coryton South – Tilbury reconductoring	2014	2014	2014
East Anglia MSC	N/A	2026	2026

### Development options

The table above shows that the lowest cost solutions for each of the scenarios.

Taking in to account the lead times and boundary benefit of each of the above reinforcements the key decision for the least regret analysis is associated with Rayleigh Main - Coryton South - Tilbury reconductoring and the Bramford Twinstead Tee.

### Selection of preferred current year option

The regrets for each of the current year options considered against each of the scenarios are shown in table 4.15. The NDP investment decisions are shown in table 4.16.

**Table 4.15**  
*East England Investment Options and Regrets*

Scenario	2013 (current year) option			
	Bramford to Twinstead	Rayleigh Main – Coryton South – Tilbury	Both	Neither
Slow Progression	£3.6m	£0m	£1.2m	£2.4m
Slow Progression (High CCGT, low coal)	£3.6m	£0m	£1.2m	£2.4m
Slow Progression (High coal, low CCGT/Biomass)	£3.6m	£0m	£1.2m	£2.4m
Gone Green	£4.9m	£0m	£0.8m	£4.1m
Gone Green (High offshore wind)	£4.9m	£0m	£0.8m	£4.1m
Gone Green (High onshore wind)	£3.2m	£0m	£1.3m	£1.9m
<b>Worst regrets</b>	<b>£4.9m</b>	<b>£0m</b>	<b>£1.3m</b>	<b>£4.1m</b>

**Table 4.16**  
*East England Investment Decisions*

Option	Decision
Bramford to Twinstead Tee	Delay
Norwich to Bramford Reconductoring	Delay
Rayleigh Main – Coryton South – Tilbury reconductoring	Complete
East Anglia MSC	No decision required

### NDP Recommendation

The worst regrets for each of the options are shown. The option to complete the Rayleigh Main - Coryton South - Tilbury reconductoring is the least regret option.

## 4.6.4

## South England

The table below summarises the regional drivers for North England and the corresponding potential transmission solutions suggested for the region.

*Table 4.17*  
*South England Investment Options*

Driver	Potential transmission solution		
	Category	Option	EISD
Limitation from Midlands into South England	Asset	Barking – Lakeside Tee New Double Circuits	2014
		Wymondley Turn-in	2017
		Hackney – Tottenham – Waltham Cross Uprate	2017
		Wymondley QBs	2018
Limitation in the south coast	Asset	Dungeness – Sellindge – Canterbury North Reconductoring	2016
		South Coast reactive compensation	2018
		New Transmission Route on South Coast	2023

#### Reinforcement Selection by Scenario

Cost benefit analysis was completed with consideration of different combinations and timings of transmission solutions until the lowest cost strategies were found for each of the scenarios. These lowest cost solutions are shown in table 4.18 below.

*Table 4.18*  
*South England Investment Strategies*

Transmission Solution	Strategy		
	Scenario Completion date		
	Slow Progression	Gone Green	Local Contracted
Wymondley Turn-in	2017	2018	2018
Barking Lakeside Tee	2014	2014	2014
Hackney - Tottenham Waltham Cross Uprate	2024	2022	2022
Wymondley QBs	2018	2019	2019
Dungeness - Sellindge - Canterbury reconductoring	2022	2018	2018
South Coast Reactive Compensation	2022	2018	2018
New Transmission Route on South Coast	N/A	2023	2023



The reinforcements in this area are all required in the scenarios, with the exception of the New Transmission route on the south coast and Dungeness-Sellindge-Canterbury reconductoring which was not required in the Slow Progression scenario.

Taking in to account the lead times and boundary benefit of each of the above reinforcements the key decision for the least regret analysis is the Wymondley turn-in and the Wymondley Quadrature Boosters.

#### Development options

The table above shows that the lowest cost strategies for each of the scenarios.

#### Selection of preferred current year option

The regrets for each of the current year options considered against each of the scenarios are shown in table 4.19. The NDP investment decisions are shown in table 4.20.

**Table 4.19**  
*South England Investment Options and Regrets*

Scenario	2013 (current year) option			
	Proceed Wymondley Turn-in	Proceed Wymondley QBs	Proceed Both	Do Nothing
Slow Progression	£0.9m	£1.9m	£0m	£2.8m
Slow Progression (High CCGT, low coal)	£0m	£1.9m	£0.5m	£1.4m
Slow Progression (High coal, low CCGT/Biomass)	£0.6m	£1.9m	£0m	£2.0m
Gone Green	£0.1m	£0.5m	£0.6m	£0m
Gone Green (High offshore wind)	£0.1m	£0.5m	£0.6m	£0m
Gone Green (High onshore wind)	£0.1m	£0.5m	£0.6m	£0m
<b>Worst regrets</b>	<b>£0.9m</b>	<b>£1.9m</b>	<b>£0.6m</b>	<b>£2.8m</b>

**Table 4.20**  
*South England Investment Decisions*

Option	Decision
Wymondley Turn-in	Commence pre-construction
Barking Lakeside Tee	Complete
Hackney - Tottenham Waltham Cross Uprate	Delay
Wymondley QBs	Commence pre-construction
Dungeness - Sellindge - Canterbury reconductoring	No decision is required
South Coast Reactive Compensation	Complete pre-construction
New Transmission Route on South Coast	Commence pre-construction scoping

**Current year recommendation**

The recommendations for this area are to commence pre-construction of the Wymondley turn-in and Quadrature boosters, complete pre-construction

activities of the reactive compensation and begin the pre-construction scoping for the New Transmission route on the south coast.

**4.6.5****West England and Wales**

The table below summarises the regional drivers for West England and Wales together with the proposed transmission solution options suggested for the region.

**Table 4.21**  
*West England and Wales Investment Options*

Driver	Potential transmission solution		
	Category	Option	EISD
Limitation on power transfer through Midlands	Asset	Bredbury – South Manchester Reconductoring	2017
		Bredbury – South Manchester Series Reactor	2017
		Cellarhead – Drakelow Reconductoring	2017
		Daines Rationalisation	2017
		Wylfa – Pembroke HVDC Link	2022
		Run Carrington and Daines Solid	2017
Limitation on power transfer from north to south of Scotland	Asset	Trawsfynydd – Treuddyn Tee Reconductoring	2014
		Pentir – Trawsfynydd Second Circuit	2018
		Pentir – Deeside and Pentir – Trawsfynydd Reconductoring	2018
		Pentir – Trawsfynydd 1 Single Core per Phase	2018
		Pentir – Trawsfynydd 2 Single Core per Phase	2018
		Wylfa – Pentir Second Transmission Route	2022
	Offshore	Celtic Array Integrated Offshore Stage One	2019
		Celtic Array Integrated Offshore Stage Two	2020
		Celtic Array Integrated Offshore Stage Three	2021
		Irish Offshore Integration Stage One	2017
Limitation on exporting power from Scotland to England	Asset	Irish Offshore Integration Stage Two	2018
		Irish Integration Stage Three	2019
		Irish Integration Stage Four	2020
		Bramley – Melksham Reconductoring	2019
		Hinkley-Seabank new circuit	2019
		Seabank local connection option	2019
		Hinkley-Bridgewater reconductoring	2020
		Local generation connection works	2019

The key limitations are the north to Midlands transfer, north Wales exports and new connections in the south west. Given the number of drivers there are a significant number of potential solutions. A number of these potential solutions are complementary, solving several of these limitations.

#### Reinforcement Selection by Scenario

Cost benefit analysis was completed with consideration of different combinations and timings of transmission solutions until the lowest cost strategies were found for each of the scenarios. These lowest cost strategies were shown in table 4.22 below.

**Table 4.22**  
*West England and Wales Investment Strategies*

Transmission Solution	Strategy		
	Scenario Completion date		
	Slow Progression	Gone Green	Local Contracted
Bredbury – South Manchester Reconductoring	2021	2021	N/A
Bredbury – South Manchester Series Reactor	N/A	N/A	N/A
Cellarhead – Drakelow Reconductoring	2022	2022	2019
Daines Rationalisation	2019	2019	N/A
Wylfa – Pembroke HVDC Link	N/A	N/A	2022
Wylfa – Pentir	2025	2023	2020
Run Carrington and Daines Solid	2019	2019	2020
Trawsfynydd – Treuddyn Tee Reconductoring	2014	2014	2014
Pentir – Trawsfynydd Second Circuit	2023	2020	2018
Pentir – Deeside and Pentir – Trawsfynydd Reconductoring	N/A	N/A	2022
Pentir – Trawsfynydd 1 Single Core per Phase	2026	2021	2020
Pentir – Trawsfynydd 2 Single Core per Phase	2026	2021	2020
Celtic Array Integrated Offshore Stage One	N/A	2023+	2022+
Irish Offshore Integration Stage One	N/A	2024	2020
Bramley – Melksham Reconductoring	2027	2025	N/A
Hinkley-Seabank new circuit	2020	2021	2019
Hinkley-Bridgewater upgrade	N/A	N/A	2025
Swansea circuit turn-in	2019	2019	2016
Local generator connection works	N/A	N/A	2019

**Development of options**

The table above shows that the lowest cost solutions for each of the scenarios are different, which indicates there is a risk of regret.

**Selection of preferred current year option**

The regrets for each of the current year options considered against each of the scenarios are shown in table 4.23. The NDP recommendations for this region are shown in table 4.24.

**Table 4.23**  
*North Wales Investment Options and Regrets*

Scenario	2013 (current year) option			
	Wylfa-Pembroke HVDC	Pentir – Traws 2nd Circuit	Both	Do Nothing
Slow Progression	£6.7m	£1.1m	£7.8m	£0m
Slow Progression (High CCGT, low coal)	£6.7m	£1.8m	£8.5m	£0m
Slow Progression (High coal, low CCGT/Biomass)	£0.4m	£3.2m	£3.7m	£0m
Gone Green	£6.7m	£0.3m	£7m	£0m
Gone Green (High offshore wind)	£0.4m	£0.5m	£1.0m	£0m
Gone Green (High onshore wind)	£0.4m	£0.5m	£1.0m	£0m
Local contracted	£44.3m	£0m	£0.4m	£43.9m
No local contracted	£6.7m	£0.8m	£7.5m	£0m
<b>Worst regrets</b>	<b>£44.3m</b>	<b>£3.2m</b>	<b>£8.5m</b>	<b>£43.9m</b>

**Table 4.24**  
*North Wales Investment Decisions*

Option	Decision
Run Carrington and Daines solid	No decision required
Bredbury – South Manchester reconductoring	No decision required
Cellarhead – Drakelow reconductoring	No decision required
Bredbury – South Manchester series reactor	No decision required
Wylfa – Pembroke HVDC link	Delay
Second Wylfa – Pentir circuit	Delay
Second Pentir –Trawsfynydd circuit	Proceed pre-construction
Pentir – Deeside reconductoring	Delay
Trawsfynydd – Treuddyn tee reconductoring	Complete
Pentir Trawsfynydd 1 SCP	No decision required
Pentir Trawsfynydd 2 SCP	No decision required
Celtic Array	Evaluation on-going

### NDP recommendation

The decisions to be made in this area are to complete the Trawsfynydd – Treuddyn tee reconductoring and to progress with the pre-construction of the 2nd Pentir-Trawsfynydd circuit.

The Celtic Array integration requires further evaluation of the option and cost benefit.

### South Wales and South West

The regrets for each of the current year options considered against each of the scenarios are shown in table 4.25 and NDP recommendations for this area are shown in table 4.26.

**Table 4.25**  
*South Wales and South West Investment Options and Regrets*

Scenario	2013 (current year) option		
	Hinkley-Seabank circuit	Seabank local connection option	Do Nothing
Slow Progression	£5.4m	£5.8m	£0m
Slow Progression (High CCGT, low coal)	£1.1m	£5.8m	£0m
Slow Progression (High coal, low CCGT/Biomass)	£5.4m	£5.8m	£0m
Gone Green	£2.2m	£5.8m	£0m
Gone Green (High offshore wind)	£2.2m	£5.8m	£0m
Gone Green (High onshore wind)	£2.2m	£5.8m	£0m
Local contracted	£0m	£49.4m	£87.3m
No local contracted	£33.8m	£5.8m	£0m
<b>Worst regrets</b>	<b>£33.8m</b>	<b>£49.4m</b>	<b>£87.3m</b>

**Table 4.26**  
*South Wales and South West Investment Decisions*

Option	Decision
Hinkley - Seabank new circuit	Proceed pre-construction
Seabank local connection option	Do not proceed
Bramley - Mealksham	Delay
Hinkley - Bridgewater	Proceed pre-construction

---

The current decisions for this area of the Network are to continue with Hinkley-Seabank and delay the other potential investments.

### **Stakeholder Engagement**

We would very much appreciate your view on the way we presented the potential future development of the NETS, and if we have explained to you clearly how development decisions were made to ensure an optimal, economic and efficient transmission strategy.

## 4.7

## Transmission Losses

### Transmission Losses introduction

Transmission losses can be generally classified into fixed losses and load related losses. Fixed losses are mostly independent from the loading of the circuits and typically come from such things as transformer iron losses and high voltage corona losses. There is some variation in the fixed losses due to variations in system voltages and weather conditions but this variation is usually small. Load related losses typically come from the resistance of circuits and is dependent on the square of the current carried ( $I^2R$ ) so changes significantly with the loading of the transmission system.

### Reporting Transmission Losses

In order to provide an indication of the transmission losses that can be seen on the NETS, the total losses for the following transmission elements are considered:

- 400kV and 275kV circuits
- 132kV circuits in Scotland
- 400/275kV transformers
- 400kV or 275kV to 132kV transformers in Scotland
- HVDC transmission circuits and converters
- Offshore transmission cables of 132kV or above
- Offshore/onshore transmission interface transformers

At winter peak the NETS losses are indicatively calculated to be as follows, assuming an intact system:

*Table 4.20*  
*Transmission Losses*

	NETS losses (MW) at Peak
Year 1	880
Year 3	830
Year 5	730
Year 7	950
Year 10	910

The calculated losses vary significantly each year as the network develops together with change in the distribution of generation. Generally as more generation is connected at the periphery of the network the losses are expected to increase. Load losses do not linearly change with circuit loading being proportional to the square of the current carried. A particularly heavily loaded circuit in one year contributing significantly to the total losses may be less loaded the next and have a much smaller proportional of the total losses. Local reactive support for voltage management avoids the transmission of reactive power over distances that would otherwise increase system losses.

Total annual NETS losses for the last year are estimated to be 5.6TWh. Energy supplied by the NETS to the transmission customers last year is approximately 320TWh so transmission loss accounts for around 1.75% of the energy supplied.

## 4.8

## Network Opportunities

This section focuses on the opportunities available to stakeholders when interacting with the NETS through new or existing connections. Generally the NETS exists to carry power from sources of generation to areas of demand. National Grid has an obligation to co-ordinate and co-operate in the development of the NETS, including the services required in the operation of the network.

Our customers and stakeholders are invited to suggest means in which they can help meet future system requirements, in terms of (i) planning capacity (Chapter 3) and (ii) managing the operation of the network (Chapter 5). It is National Grid's ambition to explore all options that help satisfy the future network requirements and allow us to deliver network capability at lowest cost to the consumer.

### 4.8.1 Potential Network Opportunities

This section provides a very high-level indication of where opportunities lie, so that developers, users and industry can make informed decisions as to how their investments will impact on the NETS, system reinforcement, and system congestion. We will be working with stakeholders during 2014 to develop services that could reduce the need for system reinforcement and congestion as described in section 4.3. The opportunity for new connection to the NETS is shown in this document and published by NGET in the *Transmission Networks Quarterly Connections Update (TNQCU)*<sup>26</sup>. The information contained in this relates to the contracted status of future and existing generation. Further opportunities related to technical operational issues are discussed in the next chapter.

### Generation

In addition to supplying all of the power necessary to meet the total NETS demand, generators play an important role in keeping the network operational by providing services such as:

- Voltage control
- Frequency response
- Emergency response
- Black start capability

The provision of a basic level of service is a condition of connection to the NETS. However, with the ever-changing NETS background there could be the opportunity for generators to provide additional services. An example may be a generator offering enhanced voltage control that could remove the need for transmission connected reactive compensation. Reduced investment in the transmission network would then be reflected by a reduction in transmission usage charges.

### Opportunity Identification and Boundary discussion

The following section presents the opportunities for connectees and the current system drivers for development associated with transmission connections. The table below provides a mapping of the areas of the transmission system to the affected boundaries. E.g. if you are connecting a new project above B1 the connection will have an effect on B1, B2, B3, B4, B5, B6, B7, B7a, B11 and B16. To aid the reader in understanding this we have colour coordinated with the developments in section 4.7 and with the aforementioned opportunities in this section.

<sup>26</sup> <http://www.nationalgrid.com/uk/Electricity/GettingConnected/ContractedGenerationInformation/TNQuUpdate/>





The connection opportunities and timescales are shown on the following map:



### Demand

As shown in the FES, the future trend appears to be for generation to be moving towards the periphery of the NETS away from the demand centres, and for increasing volumes of intermittent generation. If demand could be shaped to reduce the congestion on the NETS, then less transmission investment may be required.

There is an opportunity for stakeholders to participate in offering services, such as demand management, by curtailing their demand during peak periods. This would alleviate boundary constraints and is one of the means by which we could meet future system requirements. This could be, for example, through demand-side response, where end energy consumers reduce their demand to assist in maintaining system balance. The combination of network investment and demand-side management could lead to potential reduction in the costs to consumers, enhance security of supply, and contribute to sustainable development.

Demand-side management can be in the form of inter-trips, where an agreed automated disconnection of demand occurs during times of system constraints. Where appropriate this could be part of a commercial service and combined with relatively low cost asset solutions. Such low cost investments could include circuit reconfiguration or hot-wiring<sup>27</sup>. This could provide a solution until such a time as the needs of the system become more certain, and it is clear that making a firm long term large asset investment is economical and the right thing to do.

<sup>27</sup> Hot-wiring refers to operating existing overhead line circuits at higher temperatures to achieve higher thermal ratings. Operating at higher temperature may require minor works, for example, the re-tensioning of particular spans to ensure safety clearances.

The reactive power support seen by the NETS from GSPs is changing due to a number of factors:

- The reactive power demand seen by the NETS from GSPs is decreasing rapidly.
- There is growing volumes of embedded generation connecting to GSPs.
- Traditional generator reactive support is declining.

To help manage these changing circumstances, third parties could provide reactive power services locally. From the reinforcement options reported earlier in this chapter it can be seen where reactive compensation is required.

#### Innovation

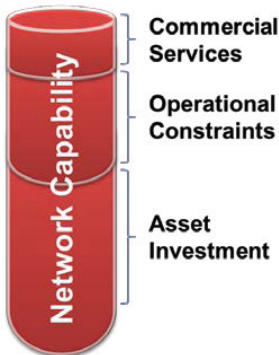

To aid the development of the electricity transmission network, new ideas are welcomed and are actively investigated. Continued research and development into new ideas in such as processes, technology and resources will help to ensure the NETS remains economic and efficient.

Recent innovations that are being applied to the NETS includes:

- first GB use of series reactive compensation.
- design of the new T-pylon.
- design of the Western HVDC link.

Innovation is constantly being applied by the customers of the NETS, such as new types of generators and changes to the distribution networks. Through regular engagement and our own research, the NETS is in a good position to innovate for the future.

#### 4.8.2 Indication of Regional Opportunities

This section explores possible wider NETS related opportunities split by regions across Scotland, England and Wales.

Colour codes are used in this section as discussed earlier in the Introduction of this chapter to help identify information for the relevant region.

#### Scotland

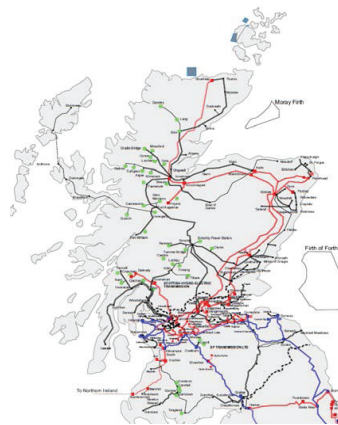

<b>Region Type</b>	High export of renewable energy
<b>Limiting Factor</b>	Circuit capacity and remoteness
<b>Network Development</b>	Major new infrastructure and upgrade of existing assets
<b>Opportunity</b>	Demand connections Reactive power services

Scotland has a growing excess of renewable generation capacity in comparison to demand. This results in periods of high north to south power flows requiring significant circuit reinforcement. If demand was to increase towards the north of Scotland it could help to reduce the need for some of the transmission reinforcements.

Low renewable generation output could lead at times to power imports to Scotland from England and Northern Ireland. Coupled with the potential closure of large conventional generators, there could be a benefit in the provision of generation that could operate at the times of low intermittent renewable generation output. There may also be the requirement for additional voltage services close to the main transmission routes and demand centres. There may be the opportunity here for third party provision of this support.

### North England



#### Region Type

Through flow

#### Limiting Factor

Circuit capability and voltage

#### Network Development

Circuit upgrades and new offshore circuits

#### Opportunity

Demand connections  
Reactive power services

New connections will increase the north to south power flows across northern England. With contracted generation connections along the east and west coasts opportunities for new generation exist towards Manchester and Sheffield, Opportunity also exists for increased demand to the far north towards Scotland that could reduce the through flows on the network.

### East England

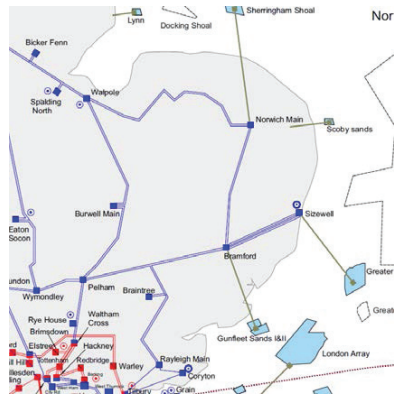

#### Region Type

Exporting to the west and south

#### Limiting Factor

Circuit capability

#### Network Development

Reconductoring of existing circuits, new transmission route and voltage compensation

#### Opportunity

Demand connections near generation  
Reactive power services

With power flow south and west towards London, and large volume of additional generation projects along the east coast, there is little opportunity for further generation connections along the east coast without significant reinforcement. Further generation could be more easily accommodated closer to London.

High power flows along the circuits towards the south lead to significant voltage drops along the circuits, so flexible voltage support in the area around Pelham and Wymondley may be beneficial to system operation.

## South England

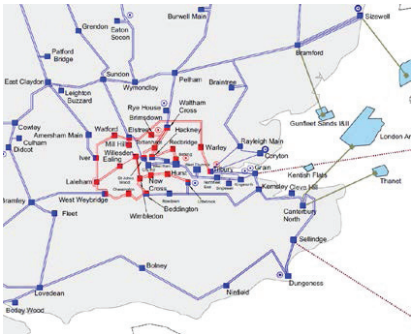

### Region Type

High demand

### Limiting Factor

Circuit capacity and voltage control

### Network Development

Circuit uprating and voltage compensation

### Opportunity

Local generation  
Demand-side response  
Demand curtailment (inter-trips)  
Reactive power services

London and the south are high demand regions, absorbing power from local generation and from surrounding areas. The continental interconnectors can further increase the flows by exporting power to the continent and drawing further power through and around London. Additional generation close to London or a means to reduce demand could be very beneficial.

The circuits along the south coast between Kemsley and Lovedean connect a long chain of substations. This is sensitive to faults at either end, leaving a long radial spur meaning additional compensation is required to maintain voltages. A reduction in demand or additional voltage support could help reduce the transmission reinforcement required in this area.

## West England & Wales

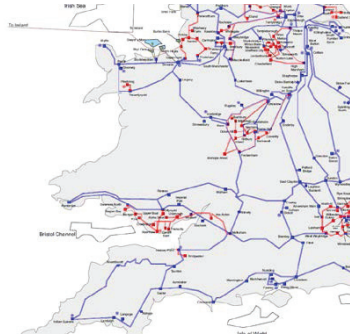

### Region Type

Increasing easterly export

### Limiting Factor

Circuit capacity

### Network Development

Circuit upgrades and new circuits

### Opportunity

Local generation  
Demand-side response  
Demand curtailment (inter-trips)

The prospective connection of large new generators in the north west and south west corners of Wales and new generation in the south west peninsula of England will lead to increasing power flows towards the east. Accommodation of new generation capacity at those points will require significant new transmission capacity. There is an opportunity for generation and demand towards the midlands and south to assist with network management through the provision of commercial services.

### Stakeholder Engagement

We would welcome your view on how we could improve the way network opportunities are presented and the information you would like to see in ETYS about network opportunities.

## 4.9

# Stakeholder Engagement

---

In this chapter we presented how the transmission network could develop and the opportunities it presented to our stakeholders over the next twenty years.

If you wish to discuss this further then please contact us at: [transmission.ety@nationalgrid.com](mailto:transmission.ety@nationalgrid.com)

### Stakeholder Engagement

We welcome views on the assumptions that we have used for onshore and offshore NETS developments in the ETYS.

### Stakeholder Engagement

We recognise that the assumptions for technology are a principle input for development of coordinated networks. We would welcome any additional information on these assumptions on cost and availability of technology.

### Stakeholder Engagement

To help deliver our engagement strategy for the development and procurement of non-build reinforcement options, we would like to determine what information, you as third party suppliers would require from National Grid, and in what timescales. We would very much welcome your input.

### Stakeholder Engagement

We would very much appreciate your views on this new section of the ETYS and also what other commercial opportunities you would like us to explore in the future.

### Stakeholder Engagement

We would welcome your view on what would incentivise Users to make more reactive power available to the NETSO.

### Stakeholder Engagement

We would welcome your view on how we could improve the way network opportunities are presented and the information you would like to see in ETYS about network opportunities.

---



# Chapter Five

## System Operation

---



# 5.1

## Introduction

The previous chapter discussed in detail the potential development of the National Electricity Transmission System (NETS) under the range of energy scenarios produced by our Future Energy Scenarios process. In this chapter we discuss the impact these scenarios will have on our system operation role as National Electricity Transmission System Operator (NETSO) and how we will maintain our world class reliability level as shown in Table 5.1.

This chapter focuses on future operation of the NETS, and makes reference to current changes in the system where they may be part of a continuing trend. Current operational issues are covered in our regular operational forums ([link](#)).

**Table 5.1**  
*Reliability of Supply*

	2012/2013	2011/2012	2010/2011
NGET System (England and Wales Network)	99.99999%	99.99972%	99.99998%
SPTL System (South of Scottish Network)	99.99968%	99.99975%	99.99600%
SHE Transmission System (North of Scottish Network)	99.99123%	99.99228%	99.99956%
National Electricity Transmission System (GB)	<b>99.99975%</b>	<b>99.99954%</b>	<b>99.99969%</b>

Using the output from FES we assess how the characteristics of the transmission system will change over time using the scenarios and associated case studies. These allow us to explore a range of operational conditions in testing the effectiveness of our future operational development strategies. We will work with our stakeholders to address any future gaps that may include the market, commercial, code and asset solutions.

This philosophy may not cover the interface between individual network licensees in ensuring economic and efficient system operability. To address this potential gap

a Cross Networks Project was commissioned by the Electricity Network Strategy Group (ENSG) to look at the extent and type of challenges facing the electricity networks in coming decades. The conclusions of the Working Group identified several areas where greater co-ordination would bring benefits:

- Early design co-ordination for voltage control between DNOs/TOs/DSOs/TSOs;
- Early design co-ordination for voltage control between onshore and offshore networks;
- Potential need for better alignment between gas and electricity regimes;
- Provide interoperability of voltage management (eg HVDC / Offshore / Smarter networks); and
- Co-ordination to create a clear market signal for transmission equipment manufacturers.

We continue to work directly with stakeholders, as well as with ENSG, to explore how we can economically and efficiently address the change in system characteristics to ensure the reliability of the transmission system.

### Change in System Characteristics

The dynamic operation of the transmission system is largely dependent on the type and amount of generation connected to it, as well as the nature of demand taken from it. The key changes to the system are:

- A reduction in system strength
- A greater variability of power flows
- A change in the nature of demand taken from the system

### Reduction in system strength

As low carbon generation replaces conventional fossil fuelled generation the overall system inertia reduces. Conventional fossil fuelled generation plant has rotating mass directly coupled to the system (known as synchronous generation). Wind turbines are connected by power electronics that effectively de-couple the rotating mass of the turbine from the system. Photovoltaic generation has no rotating elements (both wind and solar are known as asynchronous generation). HVDC Interconnectors have the same characteristics.

As the level of system inertia reduces the normal events on the system, such as a generation or demand loss, have a greater impact. These events will result in an increase in the rate of change of the frequency, a requirement for additional energy to contain the frequency within the required upper and lower limits and a reduction in the overall dynamic stability of the system.



There is also a related reduction in short circuit levels as wind and photovoltaic generation makes a reduced contribution to short circuit currents in to the system compared to thermal rotating plant. The impact of this effect will be more regional than the reduction in inertia. A reduction of short circuit levels may have a number of effects, including:

- Choice of protection systems dependant on fault current (e.g. over current relays);
- Change in the type and level of harmonics on the system;
- Change in level of voltage dips and post fault voltage recovery profiles; and
- Increased potential of commutation failure on conventional HVDC systems.

#### Greater variability of power flows

The intermittent nature of wind and solar generation increases the volatility of energy flows on the transmission system. As the volume increases the level of change in flows may become significant, particularly where the intermittent generation is connected at the periphery of the transmission network. As NETSO we are interested in how the market will respond to and address any imbalance in the supply, for example using CCGTs or interconnectors, and therefore what system balancing actions might be required result to facilitate the market actions.

#### Change in the nature of demand taken from the system

From around 2008/09 there has been a noticeable drop in the amount of reactive power demand taken from the transmission system. This decline is resulting in a change in voltages at the boundary between the transmission system and the distribution systems, particularly at low loads. There appear to be a number of contributory factors, including an increase in energy efficiency measures in homes and offices as well as the increase embedded generation connected to the distribution system via converters. We are working with academia and DNOs/TSOs to both manage the current change in characteristics and assess how the ratio of active power to reactive power is likely to change in the future.

#### System Performance

Availability of the transmission network is related to high level of reliability, and the operational measures employed to operate the system determine to a higher degree the level of continuity of power supply that can be achieved. These operational measures are dependent on the system performance characteristics which are evolving as described in FES. Therefore, by proposing new measures and technologies to operate the GB transmission system, we can continue to operate a reliable, economic and efficient system.

The system performance characteristics differ significantly at different demand periods due to the variation in electricity demand on the transmission network and the generation required to meet it. Peak, and off peak periods present a different range of issues to consider for the system operator. At high demand periods the key focus of the system operator is to ensure there is sufficient generation margin to meet the demand, adequate frequency response, sufficient reactive power support to avoid voltage collapse and to maintain the transmission capability required to meet the demand at different regions. At low demand periods there are fundamental differences in system characteristics, which arise from the reduced number of running generator units and lightly loaded transmission and distribution networks.

These challenges are likely to be at their most extreme during periods of high wind generation output, high interconnector imports and low system demand. In future the level of wind generation output on the system may be higher than the demand. Figures below shows the level of transmission connected wind generation in spot years to 2033/34 compared with summer minimum demand levels.

**Figure 5.1**  
*Wind output compared with the summer minimum demand under Slow Progression scenario*

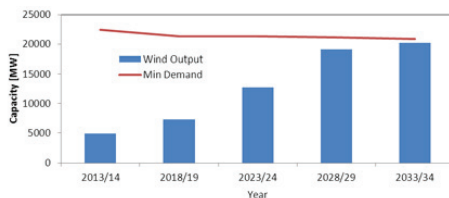

**Figure 5.2**  
*Wind output compared with the summer minimum demand under Gone Green scenario*

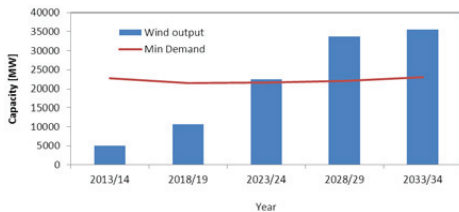

In Slow Progression the level of wind output is likely to be below the minimum level of demand. In Gone Green there are occasions beyond 2020 when the level of wind generation output may exceed the minimum level of demand. With an assumption that nuclear power provides a level of ‘baseload’ generation, occasions when the power output of wind and nuclear in combination may exceed the minimum demand may occur earlier than shown above, and more frequently.

The minimum demand levels shown in above figures are the total system demand without considering any contribution from embedded generation (such as solar PV which may be contributing at different output levels on a sunny day in the Summer) in the distribution networks.

This outlines one of the key areas in need careful consideration in operability of the transmission system. In addition, there are a number of other operability issues considered over the course of this chapter. These are generally common issues that are applicable to both scenarios. This chapter discusses these issues under the concept of “System Operability” in detail and highlights the resulting impact on the network. The chart in Figure 5.3 shows different areas of system operability which has been studied throughout this chapter.

Therefore by investigating system operability challenges and ensuring the most economic, and efficient solutions are identified early enough, the high level of reliability of supply will be maintained. In addition to this, we have identified a range of opportunities in future years in new balancing services, asset based solutions, and control tools which in collaboration with the industry and our stakeholders can be developed and delivered in the future.

This chapter has raised a number of issues that we will be seeking feedback on at a future operation forum. Details of this event will be published in due course. In the meantime we would welcome you feedback, please use the [transmission.etyts@nationalgrid.com](mailto:transmission.etyts@nationalgrid.com) email box.

**Figure 5.3**  
*Aspects of System Operability affected with regard to Future Energy Scenarios*

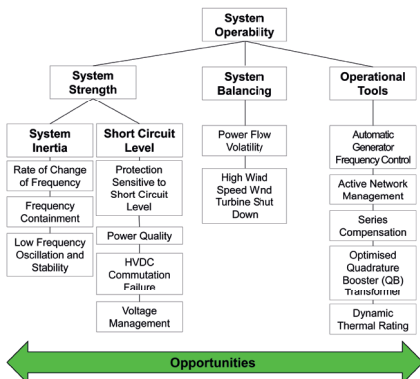

**Stakeholder Engagement**

Are there any other operational challenges that are significant to your business that you believe deserve further consideration?

## 5.2

# System Strength

The strength of a power system reflects its natural ability to remain resilient against disturbances such as switching events, faults on transmission lines, loss of load or generation. There two key indicators for system strength which are:

- A. System Inertia; and
- B. Short-circuit level.

The change in generation mix will reduce both system inertia and short-circuit level. When the majority of energy supplied to the grid is provided by synchronous generation, there is a high level of provision of rotational inertia and short circuit currents due to their inherent design and operating principles. As the penetration levels of asynchronous generation increases, it reduces the fault levels and the total system inertia on the system at modest demand periods. These impacts are discussed furthering the following sections.

### 5.2.1

#### System Inertia

System inertia is the primary contributor to the robustness of a system to frequency disturbance. Frequency disturbance arises due to an imbalance between generation and demand. Sudden frequency disturbances can occur due to loss of load or generation. The higher the inertia on the system, the slower the rate of change of frequency will be to any sudden disturbance. The inertia on the system is provided naturally via the energy stored in the rotating mass of the shaft of the electrical machines, covering both directly connected generators and motors, as illustrated in Figure across.

*Figure 5.4*  
*Rotating mass (turbine shaft) of a large synchronous power plant*

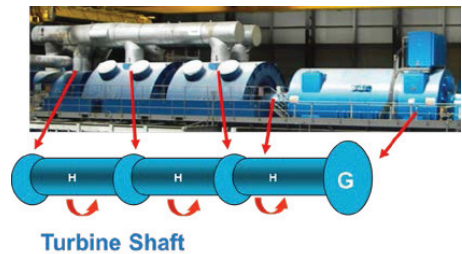

Generation technologies such as wind power turbines do not provide as much inertia per MW of installed capacity compared to large thermal synchronous power plants. This is mainly due to smaller rotating mass, or the fact that in some turbine technologies the mechanical and electrical system is de-coupled as shown below. Some technologies such as solar PVs do not work on the basis of any rotating mass and have zero inertia.

**Figure 5.5**  
Wind generation technologies deliver low or almost no Inertia

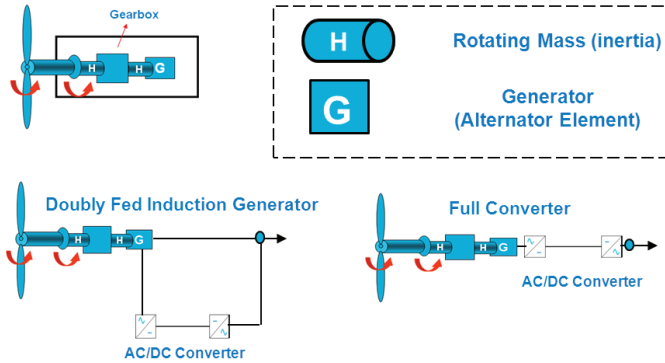

The immediate effect of a reduction in system inertia is a higher rate of change of frequency caused by a sudden imbalance between generation and demand.

This effect must be considered when deciding on operational strategies for frequency management.

**Figure 5.6**  
System frequency limits and concept of RoCoF

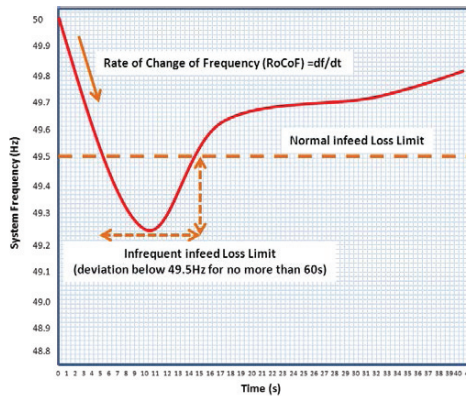

Analysis using the connected generation in the Slow Progression and Gone Green scenarios indicates a continuing reduction in the level of system inertia of the transmission system.

*Figure 5.7*  
*System Inertia Changes for Slow Progression at 70% wind power output (H= System Inertia)*

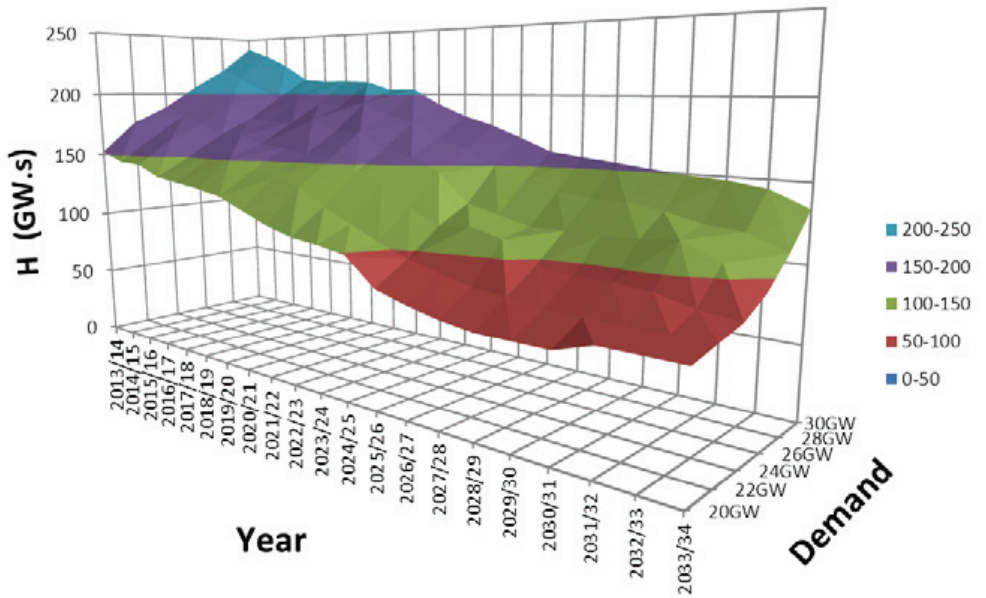

**Figure 5.8**  
*System Inertia Changes for Gone Green at 70% wind power output (H= System Inertia)*

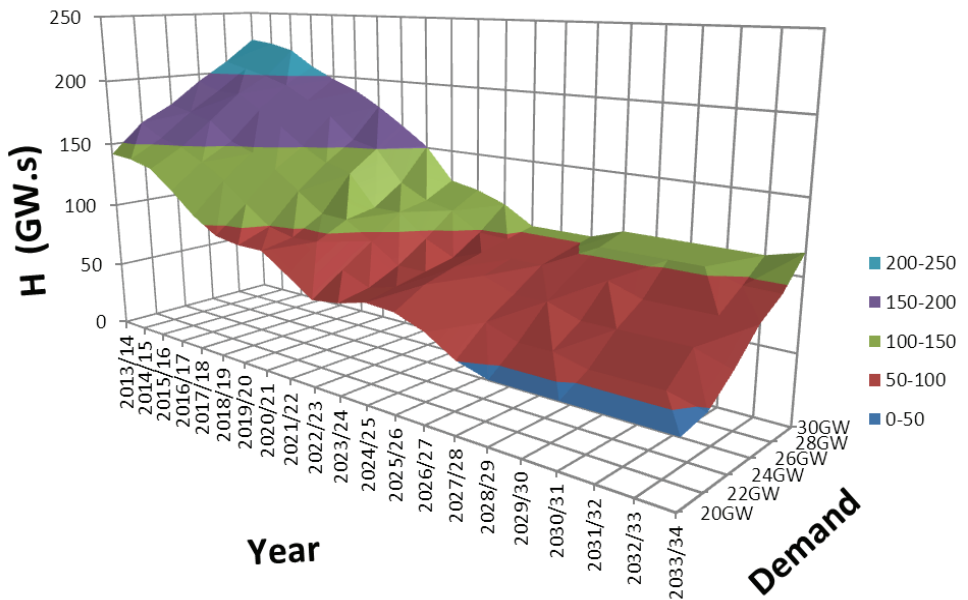

The system inertia reduces more in the Gone Green scenario compared to Slow Progression and this is mainly due to higher wind penetration on the system. From 2013/14 to 2033/34 under Gone Green, there is up to 70% reduction in the system inertia. The reduction trend is slower in Slow Progression where there is about 40% to 50% reduction in system inertia in the next 20 years.

**Embedded Solar Photo Voltaic**

The amount of solar PV connected to the system increases in both the Slow Progression and Gone Green scenarios. The impact of increase in solar PV generation is reducing the demand from the transmission system (as they are mainly connected as embedded generation

within distribution networks) and therefore reduction of number of synchronous plants needed to run to meet the demand. This results in further reduction in system inertia.

Below, the effect of increasing embedded generation on total system inertia is presented for Slow Progression and Gone Green.

*Figure 5.9*

*Effect of embedded generation installed capacity under Slow Progression scenario*

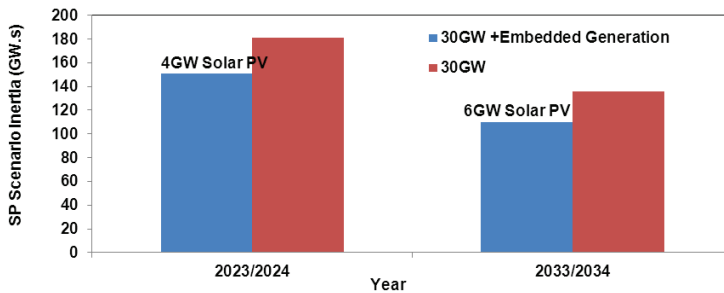

*Figure 5.10*

*Effect of embedded generation installed capacity under Gone Green scenario*

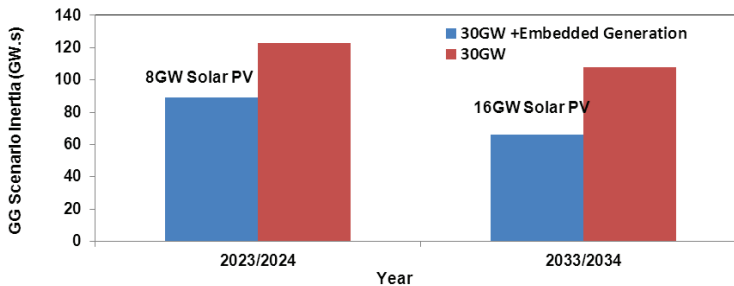

The following sections discuss the impact of changes in system inertia, and how they can be addressed. The topics discussed include:

- Embedded Generator trip due to Rate of Change of Frequency (RoCoF);
- Frequency containment; and
- Low frequency oscillation and stability.

#### **Embedded Generator trip due to Rate of Change of Frequency (RoCoF)**

The majority of the embedded generators such as solar PVs, and embedded wind as per distribution code [ER G59/ ER G83<sup>1</sup>] are required to be equipped with a Loss of Mains protection relay.

The purpose of this relay is to detect an islanding condition (when the area of the network where the embedded generator is connected to is isolated from the rest of the grid), and disconnect the embedded generator (to ensure no generation is running so the network can be reconnected safely to the main grid later). There are several solutions to detect and islanding condition, but for many it is based on detecting the rate of frequency changes (known as RoCoF relay).

RoCoF cannot always discriminate between loss of mains and system disturbances particularly when the rate of change of frequency is high. This becomes an issue with increasing the penetration of non-synchronous generation.

<sup>1</sup> The Engineering Recommendation (ER) G59 and G83 set out requirements for embedded generation connection.

Figure 5.11  
RoCoF relay operation in Embedded Generation

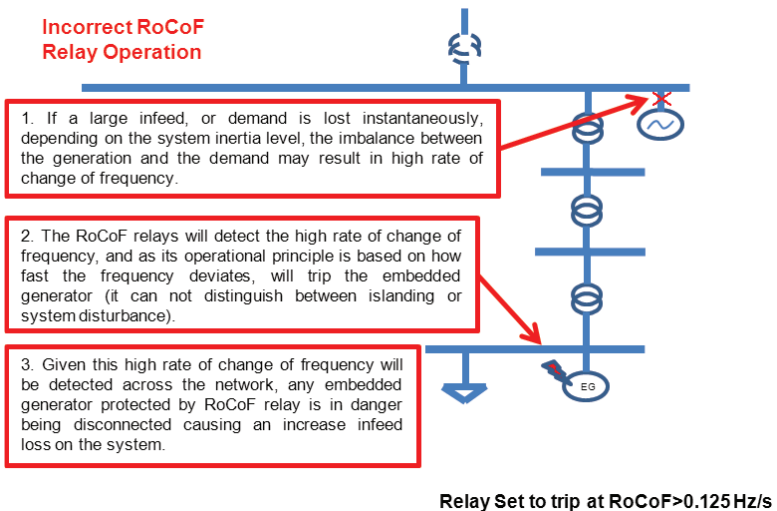
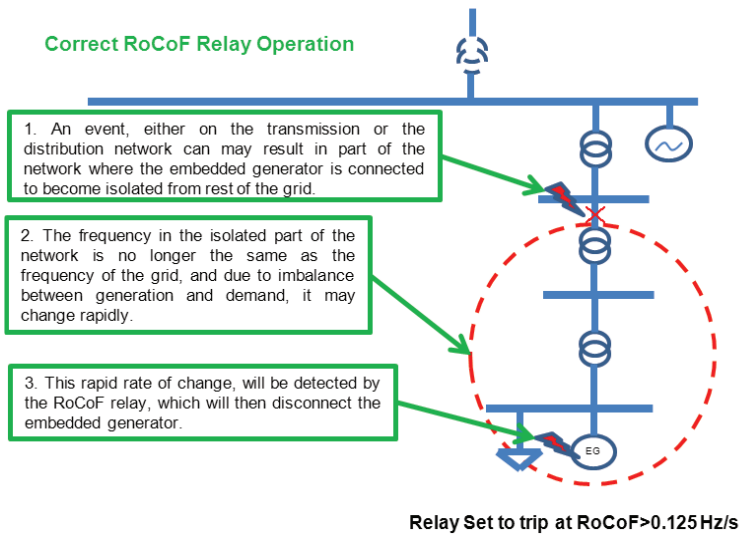



Figure 5.12

Rate of Change of Frequency (RoCoF) for Slow Progression following 1800MW infeed Loss

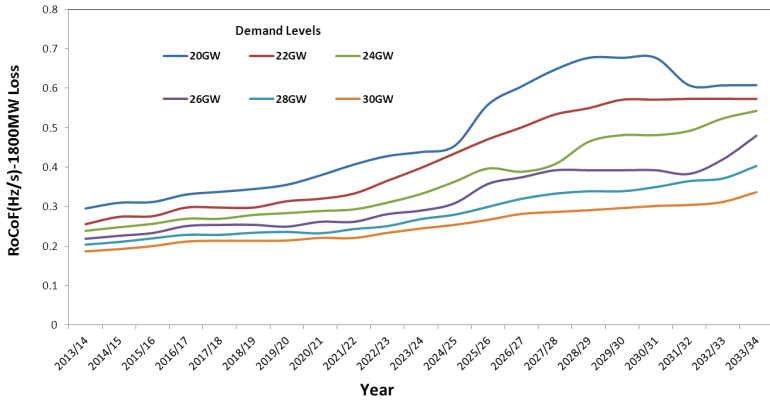
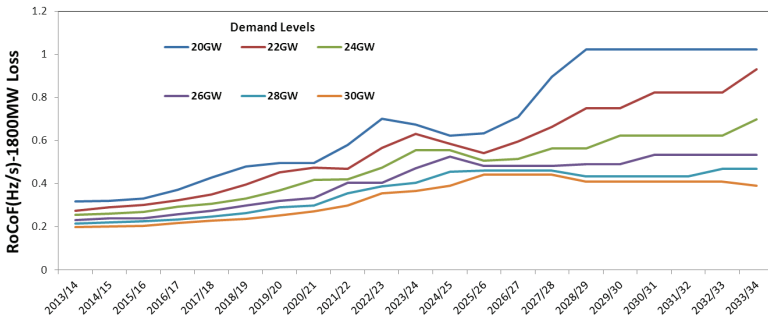

Figure 5.13

Rate of Change of Frequency (RoCoF) for Gone Green following 1800MW infeed Loss



Over the next 20 years the RoCoF is expected to continually increase following generator or demand loss on the system. Our analysis based on 1800MW loss shows an increase in RoCoF in both scenarios as presented above. The RoCoF increases faster under Gone Green due to lower inertia on the system. However, the trend changes in 2023/24 due to the commissioning of new nuclear power plants. The RoCoF of around 1Hz/s is expected in 2030 (and beyond) for Gone Green Scenario.

With the increase in the number of embedded generators on the system and the reduction in system inertia, under certain operation conditions, RoCoF is an issue that we are currently managing.

Therefore, we adopted new operational strategies, taking into account the potential impacts of embedded generator trip as a result of high rate of change of frequency. We are also working collaboratively with the industry in a joint Grid Code and Distribution Code working group<sup>2</sup> to find solutions to mitigate this risk in longer term such as changing the setting of RoCoF relays to a higher level (i.e. to 1Hz/s) in order to avoid the risk of cascading trip of embedded generators.

### Frequency Containment

With reduction of system inertia, after a loss of generator or demand, the system frequency will deviate with a higher rate, and actions to contain the frequency need to take place within a shorter time period. To ensure the frequency remains within statutory limits, additional measures have been identified and discussed below.

### Rapid Frequency Response (RFR)

RFR can be considered as a means to compensate for the reduction of system inertia by rapidly reducing the power imbalance after an infeed loss. This will have the effect on compensating for the reduced inertia in the system, hence in many literatures it is classed as "Synthetic Inertia". If RFR can be delivered it will assist with frequency recovery and act as a fast primary response on the system.

RFR can be delivered through a number of methods and we consider in turn the contributions which we could expect in terms of RFR from converter connected generation, fast demand side response and energy storage.

*Figure 5.14*  
**System Frequency Limits**

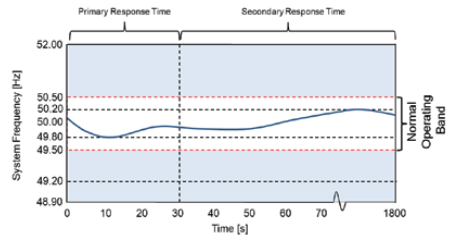

### RFR from Converter Connected Infeeds (i.e. HVDC Links, Windfarms)

The converter based generators and interconnectors (HVDC links), subject to design criteria, are capable of rapidly changing their power setpoint and therefore it enables them to have higher ramp rate compared to synchronous generator. Utilising this rapid ramp rate capability, will help with recovering the system frequency as shown below<sup>3</sup>.

<sup>2</sup> Frequency Changes during Large System disturbances Working Group. <http://www.nationalgrid.com/uk/Electricity/Codes/gridcode/workinggroups/Frequency+Changes+during+Large+System+Disturbances/>

<sup>3</sup> Such capability for HVDC links is being considered as part of European HVDC Connection Code (HCC).

**Figure 5.15**

*RFR Delivered by different Proportion of Windfarms for Different Scenarios*

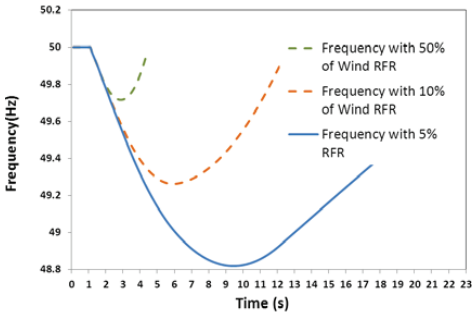

Slow Progression

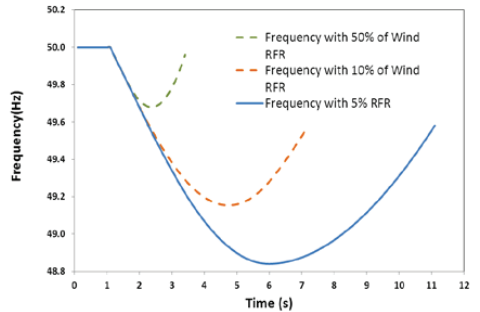

Gone Green

We have been working collaboratively with the industry and academic institutes to investigate and facilitate delivery of RFR capability<sup>4</sup>. We have recently initiated a review of our Firm Frequency Response tender process to give potential Rapid Frequency Response providers a route to market<sup>5</sup>.

#### RFR from Demand Side Response (DSR)

Delivery of a rapid power injection will reduce the generation and demand imbalance, helping with frequency containment, rapid reduction in the demand will have a similar effect. This reduction of power imbalance will also reduce the RoCoF. This concept introduces a new opportunity for consumers to provide a service delivering rapid DSR, either via voluntary load reduction in operation, or by changing power consumption through manipulating the voltage, and assist in managing the system frequency<sup>6</sup>.

#### Stakeholder Engagement

In your opinion, what are the opportunities for providing faster frequency response capability?

#### Stakeholder Engagement

What are the commercial services needed to acquire RFR from various providers?

<sup>4</sup> <https://www.nationalgrid.com/corporate/About+Us/Innovation/Electricity+Transmission+Innovation/>

<sup>5</sup> [http://www.nationalgrid.com/NR/rdonlyres/61BCA80D-8041-4BBD-8B0C-5D7D93C941AB/62672/08\\_FFR\\_Service\\_Review.pdf](http://www.nationalgrid.com/NR/rdonlyres/61BCA80D-8041-4BBD-8B0C-5D7D93C941AB/62672/08_FFR_Service_Review.pdf)

<sup>6</sup> The capability of devices being able to provide this service has been considered as part of European Demand Connection Code (DCC)

**Figure 5.16**  
*Demand Side Response (DSR) for delivering of Rapid Frequency Response*

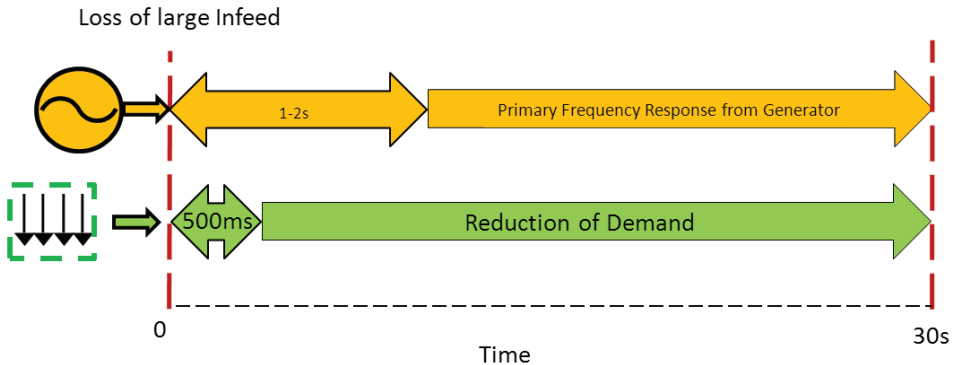

The characteristics that need to be developed to use DSR for system frequency management, include:

- Volume and speed of response;
- The duration which the services is sustained;
- Effectiveness of measures to reduce demand (i.e. voltage reduction may not have a significant effect if loads are not voltage dependent); and
- Demand recovery following the service delivery to the transmission system and the subsequent impact on the frequency.

Providing the capability within devices to provide DSR is a key milestone which has been proposed within European Demand Connection Code (DCC). We are collaborating with the industry and academia to develop DSR commercial solutions.

#### **RFR from Energy Storage**

It is possible to store the energy, which can be converted into electrical energy in various forms, such as batteries, pumped storage, and in lesser known or used forms such as Compressed Air Energy Storage (CAES), and flywheels. Energy storage technology could play a significant role in the operation of the transmission network through the improvement in the utilisation of renewable generation, the provision of flexible balancing services, and providing fast frequency response.

We have been working with some academic institutes to perform feasibility assessment on various forms of energy storage technologies in to better study the potential for energy storage technologies to deliver grid services.

#### **Use of Synchronous Compensators**

Some synchronous power plants, subject to design criteria (i.e. provision of the clutch on the generator shaft or modification of combustion control systems etc.) may be capable of contributing to system inertia at low load operating conditions. This would allow the plant to continue to run in synchronous compensator mode at times of low system inertia.

To illustrate how the use of generator synchronous compensation impacts system inertia and the potential level of reduction in RoCoF that can be achieved, we consider the use of Combined Cycle Gas Turbine (CCGT) power plants as synchronous compensation. This has been considered for both the Slow Progression and Gone Green scenarios with 30GW of total system demand. For both scenarios inertia contribution of 50% and 100% of the CCGT inertia as synchronous compensation has been considered when the plant is not actively generating.

#### **Stakeholder Engagement**

What are the opportunities for low load operation of thermal power plants to provide the services mentioned in this chapter?

Figure 5.17

The impact of Synchronous Compensation on RoCoF following 1800MW Loss for Slow Progression Scenario

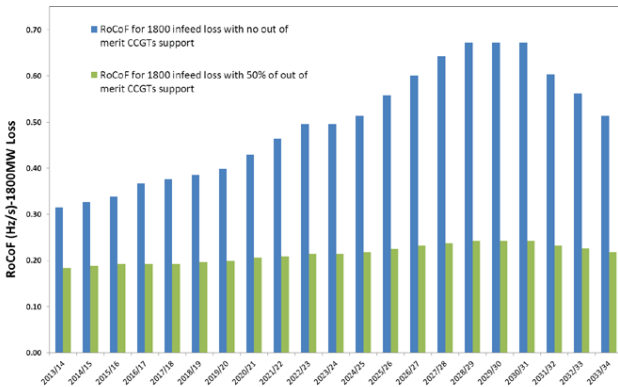
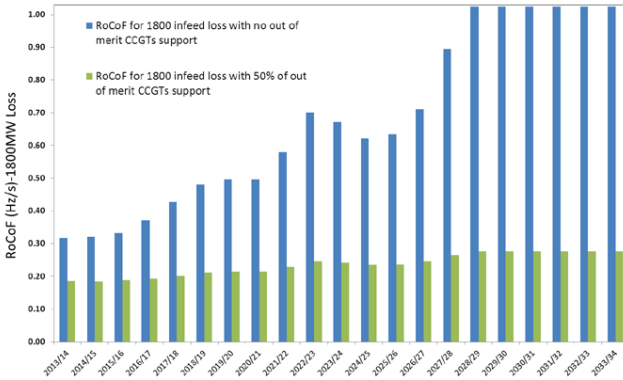

Figure 5.18

The impact of Synchronous Compensation on RoCoF following 1800MW Loss for Gone Green Scenario



The results shown above suggest that the system inertia can be significantly increased in both scenarios through the application of synchronous compensation.

We are in the process of developing commercial services to gain access to this capability (either as synchronous compensator, or on low load operation) via our Downward Regulation Inertia and Volts (DRIVE) Service<sup>7</sup> which we first indicated in 2013. The analysis we have shown provides a view of the value of large volumes of synchronous compensation. We are working with the

industry to understand the technical and commercial issues of providing this capability, and how best to get a view of the potential costs and volumes of service which could be available.

<sup>7</sup> Downward Regulation, Inertia and Volts [http://www.nationalgrid.com/NR/rdonlyres/F49CD76F-0990-4AA7-8A24-02000288CF1C/60085/06\\_Managing\\_Frequency\\_Update](http://www.nationalgrid.com/NR/rdonlyres/F49CD76F-0990-4AA7-8A24-02000288CF1C/60085/06_Managing_Frequency_Update)

The results shown above suggest that the system inertia can be significantly increased in both scenarios through the application of synchronous compensation.

We are in the process of developing commercial services to gain access to this capability (either as synchronous compensator, or on low load operation) via our Downward Regulation Inertia and Volts (DRIVE) Service which we first indicated in 2013. The analysis we have shown provides a view of the value of large volumes of synchronous compensation. We are working with the industry to understand the technical and commercial issues of providing this capability, and how best to get a view of the potential costs and volumes of service which could be available.

#### Low Frequency Power Oscillations

The existing generator based Power Oscillation Damping measures (Power System Stabiliser) are mainly provided by synchronous power plants. The increase in asynchronous generation will result in a reduction in the damping on the system.

Small disturbance angle stability, or small signal stability, describes the capability of the system to remain stable after small disturbances. These are the type of disturbances which relate to changes in the load or voltage and caused by the day-to-day operation of the transmission system, as opposed to a significant loss of infeed or a major fault on the transmission system.

Disturbances on the system cause a change in the speed and the rotor angle of the synchronous generators connected to the system. This can cause the power flows on the transmission system to oscillate. These oscillations are usually damped by the system itself, i.e. by the synchronising and damping torques from synchronous generators connected to the system. If, however, the transmission system cannot damp the oscillations, they can increase in amplitude, overloading or even damaging equipment on the transmission network.

The power oscillations caused by small disturbances are typically in the range of 0.1 Hz to 2 Hz. These are further classed by their oscillating frequency and the parts of the transmission system that they might affect:

- Intra-plant oscillations occur between generating units connected by a low impedance transmission line, such as two or more units of a single power station. These oscillations are in the range of 1 Hz – 2 Hz and do not have a significant effect on the rest of the transmission system as they can be damped by the local generator control systems.
- Local plant oscillations are oscillations between the generator and the transmission system. As with intra-plant oscillations, the frequency of oscillation of local plant oscillations are between 1 Hz - 2 Hz and the rest of the transmission system is not significantly affected as they can be damped by Power System Stabiliser (PSS) control actions. The frequency of oscillations is determined by factors such as the impedance of the line connecting the generator to the transmission system and the characteristics of the generator itself.
- Inter-area oscillations are observed when electrically large systems are connected with high impedance tie-lines. The frequency of inter-area oscillations is 0.2 Hz – 1 Hz. This low frequency mode of oscillation is usually damped by the system itself, i.e. the inertia provided by generators and loads.

Inter-area oscillations are usually experienced when transmission systems of several synchronous areas or several parts of the same synchronous area are connected by limited number of AC interconnectors, such as that exists between England and Wales Scotland. If un-damped, these oscillations can cause the rotor angles of generating units to oscillate as described above. NETS SQSS requires that the electromechanical oscillations of the generating units should not exceed 15% of initial peak deviation 20 seconds after a small disturbance has been introduced; this is illustrated in figure below.

*Figure 5.19*  
NETS SQSS System Damping Requirements

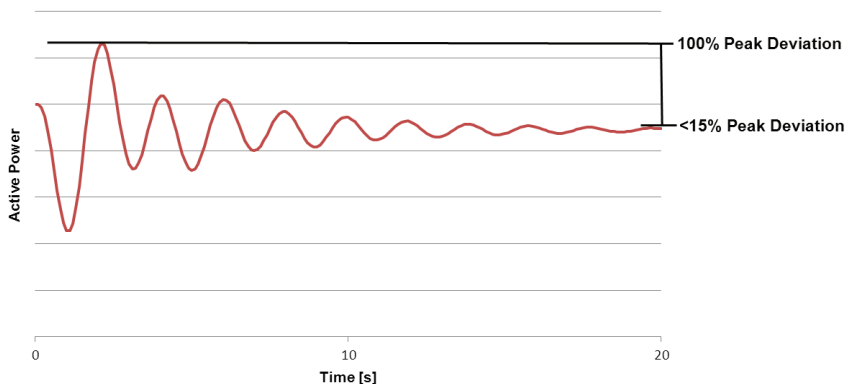

We will be reviewing the various solutions available to prevent these low frequency oscillations shifting from the current local mode to inter-area mode. Without intervention this potential shift may occur by 2023/24 under the Gone Green scenario or by 2033/34 under the Slow Progression scenario.

#### Opportunities for Mitigation of Low Frequency Power Oscillations

We have held a workshop with industry on this subject. We will be expanding our engagement with industry through a second workshop to share our initial assessments and review the range of potential solutions. In the meantime we would welcome your views<sup>8</sup>.

#### 5.2.2. Short-Circuit Level

The changes in type and pattern of generation previous discussed will also impact on the fault levels the system will experience.

To study the changes in system short circuit level in FES, the analysis results are presented for 7 regions of the GB system, as illustrated in figure across.

*Figure 5.20*  
Main areas on the GB map



The short-circuit level in a region is dependent on the following factors:

- The capacity and type of generation connected to the region.
- The short-circuit infeed from neighbouring regions, which is a function of the electrical distance (impedance) between the respective regions.



**Figure 5.21**  
 Installed Capacity of Synchronous vs Asynchronous Generation Contributing to 30GW demand in Slow Progression Scenario at different regions

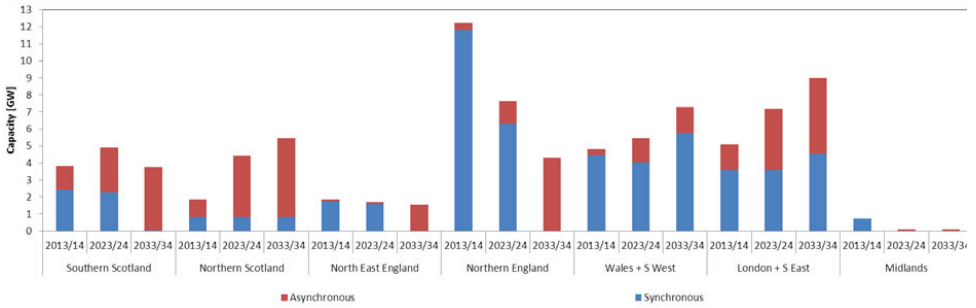

**Figure 5.22**  
 Contribution of Synchronous Generators to Short-Circuit level in Slow Progression Scenario at different regions

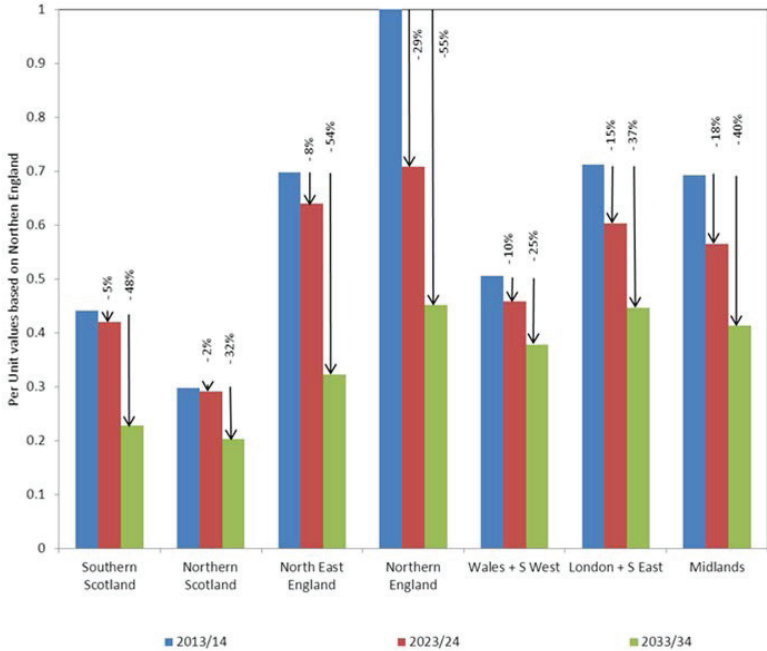

**Figure 5.23**  
*Installed Capacity of Synchronous vs Asynchronous Generation Contributing to 30GW demand in Gone Green Scenario at different regions*

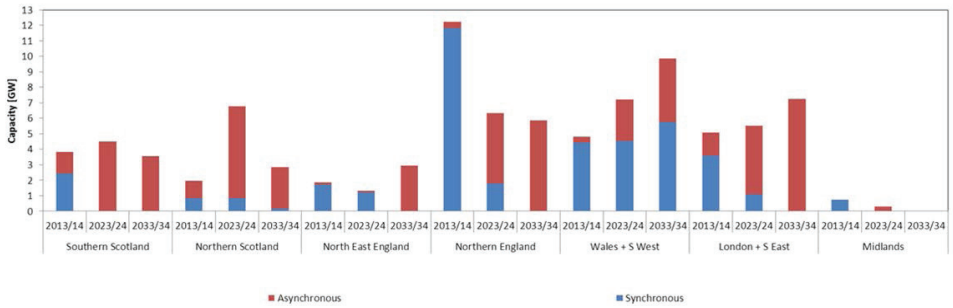

**Figure 5.24**  
*Contribution of Synchronous Generators to Short-Circuit level in Gone Green Scenario at different regions*

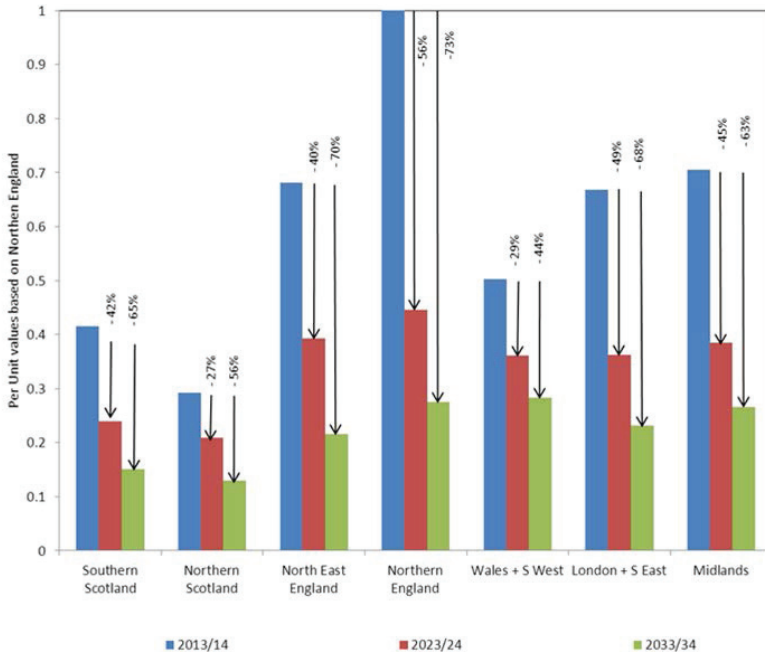

### Future System Operation Considerations with regard to low short-circuit level

The above charts for Gone Green illustrates the reduction in short-circuit level that may be expected. Due to the direct correlation between short-circuit levels and the strength of a system, different aspects of system operability which are affected by low short-circuit are discussed below:

- Protection sensitive to minimum short-circuit level;
- Power quality related issues (focus of this chapter is on voltage dips, voltage recovery, and harmonics,);
- Voltage and Reactive power demand management; and,
- Commutation issues of line commutated current-HVDC.

### Protection Sensitive to Minimum Short Circuit Level

The aim of protection systems is to detect faults on the network and disconnect the faulted equipment as quickly as possible in order to prevent damage to assets and to minimise disruptions to the power system. The protection systems are designed to have a high degree of reliability by implementing redundancy in the form of two independent main protection systems working in parallel and also with a back-up protection scheme in place should the main protection fail. The most common types of protection philosophy are described below.

**Table 5.2**  
*Effect of fault levels on protection*

Protection Scheme	Operating Principle	Affected by Low Short Circuit Levels
Differential Protection	Compares the current going in and coming out of a piece of equipment. If this difference is greater than a set bias current, the relay would trip.	Can be affected if the difference in currents during a short circuit becomes very small and is therefore not detected by the relay. Further assessments need to be made to verify the above.
Distance Protection	Calculates the impedance at the relay point and compares it with the reach impedance. If the measured impedance is smaller than the reach impedance, the relay will trip.	Possible only if the ratio of voltage to current does not decrease following the short circuit. However this is not likely.
Over current Protection	Operating time of relay is inversely proportional to the magnitude of the short circuit current.	This type of protection will be affected by low short circuit levels. However these schemes are mainly used as back-up protection and therefore the consequences may not be severe provided that the main protection schemes are not compromised.

Fault levels and the implication for protecting the system are kept under continuous review. TOs will continue to ensure that appropriate protection systems are coordinated and installed to protect the system.

We continue to work with academic institutes to research and develop novel solutions suitable for future system needs. One of the areas of development is providing the capability within converter connected generators to contribute more to the short circuit infeed and sustain the current for a certain period. This would have the effect of ensuring minimum short circuit levels and can assist with other systems characteristics such as voltage dips.

### Voltage Dips and Recovery Time on the System

A voltage dip is a temporary reduction in voltage magnitude. It is a result of a current typically flowing in some other parts of the system due to a short circuit, a starting machine or energising of a transformer. Short circuits cause the severest voltage dips on the transmission system. These can be caused by weather conditions and therefore are unavoidable.

**Figure 5.25**  
*Voltage recovery time for strong and weak system*

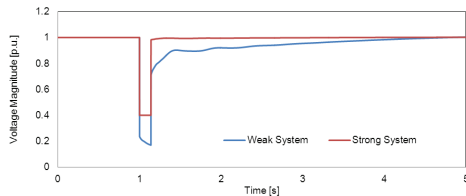

Given the change in generation the depth and the affected area will increase over time. Fault Ride Through is the capability of generation to withstand the dips in voltage and remain connected to the system. This is a mandatory requirement within GB Grid Code for transmission connected and large generators. The impact of the volume of embedded generation exposed to voltage dips will increase. To mitigate this risk European Codes are seeking to introduce a requirement for smaller generators to ride through such faults and remain connected (European Requirement for Generators (RfG)).

In addition to above policies, fast acting shunt equipment providing voltage support, synchronous compensator, or plant operating partly loaded on the system are the other measures that will help the recovery of the voltage to pre-fault levels.

#### 5.4.3. Harmonics on the System

Power quality is an important aspect for power systems because it affects the performance of the loads connected to the system. These loads have been designed in such a way that their operation is reliant on a power supply within the specified quality. The quality is determined by the purity of the voltage and current waveforms across the power system. A pure voltage or current waveform is represented by an ideal sine wave which is composed of a single frequency component at 50Hz.

In real systems, the wave shapes are distorted due to the presence of harmonics, which are waveforms of higher frequencies that superimpose on the original waveform to produce an impure waveform as shown in Figure 5.26.

Harmonics are introduced on the system through a number of means. Non-linear loads such as arc furnaces, arc welders and discharge lighting, are a common source of harmonics. Power electronic converters, railway traction systems, Static VAR Compensators and transformers are other sources of harmonics on the network. Converter connected generators such as solar PV, and wind turbines also generate harmonic current at different frequencies.

**Figure 5.26**  
*Effect of Harmonics on the Voltage Profile*

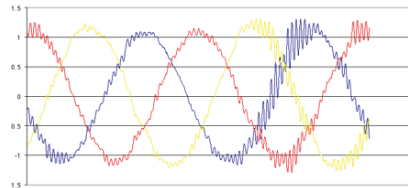

Harmonics can have a range of impacts such as heating effects on conductors, increased losses, voltage distortions, over-voltages during resonant conditions, electromagnetic interference with communications circuits and cause malfunctioning of some protection relays.

Harmonic assessments are usually carried out upon connections of new equipment (loads, generators etc.) to the transmission network to ensure that any injected harmonics do not cause any voltage distortions beyond the planning limits. Mitigating measures will be required if the limits are reached.

National Grid is investing in an innovative power quality monitoring system, placing in-house designed monitors around the network to manage the evolving challenges of power quality. The system comprises:

- The modification of Capacitor Voltage Transformers (CVT) to increase their bandwidth up to the 100th harmonic order;
- The installation of 110 fixed monitors installed at strategic locations, with access to a further 25 portable devices to support connection projects, ensure connection compliance and to support incident investigation; and
- A centralised system to collate, process, store and analyse the data.

By delivering a system which goes beyond the requirements of existing standards, we are able to lead in the technical understanding of power system performance. Our system will enable us to evaluate the Grid's performance across the vast majority of our substations, placing individual performance metrics in the context of the broader Grid performance through various seasonal and operational conditions. This will better facilitate Grid access and shed more light on incident propagation.

The reduction in strength of the system may potentially cause the network resonance to shift towards lower order harmonics, causing amplification of voltage distortion.

*Figure 5.27*  
*Shift of System Resonance to Low Order Harmonics*

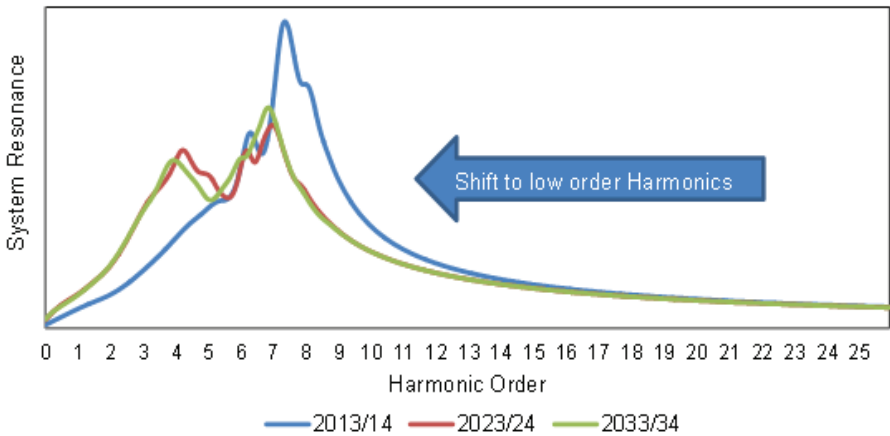

The voltage distortion existing at a particular frequency is dependent upon the harmonic current injection and the network impedance at that frequency. The implication of the shift in resonance seen above is that the voltage distortions will be amplified for the low order harmonics, assuming that the current injections remain constant.

Figures below illustrate the general trend in harmonic voltage distortion as a percentage of the G5/4<sup>9</sup> compatibility levels under future scenarios.

<sup>9</sup> The Engineering Recommendation (ER) G5/4 sets out the harmonic distortion level (at individual harmonic orders, and total harmonic distortion) at different voltage levels and is widely used for Harmonic voltage distortion compliance studies.

Figure 5.28

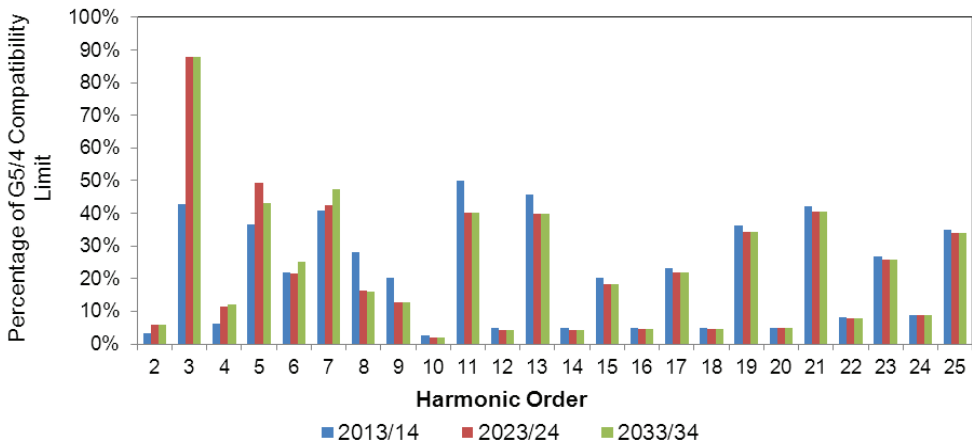
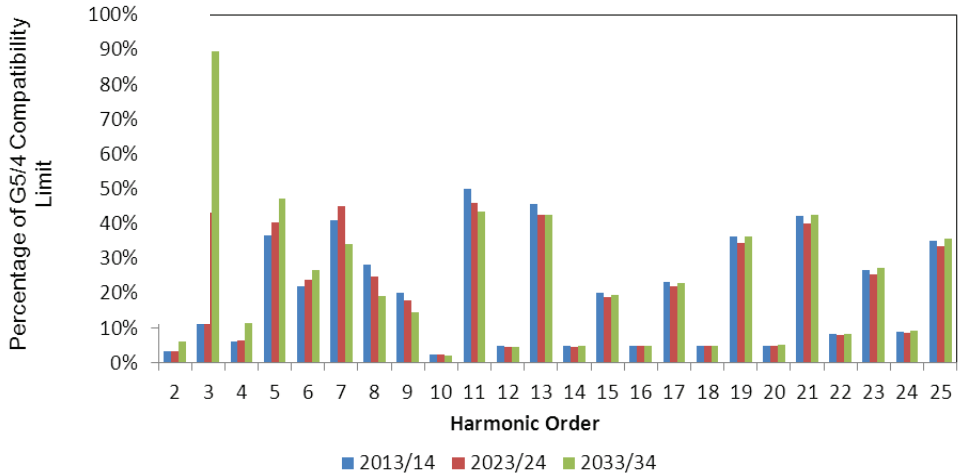

High voltages during periods of low demand are becoming increasingly frequent. This may be due to several factors, including:

- Increasing use of cables on some parts of the distribution and transmission networks.
- Lack of voltage control at certain locations.
- Reduction of reactive power demand due to new (more efficient) technologies and the impact of embedded generation.

High voltages are more likely to be experienced overnight, when the demand is lower, and therefore the charging current produced by lightly loaded circuits causes the system voltage to increase. This increase is most severe in cable dominated areas. The reactive power consumption characteristics of the load also have an impact on the voltage profile. Figure below illustrates the historic trend of the annual active and reactive power demand during periods of minimum demand on a national level. This graph shows the reduction in the ratio active power to reactive power (Q/P ratio).

*Figure 5.30*  
Average Minimum National Active (GW) and Reactive Power Demand (GVAR)

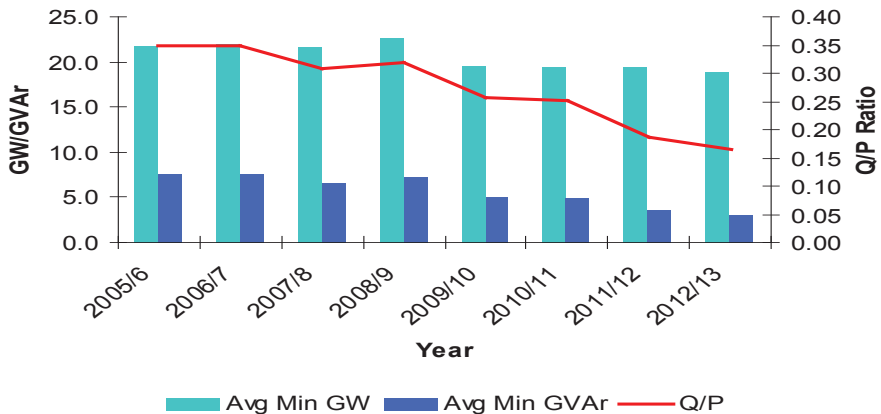

Low reactive power demand or reactive power injection has been observed at a number of Grid Supply Points (GSPs) during periods of low active power demand. In a number of cases, the reactive power demand has decreased by such an amount that on several occasions reactive power has been exported from the distribution network onto the transmission network. Reactive power

Reactive power demand is metered by averaging the demand over every half hour period. In 2012 negative national average reactive power demand was observed during a third of all GSPs over the half hour metering periods across the year. The figure below illustrates this.

**Figure 5.31**  
*Reactive Power Exchange (Import/Export) at GSPs for Every Metering Period 2010 – 2012*

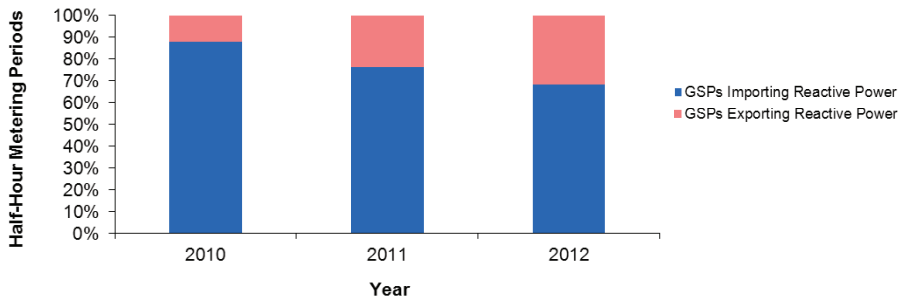

#### Opportunities to mitigate the change of Q/P ratio

We have been managing the reduction in the reactive power demand on the system using various operational tools available to us (i.e. using power plants to control the voltage, switching circuits, optimised use of reactive power compensation equipment etc.). We have been working collaboratively with the industry and academic institutes to better understand the exact cause of reduction in reactive power demand on the system, and what other measures may be required in the future to manage the volts on the system in the future.

The draft European Code Demand Connection Code (DCC) sets out limits on how much reactive power exchange can be tolerated at the grid supply points from distribution to the transmission system to avoid high voltage at low demand periods.

#### HVDC Commutation Failure Risk

The significance of the interaction between the AC and the DC systems depends on the strength of the AC system at the converter stations (particularly at the sending end; known as rectifier station). The strength of the AC system is demonstrated by its ability to maintain the voltage at the terminal during various disturbances in the power system, such as faults and generator/load changes. The ability to recover quickly from AC system faults is a typical requirement of an HVDC system.

During the converting the power from AC to DC, the “Commutation” process is essential. Commutation failures can be caused by AC voltage dips as a result of a short circuit, disturbances such as transformer inrush current, capacitor inrush current, harmonic pollution or/and instability, and system induced resonances. In the most extreme cases, a commutation failure could result in temporary interruption of HVDC power transfer capability.

In designing the transmission minimum short circuit levels are established to ensure the avoidance of commutation failure of Line Commutated Current technology based HVDC links. The availability of minimum short circuit level is studied over the lifetime of the HVDC link. Voltage Source Converter (VSC) technology based HVDC are not susceptible to the same short circuit level issue.



## 5.3

## System Balancing

The power flows across the transmission system are determined by the location of demand and generation. The amount of intermittent generation connected at the edge of the network will increasingly change the power flow patterns across the transmission network.

This section focuses on two key topics:

- Power Flow Volatility; and
- High Wind Speed Wind Turbine Shutdown.

### 5.3.1. Power Flow Volatility

In the future the power flows on the transmission system will be sensitive to wind speed given the planned location of wind farms. The flows on the transmission system may will magnitude and direction more often as the wind speed changes throughout the day.

We have carried out an initial appraisal to simulate the impact of wind speed changes on future transmission power flows. The graph presented in below show sensitivity of power flows across the GB network to wind power output variations in 2033 Gone Green scenario based. These graphs do not take in to account market balancing or operator actions in balancing the system or managing the flows.

In designing the system operational flexibility is required to manage such effects as power flow variations.

*Figure 5.32*  
Powerflow variations in the GB power system for various levels of wind production in the north and south for Gone Green 2033

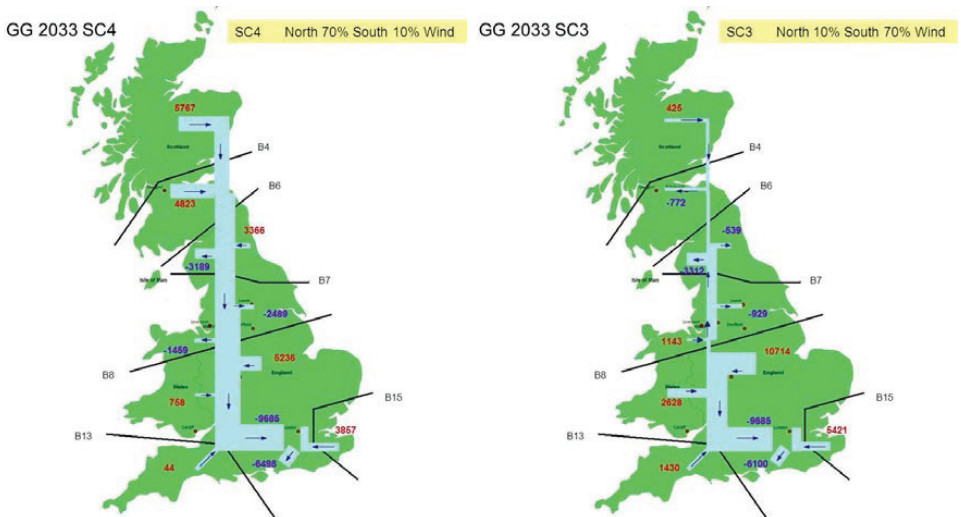

---

### 5.3.2. High Wind Speed Wind Turbine Shut Down

To protect wind turbines from very high winds automatically disconnect from the system. This cut-out is typically around 25 m/s average wind speed or for a gust of around 35 m/s. This could result in a widespread loss of power generation from wind farms and therefore a rapid reduction in power supply to the grid. This could in extreme circumstances result in a loss greater than the largest infeed loss under the NET SQSS.

We are working through a Grid Code Working Group<sup>10</sup> to find appropriate ways to ensure such events do not cause severe impact on the system. This may include solutions such as gradual reduction in the power output. Another measure that may assist is developing improved local forecasts to inform operational actions.

---

<sup>10</sup> <http://www.nationalgrid.com/uk/Electricity/Codes/gridcode/workinggroups/archive/High+Wind+Speed+Shutdown/>

---

## 5.4

# Operational Flexibility

In assessing the changes expected in the performance characteristics of the transmission system, we have considered the need for new solutions that help us to maintain our reliable power system. This section highlights solutions and technologies we are developing to enhance our operational flexibility.

### Automatic Generation Frequency Control (AFC)

As NETSO we carry out system balancing via automatic response of generator governors and via manually dispatched instructions.

The relatively moderate amount of short term variation in generation, demand and interconnection, combined with the high inertia of the system, has allowed us to manage frequency with governor action, load controllers and manual despatch mechanisms.

Given the increasing number of generators connecting to the NETS we are reviewing best practice in balancing. With increased wind penetration, smart demand response and the level of interconnector in the future, we have been considering what operational measures might be required. An option under consideration is the use of AFC.

Using AFC balancing can be considered in three time frames:

- Automatic response to address imbalance measured in seconds and delivered automatically by generator governors;
- AFC in minute timescales delivered by the system operator delivered directly to the generator governor;
- Manual despatch operating at longer time periods to restore overall balance.

We are conducting studies to investigate how AFC might improve the control of the system. To determine viability of AFC we will work closely with the industry to identify the requirements and the costs and benefits. We are also investigating the possible automation of the bid offer acceptance process as an alternative.

### Dynamic Thermal Rating

National Grid, along with many other transmission utilities, applies a constant seasonal thermal rating for overhead lines. In addition we also use short-term enhanced thermal capability of critical circuits.

The actual thermal rating which varies with the weather conditions can further enhance the capability of existing system. This is because the transmission capacity of overhead transmission lines is often constrained by temperature limitations on the conductors.

One strategy is to calculate present and future transmission capacities of the lines based on actual weather conditions and forecasts.

This is supplemented by real time measurements. An increased transmission capacity may then be available for use by the system operator.

We are undertaking trials to explore the benefits of dynamic thermal rating capability. Given the “enhanced rating” capability that are currently used for planning and operation, the overall benefit across the network may not be that high.

### Series Compensation

The capability of the transmission system for power flow transfer is determined by thermal, voltage and stability limits. By reducing the impedance of the circuit, using a series capacitor, the power flow capability may increase.

As discussed in previous chapters, there are currently plans to install series compensation on the GB system to enhance power flow capability between Scotland and the England and Wales network (B6 boundary). Series compensation may also be used to increase operational flexibility by providing power flow control.

In using series compensation a number site specific technical considerations that have been addressed, such as the impact on protection and the interaction with local generators.

### Optimised Quadrature Booster Transformer

In a highly meshed network, effective sharing of power along the meshed network is one of key focuses of both designer and operators. One of the technologies used currently for this purpose is Quadrature Booster (QB) transformer. QB transformers work by changing the phase angle and thereby redirecting power flows. This can increase and increased boundary capabilities.

Currently QBs are optimised off-line with manual control in real time. We have carried out studies on how to optimise QBs on-line to meet future operational requirements and capability.

---

### Active Network Management

Active Network Management allows the network to be operated closer to its real-time limits using extensive real time data and automatically controlling generation. Real time remote monitoring the status of the network would update a central controller via fast and reliable communication channels. The controller would then process all the information gathered and send control actions to various network devices, generation and potentially HVDC links.

We are currently developing a trial of active network management (ANM) schemes operating in Scotland and in England. These ANM trials are changing the power output of generation modules, to maximise thermal loading of selected transmission circuits.

### Stakeholder Engagement

What opportunities are there for new technology to support system operability?

---

## 5.5

# Stakeholder Engagement Summary

---

In this chapter we have presented our future operations aligned with the scenarios produced by our Future Energy Scenario process. It covers the changes of the transmission system using the scenarios along with associated case studies to ensure the effectiveness of our future operational development strategies. We work together with our stakeholders to address any gaps that may include the market, commercial, code and asset solutions. The summary of the stakeholder engagements that has been covered in this chapter are as follow:

### Stakeholder Engagement

Are there any other operational challenges that are significant to your business that you believe deserve further consideration?

### Stakeholder Engagement

In your opinion, what are the opportunities for generators providing fast frequency response?

### Stakeholder Engagement

What are the commercial services needed to acquire FFR from various providers?

### Stakeholder Engagement

What are the opportunities for low load operation of thermal power plants to provide the services mentioned in this chapter?

### Stakeholder Engagement

What opportunities are there for new technology to support system operability?

---



## 6.1

### Introduction

---

This is the second edition of the ETYS, and our first in which we fully integrate the Network Development Policy. We encourage you to provide feedback and comments on this document. Please participate in our stakeholder engagement programme in 2014 so we may better understand and respond to your future needs.

Please provide any feedback on all aspects of the 2013 ETYS via e-mail: [\*\*transmission.ety@nationalgrid.com\*\*](mailto:transmission.ety@nationalgrid.com)

---

## 6.2

# Continuous Development

---

We will ensure that we have adopted the following principles to enable the ETYS to continue to add value:

- seek to identify and understand the views and opinions of all our stakeholders
- to provide opportunities for engagement throughout the process to enable constructive debate
- to create open and two-way communication processes around assumptions, drivers and outputs with our stakeholders
- to provide feedback on how stakeholder views have been considered and the outcomes of any engagement process.

The ETYS annual review process will facilitate the continuous development of the statement, encouraging participation from all interested parties with the view of enhancing future versions of the document.

---



# Feedback from 2013 Stakeholder Engagement

## Where we received our feedback:

The ETYS 2013 consultation took place through a variety of channels; the majority of feedback was received at National Grid Future Energy Scenarios and Customer Seminar workshops. We also undertook a formal consultation via the National Grid ETYS website which was sent to key stakeholders. The written consultation only provided three responses and therefore its value and future will be reviewed for the 2014 ETYS consultation.

**Focus more on opportunities e.g. demand side response**

## You told us:

ETYS has to focus more on the opportunities available to new users and technologies in solving some of the future operational challenges associated with both the development of the network and connection opportunities.



**We would like to understand demand's role in providing response and potential services to NGET.**

## Our response:

We hope the new document layout shown for this year will provide much greater clarity on the opportunities for potential new technologies, services and locational connection opportunities. A new chapter that will build upon the System Operation and Network Requirements section "Network Development and Opportunities" will be included bringing a key focus to this area.

**Provide greater information on current operational issues**

## You told us:

Greater clarity and explanation is needed of the operational challenges facing National Grid and information of how we are solving these issues in the current environment.



**When looking for opportunities in the future it would be useful to understand today's challenges and the potential future challenges in different scenarios.**

## Our response:

The system operation chapter will introduce the key current challenges facing National Grid and provide a forecast in each area based on the scenarios for future generation backgrounds. When focusing on system operation challenges, we have highlighted the areas that are today's issue and the undergoing activities to mitigate the issues.

**Detailed technical information on harmonics**

## You told us:

To be able to develop timely connections to the National Grid a key uncertainty has been the availability of harmonic emissions limits in different areas of the network.



**Need more information on harmonics & also network information to enable analysis that developers have obligations to carry out and to analyse those connections.**

## Our response:

This is an area that we understand some of our customers have frustrations in and we will be working toward providing a solution. This is a very complex issue and one requiring high volumes of technical data, usually exchanged bilaterally. Unfortunately we will not be able to solve this issue in this year's publication. In addition, we believe that the ETYS is not the long term solution for information on harmonics and we're currently considering other ways to deliver this information to you, the customer.

**Formatting leads to lots of wasted paper**

## You told us:

Last year's ETYS had headers that were far too large leading to much of the page being wasted.

## Our response:

The formatting of our document has been discussed with NGET's branding department and this year we will look to minimise potentially wasted areas of the document.

### Links to other industry information

**You told us:**

Supplementary information is required such as Main Interconnected Transmission Maps and information on the connection process.



**Describing the connection process could be included for both offshore & onshore in the ETYS.**

**Our response:**

While we recognise many people use the ETYS in the industry we do not want it to become the source of all industry information. Including these documents and guidance notes makes the document far too large and dilutes the true purpose of the document. Therefore we will not be including these documents but provide links to other suitable industry information, such as the connection process guidance documents.

### Further integration and clear NDP process

**You told us:**

The integration of Network Development Policy (NDP) and where it is utilised needs to be clearer.

**Our response:**

The new "Network Development and Opportunities" chapter will contain all the NDP info for England and Wales only and an appendix will contain the methodology and approach associated with the NDP. We hope that this will bring clarity of what the NDP is and how it is utilised for Network Development in England and Wales.

## Stakeholder Engagement

The ETYS is subject to an annual review process, facilitated by National Grid, and involving all stakeholders who use the publication. The purpose of this review is to ensure the ETYS evolves alongside industry developments. Some of the areas to consider are:

- Does the ETYS:
  - illustrate the future development of the transmission system in a co-ordinated and efficient way?
  - provide information to assist customers in identifying opportunities to connect to the transmission network?
- Are there any areas where the ETYS can be improved to meet these aims?

In addition to the development of the ETYS document we are keen to canvass views on our Network Development Policy approach to identifying future network reinforcements. It should be noted that the NDP

only applies to the development of the network in England and Wales, but any views on the approach to network development in Scotland are of course welcome.

We are happy to receive engagement of any kind through the following means and of course at any other opportunities we get to meet:

- At consultation events as part of the customer seminars
- At Operational Forums
- Through responses to the ETYS email [transmission.etsy@nationalgrid.com](mailto:transmission.etsy@nationalgrid.com)
- Organising bilateral stakeholder meetings depending on the feedback

Our indicative timetable for the 2014 ETYS engagement programme is shown below:

*Figure 6.4.1*  
*ETYS engagement timeline 2014*

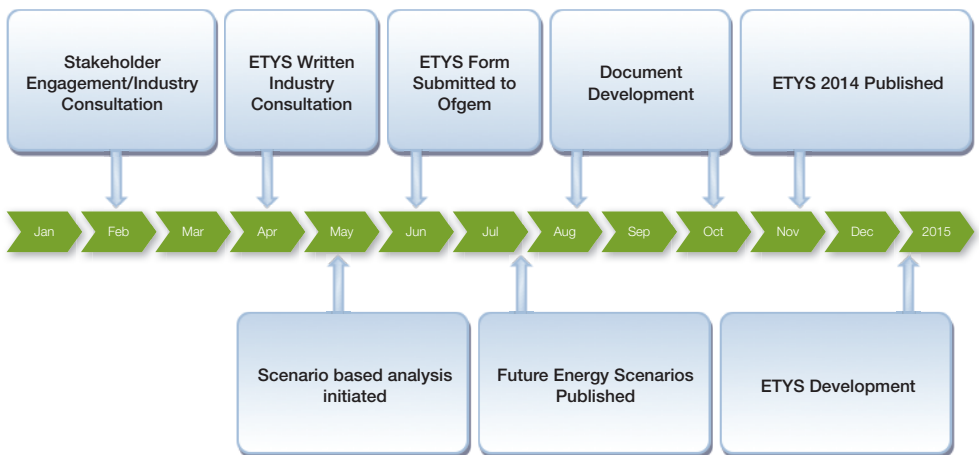

# Glossary

---

Term	Definition
Average Cold Spell Peak Demand (ACS)	The estimated unrestricted winter peak demand (MW and MVAR) on the National Electricity Transmission System for the average cold spell (ACS) condition. This represents the demand to be met by large power stations (directly connected or embedded), medium power stations and small power stations which are directly connected to the National Electricity Transmission System and by electricity imported into the onshore transmission system from external systems across external interconnections (and which is not adjusted to take into account demand management or other techniques that could modify demand).
Boundary Allowance	An allowance in MW to be added in whole or in part to transfers arising out of the Economy Planned Transfer condition to take some account of year round variations in levels of generation and demand. This allowance is calculated by an empirical method described in Appendix F of the Security and Quality of Supply Standards (SQSS).
Boundary Transfer Capacity	The maximum pre-fault power that the transmission system can carry from the region on one side of a boundary to the region on the other side of the boundary while ensuring acceptable transmission system operating conditions will exist following one of a range of different faults.
Bus Coupler	The term used to reference a device which is used to switch from one bus to another without any interruption in power supply or arcing. Bus Couplers are often comprised of circuit breakers and isolators.
Bus Section	Part of a busbar that can be isolated from another part of the same busbar.
Busbar	The common connection point of two or more transmission circuits.
Carbon Capture and Storage (CCS)	The process of trapping carbon dioxide produced by burning fossil fuels or other chemical or biological processes and storing it in such a way that it is unable to affect the atmosphere.

---

---

Combine Heat and Power (CHP)	CHP plants generate electricity whilst also capturing the usable heat that is produced as a result of this process. Using this method, plant efficiencies are often higher than those of conventional generating technologies.
Combined Cycle Gas Turbine (CCGT)	A type of thermal generation that uses a two stage process. Natural Gas is fed into a jet engine which then drives an electrical generator. The exhaust gases from this process are then used to drive a secondary set of turbines and in turn, a second electrical generator.
Contracted Generation	A term used to reference any generator who has entered into a contract to connect with the National Electricity Transmission System (NETS) on a given date whilst having a Transmission Entry Capacity (TEC) figure as a requirement of said contract.
Cost Benefit Analysis (CBA)	A method of assessing the benefits of a given project in comparison to the costs. This tool can help to provide a comparative base for all projects considered.
Crown Estate	A property business that manages the UK seabed out to a distance of 12 Nautical Miles. Since 2000, the Crown Estate has run 6 rounds of offshore wind leasing activities which involve the waters surrounding England, Scotland, Wales and Northern Ireland.
DC Converter	Any apparatus used as part of the National Electricity Transmission System to convert alternating current electricity to direct current electricity, or vice-versa. A DC converter is a standalone operative configuration at a single site comprising one or more converter bridges, together with one or more converter transformers, converter control equipment, essential protective and switching devices and auxiliaries, if any, used for conversion. In a bipolar arrangement, a DC converter represents the bipolar configuration.
Delayed Auto Reclose	This term is used to refer to a sequence of events that occur after a transient fault. Protection and control systems on an overhead line may automatically re-close circuit breakers if a fault is identified to be of a transient nature, thus re-energising the circuit.

---

---

Double Circuit Overhead Line	In the case of the onshore transmission system, this is a transmission line which consists of two circuits sharing the same towers for at least one span in SHETL's transmission system or NGET's transmission system or for at least 2 miles in SPT's transmission system. In the case of an offshore transmission system, this is a transmission line which consists of two circuits sharing the same towers for at least one span.
Embedded Generation	A term used to refer to any generation that is not directly connected to the National Electricity Transmission System. This can typically include solar panels on domestic properties along with combined heat and power plants that may supply industrial facilities.
External Interconnection	Apparatus for the transmission of electricity to or from the onshore transmission system into or out of an external system.
External System	A transmission or distribution system located outside the National Electricity Transmission System operator area, which is electrically connected to the onshore transmission system by an external interconnection.
External System	A transmission or distribution system located outside the National Electricity Transmission System operator area, which is electrically connected to the onshore transmission system by an external interconnection.
First Onshore Substation	The first onshore substation defines the onshore limit of an offshore transmission system. An offshore transmission system cannot extend beyond the first onshore substation. Accordingly, the security criteria relating to an offshore transmission system extend from the offshore GEP up to the interface point or user system interface point (as the case may be), which is located at the first onshore substation. The security criteria relating to the onshore transmission system extend from the interface point located at the first onshore substation and extend across the remainder of the onshore transmission system. The security criteria relating to an onshore user system extend from the user system interface point located at the first onshore substation and extend across the remainder of the relevant user system. The first onshore substation will comprise, inter alia, facilities for the connection between, or isolation of, transmission circuits and / or distribution circuits. These facilities will include at least one busbar to which the offshore transmission system connects and one or more circuit breakers and disconnectors. For the avoidance of doubt, if the substation does not include these elements, then it does not constitute the first onshore substation. The first onshore substation may be owned by the offshore

---

---

	<p>transmission owner, the onshore transmission owner or onshore user system owner as determined by the relevant transmission licensee and / or distribution licensee as the case may be. Normally, in the case of there being transformation facilities at the first onshore substation and unless otherwise agreed, if the offshore transmission owner owns the first onshore substation, the interface point would be on the HV busbars and, if the first onshore substation is owned by the onshore transmission owner or onshore user system owner, the interface point or user system interface point (as the case may be) would be on the LV busbars.</p>
Generating Units	An onshore generating unit or an offshore generating unit.
Generation Circuits	The sole electrical connection between one or more onshore generating units and the Main Interconnected Transmission System i.e a radial circuit which if removed would disconnect the onshore generating units.
Generation Profiles	At winter peak it can be assumed that the greatest number of generators will be operational but at other times of the year the number of generators running can be greatly reduced. Variation of generator operation can be much greater in the summer as generators undertake maintenance, demand is reduced and intermittent generation become more sporadic. Care is taken to ensure adequate support is maintained in all regions at all times.
Gone Green	A Future Energy Scenario. This scenario has been designed to meet the nation's environmental targets; 15% of all energy from renewable sources by 2020, greenhouse gas emissions meeting the carbon budgets out to 2027, and an 80% reduction in greenhouse gas emissions by 2050. There are two case studies to test uncertainty in the Gone Green generation background: one with high offshore wind; and the other with high onshore wind.
Grid Entry Point (GEP)	A point at which a generating unit directly connects to the national electricity transmission system. The default point of connection is taken to be the busbar clamp in the case of an air insulated substation, gas zone separator in the case of a gas insulated substation, or equivalent point as may be determined by the relevant transmission licensees for new types of substation. When offshore, the GEP is defined as the low voltage busbar on the platform substation.

---

---

Grid Supply Point (GSP)	A point of supply from the GB transmission system to a distribution network or transmission-connected load. Typically only large industrial loads are directly connected to the transmission system.
High Voltage Alternating Current (HVAC)	Electric power transmission in which the voltage varies in a sinusoidal fashion, resulting in a current flow that periodically reverses direction. HVAC is presently the most common form of electricity transmission and distribution, since it allows the voltage level to be raised or lowered using a transformer.
High Voltage Direct Current (HVDC)	The transmission of power using continuous voltage and current as opposed to Alternating Current (AV). HVDC is commonly used for point to point long-distance and / or subsea connections. HVDC offers various advantages over HVAC transmission, but requires the use of costly power electronic converters at each end to change the voltage level and convert it to / from AC.
Industrial Emissions Directive (IED)	Launched on 21st September 2007, the IED involved the amalgamation of seven existing directives into one. These were namely the Large Combustion Plant Directive (LCPD), the Integrated Pollution Prevention and Control Directive (IPPCD), the Waste Incineration Directive (WID), the Solvent Emissions Directive (SED) and the three existing directives on Titanium Dioxide on (i) Disposal (78/176/EEC), (ii) Monitoring and Surveillance (82/883/EEC) and (iii) programs for the Reduction of Pollution (92/112/EEC).
Interface Point	A point at which an offshore transmission system, which is directly connected to an onshore transmission system, connects to the onshore transmission system. The Interface Point is located at the first onshore substation which the offshore transmission circuits reach onshore. The default point of connection, within the first onshore substation, is taken to be the busbar clamp in the case of an air insulated substation, gas zone separator in the case of a gas insulated substation, on either the lower voltage (LV) busbars or the higher voltage (HV) busbars as may be determined by the relevant transmission licensees. Normally, and unless otherwise agreed, if the offshore transmission owner owns the first onshore substation, the interface point would be on the HV busbars and, if the first onshore substation is owned by the onshore transmission owner, the interface point would be on the LV busbars.

---



Large Combustion Plant Directive (LCPD)	The revised Large Combustion Plant Directive (LCPD, 2001/80/EC) applies to combustion plants with a thermal output of 50 MW or more. Its primary purpose is to reduce acidification, ground level ozone and particles throughout Europe.
Main Interconnected Transmission System (MITS)	This comprises all the 400 kV and 275 kV elements of the onshore transmission system and, in Scotland, the 132 kV elements of the onshore transmission system operated in parallel with the supergrid, and any elements of an offshore transmission system operated in parallel with the supergrid, but excludes generation circuits, transformer connections to lower voltage systems, external interconnections between the onshore transmission system and external systems, and any offshore transmission systems radially connected to the onshore transmission system via single interface points.
Merit Order	An ordered list of generators, sorted by margin cost.
National Electricity Transmission System (NETS)	The National Electricity Transmission System comprises the onshore and offshore transmission systems of England, Wales and Scotland.
National Electricity Transmission System Operator (NETSO)	National Grid acts as the NETSO for the whole of Great Britain whilst only owning the transmission assets in England and Wales. In Scotland, transmission assets are owned by Scottish Hydro Electricity Transmission Ltd (SHETL) in the north of the country and Scottish Power Transmission (SPT) in the south.
National Peak	The point at which electricity generation is at its highest in order to meet the nation's peak demand. This often occurs during the coldest winter days.
National Electricity Transmission System Security and Quality of Supply Standards (NETS SQSS)	A set of standards used in the planning and operation of the National Electricity Transmission System of Great Britain. For the avoidance of doubt the National Electricity Transmission System is made up of both the onshore transmission system and the offshore transmission systems.
Network Access	Maintenance and system access is typically undertaken during the spring, summer and autumn seasons when the system is less heavily loaded and access is favourable. With circuits and equipment unavailable the integrity of the system is reduced. The planning of the system access is carefully controlled to ensure system security is maintained.

---

NGET	National Grid Electricity Transmission plc (No.2366977) whose registered office is 1-3 Strand, London WC2N 5EH
Offshore	This term means wholly or partly in offshore waters.
Offshore Generating Unit	Any apparatus, which produces electricity including, a synchronous offshore generating unit and non-synchronous offshore generating unit and which is located in offshore waters.
Offshore Power Park Module	<p>A collection of one or more offshore power park strings, located in offshore waters, registered as an offshore power park module under the provisions of the Grid Code. There is no limit to the number of offshore power park strings within the offshore power park module, so long as they either:</p> <ul style="list-style-type: none"><li>a) connect to the same busbar which cannot be electrically split; or</li><li>b) connect to a collection of directly electrically connected busbars of the same nominal voltage and are configured in accordance with the operating arrangements set.</li></ul>
Offshore Power Park Strings	A collection of non-synchronous offshore generating units, located in offshore waters that are powered by an intermittent power source joined together by cables with a single point of connection to an offshore transmission system.
Offshore Power Station	An installation, located in offshore waters, comprising one or more offshore generating units or offshore power park modules or offshore gas turbines (even where sited separately) owned and / or controlled by the same generator, which may reasonably be considered as being managed as one offshore power station.
Offshore Transmission Circuit	Part of an offshore transmission system between two or more circuit breakers which includes, for example, transformers, reactors, cables, overhead lines and DC converters but excludes busbars and onshore transmission circuits.
Offshore Waters	Has the meaning given to "Offshore Waters" in Section 90(9) of the Energy Act 2004.
Onshore	This term refers to assets that are wholly on land.

---

---

Onshore Generating Unit	Any apparatus which produces electricity including a synchronous generating unit and non-synchronous generating unit but excluding an offshore generating unit.
Onshore Power Station	An installation comprising one or more onshore generating units or onshore power park module (even where sited separately) owned and / or controlled by the same generator, which may reasonably be considered as being managed as one onshore power station.
Onshore Transmission Circuit	Part of the onshore transmission system between two or more circuit breakers which includes, for example, transformers, reactors, cables and overhead lines but excludes busbars, generation circuits and offshore transmission circuits.
Onshore Transmission Licensees	NGET, SPT and SHETL
Onshore Transmission System	The system consisting (wholly or mainly) of high voltage electric lines owned or operated by onshore transmission licensees and used for the transmission of electricity from one power station to a substation or to another power station or between substations or to or from offshore transmission systems or to or from any external interconnections and includes any plant and apparatus and meters owned or operated by onshore transmission licensees within Great Britain in connection with the transmission of electricity. The onshore transmission system does not include any remote transmission assets. For the avoidance of doubt, the onshore transmission system, together with the offshore transmission systems form the National Electricity Transmission System.
Planned Transfer	A term to describe a point at which demand is set to the national peak when analysing boundary capability.
Power Station	Means an onshore power station or an offshore power station.
Ranking Order	A list of generators sorted in order of likelihood of operation at time of winter peak and used by the NETS SQSS.
Reactive Power	Reactive power is a concept used by engineers to describe the background energy movement in an Alternating Current (AC) system arising from the production of electric and magnetic fields. These fields store energy which changes through each AC cycle. Devices which store energy by virtue of a magnetic field produced by a flow of current are said to absorb reactive power; those which store energy by virtue of electric fields are said to generate reactive power.

---

---

Real Power	This term (sometimes referred to as “Active Power” provides the useful energy to a load. In an AC system, Real Power is accompanied by Reactive Power for any Power Factor other than 1.
Seasonal Circuit Ratings	The current carrying capability of circuits. Typically, this reduces during the warmer seasons as the circuit’s capability to dissipate heat is reduced. The rating of a typical 400 kV overhead line may be 20% less in the summer than in winter.
SHE Transmission	Scottish Hydro-Electric Transmission (No.SC213461) whose registered office is situated at Inveralmond HS, 200 Dunkeld Road, Perth, Perthshire PH1 3AQ.
Slow Progression	A Future Energy Scenario. This is where developments in renewable and low carbon energy are comparatively slow and the renewable energy target for 2020 is not met. The carbon reduction target for 2020 is achieved but not the indicative target for 2030. Again, there are two case studies to explore some of the uncertainty seen in fuel prices. At the moment coal is significantly cheaper to burn than gas, so one case study is based on high coal generation and the other flips the fuel price dynamic and examines a high gas generation case.
SPT	SP Transmission Limited (No. SC189126) whose registered office is situated at 1 Atlantic Quay, Robertson Street, Glasgow G2 8SP.
Station Demand	The demand drawn by power stations to operate ancillary services which prior to and after synchronisation to the NETS, support the process of electricity generation.
Summer Minimum Demand	The point at which electricity generation is at its lowest due to low demand. This is often attributed to longer daylight hours, lack of lighting demand and reduced heating demand.
Supergrid	That part of the national electricity transmission system operated at a nominal voltage of 275 kV and above.
Supergrid Transformers (SGT’s)	A term used to describe transformers on the NETS that operate in the 275 - 400 kV range.
Switchgear	The term used to describe components of a substation that can be used to carry out switching activities. This can include, but is not limited to isolators / disconnectors and circuit breakers.

---

---

System Operations (ENTSO-E)	ENTSO-E is a Europe-wide organisation that is responsible for representing all Electricity Transmission System Operators and others connecting to their network. It addresses all their technical and market issues as well as coordinating planning and operations across Europe.
System Stability	With reduced power demand and a tendency for higher system voltages during the summer months fewer generators will operate and those that do run could be at reduced power factor output. This condition has a tendency to reduce the dynamic stability of the NETS. Therefore network stability analysis is usually performed for summer minimum demand conditions as this represents the limiting period.
Transient Fault	A term used to describe a temporary fault on the network which will often clear before the Delayed Auto Reclose (DAR) operates.
Transmission Capacity	The ability of a network to transmit electricity.
Transmission Circuit	This is either an onshore transmission circuit or an offshore transmission circuit.
Transmission Entry Capacity (TEC)	The maximum amount of active power deliverable by a power station at its grid entry point (which can be onshore and offshore). This will be the maximum power deliverable simultaneously by all of the generating units that connect to the GEP, minus any auxiliary loads.
Transmission Owners	A collective term used to describe the three transmission asset owners within Great Britain, namely National Grid Electricity Transmission, Scottish Hydro-Electric Transmission Limited and SP Transmission Limited.
UK Future Energy Scenarios (FES)	A term used to describe the range of scenarios used by NGET to provide a plausible and credible projection for the future of UK Energy.
Voltage Management	At times of low demand and particularly low reactive power demand, the voltages on the NETS can naturally increase due to capacitive gain. High voltages need to be controlled to avoid equipment damage. Sufficient reactive compensation and switching options must be available to allow effective voltage control.

---

The information contained within the Electricity Ten Year Statement document ("the Document") is disclosed voluntarily and without charge.

The Document replaces the Seven Year Statement (SYS) and the Offshore Development Information Statement (ODIS) and is published in accordance with the relevant Licence conditions.

National Grid would wish to emphasise that the information must be considered as illustrative only and no warranty can be or is made as to the accuracy and completeness of the information contained within the Document. Neither National Grid Electricity Transmission, National Grid Gas nor the other companies within the National Grid group, nor the directors, nor the employees of any such company shall be under any liability for any error or misstatement or opinion on which the recipient of this Document relies or seeks to rely other than fraudulent misstatement or fraudulent misrepresentation and does not accept any responsibility for any use which is made of the information or Document which or (to the extent permitted by law) for any damages or losses incurred. Copyright National Grid 2013, all rights reserved. No part of the Document or this site may be reproduced in any material form (including photocopying and restoring in any medium or electronic means and whether or not transiently or incidentally) without the written permission of National Grid except in accordance with the provisions of the Copyright, Designs and Patents Act 1988.

**National Grid plc**

National Grid House,  
Warwick Technology Park,  
Gallows Hill, Warwick.  
CV34 6DA United Kingdom

Registered in England and Wales  
No. 4031152

**[www.nationalgrid.com](http://www.nationalgrid.com)**