

BSIS Modelling Workshop

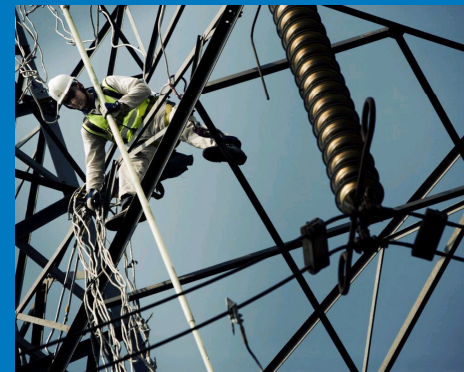

Jo Faulkner
Balancing Services Manager

Wednesday 20 February 2013

Our Objectives

- At Ofgem's workshop, stakeholders sought a more detailed understanding of the models used to derive a BSIS target
- The objectives for this afternoon's session are therefore:

Stakeholder confidence

Creating value

Creating an efficient target

Performance of the models

Inputs & how the models work



Promoting choice and value
for all gas and electricity customers

Ofgem Update

Lewis Heather

Calculating an Incentive Target

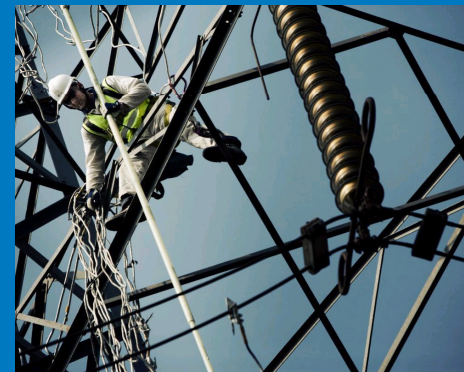

Jo Faulkner
Balancing Services Manager

Ensuring a strong incentive

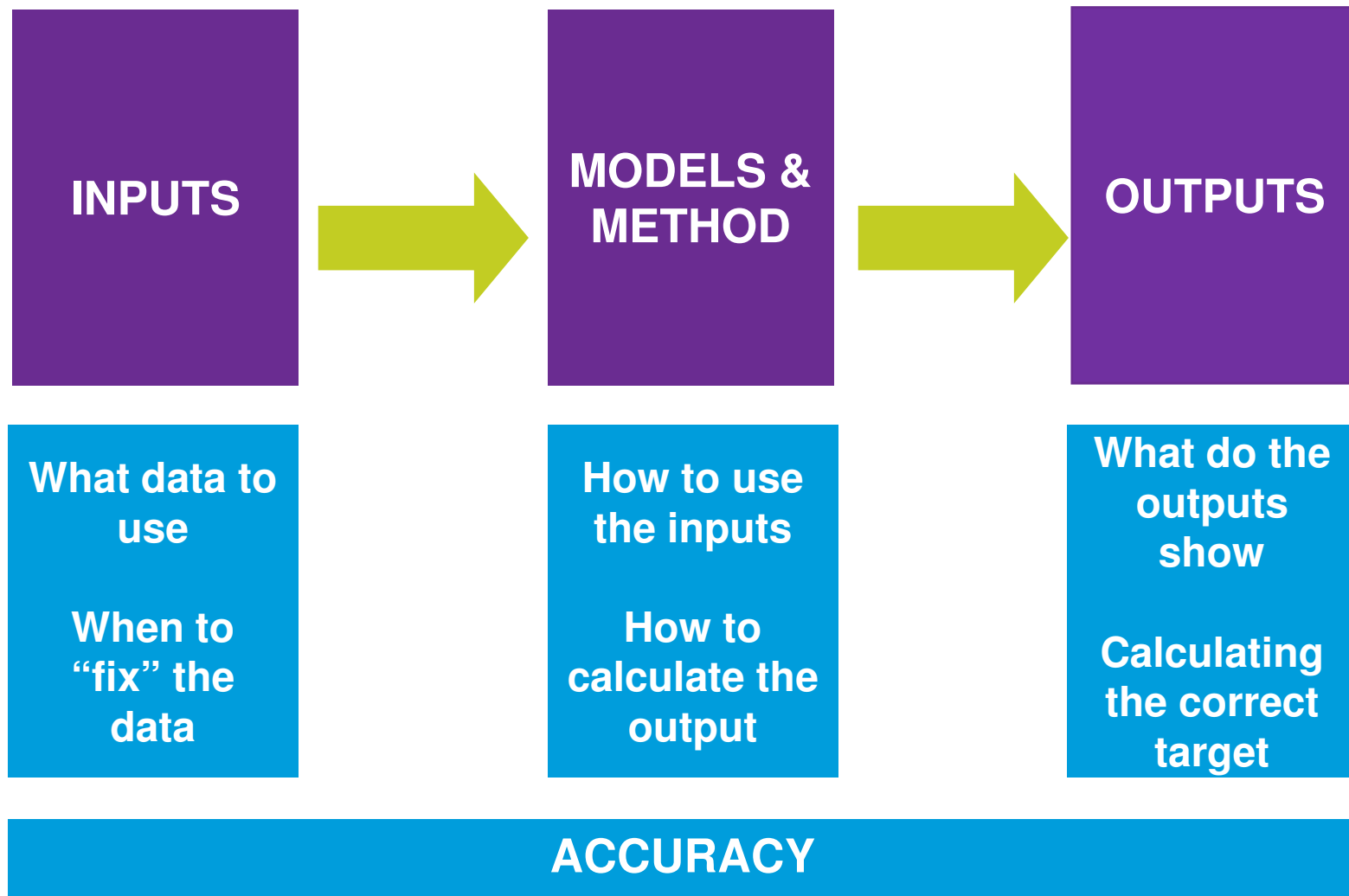

Ensuring a strong incentive

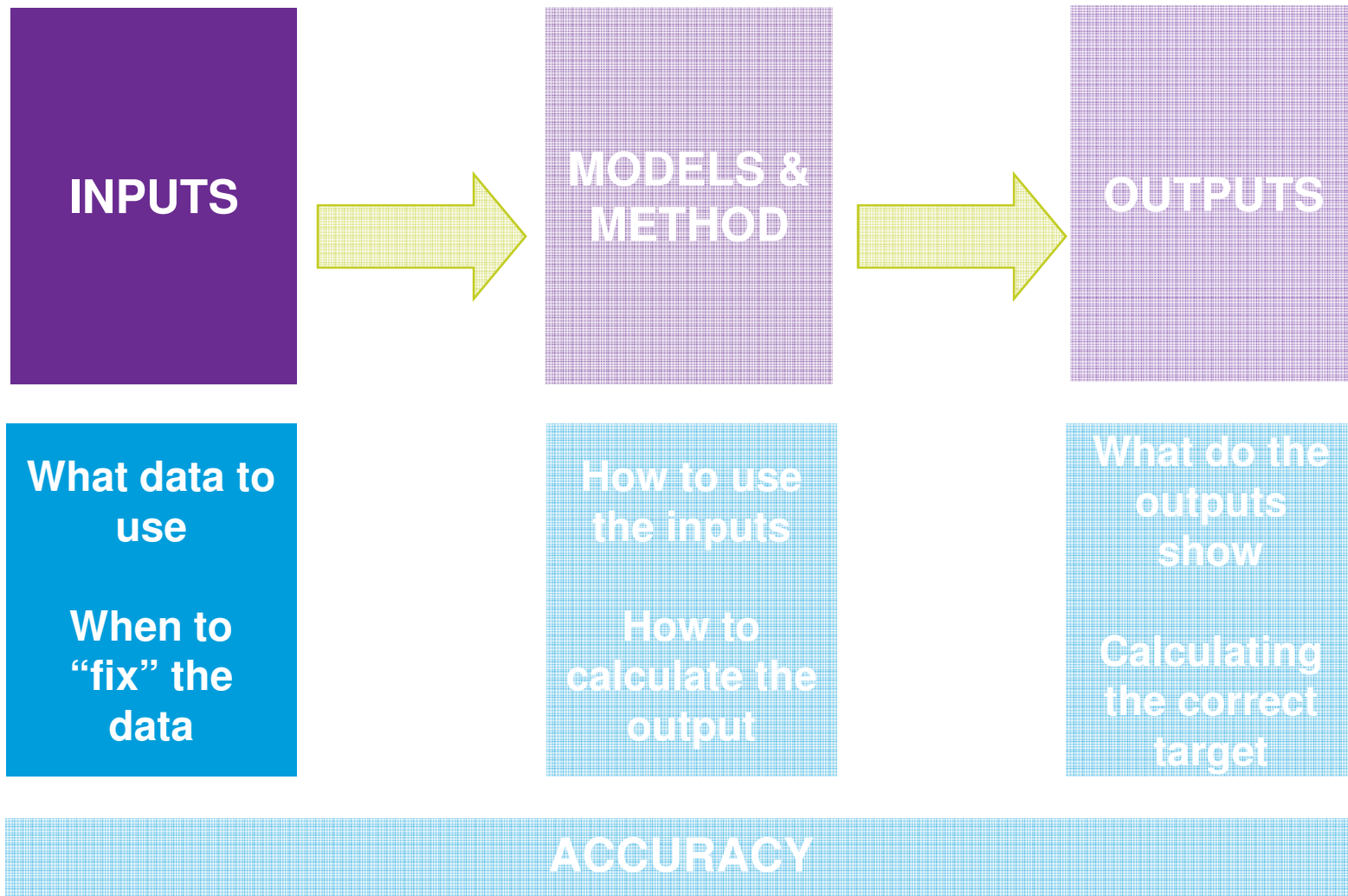

Modelling Inputs

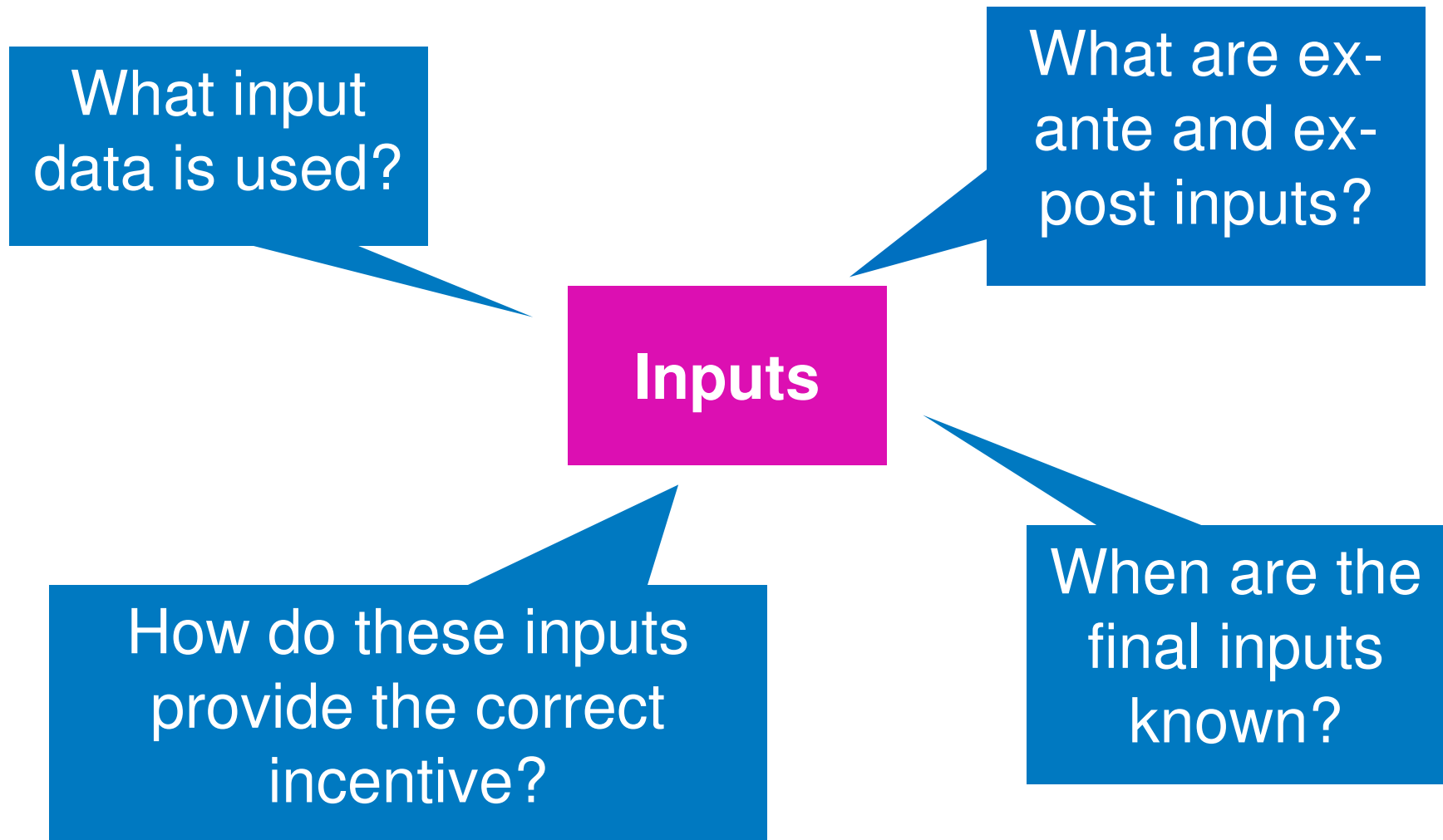

What input
data is used?

nationalgrid

A selection of data reflecting energy market price levels, demand and supply positions and transmission system capabilities is used to model the cost of balancing the system.

What are ex-ante
and ex-post
inputs?

nationalgrid

Ex-ante inputs represent those drivers of system operation costs that are more easily controlled and/or forecast by the System Operator. These data sets are agreed ahead of scheme.

Ex-post inputs are those data sets that are outside of the System Operator's control and are difficult to forecast. These inputs are input post event using outturn data.

When are the
final inputs
known?

nationalgrid

Ex-ante inputs are known and agreed ahead of the start of the scheme and will not change.

Ex- post inputs are forecast in the initial target forecast calculation and overwritten by actual data post event on a monthly basis.

A complete set of inputs for the whole scheme is therefore not known until after all actual data is known.

How do these inputs provide the correct incentive?

nationalgrid

Windfall gains and losses from inaccurate forecasts of uncontrollable and unforecastable inputs are removed from the incentive. The System Operator is therefore clearly incentivised to enhance achievable forecasting capabilities and reduce the cost of those variables that are within its control.

Ensuring a strong incentive

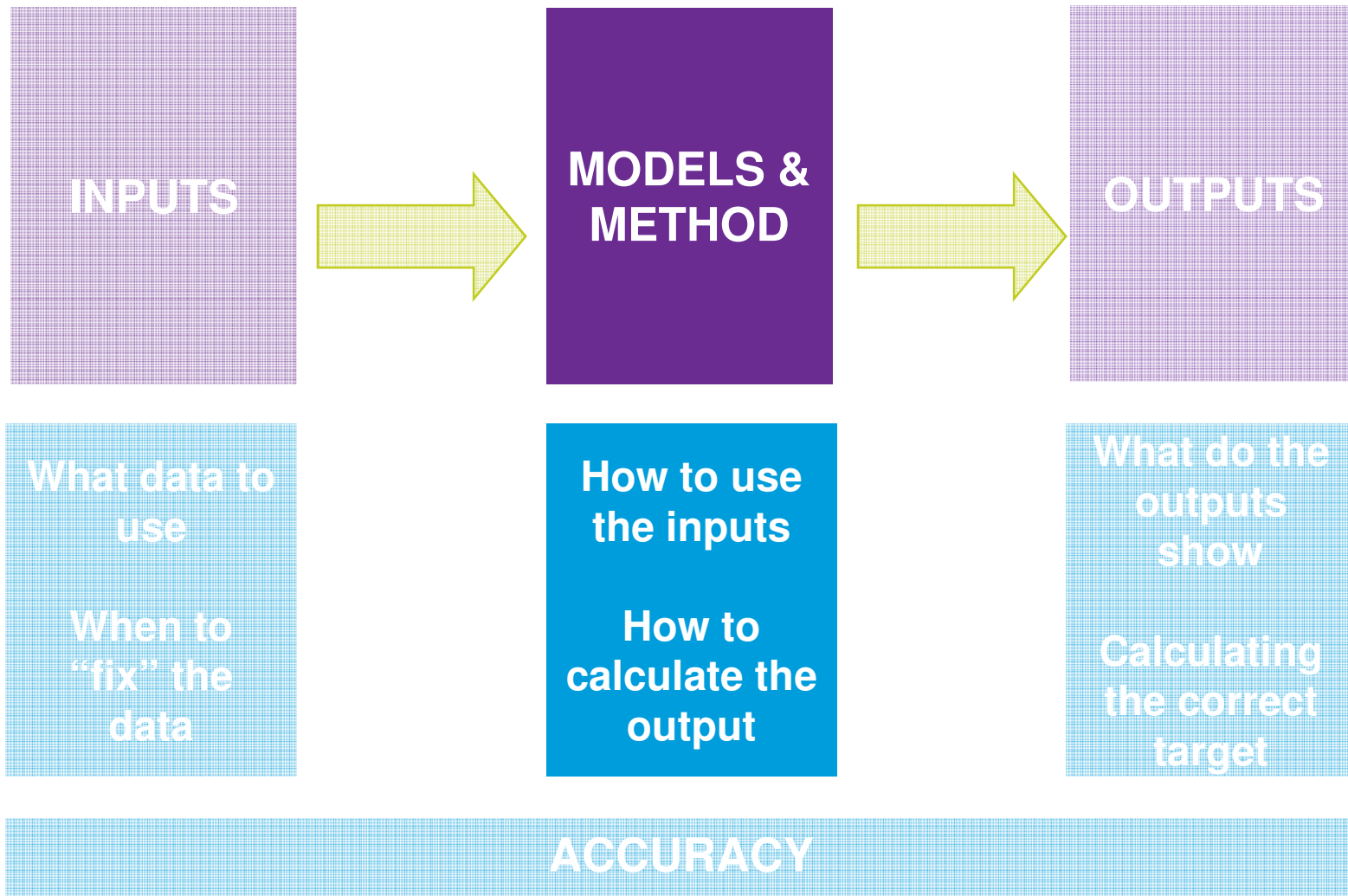

Models & Method

How are the inputs used to model costs?

How do the models “mimic” the market?

Models

How do these calculations provide the correct incentive?

Why can it be different from the market?

How are the inputs
used to model costs?

nationalgrid

There are two models used to calculate cost outputs. The energy model and the constraints model.

How are the inputs used to model costs?

nationalgrid

The **constraint model** uses the relevant inputs to calculate a cost target for managing constraints in real time.

The **energy model** uses the relevant inputs to calculate an efficient cost target for energy balancing using contract solutions and real time solutions.

How does this “mimic” the market?

Why can it be different from the market?

nationalgrid

The models are designed to undertake similar ‘steps’ to calculating costs as the System Operator would in reality by building a scenario of what system conditions will be and therefore the cost of resolving energy imbalance or system constraints.

How does
this “mimic”
the market?

Why can it be
different from
the market?

nationalgrid

The modelled costs can vary from the actual costs. This difference should reflect the actions that the System Operator has made to create value on behalf of consumers.

Energy Model: What are we modelling?

- We are creating a:
 - Statistical analysis of past costs and volumes
 - A series of relationships between inputs
 - Forecast of data we can forecast or control
- We have to create a model that captures the different procurement timescales and risks
- We have to create a model that allows for the links between components to be modelled

Energy Model:

An example, Energy Imbalance

- If the system is long or short we have to take a series of actions to bring the system to balance
- To understand the cost of this, we need to understand the required volume to balance and the prices of the actions required to procure that volume
- The volume is known as the Net Imbalance Volume (NIV)
- The cost is the cheapest actions in the BM price stack required to procure NIV
- Can NIV for every Settlement period be forecast?
- Can the price stack for every settlement period be forecast?

Constraint Model: What are we modelling?

- We use a piece of software which:
 - Uses a demand forecast (inputted by National Grid)
 - Forecasts the level and location of generation on the system to meet that forecast demand
 - Knows what and where the constraints of the system are (inputted by National Grid as system boundaries)
 - Simulates the BM to resolve system constraints using actual BM prices

- The constraint model therefore effectively calculates the cost of the BM actions required to resolve system constraints

How are the models tested to ensure they are robust?

nationalgrid

We undertake backtesting by using **all ex post data inputs** to create a cost forecast to test how closely the output aligns with real costs.

Energy Model: How do we test the model

- The energy model produces a forecast of price, volume or cost for the components of the energy model
- How well each model 'fits' the historic data is tested when the individual models are built and trained
- The performance of the individual models and the whole model is tested by back-testing using a year of outturn data
- We can compare the forecast the model would have produced compared to the actual costs
- We can run the back-test using different years to get a feel for how well the model works under different market conditions

The 2011/13 Model

Cummulative Scheme to date Target cost and outturn costs

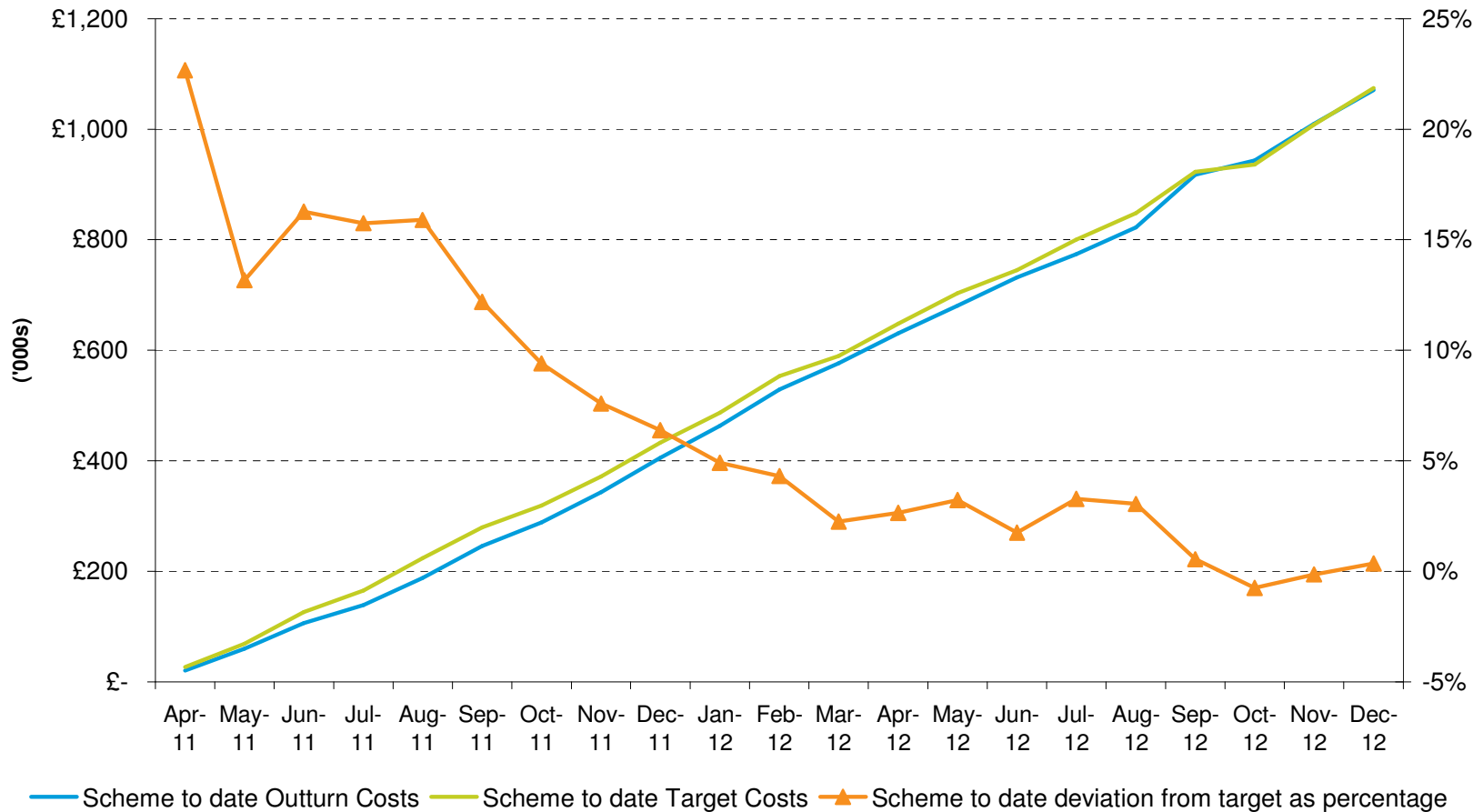

Constraint Model: How do we test the model

- The model provides a cost of constraints if all actions taken in the Balancing Mechanism
- We want to know, given perfect information, does the model predict accurate costs
- Therefore we have performed a backward looking test, using actual Final Physical Notification data and actual submitted bid and offer prices
- The constraint limits for the model were taken from Electricity National Control Room

Testing Results - Costs

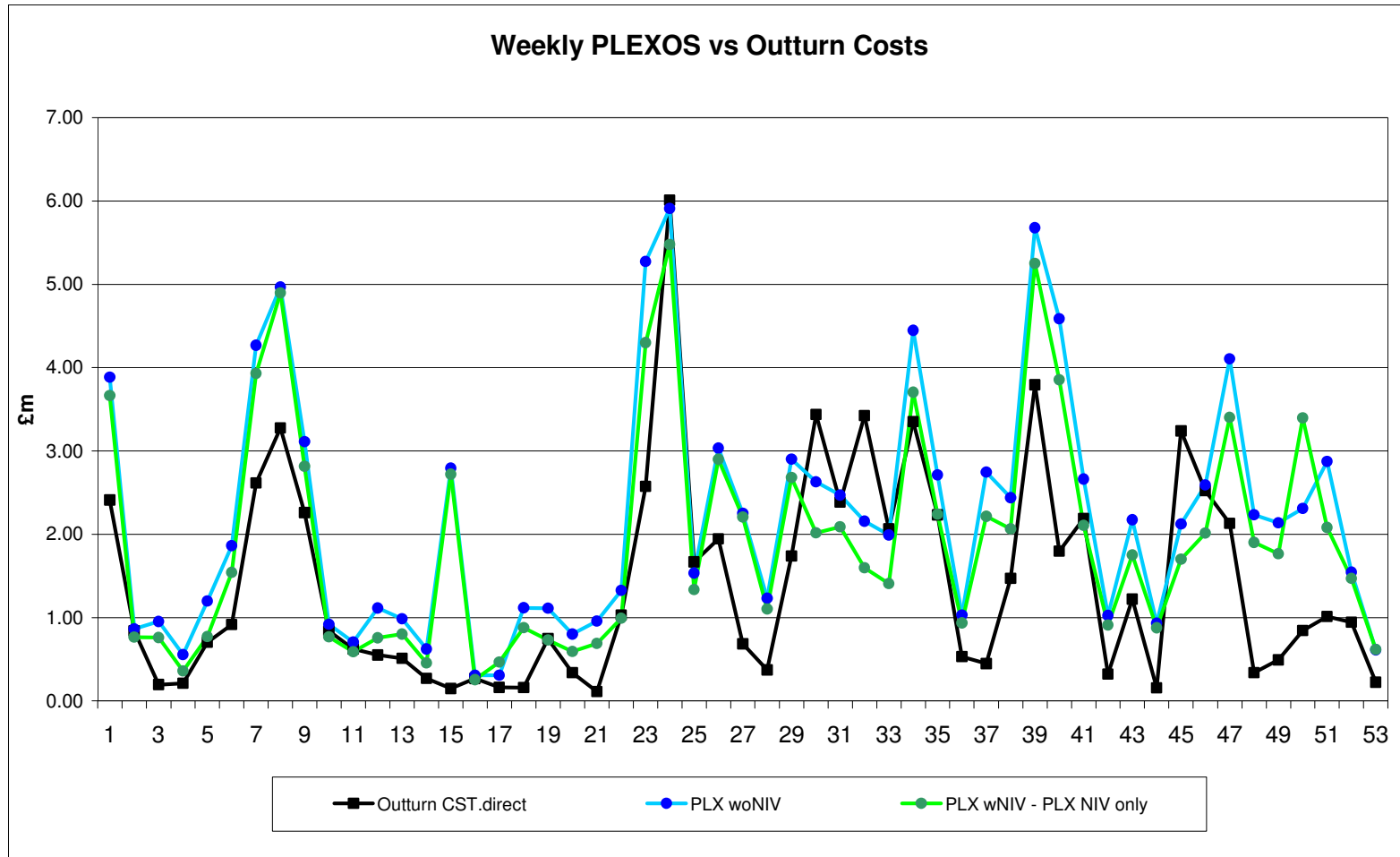

Testing Results - Volumes

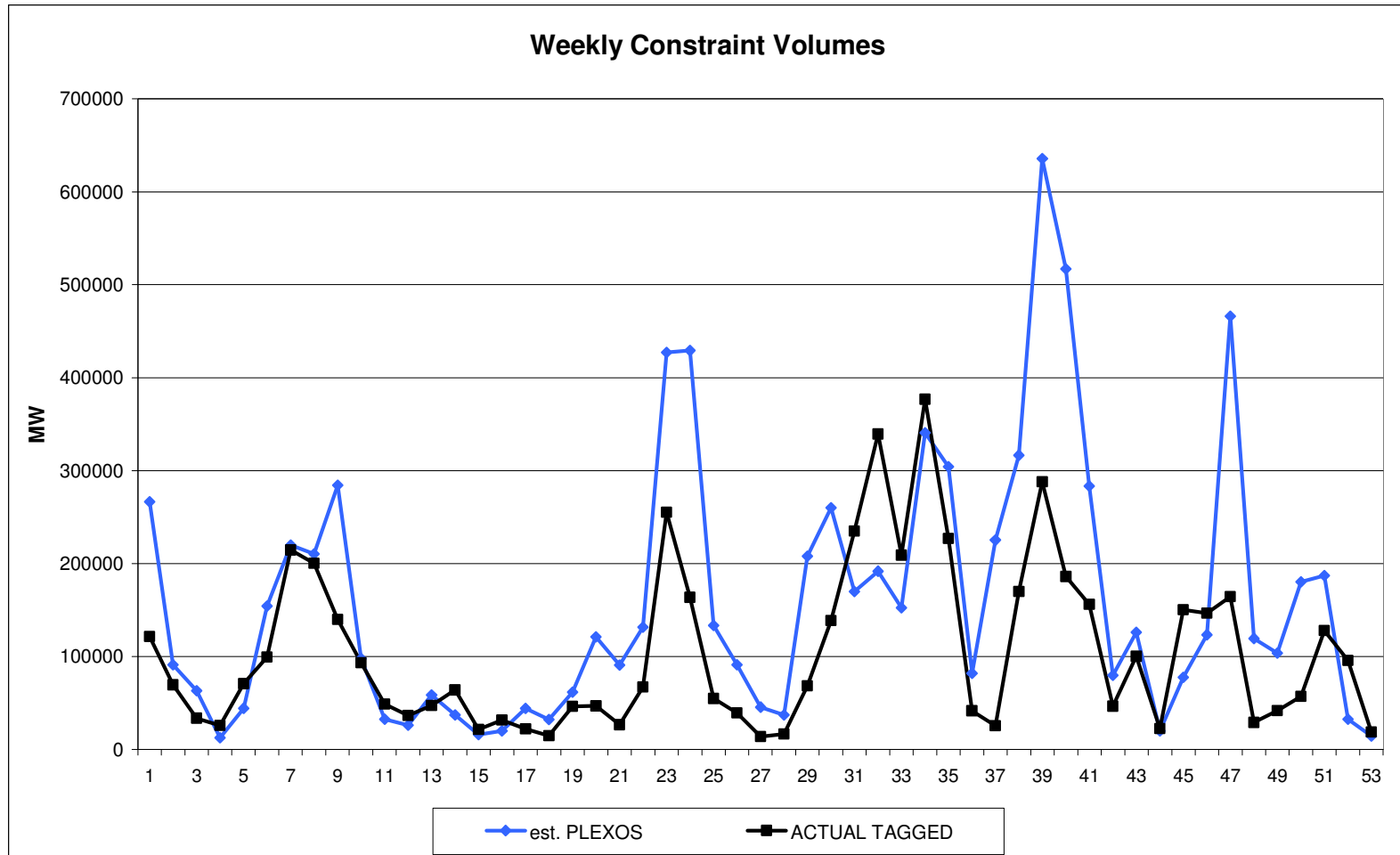

Testing Results – Cost Errors

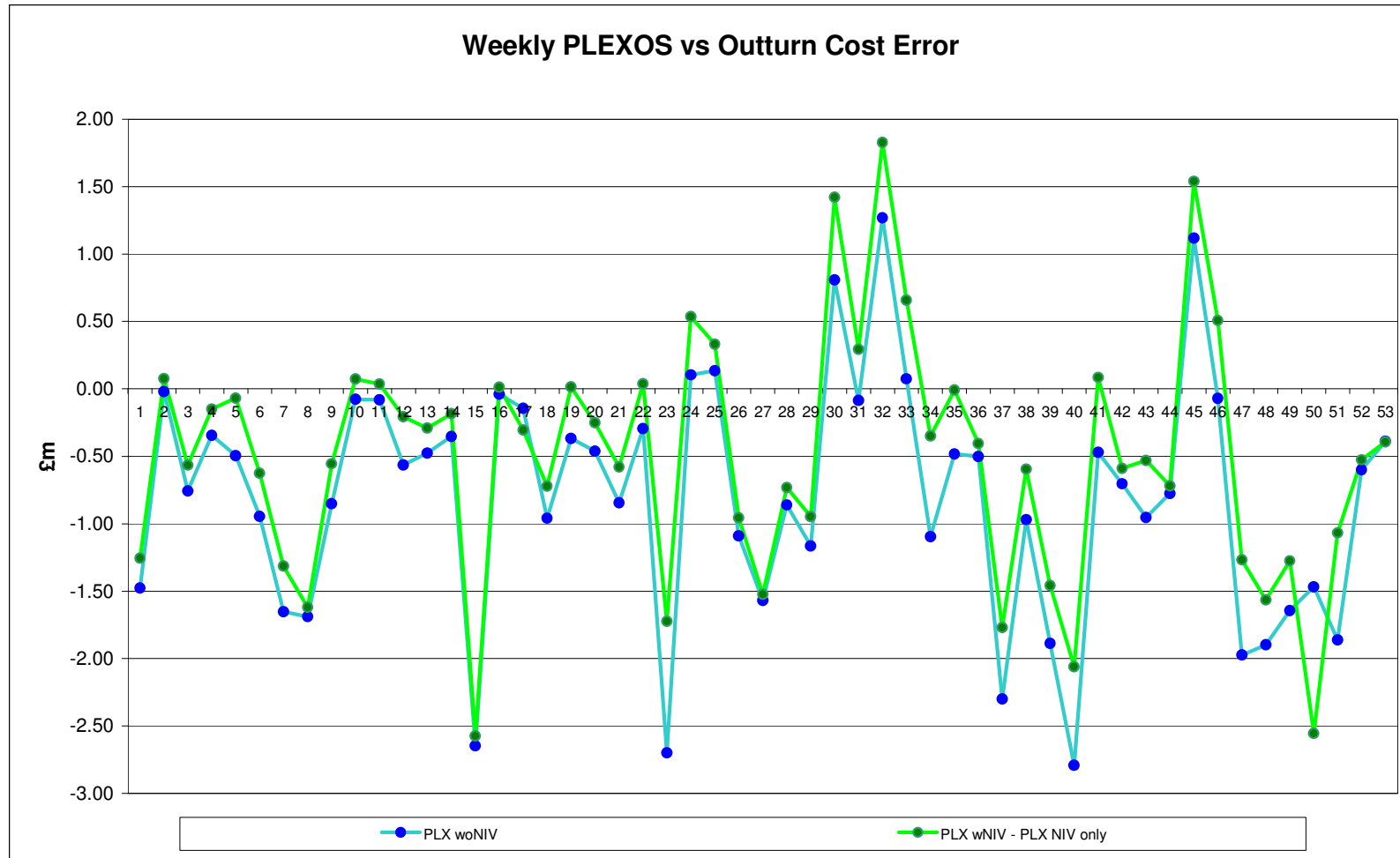

Ensuring a strong incentive

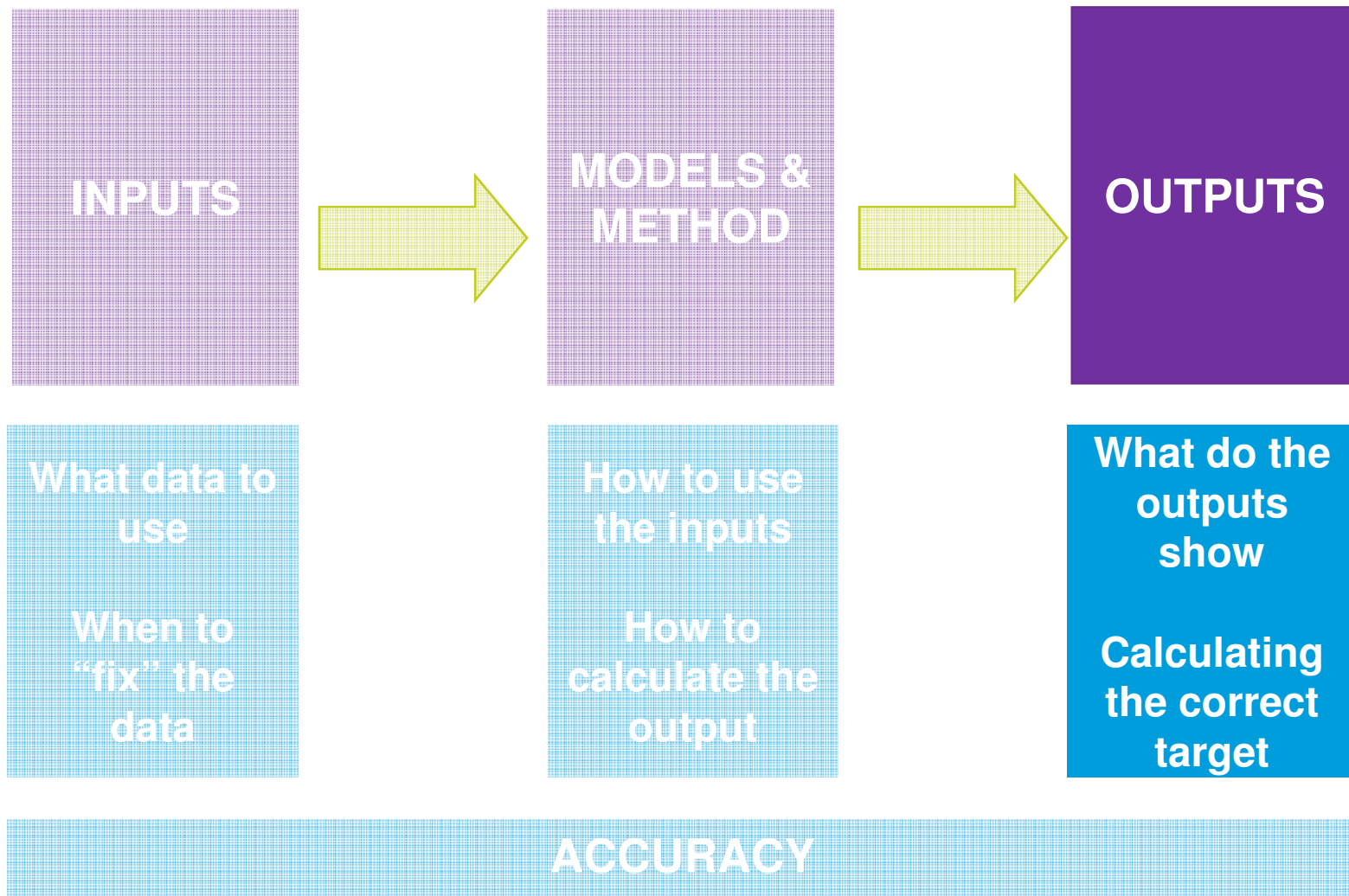

Model Outputs

What do the outputs represent?

How are the outputs used to calculate a target?

Outputs

When is the incentive target for the scheme known?

What is the system operator incentivised to do?

How do these calculations provide the correct incentive?

What do the outputs represent?

nationalgrid

The outputs represent a forecast cost of balancing the system given the various levels of cost drivers (inputs) in accordance with pre-determined relationships.

How do these calculations provide the correct incentive?

nationalgrid

The combination of the correct treatment of inputs (either ex ante or ex post) coupled with tested relationships between the inputs create an efficient incentive cost target.

How are the outputs used to calculate a target?

nationalgrid

The cost target output from the energy model is summed with the cost target output from the constraint model. This modeled output is currently then combined with pre-determined targets for Black Start and Transmission Losses to form an overall incentive target.

How are the outputs used to calculate a target?

nationalgrid

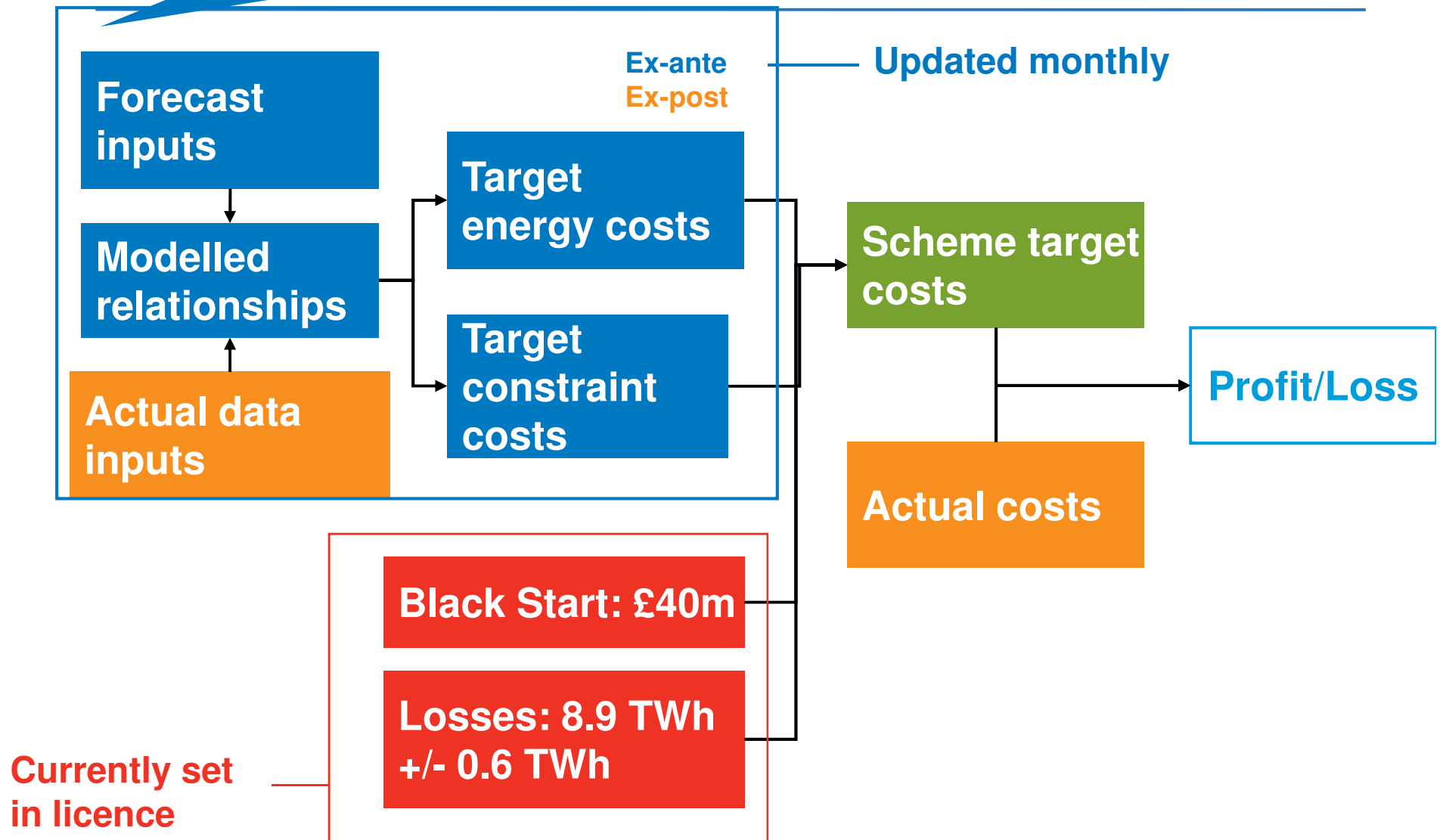

When is the incentive target for the scheme known?

nationalgrid

The target can not be calculated in total until the end of the scheme when all ex post data inputs are finally known.

What is the system operator incentivised to do?

nationalgrid

By comparing these outputs to actual spend, the System Operator is incentivised to deliver value through contracting, trading, investment and other innovative actions e.g. Code and framework change.

What is the system operator incentivised to do?

nationalgrid

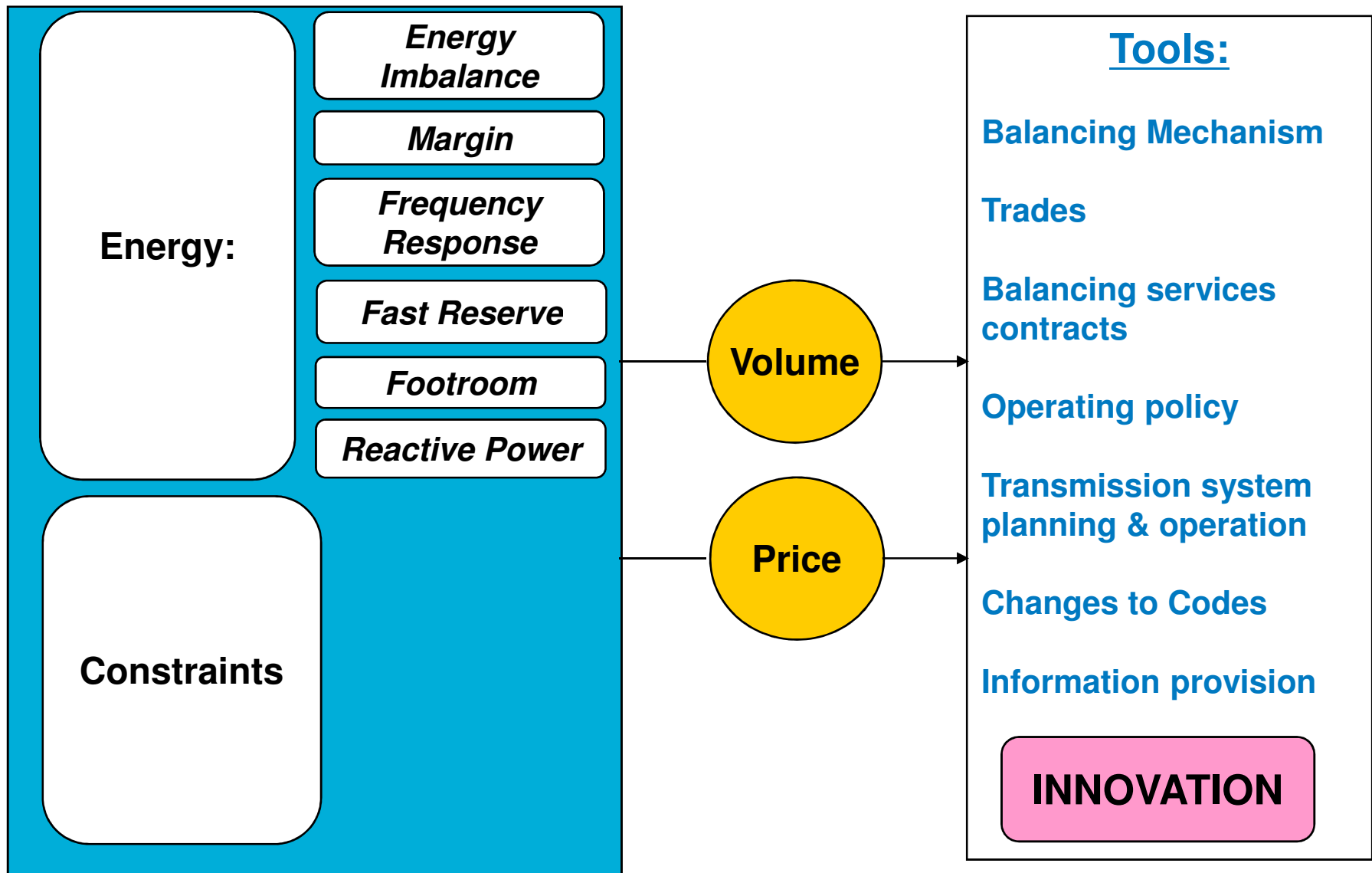

Gaining Stakeholder Confidence

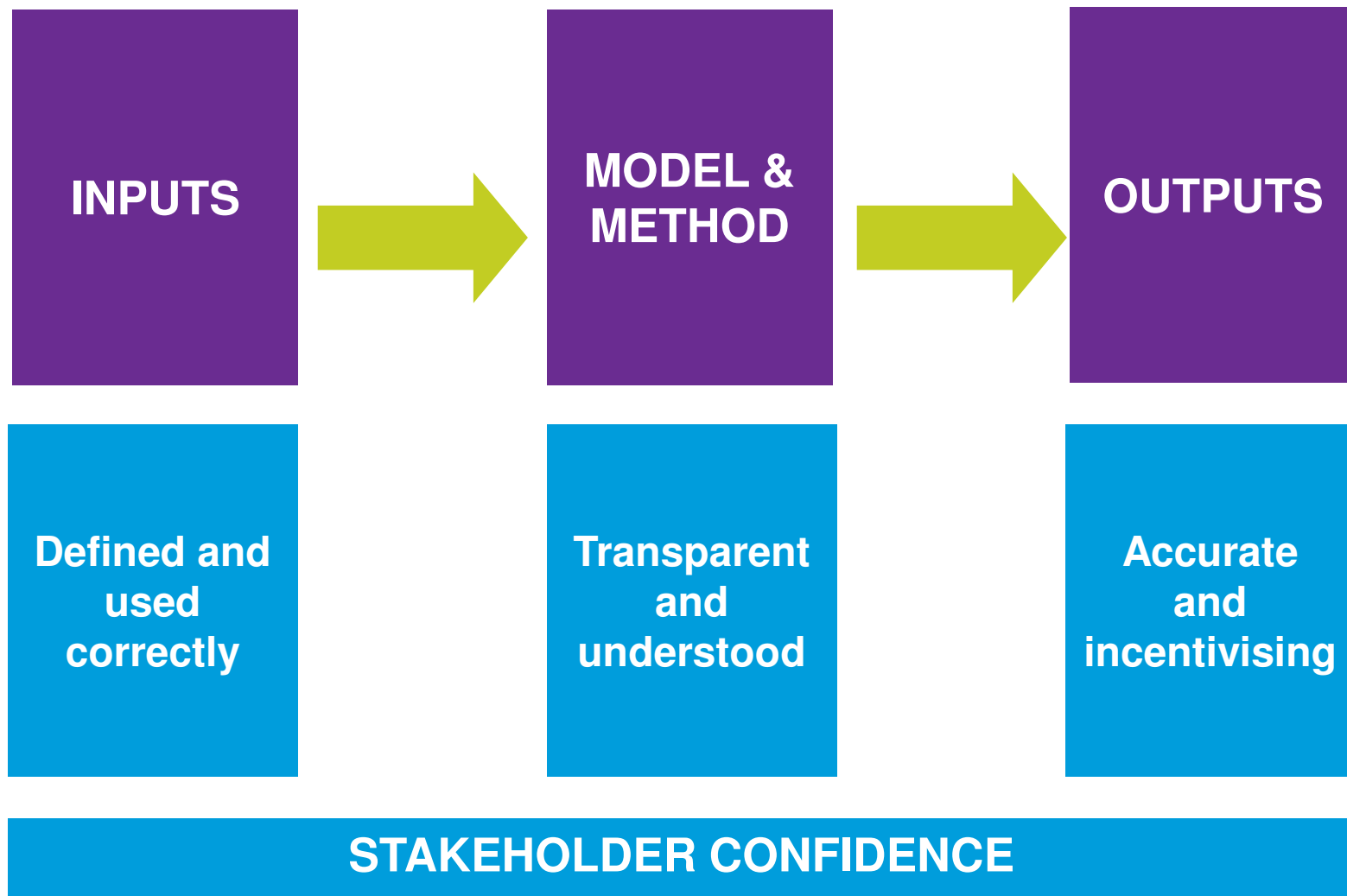

Model Demonstration and Q&A



All

Thank you for attending



Please contact us for more information:

Jo Faulkner – Jo.Faulkner@nationalgrid.com

Katharine Clench – Katharine.Clench@nationalgrid.com

2011-13 BSIS Scheme References

- Three methodology statements currently support the 2011-13 BSIS scheme. These are:

- Modelling energy costs:

http://www.nationalgrid.com/NR/rdonlyres/9A536B73-7545-4484-9BFC-D27D6E5CBD89/47901/Energy_Modelling_Methodology_Issue1_18thJuly2011.pdf

- Modelling constraint costs:

http://www.nationalgrid.com/NR/rdonlyres/919CBE24-DF5A-483C-9824-6E89C057F4A3/57001/Constraints_Modelling_Methodology_Issue1_Revision1_Sep2012_Final.pdf

- The Ex-ante or Ex-post Treatment of Modelling Inputs:

http://www.nationalgrid.com/NR/rdonlyres/9D7149B1-C8C5-40EA-B563-B1B8F9CAF744/57000/Treatment_of_Modelling_Inputs_Methodology_Issue1_Revision1_Sep2012_Final.pdf

Constraint Model



Iain McIntosh: Iain.McIntosh@nationalgrid.com

Types of constraints

- There are three types of constraint that we capture in the constraint model;
 - **Thermal** – these are constraints that are caused by a lack of capacity on the transmission network
 - **Voltage** – these can occur for a variety of reasons and tend to be local or regional – often require particular generators to be running
 - **Stability** – two types, transient and dynamic. Transient are associated with immediate post fault situations, dynamic result from oscillations between generators that are in steady state and are usually caused by weak links to high generation export groups

Thermal Constraints

- All transmission lines and cables have a rating i.e. the amount of power that can be transferred continuously.
- National Grid “secure the system” – ratings are used to ascertain that in the event of a transmission line going out of service, power can still be transferred safely.
- Most lines or cables can operate at a higher power transfer level than their continuous rating for a very short period. If the post-fault flow exceeds a short term rating (less than 10 minutes) then action (re-dispatch, switching) will have to be taken ahead of time in mitigation

Voltage & Stability Constraints

- These are reactive power related, tend to be localised but can also be regional (for example if generator running patterns reduce MVAR reserves).
- Carrying insufficient MVAR reserves could result in unacceptable voltage deviations, or in extreme, voltage collapse.
- Stability constraints generally place limits on the amount of power that can be transferred post fault. This often arises as a result of voltage drops that would otherwise occur through increased loading and impedance on transmission lines

How do we reflect constraints in the model

- In operational planning, extensive off-line transmission studies are carried out using full DC and AC analysis – performed over various timescales.
- The constraint model has the capability to perform DC load flow – however it takes a significant amount of time due to complexity. Important it cannot do AC analysis (for voltage and stability)
- An alternative means to model constraints is to derive boundary limits from off-line transmission studies. Using appropriate tools for the job – faster and more effective.
- The constraint model has to derive a cost estimate for a year in one simulation – boundary model therefore most appropriate

Boundary Limits

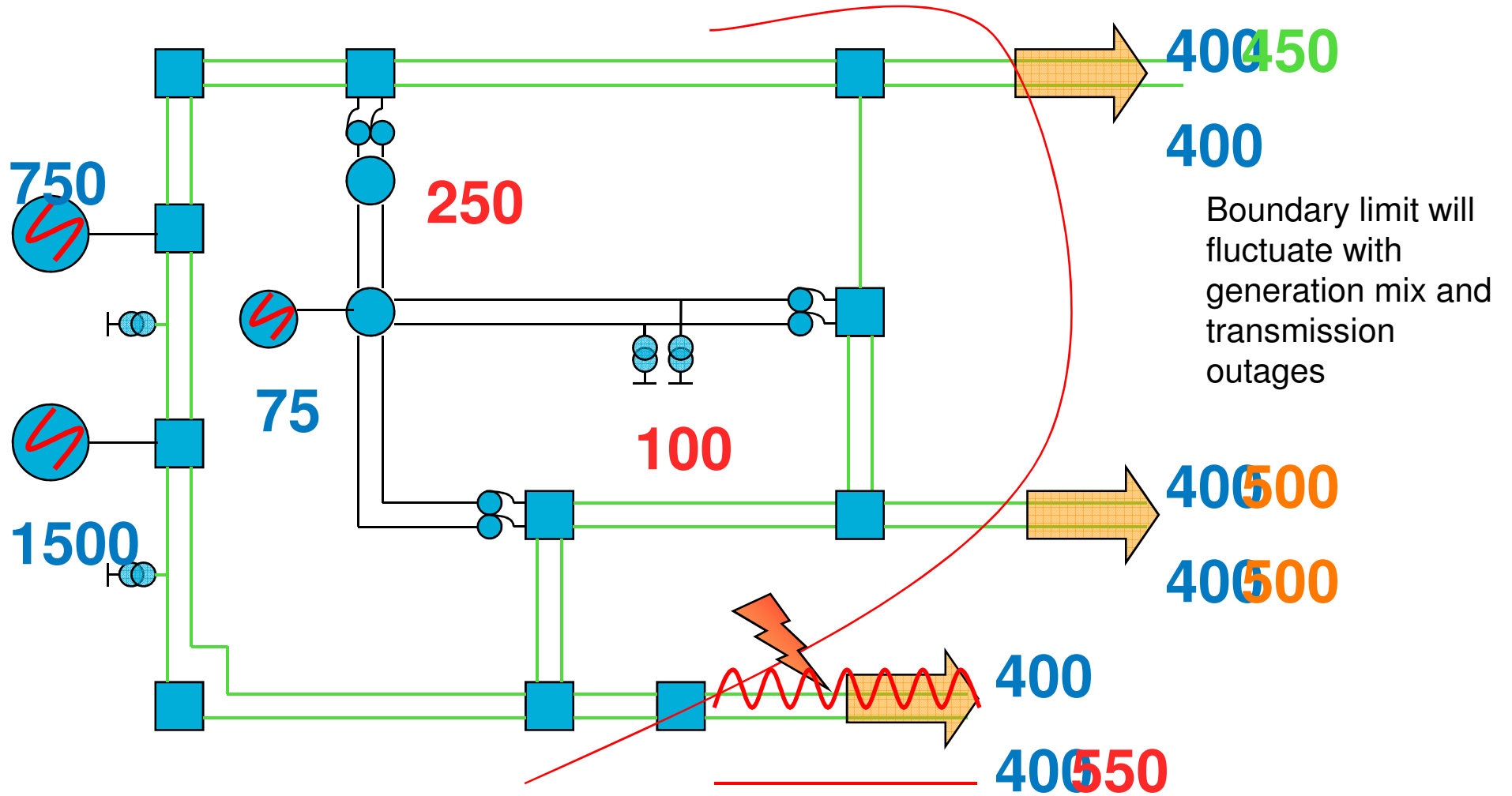

Cost of constraint

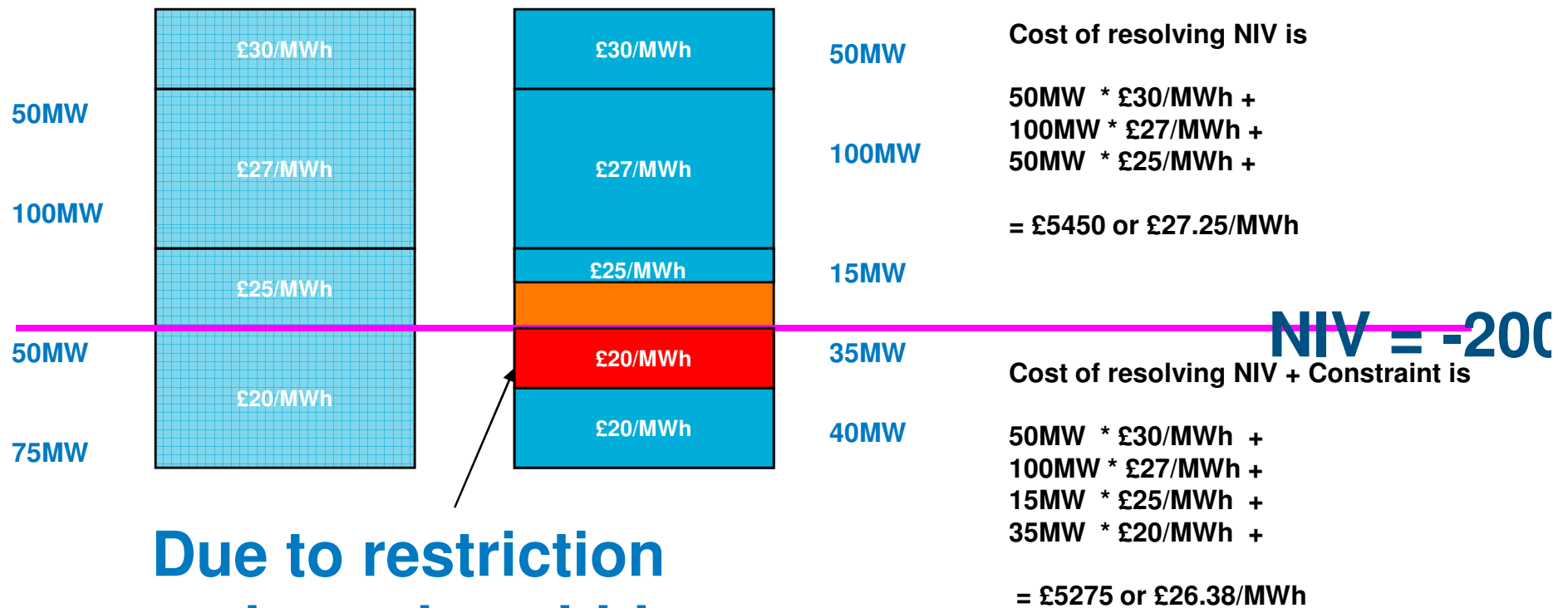

Due to restriction on boundary, bids

are accepted out of cost order.

Other costs of constraints

- There are also other costs that may be reflected within the *energy* model that would reflect other costs that can be impacted by constraints such as;
 - Constrained margin – available headroom that could have been used to meet operating margin requirements but is sterilised by the constraint
 - Downward regulating margin (foot room) – for example a unit may need to stay synchronised for a voltage constraint but the additional MWs exacerbate the problem

2011/13 Scheme Constraint Model

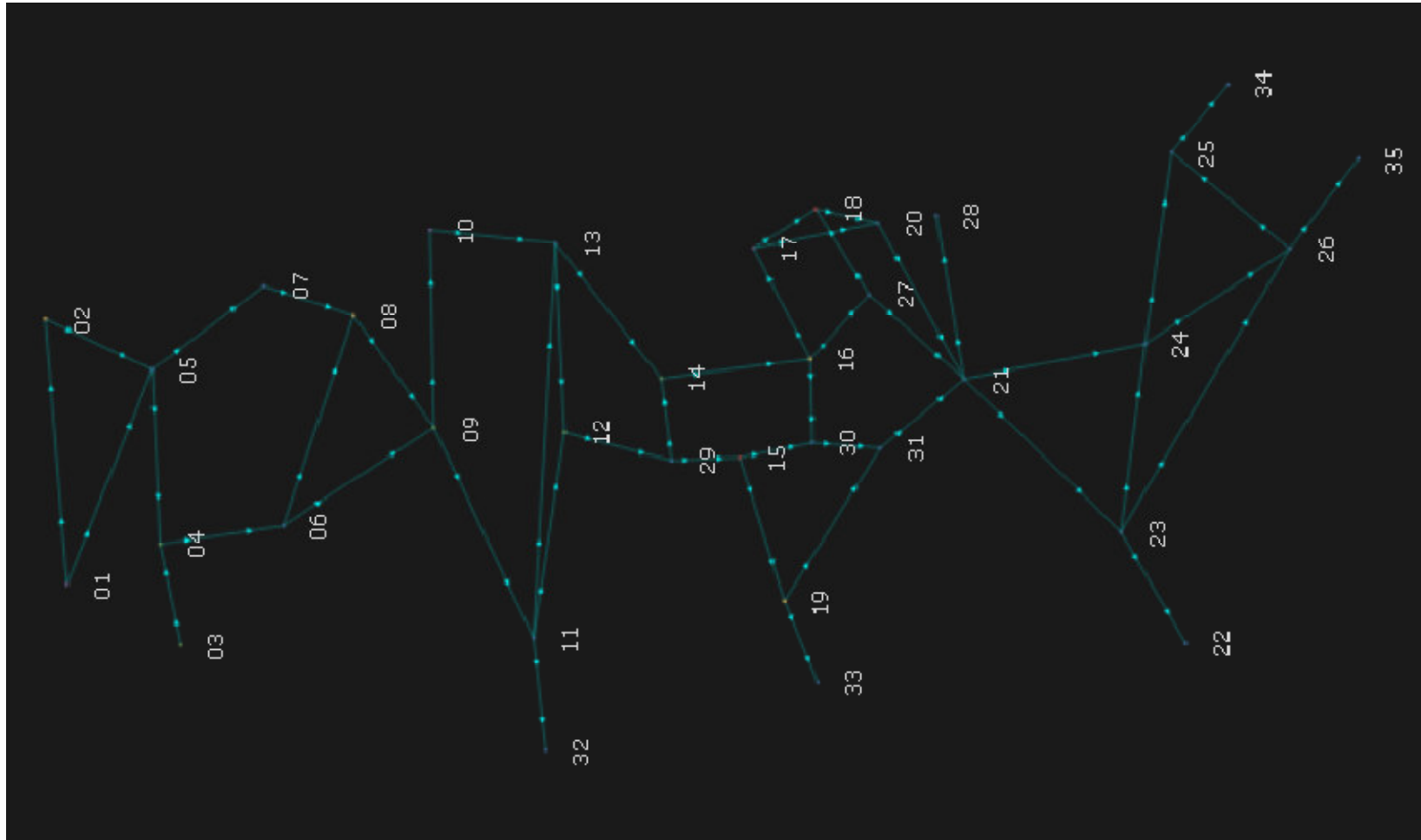

Enhanced Constraint Model

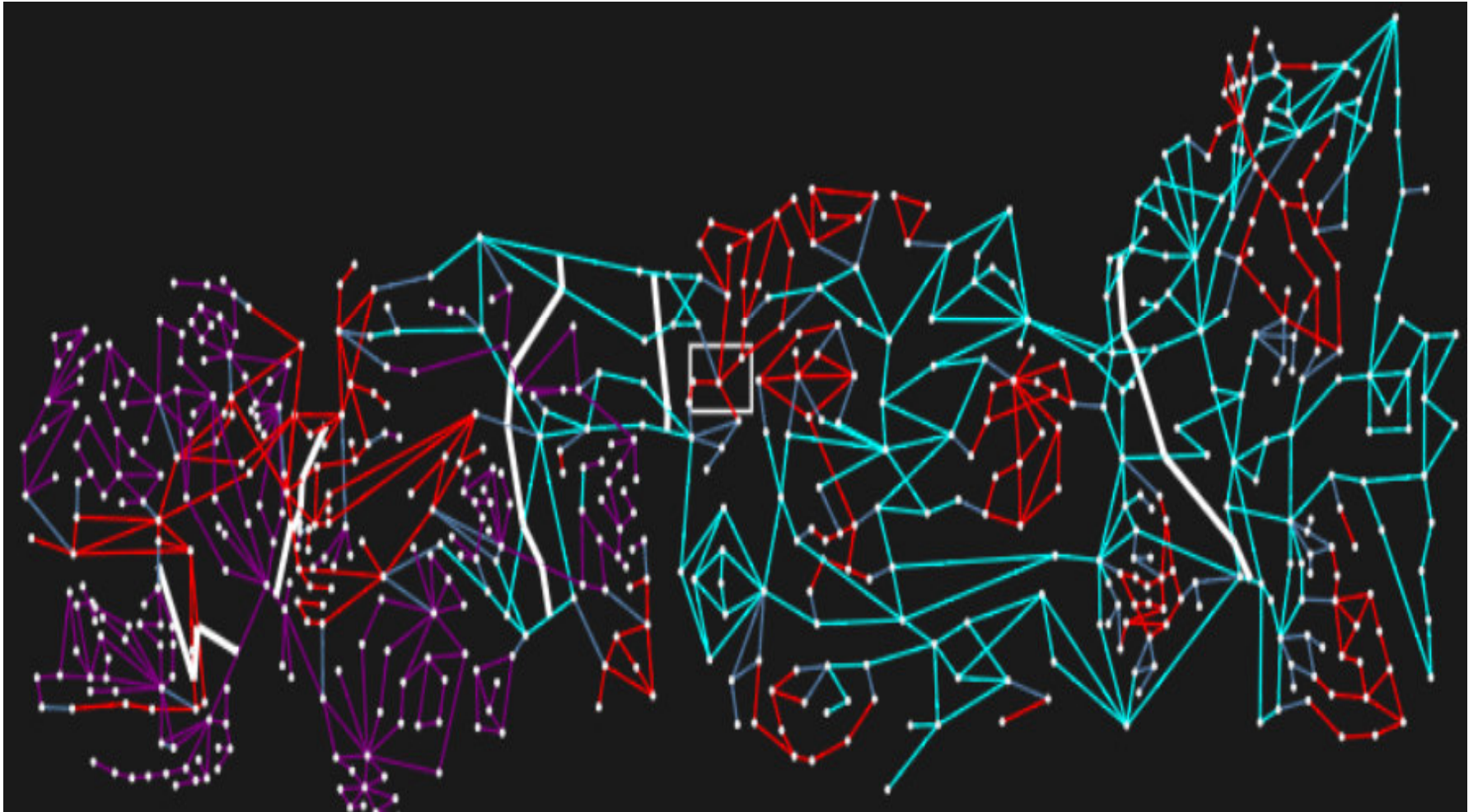

Enhanced Constraint Model Close up

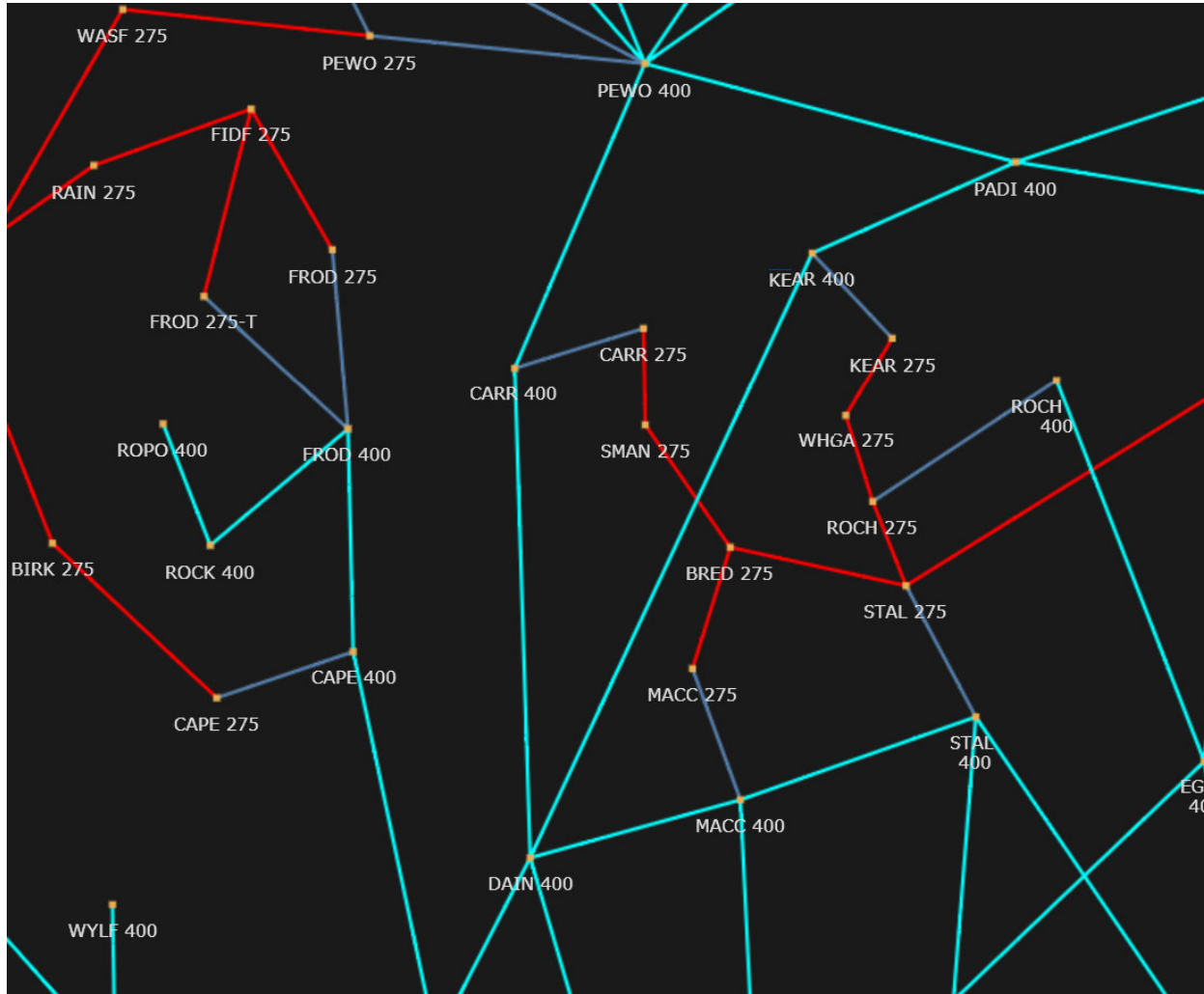

Modelled Wind – 2011/13 model

- The 2011/13 model assumed generic load factor across GB
- Due to connection points of wind, increasingly localised constraints occur. Difficult to capture with SYS boundary definitions
- Therefore, even if wind is put into model ex-post, cost allocation is not necessarily accurate
- Forecast wind profiles reflect “typical year”

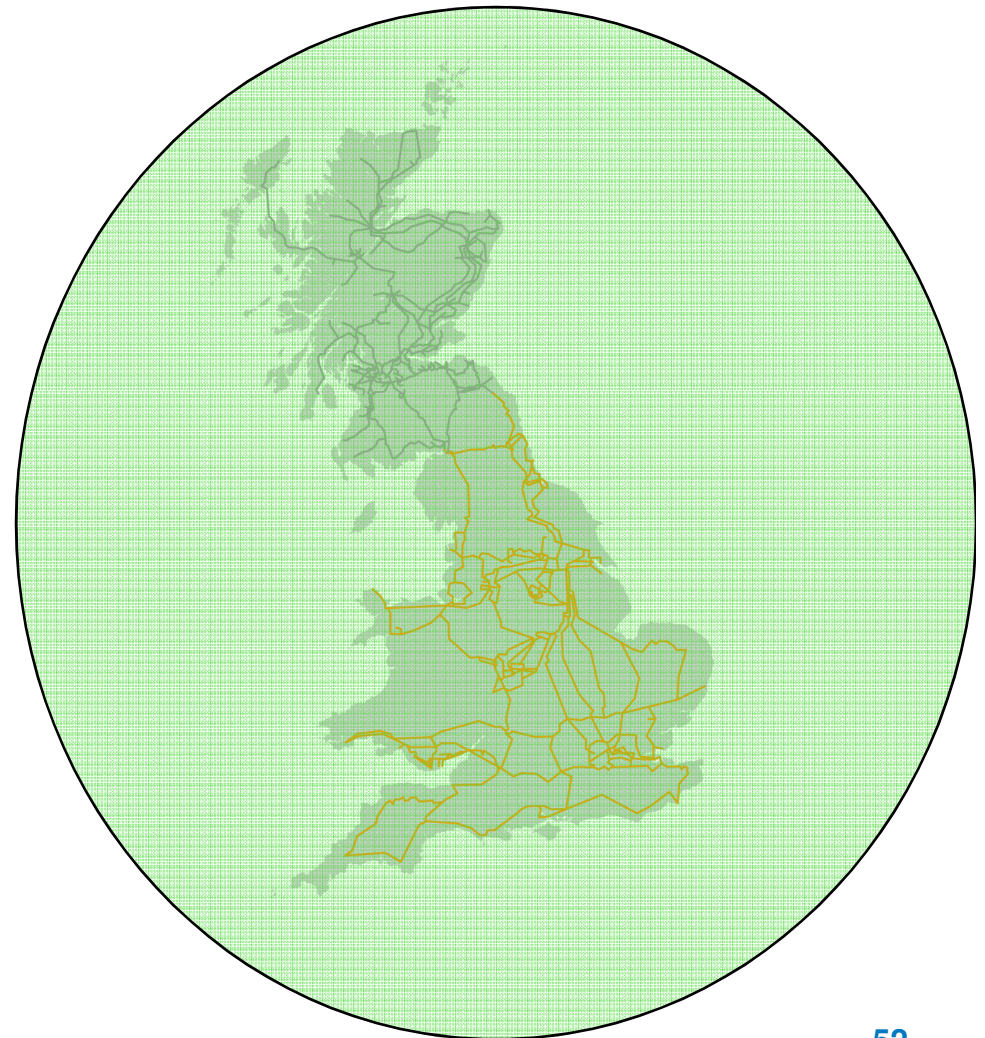

Enhanced Wind Model

- With the more discrete enhanced model, wind output can be modelled against actual transmission or GSP connection point
- Embedded wind modelled explicitly. Where no metered output exists, modelled with reference to most geographically proximate meteorological station
- Localised boundaries can now be modelled. High sensitivity

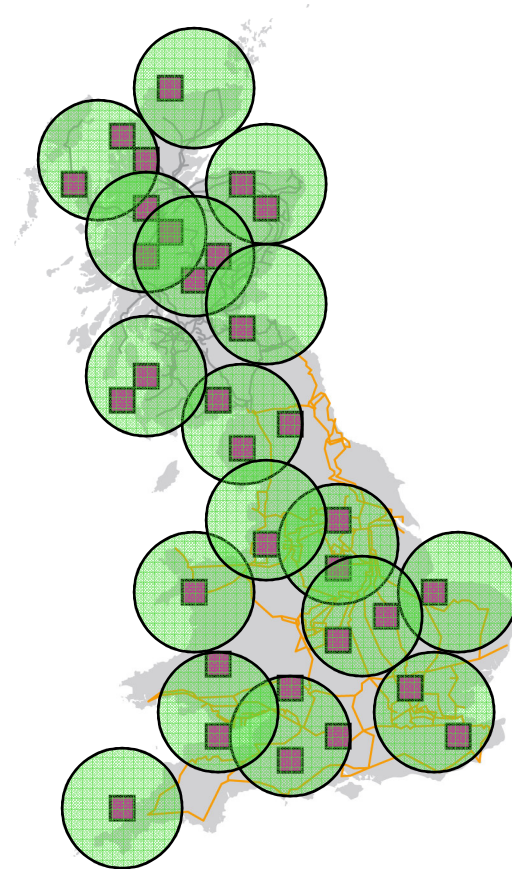

Enhanced Model Testing

- The model provides a cost of constraints if all actions taken in the Balancing Mechanism
- We want to know, given perfect information, does the model predict accurate costs
- Therefore we have performed a back-cast, using FPN data and actual submitted bid and offer prices*
- The boundary limits for the model were taken from Electricity National Control Room, system operating plans (SOP)

* The model aggregates prices submissions into energy, sync and de-synchronisation

Enhanced Model Testing

- Boundary limits captured in system operating plans are those that the control engineers predict will be active, 4-6 hours ahead and generally reflect a non inter-trip limit*
- In real time they may further optimise the system or something has changed which will potentially impact on the boundary limit.
- The constraint model has “perfect” information and cannot reflect the operational risk mitigation strategies that ENCC may employ – therefore it will always identify the ideal cost.

*Generally, arming an inter-trip will increase the boundary capability – however these have to be assessed on an economic basis

Out-turn costs for BM constraint resolution

Outturn Constraint Cost	Constraint Model without NIV	Constraint model with NIV- NIV Only	Constraint model without NIV	Constraint model with NIV- NIV Only
Total	Total	Total	Difference from Outturn	Difference from Outturn
£74.8M	£117.1M	£101.6M	£42.3M	£26.8M

Results of back-cast test - Costs

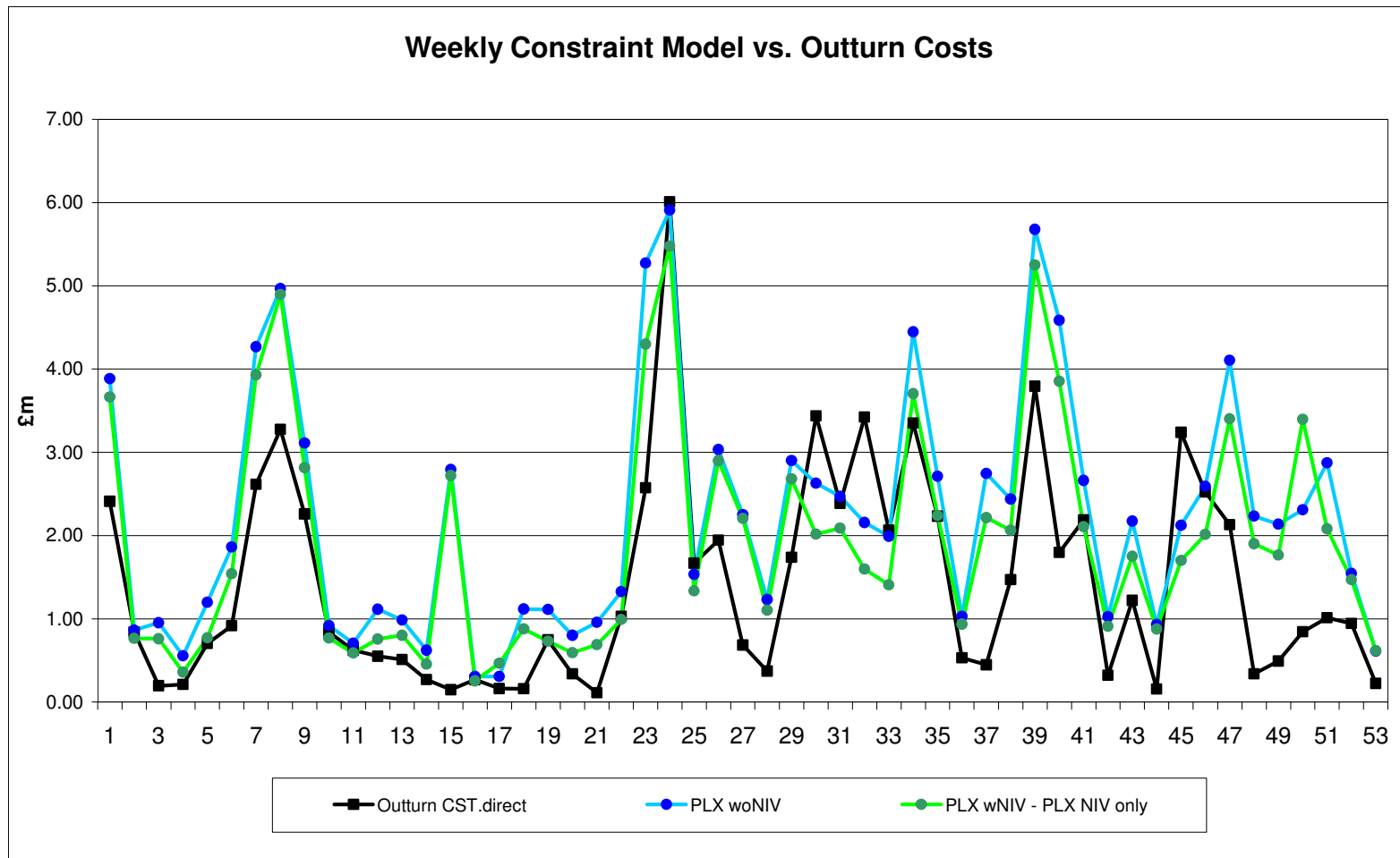

Results of back-cast test - Volumes

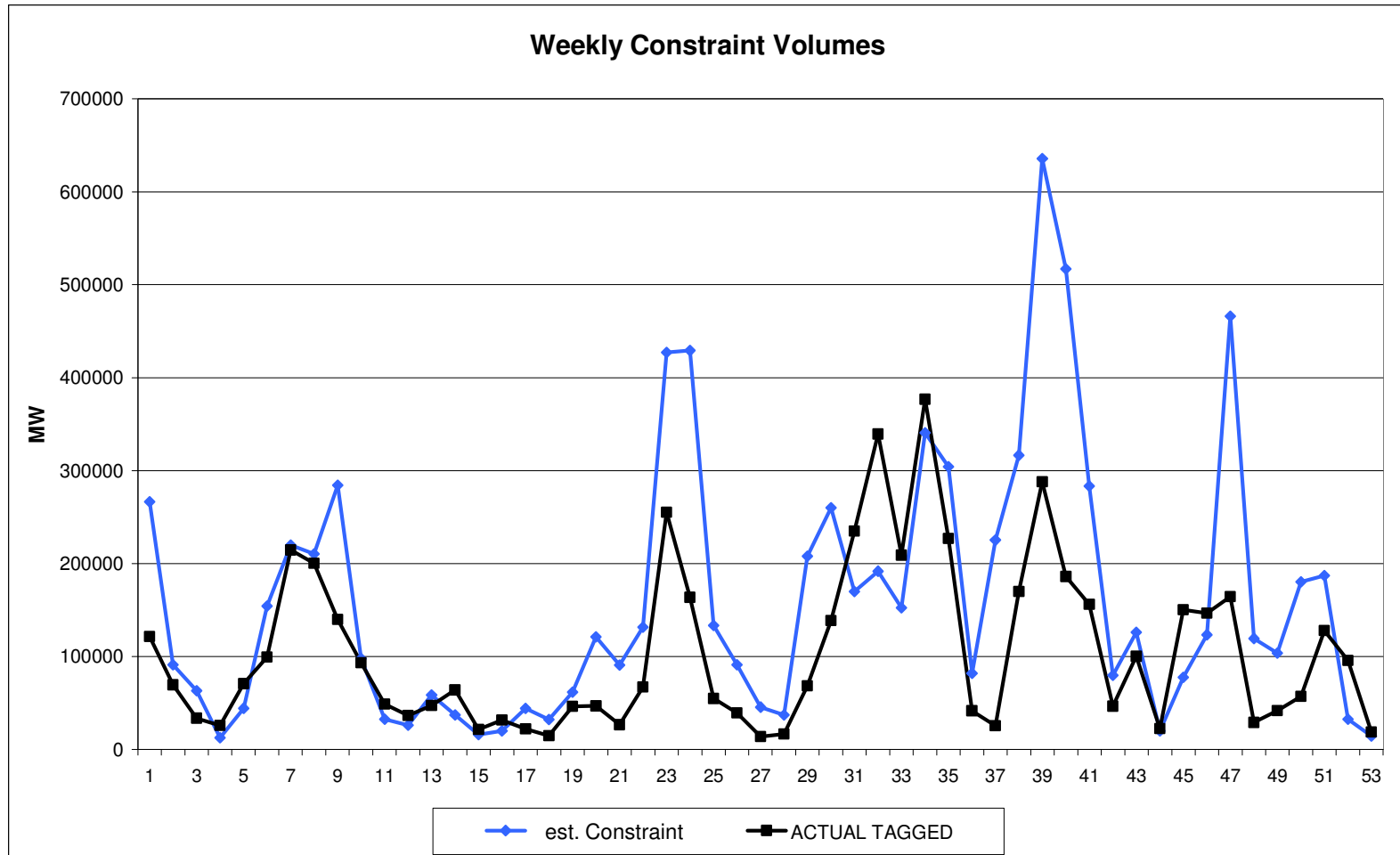

Results of back-cast test – Cost Errors

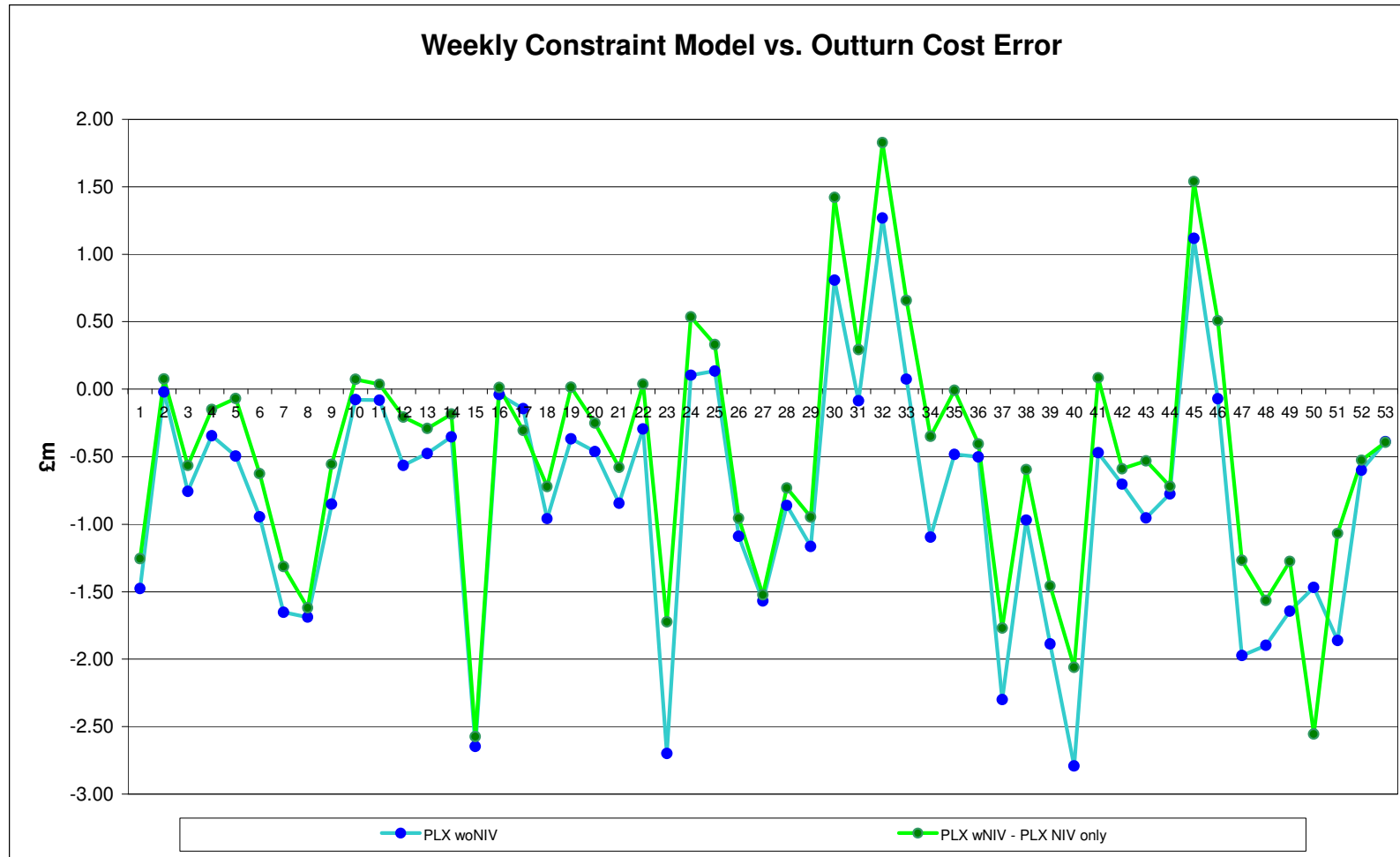

Methodology - Decisions to be made-1

- Currently, the constraint model will look to assign a cost to every action.
- Not every action available to ENCC can be modelled within the constraint model e.g. non- BM wind
 - If no cost attributed in model then constraint cost would potentially be underestimated
 - Could assign a cost of £99,999/MWh, which will overestimate cost.
 - The model can do either.
- The constraint model can be allowed to breach a constraint and accrue an associated cost.
 - This cost can be added to the BM cost or ignored.
 - It is set to £1M/MWh of constraint violation.

Methodology - Decisions to be made-2

- The improved ability to capture all constraints means that we can include very small localised constraints.
 - Tend to be prevalent on extremities of NETS
 - Very sensitive to small changes in underlying fundamentals, such as generation or demand changes
 - Testing would suggest these can incur significant modelled cost
- Recommend that at 6-week ahead stage, a number of possible boundary limits are identified and locked down
- Selection of most appropriate boundary selected ex-post, based on underlying out-turns

Next Steps

- Further testing and refinement of constraints model
- Parallel run in accordance with proposed 6 week ahead boundary setting process

Constraint Model GUI

PLEXOS 6.205 R08 x64 Edition

2011-2012C - Constrained from File

System

- Production
 - Generators
 - Coal
 - Coal LCPD Opt out
 - GT
 - Oil
 - Uranium
 - Hydro
 - Pump Storage
 - Onshore Wind
 - Offshore Wind
 - Embedded Wind
 - CHP
 - Biomass
 - Interconnector
 - Storages
 - Transmission
 - Nodes
 - Lines
 - Interfaces
 - Constraints
 - Constraints

Parent Name	Collection	Child Name	Category	Property	Band	Datetime	Value	Units
System	Generators	Aberthaw 7	Coal	Net Generation	1	05/09/2011	3.63	GWh
System	Generators	Aberthaw 7	Coal	Net Generation	1	06/09/2011	0.00	GWh
System	Generators	Aberthaw 7	Coal	Net Generation	1	07/09/2011	0.00	GWh
System	Generators	Aberthaw 7	Coal	Net Generation	1	08/09/2011	0.00	GWh
System	Generators	Aberthaw 7	Coal	Net Generation	1	09/09/2011	0.00	GWh
System	Generators	Aberthaw 7	Coal	Net Generation	1	10/09/2011	0.00	GWh
System	Generators	Aberthaw 7	Coal	Net Generation	1	11/09/2011	0.00	GWh
System	Generators	Aberthaw 7	Coal	Net Generation	1	12/09/2011	8.18	GWh
System	Generators	Aberthaw 7	Coal	Net Generation	1	13/09/2011	11.25	GWh
System	Generators	Aberthaw 7	Coal	Net Generation	1	14/09/2011	11.40	GWh
System	Generators	Aberthaw 7	Coal	Net Generation	1	15/09/2011	11.14	GWh
System	Generators	Aberthaw 7	Coal	Net Generation	1	16/09/2011	10.44	GWh
System	Generators	Aberthaw 7	Coal	Net Generation	1	17/09/2011	0.00	GWh
System	Generators	Aberthaw 7	Coal	Net Generation	1	18/09/2011	0.00	GWh
System	Generators	Aberthaw 7	Coal	Net Generation	1	19/09/2011	8.81	GWh
System	Generators	Aberthaw 7	Coal	Net Generation	1	20/09/2011	11.50	GWh
System	Generators	Aberthaw 7	Coal	Net Generation	1	21/09/2011	9.93	GWh
System	Generators	Aberthaw 7	Coal	Net Generation	1	22/09/2011	9.10	GWh
System	Generators	Aberthaw 7	Coal	Net Generation	1	23/09/2011	11.60	GWh
System	Generators	Aberthaw 7	Coal	Net Generation	1	24/09/2011	0.05	GWh
System	Generators	Aberthaw 7	Coal	Net Generation	1	25/09/2011	0.00	GWh
System	Generators	Aberthaw 7	Coal	Net Generation	1	26/09/2011	9.12	GWh
System	Generators	Aberthaw 7	Coal	Net Generation	1	27/09/2011	11.39	GWh
System	Generators	Aberthaw 7	Coal	Net Generation	1	28/09/2011	11.35	GWh

Count: 1 Sum: 3.6335 Average: 3.6335 Minimum: 3.6335 Maximum: 3.6335

14:08 19/02/2013

Unconstrained Calibration

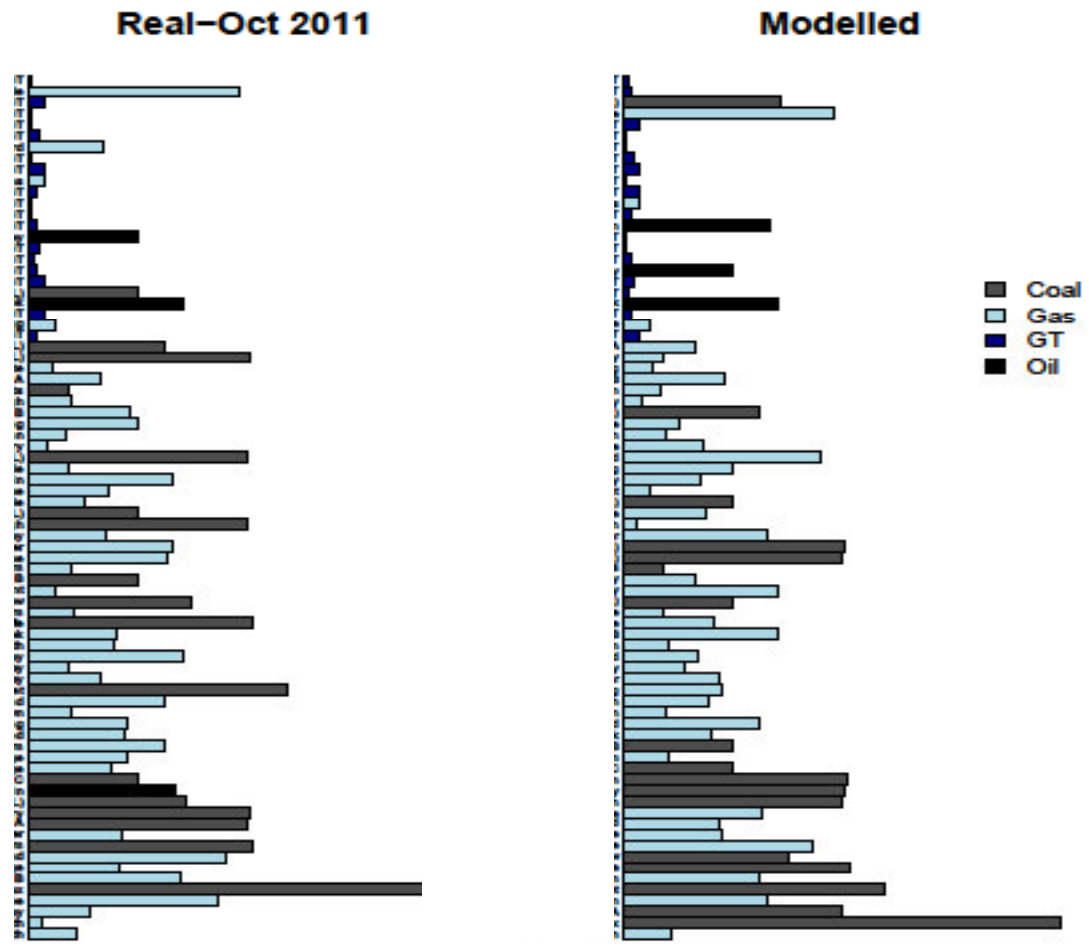

Unconstrained Calibration – Coal BMU -1

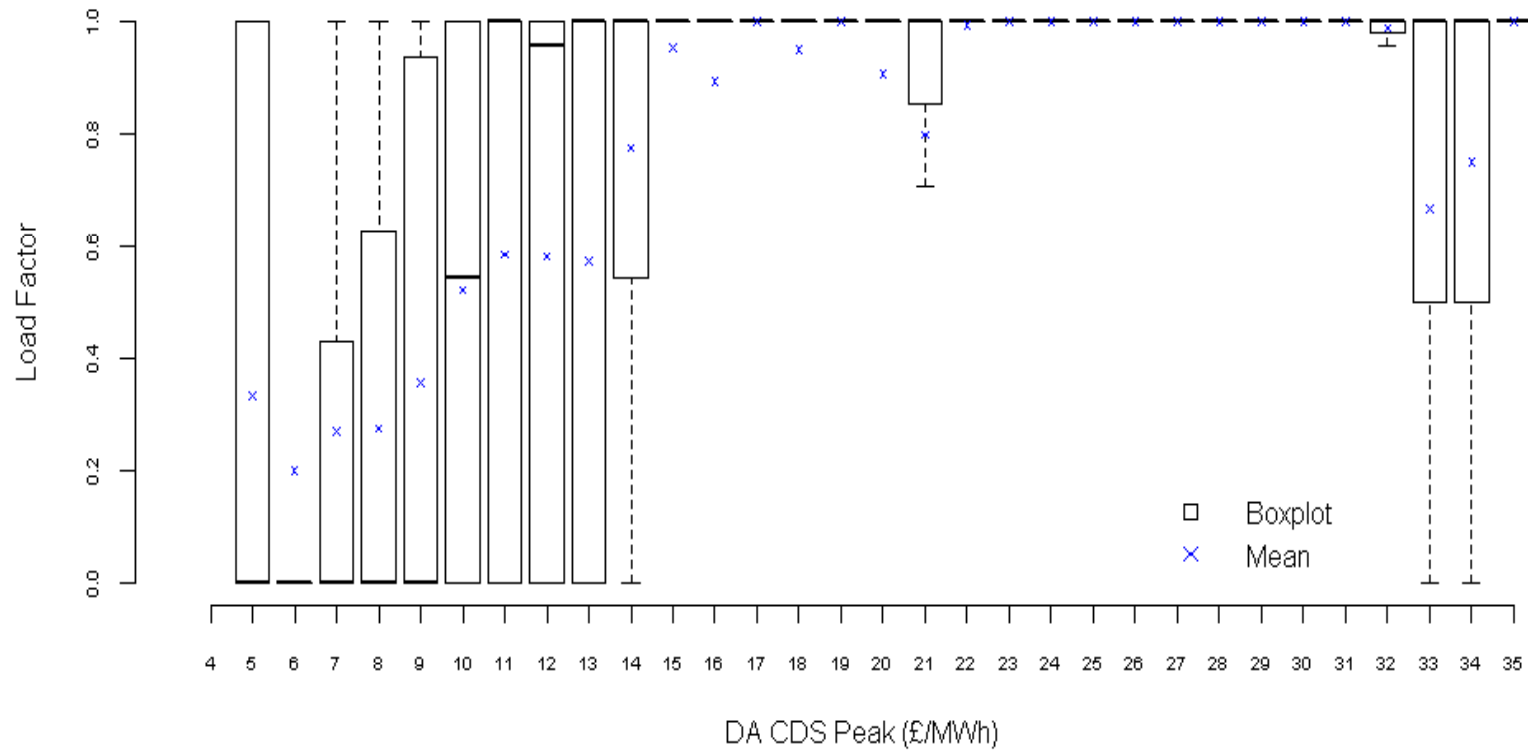

Unconstrained Calibration – Coal BMU -2

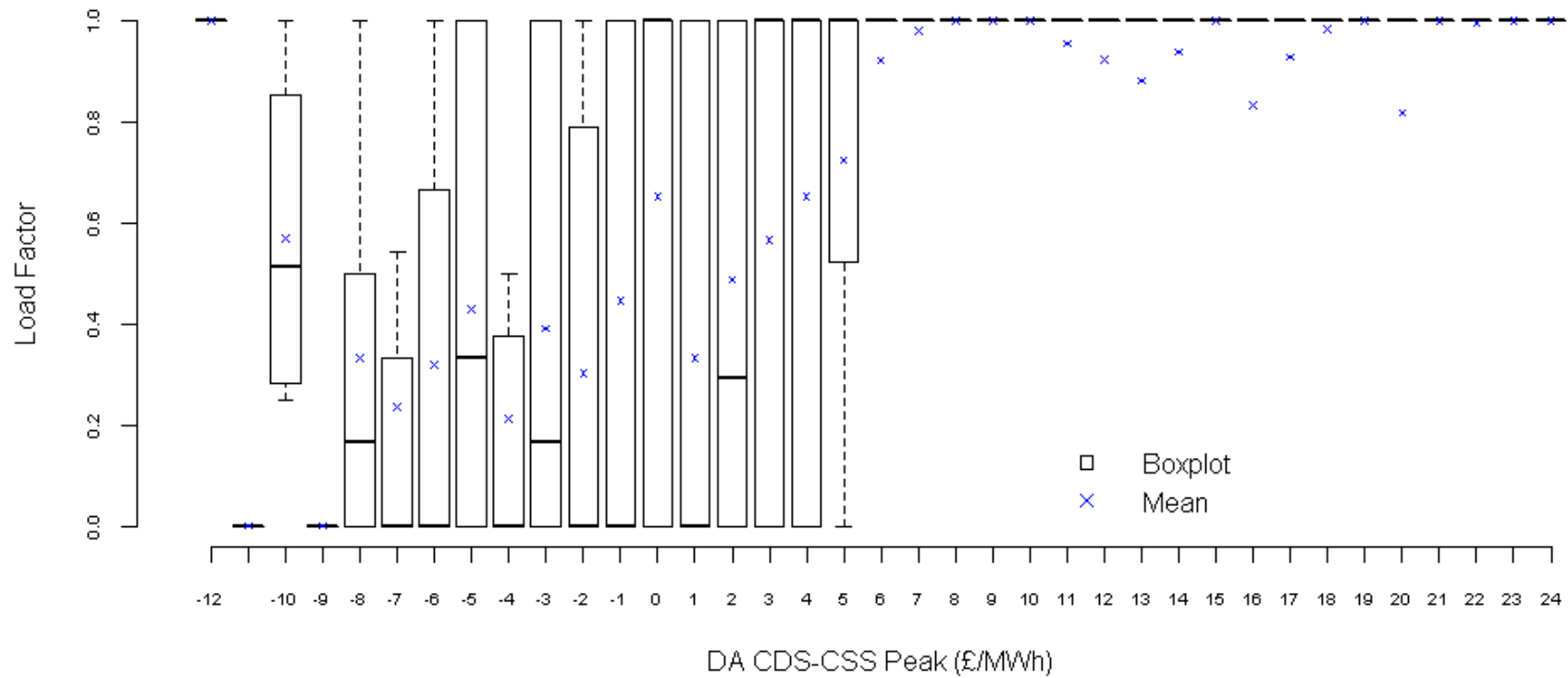

Unconstrained Calibration – Gas BMU -1

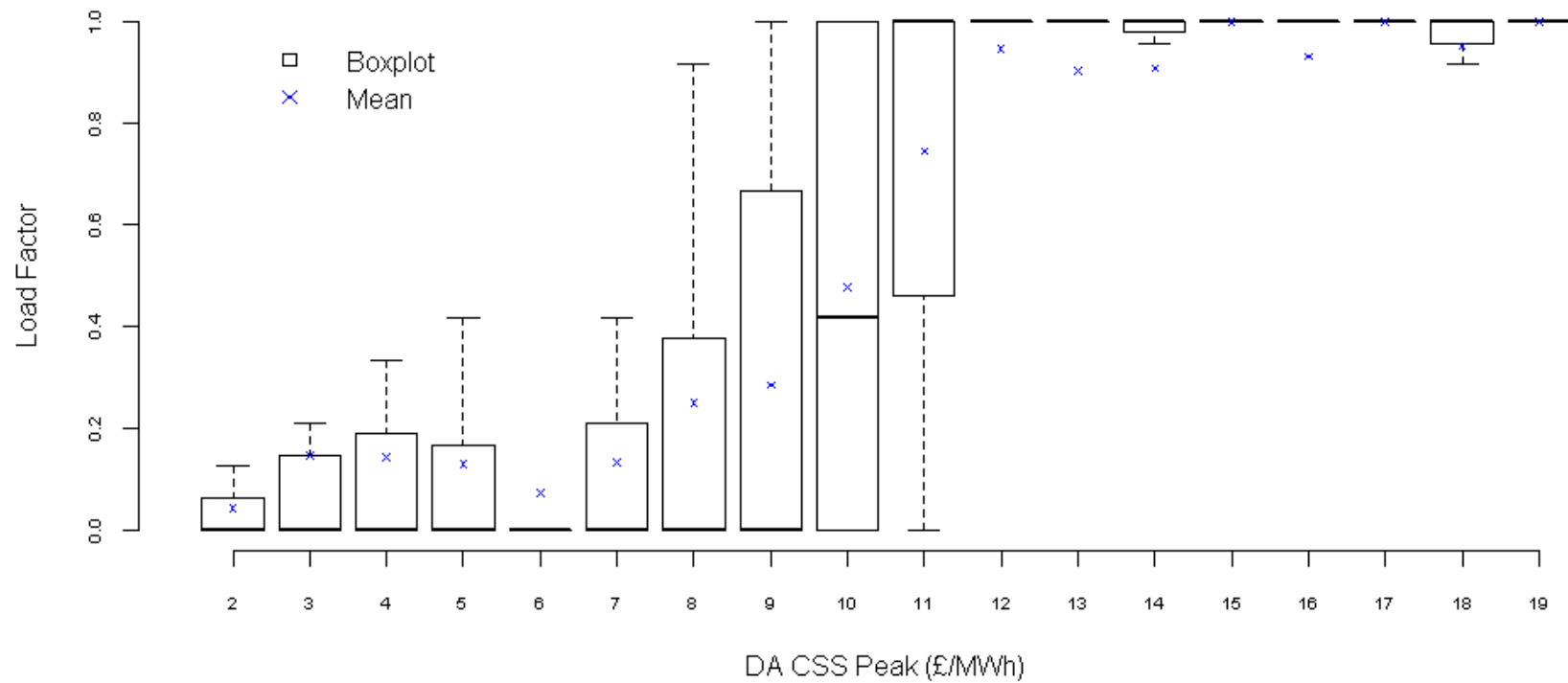

Unconstrained Calibration – Gas BMU -2

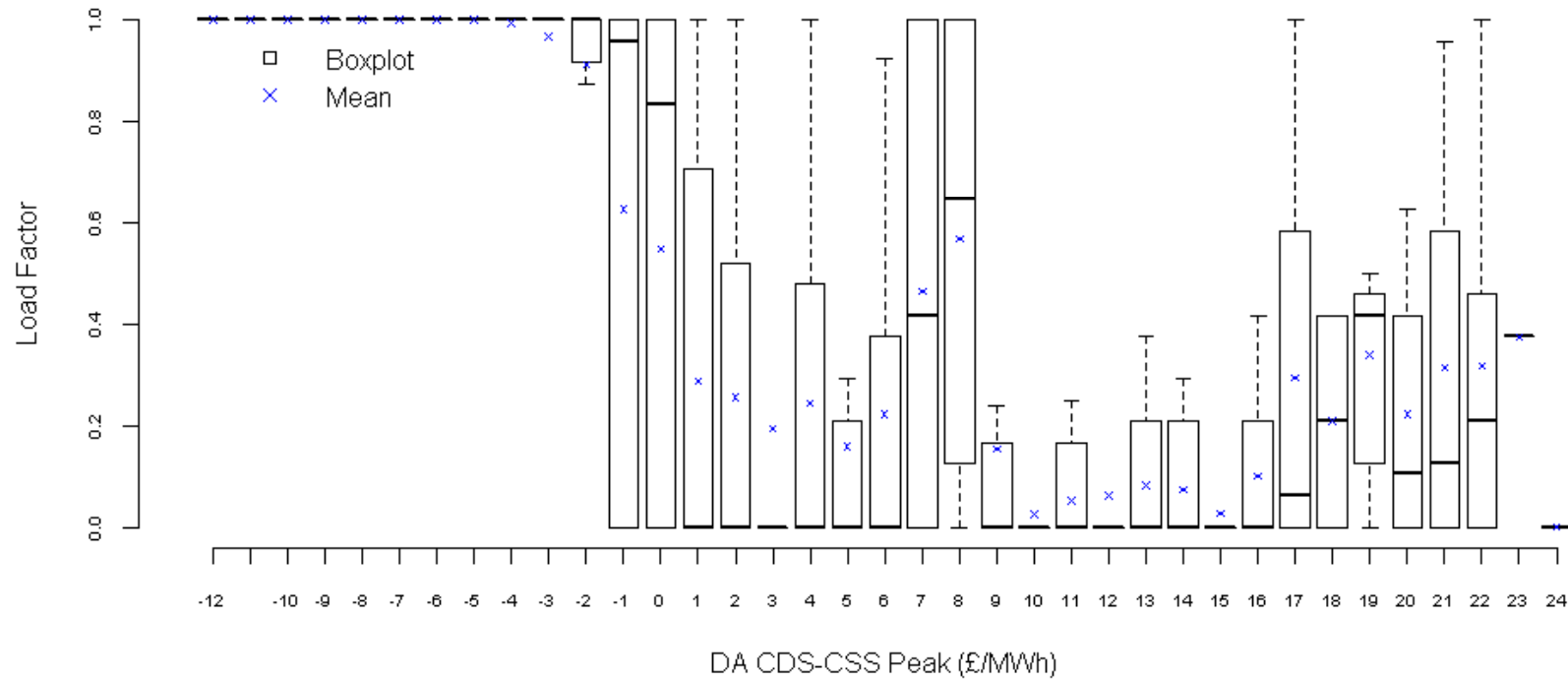

Energy Model



Peter Underhill

Role of the SO

- The System Operator is responsible for:
 - Ensuring energy balance
 - Ensuring frequency containment for large losses
 - Ensuring available reserves for forecast errors
 - Ensuring voltage stability across the system
- This is what the energy model seeks to replicate when determining a target cost for energy components

How do we do that

- We procure and manage
 - Frequency Response
 - Fast Reserve
 - Short Term Operating Reserve
 - Reactive Power procurement
 - Operating Margin

Are all these things separate

- These components often interact, i.e.
 - Reducing the output of a synchronised unit to manage energy imbalance will create 'headroom' on that unit that will provide reserve
 - Procurement of more STOR at longer timescales will offset procurement of Reserve in the short term.

When do we procure these services

- Under C16 licence condition and Balancing Services Incentive Scheme we choose the most economic solution balanced with the risk of procurement, hence we procure
 - Through tender rounds for services up to 2 years ahead of time
 - Taking actions in the Balancing Mechanism in real-time

So what are we modeling

- We are using:
 - Statistical analysis of past costs and volumes
 - Forecast of data we can forecast or control
 - Relevant information we currently have
- We have to create a model that captures the different procurement timescales and risks
- We have to create a model that allows for the links between components to be modeled

Current Energy Model

- The existing energy model as used in the BSIS scheme 2011-13 uses a combination of linear models on historic data and ex-ante relationships to calculate a cost target for all energy components.
- The models break the components down into costs, volume and price at a monthly resolution or in some cases a half-hourly resolution.
- The total energy model cost target is the sum of costs for the individual modelled components.

Historic data vs fundamentals

- The energy model is based around linear modelling of historic data.
- A fundamental model (such as the constraint model in Plexos) defines every relationship from first principles rather than using historic data to define the relationships.
- The accuracy of basic historic models can be improved by increasing the detail. Getting the balance of detail vs accuracy is important.
- The energy model could be considered a fundamental model using historic data as a proxy for more detailed fundamental relationships that are unknown/too complex to explicitly model.

How can we Improve the performance of the energy models

- Ensuring we have the right number of inputs that describe the variation in the history as well as variation expected in the future
- Only good quality ex-ante forecasts should be used as inputs to a forecast, otherwise the error is compounded
- Ex-ante forecasts should only be used if ex-post is not suitable (as long as this still provides appropriate incentive)
- Model methodology is also important in the accuracy of a model (how often the models can be re-trained, the length of forecast required)

Energy Model – The Components

- The energy Model comprises the following categories
 - Energy Imbalance
 - Reserve
 - Short Term Operating Reserve, Constrained Margin Management, BM start up
 - Frequency Response
 - Fast Reserve
 - Footroom
 - Reactive power
 - Minor components

The energy models for BSIS 2011-13

- The following slides show a visual representation of the energy models used in the BSIS 2011-13 scheme.
- The full methodology and explanation of variables can be found at <http://www.nationalgrid.com/uk/Electricity/soincentives/docs/>

BSIS Methodology 2011-13: Modelling Energy Costs

Published 19th July 2011

Energy Model – An example – Energy Imbalance

- If the system is long or short we have to take a series of actions to bring the system to balance
- To understand the cost of this, we need to understand the required volume to balance and the prices of the actions required to procure that volume
- The volume is known as the Net Imbalance Volume (NIV)
- The cost is the cheapest actions in the price stack required to procure NIV
- Can NIV for every Settlement period be forecast?
- Can the price stack for every settlement period be forecast?

Energy Imbalance

- Cost per half hour of resolving market imbalance
- Energy Imbalance cost is by definition the cheapest way of resolving NIV in the BM
- The EI cost is always the cheapest bids or offers to resolve NIV, even if they were not the BOAs taken. The other BM costs are compared against this cost.
- EI cost is therefore modelled as Net Imbalance Volume * BM pseudo price (VWA price of cheapest BOAs)

Energy Imbalance model

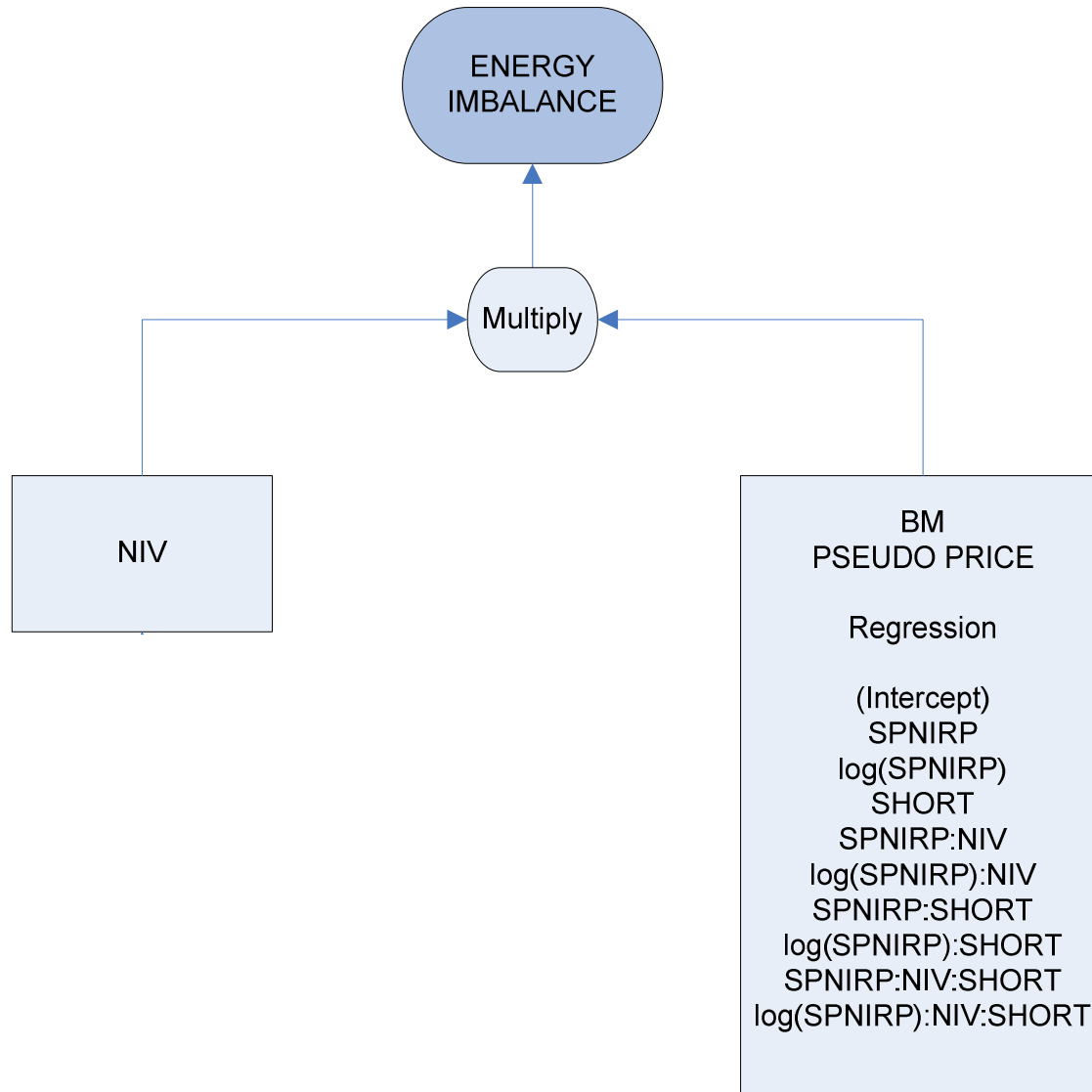

Frequency Response

- Is required to keep demand and generation perfectly balanced, thus keeping frequency stable.
- Units selected to response mode alter output to react to frequency.
- The amount of response required is related to the inertia of the system and the size of largest loss
- To position a generator to provide response may require BOAs these go into BM response costs.
- Holding fees, response energy and contract fees go in AS response costs.

Frequency Response Model

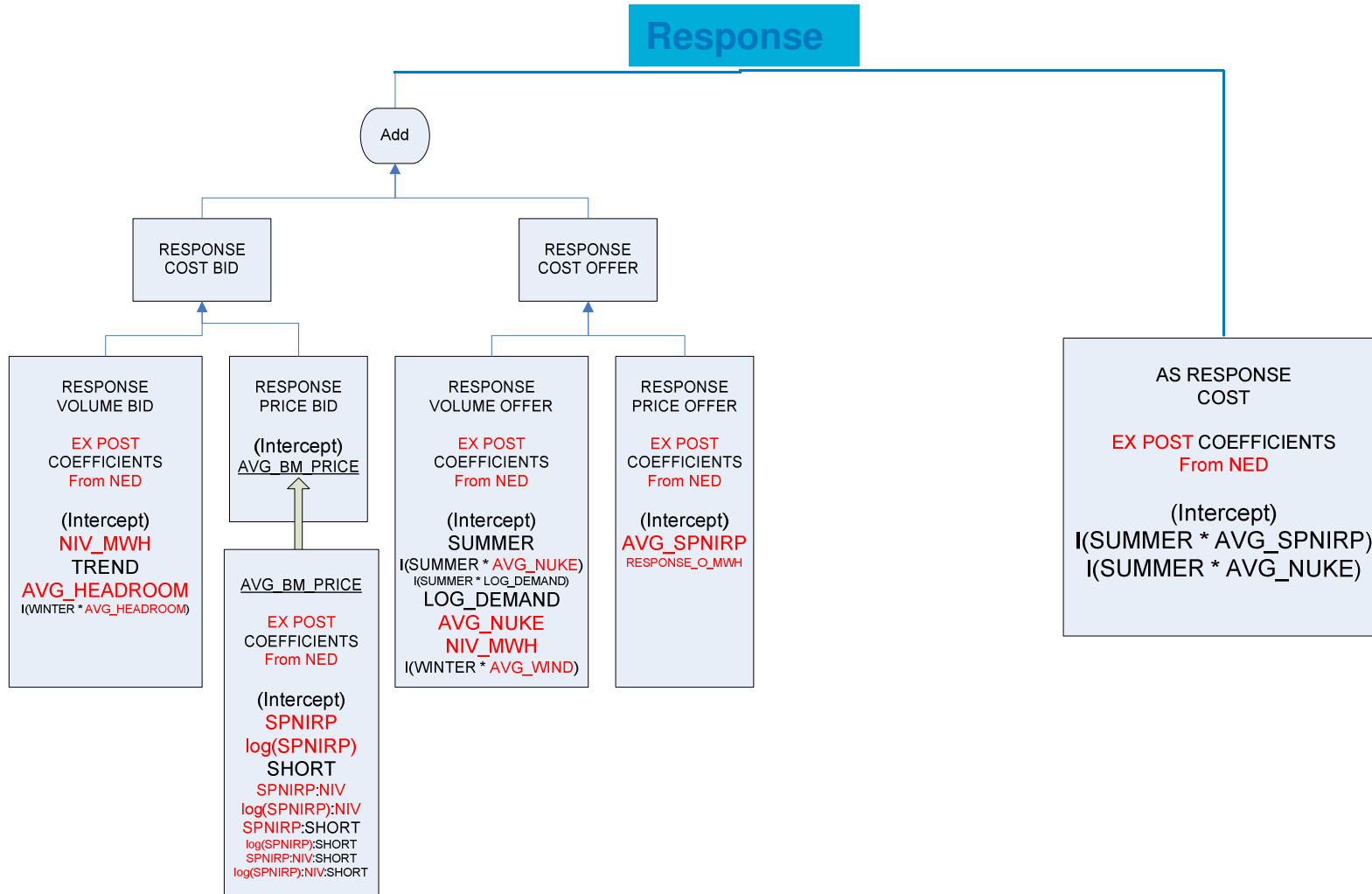

Reserve

- Ability to increase output of units on the system
- Three main requirements for reserve
 - Headroom for required response level
 - Operating reserve to cover 1 in 365 market short, breakdown, demand forecast error and wind forecast error.
 - Reserve to cover largest loss.
- Volume requirement is offset by contracted levels of response and STOR
- STOR is primarily used to cover the largest credible loss

Reserve model

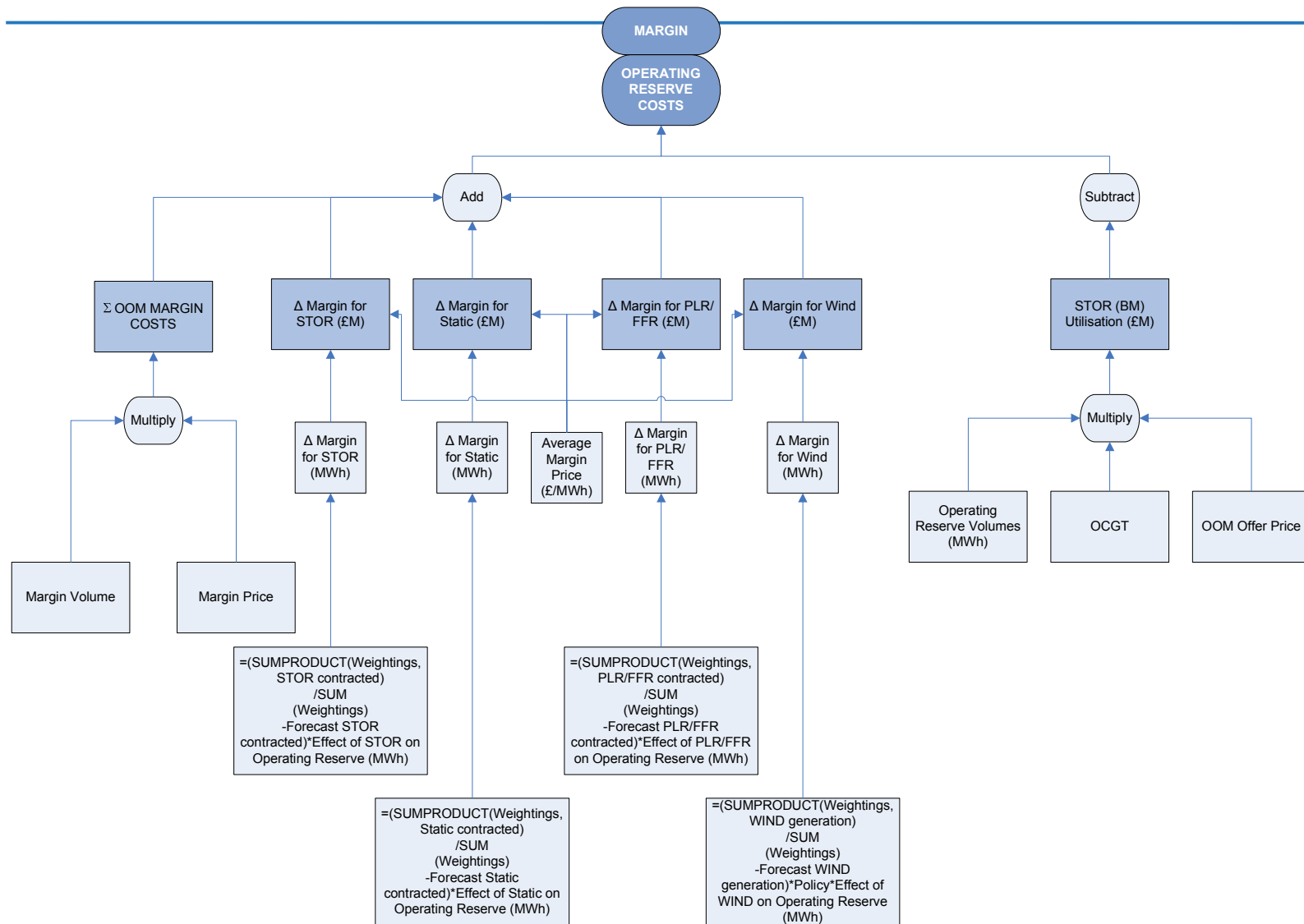

Reserve model 2

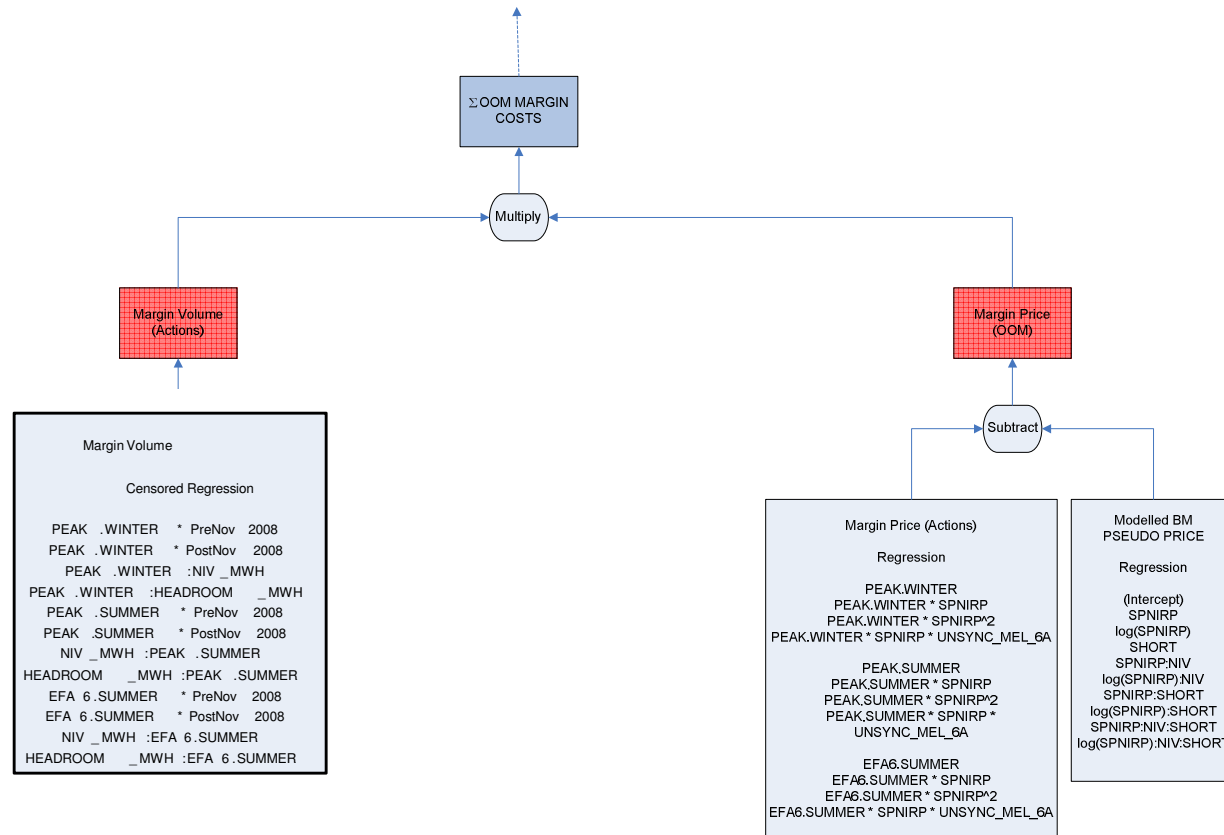

Fast Reserve

- Fits between Response and reserve in the energy timeline.
- Assists in frequency control in expected positions
 - TV pickups
 - Fast demand ramps, such as winter morning
 - Interconnector swings
 - Large scale wind cut-out
- Can be purchased via BM or from contracted units, so model has BM and AS cost pots

Fast Reserve Model

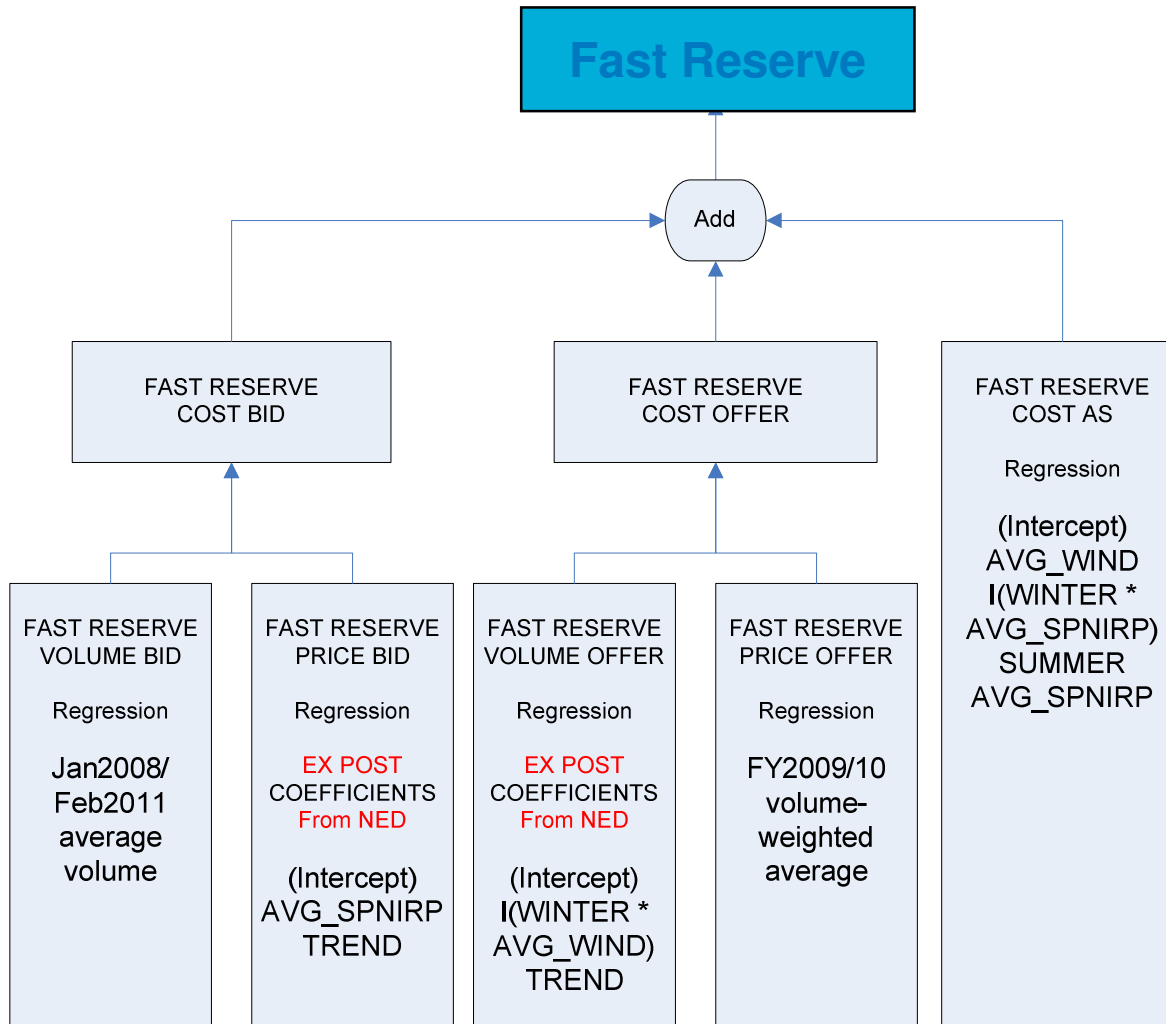

Footroom

- Negative reserve is opposite of headroom/reserve
- Ability to decrease the output of generation on the system.
- The requirement is driven by
 - the need for high frequency response and the largest demand loss.
 - Wind forecast error
- Typically costs only when at low demand with too much baseload plant.
- Becoming more frequent with changing generation mix and localised constraints

Footroom model

