

Our Ref:

Your Ref:

Date: September 2005

Commercial  
Electricity Codes

National Grid Electricity  
Transmission Ltd  
National Grid House  
Warwick Technology Park  
Gallows Hill  
Warwick  
CV34 6DA

To: All Recipients of the Serviced  
Grid Code

Tel No: 01926 656335  
Fax No: 01926 656520

Dear Sir/Madam

### THE SERVICED GRID CODE – ISSUE 3 REVISION 12

Revision 12 of Issue 3 of the Grid Code has been approved by the Authority for implementation on **30 September 2005**.

This Revision involves changes to nearly all sections of the Grid Code. Therefore this update consists of a complete new Grid Code.

The enclosed note provides a brief summary of the changes made to the text.

Please note that your Grid Code Servicing arrangements will cease on 31<sup>st</sup> December 2005 and will not be renewed. If you require e-mail notification of Grid Code updates becoming available on the Industry Information website please forward your e-mail address to:

[david.payne@ngtuk.com](mailto:david.payne@ngtuk.com)

The notification will provide a direct link to the update file in .pdf format which you will be able to download to the folder of your choice.

Yours faithfully



D Payne  
Electricity Codes



Registered Office:  
1-3 Strand  
London  
WC2N 5EH

Registered in  
England and Wales  
No 2366977



## **THE GRID CODE – ISSUE 3 REVISION 12**

### **INCLUSION OF REVISED PAGES**

Title Page

Contents Page

Preface

<u>Glossary and Definitions</u>	<b>G&amp;D</b>	-	<b>All Pages</b>
---------------------------------	----------------	---	------------------

<u>Planning Code</u>	<b>PC</b>	-	<b>All Pages</b>
----------------------	-----------	---	------------------

<u>Connection Conditions</u>	<b>CC</b>	-	<b>All Pages</b>
------------------------------	-----------	---	------------------

<u>Operating Codes</u>	<b>All Codes</b>	-	<b>All Pages</b>
------------------------	------------------	---	------------------

<u>Balancing Codes</u>	<b>All Codes</b>	-	<b>All pages</b>
------------------------	------------------	---	------------------

<u>Data Registration Code</u>	<b>DRC</b>	-	<b>All Pages</b>
-------------------------------	------------	---	------------------

<u>General Conditions</u>	<b>GC</b>	-	<b>All Pages</b>
---------------------------	-----------	---	------------------

<u>Revisions</u>			<b>All pages</b>
------------------	--	--	------------------

**NOTE:** See Page 1 of the Revisions section of the Grid Code for details of how the revisions are indicated on the pages.

**NATIONAL GRID COMPANY plc**  
**THE GRID CODE – ISSUE 3 REVISION 12**

**SUMMARY OF CHANGES**

The changes arise from the implementation of modifications proposed in the following Consultation Papers:

- **B/05** (OC1 OC2 'Phase 2 – Short Term' Proposals) in relation to the definition of Output Usable only,
- **C/05** (Re-Declaration of Availability of Frequency Sensitive Mode),
- **F/05** (Proposed changes to the Grid Code to incorporate the new Company Name), and
- **G/05** (Time Extension for the requirements of Grid Code General Conditions GC15)

B/05

1. Changes to the Glossary and Definitions amending the definition of Output Usable.
2. Deletion of OC2.1.7 as this clause is redundant following the change of definition of Output Usable. Corresponding renumbering of OC2.1.8.

C/05

3. Addition of BC2.6.1(h)
4. Addition of BC2 Appendix 4 and Appendix Annexure 1.

F/05

5. All references to NGC changed to NGET. This affects most sections of the Grid Code.
6. Additional Changes to the Glossary and Definitions to delete the definition of NGC and include a definition of NGET.

G/05

7. Cut-off date in GC.15.1 increased to 2007. Correction of a typographical error.

# **THE GRID CODE**

**Issue 3**

**Revision 12**  
**30<sup>th</sup> September 2005**

Copyright © NATIONAL GRID ELECTRICITY TRANSMISSION Ltd

No part of this publication may be reproduced, stored in a retrieval system or transmitted in any form or by any means electronic, mechanical, photocopying, recording or otherwise, without written permission.

**THIS DOCUMENT IS ISSUED BY:-**

**NATIONAL GRID ELECTRICITY TRANSMISSION Ltd  
COMMERCIAL, ELECTRICITY CODES  
NATIONAL GRID HOUSE  
WARWICK TECHNOLOGY PARK  
GALLOWS HILL  
WARWICK  
CV34 6DA**

**REGISTERED OFFICE: 1-3 Strand  
London  
WC2N 5EH**

# THE GRID CODE

## CONTENTS

<b>(PREFACE</b>	which does not form	<b>(PF))</b>
(	part of the Grid Code	)
<b>GLOSSARY AND DEFINITIONS</b>		<b>(GD)</b>
<b>PLANNING CODE</b>		<b>(PC)</b>
<b>CONNECTION CONDITIONS</b>		<b>(CC)</b>
<b>OPERATING CODES</b>		<b>(OC)</b>
OC1	Demand Forecasts	
OC2	Operational Planning and Data Provision	
OC3	Deleted	
OC4	Deleted	
OC5	Testing and Monitoring	
OC6	Demand Control	
OC7	Operational Liaison	
OC8	Safety Co-ordination	
OC9	Contingency Planning	
OC10	Event Information Supply	
OC11	Numbering and Nomenclature of HV Apparatus at Certain Sites	
OC12	System Tests	
<b>BALANCING CODES</b>		<b>(BC)</b>
BC1	Pre Gate Closure Process	
BC2	Post Gate Closure Process	
BC3	Frequency Control Process	
<b>DATA REGISTRATION CODE</b>		<b>(DRC)</b>
<b>GENERAL CONDITIONS</b>		<b>(GC)</b>
<b>(REVISIONS</b>	which does not form	<b>( R ))</b>
(	part of the Grid Code	)





## PREFACE

1. The operating procedures and principles governing **NGET's** relationship with all **Users** of the **GB Transmission System**, be they **Generators**, **DC Converter** owners, **Suppliers** or **Non-Embedded Customers** are set out in the **Grid Code**. The **Grid Code** specifies day-to-day procedures for both planning and operational purposes and covers both normal and exceptional circumstances.
2. The **Grid Code** is designed to permit the development, maintenance and operation of an efficient, co-ordinated and economical **GB Transmission System**, to facilitate competition in the generation and supply of electricity and is conceived as a statement of what is optimal (particularly from a technical point of view) for all **Users** and **NGET** itself in relation to the planning, operation and use of the **GB Transmission System**. It seeks to avoid any undue discrimination between **Users** and categories of **Users**.
3. The **Grid Code** is divided into the following sections:-
  - (a) a **Planning Code** which provides generally for the supply of certain information by **Users** in order for **NGET** to undertake the planning and development of the **GB Transmission System**;
  - (b) **Connection Conditions**, which specify the minimum technical, design and operational criteria which must be complied with by **NGET** at **Connection Sites** and by **Users** connected to or seeking connection with the **GB Transmission System** or by **Generators** (other than in respect of **Small Power Stations**) or **DC Converter** owners, connected to or seeking connection to a **User's System**;
  - (c) an **Operating Code**, which is split into a number of sections and deals with **Demand** forecasting (**OC1**); the co-ordination of the outage planning process in respect of **Large Power Stations**, the **GB Transmission System** and **User Systems** for construction, repair and maintenance, and the provision of certain types of **Operating Margin** data (**OC2**); testing and monitoring of **Users** (**OC5**); different forms of reducing **Demand** (**OC6**); the reporting of scheduled and planned actions, and unexpected occurrences such as faults (**OC7**); the co-ordination, establishment and maintenance of **Isolation** and **Earthing** in order that work and/or testing can be carried out safely (**OC8**); certain aspects of contingency planning (**OC9**); the provision of written reports on occurrences such as faults in certain circumstances (**OC10**); the procedures for numbering and nomenclature of **HV Apparatus** at certain sites (**OC11**); and the procedures for the establishment of **System Tests** (**OC12**);
  - (d) a **Balancing Code**, which is split into three sections and deals with the submission of **BM Unit Data** from **BM Participants**, and of certain other information, for the following day and ahead of **Gate Closure** (**BC1**); the post **Gate Closure** process (**BC2**); and the procedures and requirements in relation to **System Frequency** control (**BC3**);

- (e) a **Data Registration Code**, which sets out a unified listing of all data required by **NGET** from **Users**, and by **Users** from **NGET**, under the **Grid Code**;
  - (f) **General Conditions**, which are intended to ensure, so far as possible, that the various sections of the **Grid Code** work together and work in practice and include provisions relating to the establishment of a **Grid Code Review Panel** and other provisions of a general nature.
4. This **Preface** is provided to **Users** and to prospective **Users** for information only and does not constitute part of the **Grid Code**.

## GLOSSARY AND DEFINITIONS (G & D)

1. In the **Grid Code** the following words and expressions shall, unless the subject matter or context otherwise requires or is inconsistent therewith, bear the following meanings:

**Act** The Electricity Act 1989 (as amended by the Utilities Act 2000 and the Energy Act 2004)

**Active Energy** The electrical energy produced, flowing or supplied by an electric circuit during a time interval, being the integral with respect to time of the instantaneous power, measured in units of watt-hours or standard multiples thereof, ie:

1000 Wh = 1 kWh  
1000 kWh = 1 MWh  
1000 MWh = 1 GWh  
1000 GWh = 1 TWh.

**Active Power** The product of voltage and the in-phase component of alternating current measured in units of watts and standard multiples thereof, ie:

1000 Watts = 1 kW  
1000 kW = 1 MW  
1000 MW = 1 GW  
1000 GW = 1 TW.

**Affiliate** In relation to any person, any holding company or subsidiary of such person or any subsidiary of a holding company of such person, in each case within the meaning of Section 736, 736A and 736B of the Companies Act 1985 as substituted by section 144 of the Companies Act 1989 and, if that latter section is not in force at the **Transfer Date**, as if such section were in force at such date.

**Ancillary Service** A **System Ancillary Service** and/or a **Commercial Ancillary Service**, as the case may be.

**Ancillary Services Agreement** An agreement between a **User** and **NGET** for the payment by **NGET** to that **User** in respect of the provision by such **User** of **Ancillary Services**.

**Annual Average Cold Spell Conditions or ACS Conditions** A particular combination of weather elements which gives rise to a level of peak **Demand** within a **Financial Year** which has a 50% chance of being exceeded as a result of weather variation alone.

<b><u>Apparent Power</u></b>	The product of voltage and of alternating current measured in units of voltamperes and standard multiples thereof, ie:  1000 VA = 1 kVA 1000 kVA = 1 MVA.
<b><u>Apparatus</u></b>	Other than in <b>OC8</b> , means all equipment in which electrical conductors are used, supported or of which they may form a part. In <b>OC8</b> it means <b>High Voltage</b> electrical circuits forming part of a <b>System</b> on which <b>Safety Precautions</b> may be applied to allow work and/or testing to be carried out on a <b>System</b> .
<b><u>Authorised Electricity Operator</u></b>	Any person (other than <b>NGET</b> in its capacity as operator of the <b>GB Transmission System</b> ) who is authorised under the <b>Act</b> to generate, participate in the transmission of, distribute or supply electricity.
<b><u>Automatic Voltage Regulator or AVR</u></b>	A continuously acting automatic excitation system to control a <b>Generating Unit</b> terminal voltage.
<b><u>Authority for Access</u></b>	An authority which grants the holder the right to unaccompanied access to sites containing exposed <b>HV</b> conductors.
<b><u>Authority, The</u></b>	The <b>Authority</b> established by section 1 (1) of the Utilities Act 2000
<b><u>Auxiliaries</u></b>	Any item of <b>Plant</b> and/or <b>Apparatus</b> not directly a part of the boiler plant or <b>Generating Unit</b> or <b>DC Converter</b> or <b>Power Park Module</b> , but required for the boiler plant's or <b>Generating Unit's</b> or <b>DC Converter's</b> or <b>Power Park Module's</b> functional operation.
<b><u>Auxiliary Diesel Engine</u></b>	A diesel engine driving a <b>Generating Unit</b> which can supply a <b>Unit Board</b> or <b>Station Board</b> , which can start without an electrical power supply from outside the <b>Power Station</b> within which it is situated.
<b><u>Auxiliary Gas Turbine</u></b>	A <b>Gas Turbine Unit</b> , which can supply a <b>Unit Board</b> or <b>Station Board</b> , which can start without an electrical power supply from outside the <b>Power Station</b> within which it is situated.
<b><u>Average Conditions</u></b>	That combination of weather elements within a period of time which is the average of the observed values of those weather elements during equivalent periods over many years (sometimes referred to as normal weather).
<b><u>Back-Up Protection</u></b>	<b>Protection</b> equipment or system which is intended to operate when a system fault is not cleared in due time because of failure or inability of the <b>Main Protection</b> to operate or in case of failure to operate of a circuit-breaker other than the associated circuit breaker.

<b><u>Balancing and Settlement Code or BSC</u></b>	The code of that title as from time to time amended.
<b><u>Balancing Code or BC</u></b>	That portion of the <b>Grid Code</b> which specifies the <b>Balancing Mechanism</b> process.
<b><u>Balancing Mechanism</u></b>	Has the meaning set out in <b>NGET's Transmission Licence</b>
<b><u>Balancing Mechanism Reporting Agent or BMRA</u></b>	Has the meaning set out in the <b>BSC</b> .
<b><u>Balancing Mechanism Reporting Service or BMRS</u></b>	Has the meaning set out in the <b>BSC</b> .
<b><u>Balancing Principles Statement</u></b>	A statement prepared by <b>NGET</b> in accordance with Condition C16 of <b>NGET's Transmission Licence</b> .
<b><u>Bid-Offer Acceptance</u></b>	<ul style="list-style-type: none"> <li>a) A communication issued by <b>NGET</b> in accordance with <b>BC2.7</b>; or</li> <li>b) an <b>Emergency Instruction</b> to the extent provided for in BC2.9.2.3.</li> </ul>
<b><u>Bid-Offer Data</u></b>	Has the meaning set out in the <b>BSC</b> .
<b><u>Bilateral Agreement</u></b>	Has the meaning set out in the <b>CUSC</b>
<b><u>Black Start</u></b>	The procedure necessary for a recovery from a <b>Total Shutdown</b> or <b>Partial Shutdown</b> .
<b><u>Black Start Capability</u></b>	An ability in respect of a <b>Black Start Station</b> , for at least one of its <b>Gensets</b> to <b>Start-Up</b> from <b>Shutdown</b> and to energise a part of the <b>System</b> and be <b>Synchronised</b> to the <b>System</b> upon instruction from <b>NGET</b> , within two hours, without an external electrical power supply.
<b><u>Black Start Stations</u></b>	<b>Power Stations</b> which are registered, pursuant to the <b>Bilateral Agreement</b> with a <b>User</b> , as having a <b>Black Start Capability</b> .
<b><u>Black Start Test</u></b>	A <b>Black Start Test</b> carried out by a <b>Generator</b> with a <b>Black Start Station</b> , on the instructions of <b>NGET</b> , in order to demonstrate that a <b>Black Start Station</b> has a <b>Black Start Capability</b> .

<b><u>BM Participant</u></b>	A person who is responsible for and controls one or more <b>BM Units</b> or where a <b>Bilateral Agreement</b> specifies that a <b>User</b> is required to be treated as a <b>BM Participant</b> for the purposes of the <b>Grid Code</b> . For the avoidance of doubt, it does not imply that they must be active in the <b>Balancing Mechanism</b> .
<b><u>BM Unit</u></b>	Has the meaning set out in the <b>BSC</b> , except that for the purposes of the <b>Grid Code</b> the reference to “Party” in the <b>BSC</b> shall be a reference to <b>User</b> .
<b><u>BM Unit Data</u></b>	The collection of parameters associated with each <b>BM Unit</b> , as described in Appendix 1 of <b>BC1</b> .
<b><u>Boiler Time Constant</u></b>	Determined at <b>Registered Capacity</b> , the boiler time constant will be construed in accordance with the principles of the IEEE Committee Report "Dynamic Models for Steam and Hydro Turbines in Power System Studies" published in 1973 which apply to such phrase.
<b><u>British Standards or BS</u></b>	Those standards and specifications approved by the British Standards Institution.
<b><u>BSCCo</u></b>	Has the meaning set out in the <b>BSC</b> .
<b><u>BSC Panel</u></b>	Has meaning set out for “Panel” in the <b>BSC</b> .
<b><u>BS Station Test</u></b>	A <b>Black Start Test</b> carried out by a <b>Generator</b> with a <b>Black Start Station</b> while the <b>Black Start Station</b> is disconnected from all external alternating current electrical supplies.
<b><u>BS Unit Test</u></b>	A <b>Black Start Test</b> carried out on a <b>Generating Unit</b> or a <b>CCGT Unit</b> , as the case may be, at a <b>Black Start Station</b> while the <b>Black Start Station</b> remains connected to an external alternating current electrical supply.
<b><u>Business Day</u></b>	Any week day (other than a Saturday) on which banks are open for domestic business in the City of London.
<b><u>Cancellation of GB Transmission System Warning</u></b>	The notification given to <b>Users</b> when a <b>GB Transmission System Warning</b> is cancelled.

### Cascade Hydro Scheme

Two or more hydro-electric **Generating Units**, owned or controlled by the same **Generator**, which are located in the same water catchment area and are at different ordnance datums and which depend upon a common source of water for their operation, known as:

1. Moriston
2. Killin
3. Garry
4. Conon
5. Clunie
6. Beaully

which will comprise more than one **Power Station**.

### Cascade Hydro Scheme Matrix

The matrix described in Appendix 1 to **BC1** under the heading **Cascade Hydro Scheme Matrix**.

### Caution Notice

A notice conveying a warning against interference.

### Category 1 Intertripping Scheme

A **System to Generator Operational Intertripping Scheme** arising from a Variation to Connection Design following a request from the relevant **User** which is consistent with the criteria specified in the **Security and Quality of Supply Standard**.

### Category 2 Intertripping Scheme

A **System to Generator Operational Intertripping Scheme** which is:-  
(i) required to alleviate an overload on a circuit which connects the **Group** containing the **User's Connection Site** to the **GB Transmission System**; and  
(ii) installed in accordance with the requirements of the planning criteria of the **Security and Quality of Supply Standard** in order that measures can be taken to permit maintenance access for each transmission circuit and for such measures to be economically justified,  
and the operation of which results in a reduction in **Active Power** on the overloaded circuits which connect the **User's Connection Site** to the rest of the **GB Transmission System** which is equal to the reduction in **Active Power** from the **Connection Site** (once any system losses or third party system effects are discounted).

### Category 3 Intertripping Scheme

A **System to Generator Operational Intertripping Scheme** which, where agreed by **NGET** and the **User**, is installed to alleviate an overload on, and as an alternative to, the reinforcement of a third party system, such as the **Distribution System** of a **Public Distribution System Operator**.

### Category 4 Intertripping Scheme

A **System to Generator Operational Intertripping Scheme** installed to enable the disconnection of the **Connection Site** from the **GB Transmission System** in a controlled and efficient manner in order to facilitate the timely restoration of the **GB Transmission System**.

## CENELEC

European Committee for Electrotechnical Standardisation.

## CCGT Module Matrix

The matrix described in Appendix 1 to BC1 under the heading **CCGT Module Matrix**.

## CCGT Module Planning Matrix

A matrix in the form set out in Appendix 3 of OC2 showing the combination of **CCGT Units** within a **CCGT Module** which would be running in relation to any given MW output.

## Cluster

### 1. Before Telemetry

A cluster of wind turbines will be formed when the total wind capacity within any circle of five kilometre radius has a **Registered Capacity** of not less than 5MW

### 2. After Telemetry

Any wind turbine installed within a five kilometer radius of the anemometer position (whether installed before or after the installation of that anemometer) will be deemed to be within the cluster for that anemometer and will not count towards the creation of any new cluster. All other wind turbines may count towards the creation of further clusters.

## Combined Cycle Gas Turbine Module or CCGT Module

A collection of **Generating Units** (registered as a **CCGT Module** under the PC) comprising one or more **Gas Turbine Units** (or other gas based engine units) and one or more **Steam Units** where, in normal operation, the waste heat from the **Gas Turbines** is passed to the water/steam system of the associated **Steam Unit** or **Steam Units** and where the component units within the **CCGT Module** are directly connected by steam or hot gas lines which enable those units to contribute to the efficiency of the combined cycle operation of the **CCGT Module**.

## Combined Cycle Gas Turbine Unit or CCGT Unit

A **Generating Unit** within a **CCGT Module**.

## Commercial Ancillary Services

**Ancillary Services**, other than **System Ancillary Services**, utilised by NGET in operating the **Total System** if a **User** (or other person) has agreed to provide them under an **Ancillary Services Agreement** or under a **Bilateral Agreement** with payment being dealt with under an **Ancillary Services Agreement** or in the case of **Externally Interconnected System Operators** or **Interconnector Users**, under any other agreement (and in the case of **Externally Interconnected System Operators** and **Interconnector Users** includes ancillary services equivalent to or similar to **System Ancillary Services**).

## Committed Project Planning Data

Data relating to a **User Development** once the offer for a **CUSC Contract** is accepted.



<b><u>Completion Date</u></b>	Has the meaning set out in the <b>Bilateral Agreement</b> with each <b>User</b> to that term or in the absence of that term to such other term reflecting the date when a <b>User</b> is expected to connect to or start using the <b>GB Transmission System</b> .
<b><u>Complex</u></b>	A <b>Connection Site</b> together with the associated <b>Power Station</b> and/or <b>Network Operator</b> substation and/or associated <b>Plant</b> and/or <b>Apparatus</b> , as appropriate.
<b><u>Connection Conditions or CC</u></b>	That portion of the <b>Grid Code</b> which is identified as the <b>Connection Conditions</b> .
<b><u>Connection Entry Capacity</u></b>	Has the meaning set out in the <b>CUSC</b>
<b><u>Connected Planning Data</u></b>	Data which replaces data containing estimated values assumed for planning purposes by validated actual values and updated estimates for the future and by updated forecasts for <b>Forecast Data</b> items such as <b>Demand</b> .
<b><u>Connection Point</u></b>	A <b>Grid Supply Point</b> or <b>Grid Entry Point</b> , as the case may be.
<b><u>Connection Site</u></b>	A <b>Transmission Site</b> or <b>User Site</b> , as the case may be.
<b><u>Construction Agreement</u></b>	Has the meaning set out in the <b>CUSC</b>
<b><u>Contingency Reserve</u></b>	The margin of generation over forecast <b>Demand</b> which is required in the period from 24 hours ahead down to real time to cover against uncertainties in <b>Large Power Station</b> availability and against both weather forecast and <b>Demand</b> forecast errors.
<b><u>Control Calls</u></b>	A telephone call whose destination and/or origin is a key on the control desk telephone keyboard at a <b>Transmission Control Centre</b> and which has the right to exercise priority over (ie. disconnect) a call of a lower status.
<b><u>Control Centre</u></b>	A location used for the purpose of control and operation of the <b>GB Transmission System</b> or <b>DC Converter Station</b> owner's <b>System</b> or a <b>User System</b> other than a <b>Generator's System</b> or an <b>External System</b> .
<b><u>Control Engineer</u></b>	A person nominated by the relevant party for the control of its <b>Plant</b> and <b>Apparatus</b> .
<b><u>Control Person</u></b>	The term used as an alternative to " <b>Safety Co-ordinator</b> " on the <b>Site Responsibility Schedule</b> only.

<b><u>Control Phase</u></b>	The <b>Control Phase</b> follows on from the <b>Programming Phase</b> and covers the period down to real time.
<b><u>Control Point</u></b>	<p>The point from which:-</p> <p>a) A <b>Non-Embedded Customer's Plant and Apparatus</b> is controlled; or</p> <p>b) A <b>BM Unit</b> at a <b>Large Power Station</b> or at a <b>Medium Power Station</b> or representing a <b>Cascade Hydro Scheme</b> or with a <b>Demand Capacity</b> with a magnitude of 50MW or more (in England and Wales) or 5MW or more (in Scotland), is physically controlled by a <b>BM Participant</b>; or</p> <p>c) In the case of any other <b>BM Unit</b> or <b>Generating Unit</b>, data submission is co-ordinated for a <b>BM Participant</b> and instructions are received from <b>NGET</b>,</p> <p>as the case may be. For a <b>Generator</b> this will normally be at a <b>Power Station</b> but may be at an alternative location agreed with <b>NGET</b>. In the case of a <b>DC Converter Station</b>, the <b>Control Point</b> will be at a location agreed with <b>NGET</b>. In the case of a <b>BM Unit</b> of an <b>Interconnector User</b>, the <b>Control Point</b> will be the <b>Control Centre</b> of the relevant <b>Externally Interconnected System Operator</b>.</p>
<b><u>Control Telephony</u></b>	The method by which a <b>User's Responsible Engineer/Operator</b> and <b>NGET Control Engineer(s)</b> speak to one another for the purposes of control of the <b>Total System</b> in both normal and emergency operating conditions.
<b><u>CUSC</u></b>	Has the meaning set out in <b>NGET's Transmission Licence</b>
<b><u>CUSC Contract</u></b>	<p>One or more of the following agreements as envisaged in Standard Condition C1 of <b>NGET's Transmission Licence</b>:</p> <p>(a) the <b>CUSC Framework Agreement</b>;</p> <p>(b) a <b>Bilateral Agreement</b>;</p> <p>(c) a <b>Construction Agreement</b></p> <p>or a variation to an existing <b>Bilateral Agreement</b> and/or <b>Construction Agreement</b>;</p>
<b><u>CUSC Framework Agreement</u></b>	Has the meaning set out in <b>NGET's Transmission Licence</b>
<b><u>Customer</u></b>	A person to whom electrical power is provided (whether or not he is the same person as the person who provides the electrical power).
<b><u>Customer Demand Management</u></b>	Reducing the supply of electricity to a <b>Customer</b> or disconnecting a <b>Customer</b> in a manner agreed for commercial purposes between a <b>Supplier</b> and its <b>Customer</b> .

**Customer Demand Management Notification Level**

The level above which a **Supplier** has to notify **NGET** of its proposed or achieved use of **Customer Demand Management** which is 12 MW in England and Wales and 5 MW in Scotland.

**Customer Generating Plant**

A **Power Station** or **Generating Unit** of a **Customer** to the extent that it operates the same exclusively to supply all or part of its own electricity requirements, and does not export electrical power to any part of the **Total System**.

**Data Registration Code or DRC**

That portion of the **Grid Code** which is identified as the **Data Registration Code**.

**Data Validation, Consistency and Defaulting Rules**

The rules relating to validity and consistency of data, and default data to be applied, in relation to data submitted under the **Balancing Codes**, to be applied by **NGET** under the **Grid Code** as set out in the document "Data Validation, Consistency and Defaulting Rules" - Issue 7, dated 11<sup>th</sup> October 2004. The document is available on the National Grid website or upon request from **NGET**.

**DC Converter**

Any **Apparatus** with a **Completion Date** after 1 April 2005 used to convert alternating current electricity to direct current electricity, or vice-versa. A **DC Converter** is a standalone operative configuration at a single site comprising one or more converter bridges, together with one or more converter transformers, converter control equipment, essential protective and switching devices and auxiliaries, if any, used for conversion. In a bipolar arrangement, a **DC Converter** represents the bipolar configuration.

**DC Converter Station**

An installation comprising one or more **DC Converters** connecting a direct current interconnector:

to the **NGET Transmission System**; or,

(if the installation has a rating of 50MW or more) to a **User System**,

and it shall form part of the **External Interconnection** to which it relates.

**DC Network**

All items of **Plant** and **Apparatus** connected together on the direct current side of a **DC Converter**.

**De-Load**

The condition in which a **Genset** has reduced or is not delivering electrical power to the **System** to which it is **Synchronised**.

**Demand**

The demand of MW and Mvar of electricity (i.e. both **Active** and **Reactive Power**), unless otherwise stated.

<b><u>Demand Capacity</u></b>	Has the meaning as set out in the <b>BSC</b> .
<b><u>Demand Control</u></b>	Any or all of the following methods of achieving a <b>Demand</b> reduction: <ul style="list-style-type: none"> <li>(a) <b>Customer</b> voltage reduction initiated by <b>Network Operators</b> (other than following an instruction from <b>NGET</b>);</li> <li>(b) <b>Customer Demand</b> reduction by <b>Disconnection</b> initiated by <b>Network Operators</b> (other than following an instruction from <b>NGET</b>);</li> <li>(c) <b>Demand</b> reduction instructed by <b>NGET</b>;</li> <li>(d) automatic low <b>Frequency Demand Disconnection</b>;</li> <li>(e) emergency manual <b>Demand Disconnection</b>.</li> </ul>
<b><u>Demand Control Notification Level</u></b>	The level above which a <b>Network Operator</b> has to notify <b>NGET</b> of its proposed or achieved use of <b>Demand Control</b> which is 12 MW in England and Wales and 5 MW in Scotland.
<b><u>Designed Minimum Operating Level</u></b>	The output (in whole MW) below which a <b>Genset</b> or a <b>DC Converter</b> at a <b>DC Converter Station</b> (in any of its operating configurations) has no <b>High Frequency Response</b> capability.
<b><u>De-Synchronise</u></b>	<ul style="list-style-type: none"> <li>a) The act of taking a <b>Generating Unit, Power Park Module</b> or <b>DC Converter</b> off a <b>System</b> to which it has been <b>Synchronised</b>, by opening any connecting circuit breaker; or</li> <li>b) The act of ceasing to consume electricity at an importing <b>BM Unit</b>;</li> </ul> <p>and the term "<b>De-Synchronising</b>" shall be construed accordingly.</p>
<b><u>De-synchronised Island(s)</u></b>	Has the meaning set out in OC9.5.1(a)
<b><u>Detailed Planning Data</u></b>	Detailed additional data which <b>NGET</b> requires under the <b>PC</b> in support of <b>Standard Planning Data</b> . Generally it is first supplied once a <b>Bilateral Agreement</b> is entered into.
<b><u>Discrimination</u></b>	The quality where a relay or protective system is enabled to pick out and cause to be disconnected only the faulty <b>Apparatus</b> .
<b><u>Disconnection</u></b>	The physical separation of <b>Users</b> (or <b>Customers</b> ) from the <b>GB Transmission System</b> or a <b>User System</b> as the case may be.
<b><u>Disputes Resolution Procedure</u></b>	The procedure described in the <b>CUSC</b> relating to disputes resolution.

<b><u>Distribution Code</u></b>	The distribution code required to be drawn up by each <b>Electricity Distribution Licence</b> holder and approved by the <b>Authority</b> , as from time to time revised with the approval of the <b>Authority</b> .
<b><u>Droop</u></b>	The ratio of the steady state change in speed in the case of a <b>Generating Unit</b> , or in <b>Frequency</b> in the case of a <b>Power Park Module</b> , to the steady state change in power output of the <b>Generating Unit</b> or <b>Power Park Module</b> .
<b><u>Dynamic Parameters</u></b>	Those parameters listed in Appendix 1 to <b>BC1</b> under the heading <b>BM Unit Data – Dynamic Parameters</b> .
<b><u>Earth Fault Factor</u></b>	At a selected location of a three-phase <b>System</b> (generally the point of installation of equipment) and for a given <b>System</b> configuration, the ratio of the highest root mean square phase-to-earth power <b>Frequency</b> voltage on a sound phase during a fault to earth (affecting one or more phases at any point) to the root mean square phase-to-earth power <b>Frequency</b> voltage which would be obtained at the selected location without the fault.
<b><u>Earthing</u></b>	<p>A way of providing a connection between conductors and earth by an <b>Earthing Device</b> which is either:</p> <p>(a) Immobilised and <b>Locked</b> in the earthing position. Where the <b>Earthing Device</b> is <b>Locked</b> with a <b>Safety Key</b>, the <b>Safety Key</b> must be secured in a <b>Key Safe</b> and the <b>Key Safe Key</b> must be, where reasonably practicable, given to the authorised site representative of the <b>Requesting Safety Co-Ordinator</b> and is to be retained in safe custody. Where not reasonably practicable the <b>Key Safe Key</b> must be retained by the authorised site representative of the <b>Implementing Safety Co-Ordinator</b> in safe custody: or</p> <p>(b) maintained and/or secured in position by such other method which must be in accordance with the <b>Local Safety Instructions</b> of <b>NGET</b> or the <b>Safety Rules</b> of the <b>Relevant Transmission Licensee</b> or that <b>User</b>, as the case may be.</p>
<b><u>Earthing Device</u></b>	A means of providing a connection between a conductor and earth being of adequate strength and capability.
<b><u>Electrical Standard</u></b>	A standard listed in the Annex to the <b>General Conditions</b> .
<b><u>Electricity Council</u></b>	That body set up under the Electricity Act, 1957.
<b><u>Electricity Distribution Licence</u></b>	The licence granted pursuant to Section 6(1) (c) of the <b>Act</b> .

**Electricity Supply Industry Arbitration Association**

The unincorporated members' club of that name formed inter alia to promote the efficient and economic operation of the procedure for the resolution of disputes within the electricity supply industry by means of arbitration or otherwise in accordance with its arbitration rules.

**Electricity Supply Licence**

The licence granted pursuant to Section 6(1) (d) of the **Act**.

**Electromagnetic Compatibility Level**

Has the meaning set out in **Engineering Recommendation G5/4**.

**Embedded**

Having a direct connection to a **User System** or the **System** of any other **User** to which **Customers** and/or **Power Stations** are connected, such connection being either a direct connection or a connection via a busbar of another **User** or of a **Transmission Licensee** (but with no other connection to the **GB Transmission System**).

**Emergency Instruction**

An instruction issued by **NGET** in emergency circumstances, pursuant to BC2.9, to the **Control Point** of a **User**. In the case of such instructions applicable to a **BM Unit**, it may require an action or response which is outside the **Dynamic Parameters**, **QPN** or **Other Relevant Data**, and may include an instruction to trip a **Genset**.

**Engineering Recommendations**

The documents referred to as such and issued by the Electricity Association or the former Electricity Council.

**Estimated Registered Data**

Those items of **Standard Planning Data** and **Detailed Planning Data** which either upon connection will become **Registered Data**, or which for the purposes of the **Plant** and/or **Apparatus** concerned as at the date of submission are **Registered Data**, but in each case which for the seven succeeding **Financial Years** will be an estimate of what is expected.

**European Specification**

A common technical specification, a **British Standard** implementing a European standard or a European technical approval. The terms "common technical specification", "European standard" and "European technical approval" shall have the meanings respectively ascribed to them in the **Regulations**.

**Event**

An unscheduled or unplanned (although it may be anticipated) occurrence on, or relating to, a **System** (including **Embedded Power Stations**) including, without limiting that general description, faults, incidents and breakdowns and adverse weather conditions being experienced.

**Exciter**

The source of the electrical power providing the field current of a synchronous machine.

<b><u>Excitation System</u></b>	The equipment providing the field current of a machine, including all regulating and control elements, as well as field discharge or suppression equipment and protective devices.
<b><u>Excitation System No-Load Negative Ceiling Voltage</u></b>	The minimum value of direct voltage that the <b>Excitation System</b> is able to provide from its terminals when it is not loaded, which may be zero or a negative value.
<b><u>Excitation System Nominal Response</u></b>	Shall have the meaning ascribed to that term in <b>IEC 34-16-1:1991</b> [equivalent to <b>British Standard BS4999</b> Section 116.1 : 1992]. The time interval applicable is the first half-second of excitation system voltage response.
<b><u>Excitation System On-Load Positive Ceiling Voltage</u></b>	Shall have the meaning ascribed to the term 'Excitation system on load ceiling voltage' in <b>IEC 34-16-1:1991</b> [equivalent to <b>British Standard BS4999</b> Section 116.1 : 1992].
<b><u>Excitation System No-Load Positive Ceiling Voltage</u></b>	Shall have the meaning ascribed to the term 'Excitation system no load ceiling voltage' in <b>IEC 34-16-1:1991</b> [equivalent to <b>British Standard BS4999</b> Section 116.1 : 1992].
<b><u>Exemptable</u></b>	Has the meaning set out in the <b>CUSC</b> .
<b><u>Existing AGR Plant</u></b>	The following nuclear advanced gas cooled reactor plant (which was commissioned and connected to the <b>Total System</b> at the <b>Transfer Date</b> ):- <p style="margin-left: 40px;">Dungeness B Hinkley Point B Heysham 1 Heysham 2 Hartlepool Hunterston B Torness.</p>
<b><u>Existing AGR Plant Flexibility Limit</u></b>	In respect of each <b>Genset</b> within each <b>Existing AGR Plant</b> which has a safety case enabling it to so operate, 8 (or such lower number which when added to the number of instances of reduction of output as instructed by <b>NGET</b> in relation to operation in <b>Frequency Sensitive Mode</b> totals 8) instances of flexibility in any calendar year (or such lower or greater number as may be agreed by the Nuclear Installations Inspectorate and notified to <b>NGET</b> ) for the purpose of assisting in the period of low <b>System NRAPM</b> and/or low <b>Localised NRAPM</b> provided that in relation to each <b>Generating Unit</b> each change in output shall not be required to be to a level where the output of the reactor is less than 80% of the reactor thermal power limit (as notified to <b>NGET</b> and which corresponds to the limit of reactor thermal power as contained in the "Operating Rules" or "Identified Operating Instructions" forming part of the safety case agreed with the Nuclear Installations Inspectorate).

**Existing Gas Cooled Reactor Plant**

Both **Existing Magnox Reactor Plant** and **Existing AGR Plant**.

**Existing Magnox Reactor Plant**

The following nuclear gas cooled reactor plant (which was commissioned and connected to the **Total System** at the **Transfer Date**):-

Calder Hall  
Chapelcross  
Dungeness A  
Hinkley Point A  
Oldbury-on-Severn  
Bradwell  
Sizewell A  
Wylfa.

**Export and Import Limits**

Those parameters listed in Appendix 1 to **BC1** under the heading **BM Unit Data – Export and Import Limits**.

**External Interconnection**

**Apparatus** for the transmission of electricity to or from the **GB Transmission System** or a **User System** into or out of an **External System**. For the avoidance of doubt, a single **External Interconnection** may comprise several circuits operating in parallel.

**Externally Interconnected System Operator or EISO**

A person who operates an **External System** which is connected to the **GB Transmission System** or a **User System** by an **External Interconnection**.

**External System**

In relation to an **Externally Interconnected System Operator** means the transmission or distribution system which it owns or operates which is located outside **Great Britain** and any **Apparatus** or **Plant** which connects that system to the **External Interconnection** and which is owned or operated by such **Externally Interconnected System Operator**.

**Fault Current Interruption Time**

The time interval from fault inception until the end of the break time of the circuit breaker (as declared by the manufacturers).

**Fast Start**

A start by a **Genset** with a **Fast Start Capability**.

**Fast Start Capability**

The ability of a **Genset** to be **Synchronised** and **Loaded** up to full **Load** within 5 minutes.

**Final Generation Outage Programme**

An outage programme as agreed by **NGET** with each **Generator** at various stages through the **Operational Planning Phase** and **Programming Phase** which does not commit the parties to abide by it, but which at various stages will be used as the basis on which **GB Transmission System** outages will be planned.



<b><u>Final Physical Notification Data</u></b>	Has the meaning set out in the <b>BSC</b> .
<b><u>Final Report</u></b>	A report prepared by the <b>Test Proposer</b> at the conclusion of a <b>System Test</b> for submission to <b>NGET</b> (if it did not propose the <b>System Test</b> ) and other members of the <b>Test Panel</b> .
<b><u>Financial Year</u></b>	Bears the meaning given in Condition A1 (Definitions and Interpretation) of <b>NGET's Transmission Licence</b> .
<b><u>Flicker Severity (Long Term)</u></b>	A value derived from 12 successive measurements of <b>Flicker Severity (Short Term)</b> (over a two hour period) and a calculation of the cube root of the mean sum of the cubes of 12 individual measurements, as further set out in <b>Engineering Recommendation P28</b> as current at the <b>Transfer Date</b> .
<b><u>Flicker Severity (Short Term)</u></b>	A measure of the visual severity of flicker derived from the time series output of a flickermeter over a 10 minute period and as such provides an indication of the risk of <b>Customer</b> complaints.
<b><u>Forecast Data</u></b>	Those items of <b>Standard Planning Data</b> and <b>Detailed Planning Data</b> which will always be forecast.
<b><u>Frequency</u></b>	The number of alternating current cycles per second (expressed in Hertz) at which a <b>System</b> is running.
<b><u>Frequency Sensitive AGR Unit</u></b>	Each <b>Generating Unit</b> in an <b>Existing AGR Plant</b> for which the <b>Generator</b> has notified <b>NGET</b> that it has a safety case agreed with the Nuclear Installations Inspectorate enabling it to operate in <b>Frequency Sensitive Mode</b> , to the extent that such unit is within its <b>Frequency Sensitive AGR Unit Limit</b> . Each such <b>Generating Unit</b> shall be treated as if it were operating in accordance with BC3.5.1 provided that it is complying with its <b>Frequency Sensitive AGR Unit Limit</b> .
<b><u>Frequency Sensitive AGR Unit Limit</u></b>	In respect of each <b>Frequency Sensitive AGR Unit</b> , 8 (or such lower number which when added to the number of instances of flexibility for the purposes of assisting in a period of low <b>System</b> or <b>Localised NRAPM</b> totals 8) instances of reduction of output in any calendar year as instructed by <b>NGET</b> in relation to operation in <b>Frequency Sensitive Mode</b> (or such greater number as may be agreed between <b>NGET</b> and the <b>Generator</b> ), for the purpose of assisting with <b>Frequency</b> control, provided the level of operation of each <b>Frequency Sensitive AGR Unit</b> in <b>Frequency Sensitive Mode</b> shall not be outside that agreed by the Nuclear Installations Inspectorate in the relevant safety case.

**Frequency Sensitive Mode**

A **Genset** operating mode which will result in **Active Power** output changing, in response to a change in **System Frequency**, in a direction which assists in the recovery to **Target Frequency**, by operating so as to provide **Primary Response** and/or **Secondary Response** and/or **High Frequency Response**.

**Fuel Security Code**

The document of that title designated as such by the **Secretary of State**, as from time to time amended.

**Gas Turbine Unit**

A **Generating Unit** driven by a gas turbine (for instance by an aero-engine).

**Gas Zone Diagram**

A single line diagram showing boundaries of, and interfaces between, gas-insulated **HV Apparatus** modules which comprise part, or the whole, of a substation at a **Connection Site**, together with the associated stop valves and gas monitors required for the safe operation of the **GB Transmission System** or the **User System**, as the case may be.

**Gate Closure**

Has the meaning set out in the **BSC**.

**GB National Demand**

The amount of electricity supplied from the **Grid Supply Points** plus:-

- that supplied by **Embedded Large Power Stations**, and
- **GB Transmission System Losses**,

minus:-

- the **Demand** taken by **Station Transformers** and **Pumped Storage Units'**

and, for the purposes of this definition, does not include:-

- any exports from the **GB Transmission System** across **External Interconnections**.

**GB Transmission System**

The system consisting (wholly or mainly) of high voltage electric lines owned or operated by **Transmission Licensees** within **Great Britain** and used for the transmission of electricity from one **Power Station** to a substation or to another **Power Station** or between sub-stations or to or from any **External Interconnection**, and includes any **Plant** and **Apparatus** and meters owned or operated by any **Transmission Licensee** within **Great Britain** in connection with the transmission of electricity but does not include any **Remote Transmission Assets**.

**GB Transmission System Demand**

The amount of electricity supplied from the **Grid Supply Points** plus:-

- that supplied by **Embedded Large Power Stations**, and
- exports from the **GB Transmission System** across **External Interconnections**, and
- **GB Transmission System Losses**,

and, for the purposes of this definition, includes:-

- the **Demand** taken by **Station Transformers** and **Pumped Storage Units**.

**GB Transmission System Losses**

The losses of electricity incurred on the **GB Transmission System**.

**GB Transmission System Study Network Data File**

A computer file containing details of transmission plant and **Large Power Stations** and the configuration of the connection between them, together with data on **Demand** and on the **GB Transmission System**. These details, when read together as represented in the file, form **NGET's** view of an appropriate representation of the **GB Transmission System** for technical analysis purposes only. The file will only deal with the **GB Transmission System**

**GB Transmission System Warning**

A warning issued by **NGET** to **Users** (or to certain **Users** only) in accordance with OC7.4.8.2, which provides information relating to **System** conditions or **Events** and is intended to :

- (a) alert **Users** to possible or actual **Plant** shortage, **System** problems and/or **Demand** reductions;
- (b) inform of the applicable period;
- (c) indicate intended consequences for **Users**; and
- (d) enable specified **Users** to be in a state of readiness to receive instructions from **NGET**.

**GB Transmission System Warning - Demand Control Imminent**

A warning issued by **NGET**, in accordance with OC7.4.8.7, which is intended to provide short term notice, where possible, to those **Users** who are likely to receive **Demand** reduction instructions from **NGET** within 30 minutes.

**GB Transmission System Warning - High Risk of Demand Reduction**

A warning issued by **NGET**, in accordance with OC7.4.8.6, which is intended to alert recipients that there is a high risk of **Demand** reduction being implemented and which may normally result from an inadequate **System Margin**.

**GB Transmission System Warning - Inadequate System Margin**

A warning issued by **NGET**, in accordance with OC7.4.8.5, which is intended to alert recipients of an inadequate **System Margin** and which if not improved may result in **Demand** reduction being instructed.

**GB Transmission System Warning - Risk of System Disturbance**

A warning issued by **NGET**, in accordance with OC7.4.8.8, which is intended to alert **Users** of the risk of widespread and serious **System** disturbance which may affect **Users**.

**General Conditions or GC**

That portion of the **Grid Code** which is identified as the **General Conditions**.

**Generating Plant Demand Margin**

The difference between **Output Usable** and forecast **Demand**.

**Generating Unit**

Unless otherwise provided in the **Grid Code**, any **Apparatus** which produces electricity, including, a **Synchronous Generating Unit** and **Non-synchronous Generating Unit**.

**Generating Unit Data**

The **Physical Notification, Export and Import Limits and Other Relevant Data** only in respect of each **Generating Unit**:

(a) which forms part of the **BM Unit** which represents that **Cascade Hydro Scheme**;

at an **Embedded Exemptable Large Power Station**, where **NGET** reasonably requires compliance with relevant provisions of **BC1/BC2** on a **Generating Unit** basis and has specified such requirement in the relevant **Bilateral Agreement**.

**Generation Capacity**

Has the meaning set out in the **BSC**.

**Generation Planning Parameters**

Those parameters listed in Appendix 2 of **OC2**.

**Generator**

A person who generates electricity under licence or exemption under the **Act** acting in its capacity as a generator in **Great Britain**.

**Generator Performance Chart**

A diagram which shows the MW and Mvar capability limits within which a **Generating Unit** will be expected to operate under steady state conditions.

**Genset**

A **Generating Unit, Power Park Module** or **CCGT Module** at a **Large Power Station** or any **Generating Unit, Power Park Module** or **CCGT Module** which is directly connected to the **GB Transmission System**.

<b><u>Good Industry Practice</u></b>	The exercise of that degree of skill, diligence, prudence and foresight which would reasonably and ordinarily be expected from a skilled and experienced operator engaged in the same type of undertaking under the same or similar circumstances.
<b><u>Governor Deadband</u></b>	The total magnitude of the change in steady state speed (expressed as a range of Hz ( $\pm x$ Hz) where "x" is a numerical value) within which there is no resultant change in the position of the governing valves of the speed/load Governing System.
<b><u>Great Britain or GB</u></b>	Has the meaning set out in Schedule 1 of <b>NGET's Transmission Licence</b> .
<b><u>Grid Code Review Panel or Panel</u></b>	The panel with the functions set out in GC.4.
<b><u>Grid Entry Point</u></b>	A point at which a <b>Generating Unit</b> or a <b>CCGT Module</b> or a <b>CCGT Unit</b> or a <b>DC Converter</b> or a <b>Power Park Module</b> , as the case may be, which is directly connected to the <b>GB Transmission System</b> connects to the <b>GB Transmission System</b> .
<b><u>Grid Supply Point</u></b>	A point of supply from the <b>GB Transmission System</b> to <b>Network Operators</b> or <b>Non-Embedded Customers</b> .
<b><u>Group</u></b>	Those <b>GB Transmission System</b> sub-stations bounded solely by the faulted circuit(s) and the overloaded circuit(s) excluding any third party connections between the <b>Group</b> and the rest of the <b>GB Transmission System</b> , the faulted circuit(s) being a <b>Secured Event</b> .
<b><u>High Frequency Response</u></b>	An automatic reduction in <b>Active Power</b> output in response to an increase in <b>System Frequency</b> above the <b>Target Frequency</b> (or such other level of <b>Frequency</b> as may have been agreed in an <b>Ancillary Services Agreement</b> ). This reduction in <b>Active Power</b> output must be in accordance with the provisions of the relevant <b>Ancillary Services Agreement</b> which will provide that it will be released increasingly with time over the period 0 to 10 seconds from the time of the <b>Frequency</b> increase on the basis set out in the <b>Ancillary Services Agreement</b> and fully achieved within 10 seconds of the time of the start of the <b>Frequency</b> increase and it must be sustained at no lesser reduction thereafter. The interpretation of the <b>High Frequency Response</b> to a + 0.5 Hz frequency change is shown diagrammatically in Figure CC.A.3.3.
<b><u>High Voltage or HV</u></b>	In England and Wales, a voltage exceeding 650 volts. In Scotland, a voltage exceeding 1000 volts.
<b><u>HV Connections</u></b>	<b>Apparatus</b> connected at the same voltage as that of the <b>GB Transmission System</b> , including <b>Users'</b> circuits, the higher voltage windings of <b>Users'</b> transformers and associated connection <b>Apparatus</b> .

<b><u>HP Turbine Power Fraction</u></b>	Ratio of steady state mechanical power delivered by the HP turbine to the total steady state mechanical power delivered by the total steam turbine at <b>Registered Capacity</b> .
<b><u>IEC</u></b>	International Electrotechnical Commission.
<b><u>IEC Standard</u></b>	A standard approved by the International Electrotechnical Commission.
<b><u>Implementing Safety Co-ordinator</u></b>	The <b>Safety Co-ordinator</b> implementing <b>Safety Precautions</b> .
<b><u>Import Usable</u></b>	That portion of <b>Registered Import Capacity</b> which is expected to be available and which is not unavailable due to a <b>Planned Outage</b> .
<b><u>Incident Centre</u></b>	A centre established by <b>NGET</b> or a <b>User</b> as the focal point in <b>NGET</b> or in that <b>User</b> , as the case may be, for the communication and dissemination of information between the senior management representatives of <b>NGET</b> , or of that <b>User</b> , as the case may be, and the relevant other parties during a <b>Joint System Incident</b> in order to avoid overloading <b>NGET's</b> , or that <b>User's</b> , as the case may be, existing operational/control arrangements.
<b><u>Indicated Constraint Boundary Margin</u></b>	The difference between a constraint boundary transfer limit and the difference between the sum of <b>BM Unit</b> Maximum Export Limits and the forecast of local <b>Demand</b> within the constraint boundary.
<b><u>Indicated Imbalance</u></b>	The difference between the sum of <b>Physical Notifications</b> for <b>BM Units</b> comprising <b>Generating Units</b> or <b>CCGT Modules</b> and the forecast of <b>Demand</b> for the whole or any part of the <b>System</b> .
<b><u>Indicated Margin</u></b>	The difference between the sum of <b>BM Unit</b> Maximum Export Limits submitted and the forecast of <b>Demand</b> for the whole or any part of the <b>System</b>
<b><u>Instructor Facilities</u></b>	A device or system which gives certain <b>Transmission Control Centre</b> instructions with an audible or visible alarm, and incorporates the means to return message acknowledgements to the <b>Transmission Control Centre</b>
<b><u>Integral Equipment Test or IET</u></b>	A test on equipment, associated with <b>Plant</b> and/or <b>Apparatus</b> , which takes place when that <b>Plant</b> and/or <b>Apparatus</b> forms part of a <b>Synchronised System</b> and which, in the reasonable judgement of the person wishing to perform the test, may cause an <b>Operational Effect</b> .

<b><u>Interconnection Agreement</u></b>	An agreement made between <b>NGET</b> and an <b>Externally Interconnected System Operator</b> and/or an <b>Interconnector User</b> and/or other relevant persons for the <b>External Interconnection</b> relating to an <b>External Interconnection</b> and/or an agreement under which an <b>Interconnector User</b> can use an <b>External Interconnection</b> .
<b><u>Interconnector User</u></b>	Has the meaning set out in the <b>BSC</b> .
<b><u>Interface Agreement</u></b>	Has the meaning set out in the <b>CUSC</b> .
<b><u>Intermittent Power Source</u></b>	The primary source of power for a <b>Generating Unit</b> that can not be considered as controllable, e.g. wind, wave or solar.
<b><u>Intertripping</u></b>	(a) The tripping of circuit-breaker(s) by commands initiated from <b>Protection</b> at a remote location independent of the state of the local <b>Protection</b> ; or  (b) <b>Operational Intertripping</b> .
<b><u>Intertrip Apparatus</u></b>	<b>Apparatus</b> which performs <b>Intertripping</b> .
<b><u>IP Turbine Power Fraction</u></b>	Ratio of steady state mechanical power delivered by the IP turbine to the total steady state mechanical power delivered by the total steam turbine at <b>Registered Capacity</b> .
<b><u>Isolating Device</u></b>	A device for achieving <b>Isolation</b> .

## Isolation

The disconnection of **HV Apparatus** (as defined in OC8A.1.6.2 and OC8B.1.7.2) from the remainder of the **System** in which that **HV Apparatus** is situated by either of the following:

- (a) an **Isolating Device** maintained in an isolating position. The isolating position must either be:
  - (i) maintained by immobilising and **Locking** the **Isolating Device** in the isolating position and affixing a **Caution Notice** to it. Where the **Isolating Device** is **Locked** with a **Safety Key**, the **Safety Key** must be secured in a **Key Safe** and the **Key Safe Key** must be, where reasonably practicable, given to the authorised site representative of the **Requesting Safety Co-Ordinator** and is to be retained in safe custody. Where not reasonably practicable the **Key Safe Key** must be retained by the authorised site representative of the **Implementing Safety Co-Ordinator** in safe custody; or
  - (ii) maintained and/or secured by such other method which must be in accordance with the **Local Safety Instructions** of **NGET** or the **Safety Rules** of the **Relevant Transmission Licensee** or that **User**, as the case may be; or
- (b) an adequate physical separation which must be in accordance with and maintained by the method set out in the **Local Safety Instructions** of **NGET** or the **Safety Rules** of the **Relevant Transmission Licensee** or that **User**, as the case may be.

## Joint BM Unit Data

Has the meaning set out in the **BSC**.

## Joint System Incident

An **Event** wherever occurring (other than on an **Embedded Medium Power Station** or an **Embedded Small Power Station**) which, in the opinion of **NGET** or a **User**, has or may have a serious and/or widespread effect, in the case of an **Event** on a **User(s) System(s)** (other than on an **Embedded Medium Power Station** or **Embedded Small Power Station**), on the **GB Transmission System**, and in the case of an **Event** on the **GB Transmission System**, on a **User(s) System(s)** (other than on an **Embedded Medium Power Station** or **Embedded Small Power Station**).

## Key Safe

A device for the secure retention of keys.

## Key Safe Key

A key unique at a **Location** capable of operating a lock, other than a control lock, on a **Key Safe**.

## Large Power Station

A **Power Station** in **NGET's Transmission Area** with a **Registered Capacity** of 100MW or more or a **Power Station** in **SPT's Transmission Area** with a **Registered Capacity** of 30MW or more; or a **Power Station** in **SHETL's Transmission Area** with a **Registered Capacity** of 5MW or more.



<b><u>Licence</u></b>	Any licence granted to <b>NGET</b> or a <b>Relevant Transmission Licensee</b> or a <b>User</b> , under Section 6 of the <b>Act</b> .
<b><u>Licence Standards</u></b>	Those standards set out or referred to in Condition C17 of <b>NGET's Transmission Licence</b> and/or Condition D3 of a <b>Relevant Transmission Licensee's Transmission Licence</b> .
<b><u>Limited Frequency Sensitive Mode</u></b>	A mode whereby the operation of the <b>Genset</b> (or <b>DC Converter</b> at a <b>DC Converter Station</b> exporting <b>Active Power</b> to the <b>Total System</b> ) is <b>Frequency</b> insensitive except when the <b>System Frequency</b> exceeds 50.4Hz, from which point <b>Limited High Frequency Response</b> must be provided.
<b><u>Limited High Frequency Response</u></b>	A response of a <b>Genset</b> (or <b>DC Converter</b> at a <b>DC Converter Station</b> exporting <b>Active Power</b> to the <b>Total System</b> ) to an increase in <b>System Frequency</b> above 50.4Hz leading to a reduction in <b>Active Power</b> in accordance with the provisions of BC3.7.2.
<b><u>Load</u></b>	The <b>Active</b> , <b>Reactive</b> or <b>Apparent Power</b> , as the context requires, generated, transmitted or distributed.
<b><u>Loaded</u></b>	Supplying electrical power to the <b>System</b> .
<b><u>Load Factor</u></b>	The ratio of the actual output of a <b>Generating Unit</b> to the possible maximum output of that <b>Generating Unit</b> .
<b><u>Load Management Block</u></b>	A block of <b>Demand</b> controlled by a <b>Supplier</b> or other party through the means of radio teleswitching or by some other means.
<b><u>Local Joint Restoration Plan</u></b>	<p>A plan produced under OC9.4.7.11 detailing the agreed method and procedure by which a <b>Genset</b> at a <b>Black Start Station</b> (possibly with other <b>Gensets</b> at that <b>Black Start Station</b>) will energise part of the <b>Total System</b> and meet complementary blocks of local <b>Demand</b> so as to form a <b>Power Island</b>.</p> <p>In Scotland, the plan may also: cover more than one <b>Black Start Station</b>; include <b>Gensets</b> other than those at a <b>Black Start Station</b> and cover the creation of one or more <b>Power Islands</b>.</p>
<b><u>Local Safety Instructions</u></b>	For safety co-ordination in England and Wales, instructions on each <b>User Site</b> and <b>Transmission Site</b> , approved by the relevant <b>NGET</b> or <b>User's</b> manager, setting down the methods of achieving the objectives of <b>NGET's</b> or the <b>User's Safety Rules</b> , as the case may be, to ensure the safety of personnel carrying out work or testing on <b>Plant</b> and/or <b>Apparatus</b> on which his <b>Safety Rules</b> apply and, in the case of a <b>User</b> , any other document(s) on a <b>User Site</b> which contains rules with regard to maintaining or securing the isolating position of an <b>Isolating Device</b> , or maintaining a physical separation or maintaining or securing the position of an <b>Earthing Device</b> .

<b><u>Local Switching Procedure</u></b>	A procedure produced under OC7.6 detailing the agreed arrangements in respect of carrying out of <b>Operational Switching</b> at <b>Connection Sites</b> and parts of the <b>GB Transmission System</b> adjacent to those <b>Connection Sites</b> .
<b><u>Localised Negative Reserve Active Power Margin or Localised NRAPM</u></b>	That margin of <b>Active Power</b> sufficient to allow transfers to and from a <b>System Constraint Group</b> (as the case may be) to be contained within such reasonable limit as <b>NGET</b> may determine.
<b><u>Location</u></b>	Any place at which <b>Safety Precautions</b> are to be applied.
<b><u>Locked</u></b>	A condition of <b>HV Apparatus</b> that cannot be altered without the operation of a locking device.
<b><u>Locking</u></b>	The application of a locking device which enables <b>HV Apparatus</b> to be <b>Locked</b> .
<b><u>Low Frequency Relay</u></b>	Has the same meaning as <b>Under Frequency Relay</b> .
<b><u>Low Voltage or LV</u></b>	In England and Wales a voltage not exceeding 250 volts. In Scotland, a voltage exceeding 50 voltage but not exceeding 1000 volts.
<b><u>Main Protection</u></b>	<b>Protection</b> equipment or system expected to have priority in initiating either a fault clearance or an action to terminate an abnormal condition in a power system.
<b><u>Material Effect</u></b>	An effect causing <b>NGET</b> or a <b>Relevant Transmission Licensee</b> to effect any works or to alter the manner of operation of <b>Transmission Plant</b> and/or <b>Transmission Apparatus</b> at the <b>Connection Site</b> (which term shall, in this definition and in the definition of " <b>Modification</b> " only, have the meaning ascribed thereto in the <b>CUSC</b> ) or the site of connection or a <b>User</b> to effect any works or to alter the manner of operation of its <b>Plant</b> and/or <b>Apparatus</b> at the <b>Connection Site</b> or the site of connection which in either case involves that party in expenditure of more than £10,000.
<b><u>Maximum Generation Service, MGS</u></b>	A service utilised by <b>NGET</b> in accordance with the <b>CUSC</b> and the <b>Balancing Principles Statement</b> in operating the <b>Total System</b> .
<b><u>Maximum Generation Service Agreement</u></b>	An agreement between a <b>User</b> and <b>NGET</b> for the payment by <b>NGET</b> to that <b>User</b> in respect of the provision by such <b>User</b> of a <b>Maximum Generation Service</b> .
<b><u>Medium Power Station</u></b>	A <b>Power Station</b> in <b>NGET's Transmission Area</b> with a <b>Registered Capacity</b> of 50MW or more, but less than 100MW; or a <b>Power Station</b> in <b>SPT's Transmission Area</b> with a <b>Registered Capacity</b> of 5MW or more, but less than 30MW.

<b><u>Medium Voltage or MV</u></b>	In England and Wales a voltage exceeding 250 volts but not exceeding 650 volts.
<b><u>Mills</u></b>	Milling plant which supplies pulverised fuel to the boiler of a coal fired <b>Power Station</b> .
<b><u>Minimum Generation</u></b>	The minimum output (in whole MW) which a <b>Genset</b> can generate or <b>DC Converter</b> at a <b>DC Converter Station</b> can import or export to the <b>Total System</b> under stable operating conditions, as registered with <b>NGET</b> under the <b>PC</b> (and amended pursuant to the <b>PC</b> ). For the avoidance of doubt, the output may go below this level as a result of operation in accordance with BC3.7.
<b><u>Minimum Import Capacity</u></b>	The minimum input (in whole MW) into a <b>DC Converter</b> at a <b>DC Converter Station</b> (in any of its operating configurations) at the <b>Grid Entry Point</b> (or in the case of an <b>Embedded DC Converter</b> at the <b>User System Entry Point</b> ) at which a <b>DC Converter</b> can operate in a stable manner, as registered with <b>NGET</b> under the <b>PC</b> (and amended pursuant to the <b>PC</b> ).
<b><u>Modification</u></b>	Any actual or proposed replacement, renovation, modification, alteration or construction by or on behalf of a <b>User</b> or <b>NGET</b> to either that <b>User's Plant</b> or <b>Apparatus</b> or <b>Transmission Plant</b> or <b>Apparatus</b> , as the case may be, or the manner of its operation which has or may have a <b>Material Effect</b> on <b>NGET</b> or a <b>User</b> , as the case may be, at a particular <b>Connection Site</b> .
<b><u>Mothballed DC Converter at a DC Converter Station</u></b>	A <b>DC Converter</b> at a <b>DC Converter Station</b> that has previously imported or exported power which the <b>DC Converter Station</b> owner plans not to use to import or export power for the remainder of the current <b>Financial Year</b> but which could be returned to service.
<b><u>Mothballed Generating Unit</u></b>	A <b>Generating Unit</b> that has previously generated which the <b>Generator</b> plans not to use to generate for the remainder of the current <b>NGET Financial Year</b> but which could be returned to service.
<b><u>Mothballed Power Park Module</u></b>	A <b>Power Park Module</b> that has previously generated which the <b>Generator</b> plans not to use to generate for the remainder of the current <b>Financial Year</b> but which could be returned to service.
<b><u>Multiple Point of Connection</u></b>	A double (or more) <b>Point of Connection</b> , being two (or more) <b>Points of Connection</b> interconnected to each other through the <b>User's System</b> .
<b><u>Network Data</u></b>	The data to be provided by <b>NGET</b> to <b>Users</b> in accordance with the <b>PC</b> , as listed in Part 3 of the Appendix to the <b>PC</b> .

<b><u>Network Operator</u></b>	A person with a <b>User System</b> directly connected to the <b>GB Transmission System</b> to which <b>Customers</b> and/or <b>Power Stations</b> (not forming part of the <b>User System</b> ) are connected, acting in its capacity as an operator of the <b>User System</b> , but shall not include a person acting in the capacity of an <b>Externally Interconnected System Operator</b> .
<b><u>NGET</u></b>	National Grid Electricity Transmission plc (NO: 2366977) whose registered office is at 1-3 Strand, London, WC2N 5EH.
<b><u>NGET Control Engineer</u></b>	The nominated person employed by <b>NGET</b> to direct the operation of the <b>GB Transmission System</b> or such person as nominated by <b>NGET</b> .
<b><u>NGET Operational Strategy</u></b>	<b>NGET's</b> operational procedures which form the guidelines for operation of the <b>GB Transmission System</b> .
<b><u>No-Load Field Voltage</u></b>	Shall have the meaning ascribed to that term in <b>IEC 34-16-1:1991</b> [equivalent to <b>British Standard BS4999</b> Section 116.1 : 1992].
<b><u>Non-Embedded Customer</u></b>	A <b>Customer</b> in <b>Great Britain</b> , except for a <b>Network Operator</b> acting in its capacity as such, receiving electricity direct from the <b>GB Transmission System</b> irrespective of from whom it is supplied.
<b><u>Non-Synchronous Generating Unit</u></b>	A <b>Generating Unit</b> that is not a <b>Synchronous Generating Unit</b> including for the avoidance of doubt a <b>Power Park Unit</b> .
<b><u>Normal CCGT Module</u></b>	A <b>CCGT Module</b> other than a <b>Range CCGT Module</b> .
<b><u>Novel Unit</u></b>	A tidal, wave, wind, geothermal, or any similar, <b>Generating Unit</b> .
<b><u>OC9 De-synchronised Island Procedure</u></b>	Has the meaning set out in OC9.5.4.
<b><u>On-Site Generator Site</u></b>	A site which is determined by the <b>BSC Panel</b> to be a Trading Unit under the <b>BSC</b> by reason of having fulfilled the Class 1 or Class 2 requirements as such terms are used in the <b>BSC</b> .
<b><u>Operating Code or OC</u></b>	That portion of the <b>Grid Code</b> which is identified as the <b>Operating Code</b> .
<b><u>Operating Margin</u></b>	<b>Contingency Reserve</b> plus <b>Operating Reserve</b> .

<b><u>Operating Reserve</u></b>	The additional output from <b>Large Power Stations</b> or the reduction in <b>Demand</b> , which must be realisable in real-time operation to respond in order to contribute to containing and correcting any <b>System Frequency</b> fall to an acceptable level in the event of a loss of generation or a loss of import from an <b>External Interconnection</b> or mismatch between generation and <b>Demand</b> .
<b><u>Operation</u></b>	A scheduled or planned action relating to the operation of a <b>System</b> (including an <b>Embedded Power Station</b> ).
<b><u>Operational Data</u></b>	Data required under the <b>Operating Codes</b> and/or <b>Balancing Codes</b> .
<b><u>Operational Day</u></b>	The period from 0500 hours on one day to 0500 on the following day.
<b><u>Operation Diagrams</u></b>	Diagrams which are a schematic representation of the <b>HV Apparatus</b> and the connections to all external circuits at a <b>Connection Site</b> , incorporating its numbering, nomenclature and labelling.
<b><u>Operational Effect</u></b>	Any effect on the operation of the relevant other <b>System</b> which causes the <b>GB Transmission System</b> or the <b>System</b> of the other <b>User</b> or <b>Users</b> , as the case may be, to operate (or be at a materially increased risk of operating) differently to the way in which they would or may have operated in the absence of that effect.
<b><u>Operational Intertripping</u></b>	The automatic tripping of circuit-breakers to prevent abnormal system conditions occurring, such as over voltage, overload, <b>System</b> instability, etc. after the tripping of other circuit-breakers following power <b>System</b> fault(s) which includes <b>System</b> to <b>Generating Unit</b> , <b>System</b> to <b>CCGT Module</b> , <b>System</b> to <b>Power Park Module</b> , <b>System</b> to <b>DC Converter</b> and <b>System</b> to <b>Demand</b> intertripping schemes.
<b><u>Operational Planning</u></b>	Planning through various timescales the matching of generation output with forecast <b>GB Transmission System Demand</b> together with a reserve of generation to provide a margin, taking into account outages of certain <b>Generating Units</b> , of parts of the <b>GB Transmission System</b> and of parts of <b>User Systems</b> to which <b>Power Stations</b> and/or <b>Customers</b> are connected, carried out to achieve, so far as possible, the standards of security set out in <b>NGET's Transmission Licence</b> , each <b>Relevant Transmission Licensee's Transmission Licence</b> or <b>Electricity Distribution Licence</b> , as the case may be.
<b><u>Operational Planning Margin</u></b>	An operational planning margin set by <b>NGET</b> .
<b><u>Operational Planning Phase</u></b>	The period from 8 weeks to the end of the 5 <sup>th</sup> year ahead of real time operation.

<b><u>Operational Procedures</u></b>	Management instructions and procedures, both in support of the <b>Safety Rules</b> and for the local and remote operation of <b>Plant</b> and <b>Apparatus</b> , issued in connection with the actual operation of <b>Plant</b> and/or <b>Apparatus</b> at or from a <b>Connection Site</b> .
<b><u>Operational Switching</u></b>	Operation of <b>Plant</b> and/or <b>Apparatus</b> to the instruction of the relevant <b>Control Engineer</b> . For the avoidance of doubt, the operation of <b>Transmission Plant</b> and/or <b>Apparatus</b> forming part of the <b>GB Transmission System</b> in England and Wales, will be to the instruction of <b>NGET</b> and in Scotland will be to the instruction of the <b>Relevant Transmission Licensee</b> .
<b><u>Other Relevant Data</u></b>	The data listed in BC1.4.2(f) under the heading <b>Other Relevant Data</b>
<b><u>Out of Synchronism</u></b>	The condition where a <b>System</b> or <b>Generating Unit</b> cannot meet the requirements to enable it to be <b>Synchronised</b> .
<b><u>Output Usable or OU</u></b>	The (daily or weekly) forecast value (in MW), at the time of the (daily or weekly) peak demand, of the maximum level at which the <b>Genset</b> can export to the <b>Grid Entry Point</b> , or in the case of <b>Embedded Power Stations</b> , to the <b>User System Entry Point</b> .
<b><u>Over-excitation Limiter</u></b>	Shall have the meaning ascribed to that term in <b>IEC 34-16-1:1991</b> [equivalent to <b>British Standard BS4999</b> Section 116.1 : 1992].
<b><u>Part 1 System Ancillary Services</u></b>	<b>Ancillary Services</b> which are required for <b>System</b> reasons and which must be provided by <b>Users</b> in accordance with the <b>Connection Conditions</b> . An exhaustive list of <b>Part 1 System Ancillary Services</b> is included in that part of CC.8.1 headed Part 1.
<b><u>Part 2 System Ancillary Services</u></b>	<b>Ancillary Services</b> which are required for <b>System</b> reasons and which must be provided by a <b>User</b> if the <b>User</b> has agreed to provide them under a <b>Bilateral Agreement</b> . A non-exhaustive list of <b>Part 2 System Ancillary Services</b> is included in that part of CC.8.1 headed Part 2.
<b><u>Part Load</u></b>	The condition of a <b>Genset</b> , or <b>Cascade Hydro Scheme</b> which is <b>Loaded</b> but is not running at its Maximum Export Limit.

**Permit for Work for proximity work**

In England and Wales, a document issued by **NGET** or a **User** in accordance with its respective **Safety Rules** to enable work to be carried out in accordance with OC8A.8 and which provides for **Safety Precautions** to be applied and maintained. An example format of **NGET's** permit for work is attached as Appendix E to **OC8A**.

In Scotland, a document issued by a **Relevant Transmission Licensee** or a **User** in accordance with its respective **Safety Rules** to enable work to be carried out in accordance with OC8B.8 and which provides for **Safety Precautions** to be applied and maintained. Example formats of the **Relevant Transmission Licensees'** permits for work are attached as Appendix E to **OC8B**.

**Partial Shutdown**

The same as a **Total Shutdown** except that all generation has ceased in a separate part of the **Total System** and there is no electricity supply from **External Interconnections** or other parts of the **Total System** to that part of the **Total System** and, therefore, that part of the **Total System** is shutdown, with the result that it is not possible for that part of the **Total System** to begin to function again without **NGET's** directions relating to a **Black Start**.

**Phase (Voltage) Unbalance**

The ratio (in percent) between the rms values of the negative sequence component and the positive sequence component of the voltage.

**Physical Notification**

Data that describes the **BM Participant's** best estimate of the expected input or output of **Active Power** of a **BM Unit** and/or (where relevant) **Generating Unit**.

**Planning Code or PC**

That portion of the **Grid Code** which is identified as the **Planning Code**.

**Planned Maintenance Outage**

An outage of **NGET** electronic data communication facilities as provided for in CC.6.5.8 and **NGET's** associated computer facilities of which normally at least 5 days notice is given, but in any event of which at least twelve hours notice has been given by **NGET** to the **User** and which is anticipated to last no longer than 2 hours. The length of such an outage may in exceptional circumstances be extended where at least 24 hours notice has been given by **NGET** to the **User**. It is anticipated that normally any planned outage would only last around one hour.

**Planned Outage**

An outage of a **Large Power Station** or of part of the **GB Transmission System**, or of part of a **User System**, co-ordinated by **NGET** under **OC2**.

**Plant**

Fixed and movable items used in the generation and/or supply and/or transmission of electricity, other than **Apparatus**.

**Point of Common Coupling**

That point on the **GB Transmission System** electrically nearest to the **User** installation at which either **Demands** or **Loads** are, or may be, connected.

<b><u>Point of Connection</u></b>	An electrical point of connection between the <b>GB Transmission System</b> and a <b>User's System</b> .
<b><u>Point of Isolation</u></b>	The point on <b>Apparatus</b> (as defined in OC8A.1.6.2 and OC8B.1.7.2) at which <b>Isolation</b> is achieved.
<b><u>Post-Control Phase</u></b>	The period following real time operation.
<b><u>Power Factor</u></b>	The ratio of <b>Active Power</b> to <b>Apparent Power</b> .
<b><u>Power Island</u></b>	<b>Gensets</b> at an isolated <b>Power Station</b> , together with complementary local <b>Demand</b> . In Scotland a <b>Power Island</b> may include more than one <b>Power Station</b> .
<b><u>Power Park Module</u></b>	A collection of <b>Non-synchronous Generating Units</b> (registered as a <b>Power Park Module</b> under the <b>PC</b> ) that are powered by an <b>Intermittent Power Source</b> , joined together by a <b>System</b> with a single electrical point of connection to the <b>GB Transmission System</b> (or <b>User System</b> if <b>Embedded</b> ). The connection to the <b>GB Transmission System</b> (or <b>User System</b> if <b>Embedded</b> ) may include a <b>DC Converter</b> .
<b><u>Power Park Module Availability Matrix</u></b>	The matrix described in Appendix 1 to BC1 under the heading <b>Power Park Module Availability Matrix</b> .
<b><u>Power Park Module Planning Matrix</u></b>	A matrix in the form set out in Appendix 4 of OC2 showing the combination of <b>Power Park Units</b> within a <b>Power Park Module</b> which would be expected to be running under normal conditions.
<b><u>Power Park Unit</u></b>	A <b>Generating Unit</b> within a <b>Power Park Module</b> .
<b><u>Power Station</u></b>	An installation comprising one or more <b>Generating Units</b> or <b>Power Park Modules</b> (even where sited separately) owned and/or controlled by the same <b>Generator</b> , which may reasonably be considered as being managed as one <b>Power Station</b> .
<b><u>Power System Stabiliser or PSS</u></b>	Equipment controlling the <b>Exciter</b> output via the voltage regulator in such a way that power oscillations of the synchronous machines are dampened. Input variables may be speed, frequency or power (or a combination of these).
<b><u>Preface</u></b>	The preface to the <b>Grid Code</b> (which does not form part of the <b>Grid Code</b> and therefore is not binding).
<b><u>Preliminary Notice</u></b>	A notice in writing, sent by <b>NGET</b> both to all <b>Users</b> identified by it under OC12.4.2.1 and to the <b>Test Proposer</b> , notifying them of a proposed <b>System Test</b> .



**Preliminary Project Planning Data**

Data relating to a proposed **User Development** at the time the **User** applies for a **CUSC Contract** but before an offer is made and accepted.

**Primary Response**

The automatic increase in **Active Power** output of a **Genset** or, as the case may be, the decrease in **Active Power Demand** in response to a **System Frequency** fall. This increase in **Active Power** output or, as the case may be, the decrease in **Active Power Demand** must be in accordance with the provisions of the relevant **Ancillary Services Agreement** which will provide that it will be released increasingly with time over the period 0 to 10 seconds from the time of the start of the **Frequency** fall on the basis set out in the **Ancillary Services Agreement** and fully available by the latter, and sustainable for at least a further 20 seconds. The interpretation of the **Primary Response** to a – 0.5 Hz frequency change is shown diagrammatically in Figure CC.A.3.2.

**Programming Phase**

The period between **Operational Planning Phase** and the **Control Phase**. It starts at the 8 weeks ahead stage and finishes at 17:00 on the day ahead of real time.

**Proposal Notice**

A notice submitted to **NGET** by a **User** which would like to undertake a **System Test**.

**Proposal Report**

A report submitted by the **Test Panel** which contains:

- a) proposals for carrying out a **System Test** (including the manner in which the **System Test** is to be monitored);
- b) an allocation of costs (including un-anticipated costs) between the affected parties (the general principle being that the **Test Proposer** will bear the costs); and
- c) such other matters as the **Test Panel** considers appropriate.

The report may include requirements for indemnities to be given in respect of claims and losses arising from a **System Test**.

**Protection**

The provisions for detecting abnormal conditions on a **System** and initiating fault clearance or actuating signals or indications.

**Protection Apparatus**

A group of one or more **Protection** relays and/or logic elements designated to perform a specified **Protection** function.

**Pumped Storage Generator**

A **Generator** which owns and/or operates any **Pumped Storage Plant**.

**Pumped Storage Plant**

The Dinorwig, Ffestiniog, Cruachan and Foyers **Power Stations**.

**Pumped Storage Unit**

A **Generating Unit** within a **Pumped Storage Plant**.

**Quiescent Physical Notification or QPN**

Data that describes the MW levels to be deducted from the **Physical Notification** of a **BM Unit** to determine a resultant operating level to which the **Dynamic Parameters** associated with that **BM Unit** apply, and the associated times for such MW levels. The MW level of the **QPN** must always be set to zero.

**Range CCGT Module**

A **CCGT Module** where there is a physical connection by way of a steam or hot gas main between that **CCGT Module** and another **CCGT Module** or other **CCGT Modules**, which connection contributes (if open) to efficient modular operation, and which physical connection can be varied by the operator.

**Rated Field Voltage**

Shall have the meaning ascribed to that term in **IEC 34-16-1:1991** [equivalent to **British Standard BS4999** Section 116.1 : 1992].

**Rated MW**

The “rating-plate” MW output of a **Generating Unit, Power Park Module** or **DC Converter**, being:

- (a) that output up to which the **Generating Unit** was designed to operate (Calculated as specified in **British Standard BS EN 60034 – 1: 1995**);  
or
- (b) the nominal rating for the MW output of a **Power Park Module** being the maximum continuous electric output power which the **Power Park Module** was designed to achieve under normal operating conditions;  
or
- (c) the nominal rating for the MW import capacity and export capacity (if at a **DC Converter Station**) of a **DC Converter**.

**Reactive Energy**

The integral with respect to time of the **Reactive Power**.

**Reactive Power**

The product of voltage and current and the sine of the phase angle between them measured in units of voltamperes reactive and standard multiples thereof, ie:

$$\begin{aligned} 1000 \text{ VAr} &= 1 \text{ kVAr} \\ 1000 \text{ kVAr} &= 1 \text{ Mvar} \end{aligned}$$

**Record of Inter-System Safety Precautions or RISSP**

A written record of inter-system **Safety Precautions** to be compiled in accordance with the provisions of **OC8**.

### Registered Capacity

- (a) In the case of a **Generating Unit** other than that forming part of a **CCGT Module** or **Power Park Module**, the normal full load capacity of a **Generating Unit** as declared by the **Generator**, less the MW consumed by the **Generating Unit** through the **Generating Unit's Unit Transformer** when producing the same (the resultant figure being expressed in whole MW).
- (b) In the case of a **CCGT Module** or **Power Park Module**, the normal full load capacity of the **CCGT Module** or **Power Park Module** (as the case may be) as declared by the **Generator**, being the **Active Power** declared by the **Generator** as being deliverable by the **CCGT Module** or **Power Park Module** at the **Grid Entry Point** (or in the case of an **Embedded CCGT Module** or **Power Park Module**, at the **User System Entry Point**), expressed in whole MW.
- (c) In the case of a **Power Station**, the maximum amount of **Active Power** deliverable by the **Power Station** at the **Grid Entry Point** (or in the case of an **Embedded Power Station** at the **User System Entry Point**), as declared by the **Generator**, expressed in whole MW. The maximum **Active Power** deliverable is the maximum amount deliverable simultaneously by the **Generating Units** and/or **CCGT Modules** and/or **Power Park Modules** less the MW consumed by the **Generating Units** and/or **CCGT Modules** in producing that **Active Power**.
- (d) In the case of a **DC Converter** at a **DC Converter Station**, the normal full load amount of **Active Power** transferable from a **DC Converter** at the **Grid Entry Point** (or in the case of an **Embedded DC Converter Station** at the **User System Entry Point**), as declared by the **DC Converter Station** owner, expressed in whole MW.
- (e) In the case of a **DC Converter Station**, the maximum amount of **Active Power** transferable from a **DC Converter Station** at the **Grid Entry Point** (or in the case of an **Embedded DC Converter Station** at the **User System Entry Point**), as declared by the **DC Converter Station** owner, expressed in whole MW.

### Registered Data

Those items of **Standard Planning Data** and **Detailed Planning Data** which upon connection become fixed (subject to any subsequent changes).

### Registered Import Capability

In the case of a **DC Converter Station** containing **DC Converters** connected to an **External System**, the maximum amount of **Active Power** transferable into a **DC Converter Station** at the **Grid Entry Point** (or in the case of an **Embedded DC Converter Station** at the **User System Entry Point**), as declared by the **DC Converter Station** owner, expressed in whole MW.

In the case of a **DC Converter** connected to an **External System** and in a **DC Converter Station**, the normal full load amount of **Active Power** transferable into a **DC Converter** at the **Grid Entry Point** (or in the case of an **Embedded DC Converter Station** at the **User System Entry Point**), as declared by the **DC Converter** owner, expressed in whole MW.

<b><u>Regulations</u></b>	The Utilities Contracts Regulations 1996, as amended from time to time.
<b><u>Reheater Time Constant</u></b>	Determined at <b>Registered Capacity</b> , the reheater time constant will be construed in accordance with the principles of the IEEE Committee Report "Dynamic Models for Steam and Hydro Turbines in Power System Studies" published in 1973 which apply to such phrase.
<b><u>Relevant Transmission Licensee</u></b>	Means SP Transmission Ltd ( <b>SPT</b> ) in its <b>Transmission Area</b> and Scottish Hydro-Electric Transmission Ltd ( <b>SHETL</b> ) in its <b>Transmission Area</b> .
<b><u>Remote Transmission Assets</u></b>	Any <b>Plant</b> and <b>Apparatus</b> or meters owned by <b>NGET</b> which: <ul style="list-style-type: none"> <li>a) are <b>Embedded</b> in a <b>User System</b> and which are not directly connected by <b>Plant</b> and/or <b>Apparatus</b> owned by <b>NGET</b> to a sub-station owned by <b>NGET</b>; and</li> <li>b) are by agreement between <b>NGET</b> and such <b>User</b> operated under the direction and control of such <b>User</b>.</li> </ul>
<b><u>Requesting Safety Co-ordinator</u></b>	The <b>Safety Co-ordinator</b> requesting <b>Safety Precautions</b> .
<b><u>Responsible Engineer/Operator</u></b>	A person nominated by a <b>User</b> to be responsible for <b>System</b> control.
<b><u>Responsible Manager</u></b>	A manager who has been duly authorised by a <b>User</b> or <b>NGET</b> to sign <b>Site Responsibility Schedules</b> on behalf of that <b>User</b> or <b>NGET</b> , as the case may be.  For <b>Connection Sites</b> in Scotland a manager who has been duly authorised by the <b>Relevant Transmission Licensee</b> to sign <b>Site Responsibility Schedules</b> on behalf of that <b>Relevant Transmission Licensee</b> .
<b><u>Re-synchronisation</u></b>	The bringing of parts of the <b>Network Operator's User System</b> which have become <b>Out of Synchronism</b> with each other back into <b>Synchronism</b> , and like terms shall be construed accordingly.
<b><u>Safety Co-ordinator</u></b>	A person or persons nominated by <b>NGET</b> and each <b>User</b> in relation to <b>Connection Points</b> in England and Wales and/or by the <b>Relevant Transmission Licensee</b> and each <b>User</b> in relation to <b>Connection Points</b> in Scotland to be responsible for the co-ordination of <b>Safety Precautions</b> at each <b>Connection Point</b> when work (which includes testing) is to be carried out on a <b>System</b> which necessitates the provision of <b>Safety Precautions</b> on <b>HV Apparatus</b> (as defined in OC8A.1.6.2 and OC8B.1.7.2), pursuant to <b>OC8</b> .

<b><u>Safety From The System</u></b>	That condition which safeguards persons when work is to be carried out on or near a <b>System</b> from the dangers which are inherent in the <b>System</b> .
<b><u>Safety Key</u></b>	A key unique at the <b>Location</b> capable of operating a lock which will cause an <b>Isolating Device</b> and/or <b>Earthing Device</b> to be <b>Locked</b> .
<b><u>Safety Log</u></b>	A chronological record of messages relating to safety co-ordination sent and received by each <b>Safety Co-ordinator</b> under <b>OC8</b> .
<b><u>Safety Precautions</u></b>	<b>Isolation</b> and/or <b>Earthing</b> .
<b><u>Safety Rules</u></b>	The rules of <b>NGET</b> (in England and Wales) and the <b>Relevant Transmission Licensee</b> (in Scotland) or a <b>User</b> that seek to ensure that persons working on <b>Plant</b> and/or <b>Apparatus</b> to which the rules apply are safeguarded from hazards arising from the <b>System</b> .
<b><u>Secondary Response</u></b>	The automatic increase in <b>Active Power</b> output of a <b>Genset</b> or, as the case may be, the decrease in <b>Active Power Demand</b> in response to a <b>System Frequency</b> fall. This increase in <b>Active Power</b> output or, as the case may be, the decrease in <b>Active Power Demand</b> must be in accordance with the provisions of the relevant <b>Ancillary Services Agreement</b> which will provide that it will be fully available by 30 seconds from the time of the start of the <b>Frequency</b> fall and be sustainable for at least a further 30 minutes. The interpretation of the <b>Secondary Response</b> to a -0.5 Hz frequency change is shown diagrammatically in Figure CC.A.3.2.
<b><u>Secretary of State</u></b>	Has the same meaning as in the <b>Act</b> .
<b><u>Secured Event</u></b>	Has the meaning set out in the <b>Security and Quality of Supply Standard</b> .
<b><u>Security and Quality of Supply Standard</u></b>	The version of the document entitled 'Security and Quality of Supply Standard' established pursuant to the <b>Transmission Licence</b> in force at the time of entering into the relevant <b>Bilateral Agreement</b> .
<b><u>Settlement Period</u></b>	A period of 30 minutes ending on the hour and half-hour in each hour during a day.
<b><u>Seven Year Statement</u></b>	A statement, prepared by <b>NGET</b> in accordance with the terms of <b>NGET's Transmission Licence</b> , showing for each of the seven succeeding <b>Financial Years</b> , the opportunities available for connecting to and using the <b>GB Transmission System</b> and indicating those parts of the <b>GB Transmission System</b> most suited to new connections and transport of further quantities of electricity.
<b><u>SF<sub>6</sub> Gas Zone</u></b>	A segregated zone surrounding electrical conductors within a casing containing SF <sub>6</sub> gas.

## SHETL

Scottish Hydro-Electric Transmission Limited

### Shutdown

The condition of a **Generating Unit** where the generator rotor is at rest or on barring.

### Significant Incident

An **Event** which either:

- a) was notified by a **User** to **NGET** under **OC7**, and which **NGET** considers has had or may have had a significant effect on the **GB Transmission System**, and **NGET** requires the **User** to report that **Event** in writing in accordance with **OC10** and notifies the **User** accordingly; or
- b) was notified by **NGET** to a **User** under **OC7**, and which that **User** considers has had or may have had a significant effect on that **User's System**, and that **User** requires **NGET** to report that **Event** in writing in accordance with the provisions of **OC10** and notifies **NGET** accordingly.

### Simultaneous Tap Change

A tap change implemented on the generator step-up transformers of **Synchronised Gensets**, effected by **Generators** in response to an instruction from **NGET** issued simultaneously to the relevant **Power Stations**. The instruction, preceded by advance notice, must be effected as soon as possible, and in any event within one minute of receipt from **NGET** of the instruction.

### Single Line Diagram

A schematic representation of a three-phase network in which the three phases are represented by single lines. The diagram shall include (but not necessarily be limited to) busbars, overhead lines, underground cables, power transformers and reactive compensation equipment. It shall also show where **Large Power Stations** are connected, and the points at which **Demand** is supplied.

### Single Point of Connection

A single **Point of Connection**, with no interconnection through the **User's System** to another **Point of Connection**.

### Site Common Drawings

Drawings prepared for each **Connection Site** which incorporate **Connection Site** layout drawings, electrical layout drawings, common protection/ control drawings and common services drawings.

### Site Responsibility Schedule

A schedule containing the information and prepared on the basis of the provisions set out in Appendix 1 of the **CC**.

### Slope

The ratio of the steady state change in voltage to the steady state change in **Reactive Power** output.

### Small Power Station

A **Power Station** in **NGET's Transmission Area** with a **Registered Capacity** of less than 50MW or a **Power Station** in **SPT's** or **SHETL's Transmission Area** with a **Registered Capacity** of less than 5 MW.

<b><u>Speeder Motor Setting Range</u></b>	The minimum and maximum no-load speeds (expressed as a percentage of rated speed) to which the turbine is capable of being controlled, by the speeder motor or equivalent, when the <b>Generating Unit</b> terminals are on open circuit.
<b><u>SPT</u></b>	SP Transmission Limited
<b><u>Standard Planning Data</u></b>	The general data required by <b>NGET</b> under the <b>PC</b> . It is generally also the data which <b>NGET</b> requires from a new <b>User</b> in an application for a <b>CUSC Contract</b> , as reflected in the <b>PC</b> .
<b><u>Start Time</u></b>	The time named as such in an instruction issued by <b>NGET</b> pursuant to the <b>BCs</b> .
<b><u>Start-Up</u></b>	The action of bringing a <b>Generating Unit</b> from <b>Shutdown</b> to <b>Synchronous Speed</b> .
<b><u>Statement of Readiness</u></b>	Has the meaning set out in the <b>Bilateral Agreement</b> and/or <b>Construction Agreement</b> .
<b><u>Station Board</u></b>	A switchboard through which electrical power is supplied to the <b>Auxiliaries</b> of a <b>Power Station</b> , and which is supplied by a <b>Station Transformer</b> . It may be interconnected with a <b>Unit Board</b> .
<b><u>Station Transformer</u></b>	A transformer supplying electrical power to the <b>Auxiliaries</b> of <ul style="list-style-type: none"> <li>• a <b>Power Station</b>, which is not directly connected to the <b>Generating Unit</b> terminals (typical voltage ratios being 132/11kV or 275/11kV), or</li> <li>• a <b>DC Converter Station</b>.</li> </ul>
<b><u>STC Committee</u></b>	The committee established under the <b>STC</b> .
<b><u>Steam Unit</u></b>	A <b>Generating Unit</b> whose prime mover converts the heat-energy in steam to mechanical energy.
<b><u>Subtransmission System</u></b>	The part of a <b>User's System</b> which operates at a single transformation below the voltage of the relevant <b>Transmission System</b> .
<b><u>Supergrid Voltage</u></b>	Any voltage greater than 200kV.

### Supplier

- (a) A person supplying electricity under an **Electricity Supply Licence**; or
  - (b) A person supplying electricity under exemption under the **Act**;
- in each case acting in its capacity as a supplier of electricity to **Customers** in **Great Britain**.

### Surplus

A MW figure relating to a **System Zone** equal to the total **Output Usable** in the **System Zone**:

- a) minus the forecast of **Active Power Demand** in the **System Zone**, and
  - b) minus the export limit in the case of an export limited **System Zone**,
- or
- plus the import limit in the case of an import limited **System Zone**,
- and
- c) (only in the case of a **System Zone** comprising the **GB Transmission System**) minus the **Operational Planning Margin**.

For the avoidance of doubt, a **Surplus** of more than zero in an export limited **System Zone** indicates an excess of generation in that **System Zone**; and a **Surplus** of less than zero in an import limited **System Zone** indicates insufficient generation in that **System Zone**.

### Synchronised

- a) The condition where an incoming **Generating Unit or Power Park Module or DC Converter or System** is connected to the busbars of another **System** so that the **Frequencies** and phase relationships of that **Generating Unit, Power Park Module, DC Converter or System**, as the case may be, and the **System** to which it is connected are identical, like terms shall be construed accordingly.
- b) The condition where an importing **BM Unit** is consuming electricity.

### Synchronising Generation

The amount of MW (in whole MW) produced at the moment of synchronising.

### Synchronising Group

A group of two or more **Gensets**) which require a minimum time interval between their **Synchronising** or **De-Synchronising** times.

### Synchronous Compensation

The operation of rotating synchronous **Apparatus** for the specific purpose of either the generation or absorption of **Reactive Power**.



**Synchronous  
Generating Unit**

A **Generating Unit** including, for the avoidance of doubt, a **CCGT Unit** in which, under all steady state conditions, the rotor rotates at a mechanical speed equal to the electrical frequency of the **GB Transmission System** divided by the number of pole pairs of the **Generating Unit** .

**Synchronous Speed**

That speed required by a **Generating Unit** to enable it to be **Synchronised** to a **System**.

**System**

Any **User System** and/or the **GB Transmission System**, as the case may be.

**System Ancillary Services**

Collectively **Part 1 System Ancillary Services** and **Part 2 System Ancillary Services**.

**System Constraint**

A limitation on the use of a **System** due to lack of transmission capacity or other **System** conditions.

**System Constrained Capacity**

That portion of **Registered Capacity** or **Registered Import Capacity** not available due to a **System Constraint**.

**System Constraint Group**

A part of the **GB Transmission System** which, because of **System Constraints**, is subject to limits of **Active Power** which can flow into or out of (as the case may be) that part.

**System Fault Dependability Index or Dp**

A measure of the ability of **Protection** to initiate successful tripping of circuit-breakers which are associated with a faulty item of **Apparatus**. It is calculated using the formula:

$$Dp = 1 - F_1/A$$

Where:

A = Total number of **System** faults

F<sub>1</sub> = Number of **System** faults where there was a failure to trip a circuit-breaker.

**System Margin**

The margin in any period between

- (a) the sum of Maximum Export Limits and
  - (b) forecast **Demand** and the **Operating Margin**,
- for that period.

**System Negative Reserve Active Power Margin or System NRAPM**

That margin of **Active Power** sufficient to allow the largest loss of **Load** at any time.

**System Operator - Transmission Owner Code or STC**

Has the meaning set out in **NGET's Transmission Licence**

**System Tests**

Tests which involve simulating conditions, or the controlled application of irregular, unusual or extreme conditions, on the **Total System**, or any part of the **Total System**, but which do not include commissioning or recommissioning tests or any other tests of a minor nature.

**System to Demand Intertrip Scheme**

An intertrip scheme which disconnects **Demand** when a **System** fault has arisen to prevent abnormal conditions occurring on the **System**.

**System to Generator Operational Intertripping**

A **Balancing Service** involving the initiation by a **System to Generator Operational Intertripping Scheme** of automatic tripping of the **User's** circuit breaker(s) resulting in the tripping of **BM Unit(s)** or (where relevant) **Generating Unit(s)** comprised in a **BM Unit** to prevent abnormal system conditions occurring, such as over voltage, overload, **System** instability, etc, after the tripping of other circuit-breakers following power **System** fault(s).

**System to Generator Operational Intertripping Scheme**

A **System to Generating Unit** or **System to CCGT Module Intertripping Scheme** forming a condition of connection and specified in Appendix F3 of the relevant **Bilateral Agreement**, being either a **Category 1 Intertripping Scheme**, **Category 2 Intertripping Scheme**, **Category 3 Intertripping Scheme** or **Category 4 Intertripping Scheme**.

**System Zone**

A region of the **GB Transmission System** within a described boundary or the whole of the **GB Transmission System**, as further provided for in OC2.2.4, and the term "**Zonal**" will be construed accordingly.

**Target Frequency**

That **Frequency** determined by **NGET**, in its reasonable opinion, as the desired operating **Frequency** of the **Total System**. This will normally be 50.00Hz plus or minus 0.05Hz, except in exceptional circumstances as determined by **NGET**, in its reasonable opinion when this may be 49.90 or 50.10Hz. An example of exceptional circumstances may be difficulties caused in operating the **System** during disputes affecting fuel supplies.

**Technical Specification**

In relation to **Plant** and/or **Apparatus**,

- a) the relevant **European Specification**; or
- b) if there is no relevant **European Specification**, other relevant standards which are in common use in the European Community.

<b><u>Test Co-ordinator</u></b>	A person who co-ordinates <b>System Tests</b> .
<b><u>Test Panel</u></b>	A panel, whose composition is detailed in <b>OC12</b> , which is responsible, inter alia, for considering a proposed <b>System Test</b> , and submitting a <b>Proposal Report</b> and a <b>Test Programme</b> .
<b><u>Test Programme</u></b>	A programme submitted by the <b>Test Panel</b> to <b>NGET</b> , the <b>Test Proposer</b> , and each <b>User</b> identified by <b>NGET</b> under OC12.4.2.1, which states the switching sequence and proposed timings of the switching sequence, a list of those staff involved in carrying out the <b>System Test</b> (including those responsible for the site safety) and such other matters as the <b>Test Panel</b> deems appropriate.
<b><u>Test Proposer</u></b>	The person who submits a <b>Proposal Notice</b> .
<b><u>Total Shutdown</u></b>	The situation existing when all generation has ceased and there is no electricity supply from <b>External Interconnections</b> and, therefore, the <b>Total System</b> has shutdown with the result that it is not possible for the <b>Total System</b> to begin to function again without <b>NGET's</b> directions relating to a <b>Black Start</b> .
<b><u>Total System</u></b>	The <b>GB Transmission System</b> and all <b>User Systems</b> in <b>Great Britain</b> .
<b><u>Trading Point</u></b>	A commercial and, where so specified in the <b>Grid Code</b> , an operational interface between a <b>User</b> and <b>NGET</b> , which a <b>User</b> has notified to <b>NGET</b> .
<b><u>Transfer Date</u></b>	Such date as may be appointed by the <b>Secretary of State</b> by order under section 65 of the <b>Act</b> .
<b><u>Transmission</u></b>	Means, when used in conjunction with another term relating to equipment or a site, whether defined or not, that the associated term is to be read as being part of or directly associated with the <b>GB Transmission System</b> , and not of or with the <b>User System</b> .
<b><u>Transmission Area</u></b>	Has the meaning set out in the <b>Transmission Licence</b> of a <b>Transmission Licensee</b> .
<b><u>Transmission Entry Capacity</u></b>	Has the meaning set out in the <b>CUSC</b> .
<b><u>Transmission Licence</u></b>	A licence granted under Section 6(1)(b) of the <b>Act</b> .
<b><u>Transmission Licensee</u></b>	Means the holder for the time being of a <b>Transmission Licence</b> .

<b><u>Transmission Site</u></b>	In England and Wales, means a site owned (or occupied pursuant to a lease, licence or other agreement) by <b>NGET</b> in which there is a <b>Connection Point</b> . For the avoidance of doubt, a site owned by a <b>User</b> but occupied by <b>NGET</b> as aforesaid, is a <b>Transmission Site</b> .
	In Scotland, means a site owned (or occupied pursuant to a lease, licence or other agreement) by a <b>Relevant Transmission Licensee</b> in which there is a <b>Connection Point</b> . For the avoidance of doubt, a site owned by a <b>User</b> but occupied by the <b>Relevant Transmission Licensee</b> as aforesaid, is a <b>Transmission Site</b> .
<b><u>Transmission System</u></b>	Has the same meaning as the term "licensee's transmission system" in the <b>Transmission Licence</b> of a <b>Transmission Licensee</b> .
<b><u>Turbine Time Constant</u></b>	Determined at <b>Registered Capacity</b> , the turbine time constant will be construed in accordance with the principles of the IEEE Committee Report "Dynamic Models for Steam and Hydro Turbines in Power System Studies" published in 1973 which apply to such phrase.
<b><u>Two Shifting Limit</u></b>	The maximum number of times in any <b>Operational Day</b> that a <b>Genset</b> may <b>De-Synchronise</b> .
<b><u>Unbalanced Load</u></b>	The situation where the <b>Load</b> on each phase is not equal.
<b><u>Under-excitation Limiter</u></b>	Shall have the meaning ascribed to that term in <b>IEC 34-16-1:1991</b> [equivalent to <b>British Standard BS4999</b> Section 116.1 : 1992].
<b><u>Under Frequency Relay</u></b>	An electrical measuring relay intended to operate when its characteristic quantity ( <b>Frequency</b> ) reaches the relay settings by decrease in <b>Frequency</b> .
<b><u>Unit Board</u></b>	A switchboard through which electrical power is supplied to the <b>Auxiliaries</b> of a <b>Generating Unit</b> and which is supplied by a <b>Unit Transformer</b> . It may be interconnected with a <b>Station Board</b> .
<b><u>Unit Transformer</u></b>	A transformer directly connected to a <b>Generating Unit's</b> terminals, and which supplies power to the <b>Auxiliaries</b> of a <b>Generating Unit</b> . Typical voltage ratios are 23/11kV and 15/6.6Kv.
<b><u>Unit Load Controller Response Time Constant</u></b>	The time constant, expressed in units of seconds, of the power output increase which occurs in the <b>Secondary Response</b> timescale in response to a step change in <b>System Frequency</b> .
<b><u>User</u></b>	A term utilised in various sections of the <b>Grid Code</b> to refer to the persons using the <b>GB Transmission System</b> , as more particularly identified in each section of the <b>Grid Code</b> concerned. In the <b>Preface</b> and the <b>General Conditions</b> the term means any person to whom the <b>Grid Code</b> applies.

### User Development

In the **PC** means either **User's Plant** and/or **Apparatus** to be connected to the **GB Transmission System**, or a **Modification** relating to a **User's Plant** and/or **Apparatus** already connected to the **GB Transmission System**, or a proposed new connection or **Modification** to the connection within the **User System**.

### User Site

In England and Wales, a site owned (or occupied pursuant to a lease, licence or other agreement) by a **User** in which there is a **Connection Point**. For the avoidance of doubt, a site owned by **NGET** but occupied by a **User** as aforesaid, is a **User Site**.

In Scotland, a site owned (or occupied pursuant to a lease, licence or other agreement) by a **User** in which there is a **Connection Point**. For the avoidance of doubt, a site owned by a **Relevant Transmission Licensee** but occupied by a **User** as aforesaid, is a **User Site**.

### User System

Any system owned or operated by a **User** comprising:-

- (a) **Generating Units**; and/or
- (b) Systems consisting (wholly or mainly) of electric lines used for the distribution of electricity from **Grid Supply Points** or **Generating Units** or other entry points to the point of delivery to **Customers**, or other **Users**;

and **Plant** and/or **Apparatus** connecting:-

- (c) The system as described above; or
- (d) **Non-Embedded Customers** equipment;

to the **GB Transmission System** or to the relevant other **User System**, as the case may be.

The **User System** includes any **Remote Transmission Assets** operated by such **User** or other person and any **Plant** and/or **Apparatus** and meters owned or operated by the **User** or other person in connection with the distribution of electricity but does not include any part of the **GB Transmission System**.

### User System Entry Point

A point at which a **Generating Unit**, a **CCGT Module** or a **CCGT Unit** or a **Power Park Module** or a **DC Converter**, as the case may be, which is **Embedded** connects to the **User System**.

### Water Time Constant

Bears the meaning ascribed to the term "Water inertia time" in **IEC308**.

**Weekly ACS Conditions**

Means that particular combination of weather elements that gives rise to a level of peak **Demand** within a week, taken to commence on a Monday and end on a Sunday, which has a particular chance of being exceeded as a result of weather variation alone. This particular chance is determined such that the combined probabilities of **Demand** in all weeks of the year exceeding the annual peak **Demand** under **Annual ACS Conditions** is 50%, and in the week of maximum risk the weekly peak **Demand** under **Weekly ACS Conditions** is equal to the annual peak **Demand** under **Annual ACS Conditions**.

**Zonal System Security Requirements**

That generation required, within the boundary circuits defining the **System Zone**, which when added to the secured transfer capability of the boundary circuits exactly matches the **Demand** within the **System Zone**.

A number of the terms listed above are defined in other documents, such as the **Balancing and Settlement Code** and the **Transmission Licence**. Appendix 1 sets out the current definitions from the other documents of those terms so used in the **Grid Code** and defined in other documents for ease of reference, but does not form part of the **Grid Code**.

## 2. Construction of References

In the **Grid Code**:

- (i) a table of contents, a Preface, a Revision section, headings, and the Appendix to this **Glossary and Definitions** are inserted for convenience only and shall be ignored in construing the **Grid Code**;
- (ii) unless the context otherwise requires, all references to a particular paragraph, subparagraph, Appendix or Schedule shall be a reference to that paragraph, subparagraph Appendix or Schedule in or to that part of the **Grid Code** in which the reference is made;
- (iii) unless the context otherwise requires, the singular shall include the plural and vice versa, references to any gender shall include all other genders and references to persons shall include any individual, body corporate, corporation, joint venture, trust, unincorporated association, organisation, firm or partnership and any other entity, in each case whether or not having a separate legal personality;
- (iv) references to the words "include" or "including" are to be construed without limitation to the generality of the preceding words;
- (v) unless there is something in the subject matter or the context which is inconsistent therewith, any reference to an Act of Parliament or any Section of or Schedule to, or other provision of an Act of Parliament shall be construed at the particular time, as including a reference to any modification, extension or re-enactment thereof then in force and to all instruments, orders and regulations then in force and made under or deriving validity from the relevant Act of Parliament;
- (vi) where the **Glossary and Definitions** refers to any word or term which is more particularly defined in a part of the **Grid Code**, the definition in that part of the **Grid Code** will prevail (unless otherwise stated) over the definition in the **Glossary & Definitions** in the event of any inconsistency;
- (vii) a cross-reference to another document or part of the **Grid Code** shall not of itself impose any additional or further or co-existent obligation or confer any additional or further or co-existent right in the part of the text where such cross-reference is contained;
- (viii) nothing in the **Grid Code** is intended to or shall derogate from **NGET's** statutory or licence obligations;
- (ix) a "holding company" means, in relation to any person, a holding company of such person within the meaning of section 736, 736A and 736B of the Companies Act 1985 as substituted by section 144 of the Companies Act 1989 and, if that latter section is not in force at the **Transfer Date**, as if such latter section were in force at such date;
- (x) a "subsidiary" means, in relation to any person, a subsidiary of such person within the meaning of section 736, 736A and 736B of the Companies Act 1985 as substituted by section 144 of the Companies Act 1989 and, if that latter section is not in force at the **Transfer Date**, as if such latter section were in force at such date;
- (xi) references to time are to London time; and

- (xii) Where there is a reference to an item of data being expressed in a whole number of MW, fractions of a MW below 0.5 shall be rounded down to the nearest whole MW and fractions of a MW of 0.5 and above shall be rounded up to the nearest whole MW.

< End of GD >



## APPENDIX 1

### TERMS DEFINED IN OTHER DOCUMENTS

(This Appendix does not form part of the Grid Code)

The definitions detailed below are based on:

- The BSC Section X – V2.0 - 11<sup>th</sup> May 2001
- The Transmission Licence (TL) – September 2004
- Engineering Recommendation G5/4 - February 2001

<b>Term</b>	<b>Defined in</b>	<b>Definition</b>
Balancing Mechanism	TL	Means the mechanism for the making and acceptance of offers and bids pursuant to the arrangements contained in the BSC and referred to in paragraph 2(a) of standard condition C3 (Balancing and Settlement Code).
Balancing Mechanism Reporting Agent	BSC	Means the BSC Agent for Balancing Mechanism Reporting in accordance with Section E.
Balancing Mechanism Reporting Service	BSC	Means the service provided by the BMRA in accordance with Section V.
Bid-Offer Data	BSC	Data (comprising the items set out in Section Q4.1.3) to be submitted by the Transmission Company pursuant to Section Q6.2.1(d).
Bilateral Agreement	TL	Means a Bilateral Connection Agreement and/or a Bilateral Embedded Generation Agreement.
Bilateral Connection Agreement	TL	Means an agreement between the Licensee and a CUSC User supplemental to the CUSC relating to a direct connection to the GB Transmission System identifying the relevant connection site and setting out other site specific details in relation to that connection to the GB Transmission System, including provisions relating to payment of Connection Charges.
Bilateral Embedded Generation Agreement	TL	Means an agreement entered into between the Licensee and a CUSC User supplemental to the CUSC, relating to a generating station connected to a Distribution System and the use of the GB Transmission System in relation to that generating station identifying the relevant site of connection to the Distribution System and setting out other site specific details in relation to that use of the GB Transmission System.
BM Unit	BSC	Means a unit established and registered (or to be established and registered) by a Party in accordance with Section K3 or, where the context so requires, the Plant and/or Apparatus treated as comprised in or assigned to such unit for the purposes of the Code.
BSCCo	BSC	Means Elexon Limited (or any successor to that company acting in the capacity as BSCCo).

<b>Term</b>	<b>Defined in</b>	<b>Definition</b>
Construction Agreement	TL	Means an agreement between the Licensee and a CUSC User in respect of construction works required on the GB Transmission System and the associated construction works of the CUSC User in relation to a connection to the GB Transmission System or in relation to a generating station connected to a Distribution System, whether for the initial connection or a modification of the connection.
CUSC	TL	Means the Connection and Use of System Code provided for in paragraph 2 of standard condition C10 (Connection and Use of System Code), as from time to time modified in accordance with that condition.
CUSC Framework Agreement	TL	Means the agreement of that title, in the form approved by the Secretary of State, by which the CUSC is made contractually binding between the parties to that agreement, as amended from time to time with the approval of the Secretary of State.
Demand Capacity	BSC	Has the meaning given to that term in Section K3.4.8.
Electromagnetic Compatibility Level	ER G5/4	The specified disturbance level in a system which is expected to be exceeded only with small probability, this level being such that electromagnetic compatibility should exist for most equipment within the system.
Final Physical Notification Data	BSC	Means, in respect of a Settlement Period and a BM Unit, the data which is referred to in Section Q3.2.2 and which complies with the requirements of Section Q3.2.3.
Gate Closure	BSC	Means, in relation to a Settlement Period, the spot time 1 hour before the spot time at the start of that Settlement Period.
Generation Capacity	BSC	Has the meaning given to that term in Section K3.4.8.
Interconnector User	BSC	Means, in relation to an Interconnector, a Lead Party in respect of an Interconnector BM Unit other than the Interconnector Error Administrator.
Joint BM Unit Data	BSC	Means, in relation to a Joint BM Unit, the Teleswitch Group(s) and the teleswitched Standard Settlement Configuration(s) registered by a Supplier in relation to that BM Unit in accordance with Section K3.3.9.
Panel	BSC	Means the panel established pursuant to Section B1.1.1.

# PLANNING CODE

## CONTENTS

(This contents page does not form part of the Grid Code)

<u>Paragraph No/Title</u>	<u>Page Number</u>
PC.1 INTRODUCTION.....	1
PC.2 OBJECTIVE .....	2
PC.3 SCOPE .....	2
PC.4 PLANNING PROCEDURES .....	3
PC.4.2 Introduction to Data	4
PC.4.3 Data Provision	5
PC.4.4 Offer of Terms for connection	5
PC.4.5 Complex Connections	6
PC.5 PLANNING DATA .....	6
PC.6 PLANNING STANDARDS.....	9
<b>APPENDIX A - PLANNING DATA REQUIREMENTS.....</b>	<b>10</b>
PC.A.1 INTRODUCTION .....	10
PART 1 – STANDARD PLANNING DATA .....	14
PC.A.2 USER'S SYSTEM DATA .....	14
PC.A.2.1 Introduction	14
PC.A.2.2 User's System Layout	14
PC.A.2.3 Lumped System Susceptance	17
PC.A.2.4 Reactive Compensation Equipment	17
PC.A.2.5 Short Circuit Contribution to GB Transmission System	18
PC.A.3 GENERATING UNIT AND DC CONVERTER DATA.....	22
PC.A.3.1 Introduction	22
PC.A.3.2 Output Data	23
PC.A.3.3 Rated Parameters Data	27
PC.A.3.4 General Generating Unit, Power Park Module and DC Converter Data	28
PC.A.4 DEMAND AND ACTIVE ENERGY DATA .....	29
PC.A.4.1 Introduction	29

PC.A.4.2 Demand (Active Power) and Active Energy Data	29
PC.A.4.3 Connection Point Demand (Active and Reactive Power)	31
PC.A.4.5 Demand Transfer Capability	32
PC.A.4.6 Control of Demand or Reduction of Pumping Load Offered as Reserve	33
PC.A.4.7 General Demand Data	33
PART 2 – DETAILED PLANNING DATA .....	34
PC.A.5 GENERATING UNIT POWER PARK MODULE AND DC CONVERTER DATA.....	34
PC.A.5.1 Introduction	34
PC.A.5.2 Demand	35
PC.A.5.3 Synchronous Generating Unit and Associated Control System Data	35
PC.A.5.4 Non-Synchronous Generating Unit and Associated Control System Data	41
PC.A.5.5 Response data for Frequency changes	47
PC.A.5.6 Mothballed Generating Unit and Alternative Fuel Information	48
PC.A.6 USERS' SYSTEM DATA.....	49
PC.A.6.1 Introduction	49
PC.A.6.2 Transient Overvoltage Assessment Data	50
PC.A.6.3 User's Protection Data	50
PC.A.6.4 Harmonic Studies	51
PC.A.6.5 Voltage Assessment Studies	52
PC.A.6.6 Short Circuit Analysis	53
PC.A.7 ADDITIONAL DATA FOR NEW TYPES OF POWER STATIONS, DC CONVERTER STATIONS AND CONFIGURATIONS .....	53
PART 3 – NETWORK DATA .....	55
PC.A.8.1 Single Point of Connection	55
PC.A.8.2 Multiple Point of Connection	55
PC.A.8.3 Data Items	55
<b>APPENDIX B.....</b>	<b>58</b>
Single Line Diagrams	58
 <b>APPENDIX C</b>	
 PART 1 – SSE's TECHNICAL AND DESIGN CRITERIA	
PART 2 – SPT's TECHNICAL AND DESIGN CRITERIA	

## PLANNING CODE

### PC.1 INTRODUCTION

PC.1.1 The **Planning Code** ("PC") specifies the technical and design criteria and procedures to be applied by **NGET** in the planning and development of the **GB Transmission System** and to be taken into account by **Users** in the planning and development of their own **Systems**. It details information to be supplied by **Users** to **NGET**, and certain information to be supplied by **NGET** to **Users**. In Scotland, **NGET** has obligations under the **STC** to inform **Relevant Transmission Licensees** of data required for the planning of the **GB Transmission System**. **NGET** may pass on **User** data to a **Relevant Transmission Licensee** where **NGET** is required to do so under a provision of the **STC** current as at 1 April 2005. Those categories of **User** information that **NGET** is permitted to disclose to a **Relevant Transmission Licensee**, where required to do so by a provision of the **STC**, are set out in Schedule Three of the **STC** ('Information and data exchange specification').

PC.1.2 The **Users** referred to above are defined, for the purpose of the **PC**, in PC.3.1.

PC.1.3 Development of the **GB Transmission System**, involving its reinforcement or extension, will arise for a number of reasons including, but not limited to:

- (a) a development on a **User System** already connected to the **GB Transmission System**;
- (b) the introduction of a new **Connection Site** or the **Modification** of an existing **Connection Site** between a **User System** and the **GB Transmission System**;
- (c) the cumulative effect of a number of such developments referred to in (a) and (b) by one or more **Users**.

PC.1.4 Accordingly, the reinforcement or extension of the **GB Transmission System** may involve work:

- (a) at a substation at a **Connection Site** where **User's Plant** and/or **Apparatus** is connected to the **GB Transmission System**;
- (b) on transmission lines or other facilities which join that **Connection Site** to the remainder of the **GB Transmission System**;
- (c) on transmission lines or other facilities at or between points remote from that **Connection Site**.

PC.1.5 The time required for the planning and development of the **GB Transmission System** will depend on the type and extent of the necessary reinforcement and/or extension work, the need or otherwise for statutory planning consent, the associated possibility of the need for a public inquiry and the degree of complexity in undertaking the new work while maintaining satisfactory security and quality of supply on the existing **GB Transmission System**.

PC.2 OBJECTIVE

PC.2.1 The objectives of the **PC** are:

- (a) to promote **NGET/User** interaction in respect of any proposed development on the **User System** which may impact on the performance of the **GB Transmission System** or the direct connection with the **GB Transmission System**;
- (b) to provide for the supply of information to **NGET** from **Users** in order that planning and development of the **GB Transmission System** can be undertaken in accordance with the relevant **Licence Standards**, to facilitate existing and proposed connections, and also to provide for the supply of certain information from **NGET** to **Users** in relation to short circuit current contributions; and
- (c) to specify the **Licence Standards** which will be used in the planning and development of the **GB Transmission System**; and
- (d) to provide for the supply of information required by **NGET** from **Users** in respect of the following to enable **NGET** to carry out its duties under the **Act** and the **Transmission Licence**:
  - (i) **Mothballed Generating Units**; and
  - (ii) capability of gas-fired **Generating Units** to run using alternative fuels.

**NGET** will use the information provided under PC2.1(d) in providing reports to the **Authority** and the **Secretary of State** and, where directed by the **Authority** or the **Secretary of State** to do so, **NGET** may publish the information. Where it is known by **NGET** that such information is intended for wider publication the information provided under PC2.1(d) shall be aggregated such that individual data items should not be identifiable.

PC.3 SCOPE

PC.3.1 The **PC** applies to **NGET** and to **Users**, which in the **PC** means:

- (a) **Generators**;
- (b) **Network Operators**;
- (c) **Non-Embedded Customers**; and
- (d) **DC Converter Station** owners.

The above categories of **User** will become bound by the **PC** prior to them generating, operating, or consuming or importing/exporting, as the case may be, and references to the various categories (or to the general category) of

**User** should, therefore, be taken as referring to them in that prospective role as well as to **Users** actually connected.

PC.3.2

In the case of **Embedded Power Stations** and **Embedded DC Converters**, unless provided otherwise, the following provisions apply with regard to the provision of data under this **PC**:

- (a) each **Generator** shall provide the data direct to **NGET** in respect of (i) **Embedded Large Power Stations**, (ii) **Embedded Medium Power Stations** and (iii) **Embedded Small Power Stations** which form part of a **Cascade Hydro Scheme**;
- (b) each **DC Converter** owner shall provide the data direct to **NGET** in respect of **Embedded DC Converter Stations**;
- (c) although data is not normally required specifically on **Embedded Small Power Stations** or on **Embedded** installations of direct current converters which do not form a **DC Converter Station** under this **PC**, each **Network Operator** in whose **System** they are **Embedded** should provide the data (contained in the Appendix) to **NGET** in respect of **Embedded Small Power Stations** or **Embedded** installations of direct current converters which do not form a **DC Converter Station** if:
  - (i) it falls to be supplied pursuant to the application for a **CUSC Contract** or in the **Statement of Readiness** to be supplied in connection with a **Bilateral Agreement** and/or **Construction Agreement**, by the **Network Operator**; or
  - (ii) it is specifically requested by **NGET** in the circumstances provided for under this **PC**.

PC.3.3

Certain data does not normally need to be provided in respect of certain **Embedded Power Stations** or **Embedded DC Converter Stations**, as provided in PC.A.1.12.

PC.4

#### PLANNING PROCEDURES

PC.4.1

Pursuant to Condition C11 of **NGET's Transmission Licence**, the means by which **Users** and proposed **Users** of the **GB Transmission System** are able to assess opportunities for connecting to, and using, the **GB Transmission System** comprise two distinct parts, namely:

- (a) a statement, prepared by **NGET** under its **Transmission Licence**, showing for each of the seven succeeding **Financial Years**, the opportunities available for connecting to and using the **GB Transmission System** and indicating those parts of the **GB Transmission System** most suited to new connections and transport of further quantities of electricity (the "**Seven Year Statement**"); and
- (b) an offer, in accordance with its **Transmission Licence**, by **NGET** to enter into a **CUSC Contract** for connection to (or, in the case of

**Embedded Large Power Stations, Embedded Medium Power Stations and Embedded DC Converter Stations**, use of) the **GB Transmission System**. A **Bilateral Agreement** is to be entered into for every **Connection Site** (and for certain **Embedded Power Stations** and **Embedded DC Converter Stations**, as explained above) within the first two of the following categories and the existing **Bilateral Agreement** may be required to be varied in the case of the third category:

- (i) existing **Connection Sites** (and for certain **Embedded Power Stations**, as detailed above) as at the **Transfer Date**;
- (ii) new **Connection Sites** (and for certain **Embedded Power Stations** and for **Embedded DC Converter Stations**, as detailed above) with effect from the **Transfer Date**;
- (iii) a **Modification** at a **Connection Site** (or in relation to the connection of certain **Embedded Power Stations** and for **Embedded DC Converter Stations**, as detailed above) (whether such **Connection Site** or connection exist on the **Transfer Date** or are new thereafter) with effect from the **Transfer Date**.

In this **PC**, unless the context otherwise requires, "connection" means any of these 3 categories.

PC.4.2 Introduction to Data

User Data

PC.4.2.1 Under the **PC**, two types of data to be supplied by **Users** are called for:

- (a) **Standard Planning Data**; and
- (b) **Detailed Planning Data**,

as more particularly provided in PC.A.1.4.

PC.4.2.2 The **PC** recognises that these two types of data, namely **Standard Planning Data** and **Detailed Planning Data**, are considered at three different levels:

- (a) **Preliminary Project Planning Data**;
- (b) **Committed Project Planning Data**; and
- (c) **Connected Planning Data**,

as more particularly provided in **PC.5**

PC.4.2.3 **Connected Planning Data** is itself divided into:

- (a) **Forecast Data**;
- (b) **Registered Data**; and



(c) **Estimated Registered Data,**

as more particularly provided in PC.5.5

PC.4.2.4 Clearly, an existing **User** proposing a new **Connection Site** (or **Embedded Power Station** or **Embedded DC Converter Station** in the circumstances outlined in PC.4.1) will need to supply data both in an application for a **Bilateral Agreement** and under the **PC** in relation to that proposed new **Connection Site** (or **Embedded Power Station** or **Embedded DC Converter Station** in the circumstances outlined in PC.4.1) and that will be treated as **Preliminary Project Planning Data** or **Committed Project Planning Data** (as the case may be), but the data it supplies under the **PC** relating to its existing **Connection Sites** will be treated as **Connected Planning Data**.

Network Data

PC.4.2.5 In addition, there is **Network Data** supplied by **NGET** in relation to short circuit current contributions.

PC.4.3 Data Provision

PC.4.3.1 Seven Year Statement

To enable the **Seven Year Statement** to be prepared, each **User** is required to submit to **NGET** (subject to the provisions relating to **Embedded Power Stations** and **Embedded DC Converter Stations** in PC.3.2) both the **Standard Planning Data** and the **Detailed Planning Data** as listed in parts 1 and 2 of the Appendix. This data should be submitted in calendar week 24 of each year (although **Network Operators** may delay the submission until calendar week 28) and should cover each of the seven succeeding **Financial Years** (and in certain instances, the current year). Where, from the date of one submission to another, there is no change in the data (or in some of the data) to be submitted, instead of re-submitting the data, a **User** may submit a written statement that there has been no change from the data (or in some of the data) submitted the previous time. In addition, **NGET** will also use the **Transmission Entry Capacity** and **Connection Entry Capacity** data from the **CUSC Contract** in the preparation of the **Seven Year Statement** and to that extent the data will not be treated as confidential.

PC.4.3.2 Network Data

To enable **Users** to model the **GB Transmission System** in relation to short circuit current contributions, **NGET** is required to submit to **Users** the **Network Data** as listed in Part 3 of the Appendix. The data will be submitted in week 42 of each year and will cover that **Financial Year**.

PC.4.4 Offer of Terms for connection

PC.4.4.1 The completed application form for a **CUSC Contract** to be submitted by a **User** when making an application for a **CUSC Contract** will include:

- (a) a description of the **Plant** and/or **Apparatus** to be connected to the **GB Transmission System** or of the **Modification** relating to the **User's Plant** and/or **Apparatus** already connected to the **GB Transmission System** or, as the case may be, of the proposed new

connection or **Modification** to the connection within the **User System** of the **User**, each of which shall be termed a "**User Development**" in the **PC**;

- (b) the relevant **Standard Planning Data** as listed in Part 1 of the Appendix; and
- (c) the desired **Completion Date** of the proposed **User Development**.
- (d) the desired **Connection Entry Capacity** and **Transmission Entry Capacity**.

The completed application form for a **CUSC Contract** will be sent to **NGET** as more particularly provided in the application form.

PC.4.4.2 Any offer of a **CUSC Contract** will provide that it must be accepted by the applicant **User** within the period stated in the offer, after which the offer automatically lapses. Acceptance of the offer renders the **GB Transmission System** works relating to that **User Development**, reflected in the offer, committed and binds both parties to the terms of the offer. Within 28 days (or such longer period as **NGET** may agree in any particular case) of acceptance of the offer the **User** shall supply the **Detailed Planning Data** pertaining to the **User Development** as listed in Part 2 of the Appendix.

#### PC.4.5 Complex connections

PC.4.5.1 The magnitude and complexity of any **GB Transmission System** extension or reinforcement will vary according to the nature, location and timing of the proposed **User Development** which is the subject of the application and it may, in the event, be necessary for **NGET** to carry out additional more extensive system studies to evaluate more fully the impact of the proposed **User Development** on the **GB Transmission System**. Where **NGET** judges that such additional more detailed studies are necessary the offer may indicate the areas that require more detailed analysis and before such additional studies are required, the **User** shall indicate whether it wishes **NGET** to undertake the work necessary to proceed to make a revised offer within the 3 month period normally allowed or, where relevant, the timescale consented to by the **Authority**.

PC.4.5.2 To enable **NGET** to carry out any of the above mentioned necessary detailed system studies, the **User** may, at the request of **NGET**, be required to provide some or all of the **Detailed Planning Data** listed in part 2 of the Appendix in advance of the normal timescale referred in PC.4.4.2 provided that **NGET** can reasonably demonstrate that it is relevant and necessary.

#### PC.5 PLANNING DATA

PC.5.1 As far as the **PC** is concerned, there are three relevant levels of data in relation to **Users**. These levels, which relate to levels of confidentiality, commitment and validation, are described in the following paragraphs.

### Preliminary Project Planning Data

PC.5.2 At the time the **User** applies for a **CUSC Contract** but before an offer is made and accepted by the applicant **User**, the data relating to the proposed **User Development** will be considered as **Preliminary Project Planning Data**. This data will be treated as confidential within the scope of the provisions relating to confidentiality in the **CUSC**.

PC.5.3 **Preliminary Project Planning Data** will normally only contain the **Standard Planning Data** unless the **Detailed Planning Data** is required in advance of the normal timescale to enable **NGET** to carry out additional detailed system studies as described in PC.4.5.

### Committed Project Planning Data

PC.5.4 Once the offer for a **CUSC Contract** is accepted, the data relating to the **User Development** already submitted as **Preliminary Project Planning Data**, and subsequent data required by **NGET** under this **PC**, will become **Committed Project Planning Data**. This data, together with **Connection Entry Capacity** and **Transmission Entry Capacity** data from the **CUSC Contract** and other data held by **NGET** relating to the **GB Transmission System** will form the background against which new applications by any **User** will be considered and against which planning of the **GB Transmission System** will be undertaken. Accordingly, **Committed Project Planning Data**, **Connection Entry Capacity** and **Transmission Entry Capacity** data will not be treated as confidential to the extent that **NGET**:

- (a) is obliged to use it in the preparation of the **Seven Year Statement** and in any further information given pursuant to the **Seven Year Statement**;
- (b) is obliged to use it when considering and/or advising on applications (or possible applications) of other **Users** (including making use of it by giving data from it, both orally and in writing, to other **Users** making an application (or considering or discussing a possible application) which is, in **NGET's** view, relevant to that other application or possible application);
- (c) is obliged to use it for operational planning purposes;
- (d) is obliged under the terms of an **Interconnection Agreement** to pass it on as part of system information on the **Total System**.
- (e) is obliged to disclose it under **STC**.

To reflect different types of data, **Preliminary Project Planning Data** and **Committed Project Planning Data** are themselves divided into:

- (a) those items of **Standard Planning Data** and **Detailed Planning Data** which will always be forecast, known as **Forecast Data**; and

- (b) those items of **Standard Planning Data** and **Detailed Planning Data** which relate to **Plant** and/or **Apparatus** which upon connection will become **Registered Data**, but which prior to connection, for the seven succeeding **Financial Years**, will be an estimate of what is expected, known as **Estimated Registered Data**.

### **Connected Planning Data**

PC.5.5

The **PC** requires that, at the time that a **Statement of Readiness** is submitted under the **Bilateral Agreement** and/or **Construction Agreement**, any estimated values assumed for planning purposes are confirmed or, where practical, replaced by validated actual values and by updated estimates for the future and by updated forecasts for forecast data items such as **Demand**. This data is then termed **Connected Planning Data**.

To reflect the three types of data referred to above, **Connected Planning Data** is itself divided into:

- (a) those items of **Standard Planning Data** and **Detailed Planning Data** which will always be forecast data, known as **Forecast Data**; and
- (b) those items of **Standard Planning Data** and **Detailed Planning Data** which upon connection become fixed (subject to any subsequent changes), known as **Registered Data**; and
- (c) those items of **Standard Planning Data** and **Detailed Planning Data** which for the purposes of the **Plant** and/or **Apparatus** concerned as at the date of submission are **Registered Data** but which for the seven succeeding **Financial Years** will be an estimate of what is expected, known as **Estimated Registered Data**,

as more particularly provided in the Appendix.

PC.5.6

**Connected Planning Data**, together with **Connection Entry Capacity** and **Transmission Entry Capacity** data from the **CUSC Contract**, and other data held by **NGET** relating to the **GB Transmission System**, will form the background against which new applications by any **User** will be considered and against which planning of the **GB Transmission System** will be undertaken. Accordingly, **Connected Planning Data**, **Connection Entry Capacity** and **Transmission Entry Capacity** data will not be treated as confidential to the extent that **NGET**:

- (a) is obliged to use it in the preparation of the **Seven Year Statement** and in any further information given pursuant to the **Seven Year Statement**;
- (b) is obliged to use it when considering and/or advising on applications (or possible applications) of other **Users** (including making use of it by giving data from it, both orally and in writing, to other **Users** making an application (or considering or discussing a possible application) which is, in **NGET's** view, relevant to that other application or possible application);

- (c) is obliged to use it for operational planning purposes;
- (d) is obliged under the terms of an **Interconnection Agreement** to pass it on as part of system information on the **Total System**.
- (e) is obliged to disclose it under the **STC**.

PC.5.7 **Committed Project Planning Data** and **Connected Planning Data** will each contain both **Standard Planning Data** and **Detailed Planning Data**.

PC.6 PLANNING STANDARDS

PC.6.1 **NGET** shall apply the **Licence Standards** relevant to planning and development, in the planning and development of its **Transmission System**. **NGET** shall procure that each **Relevant Transmission Licensee** shall apply the **Licence Standards** relevant to planning and development, in the planning and development of the **Transmission System** of each **Relevant Transmission Licensee**.

PC.6.2 In relation to Scotland, Appendix C lists the technical and design criteria applied in the planning and development of each **Relevant Transmission Licensee's Transmission System**. The criteria are subject to review in accordance with each **Relevant Transmission Licensee's Transmission Licence** conditions. Copies of these documents are available from **NGET** on request. **NGET** will charge an amount sufficient to recover its reasonable costs incurred in providing this service.

## APPENDIX A

### PLANNING DATA REQUIREMENTS

#### PC.A.1. INTRODUCTION

PC.A.1.1 The Appendix specifies data requirements to be submitted to **NGET** by **Users**, and in certain circumstances to **Users** by **NGET**.

#### Submissions by Users

- PC.A.1.2 (a) Planning data submissions by **Users** shall be:
- (i) with respect to each of the seven succeeding **Financial Years** (other than in the case of **Registered Data** which will reflect the current position and data relating to **Demand** forecasts which relates also to the current year);
  - (ii) provided by **Users** in connection with a **CUSC Contract** (PC.4.1, PC.4.4 and PC.4.5 refer); and
  - (iii) provided by **Users** on a routine annual basis in calendar week 24 of each year to maintain an up-to-date data bank (although **Network Operators** may delay the submission until calendar week 28). Where from the date of one annual submission to another there is no change in the data (or in some of the data) to be submitted, instead of re-submitting the data, a **User** may submit a written statement that there has been no change from the data (or some of the data) submitted the previous time.
- (b) Where there is any change (or anticipated change) in **Committed Project Planning Data** or a significant change in **Connected Planning Data** in the category of **Forecast Data** or any change (or anticipated change) in **Connected Planning Data** in the categories of **Registered Data** or **Estimated Registered Data** supplied to **NGET** under the **PC**, notwithstanding that the change may subsequently be notified to **NGET** under the **PC** as part of the routine annual update of data (or that the change may be a **Modification** under the **CUSC**), the **User** shall, subject to PC.A.3.2.3 and PC.A.3.2.4, notify **NGET** in writing without delay.
- (c) The notification of the change will be in the form required under this **PC** in relation to the supply of that data and will also contain the following information:
- (i) the time and date at which the change became, or is expected to become, effective;
  - (ii) if the change is only temporary, an estimate of the time and date at which the data will revert to the previous registered form.
- (d) The routine annual update of data, referred to in (a)(iii) above, need not be submitted in respect of **Small Power Stations** or **Embedded**

installations of direct current converters which do not form a **DC Converter Station** (except as provided in PC.3.2.(c)), or unless specifically requested by **NGET**, or unless otherwise specifically provided.

PC.A.1.3

Submissions by **NGET**

**Network Data** release by **NGET** shall be:

- (a) with respect to the current **Financial Year**;
- (b) provided by **NGET** on a routine annual basis in calendar week 42 of each year. Where from the date of one annual submission to another there is no change in the data (or in some of the data) to be released, instead of repeating the data, **NGET** may release a written statement that there has been no change from the data (or some of the data) released the previous time.

The three parts of the Appendix

PC.A.1.4

The data requirements listed in this Appendix are subdivided into the following three parts:

(a) **Standard Planning Data**

This data (as listed in Part 1 of the Appendix) is first to be provided by a **User** at the time of an application for a **CUSC Contract**. It comprises data which is expected normally to be sufficient for **NGET** to investigate the impact on the **GB Transmission System** of any **User Development** associated with an application by the **User** for a **CUSC Contract**. **Users** should note that the term **Standard Planning Data** also includes the information referred to in PC.4.4.1.(a).

(b) **Detailed Planning Data**

This data (as listed in Part 2 of the Appendix) is usually first to be provided by the **User** within 28 days (or such longer period as **NGET** may agree in any particular case) of the offer for a **CUSC Contract**, being accepted by the **User**. It comprises additional, more detailed, data not normally expected to be required by **NGET** to investigate the impact on the **GB Transmission System** of any **User Development** associated with an application by the **User** for a **CUSC Contract**. **Users** should note that, although not needed within 28 days of the offer, the term **Detailed Planning Data** also includes **Operation Diagrams** and **Site Common Drawings** produced in accordance with the **CC**.

The **User** may, however, be required by **NGET** to provide the **Detailed Planning Data** in advance of the normal timescale before **NGET** can make an offer for a **CUSC Contract**, as explained in PC.4.5.

(c) **Network Data**

The data requirements for **NGET** in this Appendix are in Part 3.

### **Forecast Data, Registered Data and Estimated Registered Data**

PC.A.1.5

As explained in PC.5.4 and PC.5.5, **Planning Data** is divided into:

- (i) those items of **Standard Planning Data** and **Detailed Planning Data** known as **Forecast Data**; and
- (ii) those items of **Standard Planning Data** and **Detailed Planning Data** known as **Registered Data**; and
- (iii) those items of **Standard Planning Data** and **Detailed Planning Data** known as **Estimated Registered Data**.

PC.A.1.6

The following paragraphs in this Appendix relate to **Forecast Data**:

3.2.2(b), (h), (i) and (j)  
4.2.1  
4.3.1  
4.3.2  
4.3.3  
4.3.4  
4.3.5  
4.5(a)(ii) and (b)(ii)  
4.7.1  
5.2.1  
5.2.2  
5.6.1

PC.A.1.7

The following paragraphs in this Appendix relate to **Registered Data** and **Estimated Registered Data**:

2.2.1  
2.2.4  
2.2.5  
2.2.6  
2.3.1  
2.4.1  
2.4.2  
3.2.2(a), (c), (d), (e), (f), (g), (i)(part) and (j)  
3.4.1  
3.4.2  
4.2.3  
4.5(a)(i), (a)(iii), (b)(i) and (b)(iii)  
4.6  
5.3.2  
5.4  
5.4.2  
5.4.3  
5.5  
5.6.3  
6.2  
6.3



- PC.A.1.8 The data supplied under PC.A.3.3.1, although in the nature of **Registered Data**, is only supplied upon application for a **CUSC Contract**, and therefore does not fall to be **Registered Data**, but is **Estimated Registered Data**.
- PC.A.1.9 **Forecast Data** must contain the **User's** best forecast of the data being forecast, acting as a reasonable and prudent **User** in all the circumstances.
- PC.A.1.10 **Registered Data** must contain validated actual values, parameters or other information (as the case may be) which replace the estimated values, parameters or other information (as the case may be) which were given in relation to those data items when they were **Preliminary Project Planning Data** and **Committed Project Planning Data**, or in the case of changes, which replace earlier actual values, parameters or other information (as the case may be). Until amended pursuant to the **Grid Code**, these actual values, parameters or other information (as the case may be) will be the basis upon which the **GB Transmission System** is planned, designed, built and operated in accordance with, amongst other things, the **Transmission Licences**, the **STC** and the **Grid Code**, and on which **NGET** therefore relies. In following the processes set out in the **BCs**, **NGET** will use the data which has been supplied to it under the **BCs** and the data supplied under **OC2** in relation to **Gensets**, but the provision of such data will not alter the data supplied by **Users** under the **PC**, which may only be amended as provided in the **PC**.
- PC.A.1.11 **Estimated Registered Data** must contain the **User's** best estimate of the values, parameters or other information (as the case may be), acting as a reasonable and prudent **User** in all the circumstances.
- PC.A.1.12 Certain data does not need to be supplied in relation to **Embedded Power Stations** or **Embedded DC Converter Stations** where these are connected at a voltage level below the voltage level directly connected to the **GB Transmission System** except in connection with a **CUSC Contract**, or unless specifically requested by **NGET**.

PART 1  
**STANDARD PLANNING DATA**

PC.A.2            **USER'S SYSTEM DATA**

PC.A.2.1        **Introduction**

PC.A.2.1.1      Each **User**, whether connected directly via an existing **Connection Point** to the **GB Transmission System**, or seeking such a direct connection, shall provide **NGET** with data on its **User System** which relates to the **Connection Site** and/or which may have a system effect on the performance of the **GB Transmission System**. Such data, current and forecast, is specified in PC.A.2.2 to PC.A.2.5. In addition each **Generator** with **Embedded Large Power Stations** or **Embedded Medium Power Stations** connected to the **Subtransmission System**, shall provide **NGET** with fault infeed data as specified in PC.A.2.5.5 and each **DC Converter** owner with **Embedded DC Converter Stations** connected to the **Subtransmission System** shall provide **NGET** with fault infeed data as specified in PC.A.2.5.6.

PC.A.2.1.2      Each **User** must reflect the system effect at the **Connection Site(s)** of any third party **Embedded** within its **User System** whether existing or proposed.

PC.A.2.1.3      Although not itemised here, each **User** with an existing or proposed **Embedded Small Power Station** or **Medium Power Station** or **Embedded DC Converter Station** with a **Registered Capacity** of less than 100MW or an **Embedded** installation of direct current converters which does not form a **DC Converter Station** in its **User System** may, at **NGET's** reasonable discretion, be required to provide additional details relating to the **User's System** between the **Connection Site** and the existing or proposed **Embedded Small Power Station** or **Medium Power Station** or **Embedded DC Converter Station** or **Embedded** installation of direct current converters which does not form a **DC Converter Station**.

PC.A.2.1.4      At **NGET's** reasonable request, additional data on the **User's System** will need to be supplied. Some of the possible reasons for such a request, and the data required, are given in PC.A.6.2, PC.A.6.4, PC.A.6.5 and PC.A.6.6.

PC.A.2.2        **User's System Layout**

PC.A.2.2.1      Each **User** shall provide a **Single Line Diagram**, depicting both its existing and proposed arrangement(s) of load current carrying **Apparatus** relating to both existing and proposed **Connection Points**.

PC.A.2.2.2      The **Single Line Diagram** (three examples are shown in Appendix B) must include all parts of the **User System** operating at **Supergrid Voltage** throughout **Great Britain** and, in Scotland, also all parts of the **User System** operating at 132kV, and those parts of its **Subtransmission System** at any **Transmission Site**. In addition, the **Single Line Diagram** must include all parts of the **User's Subtransmission System** throughout **Great Britain** operating at a voltage greater than 50kV, and, in Scotland, also all parts of the **User's Subtransmission System** operating at a voltage greater than 30kV, which, under either intact network or **Planned Outage** conditions:-

- (a) normally interconnects separate **Connection Points**, or busbars at a **Connection Point** which are normally run in separate sections; or
- (b) connects **Embedded Large Power Stations**, or **Embedded Medium Power Stations**, or **Embedded DC Converter Stations** connected to the **User's Subtransmission System**, to a **Connection Point**.

At the **User's** discretion, the **Single Line Diagram** can also contain additional details of the **User's Subtransmission System** not already included above, and also details of the transformers connecting the **User's Subtransmission System** to a lower voltage. With **NGET's** agreement, the **Single Line Diagram** can also contain information about the **User's System** at a voltage below the voltage of the **Subtransmission System**.

The **Single Line Diagram** for a **Power Park Module** must include all parts of the System connecting generating equipment to the **Grid Entry Point** or (**User System Entry Point** if **Embedded**). As an alternative the **User** may choose to submit a **Single Line Diagram** of an electrically equivalent system connecting generating equipment to the **Grid Entry Point** (or **User System Entry Point** if **Embedded**). An example of a **Single Line Diagram** for a **Power Park Module** electrically equivalent system is shown in Appendix B.

The **Single Line Diagram** must include the points at which **Demand** data (provided under PC.A.4.3.4) and fault infeed data (provided under PC.A.2.5) are supplied.

PC.A.2.2.3

The above mentioned **Single Line Diagram** shall include:

- (a) electrical circuitry (ie. overhead lines, identifying which circuits are on the same towers, underground cables, power transformers, reactive compensation equipment and similar equipment); and
- (b) substation names (in full or abbreviated form) with operating voltages.

In addition, for all load current carrying **Apparatus** operating at **Supergrid Voltage** throughout **Great Britain** and, in Scotland, also at 132kV, the **Single Line Diagram** shall include:-

- (a) circuit breakers
- (b) phasing arrangements.

PC.A.2.2.3.1

For the avoidance of doubt, the **Single Line Diagram** to be supplied is in addition to the **Operation Diagram** supplied pursuant to CC.7.4.

PC.A.2.2.4

For each circuit shown on the **Single Line Diagram** provided under PC.A.2.2.1, each **User** shall provide the following details relating to that part of its **User System**:

Circuit Parameters:

Rated voltage (kV)  
Operating voltage (kV)  
Positive phase sequence reactance  
Positive phase sequence resistance  
Positive phase sequence susceptance  
Zero phase sequence reactance (both self and mutual)  
Zero phase sequence resistance (both self and mutual)  
Zero phase sequence susceptance (both self and mutual)

In the case of a **Single Line Diagram** for a **Power Park Module** electrically equivalent system the data should be on a 100MVA base. Depending on the equivalent system supplied an equivalent tap changer range may need to be supplied. Similarly mutual values, rated voltage and operating voltage may be inappropriate.

PC.A.2.2.5 For each transformer shown on the **Single Line Diagram** provided under PC.A.2.2.1, each **User** shall provide the following details:

Rated MVA  
Voltage Ratio  
Winding arrangement  
Positive sequence reactance  
(max, min and nominal tap)  
Positive sequence resistance  
(max, min and nominal tap)  
Zero sequence reactance

PC.A.2.2.5.1. In addition, for all interconnecting transformers between the **User's Supergrid Voltage System** and the **User's Subtransmission System** throughout **Great Britain** and, in Scotland, also for all interconnecting transformers between the **User's 132kV System** and the **User's Subtransmission System** the **User** shall supply the following information:-

Tap changer range  
Tap change step size  
Tap changer type: on load or off circuit  
Earthing method: Direct, resistance or reactance  
Impedance (if not directly earthed )

PC.A.2.2.6 Each **User** shall supply the following information about the **User's** equipment installed at a **Transmission Site**:-

(a) Switchgear. For all circuit breakers:-

Rated voltage (kV)  
Operating voltage (kV)  
Rated 3-phase rms short-circuit breaking current, (kA)  
Rated 1-phase rms short-circuit breaking current, (kA)  
Rated 3-phase peak short-circuit making current, (kA)  
Rated 1-phase peak short-circuit making current, (kA)  
Rated rms continuous current (A)

DC time constant applied at testing of asymmetrical breaking abilities (secs)

- (b) Substation Infrastructure. For the substation infrastructure (including, but not limited to, switch disconnectors, disconnectors, current transformers, line traps, busbars, through bushings, etc):-

Rated 3-phase rms short-circuit withstand current (kA)  
Rated 1-phase rms short-circuit withstand current (kA).  
Rated 3-phase short-circuit peak withstand current (kA)  
Rated 1- phase short-circuit peak withstand current (kA)  
Rated duration of short circuit withstand (secs)  
Rated rms continuous current (A)

A single value for the entire substation may be supplied, provided it represents the most restrictive item of current carrying apparatus.

PC.A.2.3 Lumped **System** Susceptance

PC.A.2.3.1 For all parts of the **User's Subtransmission System** which are not included in the **Single Line Diagram** provided under PC.A.2.2.1, each **User** shall provide the equivalent lumped shunt susceptance at nominal **Frequency**.

PC.A.2.3.1.1 This should include shunt reactors connected to cables which are not normally in or out of service independent of the cable (ie. they are regarded as part of the cable).

PC.A.2.3.1.2 This should not include:

- (a) independently switched reactive compensation equipment connected to the **User's System** specified under PC.A.2.4, or;
- (b) any susceptance of the **User's System** inherent in the **Demand (Reactive Power)** data specified under PC.A.4.3.1.

PC.A.2.4 Reactive Compensation Equipment

PC.A.2.4.1 For all independently switched reactive compensation equipment, including that shown on the **Single Line Diagram**, not operated by **NGET** and connected to the **User's System** at 132kV and above in England and Wales and 33kV and above in Scotland, other than power factor correction equipment associated directly with **Customers' Plant** and **Apparatus**, the following information is required:

- (a) type of equipment (eg. fixed or variable);
- (b) capacitive and/or inductive rating or its operating range in Mvar;
- (c) details of any automatic control logic to enable operating characteristics to be determined;
- (d) the point of connection to the **User's System** in terms of electrical location and **System** voltage.

PC.A.2.4.2 **DC Converter Station** owners are also required to provide information about the reactive compensation and harmonic filtering equipment required to ensure that their **Plant** and **Apparatus** complies with the criteria set out in CC.6.1.5.

PC.A.2.5 Short Circuit Contribution to **GB Transmission System**

PC.A.2.5.1 General

(a) To allow **NGET** to calculate fault currents, each **User** is required to provide data, calculated in accordance with **Good Industry Practice**, as set out in the following paragraphs of PC.A.2.5.

(b) The data should be provided for the **User's System** with all **Generating Units, Power Park Units** and **DC Converters Synchronised** to that **User's System**. The **User** must ensure that the pre-fault network conditions reflect a credible **System** operating arrangement.

(c) The list of data items required, in whole or part, under the following provisions, is set out in PC.A.2.5.6. Each of the relevant following provisions identifies which data items in the list are required for the situation with which that provision deals.

The fault currents in sub-paragraphs (a) and (b) of the data list in PC.A.2.5.6 should be based on an a.c. load flow that takes into account any pre-fault current flow across the **Point of Connection** being considered.

Measurements made under appropriate **System** conditions may be used by the **User** to obtain the relevant data.

(d) **NGET** may at any time, in writing, specifically request for data to be provided for an alternative **System** condition, for example minimum plant, and the **User** will, insofar as such request is reasonable, provide the information as soon as reasonably practicable following the request.

PC.A.2.5.2 **Network Operators** and **Non-Embedded Customers** are required to submit data in accordance with PC.A.2.5.4. **Generators** and **DC Converter Station** owners are required to submit data in accordance with PC.A.2.5.5.

PC.A.2.5.3 Where prospective short-circuit currents on equipment owned, operated or managed by **NGET** are close to the equipment rating, and in **NGET's** reasonable opinion more accurate calculations of the prospective short circuit currents are required, then **NGET** will request additional data as outlined in PC.A.6.6 below.

PC.A.2.5.4 Data from **Network Operators** and **Non-Embedded Customers**

Data is required to be provided at each node on the **Single Line Diagram** provided under PC.A.2.2.1 at which motor loads and/or **Embedded Small**

**Power Stations** and/or **Embedded Medium Power Stations** and/or **Embedded** installations of direct current converters which do not form a **DC Converter Station** are connected, assuming a fault at that location, as follows:-

The data items listed under the following parts of PC.A.2.5.6:-

- (a) (i), (ii), (iii), (iv), (v) and (vi);

and the data items shall be provided in accordance with the detailed provisions of PC.A.2.5.6(c) - (f).

PC.A.2.5.5

Data from **Generators** and **DC Converter Station** owners

PC.A.2.5.5.1

For each **Generating Unit** with one or more associated **Unit Transformers**, the **Generator** is required to provide values for the contribution of the **Power Station Auxiliaries** (including **Auxiliary Gas Turbines** or **Auxiliary Diesel Engines**) to the fault current flowing through the **Unit Transformer(s)**.

The data items listed under the following parts of PC.A.2.5.6(a) should be provided:-

- (i), (ii) and (v);

- (iii) if the associated **Generating Unit** step-up transformer can supply zero phase sequence current from the **Generating Unit** side to the **GB Transmission System**;

- (iv) if the value is not 1.0 p.u;

and the data items shall be provided in accordance with the detailed provisions of PC.A.2.5.6(c) - (f), and with the following parts of this PC.A.2.5.5.

PC.A.2.5.5.2

Auxiliary motor short circuit current contribution and any **Auxiliary Gas Turbine Unit** contribution through the **Unit Transformers** must be represented as a combined short circuit current contribution at the **Generating Unit's** terminals, assuming a fault at that location. In the case of a **Power Park Unit** in a **Power Park Module**, the combined short circuit contribution need only be provided for each type of **Power Park Unit** in the **Power Park Module**.

PC.A.2.5.5.3

If the **Power Station** or **DC Converter Station** has separate **Station Transformers**, data should be provided for the fault current contribution from each transformer at its high voltage terminals, assuming a fault at that location, as follows:-

The data items listed under the following parts of PC.A.2.5.6

- (a) (i), (ii), (iii), (iv), (v) and (vi);

and the data items shall be provided in accordance with the detailed provisions of PC.A.2.5.6(b) - (f).

PC.A.2.5.5.4 Data for the fault infeeds through both **Unit Transformers** and **Station Transformers** shall be provided for the normal running arrangement when the maximum number of **Generating Units** are **Synchronised** to the **System** or when all the **DC Converters** at a **DC Converter Station** are transferring **Rated MW** in either direction. Where there is an alternative running arrangement (or transfer in the case of a **DC Converter Station**) which can give a higher fault infeed through the **Station Transformers**, then a separate data submission representing this condition shall be made.

PC.A.2.5.5.5 Unless the normal operating arrangement within the **Power Station** is to have the **Station** and **Unit Boards** interconnected within the **Power Station**, no account should be taken of the interconnection between the **Station Board** and the **Unit Board**.

PC.A.2.5.5.6 Auxiliary motor short circuit current contribution and any auxiliary **DC Converter Station** contribution through the **Station Transformers** must be represented as a combined short circuit current contribution through the **Station Transformers**.

PC.A.2.5.6 Data Items

(a) The following is the list of data utilised in this part of the **PC**. It also contains rules on the data which generally apply:-

- (i) Root mean square of the symmetrical three-phase short circuit current infeed at the instant of fault, ( $I_1''$ );
- (ii) Root mean square of the symmetrical three-phase short circuit current after the subtransient fault current contribution has substantially decayed, ( $I_1'$ );
- (iii) the zero sequence source resistance and reactance values of the **User's System** as seen from the node on the **Single Line Diagram** provided under PC.A.2.2.1 (or **Station Transformer** high voltage terminals or **Generating Unit** terminals or **DC Converter** terminals, as appropriate) consistent with the infeed described in PC.A.2.5.1.(b);
- (iv) root mean square of the pre-fault voltage at which the maximum fault currents were calculated;
- (v) the positive sequence X/R ratio at the instant of fault;
- (vi) the negative sequence resistance and reactance values of the **User's System** seen from the node on the **Single Line Diagram** provided under PC.A.2.2.1 (or **Station Transformer** high voltage terminals, or **Generating Unit** terminals or **DC Converter** terminals if appropriate) if substantially different from the values of positive sequence resistance and reactance which would be derived from the data provided above.



- (b) In considering this data, unless the **User** notifies **NGET** accordingly at the time of data submission, **NGET** will assume that the time constant of decay of the subtransient fault current corresponding to the change from  $I_1$  to  $I_1'$ , ( $T$ ) is not significantly different from 40ms. If that assumption is not correct in relation to an item of data, the **User** must inform **NGET** at the time of submission of the data.
- (c) The value for the X/R ratio must reflect the rate of decay of the d.c. component that may be present in the fault current and hence that of the sources of the initial fault current. All shunt elements and loads must therefore be deleted from any system model before the X/R ratio is calculated.
- (d) In producing the data, the **User** may use "time step analysis" or "fixed-point-in-time analysis" with different impedances.
- (e) If a fixed-point-in-time analysis with different impedances method is used, then in relation to the data submitted under (a) (i) above, the data will be required for "time zero" to give  $I_1$ ". The figure of 120ms is consistent with a decay time constant  $T$ " of 40ms, and if that figure is different, then the figure of 120ms must be changed accordingly.
- (f) Where a "time step analysis" is carried out, the X/R ratio may be calculated directly from the rate of decay of the d.c. component. The X/R ratio is not that given by the phase angle of the fault current if this is based on a system calculation with shunt loads, but from the Thévenin equivalent of the system impedance at the instant of fault with all non-source shunts removed.

PC.A.3 **GENERATING UNIT AND DC CONVERTER DATA**

PC.A.3.1 **Introduction**

**Directly Connected**

PC.A.3.1.1 Each **Generator** and **DC Converter Station** owner with an existing, or proposed, **Power Station** or **DC Converter Station** directly connected, or to be directly connected, to the **GB Transmission System**, shall provide **NGET** with data relating to that **Power Station** or **DC Converter Station**, both current and forecast, as specified in PC.A.3.2 to PC.A.3.4.

**Embedded**

PC.A.3.1.2 (a) Each **Generator** and **DC Converter Station** owner with an existing, or proposed, **Embedded Large Power Station** and/or an **Embedded Medium Power Station** and/or **Embedded DC Converter Station** connected to the **Sub Transmission System**, shall provide **NGET** with data relating to that **Power Station** or **DC Converter Station**, both current and forecast, as specified in PC.A.3.2 to PC.A.3.4.

(b) No data need be supplied in relation to any **Small Power Station** or any **Medium Power Station** or installations of direct current converters which do not form a **DC Converter Station**, connected at a voltage level below the voltage level of the **Subtransmission System** except:-

(i) in connection with an application for, or under, a **CUSC Contract**, or

(ii) unless specifically requested by **NGET** under PC.A.3.1.4.

PC.A.3.1.3 (a) Each **Network Operator** shall provide **NGET** with the data specified in PC.A.3.2.2(c) and PC.A.3.2.2(i).

(b) **Network Operators** need not submit planning data in respect of an **Embedded Small Power Station** unless required to do so under PC.A.1.2(b) or unless specifically requested under PC.A.3.1.4 below, in which case they will supply such data.

PC.A.3.1.4 (a) PC.A.4.2.4(b) and PC.A.4.3.2(a) explain that the forecast **Demand** submitted by each **Network Operator** must be net of the output of all **Small Power Stations** and **Medium Power Stations** and **Customer Generating Plant** and all installations of direct current converters which do not form a **DC Converter Station Embedded** in that **Network Operator's System**. The **Network Operator** must inform **NGET** of the number of such **Embedded Power Stations** and such **Embedded** installations of direct current converters (including the number of **Generating Units** or **Power Park Modules** or **DC Converters**) together with their summated capacity.

- (b) On receipt of this data, the **Network Operator** or **Generator** (if the data relates to **Power Stations** referred to in PC.A.3.1.2) may be further required, at **NGET's** reasonable discretion, to provide details of **Embedded Small Power Stations** and **Embedded Medium Power Stations** and **Customer Generating Plant** and **Embedded** installations of direct current converters which do not form a **DC Converter Station**, both current and forecast, as specified in PC.A.3.2 to PC.A.3.4. Such requirement would arise where **NGET** reasonably considers that the collective effect of a number of such **Embedded Power Stations** and **Customer Generating Plants** and **Embedded** installations of direct current converters may have a significant system effect on the **GB Transmission System**.

PC.A.3.1.5 Where **Generating Units**, which term includes **CCGT Units** and **Power Park Modules**, and **DC Converters**, are connected to the **GB Transmission System** via a busbar arrangement which is or is expected to be operated in separate sections, the section of busbar to which each **Generating Unit**, **DC Converter** or **Power Park Module** is connected is to be identified in the submission.

PC.A.3.2 Output Data

PC.A.3.2.1 (a) **Large Power Stations and Gensets**

Data items PC.A.3.2.2 (a), (b), (c), (d), (e), (f) and (h) are required with respect to each **Large Power Station** and each **Generating Unit** and **Power Park Module** of each **Large Power Station** and for each **Genset** (although (a) is not required for **CCGT Units** and (b), (d) and (e) are not normally required for **CCGT Units** and (a), (b), (c), (d), (e), (f) and (h) are not normally required for **Power Park Units**).

(b) **Embedded Small Power Stations and Embedded Medium Power Stations**

Data item PC.A.3.2.2 (a) is required with respect to each **Embedded Small Power Station** and **Embedded Medium Power Station** and each **Generating Unit** and **Power Park Module** of each **Embedded Small Power Station** and **Embedded Medium Power Station** (although (a) is not required for **CCGT Units** or **Power Park Units**).

(c) **CCGT Units/Modules**

(i) Data item PC.A.3.2.2 (g) is required with respect to each **CCGT Unit**;

(ii) data item PC.A.3.2.2 (a) is required with respect to each **CCGT Module**; and

(iii) data items PC.A.3.2.2 (b), (c), (d) and (e) are required with respect to each **CCGT Module** unless **NGET** informs the relevant **User** in advance of the submission that it needs the data items with respect to each **CCGT Unit** for

particular studies, in which case it must be supplied on a **CCGT Unit** basis.

Where any definition utilised or referred to in relation to any of the data items does not reflect **CCGT Units**, such definition shall be deemed to relate to **CCGT Units** for the purposes of these data items. Any **Schedule** in the DRC which refers to these data items shall be interpreted to incorporate the **CCGT Unit** basis where appropriate;

(d) **Cascade Hydro Schemes**

Data item PC.A.3.2.2(i) is required with respect to each **Cascade Hydro Scheme**.

(e) **Power Park Units/Modules**

Data items PC.A.3.2.2 (j) is required with respect to each **Power Park Module**.

(f) **DC Converters**

Data items PC.A.3.2.2 (a), (b), (c), (d) (e) (f) (h) and (i) are required with respect to each **DC Converter Station** and each **DC Converter** in each **DC Converter Station**. For installations of direct current converters which do not form a **DC Converter Station** only data item PC.A.3.2.2.(a) is required.

PC.A.3.2.2

Items (a), (b), (d), (e), (f), (g), (h), (i), (j) and (k) are to be supplied by each **Generator**, **DC Converter Station** owner or **Network Operator** (as the case may be) in accordance with PC.A.3.1.1, PC.A.3.1.2, PC.A.3.1.3 and PC.A.3.1.4. Item (c) is to be supplied by each **Network Operator** in all cases:-

- (a) **Registered Capacity** (MW);
- (b) **Output Usable** (MW) on a monthly basis;
- (c) **System Constrained Capacity** (MW) ie. any constraint placed on the capacity of the **Embedded Generating Unit**, **Embedded Power Park Module**, or **DC Converter** at an **Embedded DC Converter Station** due to the **Network Operator's System** in which it is embedded. Where **Generating Units** (which term includes **CCGT Units**), **Power Park Modules** or **DC Converters** are connected to a **Network Operator's User System** via a busbar arrangement which is or is expected to be operated in separate sections, details of busbar running arrangements and connected circuits at the substation to which the **Embedded Generating Unit**, **Embedded Power Park Module** or **Embedded DC Converter** is connected sufficient for **NGET** to determine where the **MW** generated by each **Generating Unit**, **Power Park Module** or **DC Converter** at that **Power Station** or **DC Converter Station** would appear onto the **GB Transmission System**;

- (d) **Minimum Generation (MW);**
- (e) MW obtainable from **Generating Units, Power Park Modules or DC Converters** at a **DC Converter Station** in excess of **Registered Capacity**;
- (f) **Generator Performance Chart:**
  - (i) at the **Synchronous Generating Unit** stator terminals
  - (ii) at the electrical point of connection to the **GB Transmission System** (or **User System** if **Embedded**) for a **Non Synchronous Generating Unit** (excluding a **Power Park Unit**), **Power Park Module** and **DC Converter** at a **DC Converter Station**;
- (g) a list of the **CCGT Units** within a **CCGT Module**, identifying each **CCGT Unit**, and the **CCGT Module** of which it forms part, unambiguously. In the case of a **Range CCGT Module**, details of the possible configurations should also be submitted, together:-
  - (i) (in the case of a **Range CCGT Module** connected to the **GB Transmission System**) with details of the single **Grid Entry Point** (there can only be one) at which power is provided from the **Range CCGT Module**;
  - (ii) (in the case of an **Embedded Range CCGT Module**) with details of the single **User System Entry Point** (there can only be one) at which power is provided from the **Range CCGT Module**;

Provided that, nothing in this sub-paragraph (g) shall prevent the busbar at the relevant point being operated in separate sections;
- (h) expected running regime(s) at each **Power Station** or **DC Converter Station** and type of **Generating Unit**, eg. **Steam Unit, Gas Turbine Unit, Combined Cycle Gas Turbine Unit, Power Park Module, Novel Units** (specify by type), etc;
- (i) a list of **Power Stations** and **Generating Units** within a **Cascade Hydro Scheme**, identifying each **Generating Unit** and **Power Station** and the **Cascade Hydro Scheme** of which each form part unambiguously. In addition:
  - (i) details of the **Grid Entry Point** at which **Active Power** is provided, or if **Embedded** the **Grid Supply Point(s)** within which the **Generating Unit** is connected;
  - (ii) where the **Active Power** output of a **Generating Unit** is split between more than one **Grid Supply Points** the percentage that would appear under normal and outage conditions at each **Grid Supply Point**.

- (j) The following additional items are only applicable to **DC Converters** at **DC Converter Stations**.

**Registered Import Capacity (MW);**

**Import Usable (MW)** on a monthly basis;

**Minimum Import Capacity (MW);**

MW that may be absorbed by a **DC Converter** in excess of **Registered Import Capacity** and the duration for which this is available;

- (k) the number and types of the **Power Park Units** within a **Power Park Module**, identifying each **Power Park Unit**, and the **Power Park Module** of which it forms part, unambiguously. In the case of a **Power Station** directly connected to the **GB Transmission System** with multiple **Power Park Modules** where **Power Park Units** can be selected to run in different **Power Park Modules**, details of the possible configurations should also be submitted.

#### PC.A.3.2.3

Notwithstanding any other provision of this PC, the **CCGT Units** within a **CCGT Module**, details of which are required under paragraph (g) of PC.A.3.2.2, can only be amended in accordance with the following provisions:-

- (a) if the **CCGT Module** is a **Normal CCGT Module**, the **CCGT Units** within that **CCGT Module** can only be amended such that the **CCGT Module** comprises different **CCGT Units** if **NGET** gives its prior consent in writing. Notice of the wish to amend the **CCGT Units** within such a **CCGT Module** must be given at least 6 months before it is wished for the amendment to take effect;
- (b) if the **CCGT Module** is a **Range CCGT Module**, the **CCGT Units** within that **CCGT Module** and the **Grid Entry Point** at which the power is provided can only be amended as described in BC1.A1.6.4.

#### PC.A.3.2.4

Notwithstanding any other provision of this PC, the **Power Park Units** within a **Power Park Module**, details of which are required under paragraph (j) of PC.A.3.2.2, can only be amended in accordance with the following provisions:-

- (a) if the **Power Park Units** within that **Power Park Module** can only be amended such that the **Power Park Module** comprises different **Power Park Units** due to repair/replacement of individual **Power Park Units** if **NGET** gives its prior consent in writing. Notice of the wish to amend a **Power Park Unit** within such a **Power Park Module** must be given at least 4 weeks before it is wished for the amendment to take effect;
- (b) if the **Power Park Units** within that **Power Park Module** can be selected to run in different **Power Park Modules** as an alternative operational running arrangement the **Power Park Units** within the

**Power Park Module** and the **Grid Entry Point** at which the power is provided can only be amended as described in BC1.A.1.7.4.

PC.A.3.3. Rated Parameters Data

PC.A.3.3.1 The following information is required to facilitate an early assessment, by **NGET**, of the need for more detailed studies;

- (a) for all **Generating Units**(excluding **Power Park Units**) and **Power Park Modules**:

Rated MVA  
**Rated MW**;

- (b) for each **Synchronous Generating Unit**:

Short circuit ratio  
Direct axis transient reactance;  
Inertia constant (for whole machine), MWsecs/MVA;

- (c) for each **Synchronous Generating Unit** step-up transformer:

Rated MVA  
Positive sequence reactance (at max, min and nominal tap);

- (d) for each **DC Converter** at a **DC Converter Station** or **DC Converter** connecting a **Power Park Module**

**DC Converter** type (e.g. current/voltage sourced)  
**Rated MW** per pole for import and export  
Number of poles and pole arrangement  
Rated DC voltage/pole (kV)  
Return path arrangement  
Remote AC connection arrangement

- (e) for each type of **Power Park Unit** in a **Power Park Module** not connected to the **Total System** by a **DC Converter**:

Rated MVA  
**Rated MW**  
Rated terminal voltage  
Inertia constant, (MWsec/MVA)  
Additionally, for **Power Park Units** that are squirrel-cage or doubly-fed induction generators driven by wind turbines:  
Stator reactance.  
Magnetising reactance.  
Rotor resistance (at rated running)  
Rotor reactance (at rated running)  
The generator rotor speed range (minimum and maximum speeds in RPM) (for doubly-fed induction generators only)  
Converter MVA rating (for doubly-fed induction generators only)

For a **Power Park Unit** consisting of a synchronous machine in combination with a back-to-back **DC Converter**, or for a **Power Park Unit** not driven by a wind turbine, the data to be supplied shall be agreed with **NGET** in accordance with PC.A.7.

This information should only be given in the data supplied with the application for a **CUSC Contract** (if appropriate for any variation), as the case may be.

PC.A.3.4

General **Generating Unit Power Park Module and DC Converter** Data

PC.A.3.4.1

The point of connection to the **GB Transmission System** or the **Total System**, if other than to the **GB Transmission System**, in terms of geographical and electrical location and system voltage is also required.

PC.A.3.4.2

- (a) Type of **Generating Unit** (ie **Synchronous Generating Unit, Non-synchronous Generating Unit , DC Converter or Power Park Module**).
- (b) In the case of a **Synchronous Generating Unit** details of the **Exciter** category, for example whether it is a rotating **Exciter** or a static **Exciter** or in the case of a **Non-Synchronous Generating Unit** the voltage control system.
- (c) Whether a **Power System Stabiliser** is fitted.



PC.A.4 **DEMAND AND ACTIVE ENERGY DATA**

PC.A.4.1 **Introduction**

PC.A.4.1.1 Each **User** directly connected to the **GB Transmission System** with **Demand** shall provide **NGET** with the **Demand** data, historic, current and forecast, as specified in PC.A.4.2, PC.A.4.3 and PC.A.4.5. Paragraphs PC.A.4.1.2 and PC.A.4.1.3 apply equally to **Active Energy** requirements as to **Demand** unless the context otherwise requires.

PC.A.4.1.2 Data will need to be supplied by:

- (a) each **Network Operator**, in relation to **Demand** and **Active Energy** requirements on its **User System**;
- (b) each **Non-Embedded Customer** (including **Pumped Storage Generators** with respect to Pumping **Demand**) in relation to its **Demand** and **Active Energy** requirements.
- (c) each **DC Converter Station** owner, in relation to **Demand** and **Active Energy** transferred (imported) to its **DC Converter Station**.

**Demand of Power Stations** directly connected to the **GB Transmission System** is to be supplied by the **Generator** under PC.A.5.2.

PC.A.4.1.3 References in this **PC** to data being supplied on a half hourly basis refer to it being supplied for each period of 30 minutes ending on the hour or half-hour in each hour.

PC.A.4.2 **Demand (Active Power) and Active Energy Data**

PC.A.4.2.1 Forecast daily **Demand (Active Power)** profiles, as specified in (a), (b) and (c) below, in respect of each of the **User's User Systems** (each summated over all **Grid Supply Points** in each **User System**) are required for:

- (a) peak day on each of the **User's User Systems** (as determined by the **User**) giving the numerical value of the maximum **Demand (Active Power)** that in the **Users'** opinion could reasonably be imposed on the **GB Transmission System**;
- (b) day of peak **GB Transmission System Demand (Active Power)** as notified by **NGET** pursuant to PC.A.4.2.2;
- (c) day of minimum **GB Transmission System Demand (Active Power)** as notified by **NGET** pursuant to PC.A.4.2.2.

In addition, the total **Demand (Active Power)** in respect of the time of peak **GB Transmission System Demand** in the preceding **Financial Year** in respect of each of the **User's User Systems** (each summated over all **Grid**

**Supply Points** in each **User System**) both outturn and weather corrected shall be supplied.

PC.A.4.2.2 No later than calendar week 17 each year **NGET** shall notify each **Network Operator** and **Non-Embedded Customer** in writing of the following, for the current **Financial Year** and for each of the following seven **Financial Years**, which will, until replaced by the following year's notification, be regarded as the relevant specified days and times under PC.A.4.2.1:

- a) the date and time of the annual peak of the **GB Transmission System Demand**;
- b) the date and time of the annual minimum of the **GB Transmission System Demand**.

PC.A.4.2.3 The total **Active Energy** used on each of the **Network Operators'** or **Non-Embedded Customers' User Systems** (each summated over all **Grid Supply Points** in each **User System**) in the preceding **Financial Year**, both outturn and weather corrected, together with a prediction for the current financial year, is required. Each **Active Energy** submission shall be subdivided into the following categories of **Customer** tariff:

- LV1
- LV2
- LV3
- HV
- EHV
- Traction
- Lighting

In addition, the total **User System** losses and the **Active Energy** provided by **Embedded Small Power Stations** and **Embedded Medium Power Stations** shall be supplied.

PC.A.4.2.4 All forecast **Demand (Active Power)** and **Active Energy** specified in PC.A.4.2.1 and PC.A.4.2.3 shall:

- (a) in the case of PC.A.4.2.1(a), (b) and (c), be such that the profiles comprise average **Active Power** levels in 'MW' for each time marked half hour throughout the day;
- (b) in the case of PC.A.4.2.1(a), (b) and (c), be that remaining after any deductions reasonably considered appropriate by the **User** to take account of the output profile of all **Embedded Small Power Stations** and **Embedded Medium Power Stations** and **Customer Generating Plant** and imports across **Embedded External Interconnections** including imports across **Embedded** installations of direct current converters which do not form a **DC Converter Station** and **Embedded DC Converter Stations** with a **Registered Capacity** of less than 100MW;

- (c) in the case of PC.A.4.2.1(a) and (b), be based on **Annual ACS Conditions** and in the case of PC.A.4.2.1(c) and the details of the annual **Active Energy** required under PC.A.4.2.3 be based on **Average Conditions**.

PC.A.4.3

**Connection Point Demand (Active and Reactive Power)**

PC.A.4.3.1

Forecast **Demand (Active Power)** and **Power Factor** (values of the **Power Factor** at maximum and minimum continuous excitation may be given instead where more than 95% of the total **Demand** at a **Connection Point** is taken by synchronous motors) to be met at each are required for:

- (a) the time of the maximum **Demand (Active Power)** at the **Connection Point** (as determined by the **User**) that in the **User's** opinion could reasonably be imposed on the **GB Transmission System**;
- (b) the time of peak **GB Transmission System Demand** as provided by **NGET** under PC.A.4.2.2;
- (c) the time of minimum **GB Transmission System Demand** as provided by **NGET** under PC.A.4.2.2.

PC.A.4.3.2

All forecast **Demand** specified in PC.A.4.3.1 shall:

- (a) be that remaining after any deductions reasonably considered appropriate by the **User** to take account of the output of all **Embedded Small Power Stations** and **Embedded Medium Power Stations** and **Customer Generating Plant** and imports across **Embedded External Interconnections**, including **Embedded** installations of direct current converters which do not form a **DC Converter Station** and **Embedded DC Converter Stations** and such deductions should be separately stated;
- (b) include any **User's System** series reactive losses but exclude any reactive compensation equipment specified in PC.A.2.4 and exclude any network susceptance specified in PC.A.2.3;
- (c) in the case of PC.A.4.3.1(a) and (b) be based on **Annual ACS Conditions** and in the case of PC.A.4.3.1(c) be based on **Average Conditions**.

PC.A.4.3.3

Where two or more **Connection Points** normally run in parallel with the **GB Transmission System** under intact network conditions, and a **Single Line Diagram** of the interconnection has been provided under PC.A.2.2.2, the **User** may provide a single submission covering the aggregate **Demand** for all such **Connection Points**.

PC.A.4.3.4

Each **Single Line Diagram** provided under PC.A.2.2.2 shall include the **Demand (Active Power)** and **Power Factor** (values of the **Power Factor** at maximum and minimum continuous excitation may be given instead where more than 95% of the **Demand** is taken by synchronous motors) at the time of the peak **GB Transmission System Demand** (as provided under

PC.A.4.2.2) at each node on the **Single Line Diagram**. These **Demands** shall be consistent with those provided under PC.A.4.3.1(b) above for the relevant year.

PC.A.4.3.5 So that **NGET** is able to assess the impact on the **GB Transmission System** of the diversified **GB Transmission System Demand** at various periods throughout the year, each **User** shall provide additional forecast **Demand** data as specified in PC.A.4.3.1 and PC.A.4.3.2 but with respect to times to be specified by **NGET**. However, **NGET** shall not make such a request for additional data more than once in any calendar year.

PC.A.4.4 **NGET** will assemble and derive in a reasonable manner, the forecast information supplied to it under PC.A.4.2.1, PC.A.4.3.1. and PC.A.4.3.4 above into a cohesive forecast and will use this in preparing **Forecast Demand** information in the **Seven Year Statement** and for use in **NGET's Operational Planning**. If any **User** believes that the cohesive forecast **Demand** information in the **Seven Year Statement** does not reflect its assumptions on **Demand**, it should contact **NGET** to explain its concerns and may require **NGET**, on reasonable request, to discuss these forecasts. In the absence of such expressions, **NGET** will assume that **Users** concur with **NGET's** cohesive forecast.

#### Demand Transfer Capability

PC.A.4.5 Where a **User's Demand** or group of **Demands (Active and Reactive Power)** may be offered by the **User** to be supplied from alternative **Connection Point(s)**, (either through non-**Transmission** interconnections or through **Demand** transfer facilities) and the **User** reasonably considers it appropriate that this should be taken into account (by **NGET**) in designing the **Connection Site** the following information is required:

- (a) First Circuit (Fault) Outage Conditions
  - (i) the alternative **Connection Point(s)**;
  - (ii) the **Demand (Active and Reactive Power)** which may be transferred under the loss of the most critical circuit from or to each alternative **Connection Point** (to the nearest 5MW/5Mvar);
  - (iii) the arrangements (eg. manual or automatic) for transfer together with the time required to effect the transfer.
- (b) Second Circuit (Planned) Outage Conditions
  - (i) the alternative **Connection Point(s)**;
  - (ii) the **Demand (Active and Reactive Power)** which may be transferred under the loss of the most critical circuit from or to each alternative **Connection Point** (to the nearest 5MW/5Mvar);

- (iii) the arrangements (eg. manual or automatic) for transfer together with the time required to effect the transfer.

PC.A.4.6 Control of **Demand** or Reduction of Pumping Load Offered as Reserve

- Magnitude of **Demand** or pumping load which is tripped MW
- **System Frequency** at which tripping is initiated Hz
- Time duration of **System Frequency** below trip setting for tripping to be initiated s
- Time delay from trip initiation to tripping s

PC.A.4.7 General **Demand** Data

PC.A.4.7.1 The following information is infrequently required and should be supplied (wherever possible) when requested by **NGET**:

- (a) details of any individual loads which have characteristics significantly different from the typical range of Domestic, Commercial or Industrial loads supplied;
- (b) the sensitivity of the **Demand (Active and Reactive Power)** to variations in voltage and **Frequency** on the **GB Transmission System** at the time of the peak **Demand (Active Power)**. The sensitivity factors quoted for the **Demand (Reactive Power)** should relate to that given under PC.A.4.3.1 and, therefore, include any **User's System** series reactive losses but exclude any reactive compensation equipment specified in PC.A.2.4 and exclude any network susceptance specified in PC.A.2.3;
- (c) details of any traction loads, e.g. connection phase pairs and continuous load variation with time;
- (d) the average and maximum phase unbalance, in magnitude and phase angle, which the **User** would expect its **Demand** to impose on the **GB Transmission System**;
- (e) the maximum harmonic content which the **User** would expect its **Demand** to impose on the **GB Transmission System**;
- (f) details of all loads which may cause **Demand** fluctuations greater than those permitted under **Engineering Recommendation P28**, Stage 1 at a **Point of Common Coupling** including the **Flicker Severity (Short Term)** and the **Flicker Severity (Long Term)**.

## PART 2

### DETAILED PLANNING DATA

#### PC.A.5 GENERATING UNIT, POWER PARK MODULE AND DC CONVERTER DATA

##### PC.A.5.1 Introduction

###### Directly Connected

PC.A.5.1.1 Each **Generator**, with existing or proposed **Power Stations** directly connected, or to be directly connected, to the **GB Transmission System**, shall provide **NGET** with data relating to that **Plant and Apparatus**, both current and forecast, as specified in PC.A.5.2, PC.A.5.3 and PC.A.5.4 as applicable. Each **DC Converter Station** owner, with existing or proposed **DC Converter Stations** directly connected, or to be directly connected, to the **GB Transmission System**, shall provide **NGET** with data relating to that **Plant and Apparatus**, both current and forecast, as specified in PC.A.5.2 and PC.A.5.4.

###### Embedded

PC.A.5.1.2 Each **Generator**, with existing or proposed **Embedded Large Power Stations** and **Embedded Medium Power Stations** shall provide **NGET** with data relating to each of those **Large Power Stations** and/or **Medium Power Stations**, both current and forecast, as specified in PC.A.5.2, PC.A.5.3 and PC.A.5.4 as applicable. Each **DC Converter Station** owner, with existing or proposed **DC Converter Stations** shall provide **NGET** with data relating to each of those **DC Converter Stations**, both current and forecast, as specified in PC.A.5.2 and PC.A.5.4. However, no data need be supplied in relation to those **Embedded Medium Power Stations** if they are connected at a voltage level below the voltage level of the **Subtransmission System** except in connection with an application for, or under a, **CUSC Contract** or unless specifically requested by **NGET** under PC.A.5.1.4.

PC.A.5.1.3 Each **Network Operator** need not submit **Planning Data** in respect of **Embedded Small Power Stations** unless required to do so under PC.A.1.2(b) or unless specifically requested under PC.A.5.1.4 below, in which case they will supply such data.

PC.A.5.1.4 PC.A.4.2.4(b) and PC.A.4.3.2(a) explained that the forecast **Demand** submitted by each **Network Operator** must be net of the output of all **Medium Power Stations** and **Small Power Stations** and **Customer Generating Plant Embedded** in that **User's System**. In such cases (PC.A.3.1.4 also refers), the **Network Operator** must inform **NGET** of the number of such **Power Stations** (including the number of **Generating Units**) together with their summated capacity. On receipt of this data, the **Network Operator** or **Generator** (if the data relates to **Power Stations** referred to in PC.A.5.1.2) may be further required at **NGET's** discretion to provide details of **Embedded Small Power Stations** and **Embedded Medium Power Stations** and **Customer Generating Plant**, both current

and forecast, as specified in PC.A.5.2 and PC.A.5.3. Such requirement would arise when **NGET** reasonably considers that the collective effect of a number of such **Embedded Small Power Stations and Embedded Medium Power Stations** and **Customer Generating Plants** may have a significant system effect on the **GB Transmission System**.

PC.A.5.2      **Demand**

PC.A.5.2.1      For each **Generating Unit** which has an associated **Unit Transformer**, the value of the **Demand** supplied through this **Unit Transformer** when the **Generating Unit** is at **Rated MW** output is to be provided.

PC.A.5.2.2      Where the **Power Station** or **DC Converter Station** has associated **Demand** additional to the unit-supplied **Demand** of PC.A.5.2.1 which is supplied from either the **GB Transmission System** or the **Generator's User System** the **Generator** or **DC Converter Station** owner shall supply forecasts for each **Power Station** or **DC Converter Station** of:

- a)      the maximum **Demand** that, in the **User's** opinion, could reasonably be imposed on the **GB Transmission System** or the **Generator's User System** as appropriate;
- b)      the **Demand** at the time of the peak **GB Transmission System Demand**;
- c)      the **Demand** at the time of minimum **GB Transmission System Demand**.

PC.A.5.2.3      No later than calendar week 17 each year **NGET** shall notify each **Generator** with **Large Power Stations** and/or **Medium Power Stations** in writing of the following, for the current **Financial Year** and for each of the following seven **Financial Years**, which will be regarded as the relevant specified days and times under PC.A.5.2.2:

- a)      the date and time of the annual peak of the **GB Transmission System Demand** at **Annual ACS Conditions**;
- b)      the date and time of the annual minimum of the **GB Transmission System Demand** at **Average Conditions**.

PC.A.5.2.4      At its discretion, **NGET** may also request further details of the **Demand** as specified in PC.A.4.6

PC.A.5.3      **Synchronous Generating Unit and Associated Control System Data**

PC.A.5.3.1      The data submitted below are not intended to constrain any **Ancillary Services Agreement**

PC.A.5.3.2      The following **Synchronous Generating Unit** and **Power Station** data should be supplied:

(a) **Synchronous Generating Unit Parameters**

- Rated terminal volts (kV)
- \* Rated MVA
- \* **Rated MW**
- \* Minimum Generation MW
- \* Short circuit ratio
- Direct axis synchronous reactance
- \* Direct axis transient reactance
- Direct axis sub-transient reactance
- Direct axis short-circuit transient time constant.
- Direct axis short-circuit sub-transient time constant.
- Quadrature axis synchronous reactance
- Quadrature axis sub-transient reactance
- Quadrature axis short-circuit sub-transient time constant.
- Stator time constant
- Stator leakage reactance
- Armature winding direct-current resistance.

**Note:** The above data item relating to armature winding direct-current resistance need only be supplied by **Generators** with respect to **Generating Units** commissioned after 1st March 1996 and in cases where, for whatever reason, the **Generator** is aware of the value of the relevant parameter.

- \* Turbogenerator inertia constant (MWsec/MVA)
- Rated field current (amps) at **Rated MW** and Mvar output and at rated terminal voltage.

Field current (amps) open circuit saturation curve for **Generating Unit** terminal voltages ranging from 50% to 120% of rated value in 10% steps as derived from appropriate manufacturers test certificates.

(b) **Parameters for Generating Unit Step-up Transformers**

- \* Rated MVA
- Voltage ratio
- \* Positive sequence reactance  
(at max, min, & nominal tap)
- Positive sequence resistance  
(at max, min, & nominal tap)
- Zero phase sequence reactance
- Tap changer range
- Tap changer step size
- Tap changer type: on load or off circuit

(c) **Excitation Control System parameters**

**Note:** The data items requested under Option 1 below may continue to be provided by **Generators** in relation to **Generating Units** on the **System** at 09 January 1995



(in this paragraph, the "relevant date") or they may provide the new data items set out under Option 2. **Generators** must supply the data as set out under Option 2 (and not those under Option 1) for **Generating Unit** excitation control systems commissioned after the relevant date, those **Generating Unit** excitation control systems recommissioned for any reason such as refurbishment after the relevant date and **Generating Unit** excitation control systems where, as a result of testing or other process, the **Generator** is aware of the data items listed under Option 2 in relation to that **Generating Unit**.

#### Option 1

DC gain of **Excitation Loop**

Rated field voltage

Maximum field voltage

Minimum field voltage

Maximum rate of change of field voltage (rising)

Maximum rate of change of field voltage (falling)

Details of **Excitation Loop** described in block diagram form showing transfer functions of individual elements.

Dynamic characteristics of **Over-excitation Limiter**.

Dynamic characteristics of **Under-excitation Limiter**

#### Option 2

**Excitation System Nominal Response**

**Rated Field Voltage**

**No-Load Field Voltage**

**Excitation System On-Load Positive Ceiling Voltage**

**Excitation System No-Load Positive Ceiling Voltage**

**Excitation System No-Load Negative Ceiling Voltage**

Details of **Excitation System** (including **PSS** if fitted) described in block diagram form showing transfer functions of individual elements.

Details of **Over-excitation Limiter** described in block diagram form showing transfer functions of individual elements.

Details of **Under-excitation Limiter** described in block diagram form showing transfer functions of individual elements.

#### (d) Governor Parameters

Incremental Droop values (in %) are required for each **Generating Unit** at six MW loading points (MLP1 to MLP6) as detailed in PC.A.5.5.1 (this data item needs only be provided for **Large Power Stations**)

**Note:** The data items requested under Option 1 below may continue to be provided by **Generators** in relation to **Generating Units** on the **System** at 09 January 1995 (in this paragraph, the "relevant date") or they may provide the new data items set out under Option 2. **Generators** must supply the data as set out under Option 2 (and not those under Option 1) for **Generating Unit** governor control systems commissioned after the relevant date, those **Generating Unit** governor control systems recommissioned for any reason such as refurbishment after the relevant date and **Generating Unit** governor control systems where, as a result of testing or other process, the **Generator** is aware of the data items listed under Option 2 in relation to that **Generating Unit**.

#### Option 1

(i) Governor Parameters (for Reheat **Steam Units**)

HP governor average gain MW/Hz  
Speeder motor setting range  
HP governor valve time constant  
HP governor valve opening limits  
HP governor valve rate limits  
Reheater time constant (**Active Energy** stored in reheater)

IP governor average gain MW/Hz  
IP governor setting range  
IP governor valve time constant  
IP governor valve opening limits  
IP governor valve rate limits

Details of acceleration sensitive elements in HP & IP governor loop.  
A governor block diagram showing transfer functions of individual elements.

(ii) Governor Parameters (for Non-Reheat **Steam Units** and **Gas Turbine Units**)

Governor average gain  
Speeder motor setting range  
Time constant of steam or fuel governor valve  
Governor valve opening limits  
Governor valve rate limits  
Time constant of turbine  
Governor block diagram

The following data items need only be supplied for **Large Power Stations**:-

(iii) Boiler & Steam Turbine Data

Boiler Time Constant (Stored **Active Energy**)  
s

HP turbine response ratio:  
proportion of **Primary Response**  
%  
arising from HP turbine.

HP turbine response ratio:  
proportion of **High Frequency Response**  
%  
arising from HP turbine.

[End of Option 1]

Option 2

(i) Governor and associated prime mover Parameters -  
All **Generating Units**

Governor Block Diagram showing transfer function of individual elements including acceleration sensitive elements.

Governor Time Constant (in seconds)

Speeder Motor Setting Range (%)

Average Gain (MW/Hz)

Governor Deadband (this data item need only be provided for **Large Power Stations**)

- Maximum Setting      ±Hz

- Normal Setting        ±Hz

- Minimum Setting      ±Hz

Where the **Generating Unit** governor does not have a selectable deadband facility, then the actual value of the deadband need only be provided

(ii) Governor and associated prime mover Parameters -  
**Steam Units**

HP Valve Time Constant (in seconds)

HP Valve Opening Limits (%)

HP Valve Opening Rate Limits (%/second)

HP Valve Closing Rate Limits (%/second)

HP Turbine Time Constant (in seconds)

IP Valve Time Constant (in seconds)

IP Valve Opening Limits (%)

IP Valve Opening Rate Limits (%/second)

IP Valve Closing Rate Limits (%/second)

IP Turbine Time Constant (in seconds)

LP Valve Time Constant (in seconds)

LP Valve Opening Limits (%)  
LP Valve Opening Rate Limits (%/second)  
LP Valve Closing Rate Limits (%/second)  
LP Turbine Time Constant (in seconds)

Reheater Time Constant (in seconds)  
Boiler Time Constant (in seconds)  
HP Power Fraction (%)  
IP Power Fraction (%)

(iii) Governor and associated prime mover Parameters -  
Gas Turbine Units

Inlet Guide Vane Time Constant (in seconds)  
Inlet Guide Vane Opening Limits (%)  
Inlet Guide Vane Opening Rate Limits (%/second)  
Inlet Guide Vane Closing Rate Limits (%/second)  
Fuel Valve Constant (in seconds)  
Fuel Valve Opening Limits (%)  
Fuel Valve Opening Rate Limits (%/second)  
Fuel Valve Closing Rate Limits (%/second)

Waste Heat Recovery Boiler Time Constant (in seconds)

(iv) Governor and associated prime mover Parameters -  
Hydro Generating Units

Guide Vane Actuator Time Constant (in seconds)  
Guide Vane Opening Limits (%)  
Guide Vane Opening Rate Limits (%/second)  
Guide Vane Closing Rate Limits (%/second)  
Water Time Constant (in seconds)

[End of Option 2]

(e) Unit Control Options

The following data items need only be supplied with respect to **Large Power Stations**:

Maximum <b>Droop</b>	%
Normal <b>Droop</b>	%
Minimum <b>Droop</b>	%
Maximum <b>Frequency</b> deadband	±Hz
Normal <b>Frequency</b> deadband	±Hz
Minimum <b>Frequency</b> deadband	±Hz
Maximum output deadband	±MW
Normal output deadband	±MW
Minimum output deadband	±MW

**Frequency** settings between which Unit Load Controller **Droop** applies:

- Maximum Hz
- Normal Hz
- Minimum Hz

State if sustained response is normally selected.

(f) Plant Flexibility Performance

The following data items need only be supplied with respect to **Large Power Stations**, and should be provided with respect to each **Genset**:

- # Run-up rate to **Registered Capacity**,
- # Run-down rate from **Registered Capacity**,
- # **Synchronising Generation**,  
Regulating range  
**Load** rejection capability while still **Synchronised** and able to supply **Load**.

Data items marked with a hash (#) should be applicable to a **Genset** which has been **Shutdown** for 48 hours.

- \* Data items marked with an asterisk are already requested under part 1, PC.A.3.3.1, to facilitate an early assessment by **NGET** as to whether detailed stability studies will be required before an offer of terms for a **CUSC Contract** can be made. Such data items have been repeated here merely for completeness and need not, of course, be resubmitted unless their values, known or estimated, have changed.

PC.A.5.4 **Non-Synchronous Generating Unit and Associated Control System Data**

PC.A.5.4.1 The data submitted below are not intended to constrain any **Ancillary Services Agreement**

PC.A.5.4.2 The following **Power Park Unit**, **Power Park Module** and **Power Station** data should be supplied in the case of a **Power Park Module** not connected to the **Total System** by a **DC Converter**:

(a) **Power Park Unit** model

A mathematical model of each type of **Power Park Unit** capable of representing its transient and dynamic behaviour under both small and large disturbance conditions. The model shall include non-linear effects and represent all equipment relevant to the dynamic performance of the **Power Park Unit** as agreed with **NGET**. The model shall be suitable for the study of balanced, root mean square, positive phase sequence time-domain behaviour, excluding the effects of electromagnetic transients, harmonic and sub-harmonic frequencies.

The model shall accurately represent the overall performance of the **Power Park Unit** over its entire operating range including that which is inherent to the **Power Park Unit** and that which is achieved by use of supplementary control systems providing either continuous or stepwise control. Model resolution should be sufficient to accurately represent **Power Park Unit** behaviour both in response to operation of transmission system protection and in the context of longer-term simulations.

The overall structure of the model shall include:

- (i) any supplementary control signal modules not covered by (c), (d) and (e) below.
- (ii) any blocking, deblocking and protective trip features that are part of the **Power Park Unit** (e.g. "crowbar").
- (iii) any other information required to model the **Power Park Unit** behaviour to meet the model functional requirement described above.

The model shall be submitted in the form of a transfer function block diagram and may be accompanied by dynamic and algebraic equations. This model shall display all the transfer functions and their parameter values, any non wind-up logic, signal limits and non-linearities.

The submitted **Power Park Unit** model shall have been validated and this shall be confirmed by the **Generator**. The validation shall be based on comparing the submitted model simulation results against measured test results. Validation evidence shall also be submitted and this shall include the simulation and measured test results. The latter shall include appropriate short-circuit tests.

(b) **Power Park Unit** parameters

- \* Rated MVA
- \* **Rated MW**
- \* Rated terminal voltage
- \* Inertia constant (MWsec/MVA) at synchronous speed  
Additionally, for **Power Park Units** that are squirrel-cage or doubly-fed induction generators driven by wind turbines:
  - \* Stator resistance
  - \* Stator reactance
  - \* Magnetising reactance.
  - \* Rotor resistance.(at starting)
  - \* Rotor resistance.(at rated running)
  - \* Rotor reactance (at starting)
  - \* Rotor reactance (at rated running)
  - \* Inertia constant (MWsec/MVA) of the wind turbine rotor
  - \* Inertia constant (MWsec/MVA) of the generator rotor
  - \* Shaft stiffness (Nm/electrical radian)

Additionally for doubly-fed induction generators only:

- The generator rotor speed range (minimum and maximum speeds in RPM)
- The optimum generator rotor speed versus wind speed submitted in tabular format

## Power converter rating (MVA)

The rotor power coefficient ( $C_p$ ) versus tip speed ratio ( $\lambda$ ) curves for a range of blade angles (where applicable) together with the corresponding values submitted in tabular format. The tip speed ratio ( $\lambda$ ) is defined as  $\Omega R/U$  where  $\Omega$  is the angular velocity of the rotor,  $R$  is the radius of the wind turbine rotor and  $U$  is the wind speed.

The electrical power output versus generator rotor speed for a range of wind speeds over the entire operating range of the **Power Park Unit**, together with the corresponding values submitted in tabular format.

The blade angle versus wind speed curve together with the corresponding values submitted in tabular format.

The electrical power output versus wind speed over the entire operating range of the **Power Park Unit**, together with the corresponding values submitted in tabular format.

Transfer function block diagram, including parameters and description of the operation of the power electronic converter (where applicable).

For a **Power Park Unit** consisting of a synchronous machine in combination with a back to back **DC Converter**, or for a **Power Park Unit** not driven by a wind turbine, the data to be supplied shall be agreed with **NGET** in accordance with PC.A.7.

- (c) Torque / speed and blade angle control systems and parameters

For the **Power Park Unit**, details of the torque / speed controller and blade angle controller in the case of a wind turbine and power limitation functions (where applicable) described in block diagram form showing transfer functions and parameters of individual elements.

- (d) Voltage/**Reactive Power/Power Factor** control system parameters

For the **Power Park Unit** and **Power Park Module** details of voltage/**Reactive Power/Power Factor** controller (and **PSS** if fitted) described in block diagram form showing transfer functions and parameters of individual elements.

- (e) **Frequency** control system parameters

For the **Power Park Unit** and **Power Park Module** details of the **Frequency** controller described in block diagram form showing transfer functions and parameters of individual elements.

- (f) Protection

Details of settings for the following protection relays (to include):  
Under **Frequency**, over **Frequency**, under voltage, over voltage,  
rotor over current, stator over current, high wind speed shut down  
level.

- (g) Complete **Power Park Unit** model, parameters and controls

An alternative to PC.A.5.4.2 (a), (b), (c), (d), (e) and (f), is the submission of a single complete model that consists of the full information required under PC.A.5.4.2 (a), (b), (c), (d), (e) and (f) provided that all the information required under PC.A.5.4.2 (a), (b), (c), (d), (e) and (f) individually is clearly identifiable.

- (h) Harmonic and flicker parameters

When connecting a **Power Park Module**, it is necessary for **NGET** to evaluate the production of flicker and harmonics on **NGET** and **User's Systems**. At **NGET's** reasonable request, the **User** is required to submit the following data (as defined in IEC 61400-21 (2001)) for each **Power Park Unit**:-

Flicker coefficient for continuous operation.

Flicker step factor.

Number of switching operations in a 10 minute window.

Number of switching operations in a 2 hour window.

Voltage change factor.

Current Injection at each harmonic for each **Power Park Unit**  
and for each **Power Park Module**

\* Data items marked with an asterisk are already requested under part 1, PC.A.3.3.1, to facilitate an early assessment by **NGET** as to whether detailed stability studies will be required before an offer of terms for a **CUSC Contract** can be made. Such data items have been repeated here merely for completeness and need not, of course, be resubmitted unless their values, known or estimated, have changed.

#### PC.A.5.4.3

#### **DC Converter**

##### PC.A.5.4.3.1

For a **DC Converter** at a **DC Converter Station** or a **Power Park Module** connected to the **Total System** by a **DC Converter** the following information for each **DC Converter** and **DC Network** should be supplied:

- (a) **DC Converter** parameters
- \* **Rated MW** per pole for transfer in each direction;
  - \* **DC Converter** type (i.e. current or voltage source);
  - \* Number of poles and pole arrangement;
  - \* Rated DC voltage/pole (kV);
  - \* Return path arrangement;
- (b) **DC Converter** transformer parameters
- Rated MVA
  - Nominal primary voltage (kV);



Nominal secondary (converter-side) voltage(s) (kV);  
Winding and earthing arrangement;  
Positive phase sequence reactance at minimum, maximum and nominal tap;  
Positive phase sequence resistance at minimum, maximum and nominal tap;  
Zero phase sequence reactance;  
Tap-changer range in %;  
number of tap-changer steps;

- (c) **DC Network** parameters  
Rated DC voltage per pole;  
Rated DC current per pole;  
Single line diagram of the complete **DC Network**;  
Details of the complete **DC Network**, including resistance, inductance and capacitance of all DC cables and/or DC lines;  
Details of any DC reactors (including DC reactor resistance), DC capacitors and/or DC-side filters that form part of the **DC Network**;

- (d) AC filter reactive compensation equipment parameters

Note: The data provided pursuant to this paragraph must not include any contribution from reactive compensation plant owned by **NGET**.

Total number of AC filter banks.

Type of equipment (e.g. fixed or variable)

Single line diagram of filter arrangement and connections;

**Reactive Power** rating for each AC filter bank, capacitor bank or operating range of each item of reactive compensation equipment, at rated voltage;

Performance chart showing **Reactive Power** capability of the **DC Converter**, as a function of MW transfer, with all filters and reactive compensation plant, belonging to the **DC Converter Station** working correctly.

Note: Details in PC.A.5.4.3.1 are required for each **DC Converter** connected to the **DC Network**, unless each is identical or where the data has already been submitted for an identical **DC Converter** at another **Connection Point**.

Note: For a **Power Park Module** connected to the **Grid Entry point** or (**User System Entry Point** if **Embedded**) by a **DC Converter** the equivalent inertia and fault infeed at the **Power Park Unit** should be given.

### **DC Converter control system models**

#### PC.A.5.4.3.2

The following data is required by **NGET** to represent **DC Converters** and associated **DC Networks** in dynamic power system simulations, in which the AC power system is typically represented by a positive sequence

equivalent. **DC Converters** are represented by simplified equations and are not modeled to switching device level.

- (i) Static  $V_{DC}-I_{DC}$  (DC voltage - DC current) characteristics, for both the rectifier and inverter modes for a current source converter. Static  $V_{DC}-P_{DC}$  (DC voltage - DC power) characteristics, for both the rectifier and inverter modes for a voltage source converter. Transfer function block diagram including parameters representation of the control systems of each **DC Converter** and of the **DC Converter Station**, for both the rectifier and inverter modes. A suitable model would feature the **DC Converter** firing angle as the output variable.
- (ii) Transfer function block diagram representation including parameters of the **DC Converter** transformer tap changer control systems, including time delays
- (iii) Transfer function block diagram representation including parameters of AC filter and reactive compensation equipment control systems, including any time delays.
- (iv) Transfer function block diagram representation including parameters of any **Frequency** and/or load control systems.
- (v) Transfer function block diagram representation including parameters of any small signal modulation controls such as power oscillation damping controls or sub-synchronous oscillation damping controls, that have not been submitted as part of the above control system data
- (vi) Transfer block diagram representation of the **Reactive Power** control at converter ends for a voltage source converter.

#### Plant Flexibility Performance

PC.A.5.4.3.3 The following information on plant flexibility and performance should be supplied:

- (i) Nominal and maximum (emergency) loading rate with the **DC Converter** in rectifier mode.
- (ii) Nominal and maximum (emergency) loading rate with the **DC Converter** in inverter mode.
- (iii) Maximum recovery time, to 90% of pre-fault loading, following an AC system fault or severe voltage depression.
- (iv) Maximum recovery time, to 90% of pre-fault loading, following a transient **DC Network** fault.

PC.A.5.4.3.4 Harmonic Assessment Information

**DC Converter** owners shall provide such additional further information as required by **NET** in order that compliance with CC.6.1.5 can be demonstrated.

- \* Data items marked with an asterisk are already requested under part 1, PC.A.3.3.1, to facilitate an early assessment by **NET** as to whether detailed stability studies will be required before an offer of terms for a **CUSC Contract** can be made. Such data items have been repeated here merely for completeness and need not, of course, be resubmitted unless their values, known or estimated, have changed.

PC.A.5.5 Response data for **Frequency** changes

The information detailed below is required to describe the actual frequency response capability profile as illustrated in Figure CC.A.3.1 of the **Connection Conditions**, and need only be provided for each **Genset** at a **Large Power Stations**.

In this **PC.A.5.5**, for a **CCGT Module** with more than one **Generating Unit**, the phrase **Minimum Generation** applies to the entire **CCGT Module** operating with all **Generating Units Synchronised** to the **System**. Similarly for a **Power Park Module** with more than one **Power Park Unit**, the phrase **Minimum Generation** applies to the entire **Power Park Module** operating with all **Power Park Units Synchronised** to the **System**.

PC.A.5.5.1 MW loading points at which data is required

Response values are required at six MW loading points (MLP1 to MLP6) for each **Genset**. **Primary** and **Secondary Response** values need not be provided for MW loading points which are below **Minimum Generation**. MLP1 to MLP6 must be provided to the nearest MW.

Prior to the **Genset** being first **Synchronised**, the MW loading points must take the following values :-

MLP1	<b>Designed Minimum Operating Level</b>
MLP2	<b>Minimum Generation</b>
MLP3	70% of <b>Registered Capacity</b>
MLP4	80% of <b>Registered Capacity</b>
MLP5	95% of <b>Registered Capacity</b>
MLP6	<b>Registered Capacity</b>

When data is provided after the **Genset** is first **Synchronised**, the MW loading points may take any value between **Designed Minimum Operating Level** and **Registered Capacity** but the value of the **Designed Minimum Operating Level** must still be provided if it does not form one of the MW loading points.

PC.A.5.5.2 **Primary and Secondary Response to Frequency fall**

**Primary** and **Secondary Response** values for a -0.5Hz ramp are required at six MW loading points (MLP1 to MLP6) as detailed above

PC.A.5.5.3 **High Frequency Response to Frequency rise**

**High Frequency Response** values for a +0.5Hz ramp are required at six MW loading points (MLP1 to MLP6) as detailed above.

PC.A.5.6 **Mothballed Generating Unit Mothballed Power Park Module or Mothballed DC Converter at a DC Converter Station and Alternative Fuel Information**

Data identified under this section PC.A.5.5 must be submitted as required under PC.A.1.2 and at **NGET's** reasonable request.

PC.A.5.6.1 **Mothballed Generating Unit Information**

**Generators** and **DC Converter Station** owners must supply with respect to each **Mothballed Generating Unit, Mothballed Power Park Module or Mothballed DC Converter** at a **DC Converter Station** the estimated MW output which could be returned to service within the following time periods from the time that a decision to return was made:

- < 1 month;
- 1-2 months;
- 2-3 months;
- 3-6 months;
- 6-12 months; and
- >12 months.

The return to service time should be determined in accordance with **Good Industry Practice** assuming normal working arrangements and normal plant procurement lead times. The MW output values should be the incremental values made available in each time period as further described in the **DRC**.

PC.A.5.6.2 **Generators** and **DC Converter Station** owners must also notify **NGET** of any significant factors which may prevent the **Mothballed Generating Unit, Mothballed Power Park Module or Mothballed DC Converter** at a **DC Converter Station** achieving the estimated values provided under PC.A.5.6.1 above, excluding factors relating to **Transmission Entry Capacity**.

PC.A.5.6.3 **Alternative Fuel Information**

The following data items must be supplied with respect to each **Generating Unit** whose main fuel is gas.

For each alternative fuel type (if facility installed):

- (a) Alternative fuel type e.g. oil distillate, alternative gas supply
- (b) For the changeover from main to alternative fuel:

- Time to carry out off-line and on-line fuel changeover (minutes).
- Maximum output following off-line and on-line changeover (MW).
- Maximum output during on-line fuel changeover (MW).
- Maximum operating time at full load assuming typical and maximum possible stock levels (hours).
- Maximum rate of replacement of depleted stocks (MWh electrical/day) on the basis of **Good Industry Practice**.
- Is changeover to alternative fuel used in normal operating arrangements?
- Number of successful changeovers carried out in the last **NGET Financial Year** (choice of 0, 1-5, 6-10, 11-20, >20).

(c) For the changeover back to main fuel:

- Time to carry out off-line and on-line fuel changeover (minutes).
- Maximum output during on-line fuel changeover (MW).

PC.A.5.6.4 **Generators** must also notify **NGET** of any significant factors and their effects which may prevent the use of alternative fuels achieving the estimated values provided under PC.A.5.6.3 above (e.g. emissions limits, distilled water stocks etc.)

PC.A.6 **USERS' SYSTEM DATA**

PC.A.6.1 **Introduction**

PC.A.6.1.1 Each **User**, whether connected directly via an existing **Connection Point** to the **GB Transmission System** or seeking such a direct connection, shall provide **NGET** with data on its **User System** which relates to the **Connection Site** containing the **Connection Point** both current and forecast, as specified in PC.A.6.2 to PC.A.6.6.

PC.A.6.1.2 Each **User** must reflect the system effect at the **Connection Site(s)** of any third party **Embedded** within its **User System** whether existing or proposed.

PC.A.6.1.3 PC.A.6.2, and PC.A.6.4 to PC.A.6.6 consist of data which is only to be supplied to **NGET** at **NGET's** reasonable request. In the event that **NGET** identifies a reason for requiring this data, **NGET** shall write to the relevant **User(s)**, requesting the data, and explaining the reasons for the request. If the **User(s)** wishes, **NGET** shall also arrange a meeting at which the

request for data can be discussed, with the objective of identifying the best way in which **NGET**'s requirements can be met.

PC.A.6.2 Transient Overvoltage Assessment Data

PC.A.6.2.1 It is occasionally necessary for **NGET** to undertake transient overvoltage assessments (e.g. capacitor switching transients, switchgear transient recovery voltages, etc). At **NGET**'s reasonable request, each **User** is required to provide the following data with respect to the **Connection Site**, current and forecast, together with a **Single Line Diagram** where not already supplied under PC.A.2.2.1, as follows:-

- (a) busbar layout plan(s), including dimensions and geometry showing positioning of any current and voltage transformers, through bushings, support insulators, disconnectors, circuit breakers, surge arresters, etc. Electrical parameters of any associated current and voltage transformers, stray capacitances of wall bushings and support insulators, and grading capacitances of circuit breakers;
- (b) Electrical parameters and physical construction details of lines and cables connected at that busbar. Electrical parameters of all plant e.g., transformers (including neutral earthing impedance or zig-zag transformers, if any), series reactors and shunt compensation equipment connected at that busbar (or to the tertiary of a transformer) or by lines or cables to that busbar;
- (c) Basic insulation levels (BIL) of all **Apparatus** connected directly, by lines or by cables to the busbar;
- (d) characteristics of overvoltage **Protection** devices at the busbar and at the termination points of all lines, and all cables connected to the busbar;
- (e) fault levels at the lower voltage terminals of each transformer connected directly or indirectly to the **GB Transmission System** without intermediate transformation;
- (f) the following data is required on all transformers operating at **Supergrid Voltage** throughout **Great Britain** and, in Scotland, also at 132kV: three or five limb cores or single phase units to be specified, and operating peak flux density at nominal voltage;
- (g) an indication of which items of equipment may be out of service simultaneously during **Planned Outage** conditions.

PC.A.6.3 User's Protection Data

PC.A.6.3.1 Protection

The following information is required which relates only to **Protection** equipment which can trip or inter-trip or close any **Connection Point**

circuit-breaker or any **Transmission** circuit-breaker. This information need only be supplied once, in accordance with the timing requirements set out in PC.A.1.4(b), and need not be supplied on a routine annual basis thereafter, although **NGET** should be notified if any of the information changes

- (a) a full description, including estimated settings, for all relays and **Protection** systems installed or to be installed on the **User's System**;
- (b) a full description of any auto-reclose facilities installed or to be installed on the **User's System**, including type and time delays;
- (c) a full description, including estimated settings, for all relays and **Protection** systems or to be installed on the generator, generator transformer, **Station Transformer** and their associated connections;
- (d) for **Generating Units** (other than **Power Park Units**) or **Power Park Modules** or **DC Converters** at a **DC Converter Station** having (or intended to have) a circuit breaker at the generator terminal voltage, clearance times for electrical faults within the **Generating Unit** (other than a **Power Park Unit**) or **Power Park Module** zone;
- (e) the most probable fault clearance time for electrical faults on any part of the **User's System** directly connected to the **GB Transmission System**.

PC.A.6.4 Harmonic Studies

PC.A.6.4.1 It is occasionally necessary for **NGET** to evaluate the production/magnification of harmonic distortion on **NGET** and **User's Systems**, especially when **NGET** is connecting equipment such as capacitor banks. At **NGET's** reasonable request, each **User** is required to submit data with respect to the **Connection Site**, current and forecast, and where not already supplied under PC.A.2.2.4 and PC.A.2.2.5, as follows:-

PC.A.6.4.2 Overhead lines and underground cable circuits of the **User's Subtransmission System** must be differentiated and the following data provided separately for each type:-

- Positive phase sequence resistance;
- Positive phase sequence reactance;
- Positive phase sequence susceptance;

and for all transformers connecting the **User's Subtransmission System** to a lower voltage:-

- Rated MVA;
- Voltage Ratio;
- Positive phase sequence resistance;

Positive phase sequence reactance;

and at the lower voltage points of those connecting transformers:-

Equivalent positive phase sequence susceptance;  
Connection voltage and Mvar rating of any capacitor bank and component design parameters if configured as a filter;  
Equivalent positive phase sequence interconnection impedance with other lower voltage points;  
The minimum and maximum **Demand** (both MW and Mvar) that could occur;  
Harmonic current injection sources in Amps at the Connection voltage points. Where the harmonic injection current comes from a diverse group of sources, the equivalent contribution may be established from appropriate measurements;  
Details of traction loads, eg connection phase pairs, continuous variation with time, etc;  
An indication of which items of equipment may be out of service simultaneously during **Planned Outage** conditions.

PC.A.6.5

#### Voltage Assessment Studies

It is occasionally necessary for **NGET** to undertake detailed voltage assessment studies (e.g., to examine potential voltage instability, voltage control co-ordination or to calculate voltage step changes). At **NGET's** reasonable request, each **User** is required to submit the following data where not already supplied under PC.A.2.2.4 and PC.A.2.2.5:-

For all circuits of the **User's Subtransmission System**:-

Positive Phase Sequence Reactance;  
Positive Phase Sequence Resistance;  
Positive Phase Sequence Susceptance;  
Mvar rating of any reactive compensation equipment;

and for all transformers connecting the **User's Subtransmission System** to a lower voltage:-

Rated MVA;  
Voltage Ratio;  
Positive phase sequence resistance;  
Positive Phase sequence reactance;  
Tap-changer range;  
Number of tap steps;  
Tap-changer type: on-load or off-circuit;  
AVC/tap-changer time delay to first tap movement;  
AVC/tap-changer inter-tap time delay;

and at the lower voltage points of those connecting transformers:-

Equivalent positive phase sequence susceptance;  
Mvar rating of any reactive compensation equipment;  
Equivalent positive phase sequence interconnection impedance with other lower voltage points;



The maximum **Demand** (both MW and Mvar) that could occur;  
Estimate of voltage insensitive (constant power) load content in  
% of total load at both winter peak and 75% off-peak load  
conditions.

PC.A.6.6 Short Circuit Analysis:

PC.A.6.6.1 Where prospective short-circuit currents on equipment owned, operated or managed by **NGET** are greater than 90% of the equipment rating, and in **NGET**'s reasonable opinion more accurate calculations of short-circuit currents are required, then at **NGET**'s request each **User** is required to submit data with respect to the **Connection Site**, current and forecast, and where not already supplied under PC.A.2.2.4 and PC.A.2.2.5, as follows:

PC.A.6.6.2 For all circuits of the **User's Subtransmission System**:-

Positive phase sequence resistance;  
Positive phase sequence reactance;  
Positive phase sequence susceptance;  
Zero phase sequence resistance (both self and mutuals);  
Zero phase sequence reactance (both self and mutuals);  
Zero phase sequence susceptance (both self and mutuals);

and for all transformers connecting the **User's Subtransmission System** to a lower voltage:-

Rated MVA;  
Voltage Ratio;  
Positive phase sequence resistance (at max, min and nominal tap);  
Positive Phase sequence reactance (at max, min and nominal tap);  
Zero phase sequence reactance (at nominal tap);  
Tap changer range;  
Earthing method: direct, resistance or reactance;  
Impedance if not directly earthed;

and at the lower voltage points of those connecting transformers:-

The maximum **Demand** (in MW and Mvar) that could occur;  
Short-circuit infeed data in accordance with PC.A.2.5.6 unless the **User's** lower voltage network runs in parallel with the **User's Subtransmission System**, when to prevent double counting in each node infeed data, a  $\pi$  equivalent comprising the data items of PC.A.2.5.6 for each node together with the positive phase sequence interconnection impedance between the nodes shall be submitted.

PC.A.7 ADDITIONAL DATA FOR NEW TYPES OF POWER STATIONS, DC CONVERTER STATIONS AND CONFIGURATIONS

Notwithstanding the **Standard Planning Data** and **Detailed Planning Data** set out in this Appendix, as new types of configurations and

operating arrangements of **Power Stations** and **DC Converter Stations** emerge in future, **NGET** may reasonably require additional data to represent correctly the performance of such **Plant** and **Apparatus** on the **System**, where the present data submissions would prove insufficient for the purpose of producing meaningful **System** studies for the relevant parties.

## PART 3

### NETWORK DATA

PC.A.8 To allow a **User** to model the **GB Transmission System**, **NGET** will provide the following **Network Data** to **Users**, calculated in accordance with **Good Industry Practice**:-

PC.A.8.1 **Single Point of Connection**

For a **Single Point of Connection** to a **User's System**, as an equivalent 400kV or 275kV source and also in Scotland as an equivalent 132kV source, the data (as at the HV side of the **Point of Connection** reflecting data given to **NGET** by **Users**) will be given to a **User** as follows:-

The data items listed under the following parts of PC.A.8.3:-

(a) (i), (ii), (iii), (iv), (v) and (vi)

and the data items shall be provided in accordance with the detailed provisions of PC.A.8.3 (b) - (e).

PC.A.8.2 **Multiple Point of Connection**

For a **Multiple Point of Connection** to a **User's System**, the equivalent will normally be in the form of a  $\pi$  model or extension with a source at each node and a linking impedance. The data at the **Connection Point** will be given to a **User** as follows:-

The data items listed under the following parts of PC.A.8.3:-

(a) (i), (ii), (iv), (v), (vi), (vii) and (viii)

and the data items shall be provided in accordance with the detailed provisions of PC.A.8.3 (b) - (e).

When an equivalent of this form is not required **NGET** will not provide the data items listed under the following parts of PC.A.8.3:-

(a) (vii) and (viii)

PC.A.8.3 **Data Items**

(a) The following is a list of data utilised in this part of the **PC**. It also contains rules on the data which generally apply.

(i) symmetrical three-phase short circuit current infeed at the instant of fault from the **GB Transmission System**, ( $I_1''$ );

(ii) symmetrical three-phase short circuit current from the **GB Transmission System** after the subtransient fault current contribution has substantially decayed, ( $I_1'$ );

- (iii) the zero sequence source resistance and reactance values at the **Point of Connection**, consistent with the maximum infeed below;
  - (iv) the pre-fault voltage magnitude at which the maximum fault currents were calculated;
  - (v) the positive sequence X/R ratio at the instant of fault;
  - (vi) the negative sequence resistance and reactance values of the **GB Transmission System** seen from the **Point of Connection**, if substantially different from the values of positive sequence resistance and reactance which would be derived from the data provided above;
  - (vii) the initial positive sequence resistance and reactance values of the two (or more) sources and the linking impedance(s) derived from a fault study constituting the ( $\pi$ ) equivalent and evaluated without the **User** network and load and;
  - (viii) the corresponding zero sequence impedance values of the ( $\pi$ ) equivalent.
- (b) To enable the model to be constructed, **NGET** will provide data based on the following conditions.
- (c) The initial symmetrical three phase short circuit current and the transient period three phase short circuit current will normally be derived from the fixed impedance studies. The latter value should be taken as applying at times of 120ms and longer. Shorter values may be interpolated using a value for the subtransient time constant of 40ms. These fault currents will be obtained from a full **System** study based on load flow analysis that takes into account any existing flow across the point of connection being considered.
- (d) Since the equivalent will be produced for the 400kV or 275kV and also in Scotland 132kV parts of the **GB Transmission System** **NGET** will provide the appropriate supergrid transformer data.
- (e) The positive sequence X/R ratio and the zero sequence impedance value will correspond to the **NGET** source network only, that is with the section of network if any with which the equivalent is to be used excluded. These impedance values will be derived from the condition when all **Generating Units** are **Synchronised** to the **GB Transmission System** or a **User's System** and will take account of active sources only including any contribution from the load to the fault current. The passive component of the load itself or other system shunt impedances should not be included.
- (f) A **User** may at any time, in writing, specifically request for an equivalent to be prepared for an alternative **System** condition, for example where the **User's System** peak does not correspond to the **GB Transmission System** peak, and **NGET** will, insofar as such request is reasonable,

provide the information as soon as reasonably practicable following the request.

## PLANNING CODE APPENDIX B

### Single Line Diagram

The diagrams below show three examples of single line diagrams, showing the detail that should be incorporated in the diagram. The first example is for an **Network Operator** connection, the second for a **Generator** connection, the third for a **Power Park Module** electrically equivalent system.

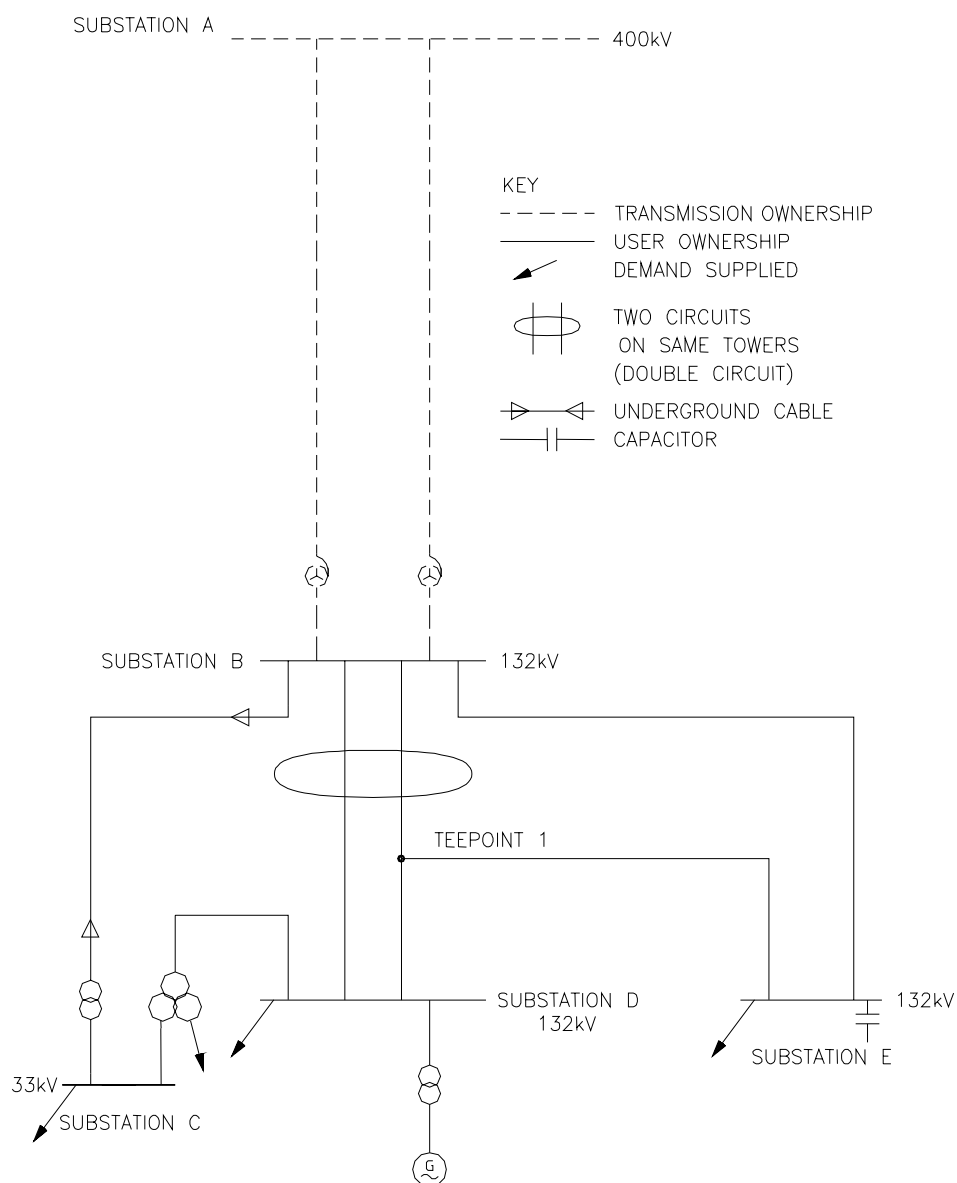

UNCONTROLLED COPY  
NOT SUBJECT TO  
REVISION SERVICES

ISS D  
41/18826\_1\_1      29-07-04

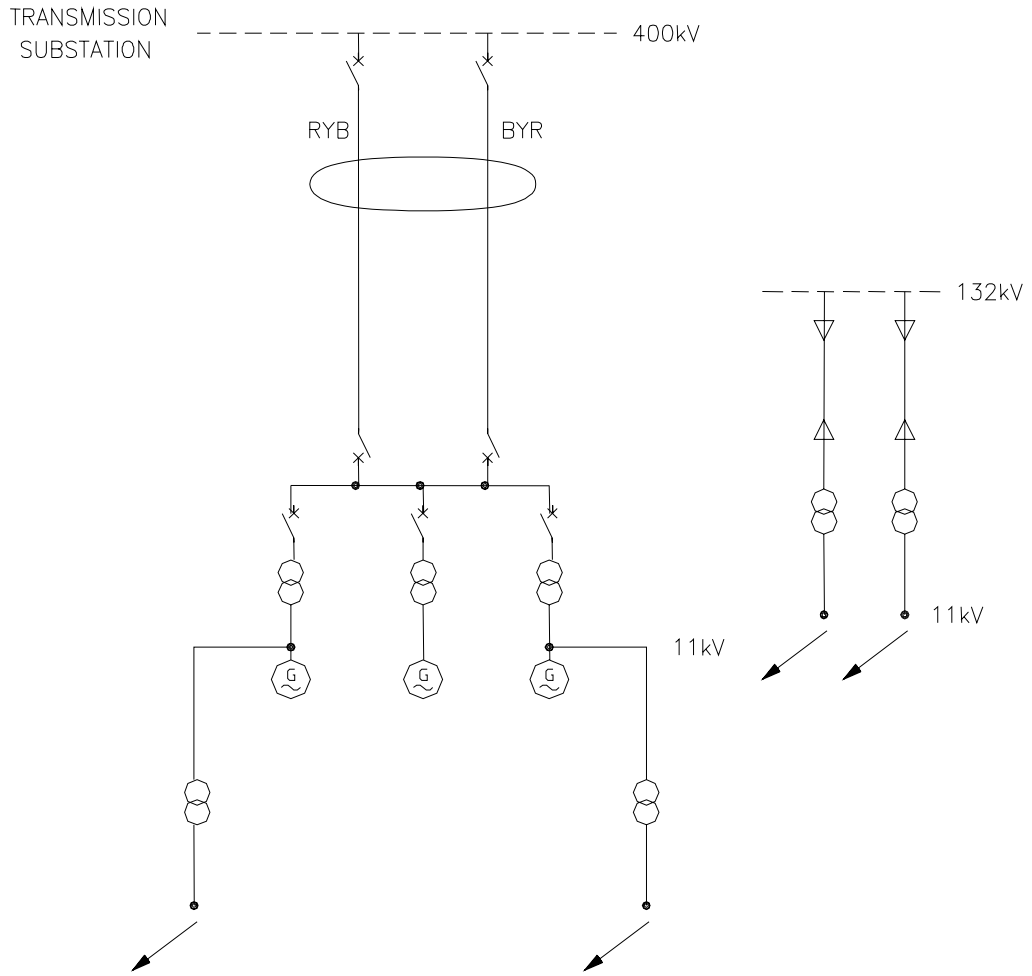

- KEY
- TRANSMISSION OWNERSHIP
  - USER OWNERSHIP
  - ↙ DEMAND SUPPLIED
  - ⊖ ⊖ TWO CIRCUITS ON SAME TOWERS (DOUBLE CIRCUIT)
  - ▷ ◁ UNDERGROUND CABLE

UNCONTROLLED COPY  
NOT SUBJECT TO  
REVISION SERVICES G

41/19468\_1\_1 ISS D  
29-07-04

## Power Park Module Single Line Diagram

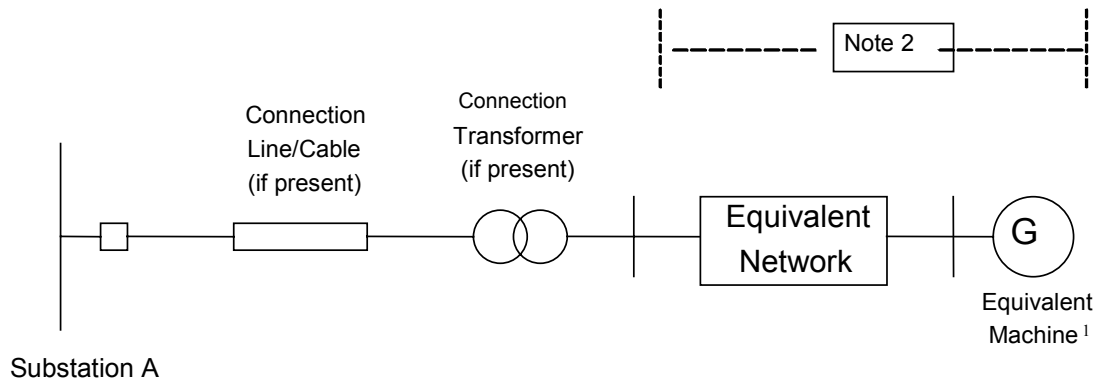

- Notes :
- 1) It is recommended that this consists of 'N' actual generators i.e. any equipment external to the generator terminals is considered as part of the Equivalent Network
  - 2) Where a Power Park Module consists of different Power Park Units, the equivalent machine and network can be repeated for each different unit



### PLANNING CODE APPENDIX C

- C1.1 Planning and design of the **SPT** and **SHETL Transmission Systems** is based generally, but not totally, on criteria which evolved from joint consultation among various **Transmission Licensees** responsible for design of the **GB Transmission System**.
- C1.2 The above criteria are set down within the standards, memoranda, recommendations and reports and are provided as a guide to system planning. It should be noted that each scheme for reinforcement or modification of the **Transmission System** is individually designed in the light of economic and technical factors associated with the particular system limitations under consideration.
- C1.3 The tables below identify the literature referred to above, together with the main topics considered within each document.

### PART 1 – SHETL's TECHNICAL AND DESIGN CRITERIA

ITEM No.	DOCUMENT	REFERENCE No.
1	GB Security and Quality of Supply Standard	Version 1
2	System Phasing	TPS 13/4
3	not used	
4	Planning Limits for Voltage Fluctuations Caused by Industrial, Commercial and Domestic Equipment in the United Kingdom	ER P28
5	EHV or HV Supplies to Induction Furnaces  Voltage unbalance limits.  Harmonic current limits.	ER P16 (Supported by ACE Report No.48)
6	Planning Levels for Harmonic Voltage Distortion and the Connection of Non-Linear Loads to Transmission Systems and Public Electricity Supply Systems in the United Kingdom  Harmonic distortion (waveform).  Harmonic voltage distortion.  Harmonic current distortion.  Stage 1 limits.  Stage 2 limits.  Stage 3 Limits  Addition of Harmonics  Short Duration Harmonics  Site Measurements	ER G5/4 (Supported by ACE Report No.73)

ITEM No.	DOCUMENT	REFERENCE No.
7	AC Traction Supplies to British Rail  Type of supply point to railway system.  Estimation of traction loads.  Nature of traction current.  System disturbance estimation.  Earthing arrangements.	ER P24
8	Operational Memoranda  Main System operating procedure.  Operational standards of security.  Voltage and reactive control on main system.  System warnings and procedures for instructed load reduction.  Continuous tape recording of system control telephone messages and instructions.  Emergency action in the event of an exceptionally serious breakdown of the main system.	(SOM)  SOM 1  SOM 3  SOM 4  SOM 7  SOM 10  SOM 15
9	Planning Limits for Voltage Unbalance in the United Kingdom.	ER P29

**PART 2 – SPT's TECHNICAL AND DESIGN CRITERIA**

ITEM No.	DOCUMENT	Reference No.
1	GB Security and Quality of Supply Standard	Version 1
2	System Phasing	TDM 13/10,002 Issue 4
3	not used	
4	Planning Limits for Voltage Fluctuations Caused by Industrial, Commercial and Domestic Equipment in the United Kingdom	ER P28
5	EHV or HV Supplies to Induction Furnaces  Voltage Unbalance limits.  Harmonic current limits.	ER P16 (Supported by ACE Report No.48)
6	Planning Levels for Harmonic Voltage Distortion and the Connection of Non-Linear Loads to Transmission Systems and Public Electricity Supply Systems in the United Kingdom  Harmonic distortion (waveform).  Harmonic voltage distortion.  Harmonic current distortion.  Stage 1 limits.  Stage 2 limits.  Stage 3 Limits  Addition of Harmonics  Short Duration Harmonics  Site Measurements	ER G5/4 Supported by ACE Report No.73)
7	AC Traction Supplies to British Rail  Type of supply point to railway system.  Estimation of traction loads.  Nature of traction current.  System disturbance estimation.  Earthing arrangements.	ER P24

< End of Planning Code (PC) >



# CONNECTION CONDITIONS

## CONTENTS

(This contents page does not form part of the Grid Code)

<u>Paragraph No/Title</u>	<u>Page Number</u>
CC.1 INTRODUCTION.....	1
CC.2 OBJECTIVE .....	1
CC.3 SCOPE .....	1
CC.4 PROCEDURE .....	1
CC.5 CONNECTION .....	2
CC.6 TECHNICAL, DESIGN AND OPERATIONAL CRITERIA	
CC.6.1 GB Transmission System Performance Characteristics.....	3
CC.6.2 Plant and Apparatus relating to Connection Site	
CC.6.2.1 General Requirements.....	5
CC.6.2.2 Requirements at Connection Points that relate to Generators or DC Converter Station owners .....	8
CC.6.2.3 Requirements. at Connection Points relating to Network Operator and Non-Embedded Customers .....	10
CC.6.3 General Generating Unit Requirements.....	13
CC.6.4 General Network Operator and Non-Embedded Customer Requirements .....	23
CC.6.5 Communications Plant.....	24
CC.6.6 System Monitoring.....	27
CC.7 SITE RELATED CONDITIONS	
CC.7.2 Responsibilities for Safety.....	27
CC.7.3 Site Responsibility Schedules.....	29
CC.7.4 Operation and Gas Zone Diagrams .....	29
CC.7.5 Site Common Drawings .....	31
CC.7.6 Access.....	32
CC.7.7 Maintenance Standards.....	33
CC.7.8 Site Operational Procedures.....	33
CC.8 ANCILLARY SERVICES	
CC.8.1 System Ancillary Services.....	34
CC.8.2 Commercial Ancillary Services.....	34
<b>APPENDIX 1 – SITE RESPONSIBILITY SCHEDULES.....</b>	<b>35</b>

<b>APPENDIX 2 - OPERATION DIAGRAMS .....</b>	<b>43</b>
<b>APPENDIX 3 - MINIMUM FREQUENCY RESPONSE REQUIREMENTS.....</b>	<b>49</b>
<b>APPENDIX 4 – FAULT RIDE THROUGH REQUIREMENT .....</b>	<b>54</b>
<b>APPENDIX 5 - LOW FREQUENCY RELAYS.....</b>	<b>57</b>

## CONNECTION CONDITIONS

### CC.1 INTRODUCTION

CC.1.1 The **Connection Conditions** ("CC") specify both the minimum technical, design and operational criteria which must be complied with by any **User** connected to or seeking connection with the **GB Transmission System** or **Generators** (other than in respect of **Small Power Stations**) or **DC Converter Station** owners connected to or seeking connection to a **User's System** which is located in **Great Britain**, and the minimum technical, design and operational criteria with which **NGET** will comply in relation to the part of the **GB Transmission System** at the **Connection Site** with **Users**.

### CC.2 OBJECTIVE

CC.2.1 The objective of the **CC** is to ensure that by specifying minimum technical, design and operational criteria the basic rules for connection to the **GB Transmission System** and (for certain **Users**) to a **User's System** are similar for all **Users** of an equivalent category and will enable **NGET** to comply with its statutory and **Transmission Licence** obligations.

### CC.3 SCOPE

CC.3.1 The **CC** applies to **NGET** and to **Users**, which in the **CC** means:

- (a) **Generators** (other than those which only have **Embedded Small Power Stations**)
- (b) **Network Operators**;
- (c) **Non-Embedded Customers**;
- (d) **DC Converter Station** owners; and
- (e) **BM Participants** and **Externally Interconnected System Operators** in respect of CC.6.5 only.

The above categories of **User** will become bound by the **CC** prior to them generating, distributing, supplying or consuming, as the case may be, and references to the various categories should, therefore, be taken as referring to them in that prospective role as well as to **Users** actually connected.

### CC.4 PROCEDURE

CC.4.1 The **CUSC** contains provisions relating to the procedure for connection to the **GB Transmission System** or, in the case of **Embedded Power Stations** or **Embedded DC Converter Stations**, becoming operational and includes provisions relating to certain conditions to be complied with by **Users** prior to **NGET** notifying the **User** that it has the right to become operational.

CC.5. CONNECTION

CC.5.1 The provisions relating to connecting to the **GB Transmission System** (or to a **User's System** in the case of a connection of an **Embedded Large Power Station** or **Embedded Medium Power Station** or **Embedded DC Converter Station**) are contained in the **CUSC** and/or **CUSC Contract** (or in the relevant application form or offer for a **CUSC Contract**), and include provisions relating to both the submission of information and reports relating to compliance with the relevant **Connection Conditions** for that **User**, **Safety Rules**, commissioning programmes, **Operation Diagrams** and approval to connect. References in this **CC** to the "**Bilateral Agreement**" and/or "**Construction Agreement**" shall be deemed to include references to the application form or offer therefor.

CC.5.2 Prior to the **Completion Date** under the **Bilateral Agreement** and/or **Construction Agreement**, the following is submitted pursuant to the terms of the **Bilateral Agreement** and/or **Construction Agreement**:

- (a) updated **Planning Code** data (both **Standard Planning Data** and **Detailed Planning Data**), with any estimated values assumed for planning purposes confirmed or, where practical, replaced by validated actual values and by updated estimates for the future and by updated forecasts for **Forecast Data** items such as **Demand**, pursuant to the requirements of the **Planning Code**;
- (b) details of the **Protection** arrangements and settings referred to in CC.6;
- (c) copies of all **Safety Rules** and **Local Safety Instructions** applicable at **Users' Sites** which will be used at the **NGET/User** interface (which, for the purpose of **OC8**, must be to **NGET's** satisfaction regarding the procedures for **Isolation** and **Earthing**. For **User Sites** in Scotland **NGET** will consult the **Relevant Transmission Licensee** when determining whether the procedures for **Isolation** and **Earthing** are satisfactory);
- (d) information to enable **NGET** to prepare **Site Responsibility Schedules** on the basis of the provisions set out in Appendix 1;
- (e) an **Operation Diagram** for all **HV Apparatus** on the **User** side of the **Connection Point** as described in CC.7;
- (f) the proposed name of the **User Site** (which shall not be the same as, or confusingly similar to, the name of any **Transmission Site** or of any other **User Site**);
- (g) written confirmation that **Safety Coordinators** acting on behalf of the **User** are authorised and competent pursuant to the requirements of **OC8**;
- (h) **RISSP** prefixes pursuant to the requirements of **OC8**. **NGET** is required to circulate prefixes utilising a proforma in accordance with **OC8**;
- (i) a list of the telephone numbers for **Joint System Incidents** at which senior management representatives nominated for the purpose can be contacted and confirmation that they are fully authorised to make binding decisions on behalf of the **User**, pursuant to **OC9**;
- (j) a list of managers who have been duly authorised to sign **Site Responsibility Schedules** on behalf of the **User**;



- (k) information to enable **NGET** to prepare **Site Common Drawings** as described in CC.7;
- (l) a list of the telephone numbers for the **Users** facsimile machines referred to in CC.6.5.9; and
- (m) for **Sites** in Scotland a list of persons appointed by the **User** to undertake operational duties on the **User's System** and to issue and receive operational messages and instructions in relation to the **User's System**; and an appointed person or persons responsible for the maintenance and testing of **User's Plant** and **Apparatus**.

CC.5.3 As explained in the **Bilateral Agreement** and/or **Construction Agreement**, of the list:

- (a) items CC.5.2 (c), (e), (g), (h), (k) and (m) need not be supplied in respect of **Embedded Power Stations** or **Embedded DC Converter Stations**,
- (b) item CC.5.2(i) need not be supplied in respect of **Embedded Small Power Stations** and **Embedded Medium Power Stations** or **Embedded DC Converter Stations** with a **Registered Capacity** of less than 100MW, and
- (c) items CC.5.2(d) and (j) are only needed in the case where the **Embedded Power Station** or the **Embedded DC Converter Station** is within a **Connection Site** with another **User**.

CC.5.4 In addition, at the time the information is given under CC.5.2(g), **NGET** will provide written confirmation to the **User** that the **Safety Co-ordinators** acting on behalf of **NGET** are authorised and competent pursuant to the requirements of **OC8**.

## CC.6 TECHNICAL, DESIGN AND OPERATIONAL CRITERIA

### CC.6.1 GB TRANSMISSION SYSTEM PERFORMANCE CHARACTERISTICS

CC.6.1.1 **NGET** shall ensure that, subject as provided in the **Grid Code**, the **GB Transmission System** complies with the following technical, design and operational criteria in relation to the part of the **GB Transmission System** at the **Connection Site** with a **User** (unless otherwise specified in CC.6) although in relation to operational criteria **NGET** may be unable (and will not be required) to comply with this obligation to the extent that there are insufficient **Power Stations** or **User Systems** are not available or **Users** do not comply with **NGET's** instructions or otherwise do not comply with the **Grid Code** and each **User** shall ensure that its **Plant** and **Apparatus** complies with the criteria set out in CC.6.1.5.

#### Grid Frequency Variations

CC.6.1.2 The **Frequency** of the **GB Transmission System** shall be nominally 50Hz and shall be controlled within the limits of 49.5 - 50.5Hz unless exceptional circumstances prevail.

CC.6.1.3 The **System Frequency** could rise to 52Hz or fall to 47Hz in exceptional circumstances. Design of **User's Plant** and **Apparatus** must enable operation of that **Plant** and **Apparatus** within that range in accordance with the following:-

<u>Frequency Range</u>	<u>Requirement</u>
47.5Hz - 52Hz	Continuous operation is required
47Hz - 47.5Hz	Operation for a period of at least 20 seconds is required each time the <b>Frequency</b> is below 47.5Hz.

#### Grid Voltage Variations

CC.6.1.4 Subject as provided below, the voltage on the 400kV part of the **GB Transmission System** at each **Connection Site** with a **User** will normally remain within  $\pm 5\%$  of the nominal value unless abnormal conditions prevail. The minimum voltage is -10% and the maximum voltage is +10% unless abnormal conditions prevail, but voltages between +5% and +10% will not last longer than 15 minutes unless abnormal conditions prevail. Voltages on the 275kV and 132kV parts of the **GB Transmission System** at each **Connection Site** with a **User** will normally remain within the limits  $\pm 10\%$  of the nominal value unless abnormal conditions prevail. At nominal **System** voltages below 132kV the voltage of the **GB Transmission System** at each **Connection Site** with a **User** will normally remain within the limits  $\pm 6\%$  of the nominal value unless abnormal conditions prevail. Under fault conditions, voltage may collapse transiently to zero at the point of fault until the fault is cleared.

**NGET** and a **User** may agree greater or lesser variations in voltage to those set out above in relation to a particular **Connection Site**, and insofar as a greater or lesser variation is agreed, the relevant figure set out above shall, in relation to that **User** at the particular **Connection Site**, be replaced by the figure agreed.

#### Voltage Waveform Quality

CC.6.1.5 All **Plant** and **Apparatus** connected to the **GB Transmission System**, and that part of the **GB Transmission System** at each **Connection Site**, should be capable of withstanding the following distortions of the voltage waveform in respect of harmonic content and phase unbalance:

(a) Harmonic Content

The **Electromagnetic Compatibility Levels** for harmonic distortion on the **GB Transmission System** from all sources under both **Planned Outage** and fault outage conditions, (unless abnormal conditions prevail) shall comply with the levels shown in the tables of Appendix A of **Engineering Recommendation G5/4**.

**Engineering Recommendation G5/4** contains planning criteria which **NGET** will apply to the connection of non-linear **Load** to the **GB Transmission System**, which may result in harmonic emission limits being specified for these **Loads** in the relevant **Bilateral Agreement**. The application of the planning criteria will take into account the position of existing and prospective **Users' Plant** and **Apparatus** in relation to harmonic emissions. **Users** must ensure that connection of distorting loads to their **User Systems** do not cause any harmonic emission limits specified in the **Bilateral Agreement**, or where no such limits are specified, the relevant planning levels specified in **Engineering Recommendation G5/4** to be exceeded.

(b) Phase Unbalance

Under **Planned Outage** conditions, the maximum **Phase (Voltage) Unbalance** on the **GB Transmission System** should remain, in England and Wales, below 1%, and in Scotland, below 2%, unless abnormal conditions prevail.

CC.6.1.6 In England and Wales, under the **Planned Outage** conditions stated in CC.6.1.5(b) infrequent short duration peaks with a maximum value of 2% are permitted for **Phase (Voltage) Unbalance**, subject to the prior agreement of **NGET** under the **Bilateral Agreement**. **NGET** will only agree following a specific assessment of the impact of these levels on **Transmission Apparatus** and other **Users Apparatus** with which it is satisfied.

Voltage Fluctuations

CC.6.1.7 Voltage fluctuations at a **Point of Common Coupling** with a fluctuating **Load** directly connected to the **GB Transmission System** shall not exceed:

- (a) In England and Wales, 1% of the voltage level for step changes which may occur repetitively. Any large voltage excursions other than step changes may be allowed up to a level of 3% provided that this does not constitute a risk to the **GB Transmission System** or, in **NGET's** view, to the **System** of any **User**. In Scotland, the limits for voltage level step changes are as set out in **Engineering Recommendation P28**.
- (b) For voltages above 132kV, **Flicker Severity (Short Term)** of 0.8 Unit and a **Flicker Severity (Long Term)** of 0.6 Unit, for voltages 132kV and below, **Flicker Severity (Short Term)** of 1.0 Unit and a **Flicker Severity (Long Term)** of 0.8 Unit, as set out in **Engineering Recommendation P28** as current at the **Transfer Date**.

CC.6.2 **PLANT AND APPARATUS RELATING TO CONNECTION SITE**

The following requirements apply to **Plant** and **Apparatus** relating to the **Connection Point**, which (except as otherwise provided in the relevant paragraph) each **User** must ensure are complied with in relation to its **Plant** and **Apparatus** and which in the case of CC.6.2.2.2, CC.6.2.3.1.1 and CC.6.2.1.1(b) only, **NGET** must ensure are complied with in relation to **Transmission Plant** and **Apparatus**, as provided in those paragraphs.

CC.6.2.1 General Requirements

CC.6.2.1.1 (a) The design of connections between the **GB Transmission System** and:-

- (i) any **Generating Unit** (other than a **CCGT Unit** or **Power Park Unit**) **DC Converter, Power Park Module** or **CCGT Module**, or
- (ii) any **Network Operator's User System**, or
- (iii) **Non-Embedded Customers** equipment;

will be consistent with the **Licence Standards**.

- (b) The **GB Transmission System** at nominal **System** voltages of 132kV and above is designed to be earthed with an **Earth Fault Factor** of, in England and Wales, below 1.4 and in Scotland, below 1.5. Under fault conditions the rated **Frequency** component of voltage could fall transiently to zero on one or more phases or, in England and Wales, rise to 140% phase-to-earth voltage, or in Scotland, rise to 150% phase-to-earth voltage. The voltage rise would last only for the time that the fault conditions exist. The fault conditions referred to here are those existing when the type of fault is single or two phase-to-earth.
- (c) For connections to the **GB Transmission System** at nominal **System** voltages of below 132kV the earthing requirements and voltage rise conditions will be advised by **NGET** as soon as practicable prior to connection.

#### CC.6.2.1.2 Substation **Plant** and **Apparatus**

- (a) The following provisions shall apply to all **Plant** and **Apparatus** which is connected at the voltage of the **Connection Point** and which is contained in equipment bays that are within the **Transmission** busbar protection zone at the **Connection Point**. This includes circuit breakers, switch disconnectors, disconnectors, **Earthing Devices**, power transformers, voltage transformers, reactors, current transformers, surge arresters, bushings, neutral equipment, capacitors, line traps, coupling devices, external insulation and insulation co-ordination devices. Where necessary, this is as more precisely defined in the **Bilateral Agreement**.

- (i) **Plant** and/or **Apparatus** prior to 1st January 1999

Each item of such **Plant** and/or **Apparatus** which at 1st January 1999 is either :-

- installed; or
- owned (but is either in storage, maintenance or awaiting installation); or
- ordered

and is the subject of a **Bilateral Agreement** with regard to the purpose for which it is in use or intended to be in use, shall comply with the relevant standards/specifications applicable at the time that the **Plant** and/or **Apparatus** was designed (rather than commissioned) and any further requirements as specified in the **Bilateral Agreement**.

- (ii) **Plant** and/or **Apparatus** post 1st January 1999 for a new **Connection Point**

Each item of such **Plant** and/or **Apparatus** installed in relation to a new **Connection Point** after 1st January 1999 shall comply with the relevant

**Technical Specifications** and any further requirements identified by **NGET**, acting reasonably, to reflect the options to be followed within the **Technical Specifications** and/or to complement if necessary the **Technical Specifications** so as to enable **NGET** to comply with its obligations in relation to the **GB Transmission System** or, in Scotland, also the **Relevant Transmission Licensee** to comply with its obligations in relation to its **Transmission System**. This information, including the application dates of the relevant **Technical Specifications**, will be as specified in the **Bilateral Agreement**.

(iii) New **Plant** and/or **Apparatus** post 1st January 1999 for an existing **Connection Point**

Each new additional and/or replacement item of such **Plant** and/or **Apparatus** installed in relation to a change to an existing **Connection Point** after 1st January 1999 shall comply with the standards/specifications applicable when the change was designed, or such other standards/specifications as necessary to ensure that the item of **Plant** and/or **Apparatus** is reasonably fit for its intended purpose having due regard to the obligations of **NGET**, the relevant **User** and, in Scotland, also the **Relevant Transmission Licensee** under their respective **Licences**. Where appropriate this information, including the application dates of the relevant standards/specifications, will be as specified in the varied **Bilateral Agreement**.

(iv) Used **Plant** and/or **Apparatus** being moved, re-used or modified

If, after its installation, any such item of **Plant** and/or **Apparatus** is subsequently:-

- moved to a new location; or
- used for a different purpose; or
- otherwise modified;

then the standards/specifications as described in (i), (ii), or (iii) above as applicable will apply as appropriate to such **Plant** and/or **Apparatus**, which must be reasonably fit for its intended purpose having due regard to the obligations of **NGET**, the relevant **User** and, in Scotland, also the **Relevant Transmission Licensee** under their respective **Licences**.

- (b) **NGET** shall at all times maintain a list of those **Technical Specifications** and additional requirements which might be applicable under this CC.6.2.1.2 and which may be referenced by **NGET** in the **Bilateral Agreement**. **NGET** shall provide a copy of the list upon request to any **User**. **NGET** shall also provide a copy of the list to any new **User** upon receipt of an application form for a **Bilateral Agreement** for a new **Connection Point**.
- (c) Where the **User** provides **NGET** with information and/or test reports in respect of **Plant** and/or **Apparatus** which the **User** reasonably believes demonstrate the compliance of such items with the provisions of a **Technical Specification** then **NGET** shall promptly and without unreasonable delay give due and proper consideration to such information.
- (d) **Plant** and **Apparatus** shall be designed, manufactured and tested in premises with an accredited certificate in accordance with the quality assurance requirements of the relevant standard in the BS EN ISO 9000 series (or equivalent as reasonably approved by **NGET**) or in respect of test

premises which do not include a manufacturing facility premises with an accredited certificate in accordance with BS EN 45001.

- (e) Each connection between a **User** and the **GB Transmission System** must be controlled by a circuit-breaker (or circuit breakers) capable of interrupting the maximum short circuit current at the point of connection. The **Seven Year Statement** gives values of short circuit current and the rating of **Transmission** circuit breakers at existing and committed **Connection Points** for future years.

CC.6.2.2 Requirements at **Connection Points** that relate to **Generators** or **DC Converter Station** owners

CC.6.2.2.1 Not Used.

CC.6.2.2.2 **Generating Unit** and **Power Station Protection** Arrangements

CC.6.2.2.2.1 Minimum Requirements

**Protection of Generating Units** (other than **Power Park Units**), **DC Converters** or **Power Park Modules** and their connections to the **GB Transmission System** must meet the minimum requirements given below. These are necessary to reduce to a practical minimum the impact on the **GB Transmission System** of faults on circuits owned by **Generators** or **DC Converter Station** owners.

CC.6.2.2.2.2 Fault Clearance Times

- (a) The fault clearance times for faults on the **Generator's** or **DC Converter Station** owner's equipment directly connected to the **GB Transmission System** and for faults on the **GB Transmission System** directly connected to the **Generator** or **DC Converter Station** owner's equipment, from fault inception to the circuit breaker arc extinction, shall be set out in accordance with the **Bilateral Agreement**. The times specified in accordance with the **Bilateral Agreement** shall not be faster than:

- (i) 80mS at 400kV
- (ii) 100mS at 275kV
- (iii) 120mS at 132kV and below

but this shall not prevent a **User** or **NGET** having faster fault clearance times.

Slower fault clearance times may be specified in accordance with the **Bilateral Agreement** for faults on the **GB Transmission System**. Slower fault clearance times for faults on the **Generator** or **DC Converter Station** owner's equipment may be agreed in accordance with the terms of the **Bilateral Agreement** but only if **System** requirements, in **NGET's** view, permit. The probability that the fault clearance times stated in accordance with the **Bilateral Agreement** will be exceeded by any given fault, must be less than 2%.

- (b) For the event that the above fault clearance times are not met as a result of failure to operate on the **Main Protection System(s)** provided, the **Generators** or **DC Converter Station** owners shall provide **Back-Up Protection**. **NGET** will also provide **Back-Up Protection** and these **Back-Up Protections** will be co-ordinated so as to provide **Discrimination**.

On a **Generating Unit** (other than **Power Park Units**), **DC Converter** or **Power Park Module** connected to the **GB Transmission System** where only one **Main Protection** is provided to clear faults on the **HV Connections** within the required fault clearance time, the **Back-Up Protection** provided by the **Generators** and **DC Converter Station** owners shall operate to give a fault clearance time of no slower than 300 ms at the minimum infeed for normal operation for faults on the **HV Connections**. On **Generating Units** (other than **Power Park Units**), **DC Converters** or **Power Park Modules** connected to the **GB Transmission System** at 400 kV and 275 kV where two **Main Protections** are provided and on **Generating Units** (other than **Power Park Units**), **DC Converters** or **Power Park Modules** connected to the **GB Transmission System** at 132 kV and below, the **Back-Up Protection** shall operate to give a fault clearance time of no slower than 800 ms in England and Wales and 300 ms in Scotland at the minimum infeed for normal operation for faults on the **HV Connections**.

**Generators'** and **DC Converter Station** owners' **Back-Up Protection** will also be required to withstand, without tripping, the loading incurred during the clearance of a fault on the **GB Transmission System** by breaker fail **Protection** at 400kV or 275kV or of a fault cleared by **Back-Up Protection** where the **Generator** or **DC Converter** is connected at 132kV and below. This will permit **Discrimination** between **Generator** or **DC Converter Back-Up Protection** and **Back-Up Protection** provided on the **GB Transmission System** and other **Users' Systems**.

- (c) When the **Generating Unit** (other than **Power Park Units**), or the **DC Converter** or **Power Park Module** is connected to the **GB Transmission System** at 400kV or 275kV, and in Scotland also at 132kV, and a circuit breaker is provided by the **Generator** or the **DC Converter Station** owner, or **NGET**, as the case may be, to interrupt fault current interchange with the **GB Transmission System**, or **Generator's System**, or **DC Converter Station** owner's **System**, as the case may be, circuit breaker fail **Protection** shall be provided by the **Generator** or **DC Converter Station** owner, or **NGET**, as the case may be, on this circuit breaker. In the event, following operation of a **Protection** system, of a failure to interrupt fault current by these circuit-breakers within the **Fault Current Interruption Time**, the circuit breaker fail **Protection** is required to initiate tripping of all the necessary electrically adjacent circuit-breakers so as to interrupt the fault current within the next 200 ms.
- (d) The target performance for the **System Fault Dependability Index** shall be not less than 99%. This is a measure of the ability of **Protection** to initiate successful tripping of circuit breakers which are associated with the faulty item of **Apparatus**.

### CC.6.2.2.3 Equipment to be provided

#### CC.6.2.2.3.1 Protection of Interconnecting Connections

The requirements for the provision of **Protection** equipment for interconnecting connections will be specified in the **Bilateral Agreement**. In this **CC** the term "interconnecting connections" means the primary conductors from the current transformer accommodation on the circuit side of the circuit breaker to the **Connection Point**.

#### CC.6.2.2.3.2 Circuit-breaker fail Protection

The **Generator** or **DC Converter Station** owner will install circuit breaker fail **Protection** equipment in accordance with the requirements of the **Bilateral Agreement**. The **Generator** or **DC Converter Station** owner will also provide a back-trip signal in the event of loss of air from its pressurised head circuit breakers, during the **Generating Unit** (other than a **CCGT Unit** or **Power Park Unit**) or **CCGT Module** or **DC Converter** or **Power Park Module** run-up sequence, where these circuit breakers are installed.

CC.6.2.2.3.3 Loss of Excitation

The **Generator** must provide **Protection** to detect loss of excitation on a **Generating Unit** and initiate a **Generating Unit** trip.

CC.6.2.2.3.4 Pole-Slipping Protection

Where, in **NGET's** reasonable opinion, **System** requirements dictate, **NGET** will specify in the **Bilateral Agreement** a requirement for **Generators** to fit pole-slipping **Protection** on their **Generating Units**.

CC.6.2.2.3.5 Signals for Tariff Metering

**Generators** and **DC Converter Station** owners will install current and voltage transformers supplying all tariff meters at a voltage to be specified in, and in accordance with, the **Bilateral Agreement**.

CC.6.2.2.4 Work on Protection Equipment

No busbar **Protection**, mesh corner **Protection**, circuit-breaker fail **Protection** relays, AC or DC wiring (other than power supplies or DC tripping associated with the **Generating Unit**, **DC Converter** or **Power Park Module** itself) may be worked upon or altered by the **Generator** or **DC Converter Station** owner personnel in the absence of a representative of **NGET** or in Scotland, a representative of **NGET**, or written authority from **NGET** to perform such work or alterations in the absence of a representative of **NGET**.

CC.6.2.2.5 Relay Settings

**Protection** and relay settings will be co-ordinated (both on connection and subsequently) across the **Connection Point** in accordance with the **Bilateral Agreement** to ensure effective disconnection of faulty **Apparatus**.

CC.6.2.3 Requirements at Connection Points relating to Network Operators and Non-Embedded Customers

CC.6.2.3.1 Protection Arrangements for Network Operators and Non-Embedded Customers

CC.6.2.3.1.1 **Protection of Network Operator and Non-Embedded Customers User Systems** directly supplied from the **GB Transmission System**, must meet the minimum requirements referred to below:

Fault Clearance Times



- (a) The fault clearance times for faults on **Network Operator** and **Non-Embedded Customer** equipment directly connected to the **GB Transmission System**, and for faults on the **GB Transmission System** directly connected to the **Network Operator's** or **Non-Embedded Customer's** equipment, from fault inception to the circuit breaker arc extinction, shall be set out in accordance with each **Bilateral Agreement**. The times specified in accordance with the **Bilateral Agreement** shall not be faster than:
- (i) 80mS at 400kV
  - (ii) 100mS at 275kV
  - (iii) 120mS at 132kV and below

but this shall not prevent a **User** or **NGET** having a faster fault clearance time.

Slower fault clearance times may be specified in accordance with the **Bilateral Agreement** for faults on the **GB Transmission System**. Slower fault clearance times for faults on the **Network Operator** and **Non-Embedded Customers** equipment may be agreed in accordance with the terms of the **Bilateral Agreement** but only if **System** requirements in **NGET's** view permit. The probability that the fault clearance times stated in accordance with the **Bilateral Agreement** will be exceeded by any given fault must be less than 2%.

- (b)
- (i) For the event of failure of the **Protection** systems provided to meet the above fault clearance time requirements, **Back-Up Protection** shall be provided by the **Network Operator** or **Non-Embedded Customer** as the case may be.
  - (ii) **NGET** will also provide **Back-Up Protection**, which will result in a fault clearance time slower than that specified for the **Network Operator** or **Non-Embedded Customer Back-Up Protection** so as to provide **Discrimination**.
  - (iii) For connections with the **GB Transmission System** at 132kV and below, it is normally required that the **Back-Up Protection** on the **GB Transmission System** shall discriminate with the **Network Operator** or **Non-Embedded Customer's Back-Up Protection**.
  - (iv) For connections with the **GB Transmission System** at 400kV or 275kV, the **Back-Up Protection** will be provided by the **Network Operator** or **Non-Embedded Customer**, as the case may be, with a fault clearance time not slower than 300mS for faults on the **Network Operator's** or **Non-Embedded Customer's Apparatus**.
  - (v) Such **Protection** will also be required to withstand, without tripping, the loading incurred during the clearance of a fault on the **GB Transmission System** by breaker fail **Protection** at 400kV or 275kV. This will permit **Discrimination** between **Network Operator** or **Non-Embedded Customer**, as the case may be, **Back-Up Protection** and **Back-Up Protection** provided on the **GB Transmission System** and other **User Systems**. The requirement for and level of **Discrimination** required will be specified in the **Bilateral Agreement**.
- (c)
- (i) Where the **Network Operator** or **Non-Embedded Customer** is connected to the **GB Transmission System** at 400kV or 275kV, and in

Scotland also at 132kV, and a circuit breaker is provided by the **Network Operator** or **Non-Embedded Customer**, or **NGET**, as the case may be, to interrupt the interchange of fault current with the **GB Transmission System** or the **System** of the **Network Operator** or **Non-Embedded Customer**, as the case may be, circuit breaker fail **Protection** will be provided by the **Network Operator** or **Non-Embedded Customer**, or **NGET**, as the case may be, on this circuit breaker.

(ii) In the event, following operation of a **Protection** system, of a failure to interrupt fault current by these circuit-breakers within the **Fault Current Interruption Time**, the circuit breaker fail **Protection** is required to initiate tripping of all the necessary electrically adjacent circuit-breakers so as to interrupt the fault current within the next 200 ms.

(d) The target performance for the **System Fault Dependability Index** shall be not less than 99%. This is a measure of the ability of **Protection** to initiate successful tripping of circuit breakers which are associated with the faulty items of **Apparatus**.

#### CC.6.2.3.2 Fault Disconnection Facilities

(a) Where no **Transmission** circuit breaker is provided at the **User's** connection voltage, the **User** must provide **NGET** with the means of tripping all the **User's** circuit breakers necessary to isolate faults or **System** abnormalities on the **GB Transmission System**. In these circumstances, for faults on the **User's System**, the **User's Protection** should also trip higher voltage **Transmission** circuit breakers. These tripping facilities shall be in accordance with the requirements specified in the **Bilateral Agreement**.

(b) **NGET** may require the installation of a **System to Generator Operational Intertripping Scheme** in order to enable the timely restoration of circuits following power **System** fault(s). These requirements shall be set out in the relevant **Bilateral Agreement**.

#### CC.6.2.3.3 Automatic Switching Equipment

Where automatic reclosure of **Transmission** circuit breakers is required following faults on the **User's System**, automatic switching equipment shall be provided in accordance with the requirements specified in the **Bilateral Agreement**.

#### CC.6.2.3.4 Relay Settings

**Protection** and relay settings will be co-ordinated (both on connection and subsequently) across the **Connection Point** in accordance with the **Bilateral Agreement** to ensure effective disconnection of faulty **Apparatus**.

#### CC.6.2.3.5 Work on Protection equipment

Where a **Transmission Licensee** owns the busbar at the **Connection Point**, no busbar **Protection**, mesh corner **Protection** relays, AC or DC wiring (other than power supplies or DC tripping associated with the **Network Operator** or **Non-Embedded Customer's Apparatus** itself) may be worked upon or altered by the **Network Operator** or **Non-Embedded Customer** personnel in the absence of a representative of **NGET** or in Scotland, a representative of **NGET**, or written authority from **NGET** to perform such work or alterations in the absence of a representative of **NGET**.

CC.6.2.3.6 Equipment to be provided

CC.6.2.3.6.1 Protection of Interconnecting Connections

The requirements for the provision of **Protection** equipment for interconnecting connections will be specified in the **Bilateral Agreement**.

CC.6.3 GENERAL GENERATING UNIT REQUIREMENTS

CC.6.3.1 This section sets out the technical and design criteria and performance requirements for **Generating Units, DC Converters and Power Park Modules** (whether directly connected to the **GB Transmission System** or **Embedded**) which each **Generator** or **DC Converter Station** owner must ensure are complied with in relation to its **Generating Units, DC Converters and Power Park Modules** but does not apply to **Small Power Stations** or individually to **Power Park Units**. References to **Generating Units, DC Converters and Power Park Modules** in this CC.6.3 should be read accordingly.

Plant Performance Requirements

- CC.6.3.2
- (a) All **Synchronous Generating Units** must be capable of supplying **Rated MW** at any point between the limits 0.85 **Power Factor** lagging and 0.95 **Power Factor** leading at the **Synchronous Generating Unit** terminals. The short circuit ratio of **Synchronous Generating Units** shall be not less than 0.5.
  - (b) Subject to paragraph (c) below, all **Non-Synchronous Generating Units, DC Converters and Power Park Modules** must be capable of maintaining zero transfer of **Reactive Power** at the **Grid Entry Point** (or **User System Entry Point** if **Embedded**) at all **Active Power** output levels under steady state voltage conditions. The steady state tolerance on **Reactive Power** transfer to and from the **GB Transmission System** expressed in MVar shall be no greater than 5% of the **Rated MW**.
  - (c) Subject to the provisions of CC.6.3.2(d) below, all **Non-Synchronous Generating Units, DC Converters** (excluding current source technology) and **Power Park Modules** (excluding those connected to the **Total System** by a current source **DC Converter**) with a **Completion Date** on or after 1 January 2006 must be capable of supplying **Rated MW** output at any point between the limits 0.95 **Power Factor** lagging and 0.95 **Power Factor** leading at the **Grid Entry Point** in England and Wales or at the HV side of the 33/132kV or 33/275kV or 33/400kV transformer for **Generators** directly connected to the **GB Transmission System** in Scotland (or **User System Entry Point** if **Embedded**). With all **Plant** in service, the **Reactive Power** limits defined at **Rated MW** at Lagging **Power Factor** will apply at all **Active Power** output levels above 20% of the **Rated MW** output as defined in Figure 1. With all **Plant** in service, the **Reactive Power** limits defined at **Rated MW** at Leading **Power Factor** will apply at all **Active Power** output levels above 50% of the **Rated MW** output as defined in Figure 1. With all **Plant** in service, the **Reactive Power** limits will reduce linearly below 50% **Active Power** output as shown in Figure 1 unless the requirement to maintain the **Reactive Power** limits defined at **Rated MW** at Leading **Power Factor** down to 20% **Active Power** output is specified in the **Bilateral Agreement**. These **Reactive Power** limits will be reduced pro rata to the amount of **Plant** in service.

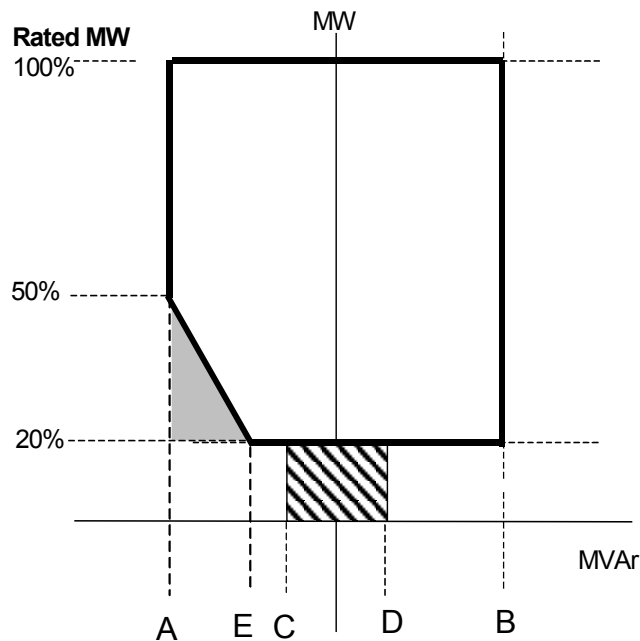

- Point A is equivalent (in MVar) to: 0.95 leading **Power Factor** at **Rated MW** output
- Point B is equivalent (in MVar) to: 0.95 lagging **Power Factor** at **Rated MW** output
- Point C is equivalent (in MVar) to: -5% of **Rated MW** output
- Point D is equivalent (in MVar) to: +5% of **Rated MW** output
- Point E is equivalent (in MVar) to: -12% of **Rated MW** output

Figure 1

- (d) All **Non-Synchronous Generating Units** and **Power Park Modules** in Scotland with a **Completion Date** after 1 April 2005 and before 1 January 2006 must be capable of supplying **Rated MW** at the range of power factors either:-
- (i) from 0.95 lead to 0.95 lag as illustrated in Figure 1 at the **User System Entry Point** for **Embedded Generators** or at the HV side of the 33/132kV or 33/275kV or 33/400kV transformer for **Generators** directly connected to the **GB Transmission System**. With all **Plant** in service, the **Reactive Power** limits defined at **Rated MW** will apply at all **Active Power** output levels above 20% of the **Rated MW** output as defined in Figure 1. These **Reactive Power** limits will be reduced pro rata to the amount of **Plant** in service.
- or,
- (ii) from 0.95 lead to 0.90 lag at the **Non-Synchronous Generating Unit** (including **Power Park Unit**) terminals. For the avoidance of doubt **Generators** complying with this option (ii) are not required to comply with CC.6.3.2(b).

CC.6.3.3 Each **Generating Unit, DC Converter, Power Park Module** and/or **CCGT Module** must be capable of

- (a) continuously maintaining constant **Active Power** output for **System Frequency** changes within the range 50.5 to 49.5 Hz; and

- (b) (subject to the provisions of CC.6.1.3) maintaining its **Active Power** output at a level not lower than the figure determined by the linear relationship shown in Figure 2 for **System Frequency** changes within the range 49.5 to 47 Hz, such that if the **System Frequency** drops to 47 Hz the **Active Power** output does not decrease by more than 5%.

In the case of a **CCGT Module**, the above requirement shall be retained down to the **Low Frequency Relay** trip setting of 48.8 Hz, which reflects the first stage of the Automatic Low **Frequency Demand Disconnection** scheme notified to **Network Operators** under OC6.6.2. For **System Frequency** below that setting, the existing requirement shall be retained for a minimum period of 5 minutes while **System Frequency** remains below that setting, and special measure(s) that may be required to meet this requirement shall be kept in service during this period. After that 5 minutes period, if **System Frequency** remains below that setting, the special measure(s) must be discontinued if there is a materially increased risk of the **Gas Turbine** tripping. The need for special measure(s) is linked to the inherent **Gas Turbine Active Power** output reduction caused by reduced shaft speed due to falling **System Frequency**

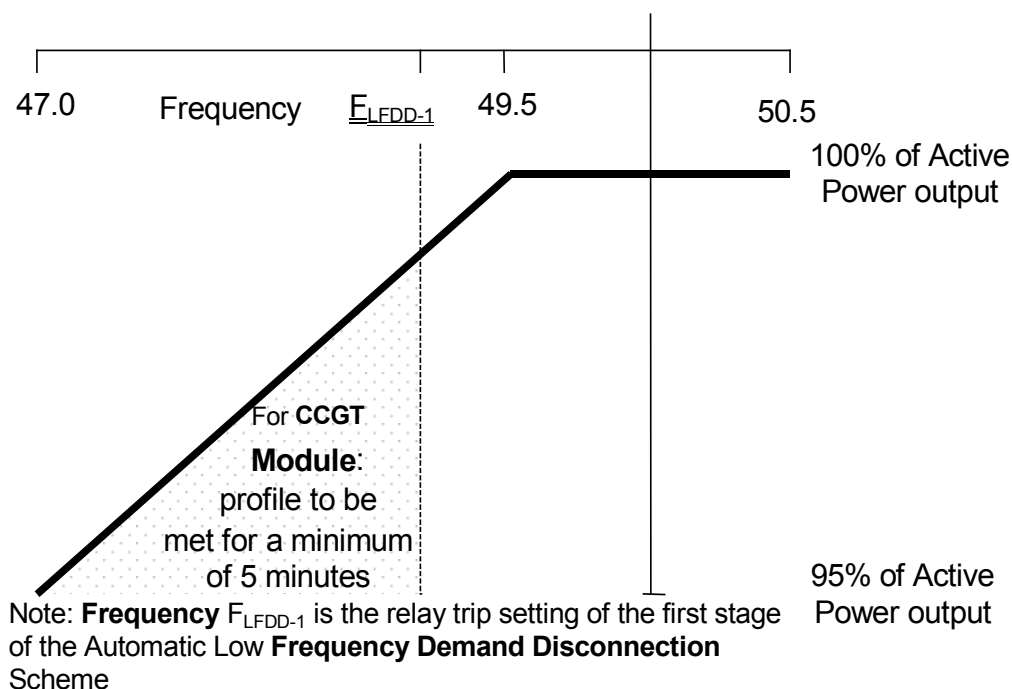

Figure 2

- (c) For the avoidance of doubt in the case of a **Generating Unit** or **Power Park Module** using an **Intermittent Power Source** where the mechanical power input will not be constant over time, the requirement is that the **Active Power** output shall be independent of **System Frequency** under (a) above and should not drop with **System Frequency** by greater than the amount specified in (b) above.
- (d) A **DC Converter Station** must be capable of maintaining its **Active Power** input (i.e. when operating in a mode analogous to **Demand**) from the **GB Transmission System** (or **User System** in the case of an **Embedded DC Converter Station**) at a level not greater than the figure determined by the linear relationship shown in Figure 3 for **System Frequency** changes within

the range 49.5 to 47 Hz, such that if the **System Frequency** drops to 47.8 Hz the **Active Power** input decreases by more than 60%.

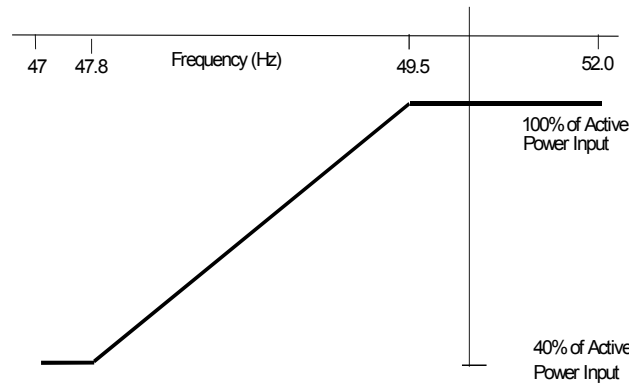

Figure 3

CC.6.3.4

At the **Grid Entry Point** the **Active Power** output under steady state conditions of any **Generating Unit, DC Converter or Power Park Module** directly connected to the **GB Transmission System** should not be affected by voltage changes in the normal operating range specified in paragraph CC.6.1.4 by more than the change in **Active Power** losses at reduced or increased voltage. The **Reactive Power** output under steady state conditions should be fully available within the voltage range  $\pm 5\%$  at 400kV, 275kV and 132kV and lower voltages, except for a **Power Park Module** or **Non-synchronous Generating Unit** if **Embedded** at 33kV and below (or directly connected to the **GB Transmission System** in England and Wales at 33kV and below) where the requirement shown in Figure 4 applies.

Voltage at **Grid Entry Point** in England and Wales or **User System Entry Point** if **Embedded** (% of Nominal) at 33 kV and below

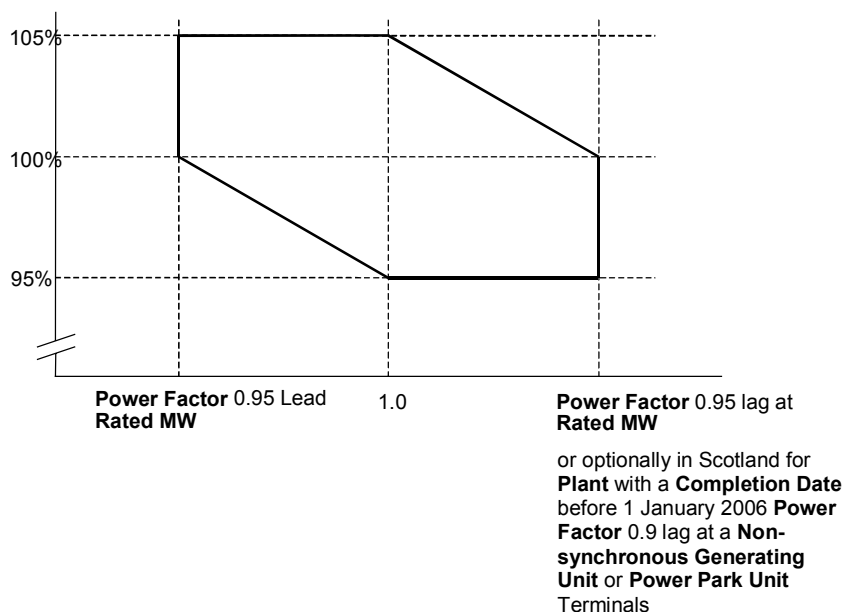

Figure 4

CC.6.3.5

It is an essential requirement that the **GB Transmission System** must incorporate a **Black Start Capability**. This will be achieved by agreeing a **Black Start Capability** at a number of strategically located **Power Stations**. For each **Power**

**Station NGET** will state in the **Bilateral Agreement** whether or not a **Black Start Capability** is required.

#### Control Arrangements

- CC.6.3.6 (a) Each:
- (i) **Generating Unit**; or,
  - (ii) **DC Converter** with a **Completion Date** on or after 1 April 2005; or,
  - (iii) **Power Park Module** in England and Wales with a **Completion Date** on or after 1 January 2006; or,
  - (iv) **Power Park Module** in operation in Scotland on or after 1 January 2006 (with a **Completion Date** after 1 July 2004 and in a **Power Station** with a **Registered Capacity** of 30MW or above),

must be capable of contributing to **Frequency** control by continuous modulation of **Active Power** supplied to the **GB Transmission System** or the **User System** in which it is **Embedded**.

- (b) Each:
- (i) **Generating Unit**; or,
  - (ii) **DC Converter** (with a **Completion Date** on or after 1 April 2005 excluding current source technologies); or
  - (iii) **Power Park Module** in England and Wales with a **Completion Date** on or after 1 January 2006; or,
  - (iv) **Power Park Module** in Scotland irrespective of **Completion Date**,

must be capable of contributing to voltage control by continuous changes to the **Reactive Power** supplied to the **GB Transmission System** or the **User System** in which it is **Embedded**.

- CC.6.3.7 (a) Each **Generating Unit**, **DC Converter** or **Power Park Module** (excluding **Power Park Modules** in Scotland with a **Completion Date** before 1 July 2004 or in a **Power Station** in Scotland with a **Registered Capacity** less than 30MW) must be fitted with a fast acting proportional **Frequency** control device (or turbine speed governor) and unit load controller or equivalent control device to provide **Frequency** response under normal operational conditions in accordance with **Balancing Code 3 (BC3)**. The **Frequency** control device (or speed governor) must be designed and operated to the appropriate:

- (i) **European Specification**; or
- (ii) in the absence of a relevant **European Specification**, such other standard which is in common use within the European Community (which may include a manufacturer specification);

as at the time when the installation of which it forms part was designed or (in the case of modification or alteration to the **Frequency** control device (or turbine speed governor)) when the modification or alteration was designed.

The **European Specification** or other standard utilised in accordance with sub-paragraph CC.6.3.7 (a) (ii) will be notified to **NGET** as:

- (i) part of the application for a **Bilateral Agreement**; or
  - (ii) part of the application for a varied **Bilateral Agreement**; or
  - (iii) soon as possible prior to any modification or alteration to the **Frequency** control device (or governor); and
- (b) The **Frequency** control device (or speed governor) in co-ordination with other control devices must control the **Generating Unit, DC Converter or Power Park Module Active Power Output** with stability over the entire operating range of the **Generating Unit, DC Converter or Power Park Module**; and
- (c) The **Frequency** control device (or speed governor) must meet the following minimum requirements:
- (i) Where a **Generating Unit, DC Converter or Power Park Module** becomes isolated from the rest of the **Total System** but is still supplying **Customers**, the **Frequency** control device (or speed governor) must also be able to control **System Frequency** below 52Hz unless this causes the **Generating Unit, DC Converter or Power Park Module** to operate below its **Designed Minimum Operating Level** when it is possible that it may, as detailed in BC 3.7.3, trip after a time. For the avoidance of doubt the **Generating Unit, DC Converter or Power Park Module** is only required to operate within the **System Frequency** range 47 - 52 Hz as defined in CC.6.1.3.;
  - (ii) the **Frequency** control device (or speed governor) must be capable of being set so that it operates with an overall speed **Droop** of between 3% and 5%;
  - (iii) in the case of all **Generating Units, DC Converter or Power Park Module** other than the **Steam Unit** within a **CCGT Module** the **Frequency** control device (or speed governor) deadband should be no greater than 0.03Hz (for the avoidance of doubt,  $\pm 0.015\text{Hz}$ ). In the case of the **Steam Unit** within a **CCGT Module**, the speed governor deadband should be set to an appropriate value consistent with the requirements of CC.6.3.7(c)(i) and the requirements of BC3.7.2 for the provision of **Limited High Frequency Response**;

For the avoidance of doubt, the minimum requirements in (ii) and (iii) for the provision of **System Ancillary Services** do not restrict the negotiation of **Commercial Ancillary Services** between **NGET** and the **User** using other parameters; and

- (d) A facility to modify, so as to fulfil the requirements of the **Balancing Codes**, the **Target Frequency** setting either continuously or in a maximum of 0.05 Hz steps over at least the range  $50 \pm 0.1$  Hz should be provided in the unit load controller or equivalent device.
- (e) (i) Each **Generating Unit** and/or **CCGT Module** which has a **Completion Date** after 1 January 2001 in England and Wales, and after 1 April 2005 in Scotland, must be capable of meeting the minimum **Frequency** response requirement profile subject to and in accordance with the provisions of Appendix 3.



- (ii) Each **DC Converter** at a **DC Converter Station** which has a **Completion Date** on or after 1 April 2005 must be capable of meeting the minimum **Frequency** response requirement profile subject to and in accordance with the provisions of Appendix 3.
  - (iii) Each **Power Park Module** in operation in England and Wales with a **Completion Date** on or after 1 January 2006 must be capable of meeting the minimum **Frequency** response requirement profile subject to and in accordance with the provisions of Appendix 3.
  - (iv) Each **Power Park Module** in operation on or after 1 January 2006 in Scotland (with a **Completion Date** on or after 1 April 2005 and a **Registered Capacity** of 30MW or greater) must be capable of meeting the minimum **Frequency** response requirement profile subject to and in accordance with the provisions of Appendix 3.
- (f) For the avoidance of doubt, the requirements of Appendix 3 do not apply to:
- (i) **Generating Units** and/or **CCGT Modules** which have a **Completion Date** before 1 January 2001 in England and Wales, and before 1 April 2005 in Scotland, for whom the remaining requirements of this clause CC.6.3.7 shall continue to apply unchanged: or
  - (ii) **DC Converters** at a **DC Converter Station** which have a **Completion Date** before 1 April 2005; or
  - (iii) **Power Park Modules** in England and Wales with a **Completion Date** before 1 January 2006 for whom only the requirements of **Limited Frequency Sensitive Mode** (BC.3.5.2) operation shall apply; or
  - (iv) **Power Park Modules** in operation in Scotland before 1 January 2006 for whom only the requirements of **Limited Frequency Sensitive Mode** (BC.3.5.2) operation shall apply; or
  - (v) **Power Park Modules** in operation after 1 January 2006 in Scotland which have a **Completion Date** before 1 April 2005 for whom the remaining requirements of this clause CC.6.3.7 shall continue to apply unchanged.

- CC.6.3.8
- (a) A continuously-acting automatic excitation control system is required to provide constant terminal voltage control of the **Synchronous Generating Unit** without instability over the entire operating range of the **Generating Unit**.
  - (b) The requirements for excitation control facilities, including **Power System Stabilisers**, where in **NGET's** view these are necessary for system reasons, will be specified in the **Bilateral Agreement**. Reference is made to on-load commissioning witnessed by **NGET** in BC2.11.2.
  - (c) In the case of a **Non-synchronous Generating Unit**, **DC Converter** or **Power Park Module** a continuously-acting automatic control system is required to provide control of the voltage (or zero transfer of **Reactive Power** as applicable to CC.6.3.2) at the **Grid Entry Point** or **User System**

**Entry Point** without instability over the entire operating range of the **Non-Synchronous Generating Unit, DC Converter or Power Park Module**. In the case of a **Power Park Module** in Scotland, voltage control may be at the **Power Park Unit** terminals, an appropriate intermediate busbar or the **Connection Point** as specified in the **Bilateral Agreement**. The automatic control system shall be designed to ensure a smooth transition between the shaded area bound by CD and the non shaded area bound by AB in Figure 1 of CC6.3.2 (c). The performance requirements for this automatic control system will be specified in the **Bilateral Agreement**.

- (d) In particular, other control facilities, including constant **Reactive Power** output control modes and constant **Power Factor** control modes (but excluding VAR limiters) are not required. However, if present in the excitation or voltage control system they will be disabled unless recorded in the **Bilateral Agreement**. Operation of such control facilities will be in accordance with the provisions contained in **BC2**.

#### Steady state Load Inaccuracies

- CC.6.3.9 The standard deviation of **Load** error at steady state **Load** over a 30 minute period must not exceed 2.5 per cent of a **Genset's Registered Capacity**. Where a **Genset** is instructed to **Frequency** sensitive operation, allowance will be made in determining whether there has been an error according to the governor droop characteristic registered under the **PC**.

For the avoidance of doubt in the case of a **Power Park Module** allowance will be made for the full variation of mechanical power output.

#### Negative Phase Sequence Loadings

- CC.6.3.10 In addition to meeting the conditions specified in CC.6.1.5(b), each **Synchronous Generating Unit** will be required to withstand, without tripping, the negative phase sequence loading incurred by clearance of a close-up phase-to-phase fault, by **System Back-Up Protection** on the **GB Transmission System** or **User System** in which it is **Embedded**.

#### Neutral Earthing

- CC.6.3.11 At nominal **System** voltages of 132kV and above the higher voltage windings of a transformer of a **Generating Unit, DC Converter or Power Park Module** must be star connected with the star point suitable for connection to earth. The earthing and lower voltage winding arrangement shall be such as to ensure that the **Earth Fault Factor** requirement of paragraph CC.6.2.1.1 (b) will be met on the **GB Transmission System** at nominal **System** voltages of 132kV and above.

#### Frequency Sensitive Relays

- CC.6.3.12 As stated in CC.6.1.3, the **System Frequency** could rise to 52Hz or fall to 47Hz. Each **Generating Unit, DC Converter, Power Park Module** or any constituent element must continue to operate within this **Frequency** range for at least the periods of time given in CC.6.1.3 unless **NGET** has agreed to any **Frequency**-level relays and/or rate-of-change-of-**Frequency** relays which will trip such **Generating Unit, DC Converter, Power Park Module** and any constituent element within this **Frequency** range, under the **Bilateral Agreement**.

CC.6.3.13 **Generators** and **DC Converter Station** owners will be responsible for protecting all their **Generating Units, DC Converters** or **Power Park Modules** against damage should **Frequency** excursions outside the range 52Hz to 47Hz ever occur. Should such excursions occur, it is up to the **Generator** or **DC Converter Station** owner to decide whether to disconnect his **Apparatus** for reasons of safety of **Apparatus, Plant** and/or personnel.

CC.6.3.14 It may be agreed in the **Bilateral Agreement** that a **Genset** shall have a **Fast-Start Capability**. Such **Gensets** may be used for **Operating Reserve** and their **Start-Up** may be initiated by **Frequency**-level relays with settings in the range 49Hz to 50Hz as specified pursuant to **OC2**.

CC.6.3.15 Fault Ride Through

(a) Short circuit faults at **Supergrid Voltage** up to 140ms in duration

(i) Each **Generating Unit, DC Converter, or Power Park Module** and any constituent **Power Park Unit** thereof shall remain transiently stable and connected to the **System** without tripping of any **Generating Unit, DC Converter** or **Power Park Module** and / or any constituent **Power Park Unit**, for a close-up solid three-phase short circuit fault or any unbalanced short circuit fault on the **GB Transmission System** operating at **Supergrid Voltages** for a total fault clearance time of up to 140 ms. A solid three-phase or unbalanced earthed fault results in zero voltage on the faulted phase(s) at the point of fault. The duration of zero voltage is dependent on local protection and circuit breaker operating times. This duration and the fault clearance times will be specified in the **Bilateral Agreement**. Following fault clearance, recovery of the **Supergrid Voltage** to 90% may take longer than 140ms as illustrated in Appendix 4 Figures CC.A.4.1 (a) and (b).

(ii) Each **Generating Unit** or **Power Park Module** shall be designed such that upon both clearance of the fault on the **GB Transmission System** as detailed in CC.6.3.15 (a) (i) and within 0.5 seconds of the restoration of the **voltage at the Grid Entry Point** to the minimum levels specified in CC.6.1.4 (or within 0.5 seconds of restoration of the voltage at the **User System Entry Point** to 90% of nominal or greater if **Embedded**), **Active Power** output shall be restored to at least 90% of the level available immediately before the fault. During the period of the fault as detailed in CC.6.3.15 (a) (i) each **Generating Unit** or **Power Park Module** shall generate maximum reactive current without exceeding the transient rating limit of the **Generating Unit** or **Power Park Module** and / or any constituent **Power Park Unit**.

(iii) Each **DC Converter** shall be designed to meet the **Active Power** recovery characteristics as specified in the **Bilateral Agreement** upon clearance of the fault on the **GB Transmission System** as detailed in CC.6.3.15 (a) (i).

(b) **Supergrid Voltage** dips greater than 140ms in duration

In addition to the requirements of CC.6.3.15 (a) each **Generating Unit** or **Power Park Module** and / or any constituent **Power Park Unit**, each with a **Completion Date** on or after the 1 April 2005 shall:

(i) remain transiently stable and connected to the **System** without tripping of any **Generating Unit** or **Power Park Module** and / or any constituent **Power Park**

**Unit**, for balanced **Supergrid Voltage** dips and associated durations anywhere on or above the heavy black line shown in Figure 5. Appendix 4 and Figures CC.A.4.3 (a), (b) and (c) provide an explanation and illustrations of Figure 5; and,

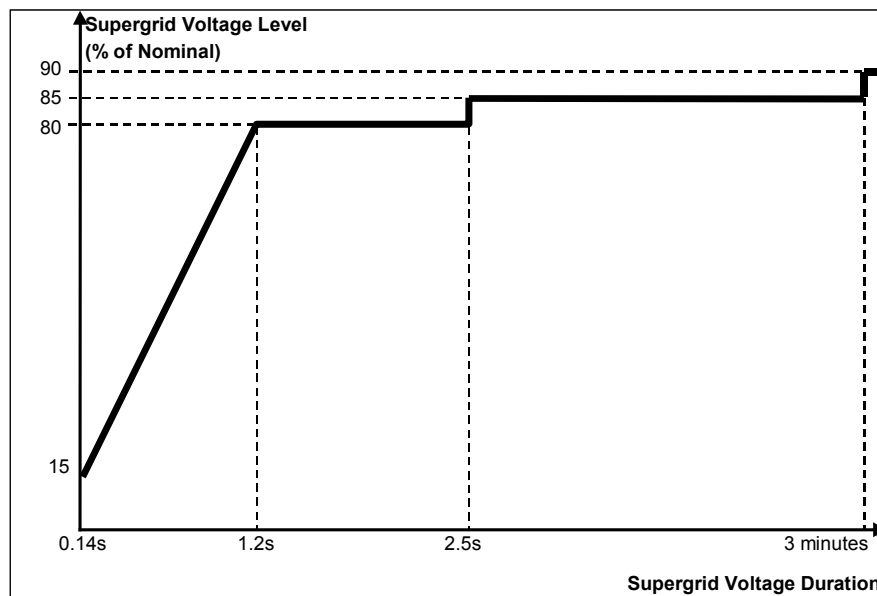

Figure 5

- (ii) provide **Active Power** output, during **Supergrid Voltage** dips as described in Figure 5, at least in proportion to the retained balanced voltage at the **Grid Entry Point** (or the retained balanced voltage at the **User System Entry Point** if **Embedded**) except in the case of a **Non-Synchronous Generating Unit** or **Power Park Module** where there has been a reduction in the **Intermittent Power Source** in the time range in Figure 5 that restricts the **Active Power** output below this level and shall generate maximum reactive current without exceeding the transient rating limits of the **Generating Unit** or **Power Park Module** and any constituent **Power Park Unit**; and,
- (iii) restore **Active Power** output, following **Supergrid Voltage** dips as described in Figure 5, within 1 second of restoration of the voltage at the **Grid Entry Point** to the minimum levels specified in CC.6.1.4 (or within 1 second of restoration of the voltage at the **User System Entry Point** to 90% of nominal or greater if **Embedded**), to at least 90% of the level available immediately before the occurrence of the dip except in the case of a **Non-Synchronous Generating Unit** or **Power Park Module** where there has been a reduction in the **Intermittent Power Source** in the time range in Figure 5 that restricts the **Active Power** output below this level.

For the avoidance of doubt a balanced **Supergrid Voltage** meets the requirements of CC.6.1.5 (b) and CC.6.1.6.

(c) Other Requirements

- (i) In the case of a **Power Park Module** (comprising of wind-turbine generator units), the requirements in CC.6.3.15(a) and CC.6.3.15(b) do not apply when the **Power Park Module** is operating at less than 5% of its **Rated MW** or during very high wind speed conditions when more than 50% of the wind turbine generator units in a **Power Park Module** have been shut down or disconnected under an emergency shutdown sequence to protect **User's Plant** and **Apparatus**.

- (ii) In addition to meeting the conditions specified in CC.6.1.5(b) and CC.6.1.6, each **Non-Synchronous Generating Unit** or **Power Park Module** and any constituent **Power Park Unit** thereof will be required to withstand, without tripping, the negative phase sequence loading incurred by clearance of a close-up phase-to-phase fault, by **System Back-Up Protection** on the **GB Transmission System** operating at **Supergrid Voltage**.
- (iii) In the case of a **Power Park Module** in Scotland with a **Completion Date** before 1 January 2004 and a **Registered Capacity** less than 30MW the requirements in CC.6.3.15 (a) do not apply. In the case of a **Power Park Module** in Scotland with a **Completion Date** on or after 1 January 2004 and before 1 July 2005 and a **Registered Capacity** less than 30MW the requirements in CC.6.3.15 (a) are relaxed from the minimum **Supergrid Voltage** of zero to a minimum **Supergrid Voltage** of 15% of nominal. In the case of a **Power Park Module** in Scotland with a **Completion Date** before 1 January 2004 and a **Registered Capacity** of 30MW and above the requirements in CC.6.3.15 (a) are relaxed from the minimum **Supergrid Voltage** of zero to a minimum **Supergrid Voltage** of 15% of nominal.
- (iv) To avoid unwanted island operation, **Non-Synchronous Generating Units** in Scotland or **Power Park Modules** in Scotland shall be tripped for the following conditions:-
  - (1) Frequency above 52Hz for more than 2 seconds
  - (2) Frequency below 47Hz for more than 2 seconds
  - (3) Voltage as measured at the **Connection Point** or **User System Entry Point** below 80% for more than 2 seconds
  - (4) Voltage as measured at the **Connection Point** or **User System Entry Point** above 120% (115% for 275kV) for more than 1 second.

The times in sections (1) and (2) are maximum trip times. Shorter times may be used to protect the **Non-Synchronous Generating Units** or **Power Park Modules**.

#### Additional Damping Control Facilities for DC Converters

- CC.6.3.16 (a) **DC Converter** owners must ensure that any of their **DC Converters** will not cause a sub-synchronous resonance problem on the **Total System**. Each **DC Converter** is required to be provided with sub-synchronous resonance damping control facilities.
- (b) Where specified in the **Bilateral Agreement**, each **DC Converter** is required to be provided with power oscillation damping or any other identified additional control facilities.

#### System to Generator Operational Intertripping Scheme

- CC.6.3.17 **NGET** may require that a **System to Generator Operational Intertripping Scheme** be installed as part of a condition of the connection of the **Generator**. Scheme specific details shall be included in the relevant **Bilateral Agreement**.

#### CC.6.4 GENERAL NETWORK OPERATOR AND NON-EMBEDDED CUSTOMER REQUIREMENTS

- CC.6.4.1 This part of the **Grid Code** describes the technical and design criteria and performance requirements for **Network Operators** and **Non-Embedded Customers**.

### Neutral Earthing

- CC.6.4.2 At nominal **System** voltages of 132kV and above the higher voltage windings of three phase transformers and transformer banks connected to the **GB Transmission System** must be star connected with the star point suitable for connection to earth. The earthing and lower voltage winding arrangement shall be such as to ensure that the **Earth Fault Factor** requirement of paragraph CC.6.2.1.1 (b) will be met on the **GB Transmission System** at nominal **System** voltages of 132kV and above.

### Frequency Sensitive Relays

- CC.6.4.3 As explained under **OC6**, each **Network Operator**, will make arrangements that will facilitate automatic low **Frequency Disconnection of Demand** (based on **Annual ACS Conditions**). The **Bilateral Agreement** will specify the manner in which **Demand** subject to low **Frequency** disconnection will be split into discrete MW blocks with associated **Low Frequency Relay** settings. Technical requirements relating to **Low Frequency Relays** are listed in Appendix 5.

### CC.6.5 COMMUNICATIONS PLANT

- CC.6.5.1 In order to ensure control of the **GB Transmission System**, telecommunications between **Users** and **NGET** must, if required by **NGET**, be established in accordance with the requirements set down below.

### Control Telephony

- CC.6.5.2 **Control Telephony** is the method by which a **User's Responsible Engineer/Operator** and **NGET Control Engineers** speak to one another for the purposes of control of the **Total System** in both normal and emergency operating conditions. **Control Telephony** provides secure point to point telephony for routine **Control Calls**, priority **Control Calls** and emergency **Control Calls**.

- CC.6.5.3 Supervisory tones indicate to the calling and receiving parties dial, engaged, ringing, secondary engaged (signifying that priority may be exercised) and priority disconnect tones.

- CC.6.5.4 Where **NGET** requires **Control Telephony**, **Users** are required to use the **Control Telephony** with **NGET** in respect of all **Connection Points** with the **GB Transmission System** and in respect of all **Embedded Large Power Stations** and **Embedded DC Converter Stations**. **NGET** will install **Control Telephony** at the **User's** location where the **User's** telephony equipment is not capable of providing the required facilities or is otherwise incompatible with the **Transmission Control Telephony**. Details of and relating to the **Control Telephony** required are contained in the **Bilateral Agreement**.

- CC.6.5.5 Detailed information on **Control Telephony** facilities and suitable equipment required for individual **User** applications will be provided by **NGET** upon request.

### Operational Metering

- CC.6.5.6 (a) **NGET** shall provide system control and data acquisition (SCADA) outstation interface equipment. The **User** shall provide such voltage, current, **Frequency**, **Active Power** and **Reactive Power** measurement outputs and

plant status indications and alarms to the **Transmission** SCADA outstation interface equipment as required by **NGET** in accordance with the terms of the **Bilateral Agreement**.

- (b) For the avoidance of doubt, for **Active Power** and **Reactive Power** measurements, circuit breaker and disconnect status indications from:
- (i) **CCGT Modules** at **Large Power Stations**, the outputs and status indications must each be provided to **NGET** on an individual **CCGT Unit** basis. In addition, where identified in the **Bilateral Agreement**, **Active Power** and **Reactive Power** measurements from **Unit Transformers** and/or **Station Transformers** must be provided.
  - (ii) **DC Converters** at **DC Converter Stations**, the outputs and status indications must each be provided to **NGET** on an individual **DC Converter** basis. In addition, where identified in the **Bilateral Agreement**, **Active Power** and **Reactive Power** measurements from converter and/or station transformers must be provided.
  - (iii) **Power Park Modules** at **Embedded Large Power Stations** and at directly connected **Power Stations**, the outputs and status indications must each be provided to **NGET** on an individual **Power Park Module** basis. In addition, where identified in the **Bilateral Agreement**, **Active Power** and **Reactive Power** measurements from station transformers must be provided.
- (c) For the avoidance of doubt, the requirements of CC.6.5.6(a) in the case of a **Cascade Hydro Scheme** will be provided for each **Generating Unit** forming part of that **Cascade Hydro Scheme**. In the case of **Embedded Generating Units** forming part of a **Cascade Hydro Scheme** the data may be provided by means other than a **NGET** SCADA outstation located at the **Power Station**, such as, with the agreement of the **Network Operator** in whose system such **Embedded Generating Unit** is located, from the **Network Operator's** SCADA system to **NGET**. Details of such arrangements will be contained in the relevant **Bilateral Agreements** between **NGET** and the **Generator** and the **Network Operator**.
- (d) In the case of a **Power Park Module** an additional energy input signal (e.g. wind speed) may be specified in the **Bilateral Agreement**. The signal may be used to establish the level of energy input from the **Intermittent Power Source** for monitoring pursuant to CC.6.6.1 and **Ancillary Services** and will, in the case of a wind farm, be used to provide **NGET** with advanced warning of excess wind speed shutdown.

#### Instructor Facilities

- CC.6.5.7 The **User** shall accommodate **Instructor Facilities** provided by **NGET** for the receipt of operational messages relating to **System** conditions.

#### Electronic Data Communication Facilities

- CC.6.5.8 (a) All **BM Participants** must ensure that appropriate electronic data communication facilities are in place to permit the submission of data, as required by the **Grid Code**, to **NGET**.

- (b) In addition, any **User** that wishes to participate in the **Balancing Mechanism** must ensure that appropriate automatic logging devices are installed at the **Control Points** of its **BM Units** to submit data to and to receive instructions from **NGET**, as required by the **Grid Code**. For the avoidance of doubt, in the case of an **Interconnector User** the **Control Point** will be at the **Control Centre** of the appropriate **Externally Interconnected System Operator**.
- (c) Detailed specifications of these required electronic facilities will be provided by **NGET** on request and they are listed as **Electrical Standards** in the Annex to the **General Conditions**.

#### Facsimile Machines

CC.6.5.9 Each **User** and **NGET** shall provide a facsimile machine or machines:-

- (a) in the case of **Generators**, at the **Control Point** of each **Power Station** and at its **Trading Point**;
- (b) in the case of **NGET** and **Network Operators**, at the **Control Centre(s)**; and
- (c) in the case of **Non-Embedded Customers** and **DC Converter Station** owners at the **Control Point**.

Each **User** shall notify, prior to connection to the **System** of the **User's Plant and Apparatus**, **NGET** of its or their telephone number or numbers, and will notify **NGET** of any changes. Prior to connection to the **System** of the **User's Plant and Apparatus** **NGET** shall notify each **User** of the telephone number or numbers of its facsimile machine or machines and will notify any changes.

CC.6.5.10 Busbar Voltage

**NGET** shall, subject as provided below, provide each **Generator** or **DC Converter Station** owner at each **Grid Entry Point** where one of its **Power Stations** or **DC Converter Stations** is connected with appropriate voltage signals to enable the **Generator** or **DC Converter Station** owner to obtain the necessary information to permit its **Gensets** or **DC Converters** to be **Synchronised** to the **GB Transmission System**. The term "voltage signal" shall mean in this context, a point of connection on (or wire or wires from) a relevant part of **Transmission Plant** and/or **Apparatus** at the **Grid Entry Point**, to which the **Generator** or **DC Converter Station** owner, with **NGET's** agreement (not to be unreasonably withheld) in relation to the **Plant** and/or **Apparatus** to be attached, will be able to attach its **Plant** and/or **Apparatus** (normally a wire or wires) in order to obtain measurement outputs in relation to the busbar.

CC.6.5.11 Bilingual Message Facilities

- (a) A Bilingual Message Facility is the method by which the **User's Responsible Engineer/Operator**, the **Externally Interconnected System Operator** and **NGET Control Engineers** communicate clear and unambiguous information in two languages for the purposes of control of the **Total System** in both normal and emergency operating conditions.



- (b) A Bilingual Message Facility, where required, will provide up to two hundred pre-defined messages with up to five hundred and sixty characters each. A maximum of one minute is allowed for the transmission to, and display of, the selected message at any destination. The standard messages must be capable of being displayed at any combination of locations and can originate from any of these locations. Messages displayed in the UK will be displayed in the English language.
- (c) Detailed information on a Bilingual Message Facility and suitable equipment required for individual **User** applications will be provided by **NGET** upon request.

## CC.6.6 SYSTEM MONITORING

- CC.6.6.1 Monitoring equipment is provided on the **GB Transmission System** to enable **NGET** to monitor its power system dynamic performance conditions. Where this monitoring equipment requires voltage and current signals on the **Generating Unit** (other than **Power Park Unit**), **DC Converter** or **Power Park Module** circuit from the **User**, **NGET** will inform the **User** and they will be provided by the **User** with both the timing of the installation of the equipment for receiving such signals and its exact position being agreed (the **User's** agreement not to be unreasonably withheld) and the costs being dealt with, pursuant to the terms of the **Bilateral Agreement**.

## CC.7 SITE RELATED CONDITIONS

- CC.7.1 Not used.

### CC.7.2 RESPONSIBILITIES FOR SAFETY

- CC.7.2.1 In England and Wales, any **User** entering and working on its **Plant** and/or **Apparatus** on a **Transmission Site** will work to the **Safety Rules** of **NGET**.

In Scotland, any **User** entering and working on its **Plant** and/or **Apparatus** on a **Transmission Site** will work to the **Safety Rules** of the **Relevant Transmission Licensee**, as advised by **NGET**.

- CC.7.2.2 **NGET** entering and working on **Transmission Plant** and/or **Apparatus** on a **User Site** will work to the **User's Safety Rules**. For **User Sites** in Scotland, **NGET** shall procure that the **Relevant Transmission Licensee** entering and working on **Transmission Plant** and/or **Apparatus** on a **User Site** will work to the **User's Safety Rules**.

- CC.7.2.3 A **User** may, with a minimum of six weeks notice, apply to **NGET** for permission to work according to that **Users** own **Safety Rules** when working on its **Plant** and/or **Apparatus** on a **Transmission Site** rather than those set out in CC.7.2.1. If **NGET** is of the opinion that the **User's Safety Rules** provide for a level of safety commensurate with those set out in CC.7.2.1, **NGET** will notify the **User**, in writing, that, with effect from the date requested by the **User**, the **User** may use its own **Safety Rules** when working on its **Plant** and/or **Apparatus** on the **Transmission Site**. For a **Transmission Site** in Scotland, in forming its opinion, **NGET** will seek the opinion of the **Relevant Transmission Licensee**. Until receipt of such written approval from **NGET**, the **User** will continue to use the **Safety Rules** as set out in CC7.2.1.

CC.7.2.4 In the case of a **User Site** in England and Wales, **NGET** may, with a minimum of six weeks notice, apply to a **User** for permission to work according to **NGET's Safety Rules** when working on **Transmission Plant** and/or **Apparatus** on that **User Site**, rather than the **User's Safety Rules**. If the **User** is of the opinion that **NGET's Safety Rules** provide for a level of safety commensurate with that of that **User's Safety Rules**, it will notify **NGET**, in writing, that, with the effect from the date requested by **NGET**, **NGET** may use its own **Safety Rules** when working on its **Transmission Plant** and/or **Apparatus** on that **User Site**. Until receipt of such written approval from the **User**, **NGET** shall continue to use the **User's Safety Rules**.

In the case of a **User Site** in Scotland, **NGET** may, with a minimum of six weeks notice, apply to a **User** for permission for the **Relevant Transmission Licensee** to work according to the **Relevant Transmission Licensee's Safety Rules** when working on **Transmission Plant** and/or **Apparatus** on that **User Site**, rather than the **User's Safety Rules**. If the **User** is of the opinion that the **Relevant Transmission Licensee's Safety Rules**, provide for a level of safety commensurate with that of that **User's Safety Rules**, it will notify **NGET**, in writing, that, with effect from the date requested by **NGET**, that the **Relevant Transmission Licensee** may use its own **Safety Rules** when working on its **Transmission Plant** and/or **Apparatus** on that **User's Site**. Until receipt of such written approval from the **User**, **NGET** shall procure that the **Relevant Transmission Licensee** shall continue to use the **User's Safety Rules**.

CC.7.2.5 For a **Transmission Site** in England and Wales, if **NGET** gives its approval for the **User's Safety Rules** to apply to the **User** when working on its **Plant** and/or **Apparatus**, that does not imply that the **User's Safety Rules** will apply to entering the **Transmission Site** and access to the **User's Plant** and/or **Apparatus** on that **Transmission Site**. Bearing in mind **NGET's** responsibility for the whole **Transmission Site**, entry and access will always be in accordance with **NGET's** site access procedures. For a **User Site** in England and Wales, if the **User** gives its approval for **NGET's Safety Rules** to apply to **NGET** when working on its **Plant** and **Apparatus**, that does not imply that **NGET's Safety Rules** will apply to entering the **User Site**, and access to the **Transmission Plant** and **Apparatus** on that **User Site**. Bearing in mind the **User's** responsibility for the whole **User Site**, entry and access will always be in accordance with the **User's** site access procedures.

For a **Transmission Site** in Scotland, if **NGET** gives its approval for the **User's Safety Rules** to apply to the **User** when working on its **Plant** and/or **Apparatus**, that does not imply that the **User's Safety Rules** will apply to entering the **Transmission Site** and access to the **User's Plant** and/or **Apparatus** on that **Transmission Site**. Bearing in mind the **Relevant Transmission Licensee's** responsibility for the whole **Transmission Site**, entry and access will always be in accordance with the **Relevant Transmission Licensee's** site access procedures. For a **User Site** in Scotland, if the **User** gives its approval for **Relevant Transmission Licensee Safety Rules** to apply to the **Relevant Transmission Licensee** when working on its **Plant** and **Apparatus**, that does not imply that the **Relevant Transmission Licensee's Safety Rules** will apply to entering the **User Site**, and access to the **Transmission Plant** and **Apparatus** on that **User Site**. Bearing in mind the **User's** responsibility for the whole **User Site**, entry and access will always be in accordance with the **User's** site access procedures

CC.7.2.6 For **User Sites** in England and Wales, **Users** shall notify **NGET** of any **Safety Rules** that apply to **NGET's** staff working on **User Sites**. For **Transmission Sites**

in England and Wales, **NGET** shall notify **Users** of any **Safety Rules** that apply to the **User's** staff working on the **Transmission Site**.

For **User Sites** in Scotland, **Users** shall notify **NGET** of any **Safety Rules** that apply to the **Relevant Transmission Licensee's** staff working on **User Sites**. For **Transmission Sites** in Scotland **NGET** shall procure that the **Relevant Transmission Licensee** shall notify **Users** of any **Safety Rules** that apply to the **User's** staff working on the **Transmission Site**.

CC.7.2.7 Each **Site Responsibility Schedule** must have recorded on it the **Safety Rules** which apply to each item of **Plant** and/or **Apparatus**.

### CC.7.3 **SITE RESPONSIBILITY SCHEDULES**

CC.7.3.1 In order to inform site operational staff and **NGET Control Engineers** of agreed responsibilities for **Plant** and/or **Apparatus** at the operational interface, a **Site Responsibility Schedule** shall be produced for **Connection Sites** in England and Wales for **NGET** and **Users** with whom they interface, and for **Connection Sites** in Scotland for **NGET**, the **Relevant Transmission Licensee** and **Users** with whom they interface.

CC.7.3.2 The format, principles and basic procedure to be used in the preparation of **Site Responsibility Schedules** are set down in Appendix 1.

### CC.7.4 **OPERATION AND GAS ZONE DIAGRAMS**

#### **Operation Diagrams**

CC.7.4.1 An **Operation Diagram** shall be prepared for each **Connection Site** at which a **Connection Point** exists using, where appropriate, the graphical symbols shown in Part 1A of Appendix 2. **Users** should also note that the provisions of **OC11** apply in certain circumstances.

CC.7.4.2 The **Operation Diagram** shall include all **HV Apparatus** and the connections to all external circuits and incorporate numbering, nomenclature and labelling, as set out in **OC11**. At those **Connection Sites** where gas-insulated metal enclosed switchgear and/or other gas-insulated **HV Apparatus** is installed, those items must be depicted within an area delineated by a chain dotted line which intersects gas-zone boundaries. The nomenclature used shall conform with that used on the relevant **Connection Site** and circuit. The **Operation Diagram** (and the list of technical details) is intended to provide an accurate record of the layout and circuit interconnections, ratings and numbering and nomenclature of **HV Apparatus** and related **Plant**.

CC.7.4.3 A non-exhaustive guide to the types of **HV Apparatus** to be shown in the **Operation Diagram** is shown in Part 2 of Appendix 2, together with certain basic principles to be followed unless equivalent principles are approved by **NGET**.

#### **Gas Zone Diagrams**

CC.7.4.4 A **Gas Zone Diagram** shall be prepared for each **Connection Site** at which a **Connection Point** exists where gas-insulated switchgear and/or other gas-insulated **HV Apparatus** is utilised. They shall use, where appropriate, the graphical symbols shown in Part 1B of Appendix 2.

- CC.7.4.5 The nomenclature used shall conform with that used in the relevant **Connection Site** and circuit.
- CC.7.4.6 The basic principles set out in Part 2 of Appendix 2 shall be followed in the preparation of **Gas Zone Diagrams** unless equivalent principles are approved by **NGET**.

Preparation of **Operation** and **Gas Zone Diagrams** for **Users' Sites**

- CC.7.4.7 In the case of a **User Site**, the **User** shall prepare and submit to **NGET**, an **Operation Diagram** for all **HV Apparatus** on the **User** side of the **Connection Point** and **NGET** shall provide the **User** with an **Operation Diagram** for all **HV Apparatus** on the **Transmission** side of the **Connection Point**, in accordance with the timing requirements of the **Bilateral Agreement** and/or **Construction Agreement** prior to the **Completion Date** under the **Bilateral Agreement** and/or **Construction Agreement**.
- CC.7.4.8 The **User** will then prepare, produce and distribute, using the information submitted on the **User's Operation Diagram** and **NGET Operation Diagram**, a composite **Operation Diagram** for the complete **Connection Site**, also in accordance with the timing requirements of the **Bilateral Agreement** and/or **Construction Agreement** .
- CC.7.4.9 The provisions of CC7.4.7 and CC.7.4.8 shall apply in relation to **Gas Zone Diagrams** where gas-insulated switchgear and/or other gas-insulated **HV Apparatus** is utilised.

Preparation of **Operation** and **Gas Zone Diagrams** for **Transmission Sites**

- CC.7.4.10 In the case of an **Transmission Site**, the **User** shall prepare and submit to **NGET** an **Operation Diagram** for all **HV Apparatus** on the **User** side of the **Connection Point**, in accordance with the timing requirements of the **Bilateral Agreement** and/or **Construction Agreement**.
- CC.7.4.11 **NGET** will then prepare, produce and distribute, using the information submitted on the **User's Operation Diagram**, a composite **Operation Diagram** for the complete **Connection Site**, also in accordance with the timing requirements of the **Bilateral Agreement** and/or **Construction Agreement** .
- CC.7.4.12 The provisions of CC7.4.10 and CC.7.4.11 shall apply in relation to **Gas Zone Diagrams** where gas-insulated switchgear and/or other gas-insulated **HV Apparatus** is utilised.

CC.7.4.13 Changes to **Operation** and **Gas Zone Diagrams**

- CC.7.4.13.1 When **NGET** has decided that it wishes to install new **HV Apparatus** or it wishes to change the existing numbering or nomenclature of **Transmission HV Apparatus** at a **Transmission Site**, **NGET** will (unless it gives rise to a **Modification** under the **CUSC**, in which case the provisions of the **CUSC** as to the timing apply) one month prior to the installation or change, send to each such **User** a revised **Operation Diagram** of that **Transmission Site**, incorporating the new **Transmission HV Apparatus** to be installed and its numbering and nomenclature or the changes, as the case may be. **OC11** is also relevant to certain **Apparatus**.

CC.7.4.13.2 When a **User** has decided that it wishes to install new **HV Apparatus**, or it wishes to change the existing numbering or nomenclature of its **HV Apparatus** at its **User Site**, the **User** will (unless it gives rise to a **Modification** under the **CUSC**, in which case the provisions of the **CUSC** as to the timing apply) one month prior to the installation or change, send to **NGET** a revised **Operation Diagram** of that **User Site** incorporating the new **User HV Apparatus** to be installed and its numbering and nomenclature or the changes as the case may be. **OC11** is also relevant to certain **Apparatus**.

CC.7.4.13.3 The provisions of CC7.4.13.1 and CC.7.4.13.2 shall apply in relation to **Gas Zone Diagrams** where gas-insulated switchgear and/or other gas-insulated **HV Apparatus** is installed.

#### Validity

CC.7.4.14 (a) The composite **Operation Diagram** prepared by **NGET** or the **User**, as the case may be, will be the definitive **Operation Diagram** for all operational and planning activities associated with the **Connection Site**. If a dispute arises as to the accuracy of the composite **Operation Diagram**, a meeting shall be held at the **Connection Site**, as soon as reasonably practicable, between **NGET** and the **User**, to endeavour to resolve the matters in dispute.

(b) An equivalent rule shall apply for **Gas Zone Diagrams** where they exist for a **Connection Site**.

### CC.7.5 **SITE COMMON DRAWINGS**

CC.7.5.1 **Site Common Drawings** will be prepared for each **Connection Site** and will include **Connection Site** layout drawings, electrical layout drawings, common **Protection/control** drawings and common services drawings.

#### Preparation of Site Common Drawings for a User Site

CC.7.5.2 In the case of a **User Site**, **NGET** shall prepare and submit to the **User**, **Site Common Drawings** for the **Transmission** side of the **Connection Point** in accordance with the timing requirements of the **Bilateral Agreement** and/or **Construction Agreement**.

CC.7.5.3 The **User** will then prepare, produce and distribute, using the information submitted on the **Transmission Site Common Drawings**, **Site Common Drawings** for the complete **Connection Site** in accordance with the timing requirements of the **Bilateral Agreement** and/or **Construction Agreement**.

#### Preparation of Site Common Drawings for a Transmission Site

CC.7.5.4 In the case of a **Transmission Site**, the **User** will prepare and submit to **NGET** **Site Common Drawings** for the **User** side of the **Connection Point** in accordance with the timing requirements of the **Bilateral Agreement** and/or **Construction Agreement**.

CC.7.5.5 **NGET** will then prepare, produce and distribute, using the information submitted in the **User's Site Common Drawings**, **Site Common Drawings** for the complete **Connection Site** in accordance with the timing requirements of the **Bilateral Agreement** and/or **Construction Agreement**.

CC.7.5.6

When a **User** becomes aware that it is necessary to change any aspect of the **Site Common Drawings** at a **Connection Site** it will:

- (a) if it is a **User Site**, as soon as reasonably practicable, prepare, produce and distribute revised **Site Common Drawings** for the complete **Connection Site**; and
- (b) if it is a **Transmission Site**, as soon as reasonably practicable, prepare and submit to **NGET** revised **Site Common Drawings** for the **User** side of the **Connection Point** and **NGET** will then, as soon as reasonably practicable, prepare, produce and distribute, using the information submitted in the **User's Site Common Drawings**, revised **Site Common Drawings** for the complete **Connection Site**.

In either case, if in the **User's** reasonable opinion the change can be dealt with by it notifying **NGET** in writing of the change and for each party to amend its copy of the **Site Common Drawings** (or where there is only one set, for the party holding that set to amend it), then it shall so notify and each party shall so amend. If the change gives rise to a **Modification** under the **CUSC**, the provisions of the **CUSC** as to timing will apply.

CC.7.5.7

When **NGET** becomes aware that it is necessary to change any aspect of the **Site Common Drawings** at a **Connection Site** it will:

- (a) if it is a **Transmission Site**, as soon as reasonably practicable, prepare, produce and distribute revised **Site Common Drawings** for the complete **Connection Site**; and
- (b) if it is a **User Site**, as soon as reasonably practicable, prepare and submit to the **User** revised **Site Common Drawings** for the **Transmission** side of the **Connection Point** and the **User** will then, as soon as reasonably practicable, prepare, produce and distribute, using the information submitted in the **Transmission Site Common Drawings**, revised **Site Common Drawings** for the complete **Connection Site**.

In either case, if in **NGET's** reasonable opinion the change can be dealt with by it notifying the **User** in writing of the change and for each party to amend its copy of the **Site Common Drawings** (or where there is only one set, for the party holding that set to amend it), then it shall so notify and each party shall so amend. If the change gives rise to a **Modification** under the **CUSC**, the provisions of the **CUSC** as to timing will apply.

Validity

CC.7.5.8 The **Site Common Drawings** for the complete **Connection Site** prepared by the **User** or **NGET**, as the case may be, will be the definitive **Site Common Drawings** for all operational and planning activities associated with the **Connection Site**. If a dispute arises as to the accuracy of the **Site Common Drawings**, a meeting shall be held at the **Site**, as soon as reasonably practicable, between **NGET** and the **User**, to endeavour to resolve the matters in dispute.

CC.7.6

ACCESS

- CC.7.6.1 The provisions relating to access to **Transmission Sites** by **Users**, and to **Users' Sites** by **Transmission Licensees**, are set out in each **Interface Agreement** with, for **Transmission Sites** in England and Wales, **NGET** and each **User**, and for **Transmission Sites** in Scotland, the **Relevant Transmission Licensee** and each **User**.
- CC.7.6.2 In addition to those provisions, where a **Transmission Site** in England and Wales contains exposed **HV** conductors, unaccompanied access will only be granted to individuals holding an **Authority for Access** issued by **NGET** and where a **Transmission Site** in Scotland contains exposed **HV** conductors, unaccompanied access will only be granted to individuals holding an **Authority for Access** issued by the **Relevant Transmission Licensee**.
- CC.7.6.3 The procedure for applying for an **Authority for Access** is contained in the **Interface Agreement**.
- CC.7.7 MAINTENANCE STANDARDS
- CC.7.7.1 It is a requirement that all **User's Plant** and **Apparatus** on **Transmission Sites** is maintained adequately for the purpose for which it is intended and to ensure that it does not pose a threat to the safety of any **Transmission Plant, Apparatus** or personnel on the **Transmission Site**. **NGET** will have the right to inspect the test results and maintenance records relating to such **Plant** and **Apparatus** at any time. In Scotland, it is the **User's** responsibility to ensure that all the **User's Plant** and **Apparatus**, including protection systems, are tested and maintained and remain rated for the duty required. An annual update of system fault levels is available as part of the **Seven Year Statement**.
- CC.7.7.2 It is a requirement that all **Transmission Plant** and **Apparatus** on **User's Sites** is maintained adequately for the purposes for which it is intended and to ensure that it does not pose a threat to the safety of any of the **User's Plant, Apparatus** or personnel on the **User Site**. **Users** will have the right to inspect the test results and maintenance records relating to such **Plant** and **Apparatus**, at any time.
- CC.7.8 SITE OPERATIONAL PROCEDURES
- CC.7.8.1 **NGET** and **Users** with an interface with **NGET**, must make available staff to take necessary **Safety Precautions** and carry out operational duties as may be required to enable work/testing to be carried out and for the operation of **Plant** and **Apparatus** connected to the **Total System**.
- CC.7.9 **Generators** and **DC Converter Station** owners shall provide a **Control Point** in respect of each **Power Station** directly connected to the **GB Transmission System** and **Embedded Large Power Station** or **DC Converter Station**. The **Control Point** shall be continuously manned (except for **Embedded Power Stations** containing **Power Park Modules** in the **SHETL Transmission Area** which have a **Registered Capacity** less than 30MW where the **Control Point** shall be manned between the hours of 0800 and 1800 each day) to receive and act upon instructions pursuant to OC7 and BC2 at all times that **Generating Units** or **Power Park Modules** at the **Power Station** are generating or available to generate or **DC Converters** at the **DC Converter Station** are importing or exporting or available to do so.

CC.8 **ANCILLARY SERVICES**

CC.8.1 **System Ancillary Services**

The **CC** contain requirements for the capability for certain **Ancillary Services**, which are needed for **System** reasons ("**System Ancillary Services**"). There follows a list of these **System Ancillary Services**, together with the paragraph number of the **CC** (or other part of the **Grid Code**) in which the minimum capability is required or referred to. The list is divided into two categories: Part 1 lists the **System Ancillary Services** which **Generators** are obliged to provide and **DC Converter Station** owners are obliged to have the capability to supply, and Part 2 lists the **System Ancillary Services** which **Generators** will provide only if agreement to provide them is reached with **NGET**:

Part 1

- (a) **Reactive Power** supplied (in accordance with CC.6.3.2) otherwise than by means of synchronous or static compensators (except in the case of a **Power Park Module** where synchronous or static compensators within the **Power Park Module** may be used to provide **Reactive Power**)
- (b) **Frequency** Control by means of **Frequency** sensitive generation - CC.6.3.7 and BC3.5.1

Part 2

- (c) **Frequency** Control by means of **Fast Start** - CC.6.3.14
- (d) **Black Start Capability** - CC.6.3.5
- (e) **System to Generator Operational Intertripping**

CC.8.2 **Commercial Ancillary Services**

Other **Ancillary Services** are also utilised by **NGET** in operating the **Total System** if these have been agreed to be provided by a **User** (or other person) under an **Ancillary Services Agreement** or under a **Bilateral Agreement**, with payment being dealt with under an **Ancillary Services Agreement** or in the case of **Externally Interconnected System Operators** or **Interconnector Users**, under any other agreement (and in the case of **Externally Interconnected System Operators** and **Interconnector Users** includes ancillary services equivalent to or similar to **System Ancillary Services**) ("**Commercial Ancillary Services**"). The capability for these **Commercial Ancillary Services** is set out in the relevant **Ancillary Services Agreement** or **Bilateral Agreement** (as the case may be).



## CONNECTION CONDITIONS

### APPENDIX 1

#### FORMAT, PRINCIPLES AND BASIC PROCEDURE TO BE USED IN THE PREPARATION OF SITE RESPONSIBILITY SCHEDULES

##### CC.A.1.1 PRINCIPLES

###### Types of Schedules

CC.A.1.1.1 At all **Complexes** the following **Site Responsibility Schedules** shall be drawn up using the relevant proforma attached or with such variations as may be agreed between **NGET** and **Users**, but in the absence of agreement the relevant proforma attached will be used:

- (a) Schedule of **HV Apparatus**
- (b) Schedule of **Plant, LV/MV Apparatus**, services and supplies;
- (c) Schedule of telecommunications and measurements **Apparatus**.

Other than at **Generating Unit, DC Converter, Power Park Module** and **Power Station** locations, the schedules referred to in (b) and (c) may be combined.

###### New Connection Sites

CC.A.1.1.2 In the case of a new **Connection Site** each **Site Responsibility Schedule** for a **Connection Site** shall be prepared by **NGET** in consultation with relevant **Users** at least 2 weeks prior to the **Completion Date** under the **Bilateral Agreement** and/or **Construction Agreement** for that **Connection Site** (which may form part of a **Complex**). Each **User** shall, in accordance with the timing requirements of the **Bilateral Agreement** and/or **Construction Agreement**, provide information to **NGET** to enable it to prepare the **Site Responsibility Schedule**.

###### Sub-division

CC.A.1.1.3 Each **Site Responsibility Schedule** will be subdivided to take account of any separate **Connection Sites** on that **Complex**.

###### Scope

CC.A.1.1.4 Each **Site Responsibility Schedule** shall detail for each item of **Plant** and **Apparatus**:-

- (a) **Plant/Apparatus** ownership;
- (b) Site Manager (Controller) (except in the case of **Plant/Apparatus** located in **SPT's Transmission Area**);
- (c) Safety issues comprising applicable **Safety Rules** and **Control Person** or other responsible person (**Safety Co-ordinator**), or such other person who is responsible for safety;

- (d) Operations issues comprising applicable **Operational Procedures** and control engineer;
- (e) Responsibility to undertake statutory inspections, fault investigation and maintenance.

Each **Connection Point** shall be precisely shown.

#### Detail

- CC.A.1.1.5 (a) In the case of **Site Responsibility Schedules** referred to in CC.A.1.1.1(b) and (c), with the exception of **Protection Apparatus** and **Intertrip Apparatus** operation, it will be sufficient to indicate the responsible **User** or **Transmission Licensee**, as the case may be.
- (b) In the case of the **Site Responsibility Schedule** referred to in CC.A.1.1.1(a) and for **Protection Apparatus** and **Intertrip Apparatus**, the responsible management unit must be shown in addition to the **User** or **Transmission Licensee**, as the case may be.
- CC.A.1.1.6 The **HV Apparatus Site Responsibility Schedule** for each **Connection Site** must include lines and cables emanating from or traversing<sup>1</sup> the **Connection Site**.

#### Issue Details

- CC.A.1.1.7 Every page of each **Site Responsibility Schedule** shall bear the date of issue and the issue number.

#### Accuracy Confirmation

- CC.A.1.1.8 When a **Site Responsibility Schedule** is prepared it shall be sent by **NGET** to the **Users** involved for confirmation of its accuracy.
- CC.A.1.1.9 The **Site Responsibility Schedule** shall then be signed on behalf of **NGET** by its **Responsible Manager** (see CC.A.1.1.16) and on behalf of each **User** involved by its **Responsible Manager** (see CC.A.1.1.16), by way of written confirmation of its accuracy. For **Connection Sites** in Scotland, the **Site Responsibility Schedule** will also be signed on behalf of the **Relevant Transmission Licensee** by its **Responsible Manager**.

#### Distribution and Availability

- CC.A.1.1.10 Once signed, two copies will be distributed by **NGET**, not less than two weeks prior to its implementation date, to each **User** which is a party on the **Site Responsibility Schedule**, accompanied by a note indicating the issue number and the date of implementation.
- CC.A.1.1.11 **NGET** and **Users** must make the **Site Responsibility Schedules** readily available to operational staff at the **Complex** and at the other relevant control points.

<sup>1</sup> Details of circuits traversing the **Connection Site** are only needed from the date which is the earlier of the date when the **Site Responsibility Schedule** is first updated and 15<sup>th</sup> October 2004. In Scotland, from a date to be agreed between **NGET** and the **Relevant Transmission Licensee**.

### Alterations to Existing **Site Responsibility Schedules**

- CC.A 1.1.12 Without prejudice to the provisions of CC.A.1.1.15 which deals with urgent changes, when a **User** identified on a **Site Responsibility Schedule** becomes aware that an alteration is necessary, it must inform **NGET** immediately and in any event 8 weeks prior to any change taking effect (or as soon as possible after becoming aware of it, if less than 8 weeks remain when the **User** becomes aware of the change). This will cover the commissioning of new **Plant** and/or Apparatus at the **Connection Site**, whether requiring a revised **Bilateral Agreement** or not, de-commissioning of **Plant** and/or **Apparatus**, and other changes which affect the accuracy of the **Site Responsibility Schedule**.
- CC.A 1.1.13 Where **NGET** has been informed of a change by a **User**, or itself proposes a change, it will prepare a revised **Site Responsibility Schedule** by not less than six weeks prior to the change taking effect (subject to it having been informed or knowing of the change eight weeks prior to that time) and the procedure set out in CC.A.1.1.8 shall be followed with regard to the revised **Site Responsibility Schedule**.
- CC.A 1.1.14 The revised **Site Responsibility Schedule** shall then be signed in accordance with the procedure set out in CC.A.1.1.9 and distributed in accordance with the procedure set out in CC.A.1.1.10, accompanied by a note indicating where the alteration(s) has/have been made, the new issue number and the date of implementation.

### Urgent Changes

- CC.A.1.1.15 When a **User** identified on a **Site Responsibility Schedule**, or **NGET**, as the case may be, becomes aware that an alteration to the **Site Responsibility Schedule** is necessary urgently to reflect, for example, an emergency situation which has arisen outside its control, the **User** shall notify **NGET**, or **NGET** shall notify the **User**, as the case may be, immediately and will discuss:
- (a) what change is necessary to the **Site Responsibility Schedule**;
  - (b) whether the **Site Responsibility Schedule** is to be modified temporarily or permanently;
  - (c) the distribution of the revised **Site Responsibility Schedule**.

**NGET** will prepare a revised **Site Responsibility Schedule** as soon as possible, and in any event within seven days of it being informed of or knowing the necessary alteration. The **Site Responsibility Schedule** will be confirmed by **Users** and signed on behalf of **NGET** and **Users** (by the persons referred to in CC.A.1.1.9) as soon as possible after it has been prepared and sent to **Users** for confirmation.

### Responsible Managers

- CC.A.1.1.16 Each **User** shall, prior to the **Completion Date** under each **Bilateral Agreement** and/or **Construction Agreement**, supply to **NGET** a list of Managers who have been duly authorised to sign **Site Responsibility Schedules** on behalf of the **User** and **NGET** shall, prior to the **Completion Date** under each **Bilateral Agreement** and/or **Construction Agreement**, supply to that **User** the name of its **Responsible Manager** and for **Connection Sites** in Scotland, the name of the **Relevant Transmission Licensee's Responsible Manager** and each shall supply to the other any changes to such list six weeks before the change takes effect where the

change is anticipated, and as soon as possible after the change, where the change was not anticipated.

De-commissioning of **Connection Sites**

CC.A.1.1.17 Where a **Connection Site** is to be de-commissioned, whichever of **NGET** or the **User** who is initiating the de-commissioning must contact the other to arrange for the **Site Responsibility Schedule** to be amended at the relevant time.

**ATTACHMENT TO APPENDIX 1 OF CONNECTION CONDITIONS**

**PROFORMA FOR SITE RESPONSIBILITY SCHEDULE**

\_\_\_\_\_ AREA

COMPLEX: \_\_\_\_\_

SCHEDULE: \_\_\_\_\_

CONNECTION SITE: \_\_\_\_\_

ITEM OF PLANT/ APPARATUS	PLANT APPARATUS OWNER	SITE MANAGER	SAFETY		OPERATIONS		PARTY RESPONSIBLE FOR UNDERTAKING STATUTORY INSPECTIONS, FAULT INVESTIGATION & MAINTENANCE	REMARKS
			SAFETY RULES	CONTROL OR OTHER RESPONSIBLE PERSON (SAFETY CO- ORDINATOR	OPERATIONAL PROCEDURES	CONTROL OR OTHER RESPONSIBLE ENGINEER		

PAGE: \_\_\_\_\_ ISSUE NO: \_\_\_\_\_ DATE: \_\_\_\_\_

**ATTACHMENT TO APPENDIX 1 OF CONNECTION CONDITIONS**

**PROFORMA FOR SITE RESPONSIBILITY SCHEDULE**

\_\_\_\_\_ AREA

COMPLEX: \_\_\_\_\_

SCHEDULE: \_\_\_\_\_

CONNECTION SITE: \_\_\_\_\_

ITEM OF PLANT/ APPARATUS	PLANT APPARATUS OWNER	SITE MANAGER	SAFETY		OPERATIONS		PARTY RESPONSIBLE FOR UNDERTAKING STATUTORY INSPECTIONS, FAULT INVESTIGATION & MAINTENANCE	REMARKS
			SAFETY RULES	CONTROL OR OTHER RESPONSIBLE PERSON (SAFETY CO- ORDINATOR	OPERATIONAL PROCEDURES	CONTROL OR OTHER RESPONSIBLE ENGINEER		

**NOTES:**

SIGNED: \_\_\_\_\_ NAME: \_\_\_\_\_ COMPANY: \_\_\_\_\_ DATE: \_\_\_\_\_

SIGNED: \_\_\_\_\_ NAME: \_\_\_\_\_ COMPANY: \_\_\_\_\_ DATE: \_\_\_\_\_

SIGNED: \_\_\_\_\_ NAME: \_\_\_\_\_ COMPANY: \_\_\_\_\_ DATE: \_\_\_\_\_

SIGNED: \_\_\_\_\_ NAME: \_\_\_\_\_ COMPANY: \_\_\_\_\_ DATE: \_\_\_\_\_

PAGE: \_\_\_\_\_ ISSUE NO: \_\_\_\_\_ DATE: \_\_\_\_\_

**SP TRANSMISSION Ltd  
SITE RESPONSIBILITY SCHEDULE  
OWNERSHIP, MAINTENANCE AND OPERATIONS OF EQUIPMENT  
IN JOINT USER SITUATIONS**

Sheet No. \_\_\_\_\_  
Revision: \_\_\_\_\_  
Date: \_\_\_\_\_

Network Area: \_\_\_\_\_

SECTION 'A' BUILDING AND SITE		SECTION 'B' CUSTOMER OR OTHER PARTY			
OWNER	ACCESS REQUIRED:-	NAME:-			
LESSEE	SPECIAL CONDITIONS:-	ADDRESS:-			
MAINTENANCE	LOCATION OF SUPPLY TERMINALS:-	TELNO:-			
SAFETY		SUB STATION:-			
SECURITY		LOCATION:-			

ITEM Nos.	EQUIPMENT	IDENTIFICATION	OWNER	SAFETY RULES APPLICABLE	OPERATION			MAINTENANCE		FAULT INVESTIGATION		TESTING	RELAY SETTINGS	REMARKS
					Tripping	Closing	Isolating	Earthing	Primary Equip.	Protection Equip.	Primary Equip.			

SECTION 'D' CONFIGURATION AND CONTROL		SECTION 'E' ADDITIONAL INFORMATION	
ITEM Nos.	CONNECTION RESPONSIBILITY	TELEPHONE NUMBER	REMARKS

**ABBREVIATIONS:-**  
D - SP AUTHORISED PERSON - DISTRIBUTION SYSTEM  
NGC - NATIONAL GRID COMPANY  
SPD - SP DISTRIBUTION LTD  
SPPS - POWERSYSTEMS  
SPT - SP TRANSMISSION Ltd  
ST - SCOTTISH POWER TELECOMMUNICATIONS  
T - SP AUTHORISED PERSON - TRANSMISSION SYSTEM  
U - USER

SIGNED \_\_\_\_\_ FOR \_\_\_\_\_ SP Transmission DATE \_\_\_\_\_  
SIGNED \_\_\_\_\_ FOR \_\_\_\_\_ SP Distribution DATE \_\_\_\_\_  
SIGNED \_\_\_\_\_ FOR \_\_\_\_\_ PowerSystems/User DATE \_\_\_\_\_

Scottish Hydro-Electric Transmission Limited  
 Site Responsibility Schedule

Substation Type							Number:			Revision:		
Equipment	Owner	Controller	Maintainer	Responsible System User	Responsible Management Unit	Control Authority	Safety Rules	Operational Procedures	Notes			















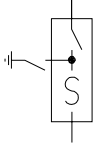

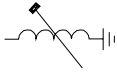



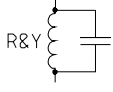

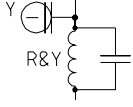

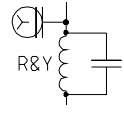
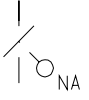

# CONNECTION CONDITIONS

## APPENDIX 2

### PART 1A

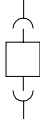
#### PROCEDURES RELATING TO OPERATION DIAGRAMS

FIXED CAPACITOR		SWITCH DISCONNECTOR	
EARTH			
EARTHING RESISTOR		SWITCH DISCONNECTOR WITH INCORPORATED EARTH SWITCH	
LIQUID EARTHING RESISTOR			
ARC SUPPRESSION COIL		DISCONNECTOR (CENTRE ROTATING POST)	
FIXED MAINTENANCE EARTHING DEVICE		DISCONNECTOR (SINGLE BREAK DOUBLE ROTATING)	
CARRIER COUPLING EQUIPMENT (WITHOUT VT)		DISCONNECTOR (SINGLE BREAK)	
CARRIER COUPLING EQUIPMENT (WITH VT ON ONE PHASE)		DISCONNECTOR (NON-INTERLOCKED)	
CARRIER COUPLING EQUIPMENT (WITH VT ON 3 PHASES)		DISCONNECTOR (POWER OPERATED) NA - NON-AUTOMATIC A - AUTOMATIC SO - SEQUENTIAL OPERATION FI - FAULT INTERFERING OPERATION	
AC GENERATOR		EARTH SWITCH	
SYNCHRONOUS COMPENSATOR			
CIRCUIT BREAKER		FAULT THROWING SWITCH (PHASE TO PHASE)	
CIRCUIT BREAKER WITH DELAYED AUTO RECLOSE		FAULT THROWING SWITCH (EARTH FAULT)	
WITHDRAWABLE METALCLAD SWITCHGEAR		SURGE ARRESTOR	
		THYRISTOR	

TRANSFORMERS  
(VECTORS TO INDICATE  
WINDING CONFIGURATION)

TWO WINDING



THREE WINDING

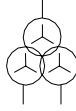

AUTO



AUTO WITH DELTA TERTIARY

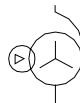

EARTHING OR AUX. TRANSFORMER

(-) INDICATE REMOTE SITE  
IF APPLICABLE

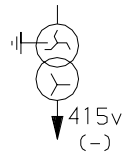

VOLTAGE TRANSFORMERS

SINGLE PHASE WOUND



THREE PHASE WOUND



SINGLE PHASE CAPACITOR



TWO SINGLE PHASE CAPACITOR



THREE PHASE CAPACITOR



\* CURRENT TRANSFORMER  
(WHERE SEPARATE PRIMARY  
APPARATUS)



\* COMBINED VT/CT UNIT  
FOR METERING

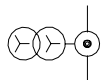

REACTOR



\* BUSBARS



\* OTHER PRIMARY CONNECTIONS



\* CABLE & CABLE SEALING END

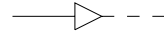

\* THROUGH WALL BUSHING

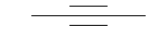

\* BYPASS FACILITY



\* CROSSING OF CONDUCTORS  
(LOWER CONDUCTOR  
TO BE BROKEN)

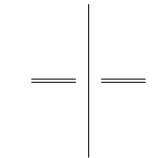

PREFERENTIAL ABBREVIATIONS

AUXILIARY TRANSFORMER	Aux T
EARTHING TRANSFORMER	ET
GAS TURBINE	Gas T
GENERATOR TRANSFORMER	Gen T
GRID TRANSFORMER	Gr T
SERIES REACTOR	Ser Reac
SHUNT REACTOR	Sh Reac
STATION TRANSFORMER	Stn T
SUPERGRID TRANSFORMER	SGT
UNIT TRANSFORMER	UT

\* NON-STANDARD SYMBOL

PORTABLE MAINTENANCE  
EARTH DEVICE



DISCONNECTOR  
(PANTOGRAPH TYPE)



QUADRATURE BOOSTER

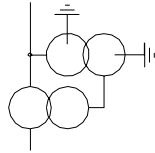

DISCONNECTOR  
(KNEE TYPE)



SHORTING/DISCHARGE SWITCH

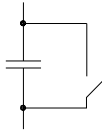

CAPACITOR  
(INCLUDING HARMONIC FILTER)



SINGLE PHASE TRANSFORMER (BR)  
NEUTRAL AND PHASE CONNECTIONS

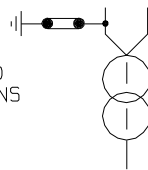

RESISTOR WITH INHERENT  
NON-LINEAR VARIABILITY,  
VOLTAGE DEPENDANT

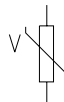

# CONNECTION CONDITIONS

## APPENDIX 2

### PART 1B

#### PROCEDURES RELATING TO GAS ZONE DIAGRAMS

GAS INSULATED  
BUSBAR

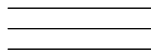

DOUBLE-BREAK  
DISCONNECTOR

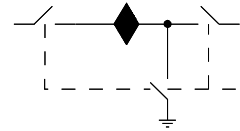

GAS BOUNDARY



EXTERNAL MOUNTED  
CURRENT TRANSFORMER  
(WHERE SEPARATE  
PRIMARY APPARATUS)

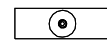

GAS/GAS BOUNDARY



STOP VALVE  
NORMALLY CLOSED



GAS/CABLE BOUNDARY



STOP VALVE  
NORMALLY OPEN



GAS/AIR BOUNDARY



GAS MONITOR



GAS/TRANSFORMER BOUNDARY



FILTER



MAINTENANCE VALVE

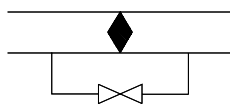

QUICK ACTING COUPLING



## CONNECTION CONDITIONS

### APPENDIX 2

#### NON-EXHAUSTIVE LIST OF APPARATUS TO BE INCLUDED ON OPERATION DIAGRAMS

##### PART 2

###### Basic Principles

1. Where practicable, all the **HV Apparatus** on any **Connection Site** shall be shown on one **Operation Diagram**. Provided the clarity of the diagram is not impaired, the layout shall represent as closely as possible the geographical arrangement on the **Connection Site**.
2. Where more than one **Operation Diagram** is unavoidable, duplication of identical information on more than one **Operation Diagram** must be avoided.
3. The **Operation Diagram** must show accurately the current status of the **Apparatus** eg. whether commissioned or decommissioned. Where decommissioned, the associated switchbay will be labelled "spare bay".
4. Provision will be made on the **Operation Diagram** for signifying approvals, together with provision for details of revisions and dates.
5. **Operation Diagrams** will be prepared in A4 format or such other format as may be agreed with **NGET**.
6. The **Operation Diagram** should normally be drawn single line. However, where appropriate, detail which applies to individual phases shall be shown. For example, some **HV Apparatus** is numbered individually per phase.

## APPARATUS TO BE SHOWN ON OPERATION DIAGRAM

1. Busbars
2. Circuit Breakers
3. Disconnect (Isolator) and Switch Disconnecters (Switching Isolators)
4. Disconnectors (Isolators) - Automatic Facilities
5. Bypass Facilities
6. Earthing Switches
7. Maintenance Earths
8. Overhead Line Entries
9. Overhead Line Traps
10. Cable and Cable Sealing Ends
11. Generating Unit
12. Generator Transformers
13. Generating Unit Transformers, Station Transformers, including the lower voltage circuit-breakers.
14. Synchronous Compensators
15. Static Variable Compensators
16. Capacitors (including Harmonic Filters)
17. Series or Shunt Reactors (Referred to as "Inductors" at nuclear power station sites)
18. Supergrid and Grid Transformers
19. Tertiary Windings
20. Earthing and Auxiliary Transformers
21. Three Phase VT's
22. Single Phase VT & Phase Identity
23. High Accuracy VT and Phase Identity
24. Surge Arrestors/Diverters
25. Neutral Earthing Arrangements on HV Plant
26. Fault Throwing Devices
27. Quadrature Boosters
28. Arc Suppression Coils
29. Single Phase Transformers (BR) Neutral and Phase Connections
30. Current Transformers (where separate plant items)
31. Wall Bushings
32. Combined VT/CT Units
33. Shorting and Discharge Switches
34. Thyristor
35. Resistor with Inherent Non-Linear Variability, Voltage Dependent
36. Gas Zone

## CONNECTION CONDITIONS

### APPENDIX 3

#### MINIMUM FREQUENCY RESPONSE REQUIREMENT PROFILE AND OPERATING RANGE for new Power Stations and DC Converter Stations.

##### CC.A.3.1 SCOPE

The frequency response capability is defined in terms of **Primary Response**, **Secondary Response** and **High Frequency Response**. This appendix defines the minimum frequency response requirement profile for:

- (a) each **Generating Unit** and/or **CCGT Module** which has a **Completion Date** after 1 January 2001 in England and Wales and 1 April 2005 in Scotland,
- (b) each **DC Converter** at a **DC Converter Station** which has a **Completion Date** on or after 1 April 2005.
- (c) each **Power Park Module** in England and Wales with a **Completion Date** on or after 1 January 2006.
- (d) each **Power Park Module** in operation in Scotland after 1 January 2006 with a **Completion Date** after 1 April 2005 and in **Power Stations** with a **Registered Capacity** of 30MW or above.

For the avoidance of doubt, this appendix does not apply to:-

- (i) **Generating Units** and/or **CCGT Modules** which have a **Completion Date** before 1 January 2001 in England and Wales and before 1 April 2005 in Scotland,
- (ii) **DC Converters** at a **DC Converter Station** which have a **Completion Date** before 1 April 2005.
- (iii) **Power Park Modules** in England and Wales with a **Completion Date** before 1 January 2006.
- (iv) **Power Park Modules** in operation in Scotland before 1 January 2006.
- (v) **Power Park Modules** in Scotland with a **Completion Date** before 1 April 2005.
- (vi) **Power Park Modules** in Scotland in **Power Stations** with a **Registered Capacity** less than 30MW.
- (vii) **Small Power Stations** or individually to **Power Park Units**.

The functional definition provides appropriate performance criteria relating to the provision of **Frequency** control by means of **Frequency** sensitive generation in addition to the other requirements identified in CC.6.3.7.

In this Appendix 3 to the **CC**, for a **CCGT Module** or a **Power Park Module** with more than one **Generating Unit**, the phrase **Minimum Generation** applies to the entire **CCGT**

**Module or Power Park Module operating with all Generating Units Synchronised to the System.**

The minimum **Frequency** response requirement profile is shown diagrammatically in Figure CC.A.3.1. The capability profile specifies the minimum required levels of **Primary Response**, **Secondary Response** and **High Frequency Response** throughout the normal plant operating range. The definitions of these **Frequency** response capabilities are illustrated diagrammatically in Figures CC.A.3.2 & CC.A.3.3.

### CC.A.3.2 PLANT OPERATING RANGE

The upper limit of the operating range is the **Registered Capacity** of the **Generating Unit** or **CCGT Module** or **DC Converter** or **Power Park Module**.

The **Minimum Generation** level may be less than, but must not be more than, 65% of the **Registered Capacity**. Each **Generating Unit** and/or **CCGT Module** and/or **Power Park Module** and/or **DC Converter** must be capable of operating satisfactorily down to the **Designed Minimum Operating Level** as dictated by **System** operating conditions, although it will not be instructed to below its **Minimum Generation** level. If a **Generating Unit** or **CCGT Module** or **Power Park Module** or **DC Converter** is operating below **Minimum Generation** because of high **System Frequency**, it should recover adequately to its **Minimum Generation** level as the **System Frequency** returns to **Target Frequency** so that it can provide **Primary** and **Secondary Response** from **Minimum Generation** if the **System Frequency** continues to fall. For the avoidance of doubt, under normal operating conditions steady state operation below **Minimum Generation** is not expected. The **Designed Minimum Operating Level** must not be more than 55% of **Registered Capacity**.

In the event of a **Generating Unit** or **CCGT Module** or **Power Park Module** or **DC Converter** load rejecting down to no less than its **Designed Minimum Operating Level** it should not trip as a result of automatic action as detailed in BC3.7. If the load rejection is to a level less than the **Designed Minimum Operating Level** then it is accepted that the condition might be so severe as to cause it to be disconnected from the **System**.

### CC.A.3.3 MINIMUM FREQUENCY RESPONSE REQUIREMENT PROFILE

Figure CC.A.3.1 shows the minimum **Frequency** response requirement profile diagrammatically for a 0.5 Hz change in **Frequency**. The percentage response capabilities and loading levels are defined on the basis of the **Registered Capacity** of the **Generating Unit** or **CCGT Module** or **Power Park Module** or **DC Converter**. Each **Generating Unit** and/or **CCGT Module** and/or **Power Park Module** and/or **DC Converter** must be capable of operating in a manner to provide **Frequency** response at least to the solid boundaries shown in the figure. If the **Frequency** response capability falls within the solid boundaries, the **Generating Unit** or **CCGT Module** or **Power Park Module** or **DC Converter** is providing response below the minimum requirement which is not acceptable. Nothing in this appendix is intended to prevent a **Generating Unit** or **CCGT Module** or **Power Park Module** or **DC Converter** from being designed to deliver a **Frequency** response in excess of the identified minimum requirement.

The **Frequency** response delivered for **Frequency** deviations of less than 0.5 Hz should be no less than a figure which is directly proportional to the minimum **Frequency** response requirement for a **Frequency** deviation of 0.5 Hz. For example, if the **Frequency** deviation is 0.2 Hz, the corresponding minimum **Frequency** response requirement is 40% of the level shown in Figure CC.A.3.1. The **Frequency** response delivered for **Frequency** deviations of more than 0.5 Hz should be no less than the response delivered for a **Frequency** deviation of 0.5 Hz.



Each **Generating Unit** and/or **CCGT Module** and/or **Power Park Module** and/or **DC Converter** must be capable of providing some response, in keeping with its specific operational characteristics, when operating between 95% to 100% of **Registered Capacity** as illustrated by the dotted lines in Figure CC.A.3.1.

At the **Minimum Generation** level, each **Generating Unit** and/or **CCGT Module** and/or **Power Park Module** and/or **DC Converter** is required to provide high and low frequency response depending on the **System Frequency** conditions. Where the **Frequency** is high, the **Active Power** output is therefore expected to fall below the **Minimum Generation** level.

The **Designed Minimum Operating Level** is the output at which a **Generating Unit** and/or **CCGT Module** and/or **Power Park Module** and/or **DC Converter** has no **High Frequency Response** capability. It may be less than, but must not be more than, 55% of the **Registered Capacity**. This implies that a **Generating Unit** or **CCGT Module** or **Power Park Module** or **DC Converter** is not obliged to reduce its output to below this level unless the **Frequency** is at or above 50.5 Hz (cf BC3.7).

#### CC.A.3.4 TESTING OF FREQUENCY RESPONSE CAPABILITY

The response capabilities shown diagrammatically in Figure CC.A.3.1 are measured by taking the responses as obtained from some of the dynamic response tests specified by **NGET** and carried out by **Generators** and **DC Converter Station** owners for compliance purposes and to validate the content of **Ancillary Services Agreements** using an injection of a **Frequency** change to the plant control system (ie governor and load controller). The injected signal is a linear ramp from zero to 0.5 Hz **Frequency** change over a ten second period, and is sustained at 0.5 Hz **Frequency** change thereafter, as illustrated diagrammatically in figures CC.A.3.2 and CC.A.3.3.

The **Primary Response** capability (P) of a **Generating Unit** or a **CCGT Module** or **Power Park Module** or **DC Converter** is the minimum increase in **Active Power** output between 10 and 30 seconds after the start of the ramp injection as illustrated diagrammatically in Figure CC.A.3.2.

The **Secondary Response** capability (S) of a **Generating Unit** or a **CCGT Module** or **Power Park Module** or **DC Converter** is the minimum increase in **Active Power** output between 30 seconds and 30 minutes after the start of the ramp injection as illustrated diagrammatically in Figure CC.A.3.2.

The **High Frequency Response** capability (H) of a **Generating Unit** or a **CCGT Module** or **Power Park Module** or **DC Converter** is the decrease in **Active Power** output provided 10 seconds after the start of the ramp injection and sustained thereafter as illustrated diagrammatically in Figure CC.A.3.3.

#### CC.A.3.5 REPEATABILITY OF RESPONSE

When a **Generating Unit** or **CCGT Module** or **Power Park Module** or **DC Converter** has responded to a significant **Frequency** disturbance, its response capability must be fully restored as soon as technically possible. Full response capability should be restored no later than 20 minutes after the initial change of **System Frequency** arising from the **Frequency** disturbance.

**Figure CC.A.3.1 - Minimum Frequency Response Requirement Profile**  
 for a 0.5 Hz frequency change from Target Frequency

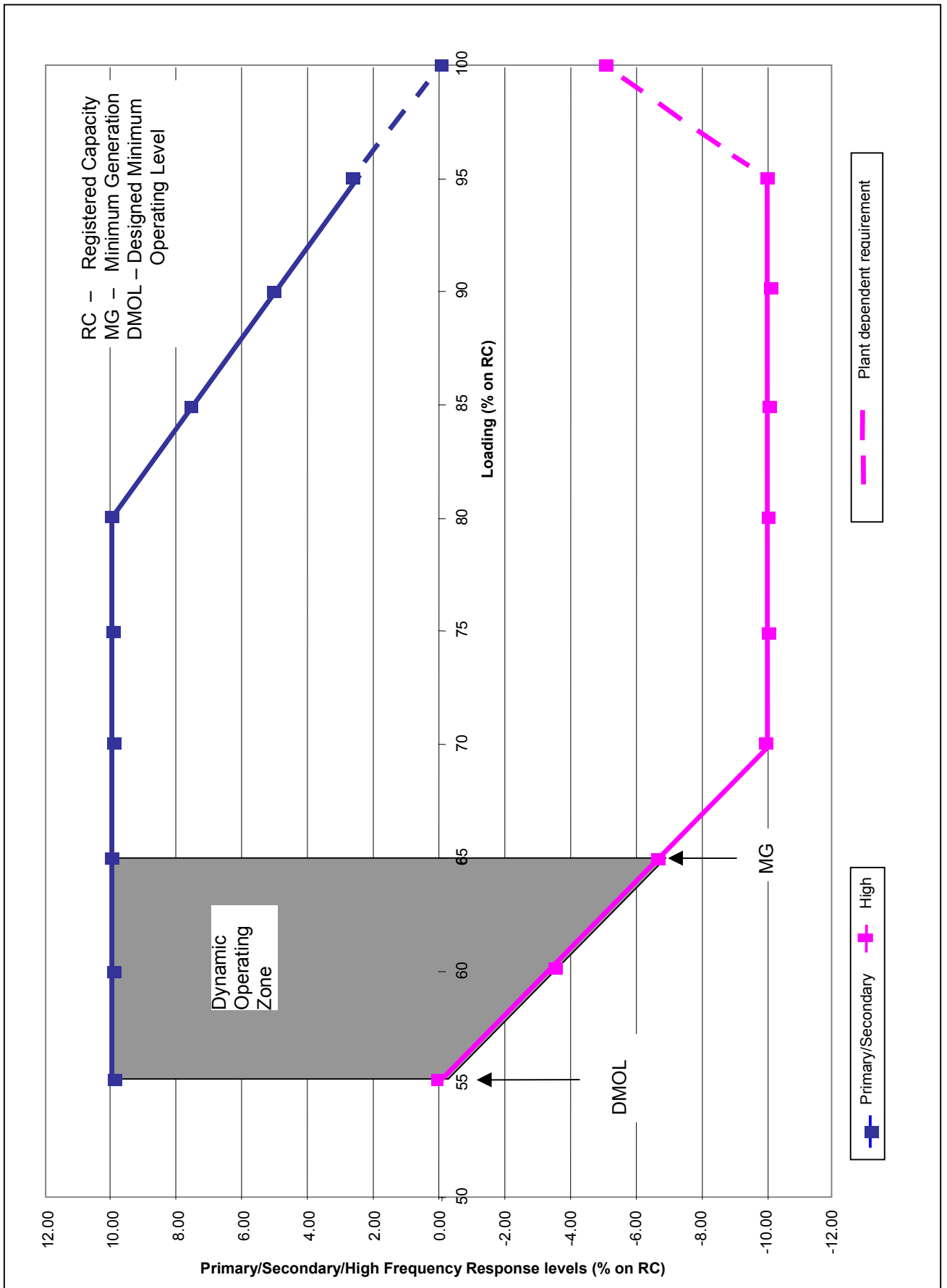

Figure CC.A.3.2 - Interpretation of Primary and Secondary Response Values

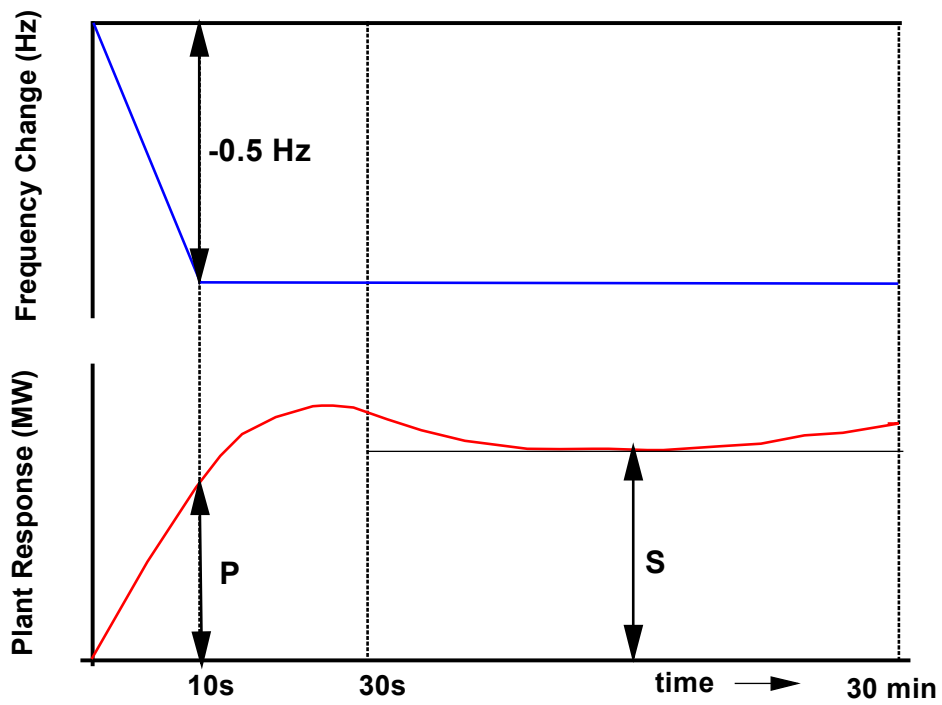
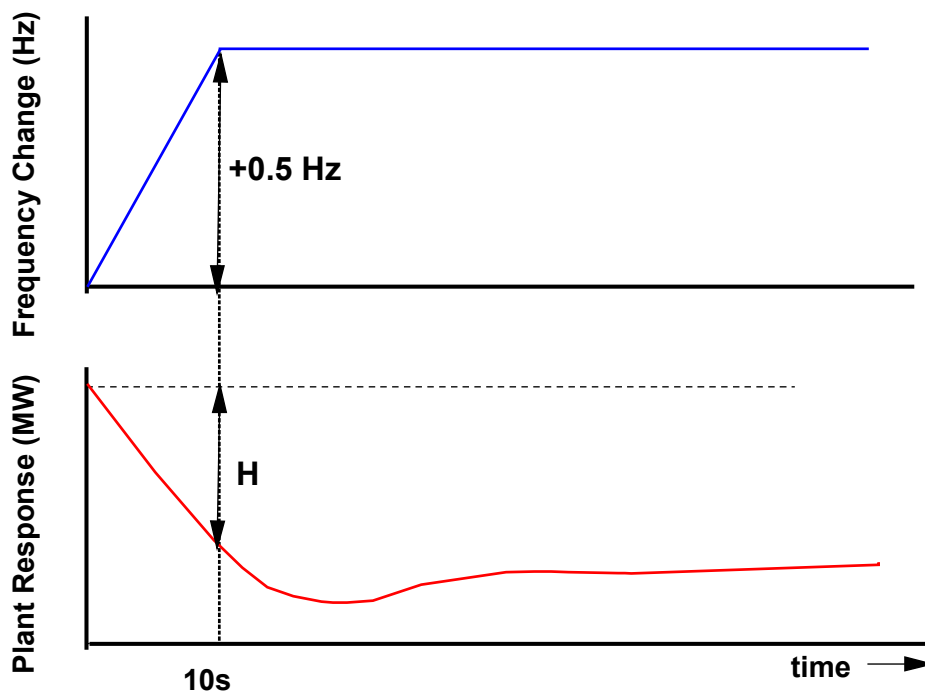

Figure CC.A.3.3 - Interpretation of High Frequency Response Values



## APPENDIX 4

### FAULT RIDE THROUGH REQUIREMENT FOR GENERATING UNITS, POWER PARK MODULES AND DC CONVERTERS

#### CC.A.4.1 SCOPE

The fault ride through requirement is defined in CC.6.3.15 (a), (b) and (c). This Appendix provides illustrations by way of examples only of CC.6.3.15 (a) (i) and further background and illustrations to CC.6.3.15 (b) (i) and is not intended to show all possible permutations.

#### CC.A.4.2 SHORT CIRCUIT FAULTS AT **SUPERGRID VOLTAGE** UP TO 140MS IN DURATION

For short circuit faults at **Supergrid Voltage** up to 140ms in duration, the fault ride through requirement is defined in CC.6.3.15 (a) (i). Figures CC.A.4.1 (a) and (b) illustrate two typical examples of voltage recovery for short-circuit faults cleared within 140ms by two circuit breakers (a) and three circuit breakers (b) respectively.

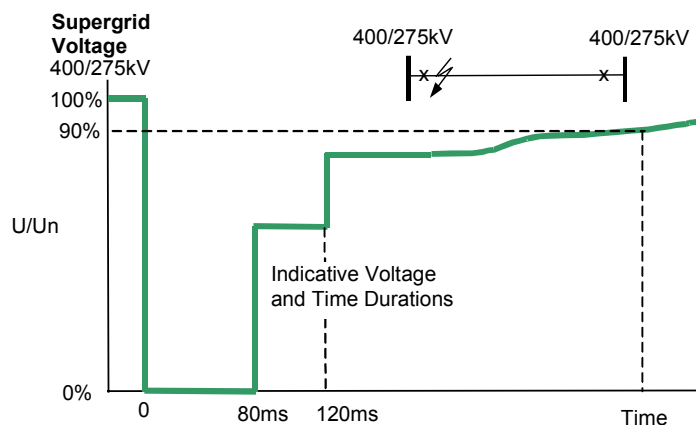

Typical fault cleared in less than 140ms: 2 ended circuit

Figure CC.A.4.1 (a)

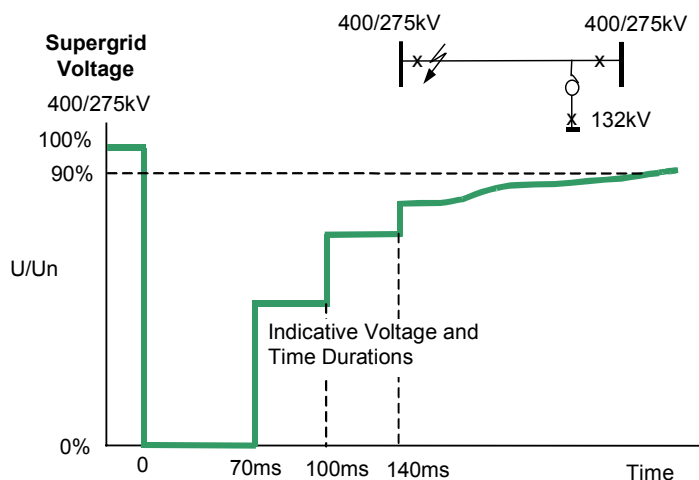

Typical fault cleared in 140ms:- 3 ended circuit

Figure CC.A.4.1 (b)

### CCA.4.3 SUPERGRID VOLTAGE DIPS GREATER THAN 140MS IN DURATION

For balanced **Supergrid voltage** dips having durations greater than 140ms and up to 3 minutes the fault ride through requirement is defined in CC6.3.15 (b) (i) and Figure 5 which is reproduced in this Appendix as Figure CC.A.4.2 and termed the the voltage–duration profile.

This profile is not a voltage-time response curve that would be obtained by plotting the transient voltage response at a point on the **GB Transmission System** or **User System** to a disturbance. Rather, each point on the profile (ie the heavy black line) represents a voltage level and an associated time duration which connected **Generating Units, or Power Park Modules** must withstand or ride through.

Figures CC.A.4.3 (c), (d) and (e) illustrate the meaning of the voltage-duration profile for voltage dips having durations greater than 140ms.

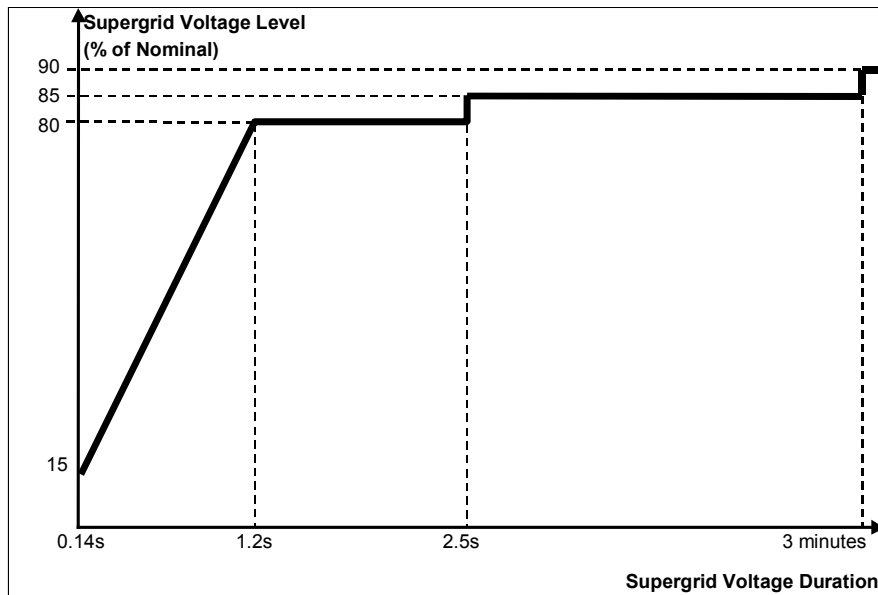
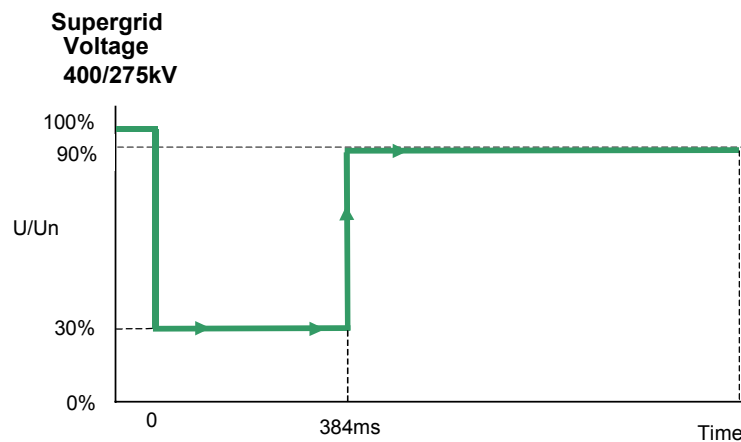
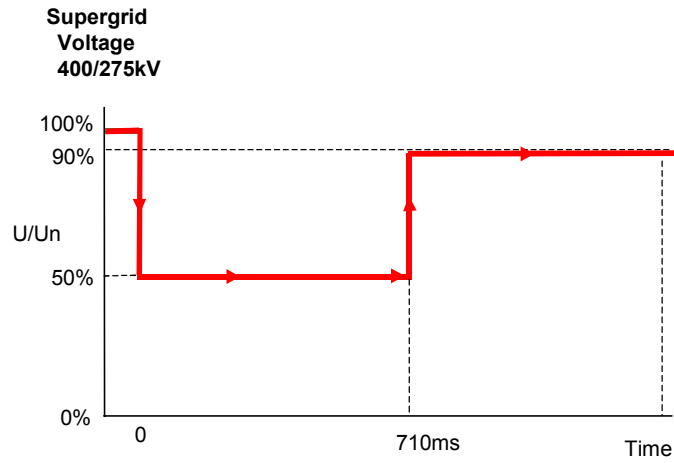

Figure CC.A.4.2



30% retained voltage, 384ms duration

Figure CC.A.4.3(a)



50% retained voltage, 710ms duration

Figure CC.A.4.3(b)

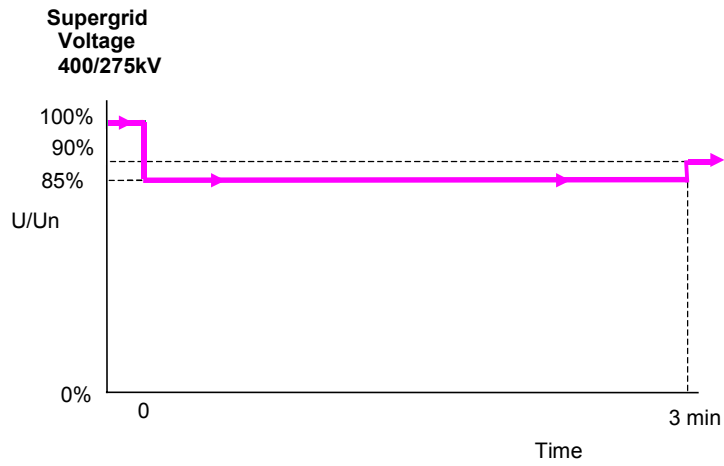

85% retained voltage, 3 minutes duration

Figure CC.A.4.3(c)

## APPENDIX 5

### TECHNICAL REQUIREMENTS LOW FREQUENCY RELAYS FOR THE AUTOMATIC DISCONNECTION OF SUPPLIES AT LOW FREQUENCY

CC.A.5.1

#### LOW FREQUENCY RELAYS

CC.A.5.1.1

The **Low Frequency Relays** to be used shall be in accordance with the requirements of the **Bilateral Agreement**. They should have a setting range of 47.0 to 50Hz and be suitable for operation from a nominal AC input of 63.5, 110 or 240V. The following general parameters on the requirements of approved **Low Frequency Relays** for automatic installations is given as an indication, without prejudice to the provisions that may be included in a **Bilateral Agreement**:

- |     |                                     |  |
|-----|-------------------------------------|--|
| (a) | <b>Frequency settings:</b>          | 47-50Hz in steps of 0.05Hz or better, preferably 0.01Hz;   |
| (b) | <b>Measurement period settings:</b> | Within a minimum selectable settings range of 4 to 6 cycles;   |
| (c) | <b>Operating time:</b>              | Between 100 and 150ms dependent on measurement period setting;                                       |
| (d) | <b>Voltage lock-out:</b>            | Selectable within a range of 55 to 90% of nominal voltage;   |
| (e) | <b>Facility stages:</b>             | One or two stages of <b>Frequency</b> operation;   |
| (f) | <b>Output contacts:</b>             | Two output contacts per stage to be capable of repetitively making and breaking for 1000 operations. |

CC.A.5.2

#### LOW FREQUENCY RELAY VOLTAGE SUPPLIES

CC.A.5.2.1

It is essential that the voltage supply to the **Low Frequency Relays** shall be derived from the primary **System** at the supply point concerned so that the **Frequency** of the **Low Frequency Relays** input voltage is the same as that of the primary **System**. This requires either:

- the use of a secure supply obtained from voltage transformers directly associated with the grid transformer(s) concerned, the supply being obtained where necessary via a suitable automatic voltage selection scheme; or
- the use of the substation 240V phase-to-neutral selected auxiliary supply, provided that this supply is always derived at the supply point concerned and is never derived from a standby

supply **Generating Unit** or from another part of the **User System**.

CC.A.5.3

SCHEME REQUIREMENTS

CC.A.5.3.1

The tripping facility should be engineered in accordance with the following reliability considerations:

(a) Dependability

Failure to trip at any one particular **Demand** shedding point would not harm the overall operation of the scheme. However, many failures would have the effect of reducing the amount of **Demand** under low **Frequency** control. An overall reasonable minimum requirement for the dependability of the **Demand** shedding scheme is 96%, ie. the average probability of failure of each **Demand** shedding point should be less than 4%. Thus the **Demand** under low **Frequency** control will not be reduced by more than 4% due to relay failure.

(b) Outages

Low **Frequency Demand** shedding schemes will be engineered such that the amount of **Demand** under control is as specified by **NGET** and is not reduced unacceptably during equipment outage or maintenance conditions.

< End of CC >



# OPERATING CODE NO. 1

## DEMAND FORECASTS

### CONTENTS

(This contents page does not form part of the Grid Code)

<u>Paragraph No/Title</u>	<u>Page Number</u>
OC1.1 INTRODUCTION.....	1
OC1.2 OBJECTIVE .....	2
OC1.3 SCOPE.....	2
OC1.4 DATA REQUIRED BY NGET IN THE OPERATIONAL PLANNING PHASE.....	2
OC1.5 DATA REQUIRED BY NGET IN THE PROGRAMMING PHASE, CONTROL PHASE AND POST-CONTROL PHASE.....	3
OC1.5.1 Programming Phase.....	3
OC1.5.5 Control Phase.....	3
OC1.5.6 Post-Control Phase .....	4
OC1.6 NGET FORECASTS.....	5



## OPERATING CODE NO. 1

### DEMAND FORECASTS

#### OC1.1 INTRODUCTION

OC1.1.1 **Operating Code No.1 ("OC1")** is concerned with **Demand** forecasting for operational purposes. In order to match generation output with **Demand** for electricity it is necessary to undertake **Demand** forecasting. It is also necessary to undertake **Demand** forecasting of **Reactive Power**.

OC1.1.2 In the **Operational Planning Phase**, **Demand** forecasting shall be conducted by **NGET** taking account of **Demand** forecasts furnished by **Network Operators** and in certain circumstances, **Generators**, who shall provide **NGET** with information in the form set out in this **OC1**. The data supplied under the **PC** is also taken into account.

OC1.1.3 In the **Programming Phase** and **Control Phase**, **NGET** will conduct its own **Demand** forecasting taking into account information to be furnished by **Suppliers**, **Network Operators** and by **Generators** and the other factors referred to in OC1.6.1.

OC1.1.4 In this **OC1**, the point of connection of the **External Interconnection** to the **GB Transmission System** shall be considered as a **Grid Supply Point**. **Reactive Power Demand** includes the series **Reactive** losses of the **User's System** but excludes any network susceptance and any **Reactive** compensation on the **User's System**. **NGET** will obtain the lumped network susceptance and details of **Reactive** compensation from the requirements to submit data under the **PC**.

OC1.1.5 Data relating to **Demand Control** should include details relating to MW.

OC1.1.6 **OC1** deals with the provision of data on **Demand Control** in the **Operational Planning Phase**, the **Programming Phase** and the **Post-Control Phase**, whereas **OC6** (amongst other things) deals with the provision of data on **Demand Control** following the **Programming Phase** and in the **Control Phase**.

OC1.1.7 In this **OC1**, Year 0 means the current **Financial Year** at any time, Year 1 means the next **Financial Year** at any time, Year 2 means the **Financial Year** after Year 1, etc.

OC1.1.8 References in **OC1** to data being supplied on a half hourly basis refer to it being supplied for each period of 30 minutes ending on the hour and half-hour in each hour.

OC1.2 OBJECTIVE

The objectives of **OC1** are to:

OC1.2.1 enable the provision of data to **NGET** by **Users** in the **Programming Phase**, **Control Phase** and **Post-Control Phase**; and

OC1.2.2 provide for the factors to be taken into account by **NGET** when **Demand** forecasting in the **Programming Phase** and **Control Phase**.

OC1.3 SCOPE

**OC1** applies to **NGET** and to **Users** which in this **OC1** means:-

- (a) **Generators**,
- (b) **Network Operators**, and
- (c) **Suppliers**.

OC1.4 DATA REQUIRED BY NGET IN THE OPERATIONAL PLANNING PHASE

OC1.4.1 (a) Each **User**, as specified in (b) below, shall provide **NGET** with the data requested in OC1.4.2 below.

(b) The data will need to be supplied by:-

- (i) each **Network Operator** directly connected to the **GB Transmission System** in relation to **Demand Control**; and
- (ii) each **Generator** with respect to the output of **Medium Power Stations**.

OC1.4.2 (a) Data  
By calendar week 28 each year each **Network Operator** will provide to **NGET** in writing the forecast information listed in (c) below for the current **Financial Year** and each of the succeeding five **Financial Years**.

(b) Data Providers  
In circumstances when the busbar arrangement at a **Grid Supply Point** is expected to be operated in separate sections, separate sets of forecast information for each section will be provided to **NGET**.

(c) Embedded Medium Power Station Output and Demand Control:  
For the specified time of the annual peak half hour **GB Transmission System Demand**, as specified by **NGET** under PC.A.5.2.2, the output of **Embedded Medium Power Stations** and forecasts of **Demand** to be relieved by **Demand Control** on a **Grid Supply Point** basis giving details of the amount and duration of the **Demand Control**.

OC1.5 DATA REQUIRED BY NGET IN THE PROGRAMMING PHASE, CONTROL PHASE and POST-CONTROL PHASE

OC1.5.1 Programming Phase

For the period of 2 to 8 weeks ahead the following will be supplied to **NGET** in writing by 1000 hours each Monday:

(a) **Demand Control:**

Each **Network Operator** will supply MW profiles of the amount and duration of their proposed use of **Demand Control** which may result in a **Demand** change equal to or greater than the **Demand Control Notification Level** (averaged over any half hour on any **Grid Supply Point**) on a half hourly and **Grid Supply Point** basis;

(b) **Medium Power Station Operation:**

Each **Generator** will, if reasonably required by **NGET**, supply MW schedules for the operation of **Medium Power Stations** on a half hourly and **Grid Supply Point** basis.

OC1.5.2 For the period 2 to 12 days ahead the following will be supplied to **NGET** in writing by 1200 hours each Wednesday:

(a) **Demand Control:**

Each **Network Operator** will supply MW profiles of the amount and duration of their proposed use of **Demand Control** which may result in a **Demand** change equal to or greater than the **Demand Control Notification Level** (averaged over any half hour on any **Grid Supply Point**) on a half hourly and **Grid Supply Point** basis;

(b) **Medium Power Station Operation:**

Each **Generator** will, if reasonably required by **NGET**, supply MW schedules for the operation of **Medium Power Stations** on a half hourly and **Grid Supply Point** basis.

OC1.5.3 **Medium Power Station Output:**

Each **Generator** will, if reasonably required by **NGET**, supply **NGET** with MW schedules for the operation of **Medium Power Stations** on a half hourly and **Grid Supply Point** basis in writing by 1000 hours each day (or such other time specified by **NGET** from time to time) for the next day (except that it will be for the next 3 days on Fridays and 2 days on Saturdays and may be longer (as specified by **NGET** at least one week in advance) to cover holiday periods);

OC1.5.4 Other Codes

Under **OC6** each **Network Operator** will notify **NGET** of their proposed use of **Demand Control** (which may result in a **Demand** change equal to or greater than the **Demand Control Notification Level**), and under **BC1**, each **Supplier** will notify **NGET** of their proposed use of **Customer Demand Management** (which may result in a **Demand** change equal to or greater than the **Customer Demand Management Notification Level**) in this timescale.

OC1.5.5 Control Phase

OC1.5.5.1 **Demand Control:**

Under **OC6**, each **Network Operator** will notify **NGET** of any **Demand Control** proposed by itself which may result in a **Demand** change equal to or greater than the **Demand Control Notification Level** averaged over any half hour on any **Grid Supply Point** which is planned after 1000 hours, and of any changes to the planned **Demand Control** notified to **NGET** prior to 1000 hours as soon as possible after the formulation of the new plans;

OC1.5.5.2 **Customer Demand Management:**

(a) Each **Supplier** will notify **NGET** of any **Customer Demand Management** proposed by itself which may result in a **Demand** change equal to or greater than the **Customer Demand Management Notification Level** averaged over any half hour on any **Grid Supply Point** which is planned to occur at any time in the **Control Phase** and of any changes to the planned **Customer Demand Management** already notified to **NGET** as soon as possible after the formulation of the new plans.

(b) The following information is required on a **Grid Supply Point** and half-hourly basis:-

(i) the proposed date, time and duration of implementation of **Customer Demand Management**; and

(ii) the proposed reduction in **Demand** by use of **Customer Demand Management**.

OC1.5.5.3 **Load Management Blocks:**

In Scotland, by 11:00 each day, each **Supplier** who controls a **Load Management Block of Demand** with a capacity of 5MW or more shall submit to **NGET** a schedule of its proposed switching times and profiles in respect of each block for the next day.

OC1.5.6 **Post-Control Phase**

The following will be supplied to **NGET** in writing by 0600 hours each day in respect of **Active Power** data and by 1000 hours each day in respect of **Reactive Power** data:

(a) **Demand Control:**

Each **Network Operator** will supply MW profiles for the previous calendar day of the amount and duration of **Demand** reduction achieved by itself from the use of **Demand Control** equal to or greater than the **Demand Control Notification Level** (averaged over any half hour on any **Grid Supply Point**), on a half hourly and **Grid Supply Point** basis.

(b) **Customer Demand Management:**

Each **Supplier** will supply MW profiles of the amount and duration of **Demand** reduction achieved by itself from the use of **Customer Demand Management** equal to or greater than the **Customer Demand Management Notification Level** (averaged over any half hour on any

**Grid Supply Point**) on a half hourly and **Grid Supply Point** basis during the previous calendar day.

OC1.6 **NGET FORECASTS**

OC1.6.1 The following factors will be taken into account by **NGET** when conducting **GB Transmission System Demand** forecasting in the **Programming Phase** and **Control Phase**:

- (a) Historic **Demand** data (this includes **GB Transmission System** losses).
- (b) Weather forecasts and the current and historic weather conditions.
- (c) The incidence of major events or activities which are known to **NGET** in advance.
- (d) Anticipated interconnection flows across **External Interconnections**.
- (e) **Demand Control** equal to or greater than the **Demand Control Notification Level** (averaged over any half hour at any **Grid Supply Point**) proposed to be exercised by **Network Operators** and of which **NGET** has been informed.
- (f) **Customer Demand Management** equal to or greater than the **Customer Demand Management Notification Level** (averaged over any half hour at any **Grid Supply point**) proposed to be exercised by **Suppliers** and of which **NGET** has been informed.
- (g) Other information supplied by **Users**.
- (h) Anticipated **Pumped Storage Unit** demand.
- (i) the sensitivity of **Demand** to anticipated market prices for electricity.
- (j) **BM Unit Data** submitted by **BM Participants** to **NGET** in accordance with the provisions of **BC1** and **BC2**.
- (k) **Demand** taken by **Station Transformers**

OC1.6.2 Taking into account the factors specified in OC1.6.1 **NGET** uses **Demand** forecast methodology to produce forecasts of **GB Transmission System Demand**. A written record of the use of the methodology must be kept by **NGET** for a period of at least 12 months.

OC1.6.3 The methodology will be based upon factors (a), (b) and (c) above to produce, by statistical means, unbiased forecasts of **GB National Demand**. **GB Transmission System Demand** will be calculated from these forecasts but will also take into account factors (d), (e), (f), (g), (h), (i) and (j) above. No other factors are taken into account by **NGET**, and it will base its **GB Transmission System Demand** forecasts on those factors only.

< End of OC1 >





## OPERATING CODE NO.2

### OPERATIONAL PLANNING AND DATA PROVISION

# CONTENTS

(This contents page does not form part of the Grid Code)

<u>Paragraph No/Title</u>	<u>Page Number</u>
OC2.1 INTRODUCTION.....	1
OC2.2 OBJECTIVE .....	2
OC2.3 SCOPE.....	2
OC2.4 PROCEDURE .....	3
OC2.4.1 Co-ordination of outages.....	3
OC2.4.1.2 Planning of Genset Outages.....	3
OC2.4.1.2.1 Operational Planning Phase – Planning for Calendar Years 3 to 5 inclusive – Weekly Resolution .....	3
OC2.4.1.2.2 Operational Planning Phase – Planning for Calendar Year 1 and Calendar Year 2 – Weekly Resolution .....	7
OC2.4.1.2.3 Planning for Calendar Year 0 – Weekly Resolution .....	9
OC2.4.1.2.4 Programming Phase – 2-49 Days Ahead – Daily Resolution .....	10
OC2.4.1.3 Planning of GB Transmission System Outages .....	11
OC2.4.1.3.1 Operational Planning Phase – Planning for Financial Years 2 to 5 inclusive .....	11
OC2.4.1.3.3 Operational Planning Phase – Planning for Financial Year 1 ahead .....	12
OC2.4.1.3.4 Operational Planning Phase – Planning for Financial Year 0.....	15
OC2.4.1.3.5 Programming Phase.....	17
OC2.4.2 Data Requirements .....	18
OC2.4.3 Negative Reserve Active Power Margins .....	21
OC2.4.4 Frequency Sensitive Operation .....	24
OC2.4.6 Operating Margin Data Requirements .....	24
APPENDIX 1 – GENERATOR PERFORMANCE CHART.....	26
APPENDIX 2 – GENERATION PLANNING PARAMETERS.....	28
APPENDIX 3 – CCGT MODULE PLANNING MATRIX.....	30
APPENDIX 4 – POWER PARK MODULE PLANNING MATRIX.....	31



## OPERATING CODE NO.2

### OPERATIONAL PLANNING AND DATA PROVISION

#### OC2.1 INTRODUCTION

OC2.1.1 **Operating Code No. 2 ("OC2")** is concerned with:

- (a) the co-ordination of the release of **Gensets**, the **GB Transmission System** and **Network Operators' Systems** for construction, repair and maintenance;
- (b) provision by **NGET** of the **Surpluses** both for the **GB Transmission System** and **System Zones**;
- (c) the provision by **Generators** of **Generation Planning Parameters** for **Gensets**, including **CCGT Module Planning Matrices** and **Power Park Module Planning Matrices**, to **NGET** for planning purposes only; and
- (d) the agreement for release of **Existing Gas Cooled Reactor Plant** for outages in certain circumstances.

OC2.1.2 (a) **Operational Planning** involves planning, through various timescales, the matching of generation output with forecast **GB Transmission System Demand** together with a reserve of generation to provide a margin, taking into account outages of certain **Generating Units**, **Power Park Modules** and **DC Converters**, and of parts of the **GB Transmission System** and of parts of **Network Operators' Systems** which is carried out to achieve, so far as possible, the standards of security set out in **NGET's Transmission Licence**, each **Relevant Transmission Licensee's Transmission Licence** or **Electricity Distribution Licence** as the case may be.

- (b) In general terms there is an "envelope of opportunity" for the release of **Gensets** and for the release of parts of the **GB Transmission System** and parts of the **Network Operator's User Systems** for outages. The envelope is defined by the difference between the total generation output expected from **Large Power Stations**, **Medium Power Stations** and **Demand**, the operational planning margin and taking into account **External Interconnections**.

OC2.1.3 In this **OC2** for the purpose of **Generator** outage co-ordination Year 0 means the current calendar year at any time, Year 1 means the next calendar year at any time, Year 2 means the calendar year after Year 1, etc. For the purpose of **Transmission** outage planning Year 0 means the current **Financial Year** at any time, Year 1 means the next **Financial Year** at any time, Year 2 means the **Financial Year** after Year 1, etc. References to 'weeks' in **OC2** are to calendar weeks as defined in ISO 8601.

OC2.1.4 References in **OC2** to a **Generator's** "best estimate" shall be that **Generator's** best estimate acting as a reasonable and prudent **Generator** in all the circumstances.

OC2.1.5 References to **NGET** planning the **GB Transmission System** outage programme on the basis of the **Final Generation Outage Programme**, are to **NGET** planning against the **Final Generation Outage Programme** current at the time it so plans.

OC2.1.6 Where in **OC2** data is required to be submitted or information is to be given on a particular day, that data does not need to be submitted and that information does not need to be given on that day if it is not a **Business Day** or it falls within a holiday period (the occurrence and length of which shall be determined by **NGET**, in its reasonable discretion, and notified to **Users**). Instead, that data shall be submitted and/or that information shall be given on such other **Business Day** as **NGET** shall, in its reasonable discretion, determine. However, **NGET** may determine that that data and/or information need not be submitted or given at all, in which case it shall notify each **User** as appropriate.

OC2.1.7 In Scotland, it may be possible with the agreement of **NGET** to reduce the administrative burden for **Users** in producing planning information where either the output or demand is small.

## OC2.2 OBJECTIVE

OC2.2.1 (a) The objective of **OC2** is to seek to enable **NGET** to harmonise outages of **Gensets** in order that such outages are co-ordinated (taking account of **Medium Power Stations**) between **Generators** and **Network Operators**, and that such outages are co-ordinated taking into account **GB Transmission System** outages and other **System** outages, so far as possible to minimise the number and effect of constraints on the **GB Transmission System** or any other **System**.

(b) In the case of **Network Operator' User Systems** directly connected to the **GB Transmission System** this means in particular that there will also need to be harmonisation of outages of **Embedded Gensets**, and **GB Transmission System** outages, with **Network Operators** in respect of their outages on those **Systems**.

OC2.2.2 The objective of **OC2** is also to enable the provision by **NGET** of the **Surpluses** both for the **GB Transmission System** and **System Zones**.

OC2.2.3 A further objective of **OC2** is to provide for the agreement for outages for **Existing Gas Cooled Reactor Plant** in certain circumstances and to enable a process to be followed in order to provide for that.

OC2.2.4 The boundaries of the **System Zones** will be determined by **NGET** from time to time taking into account the disposition of **Generators' Power Stations** within the **System Zones**. The location of the boundaries will be made available to all **Users**. Any **User** may request that **NGET** reviews any of the **System Zonal** boundaries if that **User** considers that the current boundaries are not appropriate, giving the reasons for their concerns. On receipt of such a request **NGET** will review the boundaries if, in **NGET's** reasonable opinion, such a review is justified.

## OC2.3 SCOPE

- OC2.3.1 **OC2** applies to **NGET** and to **Users** which in **OC2** means:-
- (a) **Generators**, other than those which only have **Embedded Small Power Stations** or **Embedded Medium Power Stations**, (and the term **Generator** in this **OC2** shall be construed accordingly);
  - (b) **Network Operators**; and
  - (c) **Non-Embedded Customers**; and
  - (d) **DC Converter Station** owners.

OC2.4 PROCEDURE

OC2.4.1 Co-ordination of Outages

OC2.4.1.1 Under **OC2** the interaction between **NGET** and **Users** will be as follows:

- (a) Each **Generator** and **NGET** In respect of outages of **Gensets** and in respect of outages of other **Plant** and/or **Apparatus** directly connected to the **GB Transmission System**;
- (b) **NGET** and each **Generator** in respect of **GB Transmission System** outages relevant to each **Generator** (other than in respect of **Embedded Small Power Stations** or **Embedded Medium Power Stations**);
- (c) **NGET** and each **Network Operator** in respect of outages of all **Embedded Large Power Stations** and in respect of outages of other **Plant** and/or **Apparatus** relating to such **Embedded Large Power Stations**;
- (d) **NGET** and each **Network Operator** and each **Non-Embedded Customer** in respect of **GB Transmission System** outages relevant to the particular **Network Operator** or **Non-Embedded Customers**;
- (e) Each **Network Operator** and each **Non-Embedded Customer** and **NGET** in respect of **User System** outages relevant to **NGET**.

OC2.4.1.2 PLANNING OF GENSET OUTAGES

OC2.4.1.2.1 Operational Planning Phase - Planning for Calendar Years 3 to 5 inclusive – Weekly Resolution

In each calendar year:

(a) By the end of week 2

Each **Generator** will provide **NGET** in writing with:

- (i) a provisional **Genset** outage programme (covering all non-**Embedded Power Stations** and **Embedded Large Power Stations**) for Year 3 to Year 5 (inclusive) specifying the **Genset** and MW concerned, duration of proposed outages, the preferred date for each outage and where there is a possibility of flexibility, the earliest start date and latest finishing date; and
- (ii) a best estimate weekly **Output Usable** forecast of all its **Gensets** for Year 3 to Year 5.

(b) Between the end of week 2 and the end of week 12

**NGET** will be:

- (i) calculating total winter peak generating capacity assumed to be available to the **Total System** (taking into account the import capacity which may be available from **External Interconnections**);
- (ii) calculating the total winter peak generating capacity expected from **Large Power Stations**, taking into account **Demand** forecasts and details of proposed use of **Demand Control** received under **OC1**, and an operational planning margin set by **NGET** (the "**Operational Planning Margin**");
- (iii) calculating the weekly peak generating capacity expected from **Large Power Stations** taking into account demand forecasts and details of proposed use of **Demand Control** received under **OC1**, and the **Operational Planning Margin** and **Zonal System Security Requirements**. The total weekly peak MW needed to be available is the "weekly total MW required".

The calculation under (iii) will effectively define the envelope of opportunity for outages of **Gensets**.

During this period, **NGET** may, as appropriate, contact each **Generator** who has supplied information to seek clarification on points.

(c) By the end of week 12

**NGET** will:

- (i) having taken into account the information notified to it by **Generators** and taking into account:-
  - (1) **GB Transmission System** constraints and outages,
  - (2) **Network Operator System** constraints and outages, known to **NGET**, and
  - (3) the **Output Usable** required, in its view, to meet weekly total MW requirements,

provide each **Generator** in writing with any suggested amendments to the provisional outage programme supplied by the **Generator** which **NGET** believes necessary, and will advise **Generators** with **Large Power Stations** of the **Surpluses** both for the **GB Transmission System** and **System Zones** and potential export limitations, on a weekly basis, which would occur without such amendments;

- (ii) provide each **Network Operator** in writing with potential outages of **Gensets** which may, in the reasonable opinion of **NGET** and the **Network Operator**, affect the integrity of that **Network Operator's User System** provided that, in such circumstances **NGET** has notified the **Generator** concerned at least 48 hours beforehand of its intention to do so (including identifying the **Genset** concerned).

(d) By the end of week 14

- (i) Where a **Generator** or a **Network Operator** is unhappy with the suggested amendments to its provisional outage programme (in the case of a **Generator**) or such potential outages (in the case of a **Network Operator**) it may contact **NGET** to explain its concerns and **NGET** and that **Generator** or **Network Operator** will then discuss the problem and seek to resolve it.
- (ii) The possible resolution of the problem may require **NGET** or a **User** to contact other **Generators** and **Network Operators**, and joint meetings of all parties may, if any **User** feels it would be helpful, be convened by **NGET**. The need for further discussions, be they on the telephone or at meetings, can only be determined at the time.

(e) By the end of week 25

Each **Generator** will provide **NGET** in writing with an updated provisional **Genset** outage programme covering both **Embedded** and non-**Embedded Large Power Stations** together with the best estimate weekly **Output Usable** forecasts for each **Genset**, in all cases for Year 3 to Year 5 (inclusive). The updated provisional **Genset** outage programme will contain the MW concerned, duration of proposed outages, the preferred date for each outage and, where applicable, earliest start date and latest finishing date, together with an update of the **Output Usable** estimate supplied under (a)(ii) above.

(f) Between the end of week 25 and the end of week 28

**NGET** will be considering the updated provisional **Genset** outage programme, together with the best estimate weekly **Output Usable** forecasts supplied to it by **Generators** under (e) and their **Registered Capacity** and will be analysing **Operational Planning Margins** for the period.

(g) By the end of week 28

**NGET** will:

- (i) provide each **Generator** in writing with details of any suggested revisions considered by **NGET** as being necessary to the updated provisional **Genset** outage programme supplied to **NGET** under (e) and will advise **Generators** with **Large Power Stations** of the **Surpluses** for the **GB Transmission System** and **System Zones** and potential export limitations on a weekly basis which would occur without such revisions; and
- (ii) provide each **Network Operator** in writing with the update of potential outages of **Gensets** which, in the reasonable opinion of **NGET** and the **Network Operator**, affect the integrity of that **Network Operator's User System**.

(h) By the end of week 31

Where a **Generator** or a **Network Operator** is unhappy with the revisions suggested to the updated provisional **Genset** outage programme (in the case of a **Generator**) or such update of potential outages (in the case of a **Network Operator**) under (g) it may contact **NGET** to explain its concerns and the provisions set out in (d) above will apply to that process.

(i) By the end of week 42

**NGET** will:

- (1) provide each **Generator** in writing with details of suggested revisions considered by **NGET** as being necessary to the updated provisional **Genset** outage programme supplied to **NGET** and will advise **Generators** with **Large Power Stations** of the **Surpluses** for the **GB Transmission System** and **System Zones** and potential export limitations, on a weekly basis which would occur without such revisions;
- (2) provide each **Network Operator** in writing with the update of potential outages of **Gensets** which may, in the reasonable opinion of **NGET** and the **Network Operator**, affect the integrity of that **Network Operator's User System** provided that, in such circumstances **NGET** has notified the **Generator** concerned at least 48 hours beforehand of its intention to do so (including identifying the **Gensets** concerned).

(j) By the end of week 45

**NGET** will seek to agree a **Final Generation Outage Programme** for Year 3 to Year 5. If agreement cannot be reached on all aspects, **NGET** and each **Generator** will record their agreement on as many aspects as have been agreed and **NGET** will advise each **Generator** with **Large Power Stations** and each **Network Operator**, of the **Surpluses** for the **GB Transmission System** and **System Zones** on a weekly basis which would occur in relation to those aspects not agreed. It is accepted that agreement of the **Final Generation Outage Programme** is not a commitment on **Generators** or **NGET** to abide by it, but **NGET** will be planning the **GB Transmission System** outage programme on the basis of the **Final Generation Outage Programme** and if in the event the **Generator's** outages differ from those contained in the **Final Generation Outage Programme**, or in



any way conflict with the **GB Transmission System** outage programme, **NGET** need not alter the **GB Transmission System** outage programme.

OC2.4.1.2.2 **Operational Planning Phase - Planning for Calendar Year 1 and Calendar Year 2 – Weekly Resolution**

The basis for **Operational Planning** for Year 1 and Year 2 will be the **Final Generation Outage Programmes** agreed for Years 2 and 3:

In each calendar year:

(a) **By the end of week 10**

Each **Generator** will provide **NGET** in writing with its previously agreed **Final Generation Outage Programme** updated and best estimate weekly **Output Usable** forecasts for each **Genset** for weeks 1-52 of Years 1 and 2.

(b) **Between the end of week 10 and the end of week 12**

**NGET** will be considering the updated proposed **Genset** outage programme together with the estimate of **Output Usable** supplied by **Generators** under (a) and will be analysing **Operational Planning Margins** for the period. Taking these into account together with **GB Transmission System** constraints and outages and **Network Operator User System** constraints and outages known to **NGET**, **NGET** will assess whether the estimates of **Output Usable** supplied by **Generators** are sufficient to meet forecast **GB Transmission System Demand** plus the **Operational Planning Margin**.

(c) **By the end of week 12**

**NGET** will:

(i) notify each **Generator** in writing whether the **Output Usable** estimates are adequate for weeks 1-52 of Years 1 and 2, together with suggested changes to its **Final Generation Outage Programme** where necessary and will advise each **Generator** with **Large Power Stations** of the **Surpluses** both for the **GB Transmission System** and **System Zones** and potential export limitations, on a weekly resolution which would occur without such changes;

(ii) provide each **Network Operator** in writing with weekly **Output Usable** estimates of **Generators** for weeks 1-52 of Years 1 and 2, and updated details of potential outages, in each case relating to **Gensets** which may, in the reasonable opinion of **NGET** and the **Network Operator**, affect the integrity of that **Network Operator's User System** provided that, in such circumstances, **NGET** has notified the **Generator** concerned at least 48 hours beforehand of its intention to do so (including identifying the **Gensets** concerned).

(d) **By the end of week 14**

Where a **Generator** or a **Network Operator** is unhappy with any suggested changes to its **Final Generation Outage Programme** (in the case of a **Generator**) or such update of potential outages (in the case of a **Network Operator**), equivalent provisions to those set out in OC2.4.1.2.1(d) will apply.

(e) By the end of week 34

Each **Generator** will provide **NGET** in writing with revised best estimate weekly **Output Usable** forecasts for each **Genset** for weeks 1-52 of Years 1 and 2.

(f) Between the end of week 34 and the end of week 39

**NGET** will be analysing the revised estimates of **Output Usable** supplied by **Generators** under (e) and will be analysing **Operational Planning Margins** for the period. Taking these into account together with **GB Transmission System** constraints and outages and **Network Operator User System** constraints and outages known to **NGET**, **NGET** will assess whether the estimates of **Output Usable** supplied by **Generators** are sufficient to meet forecast **GB Transmission System Demand** plus the **Operational Planning Margin**.

(g) By the end of week 39

**NGET** will:

(i) notify each **Generator** in writing whether it accepts the **Output Usable** estimates for weeks 1-52 of Years 1 and 2, and of any suggested changes to its **Final Generation Outage Programme** where necessary and will advise **Generators** with **Large Power Stations** of the **Surpluses** both for the **GB Transmission System** and **System Zones** and potential export limitations on a weekly basis which would occur without such changes;

(ii) provide each **Network Operator** in writing with **Output Usable** estimates of **Generators** for weeks 1-52 of Years 1 and 2, and updated details of potential outages, in each case relating to **Gensets** which may, in the reasonable opinion of **NGET** and the **Network Operator**, affect the integrity of that **Network Operator's User System** provided that, in such circumstances, **NGET** has notified the **Generator** concerned at least 48 hours beforehand of its intention to do so (including identifying the **Gensets** concerned).

(h) By the end of week 46

Where a **Generator** or a **Network Operator**, is unhappy with any suggested changes to its **Final Generation Outage Programme** (in the case of a **Generator**) or such update of potential outages (in the case of a **Network Operator**), equivalent provisions to those set out in OC2.4.1.2.1(d) will apply.

(i) By the end of week 48

**NGET** will seek to agree the revised **Final Generation Outage Programme** for Year 1 and Year 2. If agreement cannot be reached on all aspects, **NGET** and each **Generator** will record their agreement on as many aspects as have been agreed and **NGET** will advise each **Generator** with **Large Power Stations** and each **Network Operator**, of **Generating Plant Demand Margins** for national and zonal groups, on a weekly basis, which would occur in relation to those aspects not agreed. It is accepted that agreement of the **Final Generation Outage Programme** is not a commitment on **Generators** or **NGET** to abide by it, but **NGET** will be planning the **GB Transmission System** outage programme on the basis of the **Final Generation Outage Programme** and if, in the event, a **Generator's** outages differ from those contained in the **Final Generation Outage Programme**, or in any way conflict with the **GB Transmission System** outage programme, **NGET** need not alter the **GB Transmission System** outage programme.

#### OC2.4.1.2.3 Planning for Calendar Year 0 – Weekly Resolution

The basis for **Operational Planning** for Year 0 will be the revised **Final Generation Outage Programme** agreed for Year 1:

In each week:

(a) By 1600 hours each Wednesday – Weekly Resolution

Each **Generator** will provide **NGET** in writing with an update of the **Final Generation Outage Programme** and a best estimate weekly **Output Usable** forecast for each of its **Gensets** from the 2nd week ahead to the 52nd week ahead.

(b) Between 1600 hours Wednesday and 1600 hours Friday

**NGET** will be analysing the revised estimates of **Output Usable** supplied by **Generators** under (a) and will be analysing **Operational Planning Margins** for the period. Taking into account **GB Transmission System** constraints and outages and **Network Operator User System** constraints and outages known to **NGET**, **NGET** will assess whether the estimates of **Output Usable** supplied by **Generators** are sufficient to meet forecast **GB Transmission System Demand** plus the **Operational Planning Margin**.

(c) By 1600 hours each Friday

**NGET** will:

- (i) notify each **Generator** with **Large Power Stations** and **Network Operator**, in writing if it considers the **Output Usable** forecasts will give **Surpluses** and potential export limitations both for the **GB Transmission System** and **System Zones** from the 2<sup>nd</sup> week ahead to the 52nd week ahead;
- (ii) provide each **Network Operator**, in writing with weekly **Output Usable** estimates from the 2<sup>nd</sup> week ahead to the 52nd week ahead and updated outages, each relating to **Gensets** which may, in the reasonable opinion of **NGET** and the **Network Operator**, affect the integrity of that **Network Operator's User System** and in such

circumstances, **NGET** shall notify the **Generator** concerned within 48 hours of so providing (including identifying the **Gensets** concerned), from the 2<sup>nd</sup> week ahead to the 52<sup>nd</sup> week ahead.

OC2.4.1.2.4 Programming Phase – 2-49 Days Ahead – Daily Resolution

(a) By 1200 hours each Friday

**NGET** will notify in writing each **Generator** with **Large Power Stations** and **Network Operator** if it considers the **Output Usable** forecasts will give MW shortfalls both nationally and for constrained groups for the period 2-7 weeks ahead.

(b) By 1100 hours each Business Day

Each **Generator** shall provide **NGET** in writing with the best estimate of daily **Output Usable** for each **Genset** for the period from and including day 2 ahead to day 14 ahead, including the forecast return to service date for any such **Generating Unit** or **Power Park Module** subject to **Planned Outage** or breakdown.

(c) By 1100 hours each Wednesday

For the period 2 to 49 days ahead, every Wednesday by 11:00 hours, each **Generator** shall provide **NGET** in writing best estimate daily **Output Usable** forecasts for each **Genset**, and changes (start and finish dates) to **Planned Outage** or to the return to service times of each **Genset** which is subject to breakdown.

(d) Between 1100 hours and 1600 hours each Business Day

**NGET** will be analysing the revised estimates of **Output Usable** supplied by **Generators** under (b) and will be analysing **Operational Planning Margins** for the period 2-14 days ahead. Taking into account **GB Transmission System** constraints and outages and **Network Operator User System** constraints and outages known to **NGET**, **NGET** will assess whether the estimates of **Output Usable** are sufficient to meet forecast **GB Transmission System Demand** plus the **Operational Planning Margin**.

(e) By 1600 hours each Business Day

(i) **NGET** will notify in writing each **Generator** with **Large Power Stations** and each **Network Operator**, of the **Surpluses** both for the **GB Transmission System** and **System Zones** and potential export limitations, for the period from and including day 2 ahead to day 14 ahead which it considers the **Output Usable** forecasts will give. The time of 1600 hours can only be met in respect of any **Generator** or **Network Operator** if all the information from all **Generators** was made available to **NGET** by 1100 hours and if a suitable electronic data transmission facility is in place between **NGET** and the **Generator** or the **Network Operator**, as the case may be, and if it is

fully operational. In the event that any of these conditions is not met, or if it is necessary to revert to a manual system for analysing the information supplied and otherwise to be considered, **NGET** reserve the right to extend the timescale for issue of the information required under this sub-paragraph to each, or the relevant, **Generator** and/or **Network Operator** (as the case may be) provided that such information will in any event be issued by 1800 hours.

- (ii) **NGET** will provide each **Network Operator**, where it has an effect on that **User**, in writing with **Output Usable** estimates from and including day 2 ahead to day 14 ahead and updated outages, each relating to **Gensets** which are either in its **User System** or which may, in the reasonable opinion of **NGET** and the **Network Operator**, affect the integrity of that **Network Operator's User System** and in such circumstances, **NGET** shall notify the **Generator** concerned within 48 hours of so providing (including identifying the **Gensets** concerned), for the period from and including day 2 ahead to day 14 ahead.

#### OC2.4.1.3 Planning of **GB Transmission System** Outages

##### OC2.4.1.3.1 Operational Planning Phase - Planning for **Financial Years** 2 to 5 inclusive ahead

**NGET** shall plan **GB Transmission System** outages required in Years 2 to 5 inclusive required as a result of construction or refurbishment works. This contrasts with the planning of **GB Transmission System** outages required in Years 0 and 1 ahead, when **NGET** also takes into account **GB Transmission System** outages required as a result of maintenance.

**Users** should bear in mind that **NGET** will be planning the **GB Transmission System** outage programme on the basis of the previous year's **Final Generation Outage Programme** and if in the event a **Generator's** or **Network Operator's** outages differ from those contained in the **Final Generation Outage Programme**, or in the case of **Network Operators**, those known to **NGET**, or in any way conflict with the **GB Transmission System** outage programme, **NGET** need not alter the **GB Transmission System** outage programme.

##### OC2.4.1.3.2 In each calendar year:

- (a) By the end of week 8

Each **Network Operator** will notify **NGET** in writing of details of proposed outages in Years 2-5 ahead in its **User System** which may affect the performance of the **Total System** (which includes but is not limited to outages of **User System Apparatus** at **Grid Supply Points** and outages which constrain the output of **Gensets Embedded** within that **User System**).

(b) By the end of week 13

Each **Generator** will inform **NGET** in writing of proposed outages in Years 2 - 5 ahead of **Generator** owned **Apparatus** (eg. busbar selectors) other than **Gensets**, at each **Grid Entry Point**.

**NGET** will provide to each **Network Operator** and to each **Generator** a copy of the information given to **NGET** under paragraph (a) above (other than the information given by that **Network Operator**). In relation to a **Network Operator**, the data must only be used by that **User** in operating that **Network Operator's User System** and must not be used for any other purpose or passed on to, or used by, any other business of that **User** or to, or by, any person within any other such business or elsewhere.

(c) By the end of week 28

**NGET** will provide each **Network Operator** in writing with details of proposed outages in Years 2-5 ahead which may, in **NGET's** reasonable judgement, affect the performance of that **Network Operator's User System**.

(d) By the end of week 30

Where **NGET** or a **Network Operator** is unhappy with the proposed outages notified to it under (a), (b) or (c) above, as the case may be, equivalent provisions to those set out in OC2.4.1.2.1 (d) will apply.

(e) By the end of week 34

**NGET** will draw up a draft **GB Transmission System** outage plan covering the period Years 2 to 5 ahead and **NGET** will notify each **Generator** and **Network Operator** in writing of those aspects of the plan which may operationally affect such **Generator** (other than those aspects which may operationally affect **Embedded Small Power Stations** or **Embedded Medium Power Stations**) or **Network Operator**. **NGET** will also indicate where a need may exist to issue other operational instructions or notifications (including but not limited to the requirement for the arming of an **Operational Intertripping** scheme) or **Emergency Instructions to Users** in accordance with **BC2** to allow the security of the **GB Transmission System** to be maintained within the **Licence Standards**.

OC2.4.1.3.3 Operational Planning Phase - Planning for Financial Year 1 ahead

Each calendar year **NGET** shall update the draft **GB Transmission System** outage plan prepared under OC2.4.1.3.2 above and shall in addition take into account outages required as a result of maintenance work.

In each calendar year:

(a) By the end of week 13

**Generators** and **Non-Embedded Customers** will inform **NGET** in writing of proposed outages for Year 1 of **Generator** owned **Apparatus** at each **Grid Entry Point** (e.g. busbar selectors) other than **Gensets** or **Non-**

**Embedded Customer** owned **Apparatus**, as the case may be, at each **Grid Supply Point**.

- (b) By the end of week 28

**NGET** will provide each **Network Operator** and each **Non-Embedded Customer** in writing with details of proposed outages in Year 1 ahead which may, in **NGET's** reasonable judgement, affect the performance of its **User System** or the **Non-Embedded Customer Apparatus** at the **Grid Supply Point**.

- (c) By the end of week 32

Each **Network Operator** will notify **NGET** in writing with details of proposed outages in Year 1 in its **User System** which may affect the performance of the **Total System** (which includes but is not limited to outages of **User System Apparatus** at **Grid Supply Points** and outages which constrain the output of **Gensets Embedded** within that **User System**).

- (d) Between the end of week 32 and the end of week 34

**NGET** will draw up a revised **GB Transmission System** outage plan (which for the avoidance of doubt includes **Transmission Apparatus** at the **Connection Points**).

- (e) By the end of week 34

**NGET** will notify each **Generator** and **Network Operator**, in writing, of those aspects of the **GB Transmission System** outage programme which may, in **NGET's** reasonable opinion, operationally affect that **Generator** (other than those aspects which may operationally affect **Embedded Small Power Stations** or **Embedded Medium Power Stations**) or **Network Operator** including in particular proposed start dates and end dates of relevant **GB Transmission System** outages.

**NGET** will provide to each **Network Operator** and to each **Generator** a copy of the information given to **NGET** under paragraph (c) above (other than the information given by that **Network Operator**). In relation to a **Network Operator**, the data must only be used by that **User** in operating that **Network Operator's User System** and must not be used for any other purpose or passed on to, or used by, any other business of that **User** or to, or by, any person within any other such business or elsewhere.

- (f) By the end of week 36

Where a **Generator** or **Network Operator** is unhappy with the proposed aspects notified to it under (e) above, equivalent provisions to those set out in OC2.4.1.2.1 (d) will apply.

- (g) Between the end of week 34 and 49

**NGET** will draw up a final **GB Transmission System** outage plan covering Year 1.

(h) By the end of week 49

- (i) **NGET** will complete the final **GB Transmission System** outage plan for Year 1. The plan for Year 1 becomes the final plan for Year 0 when by expiry of time Year 1 becomes Year 0.
- (ii) **NGET** will notify each **Generator** and each **Network Operator** in writing of those aspects of the plan which may operationally affect such **Generator** (other than those aspects which may operationally affect **Embedded Small Power Stations** or **Embedded Medium Power Stations**) or **Network Operator** including in particular proposed start dates and end dates of relevant **GB Transmission System** outages. **NGET** will also indicate where a need may exist to issue other operational instructions or notifications (including but not limited to the requirement for the arming of an **Operational Intertripping** scheme) or **Emergency Instructions to Users** in accordance with **BC2** to allow the security of the **GB Transmission System** to be maintained within the **Licence Standards**. **NGET** will also inform each relevant **Non-Embedded Customer** of the aspects of the plan which may affect it.
- (iii) In addition, in relation to the final **GB Transmission System** outage plan for Year 1, **NGET** will provide to each **Generator** a copy of the final **GB Transmission System** outage plan for that year. OC2.4.1.3.4 contains provisions whereby updates of the final **GB Transmission System** outage plan are provided. The plan and the updates will be provided in writing. It should be noted that the final **GB Transmission System** outage plan for Year 1 and the updates will not give a complete understanding of how the **GB Transmission System** will operate in real time, where the **GB Transmission System** operation may be affected by other factors which may not be known at the time of the plan and the updates. Therefore, **Users** should place no reliance on the plan or the updates showing a set of conditions which will actually arise in real time.

(i) Information Release or Exchange

This paragraph (i) contains alternative requirements on **NGET**, paragraph (z) being an alternative to a combination of paragraphs (x) and (y). Paragraph (z) will only apply in relation to a particular **User** if **NGET** and that **User** agree that it should apply, in which case paragraphs (x) and (y) will not apply. In the absence of any relevant agreement between **NGET** and the **User**, **NGET** will only be required to comply with paragraphs (x) and (y).

Information Release to each **Network Operator** and **Non-Embedded Customer**

Between the end of Week 34 and 49 **NGET** will upon written request:

- (x) for radial systems, provide each **Network Operator** and **Non Embedded Customer** with data to allow the calculation by the **Network Operator**, and each **Non Embedded Customer**, of symmetrical and asymmetrical fault levels; and



- (y) for interconnected **Systems**, provide to each **Network Operator** an equivalent network, sufficient to allow the identification of symmetrical and asymmetrical fault levels, and power flows across interconnecting **User Systems** directly connected to the **GB Transmission System**;  
or

System Data Exchange

- (z) as part of a process to facilitate understanding of the operation of the **Total System**,

- (1) **NGET** will make available to each **Network Operator**, the **GB Transmission System Study Network Data Files** covering Year 1 which are of relevance to that **User's System**;

- (2) where **NGET** and a **User** have agreed to the use of data links between them, the making available will be by way of allowing the **User** access to take a copy of the **GB Transmission System Study Network Data Files** once during that period. The **User** may, having taken that copy, refer to the copy as often as it wishes. Such access will be in a manner agreed by **NGET** and may be subject to separate agreements governing the manner of access. In the absence of agreement, the copy of the **GB Transmission System Study Network Data Files** will be given to the **User** on a disc, or in hard copy, as determined by **NGET**;

- (3) the data contained in the **GB Transmission Study Network Data Files** represents **NGET's** view of indicative operating conditions only and should be used for technical analysis only on the basis that it only represents a view and that operating conditions may be different in the event;

- (4) **NGET** will notify each **Network Operator**, as soon as reasonably practicable after it has updated the **GB Transmission System Study Network Data Files** covering Year 1 that it has done so, when this update falls before the next annual update under this OC2.4.1.3.3(i). **NGET** will then make available to each **Network Operator** who has received an earlier version (and in respect of whom the agreement still exists), the updated **GB Transmission System Study Network Files** covering the balance of Years 1 and 2 which remain given the passage of time, and which are of relevance to that **User's System**. The provisions of paragraphs (2) and (3) above shall apply to the making available of these updates;

- (5) the data from the **GB Transmission System Study Network Data Files** received by each **Network Operator** must only be used by that **User** in operating that **Network Operator's User System** and must not be used for any other purpose or passed on to, or used by, any other business of that **User** or to, or by, any person within any other such business or elsewhere.

OC2.4.1.3.4 **Operational Planning Phase - Planning in Financial Year 0 down to the Programming Phase (and in the case of load transfer capability, also during the Programming Phase)**

- (a) The **GB Transmission System** outage plan for Year 1 issued under OC2.4.1.3.3 shall become the plan for Year 0 when by expiry of time Year 1 becomes Year 0.
- (b) Each **Generator** or **Network Operator** or **Non-Embedded Customer** may at any time during Year 0 request **NGET** in writing for changes to the outages requested by them under OC2.4.1.3.3. In relation to that part of Year 0, excluding the period 1-7 weeks from the date of request, **NGET** shall determine whether the changes are possible and shall notify the **Generator**, **Network Operator** or **Non-Embedded Customer** in question whether this is the case as soon as possible, and in any event within 14 days of the date of receipt by **NGET** of the written request in question.

Where **NGET** determines that any change so requested is possible and notifies the relevant **User** accordingly, **NGET** will provide to each **Network Operator** and each **Generator** a copy of the request to which **NGET** has agreed which relates to outages on **Systems of Network Operators** (other than any request made by that **Network Operator**). The information must only be used by that **Network Operator** in operating that **Network Operator's User System** and must not be used for any other purpose or passed on to, or used by, any other business of that **User** or to, or by, any person within any other such business or elsewhere.

- (c) During Year 0 (including the **Programming Phase**) each **Network Operator** shall at **NGET's** request make available to **NGET** such details of automatic and manual load transfer capability of:
- (i) 12MW or more (averaged over any half hour) for England and Wales
  - (ii) 10MW or more (averaged over any half hour) for Scotland

between **Grid Supply Points**.

- (d) When necessary during Year 0, **NGET** will notify each **Generator** and **Network Operator** and each **Non-Embedded Customer**, in writing of those aspects of the **GB Transmission System** outage programme in the period from the 8th week ahead to the 52nd week ahead, which may, in **NGET's** reasonable opinion, operationally affect that **Generator** (other than those aspects which may operationally affect **Embedded Small Power Stations** or **Embedded Medium Power Stations**) or **Network Operator** or **Non-Embedded Customer** including in particular proposed start dates and end dates of relevant **GB Transmission System** outages.

**NGET** will also notify changes to information supplied by **NGET** pursuant to OC2.4.1.3.3(i)(x) and (y) except where in relation to a **User** information was supplied pursuant to OC2.4.1.3.3(i)(z). In that case:-

- (i) **NGET** will, by way of update of the information supplied by it pursuant to OC2.4.1.3.3(i)(z), make available at the first time in Year 0 that it updates the **GB Transmission System Study Network Data Files** in respect of Year 0 (such update being an update on what was shown in respect of Year 1 which has then become Year 0) to each **Network Operator** who has received an earlier version under OC2.4.1.3.3(i)(z) (and in respect of whom the agreement still exists), the **GB Transmission System Study Network Data Files** covering Year 0 which are of relevance to that **User's System**.

- (ii) **NGET** will notify each relevant **Network Operator**, as soon as reasonably practicable after it has updated the **GB Transmission System Study Network Data Files** covering Year 0, that it has done so. **NGET** will then make available to each such **Network Operator**, the updated **GB Transmission System Study Network Data Files** covering the balance of Year 0 which remains given the passage of time, and which are of relevance to that **User's System**.
- (iii) The provisions of OC2.4.1.3.3(i)(z)(2), (3) and (5) shall apply to the provision of data under this part of OC2.4.1.3.4(d) as if set out in full.

**NGET** will also indicate where a need may exist to issue other operational instructions or notifications (including but not limited to the requirement for the arming of an **Operational Intertripping** scheme) or **Emergency Instructions to Users** in accordance with **BC2** to allow the security of the **GB Transmission System** to be maintained within the **Licence Standards**.

- (e) In addition, by the end of each month during Year 0, **NGET** will provide to each **Generator** a notice containing any revisions to the final **GB Transmission System** outage plan for Year 1, provided to the **Generator** under OC2.4.1.3.3 or previously under this provision, whichever is the more recent.

#### OC2.4.1.3.5 Programming Phase

- (a) By 1600 hours each Thursday
  - (i) **NGET** shall continue to update a preliminary **GB Transmission System** outage programme for the eighth week ahead, a provisional **GB Transmission System** outage programme for the next week ahead and a final day ahead **GB Transmission System** outage programme for the following day.
  - (ii) **NGET** will notify each **Generator** and **Network Operator** and each **Non-Embedded Customer**, in writing of those aspects of the preliminary **GB Transmission System** outage programme which may operationally affect each **Generator** (other than those aspects which may operationally affect **Embedded Small Power Stations** or **Embedded Medium Power Stations**) or **Network Operator** and each **Non-Embedded Customer** including in particular proposed start dates and end dates of relevant **GB Transmission System** outages and changes to information supplied by **NGET** pursuant to OC2.4.1.3.3(i)(x) and (y) (if OC2.4.1.3.3(i)(z) does not apply).

**NGET** will also indicate where a need may exist to arm an **Operational Intertripping** scheme, emergency switching, emergency **Demand** management or other measures including the issuing of other operational instructions or notifications or **Emergency Instructions to Users** in accordance with **BC2** to allow the security of the **GB Transmission System** to be maintained within the **Licence Standards**.

- (b) By 1000 hours each Friday

**Generators and Network Operators** will discuss with **NGET** and confirm in writing to **NGET**, acceptance or otherwise of the requirements detailed under OC2.4.1.3.5.

- (c) By 1600 hours each Friday
- (i) **NGET** shall finalise the preliminary **GB Transmission System** outage programme up to the seventh week ahead. **NGET** will endeavour to give as much notice as possible to a **Generator** with nuclear **Large Power Stations** which may be operationally affected by an outage which is to be included in such programme.
  - (ii) **NGET** shall finalise the provisional **GB Transmission System** outage programme for the next week ahead.
  - (iii) **NGET** shall finalise the **GB Transmission System** outage programme for the weekend through to the next normal working day.
  - (iv) In each case **NGET** will indicate the factors set out in (a)(ii) above (other than those aspects which may operationally affect **Embedded Small Power Stations** or **Embedded Medium Power Stations**) to the relevant **Generators** and **Network Operators** and **Non-Embedded Customers**.
  - (v) Where a **Generator** with nuclear **Large Power Stations** which may be operationally affected by the preliminary **GB Transmission System** outage programme referred to in (i) above (acting as a reasonable operator) is concerned on grounds relating to safety about the effect which an outage within such outage programme might have on one or more of its nuclear **Large Power Stations**, it may contact **NGET** to explain its concerns and discuss whether there is an alternative way of taking that outage (having regard to technical feasibility). If there is such an alternative way, but **NGET** refuses to adopt that alternative way in taking that outage, that **Generator** may involve the **Disputes Resolution Procedure** to decide on the way the outage should be taken. If there is no such alternative way, then **NGET** may take the outage despite that **Generator's** concerns.
- (d) By 1600 hours each Monday, Tuesday, Wednesday and Thursday
- (i) **NGET** shall prepare a final **GB Transmission System** outage programme for the following day.
  - (ii) **NGET** shall notify each **Generator** and **Network Operator** and **Non-Embedded Customer** in writing of the factors set out in (a)(ii) above (other than those aspects which may operationally affect **Embedded Small Power Stations** or **Embedded Medium Power Stations**).

## OC2.4.2 DATA REQUIREMENTS

OC2.4.2.1 When a **Statement of Readiness** under the **Bilateral Agreement** and/or **Construction Agreement** is submitted, and thereafter in calendar week 24 in each calendar year,

- (a) each **Generator** shall (subject to OC2.4.2.1(k)) in respect of each of its:-
- (i) **Gensets** (in the case of the **Generation Planning Parameters**); and
  - (ii) **CCGT Units** within each of its **CCGT Modules** at a **Large Power Station** (in the case of the **Generator Performance Chart**)
- submit to **NGET** in writing the **Generation Planning Parameters** and the **Generator Performance Chart**.
- (b) Each shall meet the requirements of CC.6.3.2 and shall reasonably reflect the true operating characteristics of the **Genset**.
- (c) They shall be applied (unless revised under this **OC2** or (in the case of the **Generator Performance Chart** only) **BC1** in relation to **Other Relevant Data**) from the **Completion Date**, in the case of the ones submitted with the **Statement of Readiness**, and in the case of the ones submitted in calendar week 24, from the beginning of week 25 onwards.
- (d) They shall be in the format indicated in Appendix 1 for these charts and as set out in Appendix 2 for the **Generation Planning Parameters**.
- (e) Any changes to the **Generator Performance Chart** or **Generation Planning Parameters** should be notified to **NGET** promptly.
- (f) **Generators** should note that amendments to the composition of the **CCGT Module** or **Power Park Module** at **Large Power Stations** may only be made in accordance with the principles set out in PC.A.3.2.3 or PC.A.3.2.4 respectively. If in accordance with PC.A.3.2.3 or PC.A.3.2.4 an amendment is made, any consequential changes to the **Generation Planning Parameters** should be notified to **NGET** promptly.
- (g) **The Generator Performance Chart** must be as described below and demonstrate the limitation on reactive capability of the **System** voltage at 3% above nominal. It must also include any limitations on output due to the prime mover (both maximum and minimum), **Generating Unit** step up transformer or **User System**.
- (i) For a **Synchronous Generating Unit** on a **Generating Unit** specific basis at the **Generating Unit** Stator Terminals. It must include details of the **Generating Unit** transformer parameters.
  - (ii) For a **Non-Synchronous Generating Unit** (excluding a **Power Park Unit**) on a **Generating Unit** specific basis at the **Grid Entry Point** (or **User System Entry Point** if **Embedded**).
  - (iii) For a **Power Park Module**, on a **Power Park Module** specific basis at the **Grid Entry Point** (or **User System Entry Point** if **Embedded**).
  - (iv) For a **DC Converter** on a **DC Converter** specific basis at the **Grid Entry Point** (or **User System Entry Point** if **Embedded**).

- (h) For each **CCGT Unit**, and any other **Generating Unit** or **Power Park Module** whose performance varies significantly with ambient temperature, the **Generator Performance Chart** shall show curves for at least two values of ambient temperature so that **NGET** can assess the variation in performance over all likely ambient temperatures by a process of linear interpolation or extrapolation. One of these curves shall be for the ambient temperature at which the **Generating Unit's** output, or **CCGT Module** at a **Large Power Station** output or **Power Park Module's** output, as appropriate, equals its **Registered Capacity**.
- (i) The **Generation Planning Parameters** supplied under OC2.4.2.1 shall be used by **NGET** for operational planning purposes only and not in connection with the operation of the **Balancing Mechanism** (subject as otherwise permitted in the **BCs**).
- (j) Each **Generator** shall in respect of each of its **CCGT Modules** at **Large Power Stations** submit to **NGET** in writing a **CCGT Module Planning Matrix**. It shall be prepared on a best estimate basis relating to how it is anticipated the **CCGT Module** will be running and which shall reasonably reflect the true operating characteristics of the **CCGT Module**. It will be applied (unless revised under this OC2) from the **Completion Date**, in the case of the one submitted with the **Statement of Readiness**, and in the case of the one submitted in calendar week 24, from the beginning of week 31 onwards. It must show the combination of **CCGT Units** which would be running in relation to any given MW output, in the format indicated in Appendix 3.

Any changes must be notified to **NGET** promptly. **Generators** should note that amendments to the composition of the **CCGT Module** at **Large Power Stations** may only be made in accordance with the principles set out in PC.A.3.2.3. If in accordance with PC.A.3.2.3 an amendment is made, an updated **CCGT Module Planning Matrix** must be immediately submitted to **NGET** in accordance with this OC2.4.2.1(b).

The **CCGT Module Planning Matrix** will be used by **NGET** for operational planning purposes only and not in connection with the operation of the **Balancing Mechanism**.

- (k) Each **Generator** shall in respect of each of its **Cascade Hydro Schemes** also submit the **Generation Planning Parameters** detailed at OC2.A.2.6 to OC2.A.2.10 for each **Cascade Hydro Scheme**. Such parameters need not also be submitted for the individual **Gensets** within such **Cascade Hydro Scheme**.
- (l) Each **Generator** shall in respect of each of its **Power Park Modules** at **Large Power Stations** submit to **NGET** in writing a **Power Park Module Planning Matrix**. It shall be prepared on a best estimate basis relating to how it is anticipated the **Power Park Module** will be running and which shall reasonably reflect the operating characteristics of the **Power Park Module**. It will be applied (unless revised under this OC2) from the **Completion Date**, in the case of the one submitted with the **Statement of Readiness**, and in the case of the one submitted in calendar week 24, from the beginning of week 31 onwards. It must show the number of each type of **Power Park Unit** in the **Power Park Module** typically expected to be available to generate, in the format indicated in Appendix 4. The **Power**

**Park Module Planning Matrix** shall be accompanied by a graph showing the variation in MW output with **Intermittent Power Source** (e.g. MW vs wind speed) for the **Power Park Module**. The graph shall indicate the typical value of the **Intermittent Power Source** for the **Power Park Module**.

Any changes must be notified to **NGET** promptly. **Generators** should note that amendments to the composition of the **Power Park Module** at **Large Power Stations** may only be made in accordance with the principles set out in PC.A.3.2.4. If in accordance with PC.A.3.2.4 an amendment is made, an updated **Power Park Module Planning Matrix** must be immediately submitted to **NGET** in accordance with this OC2.4.2.1(a).

The **Power Park Module Planning Matrix** will be used by **NGET** for operational planning purposes only and not in connection with the operation of the **Balancing Mechanism**.

OC2.4.2.2 Each **Network Operator** shall by 1000 hrs on the day falling seven days before each **Operational Day** inform **NGET** in writing of any changes to the circuit details called for in PC.A.2.2.1 which it is anticipated will apply on that **Operational Day** (under **BC1** revisions can be made to this data).

#### OC2.4.3 **NEGATIVE RESERVE ACTIVE POWER MARGINS**

OC2.4.3.1 In each calendar year, by the end of week 39 **NGET** will, taking into account the **Final Generation Outage Programme** and forecast of **Output Usable** supplied by each **Generator**, issue a notice in writing to:-

- (a) all **Generators** with **Large Power Stations** listing any period in which there is likely to be an unsatisfactory **System NRAPM**; and
- (b) all **Generators** with **Large Power Stations** which may, in **NGET's** reasonable opinion be affected, listing any period in which there is likely to be an unsatisfactory **Localised NRAPM**, together with the identity of the relevant **System Constraint Group** or **Groups**,

within the next calendar year, together with the margin. **NGET** and each **Generator** will take these into account in seeking to co-ordinate outages for that period.

OC2.4.3.2 (a) **By 0900 hours each Business Day**

Each **Generator** shall provide **NGET** in writing with a best estimate of **Genset** inflexibility on a daily basis for the period 2 to 14 days ahead (inclusive).

(b) **By 1600 hours each Wednesday**

Each **Generator** shall provide **NGET** in writing with a best estimate of **Genset** inflexibility on a weekly basis for the period 2 to 7 weeks ahead (inclusive).

(c) Between 1600 hours each Wednesday and 1200 hours each Friday

- (i) If **NGET**, taking into account the estimates supplied by **Generators** under (b) above, and forecast **Demand** for the period, foresees that:-
- (1) the level of the **System NRAPM** for any period within the period 2 to 7 weeks ahead (inclusive) is too low, it will issue a notice in writing to all **Generators** and **Network Operators** listing any periods and levels of **System NRAPM** within that period; and/or
  - (2) having also taken into account the appropriate limit on transfers to and from a **System Constraint Group**, the level of **Localised NRAPM** for any period within the period 2 to 7 weeks ahead (inclusive) is too low for a particular **System Constraint Group**, it will issue a notice in writing to all **Generators** and **Network Operators** which may, in **NGET's** reasonable opinion be affected by that **Localised NRAPM**, listing any periods and levels of **Localised NRAPM** within that period. A separate notice will be given in respect of each affected **System Constraint Group**.

Outages Adjustments

- (ii) **NGET** will then contact **Generators** in respect of their **Large Power Stations** to discuss outages as set out in the following paragraphs of this OC2.4.3.2.
- (iii) **NGET** will contact all **Generators** in the case of low **System NRAPM** and will contact **Generators** in relation to relevant **Large Power Stations** in the case of low **Localised NRAPM**. **NGET** will raise with each **Generator** the problems it is anticipating due to the low **System NRAPM** or **Localised NRAPM** and will discuss:-
- (1) whether any change is possible to the estimate of **Genset** inflexibility given under (b) above; and
  - (2) whether **Genset** outages can be taken to coincide with the periods of low **System NRAPM** or **Localised NRAPM** (as the case may be).

In relation to **Generators** with nuclear **Large Power Stations** the discussions on outages can include the issue of whether outages can be taken for re-fuelling purposes to coincide with the relevant low **System NRAPM** and/or **Localised NRAPM** periods.

- (iv) If agreement is reached with a **Generator** (which unlike the remainder of **OC2** will constitute a binding agreement), then such **Generator** will take such outage, as agreed with **NGET**, and **NGET** will issue a revised notice in writing to the **Generators** and **Network Operators** to which it sent notices under (i) above, reflecting the changes brought about to the periods and levels of **System NRAPM** and/or **Localised NRAPM** by the agreements with **Generators**.

(d) By 1600 hours each day



- (i) If **NGET**, taking into account the estimates supplied under (a) above, and forecast **Demand** for the period, foresees that:-
    - (1) the level of **System NRAPM** for any period within the period of 2 to 14 days ahead (inclusive) is too low, it will issue a notice in writing to all **Generators** and **Network Operators** listing the periods and levels of **System NRAPM** within those periods; and/or
    - (2) having also taken into account the appropriate limit on transfers to and from a **System Constraint Group**, the level of **Localised NRAPM** for any period within the period of 2 to 14 days ahead (inclusive) is too low for a particular **System Constraint Group**, it will issue a notice in writing to all **Generators** and **Network Operators** which may, in **NGET's** reasonable opinion be affected by that **Localised NRAPM**, listing any periods and levels of **Localised NRAPM** within that period. A separate notice will be given in respect of each affected **System Constraint Group**.
  - (ii) **NGET** will contact all **Generators** in respect of their **Large Power Stations** (or in the case of **Localised NRAPM**, all **Generators** which may, in **NGET's** reasonable opinion be affected, in respect of their relevant **Large Power Stations**) to discuss whether any change is possible to the estimate of **Genset** inflexibility given under (a) above and to consider **Large Power Station** outages to coincide with the periods of low **System NRAPM** and/or **Localised NRAPM** (as the case may be).
- (e) If on the day prior to a **Operational Day**, it is apparent from the **BM Unit Data** submitted by **Users** under **BC1** that **System NRAPM** and/or **Localised NRAPM** (as the case may be) is, in **NGET's** reasonable opinion, too low, then in accordance with the procedures and requirements set out in **BC1.5.5** **NGET** may contact **Users** to discuss whether changes to **Physical Notifications** are possible, and if they are, will reflect those in the operational plans for the next following **Operational Day** or will, in accordance with **BC2.9.4** instruct **Generators** to **De-Synchronise** a specified **Genset** for such period. In determining which **Genset** to so instruct, **BC2** provides that **NGET** will not (other than as referred to below) consider in such determination (and accordingly shall not instruct to **De-Synchronise**) any **Genset** within an **Existing Gas Cooled Reactor Plant**. **BC2** further provides that:-
- (i) **NGET** is permitted to instruct to **De-Synchronise** any **Gensets** within an **Existing AGR Plant** if those **Gensets** within an **Existing AGR Plant** have failed to offer to be flexible for the relevant instance at the request of **NGET** provided the request is within the **Existing AGR Plant Flexibility Limit**.
  - (ii) **NGET** will only instruct to **De-Synchronise** any **Gensets** within an **Existing Magnox Reactor Plant** or within an **Existing AGR Plant** (other than under (i) above) if the level of **System NRAPM** (taken together with **System** constraints) and/or **Localised NRAPM** is such that it is not possible to avoid **De-Synchronising** such **Generating Unit**, and provided the power flow across each **External**

**Interconnection** is either at zero or results in an export of power from the **Total System**. This proviso applies in all cases in the case of **System NRAPM** and in the case of **Localised NRAPM**, only when the power flow would have a relevant effect.

#### OC2.4.4 FREQUENCY SENSITIVE OPERATION

By 1600 hours each Wednesday

OC2.4.4.1 Using such information as **NGET** shall consider relevant including, if appropriate, forecast **Demand**, any estimates provided by **Generators** of **Genset** inflexibility and anticipated plant mix relating to operation in **Frequency Sensitive Mode**, **NGET** shall determine for the period 2 to 7 weeks ahead (inclusive) whether it is possible that there will be insufficient **Gensets** (other than those **Gensets** within **Existing Gas Cooled Reactor Plant** which are permitted to operate in **Limited Frequency Sensitive Mode** at all times under BC3.5.3) to operate in **Frequency Sensitive Mode** for all or any part of that period.

OC2.4.4.2 BC3.5.3 explains that **NGET** permits **Existing Gas Cooled Reactor Plant** other than **Frequency Sensitive AGR Units** to operate in a **Limited Frequency Sensitive Mode** at all times.

OC2.4.4.3 If **NGET** foresees that there will be an insufficiency in **Gensets** operating in a **Frequency Sensitive Mode**, it will contact **Generators** in order to seek to agree (as soon as reasonably practicable) that all or some of the **Gensets** (the MW amount being determined by **NGET** but the **Gensets** involved being determined by the **Generator**) will take outages to coincide with such period as **NGET** shall specify to enable replacement by other **Gensets** which can operate in a **Frequency Sensitive Mode**. If agreement is reached (which unlike the remainder of OC2 will constitute a binding agreement) then such **Generator** will take such outage as agreed with **NGET**. If agreement is not reached, then the provisions of BC2.9.5 may apply.

OC2.4.5 If in **NGET's** reasonable opinion it is necessary for both the procedure set out in OC2.4.3 (relating to **System NRAPM** and **Localised NRAPM**) and in OC2.4.4 (relating to operation in **Frequency Sensitive Mode**) to be followed in any given situation, the procedure set out in OC2.4.3 will be followed first, and then the procedure set out in OC2.4.4. For the avoidance of doubt, nothing in this paragraph shall prevent either procedure from being followed separately and independently of the other.

#### OC2.4.6 OPERATING MARGIN DATA REQUIREMENTS

##### OC2.4.6.1 Modifications to relay settings

'Relay settings' in this OC2.4.6.1 refers to the settings of **Low Frequency Relays** in respect of **Gensets** that are available for start from standby by **Low Frequency Relay** initiation with **Fast Start Capability** agreed pursuant to the **Bilateral Agreement**.

By 1600 hours each Wednesday

A change in relay settings will be sent by **NGET** no later than 1600 hours on a Wednesday to apply from 1000 hours on the Monday following. The settings allocated to particular **Large Power Stations** may be interchanged between 49.70Hz and 49.60Hz (or such other **System Frequencies** as **NGET** may have specified) provided the overall capacity at each setting and **System** requirements can, in **NGET's** view, be met.

Between 1600 hours each Wednesday and 1200 hours each Friday

If a **Generator** wishes to discuss or interchange settings it should contact **NGET** by 1200 hours on the Friday prior to the Monday on which it would like to institute the changes to seek **NGET's** agreement. If **NGET** agrees, **NGET** will then send confirmation of the agreed new settings.

By 1500 hours each Friday

If any alterations to relay settings have been agreed, then the updated version of the current relay settings will be sent to affected **Users** by 1500 hours on the Friday prior to the Monday on which the changes will take effect. Once accepted, each **Generator** (if that **Large Power Station** is not subject to forced outage or **Planned Outage**) will abide by the terms of its latest relay settings.

In addition, **NGET** will take account of any **Large Power Station** unavailability (as notified under OC2.4.1.2 submissions) in its total **Operating Reserve** policy.

**NGET** may from time to time, for confirmation purposes only, issue the latest version of the current relay settings to each affected **Generator**

OC2.4.6.2

**Operating Margins**

By 1600 hours each Wednesday

No later than 1600 hours on a Wednesday, **NGET** will provide an indication of the level of **Operating Reserve** to be utilised by **NGET** in connection with the operation of the **Balancing Mechanism** in the week beginning with the **Operational Day** commencing during the subsequent Monday, which level shall be purely indicative.

This **Operating Margin** indication will also note the possible level of **Operating Reserve** (if any) which may be provided by **Interconnector Users** in the week beginning with the **Operational Day** commencing during the subsequent Monday.

This **Operating Margin** indication will also note the possible level of **High Frequency Response** to be utilised by **NGET** in connection with the operation of the **Balancing Mechanism** in the week beginning with the **Operational Day** commencing during the subsequent Monday, which level shall be purely indicative.

OC2 APPENDIX 1

GENERATOR PERFORMANCE CHART

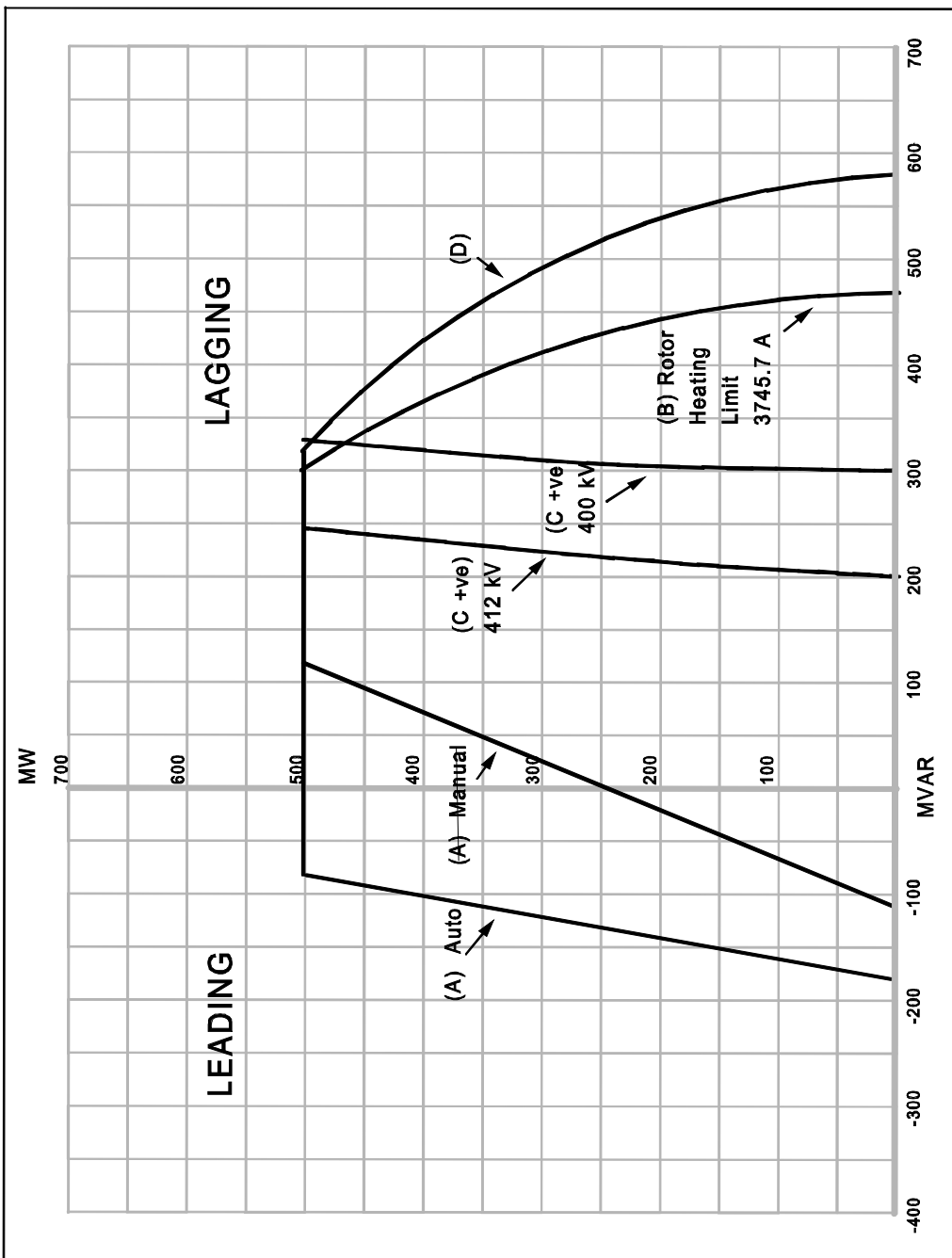

<b>KEY</b>	A) Practical Stability Limit B) Rotor Heating Limit C) Transformer Tap Limit D) Transformer MVA Limit
<b>GENERATOR</b>	MW 500 MVA 588 pf 0.85 kV 22 Xd 2.68
<b>TRANSFORMER</b>	MVA 570 Xt .147
<b>UNIT TRANSFORMER</b>	MW Load 15 MVAR Load 11.25
<b>SYSTEM VOLTAGE</b>	400 kV Nominal 412 kV High
File Ref : 76 :B	

Comments OPERATING CHART CONFIRMED BY LOADING TESTS

Generating Unit Stator Terminals

**POWER PARK MODULE PERFORMANCE CHART  
AT THE CONNECTION POINT OR USER'S SYSTEM ENTRY POINT**

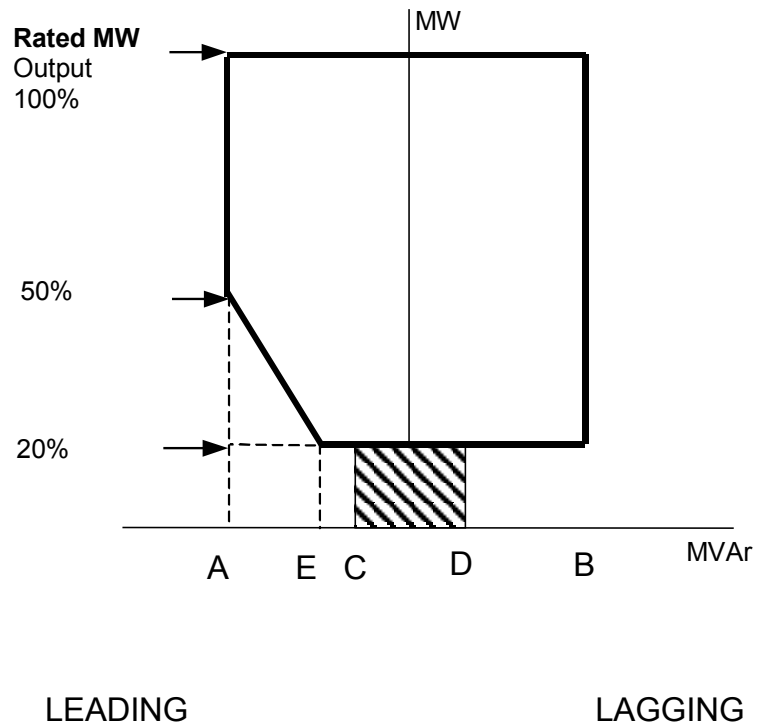

- Point A is equivalent (in MVar) to: 0.95 leading **Power Factor** at **Rated MW** output
- Point B is equivalent (in MVar) to: 0.95 lagging **Power Factor** at **Rated MW** output
- Point C is equivalent (in MVar) to: -5% of **Rated MW** output
- Point D is equivalent (in MVar) to: +5% of **Rated MW** output
- Point E is equivalent (in MVar) to: -12% of **Rated MW** output

## OC2 APPENDIX 2

### OC2.A.2 Generation Planning Parameters

The following parameters are required in respect of each **Genset**.

#### OC2.A.2.1 Regime Unavailability

Where applicable the following information must be recorded for each **Genset**.

- Earliest synchronising time:  
Monday  
Tuesday to Friday  
Saturday to Sunday
- Latest de-synchronising time:  
Monday to Thursday  
Friday  
Saturday to Sunday

#### OC2.A.2.2 Synchronising Intervals

- (a) The **Synchronising** interval between **Gensets** in a **Synchronising Group** assuming all **Gensets** have been **Shutdown** for 48 hours;
- (b) The **Synchronising Group** within the **Power Station** to which each **Genset** should be allocated.

#### OC2.A.2.3 De-Synchronising Interval

A fixed value **De-Synchronising** interval between **Gensets** within a **Synchronising Group**.

#### OC2.A.2.4 Synchronising Generation

The amount of MW produced at the moment of **Synchronising** assuming the **Genset** has been **Shutdown** for 48 hours.

#### OC2.A.2.5 Minimum Non-zero time (MNZT)

The minimum period on-load between **Synchronising** and **De-Synchronising** assuming the **Genset** has been **Shutdown** for 48 hours.

#### OC2.A.2.6 Run-Up rates

A run-up characteristic consisting of up to three stages from **Synchronising Generation** to **Output Usable** with up to two intervening break points assuming the **Genset** has been **Shutdown** for 48 hours.

#### OC2.A.2.7 Run-down rates

A run down characteristic consisting of up to three stages from **Output Usable** to **De-Synchronising** with breakpoints at up to two intermediate load levels.

OC2.A.2.8 Notice to Deviate from Zero (NDZ)

The period of time normally required to **Synchronise** a **Genset** following instruction from **NGET** assuming the **Genset** has been **Shutdown** for 48 hours.

OC2.A.2.9 Minimum Zero time (MZT)

The minimum interval between **De-Synchronising** and **Synchronising** a **Genset**.

OC2.A.2.10 Two Shifting Limit

The maximum number of times that a **Genset** may **De-Synchronise** per **Operational Day**.

OC2.A.2.11 Gas Turbine Units loading parameters

- Loading rate for fast starting
- Loading rate for slow starting

**OC2 APPENDIX 3**

**CCGT Module Planning Matrix example form**

<b>CCGT MODULE</b>	<b>CCGT GENERATING UNITS AVAILABLE</b>								
	<b>1<sup>st</sup> GT</b>	<b>2nd GT</b>	<b>3rd GT</b>	<b>4th GT</b>	<b>5th GT</b>	<b>6th GT</b>	<b>1st ST</b>	<b>2nd ST</b>	<b>3rd ST</b>
<b>OUTPUT USABLE</b>	<b>OUTPUT USABLE</b>								
<b>MW</b>	150	150	150				100		
0MW to 150MW	/								
151MW to 250MW	/						/		
251MW to 300MW	/	/							
301MW to 400MW	/	/					/		
401MW to 450MW	/	/	/						
451MW to 550MW	/	/	/				/		



**OC2 APPENDIX 4**

**Power Park Module Planning Matrix example form**

<b>POWER PARK UNITS AVAILABLE</b>	<b>POWER PARK UNITS</b>			
	Type A	Type B	Type C	Type D
Description (Make / Model)				
Number of units				

The **Power Park Module Planning Matrix** may have as many columns as are required to provide information on the different make and model for each type of **Power Park Unit** in a **Power Park Module**. The description is required to assist identification of the **Power Park Units** within the **Power Park Module** and correlation with data provided under the **Planning Code**.

< End of OC2 >



# ATTACHMENT TO OC2 – SYSTEM ZONAL BOUNDARIES



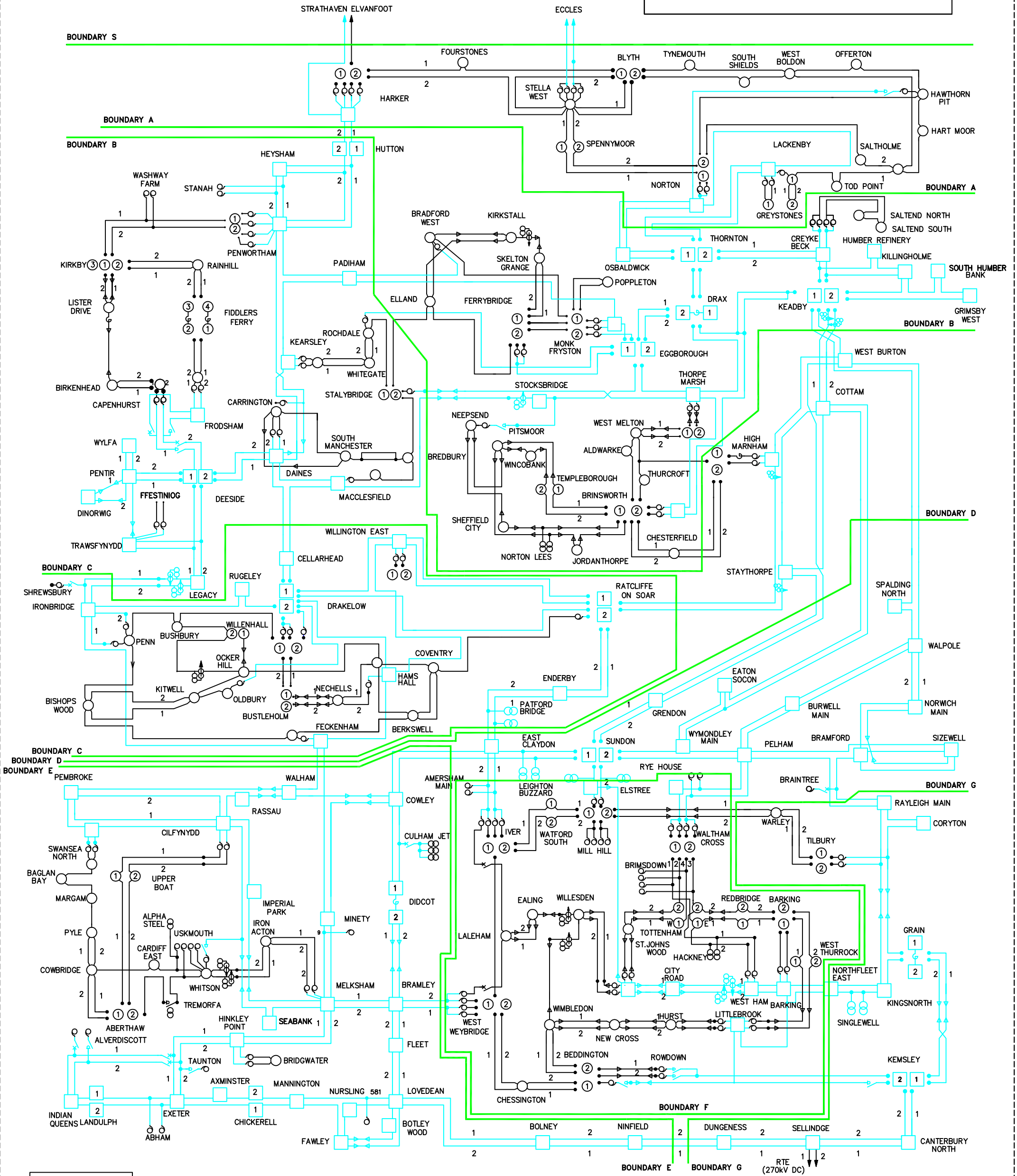
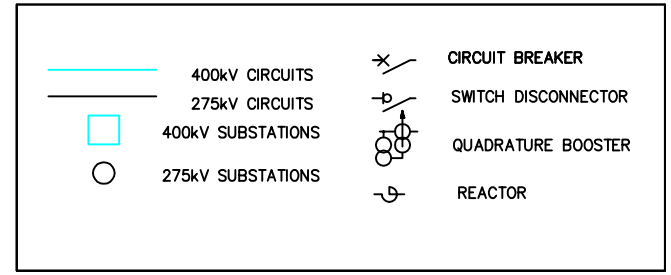

(This diagram does not form part of the Grid Code)



UNCONTROLLED COPY  
NOT SUBJECT TO  
REVISION SERVICING

# ATTACHMENT TO OC2 – SYSTEM ZONAL BOUNDARIES– SCOTLAND

(This diagram does not form part of the Grid Code)

KEY	
	275kV CIRCUITS
	132kV CIRCUITS
	400kV SUBSTATIONS
	132kV SUBSTATIONS
	275kV SUBSTATIONS

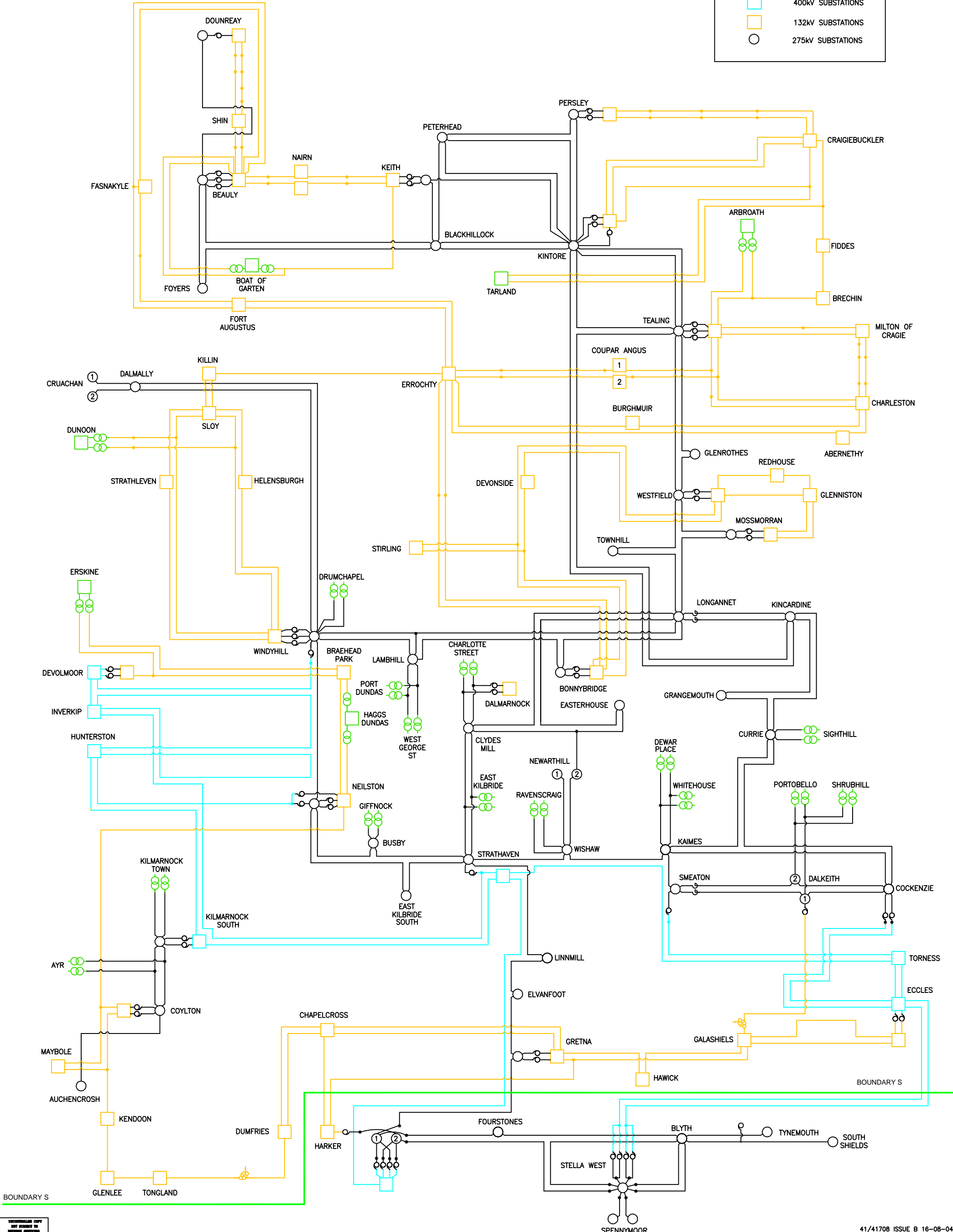

UNCONTROLLED COPY  
NOT SUBJECT TO  
ISSUANCE RESTRICTIONS

**OPERATING CODE NO. 3**

Not Used

(This contents page does not form part of the Grid Code)



**OPERATING CODE NO. 4**

Not Used

(This contents page does not form part of the Grid Code)





**OPERATING CODE NO. 5**

TESTING AND MONITORING

**CONTENTS**

(This contents page does not form part of the Grid Code)

<u>Paragraph No/Title</u>	<u>Page No</u>
OC5.1 INTRODUCTION.....	1
OC5.2 OBJECTIVE .....	2
OC5.3 SCOPE.....	2
OC5.4 MONITORING .....	3
OC5.4.1 Parameters to be monitored.....	3
OC5.4.2 Procedure for monitoring.....	3
OC5.5 PROCEDURE FOR TESTING.....	3
OC5.5.1 Request for Testing.....	3
OC5.5.2 Conduct of Test.....	5
OC5.5.3 Test Assessment .....	7
OC5.5.4 Test Failure/Re-test.....	12
OC5.5.5 Dispute following Re-test .....	12
OC5.6 DISPUTE RESOLUTION.....	12
OC5.7 BLACK START TESTING.....	13
OC5.7.1 General .....	13
OC5.7.2 Procedure for a Black Start Test .....	13
OC5.7.2.1 BS Unit Tests.....	13
OC5.7.2.2 BS Station Test.....	14
OC5.7.2.4 Failure of a Black Start Test.....	14



## OPERATING CODE NO. 5

### TESTING AND MONITORING

#### OC5.1 INTRODUCTION

**Operating Code No. 5 ("OC5")** specifies the procedures to be followed by **NGET** in carrying out:

- (a) monitoring
  - (i) of **BM Units** against their expected input or output;
  - (ii) of compliance by **Users** with the **CC** and in the case of response to **Frequency, BC3**; and
  - (iii) of the provision by **Users** of **Ancillary Services** which they are required or have agreed to provide; and
- (b) the following tests (which are subject to **System** conditions prevailing on the day):
  - (i) tests on **Gensets** and **DC Converters** to test that they have the capability to comply with the **CC** and, in the case of response to **Frequency, BC3** and to provide the **Ancillary Services** that they are either required or have agreed to provide;
  - (ii) tests on **BM Units**, to ensure that the **BM Units** are available in accordance with their submitted **Export and Import Limits, QPNs, Joint BM Unit Data** and **Dynamic Parameters**.

The **OC5** tests include the **Black Start Test** procedure.

In respect of a **Cascade Hydro Scheme** the provisions of **OC5** shall be applied as follows:

- (y) in respect of the **BM Unit** for the **Cascade Hydro Scheme** the parameters referred to at OC5.4.1 (a) and (c) in respect of **Commercial Ancillary Services** will be monitored and tested;
- (z) in respect of each **Genset** forming part of the **Cascade Hydro Scheme** the parameters referred to at OC5.4.1 (a), (b) and (c) will be tested and monitored. In respect of OC5.4.1 (a) the performance of the **Gensets** will be tested and monitored against their expected input or output derived from the data submitted under BC1.4.2(a)(2). Where necessary to give effect to the requirements for **Cascade Hydro Schemes** in the following provisions of **OC5** the term **Genset** will be read and construed in the place of **BM Unit**.

In respect of **Embedded Exemptable Large Power Stations** the provisions of **OC5** shall be applied as follows:

- (1) where there is a **BM Unit** registered in the **BSC** in respect of **Generating Units** the provisions of **OC5** shall apply as written;
- (2) in all other cases, in respect of each **Generating Unit** the parameters referred to at OC5.4.1(a), (b) and (c) will be tested and monitored. In respect of OC5.4.1(a) the performance of the **Generating Unit** will be tested and monitored against their expected input or output derived from the data submitted under BC1.4.2(a)(2). Where necessary to give effect to the requirements for such **Embedded Exemptable Large Power Stations** in the provisions of **OC5** the term **Generating Unit** will be read and construed in place of **BM Unit**.

## OC5.2 OBJECTIVE

The objectives of **OC5** are to establish:

- (a) that **Users** comply with the **CC**;
- (b) whether **BM Units** operate in accordance with their expected input or output derived from their **Final Physical Notification Data** and agreed **Bid-Offer Acceptances** issued under **BC2**;
- (c) whether each **BM Unit** is available as declared in accordance with its submitted **Export and Import Limits, QPN, Joint BM Unit Data** and **Dynamic Parameters**; and
- (d) whether **Generators, DC Converter Station** owners and **Suppliers** can provide those **Ancillary Services** which they are either required or have agreed to provide.

In certain limited circumstances as specified in this **OC5** the output of **CCGT Units** may be verified, namely the monitoring of the provision of **Ancillary Services** and the testing of **Reactive Power** and automatic **Frequency Sensitive Operation**.

## OC5.3 SCOPE

**OC5** applies to **NGET** and to **Users**, which in **OC5** means:

- (a) **Generators**;
- (b) **Network Operators**;
- (c) **Non-Embedded Customers**;
- (d) **Suppliers**; and
- (e) **DC Converter Station** owners.

OC5.4 MONITORING

OC5.4.1 Parameters to be monitored

**NGET** will monitor the performance of:

- (a) **BM Units** against their expected input or output derived from their **Final Physical Notification Data** and agreed **Bid-Offer Acceptances** issued under **BC2**;
- (b) compliance by **Users** with the **CC**; and
- (c) the provision by **Users** of **Ancillary Services** which they are required or have agreed to provide.

OC5.4.2 Procedure for Monitoring

OC5.4.2.1 In the event that a **BM Unit** fails persistently, in **NGET's** reasonable view, to follow, in any material respect, its expected input or output or a **User** fails persistently to comply with the **CC** and in the case of response to **Frequency, BC3** or to provide the **Ancillary Services** it is required, or has agreed, to provide, **NGET** shall notify the relevant **User** giving details of the failure and of the monitoring that **NGET** has carried out.

OC5.4.2.2 The relevant **User** will, as soon as possible, provide **NGET** with an explanation of the reasons for the failure and details of the action that it proposes to take to:

- (a) enable the **BM Unit** to meet its expected input or output or to provide the **Ancillary Services** it is required or has agreed to provide, within a reasonable period, or
- (b) in the case of a **Generating Unit** (excluding a **Power Park Unit**), **CCGT Module, Power Park Module** or **DC Converter** to comply with the **CC** and in the case of response to **Frequency, BC3** or to provide the **Ancillary Services** it is required or has agreed to provide, within a reasonable period.

OC5.4.2.3 **NGET** and the **User** will then discuss the action the **User** proposes to take and will endeavour to reach agreement as to:

- (a) any short term operational measures necessary to protect other **Users**; and
- (b) the parameters which are to be submitted for the **BM Unit** and the effective date(s) for the application of the agreed parameters.

OC5.4.2.4 In the event that agreement cannot be reached within 10 days of notification of the failure by **NGET** to the **User**, **NGET** or the **User** shall be entitled to require a test, as set out in OC5.5 and OC5.6, to be carried out.

OC5.5 PROCEDURE FOR TESTING

OC5.5.1 Request For Testing

OC5.5.1.1 **NGET** may at any time (although not normally more than twice in any calendar year in respect of any particular **BM Unit**) issue an instruction requiring a **User** to carry out a test, provided **NGET** has reasonable grounds of justification based upon:

- (a) a submission of data, or a statement from a **User** indicating a change in plant or apparatus or settings (including but not limited to governor and excitation control systems) that may reasonably be expected to result in a material change of performance; or
- (b) monitoring carried out in accordance with OC5.4.2; or
- (c) notification from a **User** of completion of an agreed action from OC5.4.2.

OC5.5.1.2 The test, referred to in OC5.5.1.1 and carried out at a time no sooner than 48 hours from the time that the instruction was issued, on any one or more of the **User's BM Units** should only be to demonstrate that the relevant **BM Unit**:

- (a) if active in the **Balancing Mechanism**, meets the ability to operate in accordance with its submitted **Export and Import Limits, QPN, Joint BM Unit Data** and **Dynamic Parameters** and achieve its expected input or output which has been monitored under OC5.4; and
- (b) meets the requirements of the paragraphs in the **CC** which are applicable to such **BM Units**; and

in the case of a **BM Unit** comprising a **Generating Unit**, a **CCGT Module**, a **Power Park Module** or a **DC Converter** meets,

- (c) the requirements for operation in **Frequency Sensitive Mode** and compliance with the requirements for operation in **Limited Frequency Sensitive Mode** in accordance with CC.6.3.3, BC3.5.2 and BC3.7.2; or
- (d) the terms of the applicable **Supplemental Agreement** agreed with the **Generator** to have a **Fast Start Capability**; or
- (e) the **Reactive Power** capability registered with **NGET** under **OC2** which shall meet the requirements set out in CC.6.3.2. In the case of a test on a **Generating Unit** within a **CCGT Module** the instruction need not identify the particular **CCGT Unit** within the **CCGT Module** which is to be tested, but instead may specify that a test is to be carried out on one of the **CCGT Units** within the **CCGT Module**.

OC5.5.1.3 (a) The instruction referred to in OC5.5.1.1 may only be issued if the relevant **User** has submitted **Export and Import Limits** which notify that the relevant **BM Unit** is available in respect of the **Operational Day** current at the time at which the instruction is issued. The relevant **User** shall then be obliged to submit **Export and Import Limits** with a magnitude greater than zero for that **BM Unit** in respect of the time and the duration that the test is instructed to be carried out, unless that **BM Unit** would not then be available by reason of forced outage or **Planned Outage** expected prior to this instruction.

- (b) In the case of a **CCGT Module** the **Export and Import Limits** data must relate to the same **CCGT Units** which were included in respect of the **Operational Day** current at the time at which the instruction is issued and must include, in relation to each of the **CCGT Units** within the **CCGT Module**, details of the various data set out in BC1.A.1.3 and BC1.A.1.5, which parameters **NGET** will utilise in instructing in accordance with this OC5 in issuing **Bid-Offer Acceptances**. The parameters shall reasonably reflect the true operating characteristics of each **CCGT Unit**.

OC5.5.2 Conduct Of Test

OC5.5.2.1 The performance of the **BM Unit** will be recorded at **Transmission Control Centres** notified by **NGET** with monitoring at site when necessary, from voltage and current signals provided by the **User** for each **BM Unit** under CC.6.6.1.

OC5.5.2.2 If monitoring at site is undertaken, the performance of the **BM Unit** will be recorded on a suitable recorder (with measurements, in the case of a **Synchronous Generating Unit**, taken on the **Generating Unit** Stator Terminals / on the **LV** side of the generator transformer) or in the case of a **Non-Synchronous Generating Unit** (excluding **Power Park Units**), **Power Park Module** or **DC Converter** at the point of connection in the relevant **User's Control Room**, in the presence of a reasonable number of representatives appointed and authorised by **NGET**. If **NGET** or the **User** requests, monitoring at site will include measurement of the following parameters:

- (a) for Steam Turbines: governor pilot oil pressure, valve position and steam pressure; or
- (b) for Gas Turbines: Inlet Guide Vane position, Fuel Valve positions, Fuel Demand signal and Exhaust Gas temperature; or
- (c) for Hydro Turbines: Governor Demand signal, Actuator Output signal, Guide Vane position; and/or
- (d) for Excitation Systems: Generator Field Voltage and **Power System Stabiliser** signal where appropriate.
- (e) for **Power Park Modules**: appropriate signals related to the voltage/**Reactive Power/Power Factor** control system and the **Frequency** control system as agreed at the time of connection.
- (f) for **DC Converters**: appropriate signals related to the voltage/**Reactive Power/Power Factor** control system and the **Frequency** control system as agreed at the time of connection.

OC5.5.2.3 The test will be initiated by the issue of instructions, which may be accompanied by a **Bid-Offer Acceptance**, under **BC2** (in accordance with the **Export and Import Limits, QPN, Joint BM Unit Data** and **Dynamic Parameters** which have been submitted for the day on which the test was called, or in the case of a **CCGT Unit**, in accordance with the parameters submitted under OC5.5.1.3). The instructions in respect of a **CCGT Unit** within a **CCGT Module** will be in respect of the **CCGT Unit**, as provided in BC2.

OC5.5.2.4 The **User** is responsible for carrying out the test when requested by **NGET** in accordance with OC5.5.1 and retains the responsibility for the safety of personnel and plant during the test.



OC5.5.3 Test and Monitoring Assessment

The pass criteria must be read in conjunction with the full text under the Grid Code reference. The **BM Unit** will pass the test if the criteria below are met:

Parameter to be Tested	Grid Code Reference	Pass Criteria (to be read in conjunction with the full text under the Grid Code reference)
Harmonic Content	CC.6.1.5(a)	Measured harmonic emissions do not exceed the limits specified in the <b>Bilateral Agreement</b> or where no such limits are specified, the relevant planning level specified in G5/4.
Phase Unbalance	CC.6.1.5(b)	The measured maximum <b>Phase (Voltage) Unbalance</b> on the <b>GB Transmission System</b> should remain, in England and Wales, below 1% and, in Scotland, below 2%.
Phase Unbalance	CC.6.1.6	In England and Wales, measured infrequent short duration peaks in <b>Phase (Voltage) Unbalance</b> should not exceed the maximum value stated in the <b>Bilateral Agreement</b> .
Voltage Fluctuations	CC.6.1.7(a)	In England and Wales, measured voltage fluctuations at the <b>Point of Common Coupling</b> shall not exceed 1% of the voltage level for step changes. Measured voltage excursions other than step changes may be allowed up to a level of 3%. In Scotland, measured voltage fluctuations at a <b>Point of Common Coupling</b> shall not exceed the limits set out in <b>Engineering Recommendation P28</b> .
Flicker	CC.6.1.7(b)	Measured voltage fluctuations at a <b>Point of Common Coupling</b> shall not exceed, for voltages above 132kV, <b>Flicker Severity (Short Term)</b> of 0.8 Unit and <b>Flicker Severity (Long Term)</b> of 0.6 Unit, and, for voltages at 132kV and below, shall not exceed <b>Flicker Severity (Short Term)</b> of 1.0 Unit and <b>Flicker Severity (Long Term)</b> of 0.8 Unit, as set out in <b>Engineering Recommendation P28</b> as current at the <b>Transfer Date</b> .
Voltage Quality		

Parameter to be Tested	Grid Code Reference	Pass Criteria (to be read in conjunction with the full text under the Grid Code reference)
Fault Clearance Times	CC.6.2.2.2.2(a) CC.6.2.3.1.1(a)	The fault clearance times shall be in accordance with the <b>Bilateral Agreement</b> .
<b>Back-Up Protection</b>	CC.6.2.2.2.2(b) CC.6.2.3.1.1(b)	The <b>Back-Up Protection</b> system provided by <b>Generators</b> operates in the times specified in CC.6.2.2.2.2(b). The <b>Back-Up Protection</b> system provided by <b>Network Operators</b> and <b>Non-Embedded Customers</b> operates in the times specified in CC.6.2.3.1.1(b) and with <b>Discrimination</b> as specified in the <b>Bilateral Agreement</b> .
Circuit Breaker fail <b>Protection</b>	CC.6.2.2.2.2(c) CC.6.2.3.1.1(c)	The circuit breaker fail <b>Protection</b> shall initiate tripping so as to interrupt the fault current within 200ms.
Reactive Capability	CC.6.3.2  CC.6.3.4	The <b>Generating Unit</b> , <b>DC Converter</b> or <b>Power Park Module</b> will pass the test if it is within $\pm 5\%$ of the reactive capability registered with <b>NGET</b> under <b>OC2</b> which shall meet the requirements set out in CC.6.3.2.  The duration of the test will be for a period of up to 60 minutes during which period the <b>System</b> voltage at the <b>Grid Entry Point</b> for the relevant <b>Generating Unit</b> , <b>DC Converter</b> or <b>Power Park Module</b> will be maintained by the <b>Generator</b> at the voltage specified pursuant to BC2.8 by adjustment of <b>Reactive Power</b> on the remaining <b>Generating Units</b> , <b>DC Converters</b> or <b>Power Park Modules</b> , if necessary.  Measurements of the <b>Reactive Power</b> output under steady state conditions should be consistent with Grid Code requirements i.e. fully available within the voltage range $\pm 5\%$ at 400kV, 275kV and 132kV and lower voltages.
Fault Clearance		
Reactive Capability		

Parameter to be Tested	Grid Code Reference	Pass Criteria (to be read in conjunction with the full text under the Grid Code reference)
<b>Primary, Secondary and High Frequency Response</b>		The measured response in MW/Hz is within $\pm 5\%$ of the level of response specified in the <b>Ancillary Services Agreement</b> for that <b>Genset</b> .
Stability with Voltage	CC.6.3.4	The measured <b>Active Power</b> output under steady state conditions of any <b>Generating Unit</b> , <b>DC Converter</b> or <b>Power Park Module</b> directly connected to the <b>GB Transmission System</b> should not be affected by voltage changes in the normal operating range.
Governor Standard	CC.6.3.7(a)	Measurements indicate that the Governor/ <b>Frequency</b> control system parameters are within the criteria set out in the appropriate governor/ <b>Frequency</b> control system standard (the version of which to apply being determined within CC.6.3.7).
Governor Stability	CC.6.3.7(b)	The measured <b>Generating Unit</b> , <b>DC Converter</b> or <b>Power Park Module Active Power Output</b> shall be stable over the entire operating range of the <b>Generating Unit</b> .
Governor Droop	CC.6.3.7(c)(ii)	The measured speed governor overall speed droop should be between 3% and 5%.
Governor Deadband	CC.6.3.7.(c)(iii)	Except for the <b>Steam Unit</b> within a <b>CCGT Module</b> , the measured speed governor/ <b>Frequency</b> control system deadband shall be no greater than 0.03Hz (for the avoidance of doubt, $\pm 0.015\text{Hz}$ ).
<b>Target Frequency</b>	CC.6.3.7(d)	<b>Target Frequency</b> settings over at least the range $50 \pm 0.1$ Hz shall be available.
Response Capability	CC.6.3.7(e) CC.A.3	The measured frequency response of each <b>Generating Unit</b> and/or <b>CCGT Module</b> which has a <b>Completion Date</b> after 1 January 2001 in England and Wales and after 1 April 2005 in Scotland shall meet requirement profile contained in <b>Connection Conditions</b> Appendix 3. Similarly for <b>DC Converters</b> with <b>Completion Dates</b> on or after 1 April 2005 and <b>Power Park Modules</b> using the <b>GB Transmission System</b> on or after 1 January 2006 (irrespective of its <b>Completion Date</b> excepting those in Scotland with <b>Completion Date</b> before 1 April 2005).
<b>Limited High Frequency Response</b>	BC3.7.2(b)	The measured response is within the requirements of BC3.7.2. i.e. the measured rate of change of <b>Active Power</b> output must be at least 2% of output per 0.1Hz deviation of <b>System Frequency</b> above 50.4Hz.
Output at reduced <b>System Frequency</b>	CC.6.3.3 BC3.5.1	For variations in <b>System Frequency</b> exceeding 0.1Hz within a period of less than 10 seconds, the <b>Active Power</b> output is within $\pm 0.2\%$ of the requirements of CC.6.3.3 when monitored at prevailing external air temperatures of up to 25°C.

Governor System Compliance

Parameter to be Tested	Grid Code Reference	Pass Criteria (to be read in conjunction with the full text under the Grid Code reference)
<b>Fast Start</b>		The <b>Fast Start Capability</b> requirements of the <b>Ancillary Services Agreement</b> for that <b>Genset</b> are met.
<b>Black Start</b>	OC.5.7.1	The relevant <b>Generating Unit</b> or <b>Power Park Module</b> is <b>Synchronised</b> to the <b>System</b> within two hours of the <b>Auxiliary Gas Turbine(s)</b> or <b>Auxiliary Diesel Engine(s)</b> being required to start.
<b>Excitation System/ Voltage Control</b>	CC.6.3.8(a) (b) & BC2.11.2	Measurements of the continuously acting automatic excitation control system are required to demonstrate the provision of: (i) constant terminal voltage control; or (ii) zero MVAR transfer; or, (iii) voltage control with a <b>Slope</b> of the <b>Generating Unit, DC Converter</b> or <b>Power Park Module</b> as applicable without instability over the entire operating range of the <b>Generating Unit, DC Converter</b> or <b>Power Park Module</b> . The measured performance of the automatic excitation or voltage control system should also meet the requirements (including <b>Power System Stabiliser</b> performance) specified in the <b>Bilateral Agreement</b> .

Parameter to be Tested	Grid Code Reference	Pass Criteria
<p><b>Export and Import Limits, QPN, Joint BM Unit Data and Dynamic Parameters</b></p>	<p>OC5</p>	<p>The <b>Export and Import Limits, QPN, Joint BM Unit Data and Dynamic Parameters</b> under test are within 2½% of the declared value being tested.</p> <p>The duration of the test will be consistent with and sufficient to measure the relevant expected input or output derived from the <b>Final Physical Notification Data</b> and <b>Bid-Offer Acceptances</b> issued under BC2 which are still in dispute following the procedure in OC5.4.2.</p>
<p><b>Synchronisation</b> time</p>	<p>BC2.5.2.3</p>	<p><b>Synchronisation</b> takes place within ±5 minutes of the time it should have achieved <b>Synchronisation</b>.</p> <p>The duration of the test will be consistent with and sufficient to measure the relevant expected input or output derived from the <b>Final Physical Notification Data</b> and <b>Bid-Offer Acceptances</b> issued under BC2 which are still in dispute following the procedure in OC5.4.2.</p>
<p>Run-up rates</p>	<p>OC5</p>	<p>Achieves the instructed output and, where applicable, the first and/or second intermediate breakpoints, each within ±3 minutes of the time it should have reached such output and breakpoints from <b>Synchronisation</b> (or break point, as the case may be), calculated from the run-up rates in its <b>Dynamic Parameters</b>.</p> <p>The duration of the test will be consistent with and sufficient to measure the relevant expected input or output derived from the <b>Final Physical Notification Data</b> and <b>Bid-Offer Acceptances</b> issued under BC2 which are still in dispute following the procedure in OC5.4.2.</p>
<p>Run-down rates</p>	<p>OC5</p>	<p>Achieves the instructed output within ±5 minutes of the time, calculated from the run-down rates in its <b>Dynamic Parameters</b>.</p> <p>The duration of the test will be consistent with and sufficient to measure the relevant expected input or output derived from the <b>Final Physical Notification Data</b> and <b>Bid-Offer Acceptances</b> issued under BC2 which are still in dispute following the procedure in OC5.4.2.</p>
<p><b>Dynamic Parameters</b></p>		

Due account will be taken of any conditions on the **System** which may affect the results of the test. The relevant **User** must, if requested, demonstrate, to **NGET's** reasonable satisfaction, the reliability of the suitable recorders, disclosing calibration records to the extent appropriate.

OC5.5.4 Test Failure/Re-test

If the **BM Unit** concerned fails to pass the test the **User** must provide **NGET** with a written report specifying in reasonable detail the reasons for any failure of the test so far as they are then known to the **User** after due and careful enquiry. This must be provided within five **Business Days** of the test. If a dispute arises relating to the failure, **NGET** and the relevant **User** shall seek to resolve the dispute by discussion, and, if they fail to reach agreement, the **User** may by notice require **NGET** to carry out a re-test on 48 hours' notice which shall be carried out following the procedure set out in OC5.5.2 and OC5.5.3 and subject as provided in OC5.5.1.3, as if **NGET** had issued an instruction at the time of notice from the **User**.

OC5.5.5 Dispute following Re-test

If the **BM Unit** in **NGET's** view fails to pass the re-test and a dispute arises on that re-test, either party may use the **Disputes Resolution Procedure** for a ruling in relation to the dispute, which ruling shall be binding.

OC5.6 DISPUTE RESOLUTION

OC5.6.1 If following the procedure set out in OC5.5 it is accepted that the **BM Unit** has failed the test or re-test (as applicable), the **User** shall within 14 days, or such longer period as **NGET** may reasonably agree, following such failure, submit in writing to **NGET** for approval the date and time by which the **User** shall have brought the **BM Unit** concerned to a condition where it complies with the relevant requirement. **NGET** will not unreasonably withhold or delay its approval of the **User's** proposed date and time submitted. Should **NGET** not approve the **User's** proposed date or time (or any revised proposal), the **User** should amend such proposal having regard to any comments **NGET** may have made and re-submit it for approval.

OC5.6.2 If a **BM Unit** fails the test, the **User** shall submit revised **Export and Import Limits, QPN, Joint BM Unit Data** and/or **Dynamic Parameters**, or in the case of a **BM Unit** comprising a **Generating Unit, CCGT Module, DC Converter** or **Power Park Module**, the **User** may amend, with **NGET's** approval, the relevant registered parameters of that **Generating Unit, CCGT Module, DC Converter** or **Power Park Module**, as the case may be, relating to the criteria, for the period of time until the **BM Unit** can achieve the parameters previously registered, as demonstrated in a re-test.

OC5.6.3 Once the **User** has indicated to **NGET** the date and time that the **BM Unit** can achieve the parameters previously registered or submitted, **NGET** shall either accept this information or require the **User** to demonstrate the restoration of the capability by means of a repetition of the test referred to in OC5.5.2 by an instruction requiring the **User** on 48 hours notice to carry out such a test. The provisions of this OC5.6 will apply to such further test.

OC5.7 **BLACK START TESTING**

OC.5.7.1 **General**

- (a) **NGET** may require a **Generator** with a **Black Start Station** to carry out a test (a "**Black Start Test**") on a **Genset** in a **Black Start Station** either while the **Black Start Station** remains connected to an external alternating current electrical supply (a "**BS Unit Test**") or while the **Black Start Station** is disconnected from all external alternating current electrical supplies (a "**BS Station Test**"), in order to demonstrate that a **Black Start Station** has a **Black Start Capability**.
- (b) Where **NGET** requires a **Generator** with a **Black Start Station** to carry out a **BS Unit Test**, **NGET** shall not require the **Black Start Test** to be carried out on more than one **Genset** at that **Black Start Station** at the same time, and would not, in the absence of exceptional circumstances, expect any of the other **Genset** at the **Black Start Station** to be directly affected by the **BS Unit Test**.
- (c) **NGET** may require a **Generator** with a **Black Start Station** to carry out a **BS Unit Test** at any time (but will not require a **BS Unit Test** to be carried out more than once in each calendar year in respect of any particular **Genset** unless it can justify on reasonable grounds the necessity for further tests or unless the further test is a re-test, and will not require a **BS Station Test** to be carried out more than once in every two calendar years in respect of any particular **Genset** unless it can justify on reasonable grounds the necessity for further tests or unless the further test is a re-test).
- (d) When **NGET** wishes a **Generator** with a **Black Start Station** to carry out a **Black Start Test**, it shall notify the relevant **Generator** at least 7 days prior to the time of the **Black Start Test** with details of the proposed **Black Start Test**.

OC.5.7.2 **Procedure for a Black Start Test**

The following procedure will, so far as practicable, be carried out in the following sequence for **Black Start Tests**:

OC.5.7.2.1 **BS Unit Tests**

- (a) The relevant **Generating Unit** shall be **Synchronised** and **Loaded**;
- (b) All the **Auxiliary Gas Turbines** and/or **Auxiliary Diesel Engines** in the **Black Start Station** in which that **Generating Unit** is situated, shall be **Shutdown**.
- (c) The **Generating Unit** shall be **De-Loaded** and **De-Synchronised** and all alternating current electrical supplies to its **Auxiliaries** shall be disconnected.
- (d) The **Auxiliary Gas Turbine(s)** or **Auxiliary Diesel Engine(s)** to the relevant **Generating Unit** shall be started, and shall re-energise the **Unit Board** of the relevant **Generating Unit**.

- (e) The **Auxiliaries** of the relevant **Generating Unit** shall be fed by the **Auxiliary Gas Turbine(s)** or **Auxiliary Diesel Engine(s)**, via the **Unit Board**, to enable the relevant **Generating Unit** to return to **Synchronous Speed**.
- (f) The relevant **Generating Unit** shall be **Synchronised** to the **System** but not **Loaded**, unless the appropriate instruction has been given by **NGET** under **BC2**.

#### OC.5.7.2.2 **BS Station Test**

- (a) All **Generating Units** at the **Black Start Station**, other than the **Generating Unit** on which the **Black Start Test** is to be carried out, and all the **Auxiliary Gas Turbines** and/or **Auxiliary Diesel Engines** at the **Black Start Station**, shall be **Shutdown**.
- (b) The relevant **Generating Unit** shall be **Synchronised** and **Loaded**.
- (c) The relevant **Generating Unit** shall be **De-Loaded** and **De-Synchronised**.
- (d) All external alternating current electrical supplies to the **Unit Board** of the relevant **Generating Unit**, and to the **Station Board** of the relevant **Black Start Station**, shall be disconnected.
- (e) An **Auxiliary Gas Turbine** or **Auxiliary Diesel Engine** at the **Black Start Station** shall be started, and shall re-energise either directly, or via the **Station Board**, the **Unit Board** of the relevant **Generating Unit**.
- (f) The provisions of OC.5.7.2.1 (e) and (f) shall thereafter be followed.

OC.5.7.2.3 All **Black Start Tests** shall be carried out at the time specified by **NGET** in the notice given under OC5.7.1(d) and shall be undertaken in the presence of a reasonable number of representatives appointed and authorised by **NGET**, who shall be given access to all information relevant to the **Black Start Test**.

#### OC.5.7.2.4 **Failure of a Black Start Test**

A **Black Start Station** shall fail a **Black Start Test** if the **Black Start Test** shows that it does not have a **Black Start Capability** (ie. if the relevant **Generating Unit** fails to be **Synchronised** to the **System** within two hours of the **Auxiliary Gas Turbine(s)** or **Auxiliary Diesel Engine(s)** being required to start).

OC.5.7.2.5 If a **Black Start Station** fails to pass a **Black Start Test** the **Generator** must provide **NGET** with a written report specifying in reasonable detail the reasons for any failure of the test so far as they are then known to the **Generator** after due and careful enquiry. This must be provided within five **Business Days** of the test. If a dispute arises relating to the failure, **NGET** and the relevant **Generator** shall seek to resolve the dispute by discussion, and if they fail to reach agreement, the **Generator** may require **NGET** to carry out a further **Black Start Test** on 48 hours notice which shall be carried out following the



procedure set out in OC.5.7.2.1 or OC.5.7.2.2 as the case may be, as if **NGET** had issued an instruction at the time of notice from the **Generator**.

OC.5.7.2.6 If the **Black Start Station** concerned fails to pass the re-test and a dispute arises on that re-test, either party may use the **Disputes Resolution Procedure** for a ruling in relation to the dispute, which ruling shall be binding.

OC.5.7.2.7 If following the procedure in OC.5.7.2.5 and OC.5.7.2.6 it is accepted that the **Black Start Station** has failed the **Black Start Test** (or a re-test carried out under OC.5.7.2.5), within 14 days, or such longer period as **NGET** may reasonably agree, following such failure, the relevant **Generator** shall submit to **NGET** in writing for approval, the date and time by which that **Generator** shall have brought that **Black Start Station** to a condition where it has a **Black Start Capability** and would pass the **Black Start Test**, and **NGET** will not unreasonably withhold or delay its approval of the **Generator's** proposed date and time submitted. Should **NGET** not approve the **Generator's** proposed date and time (or any revised proposal) the **Generator** shall revise such proposal having regard to any comments **NGET** may have made and resubmit it for approval.

OC.5.7.2.8 Once the **Generator** has indicated to **NGET** that the **Generating Station** has a **Black Start Capability**, **NGET** shall either accept this information or require the **Generator** to demonstrate that the relevant **Black Start Station** has its **Black Start Capability** restored, by means of a repetition of the **Black Start Test** referred to in OC5.7.1(d) following the same procedure as for the initial **Black Start Test**. The provisions of this OC.5.7.2 will apply to such test.

<End of OC5>



# OPERATING CODE NO.6

## DEMAND CONTROL

### CONTENTS

(This contents page does not form part of the Grid Code)

<u>Paragraph No/Title</u>	<u>Page Number</u>
OC6.1 INTRODUCTION .....	1
OC6.2 OBJECTIVE .....	2
OC6.3 SCOPE.....	2
OC6.4 PROCEDURE FOR THE NOTIFICATION OF DEMAND CONTROL INITIATED BY NETWORK OPERATORS.....	3
OC6.5 PROCEDURE FOR THE IMPLEMENTATION OF DEMAND CONTROL ON THE INSTRUCTIONS OF NGET .....	4
OC6.6 AUTOMATIC LOW FREQUENCY DEMAND DISCONNECTION .....	7
OC6.7 EMERGENCY MANUAL DISCONNECTION .....	8
OC6.8 OPERATION OF THE BALANCING MECHANISM DURING DEMAND CONTROL .....	9
<b>APPENDIX – SUMMARY SHEET</b> .....	<b>10</b>



## OPERATING CODE NO.6

### DEMAND CONTROL

#### OC6.1 INTRODUCTION

OC6.1.1 **Operating Code No.6 ("OC6")** is concerned with the provisions to be made by **Network Operators**, and in relation to **Non-Embedded Customers** by **NGET**, to permit the reduction of **Demand** in the event of insufficient **Active Power** generation being available to meet **Demand**, or in the event of breakdown or operating problems (such as in respect of **System Frequency**, **System** voltage levels or **System** thermal overloads) on any part of the **GB Transmission System**.

OC6.1.2 **OC6** deals with the following:

- (a) **Customer** voltage reduction initiated by **Network Operators** (other than following the instruction of **NGET**);
- (b) **Customer Demand** reduction by **Disconnection** initiated by **Network Operators** (other than following the instruction of **NGET**);
- (c) **Demand** reduction instructed by **NGET**;
- (d) automatic low frequency **Demand Disconnection**; and
- (e) emergency manual **Demand Disconnection**.

The term "**Demand Control**" is used to describe any or all of these methods of achieving a **Demand** reduction.

OC6.1.3 The procedure set out in **OC6** includes a system of warnings to give advance notice of **Demand Control** that may be required by **NGET** under this **OC6**.

OC6.1.4 Data relating to **Demand Control** should include details relating to MW

OC6.1.5 The Electricity Supply Emergency Code issued by the Department of Trade and Industry, Energy Utilities Directorate, on 30 November 1999 provides that in certain circumstances consumers are given a certain degree of "protection" when rota disconnections are implemented pursuant to a direction under the Energy Act 1976. No such protection can be given in relation to **Demand Control** under the **Grid Code**.

OC6.1.6 Connections between **Large Power Stations** and the **GB Transmission System** and between such **Power Stations** and a **User System** will not, as far as possible, be disconnected by **NGET** pursuant to the provisions of **OC6** insofar as that would interrupt supplies

- (a) for the purposes of operation of the **Power Station** (including **Start-Up** and shutting down);
- (b) for the purposes of keeping the **Power Station** in a state such that it could be Started-up when it is off-**Load** for ordinary operational reasons; or
- (c) for the purposes of compliance with the requirements of a Nuclear Site Licence.

**Demand Control** pursuant to this **OC6** therefore applies subject to this exception.

OC6.2 OBJECTIVE

OC6.2.1 The overall objective of **OC6** is to require the provision of facilities to enable **NGET** to achieve reduction in **Demand** that will either avoid or relieve operating problems on the **GB Transmission System**, in whole or in part, and thereby to enable **NGET** to instruct **Demand Control** in a manner that does not unduly discriminate against, or unduly prefer, any one or any group of **Suppliers** or **Network Operators** or **Non-Embedded Customers**. It is also to ensure that **NGET** is notified of any **Demand Control** utilised by **Users** other than following an instruction from **NGET**.

OC6.2.2 For certain **Grid Supply Points** in Scotland it is recognised that it may not be possible to meet the requirements in OC6.4.5(b), OC6.5.3(b) (in respect of **Demand Disconnection** only), OC6.5.6 (ii), OC6.6.2 (c) and OC6.7.2 (b). In these circumstances **NGET** and the relevant **Network Operator(s)** will agree equivalent requirements covering a number of **Grid Supply Points**. If **NGET** and the relevant **Network Operator** fail to agree equivalent requirements covering a number of **Grid Supply Points**, then the relevant **Network Operator** will apply the provisions of OC6.4.5(b), OC6.5.3(b) (in respect of **Demand Disconnection** only), OC6.5.6(ii), OC6.6.2(c) and OC6.7.2(b) as evenly as reasonably practicable over the relevant **Network Operator's** entire **System**.

OC6.3 SCOPE

OC6.3.1 **OC6** applies to **NGET** and to **Users** which in **OC6** means:-

- (a) **Generators**; and
- (b) **Network Operators**.

It also applies to **NGET** in relation to **Non-Embedded Customers**.

OC6.3.2 Explanation

OC6.3.2.1 (a) Although OC6 does not apply to **Suppliers**, the implementation of **Demand Control** may affect their **Customers**.

(b) In all situations envisaged in **OC6**, **Demand Control** is exercisable:-

- (i) by reference to a **Network Operator's System**; or
- (ii) by **NGET** in relation to **Non-Embedded Customers**.

(c) **Demand Control** in all situations relates to the physical organisation of the **Total System**, and not to any contractual arrangements that may exist.

OC6.3.2.2 (a) Accordingly, **Demand Control** will be exercisable with reference to, for example, five per cent (or such other figure as may be utilised under OC6.5) tranches of **Demand** by a **Network Operator**.

(b) For a **Supplier**, whose **Customers** may be spread throughout a number of **User Systems** (and the **GB Transmission System**), to split its **Customers**

into five per cent (or such other figure as may be utilised under OC6.5) tranches of **Demand** would not result in **Demand Control** being implemented effectively on the **Total System**.

(c) Where **Demand Control** is needed in a particular area, **NGET** would not know which **Supplier** to contact and (even if it were to) the resulting **Demand Control** implemented, because of the diversity of contracts, may well not produce the required result.

OC6.3.2.3 (a) **Suppliers** should note, however, that, although implementation of **Demand Control** in respect of their **Customers** is not exercisable by them, their **Customers** may be affected by **Demand Control**.

(b) This will be implemented by **Network Operators** where the **Customers** are within **User Systems** directly connected to the **GB Transmission System** and by **NGET** where they are **Non-Embedded Customers**.

(c) The contractual arrangements relating to **Customers** being supplied by **Suppliers** will, accordingly, need to reflect this.

(d) The existence of a commercial arrangement for the provision of **Customer Demand Management** or **Commercial Ancillary Services** does not relieve a **Network Operator** from the **Demand Control** provisions of OC6.5, OC6.6 and OC6.7, which may be exercised from time to time.

#### OC6.4 PROCEDURE FOR THE NOTIFICATION OF DEMAND CONTROL INITIATED BY NETWORK OPERATORS (OTHER THAN FOLLOWING THE INSTRUCTION OF NGET)

OC6.4.1 Pursuant to the provisions of **OC1**, in respect of the time periods prior to 1100 hours each day, each **Network Operator** will notify **NGET** of all **Customer** voltage reductions and/or restorations and **Demand Disconnection** or reconnection, on a **Grid Supply Point** and half-hourly basis, which will or may, either alone or when aggregated with any other **Demand Control** planned by that **Network Operator**, result in a **Demand** change equal to or greater than the **Demand Control Notification Level** averaged over any half hour on any **Grid Supply Point**, which is planned to be instructed by the **Network Operator** other than following an instruction from **NGET** relating to **Demand** reduction.

OC6.4.2 Under **OC6**, each **Network Operator** will notify **NGET** in writing by 1100 hours each day (or such other time specified by **NGET** from time to time) for the next day (except that it will be for the next 3 days on Fridays and 2 days on Saturdays and may be longer (as specified by **NGET** at least one week in advance) to cover holiday periods) of **Customer** voltage reduction or **Demand Disconnection** which will or may result in a **Demand** change equal to or greater than the **Demand Control Notification Level** averaged over any half hour on any **Grid Supply Point**, (or which when aggregated with any other **Demand Control** planned by that **Network Operator** is equal to or greater than the **Demand Control Notification Level**), planned to take place during the next **Operational Day**.

OC6.4.3 When the **Customer** voltage reduction or **Demand Disconnection** which may result in a **Demand** change equal to or greater than the **Demand Control Notification Level** averaged over any half hour on any **Grid Supply Point** (or which when

aggregated with any other **Demand Control** planned or implemented by that **Network Operator** is equal to or greater than the **Demand Control Notification Level**) is planned after 1100 hours, each **Network Operator** must notify **NGET** as soon as possible after the decision to implement has been made. If the **Customer** voltage reduction or **Demand Disconnection** is implemented immediately after the decision to implement is made, each **Network Operator** must notify **NGET** within five minutes of implementation.

OC6.4.4 Where, after **NGET** has been notified, whether pursuant to **OC1**, OC6.4.2 or OC6.4.3, the planned **Customer** voltage reduction or **Demand Disconnection** is changed, the **Network Operator** will notify **NGET** as soon as possible of the new plans, or if the **Customer** voltage reduction or **Demand Disconnection** implemented is different to that notified, the **Network Operator** will notify **NGET** of what took place within five minutes of implementation.

OC6.4.5 Any notification under OC6.4.2, OC6.4.3 or OC6.4.4 will contain the following information on a **Grid Supply Point** and half hourly basis:

(a) the proposed (in the case of prior notification) and actual (in the case of subsequent notification) date, time and duration of implementation of the **Customer** voltage reduction or **Demand Disconnection**; and

(b) the proposed reduction in **Demand** by use of the **Customer** voltage reduction or **Demand Disconnection**.

OC6.4.6 Pursuant to the provisions of OC1.5.6, each **Network Operator** will supply to **NGET** details of the amount of **Demand** reduction actually achieved by use of the **Customer** voltage reduction or **Demand Disconnection**.

OC6.5 PROCEDURE FOR THE IMPLEMENTATION OF **DEMAND CONTROL** ON THE INSTRUCTIONS OF **NGET**

OC6.5.1 A **GB Transmission System Warning - High Risk of Demand Reduction** will, where possible, be issued by **NGET**, as more particularly set out in OC6.5.4, OC7.4.8 and BC1.5.4 when **NGET** anticipates that it will or may instruct a **Network Operator** to implement **Demand** reduction. It will, as provided in OC6.5.10 and OC7.4.8.2, also be issued to **Non-Embedded Customers**.

OC6.5.2 Where **NGET** expects to instruct **Demand** reduction within the following 30 minutes, **NGET** will where possible, issue a **GB Transmission System Warning - Demand Control Imminent** in accordance with OC7.4.8.2(c) and OC7.4.8.6.

OC6.5.3 (a) Whether a **GB Transmission System Warning - High Risk of Demand Reduction** or **GB Transmission System Warning - Demand Control Imminent** has been issued or not:-

(i) provided the instruction relates to not more than 20 per cent of its total **Demand** (measured at the time the **Demand** reduction is required); and

(ii) if less than that, is in four integral multiples of between four and six per cent,



each **Network Operator** will abide by the instructions of **NGET** with regard to **Demand** reduction under OC6.5 without delay.

- (b) The **Demand** reduction must be achieved within the **Network Operator's System** as far as possible uniformly across all **Grid Supply Points** (unless otherwise specified in the **GB Transmission System Warning - High Risk of Demand Reduction**) either by **Customer** voltage reduction or by **Demand Disconnection**, as soon as possible but in any event no longer than five minutes from the instruction being given by **NGET**.
- (c) Each **Network Operator** must notify **NGET** in writing by calendar week 24 each year of the integral multiples it will use with effect from the succeeding **Financial Year** onwards. Thereafter, any changes must be notified in writing to **NGET** at least 10 **Business Days** prior to the change coming into effect.

OC6.5.4 (a) Where **NGET** wishes to instruct a **Demand** reduction of more than 20 per cent of a **Network Operator's Demand** (measured at the time the **Demand** reduction is required), it shall, if it is able, issue a **GB Transmission System Warning - High Risk of Demand Reduction** to the **Network Operator** by 1600 hours on the previous day. The warning will state the percentage level of **Demand** reduction that **NGET** may want to instruct (measured at the time the **Demand** reduction is required).

(b) The **GB Transmission System Warning - High Risk of Demand Reduction** will specify the percentage of **Demand** reduction that **NGET** may require in integral multiples of the percentage levels notified by **Users** under OC6.5.3(c) up to (and including) 20 per cent and of five per cent above 20 per cent and will not relate to more than 40 per cent of **Demand** (measured at the time the **Demand** reduction is required) of the **Demand** on the **User System** of a **Network Operator**.

(c) If **NGET** has issued the **GB Transmission System Warning - High Risk of Demand Reduction** by 1600 hours on the previous day, on receipt of it the relevant **Network Operator** shall make available the percentage reduction in **Demand** specified for use within the period of the **GB Transmission System Warning**.

(d) If **NGET** has not issued the **GB Transmission System Warning - High Risk of Demand Reduction** by 1600 hours the previous day, but after that time, the **Network Operator** shall make available as much of the required **Demand** reduction as it is able, for use within the period of the **GB Transmission System Warning**.

OC6.5.5 (a) If **NGET** has given a **GB Transmission System Warning - High Risk of Demand Reduction** to a **Network Operator**, and has issued it by 1600 hours on the previous day, it can instruct the **Network Operator** to reduce its **Demand** by the percentage specified in the **GB Transmission System Warning**.

- (b) **NGET** accepts that if it has not issued the **GB Transmission System Warning - High Risk of Demand Reduction** by 1600 hours on the previous day or if it has issued it by 1600 hours on the previous day, but it requires a further percentage of **Demand** reduction (which may be in excess of 40 per cent of the total **Demand** on the **User System** of the **Network Operator** (measured at the time the **Demand** reduction is required) from that set out in the **GB Transmission System Warning**, it can only receive an amount that can be made available at that time by the **Network Operator**.
- (c) Other than with regard to the proviso, the provisions of OC6.5.3 shall apply to those instructions.

OC6.5.6 Once a **Demand** reduction has been applied by a **Network Operator** at the instruction of **NGET**, the **Network Operator** may interchange the **Customers** to whom the **Demand** reduction has been applied provided that,

- (i) the percentage of **Demand** reduction at all times within the **Network Operator's System** does not change; and
- (ii) at all times it is achieved within the **Network Operator's System** as far as possible uniformly across all **Grid Supply Points** (unless otherwise specified in the **GB Transmission System Warning - High Risk of Demand Reduction** if one has been issued),

until **NGET** instructs that **Network Operator** in accordance with **OC6**.

OC6.5.7 Each **Network Operator** will abide by the instructions of **NGET** with regard to the restoration of **Demand** under OC6.5 without delay. It shall not restore **Demand** until it has received such instruction. The restoration of **Demand** must be achieved as soon as possible and the process of restoration must begin within 2 minutes of the instruction being given by **NGET**.

OC6.5.8 In circumstances of protracted shortage of generation or where a statutory instruction has been given (eg. a fuel security period) and when a reduction in **Demand** is envisaged by **NGET** to be prolonged, **NGET** will notify the **Network Operator** of the expected duration.

OC6.5.9 The **Network Operator** will notify **NGET** in writing that it has complied with **NGET's** instruction under OC6.5, within five minutes of so doing, together with an estimation of the **Demand** reduction or restoration achieved, as the case may be.

OC6.5.10 **NGET** may itself implement **Demand** reduction and subsequent restoration on **Non-Embedded Customers** as part of a **Demand Control** requirement and it will organise the **GB Transmission System** so that it will be able to reduce **Demand** by **Disconnection** of, or **Customer** voltage reduction to, all or any **Non-Embedded Customers**. Equivalent provisions to those in OC6.5.4 shall apply to issuing a **GB Transmission System Warning - High Risk of Demand Reduction** to **Non-Embedded Customers**, as envisaged in OC7.4.8.

OC6.5.11 Pursuant to the provisions of OC1.5.6, the **Network Operator** will supply to **NGET** details of the amount of **Demand** reduction or restoration actually achieved.

OC6.6 AUTOMATIC LOW FREQUENCY DEMAND DISCONNECTION

OC6.6.1 Each **Network Operator** will make arrangements that will enable automatic low **Frequency Disconnection** of at least, in England and Wales, 60 per cent, and in Scotland, 40 per cent, of its total peak **Demand** (based on **Annual ACS Conditions**), in order to seek to limit the consequences of a major loss of generation or an **Event** on the **Total System** which leaves part of the **Total System** with a generation deficit.

OC6.6.2 (a) The **Demand** of each **Network Operator** which is subject to automatic low **Frequency Disconnection** will be split into discrete MW blocks.

(b) The number, location, size and the associated low **Frequency** settings of these blocks, will be as specified by **NGET** by week 12 in each calendar year following discussion with the **Network Operator** in accordance with the **Bilateral Agreement** and will be reviewed annually by **NGET**.

(c) The distribution of the blocks will be such as to give a reasonably uniform **Disconnection** within the **Network Operator's System**, as the case may be, across all **Grid Supply Points**.

(d) Each **Network Operator** will notify **NGET** in writing by calendar week 24 each year of the details of the automatic low **Frequency Disconnection** on its **User System**. The information provided should identify, for each **Grid Supply Point** at the date and time of the annual peak of the **GB Transmission System Demand at Annual ACS Conditions** (as notified pursuant to OC1.4.2), the frequency settings at which **Demand Disconnection** will be initiated and amount of **Demand** disconnected at each such setting.

OC6.6.3 Where conditions are such that, following automatic low **Frequency Demand Disconnection**, and the subsequent **Frequency** recovery, it is not possible to restore a large proportion of the total **Demand** so disconnected within a reasonable period of time, **NGET** may instruct a **Network Operator** to implement additional **Demand Disconnection** manually, and restore an equivalent amount of the **Demand** that had been disconnected automatically. The purpose of such action is to ensure that a subsequent fall in **Frequency** will again be contained by the operation of automatic low **Frequency Demand Disconnection**.

OC6.6.4 Once an automatic low **Frequency Demand Disconnection** has taken place, the **Network Operator** on whose **User System** it has occurred, will not reconnect until **NGET** instructs that **Network Operator** to do so in accordance with **OC6**.

OC6.6.5 Once the **Frequency** has recovered, each **Network Operator** will abide by the instructions of **NGET** with regard to reconnection under OC6.6 without delay. Reconnection must be achieved as soon as possible and the process of reconnection must begin within 2 minutes of the instruction being given by **NGET**.

OC6.6.6 (a) **Non-Embedded Customers** (including a **Pumped Storage Generator**) must provide automatic low **Frequency** disconnection, which will be split into discrete blocks.

(b) The number and size of blocks and the associated low **Frequency** settings will be as specified by **NGET** by week 24 each calendar year following

discussion with the **Non-Embedded Customers** (including a **Pumped Storage Generator**) in accordance with the relevant **Bilateral Agreement**.

- OC6.6.7 (a) In addition, **Generators** may wish to disconnect **Generating Units** from the **System**, either manually or automatically, should they be subject to **Frequency** levels which could result in **Generating Unit** damage.
- (b) This **Disconnection** facility on such **Generating Unit** directly connected to the **GB Transmission System**, will be agreed with **NGET** in accordance with the **Bilateral Agreement**.
- (c) Any **Embedded Power Stations** will need to agree this **Disconnection** facility with the relevant **User** to whose **System** that **Power Station** is connected, which will then need to notify **NGET** of this.

OC6.6.8 The **Network Operator** or **Non-Embedded Customer**, as the case may be, will notify **NGET** with an estimation of the **Demand** reduction which has occurred under automatic low **Frequency Demand Disconnection** and similarly notify the restoration, as the case may be, in each case within five minutes of the **Disconnection** or restoration.

OC6.6.9 Pursuant to the provisions of OC1.5.6 the **Network Operator** and **Non-Embedded Customer** will supply to **NGET** details of the amount of **Demand** reduction or restoration actually achieved.

- OC6.6.10 (a) In the case of a **User**, it is not necessary for it to provide automatic low **Frequency** disconnection under OC6.6 only to the extent that it is providing, at the time it would be so needed, low **Frequency** disconnection at a higher level of **Frequency** as an **Ancillary Service**, namely if the amount provided as an **Ancillary Service** is less than that required under OC6.6 then the **User** must provide the balance required under OC6.6 at the time it is so needed.
- (b) The provisions of OC7.4.8 relating to the use of **Demand Control** should be borne in mind by **Users**.

## OC6.7 EMERGENCY MANUAL DISCONNECTION

OC6.7.1 Each **Network Operator** will make arrangements that will enable it, following an instruction from **NGET**, to disconnect **Customers** on its **User System** under emergency conditions irrespective of **Frequency** within 30 minutes. It must be possible to apply the **Demand Disconnections** to individual or specific groups of **Grid Supply Points**, as determined by **NGET**.

- OC6.7.2 (a) Each **Network Operator** shall provide **NGET** in writing by week 24 in each calendar year, in respect of the next following year beginning week 24, on a **Grid Supply Point** basis, with the following information (which is set out in a tabular format in the Appendix):
- (i) its total peak **Demand** (based on **Annual ACS Conditions**); and
- (ii) the percentage value of the total peak **Demand** that can be disconnected (and in the case of that in the first 5 minutes it must

include that which can also be reduced by voltage reduction) within timescales of 5/10/15/20/25/30 minutes.

- (b) The information should include, in relation to the first 5 minutes, as a minimum, the 20% of **Demand** that must be reduced on instruction under OC6.5.

OC6.7.3 Each **Network Operator** will abide by the instructions of **NGET** with regard to **Disconnection** under OC6.7 without delay, and the **Disconnection** must be achieved as soon as possible after the instruction being given by **NGET**, and in any case, within the timescale registered in OC6.7. The instruction may relate to an individual **Grid Supply Point** and/or groups of **Grid Supply Points**.

OC6.7.4 **NGET** will notify a **Network Operator** who has been instructed under OC6.7, of what has happened on the **GB Transmission System** to necessitate the instruction, in accordance with the provisions of **OC7** and, if relevant, **OC10**.

OC6.7.5 Once a **Disconnection** has been applied by a **Network Operator** at the instruction of **NGET**, that **Network Operator** will not reconnect until **NGET** instructs it to do so in accordance with **OC6**.

OC6.7.6 Each **Network Operator** will abide by the instructions of **NGET** with regard to reconnection under OC6.7 without delay, and shall not reconnect until it has received such instruction and reconnection must be achieved as soon as possible and the process of reconnection must begin within 2 minutes of the instruction being given by **NGET**.

OC6.7.7 **NGET** may itself disconnect manually and reconnect **Non-Embedded Customers** as part of a **Demand Control** requirement under emergency conditions.

OC6.7.8 If **NGET** determines that emergency manual **Disconnection** referred to in OC6.7 is inadequate, **NGET** may disconnect **Network Operators** and/or **Non-Embedded Customers** at **Grid Supply Points**, to preserve the security of the **GB Transmission System**.

OC6.7.9 Pursuant to the provisions of OC1.5.6 the **Network Operator** will supply to **NGET** details of the amount of **Demand** reduction or restoration actually achieved.

#### OC6.8 OPERATION OF THE **BALANCING MECHANISM** DURING **DEMAND CONTROL**

**Demand Control** will constitute an **Emergency Instruction** in accordance with BC2.9 and it may be necessary to depart from normal **Balancing Mechanism** operation in accordance with BC2 in issuing **Bid-Offer Acceptances**. **NGET** will inform affected **BM Participants** in accordance with the provisions of **OC7**.

APPENDIX

EMERGENCY MANUAL DEMAND REDUCTION/DISCONNECTION SUMMARY SHEET  
(As set out in OC6.7)

NETWORK OPERATOR \_\_\_\_\_ [YEAR] PEAK: \_\_\_\_\_

GRID SUPPLY POINT (Name)	PEAK MW	% OF GROUP DEMAND DISCONNECTION (AND/OR REDUCTION IN THE CASE OF THE FIRST 5 MINUTES) (CUMULATIVE)						REMARKS
		TIME (MINS)						
		5	10	15	20	25	30	

Notes: 1. Data to be provided annually by week 24 to cover the following year.

< End of OC6 >



OC7.5 PROCEDURE IN RELATION TO INTEGRAL EQUIPMENT TESTS..... 14

OC7.6 PROCEDURE IN RESPECT OF OPERATIONAL SWITCHING IN  
SCOTLAND..... 16

**APPENDIX –GB TRANSMISSION SYSTEM WARNINGS TABLE ..... 20**



## OPERATING CODE NO.7

### OPERATIONAL LIAISON

#### OC7.1 INTRODUCTION

OC7.1.1 **Operating Code No. 7 ("OC7")** sets out the requirements for the exchange of information in relation to **Operations** and/or **Events** on the **Total System** which have had (or may have had) or will have (or may have) an **Operational Effect**:

- (a) on the **GB Transmission System** in the case of an **Operation** and/or **Event** occurring on the **System** of a **User** or **Users**; and
- (b) on the **System** of a **User** or **Users** in the case of an **Operation** and/or **Event** occurring on the **GB Transmission System**.

It also describes the types of **GB Transmission System Warning** which may be issued by **NGET**.

OC7.1.2 The requirement to notify in **OC7** relates generally to notifying of what is expected to happen or what has happened and not the reasons why. However, as **OC7** provides, when an **Event** or **Operation** has occurred on the **GB Transmission System** which itself has been caused by (or exacerbated by) an **Operation** or **Event** on a **User's System**, **NGET** in reporting the **Event** or **Operation** on the **GB Transmission System** to another **User** can pass on what it has been told by the first **User** in relation to the **Operation** or **Event** on the first **User's System**.

OC7.1.3 Where an **Event** or **Operation** on the **GB Transmission System** falls to be reported by **NGET** to an **Externally Interconnected System Operator** under an **Interconnection Agreement**, **OC7** provides that in the situation where that **Event** or **Operation** has been caused by (or exacerbated by) an **Operation** or **Event** on a **User's System**, **NGET** can pass on what it has been told by the **User** in relation to the **Operation** or **Event** on that **User's System**.

OC7.1.4 **OC7** also deals with **Integral Equipment Tests**.

OC7.1.5 To reconfigure the **GB Transmission System**, **NGET** may reasonably require the assistance of a **User** to reconfigure parts of the **User System**. To reconfigure its **User System** a **User** may reasonably require the reasonable assistance of **NGET** to direct the reconfiguration of parts of the **GB Transmission System**.

OC7.1.6 **OC7.6** sets down the arrangements for the exchange of information required when configuring **Connection Sites** and parts of the **GB Transmission System** adjacent to those **Connection Sites** in Scotland. It also covers the setting up of a **Local Switching Procedure**. **NGET** shall procure that **Relevant Transmission Licensees** shall comply with section **OC7.6** and any relevant **Local Switching Procedure** where and to the extent that such matters apply to them.

#### OC7.2 OBJECTIVE

The objectives of **OC7** are:-

OC7.2.1 To provide for the exchange of information so that the implications of an **Operation** and/or **Event** can be considered, possible risks arising from it can be assessed and appropriate action taken by the relevant party in order to maintain the integrity of the

**Total System. OC7** does not seek to deal with any actions arising from the exchange of information, but merely with that exchange.

OC7.2.2 To provide for types of **GB Transmission System Warnings** which may be issued by **NGET**.

OC7.2.3 To provide the framework for the information flow and discussion between **NGET** and certain **Users** in relation to **Integral Equipment Tests**.

OC7.2.4 To provide the procedure to be followed in respect of **Operational Switching** in Scotland.

OC7.3 SCOPE

OC7.3.1 **OC7** applies to **NGET** and to **Users**, which in **OC7** means:-

- (a) **Generators** (other than those which only have **Embedded Small Power Stations** or **Embedded Medium Power Stations**);
- (b) **Network Operators**;
- (c) **Non-Embedded Customers**;
- (d) **Suppliers** (for the purposes of **GB Transmission System Warnings**);
- (e) **Externally Interconnected System Operators** (for the purposes of **GB Transmission System Warnings**); and
- (f) **DC Converter Station** owners.

The procedure for operational liaison by **NGET** with **Externally Interconnected System Operators** is set out in the **Interconnection Agreement** with each **Externally Interconnected System Operator**.

In Scotland OC7.6 also applies to **Relevant Transmission Licensees**.

OC7.4 PROCEDURE

OC7.4.1 The term "**Operation**" means a scheduled or planned action relating to the operation of a **System** (including an **Embedded Power Station**).

OC7.4.2 The term "**Event**" means an unscheduled or unplanned (although it may be anticipated) occurrence on, or relating to, a **System** (including an **Embedded Power Station**) including, without limiting that general description, faults, incidents and breakdowns and adverse weather conditions being experienced.

OC7.4.3 The term "**Operational Effect**" means any effect on the operation of the relevant other **System** which causes the **GB Transmission System** or the **Systems** of the other **User** or **Users**, as the case may be, to operate (or be at a materially increased risk of operating) differently to the way in which they would or may have normally operated in the absence of that effect.

OC7.4.4 References in this **OC7** to a **System** of a **User** or **User's System** shall not include **Embedded Small Power Stations** or **Embedded Medium Power Stations**, unless otherwise stated.

OC7.4.5 Requirement to notify Operations

OC7.4.5.1 Operation on the GB Transmission System

In the case of an **Operation** on the **GB Transmission System**, which will have (or may have) an **Operational Effect** on the **System(s)** of a **User** or **Users**, **NGET** will notify the **User** or **Users** whose **System(s)** will, or may, in the reasonable opinion of **NGET**, be affected, in accordance with **OC7**.

OC7.4.5.2 Operation on a User's System

In the case of an **Operation** on the **System** of a **User** which will have (or may have) an **Operational Effect** on the **GB Transmission System** (including an equivalent to an **Operation** on the equivalent of a **System** of a **User** or other person connected to that **User's System** which, via that **User System**, will or may have an **Operational Effect** on the **GB Transmission System**), the **User** will notify **NGET** in accordance with **OC7**. Following notification by the **User**, **NGET** will notify any other **User** or **Users** on whose **System(s)** the **Operation** will have, or may have, in the reasonable opinion of **NGET**, an **Operational Effect**, in accordance with **OC7** and will notify any **Externally Interconnected System Operator** on whose **System** the **Operation** will have, or may have, in the reasonable opinion of **NGET**, an **Operational Effect**, if it is required to do so by the relevant **Interconnection Agreement**.

OC7.4.5.3 Examples of situations where notification by NGET or a User may be required

Whilst in no way limiting the general requirement to notify in advance set out in OC7.4.5.1 and OC7.4.5.2, the following are examples of situations where notification in accordance with OC7.4.5 will be required if they will, or may, have an **Operational Effect**:

- (a) the implementation of a planned outage of **Plant** and/or **Apparatus** which has been arranged pursuant to **OC2**;
- (b) the operation (other than, in the case of a **User**, at the instruction of **NGET**) of any circuit breaker or isolator/disconnector or any sequence or combination of the two; or
- (c) voltage control.

OC7.4.5.4 Operations caused by another Operation or by an Event

An **Operation** may be caused by another **Operation** or an **Event** on another's **System** (including an **Embedded Power Station**) (or by the equivalent of an **Event** or **Operation** on the **System** of an **Externally Interconnected System Operator** or **Interconnector User**) and in that situation the information to be notified is different to that where the **Operation** arose independently of any other **Operation** or **Event**, as more particularly provided in OC7.4.5.6.

OC7.4.5.5 Form

A notification and any response to any questions asked under OC7.4.5, of an **Operation** which has arisen independently of any other **Operation** or of an **Event**, shall be of sufficient detail to describe the **Operation** (although it need not state the

cause) and to enable the recipient of the notification reasonably to consider and assess the implications and risks arising (provided that, in the case of an **Operation** on a **User's System** which **NGET** is notifying to other **Users** under OC7.4.5.2, **NGET** will only pass on what it has been told by the **User** which has notified it) and will include the name of the individual reporting the **Operation** on behalf of **NGET** or the **User**, as the case may be. The recipient may ask questions to clarify the notification and the giver of the notification will, insofar as it is able, answer any questions raised, provided that, in the case of an **Operation** on a **User's System** which **NGET** is notifying to other **Users** under OC7.4.5.2, in answering any question, **NGET** will not pass on anything further than that which it has been told by the **User** which has notified it. **NGET** may pass on the information contained in the notification as provided in OC7.4.5.6.

- OC7.4.5.6 (a) A notification by **NGET** of an **Operation** under OC7.4.5.1 which has been caused by another **Operation** (the "first **Operation**") or by an **Event** on a **User's System**, will describe the **Operation** and will contain the information which **NGET** has been given in relation to the first **Operation** or that **Event** by the **User**. The notification and any response to any questions asked (other than in relation to the information which **NGET** is merely passing on from a **User**) will be of sufficient detail to enable the recipient of the notification reasonably to consider and assess the implications and risks arising from the **Operation** on the **GB Transmission System** and will include the name of the individual reporting the **Operation** on behalf of **NGET**. The recipient may ask questions to clarify the notification and **NGET** will, insofar as it is able, answer any questions raised, provided that in relation to the information which **NGET** is merely passing on from a **User**, in answering any question **NGET** will not pass on anything further than that which it has been told by the **User** which has notified it.
- (b) Where a **User** is reporting an **Operation** or an **Event** which itself has been caused by an incident or scheduled or planned action affecting (but not on) its **System**, the notification to **NGET** will contain the information which the **User** has been given by the person connected to its **System** in relation to that incident or scheduled or planned action (which the **User** must require, contractually or otherwise, the person connected to its **System** to give to it) and **NGET** may pass on the information contained in the notification as provided in this OC7.4.5.6.
- OC7.4.5.7 Where an **Operation** on the **GB Transmission System** falls to be reported by **NGET** under an **Interconnection Agreement** and the **Operation** has been caused by another **Operation** (the "first **Operation**") or by an **Event** on a **User's System**, **NGET** will include in that report the information which **NGET** has been given in relation to the first **Operation** or that **Event** by the **User** (including any information relating to an incident or scheduled or planned action, as provided in OC7.4.5.6).
- OC7.4.5.8 (a) A notification to a **User** by **NGET** of an **Operation** under OC7.4.5.1 which has been caused by the equivalent of an **Operation** or of an **Event** on the equivalent of a **System** of an **Externally Interconnected System Operator** or **Interconnector User**, will describe the **Operation** on the **GB Transmission System** and will contain the information which **NGET** has been given, in relation to the equivalent of an **Operation** or of an **Event** on the equivalent of a **System** of an **Externally Interconnected System Operator** or **Interconnector User**, by that **Externally Interconnected System Operator** or **Interconnector User**.

- (b) The notification and any response to any question asked (other than in relation to the information which **NGET** is merely passing on from that **Externally Interconnected System Operator** or **Interconnector User**) will be of sufficient detail to enable the recipient of the notification reasonably to consider and assess the implications and risks arising from the **Operation** on the **GB Transmission System** and will include the name of the individual reporting the **Operation** on behalf of **NGET**. The recipient may ask questions to clarify the notification and **NGET** will, insofar as it is able, answer any questions raised, provided that, in relation to the information which **NGET** is merely passing on from an **Externally Interconnected System Operator** or **Interconnector User**, in answering any question **NGET** will not pass on anything further than that which it has been told by the **Externally Interconnected System Operator** or **Interconnector User** which has notified it.

OC7.4.5.9 (a) A **Network Operator** may pass on the information contained in a notification to it from **NGET** under OC7.4.5.1, to a **Generator** with a **Generating Unit** or a **Power Park Module** connected to its **System**, or to a **DC Converter Station** owner with a **DC Converter** connected to its **System**, or to the operator of another **User System** connected to its **System** (which, for the avoidance of doubt, could be another **Network Operator**), in connection with reporting the equivalent of an **Operation** under the **Distribution Code** (or the contract pursuant to which that **Generating Unit** or **Power Park Module** or other **User System**, or to a **DC Converter Station** is connected to the **System** of that **Network Operator**) (if the **Operation** on the **GB Transmission System** caused it).

- (b) A **Generator** may pass on the information contained in a notification to it from **NGET** under OC7.4.5.1, to another **Generator** with a **Generating Unit** or a **Power Park Module** connected to its **System**, or to the operator of a **User System** connected to its **System** (which, for the avoidance of doubt, could be a **Network Operator**), if it is required (by a contract pursuant to which that **Generating Unit** or that **Power Park Module** or that **User System** is connected to its **System**) to do so in connection with the equivalent of an **Operation** on its **System** (if the **Operation** on the **GB Transmission System** caused it).

OC7.4.5.10 (a) Other than as provided in OC7.4.5.9, a **Network Operator** or a **Generator** may not pass on any information contained in a notification to it from **NGET** under OC7.4.5.1 (and an operator of a **User System** or **Generator** receiving information which was contained in a notification to a **Generator** or a **Network Operator**, as the case may be, from **NGET** under OC7.4.5.1, as envisaged in OC7.4.5.9 may not pass on this information) to any other person, but may inform persons connected to its **System** (or in the case of a **Generator** which is also a **Supplier**, inform persons to which it supplies electricity which may be affected) that there has been an incident on the **Total System**, the general nature of the incident (but not the cause of the incident) and (if known and if power supplies have been affected) an estimated time of return to service.

- (b) In the case of a **Generator** which has an **Affiliate** which is a **Supplier**, the **Generator** may inform it that there has been an incident on the **Total System**, the general nature of the incident (but not the cause of the incident) and (if known and if power supplies have been affected in a particular area) an estimated time of return to service in that area, and that **Supplier** may

pass this on to persons to which it supplies electricity which may be affected).

- (c) Each **Network Operator** and **Generator** shall use its reasonable endeavours to procure that any **Generator** or operator of a **User System** receiving information which was contained in a notification to a **Generator** or **Network Operator**, as the case may be, from **NGET** under OC7.4.5.1, which is not bound by the **Grid Code**, does not pass on any information other than as provided above.

OC7.4.5.11 The notification will, if either party requests, be recorded by the sender and dictated to the recipient, who shall record and repeat each phrase as it is received and on completion of the dictation shall repeat back the notification in full to the sender who shall confirm that it has been accurately recorded.

OC7.4.5.12 Timing

A notification under OC7.4.5 will be given as far in advance as possible and in any event shall be given in sufficient time as will reasonably allow the recipient to consider and assess the implications and risks arising.

OC7.4.6 Requirements to notify Events

OC7.4.6.1 Events on the GB Transmission System

In the case of an **Event** on the **GB Transmission System** which has had (or may have had) an **Operational Effect** on the **System(s)** of a **User** or **Users**, **NGET** will notify the **User** or **Users** whose **System(s)** have been, or may have been, in the reasonable opinion of **NGET**, affected, in accordance with **OC7**.

OC7.4.6.2 Events on a User's System

In the case of an **Event** on the **System** of a **User** which has had (or may have had) an **Operational Effect** on the **GB Transmission System**, the **User** will notify **NGET** in accordance with **OC7**.

OC7.4.6.3 Events caused by another Event or by an Operation

An **Event** may be caused (or exacerbated by) another **Event** or by an **Operation** on another's **System** (including on an **Embedded Power Station**) (or by the equivalent of an **Event** or **Operation** on the equivalent of a **System** of an **Externally Interconnected System Operator** or **Interconnector User**) and in that situation the information to be notified is different to that where the **Event** arose independently of any other **Event** or **Operation**, as more particularly provided in OC7.4.6.7.

OC7.4.6.4 **NGET** or a **User**, as the case may be, may enquire of the other whether an **Event** has occurred on the other's **System**. If it has, and the party on whose **System** the **Event** has occurred is of the opinion that it may have had an **Operational Effect** on the **System** of the party making the enquiry, it shall notify the enquirer in accordance with **OC7**.

OC7.4.6.5 Examples of situations where notification by NGET or a User may be required

Whilst in no way limiting the general requirement to notify set out in OC7.4.6.1, OC7.4.6.2 and OC7.4.6.3, the following are examples of situations where notification in accordance with OC7.4.6 will be required if they have an **Operational Effect**:

- (a) where **Plant** and/or **Apparatus** is being operated in excess of its capability or may present a hazard to personnel;
- (b) the activation of any alarm or indication of any abnormal operating condition;
- (c) adverse weather conditions being experienced;
- (d) breakdown of, or faults on, or temporary changes in the capabilities of, **Plant** and/or **Apparatus**;
- (e) breakdown of, or faults on, control, communication and metering equipment;  
or
- (f) increased risk of inadvertent protection operation.

#### Form

OC7.4.6.6 A notification and any response to any questions asked under OC7.4.6.1 and OC7.4.6.2 of an **Event** which has arisen independently of any other **Event** or of an **Operation**, will describe the **Event**, although it need not state the cause of the **Event**, and, subject to that, will be of sufficient detail to enable the recipient of the notification reasonably to consider and assess the implications and risks arising and will include the name of the individual reporting the **Event** on behalf of **NGET** or the **User**, as the case may be. The recipient may ask questions to clarify the notification and the giver of the notification will, insofar as it is able (although it need not state the cause of the **Event**) answer any questions raised. **NGET** may pass on the information contained in the notification as provided in OC7.4.6.7.

- OC7.4.6.7
- (a) A notification (and any response to any questions asked under OC7.4.6.1) by **NGET** of (or relating to) an **Event** under OC7.4.6.1 which has been caused by (or exacerbated by) another **Event** (the "first **Event**") or by an **Operation** on a **User's System** will describe the **Event** and will contain the information which **NGET** has been given in relation to the first **Event** or that **Operation** by the **User** (but otherwise need not state the cause of the **Event**). The notification and any response to any questions asked (other than in relation to the information which **NGET** is merely passing on from a **User**) will be of sufficient detail to enable the recipient of the notification reasonably to consider and assess the implications and risks arising from the **Event** on the **GB Transmission System** and will include the name of the individual reporting the **Event** on behalf of **NGET**. The recipient may ask questions to clarify the notification and **NGET** will, insofar as it is able, answer any questions raised, provided that in relation to the information which **NGET** is merely passing on from a **User**, in answering any question **NGET** will not pass on anything further than that which it has been told by the **User** which has notified it.
  - (b) Where a **User** is reporting an **Event** or an **Operation** which itself has been caused by (or exacerbated by) an incident or scheduled or planned action affecting (but not on) its **System** the notification to **NGET** will contain the information which the **User** has been given by the person connected to its

**System** in relation to that incident or scheduled or planned action (which the **User** must require, contractually or otherwise, the person connected to its **System** to give to it) and **NGET** may pass on the information contained in the notification as provided in this OC7.4.6.7.

OC7.4.6.8 Where an **Event** on the **GB Transmission System** falls to be reported by **NGET** under an **Interconnection Agreement** and the **Event** has been caused by (or exacerbated by) another **Event** (the "first **Event**") or by an **Operation** on a **User's System**, **NGET** will include in that report the information which **NGET** has been given in relation to the first **Event** or that **Operation** by the **User** (including any information relating to an incident or scheduled or planned action on that **User's System**, as provided in OC7.4.6.7).

OC7.4.6.9 (a) A notification to a **User** (and any response to any questions asked under OC7.4.6.1) by **NGET** of (or relating to) an **Event** under OC7.4.6.1 which has been caused by (or exacerbated by) the equivalent of an **Event** or of an **Operation** on the equivalent of a **System** of an **Externally Interconnected System Operator** or **Interconnector User**, will describe the **Event** on the **GB Transmission System** and will contain the information which **NGET** has been given, in relation to the equivalent of an **Event** or of an **Operation** on the equivalent of a **System** of an **Externally Interconnected System Operator** or **Interconnector User**, by that **Externally Interconnected System Operator** or **Interconnector User** (but otherwise need not state the cause of the **Event**).

(b) The notification and any response to any questions asked (other than in relation to the information which **NGET** is merely passing on from that **Externally Interconnected System Operator** or **Interconnector User**) will be of sufficient detail to enable the recipient of the notification reasonably to consider and assess the implications and risks arising from the **Event** on the **GB Transmission System** and will include the name of the individual reporting the **Event** on behalf of **NGET**. The recipient may ask questions to clarify the notification and **NGET** will, insofar as it is able (although it need not state the cause of the **Event**) answer any questions raised, provided that, in relation to the information which **NGET** is merely passing on from an **Externally Interconnected System Operator** or **Interconnector User**, in answering any question **NGET** will not pass on anything further than that which it has been told by the **Externally Interconnected System Operator** or **Interconnector User** which has notified it.

OC7.4.6.10 (a) A **Network Operator** may pass on the information contained in a notification to it from **NGET** under OC7.4.6.1, to a **Generator** with a **Generating Unit** or a **Power Park Module** connected to its **System** or to a **DC Converter Station** owner with a **DC Converter** connected to its **System** or to the operator of another **User System** connected to its **System** (which, for the avoidance of doubt, could be a **Network Operator**), in connection with reporting the equivalent of an **Event** under the **Distribution Code** (or the contract pursuant to which that **Generating Unit** or **Power Park Module** or **DC Converter** or other **User System** is connected to the **System** of that **Network Operator**) (if the **Event** on the **GB Transmission System** caused or exacerbated it).

(b) A **Generator** may pass on the information contained in a notification to it from **NGET** under OC7.4.6.1, to another **Generator** with a **Generating Unit** or a **Power Park Module** connected to its **System** or to the operator of a



**User System** connected to its **System** (which, for the avoidance of doubt, could be a **Network Operator**), if it is required (by a contract pursuant to which that **Generating Unit** or that **Power Park Module** or that **User System** is connected to its **System**) to do so in connection with the equivalent of an **Event** on its **System** (if the **Event** on the **GB Transmission System** caused or exacerbated it).

- OC7.4.6.11 (a) Other than as provided in OC7.4.6.10, a **Network Operator** or a **Generator**, may not pass on any information contained in a notification to it from **NGET** under OC7.4.6.1 (and an operator of a **User System** or **Generator** receiving information which was contained in a notification to a **Generator** or a **Network Operator**, as the case may be, from **NGET** under OC7.4.6.1, as envisaged in OC7.4.6.10 may not pass on this information) to any other person, but may inform persons connected to its **System** (or in the case of a **Generator** which is also a **Supplier**, inform persons to which it supplies electricity which may be affected) that there has been an incident on the **Total System**, the general nature of the incident (but not the cause of the incident) and (if known and if power supplies have been affected) an estimated time of return to service.
- (b) In the case of a **Generator** which has an **Affiliate** which is a **Supplier**, the **Generator** may inform it that there has been an incident on the **Total System**, the general nature of the incident (but not the cause of the incident) and (if known and if power supplies have been affected in a particular area) an estimated time of return to service in that area, and that **Supplier** may pass this on to persons to which it supplies electricity which may be affected).
- (c) Each **Network Operator** and **Generator** shall use its reasonable endeavours to procure that any **Generator** or operator of a **User System** receiving information which was contained in a notification to a **Generator** or **Network Operator**, as the case may be, from **NGET** under OC7.4.6.1, which is not bound by the **Grid Code**, does not pass on any information other than as provided above.
- OC7.4.6.12 When an **Event** relating to a **Generating Unit**, **Power Park Module** or **DC Converter**, has been reported to **NGET** by a **Generator** or **DC Converter Station** owner under OC7.4.6 and it is necessary in order for the **Generator** or **DC Converter Station** owner to assess the implications of the **Event** on its **System** more accurately, the **Generator** or **DC Converter Station** owner may ask **NGET** for details of the fault levels from the **GB Transmission System** to that **Generating Unit**, **Power Park Module** or **DC Converter** at the time of the **Event**, and **NGET** will, as soon as reasonably practicable, give the **Generator** or **DC Converter Station** owner that information provided that **NGET** has that information.
- OC7.4.6.13 Except in an emergency situation the notification of an **Event** will, if either party requests, be recorded by the sender and dictated to the recipient, who shall record and repeat each phrase as it is received and on completion of the dictation shall repeat the notification in full to the sender who shall confirm that it has been accurately recorded.

#### Timing

OC7.4.6.14 A notification under OC7.4.6 shall be given as soon as possible after the occurrence of the **Event**, or time that the **Event** is known of or anticipated by the giver of the notification under **OC7**, and in any event within 15 minutes of such time.

#### OC7.4.7 **Significant Incidents**

OC7.4.7.1 Where a **User** notifies **NGET** of an **Event** under **OC7** which **NGET** considers has had or may have had a significant effect on the **GB Transmission System**, **NGET** will require the **User** to report that **Event** in writing in accordance with the provisions of **OC10** and will notify that **User** accordingly.

OC7.4.7.2 Where **NGET** notifies a **User** of an **Event** under **OC7** which the **User** considers has had or may have had a significant effect on that **User's System**, that **User** will require **NGET** to report that **Event** in writing in accordance with the provisions of **OC10** and will notify **NGET** accordingly.

OC7.4.7.3 **Events** which **NGET** requires a **User** to report in writing pursuant to OC7.4.7.1, and **Events** which a **User** requires **NGET** to report in writing pursuant to OC7.4.7.2, are known as "**Significant Incidents**".

OC7.4.7.4 Without limiting the general description set out in OC7.4.7.1 and OC7.4.7.2, a **Significant Incident** will include **Events** having an **Operational Effect** which result in, or may result in, the following:

- (a) operation of **Plant** and/or **Apparatus** either manually or automatically;
- (b) voltage outside statutory limits;
- (c) **Frequency** outside statutory limits; or
- (d) **System** instability.

#### OC 7.4.8 **GB TRANSMISSION SYSTEM WARNINGS**

##### OC7.4.8.1 **Role of GB Transmission System Warnings**

**GB Transmission System Warnings** as described below provide information relating to **System** conditions or **Events** and are intended to:

- (i) alert **Users** to possible or actual **Plant** shortage, **System** problems and/or **Demand** reductions;
- (ii) inform of the applicable period;
- (iii) indicate intended consequences for **Users**; and
- (iv) enable specified **Users** to be in a state of readiness to react properly to instructions received from **NGET**.

A table of **GB Transmission System Warnings**, set out in the Appendix to **OC7**, summarises the warnings and their usage. In the case of a conflict between the table and the provisions of the written text of **OC7**, the written text will prevail.

##### OC7.4.8.2 **Recipients of GB Transmission System Warnings**

- (a) Where **GB Transmission System Warnings**, (except those relating to **Demand Control Imminent**), are applicable to **System** conditions or **Events** which have widespread effect, **NGET** will notify all **Users** under **OC7**.
- (b) Where in **NGET's** judgement **System** conditions or **Events** may only have a limited effect, the **GB Transmission System Warning** will only be issued to those **Users** who are or may in **NGET's** judgement be affected.
- (c) Where a **GB Transmission System Warning - Demand Control Imminent** is issued it will only be sent to those **Users** who are likely to receive **Demand Control** instructions from **NGET**.

#### OC7.4.8.3 Preparatory Action

- (a) Where possible, and if required, recipients of the warnings should take such preparatory action as they deem necessary taking into account the information contained in the **GB Transmission System Warning**. All warnings will be of a form determined by **NGET** and will remain in force from the stated time of commencement until the cancellation, amendment or re-issue, as the case may be, is notified by **NGET**.
- (b) Where a **GB Transmission System Warning** has been issued to a **Network Operator** and is current, **Demand Control** should not (subject as provided below) be employed unless instructed by **NGET**. If **Demand Control** is, however, necessary to preserve the integrity of the **Network Operator's System**, then the impact upon the integrity of the **Total System** should be considered by the **Network Operator** and where practicable discussed with **NGET** prior to its implementation.

Where a **GB Transmission System Warning** has been issued to a **Supplier**, further **Customer Demand Management** (in addition to that previously notified under **OC1 - Demand Forecasts**) must only be implemented following notification to **NGET**.

- (c) **GB Transmission System Warnings** will be issued by fax, to the facsimile number(s) and locations agreed between **NGET** and **Users**, or by such electronic data transmission facilities as have been agreed. In the case of **Generators** with **Gensets** this will normally be at their **Trading Points** (if they have notified **NGET** that they have a **Trading Point**)
- (d) **Users** may at times be informed by telephone or other means of **GB Transmission System Warnings** and in these circumstances confirmation will be sent to those **Users** so notified, by fax as soon as possible.

#### OC7.4.8.4 Types of GB Transmission System Warnings

**GB Transmission System Warnings** consist of the following types:-

- (i) **GB Transmission System Warning - Inadequate System Margin**
- (ii) **GB Transmission System Warning - High Risk of Demand Reduction**
- (iii) **GB Transmission System Warning - Demand Control Imminent**
- (iv) **GB Transmission System Warning - Risk of System Disturbance**

OC7.4.8.5 **GB Transmission System Warning - Inadequate System Margin**

A **GB Transmission System Warning - Inadequate System Margin** may be issued to **Users** in accordance with OC7.4.8.2, at times when there is inadequate **System Margin**, as determined under BC1.5.4. It will contain the following information:

- (i) the period for which the warning is applicable; and
- (ii) the availability shortfall in MW; and
- (iii) intended consequences for **Users**, including notification that **Maximum Generation Service** may be instructed.

OC 7.4.8.6 **GB Transmission System Warning - High Risk of Demand Reduction**

(a) A **GB Transmission System Warning - High Risk of Demand Reduction** may be issued to **Users** in accordance with OC7.4.8.2 at times when there is inadequate **System Margin**, as determined under BC1.5.4 and in **NGET's** judgement there is increased risk of **Demand** reduction being implemented under OC6.5.1. It will contain the following information in addition to the required information in a **GB Transmission System Warning - Inadequate System Margin**:

- (i) the possible percentage level of **Demand** reduction required; and
- (ii) Specify those **Network Operators** and **Non Embedded Customers** who may subsequently receive instructions under OC6.5.1.

(b) A **GB Transmission System Warning - High Risk of Demand Reduction** may also be issued by **NGET** to those **Network Operators** and **Non Embedded Customers** who may subsequently receive instructions under OC6.5.1 relating to a **Demand** reduction in circumstances not related to inadequate **System Margin** (for example **Demand** reduction required to manage **System** overloading).

The **GB Transmission System Warning - High Risk of Demand Reduction** will specify the period during which **Demand** reduction may be required and the part of the **Total System** to which it applies and any other matters specified in OC6.5.

OC7.4.8.6.1 **Protracted Periods of Generation Shortage**

(a) Whenever **NGET** anticipates that a protracted period of generation shortage may exist a **GB Transmission System Warning - Inadequate System Margin** or **High Risk of Demand Reduction** may be issued, to give as much notice as possible to those **Network Operators** and **Non Embedded Customers** who may subsequently receive instructions under OC6.5.

(b) A **GB Transmission System Warning - High Risk of Demand Reduction** will in these instances include an estimate of the percentage of **Demand** reduction that may be required and the anticipated duration of the **Demand**

reduction. It may also include information relating to estimates of any further percentage of **Demand** reduction that may be required.

- (c) The issue of the **GB Transmission System Warning - Inadequate System Margin or High Risk of Demand Reduction** is intended to enable recipients to plan ahead on the various aspects of **Demand** reduction.

#### OC7.4.8.7 **GB Transmission System Warning - Demand Control Imminent**

- (a) A **GB Transmission System Warning - Demand Control Imminent**, relating to a **Demand** reduction under OC6.5, will be issued by **NGET** to **Users** in accordance with OC7.4.8.2. It will specify those **Network Operators** who may subsequently receive instructions under OC6.5.
- (b) A **GB Transmission System Warning - Demand Control Imminent**, need not be preceded by any other **GB Transmission System Warning** and will be issued when a **Demand** reduction is expected within the following 30 minutes, but will not cease to have effect after 30 minutes from its issue. However, **NGET** will either reissue the **GB Transmission System Warning - Demand Control Imminent** or cancel the **GB Transmission System Warning - Demand Control Imminent** no later than 2 hours from first issue, or from re-issue, as the case may be.

#### OC7.4.8.8 **GB Transmission System Warning - Risk of System Disturbance**

- (a) A **GB Transmission System Warning - Risk of System Disturbance** will be issued by **NGET** to **Users** who may be affected when **NGET** knows there is a risk of widespread and serious disturbance to the whole or part of, the **GB Transmission System**;
- (b) The **GB Transmission System Warning - Risk of System Disturbance** will contain such information as **NGET** deems appropriate;
- (c) for the duration of the **GB Transmission System Warning - Risk of System Disturbance**, each User in receipt of the **GB Transmission System Warning - Risk of System Disturbance** shall take the necessary steps to warn its operational staff and to maintain its **Plant** and/or **Apparatus** in the condition in which it is best able to withstand the anticipated disturbance;
- (d) During the period that the **GB Transmission System Warning - Risk of System Disturbance** is in effect, **NGET** may issue **Emergency Instructions** in accordance with **BC2** and it may be necessary to depart from normal **Balancing Mechanism** operation in accordance with **BC2** in issuing **Bid-Offer Acceptances**.

#### OC7.4.8.9 **Cancellation of GB Transmission System Warning**

- (a) **NGET** will give notification of a **Cancellation of GB Transmission System Warning** to all **Users** issued with the **GB Transmission System Warning** when in **NGET's** judgement **System** conditions have returned to normal.

- (b) A **Cancellation of GB Transmission System Warning** will identify the type of **GB Transmission System Warning** being cancelled and the period for which it was issued. The **Cancellation of GB Transmission System Warning** will also identify any **GB Transmission System Warnings** that are still in force.

OC7.4.8.10 General Management of **GB Transmission System Warnings**

- (a) **GB Transmission System Warnings** remain in force for the period specified unless superseded or cancelled by **NGET**.
- (b) A **GB Transmission System Warning** issued for a particular period may be superseded by further related warnings. This will include **GB Transmission System Warning - Inadequate System Margin** being superseded by **GB Transmission System Warning - High Risk of Demand Reduction** and vice-versa.
- (c) In circumstances where it is necessary for the period of a **GB Transmission System Warning** to be changed:
  - (i) the period applicable may be extended by the issue of a **GB Transmission System Warning** with a period which follows on from the original period, or
  - (ii) revised or updated **GB Transmission System Warnings** will be issued where there is an overlap with the period specified in an existing **GB Transmission System Warning**, but only if the revised period also includes the full period of the existing **GB Transmission System Warning**.

In any other case the existing **GB Transmission System Warning** will be cancelled and a new one issued.

- (d) A **GB Transmission System Warning** is no longer applicable once the period has passed and to confirm this **NGET** will issue a **Cancellation of GB Transmission System Warning**.

OC7.5 PROCEDURE IN RELATION TO **INTEGRAL EQUIPMENT TESTS**

OC7.5.1 This section of the **Grid Code** deals with **Integral Equipment Tests**. It is designed to provide a framework for the exchange of relevant information and for discussion between **NGET** and certain **Users** in relation to **Integral Equipment Tests**.

OC7.5.2 An **Integral Equipment Test** :-

- (a) is carried out in accordance with the provisions of this OC7.5 at:-
  - i) a **User Site**,
  - ii) a **Transmission Site**,
  - iii) an **Embedded Large Power Station**, or,
  - iv) an **Embedded DC Converter Station**;

- (b) will normally be undertaken during commissioning or re-commissioning of **Plant** and/or **Apparatus**;
- (c) may, in the reasonable judgement of the person wishing to perform the test, cause, or have the potential to cause, an **Operational Effect** on a part or parts of the **Total System** but which with prior notice is unlikely to have a materially adverse effect on any part of the **Total System**; and
- (d) may form part of an agreed programme of work.

OC7.5.3 A set of guidance notes is available from **NGET** on request, which provide further details on suggested procedures, information flows and responsibilities.

Notification of an **IET**

OC7.5.4 In order to undertake an **Integral Equipment Test** (and subject to OC7.5.8 below), the **User** or **NGET**, as the case may be, (the proposer) must notify the other (the recipient) of a proposed **IET**. Reasonable advance notification must be given, taking into account the nature of the test and the circumstances which make the test necessary. This will allow recipients time to adequately assess the impact of the **IET** on their **System**.

OC7.5.5 The notification of the **IET** must normally include the following information:-

- a) the proposed date and time of the **IET**;
- b) the name of the individual and the organisation proposing the **IET**;
- c) a proposed programme of testing; and
- d) such further detail as the proposer reasonably believes the recipient needs in order to assess the effect the **IET** may have on relevant **Plant** and/or **Apparatus**.

OC7.5.6 In the case of an **IET** in connection with commissioning or re-commissioning, the test should be incorporated as part of any overall commissioning programme agreed between **NGET** and the **User**.

Response to notification of an **IET**

OC7.5.7 The recipient of notification of an **IET** must respond within a reasonable timescale prior to the start time of the **IET** and will not unreasonably withhold or delay acceptance of the **IET** proposal.

OC7.5.8 (a) Where **NGET** receives notification of a proposed **IET** from a **User**, **NGET** will consult those other **Users** whom it reasonably believes may be affected by the proposed **IET** to seek their views. Information relating to the proposed **IET** may be passed on by **NGET** with the prior agreement of the proposer. However it is not necessary for **NGET** to obtain the agreement of any such **User** as **IETs** should not involve the application of irregular, unusual or extreme conditions. **NGET** may however consider any comments received when deciding whether or not to agree to an **IET**.

(b) In the case of an **Embedded Large Power Station** or **Embedded DC Converter Station**, the **Generator** or **DC Converter Station** owner as the

case may be must liaise with both **NGET** and the relevant **Network Operator**. **NGET** will not agree to an **IET** relating to such **Plant** until the **Generator** or **DC Converter Station** owner has shown that it has the agreement of the relevant **Network Operator**.

- (c) A **Network Operator** will liaise with **NGET** as necessary in those instances where it is aware of an **Embedded Small Power Station** or an **Embedded Medium Power Station** which intends to perform tests which in the reasonable judgement of the **Network Operator** may cause an **Operational Effect** on the **GB Transmission System**.

OC7.5.9 The response from the recipient, following notification of an **IET** must be one of the following:-

- a) to accept the **IET** proposal;
- b) to accept the **IET** proposal conditionally subject to minor modifications such as date and time;
- c) not to agree the **IET**, but to suggest alterations to the detail and timing of the **IET** that are necessary to make the **IET** acceptable.

Final confirmation of an **IET**

OC7.5.10 The date and time of an **IET** will be confirmed between **NGET** and the **User**, together with any limitations and restrictions on operation of **Plant** and/or **Apparatus**.

OC7.5.11 The **IET** may subsequently be amended following discussion and agreement between **NGET** and the **User**.

Carrying out an **IET**

OC7.5.12 **IETs** may only take place when agreement has been reached and must be carried out in accordance with the agreed programme of testing.

OC7.5.13 The implementation of an **IET** will be notified in accordance with OC7.4.5.

OC7.5.14 Where elements of the programme of testing change during the **IET**, there must be discussion between the appropriate parties to identify whether the **IET** should continue.

OC7.6 PROCEDURE IN RESPECT OF **OPERATIONAL SWITCHING** IN SCOTLAND

OC7.6.1 This section OC7.6 of the **Grid Code** sets out the procedure to be followed for **Operational Switching** in Scotland. Its provisions are supplementary to the provisions of the rest of this **OC7**.

It is designed to set down the arrangements for **NGET**, **Users** and the **Relevant Transmission Licensees** in respect of the **Operational Switching** of **Plant** and **Apparatus** at a **Connection Site** and parts of the **GB Transmission System** adjacent to that **Connection Site**.

OC7.6.2 In general:



- (i) **NGET** is responsible for directing the configuration of the **GB Transmission System**
- (ii) Each **Relevant Transmission Licensee** is responsible for the instruction and operation of its **Plant** and **Apparatus** on its **Transmission System**
- (iii) Each **User** is responsible for the configuration, instruction and operation of its **Plant** and **Apparatus**.

Definitive schedules of these responsibilities for each **Connection Site** are contained in the relevant **Site Responsibility Schedules**.

For the avoidance of doubt, where a **User** operates **Transmission Plant** and **Apparatus** on behalf of a **Relevant Transmission Licensee**, **NGET** cannot instruct the **User** to operate that **Plant** and **Apparatus**.

#### Planned Operational Switching

OC7.6.3 Following the notification of an **Operation** under OC7.4.5, **NGET** and the **User** shall discuss the **Operational Switching** required. **NGET** will then discuss and agree the details of the **Operational Switching** with the **Relevant Transmission Licensee**. The **Relevant Transmission Licensee** shall then make contact with the **User** to initiate the **Operational Switching**. For the avoidance of doubt, from the time that the **Relevant Transmission Licensee** makes contact with the **User**, the **Relevant Transmission Licensee** shall then become the primary point of operational contact with the **User** in relation to **OC7** for matters which would or could affect, or would or could be affected by the **Operational Switching**.

OC7.6.4 The **User** shall be advised by the **Relevant Transmission Licensee** on the completion of the **Operational Switching**, that **NGET** shall again become the primary point of operational contact for the **User** in relation to **OC7**.

OC7.6.5 During **Operational Switching**, either the **Relevant Transmission Licensee** or the **User** may need to unexpectedly terminate the **Operational Switching**. **NGET** may also need to terminate the **Operational Switching** during the **Operational Switching**. In the event of unexpected termination of the **Operational Switching**, **NGET** shall become the primary point of operational contact for the **User** in relation to **OC7**. Following the termination of the **Operational Switching**, it will not be permitted to restart that **Operational Switching** without the parties again following the process described in OC7.6.3.

#### Emergencies

OC7.6.6 For **Operations** and/or **Events** that present an immediate hazard to the safety of personnel, **Plant** or **Apparatus**, the **Relevant Transmission Licensee** may:

- (i) as permitted by the **STC**, carry out **Operational Switching** of **Plant** and **Apparatus** on its **Transmission System** without reference to **NGET** and the **User**, and
- (ii) request a **User** to carry out **Operational Switching** without the **User** first receiving notification from **NGET**.

In such emergency circumstances, communication between the **Relevant Transmission Licensee** and the **User** shall normally be by telephone and will

include an exchange of names. The **User** shall use all reasonable endeavours to carry out **Operational Switching** on its **Plant** and **Apparatus** without delay. Following completion of the requested **Operational Switching**, the **Relevant Transmission Licensee** shall notify **NGET** of the **Operational Switching** which has taken place. In such emergency circumstances, the **User** may only refuse to carry out **Operational Switching** on safety grounds (relating to personnel or plant) and this must be notified to the **Relevant Transmission Licensee** immediately by telephone.

OC7.6.7 For **Operations** and/or **Events** that present an immediate hazard to the safety of personnel, **Plant** or **Apparatus**, and which require **Operational Switching** of **Plant** or **Apparatus** on a **Transmission System** in order to remove the hazard, the **User** should contact the **Relevant Transmission Licensee** directly to request **Operational Switching** of **Plant** or **Apparatus** on its **Transmission System**.

In such emergency circumstances, communication between the **Relevant Transmission Licensee** and the **User** shall normally be by telephone and will include an exchange of names. The **Relevant Transmission Licensee** shall use all reasonable endeavours to carry out **Operational Switching** on its **Plant** and **Apparatus** without delay. Following completion of the requested **Operational Switching**, the **User** shall notify **NGET** of the **Operational Switching** which has taken place. In such emergency circumstances, the **Relevant Transmission Licensee** may only refuse to carry out **Operational Switching** on safety grounds (relating to personnel or plant) and this must be notified to the **User** immediately by telephone.

OC7.6.8 Establishment of a **Local Switching Procedure**

- (a) **NGET**, a **User** or a **Relevant Transmission Licensee** may reasonably require a **Local Switching Procedure** to be established.
- (b) Where the need for a **Local Switching Procedure** arises the following provisions shall apply:-
  - (i) **NGET**, **User(s)** and the **Relevant Transmission Licensee** will discuss and agree the detail of the **Local Switching Procedure** as soon as the requirement for a **Local Switching Procedure** is identified. **NGET** will notify the **Relevant Transmission Licensee** and the affected **User(s)** and will initiate these discussions.
  - (ii) Each **Local Switching Procedure** shall be in relation to either one or more **Connection Sites** and parts of the **GB Transmission System** adjacent to the **Connection Site(s)**
  - (iii) A draft **Local Switching Procedure** shall be prepared by the **Relevant Transmission Licensee** to reflect the agreement reached and shall be sent to **NGET**.
  - (iv) When a **Local Switching Procedure** has been prepared, it shall be sent by **NGET** to the **Relevant Transmission Licensee** and **User(s)** for confirmation of its accuracy.
  - (v) The **Local Switching Procedure** shall then be signed on behalf of **NGET** and on behalf of each **User** and **Relevant Transmission Licensee** by way of written confirmation of its accuracy.

- (vi) Once agreed under this OC7.6.8, the procedure will become a **Local Switching Procedure** under the **Grid Code**, and (subject to any change pursuant to this **OC7**) will apply between **NGET**, **Relevant Transmission Licensee** and the relevant **User(s)** as if it were part of the **Grid Code**.
- (vii) Once signed, **NGET** will send a copy of the **Local Switching Procedure** to the **Relevant Transmission Licensee** and the **User(s)**.
- (viii) An agreed **Local Switching Procedure** should be referenced by relevant **Site Responsibility Schedules**.
- (ix) **NGET**, the **User(s)** and the **Relevant Transmission Licensee** must make the **Local Switching Procedure** readily available to the relevant operational staff.
- (x) If the **Relevant Transmission Licensee** or the **User(s)** become aware that a change is needed to a **Local Switching Procedure**, they must inform **NGET** immediately. Where **NGET** has been informed of a need for a change, or **NGET** proposes a change, **NGET** shall notify both the affected **User** and the **Relevant Transmission Licensee** and will initiate discussions to agree a change to the **Local Switching Procedure**. The principles applying to the establishment of a new **Local Switching Procedure** shall then apply to the discussion and agreement of any changes.

**GB TRANSMISSION SYSTEM WARNINGS TABLE**

<b>WARNING TYPE</b>	<b>Grid Code</b>	<b>FORM T</b>	<b>to : for ACTION</b>	<b>to : for INFORMA</b>	<b>TIMESCALE</b>	<b>WARNING OF/OR CONSEQUENCE</b>	<b>Response From Recipients</b>
<b>GB TRANSMISSION SYSTEM WARNING</b> - Inadequate System Margin	OC7.4.8.5	Fax or other electronic means	Generators, Suppliers, Externally Interconnected System Operators, <b>DC Converter Station</b> owners	Network Operators, Non-Embedded Customers	All timescales when at the time there is not a high risk of Demand reduction.  Primarily 1200 hours onwards for a future period.	Insufficient generation available to meet forecast Demand plus Operating Margin  Notification that if not improved Demand reduction may be instructed.  (Normal initial warning of insufficient System Margin)	Offers of increased availability from Generators or <b>DC Converter Station</b> owners and Interconnector Users.  Suppliers notify <b>NGET</b> of any additional Customer Demand Management that they will initiate.
<b>GB TRANSMISSION SYSTEM WARNING</b> - High Risk of Demand Reduction	OC7.4.8.6	Fax or other electronic means	Generators, Suppliers, Network Operators, Non-Embedded Customers, Externally Interconnected System Operators, <b>DC Converter Station</b> owners		All timescales where there is a high risk of Demand reduction.  Primarily 1200 hours onwards for a future period.	Insufficient generation available to meet forecast Demand plus Operating Margin and /or a high risk of Demand reduction being instructed.  (May be issued locally as Demand reduction risk only for circuit overloads)	Offers of increased availability from Generators or <b>DC Converter Station</b> owners and Interconnector Users.  Suppliers notify <b>NGET</b> of any additional Customer Demand Management that they will initiate.  Specified Network Operators and Non-Embedded Customers to prepare their Demand reduction arrangements and take actions as necessary to enable compliance with <b>NGET</b> instructions that may follow.  (Percentages of Demand reduction above 20 % may not be achieved if <b>NGET</b> has not issued the warning by 16.00 hours the previous day).
<b>GB TRANSMISSION SYSTEM WARNING</b> - Demand Control Imminent	OC7.4.8.7	Fax/ Telephone or other electronic means	<b>Specified Users only :</b> (to whom an instruction is to be given) Network Operators, Non-Embedded Customers	None	within 30 minutes of anticipated instruction.	Possibility of Demand reduction within 30 minutes.	Network Operators specified to prepare to take action as necessary to enable them to comply with any subsequent <b>NGET</b> instruction for Demand reduction.
<b>GB TRANSMISSION SYSTEM WARNING</b> - Risk of System Disturbance	OC7.4.8.8	Fax/ Telephone or other electronic means	Generators, <b>DC Converter Station</b> owners Network Operators, Non-Embedded Customers, Externally Interconnected System Operators who may be affected.	Suppliers	Control room timescales	Risk of, or widespread system disturbance to whole or part of the <b>GB Transmission System</b>	Recipients take steps to warn operational staff and maintain plant or apparatus such that they are best able to withstand the disturbance.

< End of OC7 >

# OPERATING CODE NO.8

## SAFETY CO-ORDINATION

### CONTENTS

(This contents page does not form part of the Grid Code)

<u>Paragraph No/Title</u>	<u>Page Number</u>
OC8.1 INTRODUCTION .....	1
OC8.2 OBJECTIVE .....	1
OC8.3 SCOPE.....	1
OC8.4 PROCEDURE.....	2
OC8.4.1 Safety Co-ordination in England and Wales .....	2
OC8.4.2 Safety Co-ordination in Scotland .....	2
<b>OC8 Appendix 1</b> Safety Co-ordination in England and Wales .....	OC8A-1
<b>OC8 Appendix 2</b> Safety Co-ordination in Scotland .....	OC8B-1



## OPERATING CODE NO.8

### SAFETY CO-ORDINATION

#### OC8.1 INTRODUCTION

OC8.1.1 **OC8** specifies the standard procedures to be used for the co-ordination, establishment and maintenance of necessary **Safety Precautions** when work is to be carried out on or near the **GB Transmission System** or the **System** of a **User** and when there is a need for **Safety Precautions** on **HV Apparatus** on the other **System** for this work to be carried out safely. **OC8** Appendix 1 applies when work is to be carried out on or near to **Systems** in England and Wales and **OC8** Appendix 2 applies when work is to be carried out on or near to **Systems** in Scotland.

OC8.1.2 **OC8** also covers the co-ordination, establishment and maintenance of necessary safety precautions on the **Implementing Safety Co-ordinator's System** when work is to be carried out at a **User's Site** or a **Transmission Site** (as the case may be) on equipment of the **User** or a **Transmission Licensee** as the case may be where the work or equipment is near to **HV Apparatus** on the **Implementing Safety Co-ordinator's System**.

#### OC.8.2 OBJECTIVE

OC8.2.1 The objective of OC8 is to achieve:-

- (i) **Safety From The System** when work on or near a **System** necessitates the provision of **Safety Precautions** on another **System** on **HV Apparatus** up to a **Connection Point**; and
- (ii) **Safety From The System** when work is to be carried out at a **User's Site** or a **Transmission Site** (as the case may be) on equipment of the **User** or a **Transmission Licensee** (as the case may be) where the work or equipment is near to **HV Apparatus** on the **Implementing Safety Co-ordinator's System**.

#### OC8.3 SCOPE

OC8.3.1 **OC8** applies to **NGET** and to **Users**, which in **OC8** means:-

- (a) **Generators**;
- (b) **Network Operators**; and
- (c) **Non-Embedded Customers**.

In Scotland **OC8** also applies to **Relevant Transmission Licensees**.

The procedures for the establishment of safety co-ordination by **NGET** in relation to **External Interconnections** are set out in **Interconnection Agreements** with relevant persons for the **External Interconnections**.

OC8.4      PROCEDURE

OC8.4.1      Safety Co-ordination in England and Wales

OC8.4.1.1      **OC8** Appendix 1, OC8A, applies when work is to be carried out on or near to **Systems** in England and Wales or when **Safety Precautions** are required to be established in England and Wales when work is to be carried out on or near to **Systems** in Scotland.

OC8.4.2      Safety Co-ordination in Scotland

OC8.4.2.1      **OC8** Appendix 2, OC8B, applies when work is to be carried out on or near to **Systems** in Scotland or when **Safety Precautions** are required to be established in Scotland when work is to be carried out on or near to **Systems** in England or Wales.



## OPERATING CODE NO.8 Appendix 1 (OC8A)

### SAFETY CO-ORDINATION IN ENGLAND AND WALES

## CONTENTS

(This contents page does not form part of the Grid Code)

<u>Paragraph No/Title</u>	<u>Page Number</u>
OC8A.1 INTRODUCTION .....	OC8A -1
OC8A.2 OBJECTIVE.....	OC8A -2
OC8A.3 SCOPE.....	OC8A -3
OC8A.4 PROCEDURE.....	OC8A -3
OC8A.4.1 Approval of Local Safety Instructions .....	OC8A -3
OC8A.4.2 Safety Co-ordinators .....	OC8A -4
OC8A.4.3 RISSP .....	OC8A -4
OC8A.5 SAFETY PRECAUTIONS ON HV APPARATUS .....	OC8A -5
OC8A.5.1 Agreement of Safety Precautions.....	OC8A -5
OC8A.5.2 Implementation of Isolation .....	OC8A -6
OC8A.5.3 Implementation of Earthing .....	OC8A -7
OC8A.5.4 RISSP Issue Procedure .....	OC8A -8
OC8A.5.5 RISSP Cancellation Procedure .....	OC8A -9
OC8A.5.6 RISSP Change Control .....	OC8A -9
OC8A.6 TESTING AFFECTING ANOTHER SAFETY CO-ORDINATOR'S SYSTEM .....	OC8A -9
OC8A.7 EMERGENCY SITUATIONS .....	OC8A -9
OC8A.8 SAFETY PRECAUTIONS RELATING TO WORKING ON EQUIPMENT NEAR TO THE HV SYSTEM.....	OC8A -11
OC8A.8.1 Agreement of Safety Precautions.....	OC8A -11
OC8A.8.2 Implementation of Isolation and Earthing .....	OC8A -12
OC8A.8.3 Permit for Work for proximity work Issue Procedure .....	OC8A -12
OC8A.8.4 Permit for Work for proximity work .....	OC8A -12

OC8A.9 LOSS OF INTEGRITY OF SAFETY PRECAUTIONS.....	OC8A -13
OC8A.10 SAFETY LOG.....	OC8A -13
<b>APPENDIX A – RISSP-R.....</b>	<b>OC8A -14</b>
<b>APPENDIX B – RISSP-I.....</b>	<b>OC8A -15</b>
<b>APPENDIX C – FLOWCHARTS .....</b>	<b>OC8A -16</b>
<b>APPENDIX D – NGSC.....</b>	<b>OC8A -20</b>
<b>APPENDIX E – Form of NGET Permit for Work .....</b>	<b>OC8A -21</b>

## OPERATING CODE NO.8 APPENDIX 1 (OC8A)

### SAFETY CO-ORDINATION IN ENGLAND AND WALES

#### OC8A.1 INTRODUCTION

OC8A.1.1 **OC8A** specifies the standard procedures to be used by **NGET** and **Users** for the co-ordination, establishment and maintenance of necessary **Safety Precautions** when work is to be carried out on or near the **GB Transmission System** in England and Wales or the **System** of a **User** in England and Wales and when there is a need for **Safety Precautions** on **HV Apparatus** on the other's **System** for this work to be carried out safely. **OC8A** applies to **NGET** and **Users** only in England and Wales. Where work is to be carried out on or near equipment in Scotland, but such work requires **Safety Precautions** to be established in England and Wales, **OC8A** should be followed by **NGET** and **Users** to establish the required **Safety Precautions** in England and Wales.

**OC8B** specifies the procedures to be used by the **Relevant Transmission Licensees** and **Users** in Scotland.

In this **OC8A** the term "work" includes testing, other than **System Tests** which are covered by **OC12**.

OC8A.1.2 **OC8A** also covers the co-ordination, establishment and maintenance of necessary safety precautions on the **Implementing Safety Co-ordinator's System** when work is to be carried out at a **User's Site** or a **Transmission Site** (as the case may be) on equipment of the **User** or **NGET** as the case may be where the work or equipment is near to **HV Apparatus** on the **Implementing Safety Co-ordinator's System**.

OC8A.1.3 **OC8A** does not apply to the situation where **Safety Precautions** need to be agreed solely between **Users**. **OC8A** does not apply to the situation where **Safety Precautions** need to be agreed solely between **Transmission Licensees**.

OC8A.1.4 **OC8A** does not seek to impose a particular set of **Safety Rules** on **NGET** and **Users**; the **Safety Rules** to be adopted and used by **NGET** and each **User** shall be those chosen by each.

OC8A.1.5 **Site Responsibility Schedules** document the control responsibility for each item of **Plant** and **Apparatus** for each site.

#### OC8A.1.6 Defined terms

OC8A.1.6.1 **Users** should bear in mind that in **OC8** only, in order that **OC8** reads more easily with the terminology used in certain **Safety Rules**, the term "**HV Apparatus**" is defined more restrictively and is used accordingly in **OC8A**. **Users** should, therefore, exercise caution in relation to this term when reading and using **OC8A**.

OC8A.1.6.2 In **OC8A** only the following terms shall have the following meanings:

- (1) "**HV Apparatus**" means **High Voltage** electrical circuits forming part of a **System**, on which **Safety From The System** may be required or on which **Safety Precautions** may be applied to allow work to be carried out on a **System**.
- (2) "**Isolation**" means the disconnection of **Apparatus** from the remainder of the **System** in which that **Apparatus** is situated by either of the following:
  - (a) an **Isolating Device** maintained in an isolating position. The isolating position must either be:
    - (i) maintained by immobilising and **Locking** the **Isolating Device** in the isolating position and affixing a **Caution Notice** to it. Where the **Isolating Device** is **Locked** with a **Safety Key**, the **Safety Key** must be secured in a **Key Safe** and the **Key Safe Key** must be, where reasonably practicable, given to the authorised site representative of the **Requesting Safety Co-Ordinator** and is to be retained in safe custody. Where not reasonably practicable the **Key Safe Key** must be retained by the authorised site representative of the **Implementing Safety Co-Ordinator** in safe custody; or
    - (ii) maintained and/or secured by such other method which must be in accordance with the **Local Safety Instructions** of **NGET** or that **User**, as the case may be; or
  - (b) an adequate physical separation which must be in accordance with, and maintained by, the method set out in the **Local Safety Instructions** of **NGET** or that **User**, as the case may be, and, if it is a part of that method, a **Caution Notice** must be placed at the point of separation.
- (3) "**Earthing**" means a way of providing a connection between conductors and earth by an **Earthing Device** which is either:
  - (i) immobilised and **Locked** in the earthing position. Where the **Earthing Device** is **Locked** with a **Safety Key**, the **Safety Key** must be secured in a **Key Safe** and the **Key Safe Key** must be, where reasonably practicable, given to the authorised site representative of the **Requesting Safety Co-Ordinator** and is to be retained in safe custody. Where not reasonably practicable the **Key Safe Key** must be retained by the authorised site representative of the **Implementing Safety Co-Ordinator** in safe custody; or
  - (ii) maintained and/or secured in position by such other method which must be in accordance with the **Local Safety Instructions** of **NGET** or that **User** as the case may be.

OC8A.1.6.3 For the purpose of the co-ordination of safety relating to **HV Apparatus** the term "**Safety Precautions**" means **Isolation** and/or **Earthing**.

OC8A.2 OBJECTIVE

- OC8A.2.1 The objective of **OC8A** is to achieve:-
- (i) **Safety From The System** when work on or near a **System** necessitates the provision of **Safety Precautions** on another **System** on **HV Apparatus** up to a **Connection Point**; and
  - (ii) **Safety From The System** when work is to be carried out at a **User's Site** or a **Transmission Site** (as the case may be) on equipment of the **User** or **NGET** (as the case may be) where the work or equipment is near to **HV Apparatus** on the **Implementing Safety Co-ordinator's System**.

OC8A.2.2 A flow chart, set out in **OC8A Appendix C**, illustrates the process utilised in **OC8A** to achieve the objective set out in OC8A.2.1. In the case of a conflict between the flow chart and the provisions of the written text of **OC8A**, the written text will prevail.

### OC8A.3 SCOPE

OC8A.3.1 **OC8A** applies to **NGET** and to **Users** in England and Wales, which in OC8A means:-

- (a) **Generators**;
- (b) **Network Operators**; and
- (c) **Non-Embedded Customers**.

The procedures for the establishment of safety co-ordination by **NGET** in relation to **External Interconnections** are set out in **Interconnection Agreements** with relevant persons for the **External Interconnections**.

### OC8A.4 PROCEDURE

#### OC8A.4.1 Approval of Local Safety Instructions

- OC8A.4.1.1
- (a) In accordance with the timing requirements of its **Bilateral Agreement**, each **User** will supply to **NGET** a copy of its **Local Safety Instructions** relating to its side of the **Connection Point** at each **Connection Site**.
  - (b) In accordance with the timing requirements of each **Bilateral Agreement**, **NGET** will supply to each **User** a copy of its **Local Safety Instructions** relating to the **Transmission** side of the **Connection Point** at each **Connection Site**.
  - (c) Prior to connection **NGET** and the **User** must have approved each other's relevant **Local Safety Instructions** in relation to **Isolation** and **Earthing**.

OC8A.4.1.2 Either party may require that the **Isolation** and/or **Earthing** provisions in the other party's **Local Safety Instructions** affecting the **Connection Site** should be made more stringent in order that approval of the other party's **Local Safety Instructions** can be given. Provided these requirements are not unreasonable, the other party will make such changes as soon as reasonably practicable. These changes may need to

cover the application of **Isolation** and/or **Earthing** at a place remote from the **Connection Site**, depending upon the **System** layout. Approval may not be withheld because the party required to approve reasonably believes the provisions relating to **Isolation** and/or **Earthing** are too stringent.

OC8A.4.1.3 If, following approval, a party wishes to change the provisions in its **Local Safety Instructions** relating to **Isolation** and/or **Earthing**, it must inform the other party. If the change is to make the provisions more stringent, then the other party merely has to note the changes. If the change is to make the provisions less stringent, then the other party needs to approve the new provisions and the procedures referred to in OC8A.4.1.2 apply.

#### OC8A.4.2 **Safety Co-ordinators**

OC8A.4.2.1 For each **Connection Point**, **NGET** and each **User** will at all times have nominated and available a person or persons ("**Safety Co-ordinator(s)**") to be responsible for the co-ordination of **Safety Precautions** when work is to be carried out on a **System** which necessitates the provision of **Safety Precautions** on **HV Apparatus** pursuant to **OC8A**. A **Safety Co-ordinator** may be responsible for the co-ordination of safety on **HV Apparatus** at more than one **Connection Point**.

OC8A.4.2.2 Each **Safety Co-ordinator** shall be authorised by **NGET** or a **User**, as the case may be, as competent to carry out the functions set out in **OC8A** to achieve **Safety From The System**. Confirmation from **NGET** or a **User**, as the case may be, that its **Safety Co-ordinator(s)** as a group are so authorised is dealt with in CC.5.2. Only persons with such authorisation will carry out the provisions of **OC8A**.

OC8A.4.2.3 Contact between **Safety Co-ordinators** will be made via normal operational channels, and accordingly separate telephone numbers for **Safety Co-ordinators** need not be provided. At the time of making contact, each party will confirm that they are authorised to act as a **Safety Co-ordinator**, pursuant to **OC8A**.

OC8A.4.2.4 If work is to be carried out on a **System**, or on equipment of **NGET** or a **User** near to a **System**, as provided in this **OC8A**, which necessitates the provision of **Safety Precautions** on **HV Apparatus** in accordance with the provisions of **OC8A**, the **Requesting Safety Co-ordinator** who requires the **Safety Precautions** to be provided shall contact the relevant **Implementing Safety Co-ordinator** to co-ordinate the establishment of the **Safety Precautions**.

#### OC8A.4.3 **RISSP**

OC8A.4.3.1 **OC8A** sets out the procedures for utilising the **RISSP**, which will be used except where dealing with equipment in proximity to the other's **System** as provided in OC8A.8. Sections OC8A.4 to OC8A.7 inclusive should be read accordingly.

OC8A.4.3.2 **NGET** will use the format of the **RISSP** forms set out in Appendix A and Appendix B to **OC8A**. That set out in **OC8A** Appendix A and designated as "RISSP-R", shall be used when **NGET** is the **Requesting Safety Co-ordinator**, and that in **OC8A** Appendix B and designated as "RISSP-I", shall be used when **NGET** is the **Implementing Safety Co-ordinator**. Proformas of RISSP-R and RISSP-I will be provided for use by **NGET** staff.

- OC8A.4.3.3 (a) **Users** may either adopt the format referred to in OC8A.4.3.2, or use an equivalent format, provided that it includes sections requiring insertion of the same information and has the same numbering of sections as RISSP-R and RISSP-I as set out in Appendices A and B respectively.
- (b) Whether **Users** adopt the format referred to in OC8A.4.3.2, or use the equivalent format as above, the format may be produced and held in, and retrieved from an electronic form by the **User**.
- (c) Whichever method **Users** choose, each must provide proformas (whether in tangible or electronic form) for use by its staff.
- OC8A.4.3.4 All references to RISSP-R and RISSP-I shall be taken as referring to the corresponding parts of the alternative forms or other tangible written or electronic records used by each **User**.
- OC8A.4.3.5 RISSP-R will have an identifying number written or printed on it, comprising a prefix which identifies the location at which it is issued, and a unique (for each **User** or **NGET**, as the case may be) serial number consisting of four digits and the suffix "R".
- OC8A.4.3.6 (a) In accordance with the timing requirements set out in CC.5.2 each **User** shall apply in writing to **NGET** for **NGET's** approval of its proposed prefix.
- (b) **NGET** shall consider the proposed prefix to see if it is the same as (or confusingly similar to) a prefix used by **NGET** or another **User** and shall, as soon as possible (and in any event within ten days), respond in writing to the **User** with its approval or disapproval.
- (c) If **NGET** disapproves, it shall explain in its response why it has disapproved and will suggest an alternative prefix.
- (d) If **NGET** has disapproved, then the **User** shall either notify **NGET** in writing of its acceptance of the suggested alternative prefix or it shall apply in writing to **NGET** with revised proposals and the above procedure shall apply to that application.
- OC8A.4.3.7 The prefix allocation will be periodically circulated by **NGET** to all **Users**, for information purposes, using a National Grid Safety Circular in the form set out in **OC8A** Appendix D.

## OC8A.5 **SAFETY PRECAUTIONS ON HV APPARATUS**

### OC8A.5.1 **Agreement of Safety Precautions**

OC8A.5.1.1 The **Requesting Safety Co-ordinator** who requires **Safety Precautions** on another **System(s)** will contact the relevant **Implementing Safety Co-ordinator(s)** to agree the **Location** of the **Safety Precautions** to be established. This agreement will be recorded in the respective **Safety Logs**.

OC8A.5.1.2 It is the responsibility of the **Implementing Safety Co-ordinator** to ensure that adequate **Safety Precautions** are established and maintained, on his and/or another **System** connected to his **System**, to enable **Safety From The System** to be

achieved on the **HV Apparatus**, specified by the **Requesting Safety Co-ordinator** which is to be identified in Part 1.1 of the **RISSP**. Reference to another **System** in this OC8A.5.1.2 shall not include the **Requesting Safety Co-ordinator's System** which is dealt with in OC8A.5.1.3.

OC8A.5.1.3 When the **Implementing Safety Co-ordinator** is of the reasonable opinion that it is necessary for **Safety Precautions** on the **System** of the **Requesting Safety Co-ordinator**, other than on the **HV Apparatus** specified by the **Requesting Safety Co-ordinator**, which is to be identified in Part 1.1 of the **RISSP**, he shall contact the **Requesting Safety Co-ordinator** and the details shall be recorded in part 1.1 of the **RISSP** forms. In these circumstances it is the responsibility of the **Requesting Safety Co-ordinator** to establish and maintain such **Safety Precautions**.

OC8A.5.1.4 In the event of disagreement

In any case where the **Requesting Safety Co-ordinator** and the **Implementing Safety Co-ordinator** are unable to agree the **Location** of the **Isolation** and (if requested) **Earthing**, both shall be at the closest available points on the infeeds to the **HV Apparatus** on which **Safety From The System** is to be achieved as indicated on the **Operation Diagram**.

OC8A.5.2 Implementation of Isolation

OC8A.5.2.1 Following the agreement of the **Safety Precautions** in accordance with OC8A.5.1 the **Implementing Safety Co-ordinator** shall then establish the agreed **Isolation**.

OC8A.5.2.2 The **Implementing Safety Co-ordinator** shall confirm to the **Requesting Safety Co-ordinator** that the agreed **Isolation** has been established, and identify the **Requesting Safety Co-ordinator's HV Apparatus** up to the **Connection Point**, for which the **Isolation** has been provided. The confirmation shall specify:

- (a) for each **Location**, the identity (by means of **HV Apparatus** name, nomenclature and numbering or position, as applicable) of each point of **Isolation**;
- (b) whether **Isolation** has been achieved by an **Isolating Device** in the isolating position or by an adequate physical separation;
- (c) where an **Isolating Device** has been used whether the isolating position is either :
  - (i) maintained by immobilising and **Locking** the **Isolating Device** in the isolating position and affixing a **Caution Notice** to it. Where the **Isolating Device** has been **Locked** with a **Safety Key**, the confirmation shall specify that the **Safety Key** has been secured in a **Key Safe** and the **Key Safe Key** has been given to the authorised site representative of the **Requesting Safety Co-ordinator** where reasonably practicable and is to be retained in safe custody. Where not reasonably practicable (including where **Earthing** has been requested in OC8A.5.1), the confirmation shall specify that the **Key Safe Key** will be retained by the authorised site



representative of the **Implementing Safety Co-ordinator** in safe custody;  
or

- (ii) maintained and/or secured by such other method which must be in accordance with the **Local Safety Instructions** of **NGET** or that **User**, as the case may be; and
- (d) where an adequate physical separation has been used that it will be in accordance with, and maintained by, the method set out in the **Local Safety Instructions** of **NGET** or that **User**, as the case may be, and, if it is a part of that method, that a **Caution Notice** has been placed at the point of separation.

The confirmation of **Isolation** shall be recorded in the respective **Safety Logs**.

OC8A.5.2.3 Following the confirmation of **Isolation** being established by the **Implementing Safety Co-ordinator** and the necessary establishment of relevant **Isolation** on the **Requesting Safety Co-ordinators System**, the **Requesting Safety Co-ordinator** will then request the implementation of **Earthing** by the **Implementing Safety Co-ordinator**, if agreed in section OC8A.5.1. If the implementation of **Earthing** has been agreed, then the authorised site representative of the **Implementing Safety Co-ordinator** shall retain any **Key Safe Key** in safe custody until any **Safety Key** used for **Earthing** has been secured in the **Key Safe**.

#### OC8A.5.3 Implementation of Earthing

OC8A.5.3.1 The **Implementing Safety Co-ordinator** shall then establish the agreed **Earthing**.

OC8A.5.3.2 The **Implementing Safety Co-ordinator** shall confirm to the **Requesting Safety Co-ordinator** that the agreed **Earthing** has been established, and identify the **Requesting Safety Co-ordinator's HV Apparatus** up to the **Connection Point**, for which the **Earthing** has been provided. The confirmation shall specify:

- (a) for each **Location**, the identity (by means of **HV Apparatus** name, nomenclature and numbering or position, as is applicable) of each point of **Earthing**; and
- (b) in respect of the **Earthing Device** used, whether it is:
  - (i) immobilised and **Locked** in the earthing position. Where the **Earthing Device** has been **Locked** with a **Safety Key**, that the **Safety Key** has been secured in a **Key Safe** and the **Key Safe Key** has been given to the authorised site representative of the **Requesting Safety Co-ordinator** where reasonably practicable and is to be retained in safe custody. Where not reasonably practicable, that the **Key Safe Key** will be retained by the authorised site representative of the **Implementing Safety Co-ordinator** in safe custody; or
  - (ii) maintained and/or secured in position by such other method which is in accordance with the **Local Safety Instructions** of **NGET** or the **Relevant Transmission Licensee** or that **User**, as the case may be.

The confirmation of **Earthing** shall be recorded in the respective **Safety Logs**.

OC8A.5.3.3. The **Implementing Safety Co-ordinator** shall ensure that the established **Safety Precautions** are maintained until requested to be removed by the relevant **Requesting Safety Co-ordinator**.

OC8A.5.4 **RISSP Issue Procedure**

OC8A.5.4.1 Where **Safety Precautions** on another **System(s)** are being provided to enable work on the **Requesting Safety Co-ordinator's System**, before any work commences they must be recorded by a **RISSP** being issued. The **RISSP** is applicable to **HV Apparatus** up to the **Connection Point** identified in section 1.1 of the RISSP-R and RISSP-I forms.

OC8A.5.4.2 Where **Safety Precautions** are being provided to enable work to be carried out on both sides of the **Connection Point** a **RISSP** will need to be issued for each side of the **Connection Point** with **NGET** and the respective **User** each enacting the role of **Requesting Safety Co-ordinator**. This will result in a RISSP-R and a RISSP-I form being completed by each of the **NGET** and the **User**, with each **Requesting Safety Co-ordinator** issuing a separate **RISSP** number.

OC8A.5.4.3 Once the **Safety Precautions** have been established (in accordance with OC8A.5.2 and OC8A.5.3), the **Implementing Safety Co-ordinator** shall complete parts 1.1 and 1.2 of a RISSP-I form recording the details specified in OC8A.5.1.3, OC8A.5.2.2 and OC8A.5.3.2. Where **Earthing** has not been requested, Part 1.2(b) will be completed with the words "not applicable" or "N/A". He shall then contact the **Requesting Safety Co-ordinator** to pass on these details.

OC8A.5.4.4 The **Requesting Safety Co-ordinator** shall complete Parts 1.1 and 1.2 of the RISSP-R, making a precise copy of the details received. On completion, the **Requesting Safety Co-ordinator** shall read the entries made back to the sender and check that an accurate copy has been made.

OC8A.5.4.5 The **Requesting Safety Co-ordinator** shall then issue the number of the **RISSP**, taken from the RISSP-R, to the **Implementing Safety Co-ordinator** who will ensure that the number, including the prefix and suffix, is accurately recorded in the designated space on the RISSP-I form.

OC8A.5.4.6 The **Requesting Safety Co-ordinator** and the **Implementing Safety Co-ordinator** shall complete and sign Part 1.3 of the RISSP-R and RISSP-I respectively and then enter the time and date. When signed no alteration to the **RISSP** is permitted; the **RISSP** may only be cancelled.

OC8A.5.4.7 The **Requesting Safety Co-ordinator** is then free to authorise work (including a test that does not affect the **Implementing Safety Co-ordinator's System**) in accordance with the requirements of the relevant internal safety procedures which apply to the **Requesting Safety Co-ordinator's System**. This is likely to involve the issue of safety documents or other relevant internal authorisations. Where testing is to be carried out which affects the **Implementing Safety Co-ordinator's System**, the procedure set out below in OC8A.6 shall be implemented.

OC8A.5.5 **RISSP Cancellation Procedure**

OC8A.5.5.1 When the **Requesting Safety Co-ordinator** decides that **Safety Precautions** are no longer required, he will contact the relevant **Implementing Safety Co-ordinator** to effect cancellation of the associated **RISSP**.

OC8A.5.5.2 The **Requesting Safety Co-ordinator** will inform the relevant **Implementing Safety Co-ordinator** of the **RISSP** identifying number (including the prefix and suffix), and agree it is the **RISSP** to be cancelled.

OC8A.5.5.3 The **Requesting Safety Co-ordinator** and the relevant **Implementing Safety Co-ordinator** shall then respectively complete Part 2.1 of their respective RISSP-R and RISSP-I forms and shall then exchange details. The details being exchanged shall include their respective names and time and date. On completion of the exchange of details the respective **RISSP** is cancelled. The removal of **Safety Precautions** is as set out in OC8A.5.5.4 and OC8A.5.5.5.

OC8A.5.5.4 Neither **Safety Co-ordinator** shall instruct the removal of any **Isolation** forming part of the **Safety Precautions** as part of the returning of the **HV Apparatus** to service until it is confirmed to each by each other that every earth on each side of the **Connection Point**, within the points of isolation identified on the **RISSP**, has been removed or disconnected by the provision of additional **Points of Isolation**.

OC8A.5.5.5 Subject to the provisions in OC8A.5.5.4, the **Implementing Safety Co-ordinator** is then free to arrange the removal of the **Safety Precautions**, the procedure to achieve that being entirely an internal matter for the party the **Implementing Safety Co-ordinator** is representing. Where a **Key Safe Key** has been given to the authorised site representative of the **Requesting Safety Co-ordinator**, the **Key Safe Key** must be returned to the authorised site representative of the **Implementing Safety Co-ordinator**. The only situation in which any **Safety Precautions** may be removed without first cancelling the **RISSP** in accordance with OC8A.5.5 or OC8A.5.6 is when **Earthing** is removed in the situation envisaged in OC8A.6.2(b).

OC8A.5.6 **RISSP Change Control**

Nothing in this **OC8A** prevents **NGET** and **Users** agreeing to a simultaneous cancellation and issue of a new **RISSP**, if both agree. It should be noted, however, that the effect of that under the relevant **Safety Rules** is not a matter with which the **Grid Code** deals.

OC8A.6 **TESTING AFFECTING ANOTHER SAFETY CO-ORDINATOR'S SYSTEM**

OC8A.6.1 The carrying out of the test may affect **Safety Precautions** on **RISSPs** or work being carried out which does not require a **RISSP**. Testing can, for example, include the application of an independent test voltage. Accordingly, where the **Requesting Safety Co-ordinator** wishes to authorise the carrying out of such a test to which the procedures in OC8A.6 apply he may not do so and the test will not take place unless and until the steps in (a)-(c) below have been followed and confirmation of completion has been recorded in the respective **Safety Logs**:

- (a) confirmation must be obtained from the **Implementing Safety Co-ordinator** that:
  - (i) no person is working on, or testing, or has been authorised to work on, or test, any part of its **System** or another **System(s)** (other than the **System** of the **Requesting Safety Co-ordinator**) within the points of **Isolation** identified on the **RISSP** form relating to the test which is proposed to be undertaken, and
  - (ii) no person will be so authorised until the proposed test has been completed (or cancelled) and the **Requesting Safety Co-ordinator** has notified the **Implementing Safety Co-ordinator** of its completion (or cancellation);
- (b) any other current **RISSPs** which relate to the parts of the **System** in which the testing is to take place must have been cancelled in accordance with procedures set out in OC8A.5.5;
- (c) the **Implementing Safety Co-ordinator** must agree with the **Requesting Safety Co-ordinator** to permit the testing on that part of the **System** between the points of **Isolation** identified in the **RISSP** associated with the test and the points of **Isolation** on the **Requesting Safety Co-ordinator's System**.

- OC8A.6.2
- (a) The **Requesting Safety Co-ordinator** will inform the **Implementing Safety Co-ordinator** as soon as the test has been completed or cancelled and the confirmation shall be recorded in the respective **Safety Logs**.
  - (b) When the test gives rise to the removal of **Earthing** which it is not intended to re-apply, the relevant **RISSP** associated with the test shall be cancelled at the completion or cancellation of the test in accordance with the procedure set out in either OC8A.5.5 or OC8A.5.6. Where the **Earthing** is re-applied following the completion or cancellation of the test, there is no requirement to cancel the relevant **RISSP** associated with the test pursuant to this OC8A.6.2.

OC8A.7 EMERGENCY SITUATIONS

OC8A.7.1 There may be circumstances where **Safety Precautions** need to be established in relation to an unintended electrical connection or situations where there is an unintended risk of electrical connection between the **GB Transmission System** and a **User's System**, for example resulting from an incident where one line becomes attached or unacceptably close to another.

OC8A.7.2 In those circumstances, if both **NGET** and the respective **User** agree, the relevant provisions of OC8A.5 will apply as if the electrical connections or potential connections were, solely for the purposes of this **OC8A**, a **Connection Point**.

OC8A.7.3 (a) The relevant **Safety Co-ordinator** shall be that for the electrically closest existing **Connection Point** to that **User's System** or such other local **Connection Point** as may be agreed between **NGET** and the **User**, with discussions taking place between the relevant local **Safety Co-ordinators**. The