

All Recipients of the Serviced Grid Code

National Grid ESO
Faraday House
Gallows Hill
Warwick
CV34 6DA

grid.code@nationalgrideso.com
nationalgrideso.com

4 September 2023

THE SERVICED GRID CODE – ISSUE 6 REVISION 17

GC0148 - “Implementation of EU Emergency & Restoration Code Phase II’ has been approved by the authority for implementation on **4 September 2023**. The authority has directed that **ORIGINAL** be implemented.

To ensure your copy of the Grid Code remains up to date, you will need to replace the section affected with the revised version available on the [National Grid Electricity System Operator website](#).

The revisions document provides an overview of the changes made to the Grid Code since the previous issue.

Many thanks,

Code Administrator

National Grid Electricity System Operator

THE GRID CODE – ISSUE 6 REVISION 17

INCLUSION OF REVISED SECTION

- Glossary and Definitions
- Planning Code
- Connection Conditions
- European Connections Conditions
- European Compliance Processes
- Operating Code 5
- Operating Code 6
- General Conditions

SUMMARY OF CHANGES

The changes arise from the implementation of modifications proposed in the GC0148 Modification Report:

GC0148 - “Implementation of EU Emergency & Restoration Code Phase II’

Summary of GC0148 and Impact:

Original Proposal

This modification comprises of three parts, which include:

- The requirement to implement Article 15(5) - 15(8), Article 41 and Article 42 (1) (2) and (5) of the EU Emergency and Restoration Code which have completion dates of 18th December 2022;
- Addressing some outstanding issues from the implementation of the EU Emergency and Restoration Code in 2019 which relate to the treatment of storage under low frequency conditions and the treatment of how non-CUSC parties would fall under the remit of the EU Emergency and Restoration Code; and
- Consideration, if time permits, or as the Workgroup believe appropriate, the requirements relating to Distributed ReStart.

THE GRID CODE

ISSUE 6

REVISION 17

4 September 2023

© 2023 Copyright owned by National Grid Electricity System Operator Limited, all rights reserved.

No part of this publication may be reproduced in any material form (including photocopying and restoring in any medium or electronic means and whether or not transiently or incidentally) without the written permission of National Grid Electricity System Operator Limited, except:

1. to the extent that any party who is required to comply (or is exempt from complying) with the provisions under the Electricity Act 1989 reasonably needs to reproduce this publication to undertake its licence or statutory duties within Great Britain (or any agent appointed so to act on that party's behalf); and
2. in accordance with the provisions of the Copyright, Designs and Patents Act 1988.

GLOSSARY & DEFINITIONS (GD)

GD.1 In the Grid Code the following words and expressions shall, unless the subject matter or context otherwise requires or is inconsistent therewith, bear the following meanings:

Access Group	<p>A group of Connection Points within which a User declares under the Planning Code</p> <p>(a) An interconnection and/or</p> <p>(b) A need to redistribute Demand between those Connection Points either pre-fault or post-fault</p> <p>Where a single Connection Point does not form part of an Access Group in accordance with the above, that single Connection Point shall be considered to be an Access Group in its own right.</p>
Access Period	<p>A period of time in respect of which each Transmission Interface Circuit is to be assessed as whether or not it is capable of being maintained as derived in accordance with PC.A.4.1.4. The period shall commence and end on specified calendar weeks.</p>
Act	<p>The Electricity Act 1989 (as amended by the Utilities Act 2000 and the Energy Act 2004).</p>

<p>Active Control Based Droop Power</p>	<p>The Active Control Based Power output supplied by a Grid Forming Plant through controlled means (be it manual or automatic).</p> <p>For GBGF-I this is equivalent to a Synchronous Generating Unit with a traditional governor coupled to its prime mover.</p> <p>Active Control Based Droop Power is used by The Company to control System Frequency changes through the instruction of Primary Response and Secondary Response.</p>
<p>Active Control Based Power</p>	<p>The Active Power output supplied by a Grid Forming Plant through controlled means (be it manual or automatic) of the positive phase sequence Root Mean Square Active Power produced at fundamental System Frequency by the control system of a Grid Forming Unit.</p> <p>For GBGF-I, this is equivalent to a Synchronous Generating Unit with a traditional governor coupled to its prime mover.</p> <p>Active Control Based Power includes Active Power changes that results from a change to the Grid Forming Plant Owners available set points that have a 5 Hz limit on the bandwidth of the provided response.</p> <p>Active Control Based Power also includes Active Power components produced by the normal operation of a Grid Forming Plant that comply with the Engineering Recommendation P28 limits. These Active Power components do not have a 5 Hz limit on the bandwidth of the provided response.</p> <p>Active Control Based Power does not include Active Power components proportional to System Frequency, slip or deviation that provide damping power to emulate the natural damping function provided by a real Synchronous Generating Unit.</p>

Active Damping Power	<p>The Active Power naturally injected or absorbed by a Grid Forming Plant to reduce Active Power oscillations in the Total System.</p> <p>More specifically, Active Damping Power is the damped response of a Grid Forming Plant to an oscillation between the voltage at the Grid Entry Point or User System Entry Point and the voltage of the Internal Voltage Source of the Grid Forming Plant.</p> <p>For the avoidance of doubt, Active Damping Power is an inherent capability of a Grid Forming Plant that starts to respond naturally, within less than 5ms to low frequency oscillations in the System Frequency.</p>
Active Energy	<p>The electrical energy produced, flowing or supplied by an electric circuit during a time interval, being the integral with respect to time of the instantaneous power, measured in units of watt-hours or standard multiples thereof, ie:</p> <p>1000 Wh = 1 kWh 1000 kWh = 1 MWh 1000 MWh = 1 GWh 1000 GWh = 1 TWh</p>
Active Frequency Response Power	<p>The injection or absorption of Active Power by a Grid Forming Plant to or from the Total System during a deviation of the System Frequency away from the Target Frequency.</p> <p>For a GBGF-I this is very similar to Primary Response but with a response time to achieve the declared service capability (which could be the Maximum Capacity or Registered Capacity) within 1 second.</p> <p>For GBGF-I this can rapidly inject or absorb Active Power in addition to the phase-based Active Inertia Power to provide a system with desirable NFP plot characteristics.</p> <p>Active Frequency Response Power can be produced by any viable control technology.</p>
Active Inertia Power	<p>The injection or absorption of Active Power by a Grid Forming Plant to or from the Total System during a System Frequency change.</p> <p>The transient injection or absorption of Active Power from a Grid Forming Plant to the Total System as a result of the ROCOF value at the Grid Entry Point or User System Entry Point. This requires a sufficient energy storage capacity of the Grid Forming Plant to meet the Grid Forming Capability requirements specified in ECC.6.3.19.</p> <p>For the avoidance of doubt, this includes the rotational inertial energy of the complete drive train of a Synchronous Generating Unit.</p> <p>Active Inertia Power is an inherent capability of a Grid Forming Plant to respond naturally, within less than 5ms, to changes in the System Frequency.</p> <p>For the avoidance of doubt, the Active Inertia Power has a slower frequency response compared with Active Phase Jump Power.</p>

<p>Active Phase Jump Power</p>	<p>The transient injection or absorption of Active Power from a Grid Forming Plant to the Total System as a result of changes in the phase angle between the Internal Voltage Source of the Grid Forming Plant and the Grid Entry Point or User System Entry Point.</p> <p>In the event of a disturbance or fault on the Total System, a Grid Forming Plant will instantaneously (within 5ms) inject or absorb Active Phase Jump Power to the Total System as a result of the phase angle change.</p> <p>For GBGF-I as a minimum value this is up to the Phase Jump Angle Limit Power.</p> <p>Active Phase Jump Power is an inherent capability of a Grid Forming Plant that starts to respond naturally, within less than 5 ms and can have frequency components of over 1000 Hz.</p>
<p>Active Power</p>	<p>The product of voltage and the in-phase component of alternating current measured in units of watts and standard multiples thereof, ie:</p> <p>1000 Watts = 1 kW</p> <p>1000 kW = 1 MW</p> <p>1000 MW = 1 GW</p> <p>1000 GW = 1 TW</p>
<p>Active ROCOF Response Power</p>	<p>The Active Inertia Power developed from a Grid Forming Plant plus the Active Frequency Response Power that can be supplied by a Grid Forming Plant when subject to a rate of change of the System Frequency.</p>

Additional BM Unit	Has the meaning as set out in the BSC
Affiliate	In relation to any person, any holding company or subsidiary of such person or any subsidiary of a holding company of such person, in each case within the meaning of Section 736, 736A and 736B of the Companies Act 1985 as substituted by section 144 of the Companies Act 1989 and, if that latter section is not in force at the Transfer Date , as if such section were in force at such date.
AF Rules	Has the meaning given to “allocation framework” in section 13(2) of the Energy Act 2013.
Agency	As defined in The Company’s Transmission Licence .
Aggregator	A BM Participant who controls one or more Additional BM Units or Secondary BM Units .
Aggregator Impact Matrix	Defined for an Additional BM Unit or a Secondary BM Unit . Provides data allowing The Company to model the result of a Bid-Offer Acceptance on each of the Grid Supply Points within the GSP Group over which the Additional BM Unit or Secondary BM Unit is defined.
Alternate Member	Shall mean an alternate member for the Panel Members elected or appointed in accordance with this GR.7.2(a) or (b).
Ancillary Service	A System Ancillary Service and/or a Commercial Ancillary Service , as the case may be. An Ancillary Service may include one or more Demand Response Services .
Ancillary Services Agreement	An agreement between a User and The Company for the payment by The Company to that User in respect of the provision by such User of Ancillary Services .
Annual Average Cold Spell Conditions or ACS Conditions	A particular combination of weather elements which gives rise to a level of peak Demand within a Financial Year which has a 50% chance of being exceeded as a result of weather variation alone.
Apparatus	Other than in OC8 , means all equipment in which electrical conductors are used, supported or of which they may form a part. In OC8 , it means High Voltage electrical circuits forming part of a System on which Safety Precautions may be applied to allow work and/or testing to be carried out on a System .
Apparent Power	The product of voltage and of alternating current measured in units of voltamperes and standard multiples thereof, ie: 1000 VA = 1 kVA 1000 kVA = 1 MVA
Approved Fast Track Proposal	Has the meaning given in GR.26.7, provided that no objection is received pursuant to GR.26.12.

Approved Grid Code Self-Governance Proposal	Has the meaning given in GR.24.10.
Approved Modification	Has the meaning given in GR.22.7
Authorised Certifier	An entity that issues Equipment Certificates and Power Generating Module Documents and whose accreditation is given by the United Kingdom Accreditation Service or such other body as may be established from time to time to carry out the function of accreditation.
Authorised Electricity Operator	Any person (other than The Company) who is authorised under the Act to generate, participate in the transmission of, distribute or supply electricity which shall include any Interconnector Owner or Interconnector User .
Authority-Led Modification	A Grid Code Modification Proposal in respect of a Significant Code Review , raised by the Authority pursuant to GR.17
Authority-Led Modification Report	Has the meaning given in GR.17.4.
Authority for Access	An authority which grants the holder the right to unaccompanied access to sites containing exposed HV conductors.
Authority, The	The Authority established by section 1 (1) of the Utilities Act 2000.
Automatic Voltage Regulator or AVR	The continuously acting automatic equipment controlling the terminal voltage of a Synchronous Generating Unit or Synchronous Power Generating Module by comparing the actual terminal voltage with a reference value and controlling by appropriate means the output of an Exciter , depending on the deviations.
Auxiliaries	Any item of Plant and/or Apparatus not directly a part of the boiler plant or Power Generating Module or Generating Unit or DC Converter or HVDC Equipment or Power Park Module , but required for the boiler plant's or Power Generating Module's or Generating Unit's or DC Converter's or HVDC Equipment's or Power Park Module's functional operation.
Auxiliary Diesel Engine	A diesel engine driving a Power Generating Module or Generating Unit which can supply a Unit Board or Station Board , which can start without an electrical power supply from outside the Power Station within which it is situated.
Auxiliary Gas Turbine	A Gas Turbine Unit , which can supply a Unit Board or Station Board , which can start without an electrical power supply from outside the Power Station within which it is situated.
Average Conditions	That combination of weather elements within a period of time which is the average of the observed values of those weather elements during equivalent periods over many years (sometimes referred to as normal weather).
Back-Up Protection	A Protection system which will operate when a system fault is not cleared by other Protection .

Balancing and Settlement Code or BSC	The code of that title as from time to time amended.
Balancing Code or BC	That portion of the Grid Code which specifies the Balancing Mechanism process.
Balancing Mechanism	Has the meaning set out in The Company's Transmission Licence
Balancing Mechanism Reporting Agent or BMRA	Has the meaning set out in the BSC .
Balancing Mechanism Reporting Service or BMRS	Has the meaning set out in the BSC .
Balancing Principles Statement	A statement prepared by The Company in accordance with Condition C16 of The Company's Transmission Licence .
Baseline Forecast	Has the meaning given to the term 'baseline forecast' in Section G of the BSC .
Bid-Offer Acceptance	(a) A communication issued by The Company in accordance with BC2.7; or (b) an Emergency Instruction to the extent provided for in BC2.9.2.3.
Bid-Offer Data	Has the meaning set out in the BSC .
Bilateral Agreement	Has the meaning set out in the CUSC .
Black Start	The procedure necessary for a recovery from a Total Shutdown or Partial Shutdown .
Black Start Capability	In the case of a Black Start Station , is the ability for at least one of its Gensets to Start-Up from Shutdown and to energise a part of the System and be Synchronised to the System upon instruction from The Company , within two hours, without an external electrical power supply. In the case of a Black Start HVDC System is the ability of an HVDC System to Start-Up from Shutdown and to energise a part of the System and be Synchronised to the System upon instruction from The Company , within two hours, without an external electrical power supply from the GB Synchronous Area .
Black Start Contract	An agreement between a Black Start Service Provider and The Company under which the Black Start Service Provider provides Black Start Capability and other associated services;
Black Start HVDC System	An HVDC System or DC Converter Station which are registered, pursuant to the Bilateral Agreement with a User , as having a Black Start Capability .
Black Start HVDC Test	A Black Start Test carried out by an HVDC System Owner or DC Converter Station Owner with a Black Start HVDC System while the Black Start HVDC System is disconnected from all external electrical power supplies from the GB Synchronous Area .
Black Start Service Provider	A Generator with a Black Start Station or an HVDC System Owner or DC Converter Station Owner with a Black Start HVDC System .

Black Start Stations	Power Stations which are registered, pursuant to the Bilateral Agreement with a User , as having a Black Start Capability .
Black Start Station Test	A Black Start Test carried out by a Generator with a Black Start Station while the Black Start Station is disconnected from all external electrical power supplies from the GB Synchronous Area .
Black Start Test	A Black Start Test carried out by a Black Start Service Provider on the instructions of The Company , in order to demonstrate that a Black Start Station or a Black Start HVDC System has a Black Start Capability . For the avoidance of doubt, a Black Start Test could comprise a Black Start Station Test , a Black Start Unit Test or Black Start HVDC Test .
Black Start Unit Test	A Black Start Test carried out on a Generating Unit or a CCGT Unit or a Power Generating Module , as the case may be, at a Black Start Station while the Black Start Station remains connected to an external alternating current electrical supply.
Block Loading Capability	The incremental Active Power steps, from no load to Rated MW , which a Generating Unit or Power Generating Module or Power Park Module or HVDC System or DC Converter Station can instantaneously supply without causing it to trip or go outside the Frequency range of 47.5Hz – 52Hz (or an otherwise agreed Frequency range). The time between each incremental step shall also be provided.
BM Participant	A person who is responsible for and controls one or more BM Units or where a Bilateral Agreement specifies that a User is required to be treated as a BM Participant for the purposes of the Grid Code. For the avoidance of doubt, it does not imply that they must be active in the Balancing Mechanism .
BM Unit	Has the meaning set out in the BSC , except that for the purposes of the Grid Code the reference to “Party” in the BSC shall be a reference to User .
BM Unit Data	The collection of parameters associated with each BM Unit , as described in Appendix 1 of BC1 .
Boiler Time Constant	Determined at Registered Capacity or Maximum Capacity (as applicable), the boiler time constant will be construed in accordance with the principles of the IEEE Committee Report "Dynamic Models for Steam and Hydro Turbines in Power System Studies" published in 1973 which apply to such phrase.
British Standards or BS	Those standards and specifications approved by the British Standards Institution.
BSCCo	Has the meaning set out in the BSC .
BSC Panel	Has meaning set out for “Panel” in the BSC .
Black Start Unit Test	A Black Start Test carried out on a Generating Unit or a CCGT Unit or a Power Generating Module , as the case may be, at a Black Start Station while the Black Start Station remains connected to an external alternating current electrical supply.

Business Day	Any week day (other than a Saturday) on which banks are open for domestic business in the City of London.
Cancellation of National Electricity Transmission System Warning	The notification given to Users when a National Electricity Transmission System Warning is cancelled.
Capacity Market Documents	The Capacity Market Rules , The Electricity Capacity Regulations 2014 and any other Regulations made under Chapter 3 of Part 2 of the Energy Act 2013 which are in force from time to time.
Capacity Market Rules	The rules made under section 34 of the Energy Act 2013 as modified from time to time in accordance with that section and The Electricity Capacity Regulations 2014.
Cascade Hydro Scheme	Two or more hydro-electric Generating Units , owned or controlled by the same Generator , which are located in the same water catchment area and are at different ordnance datums and which depend upon a common source of water for their operation, known as: <ul style="list-style-type: none"> (a) Moriston (b) Killin l Garry (d) Conon (e) Clunie (f) Beauly which will comprise more than one Power Station .
Cascade Hydro Scheme Matrix	The matrix described in Appendix 1 to BC1 under the heading Cascade Hydro Scheme Matrix .
Category 1 Intertripping Scheme	A System to Generator Operational Intertripping Scheme arising from a Variation to Connection Design following a request from the relevant User which is consistent with the criteria specified in the Security and Quality of Supply Standard .
Category 2 Intertripping Scheme	A System to Generator Operational Intertripping Scheme which is:- <ul style="list-style-type: none"> (i) required to alleviate an overload on a circuit which connects the Group containing the User's Connection Site to the National Electricity Transmission System; and (ii) installed in accordance with the requirements of the planning criteria of the Security and Quality of Supply Standard in order that measures can be taken to permit maintenance access for each transmission circuit and for such measures to be economically justified, and the operation of which results in a reduction in Active Power on the overloaded circuits which connect the User's Connection Site to the rest of the National Electricity Transmission System which is equal to the reduction in Active Power from the Connection Site (once any system losses or third party system effects are discounted).

Category 3 Intertripping Scheme	A System to Generator Operational Intertripping Scheme which, where agreed by The Company and the User , is installed to alleviate an overload on, and as an alternative to, the reinforcement of a third party system, such as the Distribution System of a Public Distribution System Operator .
Category 4 Intertripping Scheme	A System to Generator Operational Intertripping Scheme installed to enable the disconnection of the Connection Site from the National Electricity Transmission System in a controlled and efficient manner in order to facilitate the timely restoration of the National Electricity Transmission System .
Caution Notice	A notice conveying a warning against interference.
CENELEC	European Committee for Electrotechnical Standardisation.
Citizens Advice	Means the National Association of Citizens Advice Bureaux.
Citizens Advice Scotland	Means the Scottish Association of Citizens Advice Bureaux.
CfD Counterparty	A person designated as a “CfD counterparty” under section 7(1) of the Energy Act 2013.
CfD Documents	The AF Rules , The Contracts for Difference (Allocation) Regulations 2014, The Contracts for Difference (Definition of Eligible Generator) Regulations 2014 and The Contracts for Difference (Electricity Supplier Obligations) Regulations 2014 and any other regulations made under Chapter 2 of Part 2 of the Energy Act 2013 which are in force from time to time.
CfD Settlement Services Provider	means any person: <ul style="list-style-type: none"> (i) appointed for the time being and from time to time by a CfD Counterparty; or (ii) who is designated by virtue of Section C1.2.1B of the Balancing and Settlement Code, in either case to carry out any of the CFD settlement activities (or any successor entity performing CFD settlement activities).
CCGT Module Matrix	The matrix described in Appendix 1 to BC1 under the heading CCGT Module Matrix .
CCGT Module Planning Matrix	A matrix in the form set out in Appendix 3 of OC2 showing the combination of CCGT Units within a CCGT Module which would be running in relation to any given MW output.
Closed Distribution System or CDSO	A distribution system classified as a Closed Distribution System by the Authority which distributes electricity within a geographically confined industrial, commercial or shared services site and does not supply household Customers , without prejudice to incidental use by a small number of households located within the area served by the System and with employment or similar associations with the owner of the System .

CM Administrative Parties	The Secretary of State , the CM Settlement Body , and any CM Settlement Services Provider .
CM Settlement Body	the Electricity Settlements Company Ltd or such other person as may from time to time be appointed as Settlement Body under regulation 80 of the Electricity Capacity Regulations 2014.
CM Settlement Services Provider	any person with whom the CM Settlement Body has entered into a contract to provide services to it in relation to the performance of its functions under the Capacity Market Documents .
Code Administration Code of Practice	Means the code of practice approved by the Authority and: <ul style="list-style-type: none"> (a) developed and maintained by the code administrators in existence from time to time; and (b) amended subject to the Authority's approval from time to time; and (c) re-published from time to time;
Code Administrator	Means The Company carrying out the role of Code Administrator in accordance with the General Conditions.
Combined Cycle Gas Turbine Module or CCGT Module	A collection of Generating Units (registered as a CCGT Module (which could be within a Power Generating Module) under the PC) comprising one or more Gas Turbine Units (or other gas based engine units) and one or more Steam Units where, in normal operation, the waste heat from the Gas Turbines is passed to the water/steam system of the associated Steam Unit or Steam Units and where the component units within the CCGT Module are directly connected by steam or hot gas lines which enable those units to contribute to the efficiency of the combined cycle operation of the CCGT Module .
Combined Cycle Gas Turbine Unit or CCGT Unit	A Generating Unit within a CCGT Module .
Commercial Ancillary Services	Ancillary Services , other than System Ancillary Services , utilised by The Company in operating the Total System if a User (or other person such as a Demand Response Provider) has agreed to provide them under an Ancillary Services Agreement or under a Bilateral Agreement with payment being dealt with under an Ancillary Services Agreement or in the case of Externally Interconnected System Operators or Interconnector Users , under any other agreement (and in the case of Externally Interconnected System Operators and Interconnector Users includes Ancillary Services equivalent to or similar to System Ancillary Services).
Commercial Boundary	Has the meaning set out in the CUSC
Committed Level	The expected Active Power output from a BM Unit after accepting a Bid- Offer Acceptance or RR Instruction or a combination of Bid-Offer Acceptances and RR Instructions .
Committed Project Planning Data	Data relating to a User Development once the offer for a CUSC Contract is accepted.

Common Collection Busbar	A busbar within a Power Park Module to which the higher voltage side of two or more Power Park Unit generator transformers are connected.
Completion Date	Has the meaning set out in the Bilateral Agreement with each User to that term or in the absence of that term to such other term reflecting the date when a User is expected to connect to or start using the National Electricity Transmission System . In the case of an Embedded Medium Power Station or Embedded DC Converter Station or Embedded HVDC System having a similar meaning in relation to the Network Operator's System as set out in the Embedded Development Agreement .
Complex	A Connection Site together with the associated Power Station and/or Network Operator substation and/or associated Plant and/or Apparatus , as appropriate.
Compliance Processes or CP	That portion of the Grid Code which is identified as the Compliance Processes .
Compliance Statement	<p>A statement completed by the relevant User confirming compliance with each of the relevant Grid Code provisions, and the supporting evidence in respect of such compliance, of its:</p> <p>Generating Unit(s); or,</p> <p>Power Generating Modules (including DC Connected Power Park Modules and/or Electricity Storage Modules); or,</p> <p>CCGT Module(s); or,</p> <p>Power Park Module(s); or,</p> <p>DC Converter(s); or</p> <p>HVDC Systems; or</p> <p>Plant and Apparatus at an EU Grid Supply Point owned or operated by a Network Operator; or</p> <p>Network Operator's entire distribution System where such Network Operator's distribution System comprises solely of Plant and Apparatus procured on or after 7 September 2018 and was connected to the National Electricity Transmission System on or after 18 August 2019. In this case, all connections to the National Electricity Transmission System would comprise only of EU Grid Supply Points;</p> <p>or</p> <p>Plant and Apparatus at an EU Grid Supply Point owned or operated by a Non-Embedded Customer where such Non-Embedded Customer is defined as an EU Code User;</p> <p>In the form provided by The Company to the relevant User or another format as agreed between the User and The Company.</p>
Configuration 1 AC Connected Offshore Power Park Module	One or more Offshore Power Park Modules that are connected to an AC Offshore Transmission System and that AC Offshore Transmission System is connected to only one Onshore substation and which has one or more Transmission Interface Points .

Configuration 2 AC Connected Offshore Power Park Module	One or more Offshore Power Park Modules that are connected to a meshed AC Offshore Transmission System and that AC Offshore Transmission System is connected to two or more Onshore substations at its Transmission Interface Points .
Configuration 1 DC Connected Power Park Module	One or more DC Connected Power Park Modules that are connected to an HVDC System or Transmission DC Converter and that HVDC System or Transmission DC Converter is connected to only one Onshore substation and which has one or more Transmission Interface Points .
Configuration 2 DC Connected Power Park Module	One or more DC Connected Power Park Modules that are connected to an HVDC System or Transmission DC Converter and that HVDC System or Transmission DC Converter is connected to more than one Onshore substation at its Transmission Interface Points .
Connection Conditions or CC	That portion of the Grid Code which is identified as the Connection Conditions being applicable to GB Code Users .
Connection Entry Capacity	Has the meaning set out in the CUSC .
Connected Planning Data	Data which replaces data containing estimated values assumed for planning purposes by validated actual values and updated estimates for the future and by updated forecasts for Forecast Data items such as Demand .
Connection Point	A Grid Supply Point or Grid Entry Point , as the case may be.
Connection Site	A Transmission Site or User Site , as the case may be.
Construction Agreement	Has the meaning set out in the CUSC
Consumer Representative	Means the person appointed by the Citizens Advice or the Citizens Advice Scotland (or any successor body) representing all categories of customers, appointed in accordance with GR.4.2(b)
Contingency Reserve	The margin of generation over forecast Demand which is required in the period from 24 hours ahead down to real time to cover against uncertainties in Large Power Station availability and against both weather forecast and Demand forecast errors.
Control Based Reactive Power	The Reactive Power supplied by a Grid Forming Plant through controlled means based on operator adjustment selectable setpoints (these may be manual or automatic).
Control Calls	Telephone calls whose destination and/or origin is a Control Centre or Control Point , either from dedicated control desk telephone systems or dedicated telephone handsets, and which, for the purpose of Control Telephony , have the right to exercise priority over (ie. disconnect) a call of a lower status.
Control Centre	A location used for the purpose of control and operation of the National Electricity Transmission System or DC Converter Station owner's System or HVDC System Owner's System or a User System other than a Generator's System or an External System .

Control Engineer	A person nominated by the relevant party for the control of its Plant and Apparatus .
Control Person	The term used as an alternative to " Safety Co-ordinator " on the Site Responsibility Schedule only.
Control Phase	The Control Phase follows on from the Programming Phase and covers the period down to real time.
Control Point	<p>The point from which:-</p> <p>(a) A Non-Embedded Customer's Plant and Apparatus is controlled; or</p> <p>(b) A BM Unit at a Large Power Station or at a Medium Power Station or representing a Cascade Hydro Scheme or with a Demand Capacity with a magnitude of:</p> <p>(i) 50MW or more in NGET's Transmission Area; or</p> <p>(ii) 30MW or more in SPT's Transmission Area; or</p> <p>(iii) 10MW or more in SHETL's Transmission Area,</p> <p>(iv) 10MW or more which is connected to an Offshore Transmission System</p> <p>is physically controlled by a BM Participant; or</p> <p>(c) In the case of any other BM Unit or Generating Unit (which could be part of a Power Generating Module), data submission is co-ordinated for a BM Participant and instructions are received from The Company,</p> <p>as the case may be. For a Generator, this will normally be at a Power Station but may be at an alternative location agreed with The Company. In the case of a DC Converter Station or HVDC System, the Control Point will be at a location agreed with The Company. In the case of a BM Unit of an Interconnector User, the Control Point will be the Control Centre of the relevant Externally Interconnected System Operator.</p>
Control Telephony	The principal method by which a User's Responsible Engineer/Operator , the relevant Transmission Licensees' Control Engineers and The Company's Control Engineers speak to one another for the purposes of control of the Total System in both normal and emergency operating conditions.
Core Industry Document	As defined in the Transmission Licence
Core Industry Document Owner	In relation to a Core Industry Document , the body(ies) or entity(ies) responsible for the management and operation of procedures for making changes to such document

<p>Critical Tools and Facilities</p>	<p>Apparatus and tools required in relation to Black Start:</p> <p>a) In the case of The Company include, but are not limited to:</p> <ul style="list-style-type: none"> i) Tools for operating and monitoring the Transmission System including but not limited to state estimation, the Balancing Mechanism, Load and System Frequency control, alarms, real time system operation and operational security analysis including off line transmission analysis; ii) The ability to control, protect and monitor transmission assets including switchgear, tap changers and other Transmission System equipment including where available auxiliary equipment and to ensure the safe operation of Plant and Apparatus and the safety of personnel; iii) Control Telephony systems as provided for in CC.6.5.1 – CC.6.5.5 and ECC.6.5.1 – ECC.6.5.5; iv) Operational telephony as provided for in STCP 04-5; and v) Tools and communications systems to facilitate cross border operations. <p>b) In the case of Generators, HVDC System Owners, DC Converter Station Owners, Defence Service Providers and Restoration Service Providers:</p> <ul style="list-style-type: none"> i) Tools for monitoring relevant Plant and Apparatus; ii) The ability to control, protect and monitor their Plant and Apparatus necessary for Black Start including as applicable primary Plant, switchgear, tap changers and other auxiliary equipment and to ensure the safe operation of Plant and personnel; and iii) Control Telephony as provided for in CC.6.5.1 – CC.6.5.5 and ECC.6.5.1 – ECC.6.5.5. <p>c) In the case of BM Participants and Virtual Lead Parties who are not Generators, HVDC System Owners, DC Converter Station owners, Defence Service Providers or Restoration Service Providers as provided for in item b) above:</p> <ul style="list-style-type: none"> i) Tools for monitoring relevant Plant and Apparatus (excluding Plant and Apparatus not owned by the BM Participant or Virtual Lead Party); and ii) Control Telephony as provided for in CC.6.5.1 – CC.6.5.5 and ECC.6.5.1 – ECC.6.5.5 <p>d) In the case of Network Operators:</p> <ul style="list-style-type: none"> i) Control room Apparatus and tools for monitoring their System including but not limited to, alarms, real time system operation and operational security analysis including off line network analysis; ii) The ability to control, protect and monitor those assets necessary for Black Start including switchgear, tap changers and other network equipment including where available auxiliary equipment and to ensure the safe operation of Plant and personnel; and iii) Control Telephony as provided for in CC.6.5.1 – CC.6.5.5 and ECC.6.5.1 – ECC.6.5.5. <p>e) In the case of Non-Embedded Customers:</p> <ul style="list-style-type: none"> i) Tools for monitoring their System including but not limited to, alarms and real time system operation;
---------------------------------------------	--------------------------------------------------------------------------------------------------------------------------------------------------------------------------------------------------------------------------------------------------------------------------------------------------------------------------------------------------------------------------------------------------------------------------------------------------------------------------------------------------------------------------------------------------------------------------------------------------------------------------------------------------------------------------------------------------------------------------------------------------------------------------------------------------------------------------------------------------------------------------------------------------------------------------------------------------------------------------------------------------------------------------------------------------------------------------------------------------------------------------------------------------------------------------------------------------------------------------------------------------------------------------------------------------------------------------------------------------------------------------------------------------------------------------------------------------------------------------------------------------------------------------------------------------------------------------------------------------------------------------------------------------------------------------------------------------------------------------------------------------------------------------------------------------------------------------------------------------------------------------------------------------------------------------------------------------------------------------------------------------------------------------------------------------------------------------------------------------------------------------------------------------------------------------------------------------------------------------------------------------------------------------------------------------------------------------------------------------------------------------------------------------------------------------------------------------------------------------------------------------------------------------------------------------------------------------------------------------------------------------------------------------------------------------------------------------------------------------------------------------------------------------------------------------------------------------------------------------------------------------------------------------------------------------------------------------------------------------------------------------------------------------------------------------------------------------------------------------------------------------------------------------------------------------------------------------------------------------------------------------------------------------------------------------------------------------------------------------------------------------------------------------------------

	<p>ii) The ability to control, protect and monitor those assets necessary for Black Start including switchgear, tap changers and other network equipment including where available auxiliary equipment and to ensure the safe operation of Plant and personnel; and</p> <p>iii) Control Telephony as provided for in CC.6.5.1 – CC.6.5.5 and ECC.6.5.1 – ECC.6.5.5</p>
CUSC	Has the meaning set out in The Company's Transmission Licence
CUSC Contract	<p>One or more of the following agreements as envisaged in Standard Condition C1 of The Company's Transmission Licence:</p> <p>(a) the CUSC Framework Agreement;</p> <p>(b) a Bilateral Agreement;</p> <p>(c) a Construction Agreement</p> <p>or a variation to an existing Bilateral Agreement and/or Construction Agreement;</p>
CUSC Framework Agreement	Has the meaning set out in The Company's Transmission Licence .
CUSC Party	As defined in the The Company's Transmission Licence and "CUSC Parties" shall be construed accordingly.
Customer	A person to whom electrical power is provided (whether or not they are the same person as the person who provides the electrical power).
Customer Demand Management	Reducing the supply of electricity to a Customer or disconnecting a Customer in a manner agreed for commercial purposes between a Supplier and its Customer .
Customer Demand Management Notification Level	The level above which a Supplier has to notify The Company of its proposed or achieved use of Customer Demand Management which is 12 MW in England and Wales and 5 MW in Scotland.
Customer Generating Plant	A Power Station or Generating Unit or Power Generating Module of a Customer to the extent that it operates the same exclusively to supply all or part of its own electricity requirements, and does not export electrical power to any part of the Total System .
Damping Factor (ζ)	<p>The ratio of the actual damping to critical damping.</p> <p>For a GBGF-I the open loop phase angle, for an open loop gain of one, is measured from the systems Nichols Chart.</p> <p>This angle is used to define the system's equivalent Damping Factor that is the same as the Damping Factor of a second order system with the same open loop phase angle.</p> <p>Alternatively, the Damping Factor refers to the damping of a specific oscillation mode that is associated with the second order system created by the power to angle transfer function as show in Figure PC.A.5.8.1(a) and PCA.5.8.1(b).</p>

Data Publisher	The person providing a reporting service, in relation to data which is submitted to the reporting service under OC2.4.2.3 or a Transmission Licensee , in relation to data which the Transmission Licensee is required to publish.
Data Registration Code or DRC	That portion of the Grid Code which is identified as the Data Registration Code .
Data Validation, Consistency and Defaulting Rules	The rules relating to validity and consistency of data, and default data to be applied, in relation to data submitted under the Balancing Codes , to be applied by The Company under the Grid Code as set out in the document “Data Validation, Consistency and Defaulting Rules” - Issue 8, dated 25 th January 2012. The document is available on the National Grid website or upon request from The Company .
DC Connected Power Park Module	A Power Park Module that is connected to one or more HVDC Interface Points .
DC Converter	Any Onshore DC Converter or Offshore DC Converter as applicable to GB Code User’s .
DC Converter Station	An installation comprising one or more Onshore DC Converters connecting a direct current interconnector: to the National Electricity Transmission System ; or, (if the installation has a rating of 50MW or more) to a User System , and it shall form part of the External Interconnection to which it relates.
DC Network	All items of Plant and Apparatus connected together on the direct current side of a DC Converter or HVDC System .
DCUSA	The Distribution Connection and Use of System Agreement approved by the Authority and required to be maintained in force by each Electricity Distribution Licence holder.
Defence Service Provider	A User or Non-CUSC Party with a legal or contractual obligation to provide a service contributing to one or several measures of the System Defence Plan .
Defined Active Damping Power	The Active Damping Power supplied by a GBGF-I when it is operating at the Grid Oscillation Value defined in Table PC.A.5.8.2
De-Load	The condition in which a Genset has reduced or is not delivering electrical power to the System to which it is Synchronised .
Δf	Deviation from Target Frequency
Demand	The demand of MW and MVA _r of electricity (i.e. both Active and Reactive Power), unless otherwise stated.
Demand Aggregation	A process where one or more Demand Facilities or Closed Distribution Systems can be controlled by a Demand Response Provider either as a single facility or Closed Distribution System for the purposes of offering one or more Demand Response Services .
Demand Capacity	Has the meaning as set out in the BSC .

Demand Control	Any or all of the following methods of achieving a Demand reduction: <ul style="list-style-type: none"> (a) Customer voltage reduction initiated by Network Operators (other than following an instruction from The Company); (b) Customer Demand reduction by Disconnection initiated by Network Operators (other than following an instruction from The Company); (c) Demand reduction instructed by The Company; (d) automatic low Frequency Demand Disconnection; (e) emergency manual Demand Disconnection.
Demand Control Notification Level	The level above which a Network Operator has to notify The Company of its proposed or achieved use of Demand Control which is 12 MW in England and Wales and 5 MW in Scotland.
Demand Facility	A facility which consumes electrical energy and is connected at one or more Grid Supply Points to the National Electricity Transmission System or connection points to a Network Operator's System . A Network Operator's System and/or auxiliary supplies of a Power Generating Module do not constitute a Demand Facility .
Demand Facility Owner	A person who owns or operates one or more Demand Units within a Demand Facility . A Demand Facility Owner who owns or operates a Demand Facility which is directly connected to the Transmission System shall be treated as a Non-Embedded Customer .
Demand Response Active Power Control	Demand within a Demand Facility or Closed Distribution System that is available for modulation by The Company or Network Operator or Relevant Transmission Licensee , which results in an Active Power modification.
Demand Response Provider	A party (other than The Company) who owns, operates, controls or manages Main Plant and Apparatus (excluding storage equipment) which was first connected to the Total System on or after 18 August 2019 and who had placed Purchase Contracts for its Main Plant and Apparatus on or after 7 September 2018 or is the subject of a Substantial Modification on or after 18 August 2019 and has an agreement with The Company to provide a Demand Response Service(s) . The party may be one or more Customers , a Network Operator or Non-Embedded Customer or EU Code User contracting bilaterally with The Company for the provision of services, or may be a third party providing Demand Aggregation from many individual Customers .
Demand Response Reactive Power Control	A Demand Response Service derived from Reactive Power or Reactive Power compensation devices in a Demand Facility or Closed Distribution System that are available for modulation by The Company or Network Operator or Relevant Transmission Licensee .
Demand Response Transmission Constraint Management	A Demand Response Service derived from Demand within a Demand Facility or Closed Distribution System that is available for modulation by The Company or Network Operator or Relevant Transmission Licensee to manage transmission constraints within the System .

Demand Response Service	<p>A Demand Response Service includes one of more of the following services:</p> <ul style="list-style-type: none"> (a) Demand Response Active Power Control; (b) Demand Response Reactive Power Control; (c) Demand Response Transmission Constraint Management; (d) Demand Response System Frequency Control; (e) Demand Response Very Fast Active Power Control. <p>The above Demand Response Services are not exclusive and do not preclude Demand Response Providers from negotiating other services for demand response capability with The Company. Where such services are negotiated they would still be treated as a Demand Response Service.</p>
Demand Response Services Code (DRSC)	That portion of the Grid Code which is identified as the Demand Response Services Code being applicable to Demand Response Providers .
Demand Response System Frequency Control	A Demand Response Service derived from a Demand within one or more Demand Facilities or Closed Distribution Systems that is available for the reduction or increase in response to Frequency fluctuations, made by an autonomous response from those Demand Facilities or Closed Distribution Systems to diminish these fluctuations.
Demand Response Unit Document (DRUD)	A document, issued either by the Non-Embedded Customer , Demand Facility Owner or the CDSO to The Company or the Network Operator (as the case may be) for Demand Units with demand response and providing a Demand Response Service which confirms the compliance of the Demand Unit with the technical requirements set out in the Grid Code and provides the necessary data and statements, including a statement of compliance.
Demand Response Very Fast Active Power Control	A Demand Response Service derived from a Demand within a Demand Facility or Closed Distribution System that can be modulated very fast in response to a Frequency deviation, which results in a very fast Active Power modification.
Demand Unit	An indivisible set of installations containing equipment which can be actively controlled at one or more sites by a Demand Response Provider , Demand Facility Owner , CDSO or by a Non Embedded Customer , either individually or commonly as part of Demand Aggregation through a third party who has agreed to provide Demand Response Services .
Designed Minimum Operating Level	The output (in whole MW) below which a Genset or a DC Converter at a DC Converter Station (in any of its operating configurations) has no High Frequency Response capability.
De-Synchronise	<ul style="list-style-type: none"> (a) The act of taking a Power Generating Module (including a DC Connected Power Park Module), Generating Unit, Power Park Module, HVDC System or DC Converter off a System to which it has been Synchronised, by opening any connecting circuit breaker; or (b) The act of ceasing to consume electricity at an importing BM Unit; and the term "De-Synchronising" shall be construed accordingly.
De-synchronised Island(s)	Has the meaning set out in OC9.5.1(a).
Detailed Planning Data	Detailed additional data which The Company requires under the PC in support of Standard Planning Data , comprising DPD I and DPD II .

Detailed Planning Data Category I or DPD I	The Detailed Planning Data categorised as such in the DRC , and submitted in accordance with PC.4.4.2 or PC.4.4.4 as applicable.
Detailed Planning Data Category II or DPD II	The Detailed Planning Data categorised as such in the DRC , and submitted in accordance with PC.4.4.2 or PC.4.4.4 as applicable.
Disconnection	The physical separation of Users (or Customers) from the National Electricity Transmission System or a User System as the case may be.
Discrimination	The quality where a relay or protective system is enabled to pick out and cause to be disconnected only the faulty Apparatus .
Disputes Resolution Procedure	The procedure described in the CUSC relating to disputes resolution.
Distribution Code	The distribution code required to be drawn up by each Electricity Distribution Licence holder and approved by the Authority , as from time to time revised with the approval of the Authority .
Droop	The ratio of the per unit steady state change in speed (or Frequency), to the per unit steady state change in Active Power output. Whilst not mandatory, it is often common practice to express Droop in percentage terms.
Dynamic Parameters	Those parameters listed in Appendix 1 to BC1 under the heading BM Unit Data – Dynamic Parameters .
Dynamic Reactive Compensation Equipment	Plant and Apparatus capable of injecting or absorbing Reactive Power in a controlled manner which includes but is not limited to Synchronous Compensators, Static Var Compensators (SVC), or STATCOM devices.
E&W Offshore Transmission System	An Offshore Transmission System with an Interface Point in England and Wales.
E&W Offshore Transmission Licensee	A person who owns or operates an E&W Offshore Transmission System pursuant to a Transmission Licence .
E&W Transmission System	Collectively NGET's Transmission System and any E&W Offshore Transmission Systems .
E&W User	A User in England and Wales or any Offshore User who owns or operates Plant and/or Apparatus connected (or which will at the OTSUA Transfer Time be connected) to an E&W Offshore Transmission System .
Earth Fault Factor	At a selected location of a three-phase System (generally the point of installation of equipment) and for a given System configuration, the ratio of the highest root mean square phase-to-earth power Frequency voltage on a sound phase during a fault to earth (affecting one or more phases at any point) to the root mean square phase-to-earth power Frequency voltage which would be obtained at the selected location without the fault.

Earthing	<p>A way of providing a connection between conductors and earth by an Earthing Device which is either:</p> <p>(a) Immobilised and Locked in the earthing position. Where the Earthing Device is Locked with a Safety Key, the Safety Key must be secured in a Key Safe and the Key Safe Key must be, where reasonably practicable, given to the authorised site representative of the Requesting Safety Co-ordinator and is to be retained in safe custody. Where not reasonably practicable the Key Safe Key must be retained by the authorised site representative of the Implementing Safety Co-ordinator in safe custody; or</p> <p>(b) maintained and/or secured in position by such other method which must be in accordance with the Local Safety Instructions of NGET or the Safety Rules of the Relevant Transmission Licensee or that User, as the case may be.</p>
Earthing Device	A means of providing a connection between a conductor and earth being of adequate strength and capability.
Elected Panel Members	<p>Shall mean the following Panel Members elected in accordance with GR4.2(a):</p> <p>(a) the representative of the Suppliers;</p> <p>(b) the representative of the Onshore Transmission Licensees;</p> <p>(c) the representative of the Offshore Transmission Licensees; and</p> <p>(d) the representatives of the Generators</p>
Electrical Standard	A standard listed in the Annex to the General Conditions .
Electricity Balancing Regulation	as defined in the CUSC .
Electricity Council	That body set up under the Electricity Act, 1957.
Electricity Distribution Licence	The licence granted pursuant to Section 6(1) (c) of the Act .
Electricity Regulation	As defined in the Transmission Licence .
Electricity Storage	The conversion of electrical energy into a form of energy which can be stored, the storing of that energy, and the subsequent reconversion of that energy back into electrical energy.
Electricity Storage Module	Is either one or more Synchronous Electricity Storage Unit(s) or Non-Synchronous Electricity Storage Unit(s) which could also be part of a Power Generating Module . For the avoidance of doubt, Non-Controllable Electricity Storage Equipment would not be considered to be classed as an Electricity Storage Module or as an Electricity Storage Unit .
Electricity Storage Unit	A Synchronous Electricity Storage Unit or Non-Synchronous Electricity Storage Unit .

Electricity Supply Industry Arbitration Association	The unincorporated members' club of that name formed inter alia to promote the efficient and economic operation of the procedure for the resolution of disputes within the electricity supply industry by means of arbitration or otherwise in accordance with its arbitration rules.
Electricity Supply Licence	The licence granted pursuant to Section 6(1) (d) of the Act .
Electromagnetic Compatibility Level	Has the meaning set out in Engineering Recommendation G5 .
Electronic Power Converter	Electrical Plant and Apparatus which uses switched solid state power electronic devices to produce a real voltage waveform, that has a fundamental component with harmonics.
Embedded	Having a direct connection to a User System or the System of any other User to which Customers and/or Power Stations are connected, such connection being either a direct connection or a connection via a busbar of another User or of a Relevant Transmission Licensee (but with no other connection to the National Electricity Transmission System).
Embedded Development	Has the meaning set out in PC.4.4.3(a).
Embedded Development Agreement	An agreement entered into between a Network Operator and an Embedded Person , identifying the relevant site of connection to the Network Operator's System and setting out other site specific details in relation to that use of the Network Operator's System .
Embedded Generation Control	Any or all of the following methods by which a Network Operator can achieve a reduction in the Active Power output of Embedded Power Stations to implement an instruction issued by The Company : (a) Embedded Generation De-energisation ; or (b) where this is achievable in a suitable timescale to comply with an instruction, arranging to reduce the Active Power output of Embedded Power Stations or Embedded Generator Unit(s) connected to their System .
Embedded Generation Deenergisation	The de-energisation by Network Operators of one or more Embedded Power Stations or Embedded Generating Units from their System as part of an Embedded Generation Control action.
Embedded Person	The party responsible for a Medium Power Station not subject to a Bilateral Agreement or DC Converter Station not subject to a Bilateral Agreement or HVDC System not subject to a Bilateral Agreement connected to or proposed to be connected to a Network Operator's System .
Emergency Deenergisation Instruction	An Emergency Instruction issued by The Company to De-Synchronise a Power Generating Module (including a DC Connected Power Park Module), Generating Unit , Power Park Module , HVDC System or DC Converter in circumstances specified in the CUSC .
Emergency Instruction	An instruction issued by The Company in emergency circumstances, pursuant to BC2.9, to the Control Point of a User . In the case of such instructions applicable to a BM Unit , it may require an action or response which is outside the Dynamic Parameters or Other Relevant Data , and may include an instruction to trip a Genset .

EMR Administrative Parties	Has the meaning given to “administrative parties” in The Electricity Capacity Regulations 2014 and each CfD Counterparty and CfD Settlement Services Provider .
EMR Documents	The Energy Act 2013, The Electricity Capacity Regulations 2014, the Capacity Market Rules , The Contracts for Difference (Allocation) Regulations 2014, The Contracts for Difference (Definition of Eligible Generator) Regulations 2014, The Contracts for Difference (Electricity Supplier Obligations) Regulations 2014, The Electricity Market Reform (General) Regulations 2014, the AF Rules and any other regulations or instruments made under Chapter 2 (contracts for difference), Chapter 3 (capacity market) or Chapter 4 (investment contracts) of Part 2 of the Energy Act 2013 which are in force from time to time.
EMR Functions	Has the meaning given to “EMR functions” in Chapter 5 of Part 2 of the Energy Act 2013.
Engineering Recommendations	The documents referred to as such and issued by the Energy Networks Association or the former Electricity Council.
Engineering Recommendation G5	Means Engineering Recommendation G5/5.
Engergisation Operational Notification or EON	A notification (in respect of Plant and Apparatus (including OTSUA) which is directly connected to the National Electricity Transmission System) from The Company to a User confirming that the User can in accordance with the Bilateral Agreement and/or Construction Agreement , energise such User’s Plant and Apparatus (including OTSUA) specified in such notification.
Equipment Certificate	A document issued by an Authorised Certifier for equipment used by a Power Generating Module, Demand Unit, Network Operators System, Non-Embedded Customers System, Demand Facility or HVDC System . The Equipment Certificate defines the scope of its validity at a national level. For the purpose of replacing specific parts of the compliance process, the Equipment Certificate may include models or equivalent information that have been verified against actual test results.
Estimated Registered Data	Those items of Standard Planning Data and Detailed Planning Data which either upon connection will become Registered Data , or which for the purposes of the Plant and/or Apparatus concerned as at the date of submission are Registered Data , but in each case which for the seven succeeding Financial Years will be an estimate of what is expected.

<p>EU Code User</p>	<p>A User who is any of the following:-</p> <ul style="list-style-type: none"> (a) A Generator in respect of a Power Generating Module (excluding a DC Connected Power Park Module) or OTSDUA (in respect of an AC Offshore Transmission System) whose Main Plant and Apparatus is connected to the System on or after 27 April 2019 and who concluded Purchase Contracts for its Main Plant and Apparatus on or after 17 May 2018 (b) A Generator in respect of any Type C or Type D Power Generating Module which is the subject of a Substantial Modification which is effective on or after 27 April 2019. (c) A Generator in respect of any DC Connected Power Park Module whose Main Plant and Apparatus is connected to the System on or after 8 September 2019 and who had concluded Purchase Contracts for its Main Plant and Apparatus on or after 28 September 2018. (d) A Generator in respect of any DC Connected Power Park Module which is the subject of a Substantial Modification which is effective on or after 8 September 2019. (e) An HVDC System Owner or OTSDUA (in respect of a DC Offshore Transmission System including a Transmission DC Converter) whose Main Plant and Apparatus is connected to the System on or after 8 September 2019 and who had concluded Purchase Contracts for its Main Plant and Apparatus on or after 28 September 2018. (f) An HVDC System Owner or OTSDUA (in respect of a DC Offshore Transmission System including a Transmission DC Converter) whose HVDC System or DC Offshore Transmission System including a Transmission DC Converter) is the subject of a Substantial Modification on or after 8 September 2019. (g) A User which the Authority has determined should be considered as an EU Code User. (h) A Network Operator whose entire distribution System was first connected to the National Electricity Transmission System on or after 18 August 2019 and who had placed Purchase Contracts for its Main Plant and Apparatus in respect of its entire distribution System on or after 7 September 2018. For the avoidance of doubt, a Network Operator will be an EU Code User if its entire distribution System is connected to the National Electricity Transmission System at EU Grid Supply Points only. (i) A Non Embedded Customer whose Main Plant and Apparatus at each EU Grid Supply Point was first connected to the National Electricity Transmission System on or after 18 August 2019 and who had placed Purchase Contracts for its Main Plant and Apparatus at each EU Grid Supply Point on or after 7 September 2018 or is the subject of a Substantial Modification on or after 18 August 2019. (j) A Storage User in respect of an Electricity Storage Module whose Main Plant and Apparatus is connected to the System on or after 20 May 2020 and who concluded Purchase
----------------------------	------------------------------------------------------------------------------------------------------------------------------------------------------------------------------------------------------------------------------------------------------------------------------------------------------------------------------------------------------------------------------------------------------------------------------------------------------------------------------------------------------------------------------------------------------------------------------------------------------------------------------------------------------------------------------------------------------------------------------------------------------------------------------------------------------------------------------------------------------------------------------------------------------------------------------------------------------------------------------------------------------------------------------------------------------------------------------------------------------------------------------------------------------------------------------------------------------------------------------------------------------------------------------------------------------------------------------------------------------------------------------------------------------------------------------------------------------------------------------------------------------------------------------------------------------------------------------------------------------------------------------------------------------------------------------------------------------------------------------------------------------------------------------------------------------------------------------------------------------------------------------------------------------------------------------------------------------------------------------------------------------------------------------------------------------------------------------------------------------------------------------------------------------------------------------------------------------------------------------------------------------------------------------------------------------------------------------------------------------------------------------------------------------------------------------------------------------------------------------------------------------------------------------------------------------------------------------------------------------------------------------------------------------------------------------------------------------------------------------------------------------------------------------------------------------------------------------------------------------------------------------------------------------------------------------------------------------------------------------------------------------------------------------------------------------------------------------------------------------------------------------------------------------------------------------------------------------------------------------------------------------------------------------------------------------------------------------------------------------------------------------------------------------------------------------------------------------

	Contracts for its Main Plant and Apparatus on or after 20 May 2019.
EU Generator	A Generator or OTSDUA who is also an EU Code User .
EU Grid Supply Point	A Grid Supply Point where either:- <ul style="list-style-type: none"> (i) (a) the Network Operator or Non-Embedded Customer had placed Purchase Contracts for all of its Plant and Apparatus at that Grid Supply Point on or after 7 September 2018, and (b) All of the Network Operator's or Non-Embedded Customer's Plant and Apparatus at that Grid Supply Point was first connected to the Transmission System on or after 18 August 2019; or (ii) the Network Operator's or Non-Embedded Customer's Plant and Apparatus at a Grid Supply Point is the subject of a Substantial Modification which is effective on or after 18 August 2019.
EU Transparency Availability Data	Such relevant data as Customers and Generators are required to provide under Articles 7.1(a) and 7.1(b) and Articles 15.1(a), 15.1(b), 15.1(c), 15.1(d) of Retained EU Law (Commission Regulation (EU) 543/2013), and which also forms part of DRC Schedule 6 (Users' Outage Data).
European Compliance Processes or ECP	That portion of the Grid Code which is identified as the European Compliance Processes .
European Connection Conditions or ECC	That portion of the Grid Code which is identified as the European Connection Conditions being applicable to EU Code Users .
European Specification	A common technical specification, a British Standard implementing a European standard or a European technical approval. The terms "common technical specification", "European standard" and "European technical approval" shall have the meanings respectively ascribed to them in the Regulations .
Event	An unscheduled or unplanned (although it may be anticipated) occurrence on, or relating to, a System (including Embedded Power Stations) including, without limiting that general description, faults, incidents and breakdowns and adverse weather conditions being experienced.
Exciter	The source of the electrical power providing the field current of a synchronous machine.
Excitation System	The equipment providing the field current of a machine, including all regulating and control elements, as well as field discharge or suppression equipment and protective devices.
Excitation System No-Load Negative Ceiling Voltage	The minimum value of direct voltage that the Excitation System is able to provide from its terminals when it is not loaded, which may be zero or a negative value.

Excitation System Nominal Response	Shall have the meaning ascribed to that term in IEC 34-16-1:1991 [equivalent to British Standard BS4999 Section 116.1: 1992]. The time interval applicable is the first half-second of excitation system voltage response.
Excitation System On-Load Positive Ceiling Voltage	Shall have the meaning ascribed to the term 'Excitation system on load ceiling voltage' in IEC 34-16-1:1991 [equivalent to British Standard BS4999 Section 116.1: 1992].
Excitation System No-Load Positive Ceiling Voltage	Shall have the meaning ascribed to the term 'Excitation system no load ceiling voltage' in IEC 34-16-1:1991 [equivalent to British Standard BS4999 Section 116.1: 1992].
Exemptable	Has the meaning set out in the CUSC .
Existing AGR Plant	The following nuclear advanced gas cooled reactor plant (which was commissioned and connected to the Total System at the Transfer Date):- <ul style="list-style-type: none"> (a) Dungeness B (b) Hinkley Point B (c) Heysham 1 (d) Heysham 2 (e) Hartlepool (f) Hunterston B (g) Torness
Existing AGR Plant Flexibility Limit	In respect of each Genset within each Existing AGR Plant which has a safety case enabling it to so operate, 8 (or such lower number which when added to the number of instances of reduction of output as instructed by The Company in relation to operation in Frequency Sensitive Mode totals 8) instances of flexibility in any calendar year (or such lower or greater number as may be agreed by the Nuclear Installations Inspectorate and notified to The Company) for the purpose of assisting in the period of low System NRAPM and/or low Localised NRAPM provided that in relation to each Generating Unit each change in output shall not be required to be to a level where the output of the reactor is less than 80% of the reactor thermal power limit (as notified to The Company and which corresponds to the limit of reactor thermal power as contained in the "Operating Rules" or "Identified Operating Instructions" forming part of the safety case agreed with the Nuclear Installations Inspectorate).
Existing Gas Cooled Reactor Plant	Both Existing Magnox Reactor Plant and Existing AGR Plant .

Existing Magnox Reactor Plant	The following nuclear gas cooled reactor plant (which was commissioned and connected to the Total System at the Transfer Date):- (a) Calder Hall (b) Chapelcross (c) Dungeness A (d) Hinkley Point A (e) Oldbury-on-Severn (f) Bradwell (g) Sizewell A (h) Wylfa
Export and Import Limits	Those parameters listed in Appendix 1 to BC1 under the heading BM Unit Data – Export and Import Limits .
External Interconnection	Apparatus for the transmission of electricity to or from the National Electricity Transmission System or a User System into or out of an External System . For the avoidance of doubt, a single External Interconnection may comprise several circuits operating in parallel.
External Interconnection Circuit	Plant or Apparatus which comprises a circuit and which operates in parallel with another circuit and which forms part of the External Interconnection .
Externally Interconnected System Operator or EISO	A person who operates an External System which is connected to the National Electricity Transmission System or a User System by an External Interconnection .
External System	In relation to an Externally Interconnected System Operator means the transmission or distribution system which it owns or operates which is located outside the National Electricity Transmission System Operator Area any Apparatus or Plant which connects that system to the External Interconnection and which is owned or operated by such Externally Interconnected System Operator .
Fast Fault Current	A current delivered by a Power Park Module or HVDC System during and after a voltage deviation caused by an electrical fault within the System with the aim of identifying a fault by network Protection systems at the initial stage of the fault, supporting System voltage retention at a later stage of the fault and System voltage restoration after fault clearance.
Fault Current Interruption Time	The time interval from fault inception until the end of the break time of the circuit breaker (as declared by the manufacturers).
Fault Ride Through	The capability of Power Generating Modules (including DC Connected Power Park Modules) and HVDC Systems to be able to remain connected to the System and operate through periods of low voltage at the Grid Entry Point or User System Entry Point caused by secured faults.
Fast Start	A start by a Genset with a Fast Start Capability .
Fast Start Capability	The ability of a Genset to be Synchronised and Loaded up to full Load within 5 minutes.

Fast Track Criteria	A proposed Grid Code Modification Proposal that, if implemented, (a) would meet the Self-Governance Criteria ; and (b) is properly a housekeeping modification required as a result of some error or factual change, including but not limited to: (i) updating names or addresses listed in the Grid Code ; (ii) correcting any minor typographical errors; (iii) correcting formatting and consistency errors, such as paragraph numbering; or (iv) updating out of date references to other documents or paragraphs
Fault Current Interruption Time	The time interval from fault inception until the end of the break time of the circuit breaker (as declared by the manufacturers).
Fault Ride Through	The capability of Power Generating Modules (including DC Connected Power Park Modules) and HVDC Systems to be able to remain connected to the System and operate through periods of low voltage at the Grid Entry Point or User System Entry Point caused by secured faults.
Final Generation Outage Programme	An outage programme as agreed by The Company with each Generator and each Interconnector Owner at various stages through the Operational Planning Phase and Programming Phase which does not commit the parties to abide by it, but which at various stages will be used as the basis on which National Electricity Transmission System outages will be planned.
Final Operational Notification or FON	A notification from The Company to a Generator or DC Converter Station owner or HVDC System Owner or Network Operator or Non-Embedded Customer confirming that the User has demonstrated compliance: (a) with the Grid Code, (or where they apply, that relevant derogations have been granted), and (b) where applicable, with Appendices F1 to F5 of the Bilateral Agreement , in each case in respect of the Plant and Apparatus specified in such notification.
Final Physical Notification Data	Has the meaning set out in the BSC .
Final Report	A report prepared by the Test Proposer at the conclusion of a System Test for submission to The Company (if it did not propose the System Test) and other members of the Test Panel .
Financial Year	Bears the meaning given in Condition A1 (Definitions and Interpretation) of The Company's Transmission Licence .

Fixed Proposed Implementation Date	The proposed date(s) for the implementation of a Grid Code Modification Proposal or Workgroup Alternative Grid Code Modification such date to be a specific date by reference to an assumed date by which a direction from the Authority approving the Grid Code Modification Proposal or Workgroup Alternative Grid Code Modification is required in order for the Grid Code Modification Proposal or any Workgroup Alternative Grid Code Modification , if it were approved, to be implemented by the proposed date.
Flicker Severity (Long Term)	A value derived from 12 successive measurements of Flicker Severity (Short Term) (over a two hour period) and a calculation of the cube root of the mean sum of the cubes of 12 individual measurements, as further set out in Engineering Recommendation P28 as current at the Transfer Date .
Flicker Severity (Short Term)	A measure of the visual severity of flicker derived from the time series output of a flickermeter over a 10 minute period and as such provides an indication of the risk of Customer complaints.
Forecast Data	Those items of Standard Planning Data and Detailed Planning Data which will always be forecast.
Frequency	The number of alternating current cycles per second (expressed in Hertz) at which a System is running.
Frequency Containment Reserves (FCR)	means, in the context of Balancing Services , the Active Power reserves available to contain System Frequency after the occurrence of an imbalance.
Frequency Response Deadband	An interval used intentionally to make the Frequency control unresponsive. In the case of mechanical governor systems, the Frequency Response Deadband is the same as Frequency Response Insensitivity .
Frequency Response Insensitivity	The inherent feature of the control system specified as the minimum magnitude of change in the Frequency or input signal that results in a change of output power or output signal.
Frequency Restoration Reserves (FRR)	Means, in the context of Balancing Services , the Active Power reserves available to restore System Frequency to the nominal Frequency .
Frequency Sensitive AGR Unit	Each Generating Unit in an Existing AGR Plant for which the Generator has notified The Company that it has a safety case agreed with the Nuclear Installations Inspectorate enabling it to operate in Frequency Sensitive Mode , to the extent that such unit is within its Frequency Sensitive AGR Unit Limit . Each such Generating Unit shall be treated as if it were operating in accordance with BC3.5.1 provided that it is complying with its Frequency Sensitive AGR Unit Limit .

Frequency Sensitive AGR Unit Limit	In respect of each Frequency Sensitive AGR Unit , 8 (or such lower number which when added to the number of instances of flexibility for the purposes of assisting in a period of low System or Localised NRAPM totals 8) instances of reduction of output in any calendar year as instructed by The Company in relation to operation in Frequency Sensitive Mode (or such greater number as may be agreed between The Company and the Generator), for the purpose of assisting with Frequency control, the level of operation of each Frequency Sensitive AGR Unit in Frequency Sensitive Mode shall not be outside that agreed by the Nuclear Installations Inspectorate in the relevant safety case.
Frequency Sensitive Mode	A Genset , or Type C Power Generating Module or Type D Power Generating Module or DC Connected Power Park Module or HVDC System operating mode which will result in Active Power output changing, in response to a change in System Frequency , in a direction which assists in the recovery to Target Frequency , by operating so as to provide Primary Response and/or Secondary Response and/or High Frequency Response .
Fuel Security Code	The document of that title designated as such by the Secretary of State , as from time to time amended.
Gas Turbine Unit	A Generating Unit driven by a gas turbine (for instance by an aero-engine).
Gas Zone Diagram	A single line diagram showing boundaries of, and interfaces between, gas-insulated HV Apparatus modules which comprise part, or the whole, of a substation at a Connection Site (or in the case of OTSDUW Plant and Apparatus, Transmission Interface Site), together with the associated stop valves and gas monitors required for the safe operation of the National Electricity Transmission System or the User System , as the case may be.
Gate Closure	Has the meaning set out in the BSC .

<p>GB Code User</p>	<p>A User in respect of:-</p> <p>(a) A Generator or OTSDUA whose Main Plant and Apparatus (excluding a DC Connected Power Park Module) is connected to the System before 27 April 2019, or who had concluded Purchase Contracts for its Main Plant and Apparatus before 17 May 2018, or whose Plant and Apparatus is not the subject of a Substantial Modification which is effective on or after 27 April 2019; or</p> <p>(b) A DC Converter Station owner whose Main Plant and Apparatus is connected to the System before 8 September 2019, or who had concluded Purchase Contracts for its Main Plant and Apparatus before 28 September 2018, or whose Plant and Apparatus is not the subject of a Substantial Modification which is effective on or after 8 September 2019; or</p> <p>(c) A Non-Embedded Customer whose Main Plant and Apparatus was connected to the National Electricity Transmission System at a GB Grid Supply Point before 18 August 2019 or who had placed Purchase Contracts for its Main Plant and Apparatus before 7 September 2018 or that Non-Embedded Customer is not the subject of a Substantial Modification which is effective on or after 18 August 2019; or</p> <p>(d) A Network Operator whose entire distribution System was connected to the National Electricity Transmission System at one or more GB Grid Supply Points before 18 August 2019 or who had placed Purchase Contracts for its Main Plant and Apparatus in respect of its entire distribution System before 7 September 2018 or its entire distribution System is not the subject of a Substantial Modification which is effective on or after 18 August 2019. For the avoidance of doubt, a Network Operator would still be classed as a GB Code User where its entire distribution System was connected to the National Electricity Transmission System at one or more GB Grid Supply Points, even where that entire distribution System may have one or more EU Grid Supply Points but still comprises of GB Grid Supply Points.</p>
<p>GB Generator</p>	<p>A Generator, or OTSDUA, who is also a GB Code User.</p>
<p>GBGF Fast Fault Current Injection</p>	<p>The ability of a Grid Forming Plant to supply reactive current, that starts to be delivered into the Total System in less than 5ms when the voltage falls below 90% of its nominal value at the Grid Entry Point or User System Entry Point.</p>
<p>GB Grid Forming - Inverter or GBGF-I</p>	<p>Is any Power Park Module, HVDC System, DC Converter, OTSDUW Plant and Apparatus, Non-Synchronous Electricity Storage Module, Dynamic Reactive Compensation Equipment or any Plant and Apparatus (including a smart load) which is connected or partly connected to the Total System via an Electronic Power Converter which has a Grid Forming Capability (GBGF-I).</p>
<p>GB Grid Forming – Synchronous or GBGF-S</p>	<p>Is a Synchronous Power Generating Module, Synchronous Electricity Storage Module or Synchronous Generating Unit with a Grid Forming Capability.</p>

GB Grid Supply Point	A Grid Supply Point which is not an EU Grid Supply Point .
GB Synchronous Area	The AC power System in Great Britain which connects User's, Relevant Transmission Licensee's whose AC Plant and Apparatus is considered to operate in synchronism with each other at each Connection Point or User System Entry Point and at the same System Frequency .
GCDF	Means the Grid Code Development Forum.
General Conditions or GC	That portion of the Grid Code which is identified as the General Conditions .
Generating Plant Demand Margin	The difference between Output Usable and forecast Demand .
Generating Unit	An Onshore Generating Unit and/or an Offshore Generating Unit which could also be part of a Power Generating Module .
Generating Unit Data	The Physical Notification, Export and Import Limits and Other Relevant Data only in respect of each Generating Unit (which could be part of a Power Generating Module): <ul style="list-style-type: none"> (a) which forms part of the BM Unit which represents that Cascade Hydro Scheme; (b) at an Embedded Exemptable Large Power Station, where the relevant Bilateral Agreement specifies that compliance with BC1 and/or BC2 is required: <ul style="list-style-type: none"> (i) to each Generating Unit, or (ii) to each Power Park Module where the Power Station comprises Power Park Modules.
Generation Capacity	Has the meaning set out in the BSC .
Generation Planning Parameters	Those parameters listed in Appendix 2 of OC2 .
Generator	A person who generates electricity or undertakes Electricity Storage under licence or exemption under the Act , acting in its capacity as a generator in Great Britain or Offshore . The term Generator includes a EU Generator and a GB Generator .
Generator Performance Chart	A diagram which shows the MW and MVA _r capability limits within which a Generating Unit will be expected to operate under steady state conditions.
Genset	A Power Generating Module (including a DC Connected Power Park Module and/or Electricity Storage Module), Generating Unit, Power Park Module or CCGT Module at a Large Power Station or any Power Generating Module (including a DC Connected Power Park Module), Generating Unit, Power Park Module or CCGT Module which is directly connected to the National Electricity Transmission System .

Good Industry Practice	The exercise of that degree of skill, diligence, prudence and foresight which would reasonably and ordinarily be expected from a skilled and experienced operator engaged in the same type of undertaking under the same or similar circumstances.
Governance Rules or GR	That portion of the Grid Code which is identified as the Governance Rules .
Governor Deadband	An interval used intentionally to make the frequency control unresponsive.
Great Britain or GB	The landmass of England and Wales and Scotland, including internal waters.
Grid Code Fast Track Proposals	A proposal to modify the Grid Code which is raised pursuant to GR.26 and has not yet been approved or rejected by the Grid Code Review Panel .
Grid Code Modification Fast Track Report	A report prepared pursuant to GR.26
Grid Code Modification Register	Has the meaning given in GR.13.1.
Grid Code Modification Report	Has the meaning given in GR.22.1.
Grid Code Modification Procedures	The procedures for the modification of the Grid Code (including the implementation of Approved Modifications) as set out in the Governance Rules .
Grid Code Modification Proposal	A proposal to modify the Grid Code which is not yet rejected pursuant to GR.15.5 or GR.15.6 and has not yet been implemented.
Grid Code Modification Self- Governance Report	Has the meaning given in GR.24.5
Grid Code Objectives	Means the objectives referred to in Paragraph 1b of Standard Condition C14 of The Company's Transmission Licence .
Grid Code Review Panel or Panel	The panel with the functions set out in GR.1.2.
Grid Code Review Panel Recommendation Vote	The vote of Panel Members undertaken by the Panel Chairperson in accordance with Paragraph GR.22.4 as to whether in their view they believe each proposed Grid Code Modification Proposal , or Workgroup Alternative Grid Code Modification would better facilitate achievement of the Grid Code Objective(s) and so should be made.
Grid Code Review Panel Self-Governance Vote	The vote of Panel Members undertaken by the Panel Chairperson in accordance with GR.24.9 as to whether they believe each proposed Grid Code Modification Proposal, as compared with the then existing provisions of the Grid Code and any Workgroup Alternative Grid Code Modification set out in the Grid Code Modification Self-Governance Report , would better facilitate achievement of the Grid Code Objective(s) .

Grid Code Self-Governance Proposals	Grid Code Modification Proposals which satisfy the Self Governance Criteria .
Grid Entry Point	An Onshore Grid Entry Point or an Offshore Grid Entry Point .
Grid Forming Active Power	Grid Forming Active Power is the inherent Active Power produced by Grid Forming Plant that includes Active Inertia Power plus Active Phase Jump Power plus Active Damping Power .
Grid Forming Capability	<p>Is (but not limited to) the capability a Power Generating Module, HVDC Converter (which could form part of an HVDC System), Generating Unit, Power Park Module, DC Converter, OTSDUW Plant and Apparatus, Electricity Storage Module, Dynamic Reactive Compensation Equipment or any Plant and Apparatus (including a smart load) whose supplied Active Power is directly proportional to the difference between the magnitude and phase of its Internal Voltage Source and the magnitude and phase of the voltage at the Grid Entry Point or User System Entry Point and the sine of the Load Angle. As a consequence, Plant and Apparatus which has a Grid Forming Capability has a frequency of rotation of the Internal Voltage Source which is the same as the System Frequency for normal operation, with only the Load Angle defining the relative position between the two. In the case of a GBGF-I, a Grid Forming Unit forming part of a GBGF-I shall be capable of sustaining a voltage at its terminals irrespective of the voltage at the Grid Entry Point or User System Entry Point for normal operating conditions.</p> <p>For GBGF-I, the control system, which determines the amplitude and phase of the Internal Voltage Source, shall have a response to the voltage and System Frequency at the Grid Entry Point or User System Entry Point) with a bandwidth that is less than a defined value as shown by the control system's NFP Plot. Exceptions to this requirement are only allowed during transients caused by System faults, voltage dips/surges and/or step or ramp changes in the phase angle which are large enough to cause damage to the Grid Forming Plant via excessive currents.</p>
Grid Forming Electronic Power Converter	A Grid Forming Plant whose output is derived from an Electronic Power Converter with a GBGF-I capability.
Grid Forming Plant	A site which contains Plant and Apparatus which is classified as either a GBGF-S or a GBGF-I
Grid Forming Plant Owner	The owner or operator of a Grid Forming Plant .
Grid Forming Unit	A Power Park Unit or Electricity Storage Unit or a Synchronous Power Generating Unit or individual Load with a Grid Forming Capability .
Grid Oscillation Value	An injected test frequency signal applied at nominal System Frequency with a superimposed oscillatory response overlaid onto the nominal System Frequency with an amplitude of 0.05 Hz peak to peak at a frequency of 1 Hz and is used for determining the rating of the Defined Active Damping Power .

Grid Supply Point	A point of supply from the National Electricity Transmission System to Network Operators or Non-Embedded Customers which could be a GB Grid Supply Point or an EU Grid Supply Point .
Group	Those National Electricity Transmission System sub-stations bounded solely by the faulted circuit(s) and the overloaded circuit(s) excluding any third party connections between the Group and the rest of the National Electricity Transmission System , the faulted circuit(s) being a Secured Event .
GSP Group	Has the meaning as set out in the BSC .
Headroom	The Power Available (in MW) less the actual Active Power exported from the Power Park Module (in MW).
High Frequency Response	An automatic reduction in Active Power output in response to an increase in System Frequency above the Target Frequency (or such other level of Frequency as may have been agreed in an Ancillary Services Agreement). This reduction in Active Power output must be in accordance with the provisions of the relevant Ancillary Services Agreement which will provide that it will be released increasingly with time over the period 0 to 10 seconds from the time of the Frequency increase on the basis set out in the Ancillary Services Agreement and fully achieved within 10 seconds of the time of the start of the Frequency increase and it must be sustained at no lesser reduction thereafter. The interpretation of the High Frequency Response to a + 0.5 Hz frequency change is shown diagrammatically in Figure CC.A.3.3 and Figure ECC.A.3.3.
High Voltage or HV	For E&W Transmission Systems , a voltage exceeding 650 volts. For Scottish Transmission Systems , a voltage exceeding 1000 volts.
Historic Frequency Data	System Frequency data at a maximum of one second intervals for the whole month, published by The Company as detailed in OC3.4.4.
Houseload Operation	Operation which ensures that a Power Station is able to continue to supply its in-house load in the event of System faults resulting in Power-Generating Modules being disconnected from the System and tripped onto their auxiliary supplies
HP Turbine Power Fraction	Ratio of steady state mechanical power delivered by the HP turbine to the total steady state mechanical power delivered by the total steam turbine at Registered Capacity or Maximum Capacity .
HV Connections	Apparatus connected at the same voltage as that of the National Electricity Transmission System , including Users' circuits, the higher voltage windings of Users' transformers and associated connection Apparatus .
HVDC Converter	Any EU Code User Apparatus used to convert alternating current electricity to direct current electricity, or vice versa. An HVDC Converter is a standalone operative configuration at a single site comprising one or more converter bridges, together with one or more converter transformers, reactors, converter control equipment, essential protective and switching devices and auxiliaries, if any, used for conversion. In a bipolar arrangement, an HVDC Converter represents the bipolar configuration.

HVDC Converter Station	Part of an HVDC System which consists of one or more HVDC Converters installed in a single location together with buildings, reactors, filters reactive power devices, control, monitoring, protective, measuring and auxiliary equipment.
HVDC Equipment	Collectively means an HVDC System and a DC Connected Power Park Module and a Remote End HVDC Converter Station .
HVDC Interface Point	A point at which HVDC Plant and Apparatus is connected to an AC System at which technical specifications affecting the performance of the Plant and Apparatus can be prescribed.
HVDC System	An electrical power system which transfers energy in the form of high voltage direct current between two or more alternating current (AC) buses and comprises at least two HVDC Converter Stations with DC Transmission lines or cables between the HVDC Converter Stations .
HVDC System Owner	A party who owns and is responsible for an HVDC System . For the avoidance of doubt a DC Connected Power Park Module owner would be treated as a Generator .
IEC	International Electrotechnical Commission.
IEC Standard	A standard approved by the International Electrotechnical Commission.
Implementation Date	Is the date and time for implementation of an Approved Modification as specified in accordance with Paragraph GR.25.3.
Implementing Safety Co-ordinator	The Safety Co-ordinator implementing Safety Precautions .
Import Usable	That portion of Registered Import Capacity which is expected to be available and which is not unavailable due to a Planned Outage .
Incident Centre	A centre established by The Company or a User as the focal point in The Company or in that User , as the case may be, for the communication and dissemination of information between the senior management representatives of The Company , or of that User , as the case may be, and the relevant other parties during a Joint System Incident in order to avoid overloading The Company's , or that User's , as the case may be, existing operational/control arrangements.
Independent Back-Up Protection	A Back-Up Protection system which utilises a discrete relay, different current transformers and an alternate operating principle to the Main Protection systems(s) such that it can operate autonomously in the event of a failure of the Main Protection .
Independent Main Protection	A Main Protection system which utilises a physically discrete relay and different current transformers to any other Main Protection .
Indicated Constraint Boundary Margin	The difference between a constraint boundary transfer limit and the difference between the sum of BM Unit Maximum Export Limits and the forecast of local Demand within the constraint boundary.
Indicated Imbalance	The difference between the sum of Physical Notifications for BM Units comprising Generating Units or CCGT Modules or Power Generating Modules and the forecast of Demand for the whole or any part of the System .

Indicated Margin	The difference between the sum of BM Unit Maximum Export Limits submitted and the forecast of Demand for the whole or any part of the System .
Inertia Constant H	For a GBGF-S the Inertia Constant H is measured in MWsec/MVA.
Inertia Constant He	For a GBGF- I Electronic Power Converter the Inertia Constant He , is measured in MWsec/MVA and produced by the Active ROCOF Response Power .
Installation Document	A simple structured document containing information about a Type A Power Generating Module or a Demand Unit , with demand response connected below 1000 V, and confirming its compliance with the relevant requirements
Instructor Facilities	A device or system which gives certain Transmission Control Centre instructions with an audible or visible alarm, and incorporates the means to return message acknowledgements to the Transmission Control Centre .
Integral Equipment Test or IET	A test on equipment, associated with Plant and/or Apparatus , which takes place when that Plant and/or Apparatus forms part of a Synchronised System and which, in the reasonable judgement of the person wishing to perform the test, may cause an Operational Effect .
Intellectual Property" or "IPRs	Patents, trade marks, service marks, rights in designs, trade names, copyrights and topography rights (whether or not any of the same are registered and including applications for registration of any of the same) and rights under licences and consents in relation to any of the same and all rights or forms of protection of a similar nature or having equivalent or similar effect to any of the same which may subsist anywhere in the world.
Interconnection Agreement	An agreement made between The Company and an Externally Interconnected System Operator and/or an Interconnector User and/or other relevant persons for the External Interconnection relating to an External Interconnection and/or an agreement under which an Interconnector User can use an External Interconnection .
Interconnector Export Capacity	In relation to an External Interconnection means the (daily or weekly) forecast value (in MW) at the time of the (daily or weekly) peak demand, of the maximum level at which the External Interconnection can export to the Grid Entry Point .
Interconnector Import Capacity	In relation to an External Interconnection means the (daily or weekly) forecast value (in MW) at the time of the (daily or weekly) peak demand of the maximum level at which the External Interconnection can import from the Grid Entry Point .
Interconnector Owner	Has the meaning given to the term in the Connection and Use of System Code .
Interconnector User	Has the meaning set out in the BSC .
Interface Agreement	Has the meaning set out in the CUSC .

Interface Point	As the context admits or requires either; (a) the electrical point of connection between an Offshore Transmission System and an Onshore Transmission System , or (b) the electrical point of connection between an Offshore Transmission System and a Network Operator’s User System .
Interface Point Capacity	The maximum amount of Active Power transferable at the Interface Point as declared by a User under the OTSDUW Arrangements expressed in whole MW.
Interface Point Target Voltage/Power factor	The nominal target voltage/power factor at an Interface Point which a Network Operator requires The Company to achieve by operation of the relevant Offshore Transmission System .
Interim Operational Notification or ION	A notification from The Company to a Generator or DC Converter Station owner or HVDC System Owner or Network Operator or Non-Embedded Customer acknowledging that the User has demonstrated compliance, except for the Unresolved Issues ; (a) with the Grid Code, and (b) where applicable, with Appendices F1 to F5 of the Bilateral Agreement , in each case in respect of the Plant and Apparatus (including OTSUA) specified in such notification and provided that in the case of the OTSDUW Arrangements such notification shall be provided to a Generator in two parts dealing with the OTSUA and Generator’s Plant and Apparatus (called respectively “ Interim Operational Notification Part A ” or “ ION A ” and “ Interim Operational Notification Part B ” or “ ION B ”) as provided for in the CP or ECP .
Intermittent Power Source	The primary source of power for a Generating Unit or Power Generating Module that cannot be considered as controllable, e.g. wind, wave or solar. For the avoidance of doubt, the output from an Electricity Storage Module would not be considered to be an Intermittent Power Source .
Internal Voltage Source or IVS	For a GBGF-S , a real magnetic field, that rotates synchronously with the System Frequency under normal operating conditions, which as a consequence induces an internal voltage (which is often referred to as the Electro Motive Force (EMF)) in the stationary generator winding that has a real impedance. In a GBGF-I , switched power electronic devices are used to produce a voltage waveform, with harmonics, that has a fundamental rotational component called the Internal Voltage Source (IVS) that rotates synchronously with the System Frequency under normal operating conditions. For a GBGF-I there must be an impedance with only real physical values, between the Internal Voltage Source and the Grid Entry Point or User System Entry Point . For the avoidance of doubt, a virtual impedance, is not permitted in GBGF-I .

Intertripping	<p>(a) The tripping of circuit-breaker(s) by commands initiated from Protection at a remote location independent of the state of the local Protection; or</p> <p>(b) Operational Intertripping.</p>
Intertrip Apparatus	Apparatus which performs Intertripping .
IP Completion Day	31 December 2020 as defined in Section 39 of the European Union (Withdrawal Agreement) Act 2020.
IP Turbine Power Fraction	Ratio of steady state mechanical power delivered by the IP turbine to the total steady state mechanical power delivered by the total steam turbine at Registered Capacity or Maximum Capacity .
Isolating Device	A device for achieving Isolation .
Isolation	<p>The disconnection of HV Apparatus (as defined in OC8A.1.6.2 and OC8B.1.7.2) from the remainder of the System in which that HV Apparatus is situated by either of the following:</p> <p>(a) an Isolating Device maintained in an isolating position. The isolating position must either be:</p> <ul style="list-style-type: none"> (i) maintained by immobilising and Locking the Isolating Device in the isolating position and affixing a Caution Notice to it. Where the Isolating Device is Locked with a Safety Key, the Safety Key must be secured in a Key Safe and the Key Safe Key must be, where reasonably practicable, given to the authorised site representative of the Requesting Safety Co-Ordinator and is to be retained in safe custody. Where not reasonably practicable the Key Safe Key must be retained by the authorised site representative of the Implementing Safety Co-ordinator in safe custody; or (ii) maintained and/or secured by such other method which must be in accordance with the Local Safety Instructions or the Safety Rules of the Relevant Transmission Licensee or that User, as the case may be; or <p>(b) an adequate physical separation which must be in accordance with and maintained by the method set out in the Local Safety Instructions or the Safety Rules of the Relevant Transmission Licensee or that User, as the case may be.</p>
Joint System Incident	An Event wherever occurring (other than on an Embedded Medium Power Station or an Embedded Small Power Station) which, in the opinion of The Company or a User , has or may have a serious and/or widespread effect, in the case of an Event on a User(s) System(s) (other than on an Embedded Medium Power Station or Embedded Small Power Station), on the National Electricity Transmission System , and in the case of an Event on the National Electricity Transmission System , on a User(s) System(s) (other than on an Embedded Medium Power Station or Embedded Small Power Station).
Key Safe	A device for the secure retention of keys.

Key Safe Key	A key unique at a Location capable of operating a lock, other than a control lock, on a Key Safe .
Large Power Station	<p>A Power Station which is</p> <p>(a) directly connected to:</p> <ul style="list-style-type: none"> (i) NGET’s Transmission System where such Power Station has a Registered Capacity of 100MW or more; or (ii) SPT’s Transmission System where such Power Station has a Registered Capacity of 30MW or more; or (iii) SHETL’s Transmission System where such Power Station has a Registered Capacity of 10MW or more; or (iv) an Offshore Transmission System where such Power Station has a Registered Capacity of 10MW or more; <p>or,</p> <p>(b) Embedded within a User System (or part thereof) where such User System (or part thereof) is connected under normal operating conditions to:</p> <ul style="list-style-type: none"> (i) NGET’s Transmission System and such Power Station has a Registered Capacity of 100MW or more; or (ii) SPT’s Transmission System and such Power Station has a Registered Capacity of 30MW or more; or (iii) SHETL’s Transmission System and such Power Station has a Registered Capacity of 10MW or more; <p>or,</p> <p>(c) Embedded within a User System (or part thereof) where the User System (or part thereof) is not connected to the National Electricity Transmission System, although such Power Station is in:</p> <ul style="list-style-type: none"> (i) NGET’s Transmission Area where such Power Station has a Registered Capacity of 100MW or more; or (ii) SPT’s Transmission Area where such Power Station has a Registered Capacity of 30MW or more; or (iii) SHETL’s Transmission Area where such Power Station has a Registered Capacity of 10MW or more; <p>For the avoidance of doubt, a Large Power Station could comprise of Type A, Type B, Type C or Type D Power Generating Modules.</p>
Legally Binding Decisions of the European Commission and/or the Agency	Any relevant legally binding decision or decisions of the European Commission and/or the Agency , but a binding decision does not include a decision that is not, or so much of a decision as is not, Retained EU Law .
Legal Challenge	Where permitted by law, a judicial review in respect of the Authority’s decision to approve or not to approve a Grid Code Modification Proposal .
Licence	Any licence granted to The Company or a Relevant Transmission Licensee or a User , under Section 6 of the Act .

Licence Standards	Those standards set out or referred to in Condition C17 of The Company's Transmission Licence and/or Condition D3 and/or Condition E16 of a Relevant Transmission Licensee's Transmission Licence .
Limited Frequency Sensitive Mode	A mode whereby the operation of the Genset or Power Generating Module (or DC Converter at a DC Converter Station or HVDC Systems exporting Active Power to the Total System) is Frequency insensitive except when the System Frequency exceeds 50.4Hz, from which point Limited High Frequency Response must be provided. For Power Generating Modules (including DC Connected Power Park Modules) and HVDC Systems , operation in Limited Frequency Sensitive Mode would require Limited Frequency Sensitive Mode – Overfrequency (LFSM-O) capability and Limited Frequency Sensitive Mode – Underfrequency (LFSM-U) capability.
Limited Frequency Sensitive Mode – Overfrequency or LFSM-O	A Power Generating Module (including a DC Connected Power Park Module) or HVDC System operating mode which will result in Active Power output reduction in response to a change in System Frequency above a certain value.
Limited Frequency Sensitive Mode – Underfrequency or LFSM-U	A Power Generating Module (including a DC Connected Power Park Module) or HVDC System operating mode which will result in Active Power output increase in response to a change in System Frequency below a certain value.
Limited High Frequency Response	A response of a Genset (or DC Converter at a DC Converter Station exporting Active Power to the Total System) to an increase in System Frequency above 50.4Hz leading to a reduction in Active Power in accordance with the provisions of BC3.7.2.1.
Limited Membership Workgroup	A Workgroup having less than five (5) but more than two (2) persons that have nominated themselves for membership in addition to the Code Administrator representative and the chairperson of the Workgroup . Members of a Limited Membership Workgroup where employed by companies that are considered to be an Affiliate of each other will be considered to be a single workgroup member for the purposes of fulfilling this minimum requirement.
Limited Operational Notification or LON	A notification from The Company to a Generator or DC Converter Station owner or HVDC System Owner or Network Operator or Non-Embedded Customer stating that the User's Plant and/or Apparatus specified in such notification may be, or is, unable to comply: (a) with the provisions of the Grid Code specified in the notice, and (b) where applicable, with Appendices F1 to F5 of the Bilateral Agreement , and specifying the Unresolved Issues .
Load	The Active, Reactive or Apparent Power , as the context requires, generated, transmitted or distributed.
Loaded	Supplying electrical power to the System .

Load Angle	The angle in radians between the voltage of the Internal Voltage Source and the voltage at the Grid Entry Point or User System Entry Point .
Load Factor	The ratio of the actual output of a Generating Unit or Power Generating Module to the possible maximum output of that Generating Unit or Power Generating Module .
Load Management Block	A block of Demand controlled by a Supplier or other party through the means of radio teleswitching or by some other means.
Local Joint Restoration Plan	<p>A plan produced under OC9.4.7.12 detailing the agreed method and procedure by which a Black Start Service Provider will energise part of the Total System and meet complementary blocks of local Demand so as to form a Power Island.</p> <p>In Scotland, the plan may also: cover more than one Black Start Service Provider; including Gensets other than those at a Black Start Station and cover the creation of one or more Power Islands.</p>
Local Safety Instructions	For safety co-ordination in England and Wales, instructions on each User Site and Transmission Site , approved by NGET's or User's relevant manager, setting down the methods of achieving the objectives of NGET's or the User's Safety Rules , as the case may be, to ensure the safety of personnel carrying out work or testing on Plant and/or Apparatus on which their Safety Rules apply and, in the case of a User , any other document(s) on a User Site which contains rules with regard to maintaining or securing the isolating position of an Isolating Device , or maintaining a physical separation or maintaining or securing the position of an Earthing Device .
Local Switching Procedure	A procedure produced under OC7.6 detailing the agreed arrangements in respect of carrying out of Operational Switching at Connection Sites and parts of the National Electricity Transmission System adjacent to those Connection Sites .
Localised Negative Reserve Active Power Margin or Localised NRAPM	That margin of Active Power sufficient to allow transfers to and from a System Constraint Group (as the case may be) to be contained within such reasonable limit as The Company may determine.
Location	Any place at which Safety Precautions are to be applied.
Locked	A condition of HV Apparatus that cannot be altered without the operation of a locking device.
Locking	The application of a locking device which enables HV Apparatus to be Locked .
Low Frequency Relay	Has the same meaning as Under Frequency Relay .
Low Voltage or LV	For E&W Transmission Systems a voltage not exceeding 250 volts. For Scottish Transmission Systems , a voltage exceeding 50 volts but not exceeding 1000 volts.
LV Side of the Offshore Platform	Unless otherwise specified in the Bilateral Agreement , the busbar on the Offshore Platform (typically 33kV) at which the relevant Offshore Grid Entry Point is located.

Main Plant and Apparatus	<p>In respect of a Power Station (including Power Stations comprising of DC Connected Power Park Modules and Electricity Storage Modules) is one or more of the principal items of Plant or Apparatus required to convert or re-convert the primary source of energy into electricity.</p> <p>In respect of HVDC Systems or DC Converters or Transmission DC Converters is one of the principal items of Plant or Apparatus used to convert high voltage direct current to high voltage alternating current or vice versa.</p> <p>In respect of a Network Operator's equipment or a Non-Embedded Customer's equipment, is one of the principal items of Plant or Apparatus required to facilitate the import or export of Active Power or Reactive Power to or from a Network Operator's or Non-Embedded Customer's System.</p>
Main Protection	A Protection system which has priority above other Protection in initiating either a fault clearance or an action to terminate an abnormal condition in a power system.
Manufacturer's Data & Performance Report	A report submitted by a manufacturer to The Company relating to a specific version of a Power Park Unit demonstrating the performance characteristics of such Power Park Unit in respect of which The Company has evaluated its relevance for the purposes of the Compliance Processes .
Manufacturer's Test Certificates	A certificate prepared by a manufacturer which demonstrates that its Power Generating Module has undergone appropriate tests and conforms to the performance requirements expected by The Company in satisfying its compliance requirements and thereby satisfies the appropriate requirements of the Grid Code and Bilateral Agreement .
Market Operation Data Interface System (MODIS)	A computer system operated by The Company and made available for use by Customers connected to or using the National Electricity Transmission System for the purpose of submitting EU Transparency Availability Data to The Company .
Market Suspension Threshold	Has the meaning given to the term 'Market Suspension Threshold' in Section G of the BSC .
Material Effect	An effect causing The Company or a Relevant Transmission Licensee to effect any works or to alter the manner of operation of Transmission Plant and/or Transmission Apparatus at the Connection Site (which term shall, in this definition and in the definition of " Modification " only, have the meaning ascribed thereto in the CUSC) or the site of connection or a User to effect any works or to alter the manner of operation of its Plant and/or Apparatus at the Connection Site or the site of connection which in either case involves that party in expenditure of more than £10,000.
Materially Affected Party	Any person or class of persons designated by the Authority as such.
Maximum Export Capability	The maximum continuous Active Power that a Network Operator or Non-Embedded Customer can export to the Transmission System at the Grid Supply Point , as specified in the Bilateral Agreement .

Maximum Export Capacity	The maximum continuous Apparent Power expressed in MVA and maximum continuous Active Power expressed in MW which can flow from an Offshore Transmission System connected to a Network Operator's User System , to that User System .
Maximum Capacity or P_{max}	The maximum continuous Active Power which a Power Generating Module can supply to the Total System , less any demand associated solely with facilitating the operation of that Power Generating Module and not fed into the System . In the case of an Electricity Storage Module , the Maximum Capacity is the maximum continuous Active Power which an Electricity Storage Module can export to the Total System less any demand associated with facilitating the operation of that Electricity Storage Module when fully charged and operating in a mode analogous to Generation .
Maximum Generation Service or MGS	A service utilised by The Company in accordance with the CUSC and the Balancing Principles Statement in operating the Total System .
Maximum Generation Service Agreement	An agreement between a User and The Company for the payment by The Company to that User in respect of the provision by such User of a Maximum Generation Service .
Maximum HVDC Active Power Transmission Capacity (PHmax)	The maximum continuous Active Power which an HVDC System can exchange with the network at each Grid Entry Point or User System Entry Point as specified in the Bilateral Agreement or as agreed between The Company and the HVDC System Owner .
Maximum Import Capability	The maximum continuous Active Power that a Network Operator or Non-Embedded Customer can import from the Transmission System at the Grid Supply Point , as specified in the Bilateral Agreement .
Maximum Import Capacity	The maximum continuous Apparent Power expressed in MVA and maximum continuous Active Power expressed in MW which can flow to an Offshore Transmission System connected to a Network Operator's User System , from that User System .
Maximum Import Power	The maximum continuous Active Power which an Electricity Storage Module can import from the Total System , when fully discharged and operating in a mode analogous to Demand .

Medium Power Station	<p>A Power Station which is</p> <p>(a) directly connected to NGET's Transmission System where such Power Station has a Registered Capacity of 50MW or more but less than 100MW;</p> <p>or,</p> <p>(b) Embedded within a User System (or part thereof) where such User System (or part thereof) is connected under normal operating conditions to NGET's Transmission System and such Power Station has a Registered Capacity of 50MW or more but less than 100MW;</p> <p>or,</p> <p>(c) Embedded within a User System (or part thereof) where the User System (or part thereof) is not connected to the National Electricity Transmission System, although such Power Station is in NGET's Transmission Area and such Power Station has a Registered Capacity of 50MW or more but less than 100MW.</p> <p>For the avoidance of doubt a Medium Power Station could comprise of Type A, Type B, Type C or Type D Power Generating Modules.</p>
Medium Voltage or MV	For E&W Transmission Systems a voltage exceeding 250 volts but not exceeding 650 volts.
Mills	Milling plant which supplies pulverised fuel to the boiler of a coal fired Power Station .
Minimum Generation	The minimum output (in whole MW) which a Genset can generate or DC Converter at a DC Converter Station or Electricity Storage Module can import or export to the Total System under stable operating conditions, as registered with The Company under the PC (and amended pursuant to the PC). For the avoidance of doubt, the output may go below this level as a result of operation in accordance with BC3.7.
Minimum Active Power Transmission Capacity (PHmin)	The minimum continuous Active Power which an HVDC System can exchange with the System at each Grid Entry Point or User System Entry Point as specified in the Bilateral Agreement or as agreed between The Company and the HVDC System Owner .
Minimum Import Capacity	The minimum input (in whole MW) into a DC Converter at a DC Converter Station or HVDC System at an HVDC Converter (in any of its operating configurations) at the Onshore Grid Entry Point (or in the case of an Embedded DC Converter or an Embedded HVDC Converter at the User System Entry Point) at which a DC Converter or HVDC Converter can operate in a stable manner, as registered with The Company under the PC (and amended pursuant to the PC).
Minimum Regulating Level	The minimum Active Power , as specified in the Bilateral Agreement or as agreed between The Company and the Generator or HVDC System Owner , down to which the Power Generating Module (including a DC Connected Power Park Module) or HVDC System can control Active Power .

Minimum Stable Operating Level	The minimum Active Power , as specified in the Bilateral Agreement or as agreed between The Company and the Generator , at which the Power Generating Module can be operated stably for an unlimited time.
Modification	Any actual or proposed replacement, renovation, modification, alteration or construction by or on behalf of a User or The Company to either that User's Plant or Apparatus or Transmission Plant or Apparatus , as the case may be, or the manner of its operation which has or may have a Material Effect on The Company or a User , as the case may be, at a particular Connection Site .
Mothballed DC Connected Power Park Module	A DC Connected Power Park Module that has previously generated which the Generator plans not to use to generate for the remainder of the current Financial Year but which could be returned to service.
Mothballed DC Converter at a DC Converter Station	A DC Converter at a DC Converter Station that has previously imported or exported power which the DC Converter Station Owner plans not to use to import or export power for the remainder of the current Financial Year but which could be returned to service.
Mothballed HVDC System	An HVDC System that has previously imported or exported power which the HVDC System Owner plans not to use to import or export power for the remainder of the current Financial Year but which could be returned to service.
Mothballed HVDC Converter	An HVDC Converter which is part of an HVDC System that has previously imported or exported power which the HVDC System Owner plans not to use to import or export power for the remainder of the current Financial Year but which could be returned to service.
Mothballed Generating Unit	A Generating Unit that has previously generated which the Generator plans not to use to generate for the remainder of the current Financial Year but which could be returned to service. For the avoidance of doubt a Mothballed Generating Unit could be part of a Power Generating Module .
Mothballed Power Generating Module	A Power Generating Module that has previously generated which the Generator plans not to use to generate for the remainder of the current Financial Year but which could be returned to service.
Mothballed Power Park Module	A Power Park Module that has previously generated which the Generator plans not to use to generate for the remainder of the current Financial Year but which could be returned to service.
Multiple Point of Connection	A double (or more) Point of Connection , being two (or more) Points of Connection interconnected to each other through the User's System .
MSID	Has the meaning a set out in the BSC , covers Metering System Identifier.

<p>National Demand</p>	<p>The amount of electricity supplied from the Grid Supply Points plus:-</p> <ul style="list-style-type: none"> • that supplied by Embedded Large Power Stations, and • National Electricity Transmission System Losses, <p>minus:-</p> <ul style="list-style-type: none"> • the Demand taken by Station Transformers and, Pumped Storage Units and Electricity Storage Modules’. <p>and, for the purposes of this definition, does not include:-</p> <ul style="list-style-type: none"> • any exports from the National Electricity Transmission System across External Interconnections.
<p>National Electricity Transmission System</p>	<p>The Onshore Transmission System and, where owned by Offshore Transmission Licensees, Offshore Transmission Systems.</p>
<p>National Electricity Transmission System Demand</p>	<p>The amount of electricity supplied from the Grid Supply Points plus:-</p> <ul style="list-style-type: none"> • that supplied by Embedded Large Power Stations, and • exports from the National Electricity Transmission System across External Interconnections, and • National Electricity Transmission System Losses, <p>and, for the purposes of this definition, includes:-</p> <ul style="list-style-type: none"> • the Demand taken by Station Transformers and, Pumped Storage Units and Electricity Storage Modules’.
<p>National Electricity Transmission System Losses</p>	<p>The losses of electricity incurred on the National Electricity Transmission System.</p>
<p>National Electricity Transmission System Operator Area</p>	<p>Has the meaning set out in Schedule 1 of The Company's Transmission Licence.</p>
<p>National Electricity Transmission System Study Network Data File</p>	<p>A computer file produced by The Company which in The Company's view provides an appropriate representation of the National Electricity Transmission System for a specific point in time. The computer file will contain information and data on Demand on the National Electricity Transmission System and on Large Power Stations including Genset power output consistent with Output Usable and The Company's view of prevailing system conditions.</p>
<p>National Electricity Transmission System Warning</p>	<p>A warning issued by The Company to Users (or to certain Users only) in accordance with OC7.4.8.2, which provides information relating to System conditions or Events and is intended to:</p> <ol style="list-style-type: none"> (a) alert Users to possible or actual Plant shortage, System problems and/or Demand reductions; (b) inform of the applicable period; (c) indicate intended consequences for Users; and (d) enable specified Users to be in a state of readiness to receive instructions from The Company.

National Electricity Transmission System Warning - Demand Control Imminent	A warning issued by The Company , in accordance with OC7.4.8.7, which is intended to provide short term notice, where possible, to those Users who are likely to receive Demand reduction instructions from The Company within 30 minutes.
National Electricity Transmission System Warning - Electricity Margin Notice	A warning issued by The Company , in accordance with OC7.4.8.5, which is intended to invite a response from and to alert recipients to a decreased System Margin .
National Electricity Transmission System Warning – Embedded Generation Control Imminent	A warning issued by The Company , in accordance with OC7.4.8.12, which is intended to provide short term notice, where possible, to those Network Operators who are likely to receive Embedded Generation Control instructions from The Company within 30 minutes.
National Electricity Transmission System Warning - High Risk of Demand Reduction	A warning issued by The Company , in accordance with OC7.4.8.6, which is intended to alert recipients that there is a high risk of Demand reduction being implemented and which may normally result from an Electricity Margin Notice .
National Electricity Transmission System Warning - High Risk of Embedded Generation Reduction	A warning issued by The Company , in accordance with OC7.4.8.11, which is intended to alert recipients that there is a high risk of Embedded Generation Control being implemented and which may result from a National Electricity Transmission System Warning – System NRAPM .
National Electricity Transmission System Warning – Localised NRAPM	A warning issued by The Company , in accordance with OC.7.4.8.10, which is intended to invite a response from and to alert recipients to a decreased Localised NRAPM .
National Electricity Transmission System Warning - Risk of System Disturbance	A warning issued by The Company , in accordance with OC7.4.8.8, which is intended to alert Users of the risk of widespread and serious System disturbance which may affect Users .
National Electricity Transmission System Warning – System NRAPM	A warning issued by The Company , in accordance with OC.7.4.8.9, which is intended to invite a response from and to alert recipients to a decreased System NRAPM .
Network Data	The data to be provided by The Company to Users in accordance with the PC , as listed in Part 3 of the Appendix to the PC .

<p>Network Frequency Perturbation Plot</p>	<p>A form of Bode Plot which plots the amplitude (%) and phase (degrees) of the resulting output oscillation responding to an applied input oscillation across a frequency base. The plot will be used to assess the capability and performance of a Grid Forming Plant and to ensure that it does not pose a risk to other Plant and Apparatus connected to the Total System.</p> <p>For GBGF-I, these are used to provide data to The Company which together with the associated Nichols Chart (or equivalent) defines the effects on a GBGF-I for changes in the frequency of the applied input oscillation.</p> <p>The input is the applied as an input oscillation and the output is the resulting oscillations in the GBGF-I's Active Power.</p> <p>For the avoidance of doubt, Generators in respect of GBGF-S can provide their data using the existing formats and do not need to supply NFP plots.</p>
<p>Network Gas Supply Emergency</p>	<p>Has the meaning set out in the BSC.</p>
<p>Network Operator</p>	<p>A person with a User System directly connected to the National Electricity Transmission System to which Customers and/or Power Stations (not forming part of the User System) are connected, acting in its capacity as an operator of the User System, but shall not include a person acting in the capacity of an Externally Interconnected System Operator or a Generator in respect of OTSUA.</p>
<p>NGET</p>	<p>National Grid Electricity Transmission plc (NO: 2366977) whose registered office is at 1-3 Strand, London, WC2N 5EH.</p>
<p>Nichols Chart</p>	<p>For a GBGF-I, a chart derived from the open loop Bode Plots that are used to produce an NFP Plot. The Nichols Chart plots open loop gain versus open loop phase angle. This enables the open loop phase for an open loop gain of 1 to be identified for use in defining the GBGF-I's equivalent Damping Factor.</p>
<p>No-Load Field Voltage</p>	<p>Shall have the meaning ascribed to that term in IEC 34-16-1:1991 [equivalent to British Standard BS4999 Section 116.1 : 1992].</p>
<p>No System Connection</p>	<p>As defined in OC8A.1.6.2 and OC8B.1.7.2.</p>
<p>Non-CUSC Party</p>	<p>A Party who does not accede to the Connection and Use of System Code (CUSC).</p>
<p>Non-Synchronous Electricity Storage Module</p>	<p>A Power Park Module comprising solely of one or more Non-Synchronous Electricity Storage Units.</p>
<p>Notification of User's Intention to Operate</p>	<p>A notification from a Network Operator or Non-Embedded Customer to The Company informing The Company of the date upon which any Network Operator's or Non-Embedded Customer's Plant and Apparatus at an EU Grid Supply Point will be ready to be connected to the Transmission System.</p>

Notification of User's Intention to Synchronise	A notification from a Generator or DC Converter Station owner or HVDC System Owner to The Company informing The Company of the date upon which any OTSUA , a Generating Unit(s) , CCGT Module(s) , Power Park Module(s) , Power Generating Module(s) (including a DC Connected Power Park Module(s)), HVDC System or DC Converter(s) will be ready to be Synchronised to the Total System .
Non-Controllable Electricity Storage Equipment	An item of storage Plant , including but not limited to a Synchronous Flywheel or Synchronous Compensation Equipment or Regenerative Braking whose active output power cannot be independently controlled.
Non-Dynamic Frequency Response Service	A Demand Response Service in which the Demand is controlled through discrete switching rather than through continuous load changes in response to System Frequency changes.
Non-Embedded Customer	A Customer in Great Britain , except for a Network Operator acting in its capacity as such, receiving electricity direct from the Onshore Transmission System irrespective of from whom it is supplied.
Non-Synchronous Electricity Storage Module	A Power Park Module comprising solely of one or more Non-Synchronous Electricity Storage Units .
Non-Synchronous Electricity Storage Unit	A Power Park Unit which can produce electrical energy by converting or re-converting another source of energy such that the frequency of the generated voltage is not inherently in synchronism with the frequency of the System .
Non-Synchronous Generating Unit	An Onshore Non-Synchronous Generating Unit or Offshore Non-Synchronous Generating Unit which could form part of a Power Generating Module .
Normal CCGT Module	A CCGT Module other than a Range CCGT Module .
Novel Unit	A tidal, wave, wind, geothermal, or any similar, Generating Unit .
OC9 De-synchronised Island Procedure	Has the meaning set out in OC9.5.4.
Offshore	Means wholly or partly in Offshore Waters , and when used in conjunction with another term and not defined means that the associated term is to be read accordingly.
Offshore DC Converter	Any User Apparatus located Offshore used to convert alternating current electricity to direct current electricity, or vice versa. An Offshore DC Converter is a standalone operative configuration at a single site comprising one or more converter bridges, together with one or more converter transformers, converter control equipment, essential protective and switching devices and auxiliaries, if any, used for conversion.
Offshore HVDC Converter	Any User Apparatus located Offshore used to convert alternating current electricity to direct current electricity, or vice versa. An Offshore HVDC Converter is a standalone operative configuration at a single site comprising one or more converter bridges, together with one or more converter transformers, converter control equipment, essential protective and switching devices and auxiliaries, if any, used for conversion.

Offshore Development Information Statement	A statement prepared by The Company in accordance with Special Condition C4 of The Company's Transmission Licence .
Offshore Generating Unit	Unless otherwise provided in the Grid Code, any Apparatus located Offshore which produces electrical energy by converting or re-converting another source of energy, including, an Offshore Synchronous Generating Unit or Offshore Non-Synchronous Generating Unit which could also be part of a Power Generating Module or Electricity Storage Module
Offshore Grid Entry Point	In the case of:- (a) an Offshore Generating Unit or an Offshore Synchronous Power Generating Module or an Offshore DC Converter or an Offshore HVDC Converter , as the case may be, which is directly connected to an Offshore Transmission System , the point at which it connects to that Offshore Transmission System , or; (b) an Offshore Power Park Module which is directly connected to an Offshore Transmission System , the point where one Power Park String (registered by itself as a Power Park Module) or the collection of points where a number of Offshore Power Park Strings (registered as a single Power Park Module) connects to that Offshore Transmission System , or; (c) an External Interconnection which is directly connected to an Offshore Transmission System , the point at which it connects to that Offshore Transmission System .
Offshore Non-Synchronous Generating Unit	An Offshore Generating Unit that is not an Offshore Synchronous Generating Unit including for the avoidance of doubt a Power Park Unit or Non-Synchronous Electricity Storage Unit located Offshore .
Offshore Platform	A single structure comprising of Plant and Apparatus located Offshore which includes one or more Offshore Grid Entry Points .
Offshore Power Park Module	A collection of one or more Offshore Power Park Strings (registered as a Power Park Module under the PC). There is no limit to the number of Power Park Strings within the Power Park Module , so long as they either: (a) connect to the same busbar which cannot be electrically split; or (b) connect to a collection of directly electrically connected busbars of the same nominal voltage and are configured in accordance with the operating arrangements set out in the relevant Bilateral Agreement .
Offshore Power Park String	A collection of Offshore Generating Units or Power Park Units or Non-Synchronous Electricity Storage Unit that are powered by an Intermittent Power Source , joined together by cables forming part of a User System with a single point of connection to an Offshore Transmission System . The connection to an Offshore Transmission System may include a DC Converter or HVDC Converter .

Offshore Synchronous Generating Unit	A Generating Unit or Synchronous Electricity Storage Unit located Offshore which could be part of an Offshore Synchronous Power Generating Module in which, under all steady state conditions, the rotor rotates at a mechanical speed equal to the electrical frequency of the National Electricity Transmission System divided by the number of pole pairs of the Generating Unit .
Offshore Synchronous Power Generating Module	A Synchronous Power Generating Module or Synchronous Electricity Storage Module located Offshore .
Offshore Tender Process	The process followed by the Authority to make, in prescribed cases, a determination on a competitive basis of the person to whom an offshore transmission licence is to be granted.
Offshore Transmission Distribution Connection Agreement	An agreement entered into by The Company and a Network Operator in respect of the connection to and use of a Network Operator's User System by an Offshore Transmission System .
Offshore Transmission Licensee	Such person in relation to whose Transmission Licence the standard conditions in Section E (offshore transmission owner standard conditions) of such Transmission Licence have been given effect, or any person in that prospective role who has acceded to the STC .
Offshore Transmission System	A system consisting (wholly or mainly) of high voltage electric lines and used for the transmission of electricity from one Power Station to a sub-station or to another Power Station or between sub-stations, and includes any Plant and Apparatus (including OTSUA) and meters in connection with the transmission of electricity but does not include any Remote Transmission Assets . An Offshore Transmission System extends from the Interface Point , or the Offshore Grid Entry Point(s) and may include Plant and Apparatus located Onshore and Offshore and, where the context permits, references to the Offshore Transmission System includes OTSUA .
Offshore Transmission System Development User Works or OTSDUW	In relation to a particular User where the OTSDUW Arrangements apply, means those activities and/or works for the design, planning, consenting and/or construction and installation of the Offshore Transmission System to be undertaken by the User as identified in Part 2 of Appendix I of the relevant Construction Agreement .
Offshore Transmission System User Assets or OTSUA	OTSDUW Plant and Apparatus constructed and/or installed by a User under the OTSDUW Arrangements which form an Offshore Transmission System that once transferred to a Relevant Transmission Licensee under an Offshore Tender Process will become part of the National Electricity Transmission System .
Offshore Waters	Has the meaning given to "offshore waters" in Section 90(9) of the Energy Act 2004.
Offshore Works Assumptions	In relation to a particular User , means those assumptions set out in Appendix P of the relevant Construction Agreement as amended from time to time.
Onshore	Means within Great Britain , and when used in conjunction with another term and not defined means that the associated term is to be read accordingly.

Onshore DC Converter	Any User Apparatus located Onshore with a Completion Date after 1 st April 2005 used to convert alternating current electricity to direct current electricity, or vice versa. An Onshore DC Converter is a standalone operative configuration at a single site comprising one or more converter bridges, together with one or more converter transformers, converter control equipment, essential protective and switching devices and auxiliaries, if any, used for conversion. In a bipolar arrangement, an Onshore DC Converter represents the bipolar configuration.
Onshore Generating Unit	Unless otherwise provided in the Grid Code, any Apparatus located Onshore which produces electrical energy by converting or re-converting another source of energy, including, an Onshore Synchronous Generating Unit or Onshore Non-Synchronous Generating Unit which could also be part of a Power Generating Module or an Electricity Storage Module .
Onshore Grid Entry Point	A point at which a Onshore Generating Unit or a CCGT Module or a CCGT Unit or an Onshore Power Generating Module or a Onshore DC Converter or an Onshore HVDC Converter or a Onshore Power Park Module or an Onshore Electricity Storage Module or an External Interconnection , as the case may be, which is directly connected to the Onshore Transmission System connects to the Onshore Transmission System .
Onshore HVDC Converter	Any User Apparatus located Onshore used to convert alternating current electricity to direct current electricity, or vice versa. An Onshore HVDC Converter is a standalone operative configuration at a single site comprising one or more converter bridges, together with one or more converter transformers, converter control equipment, essential protective and switching devices and auxiliaries, if any, used for conversion. In a bipolar arrangement, an Onshore HVDC Converter represents the bipolar configuration.
Onshore Non-Synchronous Generating Unit	A Generating Unit located Onshore that is not a Synchronous Generating Unit or Synchronous Electricity Storage Unit including for the avoidance of doubt a Power Park Unit or Non-Synchronous Electricity Storage Unit located Onshore .
Onshore Power Park Module	A collection of Non-Synchronous Generating Units that are powered by an Intermittent Power Source or connected through power electronic conversion technology or Non-Synchronous Electricity Storage Units , joined together by a System (registered as a Power Park Module under the PC) with a single electrical point of connection directly to the Onshore Transmission System (or User System if Embedded) with no intermediate Offshore Transmission System connections. The connection to the Onshore Transmission System (or User System if Embedded) may include a DC Converter or HVDC Converter .
Onshore Synchronous Generating Unit	An Onshore Generating Unit or Onshore Synchronous Electricity Storage Unit (which could also be part of an Onshore Power Generating Module) including, for the avoidance of doubt, a CCGT Unit or Synchronous Electricity Storage Unit in which, under all steady state conditions, the rotor rotates at a mechanical speed equal to the electrical frequency of the National Electricity Transmission System divided by the number of pole pairs of the Generating Unit .

Onshore Synchronous Power Generating Module	A Synchronous Power Generating Module or Synchronous Electricity Storage Module located Onshore .
Onshore Transmission Licensee	NGET, SPT, or SHETL .
Onshore Transmission System	The system consisting (wholly or mainly) of high voltage electric lines owned or operated by Onshore Transmission Licensees or operated by The Company and used for the transmission of electricity from one Power Station to a substation or to another Power Station or between substations or to or from Offshore Transmission Systems or to or from any External Interconnection , and includes any Plant and Apparatus and meters owned or operated by any Onshore Transmission Licensee in connection with the transmission of electricity but does not include any Remote Transmission Assets .
On-Site Generator Site	A site which is determined by the BSC Panel to be a Trading Unit under the BSC by reason of having fulfilled the Class 1 or Class 2 requirements as such terms are used in the BSC .
Operating Code or OC	That portion of the Grid Code which is identified as the Operating Code .
Operating Margin	Contingency Reserve plus Operating Reserve .
Operating Reserve	The additional output from Large Power Stations or the reduction in Demand , which must be realisable in real-time operation to respond in order to contribute to containing and correcting any System Frequency fall to an acceptable level in the event of a loss of generation or a loss of import from an External Interconnection or mismatch between generation and Demand .
Operation	A scheduled or planned action relating to the operation of a System (including an Embedded Power Station).
Operational Data	Data required under the Operating Codes and/or Balancing Codes .
Operational Day	The period from 0500 hours on one day to 0500 on the following day.
Operation Diagrams	Diagrams which are a schematic representation of the HV Apparatus and the connections to all external circuits at a Connection Site (and in the case of OTSDUW, Transmission Interface Site), incorporating its numbering, nomenclature and labelling.
Operational Effect	Any effect on the operation of the relevant other System which causes the National Electricity Transmission System or the System of the other User or Users , as the case may be, to operate (or be at a materially increased risk of operating) differently to the way in which they would or may have operated in the absence of that effect.
Operational Intertripping	The automatic tripping of circuit-breakers to prevent abnormal system conditions occurring, such as over voltage, overload, System instability, etc. after the tripping of other circuit-breakers following power System fault(s) which includes System to Generating Unit, System to CCGT Module, System to Power Park Module, System to Electricity Storage Module, System to DC Converter, System to Power Generating Module, System to HVDC Converter and System to Demand intertripping schemes.

Operational Notifications	Any Energisation Operational Notification , Interim Operational Notification , Final Operational Notification or Limited Operational Notification issued from The Company to a User .
Operational Planning	Planning through various timescales the matching of generation output with forecast National Electricity Transmission System Demand together with a reserve of generation to provide a margin, taking into account outages of certain Generating Units or Power Generating Modules , of parts of the National Electricity Transmission System and of parts of User Systems to which Power Stations and/or Customers are connected, carried out to achieve, so far as possible, the standards of security set out in The Company's Transmission Licence , each Relevant Transmission Licensee's Transmission Licence or Electricity Distribution Licence , as the case may be.
Operational Planning Margin	An operational planning margin set by The Company .
Operational Planning Phase	The period from 8 weeks to the end of the 5 th year ahead of real time operation.
Operational Procedures	Management instructions and procedures, both in support of the Safety Rules and for the local and remote operation of Plant and Apparatus , issued in connection with the actual operation of Plant and/or Apparatus at or from a Connection Site .
Operational Switching	Operation of Plant and/or Apparatus to the instruction of the relevant Control Engineer . For the avoidance of doubt, the operation of Transmission Plant and/or Apparatus forming part of the National Electricity Transmission System will be to the instruction of the Relevant Transmission Licensee .
Other Relevant Data	The data listed in BC1.4.2(f) under the heading Other Relevant Data .
OTSDUW Arrangements	The arrangements whereby certain aspects of the design, consenting, construction, installation and/or commissioning of transmission assets are capable of being undertaken by a User prior to the transfer of those assets to a Relevant Transmission Licensee under an Offshore Tender Process .
OTSDUW Data and Information	The data and information to be provided by Users undertaking OTSDUW , to The Company in accordance with Appendix F of the Planning Code .
OTSDUW DC Converter	A Transmission DC Converter designed and/or constructed and/or installed by a User under the OTSDUW Arrangements and/or operated by the User until the OTSUA Transfer Time .
OTSDUW Development and Data Timetable	The timetable for both the delivery of OTSDUW Data and Information and OTSDUW Network Data and Information as referred to in Appendix F of the Planning Code and the development of the scope of the OTSDUW .
OTSDUW Network Data and Information	The data and information to be provided by The Company to Users undertaking OTSDUW in accordance with Appendix F of the Planning Code .

OTSDUW Plant and Apparatus	Plant and Apparatus , including any OTSDUW DC Converter , designed by the User under the OTSDUW Arrangements .
OTSUA Transfer Time	The time and date at which the OTSUA are transferred to a Relevant Transmission Licensee .
Out of Synchronism	The condition where a System or Generating Unit or Power Generating Module cannot meet the requirements to enable it to be Synchronised .
Output Usable or OU	<p>The forecast value (in MW), profiled across the time period affected by the unplanned or planned Event of the level at which the Genset can export to the Grid Entry Point, or in the case of Embedded Power Stations, to the User System Entry Point. In addition, for a Genset powered by an Intermittent Power Source the forecast value is based upon the Intermittent Power Source being at a level which would enable the Genset to generate at Registered Capacity.</p> <p>For the purpose of OC2 only, the term Output Usable shall include the terms Interconnector Export Capacity and Interconnector Import Capacity where the term Output Usable is being applied to an External Interconnection.</p>
Over-excitation Limiter	Shall have the meaning ascribed to that term in IEC 34-16-1:1991 [equivalent to British Standard BS4999 Section 116.1: 1992].
Panel Chairperson	A person appointed as such in accordance with GR.4.1.
Panel Member	Any of the persons identified as such in GR.4.
Panel Members' Recommendation	The recommendation in accordance with the " Grid Code Review Panel Recommendation Vote ".
Panel Secretary	A person appointed as such in accordance with GR.3.1.2(d).
Part 1 System Ancillary Services	Ancillary Services which are required for System reasons and which must be provided by Users in accordance with the Connection Conditions . An exhaustive list of Part 1 System Ancillary Services is included in that part of CC.8.1 or ECC.8.1 headed Part 1.
Part 2 System Ancillary Services	Ancillary Services which are required for System reasons and which must be provided by a User if the User has agreed to provide them under a Bilateral Agreement . A non-exhaustive list of Part 2 System Ancillary Services is included in that part of CC.8.1 or ECC.8.1 headed Part 2.
Part Load	The condition of a Genset , or Cascade Hydro Scheme which is Loaded but is not running at its Maximum Export Limit.
Peak Current Rating	<p>For a GBGF-I this is the larger of either the: -</p> <ul style="list-style-type: none"> • The registered maximum steady-state current plus the maximum additional current to supply the Active ROCOF Response Power plus the Defined Active Damping Power; or. • The registered maximum steady-state current plus the maximum additional current to supply the Phase Jump Angle limit power, or. <p>This is the maximum short term total current as declared by the Grid Forming Plant Owner in accordance with PC.A.5.8.1.</p>

<p>Permit for Work for proximity work</p>	<p>In respect of E&W Transmission Systems, a document issued by the Relevant E&W Transmission Licensee or an E&W User in accordance with its respective Safety Rules to enable work to be carried out in accordance with OC8A.8 and which provides for Safety Precautions to be applied and maintained. An example format of a Relevant E&W Transmission Licensee's permit for work is attached as Appendix E to OC8A.</p> <p>In respect of Scottish Transmission Systems, a document issued by a Relevant Scottish Transmission Licensee or a Scottish User in accordance with its respective Safety Rules to enable work to be carried out in accordance with OC8B.8 and which provides for Safety Precautions to be applied and maintained. Example formats of Relevant Scottish Transmission Licensees' permits for work are attached as Appendix E to OC8B.</p>
<p>Partial Shutdown</p>	<p>The same as a Total Shutdown except that all generation has ceased in a separate part of the Total System and there is no electricity supply from External Interconnections or other parts of the Total System to that part of the Total System and, therefore, that part of the Total System is shutdown, with the result that it is not possible for that part of the Total System to begin to function again without The Company's directions relating to a Black Start.</p>
<p>Pending Grid Code Modification Proposal</p>	<p>A Grid Code Modification Proposal in respect of which, at the relevant time, the Authority has not yet made a decision as to whether to direct such Grid Code Modification Proposal to be made pursuant to the Transmission Licence (whether or not a Grid Code Modification Report has been submitted in respect of such Grid Code Modification Proposal) or, in the case of a Grid Code Self Governance Proposals, in respect of which the Grid Code Review Panel has not yet voted whether or not to approve.</p>
<p>Phase Jump Angle</p>	<p>The difference in the measured phase angle of the voltage at the Grid Entry Point or User System Entry Point in a given mains half cycle compared with the measured phase angle of the voltage at the Grid Entry Point or User System Entry Point in the previous mains half cycle.</p>
<p>Phase Jump Angle Limit</p>	<p>The maximum Phase Jump Angle when applied to a GBGF-I which will result in a linear controlled response without activating current limiting functions. This is specified for a System angle near to zero which will be considered to be the normal operating angle under steady state conditions.</p>
<p>Phase Jump Angle Withstand</p>	<p>The maximum Phase Jump Angle change when applied to a GBGF-I which will result in the GBGF-I remaining in stable operation with current limiting functions activated. This is specified for a System angle near to zero which will be considered to be the normal operating angle under steady state conditions.</p>
<p>Phase (Voltage) Unbalance</p>	<p>The ratio (in percent) between the rms values of the negative sequence component and the positive sequence component of the voltage.</p>

Physical Notification	Data that describes the BM Participant's best estimate of the expected input or output of Active Power of a BM Unit and/or (where relevant) Generating Unit , except in the instance of a Stage 2 or higher Network Gas Supply Emergency , with the accuracy of the Physical Notification being commensurate with Good Industry Practice .
Planning Code or PC	That portion of the Grid Code which is identified as the Planning Code .
Planned Maintenance Outage	An outage of The Company's electronic data communication facilities as provided for in CC.6.5.8 or ECC.6.5.8 and The Company's associated computer facilities of which normally at least 5 days notice is given, but in any event of which at least twelve hours notice has been given by The Company to the User and which is anticipated to last no longer than 2 hours. The length of such an outage may in exceptional circumstances be extended where at least 24 hours notice has been given by The Company to the User . It is anticipated that normally any planned outage would only last around one hour.
Planned Outage	An outage of a Large Power Station or of part of the National Electricity Transmission System , or of part of a User System , co-ordinated by The Company under OC2 .
Plant	Fixed and movable items used in the generation and/or supply and/or transmission of electricity, other than Apparatus .
Point of Common Coupling	That point on the National Electricity Transmission System electrically nearest to the User installation at which either Demands or Loads are, or may be, connected.
Point of Connection	An electrical point of connection between the National Electricity Transmission System and a User's System .
Point of Isolation	The point on Apparatus (as defined in OC8A.1.6.2 and OC8B.1.7.2) at which Isolation is achieved.
Post-Control Phase	The period following real time operation.
Power Available	A signal prepared in accordance with good industry practice, representing the instantaneous sum of the potential Active Power available from each individual Power Park Unit within the Power Park Module calculated using any applicable combination of electrical or mechanical or meteorological data (including wind speed) measured at each Power Park Unit at a specified time. Power Available shall be a value between 0MW and Registered Capacity or Maximum Capacity which is the sum of the potential Active Power available of each Power Park Unit within the Power Park Module . A unit that is not generating or supplying power will be considered as not available. For the avoidance of doubt, the Power Available signal would be the Active Power output that a Power Park Module could reasonably be expected to export at the Grid Entry Point or User System Entry Point taking all the above criteria into account including Power Park Unit constraints such as optimisation modes but would exclude a reduction in the Active Power export of the Power Park Module instructed by The Company (for example) for the purposes selecting a Power Park Module to operate in Frequency Sensitive Mode or when an Emergency Instruction has been issued.

Power Factor	The ratio of Active Power to Apparent Power .
Power-Generating Module	Either a Synchronous Power Generating Module , a Synchronous Electricity Storage Module , a Power Park Module or a Non-Synchronous Electricity Storage Module owned or operated by an EU Generator .
Power-Generating Module Document (PGMD)	A document provided by the Generator to The Company for a Type B or Type C Power Generating Module which confirms that the Power Generating Module's compliance with the technical criteria set out in the Grid Code has been demonstrated and provides the necessary data and statements, including a statement of compliance.
Power Generating Module Performance Chart	A diagram showing the Active Power (MW) and Reactive Power (MVar) capability limits within which a Synchronous Power Generating Module or Power Park Module at its Grid Entry Point or User System Entry Point will be expected to operate under steady state conditions.
Power Island	Gensets at an isolated Power Station , together with complementary local Demand . In Scotland a Power Island may include more than one Power Station .
Power Park Module	Any Onshore Power Park Module or Offshore Power Park Module .
Power Park Module Availability Matrix	The matrix described in Appendix 1 to BC1 under the heading Power Park Module Availability Matrix .
Power Park Module Planning Matrix	A matrix in the form set out in Appendix 4 of OC2 showing the combination of Power Park Units within a Power Park Module which would be expected to be running under normal conditions.
Power Park Unit	A Generating Unit within a Power Park Module .
Power Station	An installation comprising one or more Generating Units or Power Park Modules or Power Generating Modules or Electricity Storage Modules (even where sited separately) owned and/or controlled by the same Generator , which may reasonably be considered as being managed as one Power Station .
Power System Stabiliser or PSS	Equipment controlling the Exciter output via the voltage regulator in such a way that power oscillations of the synchronous machines are dampened. Input variables may be speed, frequency or power (or a combination of these).
Preface	The preface to the Grid Code (which does not form part of the Grid Code and therefore is not binding).
Preliminary Notice	A notice in writing, sent by The Company both to all Users identified by it under OC12.4.2.1 and to the Test Proposer , notifying them of a proposed System Test .
Preliminary Project Planning Data	Data relating to a proposed User Development at the time the User applies for a CUSC Contract but before an offer is made and accepted.

Primary Response	The automatic increase in Active Power output of a Genset or, as the case may be, the decrease in Active Power Demand in response to a System Frequency fall. This increase in Active Power output or, as the case may be, the decrease in Active Power Demand must be in accordance with the provisions of the relevant Ancillary Services Agreement which will provide that it will be released increasingly with time over the period 0 to 10 seconds from the time of the start of the Frequency fall on the basis set out in the Ancillary Services Agreement and fully available by the latter, and sustainable for at least a further 20 seconds. The interpretation of the Primary Response to a – 0.5 Hz frequency change is shown diagrammatically in Figure CC.A.3.2 and Figure ECC.A.3.2
Private Network	A network which connects to a Network Operator's System and that network belongs to a User who is not classified as a Generator, Network Operator or Non-Embedded Customer .
Programming Phase	The period between the Operational Planning Phase and the Control Phase . It starts at the 8 weeks ahead stage and finishes at 17:00 on the day ahead of real time.
Proposal Notice	A notice submitted to The Company by a User which would like to undertake a System Test .
Proposal Report	A report submitted by the Test Panel which contains: <ul style="list-style-type: none"> (a) proposals for carrying out a System Test (including the manner in which the System Test is to be monitored); (b) an allocation of costs (including un-anticipated costs) between the affected parties (the general principle being that the Test Proposer will bear the costs); and (c) such other matters as the Test Panel considers appropriate. The report may include requirements for indemnities to be given in respect of claims and losses arising from a System Test .
Proposed Implementation Date	The proposed date(s) for the implementation of a Grid Code Modification Proposal or Workgroup Alternative Grid Code Modification such date(s) to be either (i) described by reference to a specified period after a direction from the Authority approving the Grid Code Modification Proposal or Workgroup Alternative Grid Code Modification or (ii) a Fixed Proposed Implementation Date .
Proposer	In relation to a particular Grid Code Modification Proposal , the person who makes such Grid Code Modification Proposal .
Protection	The provisions for detecting abnormal conditions on a System and initiating fault clearance or actuating signals or indications.
Protection Apparatus	A group of one or more Protection relays and/or logic elements designated to perform a specified Protection function.
Pumped Storage	A hydro unit in which water can be raised by means of pumps and stored to be used for the generation of electrical energy;

Pumped Storage Generating Unit	A Generating Unit at a Pumped Storage Plant
Pumped Storage Generator	A Generator which owns and/or operates any Pumped Storage Plant .
Pumped Storage Plant	A Power Station comprising Pumped Storage Generating Units .
Pumped Storage Unit	A Generating Unit within a Pumped Storage Plant . For the avoidance of doubt, a Pumped Storage Unit is not considered to form part of an Electricity Storage Unit unless specifically declared by the Generator .
Purchase Contracts	A final and binding contract for the purchase of the Main Plant and Apparatus .
Q/Pmax	<p>The ratio of Reactive Power to the Maximum Capacity. The relationship between Power Factor and Q/Pmax is given by the formula:-</p> $\text{Power Factor} = \text{Cos} \left[\arctan \left[\frac{Q}{P_{max}} \right] \right]$ <p>For example, a Power Park Module with a Q/P value of +0.33 would equate to a Power Factor of $\text{Cos}(\arctan 0.33) = 0.95$ Power Factor lag.</p>
Quick Resynchronisation Capability	The capability of a Type C or Type D Power Generating Module as defined in ECC.6.3.5.6. For the avoidance of doubt this requirement only applies to EU Code Generators who own or operate a Type C or Type D Power Generating Module .
Quick Resynchronisation Unit Test	A test undertaken on Generating Unit forming part of a Type C or Type D Power Generating Module as detailed in OC5.7.1 and OC5.7.4 necessary to determine its ability to demonstrate a Quick Resynchronisation Capability .
Range CCGT Module	A CCGT Module where there is a physical connection by way of a steam or hot gas main between that CCGT Module and another CCGT Module or other CCGT Modules , which connection contributes (if open) to efficient modular operation, and which physical connection can be varied by the operator.
Rated Field Voltage	Shall have the meaning ascribed to that term in IEC 34-16-1:1991 [equivalent to British Standard BS4999 Section 116.1: 1992].

<p>Rated MW</p>	<p>The “rating-plate” MW output of a Power Generating Module, Generating Unit, Power Park Module, Electricity Storage Module, HVDC Converter or DC Converter, being:</p> <ul style="list-style-type: none"> (a) that output up to which the Generating Unit was designed to operate (Calculated as specified in British Standard BS EN 60034 – 1: 1995); or (b) the nominal rating for the MW output of a Power Park Module or Power Generating Module being the maximum continuous electric output power which the Power Park Module or Power Generating Module was designed to achieve under normal operating conditions; or (c) the nominal rating for the MW import capacity and export capacity (if at a DC Converter Station or HVDC Converter Station) of a DC Converter or HVDC Converter. (d) in an importing mode, is that input up to which an Electricity Storage Module was designed to operate being the maximum continuous electric input which the Electricity Storage Module was designed to achieve under normal operating conditions. In an exporting mode is:- <ul style="list-style-type: none"> (i) that output up to which the Synchronous Electricity Storage Unit was designed to operate (Calculated as specified in British Standard BS EN 60034 – 1: 1995); or (ii) the nominal rating for the MW output of a Non-Synchronous Electricity Storage Module being the maximum continuous electric output power which the Non-Synchronous Electricity Storage Module was designed to achieve under normal operating conditions.
<p>Reactive Despatch Instruction</p>	<p>Has the meaning set out in the CUSC.</p>
<p>Reactive Despatch Network Restriction</p>	<p>A restriction placed upon an Embedded Power Generating Module, Embedded Generating Unit, Embedded Power Park Module or DC Converter at an Embedded DC Converter Station or HVDC Converter at an Embedded HVDC Converter Station by the Network Operator that prevents the Generator or DC Converter Station owner or HVDC System Owner in question (as applicable) from complying with any Reactive Despatch Instruction with respect to that Power Generating Module, Generating Unit, Power Park Module or DC Converter at a DC Converter Station or HVDC Converter at a HVDC Converter Station, whether to provide MVAr over the range referred to in CC 6.3.2, ECC.6.3.2 or otherwise.</p>
<p>Reactive Despatch to Zero Mvar Network Restriction</p>	<p>A Reactive Despatch Network Restriction which prevents an Embedded Power Generating Module, an Embedded Generating Unit, Embedded Power Park Module, Embedded HVDC System, HVDC Converter at an Embedded HVDC Converter Station or DC Converter at an Embedded DC Converter Station from supplying power at zero MVAr at all Active Power output levels up to and including Rated MW at the Grid Entry Point (or User System Entry Point if Embedded).</p>
<p>Reactive Energy</p>	<p>The integral with respect to time of the Reactive Power.</p>

<p>Reactive Power</p>	<p>The product of voltage and current and the sine of the phase angle between them measured in units of voltamperes reactive and standard multiples thereof, ie: 1000 VAr = 1 kVAr 1000 kVAr = 1 MVar</p>
<p>Record of Inter-System Safety Precautions or RISSP</p>	<p>A written record of inter-system Safety Precautions to be compiled in accordance with the provisions of OC8.</p>
<p>Regenerative Braking</p>	<p>A method of braking in which energy is extracted from the parts braked, which may be returned directly to the System and the purpose of the braking is motion control.</p>

<p>Registered Capacity</p>	<ul style="list-style-type: none"> (a) In the case of a Generating Unit other than that forming part of a CCGT Module or Power Park Module or Power Generating Module, the normal full load capacity of a Generating Unit as declared by the Generator, less the MW consumed by the Generating Unit through the Generating Unit's Unit Transformer when producing the same (the resultant figure being expressed in whole MW, or in MW to one decimal place). (b) In the case of a CCGT Module or Power Park Module owned or operated by a GB Generator, the normal full load capacity of the CCGT Module or Power Park Module (as the case may be) as declared by the GB Generator, being the Active Power declared by the GB Generator as being deliverable by the CCGT Module or Power Park Module at the Grid Entry Point (or in the case of an Embedded CCGT Module or Power Park Module, at the User System Entry Point), expressed in whole MW, or in MW to one decimal place. For the avoidance of doubt Maximum Capacity would apply to Power Generating Modules which form part of a Large, Medium or Small Power Station. (c) In the case of a Power Station, the maximum amount of Active Power deliverable by the Power Station at the Grid Entry Point (or in the case of an Embedded Power Station at the User System Entry Point), as declared by the Generator, expressed in whole MW, or in MW to one decimal place. The maximum Active Power deliverable is the maximum amount deliverable simultaneously by the Power Generating Modules and/or Generating Units and/or CCGT Modules and/or Power Park Modules less the MW consumed by the Power Generating Modules and/or Generating Units and/or CCGT Modules in producing that Active Power and forming part of a Power Station. (d) In the case of a DC Converter at a DC Converter Station or HVDC Converter at an HVDC Converter Station, the normal full load amount of Active Power transferable from a DC Converter or HVDC Converter at the Onshore Grid Entry Point (or in the case of an Embedded DC Converter Station or an Embedded HVDC Converter Station at the User System Entry Point), as declared by the DC Converter Station owner or HVDC System Owner, expressed in whole MW, or in MW to one decimal place. (e) In the case of a DC Converter Station or HVDC Converter Station, the maximum amount of Active Power transferable from a DC Converter Station or HVDC Converter Station at the Onshore Grid Entry Point (or in the case of an Embedded DC Converter Station or Embedded HVDC Converter Station at the User System Entry Point), as declared by the DC Converter Station owner or HVDC System Owner, expressed in whole MW, or in MW to one decimal place. (f) In the case of an Electricity Storage Module, the normal full load amount of Active Power transferable from an Electricity Storage Module at the Grid Entry Point (or in the case of an Embedded Electricity Storage Module at the User System Entry Point), as declared by the Generator, expressed in whole MW, or in MW to one decimal place.
-----------------------------------	-----------------------------------------------------------------------------------------------------------------------------------------------------------------------------------------------------------------------------------------------------------------------------------------------------------------------------------------------------------------------------------------------------------------------------------------------------------------------------------------------------------------------------------------------------------------------------------------------------------------------------------------------------------------------------------------------------------------------------------------------------------------------------------------------------------------------------------------------------------------------------------------------------------------------------------------------------------------------------------------------------------------------------------------------------------------------------------------------------------------------------------------------------------------------------------------------------------------------------------------------------------------------------------------------------------------------------------------------------------------------------------------------------------------------------------------------------------------------------------------------------------------------------------------------------------------------------------------------------------------------------------------------------------------------------------------------------------------------------------------------------------------------------------------------------------------------------------------------------------------------------------------------------------------------------------------------------------------------------------------------------------------------------------------------------------------------------------------------------------------------------------------------------------------------------------------------------------------------------------------------------------------------------------------------------------------------------------------------------------------------------------------------------------------------------------------------------------------------------------------------------------------------------------------------------------------------------------------------------------------------------------------------------------------------------------------------------------------------------------------------------------------------------------------------------------------------------------------------------------------------------------------------------------------------------------------------------------------------------------------------------------------------------------------------------------------------------------------------------------------------------------------------------------------------------------------------------------------------------------------------------------------------------------------------------------------------------------------------------------------------------------------------------------------------------------------------------------------------------------------------------------------------------------------------------------------------------------------------------------------------------------------------------------------------------------------------------------------------------

Registered Data	Those items of Standard Planning Data and Detailed Planning Data which upon connection become fixed (subject to any subsequent changes).
Registered Import Capability	<p>In the case of a DC Converter Station or HVDC Converter Station containing DC Converters or HVDC Converters connected to an External System, the maximum amount of Active Power transferable into a DC Converter Station or HVDC Converter Station at the Onshore Grid Entry Point (or in the case of an Embedded DC Converter Station or Embedded HVDC Converter Station at the User System Entry Point), as declared by the DC Converter Station owner or HVDC System Owner, expressed in whole MW.</p> <p>In the case of a DC Converter or HVDC Converter connected to an External System and in a DC Converter Station or HVDC Converter Station, the normal full load amount of Active Power transferable into a DC Converter or HVDC Converter at the Onshore Grid Entry Point (or in the case of an Embedded DC Converter Station or Embedded HVDC Converter Station at the User System Entry Point), as declared by the DC Converter owner or HVDC System Owner, expressed in whole MW.</p> <p>In the case of an Electricity Storage Module, the maximum amount of Active Power transferable into an Electricity Storage Module at the Grid Entry Point (or in the case of an Embedded Electricity Storage Module at the User System Entry Point), as declared by the Generator, expressed in whole MW.</p>
Regulations	The Utilities Contracts Regulations 1996, as amended from time to time.
Regulated Sections	Parts of the Grid Code that are referenced in Governance Rules Annex GR.B as amended from time to time with the approval of the Authority .
Reheater Time Constant	Determined at Registered Capacity , the reheater time constant will be construed in accordance with the principles of the IEEE Committee Report "Dynamic Models for Steam and Hydro Turbines in Power System Studies" published in 1973 which apply to such phrase.
Rejected Grid Code Modification Proposal	A Grid Code Modification Proposal in respect of which the Authority has decided not to direct The Company to modify the Grid Code pursuant to The Company's Transmission Licence in the manner set out herein or, in the case of a Grid Code Self Governance Proposals , in respect of which the Grid Code Review Panel has voted not to approve.
Related Person	Means, in relation to an individual, any member of their immediate family, their employer (and any former employer of theirs within the previous 12 months), any partner with whom they are in partnership, and any company or Affiliate of a company in which they or any member of their immediate family controls more than 20% of the voting rights in respect of the shares of the company;
Relevant E&W Transmission Licensee	As the context requires NGET and/or an E&W Offshore Transmission Licensee .
Relevant Party	Has the meaning given in GR15.10(a).

Relevant Scottish Transmission Licensee	As the context requires SPT and/or SHETL and/or a Scottish Offshore Transmission Licensee .
Relevant Transmission Licensee	Means National Grid Electricity Transmission plc (NGET) in its Transmission Area or SP Transmission plc (SPT) in its Transmission Area or Scottish Hydro-Electric Transmission Ltd (SHETL) in its Transmission Area or any Offshore Transmission Licensee in its Transmission Area .
Relevant Unit	As defined in the STC , Schedule 3.
Remote End HVDC Converter Station	An HVDC Converter Station which forms part of an HVDC System and is not directly connected to the AC part of the GB Synchronous Area .
Remote Transmission Assets	Any Plant and Apparatus or meters owned by NGET which: <ul style="list-style-type: none"> (a) are Embedded in a User System and which are not directly connected by Plant and/or Apparatus owned by NGET to a sub-station owned by NGET; and (b) are by agreement between NGET and such User operated under the direction and control of such User.
Replacement Reserves (RR)	Means, in the context of Balancing Services , the Active Power reserves available to restore or support the required level of FRR to be prepared for additional system imbalances, including generation reserves;
Requesting Safety Co-ordinator	The Safety Co-ordinator requesting Safety Precautions .
Responsible Engineer/ Operator	A person nominated by a User to be responsible for System control.
Responsible Manager	A manager who has been duly authorised by a User or a Relevant Transmission Licensee to sign Site Responsibility Schedules on behalf of that User or Relevant Transmission Licensee as the case may be.
Restoration Service Provider	A Black Start Service Provider , User or Non-CUSC Party with a legal or contractual obligation to provide a service contributing to one or several measures of the System Restoration Plan .
Re-synchronisation	The bringing of parts of the System which have become Out of Synchronism with any other System back into Synchronism , and like terms shall be construed accordingly.
Retained EU Law	31 December 2020 as defined in European Union (Withdrawal) Act 2018 as amended by the European Union (Withdrawal Agreement) Act 2020.
RR Acceptance	The results of the TERRE auction for each BM Participant .
Restricted	Applies to a TERRE Bid which has been marked so that it will be passed to the TERRE Central Platform but will not be used in the auction.
ROCOF	Rate of Change of Frequency

RR Instruction	Replacement Reserve Instruction – used for instructing BM Participants after the results of the TERRE auction. An RR Instruction has the same format as a Bid-Offer Acceptance but has type field indicating it is for TERRE .
Safety Co-ordinator	A person or persons nominated by a Relevant E&W Transmission Licensee and each E&W User in relation to Connection Points (or in the case of OTSUA operational prior to the OTSUA Transfer Time, Transmission Interface Points) on an E&W Transmission System and/or by the Relevant Scottish Transmission Licensee and each Scottish User in relation to Connection Points (or in the case of OTSUA operational prior to the OTSUA Transfer Time, Transmission Interface Points) on a Scottish Transmission System to be responsible for the co-ordination of Safety Precautions at each Connection Point (or in the case of OTSUA operational prior to the OTSUA Transfer Time, Transmission Interface Points) when work (which includes testing) is to be carried out on a System which necessitates the provision of Safety Precautions on HV Apparatus (as defined in OC8A.1.6.2 and OC8B.1.7.2), pursuant to OC8 .
Safety From The System	That condition which safeguards persons when work is to be carried out on or near a System from the dangers which are inherent in the System .
Safety Key	A key unique at the Location capable of operating a lock which will cause an Isolating Device and/or Earthing Device to be Locked .
Safety Log	A chronological record of messages relating to safety co-ordination sent and received by each Safety Co-ordinator under OC8 .
Safety Precautions	Isolation and/or Earthing .
Safety Rules	The rules of the Relevant Transmission Licensee or a User that seek to ensure that persons working on Plant and/or Apparatus to which the rules apply are safeguarded from hazards arising from the System .
Scottish Offshore Transmission System	An Offshore Transmission System with an Interface Point in Scotland.
Scottish Offshore Transmission Licensee	A person who owns or operates a Scottish Offshore Transmission System pursuant to a Transmission Licence .
Scottish Transmission System	Collectively SPT’s Transmission System and SHETL’s Transmission System and any Scottish Offshore Transmission Systems .
Scottish User	A User in Scotland or any Offshore User who owns or operates Plant and/or Apparatus connected (or which will at the OTSUA Transfer Time be connected) to a Scottish Offshore Transmission System .
Secondary BM Unit	Has the same meaning set out in the BSC .

Secondary Response	The automatic increase in Active Power output of a Genset or, as the case may be, the decrease in Active Power Demand in response to a System Frequency fall. This increase in Active Power output or, as the case may be, the decrease in Active Power Demand must be in accordance with the provisions of the relevant Ancillary Services Agreement which will provide that it will be fully available by 30 seconds from the time of the start of the Frequency fall and be sustainable for at least a further 30 minutes. The interpretation of the Secondary Response to a -0.5 Hz frequency change is shown diagrammatically in Figure CC.A.3.2 or Figure ECC.A.3.2.
Secretary of State	Has the same meaning as in the Act .
Secured Event	Has the meaning set out in the Security and Quality of Supply Standard .
Security and Quality of Supply Standard (SQSS)	The version of the document entitled 'Security and Quality of Supply Standard' established pursuant to the Transmission Licence in force at the time of entering into the relevant Bilateral Agreement .
Self-Governance Criteria	A proposed Modification that, if implemented, (a) is unlikely to have a material effect on: (i) existing or future electricity consumers; and (ii) competition in the generation, storage, distribution, or supply of electricity or any commercial activities connected with the generation, storage, distribution or supply of electricity; and (iii) the operation of the National Electricity Transmission System ; and (iv) matters relating to sustainable development, safety or security of supply, or the management of market or network emergencies; and (v) the Grid Code's governance procedures or the Grid Code's modification procedures, and (b) is unlikely to discriminate between different classes of Users. (c) other than where the modification meets the Fast Track Criteria , will not constitute an amendment to the Regulated Sections of the Grid Code.
Self-Governance Modifications	A Grid Code Modification Proposal that does not fall within the scope of a Significant Code Review and that meets the Self-Governance Criteria or which the Authority directs is to be treated as such any direction under GR.24.4.
Self-Governance Statement	The statement made by the Grid Code Review Panel and submitted to the Authority : (a) confirming that, in its opinion, the Self-Governance Criteria are met and the proposed Grid Code Modification Proposal is suitable for the Self-Governance route; and (b) providing a detailed explanation of the Grid Code Review Panel's reasons for that opinion.

Setpoint Voltage	The value of voltage at the Grid Entry Point , or User System Entry Point if Embedded , on the automatic control system steady state operating characteristic, as a percentage of the nominal voltage, at which the transfer of Reactive Power between a Power Park Module , DC Converter , HVDC Converter or Non-Synchronous Generating Unit and the Transmission System , or Network Operator's system if Embedded , is zero.
Settlement Period	A period of 30 minutes ending on the hour and half-hour in each hour during a day.
Seven Year Statement	A statement, prepared by The Company in accordance with the terms of The Company's Transmission Licence , showing for each of the seven succeeding Financial Years , the opportunities available for connecting to and using the National Electricity Transmission System and indicating those parts of the National Electricity Transmission System most suited to new connections and transport of further quantities of electricity.
SF₆ Gas Zone	A segregated zone surrounding electrical conductors within a casing containing SF ₆ gas.
SHETL	Scottish Hydro-Electric Transmission Limited.
Shutdown	In the case of a Generating Unit is the condition of a Generating Unit where the generator rotor is at rest or on barring. In the case of an HVDC System or DC Converter Station , is the condition of an HVDC System or DC Converter Station where the HVDC System or DC Converter Station is de-energised and therefore not importing or exporting Apparent Power to or from the Total System .
Significant Code Review	Means the period commencing on the start date of a Significant Code Review as stated in the notice issued by the Authority , and ending in the circumstances described in GR.16.6 or GR.16.7, as appropriate.
Significant Code Review Phase	Means the period commencing on the start date of a Significant Code Review as stated in the notice issued by the Authority , and ending in the circumstances described in GR.16.6 or GR.16.7, as appropriate.
Significant Event	An Event , as defined in OC3.4.1.
Significant Incident	An Event which either: (a) was notified by a User to The Company under OC7 , and which The Company considers has had or may have had a significant effect on the National Electricity Transmission System , and The Company requires the User to report that Event in writing in accordance with OC10 and notifies the User accordingly; or (b) was notified by The Company to a User under OC7 , and which that User considers has had or may have had a significant effect on that User's System , and that User requires The Company to report that Event in writing in accordance with the provisions of OC10 and notifies The Company accordingly.

Simultaneous Tap Change	A tap change implemented on the generator step-up transformers of Synchronised Gensets , effected by Generators in response to an instruction from The Company issued simultaneously to the relevant Power Stations . The instruction, preceded by advance notice, must be effected as soon as possible, and in any event within one minute of receipt from The Company of the instruction.
Single Intraday Coupling	The continuous process where collected orders are matched and cross-zonal capacity is allocated simultaneously for different bidding zones in the intraday market.
Single Line Diagram	A schematic representation of a three-phase network in which the three phases are represented by single lines. The diagram shall include (but not necessarily be limited to) busbars, overhead lines, underground cables, power transformers and reactive compensation equipment. It shall also show where Large Power Stations are connected, and the points at which Demand is supplied.
Single Point of Connection	A single Point of Connection , with no interconnection through the User's System to another Point of Connection .
Site Common Drawings	Drawings prepared for each Connection Site (and in the case of OTSDUW, Transmission Interface Site) which incorporate Connection Site (and in the case of OTSDUW, Transmission Interface Site) layout drawings, electrical layout drawings, common protection/ control drawings and common services drawings.
Site Responsibility Schedule	A schedule containing the information and prepared on the basis of the provisions set out in Appendix 1 of the CC and Appendix E1 of the ECC .
Slope	The ratio of the steady state change in voltage, as a percentage of the nominal voltage, to the steady state change in Reactive Power output, in per unit of Reactive Power capability. For the avoidance of doubt, the value indicates the percentage voltage reduction that will result in a 1 per unit increase in Reactive Power generation.
Small Participant	Has the meaning given in the CUSC .

<p>Small Power Station</p>	<p>A Power Station which is</p> <p>(a) directly connected to:</p> <ul style="list-style-type: none"> (i) NGET’s Transmission System where such Power Station has a Registered Capacity of less than 50MW; or (ii) SPT’s Transmission System where such Power Station has a Registered Capacity of less than 30MW; or (iii) SHETL’s Transmission System where such a Power Station has a Registered Capacity of less than 10 MW; or (iv) an Offshore Transmission System where such Power Station has a Registered Capacity of less than 10MW; <p>or,</p> <p>(b) Embedded within a User System (or part thereof) where such User System (or part thereof) is connected under normal operating conditions to:</p> <ul style="list-style-type: none"> (i) NGET’s Transmission System and such Power Station has a Registered Capacity of less than 50MW; or (ii) SPT’s Transmission System and such Power Station has a Registered Capacity of less than 30MW; or (iii) SHETL’s Transmission System and such Power Station has a Registered Capacity of less than 10MW; <p>or,</p> <p>(c) Embedded within a User System (or part thereof) where the User System (or part thereof) is not connected to the National Electricity Transmission System, although such Power Station is in:</p> <ul style="list-style-type: none"> (i) NGET’s Transmission Area and such Power Station has a Registered Capacity of less than 50MW; or (ii) SPT’s Transmission Area and such Power Station has a Registered Capacity of less than 30MW; or (iii) SHETL’s Transmission Area and such Power Station has a Registered Capacity of less than 10MW; <p>For the avoidance of doubt, a Small Power Station could comprise of Type A, Type B, Type C or Type D Power Generating Modules.</p>
<p>Speeder Motor Setting Range</p>	<p>The minimum and maximum no-load speeds (expressed as a percentage of rated speed) to which the turbine is capable of being controlled, by the speeder motor or equivalent, when the Generating Unit terminals are on open circuit.</p>
<p>SPT</p>	<p>SP Transmission Limited plc</p>
<p>Standard Contract Terms</p>	<p>The standard terms and conditions applicable to Ancillary Services provided by Demand Response Providers and published on the Website from time to time.</p>

Standard Modifications	A Grid Code Modification Proposal that does not fall within the scope of a Significant Code Review subject to any direction by the Authority pursuant to GR.16.3 and GR.16.4, nor meets the Self-Governance Criteria subject to any direction by the Authority pursuant to GR.24.4 and in accordance with any direction under GR.24.2. A Grid Code Modification Proposal that constitutes an amendment to the Regulated Sections of the Grid Code shall be a Standard Modification except where it is an Urgent Modification or where it meets the Fast Track Criteria .
Standard Planning Data	The general data required by The Company under the PC . It is generally also the data which The Company requires from a User in an application for a CUSC Contract , as reflected in the PC .
Standard Product	Means a harmonised balancing product defined by all EU TSOs for the exchange of balance services.
Specific Product	Means in the context of Balancing Services a product that is not a standard product.
Start Time	The time named as such in an instruction issued by The Company pursuant to the BC .
Start-Up	In the case of a Generating Unit is the action of bringing a Generating Unit from Shutdown to Synchronous Speed . In the case of an HVDC System or DC Converter Station , is the action of bringing the HVDC System or DC Converter Station from Shutdown to a state where it is energised.
Statement of Readiness	Has the meaning set out in the Bilateral Agreement and/or Construction Agreement .
Station Board	A switchboard through which electrical power is supplied to the Auxiliaries of a Power Station , and which is supplied by a Station Transformer . It may be interconnected with a Unit Board .
Station Transformer	A transformer supplying electrical power to the Auxiliaries of (a) a Power Station , which is not directly connected to the Generating Unit terminals (typical voltage ratios being 132/11kV or 275/11kV), or (b) a DC Converter Station or HVDC Converter Station .
STC Committee	The committee established under the STC .
Steam Unit	A Generating Unit whose prime mover converts the heat-energy in steam to mechanical energy.

Storage User	<p>A Generator who owns or operates one or more Electricity Storage Modules. For the avoidance of doubt:</p> <ul style="list-style-type: none"> (a) Retained EU Law (Commission Regulation (EU) 2016/631, Commission Regulation (EU) 2016/1388 and Commission Regulation (EU) 2016/1485) shall not apply to Storage Users; and (b) the European Connection Conditions (ECC's) shall apply to Storage Users on the basis set out in Paragraph ECC1.1(d).
Subtransmission System	The part of a User's System which operates at a single transformation below the voltage of the relevant Transmission System .
Substantial Modification	A Modification in relation to modernisation or replacement of the User's Main Plant and Apparatus which impacts its technical capabilities, which, following notification by the relevant User to The Company , results in substantial amendment to the Bilateral Agreement .
Supergrid Voltage	Any voltage greater than 200kV.
Supplier	<ul style="list-style-type: none"> (a) A person supplying electricity under an Electricity Supply Licence; or (b) A person supplying electricity under exemption under the Act; <p>in each case acting in its capacity as a supplier of electricity to Customers in Great Britain.</p>
Surplus	<p>A MW figure equal to the total Output Usable:</p> <ul style="list-style-type: none"> (a) minus the forecast of Active Power Demand, and (b) minus the Operational Planning Margin.
Synchronised	<ul style="list-style-type: none"> (a) The condition where an incoming Power Generating Module, Generating Unit or Power Park Module or DC Converter or HVDC Converter or System is connected to the busbars of another System so that the Frequencies and phase relationships of that Power Generating Module, Generating Unit, Power Park Module, DC Converter, HVDC Converter or System, as the case may be, and the System to which it is connected are identical, like terms shall be construed accordingly e.g. "Synchronism". (b) The condition where an importing BM Unit is consuming electricity.
Synchronous Electricity Storage Module	A Synchronous Power Generating Module which can convert or re-convert electrical energy from another source of energy such that the frequency of the generated voltage, the rotor speed and the frequency of network voltage are in a constant ratio and thus in synchronism. For the avoidance of doubt a Synchronous Electricity Storage Module could comprise of one or more Synchronous Electricity Storage Units .

Synchronous Electricity Storage Unit	A Synchronous Generating Unit which can supply or absorb electrical energy such that the frequency of the generated voltage, the rotor speed and the frequency of the equipment are in constant ratio and thus in synchronism with the network.
Synchronising Generation	The amount of MW (in whole MW) produced at the moment of synchronising.
Synchronising Group	A group of two or more Gensets) which require a minimum time interval between their Synchronising or De-Synchronising times.
Synchronous Area	An area covered by synchronously interconnected Transmission Licensees , such as the Synchronous Areas of Continental Europe, Great Britain, Ireland-Northern Ireland and Nordic and the power systems of Lithuania, Latvia and Estonia, together referred to as 'Baltic' which are part of a wider Synchronous Area ;
Synchronous Compensation	The operation of rotating synchronous Apparatus for the specific purpose of either the generation or absorption of Reactive Power .
Synchronous Compensation Equipment	Apparatus which has the function of providing Synchronous Compensation . For the avoidance of doubt, one or more Synchronous Compensation units would not constitute an Electricity Storage Module unless it could be operated in a controllable manner.
Synchronous Electricity Storage Module	A Synchronous Power Generating Module which can convert and reconvert electrical energy from another source of energy such that the frequency of the generated voltage, the rotor speed and the frequency of network voltage are in a constant ratio and thus in synchronism. For the avoidance of doubt a Synchronous Electricity Storage Module could comprise of one or more Synchronous Electricity Storage Units .
Synchronous Electricity Storage Unit	A Synchronous Generating Unit which can supply and absorb electrical energy such that the frequency of the generated voltage, the rotor speed and the frequency of the equipment are in constant ratio and thus in synchronism with the network.
Synchronous Flywheel	An item of synchronously rotating Plant for the specific purpose of contributing inertia to the System . One or more Synchronous Flywheels would not be considered to form an Electricity Storage Module unless it could be operated in a controllable manner for its AC input and output power.
Synchronous Generating Unit	Any Onshore Synchronous Generating Unit or Offshore Synchronous Generating Unit .
Synchronous Generating Unit Performance Chart	A diagram showing the Active Power (MW) and Reactive Power (MVA _r) capability limits within which a Synchronous Generating Unit at its stator terminals (which is part of a Synchronous Power Generating Module) will be expected to operate under steady state conditions.

Synchronous Power-Generating Module	An indivisible set of installations which can convert or re-convert electrical energy from another source of energy such that the frequency of the supplied voltage, the rotor speed and the frequency of network voltage are in a constant ratio and thus in synchronism. For the avoidance of doubt, a Synchronous Power Generating Module could comprise of one or more Synchronous Generating Units or one or more Synchronous Electricity Storage Units .
Synchronous Power Generating Module Matrix	The matrix described in Appendix 1 to BC1 under the heading Synchronous Power Generating Module Matrix .
Synchronous Power Generating Module Planning Matrix	A matrix in the form set out in Appendix 5 of OC2 showing the combination of Synchronous Generating Units within a Synchronous Power Generating Module which would be running in relation to any given MW output.
Synchronous Power Generating Unit	Has the same meaning as a Synchronous Generating Unit and would be considered to be part of a Power Generating Module .
Synchronous Speed	That speed required by a Generating Unit to enable it to be Synchronised to a System .
System	Any User System and/or the National Electricity Transmission System , as the case may be.
System Ancillary Services	Collectively Part 1 System Ancillary Services and Part 2 System Ancillary Services .
System Constraint	A limitation on the use of a System due to lack of transmission capacity or other System conditions.
System Constrained Capacity	That portion of Registered Capacity or Registered Import Capacity not available due to a System Constraint .
System Constraint Group	A part of the National Electricity Transmission System which, because of System Constraints , is subject to limits of Active Power which can flow into or out of (as the case may be) that part.
System Defence Plan	A document prepared by The Company , as published on its Website , outlining how the requirements of the “defence plan”, as provided for by Retained EU Law (Commission Regulation (EU) 2017/2196), has been implemented within the GB Synchronous Area .
System Fault Dependability Index or Dp	A measure of the ability of Protection to initiate successful tripping of circuit-breakers which are associated with a faulty item of Apparatus . It is calculated using the formula: $Dp = 1 - F_1/A$ Where: A = Total number of System faults F ₁ = Number of System faults where there was a failure to trip a circuit-breaker.
System Incidents Report	A report submitted to the GCRP on a monthly basis, containing, but not limited to, a list of Significant Events , as detailed in OC3.4.1.

System Margin	The margin in any period between (a) the sum of Maximum Export Limits and (b) forecast Demand and the Operating Margin , for that period.
System Negative Reserve Active Power Margin or System NRAPM	That margin of Active Power sufficient to allow the largest loss of Load at any time.
System Operator - Transmission Owner Code or STC	Has the meaning set out in The Company's Transmission Licence
System Restoration Plan	A document prepared by The Company , as published on its Website , outlining how the requirements of the "restoration plan", as defined in Retained EU Law (Commission Regulation (EU) 2017/2196), has been implemented within the GB Synchronous Area .
System Telephony	An alternative method by which a User's Responsible Engineer/Operator , the Relevant Transmission Licensees' Control Engineers and The Company's Control Engineer(s) speak to one and another for the purposes of control of the Total System in both normal and emergency operating conditions.
System Tests	Tests which involve simulating conditions, or the controlled application of irregular, unusual or extreme conditions, on the Total System , or any part of the Total System , but which do not include commissioning or recommissioning tests or any other tests of a minor nature.
System to Demand Intertrip Scheme	An intertrip scheme which disconnects Demand when a System fault has arisen to prevent abnormal conditions occurring on the System .
System to Generator Operational Intertripping	A Balancing Service involving the initiation by a System to Generator Operational Intertripping Scheme of automatic tripping of the User's circuit breaker(s), or Relevant Transmission Licensee's circuit breaker(s) where agreed by The Company , the User and the Relevant Transmission Licensee , resulting in the tripping of BM Unit(s) or (where relevant) Generating Unit(s) comprised in a BM Unit to prevent abnormal system conditions occurring, such as over voltage, overload, System instability, etc, after the tripping of other circuit-breakers following power System fault(s).
System to Generator Operational Intertripping Scheme	A System to Generating Unit or System to CCGT Module or System to Power Park Module or System to Power Generating Module or System to Electricity Storage Module Intertripping Scheme forming a condition of connection and specified in Appendix F3 of the relevant Bilateral Agreement , being either a Category 1 Intertripping Scheme , Category 2 Intertripping Scheme , Category 3 Intertripping Scheme or Category 4 Intertripping Scheme .

Target Frequency	That Frequency determined by The Company , in its reasonable opinion, as the desired operating Frequency of the Total System . This will normally be 50.00Hz plus or minus 0.05Hz, except in exceptional circumstances as determined by The Company , in its reasonable opinion when this may be 49.90 or 50.10Hz. An example of exceptional circumstances may be difficulties caused in operating the System during disputes affecting fuel supplies.
Technical Specification	In relation to Plant and/or Apparatus , (a) the relevant European Specification ; or (b) if there is no relevant European Specification , other relevant standards which are in common use in the European Community.
TERRE	Trans European Replacement Reserves Exchange – a market covering the procurement of replacement reserves across Europe.
TERRE Activation Period	A period of time lasting 15 minutes and starting at either 0, 15, 30 or 45 minutes past the hour (e.g. 10:00 to 10:15). There are 4 TERRE Activation Periods in one TERRE Auction Period .
TERRE Auction Period	A period of time lasting one hour and starting and ending on the hour (e.g. from 10:00 to 11:00). Hence there are 24 TERRE Auction Periods in a day.
TERRE Bid	A submission by a BM Participant covering the price and MW deviation offered into the TERRE auction (please note – in the Balancing Mechanism the term bid has a different meaning – in this case a bid can be an upward or downward MW change).
TERRE Central Platform	An IT system which implements the TERRE auction.
TERRE Data Validation and Consistency Rules	A document produced by the central TERRE project detailing the correct format of submissions for TERRE .
TERRE Gate Closure	60 minutes before the start of the TERRE Auction Period (note still ongoing discussions if this may become 55 minutes).
TERRE Instruction Guide	Details specific rules for creating an RR Instruction from an RR Acceptance .
Test Co-ordinator	A person who co-ordinates System Tests .
Test Panel	A panel, whose composition is detailed in OC12 , which is responsible, inter alia, for considering a proposed System Test , and submitting a Proposal Report and a Test Programme .
Test Plan	A document prepared by The Company , as published on its Website , outlining how the requirements of the “test plan”, as provided for by Retained EU Law (Commission Regulation (EU) 2017/2196), has been implemented within the GB Synchronous Area .

Test Programme	A programme submitted by the Test Panel to The Company , the Test Proposer , and each User identified by The Company under OC12.4.2.1, which states the switching sequence and proposed timings of the switching sequence, a list of those staff involved in carrying out the System Test (including those responsible for the site safety) and such other matters as the Test Panel deems appropriate.
Test Proposer	The person who submits a Proposal Notice .
Test Signal	A signal in the form of a sine wave, applied to a GBGF-I to demonstrate its ability to contribute to Active Damping Power .
The Company	National Grid Electricity System Operator Limited (NO: 11014226) whose registered office is at 1-3 Strand, London, WC2N 5EH as the person whose Transmission Licence Section C of such Transmission Licence has been given effect.
The Company Control Engineer	The nominated person employed by The Company to direct the operation of the National Electricity Transmission System or such person as nominated by The Company .
The Company Operational Strategy	The Company's operational procedures which form the guidelines for operation of the National Electricity Transmission System .
Total Shutdown	The situation existing when all generation has ceased and there is no electricity supply from External Interconnections and, therefore, the Total System has shutdown with the result that it is not possible for the Total System to begin to function again without The Company's directions relating to a Black Start .
Total System	The National Electricity Transmission System and all User Systems in the National Electricity Transmission System Operator Area .
Trading Point	A commercial and, where so specified in the Grid Code, an operational interface between a User and The Company , which a User has notified to The Company .
Transfer Date	Such date as may be appointed by the Secretary of State by order under section 65 of the Act .
Transmission	Means, when used in conjunction with another term relating to equipment or a site, whether defined or not, that the associated term is to be read as being part of or directly associated with the National Electricity Transmission System , and not of or with the User System .
Transmission Area	Has the meaning set out in the Transmission Licence of a Transmission Licensee .
Transmission Connected Demand Facilities	A Demand Facility which has a Grid Supply Point to the National Electricity Transmission System .

Transmission DC Converter	Any Transmission Licensee Apparatus (or OTSUA that will become Transmission Licensee Apparatus at the OTSUA Transfer Time) used to convert alternating current electricity to direct current electricity, or vice versa. A Transmission Network DC Converter (which could include an HVDC System owned by an Offshore Transmission Licensee or Generator in respect of OTSUA) is a standalone operative configuration at a single site comprising one or more converter bridges, together with one or more converter transformers, converter control equipment, essential protective and switching devices and auxiliaries, if any, used for conversion.
Transmission Entry Capacity	Has the meaning set out in the CUSC .
Transmission Interface Circuit	In NGET's Transmission Area , a Transmission circuit which connects a System operating at a voltage above 132kV to a System operating at a voltage of 132kV or below In SHETL's Transmission Area and SPT's Transmission Area , a Transmission circuit which connects a System operating at a voltage of 132kV or above to a System operating at a voltage below 132kV.
Transmission Interface Point	Means the electrical point of connection between the Offshore Transmission System and an Onshore Transmission System .
Transmission Interface Site	The site at which the Transmission Interface Point is located.
Transmission Licence	A licence granted under Section 6(1)(b) of the Act .
Transmission Licensee	The Company and any Onshore Transmission Licensee or Offshore Transmission Licensee .
Transmission Site	Means a site owned (or occupied pursuant to a lease, licence or other agreement) by a Relevant Transmission Licensee in which there is a Connection Point . For the avoidance of doubt, a site owned by a User but occupied by the Relevant Transmission Licensee as aforesaid, is a Transmission Site .
Transmission System	Has the same meaning as the term "licensee's transmission system" in the Transmission Licence of a Transmission Licensee .
Turbine Time Constant	Determined at Registered Capacity , the turbine time constant will be construed in accordance with the principles of the IEEE Committee Report "Dynamic Models for Steam and Hydro Turbines in Power System Studies" published in 1973 which apply to such phrase.
Type A Power Generating Module	A Power-Generating Module (including an Electricity Storage Module) with a Grid Entry Point or User System Entry Point below 110 kV and a Maximum Capacity of 0.8 kW or greater but less than 1MW;
Type B Power Generating Module	A Power-Generating Module (including an Electricity Storage Module) with a Grid Entry Point or User System Entry Point below 110 kV and a Maximum Capacity of 1MW or greater but less than 10MW;
Type C Power Generating Module	A Power-Generating Module (including an Electricity Storage Module) with a Grid Entry Point or User System Entry Point below 110 kV and a Maximum Capacity of 10MW or greater but less than 50MW;

Type D Power Generating Module	A Power-generating Module : (including an Electricity Storage Module): with a Grid Entry Point or User System Entry Point at, or greater than, 110 kV; or with a Grid Entry Point or User System Entry Point below 110 kV and with Maximum Capacity of 50MW or greater
Unbalanced Load	The situation where the Load on each phase is not equal.
Under-excitation Limiter	Shall have the meaning ascribed to that term in IEC 34-16-1:1991 [equivalent to British Standard BS4999 Section 116.1: 1992].
Under Frequency Relay	An electrical measuring relay intended to operate when its characteristic quantity (Frequency) reaches the relay settings by a decrease in Frequency .
Unit Board	A switchboard through which electrical power is supplied to the Auxiliaries of a Generating Unit and which is supplied by a Unit Transformer . It may be interconnected with a Station Board .
Unit Transformer	A transformer directly connected to a Generating Unit's terminals, and which supplies power to the Auxiliaries of a Generating Unit . Typical voltage ratios are 23/11kV and 15/6.6kV.
Unit Load Controller Response Time Constant	The time constant, expressed in units of seconds, of the power output increase which occurs in the Secondary Response timescale in response to a step change in System Frequency .
Unresolved Issues	Any relevant Grid Code provisions or Bilateral Agreement requirements identified by The Company with which the relevant User has not demonstrated compliance to The Company's reasonable satisfaction at the date of issue of the Preliminary Operational Notification and/or Interim Operational Notification and/or Limited Operational Notification and which are detailed in such Preliminary Operational Notification and/or Interim Operational Notification and/or Limited Operational Notification .
Urgent Modification	A Grid Code Modification Proposal treated or to be treated as an Urgent Modification in accordance with GR.23.
User	A term utilised in various sections of the Grid Code to refer to the persons using the National Electricity Transmission System , as more particularly identified in each section of the Grid Code concerned. In the Preface and the General Conditions the term means any person to whom the Grid Code applies. The term User includes an EU Code User and a GB Code User .
User Data File Structure	The file structure given at DRC 18 which will be specified by The Company which a Generator or DC Converter Station owner or HVDC System Owner must use for the purposes of the CP or the ECP to submit DRC data Schedules and information demonstrating compliance with the Grid Code and, where applicable, with the CUSC Contract(s) , unless otherwise agreed by The Company .

User Development	In the PC means either User's Plant and/or Apparatus to be connected to the National Electricity Transmission System , or a Modification relating to a User's Plant and/or Apparatus already connected to the National Electricity Transmission System , or a proposed new connection or Modification to the connection within the User System .
User Self Certification of Compliance	A certificate, in the form attached at CP.A.2.(1) or ECP.A.2.(1) completed by a Generator or DC Converter Station owner or HVDC System Owner to which the Compliance Statement is attached which confirms that such Plant and Apparatus complies with the relevant Grid Code provisions and where appropriate, with the CUSC Contract(s) , as identified in the Compliance Statement and, if appropriate, identifies any Unresolved Issues and/or any exceptions to such compliance and details the derogation(s) granted in respect of such exceptions.
User Site	A site owned (or occupied pursuant to a lease, licence or other agreement) by a User in which there is a Connection Point . For the avoidance of doubt, a site owned by a Relevant Transmission Licensee but occupied by a User as aforesaid, is a User Site .
User System	Any system owned or operated by a User comprising:- (a) Power Generating Modules or Generating Units ; and/or (b) Systems consisting (wholly or mainly) of electric lines used for the distribution of electricity from Grid Supply Points or Generating Units or Power Generating Modules or other entry points to the point of delivery to Customers , or other Users ; and Plant and/or Apparatus (including prior to the OTSUA Transfer Time , any OTSUA) connecting:- (c) The system as described above; or (d) Non-Embedded Customers equipment; to the National Electricity Transmission System or to the relevant other User System , as the case may be. The User System includes any Remote Transmission Assets operated by such User or other person and any Plant and/or Apparatus and meters owned or operated by the User or other person in connection with the distribution of electricity but does not include any part of the National Electricity Transmission System .
User System Entry Point	A point at which a Power Generating Module , Generating Unit , a CCGT Module or a CCGT Unit or a Power Park Module , or an Electricity Storage Module or a DC Converter or an HVDC Converter , as the case may be, which is Embedded connects to the User System .
Virtual Lead Party	As defined in the BSC .

Voltage Jump Reactive Power	<p>The transient Reactive Power injected or absorbed from a Grid Forming Plant to the Total System as a result of either a step or ramp change in the difference between the voltage magnitude and/or phase of the voltage of the Internal Voltage Source of the Grid Forming Plant and Grid Entry Point or User System Entry Point.</p> <p>In the event of a voltage magnitude and phase change at the Grid Entry Point or User System Entry Point, a Grid Forming Plant will instantaneously (within 5ms) supply Voltage Jump Reactive Power to the Total System as a result of the voltage magnitude change.</p>
Water Time Constant	Bears the meaning ascribed to the term "Water inertia time" in IEC308.
Website	The site established by The Company on the World-Wide Web for the exchange of information among Users and other interested persons in accordance with such restrictions on access as may be determined from time to time by The Company .
Weekly ACS Conditions	Means that particular combination of weather elements that gives rise to a level of peak Demand within a week, taken to commence on a Monday and end on a Sunday, which has a particular chance of being exceeded as a result of weather variation alone. This particular chance is determined such that the combined probabilities of Demand in all weeks of the year exceeding the annual peak Demand under Annual ACS Conditions is 50%, and in the week of maximum risk the weekly peak Demand under Weekly ACS Conditions is equal to the annual peak Demand under Annual ACS Conditions .
WG Consultation Alternative Request	Any request from an Authorised Electricity Operator ; the Citizens Advice or the Citizens Advice Scotland , The Company or a Materially Affected Party for a Workgroup Alternative Grid Code Modification to be developed by the Workgroup expressed as such and which contains the information referred to at GR.20.16. For the avoidance of doubt, any WG Consultation Alternative Request does not constitute either a Grid Code Modification Proposal or a Workgroup Alternative Grid Code Modification .
Workgroup	A Workgroup established by the Grid Code Review Panel pursuant to GR.20.1;
Workgroup Consultation	As defined in GR.20.13, and any further consultation which may be directed by the Grid Code Review Panel pursuant to GR.20.20;
Workgroup Alternative Grid Code Modification	An alternative modification to the Grid Code Modification Proposal developed by the Workgroup under the Workgroup terms of reference (either as a result of a Workgroup Consultation or otherwise) and which is believed by a majority of the members of the Workgroup or by the chairperson of the Workgroup to better facilitate the Grid Code Objectives than the Grid Code Modification Proposal or the current version of the Grid Code ;
Zonal System Security Requirements	That generation required, within the boundary circuits defining the System Zone , which when added to the secured transfer capability of the boundary circuits exactly matches the Demand within the System Zone .

A number of the terms listed above are defined in other documents, such as the **Balancing and Settlement Code** and the **Transmission Licence**. Appendix 1 sets out the current definitions from the other documents of those terms so used in the Grid Code and defined in other documents for ease of reference, but does not form part of the Grid Code.

GD.2.1

In the Grid Code:

- (i) a table of contents, a Preface, a Revision section, headings, and the Appendix to this **Glossary and Definitions** are inserted for convenience only and shall be ignored in construing the Grid Code;
- (ii) unless the context otherwise requires, all references to a particular paragraph, sub-paragraph, Appendix or Schedule shall be a reference to that paragraph, sub-paragraph Appendix or Schedule in or to that part of the Grid Code in which the reference is made;
- (iii) unless the context otherwise requires, the singular shall include the plural and vice versa, references to any gender shall include all other genders and references to persons shall include any individual, body corporate, corporation, joint venture, trust, unincorporated association, organisation, firm or partnership and any other entity, in each case whether or not having a separate legal personality;
- (iv) references to the words "include" or "including" are to be construed without limitation to the generality of the preceding words;
- (v) unless there is something in the subject matter or the context which is inconsistent therewith, any reference to an Act of Parliament or any Section of or Schedule to, or other provision of an Act of Parliament shall be construed at the particular time, as including a reference to any modification, extension or re-enactment thereof then in force and to all instruments, orders and regulations then in force and made under or deriving validity from the relevant Act of Parliament;
- (vi) where the **Glossary and Definitions** refers to any word or term which is more particularly defined in a part of the Grid Code, the definition in that part of the Grid Code will prevail (unless otherwise stated) over the definition in the **Glossary & Definitions** in the event of any inconsistency;
- (vii) a cross-reference to another document or part of the Grid Code shall not of itself impose any additional or further or co-existent obligation or confer any additional or further or co-existent right in the part of the text where such cross-reference is contained;
- (viii) nothing in the Grid Code is intended to or shall derogate from **The Company's** statutory or licence obligations;
- (ix) a "holding company" means, in relation to any person, a holding company of such person within the meaning of section 736, 736A and 736B of the Companies Act 1985 as substituted by section 144 of the Companies Act 1989 and, if that latter section is not in force at the **Transfer Date**, as if such latter section were in force at such date;
- (x) a "subsidiary" means, in relation to any person, a subsidiary of such person within the meaning of section 736, 736A and 736B of the Companies Act 1985 as substituted by section 144 of the Companies Act 1989 and, if that latter section is not in force at the **Transfer Date**, as if such latter section were in force at such date;
- (xi) references to time are to London time; and
- (xii) (a) Save where (b) below applies, where there is a reference to an item of data being expressed in a whole number of MW, fractions of a MW below 0.5 shall be rounded down to the nearest whole MW and fractions of a MW of 0.5 and above shall be rounded up to the nearest whole MW;

(b) In the case of the definition of **Registered Capacity** or **Maximum Capacity**, fractions of a MW below 0.05 shall be rounded down to one decimal place and fractions of a MW of 0.05 and above shall be rounded up to one decimal place.

- (xiii) For the purposes of the Grid Code, physical quantities such as current or voltage are not defined terms as their meaning will vary depending upon the context of the obligation. For example, voltage could mean positive phase sequence root mean square voltage, instantaneous voltage, phase to phase voltage, phase to earth voltage. The same issue equally applies to current, and therefore the terms current and voltage should remain undefined with the meaning depending upon the context of the application. **Retained EU Law** (Commission Regulation (EU) 2016/631) defines requirements of current and voltage but they have not been adopted as part of EU implementation for the reasons outlined above.
- (xiv) Except where expressly stated to the contrary, reference to Commission Regulations means the Commission Regulation (EU) as it forms part of **Retained EU Law**, as such regulation may be amended.

< END OF GLOSSARY & DEFINITIONS >

PLANNING CODE

(PC)

CONTENTS

(This contents page does not form part of the Grid Code)

<u>Paragraph No/Title</u>	<u>Page Number</u>
PC.1 INTRODUCTION.....	2
PC.2 OBJECTIVE.....	3
PC.3 SCOPE.....	4
PC.4 PLANNING PROCEDURES.....	7
PC.5 PLANNING DATA.....	10
PC.6 PLANNING STANDARDS.....	13
PC.7 PLANNING LIAISON.....	14
PC.8 OTSDUW PLANNING LIAISON.....	15
APPENDIX A - PLANNING DATA REQUIREMENTS	16
PART 1 - STANDARD PLANNING DATA.....	20
PC.A.2 USER'S SYSTEM (AND OTSUA) DATA	20
PC.A.3 GENERATING UNIT AND DC CONVERTER DATA.....	28
PC.A.4 DEMAND AND ACTIVE ENERGY DATA	38
PART 2 - DETAILED PLANNING DATA.....	44
PC.A.5 POWER GENERATING MODULE, GENERATING UNIT, POWER PARK MODULE, DC CONVERTER AND OTSDUW PLANT AND APPARATUS DATA.....	44
PC.A.6 USERS' SYSTEM DATA.....	66
PC.A.7 ADDITIONAL DATA FOR NEW TYPES OF POWER STATIONS, DC CONVERTER STATIONS, OTSUA AND CONFIGURATIONS.....	71
PART 3 – DETAILED PLANNING DATA.....	72
APPENDIX B - SINGLE LINE DIAGRAMS	81
APPENDIX C - TECHNICAL AND DESIGN CRITERIA.....	84
PART 1 – SHETL's TECHNICAL AND DESIGN CRITERIA.....	84
PART 2 - SPT's TECHNICAL AND DESIGN CRITERIA	86
APPENDIX D - DATA NOT DISCLOSED TO A RELEVANT TRANSMISSION LICENSEE	87
APPENDIX E - OFFSHORE TRANSMISSION SYSTEM AND OTSDUW PLANT AND APPARATUS TECHNICAL AND DESIGN CRITERIA.....	90
APPENDIX F - OTSDUW DATA AND INFORMATION AND OTSDUW NETWORK DATA AND INFORMATION	91

PC.1 INTRODUCTION

PC.1.1 The **Planning Code ("PC")** specifies the technical and design criteria and procedures to be applied by **The Company** in the planning and development of the **National Electricity Transmission System** and to be taken into account by **Users** in the planning and development of their own **Systems**. In the case of **OTSUA**, the **PC** also specifies the technical and design criteria and procedures to be applied by the **User** in the planning and development of the **OTSUA**. It details information to be supplied by **Users** to **The Company**, and certain information to be supplied by **The Company** to **Users**. **The Company** has obligations under the **STC** to inform **Relevant Transmission Licensees** of data required for the planning of the **National Electricity Transmission System**. In respect of **PC** data, **The Company** may pass on **User** data to a **Relevant Transmission Licensee**, as detailed in PC.3.4 and PC.3.5.

PC.1.1A Provisions of the **PC** which apply in relation to **OTSDUW** and **OTSUA** shall apply up to the **OTSUA Transfer Time**, whereupon such provisions shall (without prejudice to any prior non-compliance) cease to apply, without prejudice to the continuing application of provisions of the **PC** applying in relation to the relevant **Offshore Transmission System** and/or **Connection Site**.

PC.1.1B As used in the **PC**:

- (a) **National Electricity Transmission System** excludes **OTSDUW Plant and Apparatus** (prior to the **OTSUA Transfer Time**) unless the context otherwise requires;
- (b) and User Development includes **OTSDUW** unless the context otherwise requires.

PC.1.2 The **Users** referred to above are defined, for the purpose of the **PC**, in PC.3.1.

PC.1.3 Development of the **National Electricity Transmission System**, involving its reinforcement or extension, will arise for a number of reasons including, but not limited to:

- (a) a development on a **User System** already connected to the **National Electricity Transmission System**;
- (b) the introduction of a new **Connection Site** or the **Modification** of an existing **Connection Site** between a **User System** and the **National Electricity Transmission System**;
- (c) the cumulative effect of a number of such developments referred to in (a) and (b) by one or more **Users**.

PC.1.4 Accordingly, the reinforcement or extension of the **National Electricity Transmission System** may involve work:

- (a) at a substation at a **Connection Site** where **User's Plant** and/or **Apparatus** is connected to the **National Electricity Transmission System** (or in the case of **OTSDUW**, at a substation at an **Interface Point**);
- (b) on transmission lines or other facilities which join that **Connection Site** (or in the case of **OTSDUW**, **Interface Point**) to the remainder of the **National Electricity Transmission System**;
- (c) on transmission lines or other facilities at or between points remote from that **Connection Site** (or in the case of **OTSDUW**, **Interface Point**).

PC.1.5 The time required for the planning and development of the **National Electricity Transmission System** will depend on the type and extent of the necessary reinforcement and/or extension work, the need or otherwise for statutory planning consent, the associated possibility of the need for a public inquiry and the degree of complexity in undertaking the new work while maintaining satisfactory security and quality of supply on the existing **National Electricity Transmission System**.

PC1.6 For the avoidance of doubt and the purposes of the Grid Code, **DC Connected Power Park Modules** are treated as belonging to **Generators**. **Generators** who own **DC Connected Power Park Modules** would therefore be expected to supply the same data as required under this **PC** in respect of **Power Stations** comprising **Power Park Modules** other than where specific references to **DC Connected Power Park Modules** are made.

PC1.7 As defined in the Glossary and Definitions, **Electricity Storage Modules** are treated as belonging to **Storage User's** who are a subset of **Generator's**. **Generators** who own or operate **Electricity Storage Modules** would therefore be expected to supply the same data as required under this **PC** in respect of **Power Stations**. In general, and notwithstanding the requirements of the Glossary and Definitions and the wider requirements specified in the **Planning Code**, **Generators** in respect of **Synchronous Electricity Storage Modules** would be expected to supply the same data as required from **Generators** in respect of **Synchronous Power Generating Modules** and **Generators** in respect of **Non-Synchronous Electricity Storage Modules** would be expected to supply the same data as required from **Generators** in respect of **Power Park Modules**.

PC.2 OBJECTIVE

PC.2.1 The objectives of the **PC** are:

- (a) to promote **The Company/User** interaction in respect of any proposed development on the **User System** which may impact on the performance of the **National Electricity Transmission System** or the direct connection with the **National Electricity Transmission System**;
- (b) to provide for the supply of information to **The Company** from **Users** in order that planning and development of the **National Electricity Transmission System** can be undertaken in accordance with the relevant **Licence Standards**, to facilitate existing and proposed connections, and also to provide for the supply of certain information from **The Company** to **Users** in relation to short circuit current contributions and **OTSUA**; and
- (c) to specify the **Licence Standards** which will be used in the planning and development of the **National Electricity Transmission System**; and
- (d) to provide for the supply of information required by **The Company** from **Users** in respect of the following to enable **The Company** to carry out its duties under the **Act** and the **Transmission Licence**:
 - (i) **Mothballed Generating Units, Mothballed Power Generating Modules**; and
 - (ii) capability of gas-fired **Synchronous Power Generating Modules** or **Generating Units** to run using alternative fuels.

The Company will use the information provided under PC.2.1(d) in providing reports to the **Authority** and the **Secretary of State** and, where directed by the **Authority** or the **Secretary of State** to do so, **The Company** may publish the information. Where it is known by **The Company** that such information is intended for wider publication the information provided under PC.2.1(d) shall be aggregated such that individual data items should not be identifiable.

- (e) in the case of **OTSUA**:
 - (i) to specify the minimum technical and design criteria and procedures to be applied by **Users** in the planning and development of **OTSUA**; and thereby
 - (ii) to ensure that the **OTSUA** can from the **OTSUA Transfer Time** be operated as part of the **National Electricity Transmission System**; and
 - (iii) to provide for the arrangements and supply of information and data between **The Company** and a **User** to ensure that the **User** is able to undertake **OTSDUW**; and
 - (iv) to promote **The Company/User** interaction and co-ordination in respect of any proposed development on the **National Electricity Transmission System** or the **OTSUA**, which may impact on the **OTSUA** or (as the case may be) the **National Electricity Transmission System**.

PC.3 SCOPE

PC.3.1 The **PC** applies to **The Company** and to **Users**, which in the **PC** means:

- (a) **Generators**;
- (b) **Generators** undertaking **OTSDUW**;
- (c) **Network Operators**;
- (d) **Non-Embedded Customers**;
- (e) **DC Converter Station** owners; and
- (f) **HVDC System Owners**.

The above categories of **User** will become bound by the **PC** prior to them generating, operating, or consuming or importing/exporting, as the case may be, and references to the various categories (or to the general category) of **User** should, therefore, be taken as referring to them in that prospective role as well as to **Users** actually connected.

PC.3.2 In the case of **Embedded Power Stations**, **Embedded DC Converter Stations** and **Embedded HVDC Systems**, unless provided otherwise, the following provisions apply with regard to the provision of data under this **PC**:

- (a) each **Generator** shall provide the data direct to **The Company** in respect of (i) **Embedded Large Power Stations**, (ii) **Embedded Medium Power Stations** subject to a **Bilateral Agreement** and (iii) **Embedded Small Power Stations** which form part of a **Cascade Hydro Scheme**;
- (b) each **DC Converter** owner or **HVDC System Owner** shall provide the data direct to **The Company** in respect of **Embedded DC Converter Stations** and **Embedded HVDC Systems** subject to a **Bilateral Agreement**;
- (c) each **Network Operator** shall provide the data to **The Company** in respect of each **Embedded Medium Power Station** not subject to a **Bilateral Agreement** or **Embedded DC Converter Station** not subject to a **Bilateral Agreement** or **Embedded HVDC System** not subject to a **Bilateral Agreement** connected, or proposed to be connected within such **Network Operator's System**;
- (d) although data is not normally required specifically on **Embedded Small Power Stations** or on **Embedded** installations of direct current converters which do not form a **DC Converter Station** or **HVDC System** under this **PC**, each **Network Operator** in whose **System** they are **Embedded** should provide the data (contained in the Appendix) to **The Company** in respect of **Embedded Small Power Stations** or **Embedded** installations of direct current converters which do not form a **DC Converter Station** or **Embedded** installations of **HVDC Systems** if:
 - (i) it falls to be supplied pursuant to the application for a **CUSC Contract** or in the **Statement of Readiness** to be supplied in connection with a **Bilateral Agreement** and/or **Construction Agreement**, by the **Network Operator**; or
 - (ii) it is specifically requested by **The Company** in the circumstances provided for under this **PC**.

PC.3.3 Certain data does not normally need to be provided in respect of certain **Embedded Power Stations**, **Embedded DC Converter Stations** or **Embedded HVDC Systems**, as provided in PC.A.1.12.

In summary, **Network Operators** are required to supply the following data in respect of **Embedded Medium Power Stations** not subject to a **Bilateral Agreement** or **Embedded DC Converter Stations** not subject to a **Bilateral Agreement** or **Embedded HVDC Systems** not subject to a **Bilateral Agreement** connected, or is proposed to be connected, within such **Network Operator's System**:

PC.A.2.1.1

PC.A.2.2.2
PC.A.2.5.5.2
PC.A.2.5.5.7
PC.A.2.5.6
PC.A.3.1.5
PC.A.3.2.2
PC.A.3.3.1
PC.A.3.4.1
PC.A.3.4.2
PC.A.5.2.2
PC.A.5.3.2
PC.A.5.4
PC.A.5.5.1
PC.A.5.6

For the avoidance of doubt **Network Operators** are required to supply the above data in respect of **Embedded Medium Power Stations** not subject to a **Bilateral Agreement** and **Embedded DC Converter Stations** not subject to a **Bilateral Agreement** and **Embedded HVDC Systems** not subject to a **Bilateral Agreement** which are located **Offshore** and which are connected or proposed to be connected within such **Network Operator's System**. This is because **Embedded Medium Power Stations** not subject to a **Bilateral Agreement** and **Embedded DC Converter Stations** not subject to a **Bilateral Agreement** and **Embedded HVDC Systems** not subject to a **Bilateral Agreement** are treated as **Onshore Generators** or **Onshore DC Converter Station** owners or **HVDC System Owners** connected to an **Onshore User System Entry Point**.

PC.3.4 **The Company** may provide to the **Relevant Transmission Licensees** any data which has been submitted to **The Company** by any **Users** pursuant to the following paragraphs of the **PC**. For the avoidance of doubt, **The Company** will not provide to the **Relevant Transmission Licensees**, the types of data specified in Appendix D. The **Relevant Transmission Licensees'** use of such data is detailed in the **STC**.

PC.A.2.2
PC.A.2.5
PC.A.3.1
PC.A.3.2.1
PC.A.3.2.2
PC.A.3.3
PC.A.3.4
PC.A.4
PC.A.5.1
PC.A.5.2
PC.A.5.3.1
PC.A.5.3.2
PC.A.5.4.1
PC.A.5.4.2
PC.A.5.4.3.1

PC.A.5.4.3.2

PC.A.5.4.3.3

PC.A.5.4.3.4

PC.A.7

(and in addition in respect of the data submitted in respect of the **OTSUA**)

PC.A.2.2

PC.A.2.3

PC.A.2.4

PC.A.2.5

PC.A.3.2.2

PC.A.3.3.1(d)

PC.A.4

PC.A.5.4.3.1

PC.A.5.4.3.2

PC.A.6.2

PC.A.6.3

PC.A.6.4

PC.A.6.5

PC.A.6.6

PC.A.7

PC.3.5 In addition to the provisions of PC.3.4, **The Company** may provide to the **Relevant Transmission Licensees** any data which has been submitted to **The Company** by any **Users** in respect of **Relevant Units** pursuant to the following paragraphs of the **PC**.

PC.A.2.3

PC.A.2.4

PC.A.5.5

PC.A.5.7

PC.A.6.2

PC.A.6.3

PC.A.6.4

PC.A.6.5

PC.A.6.6

PC.3.6 In the case of **Offshore Embedded Power Stations** connected to an **Offshore User System** which directly connects to an **Offshore Transmission System**, any additional data requirements in respect of such **Offshore Embedded Power Stations** may be specified in the relevant **Bilateral Agreement** with the **Network Operator** or in any **Bilateral Agreement** between **The Company** and such **Offshore Embedded Power Station**.

PC.3.7 In the case of a **Generator** undertaking **OTSDUW** connecting to an **Onshore Network Operator's System**, any additional requirements in respect of such **OTSDUW Plant and Apparatus** will be specified in the relevant **Bilateral Agreement** with the **Generator**. For the avoidance of doubt, requirements applicable to **Generators** undertaking **OTSDUW** and connecting to a **Network Operator's User System**, shall be consistent with those applicable requirements of **Generators** undertaking **OTSDUW** and connecting to a **Transmission Interface Point**.

PC.3.8 For the purpose of complying with the requirements of ECC.6.3.17.1.5 and ECC.6.3.17.2.3 **The Company** may share relevant modelling information to a **User** based on the following information submitted by a **User** to **The Company**:

PC.A.5.3.2(a), (b), (c), (d) and (g)

PC.A.5.4.2

PC.A.5.4.3

PC.A.9

PC.3.9 A **User** who receives information from **The Company** under PC.3.8 may only use the information to complete the analysis required by ECC.6.3.17.1 and EEC.6.3.17.2 as applicable and the **Bilateral Agreement**. Further conditions on the sharing of models are detailed in PC.A.9

PC.4 PLANNING PROCEDURES

PC.4.1 Pursuant to Condition C11 of **The Company's Transmission Licence**, the means by which **Users** and proposed **Users** of the **National Electricity Transmission System** are able to assess opportunities for connecting to, and using, the **National Electricity Transmission System** comprise two distinct parts, namely:

- (a) a statement, prepared by **The Company** under its **Transmission Licence**, showing for each of the seven succeeding **Financial Years**, the opportunities available for connecting to and using the **National Electricity Transmission System** and indicating those parts of the **National Electricity Transmission System** most suited to new connections and transport of further quantities of electricity (the "**Seven Year Statement**"); and
- (b) an offer, in accordance with its **Transmission Licence**, by **The Company** to enter into a **CUSC Contract**. A **Bilateral Agreement** is to be entered into for every **Connection Site** (and for certain **Embedded Power Stations** and **Embedded DC Converter Stations** and **Embedded HVDC Systems**) within the first two of the following categories and the existing **Bilateral Agreement** may be required to be varied in the case of the third category:
 - (i) existing **Connection Sites** (and for certain **Embedded Power Stations**) as at the **Transfer Date**;
 - (ii) new **Connection Sites** (and for certain **Embedded Power Stations**, **Embedded DC Converter Stations** and **Embedded HVDC Systems**) with effect from the **Transfer Date**;
 - (iii) a **Modification** at a **Connection Site** (or in relation to the connection of certain **Embedded Power Stations**, **Embedded DC Converter Stations** and **Embedded HVDC Systems** whether or not the subject of a **Bilateral Agreement**) (whether such **Connection Site** or connection exists on the **Transfer Date** or is new thereafter) with effect from the **Transfer Date**.

In this **PC**, unless the context otherwise requires, "connection" means any of these 3 categories.

PC.4.2 Introduction to Data

User Data

PC.4.2.1 Under the **PC**, two types of data to be supplied by **Users** are called for:

- (a) **Standard Planning Data**; and
- (b) **Detailed Planning Data**,

as more particularly provided in PC.A.1.4.

PC.4.2.2 The **PC** recognises that these two types of data, namely **Standard Planning Data** and **Detailed Planning Data**, are considered at three different levels:

- (a) **Preliminary Project Planning Data**;
- (b) **Committed Project Planning Data**; and

(c) **Connected Planning Data**,
as more particularly provided in PC.5

PC.4.2.3 **Connected Planning Data** is itself divided into:

- (a) **Forecast Data**;
- (b) **Registered Data**; and
- (c) **Estimated Registered Data**,

as more particularly provided in PC.5.5

PC.4.2.4 Clearly, an existing **User** proposing a new **Connection Site** (or **Embedded Power Station** or **Embedded DC Converter Station** or **Embedded HVDC System**) in the circumstances outlined in PC.4.1) will need to supply data both in an application for a **Bilateral Agreement** and under the **PC** in relation to that proposed new **Connection Site** (or **Embedded Power Station** or **Embedded DC Converter Station** or **Embedded HVDC System** in the circumstances outlined in PC.4.1) and that will be treated as **Preliminary Project Planning Data** or **Committed Project Planning Data** (as the case may be), but the data it supplies under the **PC** relating to its existing **Connection Sites** will be treated as **Connected Planning Data**.

Network Data

PC.4.2.5 In addition, there is **Network Data** supplied by **The Company** in relation to short circuit current contributions and in relation to **OTSUA**.

PC.4.3 Data Provision

PC.4.3.1 Seven Year Statement

To enable the **Seven Year Statement** to be prepared, each **User** is required to submit to **The Company** (subject to the provisions relating to **Embedded Power Stations** and **Embedded DC Converter Stations** and **Embedded HVDC Systems** in PC.3.2) both the **Standard Planning Data** and the **Detailed Planning Data** as listed in parts 1 and 2 of the Appendix. This data should be submitted in calendar week 24 of each year (although **Network Operators** may delay the submission of data (other than that to be submitted pursuant to PC.3.2(c) and PC.3.2(d)) until calendar week 28) and should cover each of the seven succeeding **Financial Years** (and in certain instances, the current year). Where, from the date of one submission to another, there is no change in the data (or in some of the data) to be submitted, instead of re-submitting the data, a **User** may submit a written statement that there has been no change from the data (or in some of the data) submitted the previous time. In addition, **The Company** will also use the **Transmission Entry Capacity** and **Connection Entry Capacity** data from the **CUSC Contract**, and any data submitted by **Network Operators** in relation to an **Embedded Medium Power Station** not subject to a **Bilateral Agreement** or **Embedded DC Converter Station** not subject to a **Bilateral Agreement**, or **Embedded HVDC System** not subject to a **Bilateral Agreement** in the preparation of the **Seven Year Statement** and to that extent the data will not be treated as confidential.

PC.4.3.2 Network Data

To enable **Users** to model the **National Electricity Transmission System** in relation to short circuit current contributions, **The Company** is required to submit to **Users**, the **Network Data** as listed in Part 3 of the Appendix. The data will be submitted in week 42 of each year and will cover that **Financial Year**.

PC.4.3.3 To enable **Users** to model the **National Electricity Transmission System** in relation to **OTSUA**, **The Company** is required to submit to **Users** the **Network Data**, as listed in Part 3 of Appendix A and Appendix F. **The Company** shall provide the **Network Data** with the offer of a **CUSC Contract** in the case of the data in PC F2.1 and otherwise in accordance with the **OTSDUW Development and Data Timetable**.

PC.4.4 Offer of Terms for Connection

PC.4.4.1 CUSC Contract – Data Requirements/Offer Timing

The completed application form for a **CUSC Contract** to be submitted by a **User** when making an application for a **CUSC Contract** will include:

- (a) a description of the **Plant** and/or **Apparatus** (excluding **OTSDUW Plant and Apparatus**) to be connected to the **National Electricity Transmission System** or of the **Modification** relating to the **User's Plant** and/or **Apparatus** (and prior to the **OTSUA Transfer Time**, any **OTSUA**) already connected to the **National Electricity Transmission System** or, as the case may be, of the proposed new connection or **Modification** to the connection within the **User System** of the **User**, each of which shall be termed a "**User Development**" in the **PC**;
- (b) the relevant **Standard Planning Data** as listed in Part 1 of the Appendix (except in respect of any **OTSUA**); and
- (c) the desired **Completion Date** of the proposed **User Development**.
- (d) the desired **Connection Entry Capacity** and **Transmission Entry Capacity**.

The completed application form for a **CUSC Contract** will be sent to **The Company** as more particularly provided in the application form.

PC.4.4.2

Any offer of a **CUSC Contract** will provide that it must be accepted by the applicant **User** within the period stated in the offer, after which the offer automatically lapses. Except as provided in the **CUSC Contract**, acceptance of the offer renders the **National Electricity Transmission System** works relating to that **User Development**, reflected in the offer, committed and binds both parties to the terms of the offer. The **User** shall then provide the **Detailed Planning Data** as listed in Part 2 of the Appendix (and in the case of **OTSUA** the **Standard Planning Data** as listed in Part 1 of Appendix A within the timeline provided in PC.A.1.4). In respect of **DPD I** this shall generally be provided within 28 days (or such shorter period as **The Company** may determine, or such longer period as **The Company** may agree, in any particular case) of acceptance of the offer and in respect of **DPD II** this shall generally be provided at least two years (or such longer period as **The Company** may determine, or such shorter period as **The Company** may agree, in any particular case or in the case of **OTSUA** such shorter period as **The Company** shall require) prior to the **Completion Date** of the **User Development**.

PC.4.4.3

Embedded Development Agreement - Data Requirements

The **Network Operator** shall submit the following data in relation to an **Embedded Medium Power Station** not subject to, or proposed to be subject to, a **Bilateral Agreement** or **Embedded DC Converter Station** not subject to, or proposed to be subject to, a **Bilateral Agreement** as soon as reasonably practicable after receipt of an application from an **Embedded Person** to connect to its **System**:

- (a) details of the proposed new connection or variation (having a similar effect on the **Network Operator's System** as a **Modification** would have on the **National Electricity Transmission System**) to the connection within the **Network Operator's System**, each of which shall be termed an "**Embedded Development**" in the **PC** (where a **User Development** has an impact on the **Network Operator's System** details shall be supplied in accordance with PC.4.4 and PC.4.5);
- (b) the relevant **Standard Planning Data** as listed in Part 1 of the Appendix;
- (c) the proposed completion date (having a similar meaning in relation to the **Network Operator's System** as **Completion Date** would have in relation to the **National Electricity Transmission System**) of the **Embedded Development**; and
- (d) upon the request of **The Company**, the relevant **Detailed Planning Data** as listed in Part 2 of the Appendix.

PC.4.4.4 The **Network Operator** shall provide the **Detailed Planning Data** as listed in Part 2 of the Appendix. In respect of **DPD I**, this shall generally be provided within 28 days (or such shorter period as **The Company** may determine, or such longer period as **The Company** may agree, in any particular case) of entry into the **Embedded Development Agreement** and in respect to **DPD II** this shall generally be provided at least two years (or such longer period as **The Company** may determine, or such shorter period as **The Company** may agree, in any particular case) prior to the **Completion Date** of the **Embedded Development**.

PC.4.5 Complex Connections

PC.4.5.1 The magnitude and complexity of any **National Electricity Transmission System** extension or reinforcement will vary according to the nature, location and timing of the proposed **User Development** which is the subject of the application and it may, in the event, be necessary for **The Company** to carry out additional more extensive system studies to evaluate more fully the impact of the proposed **User Development** on the **National Electricity Transmission System**. Where **The Company** judges that such additional more detailed studies are necessary the offer may indicate the areas that require more detailed analysis and before such additional studies are required, the **User** shall indicate whether it wishes **The Company** to undertake the work necessary to proceed to make a revised offer within the 3 month period normally allowed or, where relevant, the timescale consented to by the **Authority**.

PC.4.5.2 To enable **The Company** to carry out any of the above mentioned necessary detailed system studies, the **User** may, at the request of **The Company**, be required to provide some or all of the **Detailed Planning Data** listed in part 2 of the Appendix in advance of the normal timescale referred in PC.4.4.2 provided that **The Company** can reasonably demonstrate that it is relevant and necessary.

PC.4.5.3 To enable **The Company** to carry out any necessary detailed system studies, the relevant **Network Operator** may, at the request of **The Company**, be required to provide some or all of the **Detailed Planning Data** listed in Part 2 of the Appendix in advance of the normal timescale referred in PC.4.4.4 provided that **The Company** can reasonably demonstrate that it is relevant and necessary.

PC.5 PLANNING DATA

PC.5.1 As far as the **PC** is concerned, there are three relevant levels of data in relation to **Users**. These levels, which relate to levels of confidentiality, commitment and validation, are described in the following paragraphs.

Preliminary Project Planning Data

PC.5.2 At the time the **User** applies for a **CUSC Contract** but before an offer is made and accepted by the applicant **User**, the data relating to the proposed **User Development** will be considered as **Preliminary Project Planning Data**. Data relating to an **Embedded Development** provided by a **Network Operator** in accordance with PC.4.4.3, and PC.4.4.4 if requested, will be considered as **Preliminary Project Planning Data**. All such data will be treated as confidential within the scope of the provisions relating to confidentiality in the **CUSC**.

PC.5.3 **Preliminary Project Planning Data** will normally only contain the **Standard Planning Data** unless the **Detailed Planning Data** is required in advance of the normal timescale to enable **The Company** to carry out additional detailed system studies as described in PC.4.5.

Committed Project Planning Data

Once the offer for a **CUSC Contract** is accepted, the data relating to the **User Development** already submitted as **Preliminary Project Planning Data**, and subsequent data required by **The Company** under this **PC**, will become **Committed Project Planning Data**. Once an **Embedded Person** has entered into an **Embedded Development Agreement**, as notified to **The Company** by the **Network Operator**, the data relating to the **Embedded Development** already submitted as **Preliminary Project Planning Data**, and subsequent data required by **The Company** under the **PC**, will become **Committed Project Planning Data**. Such data, together with **Connection Entry Capacity** and **Transmission Entry Capacity** data from the **CUSC Contract** and other data held by **The Company** relating to the **National Electricity Transmission System** will form the background against which new applications by any **User** will be considered and against which planning of the **National Electricity Transmission System** will be undertaken. Accordingly, **Committed Project Planning Data**, **Connection Entry Capacity** and **Transmission Entry Capacity** data will not be treated as confidential to the extent that **The Company**:

- (a) is obliged to use it in the preparation of the **Seven Year Statement** and in any further information given pursuant to the **Seven Year Statement**;
- (b) is obliged to use it when considering and/or advising on applications (or possible applications) of other **Users** (including making use of it by giving data from it, both orally and in writing, to other **Users** making an application (or considering or discussing a possible application) which is, in **The Company's** view, relevant to that other application or possible application);
- (c) is obliged to use it for operational planning purposes;
- (d) is obliged under the terms of an **Interconnection Agreement** to pass it on as part of system information on the **Total System**;
- (e) is obliged to disclose it under the **STC**;
- (f) is obliged to use and disclose it in the preparation of the **Offshore Development Information Statement**;
- (g) is obliged to use it in order to carry out its **EMR Functions** or is obliged to disclose it under an **EMR Document**.

To reflect different types of data, **Preliminary Project Planning Data** and **Committed Project Planning Data** are themselves divided into:

- (a) those items of **Standard Planning Data** and **Detailed Planning Data** which will always be forecast, known as **Forecast Data**; and
- (b) those items of **Standard Planning Data** and **Detailed Planning Data** which relate to **Plant** and/or **Apparatus** which upon connection will become **Registered Data**, but which prior to connection, for the seven succeeding **Financial Years**, will be an estimate of what is expected, known as **Estimated Registered Data**.

Connected Planning Data

The **PC** requires that, at the time that a **Statement of Readiness** is submitted under the **Bilateral Agreement** and/or **Construction Agreement**, any estimated values assumed for planning purposes are confirmed or, where practical, replaced by validated actual values and by updated estimates for the future and by updated forecasts for forecast data items such as **Demand**. In the case of an **Embedded Development** the relevant **Network Operator** will update any estimated values assumed for planning purposes with validated actual values as soon as reasonably practicable after energisation. This data is then termed **Connected Planning Data**.

To reflect the three types of data referred to above, **Connected Planning Data** is itself divided into:

- (a) those items of **Standard Planning Data** and **Detailed Planning Data** which will always be forecast data, known as **Forecast Data**; and

- (b) those items of **Standard Planning Data** and **Detailed Planning Data** which upon connection become fixed (subject to any subsequent changes), known as **Registered Data**; and
- (c) those items of **Standard Planning Data** and **Detailed Planning Data** which for the purposes of the **Plant** and/or **Apparatus** concerned as at the date of submission are **Registered Data** but which for the seven succeeding **Financial Years** will be an estimate of what is expected, known as **Estimated Registered Data**,

as more particularly provided in the Appendix.

PC.5.6

Connected Planning Data, together with **Connection Entry Capacity** and **Transmission Entry Capacity** data from the **CUSC Contract**, and other data held by **The Company** relating to the **National Electricity Transmission System**, will form the background against which new applications by any **User** will be considered and against which planning of the **National Electricity Transmission System** will be undertaken. Accordingly, **Connected Planning Data**, **Connection Entry Capacity** and **Transmission Entry Capacity** data will not be treated as confidential to the extent that **The Company**:

- (a) is obliged to use it in the preparation of the **Seven Year Statement** and in any further information given pursuant to the **Seven Year Statement**;
- (b) is obliged to use it when considering and/or advising on applications (or possible applications) of other **Users** (including making use of it by giving data from it, both orally and in writing, to other **Users** making an application (or considering or discussing a possible application) which is, in **The Company's** view, relevant to that other application or possible application);
- (c) is obliged to use it for operational planning purposes;
- (d) is obliged under the terms of an **Interconnection Agreement** to pass it on as part of system information on the **Total System**.
- (e) is obliged to disclose it under the **STC**;
- (f) is obliged to use it in order to carry out its **EMR Functions** or is obliged to disclose it under an **EMR Document**.

PC.5.7

Committed Project Planning Data and **Connected Planning Data** will each contain both **Standard Planning Data** and **Detailed Planning Data**.

PC.6 PLANNING STANDARDS

PC.6.1 **The Company** shall apply the **Licence Standards** relevant to it in the planning and development of the **National Electricity Transmission System**. **The Company** shall procure that each **Relevant Transmission Licensee** shall apply the **Licence Standards** relevant to planning and development, in the planning and development of the **Transmission System** of each **Relevant Transmission Licensee** and that a **User** shall apply the **Licence Standards** relevant to planning and development, in the planning and development of the **OTSUA**.

PC.6.2 In relation to Scotland, Appendix C lists the technical and design criteria applied in the planning and development of each **Relevant Transmission Licensee's Transmission System**. The criteria are subject to review in accordance with each **Relevant Transmission Licensee's Transmission Licence** conditions. Copies of these documents are available from **The Company** on request. **The Company** will charge an amount sufficient to recover its reasonable costs incurred in providing this service.

PC.6.3 In relation to **Offshore**, Appendix E lists the technical and design criteria applied in the planning and development of each **Offshore Transmission System**. The criteria are subject to review in accordance with each **Offshore Transmission Licensee's Transmission Licence** conditions. Copies of these documents are available from **The Company** on request. **The Company** will charge an amount sufficient to recover its reasonable costs incurred in providing this service.

PC.6.4 In planning and developing the **OTSUA**, the **User** shall comply with (and shall ensure that (as at the **OTSUA Transfer Time**) the **OTSUA** comply with):

- (a) the **Licence Standards**; and
- (b) the technical and design criteria in Appendix E.

PC.6.5 In addition the **User** shall, in the planning and development of the **OTSUA**, to the extent it is reasonable and practicable to do so, take into account the reasonable requests of **The Company** (in the context of its obligation to develop an efficient, co-ordinated and economical system) relating to the planning and development of the **National Electricity Transmission System**.

PC.6.6 In planning and developing the **OTSUA** the **User** shall take into account the **Network Data** provided to it by **The Company** under Part 3 of Appendix A and Appendix F, and act on the basis that the **Plant** and **Apparatus** of other **Users** complies with:

- (a) the minimum technical design and operational criteria and performance requirements set out in either CC.6.1, CC.6.2, CC.6.3 and CC.6.4 or ECC.6.1, ECC.6.2, ECC.6.3 and ECC.6.4 ; or
- (b) such other criteria or requirements as **The Company** may from time to time notify the **User** are applicable to specified **Plant** and **Apparatus** pursuant to PC.6.7.

PC.6.7 Where the **OTSUA** are likely to be materially affected by the design or operation of another **User's Plant** and **Apparatus** and **The Company**:

- (a) becomes aware that such other **User** has or is likely to apply for a derogation under the Grid Code;
- (b) is itself applying for a derogation under the Grid Code in relation to the **Connection Site** on which such other **User's Plant** and **Apparatus** is located or to which it otherwise relates; or
- (c) is otherwise notified by such other **User** that specified **Plant** or **Apparatus** is normally capable of operating at levels better than those set out in CC.6.1, CC.6.2, CC.6.3 and CC.6.4 or ECC.6.1, ECC.6.2, ECC.6.3 and ECC.6.4,

The Company shall notify the **User**.

PC.7 PLANNING LIAISON

PC.7.1 This PC.7 applies to **The Company** and **Users**, which in PC.7 means

- (a) **Network Operators**
- (b) **Non-Embedded Customers**

PC.7.2 As described in PC.2.1 (b) an objective of the **PC** is to provide for the supply of information to **The Company** by **Users** in order that planning and development of the **National Electricity Transmission System** can be undertaken in accordance with the relevant **Licence Standards**.

PC.7.3 **Grid Code** amendment B/07 (“Amendment B/07”) implemented changes to the **Grid Code** which included amendments to the datasets provided by both **The Company** and **Users** to inform the planning and development of the **National Electricity Transmission System**. The **Authority** has determined that these changes are to have a phased implementation. Consequently the provisions of Appendix A to the **PC** include specific years (ranging from 2009 to 2011) with effect from which certain of the specific additional obligations brought about by Amendment B/07 on **The Company** and **Users** are to take effect. Where specific provisions of paragraphs PC.A.4.1.4, PC.A.4.2.2 and PC.A.4.3.1 make reference to a year, then the obligation on **The Company** and the **Users** shall be required to be met by the relevant calendar week (as specified within such provision) in such year.

In addition to the phased implementation of aspects of Amendment B/07, **Users** must discuss and agree with **The Company** by no later than 31 March 2009 a more detailed implementation programme to facilitate the implementation of **Grid Code** amendment B/07.

It shall also be noted by **The Company** and **Users** that the dates set out in PC.A.4 are intended to be minimum requirements and are not intended to restrict a **User** and **The Company** from the earlier fulfilment of the new requirements prior to the specified years. Where **The Company** and a **User** wish to follow the new requirements from earlier dates than those specified, this will be set out in the more detailed implementation programme agreed between **The Company** and the **User**.

The following provisions of PC.7 shall only apply with effect from 1 January 2011.

PC.7.4 Following the submission of data by a **User** in or after week 24 of each year **The Company** will provide information to **Users** by calendar week 6 of the following year regarding the results of any relevant assessment that has been made by **The Company** based upon such data submissions to verify whether **Connection Points** are compliant with the relevant **Licence Standards**.

PC.7.5 Where the result of any assessment identifies possible future non-compliance with the relevant **Licence Standards**, **The Company** shall notify the relevant **User(s)** of this fact as soon as reasonably practicable and shall agree with **Users** any opportunity to resubmit data to allow for a reassessment in accordance with PC.7.6.

PC.7.6 Following any notification by **The Company** to a **User** pursuant to PC.7.5 and following any further discussions held between the **User** and **The Company**:

- (i) **The Company** and the **User** may agree revisions to the **Access Periods** for relevant **Transmission Interface Circuits**, such revisions shall not however permit an **Access Period** to be less than 4 continuous weeks in duration or to occur other than between calendar weeks 10 and 43 (inclusive); and/or,
- (ii) The **User** shall as soon as reasonably practicable
 - (a) submit further relevant data to **The Company** that is to **The Company’s** reasonable satisfaction; and/or,
 - (b) modify data previously submitted pursuant to this **PC**, such modified data to be to **The Company’s** reasonable satisfaction; and/or
 - (c) notify **The Company** that it is the intention of the **User** to leave the data as originally submitted to **The Company** to stand as its submission.

- PC.7.7 Where an **Access Period** is amended pursuant to PC.7.6 (i) **The Company** shall notify **The Authority** that it has been necessary to do so.
- PC.7.8 When it is agreed that any resubmission of data is unlikely to confirm future compliance with the relevant **Licence Standards** the **Modification** process in the **CUSC** may apply.
- PC.7.9 A **User** may at any time, in writing, request further specified **National Electricity Transmission System** network data in order to provide **The Company** with viable **User** network data (as required under this **PC**). Upon receipt of such request, **The Company** shall consider, and where appropriate provide such **National Electricity Transmission System** network data to the **User** as soon as reasonably practicable following the request.
- PC.8 OTSDUW PLANNING LIAISON
- PC.8.1 This PC.8 applies to **The Company** and **Users**, which in PC.8 means **Users** undertaking **OTSDUW**
- PC.8.2 As described in PC.2.1 (e) an objective of the **PC** is to provide for the supply of information between **The Company** and a **User** undertaking **OTSDUW** in order that planning and development of the **National Electricity Transmission System** can be co-ordinated.
- PC.8.3 Where the **OTSUA** also require works to be undertaken by any **Relevant Transmission Licensee** on its **Transmission System** **The Company** and the **User** shall throughout the construction and commissioning of such works:
- (a) co-operate and assist each other in the development of co-ordinated construction programmes or any other planning or, in the case of **The Company**, analysis it undertakes in respect of the works; and
 - (b) provide to each other all information relating to, in the case of the **User** its own works and, in the case of **The Company**, the works on the **Transmission Systems** reasonably necessary to assist each other in the performance of that other's part of the works, and shall use all reasonable endeavours to co-ordinate and integrate their respective part of the works; and
- the **User** shall plan and develop the **OTSUA**, taking into account to the extent that it is reasonable and practicable to do so the reasonable requests of **The Company** relating to the planning and development of the **National Electricity Transmission System**.
- PC.8.4 Where **The Company** becomes aware that changes made to the investment plans of any **Relevant Transmission Licensee** may have a material effect on the **OTSUA**, **The Company** shall notify the **User** and provide the **User** with the necessary information about the relevant **Transmission Systems** sufficient for the **User** to assess the impact on the **OTSUA**.

APPENDIX A - PLANNING DATA REQUIREMENTS

PC.A.1 INTRODUCTION

PC.A.1.1 The Appendix specifies data requirements to be submitted to **The Company** by **Users**, and in certain circumstances to **Users** by **The Company**.

PC.A.1.2 Submissions by Users

- (a) Planning data submissions by **Users** shall be:
- (i) with respect to each of the seven succeeding **Financial Years** (other than in the case of **Registered Data** which will reflect the current position and data relating to **Demand** forecasts which relates also to the current year);
 - (ii) provided by **Users** in connection with a **CUSC Contract** (PC.4.1, PC.4.4 and PC.4.5 refer);
 - (iii) provided by **Users** on a routine annual basis in calendar week 24 of each year to maintain an up-to-date data bank (although **Network Operators** may delay the submission of data (other than that to be submitted pursuant to PC.3.2(c) and PC.3.2(d)) until calendar week 28). In addition the structural data in DRC Schedule 5 Tables 5(a), 5(b), 5(d), 5(e), 5(f) and DRC Schedule 13 (Lumped system susceptance (PC.A.2.3) only) provided by **Network Operators** by calendar week 28 shall be updated by calendar week 50 of each year (again which may be delayed as above until week 2 of the following calendar year). Where from the date of one annual (or in the case of Schedule 5 or Schedule 13 the calendar week 50) submission to another there is no change in the data (or in some of the data) to be submitted, instead of re-submitting the data, a **User** may submit a written statement that there has been no change from the data (or some of the data) submitted the previous time; and
 - (iv) provided by **Network Operators** in connection with **Embedded Development** (PC.4.4 refers).
- (b) Where there is any change (or anticipated change) in **Committed Project Planning Data** or a significant change in **Connected Planning Data** in the category of **Forecast Data** or any change (or anticipated change) in **Connected Planning Data** in the categories of **Registered Data** or **Estimated Registered Data** supplied to **The Company** under the **PC**, notwithstanding that the change may subsequently be notified to **The Company** under the **PC** as part of the routine annual update of data (or that the change may be a **Modification** under the **CUSC**), the **User** shall, subject to PC.A.3.2.3 and PC.A.3.2.4, notify **The Company** in writing without delay.
- (c) The notification of the change will be in the form required under this **PC** in relation to the supply of that data and will also contain the following information:
- (i) the time and date at which the change became, or is expected to become, effective;
 - (ii) if the change is only temporary, an estimate of the time and date at which the data will revert to the previous registered form.
- (d) The routine annual update of data, referred to in (a)(iii) above, need not be submitted in respect of **Small Power Stations** or **Embedded** installations of direct current converters which do not form a **DC Converter Station** or **HVDC System** (except as provided in PC.3.2.(c)), or unless specifically requested by **The Company**, or unless otherwise specifically provided.

PC.A.1.3 Submissions by The Company

Network Data release by **The Company** shall be:

- (a) with respect to the current **Financial Year**;

- (b) provided by **The Company** on a routine annual basis in calendar week 42 of each year. Where from the date of one annual submission to another there is no change in the data (or in some of the data) to be released, instead of repeating the data, **The Company** may release a written statement that there has been no change from the data (or some of the data) released the previous time.

The three parts of the Appendix

PC.A.1.4

The data requirements listed in this Appendix are subdivided into the following four parts:

(a) Standard Planning Data

This data (as listed in Part 1 of the Appendix) is first to be provided by a **User** at the time of an application for a **CUSC Contract** or in accordance with PC.4.4.3. It comprises data which is expected normally to be sufficient for **The Company** to investigate the impact on the **National Electricity Transmission System** of any **User Development** or **Embedded Development** associated with an application by the **User** for a **CUSC Contract**. **Users** should note that the term **Standard Planning Data** also includes the information referred to in PC.4.4.1.(a) and PC.4.4.3.(a). In the case of **OTSUA**, this data is first to be provided by a **User** in accordance with the time line in Appendix F.

(b) Detailed Planning Data

This data (as listed in Part 2 of the Appendix) includes both **DPD I** and **DPD II** and is to be provided in accordance with PC.4.4.2 and PC.4.4.4. It comprises additional, more detailed, data not normally expected to be required by **The Company** to investigate the impact on the **National Electricity Transmission System** of any **User Development** associated with an application by the **User** for a **CUSC Contract** or **Embedded Development Agreement**. **Users** and **Network Operators** in respect of **Embedded Developments** should note that the term **Detailed Planning Data** also includes **Operation Diagrams** and **Site Common Drawings** produced in accordance with the **CC** and **ECC**.

The **User** may, however, be required by **The Company** to provide the **Detailed Planning Data** in advance of the normal timescale before **The Company** can make an offer for a **CUSC Contract**, as explained in PC.4.5.

(c) Network Data

The data requirements for **The Company** in this Appendix are in Part 3.

(d) Offshore Transmission System (OTSDUW) Data

Generators who are undertaking **OTSDUW** are required to submit data in accordance with Appendix A as summarised in Schedule 18 of the **Data Registration Code**.

Forecast Data, Registered Data and Estimated Registered Data

PC.A.1.5

As explained in PC.5.4 and PC.5.5, **Planning Data** is divided into:

- (i) those items of **Standard Planning Data** and **Detailed Planning Data** known as **Forecast Data**; and
- (ii) those items of **Standard Planning Data** and **Detailed Planning Data** known as **Registered Data**; and
- (iii) those items of **Standard Planning Data** and **Detailed Planning Data** known as **Estimated Registered Data**.

PC.A.1.6

The following paragraphs in this Appendix relate to **Forecast Data**:

3.2.2(b), (h), (i) and (j)

4.2.1

4.3.1

4.3.2

4.3.3

4.3.4

4.3.5

4.5

4.7.1

5.2.1

5.2.2

5.6.1

PC.A.1.7 The following paragraphs in this Appendix relate to **Registered Data** and **Estimated Registered Data**:

2.2.1

2.2.4

2.2.5

2.2.6

2.3.1

2.4.1

2.4.2

3.2.2(a), (c), (d), (e), (f), (g), (i)(part) and (j)

3.4.1

3.4.2

4.2.3

4.5(a)(i), (a)(iii), (b)(i) and (b)(iii)

4.6

5.3.2

5.4

5.4.2

5.4.3

5.5

5.6.3

6.2

6.3

PC.A.1.8 The data supplied under PC.A.3.3.1, although in the nature of **Registered Data**, is only supplied either upon application for a **CUSC Contract**, or in accordance with PC.4.4.3, and therefore does not fall to be **Registered Data**, but is **Estimated Registered Data**.

PC.A.1.9 **Forecast Data** must contain the **User's** best forecast of the data being forecast, acting as a reasonable and prudent **User** in all the circumstances.

- PC.A.1.10 **Registered Data** must contain validated actual values, parameters or other information (as the case may be) which replace the estimated values, parameters or other information (as the case may be) which were given in relation to those data items when they were **Preliminary Project Planning Data** and **Committed Project Planning Data**, or in the case of changes, which replace earlier actual values, parameters or other information (as the case may be). Until amended pursuant to the Grid Code, these actual values, parameters or other information (as the case may be) will be the basis upon which the **National Electricity Transmission System** is planned, designed, built and operated in accordance with, amongst other things, the **Transmission Licences**, the **STC** and the Grid Code, and on which **The Company** therefore relies. In following the processes set out in the **BC**, **The Company** will use the data which has been supplied to it under the **BC** and the data supplied under **OC2** in relation to **Gensets**, but the provision of such data will not alter the data supplied by **Users** under the **PC**, which may only be amended as provided in the **PC**.
- PC.A.1.11 **Estimated Registered Data** must contain the **User's** best estimate of the values, parameters or other information (as the case may be), acting as a reasonable and prudent **User** in all the circumstances.
- PC.A.1.12 Certain data does not need to be supplied in relation to **Embedded Power Stations** or **Embedded DC Converter Stations** or **Embedded HVDC Systems** where these are connected at a voltage level below the voltage level directly connected to the **National Electricity Transmission System** except in connection with a **CUSC Contract**, or unless specifically requested by **The Company**.
- PC.A.1.13 In the case of **OTSUA**, Schedule 18 of the **Data Registration Code** shall be construed in such a manner as to achieve the intent of such provisions by reference to the **OTSUA** and the **Interface Point** and all **Connection Points**.

PART 1 - STANDARD PLANNING DATA

PC.A.2 USER'S SYSTEM (AND OTSUA) DATA

PC.A.2.1 Introduction

PC.A.2.1.1 Each **User**, whether connected directly via an existing **Connection Point** to the **National Electricity Transmission System**, or seeking such a direct connection, or providing terms for connection of an **Offshore Transmission System** to its **User System** to **The Company**, shall provide **The Company** with data on its **User System** (and any **OTSUA**) which relates to the **Connection Site** (and in the case of **OTSUA**, the **Interface Point**) and/or which may have a system effect on the performance of the **National Electricity Transmission System**. Such data, current and forecast, is specified in PC.A.2.2 to PC.A.2.5. In addition each **Generator** in respect of its **Embedded Large Power Stations** and its **Embedded Medium Power Stations** subject to a **Bilateral Agreement** and each **Network Operator** in respect of **Embedded Medium Power Stations** within its **System** not subject to a **Bilateral Agreement** connected to the **Subtransmission System**, shall provide **The Company** with fault infeed data as specified in PC.A.2.5.5 and each **DC Converter** owner with **Embedded DC Converter Stations** subject to a **Bilateral Agreement** and **Embedded HVDC System Owner** subject to a **Bilateral Agreement**, or **Network Operator** in the case of **Embedded DC Converter Stations** not subject to a **Bilateral Agreement** or **Embedded HVDC Systems** not subject to a **Bilateral Agreement**, connected to the **Subtransmission System** shall provide **The Company** with fault infeed data as specified in PC.A.2.5.6.

PC.A.2.1.2 Each **User** must reflect the system effect at the **Connection Site(s)** of any third party **Embedded** within its **User System** whether existing or proposed.

PC.A.2.1.3 Although not itemised here, each **User** with an existing or proposed **Embedded Small Power Station**, **Embedded Medium Power Station**, **Embedded DC Converter Station** or **HVDC System** with a **Registered Capacity** of less than 100MW or an **Embedded** installation of direct current converters which does not form a **DC Converter Station** or **HVDC System** in its **User System** may, at **The Company's** reasonable discretion, be required to provide additional details relating to the **User's System** between the **Connection Site** and the existing or proposed **Embedded Small Power Station**, **Embedded Medium Power Station**, **Embedded DC Converter Station**, **Embedded HVDC System** or **Embedded** installation of direct current converters which does not form a **DC Converter Station** or **Embedded** installation which does not form an **HVDC System**.

PC.A.2.1.4 At **The Company's** reasonable request, additional data on the **User's System** (or **OTSUA**) will need to be supplied. Some of the possible reasons for such a request, and the data required, are given in PC.A.6.2, PC.A.6.4, PC.A.6.5 and PC.A.6.6.

PC.A.2.2 User's System (and OTSUA) Layout

PC.A.2.2.1 Each **User** shall provide a **Single Line Diagram**, depicting both its existing and proposed arrangement(s) of load current carrying **Apparatus** relating to both existing and proposed **Connection Points** (including in the case of **OTSUA**, **Interface Points**).

PC.A.2.2.2 The **Single Line Diagram** (three examples are shown in Appendix B) must include all parts of the **User System** operating at **Supergrid Voltage** throughout **Great Britain** and, in Scotland and **Offshore**, also all parts of the **User System** operating at 132kV or greater, and those parts of its **Subtransmission System** at any **Transmission Site**. In the case of **OTSDUW**, the **Single Line Diagram** must also include the **OTSUA**. In addition, the **Single Line Diagram** must include all parts of the **User's Subtransmission System** (and any **OTSUA**) throughout **Great Britain** operating at a voltage greater than 50kV, and, in Scotland and **Offshore**, also all parts of the **User's Subtransmission System** (and any **OTSUA**) operating at a voltage greater than 30kV, which, under either intact network or **Planned Outage** conditions:

- (a) normally interconnects separate **Connection Points**, or busbars at a **Connection Point** which are normally run in separate sections; or

- (b) connects **Embedded Large Power Stations**, or **Embedded Medium Power Stations**, or **Embedded DC Converter Stations**, or **Embedded HVDC Systems** or **Offshore Transmission Systems** connected to the **User's Subtransmission System**, to a **Connection Point** or **Interface Point**.

At the **User's** discretion, the **Single Line Diagram** can also contain additional details of the **User's Subtransmission System** (and any **OTSUA**) not already included above, and also details of the transformers connecting the **User's Subtransmission System** to a lower voltage. With **The Company's** agreement, the **Single Line Diagram** can also contain information about the **User's System** (and any **OTSUA**) at a voltage below the voltage of the **Subtransmission System**.

The **Single Line Diagram** for a **Power Park Module** (including **DC Connected Power Park Modules**) must include all parts of the System connecting generating equipment to the **Grid Entry Point** (or **User System Entry Point** if **Embedded**). As an alternative, the **User** may choose to submit a **Single Line Diagram** with the equipment between the equivalent **Power Park Unit** and the **Common Collection Busbar** reduced to an electrically equivalent network. The format for a **Single Line Diagram** for a **Power Park Module** (including **DC Connected Power Park Modules**) electrically equivalent system is shown in Appendix B.

The **Single Line Diagram** must include the points at which **Demand** data (provided under PC.A.4.3.4 and PC.A.4.3.5, or in the case of **Generators**, PC.A.5.) and fault infeed data (provided under PC.A.2.5) are supplied.

PC.A.2.2.3 The above-mentioned **Single Line Diagram** shall include:

- (a) electrical circuitry (i.e. overhead lines, identifying which circuits are on the same towers, underground cables, power transformers, reactive compensation equipment and similar equipment); and
- (b) substation names (in full or abbreviated form) with operating voltages.

In addition, for all load current carrying **Apparatus** operating at **Supergrid Voltage** throughout **Great Britain** and, in Scotland and **Offshore**, also at 132kV or greater, (and any **OTSUA**) the **Single Line Diagram** shall include:

- (a) circuit breakers
- (b) phasing arrangements.

PC.A.2.2.3.1 For the avoidance of doubt, the **Single Line Diagram** to be supplied is in addition to the **Operation Diagram** supplied pursuant to CC.7.4 or ECC.7.4.

PC.A.2.2.4 For each circuit shown on the **Single Line Diagram** provided under PC.A.2.2.1, each **User** shall provide the following details relating to that part of its **User System** and **OTSUA**:

Circuit Parameters:

Rated voltage (kV)

Operating voltage (kV)

Positive phase sequence reactance

Positive phase sequence resistance

Positive phase sequence susceptance

Zero phase sequence reactance (both self and mutual)

Zero phase sequence resistance (both self and mutual)

Zero phase sequence susceptance (both self and mutual)

In the case of a **Single Line Diagram** for a **Power Park Module** (including **DC Connected Power Park Modules**) electrically equivalent system the data should be on a 100MVA base. Depending on the equivalent system supplied an equivalent tap changer range may need to be supplied. Similarly mutual values, rated voltage and operating voltage may be inappropriate. Additionally in the case of **OTSUA**, seasonal maximum continuous ratings and circuit lengths are to be provided in addition to the data required under PC.A.2.2.4.

PC.A.2.2.5 For each transformer shown on the **Single Line Diagram** provided under PC.A.2.2.1, each **User** (including those undertaking **OTSDUW**) shall provide the following details:

Rated MVA

Voltage Ratio

Winding arrangement

Positive sequence reactance (max, min and nominal tap)

Positive sequence resistance (max, min and nominal tap)

Zero sequence reactance

PC.A.2.2.5.1. In addition, for all interconnecting transformers between the **User's Supergrid Voltage System** and the **User's Subtransmission System** throughout **Great Britain** and, in Scotland and **Offshore**, also for all interconnecting transformers operating at 132kV or greater between the **User's System** and the **User's Subtransmission System** (and any **OTSUA**) the **User** shall supply the following information:-

Tap changer range

Tap change step size

Tap changer type: on load or off circuit

Earthing method: Direct, resistance or reactance

Impedance (if not directly earthed)

PC.A.2.2.6 Each **User** shall supply the following information about the **User's** equipment installed at a **Transmission Site** (or in the case of **OTSUA**, all **OTSDUW Plant and Apparatus**):-

(a) Switchgear. For all circuit breakers:-

Rated voltage (kV)

Operating voltage (kV)

Rated 3-phase rms short-circuit breaking current, (kA)

Rated 1-phase rms short-circuit breaking current, (kA)

Rated 3-phase peak short-circuit making current, (kA)

Rated 1-phase peak short-circuit making current, (kA)

Rated rms continuous current (A)

DC time constant applied at testing of asymmetrical breaking abilities (secs)

In the case of **OTSDUW Plant and Apparatus** operating times for circuit breaker, **Protection**, trip relay and total operating time should be provided.

(b) Substation Infrastructure. For the substation infrastructure (including, but not limited to, switch disconnectors, disconnectors, current transformers, line traps, busbars, through bushings, etc):-

Rated 3-phase rms short-circuit withstand current (kA)

Rated 1-phase rms short-circuit withstand current (kA).

Rated 3-phase short-circuit peak withstand current (kA)

Rated 1- phase short-circuit peak withstand current (kA)

Rated duration of short circuit withstand (secs)

Rated rms continuous current (A)

A single value for the entire substation may be supplied, provided it represents the most restrictive item of current carrying apparatus.

PC.A.2.2.7 In the case of **OTSUA** the following should also be provided

- (a) Automatic switching scheme schedules including diagrams and an explanation of how the **System** will operate and what plant will be affected by the schemes **Operation**.
- (b) **Intertripping** schemes both Generation and **Demand**. In each case a diagram of the scheme and an explanation of how the **System** will operate and what **Plant** will be affected by the schemes **Operation**.

PC.A.2.3 Lumped System Susceptance

PC.A.2.3.1 For all parts of the **User's Subtransmission System** (and any **OTSUA**) which are not included in the **Single Line Diagram** provided under PC.A.2.2.1, each **User** shall provide the equivalent lumped shunt susceptance at nominal **Frequency**.

PC.A.2.3.1.1 This should include shunt reactors connected to cables which are not normally in or out of service independent of the cable (ie. they are regarded as part of the cable).

PC.A.2.3.1.2 This should not include:

- (a) independently switched reactive compensation equipment connected to the **User's System** specified under PC.A.2.4, or;
- (b) any susceptance of the **User's System** inherent in the **Demand (Reactive Power)** data specified under PC.A.4.3.1.

PC.A.2.4 Reactive Compensation Equipment

PC.A.2.4.1 For all independently switched reactive compensation equipment (including any **OTSUA**), including that shown on the **Single Line Diagram**, not operated by **The Company** and connected to the **User's System** at 132kV and above in England and Wales and 33kV and above in Scotland and **Offshore** (including any **OTSDUW Plant and Apparatus** operating at **High Voltage**), other than **Power Factor** correction equipment associated directly with **Customers' Plant and Apparatus**, the following information is required:

- (a) type of equipment (eg. fixed or variable);
- (b) capacitive and/or inductive rating or its operating range in MVAR;
- (c) details of any automatic control logic to enable operating characteristics to be determined;
- (d) the point of connection to the **User's System** (including **OTSUA**) in terms of electrical location and **System** voltage.
- (e) In the case of **OTSDUW Plant and Apparatus** the **User** should also provide:-
 - (i) Connection node, voltage, rating, power loss, tap range and connection arrangement.
 - (ii) A mathematical representation in block diagram format to model the control of any dynamic compensation plant. The model should be suitable for RMS dynamic stability type studies where each time constant should be no less than 10ms.
 - (iii) For Static Var Compensation equipment the **User** should provide:

HV Node

LV Node

Control Node

Nominal Voltage (kV)

Target Voltage (kV)

Maximum MVA_r at HV
Minimum MVA_r at HV
Slope %
Voltage dependant Q Limit
Normal Running Mode
Positive and zero phase sequence resistance and reactance
Transformer winding type
Connection arrangements

PC.A.2.4.2 **DC Converter Station** owners, **HVDC System Owners** (and a **User** where the **OTSUA** includes an **OTSDUW DC Converter**) are also required to provide information about the reactive compensation and harmonic filtering equipment required to ensure that their **Plant** and **Apparatus** (and the **OTSUA**) complies with the criteria set out in CC.6.1.5 or ECC.6.1.5 (as applicable).

PC.A.2.5 Short Circuit Contribution to National Electricity Transmission System

PC.A.2.5.1 General

- (a) To allow **The Company** to calculate fault currents, each **User** is required to provide data, calculated in accordance with **Good Industry Practice**, as set out in the following paragraphs of PC.A.2.5.
- (b) The data should be provided for the **User's System** with all **Generating Units** (including **Synchronous Generating Units**), **Power Park Units**, **HVDC Systems** and **DC Converters Synchronised** to that **User's System** (and any **OTSUA** where appropriate). The **User** must ensure that the pre-fault network conditions reflect a credible **System** operating arrangement.
- (c) The list of data items required, in whole or part, under the following provisions, is set out in PC.A.2.5.6. Each of the relevant following provisions identifies which data items in the list are required for the situation with which that provision deals.

The fault currents in sub-paragraphs (a) and (b) of the data list in PC.A.2.5.6 should be based on an a.c. load flow that takes into account any pre-fault current flow across the **Point of Connection** (and in the case of **OTSUA**, **Interface Points** and **Connection Points**) being considered.

Measurements made under appropriate **System** conditions may be used by the **User** to obtain the relevant data.

- (d) **The Company** may at any time, in writing, specifically request for data to be provided for an alternative **System** condition, for example minimum plant, and the **User** will, insofar as such request is reasonable, provide the information as soon as reasonably practicable following the request.

PC.A.2.5.2 **Network Operators** and **Non-Embedded Customers** are required to submit data in accordance with PC.A.2.5.4. **Generators**, **DC Converter Station** owners, **HVDC System Owners** and **Network Operators**, in respect of **Embedded Medium Power Stations** not subject to a **Bilateral Agreement** and **Embedded DC Converter Stations** not subject to a **Bilateral Agreement** and **Embedded HVDC Systems** within such **Network Operator's Systems** are required to submit data in accordance with PC.A.2.5.5.

PC.A.2.5.3 Where prospective short-circuit currents on **Transmission** equipment are close to the equipment rating, and in **The Company's** reasonable opinion more accurate calculations of the prospective short circuit currents are required, then **The Company** will request additional data as outlined in PC.A.6.6 below.

PC.A.2.5.4 Data from Network Operators and Non-Embedded Customers

PC.A.2.5.4.1 Data is required to be provided at each node on the **Single Line Diagram** provided under PC.A.2.2.1 at which motor loads and/or **Embedded Small Power Stations** and/or **Embedded Medium Power Stations** and/or **Embedded** installations of direct current converters which do not form a **DC Converter Station** or **HVDC System** are connected, assuming a fault at that location, as follows:-

The data items listed under the following parts of PC.A.2.5.6:-

(a) (i), (ii), (iii), (iv), (v) and (vi);

and the data items shall be provided in accordance with the detailed provisions of PC.A.2.5.6(c) - (f).

PC.A.2.5.4.2 **Network Operators** shall provide the following data items in respect of each **Interface Point** within their **User System**:

(a) **Maximum Export Capacity**;

(b) **Maximum Import Capacity**; and,

(c) **Interface Point Target Voltage/Power Factor**

Network Operators shall alongside these parameters include details of any manual or automatic post fault actions to be taken by the owner / operator of the **Offshore Transmission System** connected to such **Interface Point** that are required by the **Network Operator**.

PC.A.2.5.5 Data from **Generators** (including **Generators** undertaking **OTSDUW** and those responsible for **DC Connected Power Park Modules**), **DC Converter Station** owners, **HVDC System Owners** and from **Network Operators** in respect of **Embedded Medium Power Stations** not subject to a **Bilateral Agreement** and **Embedded DC Converter Stations** not subject to a **Bilateral Agreement** and **Embedded HVDC Systems** within such **Network Operator's Systems**.

PC.A.2.5.5.1 For each **Generating Unit** (including **Synchronous Generating Units** forming part of a **Synchronous Power Generating Module**) with one or more associated **Unit Transformers**, the **Generator**, or the **Network Operator** in respect of **Embedded Medium Power Stations** not subject to a **Bilateral Agreement** and **Embedded DC Converter Stations** not subject to a **Bilateral Agreement** and **Embedded HVDC Systems** within such **Network Operator's System** is required to provide values for the contribution of the **Power Station Auxiliaries** (including **Auxiliary Gas Turbines** or **Auxiliary Diesel Engines**) to the fault current flowing through the **Unit Transformer(s)**.

The data items listed under the following parts of PC.A.2.5.6(a) should be provided:-

(i), (ii) and (v);

(iii) if the associated **Generating Unit** (including **Synchronous Generating Units** forming part of a **Synchronous Power Generating Module**) step-up transformer can supply zero phase sequence current from the **Generating Unit** side to the **National Electricity Transmission System**;

(iv) if the value is not 1.0 p.u;

and the data items shall be provided in accordance with the detailed provisions of PC.A.2.5.6(c) - (f), and with the following parts of this PC.A.2.5.5.

PC.A.2.5.5.2 Auxiliary motor short circuit current contribution and any **Auxiliary Gas Turbine Unit** contribution through the **Unit Transformers** must be represented as a combined short circuit current contribution at the **Generating Unit's** (including **Synchronous Generating Units** forming part of a **Synchronous Power Generating Module**) terminals, assuming a fault at that location.

PC.A.2.5.5.3 If the **Power Station** or **HVDC System** or **DC Converter Station** (or **OTSDUW Plant and Apparatus** which provides a fault infeed) has separate **Station Transformers**, data should be provided for the fault current contribution from each transformer at its high voltage terminals, assuming a fault at that location, as follows:-

The data items listed under the following parts of PC.A.2.5.6

- (a) (i), (ii), (iii), (iv), (v) and (vi);

and the data items shall be provided in accordance with the detailed provisions of PC.A.2.5.6(b) - (f).

- PC.A.2.5.5.4 Data for the fault infeeds through both **Unit Transformers** and **Station Transformers** shall be provided for the normal running arrangement when the maximum number of **Generating Units** (including **Synchronous Generating Units** forming part of a **Synchronous Power Generating Module**) are **Synchronised** to the **System** or when all the **DC Converters** at a **DC Converter Station** or **HVDC Converters** within an **HVDC System** are transferring **Rated MW** in either direction. Where there is an alternative running arrangement (or transfer in the case of a **DC Converter Station** or **HVDC System**) which can give a higher fault infeed through the **Station Transformers**, then a separate data submission representing this condition shall be made.
- PC.A.2.5.5.5 Unless the normal operating arrangement within the **Power Station** is to have the **Station** and **Unit Boards** interconnected within the **Power Station**, no account should be taken of the interconnection between the **Station Board** and the **Unit Board**.
- PC.A.2.5.5.6 Auxiliary motor short circuit current contribution and any auxiliary **DC Converter Station** contribution or **HVDC System** contribution through the **Station Transformers** must be represented as a combined short circuit current contribution through the **Station Transformers**.
- PC.A.2.5.5.7 Where a **Manufacturer's Data & Performance Report** exists in respect of the model of the **Power Park Unit**, the **User** may opt to reference the **Manufacturer's Data & Performance Report** as an alternative to the provision of data in accordance with this PC.A.2.5.5.7. For the avoidance of doubt, all other data provision pursuant to the Grid Code shall still be provided including a Single Line Diagram and those data pertaining thereto.

For each **Power Park Module** (including **DC Connected Power Park Modules**) and each type of **Power Park Unit** (eg. a Doubly Fed Induction Generator) (and any **OTSDUW Plant and Apparatus** which provides a fault infeed), including any **Auxiliaries**, positive, negative and zero sequence root mean square current values are to be provided of the contribution to the short circuit current flowing at:

- (i) the **Power Park Unit** terminals, or the **Common Collection Busbar** if an equivalent **Single Line Diagram** and associated data as described in PC.A.2.2.2 is provided, and
- (ii) the **Grid Entry Point** (and in case of **OTSUA, Transmission Interface Point**), or **User System Entry Point** if **Embedded**

for the following solid faults at the **Grid Entry Point** (and in case of **OTSUA, Interface Point**), or **User System Entry Point** if **Embedded**:

- (i) a symmetrical three phase short circuit
- (ii) a single phase to earth short circuit
- (iii) a phase to phase short circuit
- (iv) a two phase to earth short circuit

For a **Power Park Module** (including **DC Connected Power Park Modules**) in which one or more of the **Power Park Units** utilise a protective control such as a crowbar circuit, the data should indicate whether the protective control will act in each of the above cases and the effects of its action shall be included in the data. For any case in which the protective control will act, the data for the fault shall also be submitted for the limiting case in which the protective circuit will not act, which may involve the application of a non-solid fault, and the positive, negative and zero sequence retained voltages at;

- (i) the **Power Park Unit** terminals, or the **Common Collection Busbar** if an equivalent **Single Line Diagram** and associated data is provided and
- (ii) the **Grid Entry Point**, or **User System Entry Point** if **Embedded**

in this limiting case shall be provided.

For each fault for which data is submitted, the data items listed under the following parts of PC.A.2.5.6(a) shall be provided:-

(iv), (vii), (viii), (ix), (x);

In addition, if an equivalent **Single Line Diagram** has been provided the data items listed under the following parts of PC.A.2.5.6(a) shall be provided:-

(xi), (xii), (xiii);

In addition, for a **Power Park Module** (including **DC Connected Power Park Modules**) in which one or more of the **Power Park Units** utilise a protective control such as a crowbar circuit:-

the data items listed under the following parts of PC.A.2.5.6(a) shall be provided:-

(xiv), (xv);

All of the above data items shall be provided in accordance with the detailed provisions of PC.A.2.5.6(c), (d), (f).

Should actual data in respect of fault infeeds be unavailable at the time of the application for a **CUSC Contract** or **Embedded Development Agreement**, a limited subset of the data, representing the maximum fault infeed that may result from all of the plant types being considered, shall be submitted. This data will, as a minimum, represent the root mean square of the positive, negative and zero sequence components of the fault current for both single phase and three phase solid faults at the **Grid Entry Point** (or **User System Entry Point** if **Embedded**) at the time of fault application and 50ms following fault application. Actual data in respect of fault infeeds shall be submitted to **The Company** as soon as it is available, in line with PC.A.1.2

PC.A.2.5.6

Data Items

- (a) The following is the list of data utilised in this part of the **PC**. It also contains rules on the data which generally apply:-
- (i) Root mean square of the symmetrical three-phase short circuit current infeed at the instant of fault, (I_1);
 - (ii) Root mean square of the symmetrical three-phase short circuit current after the subtransient fault current contribution has substantially decayed, (I_1');
 - (iii) the zero sequence source resistance and reactance values of the **User's System** as seen from the node on the **Single Line Diagram** provided under PC.A.2.2.1 (or **Power Generating Module** or **Station Transformer** high voltage terminals or **Generating Unit** terminals or **DC Converter** terminals or **HVDC System** terminals, as appropriate) consistent with the infeed described in PC.A.2.5.1.(b);
 - (iv) root mean square of the pre-fault voltage at which the maximum fault currents were calculated;
 - (v) the positive sequence X/R ratio at the instant of fault;
 - (vi) the negative sequence resistance and reactance values of the **User's System** seen from the node on the **Single Line Diagram** provided under PC.A.2.2.1 (or **Power Generating Module** or **Station Transformer** high voltage terminals, or **Generating Unit** terminals or **DC Converter** terminals or **HVDC System** terminals as appropriate) if substantially different from the values of positive sequence resistance and reactance which would be derived from the data provided above;
 - (vii) A continuous trace and a table showing the root mean square of the positive, negative and zero sequence components of the short circuit current between zero and 140ms at 10ms intervals;

- (viii) The **Active Power** (or **Interface Point Capacity** being exported pre-fault by the **OTSDUW Plant and Apparatus**) being generated pre-fault by the **Power Park Module** (including **DC Connected Power Park Modules**) and by each type of **Power Park Unit**;
 - (ix) The reactive compensation shown explicitly on the **Single Line Diagram** that is switched in;
 - (x) The **Power Factor** of the **Power Park Module** (including **DC Connected Power Park Modules**) and of each **Power Park Unit** type;
 - (xi) The positive sequence X/R ratio of the equivalent at the **Common Collection Busbar** or **Interface Point** in the case of **OTSUA**;
 - (xii) The minimum zero sequence impedance of the equivalent seen from the **Common Collection Busbar** or **Interface Point** in the case of **OTSUA**;
 - (xiii) The number of **Power Park Units** represented in the equivalent **Power Park Unit**;
 - (xiv) The additional rotor resistance and reactance (if any) that is applied to the **Power Park Unit** under a fault condition;
 - (xv) A continuous trace and a table showing the root mean square of the positive, negative and zero sequence components of the retained voltage at the fault point and **Power Park Unit** terminals, or the **Common Collection Busbar** if an equivalent **Single Line Diagram** and associated data as described in PC.A.2.2.2 is provided or **Interface Point** in the case of **OTSUA**, representing the limiting case, which may involve the application of a non-solid fault, required to not cause operation of the protective control;
- (b) In considering this data, unless the **User** notifies **The Company** accordingly at the time of data submission, **The Company** will assume that the time constant of decay of the subtransient fault current corresponding to the change from I_1'' to I_1' , (T'') is not significantly different from 40ms. If that assumption is not correct in relation to an item of data, the **User** must inform **The Company** at the time of submission of the data.
 - (c) The value for the X/R ratio must reflect the rate of decay of the d.c. component that may be present in the fault current and hence that of the sources of the initial fault current. All shunt elements and loads must therefore be deleted from any system model before the X/R ratio is calculated.
 - (d) In producing the data, the **User** may use "time step analysis" or "fixed-point-in-time analysis" with different impedances.
 - (e) If a fixed-point-in-time analysis with different impedances method is used, then in relation to the data submitted under (a) (i) above, the data will be required for "time zero" to give I_1'' . The figure of 120ms is consistent with a decay time constant T'' of 40ms, and if that figure is different, then the figure of 120ms must be changed accordingly.
 - (f) Where a "time step analysis" is carried out, the X/R ratio may be calculated directly from the rate of decay of the d.c. component. The X/R ratio is not that given by the phase angle of the fault current if this is based on a system calculation with shunt loads, but from the Thévenin equivalent of the system impedance at the instant of fault with all non-source shunts removed.

PC.A.3 POWER GENERATING MODULE, GENERATING UNIT, HVDC SYSTEM AND DC CONVERTER DATA

PC.A.3.1 Introduction

Directly Connected

PC.A.3.1.1 Each **Generator, HVDC System Owner and DC Converter Station** owner (and a **User** where the **OTSUA** includes an **OTSDUW DC Converter**) with an existing, or proposed, **Power Station or DC Converter Station or HVDC System** directly connected, or to be directly connected, to the **National Electricity Transmission System** (or in the case of **OTSUA**, the **Interface Point**), shall provide **The Company** with data relating to that **Power Station or DC Converter Station or HVDC System**, both current and forecast, as specified in PC.A.3.2 to PC.A.3.4.

Embedded

- PC.A.3.1.2 (a) Each **Generator, HVDC System Owner and DC Converter Station** owner in respect of its existing, and/or proposed, **Embedded Large Power Stations** and/or **Embedded HVDC Systems** and/or **Embedded DC Converter Stations** and/or its **Embedded Medium Power Stations** subject to a **Bilateral Agreement** and each **Network Operator** in respect of its **Embedded Medium Power Stations** not subject to a **Bilateral Agreement** and/or **Embedded DC Converter Stations** not subject to a **Bilateral Agreement** and/or **Embedded HVDC Systems** not subject to a **Bilateral Agreement** within such **Network Operator's System** in each case connected to the **Subtransmission System**, shall provide **The Company** with data relating to that **Power Station or DC Converter Station or HVC System**, both current and forecast, as specified in PC.A.3.2 to PC.A.3.4.
- (b) No data need be supplied in relation to any **Small Power Station** or any **Medium Power Station** or installations of direct current converters which do not form a **DC Converter Station or HVDC System**, connected at a voltage level below the voltage level of the **Subtransmission System** except:-
- (i) in connection with an application for, or under, a **CUSC Contract**, or
 - (ii) unless specifically requested by **The Company** under PC.A.3.1.4.
- PC.A.3.1.3 (a) Each **Network Operator** shall provide **The Company** with the data specified in PC.A.3.2.2(c)(i) and (ii) and PC.A.3.2.2(i).
- (b) **Network Operators** need not submit planning data in respect of an **Embedded Small Power Station** unless required to do so under PC.A.1.2(b) or unless specifically requested under PC.A.3.1.4 below, in which case they will supply such data.
- PC.A.3.1.4 (a) PC.A.4.2.4(b) and PC.A.4.3.2(a) explain that the forecast **Demand** submitted by each **Network Operator** must be net of the output of all **Small Power Stations** and **Medium Power Stations** and **Customer Generating Plant** and all installations of direct current converters which do not form a **DC Converter Station or HVDC System**, **Embedded** within that **Network Operator's System**. The **Network Operator** must inform **The Company** of:
- (i) the number of such **Embedded Power Stations** and such **Embedded** installations of direct current converters (including the number of **Generating Units** or **Power Park Modules** (including **DC Connected Power Park Modules**) or **DC Converters** or **HVDC Systems**) together with their summated capacity; and
 - (ii) beginning from the 2015 Week 24 data submission, for each **Embedded Small Power Station** of registered capacity (as defined in the **Distribution Code**) of 1MW or more:
 - 1. A reference which is unique to each **Network Operator**;
 - 2. The production type as follows:
 - a) In the case of an **Embedded Small Power Station** first connected on or after 1 January 2015, the production type must be selected from the list below:
 - Biomass;
 - Fossil brown coal/lignite;
 - Fossil coal-derived gas;

- Fossil gas;
- Fossil hard coal;
- Fossil oil;
- Fossil oil shale;
- Fossil peat;
- Geothermal;
- Hydro pumped storage;
- Hydro run-of-river and poundage;
- Hydro water reservoir;
- Marine;
- Nuclear;
- Other renewable;
- Solar;
- Waste;
- Wind offshore;
- Wind onshore; or
- Other;

together with a statement as to whether the generation forms part of a CHP scheme;

(iii) beginning from the 2019 Week 24 data submission, for **Embedded Power Stations** with **Registered Capacity** of less than 1MW, their best estimate of the aggregated capacity of all such **Embedded Power Stations** per production type as defined in the list in PC.A.3.1.4 (a)(ii)(2)(a).

b) In the case of an **Embedded Small Power Station** first connected to the **Users' System** before 1 January 2015, as an alternative to the production type, the technology type(s) used, selected from the list set out at paragraph 2.23 in Version 2 of the Regulatory Instructions and Guidance relating to the distributed generation incentive, innovation funding incentive and registered power zones, reference 83/07, published by Ofgem in April 2007;

c) In the case of an **Embedded Small Power Station** comprising **Electricity Storage Modules** or **Electricity Storage Units** first connected the **User's System** on or after May 20 2020, the storage type must be selected from the list below:

- Chemical
 - Ammonia
 - Hydrogen
 - Synthetic Fuels
 - Drop-in Fuels
 - Methanol
 - Synthetic Natural Gas
- Electrical
 - Supercapacitors
 - Superconducting Magnetic ES (SMES)
- Mechanical
 - Adiabatic Compressed Air
 - Diabatic Compressed Air
 - Liquid Air Energy Storage
- Pumped Hydro
- Flywheels

- Thermal
 - Latent Heat Storage
 - Thermochemical Storage
 - Sensible Heat Storage
- Electrochemical
 - Classic Batteries
 - Lead Acid
 - Lithium Polymer (Li-Polymer)
 - Metal Air
 - Nickle Cadmium (Ni-Cd)
 - Sodium Nickle Chloride (Na-NiCl₂)
 - Lithium Ion (Li-ion)
 - Sodium Ion (Na-ion)
 - Lithium Sulphur (Li-S)
 - Sodium Sulphur(Na-S)
 - Nickle –Metal Hydride (Ni-MH)
 - Flow Batteries
 - Vanadium Red-Oxide
 - Zinc – Iron (Zn –Fe)
 - Zinc – Bromine (Zn –Br)
 - Other

together with a statement as to whether the storage forms part of a CHP scheme. Where this information is not held by the **Network Operator** it should provide its best view of the type of storage technology.

3. The registered capacity (as defined in the **Distribution Code**) in MW;
 4. The lowest voltage level node that is specified on the most up-to-date **Single Line Diagram** to which it connects or where it will export most of its power;
 5. Where it generates electricity from wind or PV, the geographical location using either latitude or longitude or grid reference coordinates of the primary or higher voltage substation to which it connects;
 6. The reactive power and voltage control mode, including the voltage set-point and reactive range, where it operates in voltage control mode, or the target **Power Factor**, where it operates in **Power Factor** mode;
 7. Details of the types of loss of mains **Protection** in place and their relay settings which in the case of **Embedded Small Power Stations** first connected to the **Users' System** before 1 January 2015 shall be provided on a reasonable endeavours basis.
- (b) On receipt of this data, the **Network Operator** or **Generator** (if the data relates to **Power Stations** referred to in PC.A.3.1.2) may be further required, at **The Company's** reasonable discretion, to provide details of **Embedded Small Power Stations** and **Embedded Medium Power Stations** and **Customer Generating Plant** and **Embedded** installations of direct current converters which do not form a **DC Converter Station** or **HVDC System**, both current and forecast, as specified in PC.A.3.2 to PC.A.3.4. Such requirement would arise where **The Company** reasonably considers that the collective effect of a number of such **Embedded Power Stations** and **Customer Generating Plants** and **Embedded** installations of direct current converters may have a significant system effect on the **National Electricity Transmission System**.

Busbar Arrangements

PC.A.3.1.5 Where **Generating Units**, which term includes **CCGT Units** and **Synchronous Generating Units** within a **Synchronous Power Generating Module** and **Power Park Modules** (including **DC Connected Power Park Modules**), and **DC Converters**, and **HVDC Systems** are connected to the **National Electricity Transmission System** via a busbar arrangement which is or is expected to be operated in separate sections, the section of busbar to which each **Generating Unit** (including **Synchronous Generating Units** within a **Synchronous Power Generating Module**), **DC Converter**, **HVDC System** or **Power Park Module** (including **DC Connected Power Park Modules**) is connected is to be identified in the submission.

PC.A.3.2 Output Data

PC.A.3.2.1 (a) **Large Power Stations and Gensets**

Data items PC.A.3.2.2 (a), (b), (c), (d), (e), (f) and (h) are required with respect to each **Large Power Station** and each **Generating Unit** (including **Synchronous Generating Units** within a **Synchronous Power Generating Module**) and **Power Park Module** (including **DC Connected Power Park Modules**) of each **Large Power Station** and for each **Genset** (although (a) is not required for **CCGT Units** and (b), (d) and (e) are not normally required for **CCGT Units** and (a), (b), (c), (d), (e), (f) and (h) are not normally required for **Power Park Units**).

(b) **Embedded Small Power Stations and Embedded Medium Power Stations**

Data item PC.A.3.2.2 (a) is required with respect to each **Embedded Small Power Station** and **Embedded Medium Power Station** and each **Generating Unit** (including **Synchronous Generating Units** within a **Synchronous Power Generating Module**) and **Power Park Module** (including **DC Connected Power Park Modules**) of each **Embedded Small Power Station** and **Embedded Medium Power Station** (although (a) is not required for **CCGT Units** or **Power Park Units**). In addition, data item PC.A.3.2.2(c)(ii) is required with respect to each **Embedded Medium Power Station**.

(c) **CCGT Units/Modules**

- (i) Data item PC.A.3.2.2 (g) is required with respect to each **CCGT Unit**;
- (ii) data item PC.A.3.2.2 (a) is required with respect to each **CCGT Module**; and
- (iii) data items PC.A.3.2.2 (b), (c), (d) and (e) are required with respect to each **CCGT Module** unless **The Company** informs the relevant **User** in advance of the submission that it needs the data items with respect to each **CCGT Unit** for particular studies, in which case it must be supplied on a **CCGT Unit** basis.

Where any definition utilised or referred to in relation to any of the data items does not reflect **CCGT Units**, such definition shall be deemed to relate to **CCGT Units** for the purposes of these data items. Any **Schedule** in the **DRC** which refers to these data items shall be interpreted to incorporate the **CCGT Unit** basis where appropriate;

(d) **Cascade Hydro Schemes**

Data item PC.A.3.2.2(i) is required with respect to each **Cascade Hydro Scheme**.

(e) **Power Park Units/Modules**

Data items PC.A.3.2.2 (k) is required with respect to each **Power Park Module** (including **DC Connected Power Park Modules**).

(f) **DC Converters and HVDC Systems**

Data items PC.A.3.2.2 (a), (b), (c), (d) (e) (f) (h) and (i) are required with respect of each **HVDC System**, each **DC Converter Station** and each **DC Converter** in each **DC Converter Station**. For installations of direct current converters which do not form a **DC Converter Station** only data item PC.A.3.2.2.(a) is required.

Items (a), (b), (d), (e), (f), (g), (h), (i), (j) and (k) are to be supplied by each **Generator, DC Converter Station owner, HVDC System Owner or Network Operator** (as the case may be) in accordance with PC.A.3.1.1, PC.A.3.1.2, PC.A.3.1.3 and PC.A.3.1.4. Items (a), and (f)(iv) are to be supplied (as applicable) by a **User** in the case of **OTSUA** which includes an **OTSDUW DC Converter**. Item (c) is to be supplied by each **Network Operator** in all cases:-

- (a) **Registered Capacity (MW), Maximum Capacity** (in the case of **Power Generating Modules** in addition to **Registered Capacity** on a **Power Station** basis) or **Interface Point Capacity** in the case of **OTSDUW**;
- (b) **Output Usable (MW)** on a monthly basis;
- (c) (i) **System Constrained Capacity (MW)** ie. any constraint placed on the capacity of the **Embedded Generating Unit** (including a **Synchronous Generating Unit** within a **Synchronous Power Generating Module**), **Embedded Power Park Module** (including **DC Connected Power Park Modules**) an **Offshore Transmission System** at an **Interface Point, Embedded HVDC System** or **DC Converter** at an **Embedded DC Converter Station** due to the **Network Operator's System** in which it is **Embedded**. Where **Generating Units** (which term includes **CCGT Units** and **Synchronous Generating Units** within a **Synchronous Power Generating Module**), **Power Park Modules** (including **DC Connected Power Park Modules**), **Offshore Transmission Systems** at an **Interface Point, HVDC Systems** or **DC Converters** are connected to a **Network Operator's User System** via a busbar arrangement which is or is expected to be operated in separate sections, details of busbar running arrangements and connected circuits at the substation to which the **Embedded Generating Unit** (including **Synchronous Generating Units** within an **Embedded Synchronous Power Generating Module**), **Embedded Power Park Module** (including **DC Connected Power Park Modules**), **Offshore Transmission System** at an **Interface Point, or Embedded HVDC System** or **Embedded DC Converter** is connected sufficient for **The Company** to determine where the MW generated by each **Generating Unit** (including **Synchronous Generating Units** within a **Synchronous Power Generating Module**), **Power Park Module** (including **DC Connected Power Park Modules**), **HVDC System** or **DC Converter** at that **Power Station** or **DC Converter Station** or **Offshore Transmission System** at an **Interface Point** would appear onto the **National Electricity Transmission System**;
- (ii) any **Reactive Despatch Network Restrictions**;
- (d) **Minimum Generation (MW)**, and in the case of **Power Generating Modules** only **Minimum Stable Operating Level (MW)** and **Minimum Regulating Level**;
- (e) MW obtainable from **Generating Units** (including **Synchronous Generating Units** within a **Synchronous Power Generating Module**), **Power Park Modules** (including **DC Connected Power Park Modules**), **HVDC Systems** or **DC Converters** at a **DC Converter Station** in excess of **Registered Capacity** or **Maximum Capacity**;
- (f) **Generator Performance Chart**:
 - (i) **GB Code User(s)** in respect of **Generating Units** shall provide a **Generator Performance Chart** and **EU Code Users** in respect of **Power Generating Modules** shall provide a **Power Generating Module Performance Chart** and a **Synchronous Generating Unit Performance Chart**.
 - (ii) at the electrical point of connection to the **Offshore Transmission System** for an **Offshore Synchronous Generating Unit** and **Offshore Synchronous Power Generating Module**.
 - (iii) at the electrical point of connection to the **National Electricity Transmission System** (or **User System** if **Embedded**) for a **Non Synchronous Generating Unit** (excluding a **Power Park Unit**), **Power Park Module** (including **DC Connected Power Park Modules**), **HVDC System** and **DC Converter** at a **DC Converter Station**;
 - (iv) at the **Interface Point** for **OTSDUW Plant and Apparatus**

Where a **Reactive Despatch Network Restriction** applies, its existence and details should be highlighted on the **Generator Performance Chart**, in sufficient detail for **The Company** to determine the nature of the restriction.

- (g) a list of the **CCGT Units** within a **CCGT Module**, identifying each **CCGT Unit**, and the **CCGT Module** of which it forms part, unambiguously. In the case of a **Range CCGT Module**, details of the possible configurations should also be submitted, together:-
 - (i) (in the case of a **Range CCGT Module** connected to the **National Electricity Transmission System**) with details of the single **Grid Entry Point** (there can only be one) at which power is provided from the **Range CCGT Module**;
 - (ii) (in the case of an **Embedded Range CCGT Module**) with details of the single **User System Entry Point** (there can only be one) at which power is provided from the **Range CCGT Module**;

Provided that, nothing in this sub-paragraph (g) shall prevent the busbar at the relevant point being operated in separate sections;

- (h) expected running regime(s) at each **Power Station, HVDC System** or **DC Converter Station** and type of **Power Generating Module** or **Generating Unit** (as applicable), eg. **Steam Unit, Gas Turbine Unit, Combined Cycle Gas Turbine Unit, Power Park Module** (including **DC Connected Power Park Modules**), **Novel Units** (specify by type), etc;
- (i) a list of **Power Stations** and **Generating Units** within a **Cascade Hydro Scheme**, identifying each **Generating Unit** (including **Synchronous Generating Units** within a **Synchronous Power Generating Module**) and **Power Station** and the **Cascade Hydro Scheme** of which each form part unambiguously. In addition:
 - (i) details of the **Grid Entry Point** at which **Active Power** is provided, or if **Embedded** the **Grid Supply Point(s)** within which the **Generating Unit** (including **Synchronous Generating Units** within a **Synchronous Power Generating Module**) is connected;
 - (ii) where the **Active Power** output of a **Generating Unit** is split between more than one **Grid Supply Points** the percentage that would appear under normal and outage conditions at each **Grid Supply Point**.
- (j) The following additional items are only applicable to **DC Converters** at **DC Converter Stations** and **HVDC Systems**.

Registered Import Capacity (MW);

Import Usable (MW) on a monthly basis;

Minimum Import Capacity (MW);

MW that may be absorbed by a **DC Converter** or **HVDC System** in excess of **Registered Import Capacity** and **Maximum HVDC Active Power Transmission Capacity** under importing conditions and the duration for which this is available;

- (k) the number and types of the **Power Park Units** within a **Power Park Module** (including **DC Connected Power Park Modules**), identifying each **Power Park Unit**, the **Power Park Module** of which it forms part and identifying the **BM Unit** of which each **Power Park Module** forms part, unambiguously. In the case of a **Power Station** directly connected to the **National Electricity Transmission System** with multiple **Power Park Modules** (including **DC Connected Power Park Modules**) where **Power Park Units** can be selected to run in different **Power Park Modules** and/or **Power Park Modules** can be selected to run in different **BM Units**, details of the possible configurations should also be submitted. In addition, for **Offshore Power Park Modules** (including **DC Connected Power Park Modules**), the number of **Offshore Power Park Strings** that are aggregated into one **Offshore Power Park Module** should also be submitted.

- (l) the number and types of the **Synchronous Generating Units** within a **Synchronous Power Generating Module**, identifying each **Synchronous Generating Unit**, the **Synchronous Power Generating Module** of which it forms part and identifying the **BM Unit** of which each **Synchronous Power Generating Module** forms part, unambiguously. In the case of a **Power Station** directly connected to the **National Electricity Transmission System** with multiple **Synchronous Power Generating Modules** where **Synchronous Generating Units** can be selected to run in different **Synchronous Power Generating Modules** and/or **Synchronous Power Generating Modules** can be selected to run in different **BM Units**, details of the possible configurations should also be submitted.

PC.A.3.2.3 Notwithstanding any other provision of this PC, the **CCGT Units** within a **CCGT Module**, details of which are required under paragraph (g) of PC.A.3.2.2, can only be amended in accordance with the following provisions:-

- (a) if the **CCGT Module** is a **Normal CCGT Module**, the **CCGT Units** within that **CCGT Module** can only be amended such that the **CCGT Module** comprises different **CCGT Units** if **The Company** gives its prior consent in writing. Notice of the wish to amend the **CCGT Units** within such a **CCGT Module** must be given at least 6 months before it is wished for the amendment to take effect;
- (b) if the **CCGT Module** is a **Range CCGT Module**, the **CCGT Units** within that **CCGT Module** and the **Grid Entry Point** at which the power is provided can only be amended as described in BC1.A1.6.4.

PC.A.3.2.4 Notwithstanding any other provision of this PC, the **Power Park Units** within a **Power Park Module** (including **DC Connected Power Park Modules**), and the **Power Park Modules** (including **DC Connected Power Park Modules**) within a **BM Unit**, details of which are required under paragraph (k) of PC.A.3.2.2, can only be amended in accordance with the following provisions:-

- (a) if the **Power Park Units** within that **Power Park Module** can only be amended such that the **Power Park Module** comprises different **Power Park Units** due to repair/replacement of individual **Power Park Units** if **The Company** gives its prior consent in writing. Notice of the wish to amend a **Power Park Unit** within such a **Power Park Module** (including **DC Connected Power Park Modules**) must be given at least 4 weeks before it is wished for the amendment to take effect;
- (b) if the **Power Park Units** within that **Power Park Module** (including **DC Connected Power Park Modules**) and/or the **Power Park Modules** (including **DC Connected Power Park Modules**) within that **BM Unit** can be selected to run in different **Power Park Modules** and/or **BM Units** as an alternative operational running arrangement the **Power Park Units** within the **Power Park Module**, the **BM Unit** of which each **Power Park Module** forms part, and the **Grid Entry Point** at which the power is provided can only be amended as described in BC1.A.1.8.4.

PC.A.3.2.5 Notwithstanding any other provision of this PC, the **Synchronous Generating Units** within a **Synchronous Power Generating Module**, and the **Synchronous Power Generating Modules** within a **BM Unit**, details of which are required under paragraph (l) of PC.A.3.2.2, can only be amended in accordance with the following provisions:-

- (a) if the **Synchronous Generating Units** within that **Synchronous Power Generating Module** can only be amended such that the **Synchronous Power Generating Module** comprises different **Synchronous Generating Units** due to repair/replacement of individual **Synchronous Generating Units** if **The Company** gives its prior consent in writing. Notice of the wish to amend a **Synchronous Generating Unit** within such a **Synchronous Power Generating Module** must be given at least 4 weeks before it is wished for the amendment to take effect;

- (b) if the **Synchronous Generating Units** within that **Synchronous Power Generating Module** and/or the **Synchronous Power Generating Modules** within that **BM Unit** can be selected to run in different **Synchronous Power Generating Modules** and/or **BM Units** as an alternative operational running arrangement the **Synchronous Generating Units** within the **Synchronous Power Generating Module**, the **BM Unit** of which each **Synchronous Power Generating Module** forms part, and the **Grid Entry Point** at which the power is provided can only be amended as described in BC1.A.1.9.4(c). The requirements of PC.A.3.2.5 need not be satisfied if **Generators** have already submitted data in respect of PC.A.3.2.3, PC.A.3.2.4 and PC.A.3.2.5 for the same **Power Generating Module**.

PC.A.3.3. Rated Parameters Data

PC.A.3.3.1 The following information is required to facilitate an early assessment, by **The Company**, of the need for more detailed studies;

- (a) for all **Generating Units** (excluding **Power Park Units**) and **Power Park Modules** (including **DC Connected Power Park Modules**):

Rated MVA

Rated MW;

- (b) for each **Synchronous Generating Unit** (including **Synchronous Generating Units** within a **Synchronous Power Generating Module**):

Short circuit ratio

Direct axis transient reactance;

Inertia constant (for whole machine), MWsecs/MVA;

- (c) for each **Synchronous Generating Unit** step-up transformer (including the step up transformer of a **Synchronous Generating Unit** within a **Synchronous Power Generating Module**):

Rated MVA

Positive sequence reactance (at max, min and nominal tap);

- (d) for each **DC Converter** at a **DC Converter Station, HVDC System, DC Converter** connecting a **Power Park Module** (including a **DC Connected Power Park Module**) and **Transmission DC Converter** (forming part of an **OTSUA**).

DC Converter or **HVDC Converter** type (e.g. current/voltage sourced)

Rated MW per pole for import and export

Number of poles and pole arrangement

Rated DC voltage/pole (kV)

Return path arrangement

Remote AC connection arrangement (excluding **OTSDUW DC Converters**)

Maximum HVDC Active Power Transmission Capacity

Minimum Active Power Transmission Capacity

- (e) for each type of **Power Park Unit** in a **Power Park Module** not connected to the **Total System** by a **DC Converter** or **HVDC System**:

Rated MVA

Rated MW

Rated terminal voltage

Inertia constant, (MWsec/MVA)

Additionally, for **Power Park Units** that are squirrel-cage or doubly-fed induction

generators driven by wind turbines:

Stator reactance.

Magnetising reactance.

Rotor resistance (at rated running)

Rotor reactance (at rated running)

The generator rotor speed range (minimum and maximum speeds in RPM) (for doubly-fed induction generators only)

Converter MVA rating (for doubly-fed induction generators only)

For a **Power Park Unit** consisting of a synchronous machine in combination with a back-to-back **DC Converter** or **HVDC Converter**, or for a **Power Park Unit** not driven by a wind turbine, the data to be supplied shall be agreed with **The Company** in accordance with PC.A.7.

This information should only be given in the data supplied in accordance with PC.4.4 and PC.4.5.

PC.A.3.4 General Generating Unit, Power Park Module (including **DC Connected Power Park Modules**), Power Generating Module, HVDC System and DC Converter Data

PC.A.3.4.1 The point of connection to the **National Electricity Transmission System** or the **Total System**, if other than to the **National Electricity Transmission System**, in terms of geographical and electrical location and system voltage is also required.

PC.A.3.4.2 (a) Type of **Generating Unit** (ie **Synchronous Power Generating Unit** within a **Power Generating Module, Synchronous Generating Unit, Non-Synchronous Generating Unit, DC Converter, Power Park Module (including DC Connected Power Park Modules)** or **HVDC System**).

(b) In the case of a **Synchronous Generating Unit** (including **Synchronous Generating Units** within a **Synchronous Power Generating Module**) details of the **Exciter** category, for example whether it is a rotating **Exciter** or a static **Exciter** or in the case of a **Non-Synchronous Generating Unit** the voltage control system.

(c) Whether a **Power System Stabiliser** is fitted.

PC.A.3.4.3 Each **Generator** shall supply **The Company** with the production type(s) used as the primary source of power in respect of each **Generating Unit** (including **Synchronous Generating Units** within a **Synchronous Power Generating Module**), selected from the list set out below:

- Biomass
- Fossil brown coal/lignite
- Fossil coal-derived gas
- Fossil gas
- Fossil hard coal
- Fossil oil
- Fossil oil shale
- Fossil peat
- Geothermal
- Hydro pumped storage
- Hydro run-of-river and poundage
- Hydro water reservoir
- Marine
- Nuclear

- Other renewable
- Solar
- Waste
- Wind offshore
- Wind onshore
- Other

PC.A.3.4.4 In the case of an **Electricity Storage Module** or **Electricity Storage Unit**, each **Generator** shall supply **The Company** with the production type(s) used as the primary **Electricity Storage** source (including **Synchronous Electricity Storage Units** within a **Synchronous Electricity Storage Module**), selected from the list set out below:

- Chemical
 - Ammonia
 - Hydrogen
 - Synthetic Fuels
 - Drop-in Fuels
 - Methanol
 - Synthetic Natural Gas
- Electrical
 - Supercapacitors
 - Superconducting Magnetic ES (SMES)
- Mechanical
 - Adiabatic Compressed Air
 - Diabatic Compressed Air
 - Liquid Air Energy Storage
 - Pumped Hydro
 - Flywheels
- Thermal
 - Latent Heat Storage
 - Thermochemical Storage
 - Sensible Heat Storage
- Electrochemical
 - Classic Batteries
 - Lead Acid
 - Lithium Polymer (Li-Polymer)
 - Metal Air
 - Nickle Cadmium (Ni-Cd)
 - Sodium Nickle Chloride (Na-NiCl₂)
 - Lithium Ion (Li-ion)
 - Sodium Ion (Na-ion)
 - Lithium Sulphur (Li-S)
 - Sodium Sulphur(Na-S)
 - Nickle –Metal Hydride (Ni-MH)
 - Flow Batteries
 - Vanadium Red-Oxide
 - Zinc – Iron (Zn –Fe)
 - Zinc – Bromine (Zn –Br)
 - Other

PC.A.4 DEMAND AND ACTIVE ENERGY DATA

PC.A.4.1 Introduction

PC.A.4.1.1 Each **User** directly connected to the **National Electricity Transmission System** with **Demand** shall provide **The Company** with the **Demand** data, historic, current and forecast, as specified in PC.A.4.2 and PC.A.4.3. Paragraphs PC.A.4.1.2 and PC.A.4.1.3 apply equally to **Active Energy** requirements as to **Demand** unless the context otherwise requires.

- PC.A.4.1.2 Data will need to be supplied by:
- (a) each **Network Operator**, in relation to **Demand** and **Active Energy** requirements on its **User System**;
 - (b) each **Non-Embedded Customer, Pumped Storage Generators** (with respect to Pumping **Demand**) and **Generators** in relation to **Electricity Storage Modules** in relation to their **Demand** and **Active Energy** requirements.
 - (c) each **DC Converter Station** owner or **HVDC System Owner** in relation to **Demand** and **Active Energy** transferred (imported) to its **DC Converter Station** or **HVDC System**.
 - (d) each **OTSDUW DC Converter** in relation to the Demand at each **Interface Point** and **Connection Point**.

Demand of **Power Stations** directly connected to the **National Electricity Transmission System** is to be supplied by the **Generator** under PC.A.5.2.

PC.A.4.1.3 References in this **PC** to data being supplied on a half hourly basis refer to it being supplied for each period of 30 minutes ending on the hour or half-hour in each hour.

PC.A.4.1.4 **Access Periods and Access Groups**

PC.A.4.1.4.1 Each **Connection Point** must belong to one, and only one, **Access Group**.

PC.A.4.1.4.2 Each **Transmission Interface Circuit** must have an **Access Period**.

PC.A.4.1.4.3 The **Access Period** shall

- (a) normally be a minimum of 8 continuous weeks and can occur in any one of three maintenance years during the period from calendar week 13 to calendar week 43 (inclusive) in each year; or,
- (b) exceptionally and provided that agreement is reached between **The Company** and the relevant **User(s)**, such agreement to be sought in accordance with PC.7, the **Access Period** may be of a period not less than 4 continuous weeks and can occur in any one of three maintenance years during the period from calendar week 10 to calendar week 43 (inclusive) in each year.

PC.A.4.1.4.4 **The Company** shall submit in writing no later than calendar week 6 in each year:

- (a) the calendar weeks defining the proposed start and finish of each **Access Period** for each **Transmission Interface Circuit**; and
- (b) the **Connection Points** in each **Access Group**.

The submission by **The Company** under PC.A.4.1.4.4 (a) above shall commence in 2010 and shall then continue each year thereafter. The submission by **The Company** under PC.A.4.1.4.4 (b) shall commence in 2009 and then continue each year thereafter.

PC.A.4.1.4.5 It is permitted for **Access Periods** to overlap in the same **Access Group** and in the same maintenance year. However, where possible **Access Periods** will be sought by **The Company** that do not overlap with any other **Access Period** within that **Access Group** for each maintenance year. Where it is not possible to avoid overlapping **Access Periods**, **The Company** will indicate to **Users** by calendar week 6 its initial view of which **Transmission Interface Circuits** will need to be considered out of service concurrently for the purpose of assessing compliance to **Licence Standards**. The obligation on **The Company** to indicate which **Transmission Interface Circuits** will need to be considered out of service concurrently for the purpose of assessing compliance to **Licence Standards** shall commence in 2010 and shall continue each year thereafter.

PC.A.4.1.4.6 Following the submission(s) by **The Company** by week 6 in each year and where required by either party, both **The Company** and the relevant **User(s)** shall use their reasonable endeavours to agree the appropriate **Access Group(s)** and **Access Period** for each **Transmission Interface Circuit** prior to week 17 in each year. The requirement on **The Company** and the relevant **User(s)** to agree, shall commence in respect of **Access Groups** only in 2010. This paragraph PC.A.4.1.4.6 shall apply in its entirety in 2011 and shall then continue each year thereafter.

PC.A.4.1.4.7 In exceptional circumstances, and with the agreement of all parties concerned, where a **Connection Point** is specified for the purpose of the **Planning Code** as electrically independent **Subtransmission Systems**, then data submissions can be on the basis of two (or more) individual **Connection Points**.

PC.A.4.2 User's User System Demand (Active Power) and Active Energy Data

PC.A.4.2.1 Forecast daily **Demand (Active Power)** profiles, as specified in (a), (b) and (c) below, in respect of each of the **User's User Systems** (each summated over all **Grid Supply Points** in each **User System**) are required for:

- (a) peak day on each of the **User's User Systems** (as determined by the **User**) giving the numerical value of the maximum **Demand (Active Power)** that in the **Users'** opinion could reasonably be imposed on the **National Electricity Transmission System**;
- (b) day of peak **National Electricity Transmission System Demand (Active Power)** as notified by **The Company** pursuant to PC.A.4.2.2;
- (c) day of minimum **National Electricity Transmission System Demand (Active Power)** as notified by **The Company** pursuant to PC.A.4.2.2.

In addition, the total **Demand (Active Power)** in respect of the time of peak **National Electricity Transmission System Demand** in the preceding **Financial Year** in respect of each of the **User's User Systems** (each summated over all **Grid Supply Points** in each **User System**) both outturn and weather corrected shall be supplied.

PC.A.4.2.2 No later than calendar week 17 each year, **The Company** shall notify each **Network Operator** and **Non-Embedded Customer** in writing of the following, for the current **Financial Year** and for each of the following seven **Financial Years**, which will, until replaced by the following year's notification, be regarded as the relevant specified days and times under PC.A.4.2.1:

- (a) the date and time of the annual peak of the **National Electricity Transmission System Demand**;
- (b) the date and time of the annual minimum of the **National Electricity Transmission System Demand**;
- (c) the relevant **Access Period** for each **Transmission Interface Circuit**; and,
- (d) concurrent **Access Periods** of two or more **Transmission Interface Circuits** (if any) that are situated in the same **Access Group**.

The submissions by **The Company** made under PC.A.4.2.1 (c) and PC.A.4.2.1 (d) above shall commence in 2010 and shall then continue in respect of each year thereafter.

PC.A.4.2.3 The total **Active Energy** used on each of the **Network Operators'** or **Non-Embedded Customers' User Systems** (each summated over all **Grid Supply Points** in each **User System**) in the preceding **Financial Year**, both outturn and weather corrected, together with a prediction for the current financial year, is required. Each **Active Energy** submission shall be subdivided into the following categories of **Customer** tariff:

- LV1
- LV2
- LV3
- HV
- EHV
- Traction
- Lighting

In addition, the total **User System** losses and the **Active Energy** provided by **Embedded Small Power Stations** and **Embedded Medium Power Stations** shall be supplied.

PC.A.4.2.4 All forecast **Demand (Active Power)** and **Active Energy** specified in PC.A.4.2.1 and PC.A.4.2.3 shall:

- (a) in the case of PC.A.4.2.1(a), (b) and (c), be such that the profiles comprise average **Active Power** levels in 'MW' for each time marked half hour throughout the day;
- (b) in the case of PC.A.4.2.1(a), (b) and (c), be that remaining after any deductions reasonably considered appropriate by the **User** to take account of the output profile of all **Embedded Small Power Stations** and **Embedded Medium Power Stations** and **Customer Generating Plant** and imports across **Embedded External Interconnections** including imports across **Embedded** installations of direct current converters which do not form a **DC Converter Station** or **HVDC System** and **Embedded DC Converter Stations** and **Embedded HVDC Systems** with a **Registered Capacity** or **HVDC Active Power Transmission Capacity** of less than 100MW;
- (c) be based upon **Annual ACS Conditions** for times that occur during week 44 through to week 12 (inclusive) and based on **Average Conditions** for weeks 13 to 43 (inclusive).

PC.A.4.3 Connection Point Demand (Active and Reactive Power)

PC.A.4.3.1 Forecast **Demand (Active Power)** and **Power Factor** (values of the **Power Factor** at maximum and minimum continuous excitation may be given instead where more than 95% of the total **Demand** at a **Connection Point** is taken by synchronous motors) to be met at each **Connection Point** within each **Access Group** is required for:

- (a) the time of the maximum **Demand (Active Power)** at the **Connection Point** (as determined by the **User**) that in the **User's** opinion could reasonably be imposed on the **National Electricity Transmission System**;
- (b) the time of peak **National Electricity Transmission System Demand** as provided by **The Company** under PC.A.4.2.2;
- (c) the time of minimum **National Electricity Transmission System Demand** as provided by **The Company** under PC.A.4.2.2;
- (d) the time of the maximum **Demand (Apparent Power)** at the **Connection Point** (as determined by the **User**) during the **Access Period** of each **Transmission Interface Circuit**;
- (e) at a time specified by either **The Company** or a **User** insofar as such a request is reasonable.

Instead of such forecast **Demand** to be met at each **Connection Point** within each **Access Group** the **User** may (subject to PC.A.4.3.4) submit such **Demand** at each node on the **Single Line Diagram**.

In addition, the **Demand** in respect of each of the time periods referred to in PC.A.4.3.1 (a) to (e) in the preceding **Financial Year** in respect of each **Connection Point** within each **Access Group** both outturn and weather corrected shall be supplied. The "weather correction" shall normalise outturn figures to **Annual ACS Conditions** for times that occur during calendar week 44 through to calendar week 12 (inclusive) or **Average Conditions** for the period calendar weeks 13 to calendar week 43 (inclusive) and shall be performed by the relevant **User** on a best endeavours basis.

The submission by a **User** pursuant to PC.A.4.3.1 (d) shall commence in 2011 and shall then continue each year thereafter.

PC.A.4.3.2 All forecast **Demand** specified in PC.A.4.3.1 shall:

- (a) be that remaining after any deductions reasonably considered appropriate by the **User** to take account of the output of all **Embedded Small Power Stations** and **Embedded Medium Power Stations** and **Customer Generating Plant** and imports across **Embedded External Interconnections**, including **Embedded** installations of direct current converters which do not form a **DC Converter Station**, **HVDC System** and **Embedded DC Converter Stations** and **Embedded HVDC Systems** and such deductions should be separately stated;
- (b) include any **User's System** series reactive losses but exclude any reactive compensation equipment specified in PC.A.2.4 and exclude any network susceptance specified in PC.A.2.3;

- (c) be based upon **Annual ACS Conditions** for times that occur during calendar week 44 through to calendar week 12 (inclusive) and based on **Average Conditions** for calendar weeks 13 to calendar week 43 (inclusive), both corrections being made on a best endeavours basis;
- (d) reflect the **User's** opinion of what could reasonably be imposed on the **National Electricity Transmission System**.

PC.A.4.3.3 The date and time of the forecast maximum **Demand (Apparent Power)** at the **Connection Point** as specified in PC.A.4.3.1 (a) and (d) is required.

PC.A.4.3.4 Each **Single Line Diagram** provided under PC.A.2.2.2 shall include the **Demand (Active Power)** and **Power Factor** (values of the **Power Factor** at maximum and minimum continuous excitation may be given instead where more than 95% of the **Demand** is taken by synchronous motors) at the time of the peak **National Electricity Transmission System Demand** (as provided under PC.A.4.2.2) at each node on the **Single Line Diagram**. These **Demands** shall be consistent with those provided under PC.A.4.3.1(b) above for the relevant year.

PC.A.4.3.5 The **Single Line Diagram** must represent the **User's User System** layout under the period specified in PC.A.4.3.1(b) (at the time of peak **National Electricity Transmission System Demand**). Should the **User's User System** layout during the other times specified in PC.A.4.3.1 be planned to be materially different from the **Single Line Diagram** submitted to **The Company** pursuant to PC.A.2.2.1 the **User** shall in respect of such other times submit:

- (i) an alternative **Single Line Diagram** that accurately reflects the revised layout and in such case shall also include appropriate associated data representing the relevant changes, or;
- (ii) submit an accurate and unambiguous description of the changes to the **Single Line Diagram** previously submitted for the time of peak **National Electricity Transmission System Demand**.

Where a **User** does not submit any changes, **The Company** will assume that the **Single Line Diagram** (and associated circuit and node data) provided at the time of peak **National Electricity Transmission System Demand** will be valid for all other times. In respect of such other times, where the **User** does not submit such nodal demands at the times defined in PC.A.4.3.1(a), (c), (d) and (e), the nodal demands will be pro-rata, to be consistent with the submitted **Connection Point Demands**.

PC.A.4.4 **The Company** will assemble and derive in a reasonable manner, the forecast information supplied to it under PC.A.4.2.1, PC.A.4.3.1, PC.A.4.3.4 and PC.A.4.3.5 above into a cohesive forecast and will use this in preparing **Forecast Demand** information in the **Seven Year Statement** and for use in **The Company's Operational Planning**. If any **User** believes that the cohesive forecast **Demand** information in the **Seven Year Statement** does not reflect its assumptions on **Demand**, it should contact **The Company** to explain its concerns and may require **The Company**, on reasonable request, to discuss these forecasts. In the absence of such expressions, **The Company** will assume that **Users** concur with **The Company's** cohesive forecast.

PC.A.4.5 Post Fault User System Layout

PC.A.4.5.1 Where for the purposes of **The Company** assessing against the Licence Standards an **Access Group**, the **User** reasonably considers it appropriate that revised post fault **User System** layouts should be taken into account by **The Company**, the following information is required to be submitted by the **User**:

- (i) the specified **Connection Point** assessment period (PC.A.4.3.1,(a)-(e)) that is being evaluated;
- (ii) an accurate and unambiguous description of the **Transmission Interface Circuits** considered to be switched out due to a fault;
- (iii) appropriate revised **Single Line Diagrams** and/or associated revised nodal **Demand** and circuit data detailing the revised **User System(s)** conditions;

- (iv) where the **User's** planned post fault action consists of more than one component, each component must be explicitly identified using the **Single Line Diagram** and associated nodal **Demand** and circuit data;
- (v) the arrangements for undertaking actions (eg the time taken, automatic or manual and any other appropriate information);.

The **User** must not submit any action that it does not have the capability or the intention to implement during the assessment period specified (subject to there being no further unplanned outages on the **User's User System**).

PC.A.4.6 Control of Demand or Reduction of Pumping Load Offered as Reserve

Magnitude of Demand or pumping load or Electricity Storage Module charging load which is tripped	MW
System Frequency at which tripping is initiated	Hz
Time duration of System Frequency below trip setting for tripping to be initiated	S
Time delay from trip initiation to tripping	S

PC.A.4.7 General Demand Data

PC.A.4.7.1 The following information is infrequently required and should be supplied (wherever possible) when requested by **The Company**:

- (a) details of any individual loads (including (as applicable) the load behaviour of an **Electricity Storage Module** when operating in a mode analogous to demand) which have characteristics significantly different from the typical range of Domestic, Commercial, **Electricity Storage** or Industrial loads supplied;
- (b) the sensitivity of the **Demand (Active and Reactive Power)** to variations in voltage and **Frequency** on the **National Electricity Transmission System** at the time of the peak **Demand (Active Power)**. The sensitivity factors quoted for the **Demand (Reactive Power)** should relate to that given under PC.A.4.3.1 and, therefore, include any **User's System** series reactive losses but exclude any reactive compensation equipment specified in PC.A.2.4 and exclude any network susceptance specified in PC.A.2.3;
- (c) details of any traction loads, e.g. connection phase pairs and continuous load variation with time;
- (d) the average and maximum phase unbalance, in magnitude and phase angle, which the **User** would expect its **Demand** to impose on the **National Electricity Transmission System**;
- (e) the maximum harmonic content which the **User** would expect its **Demand** to impose on the **National Electricity Transmission System**;
- (f) details of all loads which may cause **Demand** fluctuations greater than those permitted under **Engineering Recommendation P28 Issue 2, Stage 1** at a **Point of Common Coupling** including the **Flicker Severity Short Term** and the **Flicker Severity Long Term**.
- (g) In the case of **Electricity Storage Modules**, details of the **Maximum Capacity, Maximum Import Power, Registered Import Capability**, charge time, discharge time and operating periods.

PART 2 - DETAILED PLANNING DATA

PC.A.5 POWER GENERATING MODULE, GENERATING UNIT, POWER PARK MODULE (INCLUDING DC CONNECTED POWER PARK MODULES), DC CONVERTER, HVDC EQUIPMENT AND OTSDUW PLANT AND APPARATUS DATA

PC.A.5.1 Introduction

Directly Connected

PC.A.5.1.1 Each **Generator** (including those undertaking **OTSDUW**), with existing or proposed **Power Stations** directly connected, or to be directly connected, to the **National Electricity Transmission System**, shall provide **The Company** with data relating to that **Plant** and **Apparatus**, both current and forecast, as specified in PC.A.5.2, PC.A.5.3, PC.A.5.4 and PC.A.5.7 as applicable.

Each **DC Converter Station** owner or **HVDC System Owner**, with existing or proposed **DC Converter Stations** or **HVDC Systems** (including **Generators** undertaking **OTSDUW** which includes an **OTSDUW DC Converter**) directly connected, or to be directly connected, to the **National Electricity Transmission System**, shall provide **The Company** with data relating to that **Plant** and **Apparatus**, both current and forecast, as specified in PC.A.5.2 and PC.A.5.4.

GB Generators, DC Converter Station owners, **EU Generators** and **HVDC System Owners** shall ensure that the models supplied in respect of their **Plant** and **Apparatus** provide a true and accurate behaviour of the plant as built as required under PC.A.5.3.2(c), PC.A.5.4.2(a) and PC.A.5.4.3 and verified through the **Compliance Processes (CP)** or **European Compliance Processes (ECP)** as applicable.

Embedded

PC.A.5.1.2 Each **Generator**, in respect of its existing, or proposed, **Embedded Large Power Stations** and its **Embedded Medium Power Stations** subject to a **Bilateral Agreement** and each **Network Operator** in respect of **Embedded Medium Power Stations** not subject to a **Bilateral Agreement** within its **System** shall provide **The Company** with data relating to each of those **Large Power Stations** and **Medium Power Stations**, both current and forecast, as specified in PC.A.5.2, PC.A.5.3, PC.A.5.4 and PC.A.5.7 as applicable.

Each **DC Converter Station** owner or **HVDC System Owner**, or **Network Operator** in the case of an **Embedded DC Converter Station** or **Embedded HVDC System** not subject to a **Bilateral Agreement** within its **System** with existing or proposed **HVDC Systems** or **DC Converter Stations** shall provide **The Company** with data relating to each of those **HVDC Systems** or **DC Converter Stations**, both current and forecast, as specified in PC.A.5.2 and PC.A.5.4.

However, no data need be supplied in relation to those **Embedded Medium Power Stations** or **Embedded DC Converter Stations** or **Embedded HVDC Systems** if they are connected at a voltage level below the voltage level of the **Subtransmission System** except in connection with an application for, or under a, **CUSC Contract** or unless specifically requested by **The Company** under PC.A.5.1.4.

GB Generators, DC Converter Station owners, **EU Generators** and **HVDC System Owners** shall ensure that the models supplied in respect of their **Plant** and **Apparatus** provide a true and accurate behaviour of the plant as built as required under PC.A.5.3.2(c), PC.A.5.4.2(a) and PC.A.5.4.3 and verified through the **Compliance Processes (CP)** or **European Compliance Processes (ECP)** as applicable

PC.A.5.1.3 Each **Network Operator** need not submit **Planning Data** in respect of **Embedded Small Power Stations** unless required to do so under PC.A.1.2(b), PC.A.3.1.4 or unless specifically requested under PC.A.5.1.4 below, in which case they will supply such data.

PC.A.5.1.4 PC.A.4.2.4(b) and PC.A.4.3.2(a) explained that the forecast **Demand** submitted by each **Network Operator** must be net of the output of all **Medium Power Stations** and **Small Power Stations** and **Customer Generating Plant Embedded** within that **User's System**. In such cases, the **Network Operator** must provide **The Company** with the relevant information specified under PC.A.3.1.4 . On receipt of this data further details may be required at **The Company's** discretion as follows:

- (i) in the case of details required from the **Network Operator** for **Embedded Medium Power Stations** not subject to a **Bilateral Agreement** and **Embedded DC Converter Stations** not subject to a **Bilateral Agreement** and **Embedded HVDC Systems** not subject to a **Bilateral Agreement** and **Embedded Small Power Stations** and **Embedded DC Converters** and **Embedded HVDC Systems** in each case within such **Network Operator's System** and **Customer Generating Plant**; and
- (ii) in the case of details required from the **Generator** of **Embedded Large Power Stations** and **Embedded Medium Power Stations** subject to a **Bilateral Agreement**; and
- (iii) in the case of details required from the **DC Converter Station** owner of an **Embedded DC Converter** or **DC Converter Station** or **HVDC System Owner** of an **Embedded HVDC System Owner** subject to a **Bilateral Agreement**.

both current and forecast, as specified in PC.A.5.2 and PC.A.5.3. Such requirement would arise when **The Company** reasonably considers that the collective effect of a number of such **Embedded Small Power Stations**, **Embedded Medium Power Stations**, **Embedded DC Converter Stations**, **Embedded HVDC Systems**, **DC Converters** and **Customer Generating Plants** may have a significant system effect on the **National Electricity Transmission System**.

PC.A.5.1.5 DPD I and DPD II

The **Detailed Planning Data** described in this Part 2 of the Appendix comprises both **DPD I** and **DPD II**. The required data is listed and collated in the **Data Registration Code**. The **Users** need to refer to the **DRC** to establish whether data referred to here is **DPD I** or **DPD II**.

PC.A.5.2 Demand

PC.A.5.2.1 For each **Generating Unit** (including **Synchronous Generating Units** within a **Synchronous Power Generating Module**) which has an associated **Unit Transformer**, the value of the **Demand** supplied through this **Unit Transformer** when the **Generating Unit** is at **Rated MW** output is to be provided.

PC.A.5.2.2 Where the **Power Station** or **DC Converter Station** or **HVDC System** has associated **Demand** additional to the unit-supplied **Demand** of PC.A.5.2.1 which is supplied from either the **National Electricity Transmission System** or the **Generator's User System** the **Generator**, **DC Converter Station** owner, **HVDC System Owner** or the **Network Operator** (in the case of **Embedded Medium Power Stations** not subject to a **Bilateral Agreement** within its **System**), as the case may be, shall supply forecasts for each **Power Station** or **DC Converter Station** or **HVDC System** of:

- (a) the maximum **Demand** that, in the **User's** opinion, could reasonably be imposed on the **National Electricity Transmission System** or the **Generator's User System** as appropriate;
- (b) the **Demand** at the time of the peak **National Electricity Transmission System Demand**
- (c) the **Demand** at the time of minimum **National Electricity Transmission System Demand**.

PC.A.5.2.3 No later than calendar week 17 each year **The Company** shall notify each **Generator** in respect of its **Large Power Stations** and its **Medium Power Stations** and each **DC Converter** owner in respect of its **DC Converter Station** and each **HVDC System Owner** in respect of its **HVDC System** subject to a **Bilateral Agreement** and each **Network Operator** in respect of each **Embedded Medium Power Station** not subject to a **Bilateral Agreement** and each **Embedded DC Converter Station** or **Embedded HVDC System** not subject to a **Bilateral Agreement** within such **Network Operator's System** in writing of the following, for the current **Financial Year** and for each of the following seven **Financial Years**, which will be regarded as the relevant specified days and times under PC.A.5.2.2:

- (a) the date and time of the annual peak of the **National Electricity Transmission System Demand at Annual ACS Conditions**;
- (b) the date and time of the annual minimum of the **National Electricity Transmission System Demand at Average Conditions**.

PC.A.5.2.4 At its discretion, **The Company** may also request further details of the **Demand** as specified in PC.A.4.6

PC.A.5.2.5 In the case of **OTSDUW Plant and Apparatus** the following data shall be supplied:

- (a) The maximum **Demand** that could occur at the **Interface Point** and each **Connection Point** (in MW and MVA);
- (b) **Demand** at specified time of annual peak half hour of **National Electricity Transmission System Demand at Annual ACS Conditions** (in MW and MVA); and
- (c) **Demand** at specified time of annual minimum half-hour of **National Electricity Transmission System Demand** (in MW and MVA).

For the avoidance of doubt, **Demand** data associated with **Generators** undertaking **OTSDUW** which utilise an **OTSDUW DC Converter** should supply data under PC.A.4.

PC.A.5.3 Synchronous Power Generating Modules, Synchronous Generating Unit and Associated Control System Data

PC.A.5.3.1 The data submitted below are not intended to constrain any **Ancillary Services Agreement**

PC.A.5.3.2 The following **Synchronous Generating Unit** (including **Synchronous Generating Units** within a **Synchronous Power Generating Module**) and **Power Station** data should be supplied:

- (a) **Synchronous Generating Unit** Parameters

Rated terminal volts (kV)

Maximum terminal voltage set point (kV)

Terminal voltage set point step resolution – if not continuous (kV)

* Rated MVA

* **Rated MW**

* Minimum Generation MW

* Short circuit ratio

Direct axis synchronous reactance

* Direct axis transient reactance

Direct axis sub-transient reactance

Direct axis short-circuit transient time constant

Direct axis short-circuit sub-transient time constant

Quadrature axis synchronous reactance

Quadrature axis sub-transient reactance

Quadrature axis short-circuit sub-transient time constant.

Stator time constant

Stator leakage reactance

Armature winding direct-current resistance.

Note: The above data item relating to armature winding direct-current resistance need only be supplied with respect to **Generating Units** commissioned after 1st March 1996 and in cases where, for whatever reason, the **Generator** or the **Network Operator**, as the case may be is aware of the value of the relevant parameter.

- * Turbogenerator inertia constant (MWsec/MVA)

Rated field current (amps) at **Rated MW** and MVA_r output and at rated terminal voltage.

Field current (amps) open circuit saturation curve for **Generating Unit** terminal voltages ranging from 50% to 120% of rated value in 10% steps as derived from appropriate manufacturers test certificates.

- (b) Parameters for **Generating Unit** Step-up Transformers

- * Rated MVA

Voltage ratio

- * Positive sequence reactance (at max, min, & nominal tap)

Positive sequence resistance (at max, min, & nominal tap)

Zero phase sequence reactance

Tap changer range

Tap changer step size

Tap changer type: on load or off circuit

- (c) Excitation Control System parameters

Note: The data items requested under Option 1 below may continue to be provided in relation to **Generating Units** connected to the **System** at 09 January 1995 (in this paragraph, the "relevant date") or the new data items set out under Option 2 may be provided. **Generators** or **Network Operators**, as the case may be, must supply the data as set out under Option 2 (and not those under Option 1) for **Generating Unit** excitation control systems commissioned after the relevant date, those **Generating Unit** excitation control systems recommissioned for any reason such as refurbishment after the relevant date and **Generating Unit** excitation control systems where, as a result of testing or other process, the **Generator** or **Network Operator**, as the case may be, is aware of the data items listed under Option 2 in relation to that **Generating Unit**.

For any excitation control systems associated with a **Generating Unit** or **Synchronous Power Generating Module** with a **Completion Date** after 1 September 2022 and any **Generating Unit** or **Synchronous Power Generating Module** excitation control systems subject to a control system change or **Modification** after 1 September 2022, the **Generator** should supply the control system model in accordance with PC.A.9. For the avoidance of doubt, excitation control system models as detailed in PC.A.9 maybe submitted for any **Generating Unit** regardless of **Completion Date** as an alternative to block diagrams detailed below. The control system model of the **Excitation System** shall include but not limited to, the **PSS** if fitted, **Over-excitation Limiter**, **Under-excitation Limiter** and should have been verified as far as reasonably practicable by simulation studies as representing the expected behaviour of the control system. Additionally the data items listed under Option 2 below are also required.

Option 1

DC gain of Excitation Loop

Rated field voltage

Maximum field voltage

Minimum field voltage

Maximum rate of change of field voltage (rising)

Maximum rate of change of field voltage (falling)

Details of Excitation Loop described in block diagram form showing transfer functions of individual elements.

Dynamic characteristics of **Over-excitation Limiter**

Dynamic characteristics of **Under-excitation Limiter**

Option 2

Excitation System Nominal Response

Rated Field Voltage

No-Load Field Voltage

Excitation System On-Load Positive Ceiling Voltage

Excitation System No-Load Positive Ceiling Voltage

Excitation System No-Load Negative Ceiling Voltage

Stator Current Limiter (applicable only to **Synchronous Power Generating Modules**)

Details of **Excitation System** (including **PSS** if fitted) described in block diagram form showing transfer functions of individual elements.

Details of **Over-excitation Limiter** described in block diagram form showing transfer functions of individual elements.

Details of **Under-excitation Limiter** described in block diagram form showing transfer functions of individual elements.

The block diagrams submitted after 1 January 2009 in respect of the **Excitation System** (including the **Over-excitation Limiter** and the **Under-excitation Limiter**) for **Generating Units** with a **Completion date** after 1 January 2009 or subject to a **Modification** to the **Excitation System** after 1 January 2009, should have been verified as far as reasonably practicable by simulation studies as representing the expected behaviour of the system.

(d) Governor Parameters

Incremental **Droop** values (in %) are required for each **Generating Unit** at six MW loading points (MLP1 to MLP6) as detailed in PC.A.5.5.1 (this data item needs only be provided for **Large Power Stations**).

Note: The data items requested under Option 1 below may continue to be provided by **Generators** in relation to **Generating Units** on the **System** at 09 January 1995 (in this paragraph, the "relevant date") or they may provide the new data items set out under Option 2. **Generators** must supply the data as set out under Option 2 (and not those under Option 1) for **Generating Unit** governor control systems commissioned after the relevant date, those **Generating Unit** governor control systems recommissioned for any reason such as refurbishment after the relevant date and **Generating Unit** governor control systems where, as a result of testing or other process, the **Generator** is aware of the data items listed under Option 2 in relation to that **Generating Unit**. **EU Generators** are also required to submit the data as set out in option 2. Additional data required from **EU Generators** which own or operate **Type C** or **Type D Power Generating Modules** are marked in brackets with an asterisk (eg (*)). For the avoidance of doubt, items marked as (*) need not be supplied by **GB Generators**.

For any governor control systems associated with a **Generating Unit** or **Synchronous Power Generating Module** with a **Completion Date** after 1 September 2022 and any **Generating Unit** or **Synchronous Power Generating Module** governor control systems subject to a control system change or **Modification** after 1 September 2022, the **Generator** should supply the control system model in accordance with PC.A.9. For the avoidance of doubt, governor control system models as detailed in PC.A.9 maybe submitted for any **Generating Unit** regardless of **Completion Date** as an alternative to governor block diagrams. The control system model shall include but not limited to, the governor and prime mover dynamics such as steam flow, boiler, water flow which could impact on representation of the requirements required by the Grid Code. Additional the data items listed under Option 2 are also required.

Option 1

(i) Governor Parameters (for Reheat **Steam Units**)

- HP governor average gain MW/Hz
- Speeder motor setting range
- HP governor valve time constant
- HP governor valve opening limits
- HP governor valve rate limits
- Reheater time constant (**Active Energy** stored in reheater)

- IP governor average gain MW/Hz
- IP governor setting range
- IP governor valve time constant
- IP governor valve opening limits
- IP governor valve rate limits

Details of acceleration sensitive elements in HP & IP governor loop.

A governor block diagram showing transfer functions of individual elements.

(ii) Governor Parameters (for Non-Reheat **Steam Units** and **Gas Turbine Units**)

- Governor average gain
- Speeder motor setting range
- Time constant of steam or fuel governor valve
- Governor valve opening limits
- Governor valve rate limits

Time constant of turbine

Governor block diagram

The following data items need only be supplied for **Large Power Stations**:

(iii) Boiler & Steam Turbine Data

Boiler Time Constant (Stored **Active Energy**) s

HP turbine response ratio:

proportion of **Primary Response** arising from HP turbine %

HP turbine response ratio:

proportion of High Frequency Response arising from HP turbine %

[End of Option 1]

Option 2

(i) Governor and associated prime mover Parameters - All **Generating Units** (including **Synchronous Generating Units** within a **Synchronous Power Generating Module**)

Governor Block Diagram showing transfer function of individual elements including acceleration sensitive elements.

Governor Time Constant (in seconds)

Speeder Motor Setting Range (%)

Average Gain (MW/Hz)

Governor Deadband need only be provided for **Large Power Stations** owned and operated by **GB Generators** (and both **Frequency Response Deadband** and **Frequency Response Insensitivity** should be supplied in respect of **Type C** and **D Power Generating Modules** within **Large Power Stations** and **Medium Power Stations** excluding **Embedded Medium Power Stations** not subject to a **Bilateral Agreement***) owned and operated by **EU Code Generators**.

- Maximum Setting ±Hz

- Normal Setting ±Hz

- Minimum Setting ±Hz

Where the **Generating Unit** governor does not have a selectable **Governor Deadband** (or **Frequency Response Deadband** and **Frequency Response Insensitivity**)* facility as specified above, then the actual value of the **Governor Deadband** or (**Frequency Response Deadband** and **Frequency Response Insensitivity**)* need only be provided.

The block diagrams submitted after 1 January 2009 in respect of the governor system for **Generating Units** with a **Completion date** after 1 January 2009 or subject to a **Modification** to the governor system after 1 January 2009, should have been verified as far as reasonably practicable by simulation studies as representing the expected behaviour of the system.

(ii) Governor and associated prime mover Parameters - **Steam Units**

HP Valve Time Constant (in seconds)

HP Valve Opening Limits (%)

HP Valve Opening Rate Limits (%/second)

HP Valve Closing Rate Limits (%/second)

HP Turbine Time Constant (in seconds)

IP Valve Time Constant (in seconds)

IP Valve Opening Limits (%)

IP Valve Opening Rate Limits (%/second)

IP Valve Closing Rate Limits (%/second)

IP Turbine Time Constant (in seconds)

LP Valve Time Constant (in seconds)

LP Valve Opening Limits (%)

LP Valve Opening Rate Limits (%/second)

LP Valve Closing Rate Limits (%/second)

LP Turbine Time Constant (in seconds)

Reheater Time Constant (in seconds)

Boiler Time Constant (in seconds)

HP Power Fraction (%)

IP Power Fraction (%)

(iii) Governor and associated prime mover Parameters - **Gas Turbine Units**

Inlet Guide Vane Time Constant (in seconds)

Inlet Guide Vane Opening Limits (%)

Inlet Guide Vane Opening Rate Limits (%/second)

Inlet Guide Vane Closing Rate Limits (%/second)

Fuel Valve Constant (in seconds)

Fuel Valve Opening Limits (%)

Fuel Valve Opening Rate Limits (%/second)

Fuel Valve Closing Rate Limits (%/second)

Waste Heat Recovery Boiler Time Constant (in seconds)

(iv) Governor and associated prime mover Parameters - Hydro Generating Units

Guide Vane Actuator Time Constant (in seconds)

Guide Vane Opening Limits (%)

Guide Vane Opening Rate Limits (%/second)

Guide Vane Closing Rate Limits (%/second)

Water Time Constant (in seconds)

(v) Governor Parameters – Synchronous Electricity Storage Units

For **Synchronous Electricity Storage Modules** which are derived from compressed air energy storage systems, the following data should be provided. For other **Synchronous Electricity Storage Modules**, data should be supplied as required by **The Company** in accordance with PC.A.7

Valve Actuator Time Constant (in seconds)

Valve Opening Limits (%)
Valve Opening Rate Limits (%/second)
Valve Closing Rate Limits (%/second)

[End of Option 2]

(e) Unit Control Options

The following data items need only be supplied with respect to **Large Power Stations**:

Maximum Droop	%
Normal Droop	%
Minimum Droop	%
Maximum Governor Deadband or (maximum Frequency Response Deadband and maximum Frequency Response Insensitivity*)	±Hz
Normal Governor Deadband or (normal Frequency Response Deadband and normal Frequency Response Insensitivity*)	±Hz
Minimum Governor Deadband or (minimum Frequency Response Deadband and minimum Frequency Response Insensitivity*)	±Hz
Maximum output Governor Deadband (or maximum output Frequency Response Deadband and maximum Frequency Response Insensitivity*)	±MW
Normal output Governor Deadband (or normal output Frequency Response Deadband and normal output Frequency Response Insensitivity*)	±MW
Minimum output Governor Deadband or (minimum output Frequency Response Deadband and minimum output Frequency Response Insensitivity*)	±MW

Frequency settings between which Unit Load Controller **Droop** applies:

- Maximum	Hz
- Normal	Hz
- Minimum	Hz

State if sustained response is normally selected.

(* **GB Generators** which are not required to satisfy the requirements of the **European Connection Conditions** are not required to supply **Frequency Response Insensitivity** or **Frequency Response Deadband** data but should instead supply **Governor Deadband** data). For the avoidance of doubt, **EU Code Generators** in respect of **Type C** and **Type D Power Generating Modules** are required to supply **Frequency Response Deadband** and **Frequency Response Insensitivity** data).

(f) Plant Flexibility Performance

The following data items need only be supplied with respect to **Large Power Stations**, and should be provided with respect to each **Genset**:

- # Run-up rate to **Registered Capacity**,
- # Run-down rate from **Registered Capacity**,
- # **Synchronising Generation**,
Regulating range
Load rejection capability while still **Synchronised** and able to supply **Load**.

Data items marked with a hash (#) should be applicable to a **Genset** which has been **Shutdown** for 48 hours.

- * Data items marked with an asterisk are already requested under partx1, PC.A.3.3.1, to facilitate an early assessment by **The Company** as to whether detailed stability studies will be required before an offer of terms for a **CUSC Contract** can be made. Such data items have been repeated here merely for completeness and need not, of course, be resubmitted unless their values, known or estimated, have changed.

(g) Generating Unit Mechanical Parameters

It is occasionally necessary for **The Company** to assess the interaction between the **Total System** and the mechanical components of **Generating Units**. For **Generating Units** (including **Synchronous Generating Units** within a **Synchronous Power Generating Module**) with a **Completion Date** on or after 01 April 2015,

or;

with a **Completion Date** before 01 April 2015 when requested by **The Company** in accordance with good industry practice and without undue delay,

the following data items should be supplied:

The number of turbine generator masses.

Diagram showing the Inertia and parameters for each turbine generator mass (kgm^2) and Stiffness constants and parameters between each turbine generator mass for the complete drive train (Nm/rad).

Number of poles.

Relative power applied to different parts of the turbine (%).

Torsional mode frequencies (Hz).

Modal damping decrement factors for the different mechanical modes.

PC.A.5.4 Power Park Module, Non-Synchronous Generating Unit and Associated Control System Data

PC.A.5.4.1 The data submitted below are not intended to constrain any **Ancillary Services Agreement**

PC.A.5.4.2 The following **Power Park Unit**, **Power Park Module** and **Power Station** data should be supplied in the case of a **Power Park Module** not connected to the **Total System** by a **DC Converter** or **HVDC System** (and in the case of PC.A.5.4.2(f) any **OTSUA**):

Where a **Manufacturer's Data & Performance Report** exists in respect of the model of the **Power Park Unit**, the **User** may subject to **The Company's** agreement, opt to reference the **Manufacturer's Data & Performance Report** as an alternative to the provision of data in accordance with PC.A.5.4.2 except for:

- (1) the section marked thus # at sub paragraph (b); and
- (2) all of the harmonic and flicker parameters required under sub paragraph (h); and
- (3) all of the site specific model parameters relating to the voltage or frequency control systems required under sub paragraphs (d) and (e),

which must be provided by the **User** in addition to the **Manufacturer's Data & Performance Report** reference.

(a) **Power Park Unit** model

A mathematical model of each type of **Power Park Unit** (including **Electricity Storage Units**) capable of representing its transient and dynamic behaviour under both small and large disturbance conditions. The model shall include non-linear effects and represent all equipment relevant to the dynamic performance of the **Power Park Unit** as agreed with **The Company**. The model shall be suitable for the study of balanced, root mean square, positive phase sequence time-domain behaviour, excluding the effects of electromagnetic transients, harmonic and sub-harmonic frequencies.

The model shall accurately represent the overall performance of the **Power Park Unit** over its entire operating range including that which is inherent to the **Power Park Unit** and that which is achieved by use of supplementary control systems providing either continuous or stepwise control. Model resolution should be sufficient to accurately represent **Power Park Unit** behaviour both in response to operation of **Transmission System** protection and in the context of longer-term simulations.

The overall structure of the model shall include:

- (i) any supplementary control signal modules not covered by (c), (d) and (e) below.
- (ii) any blocking, deblocking and protective trip features that are part of the **Power Park Unit** (e.g. “crowbar”).
- (iii) any other information required to model the **Power Park Unit** behaviour to meet the model functional requirement described above.

The model shall be submitted in the form of a transfer function block diagram and may be accompanied by dynamic and algebraic equations.

This model shall display all the transfer functions and their parameter values, any non wind-up logic, signal limits and non-linearities.

The submitted **Power Park Unit** model and the supplementary control signal module models covered by (c), (d) and (e) below shall have been validated and this shall be confirmed by the **Generator**. The validation shall be based on comparing the submitted model simulation results against measured test results. Validation evidence shall also be submitted and this shall include the simulation and measured test results. The latter shall include appropriate short-circuit tests. In the case of an **Embedded Medium Power Station** not subject to a **Bilateral Agreement** the **Network Operator** will provide **The Company** with the validation evidence if requested by **The Company**. The validation of the supplementary control signal module models covered by (c), (d) and (e) below applies only to a **Power Park Module** with a **Completion Date** after 1 January 2009 or **Power Park Modules** within a **Power Generating Module**.

(b) **Power Park Unit** parameters

- * Rated MVA
- * **Rated MW**
- * Rated terminal voltage
- * Average site air density (kg/m^3), maximum site air density (kg/m^3) and minimum site air density (kg/m^3) for the year (as applicable)

Year for which the air density is submitted (as applicable)

Number of pole pairs (as applicable)

Blade swept area (m^2) (as applicable)

Gear box ratio (as applicable)

Mechanical drive train (as applicable)

For each **Power Park Unit**, details of the parameters of the drive train (as applicable) represented as an equivalent two mass model should be provided. This model should accurately represent the behaviour of the complete drive train for the purposes of power system analysis studies and should include the following data items:-

Equivalent inertia constant (MWsec/MVA) of the first mass (e.g. wind turbine rotor and blades) at minimum, synchronous and rated speeds

Equivalent inertia constant (MWsec/MVA) of the second mass (e.g. generator rotor) at minimum, synchronous and rated speeds

Equivalent shaft stiffness between the two masses (Nm/electrical radian)

Additionally, for **Power Park Units** that are induction generators (e.g. squirrel cage, doubly-fed) driven by wind turbines:

- * Stator resistance
- * Stator reactance
- * Magnetising reactance.
- * Rotor resistance.(at starting)
- * Rotor resistance.(at rated running)
- * Rotor reactance (at starting)
- * Rotor reactance (at rated running)

Additionally for doubly-fed induction generators only:

The generator rotor speed range (minimum and maximum speeds in RPM)

The optimum generator rotor speed versus wind speed submitted in tabular format

Power converter rating (MVA)

The rotor power coefficient (C_p) versus tip speed ratio (λ) curves for a range of blade angles (where applicable) together with the corresponding values submitted in tabular format. The tip speed ratio (λ) is defined as $\Omega R/U$ where Ω is the angular velocity of the rotor, R is the radius of the wind turbine rotor and U is the wind speed.

The electrical power output versus generator rotor speed for a range of wind speeds over the entire operating range of the **Power Park Unit**, together with the corresponding values submitted in tabular format.

The blade angle versus wind speed curve together with the corresponding values submitted in tabular format.

The electrical power output versus wind speed over the entire operating range of the **Power Park Unit**, together with the corresponding values submitted in tabular format.

Transfer function block diagram, including parameters and description of the operation of the power electronic converter and fault ride through capability (where applicable). For any **Power Park Units** in a **Power Park Module** with a **Completion Date** after 1 September 2022 and any **Power Park Units** subject to a control system change or **Modification** after 1 September 2022 control system models in accordance with PC.A.9 should be supplied. For the avoidance of doubt, a **User** may submit control system models as detailed in PC.A.9 for any **Power Park Unit** regardless of **Power Park Module Completion Date** as an alternative to this paragraph.

For a **Power Park Unit** consisting of a synchronous machine in combination with a back to back **DC Converter** or **HVDC System**, or for a **Power Park Unit** not driven by a wind turbine, the data to be supplied shall be agreed with **The Company** in accordance with PC.A.7.

- (c) Torque / speed and blade angle control systems and parameters

For the type of **Power Park Unit** (as applicable), details of the torque / speed controller and blade angle controller in the case of a wind turbine and power limitation functions (where applicable) described in block diagram form showing transfer functions and parameters of individual elements.

- (d) Voltage/**Reactive Power/Power Factor** control system parameters

For the **Power Park Unit** and **Power Park Module** details of voltage/**Reactive Power/Power Factor** controller (and **PSS** if fitted) described in block diagram form showing transfer functions and parameters of individual elements.

(e) **Frequency** control system parameters

For the **Power Park Unit** and **Power Park Module** details of the **Frequency** controller described in block diagram form showing transfer functions and parameters of individual elements.

(f) **Protection**

Details of settings for the following **Protection** relays (to include): Under **Frequency**, over **Frequency**, under voltage, over voltage, rotor over current, stator over current, high wind speed shut down level.

(g) Complete **Power Park Unit** model, parameters and controls

(i) For any **Power Park Units** in a **Power Park Module** with a **Completion Date** after 1 September 2022 and any **Power Park Units** and/or **Power Park Module(s)** subject to a control system change or **Modification** after 1 September 2022, control system models in accordance with PC.A.9 should be supplied covering the full information required under PC.A.5.4.2 (a), (b), (c), (d), (e) and (f).

(ii) For any **Power Park Units** in a **Power Park Module** with a **Completion Date** before 1 September 2022 as an alternative to PC.A.5.4.2 (a), (b), (c), (d), (e) and (f), is the submission of a single complete model that consists of the full information required under PC.A.5.4.2 (a), (b), (c), (d), (e) and (f) provided that all the information required under PC.A.5.4.2 (a), (b), (c), (d), (e) and (f) individually is clearly identifiable. For the avoidance of doubt, a **User** may submit control system models as detailed in PC.A.9 for any **Power Park Unit** or **Power Park Module** regardless of **Completion Date** as an alternative to this clause.

(h) Harmonic and flicker parameters

When connecting a **Power Park Module**, it is necessary for **The Company** to evaluate the production of flicker and harmonics on the **National Electricity Transmission System** and **User's Systems**. At **The Company's** reasonable request, the **User** (a **Network Operator** in the case of an **Embedded Power Park Module** not subject to a **Bilateral Agreement**) is required to submit the following data (as defined in IEC 61400-21 (2001)) for each **Power Park Unit**:-

Flicker coefficient for continuous operation.

Flicker step factor.

Number of switching operations in a 10 minute window.

Number of switching operations in a 2 hour window.

Voltage change factor.

Current Injection at each harmonic for each **Power Park Unit** and for each **Power Park Module**.

* Data items marked with an asterisk are already requested under part 1, PC.A.3.3.1, to facilitate an early assessment by **The Company** as to whether detailed stability studies will be required before an offer of terms for a **CUSC Contract** can be made. Such data items have been repeated here merely for completeness and need not, of course, be resubmitted unless their values, known or estimated, have changed.

PC.A.5.4.3 DC Converter and HVDC Systems

PC.A.5.4.3.1 For a **DC Converter** at a **DC Converter Station** or an **HVDC System** connected to the **Total System** by a **DC Converter** or **HVDC System** (or in the case of **OTSUA** which includes an **OTSDUW DC Converter**) the following information for each **DC Converter**, **HVDC System** and **DC Network** should be supplied:

(a) **DC Converter** and **HVDC System** parameters

- * **Rated MW** per pole for transfer in each direction;
- * **DC Converter** type (i.e. current or voltage source (including a **HVDC Converter** in an **HVDC System**));
- * Number of poles and pole arrangement;
- * Rated DC voltage/pole (kV);
- * Return path arrangement;

(b) **DC Converter** and **HVDC System** transformer parameters

Rated MVA

Nominal primary voltage (kV);

Nominal secondary (converter-side) voltage(s) (kV);

Winding and earthing arrangement;

Positive phase sequence reactance at minimum, maximum and nominal tap;

Positive phase sequence resistance at minimum, maximum and nominal tap;

Zero phase sequence reactance;

Tap-changer range in %;

number of tap-changer steps;

(c) **DC Network** parameters

Rated DC voltage per pole;

Rated DC current per pole;

Single line diagram of the complete **DC Network** and **HVDC System**;

Details of the complete **DC Network**, including resistance, inductance and capacitance of all DC cables and/or DC lines and **HVDC System**;

Details of any DC reactors (including DC reactor resistance), DC capacitors and/or DC-side filters that form part of the **DC Network** and/or **HVDC System**;

(d) AC filter reactive compensation equipment parameters

Note: The data provided pursuant to this paragraph must not include any contribution from reactive compensation plant.

Total number of AC filter banks.

Type of equipment (e.g. fixed or variable)

Single line diagram of filter arrangement and connections;

Reactive Power rating for each AC filter bank, capacitor bank or operating range of each item of reactive compensation equipment, at rated voltage;

Performance chart showing **Reactive Power** capability of the **DC Converter** and **HVDC System**, as a function of MW transfer, with all filters and reactive compensation plant, belonging to the **DC Converter Station** or **HVDC System** working correctly.

Note: Details in PC.A.5.4.3.1 are required for each **DC Converter** connected to the **DC Network** and **HVDC System**, unless each is identical or where the data has already been submitted for an identical **DC Converter** or **HVDC System** at another **Connection Point**.

Note: For a **Power Park Module** and **DC Connected Power Park Module** connected to the **Grid Entry Point** or (**User System Entry Point** if **Embedded**) by a **DC Converter** or **HVDC System** the equivalent inertia and fault infeed at the **Power Park Unit** should be given.

DC Converter and HVDC System Control System Models

PC.A.5.4.3.2 The following data is required by **The Company** to represent **DC Converters** and associated **DC Networks** and **HVDC Systems** (and including **OTSUA** which includes an **OTSDUW DC Converter**) in dynamic power system simulations,

- (a) For any any **DC Converters** and **HVDC Systems** with a **Completion Date** before 1 September 2022 in which the AC power system is typically represented by a positive sequence equivalent, it is acceptable to represent **DC Converters** and **HVDC Systems** by simplified equations rather than to the switching device level.
 - (i) Static $V_{DC-I_{DC}}$ (DC voltage - DC current) characteristics, for both the rectifier and inverter modes for a current source converter. Static $V_{DC-P_{DC}}$ (DC voltage - DC power) characteristics, for both the rectifier and inverter modes for a voltage source converter. Transfer function block diagram including parameters representation of the control systems of each **DC Converter** and of the **DC Converter Station** and the **HVDC System**, for both the rectifier and inverter modes. A suitable model would feature the **DC Converter** or **HVDC Converter** firing angle as the output variable.
 - (ii) Transfer function block diagram representation including parameters of the **DC Converter** or **HVDC Converter** transformer tap changer control systems, including time delays
 - (iii) Transfer function block diagram representation including parameters of AC filter and reactive compensation equipment control systems, including any time delays.
 - (iv) Transfer function block diagram representation including parameters of any **Frequency** and/or load control systems.
 - (v) Transfer function block diagram representation including parameters of any small signal modulation controls such as power oscillation damping controls or sub-synchronous oscillation damping controls, that have not been submitted as part of the above control system data.
 - (vi) Transfer block diagram representation of the **Reactive Power** control at converter ends for a voltage source converter.

In addition and where not provided for above, **HVDC System Owners** and **Generators** in respect of **OTSDUW DC Converters** who are also **EU Code Users** shall also provide the following dynamic simulation sub-models

- (i) **HVDC Converter** unit models
- (ii) AC component models
- (iii) DC Grid models
- (iv) Voltage and power controller
- (v) Special control features if applicable (eg power oscillation damping (POD) function, subsynchronous torsional interaction (SSTI) control;
- (vi) Multi terminal control, if applicable
- (vii) **HVDC System** protection models as agreed between **The Company** and the **HVDC System Owner**

HVDC System Owners are also required to supply an equivalent model of the control system when adverse control interactions may result with **HVDC Converter Stations** and other connections in close proximity if requested by **The Company**. The equivalent model shall contain all necessary data for the realistic simulation of the adverse control interactions.

- (b) For any **DC Converters** and **HVDC Systems** with a **Completion Date** after 1 September 2022 and any **DC Converters** and **HVDC Systems** subject to a control system change or **Modification** after 1 September 2022, control system models in accordance with PC.A.9 should be supplied covering the full functionality required under PC.A.5.4.3.2 (a).

For the avoidance of doubt a **User** may submit control system models as detailed in PC.A.9 for any **DC Converters** and **HVDC Systems** regardless of **Completion Date** as an alternative to PC.A.5.4.3.2(a).

Plant Flexibility Performance

PC.A.5.4.3.3 The following information on plant flexibility and performance should be supplied (and also in respect of **OTSUA** which includes an **OTSDUW DC Converter**):

- (i) Nominal and maximum (emergency) loading rate with the **DC Converter** or **HVDC Converter** in rectifier mode.
- (ii) Nominal and maximum (emergency) loading rate with the **DC Converter** or **HVDC Converter** in inverter mode.
- (iii) Maximum recovery time, to 90% of pre-fault loading, following an AC system fault or severe voltage depression.
- (iv) Maximum recovery time, to 90% of pre-fault loading, following a transient **DC Network** fault.

Harmonic Assessment Information

PC.A.5.4.3.4 **DC Converter** owners and **HVDC System Owners** shall provide such additional further information as required by **The Company** in order that compliance with CC.6.1.5 or ECC.6.1.5 can be demonstrated.

* Data items marked with an asterisk are already requested under part 1, PC.A.3.3.1, to facilitate an early assessment by **The Company** as to whether detailed stability studies will be required before an offer of terms for a **CUSC Contract** can be made. Such data items have been repeated here merely for completeness and need not, of course, be resubmitted unless their values, known or estimated, have changed.

PC.A.5.5 Response Data For Frequency Changes

The information detailed below is required to describe the actual frequency response capability profile as illustrated in Figure CC.A.3.1 of the **Connection Conditions** or Figure ECC.A.3.1 of the **European Connection Conditions**, and need only be provided for each:

- (i) **Genset at Large Power Stations**; and
- (ii) **Generating Unit** (including **Synchronous Generating Units** within a **Synchronous Power Generating Module**), **Power Park Module** (including a **DC Connected Power Park Module**) or **CCGT Module** at a **Medium Power Station** or **DC Converter Station** or **HVDC System** that has agreed to provide **Frequency** response in accordance with a **CUSC Contract**.

In the case of (ii) above for the rest of this PC.A.5.5 where reference is made to **Gensets**, it shall include such **Generating Units** (including **Synchronous Generating Units** within a **Synchronous Power Generating Module**), **CCGT Modules**, **Power Park Modules** (including **DC Connected Power Park Modules**), **HVDC Systems** and **DC Converters** as appropriate, but excludes **OTSDUW Plant and Apparatus** utilising **OTSDUW DC Converters**.

In this PC.A.5.5, for a **CCGT Module** with more than one **Generating Unit**, the phrase **Minimum Generation** or **Minimum Regulating Level** applies to the entire **CCGT Module** operating with all **Generating Units** (including **Synchronous Generating Units** within a **Synchronous Power Generating Module**) **Synchronised** to the **System**. Similarly for a **Power Park Module** (including a **DC Connected Power Park Module**) with more than one **Power Park Unit**, the phrase **Minimum Generation** or **Minimum Regulating Level** applies to the entire **Power Park Module** operating with all **Power Park Units Synchronised** to the **System**.

PC.A.5.5.1 MW Loading Points At Which Data Is Required

Response values are required at six MW loading points (MLP1 to MLP6) for each **Genset**. **Primary** and **Secondary Response** values need not be provided for MW loading points which are below **Minimum Generation** or **Minimum Stable Operating Level**. MLP1 to MLP6 must be provided to the nearest MW.

Prior to the **Genset** being first **Synchronised**, the MW loading points must take the following values :

MLP1	Designed Minimum Operating Level or Minimum Regulating Level
MLP2	Minimum Generation or Minimum Stable Operating Level
MLP3	70% of Registered Capacity or Maximum Capacity
MLP4	80% of Registered Capacity or Maximum Capacity
MLP5	95% of Registered Capacity or Maximum Capacity
MLP6	Registered Capacity or Maximum Capacity

When data is provided after the **Genset** is first **Synchronised**, the MW loading points may take any value between the **Designed Minimum Operating Level** or **Minimum Regulating Level** and **Registered Capacity** or **Maximum Capacity** but the value of the **Designed Minimum Operating Level** or **Minimum Regulating Level** must still be provided if it does not form one of the MW loading points.

PC.A.5.5.2 Primary And Secondary Response To Frequency Fall

Primary and **Secondary Response** values for a -0.5Hz ramp are required at six MW loading points (MLP1 to MLP6) as detailed above

PC.A.5.5.3 High Frequency Response To Frequency Rise

High Frequency Response values for a +0.5Hz ramp are required at six MW loading points (MLP1 to MLP6) as detailed above.

PC.A.5.5.4 Each **Generator** or **Defence Service Provider** or **Restoration Service Provider** or **Non-Embedded Customer** in respect of an **Electricity Storage Module**, shall provide **Frequency** response curves that demonstrate the ability of their **Electricity Storage Modules** to transition from a mode analogous to **Demand** to a mode analogous to generation (excluding **Auxiliary Supplies**) within a period of 20 seconds or less in accordance with the requirements of ECC.6.3.7.2.3, unless the provisions of ECC.6.3.7.2.3.1 apply where the requirements of OC6.6.6. relate.

PC.A.5.6 Mothballed Power Generating Module, Mothballed Generating Unit, Mothballed Power Park Module (including DC Connected Power Park Modules), Mothballed HVDC Systems or Mothballed DC Converter at a DC Converter Station And Alternative Fuel Information

Data identified under this section PC.A.5.6 must be submitted as required under PC.A.1.2 and at **The Company's** reasonable request.

In the case of **Embedded Medium Power Stations** not subject to a **Bilateral Agreement**, **Embedded HVDC Systems** not subject to a **Bilateral Agreement** and **Embedded DC Converter Stations** not subject to a **Bilateral Agreement**, upon request from **The Company** each **Network Operator** shall provide the information required in PC.A.5.6.1, PC.A.5.6.2, PC.A.5.6.3 and PC.A.5.6.4 on respect of such **Embedded Medium Power Stations** and **Embedded DC Converters Stations** and **Embedded HVDC Systems** with their **System**.

PC.A.5.6.1 Mothballed Generating Unit Information

Generators, HVDC System Owners and **DC Converter Station** owners must supply with respect to each **Mothballed Power Generating Module, Mothballed Generating Unit, Mothballed Power Park Module** (including a **DC Connected Power Park Module**), **Mothballed HVDC System** or **Mothballed DC Converter** at a **DC Converter Station** the estimated **MW** output which could be returned to service within the following time periods from the time that a decision to return was made:

- < 1 month;
- 1-2 months;
- 2-3 months;
- 3-6 months;
- 6-12 months; and
- >12 months.

The return to service time should be determined in accordance with **Good Industry Practice** assuming normal working arrangements and normal plant procurement lead times. The MW output values should be the incremental values made available in each time period as further described in the **DRC**.

PC.A.5.6.2 **Generators, HVDC System Owners** and **DC Converter Station** owners must also notify **The Company** of any significant factors which may prevent the **Mothballed Power Generating Module, Mothballed Generating Unit, Mothballed Power Park Module** (including **DC Connected Power Park Modules**), **Mothballed HVDC Systems** or **Mothballed DC Converter** at a **DC Converter Station** achieving the estimated values provided under PC.A.5.6.1 above, excluding factors relating to **Transmission Entry Capacity**.

PC.A.5.6.3 Alternative Fuel Information

The following data items must be supplied with respect to each **Generating Unit** (including **Synchronous Generating Units** within a **Synchronous Power Generating Module**) whose main fuel is gas.

For each alternative fuel type (if facility installed):

- (a) Alternative fuel type e.g. oil distillate, alternative gas supply
- (b) For the changeover from main to alternative fuel:
 - Time to carry out off-line and on-line fuel changeover (minutes).
 - Maximum output following off-line and on-line changeover (MW).
 - Maximum output during on-line fuel changeover (MW).
 - Maximum operating time at full load assuming typical and maximum possible stock levels (hours).
 - Maximum rate of replacement of depleted stocks (MWh electrical/day) on the basis of **Good Industry Practice**.
 - Is changeover to alternative fuel used in normal operating arrangements?
 - Number of successful changeovers carried out in the last of **The Company's Financial Year** (choice of 0, 1-5, 6-10, 11-20, >20).
- (c) For the changeover back to main fuel:

- Time to carry out off-line and on-line fuel changeover (minutes).
- Maximum output during on-line fuel changeover (MW).

PC.A.5.6.4 **Generators** must also notify **The Company** of any significant factors and their effects which may prevent the use of alternative fuels achieving the estimated values provided under PC.A.5.6.3 above (e.g. emissions limits, distilled water stocks etc.)

PC.A.5.7 Black Start Related Information

Data identified under this section PC.A.5.7 must be submitted as required under PC.A.1.2. This information may also be requested by **The Company** during a **Black Start** and should be provided by **Generators**, **HVDC System Owners** and **DC Converter Station Owners** where reasonably possible. For the avoidance of doubt, **Generators** in this section PC.A.5.7 means **Generators** only in respect of their **Large Power Stations**.

The following data items/text must be supplied, from each **Generator**, **HVDC System Owner** and **DC Converter Station Owner** to **The Company**. In the case of **Generators**, the data supplied should be with respect to each **BM Unit** at a **Large Power Station**. For the avoidance of doubt, the data required under PC.A.5.7 (a) and (b) below, does i) not need to be supplied in respect of **Generators** that are contracted to provide a **Black Start Capability** and ii), the data only needs to be supplied in respect of the **BM Unit** at a **Large Power Station** and does not need to include **Generating Unit** data;

- (a) Expected time for each **BM Unit** to be **Synchronised** following a **Total Shutdown** or **Partial Shutdown**. The assessment should include the **Power Station's** or **HVDC System's** or **DC Converter Station's** ability to re-synchronise all **BM Units**, if all were running immediately prior to the **Total Shutdown** or **Partial Shutdown**. Additionally this should highlight any specific issues (i.e. those that would impact on the **BM Unit's** time to be **Synchronised**) that may arise, as time progresses without external supplies being restored.
- (b) **Block Loading Capability**. This should be provided in either graphical or tabular format showing the estimated block loading capability from 0MW to **Registered Capacity**. Any particular 'hold' points should also be identified. The data of each **BM Unit** should be provided for the condition of a **Generating Unit** (which is considered as both a 'hot' unit and cold unit) that was **Synchronised** just prior to the **Total Shutdown** or **Partial Shutdown**. In the case of an **HVDC System** or **DC Converter Station**, data should be provided when the **HVDC System** or **DC Converter Station** has been considered to have run immediately before the **Total Shutdown** or **Partial Shutdown** and equally when the **HVDC System** or **DC Converter Station** has been considered to have been **Shutdown** for a period of 48 hours or more. The block loading assessment should be done against a frequency variation of 49.5Hz – 50.5Hz.

PC.A.5.8 Grid Forming Related Information

PC.A.5.8.1 The following data need only be supplied by **Users** (be they a **GB Code User** or **EU Code User**) or **Non-CUSC Parties** who wish to offer a **Grid Forming Capability** as provided for ECC.6.3.19.3. Where such a **Grid Forming Capability** is provided then the following data items and models are to be supplied.

- (i) Each **GBGF-I** shall be designed so as not to interact and affect the operation, performance, safety or capability of other **User's Plant** and **Apparatus** connected to the **Total System**. To achieve this requirement, each **User** shall be required to submit a **Network Frequency Perturbation Plot** and **Nichols Chart** (or equivalent as agreed with **The Company**) which shall be assessed in accordance with the requirements of ECP.A.3.9.3.

Each **User** or **Non-CUSC Party** is required to supply a high level equivalent architecture diagram of their **Grid Forming Plant** as shown in Figure PC.A.5.8.1 together with the equivalent linear classical block diagram model (using the Laplace Operator) of their **Grid Forming Plant** which should preferably be in the general form shown in Figure PC.A.5.8.1 (a) or Figure PC.A.5.8.1 (b). When submitting either Figure PC.A.5.8.1 (a) or Figure PC.A.5.8.1 (b), each **User** or **Non-CUSC Party** can use their own design, that may be very different to Figures PC.A.5.8.1 (a) or PC.A.5.8.1 (b), but should contain all relevant functions that can include simulation models and other equivalent data and documentation.

Each **User** or **Non-CUSC Party** shall provide a model of their **Grid Forming Plant** which provides a true and accurate reflection of its **Grid Forming Capability**.

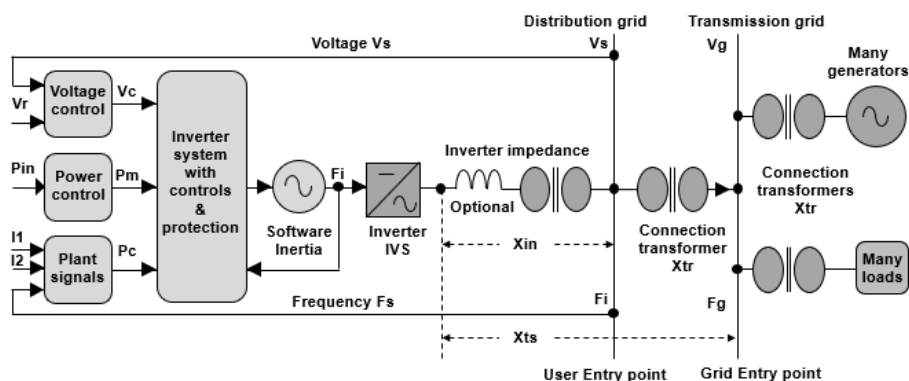

Figure PC.A.5.8.1

Typical simulation model 1

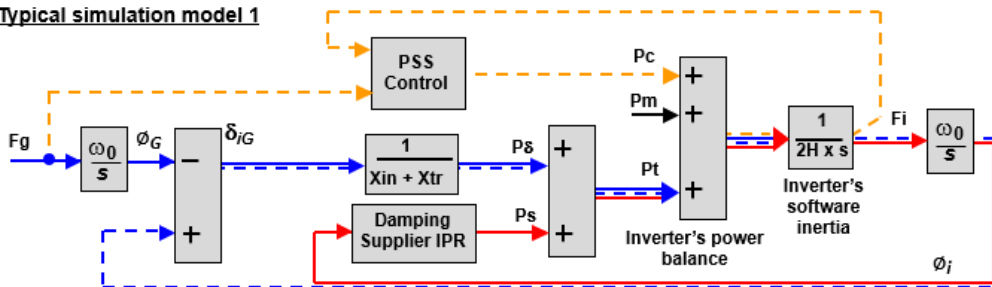

Figure PC.A.5.8.1 (a) Preferred simplified diagram of a **GBGF-I** with a **Power System Stabiliser "PSS"** that can add damping to the **GBGF-I's** closed loop function shown by the solid red line and the dotted blue line.

Typical simulation model 2

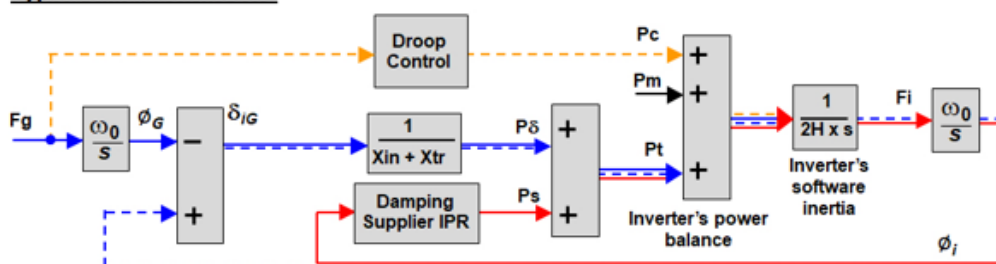

Figure PC.A.5.8.1 (b) – Preferred simplified diagram of a system with a droop control ability that can add **Control-Based Active Droop Power**. This diagram does not add extra closed loop damping to the **GBGF-I's** closed loop function shown by the solid red line and the dotted blue line.

- (ii) In order to participate in the **Grid Forming Capability** market, **User's** and **Non-CUSC Parties** are required to provide data of their **GBGF-I** in accordance with Figures PC.A.5.8.1(a) and PC.A.5.8.1(b). **Users** and **Non-CUSC Parties** in respect of **Grid Forming Plants** should indicate if the data is submitted on a unit or aggregated basis. Table PC.A.5.8.1(a) defines the notation used in Figure PC.5.8.1

Parameter	Symbol	Units
The primary reactance of the Grid Forming Unit , in pu.	X_{in} or X_{ts}	pu on MVA Rating of Grid Forming Unit
The additional reactance, in pu, between the terminals of the Grid Forming Unit and the Grid Entry Point or User System Entry Point (if Embedded).	X_{tr}	pu on MVA Rating of Grid Forming Unit
The rated angle between the Internal Voltage Source and the input terminals of the Grid Forming Unit .		radians
The rated angle between the Internal Voltage Source and Grid Entry Point or User System Entry Point (if Embedded).		radians
The rated voltage and phase of the Internal Voltage Source of the Grid Forming Unit .		Voltage - pu Phase - radians
The rated electrical angle between current and voltage at the input to the Grid transformer.		radians

Table PC.A.5.8.1

- (iii) In order to participate in a **Grid Forming Capability** market, **User's** and **Non-CUSC Parties** are also required to provide the data of their **GBGF-I** in accordance with Table PC.A.5.8.1.2 to **The Company**. The details and arrangements for **Users** and **Non-CUSC Parties** participating in this market shall be published on **The Company's Website**.

Quantity	Units	Range (where Applicable)	User Defined Parameter

Type of Grid Forming Plant (eg Generating Unit, Electricity Storage Module, Dynamic Reactive Compensation Equipment etc)	N/A		
Maximum Continuous Rating at Registered Capacity or Maximum Capacity	MVA		
Primary reactance X_{in} or X_{ts} (see Table PC.A.5.8.1)	pu on MVA		
Additional reactance X_{tr} (See Table PC.A.5.8.1)	pu on MVA		
Maximum Capacity	MW		
Active ROCOF Response Power (MW) injected or absorbed at 1Hz/s System Frequency change (which is the maximum frequency change for linear operation of the Grid Forming Plant)	MW		
Phase Jump Angle Withstand	degrees		60 degrees specified
Phase Jump Angle limit	degrees		5 degrees recommended
Phase Jump Power (MW) at the rated angle	MW		
Defined Active Damping Power for a Grid Oscillation Value of 0.05 Hz peak to peak at 1 Hz	MW		
The cumulative energy delivered for a 1Hz/s System Frequency fall from 52 Hz to 47 Hz. This is the total Active Power transient output of the Grid Forming Plant	MWs or MJ		
Inertia Constant (H) using equation 1 or declared in accordance with the simulation results of ECP.A.3.9.4	MWs/MVA		
Inertia Constant (He) using equation 2 or declared in accordance with the simulation results of ECP.A.3.9.4	MWs/MVA		
Continuous Overload Capability	% on MVA		
Short Term duration Overload capability			

Duration of Short Term Overload Capability	s		
Peak Current Rating	Pu		
Nominal Grid Entry Point or User System Entry Point voltage	kV		
Grid Entry Point or User System Entry Point	- Location		
Continuous or defined time duration MVA Rating	MVA		
Continuous or defined time duration MW Rating	MW		
For a GBGF-I the inverters maximum Internal Voltage Source (IVS) for the worst case condition – for example operation at maximum exporting Reactive Power at the maximum AC System voltage	pu		
Maximum Three Phase Short Circuit Infeed at Grid Entry Point or User System Entry Point	kA		
Maximum Single Phase Short Circuit Infeed at Grid Entry Point or User System Entry Point	kA		
Will the Grid Forming Plant contribute to any other form of commercial service – for example Dynamic Containment, Firm Frequency Response,	Details to be provided		
Equivalent Damping Factor.	Z		0.2 to 5.0 allowed

Table PC.A.5.8.2

$H = \text{Installed MWs} / \text{Rated installed MVA}$

(equation 1)

$H_e = (\text{Active ROCOF Response Power at 1 Hz} / \text{s} \times \text{System Frequency}) / (\text{Installed MVA} \times 2)$

(equation 2)

PC.A.6 USERS' SYSTEM DATA

PC.A.6.1 Introduction

PC.A.6.1.1 Each **User**, whether connected directly via an existing **Connection Point** to the **National Electricity Transmission System** or seeking such a direct connection, or providing terms for connection of an **Offshore Transmission System** to its **User System** to **The Company** or undertaking **OTSDUW**, shall provide **The Company** with data on its **User System** or **OTSDUW Plant and Apparatus** which relates to the **Connection Site** containing the **Connection Point** (or **Interface Points** or **Connection Points** in the case of **OTSUA**) both current and forecast, as specified in PC.A.6.2 to PC.A.6.6.

PC.A.6.1.2 Each **User** must reflect the system effect at the **Connection Site(s)** of any third party **Embedded** within its **User System** whether existing or proposed.

PC.A.6.1.3 PC.A.6.2, and PC.A.6.4 to PC.A.6.7 consist of data which is only to be supplied to **The Company** at **The Company's** reasonable request. In the event that **The Company** identifies a reason for requiring this data, **The Company** shall write to the relevant **User(s)**, requesting the data, and explaining the reasons for the request. If the **User(s)** wishes, **The Company** shall also arrange a meeting at which the request for data can be discussed, with the objective of identifying the best way in which **The Company's** requirements can be met. In respect of **EU Code User(s)** only, **The Company** may request the need for electromagnetic transient simulations at **The Company's** reasonable request. **Users** with **EU Grid Supply Points** may be required to provide electromagnetic transient simulations in relation to those **EU Grid Supply Points** at **The Company's** reasonable request.

Where **The Company** makes a request to a **User** for dynamic models under PC.A.6.7, each relevant **User** shall ensure that the models supplied in respect of their **Plant and Apparatus** reflect the true and accurate behaviour of the **Plant and Apparatus** as built and verified through the **Compliance Processes (CP's)** or **European Compliance Processes (ECP)**.

PC.A.6.2 Transient Overvoltage Assessment Data

PC.A.6.2.1 It is occasionally necessary for **The Company** to undertake transient overvoltage assessments (e.g. capacitor switching transients, switchgear transient recovery voltages, etc). At **The Company's** reasonable request, each **User** is required to provide the following data with respect to the **Connection Site** (and in the case of **OTSUA**, **Interface Points** and **Connection Points**), current and forecast, together with a **Single Line Diagram** where not already supplied under PC.A.2.2.1, as follows:

- (a) busbar layout plan(s), including dimensions and geometry showing positioning of any current and voltage transformers, through bushings, support insulators, disconnectors, circuit breakers, surge arresters, etc. Electrical parameters of any associated current and voltage transformers, stray capacitances of wall bushings and support insulators, and grading capacitances of circuit breakers;
- (b) Electrical parameters and physical construction details of lines and cables connected at that busbar. Electrical parameters of all plant e.g., transformers (including neutral earthing impedance or zig-zag transformers, if any), series reactors and shunt compensation equipment connected at that busbar (or to the tertiary of a transformer) or by lines or cables to that busbar;
- (c) Basic insulation levels (BIL) of all **Apparatus** connected directly, by lines or by cables to the busbar;
- (d) characteristics of overvoltage **Protection** devices at the busbar and at the termination points of all lines, and all cables connected to the busbar;
- (e) fault levels at the lower voltage terminals of each transformer connected directly or indirectly to the **National Electricity Transmission System** (including **OTSUA** at each **Interface Point** and **Connection Point**) without intermediate transformation;
- (f) the following data is required on all transformers operating at **Supergrid Voltage** throughout **Great Britain** and, in Scotland and **Offshore**, also at 132kV or greater (including **OTSUA**): three or five limb cores or single phase units to be specified, and operating peak flux density at nominal voltage;

- (g) an indication of which items of equipment may be out of service simultaneously during **Planned Outage** conditions.

PC.A.6.3 User's Protection Data

PC.A.6.3.1 Protection

The following information is required which relates only to **Protection** equipment which can trip or inter-trip or close any **Connection Point** circuit-breaker or any **Transmission** circuit-breaker (or in the case of **OTSUA**, any **Interface Point** or **Connection Point** circuit breaker). This information need only be supplied once, in accordance with the timing requirements set out in PC.A.1.4(b), and need not be supplied on a routine annual basis thereafter, although **The Company** should be notified if any of the information changes;

- (a) a full description, including estimated settings, for all relays and **Protection** systems installed or to be installed on the **User's System**;
- (b) a full description of any auto-reclose facilities installed or to be installed on the **User's System**, including type and time delays;
- (c) a full description, including estimated settings, for all relays and **Protection** systems or to be installed on the generator, generator transformer, **Station Transformer** and their associated connections;
- (d) for **Generating Units** (including **Synchronous Generating Units** forming part of a **Synchronous Power Generating Module** but excluding **Power Park Units**) or **Power Park Modules** (including **DC Connected Power Park Modules**) or **HVDC Systems** or **DC Converters** at a **DC Converter Station** or **OTSDUW Plant and Apparatus** having (or intended to have) a circuit breaker at the generator terminal voltage, clearance times for electrical faults within the **Generating Unit** (including **Synchronous Generating Units** forming part of a **Synchronous Power Generating Module** but excluding a **Power Park Unit**) or **Power Park Module** (including **DC Connected Power Park Modules**) zone, or within the **OTSDUW Plant and Apparatus**;
- (e) the most probable fault clearance time for electrical faults on any part of the **User's System** directly connected to the **National Electricity Transmission System** including **OTSDUW Plant and Apparatus**; and
- (f) in the case of **OTSDUW Plant and Apparatus**, synchronisation facilities and delayed auto reclose sequence schedules (where applicable).

PC.A.6.4 Harmonic Studies

PC.A.6.4.1 It is occasionally necessary for **The Company** to evaluate the production/magnification of harmonic distortion on the **National Electricity Transmission System** and **User's Systems** (and **OTSUA**), especially when **The Company** is connecting equipment such as capacitor banks. At **The Company's** reasonable request, each **User** is required to submit data with respect to the **Connection Site** (and in the case of **OTSUA**, each **Interface Point** and **Connection Point**), current and forecast, and where not already supplied under PC.A.2.2.4 and PC.A.2.2.5, as follows:

PC.A.6.4.2 Overhead lines and underground cable circuits of the **User's Subtransmission System** must be differentiated and the following data provided separately for each type:

- Positive phase sequence resistance;
- Positive phase sequence reactance;
- Positive phase sequence susceptance;

and for all transformers connecting the **User's Subtransmission System** and **OTSDUW Plant and Apparatus** to a lower voltage:

- Rated MVA;
- Voltage Ratio;
- Positive phase sequence resistance;

Positive phase sequence reactance;
and at the lower voltage points of those connecting transformers:
Equivalent positive phase sequence susceptance;
Connection voltage and MVA rating of any capacitor bank and component design parameters if configured as a filter;
Equivalent positive phase sequence interconnection impedance with other lower voltage points;
The minimum and maximum **Demand** (both MW and MVA) that could occur;
Harmonic current injection sources in Amps at the Connection voltage points. Where the harmonic injection current comes from a diverse group of sources, the equivalent contribution may be established from appropriate measurements;
Details of traction loads, eg connection phase pairs, continuous variation with time, etc;
An indication of which items of equipment may be out of service simultaneously during **Planned Outage** conditions.

PC.A.6.5 Voltage Assessment Studies

It is occasionally necessary for **The Company** to undertake detailed voltage assessment studies (e.g., to examine potential voltage instability, voltage control co-ordination or to calculate voltage step changes). At **The Company's** reasonable request, each **User** is required to submit the following data where not already supplied under PC.A.2.2.4 and PC.A.2.2.5:

For all circuits of the User's Subtransmission System (and any OTSUA):-

Positive Phase Sequence Reactance;
Positive Phase Sequence Resistance;
Positive Phase Sequence Susceptance;
MVA rating of any reactive compensation equipment;

and for all transformers connecting the **User's Subtransmission System** to a lower voltage (and any **OTSUA**):

Rated MVA;
Voltage Ratio;
Positive phase sequence resistance;
Positive Phase sequence reactance;
Tap-changer range;
Number of tap steps;
Tap-changer type: on-load or off-circuit;
AVC/tap-changer time delay to first tap movement;
AVC/tap-changer inter-tap time delay;

and at the lower voltage points of those connecting transformers (and any **OTSUA**):-

Equivalent positive phase sequence susceptance;
MVA rating of any reactive compensation equipment;
Equivalent positive phase sequence interconnection impedance with other lower voltage points;
The maximum **Demand** (both MW and MVA) that could occur;
Estimate of voltage insensitive (constant power) load content in % of total load at both winter peak and 75% off-peak load conditions.

PC.A.6.6 Short Circuit Analysis

PC.A.6.6.1 Where prospective short-circuit currents on **Transmission** equipment are greater than 90% of the equipment rating, and in **The Company's** reasonable opinion more accurate calculations of short-circuit currents are required, then at **The Company's** request each **User** is required to submit data with respect to the **Connection Site** (and in the case of **OTSUA**, each **Interface Point** and **Connection Point**), current and forecast, and where not already supplied under PC.A.2.2.4 and PC.A.2.2.5, as follows:

PC.A.6.6.2 For all circuits of the **User's Subtransmission System** (and any **OTSUA**):

- Positive phase sequence resistance;
- Positive phase sequence reactance;
- Positive phase sequence susceptance;
- Zero phase sequence resistance (both self and mutuals);
- Zero phase sequence reactance (both self and mutuals);
- Zero phase sequence susceptance (both self and mutuals);

and for all transformers connecting the **User's Subtransmission System** to a lower voltage (and any **OTSUA**):

- Rated MVA;
- Voltage Ratio;
- Positive phase sequence resistance (at max, min and nominal tap);
- Positive Phase sequence reactance (at max, min and nominal tap);
- Zero phase sequence reactance (at nominal tap);
- Tap changer range;
- Earthing method: direct, resistance or reactance;
- Impedance if not directly earthed;

and at the lower voltage points of those connecting transformers (and any **OTSUA**):

The maximum **Demand** (in MW and MVA_r) that could occur;

Short-circuit infeed data in accordance with PC.A.2.5.6 unless the **User's** lower voltage network runs in parallel with the **User's Subtransmission System**, when to prevent double counting in each node infeed data, a π equivalent comprising the data items of PC.A.2.5.6 for each node together with the positive phase sequence interconnection impedance between the nodes shall be submitted.

PC.A.6.7 Dynamic Models

PC.A.6.7.1 It is occasionally necessary for **The Company** to evaluate the dynamic performance of **User's Plant** and **Apparatus** at each **EU Grid Supply Point** or in the case of **EU Code Users**, their **System**. At **The Company's** reasonable request and as agreed between **The Company** and the relevant **Network Operator** or **Non-Embedded Customer**, each **User** is required to provide the following data. Where such data is required, **The Company** will work with the **Network Operator** or **Non-Embedded Customer** to establish the scope of the dynamic modelling work and share the required information where it is available:-

- (a) Dynamic model structure and block diagrams including parameters, transfer functions and individual elements (as applicable);
- (b) Power control functions and block diagrams including parameters, transfer functions and individual elements (as applicable);
- (c) Voltage control functions and block diagrams including parameters, transfer functions and individual elements (as applicable);

- (d) Converter control models and block diagrams including parameters, transfer functions and individual elements (as applicable).

PC.A.7 ADDITIONAL DATA FOR NEW TYPES OF POWER STATIONS, DC CONVERTER STATIONS, OTSUA AND CONFIGURATIONS

Notwithstanding the **Standard Planning Data** and **Detailed Planning Data** set out in this Appendix, as new types of configurations and operating arrangements of **Power Stations, HVDC Systems, DC Converter Stations** and **OTSUA** emerge in future, **The Company** may reasonably require additional data to represent correctly the performance of such **Plant** and **Apparatus** on the **System**, where the present data submissions would prove insufficient for the purpose of producing meaningful **System** studies for the relevant parties.

PART 3 - DETAILED PLANNING DATA

PC.A.8 To allow a **User** to model the **National Electricity Transmission System**, **The Company** will provide, upon request, the following **Network Data** to **Users**, calculated in accordance with **Good Industry Practice**:

To allow a **User** to assess undertaking **OTSDUW** and except where provided for in Appendix F, **The Company** will provide upon request the following **Network Data** to **Users**, calculated in accordance with **Good Industry Practice**:

PC.A.8.1 Single Point of Connection

For a **Single Point of Connection** to a **User's System** (and **OTSUA**), as a Transmission System voltage source, the data (as at the HV side of the **Point of Connection** (and in the case of **OTSUA**, each **Interface Point** and **Connection Point**) reflecting data given to **The Company** by **Users**) will be given to a **User** as follows:

The data items listed under the following parts of PC.A.8.3:

(a) (i), (ii), (iii), (iv), (v) and (vi) and the data items shall be provided in accordance with the detailed provisions of PC.A.8.3 (b) - (e).

PC.A.8.2 Multiple Point of Connection

For a **Multiple Point of Connection** to a **User's System** equivalents suitable for use in loadflow and fault level analysis shall be provided. These equivalents will normally be in the form of a π model or extension with a source (or demand for a loadflow equivalent) at each node and a linking impedance. The boundary nodes for the equivalent shall be either at the **Connection Point** (and in the case of **OTSDUW**, each **Interface Point** and **Connection Point**) or (where **The Company** agrees) at suitable nodes (the nodes to be agreed with the **User**) within the **National Electricity Transmission System**. The data at the **Connection Point** (and in the case of **OTSDUW**, each **Interface Point** and **Connection Point**) will be given to a **User** as follows:

The data items listed under the following parts of PC.A.8.3:-

(a) (i), (ii), (iv), (v), (vi), (vii), (viii), (ix), (x) and (xi)

and the data items shall be provided in accordance with the detailed provisions of PC.A.8.3 (b) - (e).

When an equivalent of this form is not required **The Company** will not provide the data items listed under the following parts of PC.A.8.3:-

(a) (vii), (viii), (ix), (x) and (xi)

PC.A.8.3 Data Items

(a) The following is a list of data utilised in this part of the **PC**. It also contains rules on the data which generally apply.

- (i) symmetrical three-phase short circuit current infeed at the instant of fault from the **National Electricity Transmission System**, (I_1'');
- (ii) symmetrical three-phase short circuit current from the **National Electricity Transmission System** after the subtransient fault current contribution has substantially decayed, (I_1');
- (iii) the zero sequence source resistance and reactance values at the **Point of Connection** (and in case of **OTSUA**, each **Interface Point** and **Connection Point**), consistent with the maximum infeed below;
- (iv) the pre-fault voltage magnitude at which the maximum fault currents were calculated;
- (v) the positive sequence X/R ratio at the instant of fault;
- (vi) the negative sequence resistance and reactance values of the **National Electricity Transmission System** seen from the **Point of Connection** (and in case of **OTSUA**, each **Interface Point** and **Connection Point**), if substantially different from the

- values of positive sequence resistance and reactance which would be derived from the data provided above;
- (vii) the initial positive sequence resistance and reactance values of the two (or more) sources and the linking impedance(s) derived from a fault study constituting the (π) equivalent and evaluated without the **User** network and load and where appropriate without elements of the **National Electricity Transmission System** between the **User** network and agreed boundary nodes (and in case of **OTSUA**, each **Interface Point** and **Connection Point**);
 - (viii) the positive sequence resistance and reactance values of the two (or more) sources and the linking impedance(s) derived from a fault study, considering the short circuit current contributions after the subtransient fault current contribution has substantially decayed, constituting the (π) equivalent and evaluated without the **User** network and load, and where appropriate without elements of the **National Electricity Transmission System** between the **User** network and agreed boundary nodes (and in case of **OTSUA**, each **Interface Point** and **Connection Point**);
 - (ix) the corresponding zero sequence impedance values of the (π) equivalent produced for use in fault level analysis;
 - (x) the **Demand** and voltage at the boundary nodes and the positive sequence resistance and reactance values of the linking impedance(s) derived from a loadflow study considering **National Electricity Transmission System** peak **Demand** constituting the (π) loadflow equivalent; and,
 - (xi) where the agreed boundary nodes are not at a **Connection Point** (and in case of **OTSUA**, **Interface Point** or **Connection Point**), the positive sequence and zero sequence impedances of all elements of the **National Electricity Transmission System** between the **User** network and agreed boundary nodes that are not included in the equivalent (and in case of **OTSUA**, each **Interface Point** and **Connection Point**).
- (b) To enable the model to be constructed, **The Company** will provide data based on the following conditions.
 - (c) The initial symmetrical three phase short circuit current and the transient period three phase short circuit current will normally be derived from the fixed impedance studies. The latter value should be taken as applying at times of 120ms and longer. Shorter values may be interpolated using a value for the subtransient time constant of 40ms. These fault currents will be obtained from a full **System** study based on load flow analysis that takes into account any existing flow across the point of connection being considered.
 - (d) **The Company** will provide the appropriate supergrid transformer data for the **National Electricity Transmission System** associated with equivalent voltage source data.
 - (e) The positive sequence X/R ratio and the zero sequence impedance value will correspond to **The Company's** source network only, that is with the section of network if any with which the equivalent is to be used excluded. These impedance values will be derived from the condition when all **Generating Units** (including **Synchronous Generating Units** forming part of a **Synchronous Power Generating Module**) are **Synchronised** to the **National Electricity Transmission System** or a **User's System** and will take account of active sources only including any contribution from the load to the fault current. The passive component of the load itself or other system shunt impedances should not be included.
 - (f) A **User** may at any time, in writing, specifically request for an equivalent to be prepared for an alternative **System** condition, for example where the **User's System** peak does not correspond to the **National Electricity Transmission System** peak, and **The Company** will, insofar as such request is reasonable, provide the information as soon as reasonably practicable following the request.

PC.A.9 **CONTROL SYSTEM MODEL REQUIREMENTS FOR USERS**

PC.A.9.1 **OBJECTIVE**

PC.A.9.1.1 Control and protection system models, along with other **Plant** and **Apparatus** information are required by this **PC**, with supporting documentation provided to **The Company** in order for **The Company** and **Transmission Licensees** to assess the impact of the **User's Plant and Apparatus** on the transient performance, security and stability of the **Transmission System**.

PC.A.9.1.2 The control and protection system models submitted by the **User** shall be representative of the **User's Plant and Apparatus** at the **Connection Point** appropriate to the type of model eg. RMS or EMT. All control and protection system models must take into account all communication, controller and processing delays relevant to modelling the performance of the **User's Plant and Apparatus**. If all **Power Park Units** or **DC Converters** or **HVDC Converters** contained within the **Users Plant and Apparatus** are not identical, the control system model shall account for this by accurately representing the overall performance of the **Users Plant and Apparatus** at the **Connection Point**.

PC.A.9.1.3 The control and protection system models shall include representation of all relevant functionality required by the Grid Code including services provided to **The Company**. For example, this includes voltage control, LFSM-O, LFSM-U, frequency response, fault ride through, fast fault current injection, protection and automatic switching of shunt devices. Where modes of operation are selectable, the ability to select the mode of operation shall be included within the control system model. Additional guidance on relevant functionality will be published on **The Company** website.

PC.A.9.2. **SCOPE**

PC.A.9.2.1 All **Users** shall provide root mean-square (RMS) models which represent the **Users Plant and Apparatus** and controllers in balanced, RMS, positive phase-sequence, time domain studies.

PC.A.9.2.2 All **Generators, HVDC Converter Station Owners, or HVDC System Owners** directly connected to the **Transmission System** or **Generators with Large Power Stations and HVDC Converter Station Owners or HVDC System Owners with DC Converter Stations or HVDC Systems** embedded within a **User** system which employ converters/invertors to import or export power to or from the **System** shall provide Electro-Magnetic Transient (EMT) models which represent the **Users Plant and Apparatus** in electromagnetic transient studies on the transmission and distribution system. For the avoidance of doubt this includes **Generators** who own and operate a **Power Park Module** comprising doubly fed induction generators and may include the excitation and governor control systems associated with **Synchronous Generating Units** if these impact on the types of study described on **The Company** website.

PC.A.9.2.3 **The Company** may specify requirements for other models in the **Bilateral Agreement** if required for specific connections in accordance with good industry practice. For example Real Time Dynamic Simulator (RTDS) Models may be required for protection co-ordination.

PC.A.9.3 **Balanced Root Mean Squared (RMS) Control System Model**

PC.A.9.3.1 The balanced, root mean-square positive sequence time-domain models shall be able to calculate how aspects, (including but not limited to; **Active Power** and **Reactive Power**) of the **User's Plant and Apparatus** vary due to changes in **System Frequency** and voltage at the **Connection Point**.

PC.A.9.3.2 The RMS models shall include all electrical and mechanical phenomena that impact on the **Active Power** and/or **Reactive Power** of the **User's Plant and Apparatus** for sub-transient, transient and synchronous dynamics within the context of an RMS study assumptions up to and including **Primary** and **Secondary Response** timeframes or when post-event steady state conditions have been achieved.

PC.A.9.3.3 The **User** shall provide RMS models in the software package specified in PC.A.9.8.1.

- PC.A.9.3.4 The RMS models maybe either a User specific model or a standard open-source models, such as a standard WECC, IEEE or IEC control system model available in the software format as specified by **The Company** provided this model represents the **User's Plant and Apparatus** at the **Connection Point**. Where the **User** is referencing a standard model, the **User** will submit an unambiguous reference to the model and a full set of parameters for the control system model representing the control system performance of the real **Plant and Apparatus**.
- PC.A.9.3.4.1 Where a **User** specific model is provided sufficient information shall be provided by the **User** to allow for **The Company** to redevelop RMS models in the event of future software environment changes or version updates. All models shall be accompanied with appropriate documentation with sufficient detail as specified and deemed complete by **The Company** (such agreement not to be unreasonably withheld).
- PC.A.9.3.4.2 Where a **User** specific model is provided the **User** shall provide information:
- (i) a full description of the models structure, functionality and the **User's Plant and Apparatus** represented.
 - (ii) inputs/outputs and functionality,
 - (iii) the information described in PC.A.5 relevant to the technology modelled.
- PC.A.9.3.5 **The Company** may, when necessary, require the **User** to provide details of the proper operation of its complete RMS system representation or to facilitate its understanding of the results of a RMS dynamic simulation or request additional information concerning the RMS control system model. This should take place no later than the issuance of the FON.
- PC.A.9.3.5 The performance requirements for the RMS models are included in Appendix PC.A.9.8
- PC.A.9.4 **Electromagnetic Transient (EMT) Model**
- PC.A.9.4.1 The three-phase electromagnetic transient control and supporting informtion shall include all material aspects of the **User's Plant and Apparatus** that affect the voltage and current outputs, including those of the control and protection response from the **User's Plant and Apparatus**. The models shall represent phenomena that materially affect the voltage and **Frequency** on the **Total System** over timeframes of sub-cycle up to 50 cycles including, but not limited to, switching electronic devices, transformer saturation and equipment energisation.
- PC.A.9.4.2 The **User** shall provide EMT models in the software package specified in PC.A.9.9.1.
- PC.A.9.4.3 The performance requirements for the EMT control system model are included in Appendix PC.A.9.9
- PC.A.9.5 **Replica Control Systems, RTDS, RSCAd**
- PC.A.9.5.1 Where required by the Bilateral Agreement, the **User** shall provide replica and/or suitable Real Time Dynamic Simulator models. The details of any such rmodels will be included in the Bilateral Agreement.
- PC.A.9.6 **CONFIDENTIALITY AND SHARING**
- PC.A.9.6.1 **CONFIDENTIALITY AND SHARING RMS TYPE MODELS**
- PC.A.9.6.1.1 The models, supporting documentation and associated data are provided to **The Company** in order to carry out its duties to meet its **Transmission Licence** and Grid Code obligations. In that regard, **the Company** is entitled to share the models, supporting documentation and associated data with the **Transmission Licensees**. **The Company** and/or **Transmission Licensees** may share the models with companies/contractors employed by **the Company** or **Transmission Licensees** to carry out licensed activities. Where such data is shared with third parties working with **The Company** or **Transmission Licensees**, this data will be shared as provided in GC.12.

- PC.A.9.6.1.2 It is the responsibility of the **User** to provide the RMS models, supporting documentation and associated data to **The Company**. **The Company** will accept the models, supporting documentation and associated data from a manufacturer as a **Manufacturers Data and Performance Report** (See ECP.10). **The Company** will only accept this information from a third party manufacturer provided the third party manufacturer agrees to enter into **The Company's** standard confidentiality agreement for **Users** for sharing of the model as outlined in PC.A.9.6.1. In the event the third party manufacturer is unable to enter into **The Company's** standard confidentiality agreement, the **User** shall be responsible for the provision of the RMS models, supporting documentation and associated data to **The Company**.
- PC.A.9.6.1.3 It may also be necessary for **The Company** to share a representative RMS model with another **User** to comply with applicable Grid Code requirements (e.g. ECC.6.3.17.1.5 and ECC.6.3.17.2.3) and Bilateral Agreement. For these purposes the **User** must recorded in the **Compliance Statements** either:
- (i) A declaration that the models submitted for compliance purposes may be shared; or,
 - (ii) provide an equivalent encrypted version of the model that may be shared. In this event the **User** shall demonstrate that the performance of the models and the encrypted model are comparable.
- PC.A.9.6.1.4 The **User** shall notify **The Company** of any changes to RMS models in accordance with PC.A.1.2. Unless specified otherwise in the **Bilateral Agreement**, RMS models must be submitted:
- (i) at least 3 months prior to date requested for issue of the **Interim Operational Notification**
 - (ii) at least 1 month prior to date of issue of a **Limited Operational Notification** for the **Users Plant and Apparatus**.
- PC.A.9.6.2 CONFIDENTIALITY AND SHARING EMT TYPE MODELS
- PC.A.9.6.2.1 The EMT model, supporting documentation and associated data are provided to **The Company** in order to carry out its duties to meet its **Transmission Licence** and Grid Code obligations. In that regard, **the Company** is entitled to share the EMT models, supporting documentation and associated data with the **Transmission Licensees**. **The Company** and/or **Transmission Licensees** may share the EMT model with companies/contractors employed by **the Company** or **Transmission Licensees** to carry out licensed activities. Where such data is shared with third parties working with **The Company** or **Transmission Licensees**, this data will be shared and protected as provided in GC.12.
- PC.A.9.6.2.2 It is the responsibility of the **User** to provide the EMT models, supporting documentation and associated data to **The Company**. **The Company** will accept the EMT models, supporting documentation and associated data from a manufacturer as a **Manufacturers Data and Performance Report** (See ECP.10). **The Company** will only accept this information from a third party manufacturer provided the third party manufacturer agrees to enter into **The Company's** standard confidentiality agreement for **Users** for sharing of the model as outlined in PC.A.9.6.2. In the event the third party manufacturer is unable to enter into **The Company's** standard confidentiality agreement, the **User** shall be responsible for the provision of the EMT models, supporting documentation and associated data to **The Company**.
- PC.A.9.6.2.3 It may be necessary for **The Company** to share a representative EMT model with another **User** to comply with applicable Grid Code requirements (e.g. ECC.6.3.17.1.5 and ECC.6.3.17.2.3) and Bilateral Agreement. For these purposes the **User** must record in the **Compliance Statements** either:
- (i) a declaration that the EMT model submitted for compliance purposes (PC.A.9.6.2.1) may be shared with another **User** for the purpose of fulfilling relevant Grid Code requirements; or,
 - (ii) provide an equivalent EMT model that maybe shared with another **User** for the purpose of fulfilling relevant Grid Code requirements. In this event the **User** shall declare that the performance of the equivalent EMT model is adequate for the purposes of fulfilling relevant Grid Requirements as published on **The Company** website.

- PC.A.9.6.2.4 Where it is necessary for **The Company** to share a representative EMT model with another **User**, the **User** in receipt of the model shall:
- (i) limit of the use of the EMT model to a specific purpose agreed with **The Company** (e.g. simulation requirements to demonstrate compliance with Grid Code including ECC.6.3.17.1 and ECC.6.3.17.2 and Bilateral Agreement)
 - (ii) control access to the EMT model to only those individuals who are strictly necessary for the execution of the specific purpose.
 - (iii) establish and maintain security measures to restrict access to and prevent distribution of the EMT model (e.g. single computer terminal containing the EMT model and restricting access to file areas where the model resides)
 - (iv) ensure any publication is only for demonstrating compliance with the specific purpose agreed with **The Company** and shall not include any data directly derived from the EMT model
 - (v) not disclose the EMT model
 - (vi) destroy all copies of the EMT model and supporting material in a confidentially secure manner after the execution of the specific purpose is complete. Destruction of the EMT model and supporting material shall be confirmed to **The Company** in writing.
- PC.A.9.6.2.5 The **User** shall notify **The Company** of any changes to EMT models in accordance with PC.A.1.2. Unless specified otherwise in the **Bilateral Agreement**, EMT models must be submitted:
- (i) at least 3 months prior to date requested for issue of the **Interim Operational Notification**
 - (ii) at least 1 month prior to date of issue of a **Limited Operational Notification** for the **Users Plant and Apparatus**.
- PC.A.9.7 VALIDATION
- PC.A.9.7.1 The **User** shall submit evidence that the models have been validated demonstrating that the models under simulation conditions is representative of the **User's Plant and Apparatus** under equivalent conditions. Validation of models before commissioning may be against test results at other comparable sites, Factory Acceptance Tests of comparable equipment, or type test results to show that the responses shown by the models are representative of the **Users Plant and Apparatus**. Results from model validation in accordance internationally recommended standards (for example IEC) where applicable are also acceptable.
- PC.A.9.7.2 A User may request agreement from **The Company** on the process for validating the models. In particular, for **Users Plant and Apparatus** where Factory Acceptance Testing is to be carried out details of any additional model validation at this stage should be agreed in a timely manner prior to the testing being carried out. Tests should generally include steady state **Reactive Power** capability, voltage control, **Fault Ride Through** and **Frequency** response.
- PC.A.9.7.3 After final compliance testing as required under the **CP** or **ECP**, the **User** shall carry out validation of the model simulation results against measurements from final compliance testing in accordance with CP.A.3 or ECP.A.3, to ensure the model responses are representative of the **Users Plant and Apparatus**.
- PC.A.9.7.4 If these tests show the models are not representative of the **User's Plant and Apparatus**, the **User** shall provide updated models, supporting documentation and associated data to ensure the responses shown by the model is representative of the responses shown by **User's Plant and Apparatus** during testing.

- PC.A.9.7.5 In the event **The Company** identifies through lifetime monitoring (OC5) that that the response of the models are not representative of the **User's Plant and Apparatus**, **The Company** shall notify the **User**. The **User** shall provide the revised models, supporting documentation and associated data whose response is representative of the **Users Plant and Apparatus** as soon as reasonably practicable, but in any case no longer than 54 days after notification by **The Company**. In the event of revised models not being made available a **Limited Operational Notification** (as detailed in CP.9 or ECP.9 as applicable) may be issued with appropriate restrictions.
- PC.A.9.7.6 The **User** is responsible for ensuring the models remain representative of the **User's Plant and Apparatus** throughout the operational lifetime of the **User's Plant and Apparatus**. In the event of the **User** modifying hardware/software which affects the control and/or operation of the **Users Plant and Apparatus**, the **User** shall provide **The Company** with updated models, supporting documentation and associated data to enable **The Company** to assess the impact of the modification of the **Users Plant and Apparatus** on the **Total System**. Such changes may require other compliance activity as described in the **CP** or **ECP** as applicable.
- PC.A.9.7.7 The **User** shall demonstrate that the representation of a **User's Plant and Apparatus** and models perform correctly in a sample network model published by **The Company** before being accepted. The **User** should represent the **User's Plant and Apparatus** modelled in accordance with the **Single Line Diagram** and parameters submitted under the **Planning Code** and **DRC** in Schedules 1, 5 or 18 aggregating multiple **Power Park Units** and the collector grid to a single **Power Park Unit** representing a **Power Park Module**.
- PC.A.9.8 RMS MODEL PERFORMANCE SPECIFICATION
- PC.A.9.8.1 The RMS models shall be provided in the format required by **The Company**. **The Company** shall publish on **The Company** website acceptable software versions. **The Company** will act reasonable in determining acceptable software versions or compatible formats. In accordance with good industry practice **The Company** will consult with the industry prior to changing the format required. Prior to the start of model development the **User** may request formal agreement from **The Company** of the software version. The RMS models shall be compatible with Objectives as outlined in Grid Code PC.A.9.1 Additional guidance on RMS model is published on **The Company** website.
- PC.A.9.8.2 GENERAL
- PC.A.9.8.2.1 User RMS models shall interface with the software in a manner that is consistent with the behaviour of standard library models.
- PC.A.9.8.2.1 The models shall use standard library functional blocks representing using standard Laplace block diagram format to the extent practicable.. Where user defined functional blocks have been submitted the **User** must provide **The Company** with the relevant documentation for the model including transfer block diagrams and an explanation of any coding to the satisfaction of **The Company**.
- PC.A.9.8.2.2 The use of any "black boxes" encrypted code or external DLLs is not acceptable. An additional RMS model with these features maybe provided for comparison but for the avoidance of doubt does not meet the requirements of PC.A.9.
- PC.A.9.8.2.3 The **User** shall specify the operating ranges for the model and shall be consistent with the real physical values and the actual performance of the **Plant and Apparatus**. This may include **Reactive Power** limits and allowable voltage ranges with control mode and **Droop** settings configured according to the usual operation. This information shall be provided either on the appropriate per unit base or in physical units.
- PC.A.9.8.2.4 The RMS model must compile without errors. Warnings must be kept to a minimum.
- PC.A.9.8.3 INITIALISATION
- PC.A.9.8.3.1 The RMS model shall be self contained. The combined load-flow and dynamic model shall solve with minimal warnings without the need for manual adjustment or to run external software routines that adjust parameters in either the load-flow case or the dynamic case or both. External software or automation routines to integrate the model are not acceptable.

- PC.A.9.8.3.2 The RMS model shall automatically initialise its parameters from load flow simulations without errors and with minimal warnings , must not result in run time errors and run with minimal warnings , and there must not be any interactions or conflicts with other models. The RMS models initialisation shall be invariant to simulation start time (i.e. not require the simulation to be initialised at a particular time). External software or automation routines to initialise the model are not acceptable.
- PC.A.9.8.3.3 The RMS model is expected to be numerically stable and must adequately represent the expected equipment behaviour over the operational range of the **Plant and Apparatus** at the **Connection Point**. This includes the full load and **Reactive Power** range of the **Plant and Apparatus**, the range of system voltage and **frequency** operating range (described in Grid Code CC.6.1/ECC.6.1), short circuit levels and X/R ratio at the **Connection Point** where it would be in operation. These values maybe requested from **The Company** or the **Distribution Network Owner** during the compliance process. If necessary, the **User** shall provide a supplementary model for specific conditions. All information on the model capabilities shall be addressed in the model documentation provided to **The Company**.
- PC.A.9.8.4 OUTPUT MESSAGES
- PC.A.9.8.4.1 It is not acceptable for the models to crash catastrophically and provide no documentary evidence as to why the simulation failed.
- PC.A.9.8.4.2 RMS models shall allow all appropriate internal variables to be requested for output for the duration of the simulation.
- PC.A.9.8.4.3 In the case where the **User's Plant** trips during simulation, the relevant RMS models shall set the flag that indicates that the **User's Plant** has tripped.
- PC.A.9.8.4.4 For protection events (e.g. crow bar controller operation) the simulation events, including initial detection, operation, and time-out, should be reported to the PowerFactory output window during the simulation.
- PC.A.9.8.5 Integration Time Step
- PC.A.9.8.5.1 The dynamic model must support time domain simulations with a minimum integration step size of 0.01 s.
- PC.A.9.8.5.2 The models must not include algorithms that require use of a particular integration step size (for example the control system model should not fail to solve, or the response be materially different for an integration step size of 0.005 s).
- PC.A.9.8.5.3 Time constants below 0.01 s should only be included if their inclusion is critical to the performance of the dynamic model and should be agreed with **The Company**. In this case, an alternative model may be requested according to PC.A.9.8.3.3, if required.
- PC.A.9.8.5.4 Internal integration algorithms should only be included if their inclusion is critical to meeting the accuracy requirements, and should not materially detract from model simulation speed performance.
- PC.A.9.9 EMT MODEL PERFORMANCE SPECIFICATION
- PC.A.9.9.1 The **User** shall provide EMT models in the format required by **The Company**. **The Company** shall maintain a list of acceptable software versions, and compiler version which shall be published on **The Company** website. **The Company** will act reasonable in determining acceptable software versions or compatible formats. In accordance with good industry practice **The Company** will consult with the industry prior to changing the format required. The EMT models shall be compatible with Objectives as outlined in Grid Code PC.A.9.1 and **The Company** shall also publish on **The Company** website a description of the types of study that **The Company** and **Transmission Licensees** will use the EMT control system models in. Additional guidance on EMT model is also published on **The Company** website.

PC.A.9.9.2 The EMT models maybe encrypted. The scope, behaviour and performance of all encrypted elements must be documented. Documentation should include behaviour and performance of all encrypted inner and outer loop control functionality such as voltage control, frequency control, protection systems, convertor controls and phase locked loop controllers (PLL). Aspects of the control system may be omitted provided the study objectives published by **The Company** in accordance with PC.A.9.4.2 are met in which case the documentation should explain any functionality not included in the EMT control system model.

PC.A.9.9.3 The EMT model shall:

- i) have adjustable operational control parameters. For example this would be expected to include setpoints, control drops, operational limits, relay thresholds. The **User** may seek agreement from **The Company** on the list of adjustable parameters prior to submission of the model.
- ii) be based on plant design and validated against testing of the **Plant and Apparatus** (See Model Validation)
- iii) include all control systems from outer loop control down to inner and switching functions
- iv) represent all electrical, mechanical and control features appropriate for the **Plant and Apparatus** including switching algorithms of power convertors applicable to studies described by **The Company**.
- v) Have all appropriate protection systems modelled for power system transient stability analysis including balanced and unbalanced fault conditions, **Frequency** and voltage disturbances configured to match the site specific installation of the **Plant and Apparatus**. Any protections which relate to multiple disturbances should have an option to be disabled.
- vi) Allow **Plant and Apparatus** to be scaled where appropriate in accordance with good industry practice. For example representation of multiple **Power Park Units** by a single equivalent unit.
- vii) Have time steps which must be appropriate for the accurate representation of the switching algorithms used in the **Plant and Apparatus** and compatible with study time steps down to 10us.
- viii) Be portable between network models which may be any size between a single machine infinite bus power system representation and a full multi node power system network depending on the studies that need to be undertaken.
- ix) Allow multiple instances within a network and be compatible with other control system models within a network.
- x) Be capable of self initiation to **User** defined terminal conditions within 4 seconds of the simulation time when connected to an equivalent Thevenin source. In the case of complex models **The Company** may agree a self initiation simulation time within 6 seconds.
- xi) Warn the **User** by way of an output message when **System** conditions exceed the operational limits of the **Plant and Apparatus** or are not valid for continued operation.
- xii) Be able to be initialised from a snapshot of network conditions

APPENDIX B - SINGLE LINE DIAGRAMS

PC.B.1

The diagrams below show three examples of single line diagrams, showing the detail that should be incorporated in the diagram. The first example is for an **Network Operator** connection, the second for a **Generator** connection, the third for a **Power Park Module** electrically equivalent system.

Network Operator Single Line Diagram

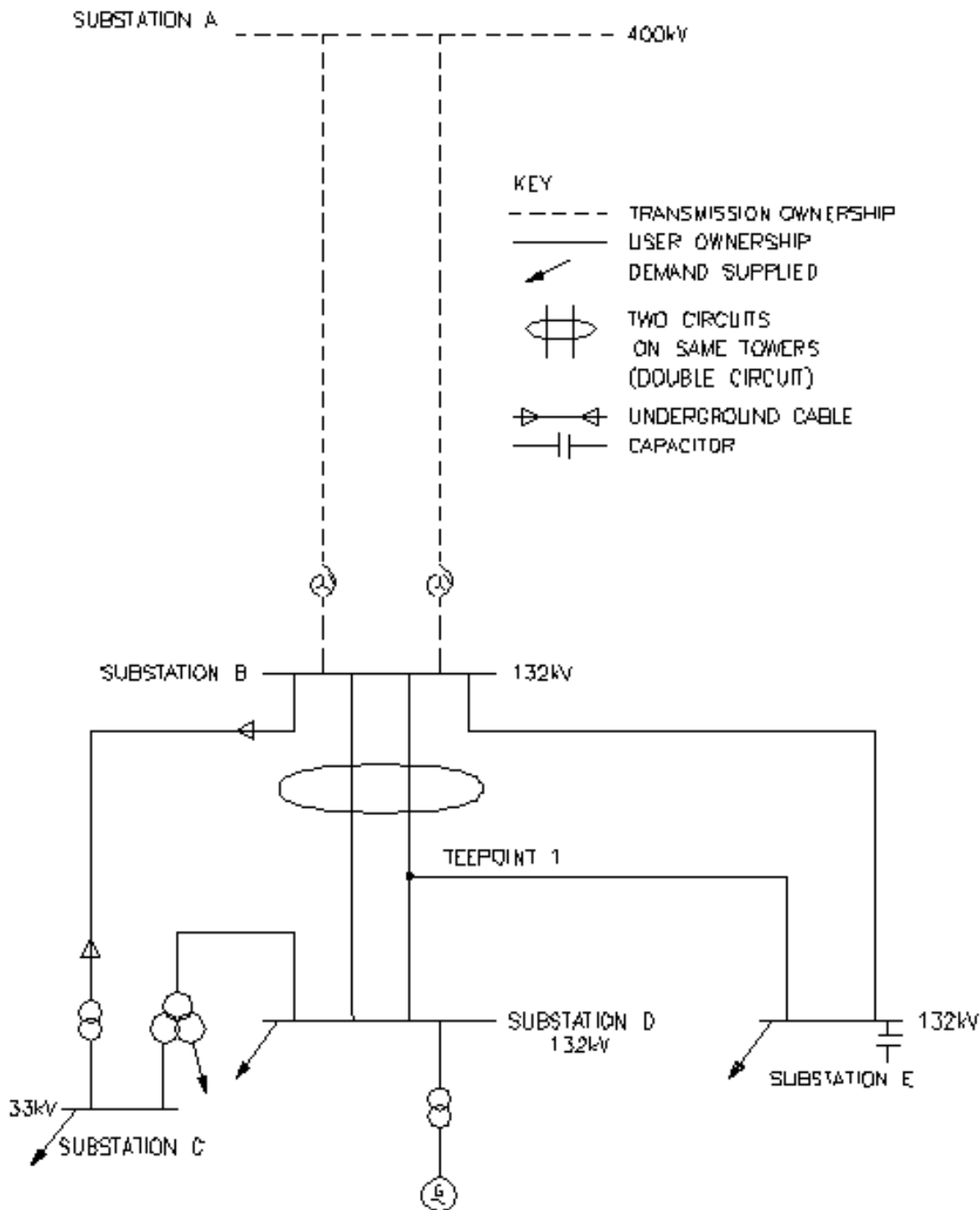

DISSEMINATED BY COMPTON
FOR THE USE OF THE
GENERAL SERVICE

ISS D
41/18826_1_1 29-07-04

Generator Single Line Diagram

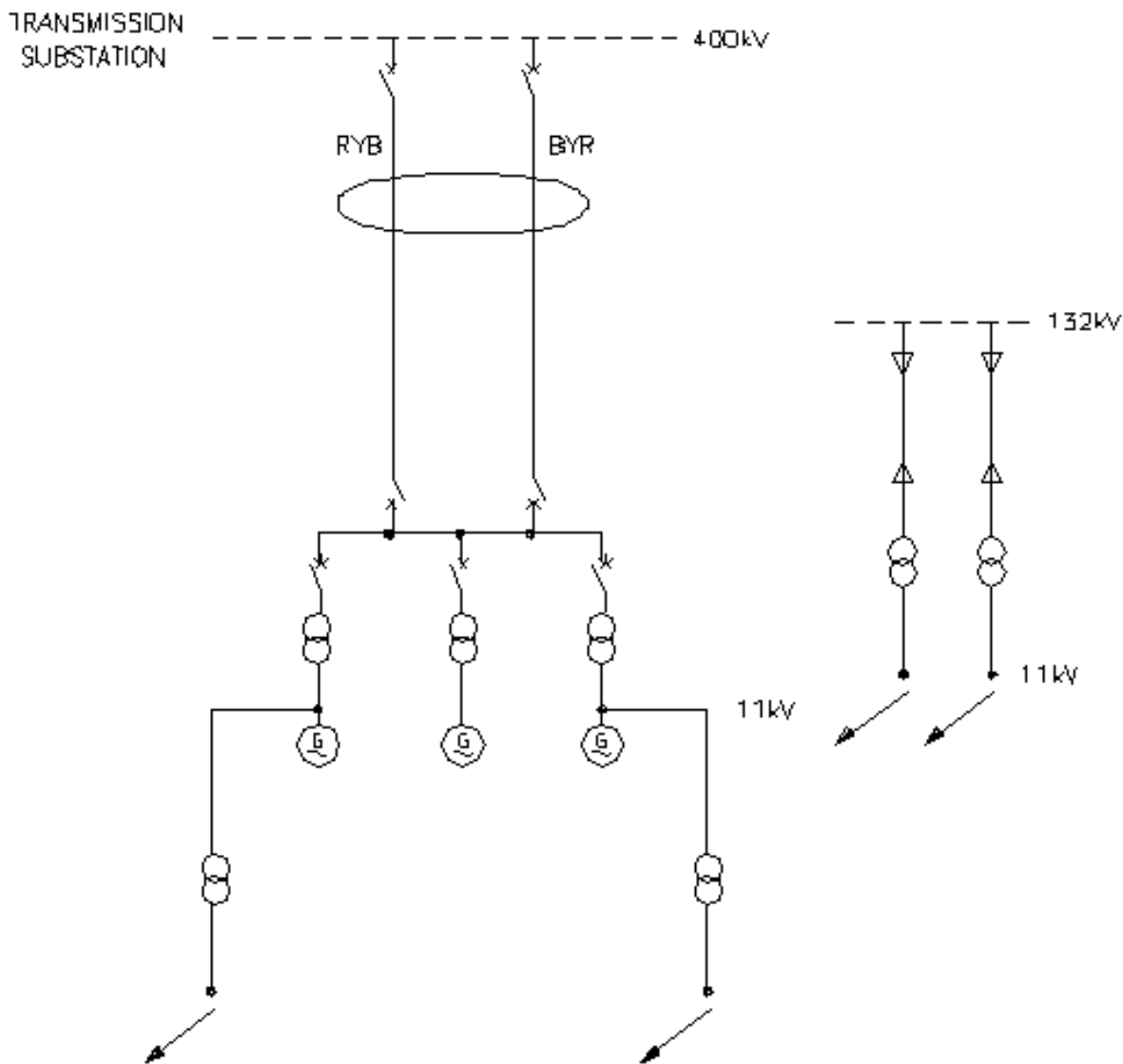

- KEY**
- TRANSMISSION OWNERSHIP
 - USER OWNERSHIP
 - ↙ DEMAND SUPPLIED
 - ⊖ TWO CIRCUITS ON SAME TOWERS (DOUBLE CIRCUIT)
 - ⇄ UNDERGROUND CABLE

TECHNICAL DRAWING
NET ENERGY CO
BYRON REGION

ISS D
41 / 19468_1_1 29-07-04

Power Park Module Single Line Diagram

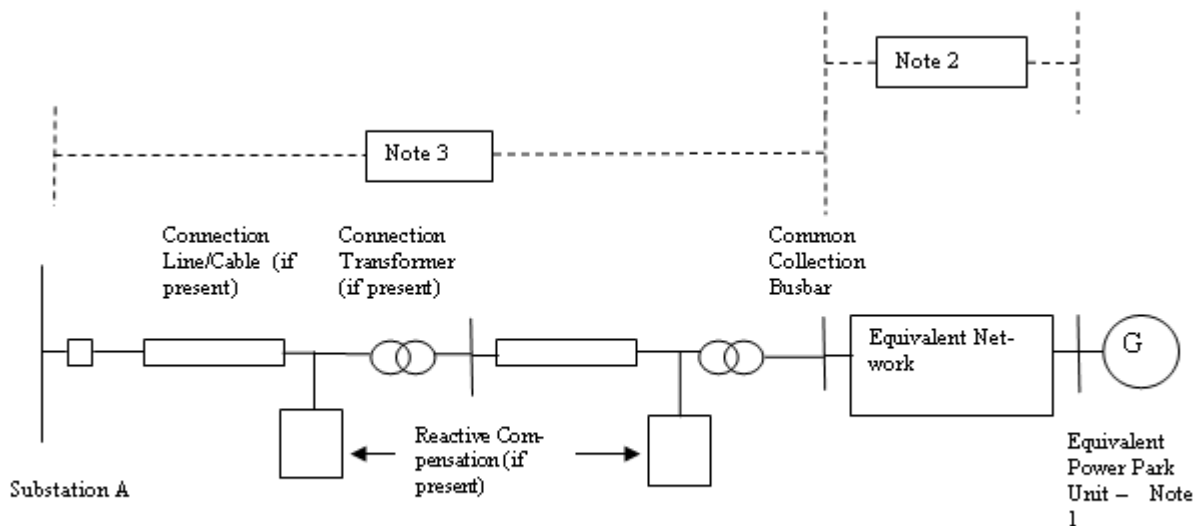

Notes:

- (1) The electrically equivalent **Power Park Unit** consists of a number of actual **Power Park Units** of the same type ie. any equipment external to the **Power Park Unit** terminals is considered as part of the equivalent network. **Power Park Units** of different types shall be included in separate electrically equivalent **Power Park Units**. The total number of equivalent **Power Park Units** shall represent all of the actual **Power Park Units** in the **Power Park Module** (which could be a **DC Connected Power Park Module**).
- (2) Separate electrically equivalent networks are required for each different type of electrically equivalent **Power Park Unit**. The electrically equivalent network shall include all equipment between the **Power Park Unit** terminals and the **Common Collection Busbar**.
- (3) All **Plant** and **Apparatus** including the circuit breakers, transformers, lines, cables and reactive compensation plant between the **Common Collection Busbar** and Substation A shall be shown.

APPENDIX C - TECHNICAL AND DESIGN CRITERIA

- PC.C.1 Planning and design of the **SPT** and **SHETL Transmission Systems** is based generally, but not totally, on criteria which evolved from joint consultation among various **Transmission Licensees** responsible for design of the **National Electricity Transmission System**.
- PC.C.2 The above criteria are set down within the standards, memoranda, recommendations and reports and are provided as a guide to system planning. It should be noted that each scheme for reinforcement or modification of the **Transmission System** is individually designed in the light of economic and technical factors associated with the particular system limitations under consideration.
- PC.C.3 The tables below identify the literature referred to above, together with the main topics considered within each document.

PART 1 – SHETL's TECHNICAL AND DESIGN CRITERIA

ITEM No.	DOCUMENT	REFERENCE No.
1	National Electricity Transmission System Security and Quality of Supply Standard	Version []
2	System Phasing	TPS 13/4
3	Not used	
4	Voltage fluctuations and the connection of disturbing equipment to transmission systems and distribution networks in the United Kingdom	EREC P28 Issue 2
5	EHV or HV Supplies to Induction Furnaces Voltage unbalance limits. Harmonic current limits.	ER P16 (Supported by ACE Report No.48)
6	Planning Levels for Harmonic Voltage Distortion and the Connection of Non-Linear Loads to Transmission Systems and Public Electricity Supply Systems in the United Kingdom Harmonic distortion (waveform). Harmonic voltage distortion. Harmonic current distortion. Stage 1 limits. Stage 2 limits. Stage 3 Limits Addition of Harmonics Short Duration Harmonics Site Measurements	ER G5 (Supported by ACE Report No.73)
7	AC Traction Supplies to British Rail Type of supply point to railway system. Estimation of traction loads. Nature of traction current. System disturbance estimation. Earthing arrangements.	ER P24

ITEM No.	DOCUMENT	REFERENCE No.
8	<p data-bbox="427 152 724 185">Operational Memoranda</p> <p data-bbox="491 219 903 253">Main System operating procedure.</p> <p data-bbox="491 286 895 320">Operational standards of security.</p> <p data-bbox="491 353 1027 387">Voltage and reactive control on main system.</p> <p data-bbox="491 421 1114 488">System warnings and procedures for instructed load reduction.</p> <p data-bbox="491 521 1145 589">Continuous tape recording of system control telephone messages and instructions.</p> <p data-bbox="491 622 1086 689">Emergency action in the event of an exceptionally serious breakdown of the main system.</p>	<p data-bbox="1257 152 1347 185">(SOM)</p> <p data-bbox="1257 219 1347 253">SOM 1</p> <p data-bbox="1257 286 1347 320">SOM 3</p> <p data-bbox="1257 353 1347 387">SOM 4</p> <p data-bbox="1257 421 1347 454">SOM 7</p> <p data-bbox="1257 521 1347 555">SOM 10</p> <p data-bbox="1257 622 1347 656">SOM 15</p>
9	<p data-bbox="427 694 1046 757">Planning Limits for Voltage Unbalance in the United Kingdom.</p>	<p data-bbox="1257 694 1347 728">ER P29</p>

PART 2 - SPT's TECHNICAL AND DESIGN CRITERIA

ITEM No.	DOCUMENT	REFERENCE No.
1	National Electricity Transmission System Security and Quality of Supply Standard	Version []
2	System Phasing	TDM 13/10,002 Issue 4
3	Not used	
4	Voltage fluctuations and the connection of disturbing equipment to transmission systems and distribution networks in the United Kingdom	EREC P28 Issue 2
5	EHV or HV Supplies to Induction Furnaces Voltage Unbalance limits. Harmonic current limits.	ER P16 (Supported by ACE Report No.48)
6	Planning Levels for Harmonic Voltage Distortion and the Connection of Non-Linear Loads to Transmission Systems and Public Electricity Supply Systems in the United Kingdom Harmonic distortion (waveform). Harmonic voltage distortion. Harmonic current distortion. Stage 1 limits. Stage 2 limits. Stage 3 Limits Addition of Harmonics Short Duration Harmonics Site Measurements	ER G5 (Supported by ACE Report No.73)
7	AC Traction Supplies to British Rail Type of supply point to railway system. Estimation of traction loads. Nature of traction current. System disturbance estimation. Earthing arrangements.	ER P24

APPENDIX D - DATA NOT DISCLOSED TO A RELEVANT TRANSMISSION LICENSEE

PC.D.1 Pursuant to PC.3.4, **The Company** will not disclose to a **Relevant Transmission Licensee** data items specified in the below extract:

PC REFERENCE	DATA DESCRIPTION	UNITS	DATA CATEGORY
PC.A.3.2.2 (f) (i)	<p>(i) For GB Code Users</p> <p>The Generator Performance Chart at the Generating Unit stator terminals</p> <p>(ii) For EU Code Users:-</p> <p>The Power Generating Module Performance Chart, and Synchronous Generating Unit Performance Chart;</p>		SPD
PC.A.3.2.2 (b)	Output Usable (on a monthly basis)	MW	SPD
PC.A.5.3.2 (d) Option 1 (iii)	<p>GOVERNOR AND ASSOCIATED PRIME MOVER PARAMETERS</p> <p>Option 1</p> <p>BOILER & STEAM TURBINE DATA</p> <p>Boiler time constant (Stored Active Energy)</p> <p>HP turbine response ratio: (Proportion of Primary Response arising from HP turbine)</p> <p>HP turbine response ratio: (Proportion of High Frequency Response arising from HP turbine)</p>	<p>S</p> <p>%</p> <p>%</p>	<p>DPD II</p> <p>DPD II</p> <p>DPD II</p>
Part of PC.A.5.3.2 (d) Option 2 (i)	<p>Option 2</p> <p>All Generating Units (including Synchronous Generating Units forming part of a Synchronous Power Generating Module)</p> <p>Governor Deadband or (Frequency Response Deadband and Frequency Response Insensitivity)*</p> <p>- Maximum Setting</p> <p>- Normal Setting</p> <p>- Minimum Setting</p> <p>*(Note GB Generators who are not required to satisfy the requirements of the European Connection Conditions do not need to supply Frequency Response Deadband or Frequency Response Insensitivity data).</p>	<p>±Hz</p> <p>±Hz</p> <p>±Hz</p>	<p>DPD II</p> <p>DPD II</p> <p>DPD II</p>
Part of PC.A.5.3.2 (d) Option 2 (ii)	Steam Units		

PC REFERENCE	DATA DESCRIPTION	UNITS	DATA CATEGORY
	Reheater Time Constant	sec	DPD II
	Boiler Time Constant	sec	DPD II
	HP Power Fraction	%	DPD II
	IP Power Fraction	%	DPD II
Part of PC.A.5.3.2 (d) Option 2 (iii)	Gas Turbine Units Waste Heat Recovery Boiler Time Constant		
Part of PC.A.5.3.2 (e)	UNIT CONTROL OPTIONS		
	Maximum droop	%	DPD II
	Minimum droop	%	DPD II
	Maximum Governor Deadband or (Maximum Frequency Response Deadband and Maximum Frequency Response Insensitivity)*	±Hz	DPD II
	Normal Governor Deadband or (normal Frequency Response Deadband and normal Frequency Response Insensitivity)*	±Hz	DPD II
	Minimum Governor Deadband or (minimum Frequency Response Deadband and minimum Frequency Response Insensitivity)*	±Hz	DPD II
	Maximum Output Governor Deadband or (Maximum Output Frequency Response Deadband and Maximum Output Frequency Response Insensitivity)*	±MW	DPD II
	Normal Output Governor Deadband or (Normal Output Frequency Response Deadband and Normal Output Frequency Response Insensitivity)*	±MW	DPD II
	Minimum Output Governor Deadband or (Minimum Output Frequency Response Deadband and Minimum Output Frequency Response Insensitivity)*	±MW	DPD II
	(Note Generators who are not required to satisfy the requirements of the European Connection Conditions do not need to supply Frequency Response Deadband and Frequency Response Insensitivity data).		
	Frequency settings between which Unit Load Controller droop applies:		
	Maximum	Hz	DPD II
	Normal	Hz	DPD II
	Minimum	Hz	DPD II
	Sustained response normally selected	Yes/No	DPD II
PC.A.3.2.2 (f) (ii)	Performance Chart of a Power Park Modules (including DC Connected Power Park Modules) at the connection point		SPD

PC REFERENCE	DATA DESCRIPTION	UNITS	DATA CATEGORY
PC.A.3.2.2 (b)	Output Usable (on a monthly basis)	MW	SPD
PC.A.3.2.2 (e) and (j)	DC CONVERTER STATION AND HVDC SYSTEM DATA ACTIVE POWER TRANSFER CAPABILITY (PC.A.3.2.2) Import MW available in excess of Registered Import Capacity . Time duration for which MW in excess of Registered Import Capacity is available Export MW available in excess of Registered Capacity . Time duration for which MW in excess of Registered Capacity is available	MW Min MW Min	SPD SPD SPD SPD
Part of PC.A.5.4.3.3	LOADING PARAMETERS MW Export Nominal loading rate Maximum (emergency) loading rate MW Import Nominal loading rate Maximum (emergency) loading rate	MW MW/s MW/s MW/s MW/s	SPD DPD I DPD I DPD I DPD I

**APPENDIX E - OFFSHORE TRANSMISSION SYSTEM AND OTSDUW PLANT AND APPARATUS
TECHNICAL AND DESIGN CRITERIA**

PC.E.1 In the absence of any relevant **Electrical Standards, Offshore Transmission Licensees and Generators** undertaking **OTSDUW** are required to ensure that all equipment used in the construction of their network is:

- (i) Fully compliant and suitably designed to any relevant **Technical Specification**;
- (ii) Suitable for use and operation in an **Offshore** environment, where such parts of the **Offshore Transmission System** and **OTSDUW Plant and Apparatus** are located in **Offshore Waters** and are not installed in an area that is protected from that **Offshore** environment, and
- (iii) Compatible with any relevant **Electrical Standards** or **Technical Specifications** at the **Offshore Grid Entry Point** and **Interface Point**.

PC.E.2 The table below identifies the technical and design criteria that will be used in the design and development of an **Offshore Transmission System** and **OTSDUW Plant and Apparatus**.

ITEM No.	DOCUMENT	REFERENCE No.
1	National Electricity Transmission System Security and Quality of Supply Standard	Version []
2*	Voltage fluctuations and the connection of disturbing equipment to transmission systems and distribution networks in the United Kingdom	EREC P28 Issue 2
3*	Planning Levels for Harmonic Voltage Distortion and the Connection of Non-Linear Loads to Transmission Systems and Public Electricity Supply Systems in the United Kingdom	ER G5
4*	Planning Limits for Voltage Unbalance in the United Kingdom	ER P29

* Note:- Items 2, 3 and 4 above shall only apply at the **Interface Point**.

APPENDIX F - OTSDUW DATA AND INFORMATION AND OTSDUW NETWORK DATA AND INFORMATION

- PC.F.1 Introduction
- PC.F.1.1 Appendix F specifies data requirements to be submitted to **The Company** by **Users** and **Users** by **The Company** in respect of **OTSDUW**.
- PC.F.1.2 Such **User** submissions shall be in accordance with the **OTSDUW Development and Data Timetable** in a **Construction Agreement**.
- PC.F.1.3 Such submissions shall be issued to **The Company** with the offer of a **CUSC Contract** in the case of the data in Part 1 and otherwise in accordance with the **OTSDUW Development and Data Timetable** in a **Construction Agreement**.
- PC.F.2. OTSDUW Network Data and Information
- PC.F.2.1 With the offer of a **CUSC Contract** under the **OTSDUW Arrangements** **The Company** shall provide:
- (a) the site specific technical design and operational criteria for the **Connection Site**;
 - (b) the site specific technical design and operational criteria for the **Interface Point**, and
 - (c) details of **The Company's** preliminary identification and consideration of the options available for the **Interface Point** in the context of the **User's** application for connection or modification, the preliminary costs used by **The Company** in assessing such options and the **Offshore Works Assumptions** including the assumed **Interface Point** identified during these preliminary considerations.
- PC.F.2.2 In accordance with the **OTSDUW Development and Data Timetable** in a **Construction Agreement** **The Company** shall provide the following information and data to a **User**:
- (a) equivalent of the fault infeed or fault level ratings at the Interface Point (as identified in the **Offshore Works Assumptions**)
 - (b) notification of numbering and nomenclature of the **HV Apparatus** comprised in the **OTSDUW**;
 - (i) past or present physical properties, including both actual and designed physical properties, of **Plant** and **Apparatus** forming part of the **National Electricity Transmission System** at the Interface Point at which the **OTSUA** will be connected to the extent it is required for the design and construction of the **OTSDUW**, including but not limited to:
 - (ii) the voltage of any part of such **Plant** and **Apparatus**;
 - (iii) the electrical current flowing in or over such **Plant** and **Apparatus**;
 - (iv) the configuration of any part of such **Plant** and **Apparatus**
 - (v) the temperature of any part of such **Plant** and **Apparatus**;
 - (vi) the pressure of any fluid forming part of such **Plant** and **Apparatus**
 - (vii) the electromagnetic properties of such **Plant** and **Apparatus**; and
 - (viii) the technical specifications, settings or operation of any **Protection Systems** forming part of such **Plant** and **Apparatus**.
 - (c) information necessary to enable the **User** to harmonise the **OTSDUW** with construction works elsewhere on the **National Electricity Transmission System** that could affect the **OTSDUW**;
 - (d) information related to the current or future configuration of any circuits of the **Onshore Transmission System** with which the **OTSUA** are to connect;
 - (e) any changes which are planned on the **National Electricity Transmission System** in the current or following six **Financial Years** and which will materially affect the planning or development of the **OTSDUW**.

- PC.F.2.3 At the **Users** reasonable request, additional information and data in respect of the **National Electricity Transmission System** shall be provided.
- PC.F.2.4 OTSDUW Data And Information
- PC.F.2.4.1 In accordance with the **OTSDUW Development and Data Timetable** in a **Construction Agreement**, the **User** shall provide to **The Company**, the following information and data relating to the **OTSDUW Plant and Apparatus** in accordance with Appendix A of the **Planning Code**.

< END OF PLANNING CODE >

CONNECTION CONDITIONS

(CC)

CONTENTS

(This contents page does not form part of the Grid Code)

<u>Paragraph No/Title</u>	<u>Page Number</u>
CC.1 INTRODUCTION.....	2
CC.2 OBJECTIVE	2
CC.3 SCOPE	2
CC.4 PROCEDURE	4
CC.5 CONNECTION	4
CC.6 TECHNICAL, DESIGN AND OPERATIONAL CRITERIA.....	6
CC.7 SITE RELATED CONDITIONS	47
CC.8 ANCILLARY SERVICES	53
APPENDIX 1 - SITE RESPONSIBILITY SCHEDULES	55
PROFORMA FOR SITE RESPONSIBILITY SCHEDULE	57
APPENDIX 2 - OPERATION DIAGRAMS.....	61
PART 1A - PROCEDURES RELATING TO OPERATION DIAGRAMS	61
PART 1B - PROCEDURES RELATING TO GAS ZONE DIAGRAMS	64
PART 2 - NON-EXHAUSTIVE LIST OF APPARATUS TO BE INCLUDED ON OPERATION DIAGRAMS.....	65
APPENDIX 3 - MINIMUM FREQUENCY RESPONSE REQUIREMENT PROFILE AND OPERATING RANGE FOR NEW POWER STATIONS AND DC CONVERTER STATIONS	68
APPENDIX 4 - FAULT RIDE THROUGH REQUIREMENTS.....	72
APPENDIX 4A	72
APPENDIX 4B	78
APPENDIX 5 - TECHNICAL REQUIREMENTS LOW FREQUENCY RELAYS FOR THE AUTOMATIC DISCONNECTION OF SUPPLIES AT LOW FREQUENCY	84
APPENDIX 6 - PERFORMANCE REQUIREMENTS FOR CONTINUOUSLY ACTING AUTOMATIC EXCITATION CONTROL SYSTEMS FOR ONSHORE SYNCHRONOUS GENERATING UNITS.....	87
APPENDIX 7 - PERFORMANCE REQUIREMENTS FOR CONTINUOUSLY ACTING AUTOMATIC VOLTAGE CONTROL SYSTEMS FOR ONSHORE NON-SYNCHRONOUS GENERATING UNITS, ONSHORE DC CONVERTERS, ONSHORE POWER PARK MODULES AND OTSDUW PLANT AND APPARATUS AT THE INTERFACE POINT	91

CC.1 INTRODUCTION

CC.1.1 The **Connection Conditions** ("CC") specify both:

- (a) the minimum technical, design and operational criteria which must be complied with by:
 - (i) any **GB Code User** connected to or seeking connection with the **National Electricity Transmission System**, or
 - (ii) **GB Code User's** in respect of **GB Generators** (other than in respect of **Small Power Stations**) or **GB Code User's** in respect of **DC Converter Station** owners connected to or seeking connection to a **User's System** which is located in **Great Britain** or **Offshore**, and
- (b) the minimum technical, design and operational criteria with which **The Company** will comply in relation to the part of the **National Electricity Transmission System** at the **Connection Site** with **GB Code Users**. In the case of any **OTSDUW Plant and Apparatus**, the **CC** also specify the minimum technical, design and operational criteria which must be complied with by those **GB Code Users** when undertaking **OTSDUW**.
- (c) For the avoidance of doubt, the requirements of these **CC's** do not apply to **EU Code User's** for whom the requirements of the **ECC's** shall apply.

CC.2 OBJECTIVE

CC.2.1 The objective of the **CC** is to ensure that by specifying minimum technical, design and operational criteria, the basic rules for connection to the **National Electricity Transmission System** and (for certain **GB Code Users**) to a **User's System** are similar for all **GB Code Users** of an equivalent category and will enable **The Company** to comply with its statutory and **Transmission Licence** obligations.

CC.2.2 In the case of any **OTSDUW**, the objective of the **CC** is to ensure that by specifying the minimum technical, design and operational criteria, the basic rules relating to an **Offshore Transmission System** designed and constructed by an **Offshore Transmission Licensee** or designed and/or constructed by an **GB Code User** under the **OTSDUW Arrangements** are equivalent.

CC.2.3 Provisions of the **CC** which apply in relation to **OTSDUW** and **OTSUA**, and/or a **Transmission Interface Site**, shall (in any particular case) apply up to the **OTSUA Transfer Time**, whereupon such provisions shall (without prejudice to any prior non-compliance) cease to apply, without prejudice to the continuing application of provisions of the **CC** applying in relation to the relevant **Offshore Transmission System** and/or **Connection Site**. It is the case therefore that in cases where the **OTSUA** becomes operational prior to the **OTSUA Transfer Time** that a **GB Generator** is required to comply with this **CC** both as it applies to its **Plant** and **Apparatus** at a **Connection Site/Connection Point** and the **OTSUA** at the **Transmission Interface Site/Transmission Interface Point** until the **OTSUA Transfer Time** and this **CC** shall be construed accordingly.

CC.2.4 In relation to **OTSDUW**, provisions otherwise to be contained in a **Bilateral Agreement** may be contained in the **Construction Agreement**, and accordingly a reference in the **CC** to a relevant **Bilateral Agreement** includes the relevant **Construction Agreement**.

CC.3 SCOPE

CC.3.1 The **CC** applies to **The Company** and to **GB Code Users**, which in the **CC** means:

- (a) **GB Generators** (other than those which only have **Embedded Small Power Stations**), including those undertaking **OTSDUW**;
- (b) **Network Operators**;
- (c) **Non-Embedded Customers**;

- (d) **DC Converter Station** owners; and
- (e) **BM Participants** and **Externally Interconnected System Operators** in respect of CC.6.5 , CC.7.9 and CC.7.10 only.

CC.3.2 The above categories of **GB Code User** will become bound by the **CC** prior to them generating, distributing, supplying or consuming, as the case may be, and references to the various categories should, therefore, be taken as referring to them in that prospective role as well as to **GB Code Users** actually connected.

CC.3.3 **Embedded Medium Power Stations** not subject to a **Bilateral Agreement** and **Embedded DC Converter Stations** not subject to a **Bilateral Agreement** Provisions.

The following provisions apply in respect of **Embedded Medium Power Stations** not subject to a **Bilateral Agreement** and **Embedded DC Converter Stations** not subject to a **Bilateral Agreement**.

CC.3.3.1 The obligations within the **CC** that are expressed to be applicable to **GB Generators** in respect of **Embedded Medium Power Stations** not subject to a **Bilateral Agreement** and **DC Converter Station** Owners in respect of **Embedded DC Converter Stations** not subject to a **Bilateral Agreement** (where the obligations are in each case listed in CC.3.3.2) shall be read and construed as obligations that the **Network Operator** within whose **System** any such **Medium Power Station** or **DC Converter Station** is **Embedded** must ensure are performed and discharged by the **GB Generator** or the **DC Converter Station** owner. **Embedded Medium Power Stations** not subject to a **Bilateral Agreement** and **Embedded DC Converter Stations** not subject to a **Bilateral Agreement** which are located **Offshore** and which are connected to an **Onshore GB Code Users System** will be required to meet the applicable requirements of the Grid Code as though they are an **Onshore GB Generator** or **Onshore DC Converter Station Owner** connected to an **Onshore User System Entry Point**.

CC.3.3.2 The **Network Operator** within whose **System** a **Medium Power Station** not subject to a **Bilateral Agreement** is **Embedded** or a **DC Converter Station** not subject to a **Bilateral Agreement** is **Embedded** must ensure that the following obligations in the **CC** are performed and discharged by the **GB Generator** in respect of each such **Embedded Medium Power Station** or the **DC Converter Station** owner in the case of an **Embedded DC Converter Station**:

CC.5.1

CC.5.2.2

CC.5.3

CC.6.1.3

CC.6.1.5 (b)

CC.6.3.2, CC.6.3.3, CC.6.3.4, CC.6.3.6, CC.6.3.7, CC.6.3.8, CC.6.3.9, CC.6.3.10, CC.6.3.12, CC.6.3.13, CC.6.3.15, CC.6.3.16

CC.6.4.4

CC.6.5.6 (where required by CC.6.4.4)

In respect of CC.6.2.2.2, CC.6.2.2.3, CC.6.2.2.5, CC.6.1.5(a), CC.6.1.5(b) and CC.6.3.11 equivalent provisions as co-ordinated and agreed with the **Network Operator** and **GB Generator** or **DC Converter Station** owner may be required. Details of any such requirements will be notified to the **Network Operator** in accordance with CC.3.5.

CC.3.3.3 In the case of **Embedded Medium Power Stations** not subject to a **Bilateral Agreement** and **Embedded DC Converter Stations** not subject to a **Bilateral Agreement** the requirements in:

CC.6.1.6

- CC.6.3.8
- CC.6.3.12
- CC.6.3.15
- CC.6.3.16

that would otherwise have been specified in a **Bilateral Agreement** will be notified to the relevant **Network Operator** in writing in accordance with the provisions of the **CUSC** and the **Network Operator** must ensure such requirements are performed and discharged by the **GB Generator** or the **DC Converter Station** owner.

- CC.3.4 In the case of **Offshore Embedded Power Stations** connected to an **Offshore GB Code User's System** which directly connects to an **Offshore Transmission System**, any additional requirements in respect of such **Offshore Embedded Power Stations** may be specified in the relevant **Bilateral Agreement** with the **Network Operator** or in any **Bilateral Agreement** between **The Company** and such **Offshore Embedded Power Station**.
- CC.3.5 In the case of a **GB Generator** undertaking **OTSDUW** connecting to an **Onshore Network Operator's System**, any additional requirements in respect of such **OTSDUW Plant and Apparatus** will be specified in the relevant **Bilateral Agreement** with the **GB Generator**. For the avoidance of doubt, requirements applicable to **GB Generators** undertaking **OTSDUW** and connecting to a **Network Operator's System**, shall be consistent with those applicable requirements of **GB Generators** undertaking **OTSDUW** and connecting to a **Transmission Interface Point**.

CC.4 PROCEDURE

- CC.4.1 The **CUSC** contains certain provisions relating to the procedure for connection to the **National Electricity Transmission System** or, in the case of **Embedded Power Stations** or **Embedded DC Converter Stations**, becoming operational and includes provisions relating to certain conditions to be complied with by **GB Code Users** prior to and during the course of **The Company** notifying the **GB Code User** that it has the right to become operational. The procedure for a **GB Code User** to become connected is set out in the **Compliance Processes**.

CC.5 CONNECTION

- CC.5.1 The provisions relating to connecting to the **National Electricity Transmission System** (or to a **User's System** in the case of a connection of an **Embedded Large Power Station** or **Embedded Medium Power Station** or **Embedded DC Converter Station**) are contained in:

- (a) the **CUSC** and/or **CUSC Contract** (or in the relevant application form or offer for a **CUSC Contract**);
- (b) or, in the case of an **Embedded Development**, the relevant **Distribution Code** and/or the **Embedded Development Agreement** for the connection (or in the relevant application form or offer for an **Embedded Development Agreement**),

and include provisions relating to both the submission of information and reports relating to compliance with the relevant **Connection Conditions** for that **GB Code User**, **Safety Rules**, commissioning programmes, **Operation Diagrams** and approval to connect (and their equivalents in the case of **Embedded Medium Power Stations** not subject to a **Bilateral Agreement** or **Embedded DC Converter Stations** not subject to a **Bilateral Agreement**). References in the **CC** to the "**Bilateral Agreement**" and/or "**Construction Agreement**" and/or "**Embedded Development Agreement**" shall be deemed to include references to the application form or offer therefor.

CC.5.2 Items For Submission

CC.5.2.1

Prior to the **Completion Date** (or, where the **GB Generator** is undertaking **OTSDUW**, any later date specified) under the **Bilateral Agreement** and/or **Construction Agreement**, the following is submitted pursuant to the terms of the **Bilateral Agreement** and/or **Construction Agreement**:

- (a) updated **Planning Code** data (both **Standard Planning Data** and **Detailed Planning Data**), with any estimated values assumed for planning purposes confirmed or, where practical, replaced by validated actual values and by updated estimates for the future and by updated forecasts for **Forecast Data** items such as **Demand**, pursuant to the requirements of the **Planning Code**;
- (b) details of the **Protection** arrangements and settings referred to in CC.6;
- (c) copies of all **Safety Rules** and **Local Safety Instructions** applicable at **Users' Sites** which will be used at the **Transmission/User** interface (which, for the purpose of **OC8**, must be to **The Company's** satisfaction regarding the procedures for **Isolation** and **Earthing**. **The Company** will consult the **Relevant Transmission Licensee** when determining whether the procedures for **Isolation** and **Earthing** are satisfactory);
- (d) information to enable the preparation of the **Site Responsibility Schedules** on the basis of the provisions set out in Appendix 1;
- (e) an **Operation Diagram** for all **HV Apparatus** on the **User** side of the **Connection Point** as described in CC.7;
- (f) the proposed name of the **User Site** (which shall not be the same as, or confusingly similar to, the name of any **Transmission Site** or of any other **User Site**);
- (g) written confirmation that **Safety Co-ordinators** acting on behalf of the **User** are authorised and competent pursuant to the requirements of **OC8**;
- (h) Such **RISSP** prefixes pursuant to the requirements of **OC8**. Prefixes shall be circulated utilising a proforma in accordance with **OC8**;
- (i) a list of the telephone numbers for **Joint System Incidents** at which senior management representatives nominated for the purpose can be contacted and confirmation that they are fully authorised to make binding decisions on behalf of the **User**, pursuant to **OC9**;
- (j) a list of managers who have been duly authorised to sign **Site Responsibility Schedules** on behalf of the **User**;
- (k) information to enable the preparation of the **Site Common Drawings** as described in CC.7;
- (l) a list of the telephone numbers for the **Users** facsimile machines referred to in CC.6.5.9; and
- (m) for **Sites** in Scotland and **Offshore** a list of persons appointed by the **User** to undertake operational duties on the **User's System** (including any **OTSDUW** prior to the **OTSUA Transfer Time**) and to issue and receive operational messages and instructions in relation to the **User's System** (including any **OTSDUW** prior to the **OTSUA Transfer Time**); and an appointed person or persons responsible for the maintenance and testing of **User's Plant** and **Apparatus**.

CC.5.2.2

Prior to the **Completion Date** the following must be submitted to **The Company** by the **Network Operator** in respect of an **Embedded Development**:

- (a) updated **Planning Code** data (both **Standard Planning Data** and **Detailed Planning Data**), with any estimated values assumed for planning purposes confirmed or, where practical, replaced by validated actual values and by updated estimates for the future and by updated forecasts for **Forecast Data** items such as **Demand**, pursuant to the requirements of the **Planning Code**;
- (b) details of the **Protection** arrangements and settings referred to in CC.6;

- (c) the proposed name of the **Embedded Medium Power Station** or **Embedded DC Converter Station Site** (which shall be agreed with **The Company** unless it is the same as, or confusingly similar to, the name of other **Transmission Site** or **User Site**);

CC.5.2.3 Prior to the **Completion Date** contained within an **Offshore Transmission Distribution Connection Agreement**, the following must be submitted to **The Company** by the **Network Operator** in respect of a proposed new **Interface Point** within its **User System**:

- (a) updated **Planning Code** data (both **Standard Planning Data** and **Detailed Planning Data**), with any estimated values assumed for planning purposes confirmed or, where practical, replaced by validated actual values and by updated estimates for the future and by updated forecasts for **Forecast Data** items such as **Demand**, pursuant to the requirements of the **Planning Code**;
- (b) details of the **Protection** arrangements and settings referred to in CC.6;
- (c) the proposed name of the **Interface Point** (which shall not be the same as, or confusingly similar to, the name of any **Transmission Site** or of any other **User Site**);

CC.5.2.4 In the case of **OTSDUW Plant and Apparatus** (in addition to items under CC.5.2.1 in respect of the **Connection Site**), prior to the **Completion Date** (or any later date specified) under the **Construction Agreement** the following must be submitted to **The Company** by the **GB Code User** in respect of the proposed new **Connection Point** and **Interface Point**:

- (a) updated **Planning Code** data (**Standard Planning Data**, **Detailed Planning Data** and **OTSDUW Data and Information**), with any estimated values assumed for planning purposes confirmed or, where practical, replaced by validated actual values and by updated estimates for the future and by updated forecasts for **Forecast Data** items such as **Demand**, pursuant to the requirements of the **Planning Code**;
- (b) details of the **Protection** arrangements and settings referred to in CC.6;
- (c) information to enable preparation of the **Site Responsibility Schedules** at the **Transmission Interface Site** on the basis of the provisions set out in Appendix 1.
- (d) the proposed name of the **Interface Point** (which shall not be the same as, or confusingly similar to, the name of any **Transmission Site** or of any other **User Site**);

- CC.5.3
- (a) Of the items CC.5.2.1 (c), (e), (g), (h), (k) and (m) need not be supplied in respect of **Embedded Power Stations** or **Embedded DC Converter Stations**,
 - (b) item CC.5.2.1(i) need not be supplied in respect of **Embedded Small Power Stations** and **Embedded Medium Power Stations** or **Embedded DC Converter Stations** with a **Registered Capacity** of less than 100MW, and
 - (c) items CC.5.2.1(d) and (j) are only needed in the case where the **Embedded Power Station** or the **Embedded DC Converter Station** is within a **Connection Site** with another **User**.

CC.6 TECHNICAL, DESIGN AND OPERATIONAL CRITERIA

CC.6.1 National Electricity Transmission System Performance Characteristics

CC.6.1.1 **The Company** shall ensure that, subject as provided in the **Grid Code**, the **National Electricity Transmission System** complies with the following technical, design and operational criteria in relation to the part of the **National Electricity Transmission System** at the **Connection Site** with a **GB Code User** and in the case of **OTSDUW Plant and Apparatus**, a **Transmission Interface Point** (unless otherwise specified in CC.6) although in relation to operational criteria **The Company** may be unable (and will not be required) to comply with this obligation to the extent that there are insufficient **Power Stations** or **User Systems** are not available, or **Users** do not comply with **The Company's** instructions or otherwise do not comply with the **Grid Code** and each **GB Code User** shall ensure that its **Plant** and **Apparatus** complies with the criteria set out in CC.6.1.5.

Grid Frequency Variations

- CC.6.1.2 The **Frequency** of the **National Electricity Transmission System** shall be nominally 50Hz and shall be controlled within the limits of 49.5 - 50.5Hz unless exceptional circumstances prevail.
- CC.6.1.3 The **System Frequency** could rise to 52Hz or fall to 47Hz in exceptional circumstances. Design of **GB Code User's Plant and Apparatus** and **OTSDUW Plant and Apparatus** must enable operation of that **Plant** and **Apparatus** within that range in accordance with the following:

<u>Frequency Range</u>	<u>Requirement</u>
51.5Hz - 52Hz	Operation for a period of at least 15 minutes is required each time the Frequency is above 51.5Hz.
51Hz - 51.5Hz	Operation for a period of at least 90 minutes is required each time the Frequency is above 51Hz.
49.0Hz - 51Hz	Continuous operation is required
47.5Hz - 49.0Hz	Operation for a period of at least 90 minutes is required each time the Frequency is below 49.0Hz.
47Hz - 47.5Hz	Operation for a period of at least 20 seconds is required each time the Frequency is below 47.5Hz.

For the avoidance of doubt, disconnection, by frequency or speed based relays is not permitted within the frequency range 47.5Hz to 51.5Hz, unless agreed with **The Company** in accordance with CC.6.3.12.

Grid Voltage Variations

- CC.6.1.4 Subject as provided below, the voltage on the 400kV part of the **National Electricity Transmission System** at each **Connection Site** with a **GB Code User** (and in the case of **OTSDUW Plant and Apparatus**, a **Transmission Interface Point**) will normally remain within $\pm 5\%$ of the nominal value unless abnormal conditions prevail. The minimum voltage is -10% and the maximum voltage is $+10\%$ unless abnormal conditions prevail, but voltages between $+5\%$ and $+10\%$ will not last longer than 15 minutes unless abnormal conditions prevail. Voltages on the 275kV and 132kV parts of the **National Electricity Transmission System** at each **Connection Site** with a **User** (and in the case of **OTSDUW Plant and Apparatus**, a **Transmission Interface Point**) will normally remain within the limits $\pm 10\%$ of the nominal value unless abnormal conditions prevail. At nominal **System** voltages below 132kV the voltage of the **National Electricity Transmission System** at each **Connection Site** with a **User** (and in the case of **OTSDUW Plant and Apparatus**, a **Transmission Interface Point**) will normally remain within the limits $\pm 6\%$ of the nominal value unless abnormal conditions prevail. Under fault conditions, voltage may collapse transiently to zero at the point of fault until the fault is cleared. The normal operating ranges of the **National Electricity Transmission System** are summarised below:

<u>National Electricity Transmission System</u> <u>Nominal Voltage</u>	<u>Normal Operating Range</u>
400kV	400kV $\pm 5\%$
275kV	275kV $\pm 10\%$
132kV	132kV $\pm 10\%$

The Company and a **GB Code User** may agree greater or lesser variations in voltage to those set out above in relation to a particular **Connection Site**, and insofar as a greater or lesser variation is agreed, the relevant figure set out above shall, in relation to that **GB Code User** at the particular **Connection Site**, be replaced by the figure agreed.

Voltage Waveform Quality

CC.6.1.5

All **Plant** and **Apparatus** connected to the **National Electricity Transmission System**, and that part of the **National Electricity Transmission System** at each **Connection Site** or, in the case of **OTSDUW Plant and Apparatus**, at each **Interface Point**, should be capable of withstanding the following distortions of the voltage waveform in respect of harmonic content and phase unbalance:

(a) Harmonic Content

The **Electromagnetic Compatibility Levels** for harmonic distortion on the **Onshore Transmission System** from all sources under both **Planned Outage** and fault outage conditions, (unless abnormal conditions prevail) shall comply with **Engineering Recommendation G5**. The **Electromagnetic Compatibility Levels** for harmonic distortion on an **Offshore Transmission System** will be defined in relevant **Bilateral Agreements**.

Engineering Recommendation G5 contains planning criteria which **The Company** will apply to the connection of non-linear **Load** to the **National Electricity Transmission System**, which may result in harmonic emission limits being specified for these **Loads** in the relevant **Bilateral Agreement**. The application of the planning criteria will take into account the position of **GB Code Users'** and **EU Code Users' Plant and Apparatus** (and **OTSDUW Plant and Apparatus**) in relation to harmonic emissions. **GB Code Users** must ensure that connection of distorting loads to their **User Systems** do not cause any harmonic emission limits specified in the **Bilateral Agreement**, or where no such limits are specified, the relevant planning levels specified in **Engineering Recommendation G5** to be exceeded.

(b) Phase Unbalance

Under **Planned Outage** conditions, the weekly 95 percentile of **Phase (Voltage) Unbalance**, calculated in accordance with IEC 61000-4-30 and IEC 61000-3-13, on the **National Electricity Transmission System** for voltages above 150kV should remain, in England and Wales, below 1.5%, and in Scotland, below 2%, and for voltages of 150kV and below, across GB below 2%, unless abnormal conditions prevail and **Offshore** (or in the case of **OTSDUW, OTSDUW Plant and Apparatus**) will be defined in relevant **Bilateral Agreements**.

The **Phase (Voltage) Unbalance** is calculated from the ratio of root mean square (rms) of negative phase sequence voltage to rms of positive phase sequence voltage, based on 10-minute average values, in accordance with IEC 61000-4-30.

CC.6.1.6

Across GB, under the **Planned Outage** conditions stated in CC.6.1.5(b) infrequent short duration peaks with a maximum value of 2% are permitted for **Phase (Voltage) Unbalance**, for voltages above 150kV, subject to the prior agreement of **The Company** under the **Bilateral Agreement** and in relation to **OTSDUW**, the **Construction Agreement**. **The Company** will only agree following a specific assessment of the impact of these levels on **Transmission Apparatus** and other **Users Apparatus** with which it is satisfied.

Voltage Fluctuations

CC.6.1.7 Voltage changes at a **Point of Common Coupling** on the **Onshore Transmission System** shall not exceed:

(a) The limits specified in Table CC.6.1.7(a) with the stated frequency of occurrence, where:

(i)

$$\% \Delta V_{\text{steadystate}} = \left| 100 \times \frac{\Delta V_{\text{steadystate}}}{V_n} \right|$$

and

$$\% \Delta V_{\text{max}} = 100 \times \frac{\Delta V_{\text{max}}}{V_n} ;$$

- (ii) V_n is the nominal system voltage;
- (iii) $V_{\text{steadystate}}$ is the voltage at the end of a period of 1 s during which the rate of change of system voltage over time is $\leq 0.5\%$;
- (iv) $\Delta V_{\text{steadystate}}$ is the difference in voltage between the initial steady state voltage prior to the RVC (V_0) and the final steady state voltage after the RVC (V_0);
- (v) ΔV_{max} is the absolute change in the system voltage relative to the initial steady state system voltage (V_0);
- (vi) All voltages are the r.m.s. of the voltage measured over one cycle refreshed every half a cycle as per BS EN 61000-4-30; and
- (vii) The applications in the 'Example Applicability' column are examples only and are not definitive.

Cat-egory	Title	Maximum number of occurrence	Limits %ΔV_{max} & %$\Delta V_{\text{steadystate}}$	Example Applicability
1	Frequent events	(see NOTE 1)	As per Figure CC.6.1.7 (1)	Any single or repetitive RVC that falls inside Figure CC.6.1.7 (1)
2	Infrequent events	4 events in 1 calendar month (see NOTE 2)	As per Figure CC.6.1.7 (2) % $\Delta V_{\text{steadystate}}$ $\leq 3\%$ For decrease in voltage: % ΔV_{max} $\leq 10\%$ (see NOTE 3) For increase in voltage: % ΔV_{max} $\leq 6\%$ (see NOTE 4)	Infrequent motor starting, transformer energisation, re-energisation (see NOTE 7)
3	Very infrequent events	1 event in 3 calendar months (see NOTE 2)	As per Figure CC.6.1.7 (3) % $\Delta V_{\text{steadystate}}$ $\leq 3\%$ For decrease in voltage: % ΔV_{max} $\leq 12\%$ (see NOTE 5) For increase in voltage: % ΔV_{max} $\leq 6\%$ (see NOTE 6)	Commissioning, maintenance & post fault switching (see NOTE 7)

NOTE 1: $\pm 6\%$ is permissible for 100 ms reduced to $\pm 3\%$ thereafter as per Figure CC.6.1.7 (1).
If the profile of repetitive voltage change(s) falls within the envelope given in Figure CC.6.1.7 (1), the assessment of such voltage change(s) shall be undertaken according to the recommendations for assessment of flicker and shall conform to the planning levels provided for flicker.
If any part of the voltage change(s) falls outside the envelope given in Figure CC.6.1.7(1), the assessment of such voltage changes, repetitive or not, shall be done according to the guidance and limits for RVCs.

NOTE 2: No more than 1 event is permitted per day, consisting of up to 4 RVCs, each separated by at least 10 minutes with all switching completed within a two-hour window.

NOTE 3: -10% is permissible for 100 ms reduced to -6% until 2 s then reduced to -3% thereafter as per Figure CC.6.1.7 (2).

- NOTE 4: +6% is permissible for 0.8 s from the instant the event begins then reduced to +3% thereafter as per Figure CC.6.1.7 (2).
- NOTE 5: -12% is permissible for 100 ms reduced to -10% until 2 s then reduced to -3% thereafter as per Figure CC.6.1.7 (3).
- NOTE 6: +6% is permissible for 0.8 s from the instant the event begins then reduced to +3% thereafter as per Figure CC.6.1.7 (3).
- NOTE 7: These are examples only. Customers may opt to conform to the limits of another category providing the frequency of occurrence is not expected to exceed the 'Maximum number of occurrence' for the chosen category.

Table CC.6.1.7 (a) – Planning levels for RVC

- (b) The voltage change limit is the absolute maximum allowed of either the phase-to-earth voltage change or the phase-to-phase voltage change, whichever is the highest. The limits do not apply to single phasor equivalent voltages, e.g. positive phase sequence (PPS) voltages. For high impedance earthed systems, the maximum phase-to-phase, i.e. line voltage, should be used for assessment.
- (c) The RVCs in Category 2 and 3 should not exceed the limits depicted in the time dependent characteristic shown in Figure CC.6.1.7 (2) and Figure CC.6.1.7 (3) respectively. These limits do not apply to: 1) fault clearance operations; or 2) immediate operations in response to fault conditions; or 3) operations relating to post fault system restoration (for the avoidance of doubt this third exception pertains to a fault that is external to the **Users Plant and Apparatus**).
- (d) Any RVCs permitted in Category 2 and Category 3 should be at least 10 minutes apart.
- (e) The value of $V_{\text{steadystate}}$ should be established immediately prior to the start of a RVC. Following a RVC, the voltage should remain within the relevant envelope, as shown in Figures CC.6.1.7 (1), CC.6.1.7 (2), CC.6.1.7 (3), until a $V_{\text{steadystate}}$ condition has been satisfied.

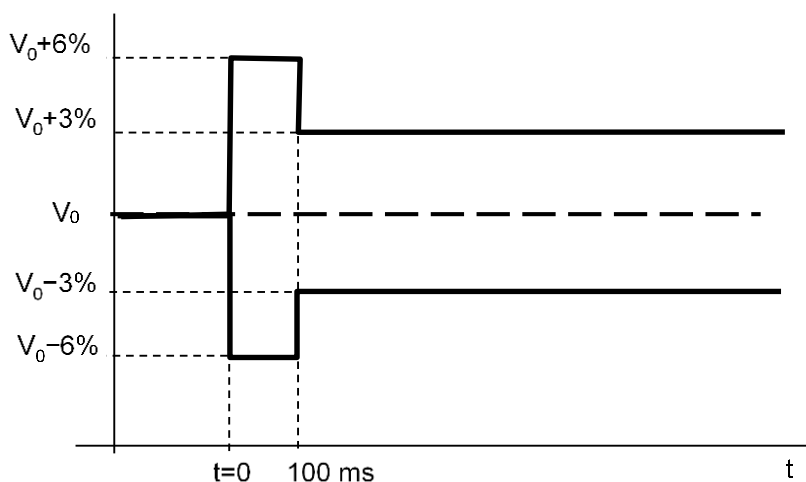

Figure CC.6.1.7 (1) — Voltage characteristic for frequent events

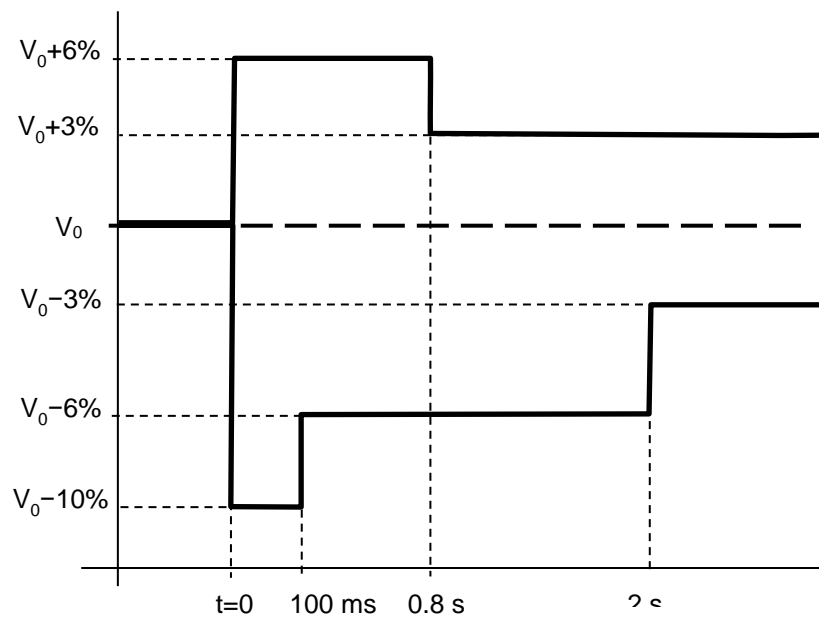

Figure CC.6.1.7 (2) — Voltage characteristic for infrequent events

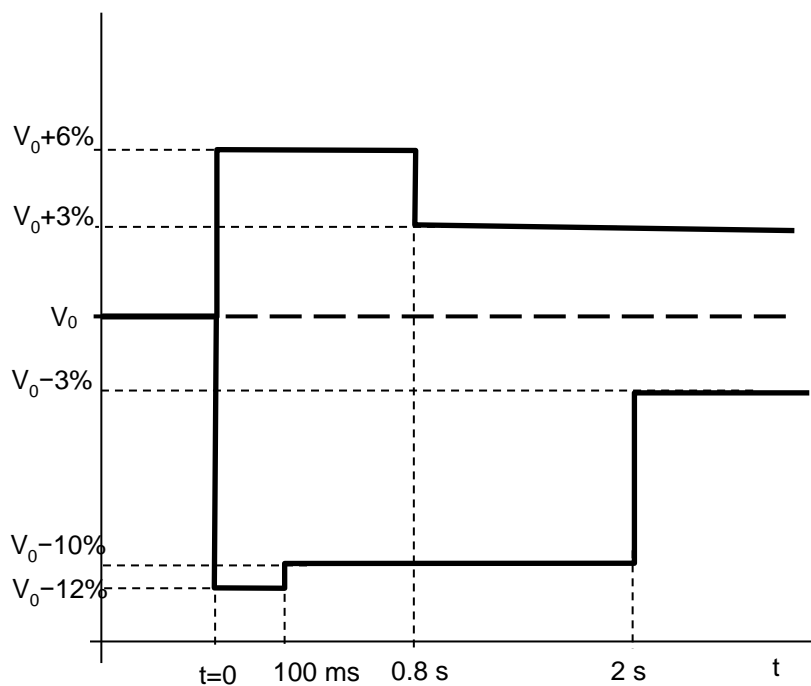

Figure CC.6.1.7 (3) — Voltage characteristic for very infrequent events

- (f) The voltage change between two steady state voltage conditions should not exceed 3%. (The limit is based on 3% of the nominal voltage of the system (V_n) as measured at the Point of Common Coupling. The step voltage change as measured at the customer's supply terminals or equipment terminals could be greater. For example: The step voltage change limit stated in BS EN 61000-3-3 and BS EN 61000-3-11 is 3.3% when measured at the equipment terminals.)
- (g) The limits apply to voltage changes measured at the **Point of Common Coupling**.
- (h) Category 3 events that are planned should be notified to **The Company** in advance.

- (i) For connections with a **Completion Date** after 1st September 2015 and where voltage changes would constitute a risk to the **National Electricity Transmission System** or, in **The Company's** view, the **System** of any **GB Code User**, **Bilateral Agreements** may include provision for **The Company** to reasonably limit the number of voltage changes in Category 2 or 3 to a lower number than specified in Table CC.6.1.7(a) to ensure that the total number of voltage changes at the **Point of Common Coupling** across multiple **Users** remains within the limits of Table CC.6.1.7(a).
- (j) The planning levels applicable to **Flicker Severity Short Term (P_{st})** and **Flicker Severity Long Term (P_{lt})** are set out in Table CC.6.1.7(b).

Supply system Nominal voltage	Planning level	
	Flicker Severity Short Term (P _{st})	Flicker Severity Long Term (P _{lt})
3.3 kV, 6.6 kV, 11 kV, 20 kV, 33 kV	0.9	0.7
66 kV, 110 kV, 132 kV, 150 kV, 200 kV, 220 kV, 275 kV, 400 kV	0.8	0.6
NOTE 1: The magnitude of P _{st} is linear with respect to the magnitude of the voltage changes giving rise to it. NOTE 2: Extreme caution is advised in allowing any excursions of P _{st} and P _{lt} above the planning level.		

Table CC.6.7.1(b) — Planning levels for flicker

The values and figures referred to in this paragraph CC.6.1.7 are derived from Engineering Recommendation P28 Issue 2.

- CC.6.1.8 Voltage fluctuations at a **Point of Common Coupling** with a fluctuating **Load** directly connected to an **Offshore Transmission System** (or in the case of **OTSDUW, OTSDUW Plant and Apparatus**) shall not exceed the limits set out in the **Bilateral Agreement**.
Sub-Synchronous Resonance and Sub-Synchronous Torsional Interaction
- CC.6.1.9 **The Company** shall ensure that **GB Code Users' Plant and Apparatus** will not be subject to unacceptable Sub-Synchronous Oscillation conditions as specified in the relevant **Licence Standards**.
- CC.6.1.10 **The Company** shall ensure where necessary, and in consultation with **Relevant Transmission Licensees** where required, that any relevant site specific conditions applicable at a **GB Code User's Connection Site**, including a description of the Sub-Synchronous Oscillation conditions considered in the application of the relevant **License Standards**, are set out in the **GB Code User's Bilateral Agreement**.

CC.6.2 Plant and Apparatus relating to Connection Site and Interface Point

The following requirements apply to **Plant** and **Apparatus** relating to the **Connection Point**, and **OTSDUW Plant and Apparatus** relating to the **Interface Point** (until the **OTSUA Transfer Time**) and **Connection Point** which (except as otherwise provided in the relevant paragraph) each **GB Code User** must ensure are complied with in relation to its **Plant** and **Apparatus** and which in the case of CC.6.2.2.2.2, CC.6.2.3.1.1 and CC.6.2.1.1(b) only, **The Company** must ensure are complied with in relation to **Transmission Plant and Apparatus**, as provided in those paragraphs.

CC.6.2.1 General Requirements

- CC.6.2.1.1 (a) The design of connections between the **National Electricity Transmission System** and:
- (i) any **Generating Unit** (other than a **CCGT Unit** or **Power Park Unit**), **DC Converter**, **Power Park Module** or **CCGT Module**, or
 - (ii) any **Network Operator's System**, or
 - (iii) **Non-Embedded Customers** equipment;
- will be consistent with the **Licence Standards**.

In the case of **OTSDUW**, the design of the **OTSUA's** connections at the **Interface Point** and **Connection Point** will be consistent with **Licence Standards**.

- (b) The **National Electricity Transmission System** (and any **OTSDUW Plant and Apparatus**) at nominal **System** voltages of 132kV and above is/shall be designed to be earthed with an **Earth Fault Factor** of, in England and Wales or **Offshore**, below 1.4 and in Scotland, below 1.5. Under fault conditions the rated **Frequency** component of voltage could fall transiently to zero on one or more phases or, in England and Wales, rise to 140% phase-to-earth voltage, or in Scotland, rise to 150% phase-to-earth voltage. The voltage rise would last only for the time that the fault conditions exist. The fault conditions referred to here are those existing when the type of fault is single or two phase-to-earth.
- (c) For connections to the **National Electricity Transmission System** at nominal **System** voltages of below 132kV the earthing requirements and voltage rise conditions will be advised by **The Company** as soon as practicable prior to connection and in the case of **OTSDUW Plant and Apparatus** shall be advised to **The Company** by the **GB Code User**.

CC.6.2.1.2 Substation Plant and Apparatus

- (a) The following provisions shall apply to all **Plant** and **Apparatus** which is connected at the voltage of the **Connection Point** (and **OTSDUW Plant and Apparatus** at the **Interface Point**) and which is contained in equipment bays that are within the **Transmission busbar Protection** zone at the **Connection Point**. This includes circuit breakers, switch disconnectors, disconnectors, **Earthing Devices**, power transformers, voltage transformers, reactors, current transformers, surge arresters, bushings, neutral equipment, capacitors, line traps, coupling devices, external insulation and insulation co-ordination devices. Where necessary, this is as more precisely defined in the **Bilateral Agreement**.

- (i) Plant and/or Apparatus prior to 1st January 1999

Each item of such **Plant** and/or **Apparatus** which at 1st January 1999 is either :

- installed; or
- owned (but is either in storage, maintenance or awaiting installation); or
- ordered;

and is the subject of a **Bilateral Agreement** with regard to the purpose for which it is in use or intended to be in use, shall comply with the relevant standards/specifications applicable at the time that the **Plant** and/or **Apparatus** was

designed (rather than commissioned) and any further requirements as specified in the **Bilateral Agreement**.

- (ii) Plant and/or Apparatus post 1st January 1999 for a new Connection Point (including OTSDUW Plant and Apparatus at the Interface Point)

Each item of such **Plant** and/or **Apparatus** installed in relation to a new **Connection Point** (or **OTSDUW Plant and Apparatus** at the **Interface Point**) after 1st January 1999 shall comply with the relevant **Technical Specifications** and any further requirements identified by **The Company**, acting reasonably, to reflect the options to be followed within the **Technical Specifications** and/or to complement if necessary the **Technical Specifications** so as to enable **The Company** to comply with its obligations in relation to the **National Electricity Transmission System** or the **Relevant Transmission Licensee** to comply with its obligations in relation to its **Transmission System**. This information, including the application dates of the relevant **Technical Specifications**, will be as specified in the **Bilateral Agreement**.

- (iii) New Plant and/or Apparatus post 1st January 1999 for an existing Connection Point (including OTSDUW Plant and Apparatus at the Interface Point)

Each new additional and/or replacement item of such **Plant** and/or **Apparatus** installed in relation to a change to an existing **Connection Point** (or **OTSDUW Plant and Apparatus** at the **Interface Point** and **Connection Point**) after 1st January 1999 shall comply with the standards/specifications applicable when the change was designed, or such other standards/specifications as necessary to ensure that the item of **Plant** and/or **Apparatus** is reasonably fit for its intended purpose having due regard to the obligations of **The Company**, the relevant **GB Code User** and the **Relevant Transmission Licensee** under their respective **Licences**. Where appropriate this information, including the application dates of the relevant standards/specifications, will be as specified in the varied **Bilateral Agreement**.

- (iv) Used Plant and/or Apparatus being moved, re-used or modified

If, after its installation, any such item of **Plant** and/or **Apparatus** is subsequently:

- moved to a new location; or
- used for a different purpose; or
- otherwise modified;

then the standards/specifications as described in (i), (ii), or (iii) above or in ECC.6.2.1.2 (as applicable) will apply as appropriate to such **Plant** and/or **Apparatus**, which must be reasonably fit for its intended purpose having due regard to the obligations of **The Company**, the relevant **GB Code User** or **EU Code User** (as applicable) and the **Relevant Transmission Licensee** under their respective **Licences**.

- (b) **The Company** shall at all times maintain a list of those **Technical Specifications** and additional requirements which might be applicable under this CC.6.2.1.2 and which may be referenced by **The Company** in the **Bilateral Agreement**. **The Company** shall provide a copy of the list upon request to any **User**.
- (c) Where the **GB Code User** provides **The Company** with information and/or test reports in respect of **Plant** and/or **Apparatus** which the **GB Code User** reasonably believes demonstrate the compliance of such items with the provisions of a **Technical Specification**, then **The Company** shall promptly and without unreasonable delay give due and proper consideration to such information.
- (d) **Plant** and **Apparatus** shall be designed, manufactured and tested in premises with an accredited certificate in accordance with the quality assurance requirements of the relevant standard in the BS EN ISO 9000 series (or equivalent as reasonably approved by **The Company**) or in respect of test premises which do not include a manufacturing facility premises with an accredited certificate in accordance with BS EN 45001.

- (e) Each connection between an **GB Code User** and the **National Electricity Transmission System** must be controlled by a circuit-breaker (or circuit breakers) capable of interrupting the maximum short circuit current at the point of connection. The **Seven Year Statement** gives values of short circuit current and the rating of **Transmission** circuit breakers at existing and committed **Connection Points** for future years.
- (f) Each connection between a **GB Generator** undertaking **OTSDUW** or an **Onshore Transmission Licensee**, must be controlled by a circuit breaker (or circuit breakers) capable of interrupting the maximum short circuit current at the **Transmission Interface Point**. The **Seven Year Statement** gives values of short circuit current and the rating of **Transmission** circuit breakers at existing and committed **Transmission Interface Points** for future years.

CC.6.2.2 Requirements at Connection Points or, in the case of OTSDUW at Interface Points that relate to GB Generators or OTSDUW Plant and Apparatus or DC Converter Station owners

CC.6.2.2.1 Not Used.

CC.6.2.2.2 Generating Unit, OTSDUW Plant and Apparatus and Power Station Protection Arrangements

CC.6.2.2.2.1 Minimum Requirements

Protection of Generating Units (other than **Power Park Units**), **DC Converters**, **OTSDUW Plant and Apparatus** or **Power Park Modules** and their connections to the **National Electricity Transmission System** shall meet the requirements given below. These are necessary to reduce the impact on the **National Electricity Transmission System** of faults on **OTSDUW Plant and Apparatus** circuits or circuits owned by **GB Generators** or **DC Converter Station** owners.

CC.6.2.2.2.2 Fault Clearance Times

- (a) The required fault clearance time for faults on the **GB Generator's** or **DC Converter Station** owner's equipment directly connected to the **National Electricity Transmission System** or **OTSDUW Plant and Apparatus** and for faults on the **National Electricity Transmission System** directly connected to the **GB Generator** or **DC Converter Station** owner's equipment or **OTSDUW Plant and Apparatus**, from fault inception to the circuit breaker arc extinction, shall be set out in the **Bilateral Agreement**. The fault clearance time specified in the **Bilateral Agreement** shall not be shorter than the durations specified below:

- (i) 80ms at 400kV
- (ii) 100ms at 275kV
- (iii) 120ms at 132kV and below

but this shall not prevent the **GB Code User** or the **Relevant Transmission Licensee** or the **GB Generator** (including in respect of **OTSDUW Plant and Apparatus**) from selecting a shorter fault clearance time on their own **Plant and Apparatus** provided **Discrimination** is achieved.

A longer fault clearance time may be specified in the **Bilateral Agreement** for faults on the **National Electricity Transmission System**. A longer fault clearance time for faults on the **GB Generator** or **DC Converter Station** owner's equipment or **OTSDUW Plant and Apparatus** may be agreed with **The Company** in accordance with the terms of the **Bilateral Agreement** but only if **System** requirements, in **The Company's** view, permit. The probability that the fault clearance time stated in the **Bilateral Agreement** will be exceeded by any given fault, must be less than 2%.

- (b) In the event that the required fault clearance time is not met as a result of failure to operate on the **Main Protection System(s)** provided, **GB Generators** or **DC Converter Station** owners or **GB Generators** in the case of **OTSDUW Plant and Apparatus** shall, except as specified below provide **Independent Back-Up Protection**. The **Relevant Transmission Licensee** will also provide **Back-Up Protection**; and the **Relevant Transmission Licensee's** and the **GB Code User's Back-Up Protections** will be co-ordinated so as to provide **Discrimination**.

On a **Generating Unit** (other than a **Power Park Unit**), **DC Converter** or **Power Park Module** or **OTSDUW Plant and Apparatus** in respect of which the **Completion Date** is after 20 January 2016 and connected to the **National Electricity Transmission System** at 400kV or 275kV and where two **Independent Main Protections** are provided to clear faults on the **HV Connections** within the required fault clearance time, the **Back-Up Protection** provided by **GB Generators** (including in respect of **OTSDUW Plant and Apparatus**) and **DC Converter Station** owner shall operate to give a fault clearance time of no longer than 300ms at the minimum infeed for normal operation for faults on the **HV Connections**. Where two **Independent Main Protections** are installed, the **Back-Up Protection** may be integrated into one (or both) of the **Independent Main Protection** relays.

On a **Generating Unit** (other than a **Power Park Unit**), **DC Converter** or **Power Park Module** or **OTSDUW Plant and Apparatus** in respect of which the **Completion Date** is after 20 January 2016 and connected to the **National Electricity Transmission System** at 132 kV and where only one **Main Protection** is provided to clear faults on the **HV Connections** within the required fault clearance time, the **Independent Back-Up Protection** provided by the **GB Generator** (including in respect of **OTSDUW Plant and Apparatus**) and the **DC Converter Station** owner shall operate to give a fault clearance time of no longer than 300ms at the minimum infeed for normal operation for faults on the **HV Connections**.

On a **Generating Unit** (other than a **Power Park Unit**), **DC Converter** or **Power Park Module** or **OTSDUW Plant and Apparatus** connected to the **National Electricity Transmission System** and on **Generating Units** (other than a **Power Park Unit**), **DC Converters** or **Power Park Modules** or **OTSDUW Plant and Apparatus** connected to the **National Electricity Transmission System** at 400 kV or 275 kV or 132 kV, in respect of which the **Completion Date** is before the 20 January 2016, the **Back-Up Protection** or **Independent Back-Up Protection** shall operate to give a fault clearance time of no longer than 800ms in England and Wales or 300ms in Scotland at the minimum infeed for normal operation for faults on the **HV Connections**.

A Generating Unit (other than a **Power Park Unit**), **DC Converter** or **Power Park Module** or **OTSDUW Plant and Apparatus**) with **Back-Up Protection** or **Independent Back-Up Protection** will also be required to withstand, without tripping, the loading incurred during the clearance of a fault on the **National Electricity Transmission System** by breaker fail **Protection** at 400kV or 275kV or of a fault cleared by **Back-Up Protection** where the **GB Generator** (including in the case of **OTSDUW Plant and Apparatus**) or **DC Converter** is connected at 132kV and below. This will permit **Discrimination** between **GB Generator** in respect of **OTSDUW Plant and Apparatus** or **DC Converter Station** owners' **Back-Up Protection** or **Independent Back-Up Protection** and the **Back-Up Protection** provided on the **National Electricity Transmission System** and other **Users' Systems**.

- (c) When the **Generating Unit** (other than **Power Park Units**), or the **DC Converter** or **Power Park Module** or **OTSDUW Plant and Apparatus** is connected to the **National Electricity Transmission System** at 400kV or 275kV, and in Scotland and **Offshore** also at 132kV, and a circuit breaker is provided by the **GB Generator** (including in respect of **OTSDUW Plant and Apparatus**) or the **DC Converter Station** owner, or the **Relevant Transmission Licensee**, as the case may be, to interrupt fault current interchange with the **National Electricity Transmission System**, or **GB Generator's System**, or **DC Converter Station** owner's **System**, as the case may be, circuit breaker fail **Protection** shall be provided by the **GB Generator** (including in respect of **OTSDUW Plant and Apparatus**) or **DC Converter Station** owner, or the **Relevant Transmission Licensee** as the case may be, on this circuit breaker. In the event, following operation of a **Protection** system, of a failure to interrupt fault current by these circuit-breakers within the **Fault Current Interruption Time**, the circuit breaker fail **Protection** is required to initiate tripping of all the necessary electrically adjacent circuit-breakers so as to interrupt the fault current within the next 200ms.
- (d) The target performance for the **System Fault Dependability Index** shall be not less than 99%. This is a measure of the ability of **Protection** to initiate successful tripping of circuit breakers which are associated with the faulty item of **Apparatus**.

CC.6.2.2.3 Equipment to be provided

CC.6.2.2.3.1 Protection of Interconnecting Connections

The requirements for the provision of **Protection** equipment for interconnecting connections will be specified in the **Bilateral Agreement**. In this **CC**, the term "interconnecting connections" means the primary conductors from the current transformer accommodation on the circuit side of the circuit breaker to the **Connection Point** or the primary conductors from the current transformer accommodation on the circuit side of the **OTSDUW Plant and Apparatus** of the circuit breaker to the **Transmission Interface Point**.

CC.6.2.2.3.2 Circuit-breaker fail Protection

The **GB Generator** or **DC Converter Station** owner will install circuit breaker fail **Protection** equipment in accordance with the requirements of the **Bilateral Agreement**. The **GB Generator** or **DC Converter Station** owner will also provide a back-trip signal in the event of loss of air from its pressurised head circuit breakers, during the **Generating Unit** (other than a **CCGT Unit** or **Power Park Unit**) or **CCGT Module** or **DC Converter** or **Power Park Module** run-up sequence, where these circuit breakers are installed.

CC.6.2.2.3.3 Loss of Excitation

The **GB Generator** must provide **Protection** to detect loss of excitation on a **Generating Unit** and initiate a **Generating Unit** trip.

CC.6.2.2.3.4 Pole-Slipping Protection

Where, in **The Company's** reasonable opinion, **System** requirements dictate, **The Company** will specify in the **Bilateral Agreement** a requirement for **GB Generators** to fit pole-slipping **Protection** on their **Generating Units**.

CC.6.2.2.3.5 Signals for Tariff Metering

GB Generators and **DC Converter Station** owners will install current and voltage transformers supplying all tariff meters at a voltage to be specified in, and in accordance with, the **Bilateral Agreement**.

CC.6.2.2.4 Work on Protection Equipment

No busbar **Protection**, mesh corner **Protection**, circuit-breaker fail **Protection** relays, AC or DC wiring (other than power supplies or DC tripping associated with the **Generating Unit, DC Converter** or **Power Park Module** itself) may be worked upon or altered by the **GB Generator** or **DC Converter Station** owner personnel in the absence of a representative of the **Relevant Transmission Licensee**, or written authority from the **Relevant Transmission Licensee** to perform such work or alterations in the absence of a representative of the **Relevant Transmission Licensee**.

CC.6.2.2.5 Relay Settings

Protection and relay settings will be co-ordinated (both on connection and subsequently) across the **Connection Point** in accordance with the **Bilateral Agreement** and in relation to **OTSDUW Plant and Apparatus**, across the **Interface Point** in accordance with the **Bilateral Agreement** to ensure effective disconnection of faulty **Apparatus**.

CC.6.2.3 Requirements at Connection Points relating to Network Operators and Non-Embedded Customers

CC.6.2.3.1 Protection Arrangements for Network Operators and Non-Embedded Customers

CC.6.2.3.1.1 **Protection** of **Network Operator** and **Non-Embedded Customers Systems** directly connected to the **National Electricity Transmission System**, shall meet the requirements given below:

Fault Clearance Times

(a) The required fault clearance time for faults on **Network Operator** and **Non-Embedded Customer** equipment directly connected to the **National Electricity Transmission System**, and for faults on the **National Electricity Transmission System** directly connected to the **Network Operator's** or **Non-Embedded Customer's** equipment, from fault inception to the circuit breaker arc extinction, shall be set out in each **Bilateral Agreement**. The fault clearance time specified in the **Bilateral Agreement** shall not be shorter than the durations specified below:

- (i) 80ms at 400kV
- (ii) 100ms at 275kV
- (iii) 120ms at 132kV and below

but this shall not prevent the **GB Code User** or the **Relevant Transmission Licensee** from selecting a shorter fault clearance time on its own **Plant** and **Apparatus** provided **Discrimination** is achieved.

For the purpose of establishing the **Protection** requirements in accordance with CC.6.2.3.1.1 only, the point of connection of the **Network Operator** or **Non-Embedded Customer** equipment to the **National Electricity Transmission System** shall be deemed to be the low voltage busbars at a **GB Grid Supply Point**, irrespective of the ownership of the equipment at the **GB Grid Supply Point**.

A longer fault clearance time may be specified in the **Bilateral Agreement** for faults on the **National Electricity Transmission System**. A longer fault clearance time for faults on the **Network Operator** and **Non-Embedded Customers** equipment may be agreed with **The Company** in accordance with the terms of the **Bilateral Agreement** but only if **System** requirements in **The Company's** view permit. The probability that the fault clearance time stated in the **Bilateral Agreement** will be exceeded by any given fault must be less than 2%.

- (b) (i) For the event of failure of the **Protection** systems provided to meet the above fault clearance time requirements, **Back-Up Protection** shall be provided by the **Network Operator** or **Non-Embedded Customer** as the case may be.
- (ii) The **Relevant Transmission Licensee** will also provide **Back-Up Protection**, which will result in a fault clearance time longer than that specified for the **Network Operator** or **Non-Embedded Customer Back-Up Protection** so as to provide **Discrimination**.

- (iii) For connections with the **National Electricity Transmission System** at 132kV and below, it is normally required that the **Back-Up Protection** on the **National Electricity Transmission System** shall discriminate with the **Network Operator** or **Non-Embedded Customer's Back-Up Protection**.
 - (iv) For connections with the **National Electricity Transmission System** at 400kV or 275kV, the **Back-Up Protection** will be provided by the **Network Operator** or **Non-Embedded Customer**, as the case may be, with a fault clearance time not longer than 300ms for faults on the **Network Operator's** or **Non-Embedded Customer's Apparatus**.
 - (v) Such **Protection** will also be required to withstand, without tripping, the loading incurred during the clearance of a fault on the **National Electricity Transmission System** by breaker fail **Protection** at 400kV or 275kV. This will permit **Discrimination** between **Network Operator's Back-Up Protection** or **Non-Embedded Customer's Back-Up Protection**, as the case may be, and **Back-Up Protection** provided on the **National Electricity Transmission System** and other **User Systems**. The requirement for and level of **Discrimination** required will be specified in the **Bilateral Agreement**.
- (c) (i) Where the **Network Operator** or **Non-Embedded Customer** is connected to the **National Electricity Transmission System** at 400kV or 275kV, and in Scotland also at 132kV, and a circuit breaker is provided by the **Network Operator** or **Non-Embedded Customer**, or the **Relevant Transmission Licensee**, as the case may be, to interrupt the interchange of fault current with the **National Electricity Transmission System** or the **System** of the **Network Operator** or **Non-Embedded Customer**, as the case may be, circuit breaker fail **Protection** will be provided by the **Network Operator** or **Non-Embedded Customer**, or the **Relevant Transmission Licensee**, as the case may be, on this circuit breaker.
- (ii) In the event, following operation of a **Protection** system, of a failure to interrupt fault current by these circuit-breakers within the **Fault Current Interruption Time**, the circuit breaker fail **Protection** is required to initiate tripping of all the necessary electrically adjacent circuit-breakers so as to interrupt the fault current within the next 200ms.
- (d) The target performance for the **System Fault Dependability Index** shall be not less than 99%. This is a measure of the ability of **Protection** to initiate successful tripping of circuit breakers which are associated with the faulty items of **Apparatus**.

CC.6.2.3.2 Fault Disconnection Facilities

- (a) Where no **Transmission** circuit breaker is provided at the **GB Code User's** connection voltage, the **GB Code User** must provide **The Company** with the means of tripping all the **GB Code User's** circuit breakers necessary to isolate faults or **System** abnormalities on the **National Electricity Transmission System**. In these circumstances, for faults on the **GB Code User's System**, the **GB Code User's Protection** should also trip higher voltage **Transmission** circuit breakers. These tripping facilities shall be in accordance with the requirements specified in the **Bilateral Agreement**.
- (b) **The Company** may require the installation of a **System to Generator Operational Intertripping Scheme** in order to enable the timely restoration of circuits following power **System** fault(s). These requirements shall be set out in the relevant **Bilateral Agreement**.

CC.6.2.3.3 Automatic Switching Equipment

Where automatic reclosure of **Transmission** circuit breakers is required following faults on the **GB Code User's System**, automatic switching equipment shall be provided in accordance with the requirements specified in the **Bilateral Agreement**.

CC.6.2.3.4 Relay Settings

Protection and relay settings will be co-ordinated (both on connection and subsequently) across the **Connection Point** in accordance with the **Bilateral Agreement** to ensure effective disconnection of faulty **Apparatus**.

CC.6.2.3.5 Work on Protection equipment

Where a **Transmission Licensee** owns the busbar at the **Connection Point**, no busbar **Protection**, mesh corner **Protection** relays, AC or DC wiring (other than power supplies or DC tripping associated with the **Network Operator** or **Non-Embedded Customer's Apparatus** itself) may be worked upon or altered by the **Network Operator** or **Non-Embedded Customer** personnel in the absence of a representative of the **Relevant Transmission Licensee** or written authority from the **Relevant Transmission Licensee** to perform such work or alterations in the absence of a representative of the **Relevant Transmission Licensee**.

CC.6.2.3.6 Equipment to be provided

CC.6.2.3.6.1 Protection of Interconnecting Connections

The requirements for the provision of **Protection** equipment for interconnecting connections will be specified in the **Bilateral Agreement**.

CC.6.3 GENERAL GENERATING UNIT (AND OTSDUW) REQUIREMENTS

CC.6.3.1 This section sets out the technical and design criteria and performance requirements for **Generating Units**, **DC Converters** and **Power Park Modules** (whether directly connected to the **National Electricity Transmission System** or **Embedded**) and (where provided in this section) **OTSDUW Plant and Apparatus** which each **GB Generator** or **DC Converter Station** owner must ensure are complied with in relation to its **Generating Units**, **DC Converters** and **Power Park Modules** and **OTSDUW Plant and Apparatus** but does not apply to **Small Power Stations** or individually to **Power Park Units**. References to **Generating Units**, **DC Converters** and **Power Park Modules** in this CC.6.3 should be read accordingly. The performance requirements that **OTSDUW Plant and Apparatus** must be capable of providing at the **Interface Point** under this section may be provided using a combination of **GB Generator Plant and Apparatus** and/or **OTSDUW Plant and Apparatus**.

Plant Performance Requirements

- (a) When supplying **Rated MW** all **Onshore Synchronous Generating Units** must be capable of continuous operation at any point between the limits 0.85 **Power Factor** lagging and 0.95 **Power Factor** leading at the **Onshore Synchronous Generating Unit** terminals. At **Active Power** output levels other than **Rated MW**, all **Onshore Synchronous Generating Units** must be capable of continuous operation at any point between the **Reactive Power** capability limits identified on the **Generator Performance Chart**.

In addition to the above paragraph, where **Onshore Synchronous Generating Unit(s)**:

- (i) have a **Connection Entry Capacity** which has been increased above **Rated MW** (or the **Connection Entry Capacity** of the **CCGT module** has increased above the sum of the **Rated MW** of the **Generating Units** comprising the **CCGT module**), and such increase takes effect after 1st May 2009, the minimum lagging **Reactive Power** capability at the terminals of the **Onshore Synchronous Generating Unit(s)** must be 0.9 **Power Factor** at all **Active Power** output levels in excess of **Rated MW**. Further, the **User** shall comply with the provisions of and any instructions given pursuant to BC1.8 and the relevant **Bilateral Agreement**; or
- (ii) have a **Connection Entry Capacity** in excess of **Rated MW** (or the **Connection Entry Capacity** of the **CCGT module** exceeds the sum of **Rated MW** of the **Generating Units** comprising the **CCGT module**) and a **Completion Date** before 1st May 2009, alternative provisions relating to **Reactive Power** capability may be specified in the **Bilateral Agreement** and where this is the case such provisions must be complied with.

The short circuit ratio of **Onshore Synchronous Generating Units** with an **Apparent Power** rating of less than 1600MVA shall be not less than 0.5. The short circuit ratio of **Onshore Synchronous Generating Units** with a rated **Apparent Power** of 1600MVA or above shall be not less than 0.4.

- (b) Subject to paragraph (c) below, all **Onshore Non-Synchronous Generating Units**, **Onshore DC Converters** and **Onshore Power Park Modules** must be capable of maintaining zero transfer of **Reactive Power** at the **Onshore Grid Entry Point** (or **User System Entry Point** if **Embedded**) at all **Active Power** output levels under steady state voltage conditions. For **Onshore Non-Synchronous Generating Units** and **Onshore Power Park Modules** the steady state tolerance on **Reactive Power** transfer to and from the **National Electricity Transmission System** expressed in MVA shall be no greater than 5% of the **Rated MW**. For **Onshore DC Converters** the steady state tolerance on **Reactive Power** transfer to and from the **National Electricity Transmission System** shall be specified in the **Bilateral Agreement**.

- (c) Subject to the provisions of CC.6.3.2(d) below, all **Onshore Non-Synchronous Generating Units, Onshore DC Converters** (excluding current source technology) and **Onshore Power Park Modules** (excluding those connected to the **Total System** by a current source **Onshore DC Converter**) and **OTSDUW Plant and Apparatus** at the **Interface Point** with a **Completion Date** on or after 1 January 2006 must be capable of supplying **Rated MW** output or **Interface Point Capacity** in the case of **OTSDUW Plant and Apparatus** at any point between the limits 0.95 **Power Factor** lagging and 0.95 **Power Factor** leading at the **Onshore Grid Entry Point** in England and Wales or **Interface Point** in the case of **OTSDUW Plant and Apparatus** or at the HV side of the 33/132kV or 33/275kV or 33/400kV transformer for **GB Generators** directly connected to the **Onshore Transmission System** in Scotland (or **User System Entry Point** if **Embedded**). With all **Plant** in service, the **Reactive Power** limits defined at **Rated MW** or **Interface Point Capacity** in the case of **OTSDUW Plant and Apparatus** at Lagging **Power Factor** will apply at all **Active Power** output levels above 20% of the **Rated MW** or **Interface Point Capacity** in the case of **OTSDUW Plant and Apparatus** output as defined in Figure 1. With all **Plant** in service, the **Reactive Power** limits defined at **Rated MW** at Leading **Power Factor** will apply at all **Active Power** output levels above 50% of the **Rated MW** output or **Interface Point Capacity** in the case of **OTSDUW Plant and Apparatus** as defined in Figure 1. With all **Plant** in service, the **Reactive Power** limits will reduce linearly below 50% **Active Power** output as shown in Figure 1 unless the requirement to maintain the **Reactive Power** limits defined at **Rated MW** or **Interface Point Capacity** in the case of **OTSDUW Plant and Apparatus** at Leading **Power Factor** down to 20% **Active Power** output is specified in the **Bilateral Agreement**. These **Reactive Power** limits will be reduced pro rata to the amount of **Plant** in service.

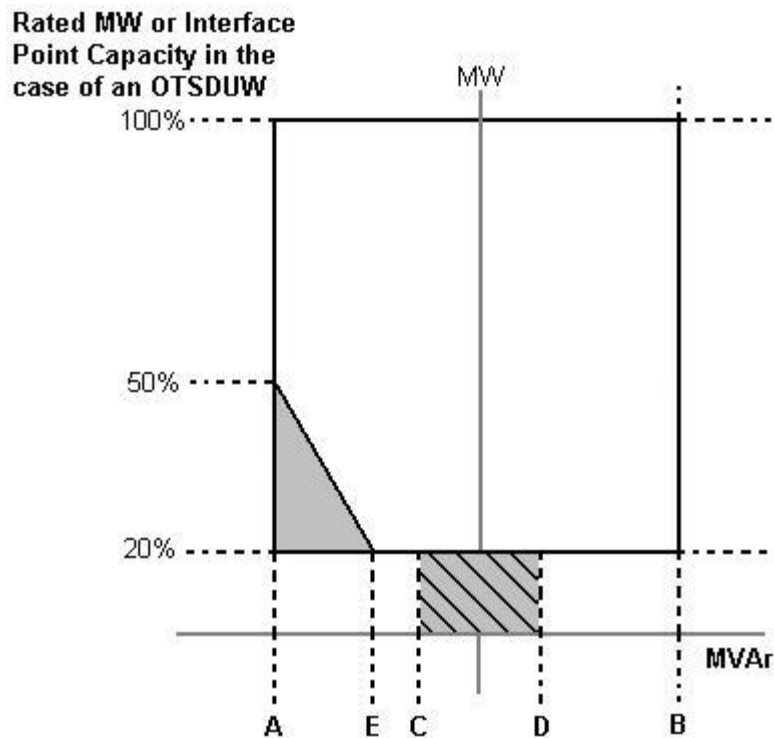

Figure 1

- | | |
|-------------------------------------|------------------------------------------------------------------------------------------------------------------------------------------------|
| Point A is equivalent (in MVAr) to | 0.95 leading Power Factor at Rated MW output or Interface Point Capacity in the case of OTSDUW Plant and Apparatus |
| Point B is equivalent (in MVAr) to: | 0.95 lagging Power Factor at Rated MW output or Interface Point Capacity in the case of OTSDUW Plant and Apparatus |
| Point C is equivalent (in MVAr) to: | -5% of Rated MW output or Interface Point Capacity in the case of OTSDUW Plant and Apparatus |
| Point D is equivalent | +5% of Rated MW output or Interface Point Capacity in the case |

(in MVar) to: of **OTSDUW Plant and Apparatus**

Point E is equivalent -12% of **Rated MW** output or **Interface Point Capacity** in the
(in MVar) to: case of **OTSDUW Plant and Apparatus**

- (d) All **Onshore Non-Synchronous Generating Units** and **Onshore Power Park Modules** in Scotland with a **Completion Date** after 1 April 2005 and before 1 January 2006 must be capable of supplying **Rated MW** at the range of power factors either:
- (i) from 0.95 lead to 0.95 lag as illustrated in Figure 1 at the **User System Entry Point** for **Embedded GB Generators** or at the HV side of the 33/132kV or 33/275kV or 33/400kV transformer for **GB Generators** directly connected to the **Onshore Transmission System**. With all **Plant** in service, the **Reactive Power** limits defined at **Rated MW** will apply at all **Active Power** output levels above 20% of the **Rated MW** output as defined in Figure 1. These **Reactive Power** limits will be reduced pro rata to the amount of **Plant** in service, or
 - (ii) from 0.95 lead to 0.90 lag at the **Onshore Non-Synchronous Generating Unit** (including **Power Park Unit**) terminals. For the avoidance of doubt **GB Generators** complying with this option (ii) are not required to comply with CC.6.3.2(b).
- (e) The short circuit ratio of **Offshore Synchronous Generating Units** at a **Large Power Station** shall be not less than 0.5. At a **Large Power Station** all **Offshore Synchronous Generating Units**, **Offshore Non-Synchronous Generating Units**, **Offshore DC Converters** and **Offshore Power Park Modules** must be capable of maintaining:
- (i) zero transfer of **Reactive Power** at the **Offshore Grid Entry Point** for all **GB Generators** with an **Offshore Grid Entry Point** at the **LV Side of the Offshore Platform** at all **Active Power** output levels under steady state voltage conditions. The steady state tolerance on **Reactive Power** transfer to and from an **Offshore Transmission System** expressed in MVar shall be no greater than 5% of the **Rated MW**, or
 - (ii) a transfer of **Reactive Power** at the **Offshore Grid Entry Point** at a value specified in the **Bilateral Agreement** that will be equivalent to zero at the **LV Side of the Offshore Platform**. In addition, the steady state tolerance on **Reactive Power** transfer to and from an **Offshore Transmission System** expressed in MVar at the **LV Side of the Offshore Platform** shall be no greater than 5% of the **Rated MW**, or
 - (iii) the **Reactive Power** capability (within an associated steady state tolerance) specified in the **Bilateral Agreement** if any alternative has been agreed with the **GB Generator**, **Offshore Transmission Licensee** and **The Company**.
- (f) In addition, a **Genset** shall meet the operational requirements as specified in BC2.A.2.6.

CC.6.3.3

Each **Generating Unit**, **DC Converter** (including an **OTSDUW DC Converter**), **Power Park Module** and/or **CCGT Module** must be capable of:

- (a) continuously maintaining constant **Active Power** output for **System Frequency** changes within the range 50.5 to 49.5 Hz; and

- (b) (subject to the provisions of CC.6.1.3) maintaining its **Active Power** output at a level not lower than the figure determined by the linear relationship shown in Figure 2 for **System Frequency** changes within the range 49.5 to 47 Hz, such that if the **System Frequency** drops to 47 Hz the **Active Power** output does not decrease by more than 5%. In the case of a **CCGT Module**, the above requirement shall be retained down to the **Low Frequency Relay** trip setting of 48.8 Hz, which reflects the first stage of the automatic **Low Frequency Demand Disconnection** scheme notified to **Network Operators** under OC6.6.2. For **System Frequency** below that setting, the existing requirement shall be retained for a minimum period of 5 minutes while **System Frequency** remains below that setting, and special measure(s) that may be required to meet this requirement shall be kept in service during this period. After that 5 minute period, if **System Frequency** remains below that setting, the special measure(s) must be discontinued if there is a materially increased risk of the **Gas Turbine** tripping. The need for special measure(s) is linked to the inherent **Gas Turbine Active Power** output reduction caused by reduced shaft speed due to falling **System Frequency**.

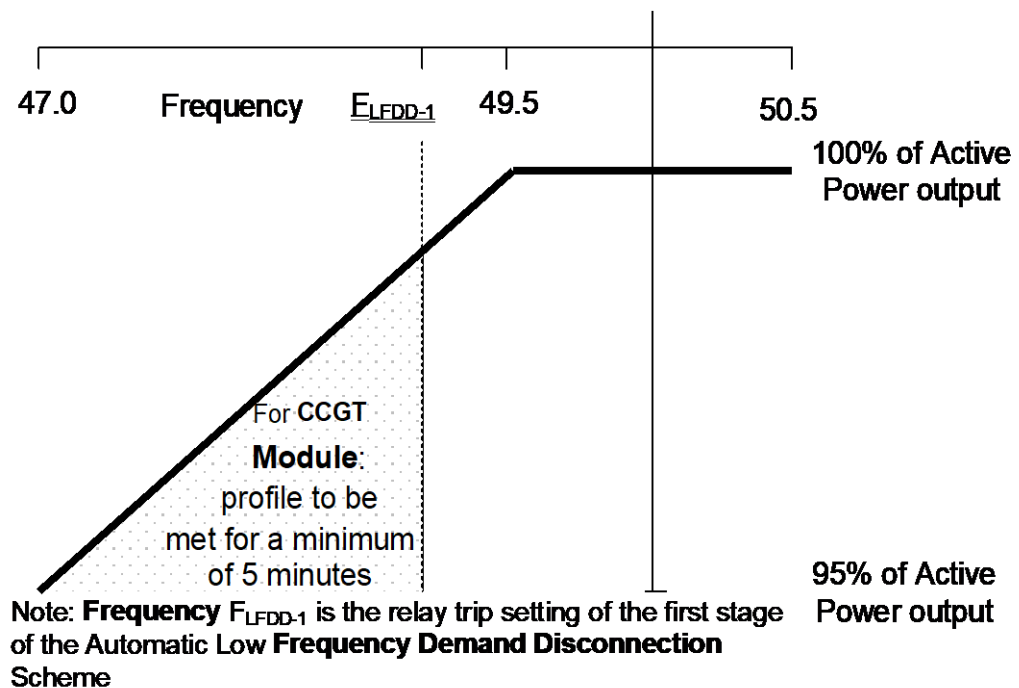

Figure 2

- (c) For the avoidance of doubt, in the case of a **Generating Unit** or **Power Park Module** (or **OTSDUW DC Converters** at the **Interface Point**) using an **Intermittent Power Source** where the mechanical power input will not be constant over time, the requirement is that the **Active Power** output shall be independent of **System Frequency** under (a) above and should not drop with **System Frequency** by greater than the amount specified in (b) above.
- (d) A **DC Converter Station** must be capable of maintaining its **Active Power** input (i.e. when operating in a mode analogous to **Demand**) from the **National Electricity Transmission System** (or **User System** in the case of an **Embedded DC Converter Station**) at a level not greater than the figure determined by the linear relationship shown in Figure 3 for **System Frequency** changes within the range 49.5 to 47 Hz, such that if the **System Frequency** drops to 47.8 Hz the **Active Power** input decreases by more than 60%.

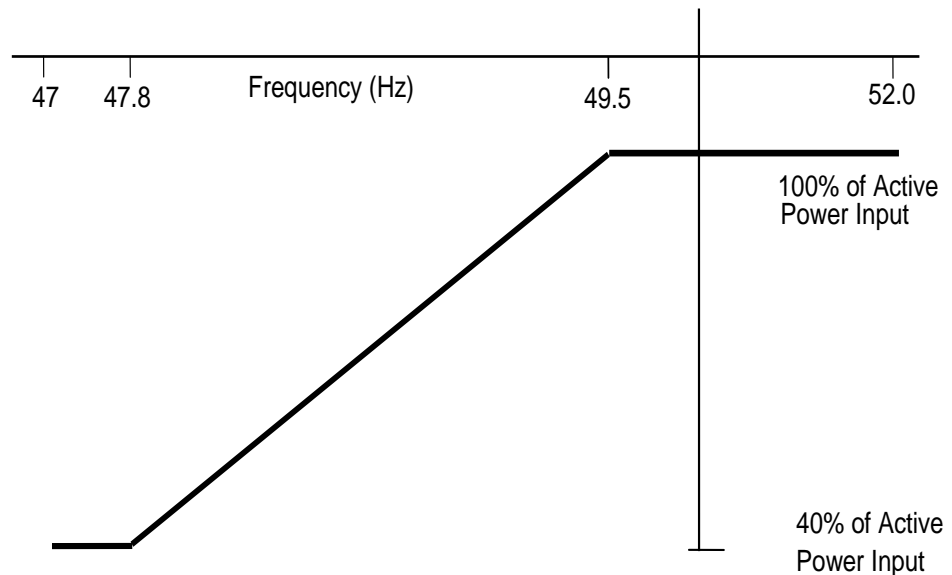

Figure 3

- (e) At a **Large Power Station**, in the case of an **Offshore Generating Unit, Offshore Power Park Module, Offshore DC Converter** and **OTSDUW DC Converter**, the **GB Generator** shall comply with the requirements of CC.6.3.3. **GB Generators** should be aware that Section K of the **STC** places requirements on **Offshore Transmission Licensees** which utilise a **Transmission DC Converter** as part of their **Offshore Transmission System** to make appropriate provisions to enable **GB Generators** to fulfil their obligations.
- (f) In the case of an **OTSDUW DC Converter** the **OTSDUW Plant and Apparatus** shall provide a continuous signal indicating the real time frequency measured at the **Interface Point** to the **Offshore Grid Entry Point**.

CC.6.3.4

At the **Grid Entry Point**, the **Active Power** output under steady state conditions of any **Generating Unit, DC Converter** or **Power Park Module** directly connected to the **National Electricity Transmission System** or in the case of **OTSDUW**, the **Active Power** transfer at the **Interface Point**, under steady state conditions of any **OTSDUW Plant and Apparatus** should not be affected by voltage changes in the normal operating range specified in paragraph CC.6.1.4 by more than the change in **Active Power** losses at reduced or increased voltage. In addition:

- (a) For any **Onshore Generating Unit, Onshore DC Converter** and **Onshore Power Park Module** or **OTSDUW Plant and Apparatus**, the **Reactive Power** output under steady state conditions should be fully available within the voltage range $\pm 5\%$ at 400kV, 275kV and 132kV and lower voltages, except for an **Onshore Power Park Module** or **Onshore Non-Synchronous Generating Unit** if **Embedded** at 33kV and below (or directly connected to the **Onshore Transmission System** at 33kV and below) where the requirement shown in Figure 4 applies.
- (b) At a **Large Power Station**, in the case of an **Offshore Generating Unit, Offshore DC Converter** and **Offshore Power Park Module** where an alternative reactive capability has been agreed with the **GB Generator**, as specified in CC.6.3.2(e) (iii), the voltage / **Reactive Power** requirement shall be specified in the **Bilateral Agreement**. The **Reactive Power** output under steady state conditions shall be fully available within the voltage range $\pm 5\%$ at 400kV, 275kV and 132kV and lower voltages.

Voltage at an **Onshore Grid Entry Point** or **User System Entry Point** if Embedded
(% of Nominal) at 33 kV and below

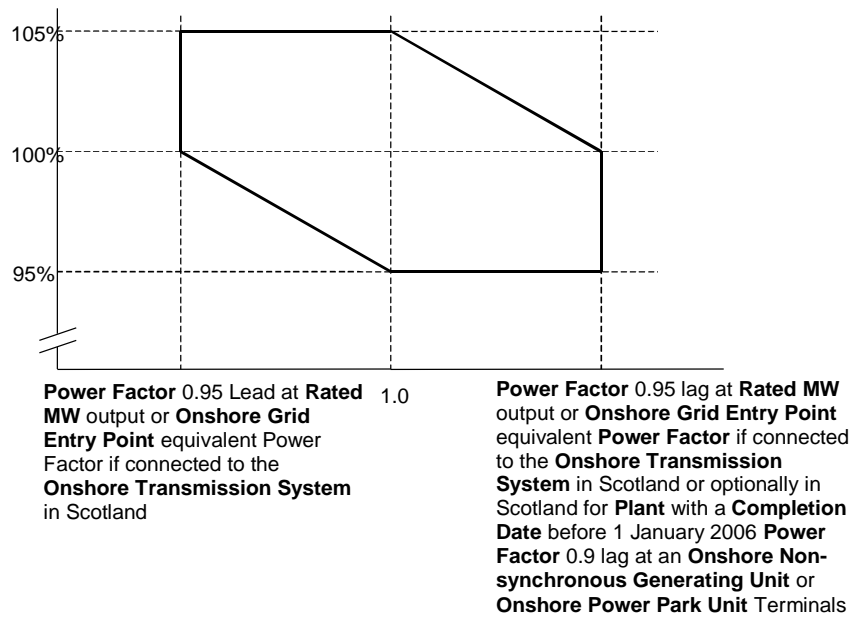

Figure 4

CC.6.3.5 It is an essential requirement that the **National Electricity Transmission System** must incorporate a **Black Start Capability**. This will be achieved by agreeing a **Black Start Capability** with a number of strategically located **Black Start Service Providers**. For each **Black Start Service Provider** The Company will state in the **Bilateral Agreement** whether or not a **Black Start Capability** is required. For the avoidance of doubt, a **GBGF-I** designed with a **Black Start Capability** will also be required to have a **Grid Forming Capability** in accordance with the requirements of ECC.6.3.19.

Control Arrangements

- CC.6.3.6 (a) Each:
- (i) **Offshore Generating Unit** in a **Large Power Station** or **Onshore Generating Unit**; or,
 - (ii) **Onshore DC Converter** with a **Completion Date** on or after 1 April 2005 or **Offshore DC Converter** at a **Large Power Station**; or,
 - (iii) **Onshore Power Park Module** in England and Wales with a **Completion Date** on or after 1 January 2006; or,
 - (iv) **Onshore Power Park Module** in operation in Scotland on or after 1 January 2006 (with a **Completion Date** after 1 July 2004 and in a **Power Station** with a **Registered Capacity** of 50MW or more); or,
 - (v) **Offshore Power Park Module** in a **Large Power Station** with a **Registered Capacity** of 50MW or more;

must be capable of contributing to **Frequency** control by continuous modulation of **Active Power** supplied to the **National Electricity Transmission System** or the **User System** in which it is **Embedded**. For the avoidance of doubt, each **OTSDUW DC Converter** shall provide each **GB Code User** in respect of its **Offshore Power Stations** connected to and/or using an **Offshore Transmission System** a continuous signal indicating the real time **Frequency** measured at the **Transmission Interface Point**.

- (b) Each:
- (i) **Onshore Generating Unit**; or,
 - (ii) **Onshore DC Converter** (with a **Completion Date** on or after 1 April 2005 excluding

current source technologies); or

- (iii) **Onshore Power Park Module** in England and Wales with a **Completion Date** on or after 1 January 2006; or,
- (iv) **Onshore Power Park Module** in Scotland irrespective of **Completion Date**; or,
- (v) **Offshore Generating Unit** at a **Large Power Station**, **Offshore DC Converter** at a **Large Power Station** or **Offshore Power Park Module** at a **Large Power Station** which provides a reactive range beyond the minimum requirements specified in CC.6.3.2(e) (iii); or,
- (vi) **OTSDUW Plant and Apparatus** at a **Transmission Interface Point**

must be capable of contributing to voltage control by continuous changes to the **Reactive Power** supplied to the **National Electricity Transmission System** or the **User System** in which it is **Embedded**.

CC.6.3.7

- (a) Each **Generating Unit**, **DC Converter** or **Power Park Module** (excluding **Onshore Power Park Modules** in Scotland with a **Completion Date** before 1 July 2004 or **Onshore Power Park Modules** in a **Power Station** in Scotland with a **Registered Capacity** less than 50MW or **Offshore Power Park Modules** in a **Large Power Station** located **Offshore** with a **Registered Capacity** less than 50MW) must be fitted with a fast acting proportional **Frequency** control device (or turbine speed governor) and unit load controller or equivalent control device to provide **Frequency** response under normal operational conditions in accordance with **Balancing Code 3 (BC3)**. In the case of a **Power Park Module** the **Frequency** or speed control device(s) may be on the **Power Park Module** or on each individual **Power Park Unit** or be a combination of both. The **Frequency** control device(s) (or speed governor(s)) must be designed and operated to the appropriate:

- (i) **European Specification**; or
- (ii) in the absence of a relevant **European Specification**, such other standard which is in common use within the European Community (which may include a manufacturer specification);

as at the time when the installation of which it forms part was designed or (in the case of modification or alteration to the **Frequency** control device (or turbine speed governor)) when the modification or alteration was designed.

The **European Specification** or other standard utilised in accordance with subparagraph CC.6.3.7 (a) (ii) will be notified to **The Company** by the **GB Generator** or **DC Converter Station** owner or, in the case of an **Embedded Medium Power Station** not subject to a **Bilateral Agreement** or **Embedded DC Converter Station** not subject to a **Bilateral Agreement**, the relevant **Network Operator**:

- (i) as part of the application for a **Bilateral Agreement**; or
 - (ii) as part of the application for a varied **Bilateral Agreement**; or
 - (iii) in the case of an **Embedded Development**, within 28 days of entry into the **Embedded Development Agreement** (or such later time as agreed with **The Company**); or
 - (iv) as soon as possible prior to any modification or alteration to the **Frequency** control device (or governor); and
- (b) The **Frequency** control device (or speed governor) in co-ordination with other control devices must control the **Generating Unit**, **DC Converter** or **Power Park Module Active Power Output** with stability over the entire operating range of the **Generating Unit**, **DC Converter** or **Power Park Module**; and
 - (c) The **Frequency** control device (or speed governor) must meet the following minimum requirements:

- (i) Where a **Generating Unit, DC Converter or Power Park Module** becomes isolated from the rest of the **Total System** but is still supplying **Customers**, the **Frequency** control device (or speed governor) must also be able to control **System Frequency** below 52Hz unless this causes the **Generating Unit, DC Converter or Power Park Module** to operate below its **Designed Minimum Operating Level** when it is possible that it may, as detailed in BC 3.7.3, trip after a time. For the avoidance of doubt, the **Generating Unit, DC Converter or Power Park Module** is only required to operate within the **System Frequency** range 47 - 52 Hz as defined in CC.6.1.3;
- (ii) the **Frequency** control device (or speed governor) must be capable of being set so that it operates with an overall speed **Droop** of between 3% and 5%. For the avoidance of doubt, in the case of a **Power Park Module** the speed **Droop** should be equivalent of a fixed setting between 3% and 5% applied to each **Power Park Unit** in service;
- (iii) in the case of all **Generating Units, DC Converter or Power Park Module** other than the **Steam Unit** within a **CCGT Module** the **Frequency** control device (or speed governor) deadband should be no greater than 0.03Hz (for the avoidance of doubt, $\pm 0.015\text{Hz}$). In the case of the **Steam Unit** within a **CCGT Module**, the speed **Governor Deadband** should be set to an appropriate value consistent with the requirements of CC.6.3.7(c)(i) and the requirements of BC3.7.2 for the provision of **Limited High Frequency Response**;

For the avoidance of doubt, the minimum requirements in (ii) and (iii) for the provision of **System Ancillary Services** do not restrict the negotiation of **Commercial Ancillary Services** between **The Company** and the **GB Code User** using other parameters; and

- (d) A facility to modify, so as to fulfil the requirements of the **Balancing Codes**, the **Target Frequency** setting either continuously or in a maximum of 0.05 Hz steps over at least the range 50 ± 0.1 Hz should be provided in the unit load controller or equivalent device.
- (e)
 - (i) Each **Onshore Generating Unit** and/or **CCGT Module** which has a **Completion Date** after 1 January 2001 in England and Wales, and after 1 April 2005 in Scotland, must be capable of meeting the minimum **Frequency** response requirement profile subject to and in accordance with the provisions of Appendix 3.
 - (ii) Each **DC Converter** at a **DC Converter Station** which has a **Completion Date** on or after 1 April 2005 and each **Offshore DC Converter** at a **Large Power Station** must be capable of meeting the minimum **Frequency** response requirement profile subject to and in accordance with the provisions of Appendix 3.
 - (iii) Each **Onshore Power Park Module** in operation in England and Wales with a **Completion Date** on or after 1 January 2006 must be capable of meeting the minimum **Frequency** response requirement profile subject to and in accordance with the provisions of Appendix 3.
 - (iv) Each **Onshore Power Park Module** in operation on or after 1 January 2006 in Scotland (with a **Completion Date** on or after 1 April 2005 and a **Registered Capacity** of 50MW or more) must be capable of meeting the minimum **Frequency** response requirement profile subject to and in accordance with the provisions of Appendix 3.
 - (v) Each **Offshore Generating Unit** in a **Large Power Station** must be capable of meeting the minimum **Frequency** response requirement profile subject to and in accordance with the provisions of Appendix 3.
 - (vi) Each **Offshore Power Park Module** in a **Large Power Station** with a **Registered Capacity** of 50 MW or greater, must be capable of meeting the minimum **Frequency** response requirement profile subject to and in accordance with the provisions of Appendix 3.
 - (vii) Subject to the requirements of CC.6.3.7(e), **Offshore Generating Units** at a **Large Power Station**, **Offshore Power Park Modules** at a **Large Power Station** and **Offshore DC Converters** in a **Large Power Station** shall comply with the

requirements of CC.6.3.7. **GB Generators** should be aware that Section K of the **STC** places requirements on **Offshore Transmission Licensees** which utilise a **Transmission DC Converter** as part of their **Offshore Transmission System** to make appropriate provisions to enable **GB Generators** to fulfil their obligations.

- (viii) Each **OTSDUW DC Converter** must be capable of providing a continuous signal indicating the real time frequency measured at the **Interface Point** to the **Offshore Grid Entry Point**.
- (f) For the avoidance of doubt, the requirements of Appendix 3 do not apply to:
 - (i) **Generating Units** and/or **CCGT Modules** which have a **Completion Date** before 1 January 2001 in England and Wales, and before 1 April 2005 in Scotland, for whom the remaining requirements of this clause CC.6.3.7 shall continue to apply unchanged; or
 - (ii) **DC Converters** at a **DC Converter Station** which have a **Completion Date** before 1 April 2005; or
 - (iii) **Onshore Power Park Modules** in England and Wales with a **Completion Date** before 1 January 2006 for whom only the requirements of **Limited Frequency Sensitive Mode** (BC3.5.2) operation shall apply; or
 - (iv) **Onshore Power Park Modules** in operation in Scotland before 1 January 2006 for whom only the requirements of **Limited Frequency Sensitive Mode** (BC3.5.2) operation shall apply; or
 - (v) **Onshore Power Park Modules** in operation after 1 January 2006 in Scotland which have a **Completion Date** before 1 April 2005 for whom the remaining requirements of this clause CC.6.3.7 shall continue to apply unchanged; or
 - (vi) **Offshore Power Park Modules** which are in a **Large Power Station** with a **Registered Capacity** less than 50MW for whom only the requirements of **Limited Frequency Sensitive Mode** (BC3.5.2) operation shall apply; or

Excitation and Voltage Control Performance Requirements

- CC.6.3.8
- (a) Excitation and voltage control performance requirements applicable to **Onshore Generating Units, Onshore Power Park Modules, Onshore DC Converters** and **OTSDUW Plant and Apparatus**.
 - (i) A continuously-acting automatic excitation control system is required to provide constant terminal voltage control of the **Onshore Synchronous Generating Unit** without instability over the entire operating range of the **Onshore Generating Unit**.
 - (ii) In respect of **Onshore Synchronous Generating Units** with a **Completion Date** before 1 January 2009, the requirements for excitation control facilities, including **Power System Stabilisers**, where in **The Company's** view these are necessary for system reasons, will be specified in the **Bilateral Agreement**. If any **Modification** to the excitation control facilities of such **Onshore Synchronous Generating Units** is made on or after 1 January 2009 the requirements that shall apply may be specified in the **Bilateral Agreement** as varied. To the extent that the **Bilateral Agreement** does not specify, the requirements given or referred to in CC.A.6 shall apply. The performance requirements for a continuously acting automatic excitation control system that shall be complied with by the **GB Code User** in respect of such **Onshore Synchronous Generating Units** with a **Completion Date** on or after 1 January 2009 are given or referred to in CC.A.6. Reference is made to on-load commissioning witnessed by **The Company** in BC2.11.2.
 - (iii) In the case of an **Onshore Non-Synchronous Generating Unit, Onshore DC Converter, Onshore Power Park Module** or **OTSDUW Plant and Apparatus** at the **Interface Point** a continuously-acting automatic control system is required to provide control of the voltage (or zero transfer of **Reactive Power** as applicable to CC.6.3.2) at the **Onshore Grid Entry Point** or **User System Entry Point** or in the case of **OTSDUW Plant and Apparatus** at the **Interface Point** without instability

over the entire operating range of the **Onshore Non-Synchronous Generating Unit, Onshore DC Converter, Onshore Power Park Module or OTSDUW Plant and Apparatus**. Any **Plant or Apparatus** used in the provisions of such voltage control within an **Onshore Power Park Module** may be located at the **Power Park Unit** terminals, an appropriate intermediate busbar or the **Connection Point**. **OTSDUW Plant and Apparatus** used in the provision of such voltage control may be located at the **Offshore Grid Entry Point**, an appropriate intermediate busbar or at the **Interface Point**. In the case of an **Onshore Power Park Module** in Scotland with a **Completion Date** before 1 January 2009, voltage control may be at the **Power Park Unit** terminals, an appropriate intermediate busbar or the **Connection Point** as specified in the **Bilateral Agreement**. When operating below 20% **Rated MW** the automatic control system may continue to provide voltage control utilising any available reactive capability. If voltage control is not being provided, the automatic control system shall be designed to ensure a smooth transition between the shaded area bound by CD and the non-shaded area bound by AB in Figure 1 of CC.6.3.2 (c).

- (iv) The performance requirements for a continuously acting automatic voltage control system in respect of **Onshore Power Park Modules, Onshore Non-Synchronous Generating Units and Onshore DC Converters** with a **Completion Date** before 1 January 2009 will be specified in the **Bilateral Agreement**. If any **Modification** to the continuously acting automatic voltage control system of such **Onshore Power Park Modules, Onshore Non-Synchronous Generating Units and Onshore DC Converters** is made on or after 1 January 2009 the requirements that shall apply may be specified in the **Bilateral Agreement** as varied. To the extent that the **Bilateral Agreement** does not specify, the requirements given or referred to in CC.A.7 shall apply. The performance requirements for a continuously acting automatic voltage control system that shall be complied with by the **GB Code User** in respect of **Onshore Power Park Modules, Onshore Non-Synchronous Generating Units and Onshore DC Converters or OTSDUW Plant and Apparatus** at the **Interface Point** with a **Completion Date** on or after 1 January 2009 are given or referred to in CC.A.7.
 - (v) Unless otherwise required for testing in accordance with OC5.A.2, the automatic excitation control system of an **Onshore Synchronous Generating Unit** shall always be operated such that it controls the **Onshore Synchronous Generating Unit** terminal voltage to a value that is
 - equal to its rated value; or
 - only where provisions have been made in the **Bilateral Agreement**, greater than its rated value.
 - (vi) In particular, other control facilities, including constant **Reactive Power** output control modes and constant **Power Factor** control modes (but excluding VAr limiters) are not required. However, if present in the excitation or voltage control system they will be disabled unless the **Bilateral Agreement** records otherwise. Operation of such control facilities will be in accordance with the provisions contained in **BC2**.
- (b) Excitation and voltage control performance requirements applicable to **Offshore Generating Units at a Large Power Station, Offshore Power Park Modules at a Large Power Station and Offshore DC Converters at a Large Power Station**.

A continuously acting automatic control system is required to provide either:

- (i) control of **Reactive Power** (as specified in CC.6.3.2(e) (i) (ii)) at the **Offshore Grid Entry Point** without instability over the entire operating range of the **Offshore Generating Unit, Offshore DC Converter or Offshore Power Park Module**. The performance requirements for this automatic control system will be specified in the **Bilateral Agreement** or;
- (ii) where an alternative reactive capability has been specified in the **Bilateral**

Agreement, in accordance with CC.6.3.2 (e) (iii), the **Offshore Generating Unit, Offshore Power Park Module or Offshore DC Converter** will be required to control voltage and / or **Reactive Power** without instability over the entire operating range of the **Offshore Generating Unit, Offshore Power Park Module or Offshore DC Converter**. The performance requirements of the control system will be specified in the **Bilateral Agreement**.

In addition to CC.6.3.8(b) (i) and (ii) the requirements for excitation control facilities, including **Power System Stabilisers**, where in **The Company's** view these are necessary for system reasons, will be specified in the **Bilateral Agreement**. Reference is made to on-load commissioning witnessed by **The Company** in BC2.11.2.

Steady state Load Inaccuracies

CC.6.3.9 The standard deviation of **Load** error at steady state **Load** over a 30 minute period must not exceed 2.5 per cent of a **Genset's Registered Capacity**. Where a **Genset** is instructed to **Frequency** sensitive operation, allowance will be made in determining whether there has been an error according to the governor droop characteristic registered under the **PC**.

For the avoidance of doubt in the case of a **Power Park Module** allowance will be made for the full variation of mechanical power output.

Negative Phase Sequence Loadings

CC.6.3.10 In addition to meeting the conditions specified in CC.6.1.5(b), each **Synchronous Generating Unit** will be required to withstand, without tripping, the negative phase sequence loading incurred by clearance of a close-up phase-to-phase fault, by **System Back-Up Protection** on the **National Electricity Transmission System or User System** located **Onshore** in which it is **Embedded**.

Neutral Earthing

CC.6.3.11 At nominal **System** voltages of 132kV and above the higher voltage windings of a transformer of a **Generating Unit, DC Converter, Power Park Module** or transformer resulting from **OTSDUW** must be star connected with the star point suitable for connection to earth. The earthing and lower voltage winding arrangement shall be such as to ensure that the **Earth Fault Factor** requirement of paragraph CC.6.2.1.1 (b) will be met on the **National Electricity Transmission System** at nominal **System** voltages of 132kV and above.

Frequency Sensitive Relays

CC.6.3.12 As stated in CC.6.1.3, the **System Frequency** could rise to 52Hz or fall to 47Hz. Each **Generating Unit, DC Converter, OTSDUW Plant and Apparatus, Power Park Module** or any constituent element must continue to operate within this **Frequency** range for at least the periods of time given in CC.6.1.3 unless **The Company** has agreed to any **Frequency**-level relays and/or rate-of-change-of-**Frequency** relays which will trip such **Generating Unit, DC Converter, OTSDUW Plant and Apparatus, Power Park Module** and any constituent element within this **Frequency** range, under the **Bilateral Agreement**.

CC.6.3.13 **GB Generators** (including in respect of **OTSDUW Plant and Apparatus**) and **DC Converter Station** owners will be responsible for protecting all their **Generating Units** (and **OTSDUW Plant and Apparatus**), **DC Converters** or **Power Park Modules** against damage should **Frequency** excursions outside the range 52Hz to 47Hz ever occur. Should such excursions occur, it is up to the **GB Generator or DC Converter Station** owner to decide whether to disconnect their **Apparatus** for reasons of safety of **Apparatus, Plant** and/or personnel.

CC.6.3.14 It may be agreed in the **Bilateral Agreement** that a **Genset** shall have a **Fast-Start Capability**. Such **Gensets** may be used for **Operating Reserve** and their **Start-Up** may be initiated by **Frequency**-level relays with settings in the range 49Hz to 50Hz as specified pursuant to **OC2**.

CC.6.3.15 Fault Ride Through

This section sets out the fault ride through requirements on **Generating Units, Power Park Modules, DC Converters and OTSDUW Plant and Apparatus. Onshore Generating Units, Onshore Power Park Modules, Onshore DC Converters** (including **Embedded Medium Power Stations** and **Embedded DC Converter Stations** not subject to a **Bilateral Agreement** and with an **Onshore User System Entry Point** (irrespective of whether they are located **Onshore** or **Offshore**)) and **OTSDUW Plant and Apparatus** are required to operate through **System** faults and disturbances as defined in CC.6.3.15.1 (a), CC.6.3.15.1 (b) and CC.6.3.15.3. **Offshore GB Generators** in respect of **Offshore Generating Units** at a **Large Power Station, Offshore Power Park Modules** at a **Large Power Station** and **DC Converter Station** owners in respect of **Offshore DC Converters** at a **Large Power Station** shall have the option of meeting either:

- (i) CC.6.3.15.1 (a), CC.6.3.15.1 (b) and CC.6.3.15.3, or:
- (ii) CC.6.3.15.2 (a), CC.6.3.15.2 (b) and CC.6.3.15.3

Offshore GB Generators and **Offshore DC Converter** owners, should notify **The Company** which option they wish to select within 28 days (or such longer period as **The Company** may agree, in any event this being no later than 3 months before the **Completion Date** of the offer for a final **CUSC Contract** which would be made following the appointment of the **Offshore Transmission Licensee**).

For up to 30 minutes following such a fault or disturbance **Generating Units, Power Park Modules, DC Converters** and **OTSDUW Plant and Apparatus** are required to remain connected and stable provided **System** operating conditions have returned within those specified in CC.6.1.

CC.6.3.15.1 Fault Ride through applicable to **Generating Units, Power Park Modules** and **DC Converters** and **OTSDUW Plant and Apparatus**

- (a) Short circuit faults on the **Onshore Transmission System** (which may include an **Interface Point**) at **Supergrid Voltage** up to 140ms in duration.
 - (i) Each **Generating Unit, DC Converter, or Power Park Module** and any constituent **Power Park Unit** thereof and **OTSDUW Plant and Apparatus** shall remain transiently stable and connected to the **System** without tripping of any **Generating Unit, DC Converter or Power Park Module** and / or any constituent **Power Park Unit, OTSDUW Plant and Apparatus**, and for **Plant and Apparatus** installed on or after 1 December 2017, reactive compensation equipment, for a close-up solid three-phase short circuit fault or any unbalanced short circuit fault on the **Onshore Transmission System** (including in respect of **OTSDUW Plant and Apparatus**, the **Interface Point**) operating at **Supergrid Voltages** for a total fault clearance time of up to 140 ms. A solid three-phase or unbalanced earthed fault results in zero voltage on the faulted phase(s) at the point of fault. The duration of zero voltage is dependent on local **Protection** and circuit breaker operating times. This duration and the fault clearance times will be specified in the **Bilateral Agreement**. Following fault clearance, recovery of the **Supergrid Voltage** on the **Onshore Transmission System** to 90% may take longer than 140ms as illustrated in Appendix 4A Figures CC.A.4A.1 (a) and (b). It should be noted that in the case of an **Offshore Generating Unit, Offshore DC Converter or Offshore Power Park Module** (including any **Offshore Power Park Unit** thereof) which is connected to an **Offshore Transmission System** which includes a **Transmission DC Converter** as part of that **Offshore Transmission System**, the **Offshore Grid Entry Point** voltage may not indicate the presence of a fault on the **Onshore Transmission System**. The fault will affect the level of **Active Power** that can be transferred to the **Onshore Transmission System** and therefore subject the **Offshore Generating Unit, Offshore DC Converter or Offshore Power Park Module** (including any **Offshore Power Park Unit** thereof) to a load rejection.
 - (ii) Each **Generating Unit, Power Park Module** and **OTSDUW Plant and Apparatus**, shall be designed such that upon both clearance of the fault on the **Onshore**

Transmission System as detailed in CC.6.3.15.1 (a) (i) and within 0.5 seconds of the restoration of the voltage at the **Onshore Grid Entry Point** (for **Onshore Generating Units** or **Onshore Power Park Modules**) or **Interface Point** (for **Offshore Generating Units**, **Offshore Power Park Modules** or **OTSDUW Plant and Apparatus**) to the minimum levels specified in CC.6.1.4 (or within 0.5 seconds of restoration of the voltage at the **User System Entry Point** to 90% of nominal or greater if **Embedded**), **Active Power** output or in the case of **OTSDUW Plant and Apparatus**, **Active Power** transfer capability, shall be restored to at least 90% of the level available immediately before the fault. Once the **Active Power** output, or in the case of **OTSDUW Plant and Apparatus**, **Active Power** transfer capability, has been restored to the required level, **Active Power** oscillations shall be acceptable provided that:

- the total **Active Energy** delivered during the period of the oscillations is at least that which would have been delivered if the **Active Power** was constant
- the oscillations are adequately damped

During the period of the fault as detailed in CC.6.3.15.1 (a) (i) for which the voltage at the **Grid Entry Point** (or **Interface Point** in the case of **OTSDUW Plant and Apparatus**) is outside the limits specified in CC.6.1.4, each **Generating Unit** or **Power Park Module** or **OTSDUW Plant and Apparatus** shall generate maximum reactive current without exceeding the transient rating limit of the **Generating Unit**, **OTSDUW Plant and Apparatus** or **Power Park Module** and / or any constituent **Power Park Unit** or reactive compensation equipment. For **Plant and Apparatus** installed on or after 1 December 2017, switched reactive compensation equipment (such as mechanically switched capacitors and reactors) shall be controlled such that it is not switched in or out of service during the fault but may act to assist in post fault voltage recovery.

- (iii) Each **DC Converter** shall be designed to meet the **Active Power** recovery characteristics (and **OTSDUW DC Converter** shall be designed to meet the **Active Power** transfer capability at the **Interface Point**) as specified in the **Bilateral Agreement** upon clearance of the fault on the **Onshore Transmission System** as detailed in CC.6.3.15.1 (a) (i).
- (b) **Supergrid Voltage** dips on the **Onshore Transmission System** greater than 140ms in duration
- (1b) Requirements applicable to **Synchronous Generating Units** subject to **Supergrid Voltage** dips on the **Onshore Transmission System** greater than 140ms in duration.

In addition to the requirements of CC.6.3.15.1 (a) each **Synchronous Generating Unit**, each with a **Completion Date** on or after **1 April 2005** shall:

- (i) remain transiently stable and connected to the **System** without tripping of any **Synchronous Generating Unit** for balanced **Supergrid Voltage** dips and associated durations on the **Onshore Transmission System** (which could be at the **Interface Point**) anywhere on or above the heavy black line shown in Figure 5a. Appendix 4A and Figures CC.A.4A.3.2 (a), (b) and (c) provide an explanation and illustrations of Figure 5a; and,

NOT TO SCALE

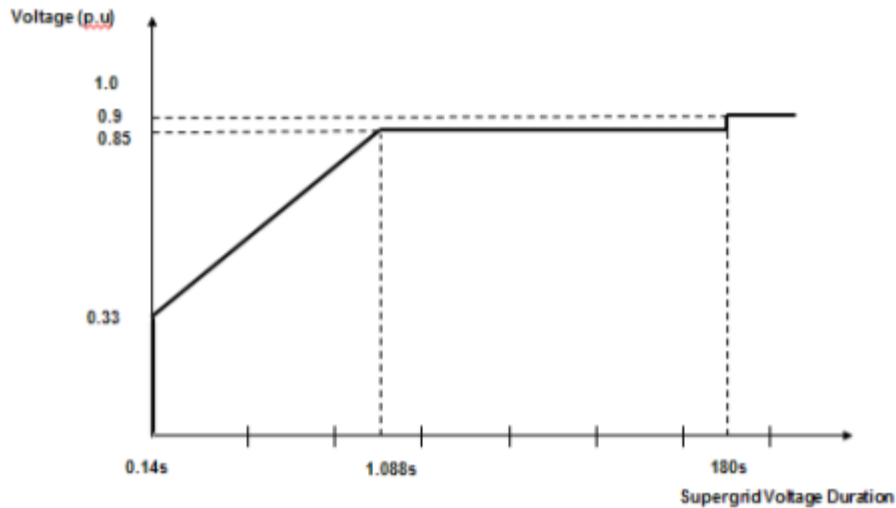

Figure 5a

- (ii) provide **Active Power** output at the **Grid Entry Point**, during **Supergrid Voltage** dips on the **Onshore Transmission System** as described in Figure 5a, at least in proportion to the retained balanced voltage at the **Onshore Grid Entry Point** (for **Onshore Synchronous Generating Units**) or **Interface Point** (for **Offshore Synchronous Generating Units**) (or the retained balanced voltage at the **User System Entry Point** if **Embedded**) and shall generate maximum reactive current (where the voltage at the **Grid Entry Point** is outside the limits specified in CC.6.1.4) without exceeding the transient rating limits of the **Synchronous Generating Unit** and,
- (iii) restore **Active Power** output following **Supergrid Voltage** dips on the **Onshore Transmission System** as described in Figure 5a, within 1 second of restoration of the voltage to 1.0p.u of the nominal voltage at the:

Onshore Grid Entry Point for directly connected **Onshore Synchronous Generating Units** or,

Interface Point for **Offshore Synchronous Generating Units** or,

User System Entry Point for **Embedded Onshore Synchronous Generating Units** or,

User System Entry Point for **Embedded Medium Power Stations** not subject to a **Bilateral Agreement** which comprise **Synchronous Generating Units** and with an **Onshore User System Entry Point** (irrespective of whether they are located **Onshore** or **Offshore**)

to at least 90% of the level available immediately before the occurrence of the dip. Once the **Active Power** output has been restored to the required level, **Active Power** oscillations shall be acceptable provided that:

- the total **Active Energy** delivered during the period of the oscillations is at least that which would have been delivered if the **Active Power** was constant
- the oscillations are adequately damped.

For the avoidance of doubt a balanced **Onshore Transmission System Supergrid Voltage** meets the requirements of CC.6.1.5 (b) and CC.6.1.6.

- (2b) Requirements applicable to **OTSDUW Plant and Apparatus** and **Power Park Modules** subject to **Supergrid Voltage** dips on the **Onshore Transmission System** greater than 140ms in duration

In addition to the requirements of CC.6.3.15.1 (a) each **OTSDUW Plant and Apparatus** or each **Power Park Module** and / or any constituent **Power Park Unit**, each with a **Completion Date** on or after the 1 April 2005 shall:

- (i) remain transiently stable and connected to the **System** without tripping of any **OTSDUW Plant and Apparatus**, or **Power Park Module** and / or any constituent **Power Park Unit**, for balanced **Supergrid Voltage** dips and associated durations on the **Onshore Transmission System** (which could be at the **Interface Point**) anywhere on or above the heavy black line shown in Figure 5b. Appendix 4A and Figures CC.A.4A.3.4 (a), (b) and (c) provide an explanation and illustrations of Figure 5b; and,

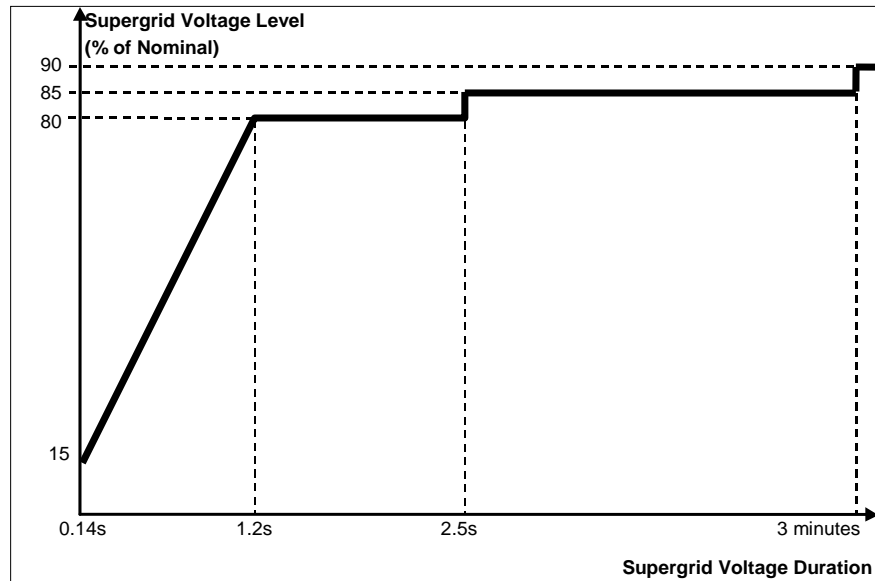

Figure 5b

- (ii) provide **Active Power** output at the **Grid Entry Point** or in the case of an **OTSDUW**, **Active Power** transfer capability at the **Transmission Interface Point**, during **Supergrid Voltage** dips on the **Onshore Transmission System** as described in Figure 5b, at least in proportion to the retained balanced voltage at the **Onshore Grid Entry Point** (for **Onshore Power Park Modules**) or **Interface Point** (for **OTSDUW Plant and Apparatus** and **Offshore Power Park Modules**) (or the retained balanced voltage at the **User System Entry Point** if **Embedded**) except in the case of a **Non-Synchronous Generating Unit** or **OTSDUW Plant and Apparatus** or **Power Park Module** where there has been a reduction in the **Intermittent Power Source** or in the case of **OTSDUW Active Power** transfer capability in the time range in Figure 5b that restricts the **Active Power** output or in the case of an **OTSDUW Active Power** transfer capability below this level and shall generate maximum reactive current (where the voltage at the **Grid Entry Point**, or in the case of an **OTSDUW Plant and Apparatus**, the **Interface Point** voltage, is outside the limits specified in CC.6.1.4) without exceeding the transient rating limits of the **OTSDUW Plant and Apparatus** or **Power Park Module** and any constituent **Power Park Unit**; and,
- (iii) restore **Active Power** output (or, in the case of **OTSDUW**, **Active Power** transfer capability), following **Supergrid Voltage** dips on the **Onshore Transmission System** as described in Figure 5b, within 1 second of restoration of the voltage at the:

Onshore Grid Entry Point for directly connected **Onshore Power Park Modules** or,

Interface Point for **OTSDUW Plant and Apparatus** and **Offshore Power Park**

Modules or,

User System Entry Point for **Embedded Onshore Power Park Modules** or,

User System Entry Point for **Embedded Medium Power Stations** which comprise **Power Park Modules** not subject to a **Bilateral Agreement** and with an **Onshore User System Entry Point** (irrespective of whether they are located **Onshore** or **Offshore**)

to the minimum levels specified in CC.6.1.4 to at least 90% of the level available immediately before the occurrence of the dip except in the case of a **Non-Synchronous Generating Unit, OTSDUW Plant and Apparatus** or **Power Park Module** where there has been a reduction in the **Intermittent Power Source** in the time range in Figure 5b that restricts the **Active Power** output or, in the case of **OTSDUW, Active Power** transfer capability below this level. Once the **Active Power** output or, in the case of **OTSDUW, Active Power** transfer capability has been restored to the required level, **Active Power** oscillations shall be acceptable provided that:

- the total **Active Energy** delivered during the period of the oscillations is at least that which would have been delivered if the **Active Power** was constant
- the oscillations are adequately damped.

For the avoidance of doubt a balanced **Onshore Transmission System Supergrid Voltage** meets the requirements of CC.6.1.5 (b) and CC.6.1.6.

CC.6.3.15.2 Fault Ride Through applicable to **Offshore Generating Units** at a **Large Power Station, Offshore Power Park Modules** at a **Large Power Station** and **Offshore DC Converters** at a **Large Power Station** who choose to meet the fault ride through requirements at the **LV side of the Offshore Platform**

- (a) Requirements on **Offshore Generating Units, Offshore Power Park Modules** and **Offshore DC Converters** to withstand voltage dips on the **LV Side of the Offshore Platform** for up to 140ms in duration as a result of faults and / or voltage dips on the **Onshore Transmission System** operating at **Supergrid Voltage**.
 - (i) Each **Offshore Generating Unit, Offshore DC Converter, or Offshore Power Park Module** and any constituent **Power Park Unit** thereof shall remain transiently stable and connected to the **System** without tripping of any **Offshore Generating Unit, or Offshore DC Converter or Offshore Power Park Module** and / or any constituent **Power Park Unit** or, in the case of **Plant and Apparatus** installed on or after 1 December 2017, reactive compensation equipment, for any balanced or unbalanced voltage dips on the **LV Side of the Offshore Platform** whose profile is anywhere on or above the heavy black line shown in Figure 6. For the avoidance of doubt, the profile beyond 140ms in Figure 6 shows the minimum recovery in voltage that will be seen by the **Generator's Plant and Apparatus** following clearance of the fault at 140ms. Appendix 4B and Figures CC.A.4B.2 (a) and (b) provide further illustration of the voltage recovery profile that may be seen. It should be noted that in the case of an **Offshore Generating Unit, Offshore DC Converter or Offshore Power Park Module** (including any **Offshore Power Park Unit** thereof) which is connected to an **Offshore Transmission System** which includes a **Transmission DC Converter** as part of that **Offshore Transmission System**, the **Offshore Grid Entry Point** voltage may not indicate the presence of a fault on the **Onshore Transmission System**. The voltage dip will affect the level of **Active Power** that can be transferred to the **Onshore Transmission System** and therefore subject the **Offshore Generating Unit, Offshore DC Converter or Offshore Power Park Module** (including any **Offshore Power Park Unit** thereof) to a load rejection.

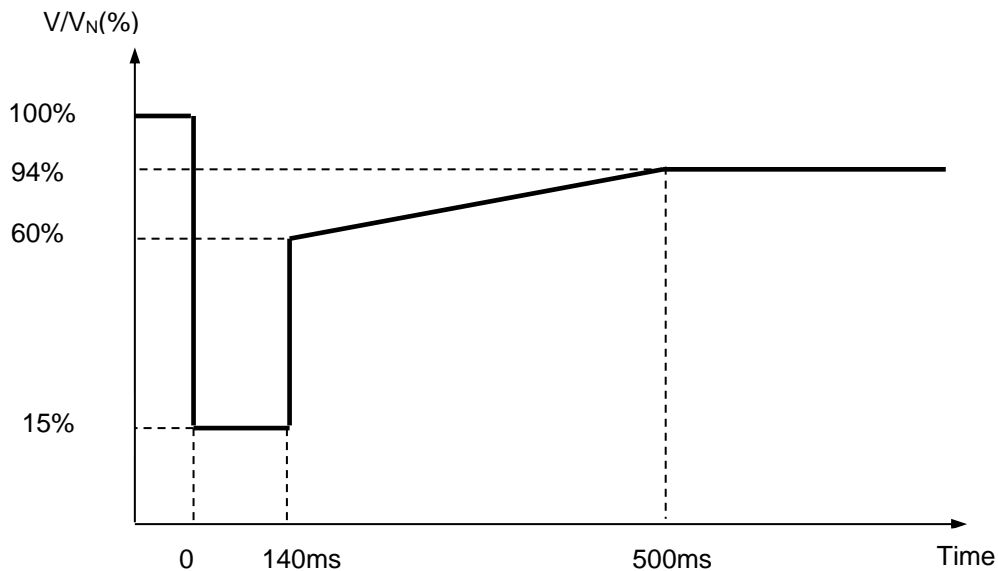

Figure 6

V/V_N is the ratio of the actual voltage on one or more phases at the **LV Side of the Offshore Platform** to the nominal voltage of the **LV Side of the Offshore Platform**.

- (ii) Each **Offshore Generating Unit**, or **Offshore Power Park Module** and any constituent **Power Park Unit** thereof shall provide **Active Power** output, during voltage dips on the **LV Side of the Offshore Platform** as described in Figure 6, at least in proportion to the retained voltage at the **LV Side of the Offshore Platform** except in the case of an **Offshore Non-Synchronous Generating Unit** or **Offshore Power Park Module** where there has been a reduction in the **Intermittent Power Source** in the time range in Figure 6 that restricts the **Active Power** output below this level and shall generate maximum reactive current without exceeding the transient rating limits of the **Offshore Generating Unit** or **Offshore Power Park Module** and any constituent **Power Park Unit** or, in the case of **Plant and Apparatus** installed on or after 1 December 2017, reactive compensation equipment. Once the **Active Power** output has been restored to the required level, **Active Power** oscillations shall be acceptable provided that:
- the total **Active Energy** delivered during the period of the oscillations is at least that which would have been delivered if the **Active Power** was constant
 - the oscillations are adequately damped
- and;
- (iii) Each **Offshore DC Converter** shall be designed to meet the **Active Power** recovery characteristics as specified in the **Bilateral Agreement** upon restoration of the voltage at the **LV Side of the Offshore Platform**.

- (b) Requirements of **Offshore Generating Units**, **Offshore Power Park Modules**, to withstand voltage dips on the **LV Side of the Offshore Platform** greater than 140ms in duration.
- (1b) Requirements applicable to **Offshore Synchronous Generating Units** to withstand voltage dips on the **LV Side of the Offshore Platform** greater than 140ms in duration.

In addition to the requirements of CC.6.3.15.2. (a) each **Offshore Synchronous Generating Unit** shall:

- (i) remain transiently stable and connected to the **System** without tripping of any **Offshore Synchronous Generating Unit** for any balanced voltage dips on the **LV**

side of the Offshore Platform and associated durations anywhere on or above the heavy black line shown in Figure 7a. Appendix 4B and Figures CC.A.4B.3.2 (a), (b) and (c) provide an explanation and illustrations of Figure 7a. It should be noted that in the case of an **Offshore Synchronous Generating Unit** which is connected to an **Offshore Transmission System** which includes a **Transmission DC Converter** as part of that **Offshore Transmission System**, the **Offshore Grid Entry Point** voltage may not indicate the presence of a voltage dip on the **Onshore Transmission System**. The voltage dip will affect the level of **Active Power** that can be transferred to the **Onshore Transmission System** and therefore subject the **Offshore Generating Unit**, to a load rejection.

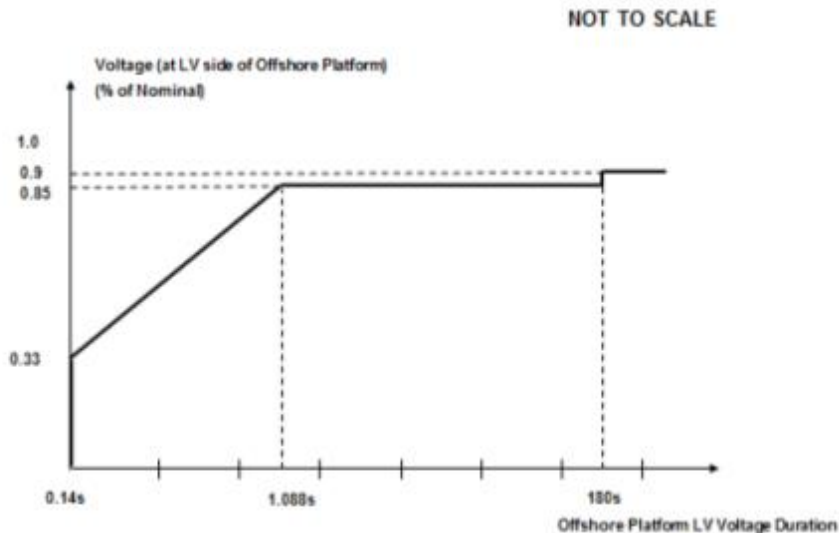

- (ii) provide **Active Power** output, during voltage dips on the **LV Side of the Offshore Platform** as described in Figure 7a, at least in proportion to the retained balanced or unbalanced voltage at the **LV Side of the Offshore Platform** and shall generate maximum reactive current (where the voltage at the **Offshore Grid Entry Point** is outside the limits specified in CC.6.1.4) without exceeding the transient rating limits of the **Offshore Synchronous Generating Unit** and,
- (iii) within 1 second of restoration of the voltage to 1.0p.u of the nominal voltage at the **LV Side of the Offshore Platform**, restore **Active Power** to at least 90% of the **Offshore Synchronous Generating Unit's** immediate pre-disturbed value, unless there has been a reduction in the **Intermittent Power Source** in the time range in Figure 7a that restricts the **Active Power** output below this level. Once the **Active Power** output has been restored to the required level, **Active Power** oscillations shall be acceptable provided that:
 - the total **Active Energy** delivered during the period of the oscillations is at least that which would have been delivered if the **Active Power** was constant
 - the oscillations are adequately damped

(2b) Requirements applicable to **Offshore Power Park Modules** to withstand voltage dips on the **LV Side of the Offshore Platform** greater than 140ms in duration.

In addition to the requirements of CC.6.3.15.2. (a) each **Offshore Power Park Module** and / or any constituent **Power Park Unit**, shall:

- (i) remain transiently stable and connected to the **System** without tripping of any **Offshore Power Park Module** and / or any constituent **Power Park Unit**, for any balanced voltage dips on the **LV side of the Offshore Platform** and associated durations anywhere on or above the heavy black line shown in Figure 7b. Appendix 4B and Figures CC.A.4B.5. (a), (b) and (c) provide an explanation and illustrations of Figure 7b. It should be noted that in the case of an **Offshore Power Park Module** (including any **Offshore Power Park Unit** thereof) which is connected to an **Offshore Transmission System** which includes a **Transmission DC Converter** as part of that **Offshore Transmission System**, the **Offshore Grid Entry Point** voltage may not indicate the presence of a voltage dip on the **Onshore Transmission System**. The voltage dip will affect the level of **Active Power** that can be transferred to the **Onshore Transmission System** and therefore subject the **Offshore Power Park Module** (including any **Offshore Power Park Unit** thereof) to a load rejection.

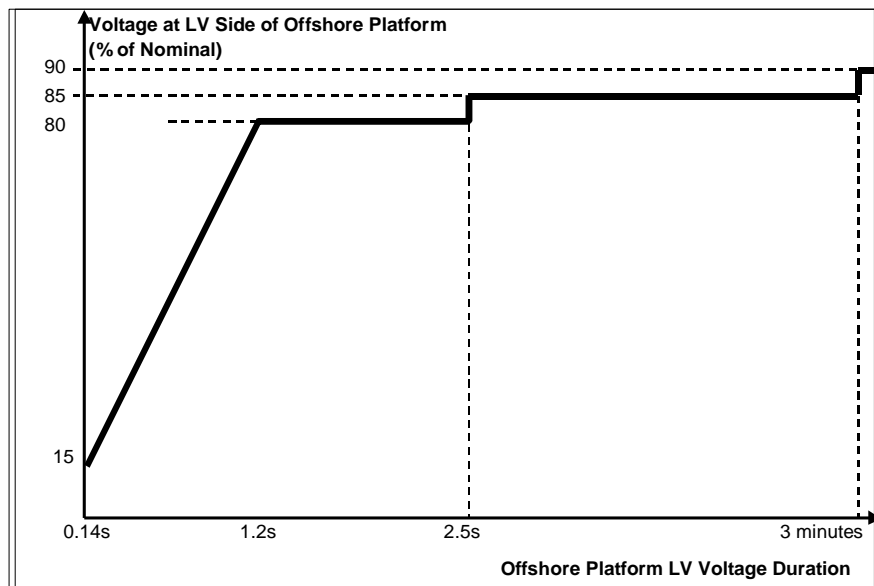

Figure 7b

- (ii) provide **Active Power** output, during voltage dips on the **LV Side of the Offshore Platform** as described in Figure 7b, at least in proportion to the retained balanced or unbalanced voltage at the **LV Side of the Offshore Platform** except in the case of an **Offshore Non-Synchronous Generating Unit** or **Offshore Power Park Module** where there has been a reduction in the **Intermittent Power Source** in the time range in Figure 7b that restricts the **Active Power** output below this level and shall generate maximum reactive current (where the voltage at the **Offshore Grid Entry Point** is outside the limits specified in CC.6.1.4) without exceeding the transient rating limits of the **Offshore Power Park Module** and any constituent **Power Park Unit** or reactive compensation equipment. For **Plant and Apparatus** installed on or after 1 December 2017, switched reactive compensation equipment (such as mechanically switched capacitors and reactors) shall be controlled such that it is not switched in or out of service during the fault but may act to assist in post fault voltage recovery; and,
- (iii) within 1 second of the restoration of the voltage at the **LV Side of the Offshore Platform** (to the minimum levels specified in CC.6.1.4) restore **Active Power** to at least 90% of the **Offshore Power Park Module's** immediate pre-disturbed value, unless there has been a reduction in the **Intermittent Power Source** in the time range in Figure 7b that restricts the **Active Power** output below this level. Once the **Active Power** output has been restored to the required level, **Active Power** oscillations shall be acceptable provided that:
- the total **Active Energy** delivered during the period of the oscillations is at least that which would have been delivered if the **Active Power** was constant

- the oscillations are adequately damped

CC.6.3.15.3 Other Requirements

- (i) In the case of a **Power Park Module** (comprising of wind-turbine generator units), the requirements in CC.6.3.15.1 and CC.6.3.15.2 do not apply when the **Power Park Module** is operating at less than 5% of its **Rated MW** or during very high wind speed conditions when more than 50% of the wind turbine generator units in a **Power Park Module** have been shut down or disconnected under an emergency shutdown sequence to protect **GB Code User's Plant and Apparatus**.
- (ii) In addition to meeting the conditions specified in CC.6.1.5(b) and CC.6.1.6, each **Non-Synchronous Generating Unit, OTSDUW Plant and Apparatus** or **Power Park Module** with a **Completion Date** after 1 April 2005 and any constituent **Power Park Unit** thereof will be required to withstand, without tripping, the negative phase sequence loading incurred by clearance of a close-up phase-to-phase fault, by **System Back-Up Protection** on the **Onshore Transmission System** operating at **Supergrid Voltage**.
- (iii) In the case of an **Onshore Power Park Module** in Scotland with a **Completion Date** before 1 January 2004 and a **Registered Capacity** less than 30MW, the requirements in CC.6.3.15.1 (a) do not apply. In the case of an **Onshore Power Park Module** in Scotland with a **Completion Date** on or after 1 January 2004 and before 1 July 2005 and a **Registered Capacity** less than 30MW the requirements in CC.6.3.15.1 (a) are relaxed from the minimum **Onshore Transmission System Supergrid Voltage** of zero to a minimum **Onshore Transmission System Supergrid Voltage** of 15% of nominal. In the case of an **Onshore Power Park Module** in Scotland with a **Completion Date** before 1 January 2004 and a **Registered Capacity** of 30MW and above the requirements in CC.6.3.15.1 (a) are relaxed from the minimum **Onshore Transmission System Supergrid Voltage** of zero to a minimum **Onshore Transmission System Supergrid Voltage** of 15% of nominal.
- (iv) To avoid unwanted island operation, **Non-Synchronous Generating Units** in Scotland (and those directly connected to a **Scottish Offshore Transmission System**), **Power Park Modules** in Scotland (and those directly connected to a **Scottish Offshore Transmission System**), or **OTSDUW Plant and Apparatus** with an **Interface Point** in Scotland shall be tripped for the following conditions:
 - (1) **Frequency** above 52Hz for more than 2 seconds
 - (2) **Frequency** below 47Hz for more than 2 seconds
 - (3) Voltage as measured at the **Onshore Connection Point** or **Onshore User System Entry Point** or **Offshore Grid Entry Point** or **Interface Point** in the case of **OTSDUW Plant and Apparatus** is below 80% for more than 2.5 seconds
 - (4) Voltage as measured at the **Onshore Connection Point** or **Onshore User System Entry Point** or **Offshore Grid Entry Point** or **Interface Point** in the case of **OTSDUW Plant and Apparatus** is above 120% (115% for 275kV) for more than 1 second.

The times in sections (1) and (2) are maximum trip times. Shorter times may be used to protect the **Non-Synchronous Generating Units**, or **OTSDUW Plant and Apparatus** or **Power Park Modules**.

Additional Damping Control Facilities for DC Converters

- CC.6.3.16 (a) **DC Converter** owners, or **GB Generators** in respect of **OTSDUW DC Converters** or **Network Operators** in the case of an **Embedded DC Converter Station** not subject to a **Bilateral Agreement** must ensure that any of their **Onshore DC Converters** or **OTSDUW DC Converters** will not cause a sub-synchronous resonance problem on the **Total System**. Each **DC Converter** or **OTSDUW DC Converter** is required to be provided with sub-synchronous resonance damping control facilities.
- (b) Where specified in the **Bilateral Agreement**, each **DC Converter** or **OTSDUW DC Converter** is required to be provided with power oscillation damping or any other identified additional control facilities.

System to Generator Operational Intertripping Scheme

CC.6.3.17 **The Company** may require that a **System to Generator Operational Intertripping Scheme** be installed as part of a condition of the connection of the **GB Generator**. Scheme specific details shall be included in the relevant **Bilateral Agreement** and shall, in respect of **Bilateral Agreements** entered into on or after 16th March 2009 include the following information:

- (1) the relevant category(ies) of the scheme (referred to as Category 1 Intertripping Scheme, Category 2 Intertripping Scheme, Category 3 Intertripping Scheme and Category 4 Intertripping Scheme);
- (2) the **Generating Unit(s)** or **CCGT Module(s)** or **Power Park Module(s)** to be either permanently armed or that can be instructed to be armed in accordance with BC2.8;
- (3) the time within which the **Generating Unit(s)** or **CCGT Module(s)** or **Power Park Module(s)** circuit breaker(s) are to be automatically tripped;
- (4) the location to which the trip signal will be provided by **The Company**. Such location will be provided by **The Company** prior to the commissioning of the **Generating Unit(s)** or **CCGT Module(s)** or **Power Park Module(s)**.

Where applicable, the **Bilateral Agreement** shall include the conditions on the **National Electricity Transmission System** during which **The Company** may instruct the **System to Generator Operational Intertripping Scheme** to be armed and the conditions that would initiate a trip signal.

CC.6.3.18 The time within which the **Generating Unit(s)** or **CCGT Module** or **Power Park Module** circuit breaker(s) need to be automatically tripped is determined by the specific conditions local to the **GB Generator**. This 'time to trip' (defined as time from provision of the trip signal by **The Company** to the specified location, to circuit breaker main contact opening) can typically range from 100ms to 10sec. A longer time to trip may allow the initiation of an automatic reduction in the **Generating Unit(s)** or **CCGT Module(s)** or **Power Park Module(s)** output prior to the automatic tripping of the **Generating Unit(s)** or **CCGT Module(s)** or **Power Park Module(s)** circuit breaker. Where applicable **The Company** may provide separate trip signals to allow for either a longer or shorter 'time to trip' to be initiated.

CC.6.4 General Network Operator And Non-Embedded Customer Requirements

CC.6.4.1 This part of the **Grid Code** describes the technical and design criteria and performance requirements for **Network Operators** and **Non-Embedded Customers**.

Neutral Earthing

- CC.6.4.2 At nominal **System** voltages of 132kV and above the higher voltage windings of three phase transformers and transformer banks connected to the **National Electricity Transmission System** must be star connected with the star point suitable for connection to earth. The earthing and lower voltage winding arrangement shall be such as to ensure that the **Earth Fault Factor** requirement of paragraph CC.6.2.1.1 (b) will be met on the **National Electricity Transmission System** at nominal **System** voltages of 132kV and above.

Frequency Sensitive Relays

- CC.6.4.3 As explained under OC6, each **Network Operator**, will make arrangements that will facilitate automatic low **Frequency Disconnection of Demand** (based on **Annual ACS Conditions**). CC.A.5.5. of Appendix 5 includes specifications of the local percentage **Demand** that shall be disconnected at specific frequencies. The manner in which **Demand** subject to low **Frequency** disconnection will be split into discrete MW blocks is specified in OC6.6. Technical requirements relating to **Low Frequency Relays** are also listed in Appendix 5.

Operational Metering

- CC.6.4.4 Where **The Company** can reasonably demonstrate that an **Embedded Medium Power Station** or **Embedded DC Converter Station** has a significant effect on the **National Electricity Transmission System**, it may require the **Network Operator** within whose **System** the **Embedded Medium Power Station** or **Embedded DC Converter Station** is situated to ensure that the operational metering equipment described in CC.6.5.6 is installed such that **The Company** can receive the data referred to in CC.6.5.6. In the case of an **Embedded Medium Power Station** subject to, or proposed to be subject to a **Bilateral Agreement**, **The Company** shall notify such **Network Operator** of the details of such installation in writing within 3 months of being notified of the application to connect under **CUSC** and in the case of an **Embedded Medium Power Station** not subject to, or not proposed to be subject to a **Bilateral Agreement** in writing as a **Site Specific Requirement** in accordance with the timescales in CUSC 6.5.5. In either case the **Network Operator** shall ensure that the data referred to in CC.6.5.6 is provided to **The Company**.

CC.6.5 Communications Plant

- CC.6.5.1 In order to ensure control of the **National Electricity Transmission System**, telecommunications between **GB Code Users** and **The Company** must (including in respect of any **OTSDUW Plant and Apparatus** at the **OTSUA Transfer Time**), if required by **The Company**, be established in accordance with the requirements set down below.

CC.6.5.2 Control Telephony and System Telephony

- CC.6.5.2.1 **Control Telephony** provides secure point to point telephony for routine **Control Calls**, priority **Control Calls** and emergency **Control Calls**.

- CC.6.5.2.2 **System Telephony** uses an appropriate public communications network to provide telephony for **Control Calls**, inclusive of emergency **Control Calls**. For the avoidance of doubt, **System Telephony** could include, but shall not be limited to: an analogue or digital telephone line; a mobile telephone or an internet-based voice communication system, all of which shall be connected to an appropriate public communications network.

- CC.6.5.2.3 Calls made and received over **Control Telephony** and **System Telephony** may be recorded and subsequently replayed for commercial and operational reasons.

CC.6.5.4 Obligations in respect of Control Telephony and System Telephony

- CC.6.5.4.1 Where **The Company** requires **Control Telephony**, **Users** are required to use the **Control Telephony** to communicate with **The Company** and / or the **Transmission Licensees'** in respect of all **Connection Points** with the **National Electricity Transmission System**, all **Embedded Large Power Stations**, all **Embedded DC Converter Stations** and **Network Operators Control Centres** as appropriate. **The Company** shall provide **Control Telephony** interface equipment at the **GB Code User's Control Point** or the **Network Operators Control Centre** as appropriate. Where the **GB Code User's** or **Network Operators Control Centre** telephony equipment is not capable of providing the required facilities or is otherwise incompatible with the **Transmission Control Telephony**, **The Company** shall provide a **Control Telephony** handset(s). Details of the **Control Telephony** required are contained in the **Bilateral Agreement** with **GB Code User's**.
- CC.6.5.4.2 Where in **The Company's** sole opinion the installation of **Control Telephony** is not practicable at a **GB Code User's Control Point(s)**, **The Company** shall specify in the **Bilateral Agreement** whether **System Telephony** is required. Where **System Telephony** is required by **The Company**, the **GB Code User** shall ensure that **System Telephony** is installed.
- CC.6.5.4.3 Where **System Telephony** is installed, **GB Code Users** are required to use the **System Telephony** for communication with **The Company** and the relevant **Transmission Licensees' Control Engineers** in respect of those **Control Point(s)** for which it has been installed. Details of and relating to the **System Telephony** required are contained in the **Bilateral Agreement**.
- CC.6.5.4.4 Where **Control Telephony** or **System Telephony** is installed, routine testing of such facilities may be required by **The Company** (not normally more than once in any calendar month). The **GB Code User** and **The Company** shall use reasonable endeavours to agree a test programme and where **The Company** requests the assistance of the **GB Code User** in performing the agreed test programme the **User** shall provide such assistance. **The Company** requires the **GB Code User** to test the backup power supplies feeding its **Control Telephony** facilities at least once every 5 years.
- CC.6.5.4.5 **Control Telephony** and **System Telephony** shall only be used for the purposes of operational voice communication between **The Company** and the relevant **User**.
- CC.6.5.4.6 **Control Telephony** contains emergency calling functionality to be used for operational communication only under normal and emergency conditions. Functionality enables **The Company** and **Users** to prioritise a call in the event of an emergency. **The Company** and **GB Code Users** shall only use such priority call functionality for urgent operational communications.
- CC.6.5.5 Technical Requirements for Control Telephony and System Telephony
- CC.6.5.5.1 Detailed information on the technical interfaces and support requirements for **Control Telephony** is provided in the **Control Telephony Electrical Standard** identified in the Annex to the **General Conditions**. Where additional information, or information in relation to **Control Telephony** applicable in Scotland, is requested by **GB Code Users**, this will be provided, where possible, by **The Company**.
- CC.6.5.5.2 **System Telephony** shall consist of a dedicated telephone connected to an appropriate public communications network, that shall be configured by the relevant **GB Code User**. **The Company** shall provide a dedicated free phone number (UK only), for the purposes of receiving incoming calls to **The Company**, which **GB Code Users** shall utilise for **System Telephony**. **System Telephony** shall only be utilised by **The Company Control Engineer** the relevant **Transmission Licensees' Control Engineers** and the **GB Code User's Responsible Engineer/Operator** for the purposes of operational communications.

Operational Metering

- (a) **The Company** or **The Relevant Transmission Licensee**, as applicable, shall provide system control and data acquisition (SCADA) outstation interface equipment. The **GB Code User** shall provide such voltage, current, **Frequency, Active Power** and **Reactive Power** measurement outputs and plant status indications and alarms to the **Transmission SCADA** outstation interface equipment as required by **The Company** in accordance with the terms of the **Bilateral Agreement**. In the case of **OTSDUW**, the **GB Code User** shall provide such SCADA outstation interface equipment and voltage, current, **Frequency, Active Power** and **Reactive Power** measurement outputs and plant status indications and alarms to the SCADA outstation interface equipment as required by **The Company** in accordance with the terms of the **Bilateral Agreement**.
- (b) For the avoidance of doubt, for **Active Power** and **Reactive Power** measurements, circuit breaker and disconnect status indications from:
- (i) **CCGT Modules** at **Large Power Stations**, the outputs and status indications must each be provided to **The Company** on an individual **CCGT Unit** basis. In addition, where identified in the **Bilateral Agreement**, **Active Power** and **Reactive Power** measurements from **Unit Transformers** and/or **Station Transformers** must be provided.
 - (ii) **DC Converters** at **DC Converter Stations** and **OTSDUW DC Converters**, the outputs and status indications must each be provided to **The Company** on an individual **DC Converter** basis. In addition, where identified in the **Bilateral Agreement**, **Active Power** and **Reactive Power** measurements from converter and/or station transformers must be provided.
 - (iii) **Power Park Modules** at **Embedded Large Power Stations** and at directly connected **Power Stations**, the outputs and status indications must each be provided to **The Company** on an individual **Power Park Module** basis. In addition, where identified in the **Bilateral Agreement**, **Active Power** and **Reactive Power** measurements from station transformers must be provided.
 - (iv) In respect of **OTSDUW Plant and Apparatus**, the outputs and status indications must be provided to **The Company** for each piece of electrical equipment. In addition, where identified in the **Bilateral Agreement**, **Active Power** and **Reactive Power** measurements at the **Interface Point** must be provided.
- (c) For the avoidance of doubt, the requirements of CC.6.5.6(a) in the case of a **Cascade Hydro Scheme** will be provided for each **Generating Unit** forming part of that **Cascade Hydro Scheme**. In the case of **Embedded Generating Units** forming part of a **Cascade Hydro Scheme** the data may be provided by means other than the SCADA outstation located at the **Power Station**, such as, with the agreement of the **Network Operator** in whose system such **Embedded Generating Unit** is located, from the **Network Operator's** SCADA system to **The Company**. Details of such arrangements will be contained in the relevant **Bilateral Agreements** between **The Company** and the **GB Generator** and the **Network Operator**.
- (d) In the case of a **Power Park Module**, additional energy input signals (e.g. wind speed, and wind direction) may be specified in the **Bilateral Agreement**. For **Power Park Modules** with a **Completion Date** on or after 1st April 2016, a **Power Available** signal will also be specified in the **Bilateral Agreement**. The signals would be used to establish the potential level of energy input from the **Intermittent Power Source** for monitoring pursuant to CC.6.6.1 and **Ancillary Services** and will, in the case of a wind farm, be used to provide **The Company** with advanced warning of excess wind speed shutdown and to determine the level of **Headroom** available from **Power Park Modules** for the purposes of calculating response and reserve. For the avoidance of doubt, the **Power Available** signal would be automatically provided to **The Company** and represent the sum of the potential output of all available and operational **Power Park Units** within the **Power Park Module**. The refresh rate of the **Power Available** signal shall be specified in the **Bilateral Agreement**.

Instructor Facilities

CC.6.5.7 The **User** shall accommodate **Instructor Facilities** provided by **The Company** for the receipt of operational messages relating to **System** conditions.

Electronic Data Communication Facilities

CC.6.5.8 (a) All **BM Participants** must ensure that appropriate electronic data communication facilities are in place to permit the submission of data, as required by the **Grid Code**, to **The Company**.

(b) In addition,

(1) any **GB Code User** that wishes to participate in the **Balancing Mechanism**;

or

(2) any **BM Participant** in respect of its **BM Units** at a **Power Station** where the **Construction Agreement** and/or a **Bilateral Agreement** has a **Completion Date** on or after 1 January 2013 and the **BM Participant** is required to provide all **Part 1 System Ancillary Services** in accordance with CC.8.1 (unless **The Company** has otherwise agreed)

must ensure that appropriate automatic logging devices are installed at the **Control Points** of its **BM Units** to submit data to and to receive instructions from **The Company**, as required by the **Grid Code**. For the avoidance of doubt, in the case of an **Interconnector User**, the **Control Point** will be at the **Control Centre** of the appropriate **Externally Interconnected System Operator**.

(c) Detailed specifications of these required electronic facilities will be provided by **The Company** on request and they are listed as **Electrical Standards** in the Annex to the **General Conditions**.

Facsimile Machines

CC.6.5.9 Each **GB Code User** and **The Company** shall provide a facsimile machine or machines:

(a) in the case of **GB Generators**, at the **Control Point** of each **Power Station** and at its **Trading Point**;

(b) in the case of **The Company** and **Network Operators**, at the **Control Centre(s)**; and

(c) in the case of **Non-Embedded Customers** and **DC Converter Station** owners at the **Control Point**.

Each **GB Code User** shall notify, prior to connection to the **System** of the **GB Code User's Plant and Apparatus**, **The Company** of its or their telephone number or numbers, and will notify **The Company** of any changes. Prior to connection to the **System** of the **GB Code User's Plant and Apparatus**, **The Company** shall notify each **GB Code User** of the telephone number or numbers of its facsimile machine or machines and will notify any changes.

CC.6.5.10 Busbar Voltage

The **Relevant Transmission Licensee** shall, subject as provided below, provide each **GB Generator** or **DC Converter Station** owner at each **Grid Entry Point** where one of its **Power Stations** or **DC Converter Stations** is connected with appropriate voltage signals to enable the **GB Generator** or **DC Converter Station** owner to obtain the necessary information to permit its **Gensets** or **DC Converters** to be **Synchronised** to the **National Electricity Transmission System**. The term "voltage signal" shall mean in this context, a point of connection on (or wire or wires from) a relevant part of **Transmission Plant** and/or **Apparatus** at the **Grid Entry Point**, to which the **GB Generator** or **DC Converter Station** owner, with **The Company's** agreement (not to be unreasonably withheld) in relation to the **Plant** and/or **Apparatus** to be attached, will be able to attach its **Plant** and/or **Apparatus** (normally a wire or wires) in order to obtain measurement outputs in relation to the busbar.

CC.6.5.11 Bilingual Message Facilities

- (a) A Bilingual Message Facility is the method by which the **User's Responsible Engineer/Operator**, the **Externally Interconnected System Operator** and **The Company's Control Engineers** communicate clear and unambiguous information in two languages for the purposes of control of the **Total System** in both normal and emergency operating conditions.
- (b) A Bilingual Message Facility, where required, will provide up to two hundred pre-defined messages with up to five hundred and sixty characters each. A maximum of one minute is allowed for the transmission to, and display of, the selected message at any destination. The standard messages must be capable of being displayed at any combination of locations and can originate from any of these locations. Messages displayed in the UK will be displayed in the English language.
- (c) Detailed information on a Bilingual Message Facility and suitable equipment required for individual **GB Code User** applications will be provided by **The Company** upon request.

CC.6.6 System Monitoring

CC.6.6.1 Monitoring equipment is provided on the **National Electricity Transmission System** to enable **The Company** to monitor its power system dynamic performance conditions. Where this monitoring equipment requires voltage and current signals on the **Generating Unit** (other than **Power Park Unit**), **DC Converter** or **Power Park Module** circuit from the **GB Code User** or from **OTSDUW Plant and Apparatus**, **The Company** will inform the **GB Code User** and they will be provided by the **GB Code User** with both the timing of the installation of the equipment for receiving such signals and its exact position being agreed (the **GB Code User's** agreement not to be unreasonably withheld) and the costs being dealt with, pursuant to the terms of the **Bilateral Agreement**.

CC.6.6.2 For all on site monitoring by **The Company** of witnessed tests pursuant to the **CP** or **OC5** the **GB Code User** shall provide suitable test signals as outlined in OC5.A.1.

CC.6.6.2.1 The signals which shall be provided by the **GB Code User** to **The Company** for onsite monitoring shall be of the following resolution, unless otherwise agreed by **The Company**:

- (i) 1 Hz for reactive range tests
- (ii) 10 Hz for frequency control tests
- (iii) 100 Hz for voltage control tests

CC.6.6.2.2 The **GB Code User** will provide all relevant signals for this purpose in the form of d.c. voltages within the range -10V to +10V. In exceptional circumstances, some signals may be accepted as d.c. voltages within the range -60V to +60V with prior agreement between the **GB Code User** and **The Company**. All signals shall:

- (i) in the case of an **Onshore Power Park Module**, **DC Converter Station** or **Synchronous Generating Unit**, be suitably terminated in a single accessible location at the **GB Generator** or **DC Converter Station** owner's site.
- (ii) in the case of an **Offshore Power Park Module** and **OTSDUW Plant and Apparatus**, be transmitted onshore without attenuation, delay or filtering which would result in the inability to fully demonstrate the objectives of the test, or identify any potential safety or plant instability issues, and be suitably terminated in a single robust location normally located at or near the onshore **Interface Point** of the **Offshore Transmission System** to which it is connected.

CC.6.6.2.3 All signals shall be suitably scaled across the range. The following scaling would (unless **The Company** notify the **GB Code User** otherwise) be acceptable to **The Company**:

- (a) 0MW to **Registered Capacity** or **Interface Point Capacity** 0-8V dc
- (b) Maximum leading **Reactive Power** to maximum lagging **Reactive Power** -8 to 8V dc
- (c) 48 – 52Hz as -8 to 8V dc
- (d) Nominal terminal or connection point voltage -10% to +10% as -8 to 8V dc

- CC.6.6.2.4 The **GB Code User** shall provide to **The Company** a 230V power supply adjacent to the signal terminal location.
- CC.7 SITE RELATED CONDITIONS
- CC.7.1 Not used.
- CC.7.2 Responsibilities For Safety
- CC.7.2.1 Any **User** entering and working on its **Plant** and/or **Apparatus** (including, until the **OTSUA Transfer Time**, any **OTSUA**) on a **Transmission Site** will work to the **Safety Rules** of the **Relevant Transmission Licensee**, as advised by **The Company**.
- CC.7.2.2 For **User Sites**, **The Company** shall procure that the **Relevant Transmission Licensee** entering and working on **Transmission Plant** and/or **Apparatus** on a **User Site** will work to the **User's Safety Rules**.
- CC.7.2.3 A **User** may, with a minimum of six weeks notice, apply to **The Company** for permission to work according to that **Users** own **Safety Rules** when working on its **Plant** and/or **Apparatus** on a **Transmission Site** rather than those set out in CC.7.2.1. If **The Company** is of the opinion that the **User's Safety Rules** provide for a level of safety commensurate with those set out in CC.7.2.1, **The Company** will notify the **User**, in writing, that, with effect from the date requested by the **User**, the **User** may use its own **Safety Rules** when working on its **Plant** and/or **Apparatus** on the **Transmission Site**. In forming its opinion, **The Company** will seek the opinion of the **Relevant Transmission Licensee**. Until receipt of such written approval from **The Company**, the **GB Code User** will continue to use the **Safety Rules** as set out in CC.7.2.1.
- CC.7.2.4 In the case of a **User Site**, **The Company** may, with a minimum of six weeks notice, apply to a **User** for permission for the **Relevant Transmission Licensee** to work according to the **Relevant Transmission Licensee's Safety Rules** when working on **Transmission Plant** and/or **Apparatus** on that **User Site**, rather than the **User's Safety Rules**. If the **User** is of the opinion that the **Relevant Transmission Licensee's Safety Rules**, provide for a level of safety commensurate with that of that **User's Safety Rules**, it will notify **The Company**, in writing, that, with effect from the date requested by **The Company**, that the **Relevant Transmission Licensee** may use its own **Safety Rules** when working on its **Transmission Plant** and/or **Apparatus** on that **User's Site**. Until receipt of such written approval from the **User**, **The Company** shall procure that the **Relevant Transmission Licensee** shall continue to use the **User's Safety Rules**.
- CC.7.2.5 For a **Transmission Site**, if **The Company** gives its approval for the **User's Safety Rules** to apply to the **User** when working on its **Plant** and/or **Apparatus**, that does not imply that the **User's Safety Rules** will apply to entering the **Transmission Site** and access to the **User's Plant** and/or **Apparatus** on that **Transmission Site**. Bearing in mind the **Relevant Transmission Licensee's** responsibility for the whole **Transmission Site**, entry and access will always be in accordance with the **Relevant Transmission Licensee's** site access procedures. For a **User Site**, if the **User** gives its approval for **Relevant Transmission Licensee Safety Rules** to apply to the **Relevant Transmission Licensee** when working on its **Plant** and **Apparatus**, that does not imply that the **Relevant Transmission Licensee's Safety Rules** will apply to entering the **User Site**, and access to the **Transmission Plant** and **Apparatus** on that **User Site**. Bearing in mind the **User's** responsibility for the whole **User Site**, entry and access will always be in accordance with the **User's** site access procedures.
- CC.7.2.6 For **User Sites**, **Users** shall notify **The Company** of any **Safety Rules** that apply to the **Relevant Transmission Licensee's** staff working on **User Sites**. **The Company** shall procure that the **Relevant Transmission Licensee** shall notify **Users** of any **Safety Rules** that apply to the **User's** staff working on the **Transmission Site**.
- CC.7.2.7 Each **Site Responsibility Schedule** must have recorded on it the **Safety Rules** which apply to each item of **Plant** and/or **Apparatus**.

- CC.7.2.8 In the case of **OTSUA a User Site or Transmission Site** shall, for the purposes of this CC.7.2, include a site at which there is an **Interface Point** until the **OTSUA Transfer Time** when it becomes part of the **National Electricity Transmission System**.
- CC.7.3 Site Responsibility Schedules
- CC.7.3.1 In order to inform site operational staff and **The Company's Control Engineers** of agreed responsibilities for **Plant** and/or **Apparatus** at the operational interface, a **Site Responsibility Schedule** shall be produced for **Connection Sites** (and in the case of **OTSUA**, until the **OTSUA Transfer Time, Interface Sites**) for **The Company**, the **Relevant Transmission Licensee** and **Users** with whom they interface.
- CC.7.3.2 The format, principles and basic procedure to be used in the preparation of **Site Responsibility Schedules** are set down in Appendix 1.
- CC.7.4 Operation And Gas Zone Diagrams
- Operation Diagrams
- CC.7.4.1 An **Operation Diagram** shall be prepared for each **Connection Site** at which a **Connection Point** exists (and in the case of **OTSDUW Plant and Apparatus**, by **User's** for each **Interface Point**) using, where appropriate, the graphical symbols shown in Part 1A of Appendix 2. **Users** should also note that the provisions of **OC11** apply in certain circumstances.
- CC.7.4.2 The **Operation Diagram** shall include all **HV Apparatus** and the connections to all external circuits and incorporate numbering, nomenclature and labelling, as set out in **OC11**. At those **Connection Sites** (or in the case of **OTSDUW Plant and Apparatus, Interface Points**) where gas-insulated metal enclosed switchgear and/or other gas-insulated **HV Apparatus** is installed, those items must be depicted within an area delineated by a chain dotted line which intersects gas-zone boundaries. The nomenclature used shall conform with that used on the relevant **Connection Site** and circuit (and in the case of **OTSDUW Plant and Apparatus, Interface Point** and circuit). The **Operation Diagram** (and the list of technical details) is intended to provide an accurate record of the layout and circuit interconnections, ratings and numbering and nomenclature of **HV Apparatus** and related **Plant**.
- CC.7.4.3 A non-exhaustive guide to the types of **HV Apparatus** to be shown in the **Operation Diagram** is shown in Part 2 of Appendix 2, together with certain basic principles to be followed unless equivalent principles are approved by **The Company**.
- Gas Zone Diagrams
- CC.7.4.4 A **Gas Zone Diagram** shall be prepared for each **Connection Site** at which a **Connection Point** (and in the case of **OTSDUW Plant and Apparatus**, by **User's** for an **Interface Point**) exists where gas-insulated switchgear and/or other gas-insulated **HV Apparatus** is utilised. They shall use, where appropriate, the graphical symbols shown in Part 1B of Appendix 2.
- CC.7.4.5 The nomenclature used shall conform with that used in the relevant **Connection Site** and circuit (and in the case of **OTSDUW Plant and Apparatus**, relevant **Interface Point** and circuit).
- CC.7.4.6 The basic principles set out in Part 2 of Appendix 2 shall be followed in the preparation of **Gas Zone Diagrams** unless equivalent principles are approved by **The Company**.
- Preparation of Operation and Gas Zone Diagrams for Users' Sites and Transmission Interface Sites
- CC.7.4.7 In the case of a **User Site**, the **User** shall prepare and submit to **The Company**, an **Operation Diagram** for all **HV Apparatus** on the **User** side of the **Connection Point** (and in the case of **OTSDUW Plant and Apparatus**, on what will be the **Offshore Transmission** side of the **Connection Point** and the **Interface Point**) and **The Company** shall provide the **User** with an **Operation Diagram** for all **HV Apparatus** on the **Transmission** side of the **Connection Point** (and in the case of **OTSDUW Plant and Apparatus** on what will be the **Onshore Transmission** side of the **Interface Point**), in accordance with the timing requirements of the **Bilateral Agreement** and/or **Construction Agreement** prior to the **Completion Date** under the **Bilateral Agreement** and/or **Construction Agreement**.

CC.7.4.8 The **User** will then prepare, produce and distribute, using the information submitted on the **User's Operation Diagram** and **The Company Operation Diagram**, a composite **Operation Diagram** for the complete **Connection Site** (and in the case of **OTSDUW Plant and Apparatus, Interface Point**), also in accordance with the timing requirements of the **Bilateral Agreement** and/or **Construction Agreement** .

CC.7.4.9 The provisions of CC.7.4.7 and CC.7.4.8 shall apply in relation to **Gas Zone Diagrams** where gas-insulated switchgear and/or other gas-insulated **HV Apparatus** is utilised.

Preparation of Operation and Gas Zone Diagrams for Transmission Sites

CC.7.4.10 In the case of an **Transmission Site**, the **User** shall prepare and submit to **The Company** an **Operation Diagram** for all **HV Apparatus** on the **User** side of the **Connection Point**, in accordance with the timing requirements of the **Bilateral Agreement** and/or **Construction Agreement**.

CC.7.4.11 **The Company** will then prepare, produce and distribute, using the information submitted on the **User's Operation Diagram**, a composite **Operation Diagram** for the complete **Connection Site**, also in accordance with the timing requirements of the **Bilateral Agreement** and/or **Construction Agreement**.

CC.7.4.12 The provisions of CC.7.4.10 and CC.7.4.11 shall apply in relation to **Gas Zone Diagrams** where gas-insulated switchgear and/or other gas-insulated **HV Apparatus** is utilised.

Changes to Operation and Gas Zone Diagrams

CC.7.4.13.1 When the **Relevant Transmission Licensee** has decided that it wishes to install new **HV Apparatus** or it wishes to change the existing numbering or nomenclature of **Transmission HV Apparatus** at a **Transmission Site**, **The Company**, in coordination with the **Relevant Transmission Licensee** will (unless it gives rise to a **Modification** under the **CUSC**, in which case the provisions of the **CUSC** as to the timing apply) one month prior to the installation or change, send to each such **User** a revised **Operation Diagram** of that **Transmission Site**, incorporating the new **Transmission HV Apparatus** to be installed and its numbering and nomenclature or the changes, as the case may be. **OC11** is also relevant to certain **Apparatus**.

CC.7.4.13.2 When a **User** has decided that it wishes to install new **HV Apparatus**, or it wishes to change the existing numbering or nomenclature of its **HV Apparatus** at its **User Site**, the **User** will (unless it gives rise to a **Modification** under the **CUSC**, in which case the provisions of the **CUSC** as to the timing apply) one month prior to the installation or change, send to **The Company** a revised **Operation Diagram** of that **User Site** incorporating the new **User HV Apparatus** to be installed and its numbering and nomenclature or the changes as the case may be. **OC11** is also relevant to certain **Apparatus**.

CC.7.4.13.3 The provisions of CC.7.4.13.1 and CC.7.4.13.2 shall apply in relation to **Gas Zone Diagrams** where gas-insulated switchgear and/or other gas-insulated **HV Apparatus** is installed.

Validity

CC.7.4.14 (a) The composite **Operation Diagram** prepared by **The Company** or the **User**, as the case may be, will be the definitive **Operation Diagram** for all operational and planning activities associated with the **Connection Site**. If a dispute arises as to the accuracy of the composite **Operation Diagram**, a meeting shall be held at the **Connection Site**, as soon as reasonably practicable, between **The Company** and the **User**, to endeavour to resolve the matters in dispute.

(b) The composite **Operation Diagram** prepared by **The Company** or the **User**, as the case may be, will be the definitive **Operation Diagram** for all operational and planning activities associated with the **Interface Point** until the **OTSUA Transfer Time**. If a dispute arises as to the accuracy of the composite **Operation Diagram** prior to the **OTSUA Transfer Time**, a meeting shall be held at the **Interface Point**, as soon as reasonably practicable, between **The Company** and the **User**, to endeavour to resolve the matters in dispute.

(c) An equivalent rule shall apply for **Gas Zone Diagrams** where they exist for a **Connection Site**.

CC.7.4.15 In the case of **OTSUA**, a **User Site** and **Transmission Site** shall, for the purposes of this CC.7.4, include a site at which there is an **Interface Point** until the **OTSUA Transfer Time** when it becomes part of the **National Electricity Transmission System** and references to **HV Apparatus** in this CC.7.4 shall include references to **HV OTSUA**.

CC.7.5 Site Common Drawings

CC.7.5.1 **Site Common Drawings** will be prepared for each **Connection Site** (and in the case of **OTSDUW**, each **Interface Point**) and will include **Connection Site** (and in the case of **OTSDUW**, **Interface Point**) layout drawings, electrical layout drawings, common **Protection/control** drawings and common services drawings.

Preparation of Site Common Drawings for a User Site and Transmission Interface Site

CC.7.5.2 In the case of a **User Site**, **The Company** shall prepare and submit to the **User**, **Site Common Drawings** for the **Transmission** side of the **Connection Point** (and in the case of **OTSDUW Plant and Apparatus**, on what will be the **Onshore Transmission** side of the **Interface Point**), and the **User** shall prepare and submit to **The Company**, **Site Common Drawings** for the **User** side of the **Connection Point** (and in the case of **OTSDUW**, on what will be the **Offshore Transmission** side of the **Interface Point**) in accordance with the timing requirements of the **Bilateral Agreement** and/or **Construction Agreement**.

CC.7.5.3 The **User** will then prepare, produce and distribute, using the information submitted on the **Transmission Site Common Drawings**, **Site Common Drawings** for the complete **Connection Site** (and in the case of **OTSDUW**, **Interface Point**) in accordance with the timing requirements of the **Bilateral Agreement** and/or **Construction Agreement** .

Preparation of Site Common Drawings for a Transmission Site

CC.7.5.4 In the case of a **Transmission Site**, the **User** will prepare and submit to **The Company Site Common Drawings** for the **User** side of the **Connection Point** in accordance with the timing requirements of the **Bilateral Agreement** and/or **Construction Agreement**.

CC.7.5.5 **The Company** will then prepare, produce and distribute, using the information submitted in the **User's Site Common Drawings**, **Site Common Drawings** for the complete **Connection Site** in accordance with the timing requirements of the **Bilateral Agreement** and/or **Construction Agreement**.

CC.7.5.6 When a **User** becomes aware that it is necessary to change any aspect of the **Site Common Drawings** at a **Connection Site** (and in the case of **OTSDUW**, **Interface Point**) it will:

- (a) if it is a **User Site**, as soon as reasonably practicable, prepare, produce and distribute revised **Site Common Drawings** for the complete **Connection Site** (and in the case of **OTSDUW**, **Interface Point**); and
- (b) if it is a **Transmission Site**, as soon as reasonably practicable, prepare and submit to **The Company** revised **Site Common Drawings** for the **User** side of the **Connection Point** (and in the case of **OTSDUW**, **Interface Point**) and **The Company** will then, as soon as reasonably practicable, prepare, produce and distribute, using the information submitted in the **User's Site Common Drawings**, revised **Site Common Drawings** for the complete **Connection Site** (and in the case of **OTSDUW**, **Interface Point**).

In either case, if in the **User's** reasonable opinion the change can be dealt with by it notifying **The Company** in writing of the change and for each party to amend its copy of the **Site Common Drawings** (or where there is only one set, for the party holding that set to amend it), then it shall so notify and each party shall so amend. If the change gives rise to a **Modification** under the **CUSC**, the provisions of the **CUSC** as to timing will apply.

CC.7.5.7 When **The Company** becomes aware that it is necessary to change any aspect of the **Site Common Drawings** at a **Connection Site** (and in the case of **OTSDUW**, **Interface Point**) it will:

- (a) if it is a **Transmission Site**, as soon as reasonably practicable, prepare, produce and distribute revised **Site Common Drawings** for the complete **Connection Site** (and in the case of **OTSDUW**, **Interface Point**); and

- (b) if it is a **User Site**, as soon as reasonably practicable, prepare and submit to the **User** revised **Site Common Drawings** for the **Transmission** side of the **Connection Point** (in the case of **OTSDUW, Interface Point**) and the **User** will then, as soon as reasonably practicable, prepare, produce and distribute, using the information submitted in the **Transmission Site Common Drawings**, revised **Site Common Drawings** for the complete **Connection Site** (and in the case of **OTSDUW, Interface Point**).

In either case, if in **The Company's** reasonable opinion the change can be dealt with by it notifying the **User** in writing of the change and for each party to amend its copy of the **Site Common Drawings** (or where there is only one set, for the party holding that set to amend it), then it shall so notify and each party shall so amend. If the change gives rise to a **Modification** under the **CUSC**, the provisions of the **CUSC** as to timing will apply.

Validity

- CC.7.5.8 (a) The **Site Common Drawings** for the complete **Connection Site** prepared by the **User** or **The Company**, as the case may be, will be the definitive **Site Common Drawings** for all operational and planning activities associated with the **Connection Site**. If a dispute arises as to the accuracy of the **Site Common Drawings**, a meeting shall be held at the **Site**, as soon as reasonably practicable, between **The Company** and the **User**, to endeavour to resolve the matters in dispute.
- (b) The **Site Common Drawing** prepared by **The Company** or the **User**, as the case may be, will be the definitive **Site Common Drawing** for all operational and planning activities associated with the **Interface Point** until the **OTSUA Transfer Time**. If a dispute arises as to the accuracy of the composite **Operation Diagram** prior to the **OTSUA Transfer Time**, a meeting shall be held at the **Interface Point**, as soon as reasonably practicable, between **The Company** and the **User**, to endeavour to resolve the matters in dispute.

CC.7.5.9 In the case of **OTSUA**, a **User Site** and **Transmission Site** shall, for the purposes of this CC.7.5, include a site at which there is an **Interface Point** until the **OTSUA Transfer Time** when it becomes part of the **National Electricity Transmission System**.

CC.7.6 Access

CC.7.6.1 The provisions relating to access to **Transmission Sites** by **Users**, and to **Users' Sites** by **Relevant Transmission Licensees**, are set out in each **Interface Agreement** (or in the case of **Interfaces Sites** prior to the **OTSUA Transfer Time** agreements in similar form) with, the **Relevant Transmission Licensee** and each **User**.

CC.7.6.2 In addition to those provisions, where a **Transmission Site** contains exposed **HV** conductors, unaccompanied access will only be granted to individuals holding an **Authority for Access** issued by the **Relevant Transmission Licensee**.

CC.7.6.3 The procedure for applying for an **Authority for Access** is contained in the **Interface Agreement**.

CC.7.7 Maintenance Standards

CC.7.7.1 It is the **User's** responsibility to ensure that all its **Plant** and **Apparatus** (including, until the **OTSUA Transfer Time**, any **OTSUA**) on a **Transmission Site** is tested and maintained adequately for the purpose for which it is intended, and to ensure that it does not pose a threat to the safety of any **Transmission Plant, Apparatus** or personnel on the **Transmission Site**. **The Company** will have the right to inspect the test results and maintenance records relating to such **Plant** and **Apparatus** at any time

CC.7.7.2 For **User Sites**, **The Company** shall procure that the **Relevant Transmission Licensee** has a responsibility to ensure that all **Transmission Plant** and **Apparatus** on a **User Site** is tested and maintained adequately for the purposes for which it is intended and to ensure that it does not pose a threat to the safety of any **User's Plant, Apparatus** or personnel on the **User Site**.

The **User** will have the right to inspect the test results and maintenance records relating to such **Plant** and **Apparatus** on its **User Site** at any time.

CC.7.8 Site Operational Procedures

CC.7.8.1 Where there is an interface with **National Electricity Transmission System**, **The Company** and **Users**, must make available staff to take necessary **Safety Precautions** and carry out operational duties as may be required to enable work/testing to be carried out and for the operation of **Plant** and **Apparatus** (including, prior to the **OTSUA Transfer Time**, any **OTSUA**) connected to the **Total System**.

CC.7.9 **GB Generators, DC Converter Station** owners and **BM Participants** (including **Virtual Lead Parties**) shall provide a **Control Point**.

- a) In the case of **GB Generators** and **DC Converter Station** owners, for each **Power Station** or **DC Converter Station** directly connected to the **National Electricity Transmission System** and for each **Embedded Large Power Station** or **Embedded DC Converter Station**, the **Control Point** shall receive and act upon instructions pursuant to OC7 and BC2 at all times that **Generating Units** or **Power Park Modules** at the **Power Station** are generating or available to generate or **DC Converters** at the **DC Converter Station** are importing or exporting or available to do so. In the case of all **BM Participants**, the **Control Point** shall be continuously staffed except where the **Bilateral Agreement** specifies that compliance with BC2 is not required, in which case the **Control Point** shall be staffed between the hours of 0800 and 1800 each day.
- b) In the case of **BM Participants**, the **BM Participant's Control Point** shall be capable of receiving and acting upon instructions from **The Company** and the relevant **Transmission Licensees' Control Engineers**.

The Company will normally issue instructions via automatic logging devices in accordance with the requirements of CC.6.5.8(b).

Where the **BM Participant's Plant** and **Apparatus** does not respond to an instruction from **The Company** via automatic logging devices, or where it is not possible for **The Company** to issue the instruction via automatic logging devices, **The Company** shall issue the instruction by telephone.

In the case of **BM Participants** who own and/or operate a **Power Station** or **DC Converter Station** with an aggregated **Registered Capacity** or **BM Participants** with **BM Units** with an aggregated **Demand Capacity** per **Control Point** of less than 50MW, or, where a site is not part of a **Virtual Lead Party** as defined in the **BSC**, a **Registered Capacity** or **Demand Capacity** per site of less than 10MW:

- a) where this situation arises, a representative of the **BM Participant** is required to be available to respond to instructions from **The Company** via the **Control Telephony** or **System Telephony** system, as provided for in CC.6.5.4, between the hours of 0800-1800 each day.
- b) Outside the hours of 0800-1800 each day, the requirements of BC2.9.7 shall apply.

For the avoidance of doubt, where **The Company** has agreed with a **BM Participant** that **Control Telephony** is not required and where the **BM Participant** does not have a continuously staffed **Control Point** the **BM Participant** may be unable to act as a **Defence Service Provider** and shall be unable to act as a **Restoration Service Provider** or **Black Start Service Provider** where these require **Control Telephony** or a **Control Point** in respect of the specification of any such services falling into these categories.

CC.7.10 Obligations on Users in respect of Critical Tools and Facilities

CC.7.10.1 From 04/09/2024 **The Company**, each **Generator, DC Converter Station** owner, **Network Operator, Non-Embedded Customer** and each **Restoration Service Provider** with a continuously staffed **Control Point** or **Control Centre** as provided for in CC.7.9 shall:-

- (i) Ensure they have the appropriate **Critical Tools and Facilities** necessary to control their assets for **Black Start**, from their **Control Point** or **Control Centre** as appropriate for a minimum period of 72 hours (or such longer period as agreed between the **Generator, DC Converter Station** owner, **Network Operator, Non-Embedded Customer** and/or

Restoration Service Provider and The Company) following a Total Shutdown or Partial Shutdown.

(ii) Ensure as far as reasonably practical that they have adequate control equipment redundancy in place so that in the event of a failure of one or more components of the control system its function is unimpaired

(iii) Report on the results of their management and testing for their **Critical Tools and Facilities** on request by **The Company**.

CC.7.10.2 From 04/09/2024 each **BM Participant** including a **Virtual Lead Party** with a continuously staffed **Control Point** as provided for in CC.7.9 (excluding those **BM Participants** covered by the requirements of CC.7.10.1), shall:-

(i) Ensure they have the appropriate **Critical Tools and Facilities** (as defined in clause (c) of the definition of **Critical Tools and Facilities** in the **Grid Code Glossary and Definitions**) for a minimum period of 72 hours (or such longer period as agreed between the **BM Participant** including a **Virtual Lead Party** and **The Company**) following a **Total Shutdown** or **Partial Shutdown**.

(ii) Ensure as far as reasonably practical that they have adequate control equipment redundancy in place at their **Control Point** so that in the event of a failure of one or more components of their **Critical Tools and Facilities** its function is unimpaired.

(iii) Report on the results of their management and testing for their **Critical Tools and Facilities** on request by **The Company**.

CC.7.10.3 In the case of a **BM Participant** or **Virtual Lead Party** which has a **Black Start Contract** in respect of one or more of its aggregated **Plants**, the requirements of CC.7.10.1 shall only apply between the **Control Point** of the **BM Participant** or **Virtual Lead Party** and that **Plant** with a **Black Start Contract**. For other non-contracted **Plants** under the control of the **BM Participant** or **Virtual Lead Party**, the requirements of CC.7.10.2 shall continue to apply.

CC.8 ANCILLARY SERVICES

CC.8.1 System Ancillary Services

The **CC's** contain requirements for the capability for certain **Ancillary Services**, which are needed for **System** reasons ("**System Ancillary Services**"). There follows a list of these **System Ancillary Services**, together with the paragraph number of the **CC** (or other part of the **Grid Code**) in which the minimum capability is required or referred to. The list is divided into two categories: Part 1 lists the **System Ancillary Services** which

(a) **GB Generators** in respect of **Large Power Stations** are obliged to provide (except **GB Generators** in respect of **Large Power Stations** which have a **Registered Capacity** of less than 50MW and comprise **Power Park Modules**); and,

(b) **GB Generators** in respect of **Large Power Stations** with a **Registered Capacity** of less than 50MW and comprise **Power Park Modules** are obliged to provide in respect of **Reactive Power** only; and,

(c) **DC Converter Station** owners are obliged to have the capability to supply; and

(d) **GB Generators** in respect of **Medium Power Stations** (except **Embedded Medium Power Stations**) are obliged to provide in respect of **Reactive Power** only;

and Part 2 lists the **System Ancillary Services** which **GB Generators** will provide only if agreement to provide them is reached with **The Company**:

Part 1

(a) **Reactive Power** supplied (in accordance with CC.6.3.2) otherwise than by means of synchronous or static compensators (except in the case of a **Power Park Module** where synchronous or static compensators within the **Power Park Module** may be used to provide **Reactive Power**)

(b) **Frequency Control** by means of **Frequency** sensitive generation - CC.6.3.7 and BC3.5.1

Part 2

(c) **Frequency Control** by means of **Fast Start** - CC.6.3.14

(d) **Black Start Capability** - CC.6.3.5

(e) **System to Generator Operational Intertripping**

CC.8.2

Commercial Ancillary Services

Other **Ancillary Services** are also utilised by **The Company** in operating the **Total System** if these have been agreed to be provided by a **GB Code User** (or other person) under an **Ancillary Services Agreement** or under a **Bilateral Agreement**, with payment being dealt with under an **Ancillary Services Agreement** or in the case of **Externally Interconnected System Operators** or **Interconnector Users**, under any other agreement (and in the case of **Externally Interconnected System Operators** and **Interconnector Users** includes **Ancillary Services** equivalent to or similar to **System Ancillary Services**) ("**Commercial Ancillary Services**"). The capability for these **Commercial Ancillary Services** is set out in the relevant **Ancillary Services Agreement** or **Bilateral Agreement** (as the case may be).

APPENDIX 1 - SITE RESPONSIBILITY SCHEDULES

FORMAT, PRINCIPLES AND BASIC PROCEDURE TO BE USED IN THE PREPARATION OF SITE RESPONSIBILITY SCHEDULES

CC.A.1.1 Principles

Types of Schedules

CC.A.1.1.1 At all **Complexes** (which in the context of this **CC** shall include, **Interface Sites** until the **OTSUA Transfer Time**) the following **Site Responsibility Schedules** shall be drawn up using the relevant proforma attached or with such variations as may be agreed between **The Company** and **Users**, but in the absence of agreement the relevant proforma attached will be used. In addition, in the case of **OTSDUW Plant and Apparatus**, and in readiness for the **OTSUA Transfer Time**, the **User** shall provide **The Company** with the necessary information such that **Site Responsibility Schedules** in this form can be prepared by the **Relevant Transmission Licensees** for the **Transmission Interface Site**:

- (a) Schedule of **HV Apparatus**
- (b) Schedule of **Plant, LV/MV Apparatus**, services and supplies;
- (c) Schedule of telecommunications and measurements **Apparatus**.

Other than at **Generating Unit, DC Converter, Power Park Module** and **Power Station** locations, the schedules referred to in (b) and (c) may be combined.

New Connection Sites

CC.A.1.1.2 In the case of a new **Connection Site** each **Site Responsibility Schedule** for a **Connection Site** shall be prepared by **The Company** in consultation with relevant **GB Code Users** at least 2 weeks prior to the **Completion Date** (or, where the **OTSUA** is to become **Operational** prior to the **OTSUA Transfer Time**, an alternative date) under the **Bilateral Agreement** and/or **Construction Agreement** for that **Connection Site** (which may form part of a **Complex**). In the case of a new **Interface Site** where the **OTSUA** is to become **Operational** prior to the **OTSUA Transfer Time** each **Site Responsibility Schedule** for an **Interface Site** shall be prepared by **The Company** in consultation with relevant **GB Code Users** at least 2 weeks prior to the **Completion Date** under the **Bilateral Agreement** and/or **Construction Agreement** for that **Interface Site** (which may form part of a **Complex**) (and references to and requirements placed on “**Connection Site**” in this **CC** shall also be read as “**Interface Site**” where the context requires and until the **OTSUA Transfer Time**). Each **GB Code User** shall, in accordance with the timing requirements of the **Bilateral Agreement** and/or **Construction Agreement**, provide information to **The Company** to enable it to prepare the **Site Responsibility Schedule**.

Sub-division

CC.A.1.1.3 Each **Site Responsibility Schedule** will be subdivided to take account of any separate **Connection Sites** on that **Complex**.

Scope

CC.A.1.1.4 Each **Site Responsibility Schedule** shall detail for each item of **Plant** and **Apparatus**:

- (a) **Plant/Apparatus** ownership;
- (b) Site Manager (Controller) (except in the case of **Plant/Apparatus** located in **SPT’s Transmission Area**);
- (c) Safety issues comprising applicable **Safety Rules** and **Control Person** or other responsible person (**Safety Co-ordinator**), or such other person who is responsible for safety;
- (d) Operations issues comprising applicable **Operational Procedures** and **Control Engineer**;

(e) Responsibility to undertake statutory inspections, fault investigation and maintenance.

Each **Connection Point** shall be precisely shown.

Detail

- CC.A.1.1.5 (a) In the case of **Site Responsibility Schedules** referred to in CC.A.1.1.1(b) and (c), with the exception of **Protection Apparatus** and **Intertrip Apparatus** operation, it will be sufficient to indicate the responsible **User** or **Transmission Licensee**, as the case may be.
- (b) In the case of the **Site Responsibility Schedule** referred to in CC.A.1.1.1(a) and for **Protection Apparatus** and **Intertrip Apparatus**, the responsible management unit must be shown in addition to the **User** or **Transmission Licensee**, as the case may be.
- CC.A.1.1.6 The **HV Apparatus Site Responsibility Schedule** for each **Connection Site** must include lines and cables emanating from or traversing¹ the **Connection Site**.

Issue Details

- CC.A.1.1.7 Every page of each **Site Responsibility Schedule** shall bear the date of issue and the issue number.

Accuracy Confirmation

- CC.A.1.1.8 When a **Site Responsibility Schedule** is prepared it shall be sent by **The Company** to the **Users** involved for confirmation of its accuracy.
- CC.A.1.1.9 The **Site Responsibility Schedule** shall then be signed on behalf of **The Company** by its **Responsible Manager** (see CC.A.1.1.16) and on behalf of each **User** involved by its **Responsible Manager** (see CC.A.1.1.16), by way of written confirmation of its accuracy. The **Site Responsibility Schedule** will also be signed on behalf of the **Relevant Transmission Licensee** by its **Responsible Manager**.

Distribution and Availability

- CC.A.1.1.10 Once signed, two copies will be distributed by **The Company**, not less than two weeks prior to its implementation date, to each **User** which is a party on the **Site Responsibility Schedule**, accompanied by a note indicating the issue number and the date of implementation.
- CC.A.1.1.11 **The Company** and **Users** must make the **Site Responsibility Schedules** readily available to operational staff at the **Complex** and at the other relevant control points.

Alterations to Existing Site Responsibility Schedules

- CC.A.1.1.12 Without prejudice to the provisions of CC.A.1.1.15 which deals with urgent changes, when a **User** identified on a **Site Responsibility Schedule** becomes aware that an alteration is necessary, it must inform **The Company** immediately and in any event 8 weeks prior to any change taking effect (or as soon as possible after becoming aware of it, if less than 8 weeks remain when the **User** becomes aware of the change). This will cover the commissioning of new **Plant** and/or **Apparatus** at the **Connection Site**, whether requiring a revised **Bilateral Agreement** or not, de-commissioning of **Plant** and/or **Apparatus**, and other changes which affect the accuracy of the **Site Responsibility Schedule**.
- CC.A.1.1.13 Where **The Company** has been informed of a change by an **GB Code User**, or itself proposes a change, it will prepare a revised **Site Responsibility Schedule** by not less than six weeks prior to the change taking effect (subject to it having been informed or knowing of the change eight weeks prior to that time) and the procedure set out in CC.A.1.1.8 shall be followed with regard to the revised **Site Responsibility Schedule**.

¹ Details of circuits traversing the **Connection Site** are only needed from the date which is the earlier of the date when the **Site Responsibility Schedule** is first updated and 15th October 2004. In Scotland or **Offshore**, from a date to be agreed between **The Company** and the **Relevant Transmission Licensee**.

CC.A.1.1.14 The revised **Site Responsibility Schedule** shall then be signed in accordance with the procedure set out in CC.A.1.1.9 and distributed in accordance with the procedure set out in CC.A.1.1.10, accompanied by a note indicating where the alteration(s) has/have been made, the new issue number and the date of implementation.

Urgent Changes

CC.A.1.1.15 When an **GB Code User** identified on a **Site Responsibility Schedule**, or **The Company**, as the case may be, becomes aware that an alteration to the **Site Responsibility Schedule** is necessary urgently to reflect, for example, an emergency situation which has arisen outside its control, the **GB Code User** shall notify **The Company**, or **The Company** shall notify the **GB Code User**, as the case may be, immediately and will discuss:

- (a) what change is necessary to the **Site Responsibility Schedule**;
- (b) whether the **Site Responsibility Schedule** is to be modified temporarily or permanently;
- (c) the distribution of the revised **Site Responsibility Schedule**.

The Company will prepare a revised **Site Responsibility Schedule** as soon as possible, and in any event within seven days of it being informed of or knowing the necessary alteration. The **Site Responsibility Schedule** will be confirmed by **GB Code Users** and signed on behalf of **The Company** and **GB Code Users** and the **Relevant Transmission Licensee** (by the persons referred to in CC.A.1.1.9) as soon as possible after it has been prepared and sent to **GB Code Users** for confirmation.

Responsible Managers

CC.A.1.1.16 Each **GB Code User** shall, prior to the **Completion Date** under each **Bilateral Agreement** and/or **Construction Agreement**, supply to **The Company** a list of Managers who have been duly authorised to sign **Site Responsibility Schedules** on behalf of the **GB Code User** and **The Company** shall, prior to the **Completion Date** under each **Bilateral Agreement** and/or **Construction Agreement**, supply to that **GB Code User** the name of the **Relevant Transmission Licensee's Responsible Manager** and each shall supply to the other any changes to such list six weeks before the change takes effect where the change is anticipated, and as soon as possible after the change, where the change was not anticipated.

De-commissioning of Connection Sites

CC.A.1.1.17 Where a **Connection Site** is to be de-commissioned, whichever of **The Company** or the **GB Code User** who is initiating the de-commissioning must contact the other to arrange for the **Site Responsibility Schedule** to be amended at the relevant time.

PROFORMA FOR SITE RESPONSIBILITY SCHEDULE

_____ AREA

COMPLEX: _____

SCHEDULE: _____

CONNECTION SITE: _____

ITEM OF PLANT/ APPARATUS	PLANT APPARATUS OWNER	SITE MANAGER	SAFETY		OPERATIONS		PARTY RESPONSIBLE FOR UNDERTAKING STATUTORY INSPECTIONS, FAULT INVESTIGATION & MAINTENANCE	REMARKS
			SAFETY RULES	CONTROL OR OTHER RESPONSIBLE PERSON (SAFETY CO- ORDINATOR)	OPERATIONAL PROCEDURES	CONTROL OR OTHER RESPONSIBLE ENGINEER		

PAGE: _____

ISSUE NO: _____

DATE: _____

PROFORMA FOR SITE RESPONSIBILITY SCHEDULE

_____ AREA

COMPLEX: _____

SCHEDULE: _____

CONNECTION SITE: _____

ITEM OF PLANT/ APPARATUS	PLANT APPARATUS OWNER	SITE MANAGER	SAFETY		OPERATIONS		PARTY RESPONSIBLE FOR UNDERTAKING STATUTORY INSPECTIONS, FAULT INVESTIGATION & MAINTENANCE	REMARKS
			SAFETY RULES	CONTROL OR OTHER RESPONSIBLE PERSON (SAFETY CO-ORDINATOR)	OPERATIONAL PROCEDURES	CONTROL OR OTHER RESPONSIBLE ENGINEER		

NOTES:

SIGNED: _____ NAME: _____ COMPANY: _____ DATE: _____

SIGNED: _____ NAME: _____ COMPANY: _____ DATE: _____

SIGNED: _____ NAME: _____ COMPANY: _____ DATE: _____

SIGNED: _____ NAME: _____ COMPANY: _____ DATE: _____

PAGE: _____ ISSUE NO: _____ DATE: _____

**SP TRANSMISSION Ltd
 SITE RESPONSIBILITY SCHEDULE
 OWNERSHIP, MAINTENANCE AND OPERATIONS OF EQUIPMENT
 IN JOINT USER SITUATIONS**

Sheet No. _____
 Revision: _____
 Date: _____

Network Area: _____

SECTION 'A' BUILDING AND SITE

OWNER	ACCESS REQUIRED:-	SECTION 'B' CUSTOMER OR OTHER PARTY
LESSEE	SPECIAL CONDITIONS:-	
MAINTENANCE	LOCATION OF SUPPLY	
SAFETY	TERMINALS:-	
SECURITY		

SECTION 'B' CUSTOMER OR OTHER PARTY

NAME:-
ADDRESS:-
TEL NO:-
SUB STATION:-
LOCATION:-

SECTION 'C' PLANT

ITEM Nos.	EQUIPMENT	IDENTIFICATION	OWNER	SAFETY RULES APPLICABLE	OPERATION			MAINTENANCE		FAULT INVESTIGATION		TESTING		RELAY SETTINGS	REMARKS
					Tripping	Closing	Isolating	Earthing	Primary Equip.	Protection Equip.	Primary Equip.	Protection Equip.	Trip and Alarm		

SECTION 'D' CONFIGURATION AND CONTROL

ITEM Nos.	CONFIGURATION RESPONSIBILITY	TELEPHONE NUMBER	REMARKS

SECTION 'E' ADDITIONAL INFORMATION

--

ABBREVIATIONS:-

- D - SP AUTHORIZED PERSON - DISTRIBUTION SYSTEM
- NGC - NATIONAL GRID COMPANY
- SPD - SP DISTRIBUTION Ltd
- SPPS - POWERSYSTEMS
- SPT - SP TRANSMISSION Ltd
- ST - SCOTTISH POWER TELECOMMUNICATIONS
- T - SP AUTHORIZED PERSON - TRANSMISSION SYSTEM
- U - USER

SIGNED _____ FOR _____ SP Transmission DATE _____

SIGNED _____ FOR _____ SP Distribution DATE _____

SIGNED _____ FOR _____ PowerSystems/User DATE _____

APPENDIX 2 - OPERATION DIAGRAMS

PART 1A - PROCEDURES RELATING TO OPERATION DIAGRAMS

FIXED CAPACITOR		SWITCH DISCONNECTOR	
EARTH		SWITCH DISCONNECTOR WITH INCORPORATED EARTH SWITCH	
EARTHING RESISTOR		DISCONNECTOR (CENTRE ROTATING POST)	
LIQUID EARTHING RESISTOR		DISCONNECTOR (SINGLE BREAK DOUBLE ROTATING)	
ARC SUPPRESSION COIL		DISCONNECTOR (SINGLE BREAK)	
FIXED MAINTENANCE EARTHING DEVICE		DISCONNECTOR (NON-INTERLOCKED)	
CARRIER COUPLING EQUIPMENT (WITHOUT VT)		DISCONNECTOR (POWER OPERATED)	
CARRIER COUPLING EQUIPMENT (WITH VT ON ONE PHASE)		DISCONNECTOR (NON-AUTOMATIC)	
CARRIER COUPLING EQUIPMENT (WITH VT ON 3 PHASES)		DISCONNECTOR (AUTOMATIC)	
AC GENERATOR		DISCONNECTOR (SEQUENTIAL OPERATION)	
SYNCHRONOUS COMPENSATOR		DISCONNECTOR (FAULT INTERFERING OPERATION)	
CIRCUIT BREAKER		EARTH SWITCH	
CIRCUIT BREAKER WITH DELAYED AUTO RECLOSE		FAULT THROWING SWITCH (PHASE TO PHASE)	
WITHDRAWABLE METALCLAD SWITCHGEAR		FAULT THROWING SWITCH (EARTH FAULT)	
		SURGE ARRESTOR	
		THYRISTOR	

TRANSFORMERS
(VECTORS TO INDICATE
WINDING CONFIGURATION)

TWO WINDING



THREE WINDING

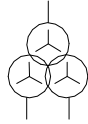

AUTO



AUTO WITH DELTA TERTIARY

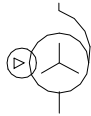

EARTHING OR AUX. TRANSFORMER

(-) INDICATE REMOTE SITE
IF APPLICABLE

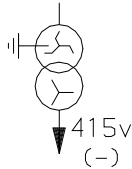

VOLTAGE TRANSFORMERS

SINGLE PHASE WOUND



THREE PHASE WOUND



SINGLE PHASE CAPACITOR



TWO SINGLE PHASE CAPACITOR

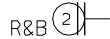

THREE PHASE CAPACITOR



* CURRENT TRANSFORMER
(WHERE SEPARATE PRIMARY
APPARATUS)



* COMBINED VT/CT UNIT
FOR METERING

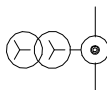

REACTOR



* BUSBARS



* OTHER PRIMARY CONNECTIONS



* CABLE & CABLE SEALING END

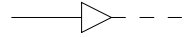

* THROUGH WALL BUSHING

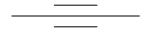

* BYPASS FACILITY



* CROSSING OF CONDUCTORS
(LOWER CONDUCTOR
TO BE BROKEN)

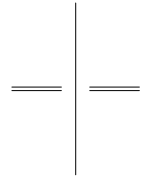

PREFERENTIAL ABBREVIATIONS

AUXILIARY TRANSFORMER	Aux T
EARTHING TRANSFORMER	ET
GAS TURBINE	Gas T
GENERATOR TRANSFORMER	Gen T
GRID TRANSFORMER	Gr T
SERIES REACTOR	Ser Reac
SHUNT REACTOR	Sh Reac
STATION TRANSFORMER	Stn T
SUPERGRID TRANSFORMER	SGT
UNIT TRANSFORMER	UT

* NON-STANDARD SYMBOL

PORTABLE MAINTENANCE
EARTH DEVICE



DISCONNECTOR
(PANTOGRAPH TYPE)



QUADRATURE BOOSTER

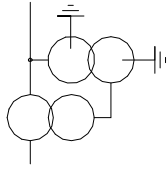

DISCONNECTOR
(KNEE TYPE)



SHORTING/DISCHARGE SWITCH

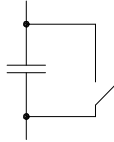

CAPACITOR
(INCLUDING HARMONIC FILTER)



SINGLE PHASE TRANSFORMER (BR)
NEUTRAL AND PHASE CONNECTIONS

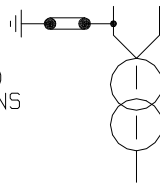

RESISTOR WITH INHERENT
NON-LINEAR VARIABILITY,
VOLTAGE DEPENDANT

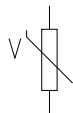

PART 1B - PROCEDURES RELATING TO GAS ZONE DIAGRAMS

GAS INSULATED
BUSBAR

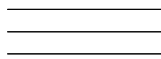

DOUBLE-BREAK
DISCONNECTOR

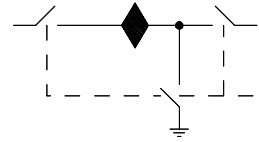

GAS BOUNDARY



EXTERNAL MOUNTED
CURRENT TRANSFORMER
(WHERE SEPARATE
PRIMARY APPARATUS)

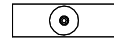

GAS/GAS BOUNDARY



STOP VALVE
NORMALLY CLOSED



GAS/CABLE BOUNDARY



STOP VALVE
NORMALLY OPEN



GAS/AIR BOUNDARY



GAS MONITOR



GAS/TRANSFORMER BOUNDARY



FILTER



MAINTENANCE VALVE

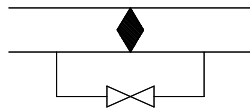

QUICK ACTING COUPLING



PART 2 - NON-EXHAUSTIVE LIST OF APPARATUS TO BE INCLUDED ON OPERATION DIAGRAMS

Basic Principles

- (1) Where practicable, all the **HV Apparatus** on any **Connection Site** shall be shown on one **Operation Diagram**. Provided the clarity of the diagram is not impaired, the layout shall represent as closely as possible the geographical arrangement on the **Connection Site**.
- (2) Where more than one **Operation Diagram** is unavoidable, duplication of identical information on more than one **Operation Diagram** must be avoided.
- (3) The **Operation Diagram** must show accurately the current status of the **Apparatus** e.g. whether commissioned or decommissioned. Where decommissioned, the associated switchbay will be labelled "spare bay".
- (4) Provision will be made on the **Operation Diagram** for signifying approvals, together with provision for details of revisions and dates.
- (5) **Operation Diagrams** will be prepared in A4 format or such other format as may be agreed with **The Company**.
- (6) The **Operation Diagram** should normally be drawn single line. However, where appropriate, detail which applies to individual phases shall be shown. For example, some **HV Apparatus** is numbered individually per phase.

Apparatus To Be Shown On Operation Diagram

- (1) Busbars
- (2) Circuit Breakers
- (3) Disconnecter (Isolator) and Switch Disconnecters (Switching Isolators)
- (4) Disconnectors (Isolators) - Automatic Facilities
- (5) Bypass Facilities
- (6) Earthing Switches
- (7) Maintenance Earths
- (8) Overhead Line Entries
- (9) Overhead Line Traps
- (10) Cable and Cable Sealing Ends
- (11) Generating Unit
- (12) Generator Transformers
- (13) Generating Unit Transformers, Station Transformers, including the lower voltage circuit-breakers.
- (14) Synchronous Compensators
- (15) Static Variable Compensators
- (16) Capacitors (including Harmonic Filters)
- (17) Series or Shunt Reactors (Referred to as "Inductors" at nuclear power station sites)
- (18) Supergrid and Grid Transformers
- (19) Tertiary Windings
- (20) Earthing and Auxiliary Transformers
- (21) Three Phase VT's

- (22) Single Phase VT & Phase Identity
- (23) High Accuracy VT and Phase Identity
- (24) Surge Arrestors/Diverter
- (25) Neutral Earthing Arrangements on HV Plant
- (26) Fault Throwing Devices
- (27) Quadrature Boosters
- (28) Arc Suppression Coils
- (29) Single Phase Transformers (BR) Neutral and Phase Connections
- (30) Current Transformers (where separate plant items)
- (31) Wall Bushings
- (32) Combined VT/CT Units
- (33) Shorting and Discharge Switches
- (34) Thyristor
- (35) Resistor with Inherent Non-Linear Variability, Voltage Dependent
- (36) Gas Zone

APPENDIX 3 - MINIMUM FREQUENCY RESPONSE REQUIREMENT PROFILE AND OPERATING RANGE FOR NEW POWER STATIONS AND DC CONVERTER STATIONS

CC.A.3.1 Scope

The **Frequency** response capability is defined in terms of **Primary Response**, **Secondary Response** and **High Frequency Response**. This appendix defines the minimum **Frequency** response requirement profile for:

- (a) each **Onshore Generating Unit** and/or **CCGT Module** which has a **Completion Date** after 1 January 2001 in England and Wales and 1 April 2005 in Scotland and **Offshore Generating Unit** in a **Large Power Station**,
- (b) each **DC Converter** at a **DC Converter Station** which has a **Completion Date** on or after 1 April 2005 or each **Offshore DC Converter** which is part of a **Large Power Station**.
- (c) each **Onshore Power Park Module** in England and Wales with a **Completion Date** on or after 1 January 2006.
- (d) each **Onshore Power Park Module** in operation in Scotland after 1 January 2006 with a **Completion Date** after 1 April 2005 and in **Power Stations** with a **Registered Capacity** of 50MW or more.
- (e) each **Offshore Power Park Module** in a **Large Power Station** with a **Registered Capacity** of 50MW or more.

For the avoidance of doubt, this appendix does not apply to:

- (i) **Generating Units** and/or **CCGT Modules** which have a **Completion Date** before 1 January 2001 in England and Wales and before 1 April 2005 in Scotland,
- (ii) **DC Converters** at a **DC Converter Station** which have a **Completion Date** before 1 April 2005.
- (iii) **Power Park Modules** in England and Wales with a **Completion Date** before 1 January 2006.
- (iv) **Power Park Modules** in operation in Scotland before 1 January 2006.
- (v) **Power Park Modules** in Scotland with a **Completion Date** before 1 April 2005.
- (vi) **Power Park Modules** in **Power Stations** with a **Registered Capacity** less than 50MW.
- (vii) **Small Power Stations** or individually to **Power Park Units**; or.
- (viii) an **OTSDUW DC Converter** where the **Interface Point Capacity** is less than 50MW.

OTSDUW Plant and Apparatus should facilitate the delivery of **Frequency** response services provided by **Offshore Generating Units** and **Offshore Power Park Modules** at the **Interface Point**.

The functional definition provides appropriate performance criteria relating to the provision of **Frequency** control by means of **Frequency** sensitive generation in addition to the other requirements identified in CC.6.3.7.

In this Appendix 3 to the **CC**, for a **CCGT Module** or a **Power Park Module** with more than one **Generating Unit**, the phrase **Minimum Generation** applies to the entire **CCGT Module** or **Power Park Module** operating with all **Generating Units Synchronised** to the **System**.

The minimum **Frequency** response requirement profile is shown diagrammatically in Figure CC.A.3.1. The capability profile specifies the minimum required levels of **Primary Response**, **Secondary Response** and **High Frequency Response** throughout the normal plant operating range. The definitions of these **Frequency** response capabilities are illustrated diagrammatically in Figures CC.A.3.2 & CC.A.3.3.

CC.A.3.2 Plant Operating Range

The upper limit of the operating range is the **Registered Capacity** of the **Generating Unit** or **CCGT Module** or **DC Converter** or **Power Park Module**.

The **Minimum Generation** level may be less than, but must not be more than, 65% of the **Registered Capacity**. Each **Generating Unit** and/or **CCGT Module** and/or **Power Park Module** and/or **DC Converter** must be capable of operating satisfactorily down to the **Designed Minimum Operating Level** as dictated by **System** operating conditions, although it will not be instructed to below its **Minimum Generation** level. If a **Generating Unit** or **CCGT Module** or **Power Park Module** or **DC Converter** is operating below **Minimum Generation** because of high **System Frequency**, it should recover adequately to its **Minimum Generation** level as the **System Frequency** returns to **Target Frequency** so that it can provide **Primary** and **Secondary Response** from **Minimum Generation** if the **System Frequency** continues to fall. For the avoidance of doubt, under normal operating conditions steady state operation below **Minimum Generation** is not expected. The **Designed Minimum Operating Level** must not be more than 55% of **Registered Capacity**.

In the event of a **Generating Unit** or **CCGT Module** or **Power Park Module** or **DC Converter** load rejecting down to no less than its **Designed Minimum Operating Level** it should not trip as a result of automatic action as detailed in BC3.7. If the load rejection is to a level less than the **Designed Minimum Operating Level** then it is accepted that the condition might be so severe as to cause it to be disconnected from the **System**.

CC.A.3.3 Minimum Frequency Response Requirement Profile

Figure CC.A.3.1 shows the minimum **Frequency** response requirement profile diagrammatically for a 0.5 Hz change in **Frequency**. The percentage response capabilities and loading levels are defined on the basis of the **Registered Capacity** of the **Generating Unit** or **CCGT Module** or **Power Park Module** or **DC Converter**. Each **Generating Unit** and/or **CCGT Module** and/or **Power Park Module** and/or **DC Converter** must be capable of operating in a manner to provide **Frequency** response at least to the solid boundaries shown in the figure. If the **Frequency** response capability falls within the solid boundaries, the **Generating Unit** or **CCGT Module** or **Power Park Module** or **DC Converter** is providing response below the minimum requirement which is not acceptable. Nothing in this appendix is intended to prevent a **Generating Unit** or **CCGT Module** or **Power Park Module** or **DC Converter** from being designed to deliver a **Frequency** response in excess of the identified minimum requirement.

The **Frequency** response delivered for **Frequency** deviations of less than 0.5 Hz should be no less than a figure which is directly proportional to the minimum **Frequency** response requirement for a **Frequency** deviation of 0.5 Hz. For example, if the **Frequency** deviation is 0.2 Hz, the corresponding minimum **Frequency** response requirement is 40% of the level shown in Figure CC.A.3.1. The **Frequency** response delivered for **Frequency** deviations of more than 0.5 Hz should be no less than the response delivered for a **Frequency** deviation of 0.5 Hz.

Each **Generating Unit** and/or **CCGT Module** and/or **Power Park Module** and/or **DC Converter** must be capable of providing some response, in keeping with its specific operational characteristics, when operating between 95% to 100% of **Registered Capacity** as illustrated by the dotted lines in Figure CC.A.3.1.

At the **Minimum Generation** level, each **Generating Unit** and/or **CCGT Module** and/or **Power Park Module** and/or **DC Converter** is required to provide high and low frequency response depending on the **System Frequency** conditions. Where the **Frequency** is high, the **Active Power** output is therefore expected to fall below the **Minimum Generation** level.

The **Designed Minimum Operating Level** is the output at which a **Generating Unit** and/or **CCGT Module** and/or **Power Park Module** and/or **DC Converter** has no **High Frequency Response** capability. It may be less than, but must not be more than, 55% of the **Registered Capacity**. This implies that a **Generating Unit** or **CCGT Module** or **Power Park Module** or **DC Converter** is not obliged to reduce its output to below this level unless the **Frequency** is at or above 50.5 Hz (cf BC3.7).

CC.A.3.4 Testing of Frequency Response Capability

The response capabilities shown diagrammatically in Figure CC.A.3.1 are measured by taking the responses as obtained from some of the dynamic response tests specified by **The Company** and carried out by **GB Generators** and **DC Converter Station** owners for compliance purposes and to validate the content of **Ancillary Services Agreements** using an injection of a **Frequency** change to the plant control system (i.e. governor and load controller). The injected signal is a linear ramp from zero to 0.5 Hz **Frequency** change over a ten second period, and is sustained at 0.5 Hz **Frequency** change thereafter, as illustrated diagrammatically in figures CC.A.3.2 and CC.A.3.3. In the case of an **Embedded Medium Power Station** not subject to a **Bilateral Agreement** or **Embedded DC Converter Station** not subject to a **Bilateral Agreement**, **The Company** may require the **Network Operator** within whose **System** the **Embedded Medium Power Station** or **Embedded DC Converter Station** is situated, to ensure that the **Embedded Person** performs the dynamic response tests reasonably required by **The Company** in order to demonstrate compliance within the relevant requirements in the **CC**.

The **Primary Response** capability (P) of a **Generating Unit** or a **CCGT Module** or **Power Park Module** or **DC Converter** is the minimum increase in **Active Power** output between 10 and 30 seconds after the start of the ramp injection as illustrated diagrammatically in Figure CC.A.3.2. This increase in **Active Power** output should be released increasingly with time over the period 0 to 10 seconds from the time of the start of the **Frequency** fall as illustrated by the response from Figure CC.A.3.2.

The **Secondary Response** capability (S) of a **Generating Unit** or a **CCGT Module** or **Power Park Module** or **DC Converter** is the minimum increase in **Active Power** output between 30 seconds and 30 minutes after the start of the ramp injection as illustrated diagrammatically in Figure CC.A.3.2.

The **High Frequency Response** capability (H) of a **Generating Unit** or a **CCGT Module** or **Power Park Module** or **DC Converter** is the decrease in **Active Power** output provided 10 seconds after the start of the ramp injection and sustained thereafter as illustrated diagrammatically in Figure CC.A.3.3. This reduction in **Active Power** output should be released increasingly with time over the period 0 to 10 seconds from the time of the start of the **Frequency** rise as illustrated by the response in Figure CC.A.3.2.

CC.A.3.5 Repeatability Of Response

When a **Generating Unit** or **CCGT Module** or **Power Park Module** or **DC Converter** has responded to a significant **Frequency** disturbance, its response capability must be fully restored as soon as technically possible. Full response capability should be restored no later than 20 minutes after the initial change of **System Frequency** arising from the **Frequency** disturbance.

Figure CC.A.3.1 - Minimum Frequency Response Requirement Profile for a 0.5 Hz frequency change from Target Frequency

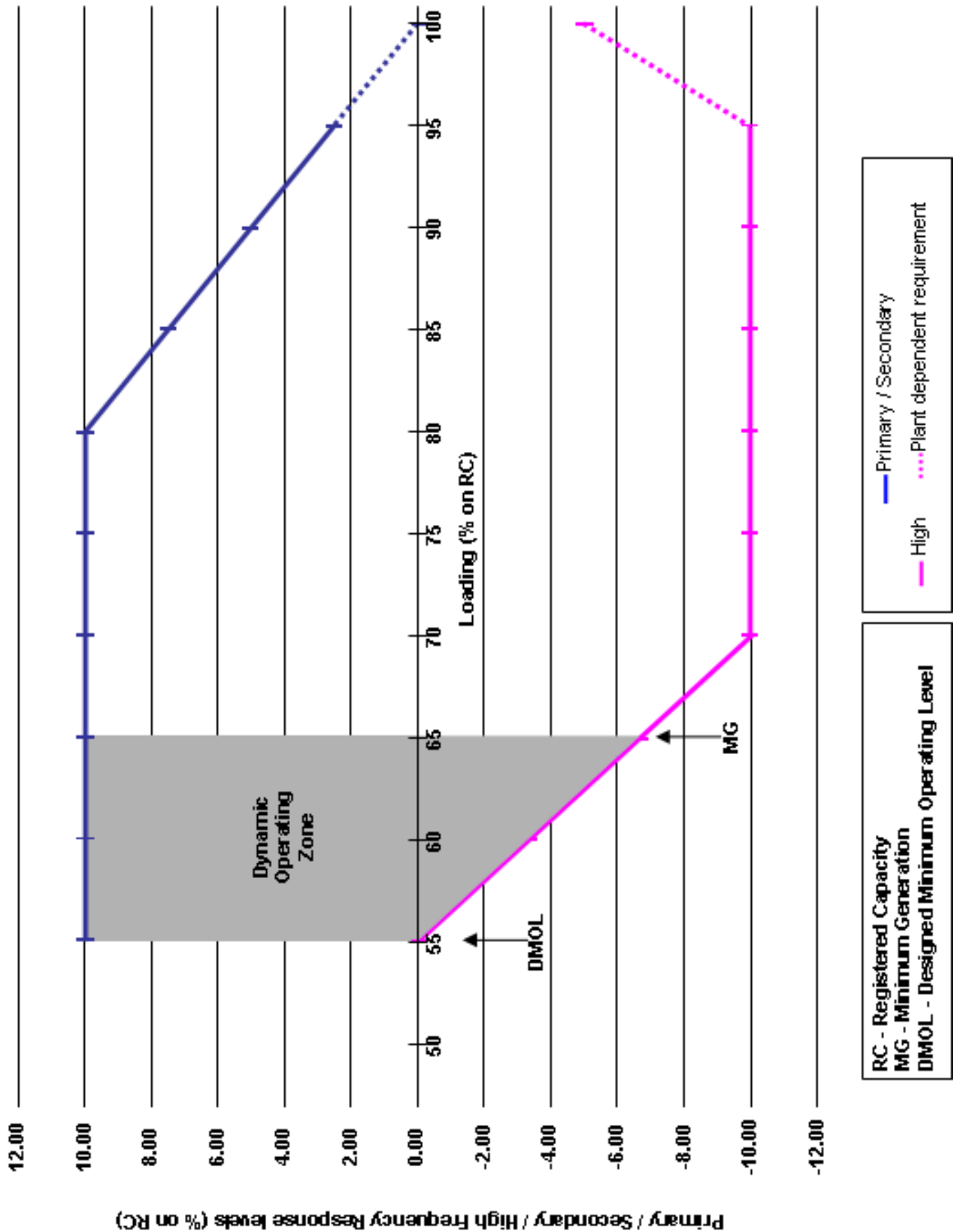

Figure CC.A.3.2 - Interpretation of Primary and Secondary Response Values

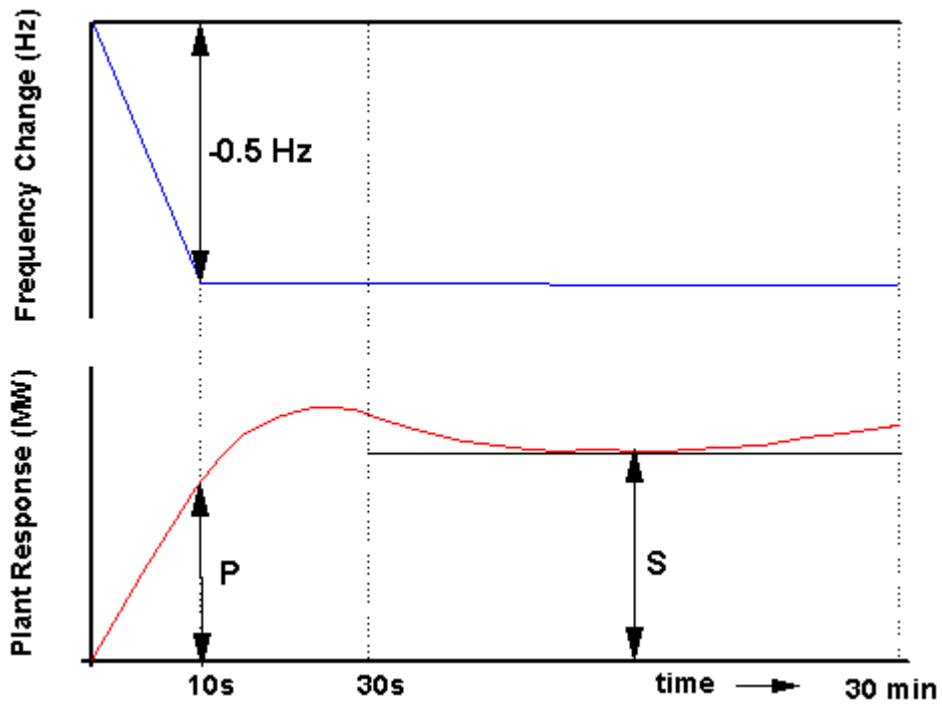
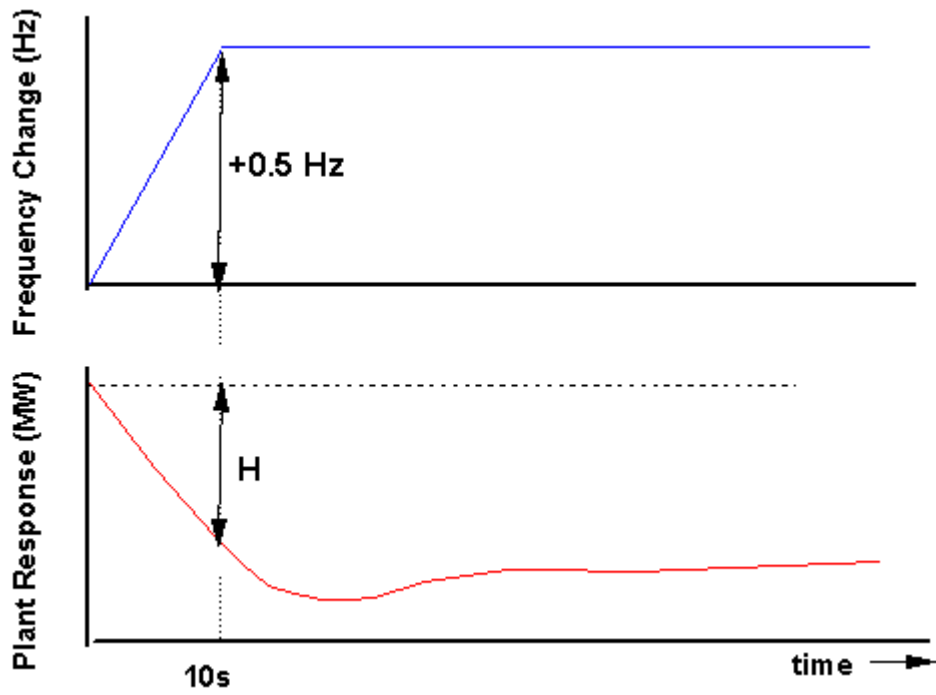

Figure CC.A.3.3 - Interpretation of High Frequency Response Values



APPENDIX 4 - FAULT RIDE THROUGH REQUIREMENTS

APPENDIX 4A - FAULT RIDE THROUGH REQUIREMENTS FOR ONSHORE SYNCHRONOUS GENERATING UNITS, ONSHORE POWER PARK MODULES, ONSHORE DC CONVERTERS OTSDUW PLANT AND APPARATUS AT THE INTERFACE POINT, OFFSHORE SYNCHRONOUS GENERATING UNITS IN A LARGE POWER STATION, OFFSHORE POWER PARK MODULES IN A LARGE POWER STATION AND OFFSHORE DC CONVERTERS IN A LARGE POWER STATION WHICH SELECT TO MEET THE FAULT RIDE THROUGH REQUIREMENTS AT THE INTERFACE POINT

CC.A.4A.1 Scope

The fault ride through requirement is defined in CC.6.3.15.1 (a), (b) and CC.6.3.15.3. This Appendix provides illustrations by way of examples only of CC.6.3.15.1 (a) (i) and further background and illustrations to CC.6.3.15.1 (1b) (i) and CC.6.3.15.1 (2b) (i) and is not intended to show all possible permutations.

CC.A.4A.2 Short Circuit Faults At Supergrid Voltage On The Onshore Transmission System Up To 140ms In Duration

For short circuit faults at **Supergrid Voltage** on the **Onshore Transmission System** (which could be at an **Interface Point**) up to 140ms in duration, the fault ride through requirement is defined in CC.6.3.15.1 (a) (i). Figures CC.A.4A.1 (a) and (b) illustrate two typical examples of voltage recovery for short-circuit faults cleared within 140ms by two circuit breakers (a) and three circuit breakers (b) respectively.

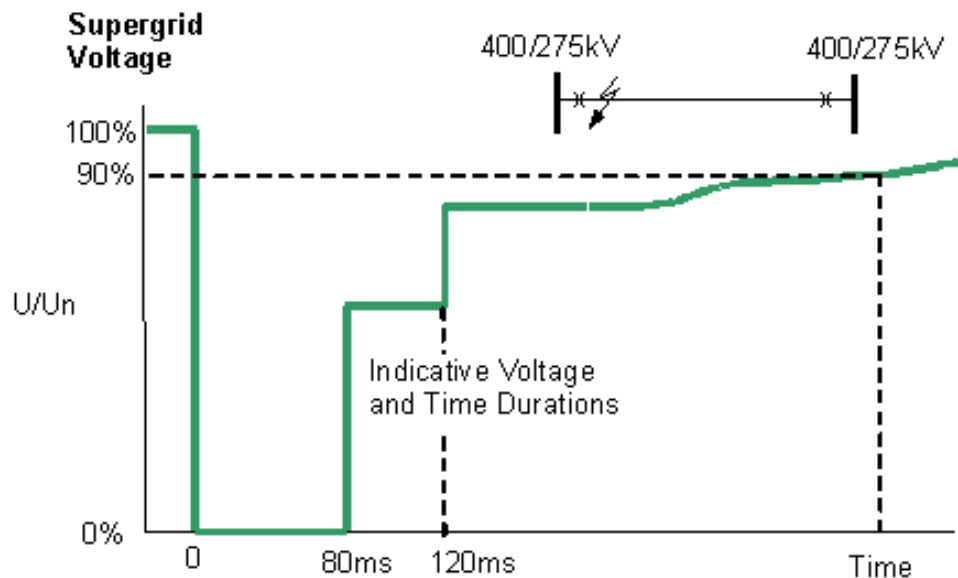

Typical fault cleared in less than 140ms: 2 ended circuit

Figure CC.A.4A.1 (a)

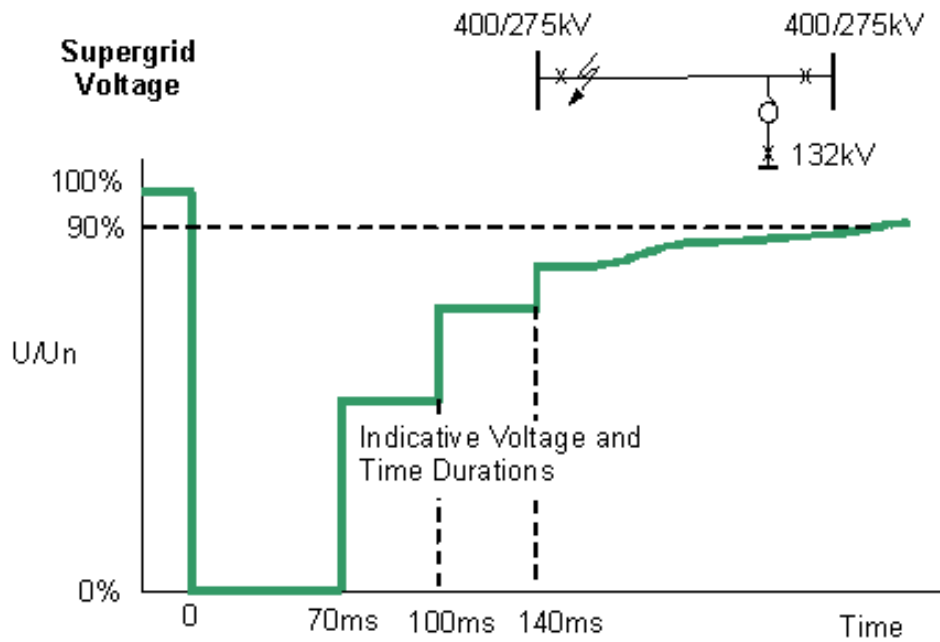

Typical fault cleared in 140ms:- 3 ended circuit

Figure CC.A.4A.1 (b)

CC.A.4A.3 Supergrid Voltage Dips On The Onshore Transmission System Greater Than 140ms In Duration

CC.A.4A3.1 Requirements applicable to **Synchronous Generating Units** subject to **Supergrid Voltage** dips on the **Onshore Transmission System** greater than 140ms in duration.

For balanced **Supergrid Voltage** dips on the **Onshore Transmission System** having durations greater than 140ms and up to 3 minutes, the fault ride through requirement is defined in CC.6.3.15.1 (1b) and Figure 5a which is reproduced in this Appendix as Figure CC.A.4A3.1 and termed the voltage–duration profile.

This profile is not a voltage-time response curve that would be obtained by plotting the transient voltage response at a point on the **Onshore Transmission System** (or **User System** if located **Onshore**) to a disturbance. Rather, each point on the profile (i.e. the heavy black line) represents a voltage level and an associated time duration which connected **Synchronous Generating Units** must withstand or ride through.

Figures CC.A.4A3.2 (a), (b) and (c) illustrate the meaning of the voltage-duration profile for voltage dips having durations greater than 140ms.

NOT TO SCALE

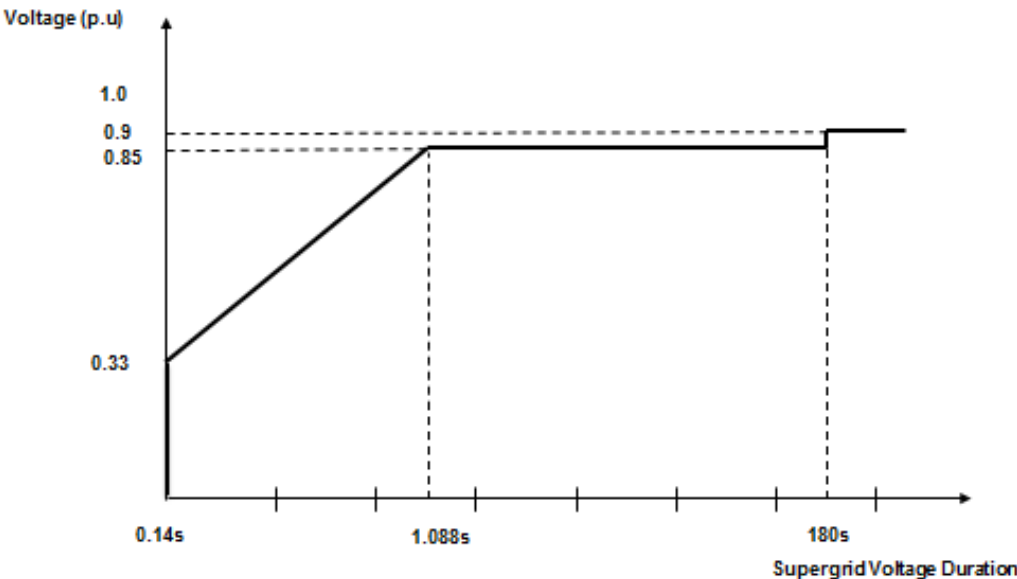

Figure CC.A.4A3.1

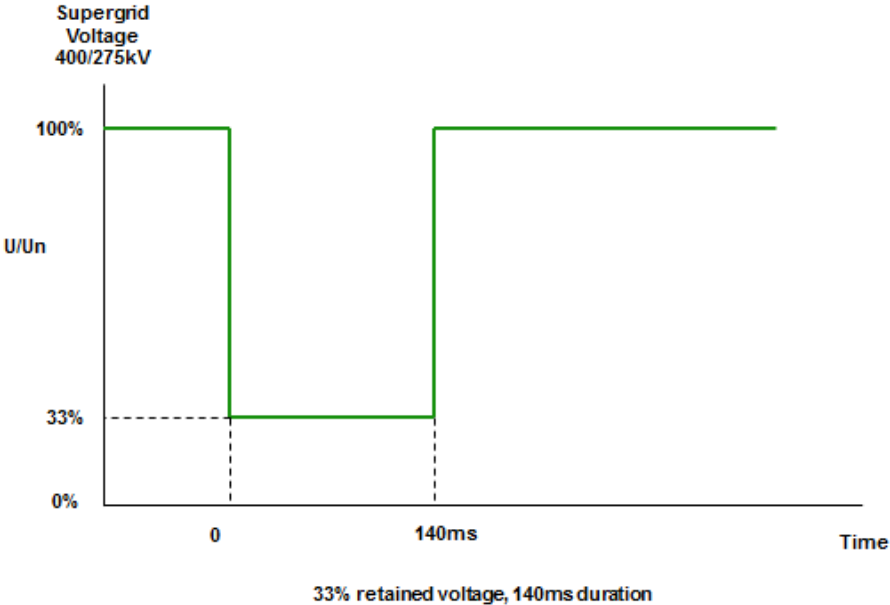

Figure CC.A.4A3.2 (a)

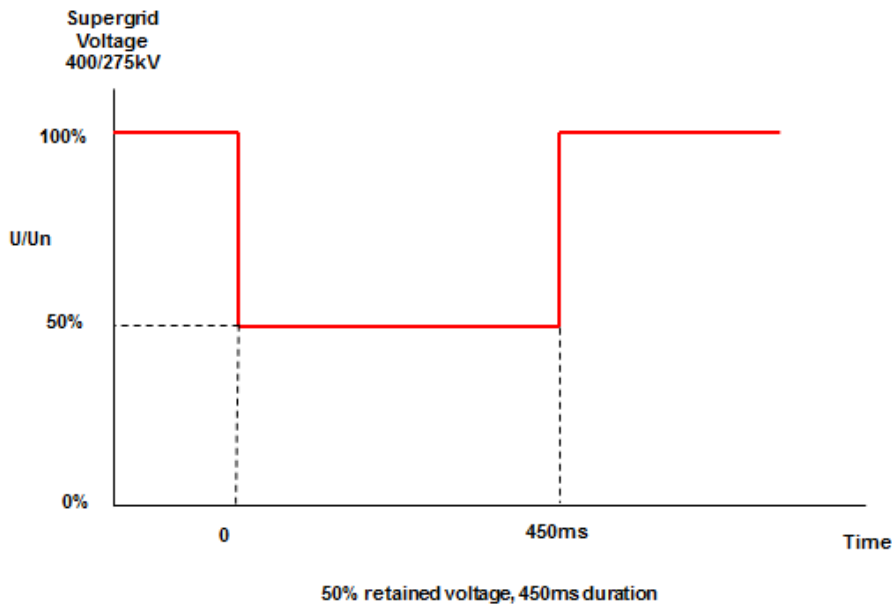

Figure CC.A.4A3.2 (b)

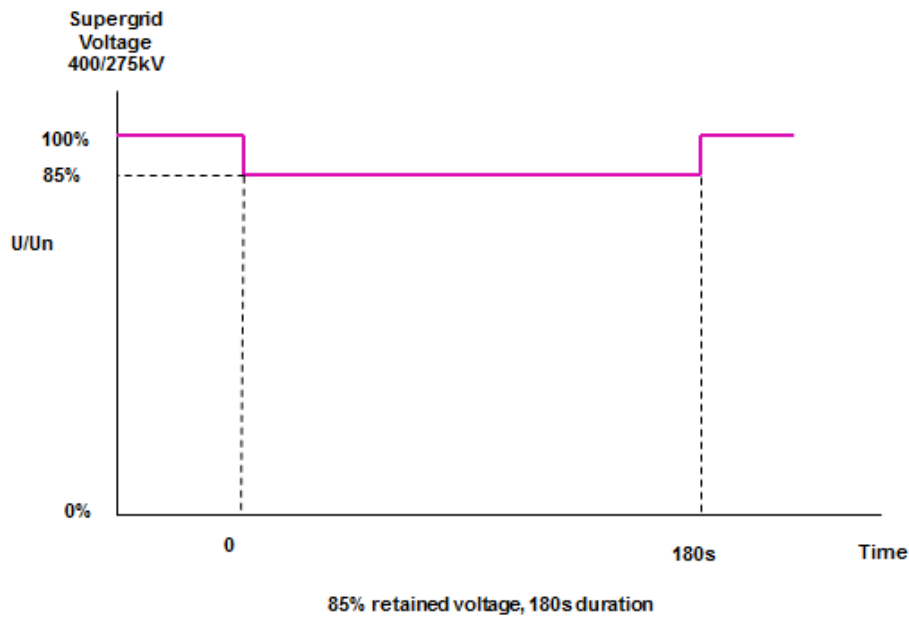

Figure CC.A.4A3.2 (c)

CC.A.4A3.2 Requirements applicable to **Power Park Modules** or **OTSDUW Plant and Apparatus** subject to **Supergrid Voltage** dips on the **Onshore Transmission System** greater than 140ms in duration.

For balanced **Supergrid Voltage** dips on the **Onshore Transmission System** (which could be at an **Interface Point**) having durations greater than 140ms and up to 3 minutes the fault ride through requirement is defined in CC.6.3.15.1 (2b) and Figure 5b which is reproduced in this Appendix as Figure CC.A.4A3.3 and termed the voltage–duration profile.

This profile is not a voltage-time response curve that would be obtained by plotting the transient voltage response at a point on the **Onshore Transmission System** (or **User System** if located **Onshore**) to a disturbance. Rather, each point on the profile (i.e. the heavy black line) represents a voltage level and an associated time duration which connected **Power Park Modules** or **OTSDUW Plant and Apparatus** must withstand or ride through.

Figures CC.A.4A.4 (a), (b) and (c) illustrate the meaning of the voltage-duration profile for voltage dips having durations greater than 140ms.

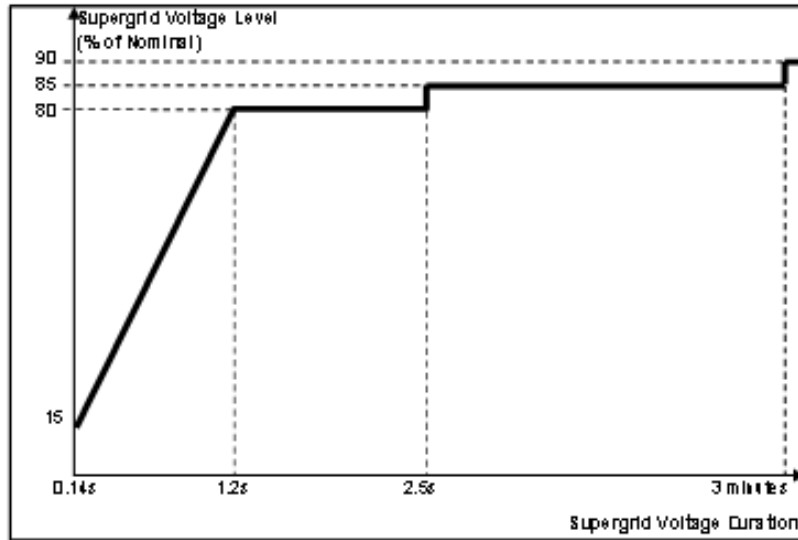
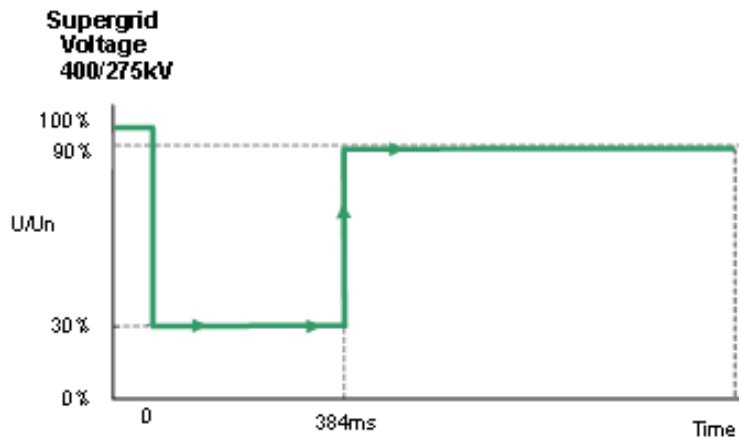

Figure CC.A.4A3.3



30 % retained voltage, 384ms duration

Figure CC.A.4A3.4 (a)

**Supergrid
Voltage
400/275kV**

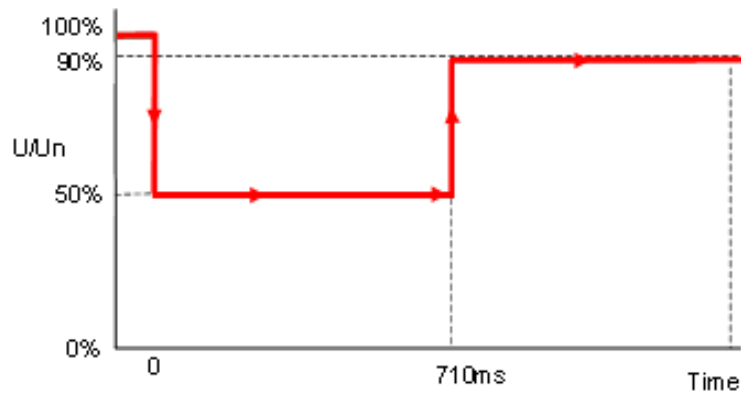

50% retained voltage, 710ms duration

Figure CC.A.4A3.4 (b)

**Supergrid
Voltage
400/275kV**

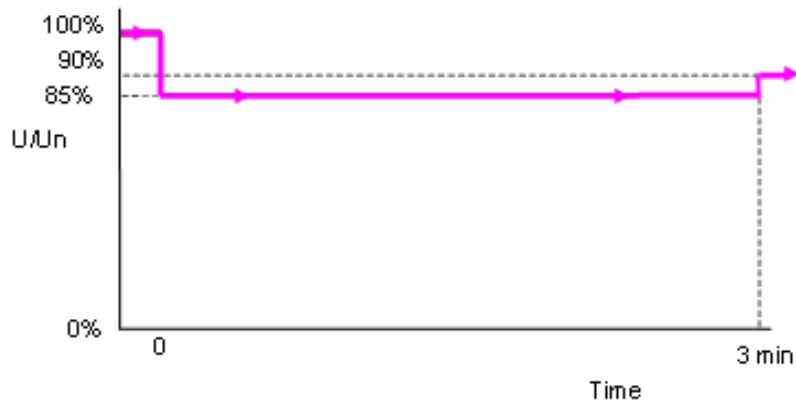

85% retained voltage, 3 minutes duration

Figure CC.A.4A3.4 (c)

APPENDIX 4B - FAULT RIDE THROUGH REQUIREMENTS FOR OFFSHORE GENERATING UNITS IN A LARGE POWER STATION, OFFSHORE POWER PARK MODULES IN A LARGE POWER STATION AND OFFSHORE DC CONVERTERS IN A LARGE POWER STATION WHICH SELECT TO MEET THE FAULT RIDE THROUGH REQUIREMENTS AT THE LV SIDE OF THE OFFSHORE PLATFORM AS SPECIFIED IN CC.6.3.15.2

CC.A.4B.1 Scope

The fault ride through requirement is defined in CC.6.3.15.2 (a), (b) and CC.6.3.15.3. This Appendix provides illustrations by way of examples only of CC.6.3.15.2 (a) (i) and further background and illustrations to CC.6.3.15.2 (1b) and CC.6.3.15.2 (2b) and is not intended to show all possible permutations.

CC.A.4B.2 Voltage Dips On The LV Side Of The Offshore Platform Up To 140ms In Duration

For voltage dips on the **LV Side of the Offshore Platform** which last up to 140ms in duration, the fault ride through requirement is defined in CC.6.3.15.2 (a) (i). This includes Figure 6 which is reproduced here in Figure CC.A.4B.1. The purpose of this requirement is to translate the conditions caused by a balanced or unbalanced fault which occurs on the **Onshore Transmission System** (which may include the **Interface Point**) at the **LV Side of the Offshore Platform**.

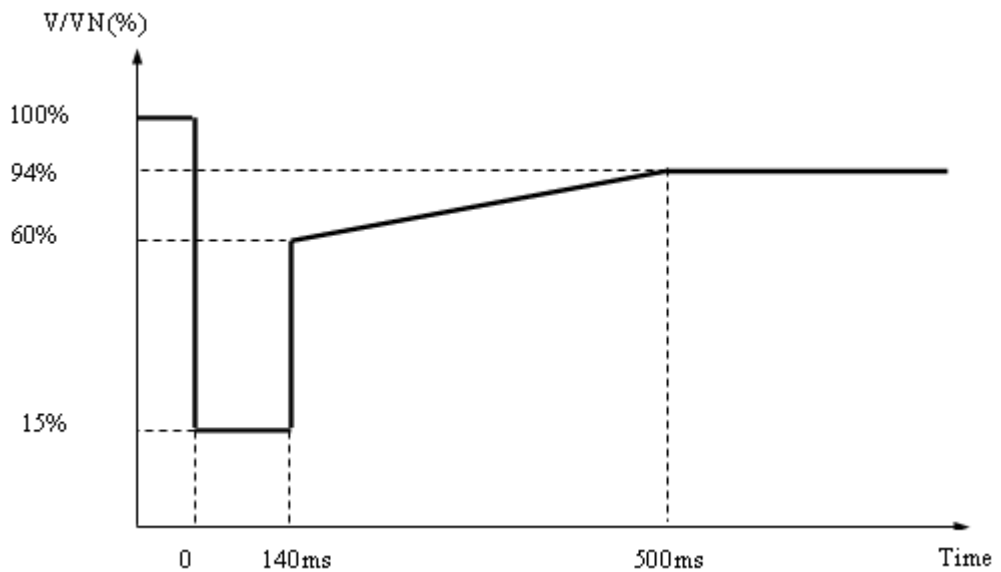

V/V_N is the ratio of the voltage at the **LV side of the Offshore Platform** to the nominal voltage of the LV side of the **Offshore Platform**.

Figure CC.A.4B.1

Figures CC.A.4B.2 (a) and CC.A.4B.2 (b) illustrate two typical examples of the voltage recovery seen at the **LV Side of the Offshore Platform** for a short circuit fault cleared within 140ms by (a) two circuit breakers and (b) three circuit breakers on the **Onshore Transmission System**.

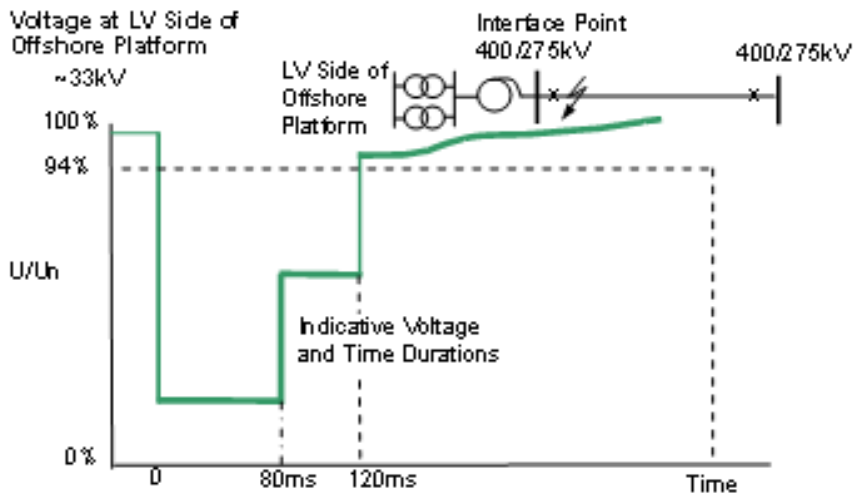

Typical fault cleared in less than 140ms: 2 ended circuit

Figure CC.A.4B.2 (a)

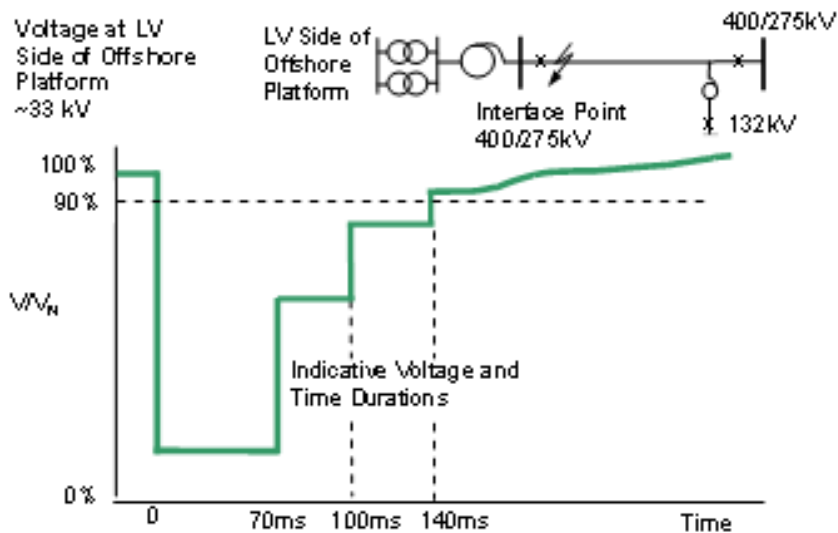

Typical fault cleared in 140ms:- 3 ended circuit

Figure CC.A.4B.2 (b)

CCA.4B.3 Voltage Dips Which Occur On The LV Side Of The Offshore Platform Greater Than 140ms In Duration

CC.A.4B.3.1 Requirements applicable to **Offshore Synchronous Generating Units** subject to voltage dips which occur on the **LV Side of the Offshore Platform** greater than 140ms in duration.

In addition to CC.A.4B.2 the fault ride through requirements applicable to **Offshore Synchronous Generating Units** during balanced voltage dips which occur at the **LV Side of the Offshore Platform** and having durations greater than 140ms and up to 3 minutes are defined in CC.6.3.15.2 (1b) and Figure 7a which is reproduced in this Appendix as Figure CC.A.4B.3.1 and termed the voltage-duration profile.

This profile is not a voltage-time response curve that would be obtained by plotting the transient voltage response at the **LV Side of the Offshore Platform** to a disturbance. Rather, each point on the profile (i.e. the heavy black line) represents a voltage level and an associated time duration which connected **Offshore Synchronous Generating Units** must withstand or ride through.

Figures CC.A.4B3.2 (a), (b) and (c) illustrate the meaning of the voltage-duration profile for voltage dips having durations greater than 140ms.

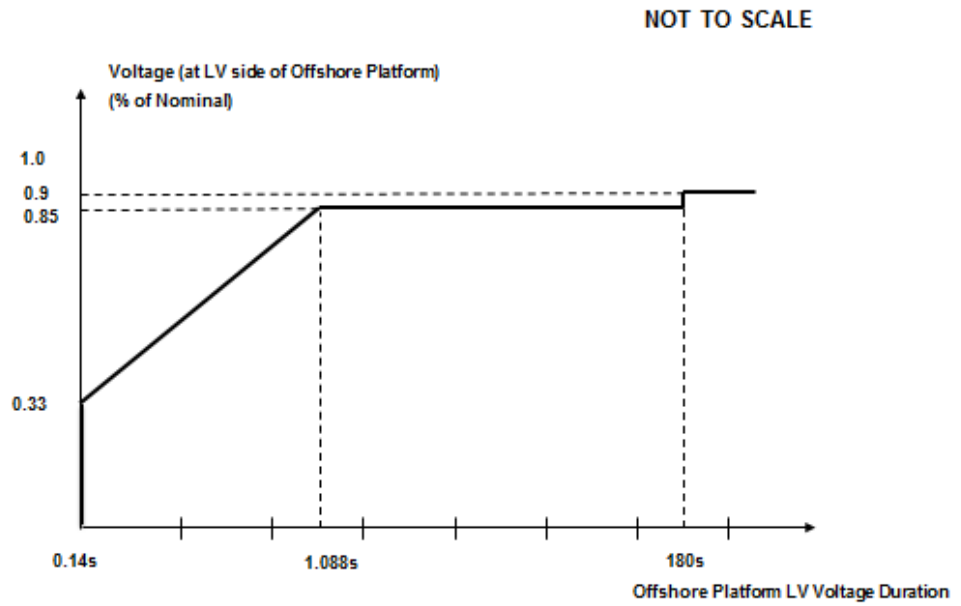

Figure CC.A.4B3.1

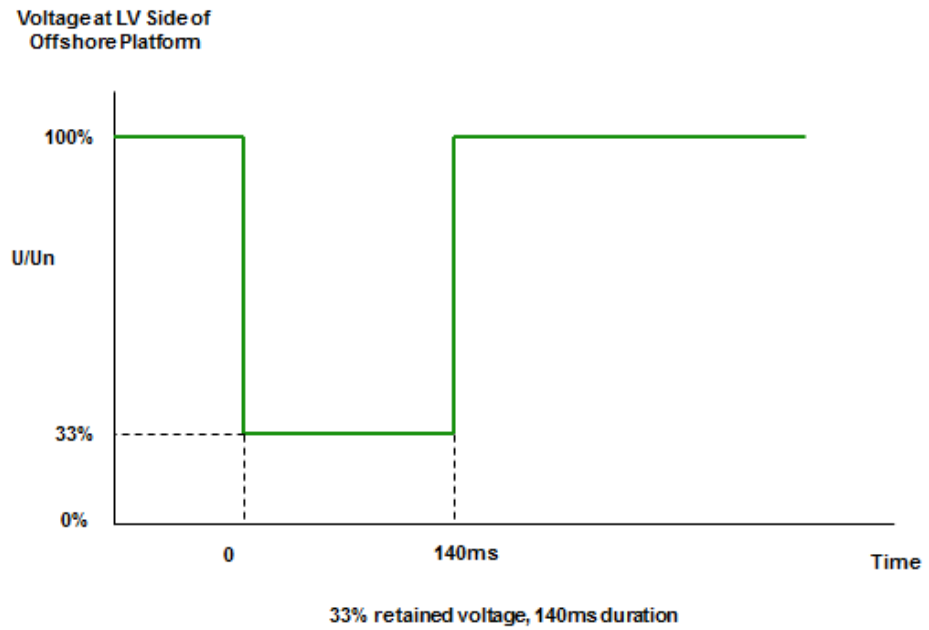
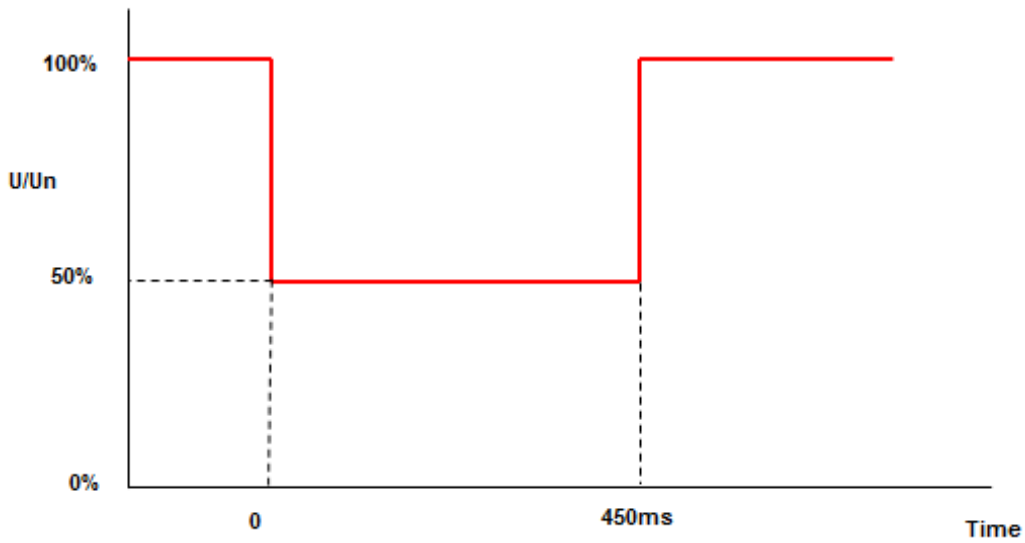

Figure CC.A.4B3.2 (a)

Voltage at LV Side of Offshore Platform



50% retained voltage, 450ms duration

Figure CC.A.4B3.2 (b)

Voltage at LV Side of Offshore Platform

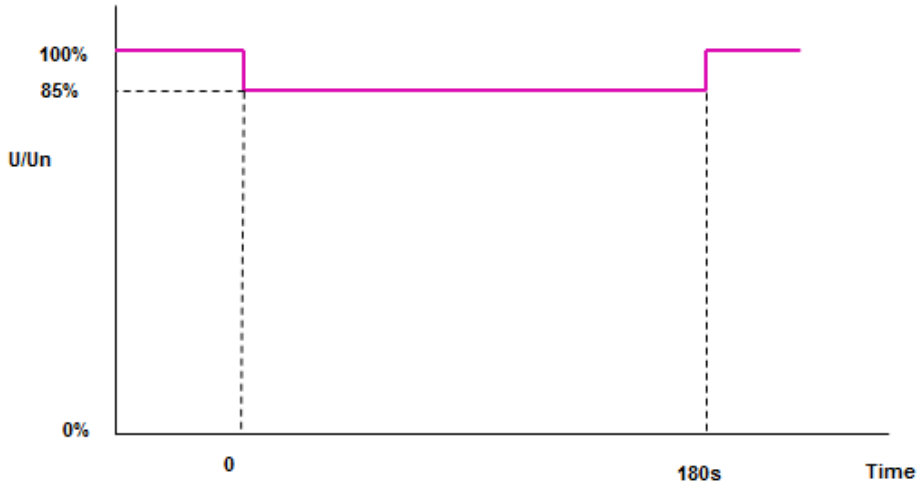

85% retained voltage, 180s duration

Figure CC.A.4B3.2 (c)

CC.A.4B.3.2 Requirements applicable to **Offshore Power Park Modules** subject to Voltage which occur on **The LV Side Of The Offshore Platform** greater than 140ms in duration.

In addition to CCA.4B.2 the fault ride through requirements applicable for **Offshore Power Park Modules** during balanced voltage dips which occur at the **LV Side of the Offshore Platform** and have durations greater than 140ms and up to 3 minutes are defined in CC.6.3.15.2 (2b) (i) and Figure 7b which is reproduced in this Appendix as Figure CC.A.4B.4 and termed the voltage–duration profile.

This profile is not a voltage-time response curve that would be obtained by plotting the transient voltage response at the **LV Side of the Offshore Platform** to a disturbance. Rather, each point on the profile (i.e. the heavy black line) represents a voltage level and an associated time duration which connected **Offshore Power Park Modules** must withstand or ride through.

Figures CC.A.4B.5 (a), (b) and (c) illustrate the meaning of the voltage-duration profile for voltage dips having durations greater than 140ms.

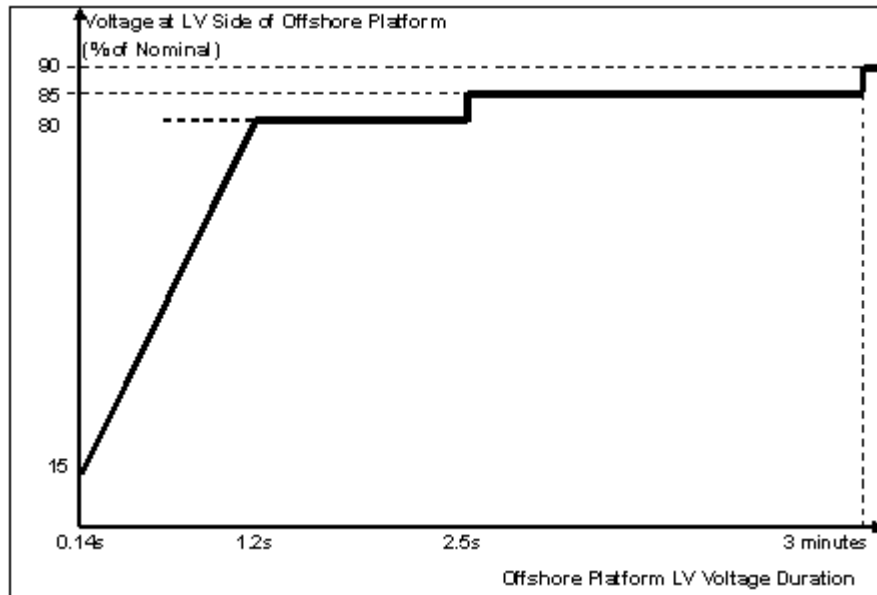

Figure CC.A.4B.4

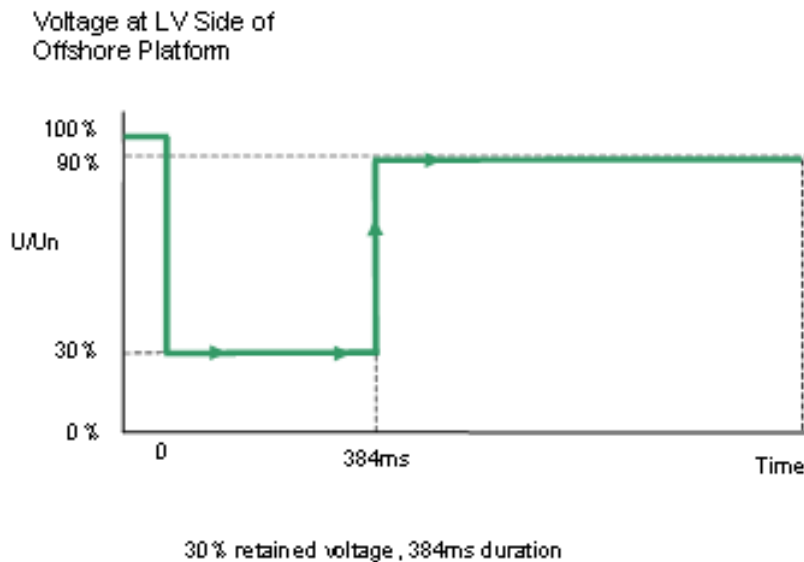
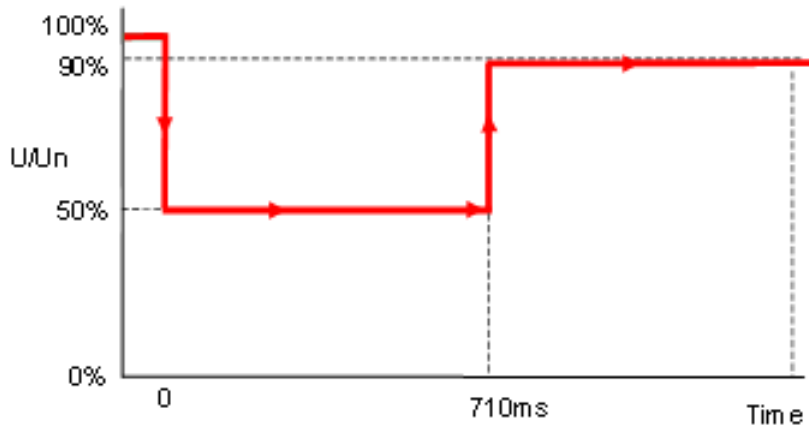

Figure CC.A.4B.5 (a)

Voltage at LV Side of Offshore Platform



50% retained voltage, 710ms duration

Figure CC.A.4B.5(b)

Voltage at LV Side of Offshore Platform

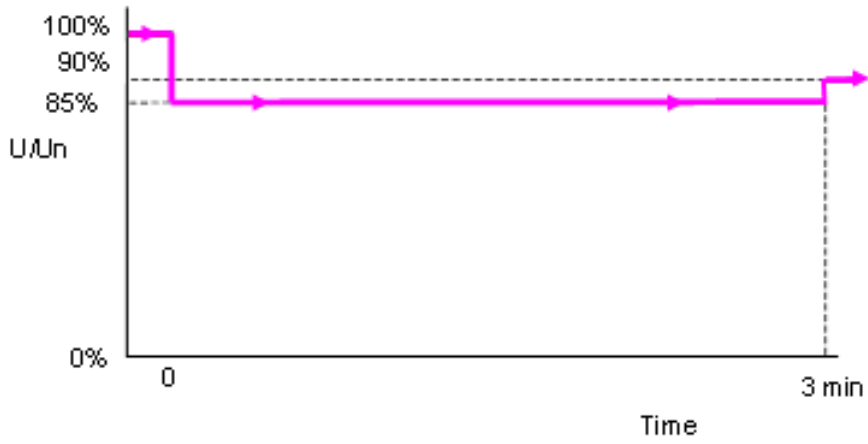

85% retained voltage, 3 minutes duration

Figure CC.A.4B.5(c)

APPENDIX 5 - TECHNICAL REQUIREMENTS

LOW FREQUENCY RELAYS FOR THE AUTOMATIC DISCONNECTION OF SUPPLIES AT LOW FREQUENCY

CC.A.5.1 Low Frequency Relays

CC.A.5.1.1 The **Low Frequency Relays** to be used shall have a setting range of 47.0 to 50Hz and be suitable for operation from a nominal AC input of 63.5, 110 or 240V. The following general parameters specify the requirements of approved **Low Frequency Relays** for automatic installations installed and commissioned after 1st April 2007 and provide an indication, without prejudice to the provisions that may be included in a **Bilateral Agreement**, for those installed and commissioned before 1st April 2007:

- (a) **Frequency** settings: 47-50Hz in steps of 0.05Hz or better, preferably 0.01Hz;
- (b) Operating time: Relay operating time shall not be more than 150 ms;
- (c) Voltage lock-out: Selectable within a range of 55 to 90% of nominal voltage;
- (d) Facility stages: One or two stages of **Frequency** operation;
- (e) Output contacts: Two output contacts per stage to be capable of repetitively making and breaking for 1000 operations;
- (f) Accuracy: 0.01 Hz maximum error under reference environmental and system voltage conditions.
0.05 Hz maximum error at 8% of total harmonic distortion
Electromagnetic Compatibility Level.

CC.A.5.2 Low Frequency Relay Voltage Supplies

CC.A.5.2.1 It is essential that the voltage supply to the **Low Frequency Relays** shall be derived from the primary **System** at the supply point concerned so that the **Frequency** of the **Low Frequency Relays** input voltage is the same as that of the primary **System**. This requires either:

- (a) the use of a secure supply obtained from voltage transformers directly associated with the grid transformer(s) concerned, the supply being obtained where necessary via a suitable automatic voltage selection scheme; or
- (b) the use of the substation 240V phase-to-neutral selected auxiliary supply, provided that this supply is always derived at the supply point concerned and is never derived from a standby supply **Generating Unit** or from another part of the **User System**.

CC.A.5.3 Scheme Requirements

CC.A.5.3.1 The tripping facility should be engineered in accordance with the following reliability considerations:

(a) Dependability

Failure to trip at any one particular **Demand** shedding point would not harm the overall operation of the scheme. However, many failures would have the effect of reducing the amount of **Demand** under low **Frequency** control. An overall reasonable minimum requirement for the dependability of the **Demand** shedding scheme is 96%, i.e. the average probability of failure of each **Demand** shedding point should be less than 4%. Thus the **Demand** under low **Frequency** control will not be reduced by more than 4% due to relay failure.

(b) Outages

Low **Frequency Demand** shedding schemes will be engineered such that the amount of **Demand** under control is as specified in Table CC.A.5.5.1a and is not reduced unacceptably during equipment outage or maintenance conditions.

CC.A.5.3.2 The total operating time of the scheme, including circuit breakers operating time, shall where reasonably practicable, be less than 200ms. For the avoidance of doubt, the replacement of plant installed prior to October 2009 will not be required in order to achieve lower total scheme operating times.

CC.A.5.4 Low Frequency Relay Testing

CC.A.5.4.1 **Low Frequency Relays** installed and commissioned after 1st January 2007 shall be type tested in accordance with and comply with the functional test requirements for **Frequency Protection** contained in Energy Networks Association Technical Specification 48-6-5 Issue 1 dated 2005 “**ENA Protection Assessment Functional Test Requirements – Voltage and Frequency Protection**”.

For the avoidance of doubt, **Low Frequency Relays** installed and commissioned before 1st January 2007 shall comply with the version of CC.A.5.1.1 applicable at the time such **Low Frequency Relays** were commissioned.

CC.A.5.4.2 Each **Non-Embedded Customer** shall aim to execute testing on its low frequency demand disconnection relays installed within its network and in service at least once every three years, although this may be extended to no more than every five years if considered to be required for operational purposes.

CC.A.5.4.3 Each **Network Operator** and **Relevant Transmission Licensee** shall aim to execute testing on its low frequency demand disconnection relays installed within its network and in service at least once every three years, although this may be extended to no more than every five years if considered to be required for operational purposes.

CC.A.5.5 Scheme Settings

CC.A.5.5.1 Table CC.A.5.5.1a shows, for each **Transmission Area**, the percentage of **Demand** (based on **Annual ACS Conditions**) at the time of forecast **National Electricity Transmission System** peak **Demand** that each **Network Operator** whose **System** is connected to the **Onshore Transmission System** within such **Transmission Area** shall disconnect by **Low Frequency Relays** at a range of frequencies. Where a **Network Operator’s System** is connected to the **National Electricity Transmission System** in more than one **Transmission Area**, the settings for the **Transmission Area** in which the majority of the **Demand** is connected shall apply.

Frequency Hz	% Demand disconnection for each Network Operator in Transmission Area		
	NGET	SPT	SHTL
48.8	5		
48.75	5		
48.7	10		
48.6	7.5		10
48.5	7.5	10	
48.4	7.5	10	10
48.2	7.5	10	10
48.0	5	10	10
47.8	5		
Total % Demand	60	40	40

Table CC.A.5.5.1a

Note – the percentages in table CC.A.5.5.1a are cumulative such that, for example, should the frequency fall to 48.6 Hz in the **NGET Transmission Area**, 27.5% of the total **Demand** connected to the **National Electricity Transmission System** in the **NGET Transmission Area** shall be disconnected by the action of **Low Frequency Relays**.

The percentage **Demand** at each stage shall be allocated as far as reasonably practicable. The cumulative total percentage **Demand** is a minimum.

APPENDIX 6 - PERFORMANCE REQUIREMENTS FOR CONTINUOUSLY ACTING AUTOMATIC EXCITATION CONTROL SYSTEMS FOR ONSHORE SYNCHRONOUS GENERATING UNITS

CC.A.6.1 Scope

CC.A.6.1.1 This Appendix sets out the performance requirements of continuously acting automatic excitation control systems for **Onshore Synchronous Generating Units** that must be complied with by the **GB Code User**. This Appendix does not limit any site specific requirements that may be included in a **Bilateral Agreement** where in **The Company's** reasonable opinion these facilities are necessary for system reasons.

CC.A.6.1.2 Where the requirements may vary the likely range of variation is given in this Appendix. It may be necessary to specify values outside this range where **The Company** identifies a system need, and notwithstanding anything to the contrary **The Company** may specify in the **Bilateral Agreement** values outside of the ranges provided in this Appendix 6. The most common variations are in the on-load excitation ceiling voltage requirements and the response time required of the **Exciter**. Actual values will be included in the **Bilateral Agreement**.

CC.A.6.1.3 Should a **GB Generator** anticipate making a change to the excitation control system it shall notify **The Company** under the **Planning Code** (PC.A.1.2(b) and (c)) as soon as the **GB Generator** anticipates making the change. The change may require a revision to the **Bilateral Agreement**.

CC.A.6.2 Requirements

CC.A.6.2.1 The **Excitation System** of an **Onshore Synchronous Generating Unit** shall include an excitation source (**Exciter**), a **Power System Stabiliser** and a continuously acting **Automatic Voltage Regulator (AVR)** and shall meet the following functional specification.

CC.A.6.2.2 In respect of **Onshore Synchronous Generating Units** with a **Completion Date** on or after 1 January 2009, and **Onshore Synchronous Generating Units** with a **Completion Date** before 1 January 2009 subject to a **Modification** to the excitation control facilities where the **Bilateral Agreement** does not specify otherwise, the continuously acting automatic excitation control system shall include a **Power System Stabiliser (PSS)** as a means of supplementary control. The functional specification of the **Power System Stabiliser** is included in CC.A.6.2.5.

CC.A.6.2.3 Steady State Voltage Control

CC.A.6.2.3.1 An accurate steady state control of the **Onshore Generating Unit** pre-set terminal voltage is required. As a measure of the accuracy of the steady-state voltage control, the **Automatic Voltage Regulator** shall have static zero frequency gain, sufficient to limit the change in terminal voltage to a drop not exceeding 0.5% of rated terminal voltage, when the **Onshore Generating Unit** output is gradually changed from zero to rated MVA output at rated voltage, **Active Power** and **Frequency**.

CC.A.6.2.4 Transient Voltage Control

CC.A.6.2.4.1 For a step change from 90% to 100% of the nominal **Onshore Generating Unit** terminal voltage, with the **Onshore Generating Unit** on open circuit, the **Excitation System** response shall have a damped oscillatory characteristic. For this characteristic, the time for the **Onshore Generating Unit** terminal voltage to first reach 100% shall be less than 0.6 seconds. Also, the time to settle within 5% of the voltage change shall be less than 3 seconds.

CC.A.6.2.4.2 To ensure that adequate synchronising power is maintained, when the **Onshore Generating Unit** is subjected to a large voltage disturbance, the **Exciter** whose output is varied by the **Automatic Voltage Regulator** shall be capable of providing its achievable upper and lower limit ceiling voltages to the **Onshore Generating Unit** field in a time not exceeding that specified in the **Bilateral Agreement**. This will normally be not less than 50ms and not greater than 300ms. The achievable upper and lower limit ceiling voltages may be dependent on the voltage disturbance.

- CC.A.6.2.4.3 The **Exciter** shall be capable of attaining an **Excitation System On Load Positive Ceiling Voltage** of not less than a value specified in the **Bilateral Agreement** that will be:
- not less than 2 per unit (pu)
 - normally not greater than 3 pu
 - exceptionally up to 4 pu
- of **Rated Field Voltage** when responding to a sudden drop in voltage of 10 percent or more at the **Onshore Generating Unit** terminals. **The Company** may specify a value outside the above limits where **The Company** identifies a **System** need.
- CC.A.6.2.4.4 If a static type **Exciter** is employed:
- (i) the field voltage should be capable of attaining a negative ceiling level specified in the **Bilateral Agreement** after the removal of the step disturbance of CC.A.6.2.4.3. The specified value will be 80% of the value specified in CC.A.6.2.4.3. **The Company** may specify a value outside the above limits where **The Company** identifies a system need.
 - (ii) the **Exciter** must be capable of maintaining free firing when the **Onshore Generating Unit** terminal voltage is depressed to a level which may be between 20% to 30% of rated terminal voltage
 - (iii) the **Exciter** shall be capable of attaining a positive ceiling voltage not less than 80% of the **Excitation System On Load Positive Ceiling Voltage** upon recovery of the **Onshore Generating Unit** terminal voltage to 80% of rated terminal voltage following fault clearance. **The Company** may specify a value outside the above limits where **The Company** identifies a system need.
 - (iv) The requirement to provide a separate power source for the **Exciter** will be specified in the **Bilateral Agreement** if **The Company**, in coordination with the **Relevant Transmission Licensee**, identifies a **Transmission System** need.
- CC.A.6.2.5 Power Oscillations Damping Control
- CC.A.6.2.5.1 To allow the **Onshore Generating Unit** to maintain second and subsequent swing stability and also to ensure an adequate level of low frequency electrical damping power, the **Automatic Voltage Regulator** shall include a **Power System Stabiliser** as a means of supplementary control.
- CC.A.6.2.5.2 Whatever supplementary control signal is employed, it shall be of the type which operates into the **Automatic Voltage Regulator** to cause the field voltage to act in a manner which results in the damping power being improved while maintaining adequate synchronising power.
- CC.A.6.2.5.3 The arrangements for the supplementary control signal shall ensure that the **Power System Stabiliser** output signal relates only to changes in the supplementary control signal and not the steady state level of the signal. For example, if generator electrical power output is chosen as a supplementary control signal then the **Power System Stabiliser** output should relate only to changes in generator electrical power output and not the steady state level of power output. Additionally the **Power System Stabiliser** should not react to mechanical power changes in isolation for example during rapid changes in steady state load or when providing frequency response.
- CC.A.6.2.5.4 The output signal from the **Power System Stabiliser** shall be limited to not more than $\pm 10\%$ of the **Onshore Generating Unit** terminal voltage signal at the **Automatic Voltage Regulator** input. The gain of the **Power System Stabiliser** shall be such that an increase in the gain by a factor of 3 shall not cause instability.
- CC.A.6.2.5.5 The **Power System Stabiliser** shall include elements that limit the bandwidth of the output signal. The bandwidth limiting must ensure that the highest frequency of response cannot excite torsional oscillations on other plant connected to the network. A bandwidth of 0-5Hz would be judged to be acceptable for this application.

- CC.A.6.2.5.6 The **GB Generator** will agree **Power System Stabiliser** settings with **The Company**, in coordination with the **Relevant Transmission Licensee** prior to the on-load commissioning detailed in BC2.11.2(d). To allow assessment of the performance before on-load commissioning the **GB Generator** will provide to **The Company** a report covering the areas specified in CP.A.3.2.1.
- CC.A.6.2.5.7 The **Power System Stabiliser** must be active within the **Excitation System** at all times when **Synchronised** including when the **Under Excitation Limiter** or **Over Excitation Limiter** are active. When operating at low load when **Synchronising** or **De-Synchronising** an **Onshore Generating Unit**, the **Power System Stabiliser** may be out of service.
- CC.A.6.2.5.8 Where a **Power System Stabiliser** is fitted to a **Pumped Storage Unit** it must function when the **Pumped Storage Unit** is in both generating and pumping modes.
- CC.A.6.2.6 Overall **Excitation System** Control Characteristics
- CC.A.6.2.6.1 The overall **Excitation System** shall include elements that limit the bandwidth of the output signal. The bandwidth limiting must be consistent with the speed of response requirements and ensure that the highest frequency of response cannot excite torsional oscillations on other plant connected to the network. A bandwidth of 0-5 Hz will be judged to be acceptable for this application.
- CC.A.6.2.6.2 The response of the **Automatic Voltage Regulator** combined with the **Power System Stabiliser** shall be demonstrated by injecting similar step signal disturbances into the **Automatic Voltage Regulator** reference as detailed in OC5A.2.2 and OC5.A.2.4. The **Automatic Voltage Regulator** shall include a facility to allow step injections into the **Automatic Voltage Regulator** voltage reference, with the **Onshore Generating Unit** operating at points specified by **The Company** (up to rated MVA output). The damping shall be judged to be adequate if the corresponding **Active Power** response to the disturbances decays within two cycles of oscillation.
- CC.A.6.2.6.3 A facility to inject a band limited random noise signal into the **Automatic Voltage Regulator** voltage reference shall be provided for demonstrating the frequency domain response of the **Power System Stabiliser**. The tuning of the **Power System Stabiliser** shall be judged to be adequate if the corresponding **Active Power** response shows improved damping with the **Power System Stabiliser** in combination with the **Automatic Voltage Regulator** compared with the **Automatic Voltage Regulator** alone over the frequency range 0.3Hz – 2Hz.
- CC.A.6.2.7 Under-Excitation Limiters
- CC.A.6.2.7.1 The security of the power system shall also be safeguarded by means of MVar **Under Excitation Limiters** fitted to the generator **Excitation System**. The **Under Excitation Limiter** shall prevent the **Automatic Voltage Regulator** reducing the generator excitation to a level which would endanger synchronous stability. The **Under Excitation Limiter** shall operate when the excitation system is providing automatic control. The **Under Excitation Limiter** shall respond to changes in the **Active Power** (MW) and the **Reactive Power** (MVar), and to the square of the generator voltage in such a direction that an increase in voltage will permit an increase in leading MVar. The characteristic of the **Under Excitation Limiter** shall be substantially linear from no-load to the maximum **Active Power** output of the **Onshore Generating Unit** at any setting and shall be readily adjustable.
- CC.A.6.2.7.2 The performance of the **Under Excitation Limiter** shall be independent of the rate of change of the **Onshore Generating Unit** load and shall be demonstrated by testing as detailed in OC5.A.2.5. The resulting maximum overshoot in response to a step injection which operates the **Under Excitation Limiter** shall not exceed 4% of the **Onshore Generating Unit** rated MVA. The operating point of the **Onshore Generating Unit** shall be returned to a steady state value at the limit line and the final settling time shall not be greater than 5 seconds. When the step change in **Automatic Voltage Regulator** reference voltage is reversed, the field voltage should begin to respond without any delay and should not be held down by the **Under Excitation Limiter**. Operation into or out of the preset limit levels shall ensure that any resultant oscillations are damped so that the disturbance is within 0.5% of the **Onshore Generating Unit** MVA rating within a period of 5 seconds.

- CC.A.6.2.7.3 The **GB Generator** shall also make provision to prevent the reduction of the **Onshore Generating Unit** excitation to a level which would endanger synchronous stability when the **Excitation System** is under manual control.
- CC.A.6.2.8 Over-Excitation Limiters
- CC.A.6.2.8.1 The settings of the **Over-Excitation Limiter**, where it exists, shall ensure that the **Generating Unit's** excitation is not limited to less than the maximum value that can be achieved whilst ensuring the **Onshore Generating Unit** is operating within its design limits. If the **Generating Unit's** excitation is reduced following a period of operation at a high level, the rate of reduction shall not exceed that required to remain within any time dependent operating characteristics of the **Onshore Generating Unit**.
- CC.A.6.2.8.2 The performance of the **Over-Excitation Limiter**, where it exists, shall be demonstrated by testing as described in OC5.A.2.6. Any operation beyond the **Over-Excitation Limit** shall be controlled by the **Over-Excitation Limiter** without the operation of any **Protection** that could trip the **Onshore Generating Unit**.
- CC.A.6.2.8.3 The **GB Generator** shall also make provision to prevent any over-excitation restriction of the generator when the **Excitation System** is under manual control, other than that necessary to ensure the **Onshore Generating Unit** is operating within its design limits.

APPENDIX 7 - PERFORMANCE REQUIREMENTS FOR CONTINUOUSLY ACTING AUTOMATIC VOLTAGE CONTROL SYSTEMS FOR ONSHORE NON-SYNCHRONOUS GENERATING UNITS, ONSHORE DC CONVERTERS, ONSHORE POWER PARK MODULES AND OTSDUW PLANT AND APPARATUS AT THE INTERFACE POINT

CC.A.7.1 Scope

CC.A.7.1.1 This Appendix sets out the performance requirements of continuously acting automatic voltage control systems for **Onshore Non-Synchronous Generating Units, Onshore DC Converters, Onshore Power Park Modules** and **OTSDUW Plant and Apparatus** at the **Interface Point** that must be complied with by the **GB Code User**. This Appendix does not limit any site specific requirements that may be included in a **Bilateral Agreement** where in **The Company's** reasonable opinion these facilities are necessary for system reasons.

CC.A.7.1.2 Proposals by **GB Generators** to make a change to the voltage control systems are required to be notified to **The Company** under the **Planning Code** (PC.A.1.2(b) and (c)) as soon as the **GB Generator** anticipates making the change. The change may require a revision to the **Bilateral Agreement**.

CC.A.7.2 Requirements

CC.A.7.2.1 **The Company** requires that the continuously acting automatic voltage control system for the **Onshore Non-Synchronous Generating Unit, Onshore DC Converter** or **Onshore Power Park Module** or **OTSDUW Plant and Apparatus** shall meet the following functional performance specification. If a **Network Operator** has confirmed to **The Company** that its network to which an **Embedded Onshore Non-Synchronous Generating Unit, Onshore DC Converter, Onshore Power Park Module** or **OTSDUW Plant and Apparatus** is connected is restricted such that the full reactive range under the steady state voltage control requirements (CC.A.7.2.2) cannot be utilised, **The Company** may specify in the **Bilateral Agreement** alternative limits to the steady state voltage control range that reflect these restrictions. Where the **Network Operator** subsequently notifies **The Company** that such restriction has been removed, **The Company** may propose a **Modification** to the **Bilateral Agreement** (in accordance with the **CUSC** contract) to remove the alternative limits such that the continuously acting automatic voltage control system meets the following functional performance specification. All other requirements of the voltage control system will remain as in this Appendix.

CC.A.7.2.2 Steady State Voltage Control

CC.A.7.2.2.1 The **Onshore Non-Synchronous Generating Unit, Onshore DC Converter, Onshore Power Park Module** or **OTSDUW Plant and Apparatus** shall provide continuous steady state control of the voltage at the **Onshore Grid Entry Point** (or **Onshore User System Entry Point** if **Embedded**) (or the **Interface Point** in the case of **OTSDUW Plant and Apparatus**) with a **Setpoint Voltage** and **Slope** characteristic as illustrated in Figure CC.A.7.2.2a. It should be noted that where the **Reactive Power** capability requirement of a directly connected **Onshore Non-Synchronous Generating Unit, Onshore DC Converter, Onshore Power Park Module** in Scotland, or **OTSDUW Plant and Apparatus** in Scotland as specified in CC.6.3.2 (c), is not at the **Onshore Grid Entry Point** or **Interface Point**, the values of Q_{min} and Q_{max} shown in this figure will be as modified by the 33/132kV or 33/275kV or 33/400kV transformer.

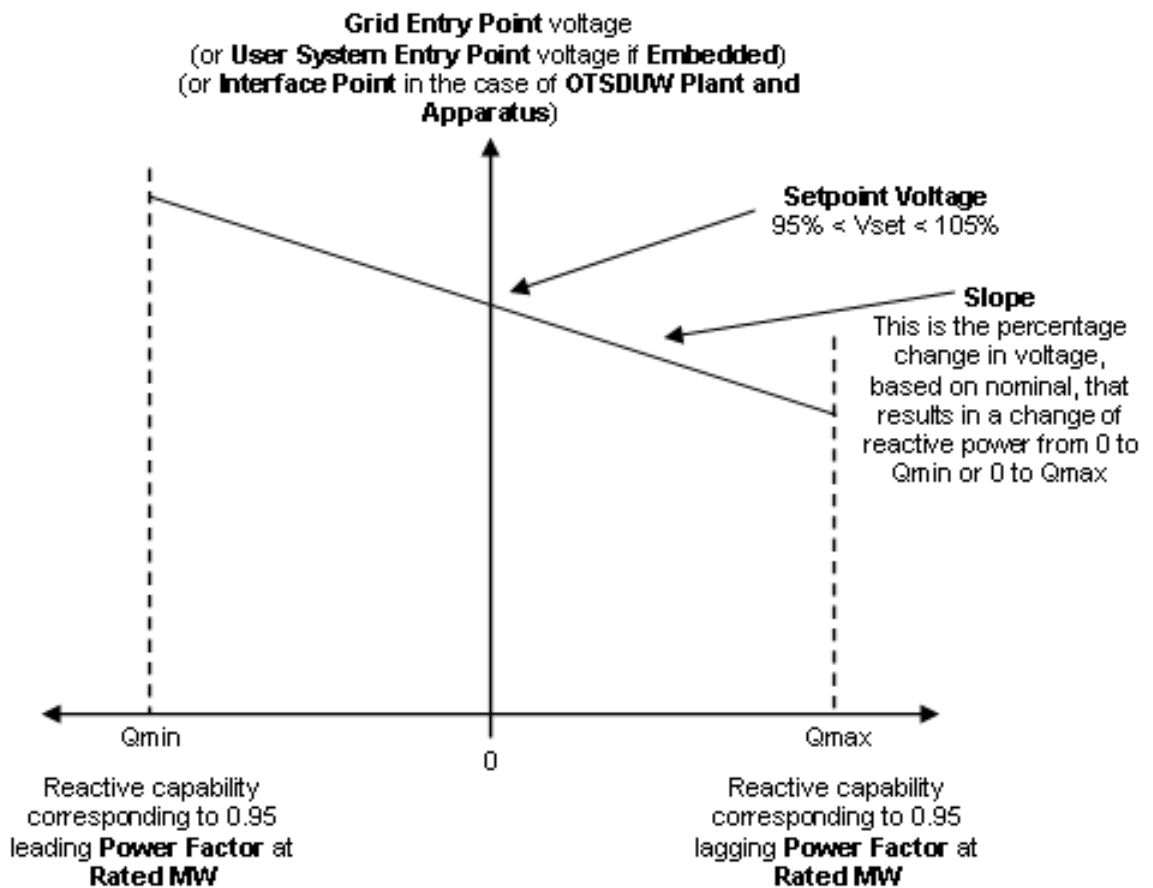

Figure CC.A.7.2.2a

- CC.A.7.2.2.2 The continuously acting automatic control system shall be capable of operating to a **Setpoint Voltage** between 95% and 105% with a resolution of 0.25% of the nominal voltage. For the avoidance of doubt, values of 95%, 95.25%, 95.5% ... may be specified, but not intermediate values. The initial **Setpoint Voltage** will be 100%. The tolerance within which this **Setpoint Voltage** shall be achieved is specified in BC2.A.2.6. For the avoidance of doubt, with a tolerance of 0.25% and a **Setpoint Voltage** of 100%, the achieved value shall be between 99.75% and 100.25%. **The Company** may request the **GB Generator** to implement an alternative **Setpoint Voltage** within the range of 95% to 105%. For **Embedded GB Generators** the **Setpoint Voltage** will be discussed between **The Company** and the relevant **Network Operator** and will be specified to ensure consistency with CC.6.3.4.
- CC.A.7.2.2.3 The **Slope** characteristic of the continuously acting automatic control system shall be adjustable over the range 2% to 7% (with a resolution of 0.5%). For the avoidance of doubt values of 2%, 2.5%, 3% may be specified, but not intermediate values. The initial **Slope** setting will be 4%. The tolerance within which this **Slope** shall be achieved is specified in BC2.A.2.6. For the avoidance of doubt, with a tolerance of 0.5% and a **Slope** setting of 4%, the achieved value shall be between 3.5% and 4.5%. **The Company** may request the **GB Generator** to implement an alternative slope setting within the range of 2% to 7%. For **Embedded GB Generators** the **Slope** setting will be discussed between **The Company** and the relevant **Network Operator** and will be specified to ensure consistency with CC.6.3.4.

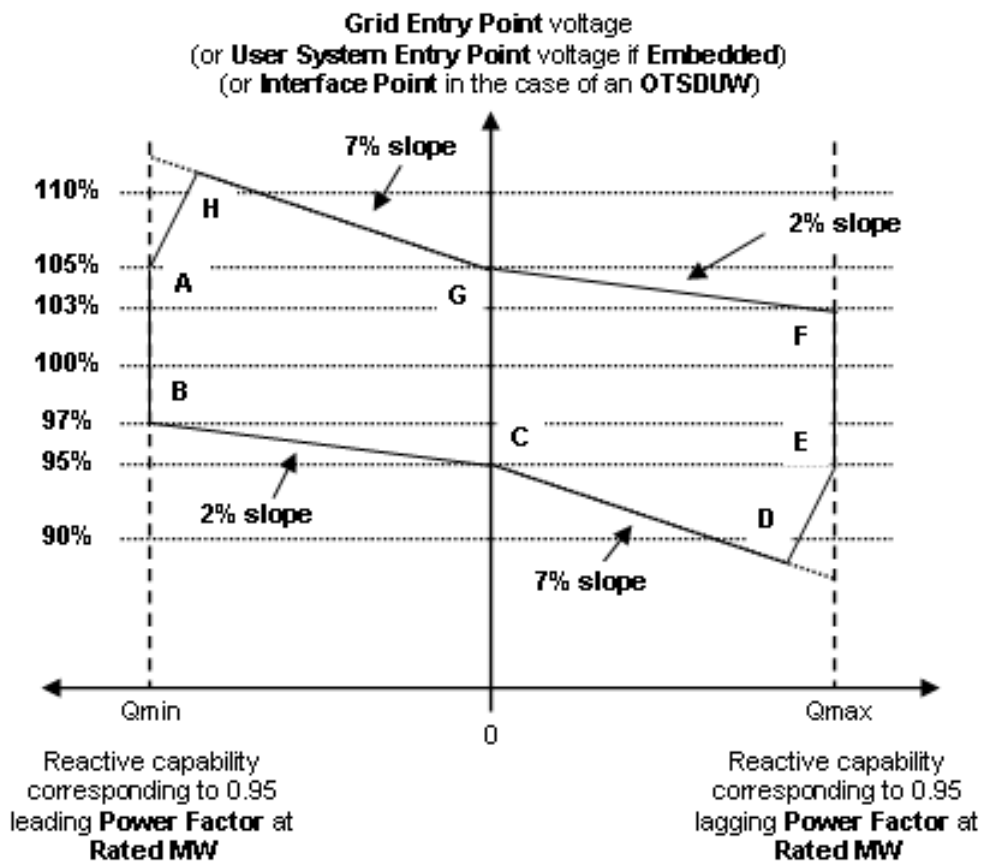

Figure CC.A.7.2.2b

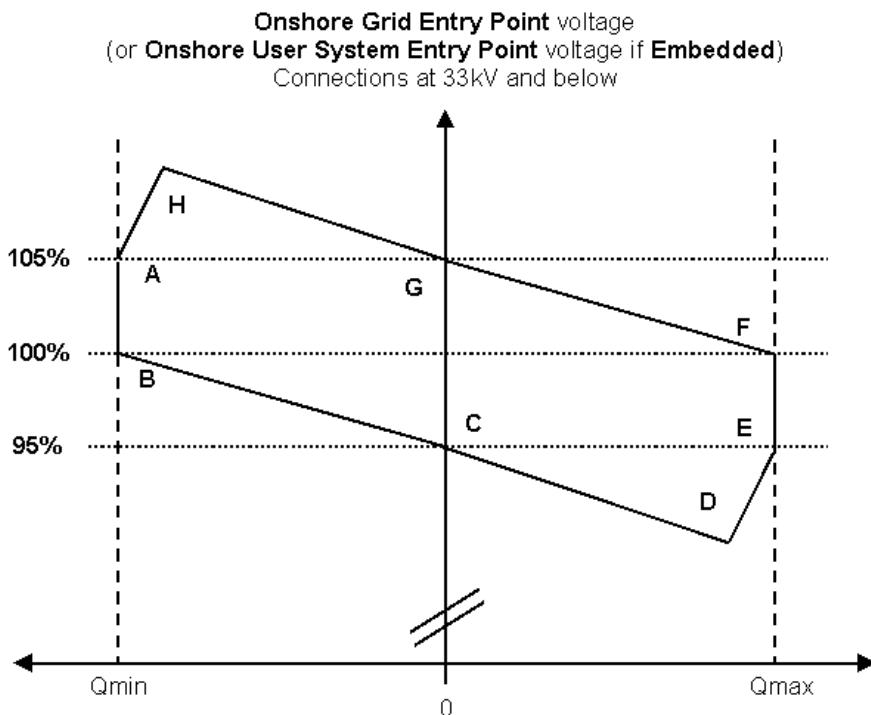
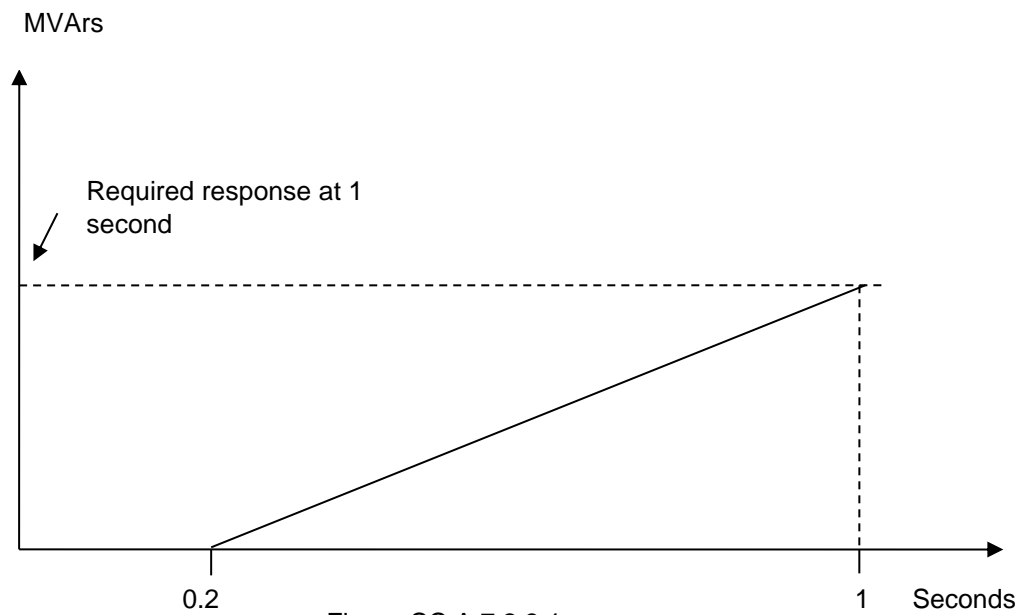

Figure CC.A.7.2.2c

- CC.A.7.2.2.4 Figure CC.A.7.2.2b shows the required envelope of operation for **Onshore Non-Synchronous Generating Units, Onshore DC Converters, OTSDUW Plant and Apparatus** and **Onshore Power Park Modules** except for those **Embedded** at 33kV and below or directly connected to the **National Electricity Transmission System** at 33kV and below. Figure CC.A.7.2.2c shows the required envelope of operation for **Onshore Non-Synchronous Generating Units, Onshore DC Converters** and **Onshore Power Park Modules Embedded** at 33kV and below or directly connected to the **National Electricity Transmission System** at 33kV and below. Where the **Reactive Power** capability requirement of a directly connected **Onshore Non-Synchronous Generating Unit, Onshore DC Converter, OTSDUW Plant and Apparatus** or **Onshore Power Park Module** in Scotland, as specified in CC.6.3.2 (c), is not at the **Onshore Grid Entry Point** or **Interface Point** in the case of **OTSDUW Plant and Apparatus**, the values of Q_{min} and Q_{max} shown in this figure will be as modified by the 33/132kV or 33/275kV or 33/400kV transformer. The enclosed area within points ABCDEFGH is the required capability range within which the **Slope** and **Setpoint Voltage** can be changed.
- CC.A.7.2.2.5 Should the operating point of the **Onshore Non-Synchronous Generating Unit, Onshore DC Converter, OTSDUW Plant and Apparatus** or **Onshore Power Park Module** deviate so that it is no longer a point on the operating characteristic (figure CC.A.7.2.2a) defined by the target **Setpoint Voltage** and **Slope**, the continuously acting automatic voltage control system shall act progressively to return the value to a point on the required characteristic within 5 seconds.
- CC.A.7.2.2.6 Should the **Reactive Power** output of the **Onshore Non-Synchronous Generating Unit, Onshore DC Converter, OTSDUW Plant and Apparatus** or **Onshore Power Park Module** reach its maximum lagging limit at an **Onshore Grid Entry Point** voltage (or **Onshore User System Entry Point** voltage if **Embedded** or **Interface Point** in the case of **OTSDUW Plant and Apparatus**) above 95%, the **Onshore Non-Synchronous Generating Unit, Onshore DC Converter, OTSDUW Plant and Apparatus** or **Onshore Power Park Module** shall maintain maximum lagging **Reactive Power** output for voltage reductions down to 95%. This requirement is indicated by the line EF in figures CC.A.7.2.2b and CC.A.7.2.2c. Should the **Reactive Power** output of the **Onshore Non-Synchronous Generating Unit, Onshore DC Converter, OTSDUW Plant and Apparatus** or **Onshore Power Park Module** reach its maximum leading limit at an **Onshore Grid Entry Point** voltage (or **Onshore User System Entry Point** voltage if **Embedded** or **Interface Point** in the case of **OTSDUW Plant and Apparatus**) below 105%, the **Onshore Non-Synchronous Generating Unit, Onshore DC Converter, OTSDUW Plant and Apparatus** or **Onshore Power Park Module** shall maintain maximum leading **Reactive Power** output for voltage increases up to 105%. This requirement is indicated by the line AB in figures CC.A.7.2.2b and CC.A.7.2.2c.

- CC.A.7.2.2.7 For **Onshore Grid Entry Point** voltages (or **Onshore User System Entry Point** voltages if Embedded or **Interface Point** voltages) below 95%, the lagging **Reactive Power** capability of the **Onshore Non-Synchronous Generating Unit, Onshore DC Converter, OTSDUW Plant and Apparatus** or **Onshore Power Park Module** should be that which results from the supply of maximum lagging reactive current whilst ensuring the current remains within design operating limits. An example of the capability is shown by the line DE in figures CC.A.7.2.2b and CC.A.7.2.2c. For **Onshore Grid Entry Point** voltages (or **User System Entry Point** voltages if **Embedded** or **Interface Point** voltages) above 105%, the leading **Reactive Power** capability of the **Onshore Non-Synchronous Generating Unit, Onshore DC Converter, OTSDUW Plant and Apparatus** or **Onshore Power Park Module** should be that which results from the supply of maximum leading reactive current whilst ensuring the current remains within design operating limits. An example of the capability is shown by the line AH in figures CC.A.7.2.2b and CC.A.7.2.2c. Should the **Reactive Power** output of the **Onshore Non-Synchronous Generating Unit, Onshore DC Converter, OTSDUW Plant and Apparatus** or **Onshore Power Park Module** reach its maximum lagging limit at an **Onshore Grid Entry Point** voltage (or **Onshore User System Entry Point** voltage if **Embedded** or **Interface Point** in the case of **OTSDUW Plant and Apparatus**) below 95%, the **Onshore Non-Synchronous Generating Unit, Onshore DC Converter** or **Onshore Power Park Module** shall maintain maximum lagging reactive current output for further voltage decreases. Should the **Reactive Power** output of the **Onshore Non-Synchronous Generating Unit, Onshore DC Converter, OTSDUW Plant and Apparatus** or **Onshore Power Park Module** reach its maximum leading limit at a **Onshore Grid Entry Point** voltage (or **User System Entry Point** voltage if **Embedded** or **Interface Point** voltage in the case of an **OTSDUW Plant and Apparatus**) above 105%, the **Onshore Non-Synchronous Generating Unit, Onshore DC Converter, OTSDUW Plant and Apparatus** or **Onshore Power Park Module** shall maintain maximum leading reactive current output for further voltage increases.
- CC.A.7.2.2.8 All **OTSDUW Plant and Apparatus** must be capable of enabling **GB Code Users** undertaking **OTSDUW** to comply with an instruction received from **The Company** relating to a variation of the **Setpoint Voltage** at the **Interface Point** within 2 minutes of such instruction being received.
- CC.A.7.2.2.9 For **OTSDUW Plant and Apparatus** connected to a **Network Operator's System** where the **Network Operator** has confirmed to **The Company** that its **System** is restricted in accordance with CC.A.7.2.1, clause CC.A.7.2.2.8 will not apply unless **The Company** can reasonably demonstrate that the magnitude of the available change in **Reactive Power** has a significant effect on voltage levels on the **Onshore National Electricity Transmission System**.
- CC.A.7.2.3 Transient Voltage Control
- CC.A.7.2.3.1 For an on-load step change in **Onshore Grid Entry Point** or **Onshore User System Entry Point** voltage, or in the case of **OTSDUW Plant and Apparatus** an on-load step change in **Transmission Interface Point** voltage, the continuously acting automatic control system shall respond according to the following minimum criteria:
- (i) the **Reactive Power** output response of the **Onshore Non-Synchronous Generating Unit, Onshore DC Converter, OTSDUW Plant and Apparatus** or **Onshore Power Park Module** shall commence within 0.2 seconds of the application of the step. It shall progress linearly although variations from a linear characteristic shall be acceptable provided that the MVar seconds delivered at any time up to 1 second are at least those that would result from the response shown in figure CC.A.7.2.3.1a.
 - (ii) the response shall be such that 90% of the change in the **Reactive Power** output of the **Onshore Non-Synchronous Generating Unit, Onshore DC Converter, OTSDUW Plant and Apparatus** or **Onshore Power Park Module**, will be achieved within
 - 1 second, where the step is sufficiently large to require a change in the steady state **Reactive Power** output from zero to its maximum leading value or maximum lagging value, as required by CC.6.3.2 (or, if appropriate, CC.A.7.2.2.6 or CC.A.7.2.2.7); and

- 2 seconds, for **Plant and Apparatus** installed on or after 1 December 2017, where the step is sufficiently large to require a change in the steady state **Reactive Power** output from its maximum leading value to its maximum lagging value or vice versa.
- (iii) the magnitude of the **Reactive Power** output response produced within 1 second shall vary linearly in proportion to the magnitude of the step change.
- (iv) within 2 seconds from achieving 90% of the response as defined in CC.A.7.2.3.1 (ii), the peak to peak magnitude of any oscillations shall be less than 5% of the change in steady state **Reactive Power**.
- (v) following the transient response, the conditions of CC.A.7.2.2 apply.



CC.A.7.2.3.2 An **Onshore Non-Synchronous Generating Unit, Onshore DC Converter, OTSDUW Plant and Apparatus** or **Onshore Power Park Module** installed on or after 1 December 2017 shall be capable of;

- (a) changing its **Reactive Power** output from its maximum lagging value to its maximum leading value, or vice versa, then reverting back to the initial level of **Reactive Power** output once every 15 seconds for at least 5 times within any 5 minute period; and
- (b) changing its **Reactive Power** output from zero to its maximum leading value then reverting back to zero **Reactive Power** output at least 25 times within any 24 hour period and from zero to its maximum lagging value then reverting back to zero **Reactive Power** output at least 25 times within any 24 hour period. Any subsequent restriction on reactive capability shall be notified to **The Company** in accordance with BC2.5.3.2, and BC2.6.1.

In all cases, the response shall be in accordance to CC.A.7.2.3.1 where the change in **Reactive Power** output is in response to an on-load step change in **Onshore Grid Entry Point** or **Onshore User System Entry Point** voltage, or in the case of **OTSDUW Plant and Apparatus** an on-load step change in **Transmission Interface Point** voltage.

CC.A.7.2.4 Power Oscillation Damping

- CC.A.7.2.4.1 The requirement for the continuously acting voltage control system to be fitted with a **Power System Stabiliser (PSS)** shall be specified in the **Bilateral Agreement** if, in **The Company's** view, this is required for system reasons. However if a **Power System Stabiliser** is included in the voltage control system its settings and performance shall be agreed with **The Company** and commissioned in accordance with BC2.11.2. To allow assessment of the performance before on-load commissioning the **GB Generator** will provide to **The Company** a report covering the areas specified in CP.A.3.2.2.
- CC.A.7.2.5 Overall Voltage Control System Characteristics
- CC.A.7.2.5.1 The continuously acting automatic voltage control system is required to respond to minor variations, steps, gradual changes or major variations in **Onshore Grid Entry Point** voltage (or **Onshore User System Entry Point** voltage if **Embedded** or **Interface Point** voltage in the case of **OTSDUW Plant and Apparatus**).
- CC.A.7.2.5.2 The overall voltage control system shall include elements that limit the bandwidth of the output signal. The bandwidth limiting must be consistent with the speed of response requirements and ensure that the highest frequency of response cannot excite torsional oscillations on other plant connected to the network. A bandwidth of 0-5Hz would be judged to be acceptable for this application. All other control systems employed within the **Onshore Non-Synchronous Generating Unit, Onshore DC Converter, OTSDUW Plant and Apparatus** or **Onshore Power Park Module** should also meet this requirement
- CC.A.7.2.5.3 The response of the voltage control system (including the **Power System Stabiliser** if employed) shall be demonstrated by testing in accordance with OC5A.A.3.

< END OF CONNECTION CONDITIONS

EUROPEAN CONNECTION CONDITIONS

(ECC)

CONTENTS

(This contents page does not form part of the Grid Code)

<u>Paragraph No/Title</u>	<u>Page Number</u>
ECC.1 INTRODUCTION	2
ECC.2 OBJECTIVE	3
ECC.3 SCOPE	3
ECC.4 PROCEDURE	5
ECC.5 CONNECTION.....	5
ECC.6 TECHNICAL, DESIGN AND OPERATIONAL CRITERIA	7
ECC.7 SITE RELATED CONDITIONS.....	86
ECC.8 ANCILLARY SERVICES.....	92
APPENDIX E1 - SITE RESPONSIBILITY SCHEDULES.....	94
PROFORMA FOR SITE RESPONSIBILITY SCHEDULE	97
APPENDIX E2 - OPERATION DIAGRAMS	103
PART 1A - PROCEDURES RELATING TO OPERATION DIAGRAMS	103
PART E1B - PROCEDURES RELATING TO GAS ZONE DIAGRAMS.....	106
PART E2 - NON-EXHAUSTIVE LIST OF APPARATUS TO BE INCLUDED ON OPERATION DIAGRAMS.....	107
APPENDIX E3 - MINIMUM FREQUENCY RESPONSE CAPABILITY REQUIREMENT PROFILE AND OPERATING RANGE FOR POWER GENERATING MODULES AND HVDC EQUIPMENT	109
APPENDIX 4 - FAULT RIDE THROUGH REQUIREMENTS.....	115
APPENDIX E5 - TECHNICAL REQUIREMENTS LOW FREQUENCY RELAYS FOR THE AUTOMATIC DISCONNECTION OF SUPPLIES AT LOW FREQUENCY	121
APPENDIX E6 - PERFORMANCE REQUIREMENTS FOR CONTINUOUSLY ACTING AUTOMATIC EXCITATION CONTROL SYSTEMS FOR ONSHORE SYNCHRONOUS GENERATING UNITS....	124
APPENDIX E7 - PERFORMANCE REQUIREMENTS FOR CONTINUOUSLY ACTING AUTOMATIC VOLTAGE CONTROL SYSTEMS FOR ONSHORE NON-SYNCHRONOUS GENERATING UNITS, ONSHORE DC CONVERTERS, ONSHORE POWER PARK MODULES AND OTSDUW PLANT AND APPARATUS AT THE INTERFACE POINT	128
APPENDIX E8 - PERFORMANCE REQUIREMENTS FOR CONTINUOUSLY ACTING AUTOMATIC VOLTAGE CONTROL SYSTEMS FOR CONFIGURATION 2 AC CONNECTED OFFSHORE POWER PARK MODULES AND CONFIGURATION 2 DC CONNECTED POWER PARK MODULES	135

ECC.1

INTRODUCTION

ECC.1.1

The **European Connection Conditions** ("**ECC**") specify both:

- (a) the minimum technical, design and operational criteria which must be complied with by:
 - (i) any **EU Code User** connected to or seeking connection with the **National Electricity Transmission System**, or
 - (ii) **EU Generators** or **HVDC System Owners** connected to or seeking connection to a **User's System** which is located in **Great Britain** or **Offshore**, or
 - (iii) **Network Operators** who are **EU Code Users**
 - (iv) **Network Operators** who are **GB Code Users** but only in respect of:-
 - (a) Their obligations in respect of **Embedded Medium Power Stations** not subject to a **Bilateral Agreement** for whom the requirements of ECC.3.1(b)(iii) apply alone; and/or
 - (b) The requirements of this **ECC** only in relation to each **EU Grid Supply Point. Network Operators** in respect of all other **Grid Supply Points** should continue to satisfy the requirements as specified in the **CCs**.
 - (v) **Non-Embedded Customers** who are **EU Code Users**
- (b) the minimum technical, design and operational criteria with which **The Company** will comply in relation to the part of the **National Electricity Transmission System** at the **Connection Site** with **Users**. In the case of any **OTSDUW Plant and Apparatus**, the **ECC** also specify the minimum technical, design and operational criteria which must be complied with by the **User** when undertaking **OTSDUW**.
- (c) The requirements of **Retained EU Law** (Commission Regulation (EU) 2016/631) shall not apply to
 - (i) **Power Generating Modules** that are installed to provide backup power and operate in parallel with the **Total System** for less than 5 minutes per calendar month while the **System** is in normal state. Parallel operation during maintenance or commissioning of tests of that **Power Generating Module** shall not count towards that five minute limit.
 - (ii) **Power Generating Modules** connected to the **Transmission System** or **Network Operators System** which are not operated in synchronism with a **Synchronous Area**.
 - (iii) **Power Generating Modules** that do not have a permanent **Connection Point** or **User System Entry Point** and used by **The Company** to temporarily provide power when normal **System** capacity is partly or completely unavailable.
 - (iv) **Electricity Storage Modules**.
- (d) **Storage Users** are required to comply with the entirety of the **ECC** but are not subject to the requirements of **Retained EU Law** (Commission Regulation (EU) 2016/631, Commission Regulation (EU) 2016/1388 and Commission Regulation (EU) 2016/1485). The requirements of the **ECC** shall therefore be enforceable against **Storage Users** under the Grid Code only (and not under any of the aforementioned **Retained EU Law**) and any derogation sought by a **Storage User** in respect of the **ECC** shall be deemed a derogation from the Grid Code only (and not from the aforementioned **Retained EU Law**).

ECC.2 OBJECTIVE

ECC.2.1 The objective of the **ECC** is to ensure that by specifying minimum technical, design and operational criteria the basic rules for connection to the **National Electricity Transmission System** and (for certain **Users**) to a **User's System** are similar for all **Users** of an equivalent category and will enable **The Company** to comply with its statutory and **Transmission Licence** obligations and the applicable **Retained EU Law**.

ECC.2.2 In the case of any **OTSDUW** the objective of the **ECC** is to ensure that by specifying the minimum technical, design and operational criteria the basic rules relating to an **Offshore Transmission System** designed and constructed by an **Offshore Transmission Licensee** and designed and/or constructed by a **User** under the **OTSDUW Arrangements** are equivalent.

ECC.2.3 Provisions of the **ECC** which apply in relation to **OTSDUW** and **OTSUA**, and/or a **Transmission Interface Site**, shall (in any particular case) apply up to the **OTSUA Transfer Time**, whereupon such provisions shall (without prejudice to any prior non-compliance) cease to apply, without prejudice to the continuing application of provisions of the **ECC** applying in relation to the relevant **Offshore Transmission System** and/or **Connection Site**. It is the case therefore that in cases where the **OTSUA** becomes operational prior to the **OTSUA Transfer Time** that a **EU Generator** is required to comply with this **ECC** both as it applies to its **Plant** and **Apparatus** at a **Connection Site/Connection Point** and the **OTSUA** at the **Transmission Interface Site/Transmission Interface Point** until the **OTSUA Transfer Time** and this **ECC** shall be construed accordingly.

ECC.2.4 In relation to **OTSDUW**, provisions otherwise to be contained in a **Bilateral Agreement** may be contained in the **Construction Agreement**, and accordingly a reference in the **ECC** to a relevant **Bilateral Agreement** includes the relevant **Construction Agreement**.

ECC.3 SCOPE

ECC.3.1 The **ECC** applies to **The Company** and to **Users**, which in the **ECC** means:

- (a) **EU Generators** (other than those which only have **Embedded Small Power Stations**), including those undertaking **OTSDUW** including **Power Generating Modules**, and **DC Connected Power Park Modules**. For the avoidance of doubt, **Electricity Storage Modules** are included within the definition of **Power Generating Modules** for which the requirements of the **ECC** would be equally applicable.
- (b) **Network Operators** but only in respect of:-
 - (i) **Network Operators** who are **EU Code Users**
 - (ii) **Network Operators** who only have **EU Grid Supply Points**
 - (iii) **Embedded Medium Power Stations** not subject to a **Bilateral Agreement** as provided for in ECC.3.2, ECC.3.3, EC3.4, EC3.5, ECC5.1, ECC.6.4.4 and ECA.3.4;
 - (iv) Notwithstanding the requirements of ECC3.1(b)(i)(ii) and (iii) , **Network Operators** who own and/or operate **EU Grid Supply Points**, are only required to satisfy the requirements of this **ECC** in relation to each **EU Grid Supply Point**. **Network Operators** in respect of all other **Grid Supply Points** should continue to satisfy the requirements as specified in the **CCs**.
- (c) **Non-Embedded Customers** who are also **EU Code Users** ;
- (d) **HVDC System Owners** who are also **EU Code Users**; and
- (e) **BM Participants** and **Externally Interconnected System Operators** who are also **EU Code Users** in respect of ECC.6.5, ECC.7.9 and ECC.7.10 only.

ECC.3.2 The above categories of **User** will become bound by the applicable sections of the **ECC** prior to them generating, distributing, storing, supplying or consuming, as the case may be, and references to the various categories should, therefore, be taken as referring to them in that prospective role.

ECC.3.3 **Embedded Medium Power Stations** not subject to a **Bilateral Agreement** and **Embedded HVDC Systems** not subject to a **Bilateral Agreement** Provisions.

The following provisions apply in respect of **Embedded Medium Power Stations** not subject to a **Bilateral Agreement** and **Embedded HVDC Systems** not subject to a **Bilateral Agreement**.

ECC.3.3.1 The obligations within the **ECC** that are expressed to be applicable to **EU Generators** in respect of **Embedded Medium Power Stations** not subject to a **Bilateral Agreement** and **HVDC System Owners** in respect of **Embedded HVDC Systems** not subject to a **Bilateral Agreement** (where the obligations are in each case listed in ECC.3.3.2) shall be read and construed as obligations that the **Network Operator** within whose **System** any such **Medium Power Station** or **HVDC System** is **Embedded** must ensure are performed and discharged by the **EU Generator** or the **HVDC Owner**. **Embedded Medium Power Stations** not subject to a **Bilateral Agreement** and **Embedded HVDC Systems** not subject to a **Bilateral Agreement** which are located **Offshore** and which are connected to an **Onshore User System** will be required to meet the applicable requirements of the Grid Code as though they are an **Onshore Generator** or **Onshore HVDC System Owner** connected to an **Onshore User System Entry Point**.

ECC.3.3.2 The **Network Operator** within whose **System** a **Medium Power Station** not subject to a **Bilateral Agreement** is **Embedded** or a **HVDC System** not subject to a **Bilateral Agreement** is **Embedded** must ensure that the following obligations in the **ECC** are performed and discharged by the **EU Generator** in respect of each such **Embedded Medium Power Station** or the **HVDC System Owner** in the case of an **Embedded HVDC System**:

ECC.5.1

ECC.5.2.2

ECC.5.3

ECC.6.1.3

ECC.6.1.5 (b)

ECC.6.3.2, ECC.6.3.3, ECC.6.3.4, ECC.6.3.6, ECC.6.3.7, ECC.6.3.8, ECC.6.3.9, ECC.6.3.10, ECC.6.3.12, ECC.6.3.13, ECC.6.3.15, ECC.6.3.16

ECC.6.4.4

ECC.6.5.6 (where required by ECC.6.4.4)

In respect of ECC.6.2.2.2, ECC.6.2.2.3, ECC.6.2.2.5, ECC.6.1.5(a), ECC.6.1.5(b) and ECC.6.3.11 equivalent provisions as co-ordinated and agreed with the **Network Operator** and **EU Generator** or **HVDC System Owner** may be required. Details of any such requirements will be notified to the **Network Operator** in accordance with ECC.3.5.

ECC.3.3.3 In the case of **Embedded Medium Power Stations** not subject to a **Bilateral Agreement** and **Embedded HVDC Systems** not subject to a **Bilateral Agreement** the requirements in:

ECC.6.1.6

ECC.6.3.8

ECC.6.3.12

ECC.6.3.15

ECC.6.3.16

ECC.6.3.17

that would otherwise have been specified in a **Bilateral Agreement** will be notified to the relevant **Network Operator** in writing in accordance with the provisions of the **CUSC** and the **Network Operator** must ensure such requirements are performed and discharged by the **Generator** or the **HVDC System** owner.

ECC.3.4 In the case of **Offshore Embedded Power Generating Modules** connected to an **Offshore User's System** which directly connects to an **Offshore Transmission System**, any additional requirements in respect of such **Offshore Embedded Power Generating Modules** may be specified in the relevant **Bilateral Agreement** with the **Network Operator** or in any **Bilateral Agreement** between **The Company** and such **Offshore Generator**.

ECC.3.5 In the case of a **Generator** undertaking **OTSDUW** connecting to an **Onshore Network Operator's System**, any additional requirements in respect of such **OTSDUW Plant and Apparatus** will be specified in the relevant **Bilateral Agreement** with the **EU Generator**. For the avoidance of doubt, requirements applicable to **EU Generators** undertaking **OTSDUW** and connecting to a **Network Operator's User System**, shall be consistent with those applicable requirements of **Generators** undertaking **OTSDUW** and connecting to a **Transmission Interface Point**.

ECC.3.6 The requirements of this **ECC** shall apply to **EU Code Users** in respect of **Power Generating Modules** (including **DC Connected Power Park Modules** and **Electricity Storage Modules**) and **HVDC Systems**.

ECC.4 PROCEDURE

ECC.4.1 The **CUSC** contains certain provisions relating to the procedure for connection to the **National Electricity Transmission System** or, in the case of **Embedded Power Stations** or **Embedded HVDC Systems**, becoming operational and includes provisions relating to certain conditions to be complied with by **EU Code Users** prior to and during the course of **The Company** notifying the **User** that it has the right to become operational. The procedure for an **EU Code User** to become connected is set out in the **Compliance Processes**.

ECC.5 CONNECTION

ECC.5.1 The provisions relating to connecting to the **National Electricity Transmission System** (or to a **User's System** in the case of a connection of an **Embedded Large Power Station** or **Embedded Medium Power Stations** or **Embedded HVDC System**) are contained in:

- (a) the **CUSC** and/or **CUSC Contract** (or in the relevant application form or offer for a **CUSC Contract**);
- (b) or, in the case of an **Embedded Development**, the relevant **Distribution Code** and/or the **Embedded Development Agreement** for the connection (or in the relevant application form or offer for an **Embedded Development Agreement**),

and include provisions relating to both the submission of information and reports relating to compliance with the relevant **European Connection Conditions** for that **EU Code User**, **Safety Rules**, commissioning programmes, **Operation Diagrams** and approval to connect (and their equivalents in the case of **Embedded Medium Power Stations** not subject to a **Bilateral Agreement** or **Embedded HVDC Systems** not subject to a **Bilateral Agreement**). References in the **ECC** to the "**Bilateral Agreement**" and/or "**Construction Agreement**" and/or "**Embedded Development Agreement**" shall be deemed to include references to the application form or offer therefor.

ECC.5.2 Items For Submission

ECC.5.2.1

Prior to the **Completion Date** (or, where the **EU Generator** is undertaking **OTSDUW**, any later date specified) under the **Bilateral Agreement** and/or **Construction Agreement**, the following is submitted pursuant to the terms of the **Bilateral Agreement** and/or **Construction Agreement**:

- (a) updated **Planning Code** data (both **Standard Planning Data** and **Detailed Planning Data**), with any estimated values assumed for planning purposes confirmed or, where practical, replaced by validated actual values and by updated estimates for the future and by updated forecasts for **Forecast Data** items such as **Demand**, pursuant to the requirements of the **Planning Code**;
- (b) details of the **Protection** arrangements and settings referred to in ECC.6;
- (c) copies of all **Safety Rules** and **Local Safety Instructions** applicable at **Users' Sites** which will be used at the **Transmission/User** interface (which, for the purpose of **OC8**, must be to **The Company's** satisfaction regarding the procedures for **Isolation** and **Earthing**. **The Company** will consult the **Relevant Transmission Licensee** when determining whether the procedures for **Isolation** and **Earthing** are satisfactory);
- (d) information to enable the preparation of the **Site Responsibility Schedules** on the basis of the provisions set out in Appendix 1;
- (e) an **Operation Diagram** for all **HV Apparatus** on the **User** side of the **Connection Point** as described in ECC.7;
- (f) the proposed name of the **User Site** (which shall not be the same as, or confusingly similar to, the name of any **Transmission Site** or of any other **User Site**);
- (g) written confirmation that **Safety Co-ordinators** acting on behalf of the **User** are authorised and competent pursuant to the requirements of **OC8**;
- (h) Such **RISSP** prefixes pursuant to the requirements of **OC8**. Such **RISSP** prefixes shall be circulated utilising a proforma in accordance with **OC8**;
- (i) a list of the telephone numbers for **Joint System Incidents** at which senior management representatives nominated for the purpose can be contacted and confirmation that they are fully authorised to make binding decisions on behalf of the **User**, pursuant to **OC9**;
- (j) a list of managers who have been duly authorised to sign **Site Responsibility Schedules** on behalf of the **User**;
- (k) information to enable the preparation of the **Site Common Drawings** as described in ECC.7;
- (l) a list of the telephone numbers for the **Users** facsimile machines referred to in ECC.6.5.9; and
- (m) for **Sites** in Scotland and **Offshore** a list of persons appointed by the **User** to undertake operational duties on the **User's System** (including any **OTSDUW** prior to the **OTSUA Transfer Time**) and to issue and receive operational messages and instructions in relation to the **User's System** (including any **OTSDUW** prior to the **OTSUA Transfer Time**); and an appointed person or persons responsible for the maintenance and testing of **User's Plant** and **Apparatus**.

ECC.5.2.2

Prior to the **Completion Date** the following must be submitted to **The Company** by the **Network Operator** in respect of an **Embedded Development**:

- (a) updated **Planning Code** data (both **Standard Planning Data** and **Detailed Planning Data**), with any estimated values assumed for planning purposes confirmed or, where practical, replaced by validated actual values and by updated estimates for the future and by updated forecasts for **Forecast Data** items such as **Demand**, pursuant to the requirements of the **Planning Code**;
- (b) details of the **Protection** arrangements and settings referred to in ECC.6;

- (c) the proposed name of the **Embedded Medium Power Station** or **Embedded HVDC System** (which shall be agreed with **The Company** unless it is the same as, or confusingly similar to, the name of other **Transmission Site** or **User Site**);
- ECC.5.2.3 Prior to the **Completion Date** contained within an **Offshore Transmission Distribution Connection Agreement** the following must be submitted to **The Company** by the **Network Operator** in respect of a proposed new **Interface Point** within its **User System**:
- (a) updated **Planning Code** data (both **Standard Planning Data** and **Detailed Planning Data**), with any estimated values assumed for planning purposes confirmed or, where practical, replaced by validated actual values and by updated estimates for the future and by updated forecasts for **Forecast Data** items such as **Demand**, pursuant to the requirements of the **Planning Code**;
- (b) details of the **Protection** arrangements and settings referred to in ECC.6;
- (c) the proposed name of the **Interface Point** (which shall not be the same as, or confusingly similar to, the name of any **Transmission Site** or of any other **User Site**);
- ECC.5.2.4 In the case of **OTSDUW Plant and Apparatus** (in addition to items under ECC.5.2.1 in respect of the **Connection Site**), prior to the **Completion Date** (or any later date specified) under the **Construction Agreement** the following must be submitted to **The Company** by the **User** in respect of the proposed new **Connection Point** and **Interface Point**:
- (a) updated **Planning Code** data (**Standard Planning Data**, **Detailed Planning Data** and **OTSDUW Data and Information**), with any estimated values assumed for planning purposes confirmed or, where practical, replaced by validated actual values and by updated estimates for the future and by updated forecasts for **Forecast Data** items such as **Demand**, pursuant to the requirements of the **Planning Code**;
- (b) details of the **Protection** arrangements and settings referred to in ECC.6;
- (c) information to enable preparation of the **Site Responsibility Schedules** at the **Transmission Interface Site** on the basis of the provisions set out in Appendix E1.
- (d) the proposed name of the **Interface Point** (which shall not be the same as, or confusingly similar to, the name of any **Transmission Site** or of any other **User Site**);
- ECC.5.3
- (a) Of the items ECC.5.2.1 (c), (e), (g), (h), (k) and (m) need not be supplied in respect of **Embedded Power Stations** or **Embedded HVDC Systems**,
- (b) item ECC.5.2.1(i) need not be supplied in respect of **Embedded Small Power Stations** and **Embedded Medium Power Stations** or **Embedded HVDC Systems** with a **Registered Capacity** of less than 100MW, and
- (c) items ECC.5.2.1(d) and (j) are only needed in the case where the **Embedded Power Station** or the **Embedded HVDC System** is within a **Connection Site** with another **User**.

ECC.6 TECHNICAL, DESIGN AND OPERATIONAL CRITERIA

ECC.6.1 National Electricity Transmission System Performance Characteristics

ECC.6.1.1 **The Company** shall ensure that, subject as provided in the **Grid Code**, the **National Electricity Transmission System** complies with the following technical, design and operational criteria in relation to the part of the **National Electricity Transmission System** at the **Connection Site** with a **User** and in the case of **OTSDUW Plant and Apparatus**, a **Transmission Interface Point** (unless otherwise specified in ECC.6) although in relation to operational criteria **The Company** may be unable (and will not be required) to comply with this obligation to the extent that there are insufficient **Power Stations** or **User Systems** are not available or **Users** do not comply with **The Company's** instructions or otherwise do not comply with the **Grid Code** and each **User** shall ensure that its **Plant** and **Apparatus** complies with the criteria set out in ECC.6.1.5.

ECC.6.1.2 Grid Frequency Variations

ECC.6.1.2.1 Grid Frequency Variations

ECC.6.1.2.1.1 The **Frequency** of the **National Electricity Transmission System** shall be nominally 50Hz and shall be controlled within the limits of 49.5 - 50.5Hz unless exceptional circumstances prevail.

ECC.6.1.2.1.2 The **System Frequency** could rise to 52Hz or fall to 47Hz in exceptional circumstances. Design of **User's Plant and Apparatus** and **OTSDUW Plant and Apparatus** must enable operation of that **Plant and Apparatus** within that range in accordance with the following:

<u>Frequency Range</u>	<u>Requirement</u>
51.5Hz - 52Hz	Operation for a period of at least 15 minutes is required each time the Frequency is above 51.5Hz.
51Hz - 51.5Hz	Operation for a period of at least 90 minutes is required each time the Frequency is above 51Hz.
49.0Hz - 51Hz	Continuous operation is required
47.5Hz - 49.0Hz	Operation for a period of at least 90 minutes is required each time the Frequency is below 49.0Hz.
47Hz - 47.5Hz	Operation for a period of at least 20 seconds is required each time the Frequency is below 47.5Hz.

ECC.6.1.2.1.3 For the avoidance of doubt, disconnection, by frequency or speed based relays is not permitted within the frequency range 47.5Hz to 51.5Hz. **EU Generators** should however be aware of the combined voltage and frequency operating ranges as defined in ECC.6.3.12 and ECC.6.3.13.

ECC.6.1.2.1.4 **The Company** in co-ordination with the **Relevant Transmission Licensee** and/or **Network Operator** and a **User** may agree on wider variations in frequency or longer minimum operating times to those set out in ECC.6.1.2.1.2 or specific requirements for combined frequency and voltage deviations. Any such requirements in relation to **Power Generating Modules** shall be in accordance with ECC.6.3.12 and ECC.6.3.13. A **User** shall not unreasonably withhold consent to apply wider frequency ranges or longer minimum times for operation taking account of their economic and technical feasibility.

ECC.6.1.2.2 Grid Frequency variations for HVDC Systems and Remote End HVDC Converter Stations

ECC.6.1.2.2.1 **HVDC Systems** and **Remote End HVDC Converter Stations** shall be capable of staying connected to the **System** and remaining operable within the frequency ranges and time periods specified in Table ECC.6.1.2.2 below. This requirement shall continue to apply during the **Fault Ride Through** conditions defined in ECC.6.3.15

Frequency Range (Hz)	Time Period for Operation (s)
47.0 – 47.5Hz	60 seconds
47.5 – 49.0Hz	90 minutes and 30 seconds
49.0 – 51.0Hz	Unlimited
51.0 – 51.5Hz	90 minutes and 30 seconds
51.5Hz – 52 Hz	20 minutes

Table ECC.6.1.2.2 – Minimum time periods **HVDC Systems** and **Remote End HVDC Converter Stations** shall be able to operate for different frequencies deviating from a nominal value without disconnecting from the **National Electricity Transmission System**

ECC.6.1.2.2.2 **The Company** in coordination with the **Relevant Transmission Licensee** and a **HVDC System Owner** may agree wider frequency ranges or longer minimum operating times if required to preserve or restore system security. If wider frequency ranges or longer minimum times for operation are economically and technically feasible, the **HVDC System Owner** shall not unreasonably withhold consent.

ECC.6.1.2.2.3 Notwithstanding the requirements of ECC.6.1.2.2.1, an **HVDC System** or **Remote End HVDC Converter Station** shall be capable of automatic disconnection at frequencies specified by **The Company** and/or **Relevant Network Operator**.

ECC.6.1.2.2.4 In the case of **Remote End HVDC Converter Stations** where the **Remote End HVDC Converter Station** is operating at either nominal frequency other than 50Hz or a variable frequency, the requirements defined in ECC6.1.2.2.1 to ECC.6.1.2.2.3 shall apply to the **Remote End HVDC Converter Station** other than in respect of the frequency ranges and time periods.

ECC.6.1.2.3 Grid Frequency Variations for DC Connected Power Park Modules

ECC.6.1.2.3.1 **DC Connected Power Park Modules** shall be capable of staying connected to the **Remote End DC Converter** network at the HVDC Interface Point and operating within the **Frequency** ranges and time periods specified in Table ECC.6.1.2.3 below. Where a nominal frequency other than 50Hz, or a **Frequency** variable by design is used as agreed with **The Company** and the **Relevant Transmission Licensee** the applicable **Frequency** ranges and time periods shall be specified in the **Bilateral Agreement** which shall (where applicable) reflect the requirements in Table ECC.6.1.2.3 .

Frequency Range (Hz)	Time Period for Operation (s)
47.0 – 47.5Hz	20 seconds
47.5 – 49.0Hz	90 minutes
49.0 – 51.0Hz	Unlimited
51.0 – 51.5Hz	90 minutes
51.5Hz – 52 Hz	15 minutes

Table ECC.6.1.2.3 – Minimum time periods a **DC Connected Power Park Module** shall be able to operate for different frequencies deviating from a nominal value without disconnecting from the **System**

ECC.6.1.2.3.2 **The Company** in coordination with the **Relevant Transmission Licensee** and a **Generator** may agree wider frequency ranges or longer minimum operating times if required to preserve or restore system security and to ensure the optimum capability of the **DC Connected Power Park Module**. If wider frequency ranges or longer minimum times for operation are economically and technically feasible, the **EU Generator** shall not unreasonably withhold consent.

ECC.6.1.3 Not used

ECC.6.1.4 Grid Voltage Variations

ECC.6.1.4.1 Grid Voltage Variations for Users excluding DC Connected Power Park Modules and Remote End HVDC Converters

The voltage on part of the **National Electricity Transmission System** operating at nominal voltages of greater than 300kV at each **Connection Site** with a **User** (and in the case of **OTSDUW Plant and Apparatus, a Transmission Interface Point, excluding DC Connected Power Park Modules and Remote End HVDC Converters**) will normally remain within $\pm 5\%$ of the nominal value unless abnormal conditions prevail. The minimum voltage is -10% and the maximum voltage is $+10\%$ unless abnormal conditions prevail, but voltages between $+5\%$ and $+10\%$ will not last longer than 15 minutes unless abnormal conditions prevail. For nominal voltages of 110kV and up to and including 300kV voltages on the parts of the **National Electricity Transmission System** at each **Connection Point** (and in the case of **OTSDUW Plant and Apparatus, a Transmission Interface Point**) will normally remain within the limits $\pm 10\%$ of the nominal value unless abnormal conditions prevail. At nominal **System** voltages below 110kV the voltage of the **National Electricity Transmission System** at each **Connection Site** with a **User** (and in the case of **OTSDUW Plant and Apparatus, a Transmission Interface Point**), excluding **Connection Sites for DC Connected Power Park Modules and Remote End HVDC Converters**) will normally remain within the limits $\pm 6\%$ of the nominal value unless abnormal conditions prevail. Under fault conditions, the voltage may collapse transiently to zero at the point of fault until the fault is cleared. The normal operating ranges of the **National Electricity Transmission System** are summarised below:

National Electricity Transmission System Nominal Voltage	Normal Operating Range		Time period for Operation
	Voltage (percentage of Nominal Voltage)	Pu (1pu relates to the Nominal Voltage)	
Greater than 300kV	V -10% to $+5\%$	0.90pu- 1.05pu	Unlimited
	V $+5\%$ to $+10\%$	1.05pu- 1.10pu	15 minutes
110kV up to 300kV	V $\pm 10\%$	0.90- 1.10pu	Unlimited
Below 110kV	$\pm 6\%$	0.94pu- 1.06pu	Unlimited

The Company and a **User** may agree greater variations or longer minimum time periods of operation in voltage to those set out above in relation to a particular **Connection Site**, and insofar as a greater variation is agreed, the relevant figure set out above shall, in relation to that **User** at the particular **Connection Site**, be replaced by the figure agreed.

ECC.6.1.4.2 Grid Voltage Variations for all DC Connected Power Park Modules

ECC.6.1.4.2.1 All **DC Connected Power Park Modules** shall be capable of staying connected to the **Remote End HVDC Converter Station** at the **HVDC Interface Point** and operating within the voltage ranges and time periods specified in Tables ECC.6.1.4.2(a) and ECC.6.1.4.2(b) below. The applicable voltage range and time periods specified are selected based on the reference 1pu voltage.

Voltage Range (pu)	Time Period for Operation (s)
0.85pu – 0.9pu	60 minutes
0.9pu – 1.1pu	Unlimited
1.1pu – 1.15pu	15 minutes

Table ECC.6.1.4.2(a) – Minimum time periods for which **DC Connected Power Park Modules** shall be capable of operating for different voltages deviating from reference 1pu without disconnecting from the network where the nominal voltage base is 110kV or above and less than 300kV.

Voltage Range (pu)	Time Period for Operation (s)
--------------------	-------------------------------

0.85pu – 0.9pu	60 minutes
0.9pu – 1.05pu	Unlimited
1.05pu – 1.15pu	15 minutes

Table ECC.6.1.4.2(b) – Minimum time periods for which **DC Connected Power Park Modules** shall be capable of operating for different voltages deviating from reference 1pu without disconnecting from the network where the nominal voltage base is from 300kV up to and including 400kV.

ECC.6.1.4.2.2 **The Company** and a **EU Generator** in respect of a **DC Connected Power Park Module** may agree greater voltage ranges or longer minimum operating times. If greater voltage ranges or longer minimum times for operation are economically and technically feasible, the **EU Generator** shall not unreasonably withhold any agreement.

ECC.6.1.4.2.3 For **DC Connected Power Park Modules** which have an **HVDC Interface Point** to the **Remote End HVDC Converter Station**, **The Company** in coordination with the **Relevant Transmission Licensee** may specify voltage limits at the **HVDC Interface Point** at which the **DC Connected Power Park Module** is capable of automatic disconnection.

ECC.6.1.4.2.4 For **HVDC Interface Points** which fall outside the scope of ECC.6.1.4.2.1, ECC.6.1.4.2.2 and ECC.6.1.4.2.3, **The Company** in coordination with the **Relevant Transmission Licensee** shall specify any applicable requirements at the **Grid Entry Point** or **User System Entry Point**.

ECC.6.1.4.2.5 Where the nominal frequency of the AC collector **System** which is connected to an **HVDC Interface Point** is at a value other than 50Hz, the voltage ranges and time periods specified by **The Company** in coordination with the **Relevant Transmission Licensee** shall be proportional to the values specified in Table ECC.6.1.4.2(a) and Table ECC.6.1.4.2(b)

ECC.6.1.4.3 Grid Voltage Variations for all Remote End HVDC Converters

ECC.6.1.4.3.1 All **Remote End HVDC Converter Stations** shall be capable of staying connected to the **HVDC Interface Point** and operating within the voltage ranges and time periods specified in Tables ECC.6.1.4.3(a) and ECC.6.1.4.3(b) below. The applicable voltage range and time periods specified are selected based on the reference 1pu voltage.

Voltage Range (pu)	Time Period for Operation (s)
0.85pu – 0.9pu	60 minutes
0.9pu – 1.1pu	Unlimited
1.1pu – 1.15pu	15 minutes

Table ECC.6.1.4.3(a) – Minimum time periods for which a **Remote End HVDC Converter** shall be capable of operating for different voltages deviating from reference 1pu without disconnecting from the network where the nominal voltage base is 110kV or above and less than 300kV.

Voltage Range (pu)	Time Period for Operation (s)
0.85pu – 0.9pu	60 minutes
0.9pu – 1.05pu	Unlimited
1.05pu – 1.15pu	15 minutes

Table ECC.6.1.4.3(b) – Minimum time periods for which a **Remote End HVDC Converter** shall be capable of operating for different voltages deviating from reference 1pu without disconnecting from the network where the nominal voltage base is from 300kV up to and including 400kV.

- ECC.6.1.4.3.2 **The Company** and a **HVDC System Owner** may agree greater voltage ranges or longer minimum operating times which shall be in accordance with the requirements of ECC.6.1.4.2.
- ECC.6.1.4.3.4 For **HVDC Interface Points** which fall outside the scope of ECC.6.1.4.3.1 **The Company** in coordination with the **Relevant Transmission Licensee** shall specify any applicable requirements at the **Grid Entry Point** or **User System Entry Point**.
- ECC.6.1.4.3.5 Where the nominal frequency of the AC collector **System** which is connected to an **HVDC Interface Point** is at a value other than 50Hz, the voltage ranges and time periods specified by **The Company** in coordination with the **Relevant Transmission Licensee** shall be proportional to the values specified in Table ECC.6.1.4.3(a) and Table ECC.6.1.4.3(b)

Voltage Waveform Quality

- ECC.6.1.5 All **Plant** and **Apparatus** connected to the **National Electricity Transmission System**, and that part of the **National Electricity Transmission System** at each **Connection Site** or, in the case of **OTSDUW Plant and Apparatus**, at each **Interface Point**, should be capable of withstanding the following distortions of the voltage waveform in respect of harmonic content and phase unbalance:

(a) Harmonic Content

The **Electromagnetic Compatibility Levels** for harmonic distortion on the **Onshore Transmission System** from all sources under both **Planned Outage** and fault outage conditions, (unless abnormal conditions prevail) shall comply with **Engineering Recommendation G5**. The **Electromagnetic Compatibility Levels** for harmonic distortion on an **Offshore Transmission System** will be defined in relevant **Bilateral Agreements**.

Engineering Recommendation G5 contains planning criteria which **The Company** will apply to the connection of non-linear **Load** to the **National Electricity Transmission System**, which may result in harmonic emission limits being specified for these **Loads** in the relevant **Bilateral Agreement**. The application of the planning criteria will take into account the position of existing **GB Code User's** and **EU Code Users' Plant and Apparatus** (and **OTSDUW Plant and Apparatus**) in relation to harmonic emissions. **EU Code Users** must ensure that connection of distorting loads to their **User Systems** do not cause any harmonic emission limits specified in the **Bilateral Agreement**, or where no such limits are specified, the relevant planning levels specified in **Engineering Recommendation G5** to be exceeded.

(b) Phase Unbalance

Under **Planned Outage** conditions, the weekly 95 percentile of **Phase (Voltage) Unbalance**, calculated in accordance with IEC 61000-4-30 and IEC 61000-3-13, on the **National Electricity Transmission System** for voltages above 150kV should remain, in England and Wales, below 1.5%, and in Scotland, below 2%, and for voltages of 150kV and below, across GB below 2%, unless abnormal conditions prevail and **Offshore** (or in the case of **OTSDUW, OTSDUW Plant and Apparatus**) will be defined in relevant **Bilateral Agreements**.

The Phase Unbalance is calculated from the ratio of root mean square (rms) of negative phase sequence voltage to rms of positive phase sequence voltage, based on 10-minute average values, in accordance with IEC 61000-4-30.

- ECC.6.1.6 Across GB, under the **Planned Outage** conditions stated in ECC.6.1.5(b) infrequent short duration peaks with a maximum value of 2% are permitted for **Phase (Voltage) Unbalance**, for voltages above 150kV, subject to the prior agreement of **The Company** under the **Bilateral Agreement** and in relation to **OTSDUW**, the **Construction Agreement**. **The Company** will only agree following a specific assessment of the impact of these levels on **Transmission Apparatus** and other **Users Apparatus** with which it is satisfied.

Voltage Fluctuations

ECC.6.1.7 Voltage changes at a **Point of Common Coupling** on the **Onshore Transmission System** shall not exceed:

(a) The limits specified in Table ECC.6.1.7(a) with the stated frequency of occurrence, where:

(i)

$$\% \Delta V_{\text{steadystate}} = \left| 100 \times \frac{\Delta V_{\text{steadystate}}}{V_n} \right| \quad \text{and}$$

$$\% \Delta V_{\text{max}} = 100 \times \frac{\Delta V_{\text{max}}}{V_n} ;$$

- (ii) V_n is the nominal system voltage;
- (iii) $V_{\text{steadystate}}$ is the voltage at the end of a period of 1 s during which the rate of change of system voltage over time is $\leq 0.5\%$;
- (iv) $\Delta V_{\text{steadystate}}$ is the difference in voltage between the initial steady state voltage prior to the RVC (V_0) and the final steady state voltage after the RVC (V_0');
- (v) ΔV_{max} is the absolute change in the system voltage relative to the initial steady state system voltage (V_0);
- (vi) All voltages are the r.m.s. of the voltage measured over one cycle refreshed every half a cycle as per BS EN 61000-4-30; and
- (vii) The applications in the 'Example Applicability' column are examples only and are not definitive.

Cat-egory	Title	Maximum number of occurrence	Limits %ΔV_{max} & %$\Delta V_{\text{steadystate}}$	Example Applicability
1	Frequent events	(see NOTE 1)	As per Figure ECC.6.1.7 (1)	Any single or repetitive RVC that falls inside Figure ECC.6.1.7 (1)
2	Infrequent events	4 events in 1 calendar month (see NOTE 2)	As per Figure ECC.6.1.7 (2) $ \% \Delta V_{\text{steadystate}} \leq 3\%$ For decrease in voltage: $ \% \Delta V_{\text{max}} \leq 10\%$ (see NOTE 3) For increase in voltage: $ \% \Delta V_{\text{max}} \leq 6\%$ (see NOTE 4)	Infrequent motor starting, transformer energisation, re-energisation (see NOTE 7)

3	Very infrequent events	1 event in 3 calendar months (see NOTE 2)	As per Figure ECC.6.1.7 (3) $ \% \Delta V_{\text{steadystate}} \leq 3\%$ For decrease in voltage: $ \% \Delta V_{\text{max}} \leq 12\%$ (see NOTE 5) For increase in voltage: $ \% \Delta V_{\text{max}} \leq 6\%$ (see NOTE 6)	Commissioning, maintenance & post fault switching (see NOTE 7)
<p>NOTE 1: $\pm 6\%$ is permissible for 100 ms reduced to $\pm 3\%$ thereafter as per Figure ECC.6.1.7 (1) . If the profile of repetitive voltage change(s) falls within the envelope given in Figure ECC.6.1.7 (1) , the assessment of such voltage change(s) shall be undertaken according to the recommendations for assessment of flicker <u>and</u> shall conform to the planning levels provided for flicker. If any part of the voltage change(s) falls outside the envelope given in Figure ECC.6.1.7(1), the assessment of such voltage changes, repetitive or not, shall be done according to the guidance and limits for RVCs.</p> <p>NOTE 2: No more than 1 event is permitted per day, consisting of up to 4 RVCs, each separated by at least 10 minutes with all switching completed within a two-hour window.</p> <p>NOTE 3: -10% is permissible for 100 ms reduced to -6% until 2 s then reduced to -3% thereafter as per Figure ECC.6.1.7 (2).</p> <p>NOTE 4: $+6\%$ is permissible for 0.8 s from the instant the event begins then reduced to $+3\%$ thereafter as per Figure ECC.6.1.7 (2).</p> <p>NOTE 5: -12% is permissible for 100 ms reduced to -10% until 2 s then reduced to -3% thereafter as per Figure ECC.6.1.7 (3).</p> <p>NOTE 6: $+6\%$ is permissible for 0.8 s from the instant the event begins then reduced to $+3\%$ thereafter as per Figure ECC.6.1.7 (3).</p> <p>NOTE 7: These are examples only. Customers may opt to conform to the limits of another category providing the frequency of occurrence is not expected to exceed the 'Maximum number of occurrence' for the chosen category.</p>				

Table ECC.6.1.7 (a) – Planning levels for RVC

- (b) The voltage change limit is the absolute maximum allowed of either the phase-to-earth voltage change or the phase-to-phase voltage change, whichever is the highest. The limits do not apply to single phasor equivalent voltages, e.g. positive phase sequence (PPS) voltages. For high impedance earthed systems, the maximum phase-to-phase, i.e. line voltage, should be used for assessment.
- (c) The RVCs in Category 2 and 3 should not exceed the limits depicted in the time dependent characteristic shown in Figure ECC.6.1.7 (2) and Figure ECC.6.1.7 (3) respectively. These limits do not apply to: 1) fault clearance operations; or 2) immediate operations in response to fault conditions; or 3) operations relating to post fault system restoration (for the avoidance of doubt this third exception pertains to a fault that is external to the **Users** plant and apparatus).
- (d) Any RVCs permitted in Category 2 and Category 3 should be at least 10 minutes apart.
- (e) The value of $V_{\text{steadystate}}$ should be established immediately prior to the start of a RVC. Following a RVC, the voltage should remain within the relevant envelope, as shown in Figures ECC.6.1.7 (1), ECC.6.1.7 (2), ECC.6.1.7 (3), until a $V_{\text{steadystate}}$ condition has been satisfied.

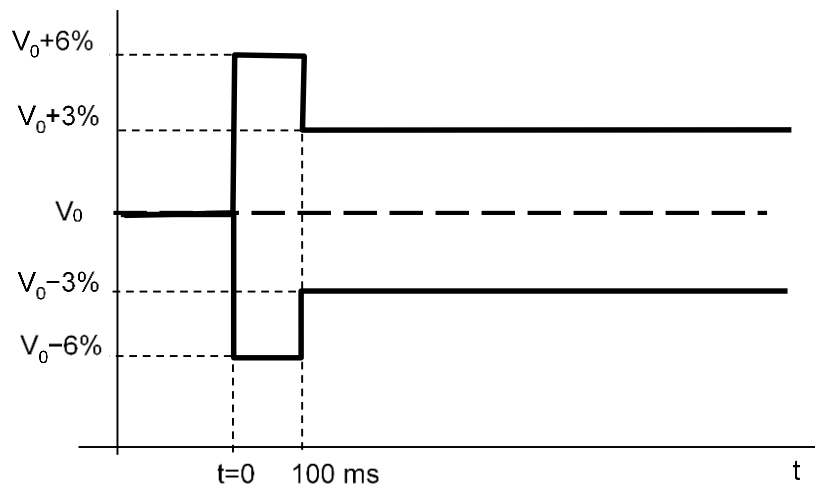

Figure ECC.6.1.7 (1) — Voltage characteristic for frequent events

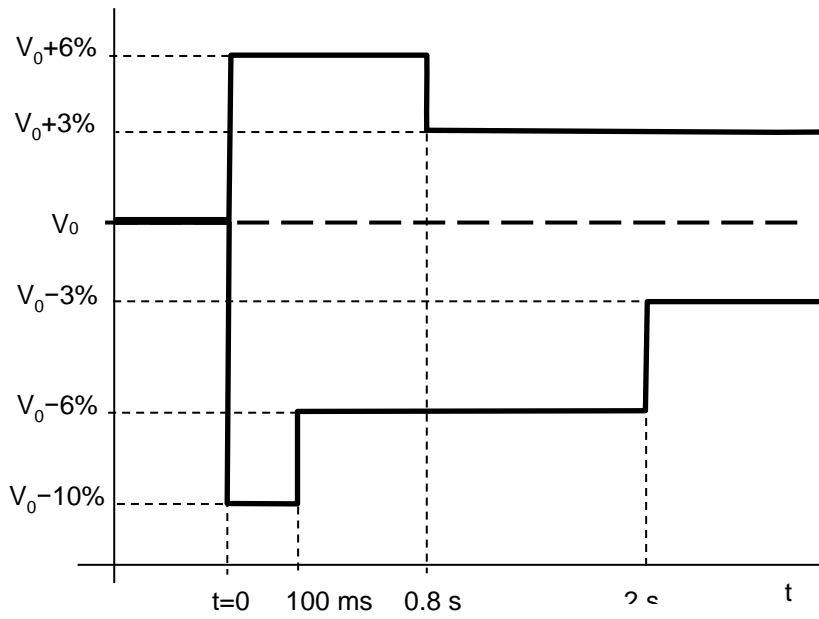

Figure ECC.6.1.7 (2) — Voltage characteristic for infrequent events

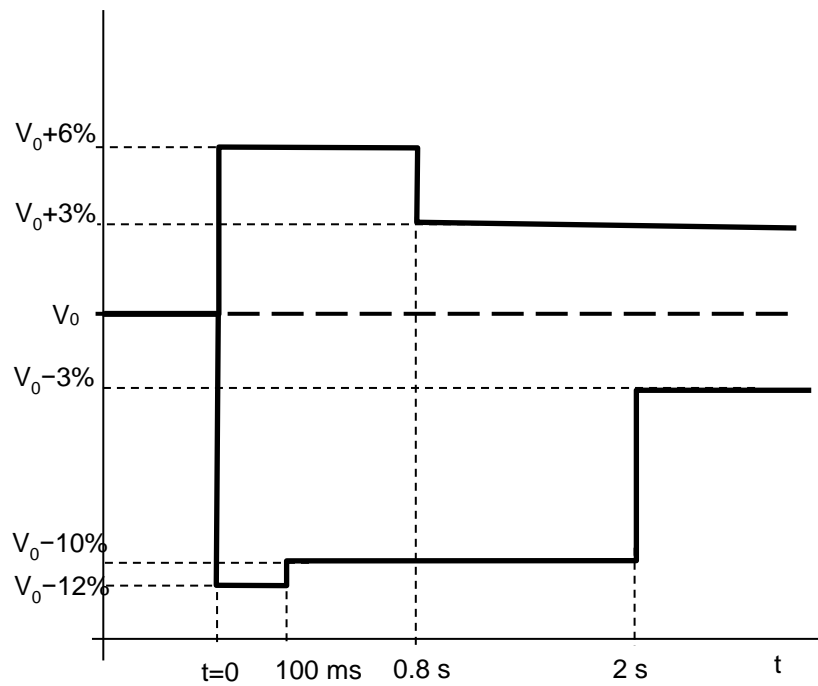

Figure ECC.6.1.7 (3) — Voltage characteristic for very infrequent events

- (f) The voltage change between two steady state voltage conditions should not exceed 3%. (The limit is based on 3% of the nominal voltage of the system (V_n) as measured at the PCC. The step voltage change as measured at the customer's supply terminals or equipment terminals could be greater. For example: The step voltage change limit stated in BS EN 61000-3-3 and BS EN 61000-3-11 is 3.3% when measured at the equipment terminals.)
- (g) The limits apply to voltage changes measured at the **Point of Common Coupling**.
- (h) Category 3 events that are planned should be notified to the Company in advance.
- (i) For connections where voltage changes would constitute a risk to the **National Electricity Transmission System** or, in **The Company's** view, the **System** of any **GB Code User, Bilateral Agreements** may include provision for **The Company** to reasonably limit the number of voltage changes in Category 2 or 3 to a lower number than specified in Table ECC.6.1.7(a) to ensure that the total number of voltage changes at the **Point of Common Coupling** across multiple **Users** remains within the limits of Table ECC.6.1.7(a).
- (j) The planning levels applicable to Flicker Severity Short Term (Pst) and Flicker Severity Long Term (Plt) are set out in Table ECC.6.1.7(b).

Supply system Nominal voltage	Planning level	
	Flicker Severity Short Term (Pst)	Flicker Severity Long Term (Plt)
Up to and including 33 kV	0.9	0.7
66kV and greater	0.8	0.6
NOTE 1: The magnitude of Pst is linear with respect to the magnitude of the voltage changes giving rise to it. NOTE 2: Extreme caution is advised in allowing any excursions of Pst and Plt above the planning level.		

Table ECC.6.7.1(b) — Planning levels for flicker

The values and figures referred to in this paragraph ECC.6.1.7 are derived from Engineering Recommendation P28 Issue 2.

ECC.6.1.8 Voltage fluctuations at a **Point of Common Coupling** with a fluctuating **Load** directly connected to an **Offshore Transmission System** (or in the case of **OTSDUW, OTSDUW Plant and Apparatus**) shall not exceed the limits set out in the **Bilateral Agreement**.

Sub-Synchronous Resonance and Sub-Synchronous Torsional Interaction (SSTI)

ECC.6.1.9 **The Company** shall ensure that **Users' Plant and Apparatus** will not be subject to unacceptable Sub-Synchronous Oscillation conditions as specified in the relevant **License Standards**.

ECC.6.1.10 **The Company** shall ensure where necessary, and in consultation with **Relevant Transmission Licensees** where required, that any relevant site specific conditions applicable at a **User's Connection Site**, including a description of the Sub-Synchronous Oscillation conditions considered in the application of the relevant **License Standards**, are set out in the **User's Bilateral Agreement**.

7

ECC.6.2 Plant and Apparatus relating to Connection Sites and Interface Points and HVDC Interface Points

The following requirements apply to **Plant** and **Apparatus** relating to the **Connection Point** and **OTSDUW Plant and Apparatus** relating to the **Interface Point** (until the **OTSUA Transfer Time**), **HVDC Interface Points** relating to **Remote End HVDC Converters** and **Connection Points** which (except as otherwise provided in the relevant paragraph) each **EU Code User** must ensure are complied with in relation to its **Plant** and **Apparatus** and which in the case of ECC.6.2.2.2.2, ECC.6.2.3.1.1 and ECC.6.2.1.1(b) only, **The Company** must ensure are complied with in relation to **Transmission Plant and Apparatus**, as provided in those paragraphs.

ECC.6.2.1 General Requirements

- ECC.6.2.1.1 (a) The design of connections between the **National Electricity Transmission System** and:
- (i) any **Power Generating Module Generating Unit** (other than a **CCGT Unit** or **Power Park Unit**) **HVDC Equipment, Power Park Module** or **CCGT Module**, or
 - (ii) any **Network Operator's User System**, or
 - (iii) **Non-Embedded Customers** equipment;
- will be consistent with the **Licence Standards**.

In the case of **OTSDUW**, the design of the **OTSUA's** connections at the **Interface Point** and **Connection Point** will be consistent with **Licence Standards**.

- (b) The **National Electricity Transmission System** (and any **OTSDUW Plant and Apparatus**) at nominal **System** voltages of 132kV and above is/shall be designed to be earthed with an **Earth Fault Factor** of, in England and Wales or **Offshore**, below 1.4 and in Scotland, below 1.5. Under fault conditions the rated **Frequency** component of voltage could fall transiently to zero on one or more phases or, in England and Wales, rise to 140% phase-to-earth voltage, or in Scotland, rise to 150% phase-to-earth voltage. The voltage rise would last only for the time that the fault conditions exist. The fault conditions referred to here are those existing when the type of fault is single or two phase-to-earth.
- (c) For connections to the **National Electricity Transmission System** at nominal **System** voltages of below 132kV the earthing requirements and voltage rise conditions will be advised by **The Company** as soon as practicable prior to connection and in the case of **OTSDUW Plant and Apparatus** shall be advised to **The Company** by the **EU Code User**.

ECC.6.2.1.2 Substation Plant and Apparatus

- (a) The following provisions shall apply to all **Plant** and **Apparatus** which is connected at the voltage of the **Connection Point** (and **OTSDUW Plant and Apparatus** at the **Interface Point**) and which is contained in equipment bays that are within the **Transmission** busbar **Protection** zone at the **Connection Point**. This includes circuit breakers, switch disconnectors, disconnectors, **Earthing Devices**, power transformers, voltage transformers, reactors, current transformers, surge arresters, bushings, neutral equipment, capacitors, line traps, coupling devices, external insulation and insulation co-ordination devices. Where necessary, this is as more precisely defined in the **Bilateral Agreement**.
- (i) Plant and/or Apparatus in respect of EU Code Users connecting to a new Connection Point (including OTSDUW Plant and Apparatus at the Interface Point)

Each item of such **Plant** and/or **Apparatus** installed in relation to a new **Connection Point** (or **OTSDUW Plant and Apparatus** at the **Interface Point** or **Remote End HVDC Converter Station** at the **HVDC Interface Point**) shall comply with the relevant **Technical Specifications** and any further requirements identified by **The Company**, acting reasonably, to reflect the options to be followed within the **Technical Specifications** and/or to complement if necessary the **Technical**

Specifications so as to enable **The Company** to comply with its obligations in relation to the **National Electricity Transmission System** or the **Relevant Transmission Licensee** to comply with its obligations in relation to its **Transmission System**. This information, including the application dates of the relevant **Technical Specifications**, will be as specified in the **Bilateral Agreement**.

- (ii) EU Code User's Plant and/or Apparatus connecting to an existing Connection Point (including OTSDUW Plant and Apparatus at the Interface Point)

Each new additional and/or replacement item of such **Plant** and/or **Apparatus** installed in relation to a change to an existing **Connection Point** (or **OTSDUW Plant and Apparatus** at the **Interface Point** and **Connection Point** or **Remote End HVDC Converter Stations** at the **HVDC Interface Point**)—shall comply with the standards/specifications applicable when the change was designed, or such other standards/specifications as necessary to ensure that the item of **Plant** and/or **Apparatus** is reasonably fit for its intended purpose having due regard to the obligations of **The Company**, the relevant **User** the **Relevant Transmission Licensee** under their respective **Licences**. Where appropriate this information, including the application dates of the relevant standards/specifications, will be as specified in the varied **Bilateral Agreement**.

- (iii) Used Plant and/or Apparatus being moved, re-used or modified

If, after its installation, any such item of **Plant** and/or **Apparatus** is subsequently:

- moved to a new location; or
- used for a different purpose; or
- otherwise modified;

then the standards/specifications as described in (i) or (ii) above as applicable will apply as appropriate to such **Plant** and/or **Apparatus**, which must be reasonably fit for its intended purpose having due regard to the obligations of **The Company**, the relevant **User** and the **Relevant Transmission Licensee** under their respective **Licences**.

- (b) **The Company** shall at all times maintain a list of those **Technical Specifications** and additional requirements which might be applicable under this ECC.6.2.1.2 and which may be referenced by **The Company** in the **Bilateral Agreement**. **The Company** shall provide a copy of the list upon request to any **EU Code User**. **The Company** shall also provide a copy of the list to any **EU Code User** upon receipt of an application form for a **Bilateral Agreement** for a new **Connection Point**.
- (c) Where the **EU Code User** provides **The Company** with information and/or test reports in respect of **Plant** and/or **Apparatus** which the **EU Code User** reasonably believes demonstrate the compliance of such items with the provisions of a **Technical Specification** then **The Company** shall promptly and without unreasonable delay give due and proper consideration to such information.
- (d) **Plant** and **Apparatus** shall be designed, manufactured and tested in premises with an accredited certificate in accordance with the quality assurance requirements of the relevant standard in the BS EN ISO 9000 series (or equivalent as reasonably approved by **The Company**) or in respect of test premises which do not include a manufacturing facility premises with an accredited certificate in accordance with BS EN 45001.
- (e) Each connection between a **User** and the **National Electricity Transmission System** must be controlled by a circuit-breaker (or circuit breakers) capable of interrupting the maximum short circuit current at the point of connection. The **Seven Year Statement** gives values of short circuit current and the rating of **Transmission** circuit breakers at existing and committed **Connection Points** for future years.

- (f) Each connection between a **Generator** undertaking **OTSDUW** or an **Onshore Transmission Licensee**, must be controlled by a circuit breaker (or circuit breakers) capable of interrupting the maximum short circuit current at the **Transmission Interface Point**. The **Seven Year Statement** gives values of short circuit current and the rating of **Transmission** circuit breakers at existing and committed **Transmission Interface Points** for future years.

ECC.6.2.2 Requirements at **Connection Points** or, in the case of **OTSDUW** at **Interface Points** that relate to **Generators** or **OTSDUW Plant and Apparatus**

ECC.6.2.2.1 Not Used.

ECC.6.2.2.2 **Power Generating Module, OTSDUW Plant and Apparatus, HVDC Equipment and Power Station Protection Arrangements**

ECC.6.2.2.2.1 Minimum Requirements

Protection of Power Generating Modules (other than **Power Park Units**), **HVDC Equipment, OTSDUW Plant and Apparatus** and their connections to the **National Electricity Transmission System** shall meet the requirements given below. These are necessary to reduce the impact on the **National Electricity Transmission System** of faults on **OTSDUW Plant and Apparatus** circuits or circuits owned by **Generators** (including **DC Connected Power Park Modules**) or **HVDC System Owners**.

ECC.6.2.2.2.2 Fault Clearance Times

- (a) The required fault clearance time for faults on the **Generator's** (including **DC Connected Power Park Modules**) or **HVDC System Owner's** equipment directly connected to the **National Electricity Transmission System** or **OTSDUW Plant and Apparatus** and for faults on the **National Electricity Transmission System** directly connected to the **EU Generator** (including **DC Connected Power Park Modules**) or **HVDC System Owner's** equipment or **OTSDUW Plant and Apparatus**, from fault inception to the circuit breaker arc extinction, shall be set out in the **Bilateral Agreement**. The fault clearance time specified in the **Bilateral Agreement** shall not be shorter than the durations specified below:

- (i) 80ms for connections operating at a nominal voltage of greater than 300kV
- (ii) 100ms for connections operating at a nominal voltage of greater than 132kV and up to 300kV
- (iii) 120ms for connections operating at a nominal voltage of 132kV and below

but this shall not prevent the **User** or **The Company** or the **Relevant Transmission Licensee** or the **EU Generator** (including in respect of **OTSDUW Plant and Apparatus** and **DC Connected Power Park Modules**) from selecting a shorter fault clearance time on their own **Plant** and **Apparatus** provided **Discrimination** is achieved.

A longer fault clearance time may be specified in the **Bilateral Agreement** for faults on the **National Electricity Transmission System**. A longer fault clearance time for faults on the **EU Generator** or **HVDC System Owner's** equipment or **OTSDUW Plant and Apparatus** may be agreed with **The Company** in accordance with the terms of the **Bilateral Agreement** but only if **System** requirements, in **The Company's** view, permit. The probability that the fault clearance time stated in the **Bilateral Agreement** will be exceeded by any given fault, must be less than 2%.

- (b) In the event that the required fault clearance time is not met as a result of failure to operate on the **Main Protection System(s)** provided, the **Generators** or **HVDC System Owners** or **Generators** in the case of **OTSDUW Plant and Apparatus** shall, except as specified below provide **Independent Back-Up Protection**. The **Relevant Transmission Licensee** will also provide **Back-Up Protection** and the **Relevant Transmission Licensee's** and the **User's Back-Up Protections** will be co-ordinated so as to provide **Discrimination**.

On a **Power Generating Module** (other than a **Power Park Unit**), **HVDC Equipment** or **OTSDUW Plant and Apparatus** and connected to the **National Electricity Transmission System** operating at a nominal voltage of greater than 132kV and where two **Independent Main Protections** are provided to clear faults on the **HV Connections** within the required fault clearance time, the **Back-Up Protection** provided by **EU Generators** (including in respect of **OTSDUW Plant and Apparatus** and **DC Connected Power Park Modules**) and **HVDC System Owners** shall operate to give a fault clearance time of no longer than 300ms at the minimum infeed for normal operation for faults on the **HV Connections**. Where two **Independent Main Protections** are installed the **Back-Up Protection** may be integrated into one (or both) of the **Independent Main Protection** relays.

On a **Power Generating Module** (other than a **Power Park Unit**), **HVDC Equipment** or **OTSDUW Plant and Apparatus** and connected to the **National Electricity Transmission System** at 132 kV and below and where only one **Main Protection** is provided to clear faults on the **HV Connections** within the required fault clearance time, the **Independent Back-Up Protection** provided by the **Generator** (including in respect of **OTSDUW Plant and Apparatus** and **DC Connected Power Park Modules**) and the **HVDC System Owner** shall operate to give a fault clearance time of no longer than 300ms at the minimum infeed for normal operation for faults on the **HV Connections**.

A Power Generating Module (other than a **Power Park Unit**), **HVDC Equipment** or **OTSDUW Plant and Apparatus**) with **Back-Up Protection** or **Independent Back-Up Protection** will also be required to withstand, without tripping, the loading incurred during the clearance of a fault on the **National Electricity Transmission System** by breaker fail **Protection** at a nominal voltage of greater than 132kV or of a fault cleared by **Back-Up Protection** where the **EU Generator** (including in the case of **OTSDUW Plant and Apparatus** or **DC Connected Power Park Module**) or **HVDC System** is connected at 132kV and below. This will permit **Discrimination** between the **Generator** in respect of **OTSDUW Plant and Apparatus** or **DC Connected Power Park Modules** or **HVDC System Owners' Back-Up Protection** or **Independent Back-Up Protection** and the **Back-Up Protection** provided on the **National Electricity Transmission System** and other **Users' Systems**.

- (c) When the **Power Generating Module** (other than **Power Park Units**), or the **HVDC Equipment** or **OTSDUW Plant and Apparatus** is connected to the **National Electricity Transmission System** operating at a nominal voltage of greater than 132kV, and in Scotland and **Offshore** also at 132kV, and a circuit breaker is provided by the **Generator** (including in respect of **OTSDUW Plant and Apparatus** or **DC Connected Power Park Modules**) or the **HVDC System** owner, or the **Relevant Transmission Licensee**, as the case may be, to interrupt fault current interchange with the **National Electricity Transmission System**, or **Generator's System**, or **HVDC System Owner's System**, as the case may be, circuit breaker fail **Protection** shall be provided by the **Generator** (including in respect of **OTSDUW Plant and Apparatus** or **DC Connected Power Park Modules**) or **HVDC System-Owner**, or the **Relevant Transmission Licensee**, as the case may be, on this circuit breaker. In the event, following operation of a **Protection** system, of a failure to interrupt fault current by these circuit-breakers within the **Fault Current Interruption Time**, the circuit breaker fail **Protection** is required to initiate tripping of all the necessary electrically adjacent circuit-breakers so as to interrupt the fault current within the next 200ms.
- (d) The target performance for the **System Fault Dependability Index** shall be not less than 99%. This is a measure of the ability of **Protection** to initiate successful tripping of circuit breakers which are associated with the faulty item of **Apparatus**.

ECC.6.2.2.3 Equipment including **Protection** equipment to be provided

The **Relevant Transmission Licensee** shall specify the **Protection** schemes and settings necessary to protect the **National Electricity Transmission System**, taking into account the characteristics of the **Power Generating Module** or **HVDC Equipment**.

The protection schemes needed for the **Power Generating Module** or **HVDC Equipment** and the **National Electricity Transmission System** as well as the settings relevant to the **Power Generating Module** and/or **HVDC Equipment** shall be coordinated and agreed between **The Company** and the **EU Generator** or **HVDC System Owner**. The agreed **Protection** schemes and settings will be specified in the **Bilateral Agreement**.

The protection schemes and settings for internal electrical faults must not prevent the **Power Generating Module** or **HVDC Equipment** from satisfying the requirements of the Grid Code although **EU Generators** should be aware of the requirements of ECC.6.3.13.1. ;

~~electrical~~ **Protection** of the **Power Generating Module** or **HVDC Equipment** shall take precedence over operational controls, taking into account the security of the **National Electricity Transmission System** and the health and safety of personnel, as well as mitigating any damage to the **Power Generating Module** or **HVDC Equipment**.

ECC.6.2.2.3.1 Protection of Interconnecting Connections

The requirements for the provision of **Protection** equipment for interconnecting connections will be specified in the **Bilateral Agreement**. In this **ECC** the term "interconnecting connections" means the primary conductors from the current transformer accommodation on the circuit side of the circuit breaker to the **Connection Point** or the primary conductors from the current transformer accommodation on the circuit side of the **OTSDUW Plant and Apparatus** of the circuit breaker to the **Transmission Interface Point**.

ECC.6.2.2.3.2 Circuit-breaker fail Protection

The **EU Generator** or **HVDC System Owner** will install circuit breaker fail **Protection** equipment in accordance with the requirements of the **Bilateral Agreement**. The **EU Generator** or **HVDC System Owner** will also provide a back-trip signal in the event of loss of air from its pressurised head circuit breakers, during the **Power Generating Module** (other than a **CCGT Unit** or **Power Park Unit**) or **HVDC Equipment** run-up sequence, where these circuit breakers are installed.

ECC.6.2.2.3.3 Loss of Excitation

The **EU Generator** must provide **Protection** to detect loss of excitation in respect of each of its **Generating Units** within a **Synchronous Power Generating Module** to initiate a **Generating Unit** trip.

ECC.6.2.2.3.4 Pole-Slipping Protection

Where, in **The Company's** reasonable opinion, **System** requirements dictate, **The Company** will specify in the **Bilateral Agreement** a requirement for **EU Generators** to fit pole-slipping **Protection** on their **Generating Units** within each **Synchronous Power Generating Module**.

ECC.6.2.2.3.5 Signals for Tariff Metering

EU Generators and **HVDC System Owners** will install current and voltage transformers supplying all tariff meters at a voltage to be specified in, and in accordance with, the **Bilateral Agreement**.

ECC.6.2.2.3.6 Commissioning of Protection Systems

No **EU Generator** or **HVDC System Owner** equipment shall be energised until the **Protection** settings have been finalised. The **EU Generator** or **HVDC System Owner** shall agree with **The Company** (in coordination with the **Relevant Transmission Licensee**) and carry out a combined commissioning programme for the **Protection** systems, and generally, to a minimum standard as specified in the **Bilateral Agreement**.

ECC.6.2.2.4 Work on Protection Equipment

No busbar **Protection**, mesh corner **Protection**, circuit-breaker fail **Protection** relays, AC or DC wiring (other than power supplies or DC tripping associated with the **Power Generating Module, HVDC Equipment** itself) may be worked upon or altered by the **EU Generator** or **HVDC System Owner** personnel in the absence of a representative of the **Relevant Transmission Licensee** or written authority from the **Relevant Transmission Licensee** to perform such work or alterations in the absence of a representative of the **Relevant Transmission Licensee**.

ECC.6.2.2.5 Relay Settings

Protection and relay settings will be co-ordinated (both on connection and subsequently) across the **Connection Point** in accordance with the **Bilateral Agreement** and in relation to **OTSDUW Plant and Apparatus**, across the **Interface Point** in accordance with the **Bilateral Agreement** to ensure effective disconnection of faulty **Apparatus**.

ECC.6.2.2.6 Changes to Protection Schemes and HVDC System Control Modes

ECC.6.2.2.6.1 Any subsequent alterations to the protection settings (whether by **The Company**, the **Relevant Transmission Licensee**, the **EU Generator** or the **HVDC System Owner**) shall be agreed between **The Company** (in co-ordination with the **Relevant Transmission Licensee**) and the **EU Generator** or **HVDC System Owner** in accordance with the Grid Code (ECC.6.2.2.5). No alterations are to be made to any protection schemes unless agreement has been reached between **The Company**, the **Relevant Transmission Licensee**, the **EU Generator** or **HVDC System Owner**.

ECC.6.2.2.6.2 The parameters of different control modes of the **HVDC System** shall be able to be changed in the **HVDC Converter Station**, if required by **The Company** in coordination with the **Relevant Transmission Licensee** and in accordance with ECC.6.2.2.6.4.

ECC.6.2.2.6.3 Any change to the schemes or settings of parameters of the different control modes and protection of the **HVDC System** including the procedure shall be agreed with **The Company** in coordination with the **Relevant Transmission Licensee** and the **HVDC System Owner**.

ECC.6.2.2.6.4 The control modes and associated set points shall be capable of being changed remotely, as specified by **The Company** in coordination with the **Relevant Transmission Licensee**.

ECC.6.2.2.7 Control Schemes and Settings

ECC.6.2.2.7.1 The schemes and settings of the different control devices on the **Power Generating Module** and **HVDC Equipment** that are necessary for **Transmission System** stability and for taking emergency action shall be agreed with **The Company** in coordination with the **Relevant Transmission Licensee** and the **EU Generator** or **HVDC System Owner**.

ECC.6.2.2.7.2 Subject to the requirements of ECC.6.2.2.7.1 any changes to the schemes and settings, defined in ECC.6.2.2.7.1, of the different control devices of the **Power Generating Module** or **HVDC Equipment** shall be coordinated and agreed between , the **Relevant Transmission Licensee**, the **EU Generator** and **HVDC System Owner**.

ECC.6.2.2.8 Ranking of Protection and Control

ECC.6.2.2.8.1 **The Company** in coordination with **Relevant Transmission Licensees**, shall agree and coordinate the protection and control devices of **EU Generators Plant and Apparatus** in accordance with the following general priority ranking (from highest to lowest):

- (i) The interface between the **National Electricity Transmission System** and the **Power Generating Module** or **HVDC Equipment Protection** equipment;
- (ii) frequency control (active power adjustment);
- (iii) power restriction; and
- (iv) power gradient constraint;

- ECC.6.2.2.8.2 A control scheme, specified by the **HVDC System Owner** consisting of different control modes, including the settings of the specific parameters, shall be coordinated and agreed between **The Company** in coordination with the **Relevant Transmission Licensee** and the **HVDC System Owner**. These details would be specified in the **Bilateral Agreement**.
- ECC.6.2.2.8.3 **The Company** in coordination with **Relevant Transmission Licensees**, shall agree and coordinate the protection and control devices of **HVDC System Owners Plant and Apparatus** in accordance with the following general priority ranking (from highest to lowest)
- (i) The interface between the **National Electricity Transmission System** and **HVDC System Protection** equipment;
 - (ii) **Active Power** control for emergency assistance
 - (iii) automatic remedial actions as specified in ECC.6.3.6.1.2.5
 - (iv) **Limited Frequency Sensitive Mode (LFSM)** of operation;
 - (v) **Frequency Sensitive Mode** of operation and **Frequency** control; and
 - (vi) power gradient constraint.
- ECC.6.2.2.9 Synchronising
- ECC.6.2.2.9.1 For any **Power Generating Module** directly connected to the **National Electricity Transmission System** or **Type D Power Generating Module**, synchronisation shall be performed by the **EU Generator** only after instruction by **The Company** in accordance with the requirements of BC.2.5.2.
- ECC.6.2.2.9.2 Each **Power Generating Module** directly connected to the **National Electricity Transmission System** or **Type D Power Generating Module** shall be equipped with the necessary synchronisation facilities. Synchronisation shall be possible within the range of frequencies specified in ECC.6.1.2.
- ECC.6.2.2.9.3 The requirements for synchronising equipment shall be specified in accordance with the requirements in the **Electrical Standards** listed in the annex to the **General Conditions**. The synchronisation settings shall include the following elements below. Any variation to these requirements shall be pursuant to the terms of the **Bilateral Agreement**.
- (a) voltage
 - (b) **Frequency**
 - (c) phase angle range
 - (d) phase sequence
 - (e) deviation of voltage and **Frequency**
- ECC.6.2.2.9.4 **HVDC Equipment** shall be required to satisfy the requirements of ECC.6.2.2.9.1 – ECC.6.2.2.9.3. In addition, unless otherwise specified by **The Company**, during the synchronisation of a **DC Connected Power Park Module** to the **National Electricity Transmission System**, any **HVDC Equipment** shall have the capability to limit any steady state voltage changes to the limits specified within ECC.6.1.7 or ECC.6.1.8 (as applicable) which shall not exceed 5% of the pre-synchronisation voltage. **The Company** in coordination with the **Relevant Transmission Licensee** shall specify any additional requirements for the maximum magnitude, duration and measurement of the voltage transients over and above those defined in ECC.6.1.7 and ECC.6.1.8 in the **Bilateral Agreement**.
- ECC.6.2.2.9.5 **EU Generators** in respect of **DC Connected Power Park Modules** shall also provide output synchronisation signals specified by **The Company** in co-ordination with the **Relevant Transmission Licensee**.

ECC.6.2.2.9.6 In addition to the requirements of ECC.6.2.2.9.1 to ECC.6.2.2.9.5, **EU Generators** and **HVDC System Owners** should also be aware of the requirements of ECC.6.5.10 relating to busbar voltage

ECC.6.2.2.9.10 HVDC Parameters and Settings

ECC.6.2.2.9.10.1 The parameters and settings of the main control functions of an **HVDC System** shall be agreed between the **HVDC System** owner and **The Company**, in coordination with the **Relevant Transmission Licensee**. The parameters and settings shall be implemented within such a control hierarchy that makes their modification possible if necessary. Those main control functions are at least:

- (b) **Frequency Sensitive Modes** (FSM, LFSM-O, LFSM-U);
- (c) **Frequency** control, if applicable;
- (d) **Reactive Power** control mode, if applicable;
- (e) power oscillation damping capability;
- (f) subsynchronous torsional interaction damping capability,.

ECC.6.2.2.11 Automatic Reconnection

ECC.6.2.2.11.1 **EU Generators** in respect of **Type A, Type B, Type C** and **Type D Power Generating Modules** (including **DC Connected Power Park Modules**) which have signed a **CUSC Contract** with **The Company** are not permitted to automatically reconnect to the **Total System** without instruction from **The Company**. **The Company** will issue instructions for reconnection or re-synchronisation in accordance with the requirements of BC2.5.2. Where synchronising is permitted in accordance with BC2.5.2, the voltage and frequency at the **Grid Entry Point** or **User System Entry Point** shall be within the limits defined in ECC.6.1.2 and ECC.6.1.4 and the ramp rate limits pursuant to BC1.A.1.1. For the avoidance of doubt this requirement does not apply to **EU Generators** who are not required to satisfy the requirements of the Balancing Codes.

ECC.6.2.2.12 Automatic Disconnection

ECC.6.2.2.12.1 No **Power Generating Module** or **HVDC Equipment** shall disconnect within the frequency range or voltage range defined in ECC.6.1.2 and ECC.6.1.4.

ECC.6.2.2.13 Special Provisions relating to Power Generating Modules embedded within Industrial Sites which supply electricity as a bi-product of their industrial process

ECC.6.2.2.13.1 **Generators** in respect of **Power Generating Modules** which form part of an industrial network, where the **Power Generating Module** is used to supply critical loads within the industrial process shall be permitted to operate isolated from the **Total System** if agreed with **The Company** in the **Bilateral Agreement**.

ECC.6.2.2.13.2 Except for the requirements of ECC.6.3.3 and ECC.6.3.7.1, **Power Generating Modules** which are embedded within industrial sites are not required to satisfy the requirements of ECC.6.3.6.2.1 and ECC.6.3.9. In this case this exception would only apply to **Power Generating Modules** on industrial sites used for combined heat and power production which are embedded in the network of an industrial site where all the following criteria are met.

- (a) The primary purpose of these sites is to produce heat for production processes of the industrial site concerned,
- (b) Heat and power generation is inextricably interlinked, that is to say any change to heat generation results inadvertently in a change of active power generating and visa versa.
- (c) The **Power Generating Modules** are of **Type A, Type B** or **Type C**.
- (d) Combined heat and power generating facilities shall be assessed on the basis of their electrical **Maximum Capacity**.

ECC.6.2.3 Requirements at EU Grid Supply Points relating to Network Operators and Non-Embedded Customers

ECC.6.2.3.1 Protection Arrangements for EU Code Users in respect of Network Operators and Non-Embedded Customers

ECC.6.2.3.1.1 **Protection** arrangements for **EU Code Users** in respect of **Network Operators** and **Non-Embedded Customers User Systems** directly connected to the **National Electricity Transmission System**, shall meet the requirements given below:

Fault Clearance Times

(a) The required fault clearance time for faults on **Network Operator** and **Non-Embedded Customer** equipment directly connected to the **National Electricity Transmission System**, and for faults on the **National Electricity Transmission System** directly connected to the **Network Operator's** or **Non-Embedded Customer's equipment**, from fault inception to the circuit breaker arc extinction, shall be set out in each **Bilateral Agreement**. The fault clearance time specified in the **Bilateral Agreement** shall not be shorter than the durations specified below:

- (i) 80ms for connections operating at a nominal voltage of greater than 300kV
- (ii) 100ms for connections operating at a nominal voltage of greater than 132kV and up to 300kV
- (iii) 120ms for connections operating at a nominal voltage of greater than 132kV and below

but this shall not prevent the **User** or **The Company** or **Relevant Transmission Licensee** from selecting a shorter fault clearance time on its own **Plant** and **Apparatus** provided **Discrimination** is achieved.

For the purpose of establishing the **Protection** requirements in accordance with ECC.6.2.3.1.1 only, the point of connection of the **Network Operator** or **Non-Embedded Customer** equipment to the **National Electricity Transmission System** shall be deemed to be the low voltage busbars at an **EU Grid Supply Point**, irrespective of the ownership of the equipment at the **EU Grid Supply Point**.

A longer fault clearance time may be specified in the **Bilateral Agreement** for faults on the **National Electricity Transmission System**. A longer fault clearance time for faults on the **Network Operator** and **Non-Embedded Customers** equipment may be agreed with **The Company** in accordance with the terms of the **Bilateral Agreement** but only if **System** requirements in **The Company's** view permit. The probability that the fault clearance time stated in the **Bilateral Agreement** will be exceeded by any given fault must be less than 2%.

- (b) (i) For the event of failure of the **Protection** systems provided to meet the above fault clearance time requirements, **Back-Up Protection** shall be provided by the **Network Operator** or **Non-Embedded Customer** as the case may be.
- (ii) The **Relevant Transmission Licensee** will also provide **Back-Up Protection**, which will result in a fault clearance time longer than that specified for the **Network Operator** or **Non-Embedded Customer Back-Up Protection** so as to provide **Discrimination**.
- (iii) For connections with the **National Electricity Transmission System** at 132kV and below, it is normally required that the **Back-Up Protection** on the **National Electricity Transmission System** shall discriminate with the **Network Operator** or **Non-Embedded Customer's Back-Up Protection**.
- (iv) For connections with the **National Electricity Transmission System** operating at a nominal voltage greater than 132kV, the **Back-Up Protection** will be provided by the **Network Operator** or **Non-Embedded Customer**, as the case may be, with a fault clearance time not longer than 300ms for faults on the **Network Operator's** or **Non-Embedded Customer's Apparatus**.

- (v) Such **Protection** will also be required to withstand, without tripping, the loading incurred during the clearance of a fault on the **National Electricity Transmission System** by breaker fail **Protection** operating at a nominal voltage of greater than 132kV. This will permit **Discrimination** between **Network Operator's Back-Up Protection** or **Non-Embedded Customer's Back-Up Protection**, as the case may be, and **Back-Up Protection** provided on the **National Electricity Transmission System** and other **User Systems**. The requirement for and level of **Discrimination** required will be specified in the **Bilateral Agreement**.
- (c) (i) Where the **Network Operator** or **Non-Embedded Customer** is connected to part of the **National Electricity Transmission System** operating at a nominal voltage greater than 132kV and in Scotland also at 132kV, and a circuit breaker is provided by the **Network Operator** or **Non-Embedded Customer**, or the **Relevant Transmission Licensee**, as the case may be, to interrupt the interchange of fault current with the **National Electricity Transmission System** or the **System** of the **Network Operator** or **Non-Embedded Customer**, as the case may be, circuit breaker fail **Protection** will be provided by the **Network Operator** or **Non-Embedded Customer**, or the **Relevant Transmission Licensee**, as the case may be, on this circuit breaker.
 - (ii) In the event, following operation of a **Protection** system, of a failure to interrupt fault current by these circuit-breakers within the **Fault Current Interruption Time**, the circuit breaker fail **Protection** is required to initiate tripping of all the necessary electrically adjacent circuit-breakers so as to interrupt the fault current within the next 200ms.
- (d) The target performance for the **System Fault Dependability Index** shall be not less than 99%. This is a measure of the ability of **Protection** to initiate successful tripping of circuit breakers which are associated with the faulty items of **Apparatus**.

ECC.6.2.3.2 Fault Disconnection Facilities

- (a) Where no **Transmission** circuit breaker is provided at the **User's** connection voltage, the **User** must provide **The Company** with the means of tripping all the **User's** circuit breakers necessary to isolate faults or **System** abnormalities on the **National Electricity Transmission System**. In these circumstances, for faults on the **User's System**, the **User's Protection** should also trip higher voltage **Transmission** circuit breakers. These tripping facilities shall be in accordance with the requirements specified in the **Bilateral Agreement**.
- (b) **The Company** may require the installation of a **System to Generator Operational Intertripping Scheme** in order to enable the timely restoration of circuits following power **System** fault(s). These requirements shall be set out in the relevant **Bilateral Agreement**.

ECC.6.2.3.3 Automatic Switching Equipment

Where automatic reclosure of **Transmission** circuit breakers is required following faults on the **User's System**, automatic switching equipment shall be provided in accordance with the requirements specified in the **Bilateral Agreement**.

ECC.6.2.3.4 Relay Settings

Protection and relay settings will be co-ordinated (both on connection and subsequently) across the **Connection Point** in accordance with the **Bilateral Agreement** to ensure effective disconnection of faulty **Apparatus**.

ECC.6.2.3.5 Work on Protection equipment

Where a **Transmission Licensee** owns the busbar at the **Connection Point**, no busbar **Protection**, mesh corner **Protection** relays, AC or DC wiring (other than power supplies or DC tripping associated with the **Network Operator** or **Non-Embedded Customer's Apparatus** itself) may be worked upon or altered by the **Network Operator** or **Non-Embedded Customer** personnel in the absence of a representative of the **Relevant Transmission Licensee** or written authority from the **Relevant Transmission Licensee** to perform such work or alterations in the absence of a representative of the **Relevant Transmission Licensee**.

ECC.6.2.3.6 Equipment including Protection equipment to be provided

The Company in coordination with the **Relevant Transmission Licensee** shall specify and agree the **Protection** schemes and settings at each **EU Grid Supply Point** required to protect the **National Electricity Transmission System** in accordance with the characteristics of the **Network Operator's** or **Non Embedded Customer's System**. **The Company** in coordination with the **Relevant Transmission Licensee** and the **Network Operator** or **Non Embedded Customer** shall agree on the protection schemes and settings in respect of the busbar protection zone in respect of each **EU Grid Supply Point**.

Protection of the **Network Operator's** or **Non Embedded Customer's System** shall take precedence over operational controls whilst respecting the security of the **National Electricity Transmission System** and the health and safety of staff and the public.

ECC.6.2.3.6.1 Protection of Interconnecting Connections

The requirements for the provision of **Protection** equipment for interconnecting connections will be specified in the **Bilateral Agreement**.

ECC.6.2.3.7 Changes to Protection Schemes at EU Grid Supply Points

Any subsequent alterations to the busbar protection settings at the **EU Grid Supply Point** (whether by **The Company**, the **Relevant Transmission Licensee**, the **Network Operator** or the **Non Embedded Customer**) shall be agreed between **The Company** (in co-ordination with the **Relevant Transmission Licensee**) and the **Network Operator** or **Non Embedded Customer** in accordance with the Grid Code (ECC.6.2.3.4). No alterations are to be made to any busbar protection schemes unless agreement has been reached between **The Company**,

the **Relevant Transmission Licensee**, the **Network Operator** or **Non Embedded Customer**.

No **Network Operator** or **Non Embedded Customer** equipment shall be energised until the **Protection** settings have been agreed prior to commissioning. The **Network Operator** or **Non Embedded Customer** shall agree with **The Company** (in coordination with the **Relevant Transmission Licensee**) and carry out a combined commissioning programme for the **Protection** systems, and generally, to a minimum standard as specified in the **Bilateral Agreement**.

ECC.6.2.3.8 Control Requirements

ECC.6.2.3.8.1 **The Company** in coordination with the **Relevant Transmission Licensee** and the **Network Operator** or **Non Embedded Customer** shall agree on the control schemes and settings at each **EU Grid Supply Point** of the different control devices of the **Network Operator's** or **Non Embedded Customer's System** relevant for security of the **National Electricity Transmission System**. Such requirements would be pursuant to the terms of the **Bilateral Agreement** which shall also cover at least the following elements:

- (a) Isolated (**National Electricity Transmission System**) operation;
- (b) Damping of oscillations;
- (c) Disturbances to the **National Electricity Transmission System**;
- (d) Automatic switching to emergency supply and restoration to normal topology;
- (e) Automatic circuit breaker re-closure (on 1-phase faults).

ECC.6.2.3.8.2 Subject to the requirements of ECC.6.2.3.8.1 any changes to the schemes and settings, defined in ECC.6.2.3.8.1 of the different control devices of the **Network Operator's** or **Non-Embedded Customer's System** at the **EU Grid Supply Point** shall be coordinated and agreed between **The Company**, the **Relevant Transmission Licensee**, the **Network Operator** or **Non Embedded Customer**.

ECC.6.2.3.9 Ranking of Protection and Control

ECC.6.2.3.9.1 The **Network Operator** or the **Non Embedded Customer** who owns or operates an **EU Grid Supply Point** shall set the **Protection** and control devices of its **System**, in compliance with the following priority ranking, organised in decreasing order of importance:

- (a) **National Electricity Transmission System Protection**;
- (b) **Protection** equipment at each **EU Grid Supply Point**;
- (c) **Frequency** control (**Active Power** adjustment);
- (d) **Power** restriction.

ECC.6.2.3.10 Synchronising

ECC.6.2.3.10.1 Each **Network Operator** or **Non Embedded Customer** at each **EU Grid Supply Point** shall be capable of synchronisation within the range of frequencies specified in ECC.6.1.2 unless otherwise agreed with **The Company**.

ECC.6.2.3.10.2 **The Company** and the **Network Operator** or **Non Embedded Customer** shall agree on the settings of the synchronisation equipment at each **EU Grid Supply Point** prior to the **Completion Date**. **The Company** and the relevant **Network Operator** or **Non-Embedded Customer** shall agree the synchronisation settings which shall include the following elements.

- (a) Voltage;
- (b) **Frequency**;
- (c) phase angle range;
- (d) deviation of voltage and **Frequency**.

ECC.6.3 GENERAL POWER GENERATING MODULE, OTSDUW AND HVDC EQUIPMENT REQUIREMENTS

ECC.6.3.1 This section sets out the technical and design criteria and performance requirements for **Power Generating Modules** (which includes **Electricity Storage Modules**) and **HVDC Equipment** (whether directly connected to the **National Electricity Transmission System** or **Embedded**) and (where provided in this section) **OTSDUW Plant and Apparatus** which each **Generator** or **HVDC System Owner** must ensure are complied with in relation to its **Power Generating Modules**, **HVDC Equipment** and **OTSDUW Plant and Apparatus**. References to **Power Generating Modules**, **HVDC Equipment** in this ECC.6.3 should be read accordingly. For the avoidance of doubt, the requirements applicable to **Synchronous Power Generating Modules** also apply to **Synchronous Electricity Storage Modules** and the requirements applicable to **Power Park Modules** apply to **Non-Synchronous Electricity Storage Modules**. In addition, the requirements applicable to **Electricity Storage Modules** also apply irrespective of whether the **Electricity Storage Module** operates in such a mode as to import or export power from the **Total System**.

Plant Performance Requirements

ECC.6.3.2 REACTIVE CAPABILITY

ECC.6.3.2.1 Reactive Capability for Type B Synchronous Power Generating Modules

ECC.6.3.2.1.1 When operating at **Maximum Capacity**, all **Type B Synchronous Power Generating Modules** must be capable of continuous operation at any points between the limits of 0.95 **Power Factor** lagging and 0.95 **Power Factor** leading at the **Grid Entry Point** or **User System Entry Point** unless otherwise agreed with **The Company** or relevant **Network Operator**. At **Active Power** output levels other than **Maximum Capacity**, all **Generating Units** within a **Type B Synchronous Power Generating Module** must be capable of continuous operation at any point between the **Reactive Power** capability limits identified on the **HV Generator Performance Chart** unless otherwise agreed with **The Company** or relevant **Network Operator**.

ECC.6.3.2.2 Reactive Capability for Type B Power Park Modules

ECC.6.3.2.2.1 When operating at **Maximum Capacity** all **Type B Power Park Modules** must be capable of continuous operation at any points between the limits of 0.95 **Power Factor** lagging and 0.95 **Power Factor** leading at the **Grid Entry Point** or **User System Entry Point** unless otherwise agreed with **The Company** or relevant **Network Operator**. At **Active Power** output levels other than **Maximum Capacity**, each **Power Park Module** must be capable of continuous operation at any point between the **Reactive Power** capability limits identified on the **HV Generator Performance Chart** unless otherwise agreed with **The Company** or **Network Operator**.

ECC.6.3.2.3 Reactive Capability for Type C and D Synchronous Power Generating Modules

ECC.6.3.2.3.1 In addition to meeting the requirements of ECC.6.3.2.3.2 – ECC.6.3.2.3.5, **EU Generators** which connect a **Type C** or **Type D Synchronous Power Generating Module(s)** to a **Non Embedded Customers System** or private network, may be required to meet additional reactive compensation requirements at the point of connection between the **System** and the **Non Embedded Customer** or private network where this is required for **System** reasons.

ECC.6.3.2.3.2 All **Type C** and **Type D Synchronous Power Generating Modules** shall be capable of satisfying the **Reactive Power** capability requirements at the **Grid Entry Point** or **User System Entry Point** as defined in Figure ECC.6.3.2.3 when operating at **Maximum Capacity**.

ECC.6.3.2.3.3

At **Active Power** output levels other than **Maximum Capacity**, all **Generating Units** within a **Synchronous Power Generating Module** must be capable of continuous operation at any point between the **Reactive Power** capability limit identified on the **HV Generator Performance Chart** at least down to the **Minimum Stable Operating Level**. At reduced **Active Power** output, **Reactive Power** supplied at the **Grid Entry Point** (or **User System Entry Point if Embedded**) shall correspond to the **HV Generator Performance Chart** of the **Synchronous Power Generating Module**, taking the auxiliary supplies and the **Active Power** and **Reactive Power** losses of the **Generating Unit** transformer or **Station Transformer** into account.

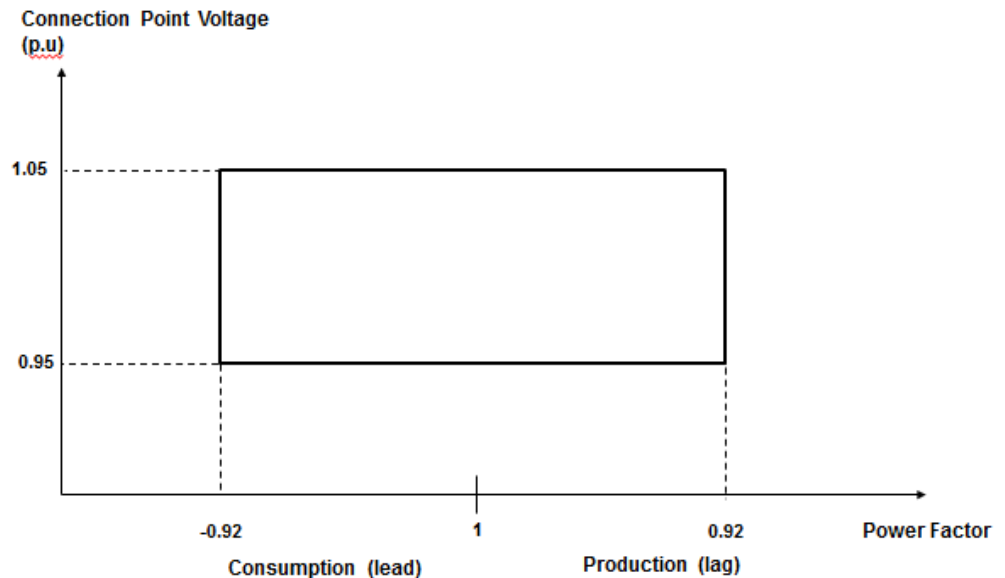

Figure ECC.6.3.2.3

ECC.6.3.2.3.4

In addition, to the requirements of ECC.6.3.2.3.1 – ECC.6.3.2.3.3 the short circuit ratio of all **Onshore Synchronous Generating Units** with an **Apparent Power** rating of less than 1600MVA shall not be less than 0.5. The short circuit ratio of **Onshore Synchronous Generating Units** with a rated **Apparent Power** of 1600MVA or above shall be not less than 0.4.

ECC.6.3.2.4

Reactive Capability for Type C and D Power Park Modules, HVDC Equipment and OTSDUW Plant and Apparatus at the Interface Point

ECC.6.3.2.4.1

EU Generators or **HVDC System Owners** which connect an **Onshore Type C** or **Onshore Type D Power Park Module** or **HVDC Equipment** to a **Non Embedded Customers System** or private network, may be required to meet additional reactive compensation requirements at the point of connection between the **System** and the **Non Embedded Customer** or private network where this is required for **System** reasons.

ECC.6.3.2.4.2

All **Onshore Type C Power Park Modules** and **Onshore Type D Power Park Modules** or **HVDC Converters** at an **HVDC Converter Station** with a **Grid Entry Point** or **User System Entry Point** voltage above 33kV, or **Remote End HVDC Converters** with an **HVDC Interface Point** voltage above 33kV, or **OTSDUW Plant and Apparatus** with an **Interface Point** voltage above 33kV shall be capable of satisfying the **Reactive Power** capability requirements at the **Grid Entry Point** or **User System Entry Point** (or **Interface Point** in the case of **OTSDUW Plant and Apparatus**, or **HVDC Interface Point** in the case of a **Remote End HVDC Converter Station**) as defined in Figure ECC.6.3.2.4(a) when operating at **Maximum Capacity** (or **Interface Point Capacity** in the case of **OTSUW Plant and Apparatus**). In the case of **Remote End HVDC Converters** and **DC Connected Power Park Modules**, **The Company** in co-ordination with the **Relevant Transmission Licensee** may agree to alternative reactive capability requirements to those specified in Figure ECC.6.3.2.4(a), where it is demonstrated that it is uneconomic and inefficient to do so, for example in the case of new technologies or advanced control strategies. For the avoidance of doubt, the requirements for **Offshore Power Park Modules** and **DC Connected Power Park Modules** are defined in ECC.6.3.2.5 and ECC.6.3.2.6.

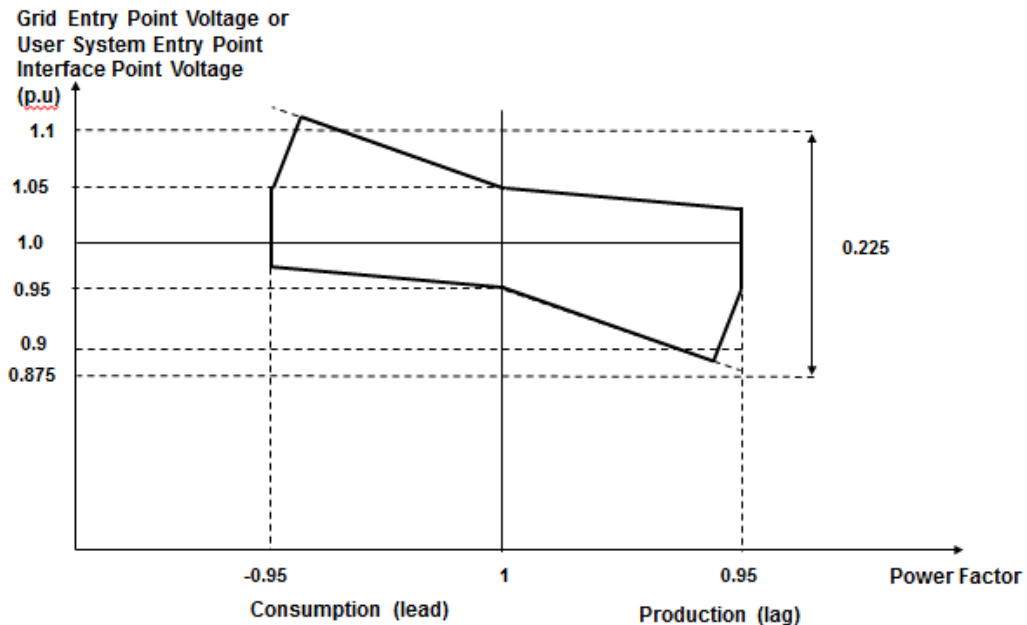

Figure ECC.6.3.2.4(a)

ECC.6.3.2.4.3

All **Onshore Type C** or **Type D Power Park Modules** or **HVDC Converters** at a **HVDC Converter Station** with a **Grid Entry Point** or **User System Entry Point** voltage at or below 33kV or **Remote End HVDC Converter Station** with an **HVDC Interface Point Voltage** at or below 33kV shall be capable of satisfying the **Reactive Power** capability requirements at the **Grid Entry Point** or **User System Entry Point** as defined in Figure ECC.6.3.2.4(b) when operating at **Maximum Capacity**. In the case of **Remote End HVDC Converters** **The Company** in co-ordination with the **Relevant Transmission Licensee** may agree to alternative reactive capability requirements to those specified in Figure ECC.6.3.2.4(b), where it is demonstrated that it is uneconomic and inefficient to do so, for example in the case of new technologies or advanced control strategies. For the avoidance of doubt, the requirements for **Offshore Power Park Modules** and **DC Connected Power Park Modules** are defined in ECC.6.3.2.5 and ECC.6.3.2.6.

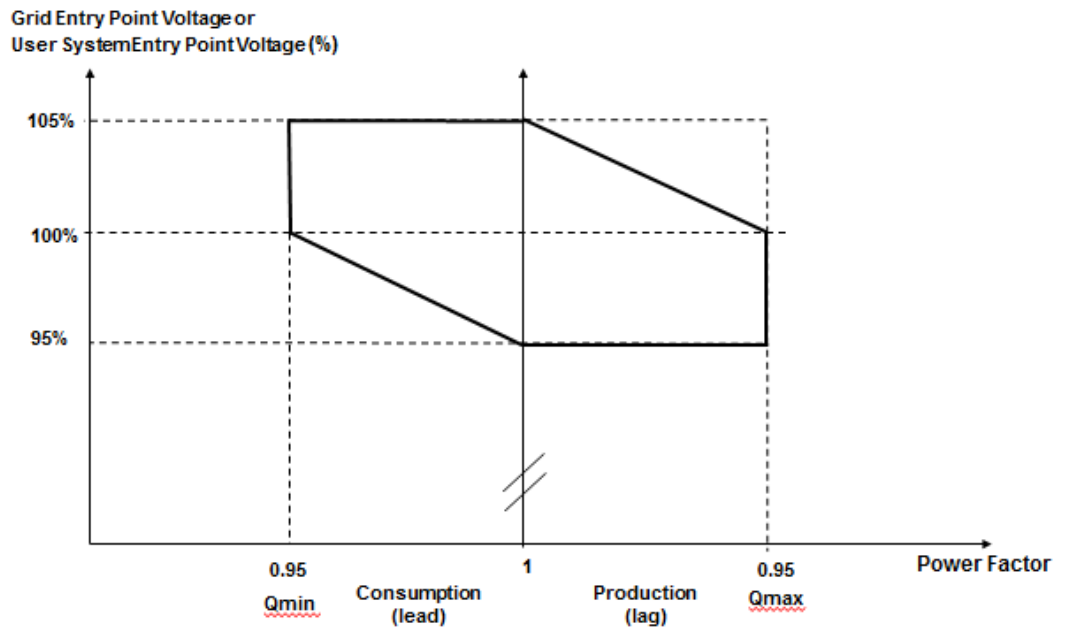

Figure ECC.6.3.2.4(b)

ECC.6.3.2.4.4 All **Type C** and **Type D Power Park Modules, HVDC Converters** at a **HVDC Converter Station** including **Remote End HVDC Converters** or **OTSDUW Plant and Apparatus**, shall be capable of satisfying the **Reactive Power** capability requirements at the **Grid Entry Point** or **User System Entry Point** (or **Interface Point Capacity** in the case of **OTSUW Plant and Apparatus** or **HVDC Interface Point** in the case of **Remote End HVDC Converter Stations**) as defined in Figure ECC.6.3.2.4(c) when operating below **Maximum Capacity**. With all **Plant** in service, the **Reactive Power** limits will reduce linearly below 50% **Active Power** output as shown in Figure ECC.6.3.2.4(c) unless the requirement to maintain the **Reactive Power** limits defined at **Maximum Capacity** (or **Interface Point Capacity** in the case of **OTSDUW Plant and Apparatus**) under absorbing **Reactive Power** conditions down to 20% **Active Power** output has been specified by **The Company**. These **Reactive Power** limits will be reduced pro rata to the amount of **Plant** in service. In the case of **Remote End HVDC Converters**, **The Company** in co-ordination with the **Relevant Transmission Licensee** may agree to alternative reactive capability requirements to those specified in Figure ECC.6.3.2.4(a), where it is demonstrated that it is uneconomic and inefficient to do so, for example in the case of new technologies or advanced control strategies. For the avoidance of doubt, the requirements for **Offshore Power Park Modules** and **DC Connected Power Park Modules** are defined in ECC.6.3.2.5 and ECC.6.3.2.6.

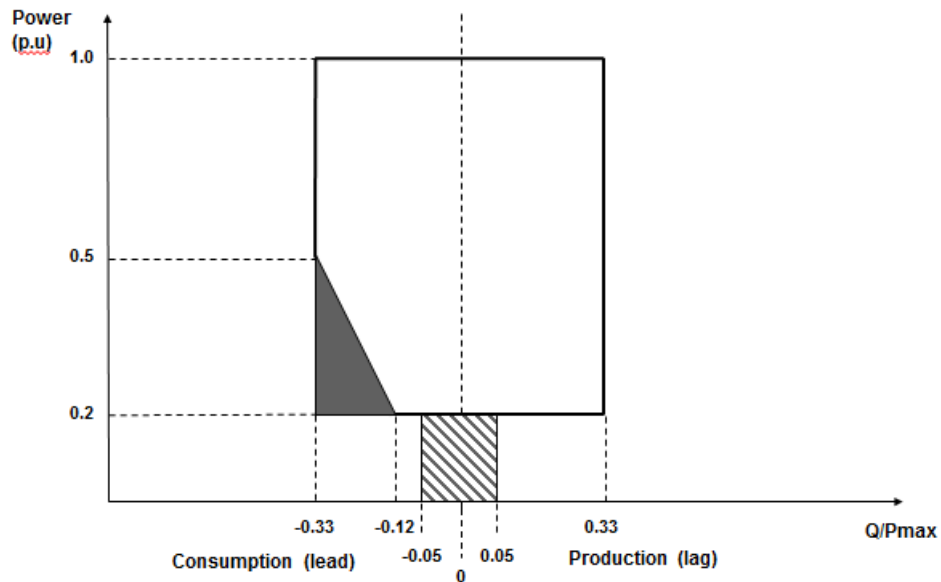

Figure ECC.6.3.2.4(c)

ECC.6.3.2.5 Reactive Capability for Offshore Synchronous Power Generating Modules, Configuration 1 AC connected Offshore Power Park Modules and Configuration 1 DC Connected Power Park Modules.

ECC.6.3.2.5.1 The short circuit ratio of any **Offshore Synchronous Generating Units** within a **Synchronous Power Generating Module** shall not be less than 0.5. All **Offshore Synchronous Generating Units, Configuration 1 AC connected Offshore Power Park Modules or Configuration 1 DC Connected Power Park Modules** must be capable of maintaining zero transfer of **Reactive Power** at the **Offshore Grid Entry Point**. The steady state tolerance on **Reactive Power** transfer to and from an **Offshore Transmission System** expressed in **MVar** shall be no greater than 5% of the **Maximum Capacity**.

ECC.6.3.2.5.2 For the avoidance of doubt if an **EU Generator** (including those in respect of **DC Connected Power Park Modules**) wishes to provide a **Reactive Power** capability in excess of the minimum requirements defined in ECC.6.3.2.5.1 then such capability (including steady state tolerance) shall be agreed between the **Generator, Offshore Transmission Licensee and The Company** and/or the relevant **Network Operator**.

ECC.6.3.2.6 Reactive Capability for Configuration 2 AC Connected Offshore Power Park Modules and Configuration 2 DC Connected Power Park Modules.

ECC.6.3.2.6.1 All **Configuration 2 AC connected Offshore Power Park Modules and Configuration 2 DC Connected Power Park Modules** shall be capable of satisfying the minimum **Reactive Power** capability requirements at the **Offshore Grid Entry Point** as defined in Figure ECC.6.3.2.6(a) when operating at **Maximum Capacity**. **The Company** in co-ordination with the **Relevant Transmission Licensee** may agree to alternative reactive capability requirements to those specified in Figure ECC.6.3.2.6(a), where it is demonstrated that it is uneconomic and inefficient to do so, for example in the case of new technologies or advanced control strategies.

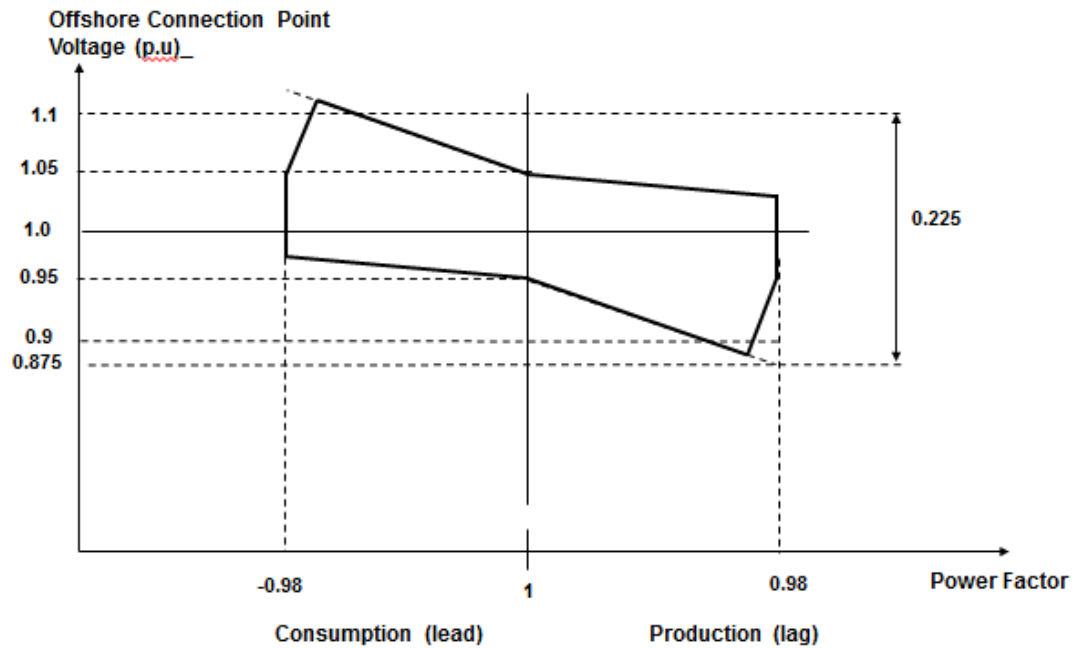

Figure ECC.6.3.2.6(a)

ECC.6.3.2.6.2 All **AC Connected Configuration 2 Offshore Power Park Modules** and **Configuration 2 DC Connected Power Park Modules** shall be capable of satisfying the **Reactive Power** capability requirements at the **Offshore Grid Entry Point** as defined in Figure ECC.6.3.2.6(b) when operating below **Maximum Capacity**. With all **Plant** in service, the **Reactive Power** limits will reduce linearly below 50% **Active Power** output as shown in Figure ECC.6.3.2.6(b) unless the requirement to maintain the **Reactive Power** limits defined at **Maximum Capacity** (or **Interface Point Capacity** in the case of **OTSDUW Plant and Apparatus**) under absorbing **Reactive Power** conditions down to 20% **Active Power** output has been specified with **The Company**. These **Reactive Power** limits will be reduced pro rata to the amount of **Plant** in service. **The Company** in co-ordination with the **Relevant Transmission Licensee** may agree to alternative reactive capability requirements to those specified in Figure ECC.6.3.2.6(b), where it is demonstrated that it is uneconomic and inefficient to do so, for example in the case of new technologies or advanced control strategies.

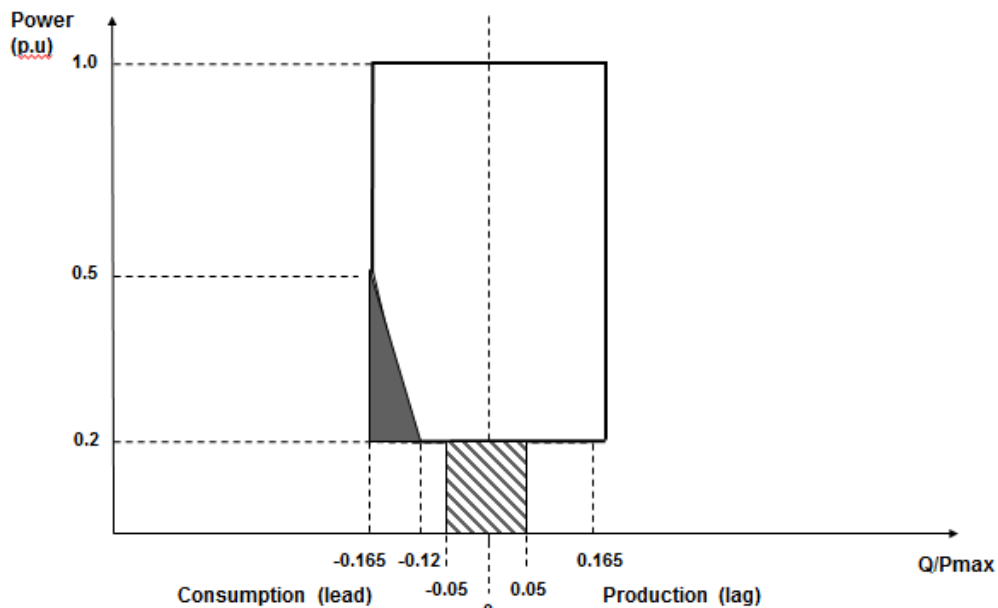

Figure ECC.6.3.2.6(b)

ECC.6.3.2.6.3 For the avoidance of doubt if an **EU Generator** (including **Generators** in respect of **DC Connected Power Park Modules** referred to in ECC.6.3.2.6.2) wishes to provide a **Reactive Power** capability in excess of the minimum requirements defined in ECC.6.3.2.6.1 then such capability (including any steady state tolerance) shall be between the **EU Generator, Offshore Transmission Licensee** and **The Company** and/or the relevant **Network Operator**.

ECC.6.3.3 OUTPUT POWER WITH FALLING FREQUENCY

ECC.6.3.3.1 Output power with falling frequency for **Power Generating Modules** and **HVDC Equipment**

ECC.6.3.3.1.1 Each **Power Generating Module** and **HVDC Equipment** must be capable of:

- (a) continuously maintaining constant **Active Power** output for **System Frequency** changes within the range 50.5 to 49.5 Hz; and
- (b) (subject to the provisions of ECC.6.1.2) maintaining its **Active Power** output at a level not lower than the figure determined by the linear relationship shown in Figure ECC.6.3.3(a) for **System Frequency** changes within the range 49.5 to 47 Hz for all ambient temperatures up to and including 25⁰C, such that if the **System Frequency** drops to 47 Hz the **Active Power** output does not decrease by more than 5%. In the case of a **CCGT Module**, the above requirement shall be retained down to the **Low Frequency Relay** trip setting of 48.8 Hz, which reflects the first stage of the **Automatic Low Frequency Demand Disconnection** scheme notified to **Network Operators** under OC6.6.2. For **System Frequency** below that setting, the existing requirement shall be retained for a minimum period of 5 minutes while **System Frequency** remains below that setting, and special measure(s) that may be required to meet this requirement shall be kept in service during this period. After that 5 minutes period, if **System Frequency** remains below that setting, the special measure(s) must be discontinued if there is a materially increased risk of the **Gas Turbine** tripping. The need for special measure(s) is linked to the inherent **Gas Turbine Active Power** output reduction caused by reduced shaft speed due to falling **System Frequency**. Where the need for special measures is identified in order to maintain output in line with the level identified in Figure ECC.6.3.3(a) these measures should be still continued at ambient temperatures above 25⁰C maintaining as much of the **Active Power** achievable within the capability of the plant. For the avoidance of doubt, **Generators** in respect of **Pumped Storage** shall also be required to satisfy the requirements of OC6.6.6.

Figure ECC.6.3.3(a) **Active Power** Output with falling frequency for **Power Generating Modules** and **HVDC Systems** and **Electricity Storage Modules** when operating in an exporting mode of operation

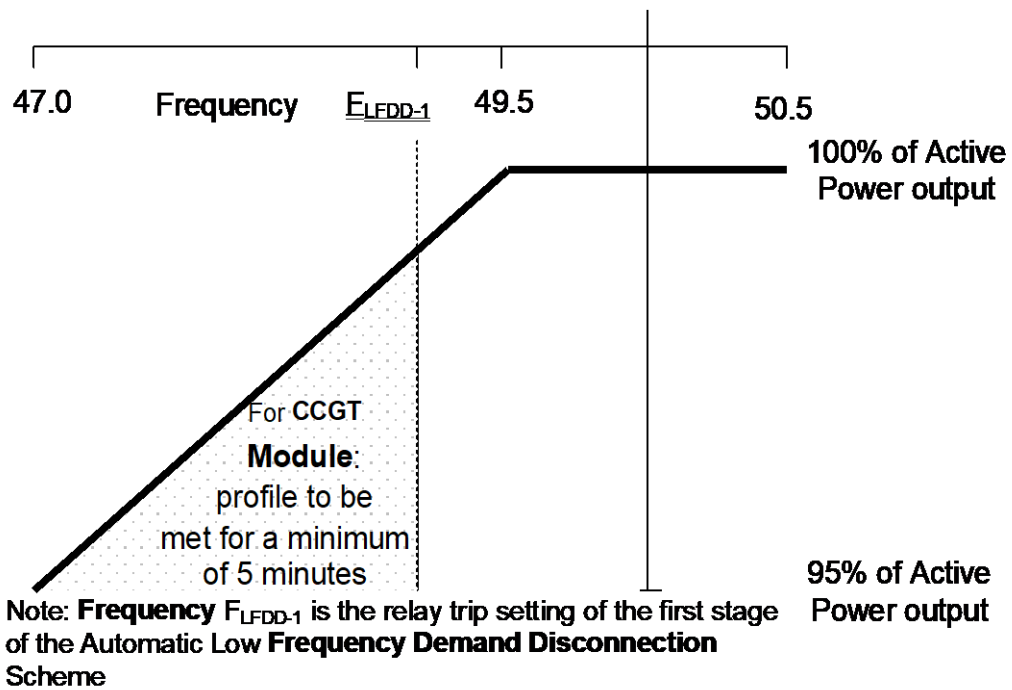

- (c) For the avoidance of doubt, in the case of a **Power Generating Module** including a **DC Connected Power Park Module** using an **Intermittent Power Source** where the mechanical power input will not be constant over time, the requirement is that the **Active Power** output shall be independent of **System Frequency** under (a) above and should not drop with **System Frequency** by greater than the amount specified in (b) above.
- (d) An **HVDC System** must be capable of maintaining its **Active Power** input (i.e. when operating in a mode analogous to **Demand**) from the **National Electricity Transmission System** (or **User System** in the case of an **Embedded HVDC System**) at a level not greater than the figure determined by the linear relationship shown in Figure ECC.6.3.3(b) for **System Frequency** changes within the range 49.5 to 47 Hz, such that if the **System Frequency** drops to 47.8 Hz the **Active Power** input decreases by more than 60%.

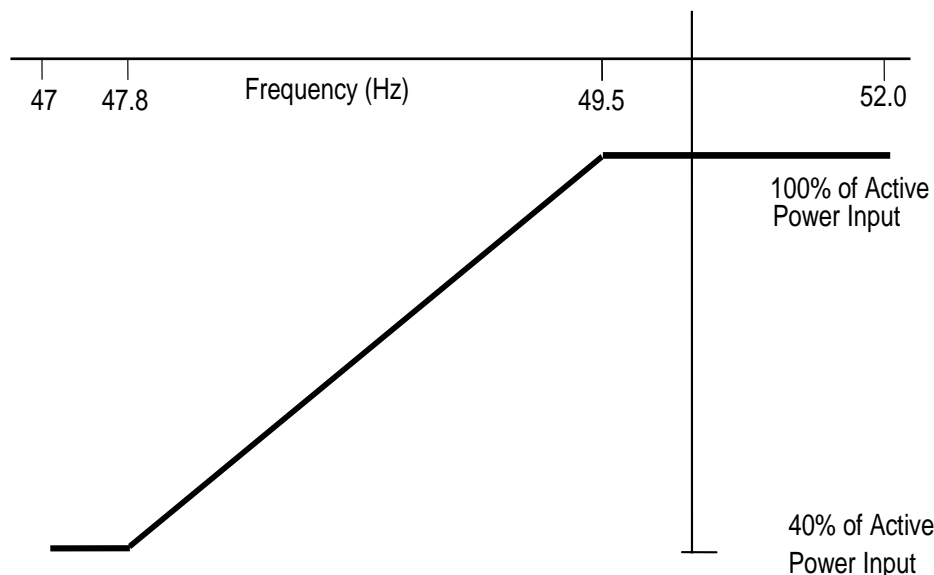

Figure ECC.6.3.3(b) **Active Power** input with falling frequency for **HVDC Systems**

- (e) In the case of an **Offshore Generating Unit** or **Offshore Power Park Module** or **DC Connected Power Park Module** or **Remote End HVDC Converter** or **Transmission DC Converter**, the **EU Generator** shall comply with the requirements of ECC.6.3.3. **EU Generators** should be aware that Section K of the **STC** places requirements on **Offshore Transmission Licensees** which utilise a **Transmission DC Converter** as part of their **Offshore Transmission System** to make appropriate provisions to enable **EU Generators** to fulfil their obligations.
- (f) **Transmission DC Converters** and **Remote End HVDC Converters** shall provide a continuous signal indicating the real time frequency measured at the **Interface Point** to the **Offshore Grid Entry Point** or **HVDC Interface Point** for the purpose of **Offshore Generators** or **DC Connected Power Park Modules** to respond to changes in **System Frequency** on the Main Interconnected **Transmission System**. A **DC Connected Power Park Module** or **Offshore Power Generating Module** shall be capable of receiving and processing this signal within 100ms.

ECC.6.3.4 ACTIVE POWER OUTPUT UNDER SYSTEM VOLTAGE VARIATIONS

ECC.6.3.4.1 At the **Grid Entry Point** or **User System Entry Point**, the **Active Power** output under steady state conditions of any **Power Generating Module** or **HVDC Equipment** directly connected to the **National Electricity Transmission System** or in the case of **OTSDUW**, the **Active Power** transfer at the **Interface Point**, under steady state conditions of any **OTSDUW Plant and Apparatus** should not be affected by voltage changes in the normal operating range specified in paragraph ECC.6.1.4 by more than the change in **Active Power** losses at reduced or increased voltage.

ECC.6.3.5 BLACK START

ECC.6.3.5.1 **Black Start** is not a mandatory requirement, however **EU Code Users** may wish to notify **The Company** of their ability to provide a **Black Start** facility and the cost of the service. **The Company** will then consider whether it wishes to contract with the **EU Code User** for the provision of a **Black Start** service which would be specified via a **Black Start Contract**. Where an **EU Code User** does not offer to provide a cost for the provision of a **Black Start Capability**, **The Company** may make such a request if it considers **System** security to be at risk due to a lack of **Black Start** capability.

ECC.6.3.5.2 It is an essential requirement that the **National Electricity Transmission System** must incorporate a **Black Start Capability**. This will be achieved by agreeing a **Black Start Capability** at a number of strategically located **Power Stations** and **HVDC Systems**. For each **Power Station** or **HVDC System**, **The Company** will state in the **Bilateral Agreement** whether or not a **Black Start Capability** is required.

ECC.6.3.5.3 Where an **EU Code User** has entered into a **Black Start Contract** to provide a **Black Start Capability** in respect of a **Type C Power Generating Module** or **Type D Power Generating Module** (including **DC Connected Power Park Modules**) the following requirements shall apply.

- (i) The **Power-Generating Module** or **DC Connected Power Park Module** shall be capable of starting from shutdown without any external electrical energy supply within a time frame specified by **The Company** in the **Black Start Contract**.
- (ii) Each **Power Generating Module** or **DC Connected Power Park Module** shall be able to synchronise within the frequency limits defined in ECC.6.1. and, where applicable, voltage limits specified in ECC.6.1.4;
- (iii) The **Power Generating Module** or **DC Connected Power Park Module** shall be capable of connecting on to an unenergised **System**.
- (iv) The **Power-Generating Module** or **DC Connected Power Park Module** shall be capable of automatically regulating dips in voltage caused by connection of demand;
- (v) The **Power Generating Module** or **DC Connected Power Park Module** shall:
 - be capable of **Block Load Capability**,

be capable of operating in **LFSM-O** and **LFSM-U**, as specified in ECC.6.3.7.1 and ECC.6.3.7.2

control **Frequency** in case of overfrequency and underfrequency within the whole **Active Power** output range between the **Minimum Regulating Level** and **Maximum Capacity** as well as at houseload operation levels

be capable of parallel operation of a few **Power Generating Modules** including **DC Connected Power Park Modules** within an isolated part of the **Total System** that is still supplying **Customers**, and control voltage automatically during the system restoration phase;

- (vi) **Power Park Modules** (including **DC Connected Power Park Modules**) and **HVDC Equipment** which provide a **Black Start Capability**, shall also be capable of satisfying the **Grid Forming Capability** requirements defined in ECC.6.3.19.

ECC.6.3.5.4 Each **HVDC System** or **Remote End HVDC Converter Station** which has a **Black Start Capability** shall be capable of energising the busbar of an AC substation to which the another **HVDC Converter Station** is connected. The timeframe after shutdown of the **HVDC System** prior to energisation of the AC substation shall be pursuant to the terms of the **Black Start Contract**. The **HVDC System** shall be able to synchronise within the **Frequency** limits defined in ECC.6.1.2.1.2 and voltage limits defined in ECC.6.1.4.1 unless otherwise specified in the **Black Start Contract**. Wider **Frequency** and voltage ranges can be specified in the **Black Start Contract** in order to restore **System** security.

ECC.6.3.5.5 With regard to the capability to take part in operation of an isolated part of the **Total System** that is still supplying **Customers**:

(b) **Power Generating Modules** including **DC Connected Power Park Modules** shall be capable of taking part in island operation if specified in the **Black Start Contract** required by **The Company** and:

the **Frequency** limits for island operation shall be those specified in ECC.6.1.2,

the voltage limits for island operation shall be those defined in ECC.6.1.4;

- (i) **Power Generating Modules** including **DC Connected Power Park Modules** shall be able to operate in **Frequency Sensitive Mode** during island operation, as specified in ECC.6.3.7.3. In the event of a power surplus, **Power Generating Modules** including **DC Connected Power Park Modules** shall be capable of reducing the **Active Power** output from a previous operating point to any new operating point within the **Power Generating Module Performance Chart**. **Power Generating Modules** including **DC Connected Power Park Modules** shall be capable of reducing **Active Power** output as much as inherently technically feasible, but to at least 55 % of **Maximum Capacity**;
- (iii) The method for detecting a change from interconnected system operation to island operation shall be agreed between the **EU Generator**, **The Company** and the **Relevant Transmission Licensee**. The agreed method of detection must not rely solely on **The Company**, **Relevant Transmission Licensee's** or **Network Operators** switchgear position signals;
- (iv) **Power Generating Modules** including **DC Connected Power Park Modules** shall be able to operate in **LFSM-O** and **LFSM-U** during island operation, as specified in ECC.6.3.7.1 and ECC.6.3.7.2;

ECC.6.3.5.6 With regard to quick re-synchronisation capability:

- (b) In case of disconnection of the **Power Generating Module** including **DC Connected Power Park Modules** from the **System**, the **Power Generating Module** shall be capable of quick re-synchronisation in line with the **Protection** strategy agreed between **The Company** and/or **Network Operator** in co-ordination with the **Relevant Transmission Licensee** and the **Generator**;

- (i) A **Power Generating Module** including a **DC Connected Power Park Module** with a minimum re-synchronisation time greater than 15 minutes after its disconnection from any external power supply must be capable of **Houseload Operation** from any operating point on its **Power Generating Module Performance Chart**. In this case, the identification of **Houseload Operation** must not be based solely on the **Total System's** switchgear position signals;
- (ii) **Power Generating Modules** including **DC Connected Power Park Modules** shall be capable of **Houseload Operation**, irrespective of any auxiliary connection to the **Total System**. The minimum operation time shall be specified by **The Company**, taking into consideration the specific characteristics of prime mover technology.

ECC.6.3.6 CONTROL ARRANGEMENTS

ECC.6.3.6.1 ACTIVE POWER CONTROL

ECC.6.3.6.1.1 Active Power control in respect of Power Generating Modules including DC Connected Power Park Modules

ECC.6.3.6.1.1.1 **Type A Power Generating Modules** shall be equipped with a logic interface (input port) in order to cease **Active Power** output within five seconds following receipt of a signal from **The Company**. **The Company** shall specify the requirements for such facilities, including the need for remote operation, in the **Bilateral Agreement** where they are necessary for **System** reasons .

ECC.6.3.6.1.1.2 **Type B Power Generating Modules** shall be equipped with an interface (input port) in order to be able to reduce **Active Power** output following receipt of a signal from **The Company**. **The Company** shall specify the requirements for such facilities, including the need for remote operation, in the **Bilateral Agreement** where they are necessary for **System** reasons.

ECC.6.3.6.1.1.3 **Type C and Type D Power Generating Modules and DC Connected Power Park Modules** shall be capable of adjusting the **Active Power** setpoint in accordance with instructions issued by **The Company**.

ECC.6.3.6.1.2 Active Power control in respect of HVDC Systems and Remote End HVDC Converter Stations

ECC.6.3.6.1.2.1 **HVDC Systems** shall be capable of adjusting the transmitted **Active Power** upon receipt of an instruction from **The Company** which shall be in accordance with the requirements of BC2.6.1.

ECC.6.3.6.1.2.2 The requirements for fast **Active Power** reversal (if required) shall be specified by **The Company**. Where **Active Power** reversal is specified in the **Bilateral Agreement**, each **HVDC System** and **Remote End HVDC Converter Station** shall be capable of operating from maximum import to maximum export in a time which is as fast as technically feasible or in a time that is no greater than 2 seconds except where a **HVDC Converter Station Owner** has justified to **The Company** that a longer reversal time is required.

ECC.6.3.6.1.2.3 Where an **HVDC System** connects various **Control Areas** or **Synchronous Areas**, each **HVDC System** or **Remote End HVDC Converter Station** shall be capable of responding to instructions issued by **The Company** under the **Balancing Code** to modify the transmitted **Active Power** for the purposes of cross-border balancing.

ECC.6.3.6.1.2.4 An **HVDC System** shall be capable of adjusting the ramping rate of **Active Power** variations within its technical capabilities in accordance with instructions issued by **The Company** . In case of modification of **Active Power** according to ECC.6.3.15 and ECC.6.3.6.1.2.2, there shall be no adjustment of ramping rate.

ECC.6.3.6.1.2.5 If specified by **The Company**, in coordination with the **Relevant Transmission Licensees**, the control functions of an **HVDC System** shall be capable of taking automatic remedial actions including, but not limited to, stopping the ramping and blocking FSM, LFSM-O, LFSM-U and **Frequency** control. The triggering and blocking criteria shall be specified by **The Company**.

ECC.6.3.6.2 MODULATION OF ACTIVE POWER

ECC.6.3.6.2.1 Each **Power Generating Module** (including **DC Connected Power Park Modules**) and **Onshore HVDC Converters** at an **Onshore HVDC Converter Station** must be capable of contributing to **Frequency** control by continuous modulation of **Active Power** supplied to the **National Electricity Transmission System**. For the avoidance of doubt each **Onshore HVDC Converter** at an **Onshore HVDC Converter Station** and/or **OTSDUW DC Converter** shall provide each **EU Code User** in respect of its **Offshore Power Stations** connected to and/or using an **Offshore Transmission System** a continuous signal indicating the real time **Frequency** measured at the **Transmission Interface Point**. A **DC Connected Power Park Module** or **Offshore Power Generating Module** shall be capable of receiving and processing this signal within 100ms.

ECC.6.3.6.3 MODULATION OF REACTIVE POWER

ECC.6.3.6.3.1 Notwithstanding the requirements of ECC.6.3.2, each **Power Generating Module** or **HVDC Equipment** (and **OTSDUW Plant and Apparatus** at a **Transmission Interface Point** and **Remote End HVDC Converter** at an **HVDC Interface Point**) (as applicable) must be capable of contributing to voltage control by continuous changes to the **Reactive Power** supplied to the **National Electricity Transmission System** or the **User System** in which it is **Embedded**.

ECC.6.3.7 FREQUENCY RESPONSE

ECC.6.3.7.1 Limited Frequency Sensitive Mode – Overfrequency (LFSM-O)

ECC.6.3.7.1.1 Each **Power Generating Module** (including **DC Connected Power Park Modules**) and **HVDC Systems** shall be capable of reducing **Active Power** output in response to **Frequency** on the **Total System** when this rises above 50.4Hz. For the avoidance of doubt, the provision of this reduction in **Active Power** output is not an **Ancillary Service**. Such provision is known as **Limited High Frequency Response**. The **Power Generating Module** (including **DC Connected Power Park Modules**) or **HVDC Systems** shall be capable of operating stably during **LFSM-O** operation. However for a **Power Generating Module** (including **DC Connected Power Park Modules**) or **HVDC Systems** operating in **Frequency Sensitive Mode** the requirements of **LFSM-O** shall apply when the frequency exceeds 50.5Hz.

- ECC.6.3.7.1.2
- (i) The rate of change of **Active Power** output must be at a minimum a rate of 2 percent of output per 0.1 Hz deviation of **System Frequency** above 50.4Hz (ie a **Droop** of 10%) as shown in Figure ECC.6.3.7.1 below. This would not preclude a **EU Generator** or **HVDC System Owner** from designing their **Power Generating Module** with a **Droop** of less than 10% but in all cases the **Droop** should be 2% or greater.
 - (ii) The reduction in **Active Power** output must be continuously and linearly proportional, as far as is practicable, to the excess of **Frequency** above 50.4 Hz and must be provided increasingly with time over the period specified in (iii) below.
 - (iii) As much as possible of the proportional reduction in **Active Power** output must result from the frequency control device (or speed governor) action and must be achieved within 10 seconds of the time of the **Frequency** increase above 50.4 Hz. The **Power Generating Module** (including **DC Connected Power Park Modules**) or **HVDC Systems** shall be capable of initiating a power **Frequency** response with an initial delay that is as short as possible. If the delay exceeds 2 seconds the **EU Generator** or **HVDC System Owner** shall justify the variation, providing technical evidence to **The Company**.
 - (iii) The residue of the proportional reduction in **Active Power** output which results from automatic action of the **Power Generating Module** (including **DC Connected Power**

Park Modules) or **HVDC System** output control devices other than the frequency control devices (or speed governors) must be achieved within 3 minutes for the time of the **Frequency** increase above 50.4Hz.

- (iv) For the avoidance of doubt, the **LFSM-O** response must be reduced when the **Frequency** falls again and, when to a value less than 50.4Hz, as much as possible of the increase in **Active Power** must be achieved within 10 seconds.
- (v) For **Type A** and **Type B Power Generating Modules** which are not required to have **Frequency Sensitive Mode (FSM)** as described in ECC.6.3.7.3 for deviations in **Frequency** up to 50.9Hz at least half of the proportional reduction in **Active Power** output must be achieved in 10 seconds of the time of the **Frequency** increase above 50.4Hz. For deviations in **Frequency** beyond 50.9Hz the measured rate of change of **Active Power** reduction must exceed 0.5%/sec of the initial output. The **LFSM-O** response must be reduced when the **Frequency** subsequently falls again and when to a value less than 50.4Hz, at least half the increase in **Active Power** must be achieved in 10 seconds. For a **Frequency** excursion returning from beyond 50.9Hz the measured rate of change of **Active Power** increase must exceed 0.5%/second.

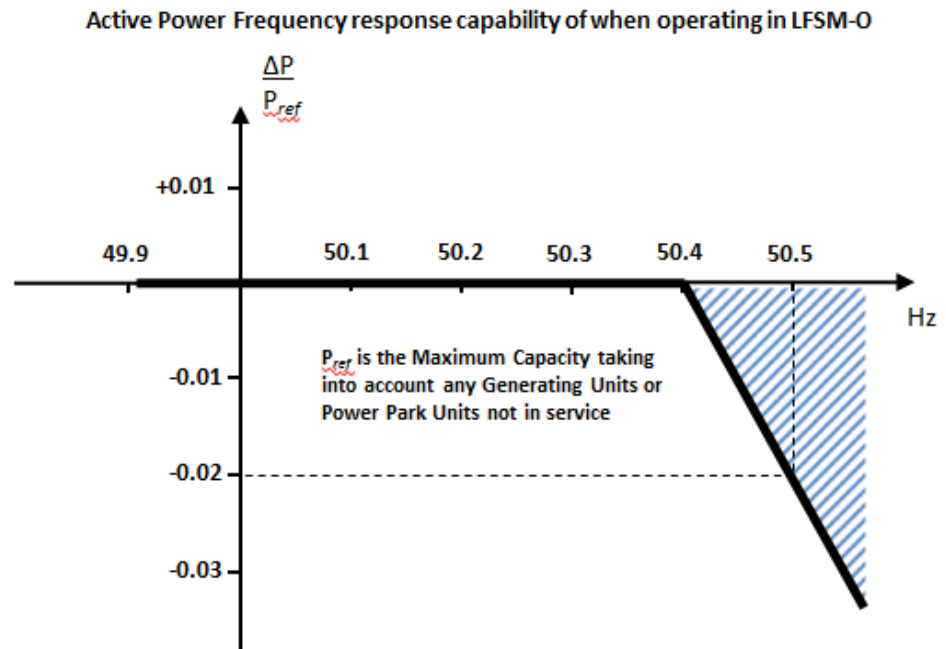

Figure ECC.6.3.7.1 – P_{ref} is the reference **Active Power** to which ΔP is related and ΔP is the change in **Active Power** output from the **Power Generating Module** (including **DC Connected Power Park Modules**) or **HVDC System**. The **Power Generating Module** (including **DC Connected Power Park Modules** or **HVDC Systems**) has to provide a negative **Active Power** output change with a droop of 10% or less based on P_{ref} .

ECC.6.3.7.1.3 Each **Power Generating Module** (including **DC Connected Power Park Modules**) or **HVDC Systems** which is providing **Limited High Frequency Response (LFSM-O)** must continue to provide it until the **Frequency** has returned to or below 50.4Hz or until otherwise instructed by **The Company**. **EU Generators** in respect of **Gensets** and **HVDC Converter Station Owners** in respect of an **HVDC System** should also be aware of the requirements in BC.3.7.2.2.

ECC.6.3.7.1.4 Steady state operation below the **Minimum Stable Operating Level** in the case of **Power Generating Modules** including **DC Connected Power Park Modules** or **Minimum Active Power Transmission Capacity** in the case of **HVDC Systems** is not expected but if **System** operating conditions cause operation below the **Minimum Stable Operating Level** or **Minimum Active Power Transmission Capacity** which could give rise to operational

difficulties for the **Power Generating Module** including a **DC Connected Power Park Module** or **HVDC Systems** then the **EU Generator** or **HVDC System Owner** shall be able to return the output of the **Power Generating Module** including a **DC Connected Power Park Module** to an output of not less than the **Minimum Stable Operating Level** or **HVDC System** to an output of not less than the **Minimum Active Power Transmission Capacity**.

ECC.6.3.7.1.5 All reasonable efforts should in the event be made by the **EU Generator** or **HVDC System Owner** to avoid such tripping provided that the **System Frequency** is below 52Hz in accordance with the requirements of ECC.6.1.2. If the **System Frequency** is at or above 52Hz, the requirement to make all reasonable efforts to avoid tripping does not apply and the **EU Generator** or **HVDC System Owner** is required to take action to protect its **Power Generating Modules** including **DC Connected Power Park Modules** or **HVDC Converter Stations**.

ECC.6.3.7.2 Limited Frequency Sensitive Mode – Underfrequency (LFSM-U)

ECC.6.3.7.2.1 Each **Type C Power Generating Module** and **Type D Power Generating Module** (including **DC Connected Power Park Modules**) or **HVDC Systems** operating in **Limited Frequency Sensitive Mode** shall be capable of increasing **Active Power** output in response to **System Frequency** when this falls below 49.5Hz. For the avoidance of doubt, the provision of this increase in **Active Power** output is not a mandatory **Ancillary Service** and it is not anticipated **Power Generating Modules** (including **DC Connected Power Park Modules**) or **HVDC Systems** are operated in an inefficient mode to facilitate delivery of **LFSM-U** response, but any inherent capability (where available) should be made without undue delay. The **Power Generating Module** (including **DC Connected Power Park Modules**) or **HVDC Systems** shall be capable of stable operation during **LFSM-U Mode**. For example, a **EU Generator** which is operating with no headroom (eg it is operating at maximum output or is de-loading as part of a run down sequence and has no headroom) would not be required to provide **LFSM-U**.

ECC.6.3.7.2.2 (i) The rate of change of **Active Power** output must be at a minimum a rate of 2 percent of output per 0.1 Hz deviation of **System Frequency** below 49.5Hz (ie a **Droop** of 10%) as shown in Figure ECC.6.3.7.2.2 below. This requirement only applies if the **Power Generating Module** has headroom and the ability to increase **Active Power** output. In the case of a **Power Park Module** or **DC Connected Power Park Module** the requirements of Figure ECC.6.3.7.2.2 shall be reduced pro-rata to the amount of **Power Park Units** in service and available to generate. For the avoidance of doubt, this would not preclude an **EU Generator** or **HVDC System Owner** from designing their **Power Generating Module** with a lower **Droop** setting, for example between 3 – 5%.

(ii) As much as possible of the proportional increase in **Active Power** output must result from the **Frequency** control device (or speed governor) action and must be achieved for **Frequencies** below 49.5 Hz. The **Power Generating Module** (including **DC Connected Power Park Modules**) or **HVDC Systems** shall be capable of initiating a power **Frequency** response with minimal delay. If the delay exceeds 2 seconds the **EU Generator** or **HVDC System Owner** shall justify the delay, providing technical evidence to **The Company**).

(iii) The actual delivery of **Active Power Frequency Response** in **LFSM-U** mode shall take into account

The ambient conditions when the response is to be triggered

The operating conditions of the **Power Generating Module** (including **DC Connected Power Park Modules**) or **HVDC Systems** in particular limitations on operation near **Maximum Capacity** or **Maximum HVDC Active Power Transmission Capacity** at low frequencies and the respective impact of ambient conditions as detailed in ECC.6.3.3.

The availability of primary energy sources.

- (iv) In **LFSM_U Mode**, the **Power Generating Module** (including **DC Connected Power Park Modules**) and **HVDC Systems**, shall be capable of providing a power increase up to its **Maximum Capacity** or **Maximum HVDC Active Power Transmission Capacity** (as applicable).

Active Power Frequency response capability of when operating in LFSM-U

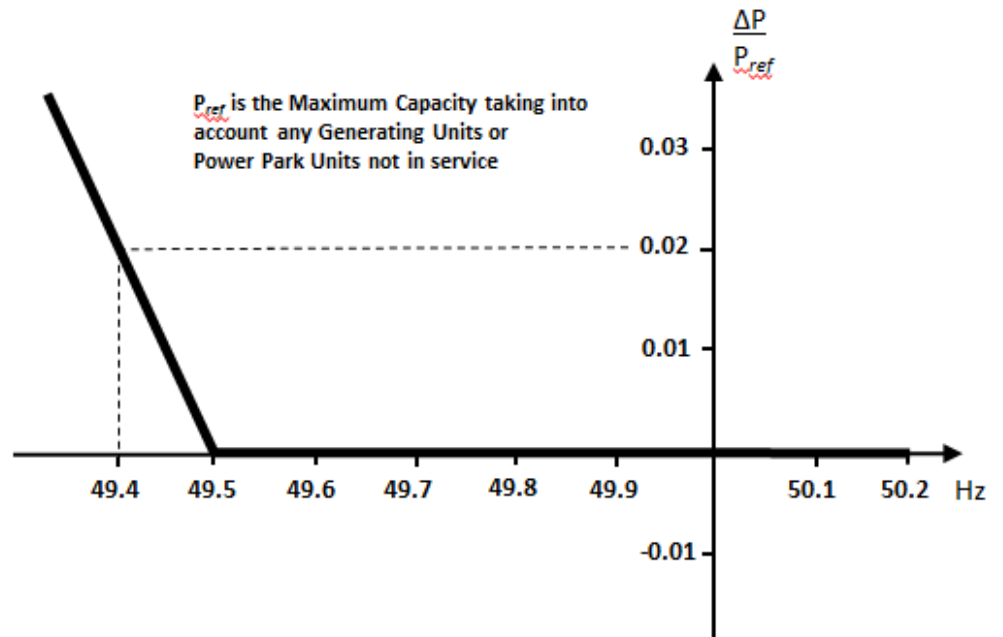

Figure ECC.6.3.7.2.2 – P_{ref} is the reference **Active Power** to which ΔP is related and ΔP is the change in **Active Power** output from the **Power Generating Module** (including **DC Connected Power Park Modules**) or **HVDC System**. The **Power Generating Module** (including **DC Connected Power Park Modules** or **HVDC Systems**) has to provide a positive **Active Power** output change with a droop of 10% or less based on P_{ref} .

ECC.6.3.7.2.3 Limited Frequency Sensitive Mode Electricity Storage Modules when operating in an importing mode of operation

ECC.6.3.7.2.3.1 Each **Generator** or **Defence Service Provider** or **Restoration Service Provider** or **Non-Embedded Customer** in respect of an **Electricity Storage Module** is required to meet the requirements of ECC.6.3.7.2.3.1 (a) – (f) except where it has been agreed with **The Company** that such an **Electricity Storage Module** is unable to meet these requirements in which case the requirements of OC6.6.6 shall apply:-

- (a) Be capable of automatically maintaining its **Active Power** output within the shaded operating region shown in Figure ECC.6.3.7.2.3(a) until the stored energy has been depleted, except in the case where the **Black Start Service Provider** or **Restoration Service Provider** has a **Black Start Contract** in which case the stored energy shall not be depleted below the level required to meet the contractual obligations of their **Black Start Contract**. The **Electricity Storage Module** could initially be operating at any level of import between zero **Active Power** and the **Maximum Import Power** within a **System Frequency** range of 50Hz and 49.5Hz as shown in Figure ECC.6.3.7.2.3(a). For the avoidance of doubt, the **Electricity Storage Module** would only be required to reach its **Maximum Capacity** if the **Electricity Storage Module** has headroom and the ability to increase **Active Power** output. A typical value of the **Droop** would be 0.6% where this does not result in control system instability or plant difficulties. In all cases the **Droop** shall be between 0.6% and 1.2% and shall be agreed with **The Company**.

- (b) Automatically respond in accordance with the characteristic of Figure ECC.6.3.7.2.3(a) when the **System Frequency** falls to 49.5Hz and below.
- (c) The reduction in **Active Power** import (during an import mode of operation), and the transition to the final value of **Active Power** output shall be continuously and linearly proportional, as far as is practicable, to the reduction in **Frequency** below 49.5 Hz. **Active Power** output must be provided increasingly with time as required by ECC.6.3.7.2.3.1 (d) below.
- (d) As much as possible of the proportional reduction in **Active Power** import (when the **Electricity Storage Module** is in a mode analogous to **Demand**) must result from the **Frequency** control device (or speed governor) action and must be achieved within 10 seconds of the time of the **Frequency** decreases below 49.5 Hz. The **Electricity Storage Module** shall be capable of initiating a power **Frequency** response with an initial delay that is as short as possible. Delays that exceed 2 seconds shall be justified by the **Generator** or **Defence Service Provider** or **Restoration Service Provider** or **Non-Embedded Customer** providing technical evidence to **The Company** and in any event as much as possible of the proportional reduction in **Active Power** import shall be achieved within 10 seconds. This performance requirement is to be maintained when the **Electricity Storage Module** makes the transition to an **Active Power** export mode of operation unless the energy store is depleted, in which case it shall be required to operate at zero **Active Power** output.
- (e) Where the **Electricity Storage Module** is not capable of making a transition from import operation to export operation within 20 seconds of the **System Frequency** falling to 49.2Hz, then it shall then immediately reduce its **Active Power** import to zero.
- (f) If the **Electricity Storage Module** has not achieved at least a zero **Active Power** import when the **System Frequency** has reached 48.9Hz, it shall be instantaneously tripped. Where a **Electricity Storage Module** trips, it shall not be permitted to reconnect to the **System** until instructed by **The Company** in accordance with BC2.5.2 and as provided for in ECC.6.2.2.11.

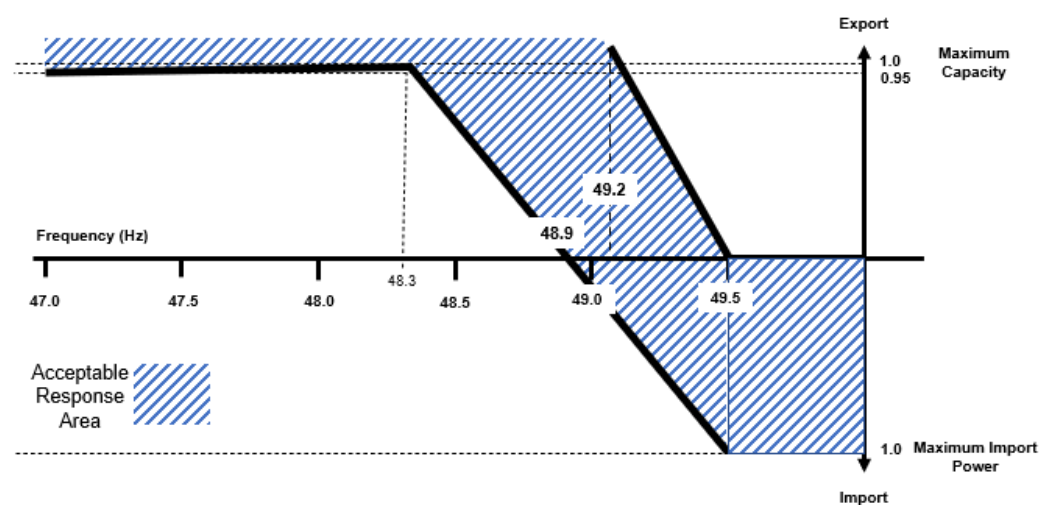

Figure ECC.6.3.7.2.3(a) **Active Power** performance with falling frequency

ECC.6.3.7.2.3.2 Where an **Electricity Storage Module** has been importing and has responded in accordance with the requirements of ECC.6.3.7.2.3.1, its performance, once the **System Frequency** starts to rise above the minimum reached, shall be in accordance with Figure ECC.6.3.7.2.3(b) in respect of the **Active Power** output and **Active Power** import. For example, Figure ECC.6.3.7.2.3(b), illustrates the four operating points W, X, Y and Z. If points W, X, Y and Z denotes the minimum frequency that the **Total System** reached during a particular low **System Frequency** event, as the **System Frequency** starts to rise, the **Active Power** output of the **Electricity Storage Module** should remain at a constant level (where the energy source has not been depleted) until 49.5Hz is reached as denoted by the dashed black lines. Once the **System Frequency** has risen above 49.5Hz the **Electricity Storage Module** is permitted to reduce **Active Power** output so long as it operates within the shaded area above 49.5Hz shown in Figure ECC.6.3.7.2.3(b), unless the **Electricity Storage Module** has insufficient capability in which case it shall operate at zero **Active Power**

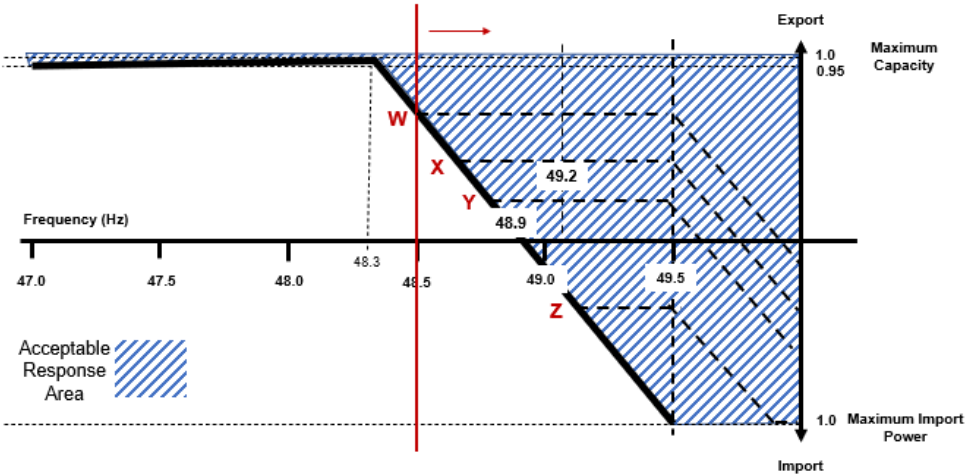

Figure ECC.6.3.7.2.3(b) **Active Power** performance with increasing frequency

ECC.6.3.7.2.3.3 Where an **Electricity Storage Module** is exporting **Active Power** to the **Total System** (including zero) and the **System Frequency** falls below 49.5Hz the requirements of ECC.6.3.7.2.1 and ECC.6.3.7.2.2 shall apply.

ECC.6.3.7.3 Frequency Sensitive Mode – (FSM)

ECC.6.3.7.3.1 In addition to the requirements of ECC.6.3.7.1 and ECC.6.3.7.2 each **Type C Power Generating Module** and **Type D Power Generating Module** (including **DC Connected Power Park Modules**) or **HVDC Systems** must be fitted with a fast acting proportional **Frequency** control device (or turbine speed governor) and unit load controller or equivalent control device to provide **Frequency** response under normal operational conditions in accordance with **Balancing Code 3 (BC3)**. In the case of a **Power Park Module** including a **DC Connected Power Park Module**, the **Frequency** or speed control device(s) may be on the **Power Park Module** (including a **DC Connected Power Park Module**) or on each individual **Power Park Unit** (including a **Power Park Unit** within a **DC Connected Power Park Module**) or be a combination of both. The **Frequency** control device(s) (or speed governor(s)) must be designed and operated to the appropriate:

- (i) **European Specification:** or

- (ii) in the absence of a relevant **European Specification**, such other standard which is in common use within the European Community (which may include a manufacturer specification);

as at the time when the installation of which it forms part was designed or (in the case of modification or alteration to the **Frequency** control device (or turbine speed governor)) when the modification or alteration was designed.

The **European Specification** or other standard utilised in accordance with sub paragraph ECC.6.3.7.3.1 (a) (ii) will be notified to **The Company** by the **EU Generator** or **HVDC System Owner**:

- (i) as part of the application for a **Bilateral Agreement**; or
- (ii) as part of the application for a varied **Bilateral Agreement**; or
- (iii) in the case of an Embedded Development, within 28 days of entry into the Embedded Development Agreement (or such later time as agreed with **The Company**) or
- (iv) as soon as possible prior to any modification or alteration to the **Frequency** control device (or governor); and

ECC.6.3.7.3.2 The **Frequency** control device (or speed governor) in co-ordination with other control devices must control each **Type C Power Generating Module** and **Type D Power Generating Module** (including **DC Connected Power Park Modules**) or **HVDC Systems Active Power Output** or **Active Power** transfer capability with stability over the entire operating range of the **Power Generating Module** (including **DC Connected Power Park Modules**) or **HVDC Systems** ; and

ECC.6.3.7.3.3 **Type C** and **Type D Power Generating Modules** and **DC Connected Power Park Modules** shall also meet the following minimum requirements:

- (i) capable of providing **Active Power Frequency** response in accordance with the performance characteristic shown in Figure 6.3.7.3.3(a) and parameters in Table 6.3.7.3.3(a)

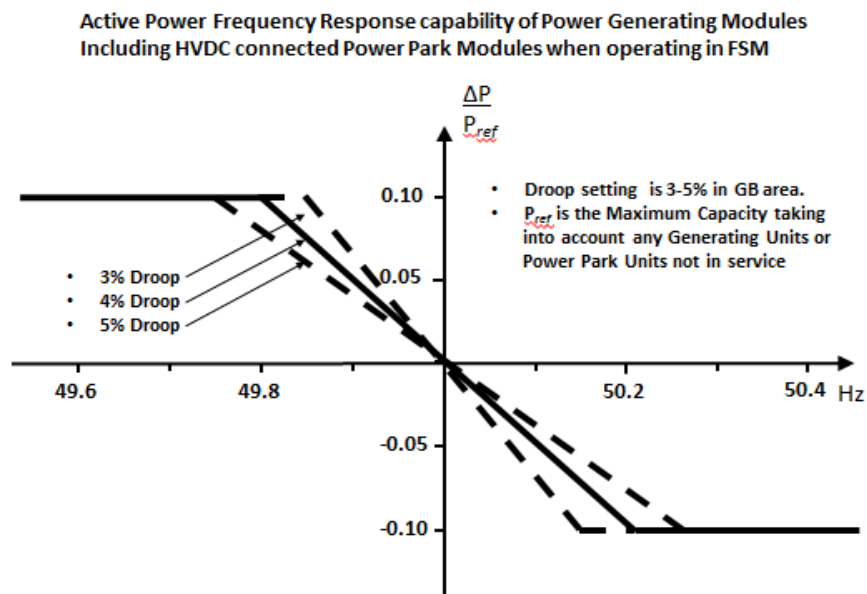

Figure 6.3.7.3.3(a) – **Frequency Sensitive Mode** capability of **Power Generating Modules** and **DC Connected Power Park Modules**

Parameter	Setting
Nominal System Frequency	50Hz

Active Power as a percentage of Maximum Capacity ($\frac{ \Delta P_1 }{P_{max}}$)	10%
Frequency Response Insensitivity in mHz ($ \Delta f_i $)	±15mHz
Frequency Response Insensitivity as a percentage of nominal frequency ($\frac{ \Delta f_i }{f_n}$)	±0.03%
Frequency Response Deadband in mHz	0 (mHz)
Droop (%)	3 – 5%

Table 6.3.7.3.3(a) – Parameters for **Active Power Frequency** response in **Frequency Sensitive Mode** including the mathematical expressions in Figure 6.3.7.3.3(a).

- (ii) In satisfying the performance requirements specified in ECC.6.3.7.3(i) **EU Generators** in respect of each **Type C** and **Type D Power Generating Modules and DC Connected Power Park Module** should be aware:-

in the case of overfrequency, the **Active Power Frequency** response is limited by the **Minimum Regulating Level**,

in the case of underfrequency, the **Active Power Frequency** response is limited by the **Maximum Capacity**,

the actual delivery of **Active Power** frequency response depends on the operating and ambient conditions of the **Power Generating Module** (including **DC Connected Power Park Modules**) when this response is triggered, in particular limitations on operation near **Maximum Capacity** at low **Frequencies** as specified in ECC.6.3.3 and available primary energy sources.

The frequency control device (or speed governor) must also be capable of being set so that it operates with an overall speed **Droop** of between 3 – 5%. The **Frequency Response Deadband** and **Droop** must be able to be reselected repeatedly. For the avoidance of doubt, in the case of a **Power Park Module** (including **DC Connected Power Park Modules**) the speed **Droop** should be equivalent of a fixed setting between 3% and 5% applied to each **Power Park Unit** in service.

- (iii) In the event of a **Frequency** step change, each **Type C** and **Type D Power Generating Module** and **DC Connected Power Park Module** shall be capable of activating full and stable **Active Power Frequency** response (without undue power oscillations), in accordance with the performance characteristic shown in Figure 6.3.7.3.3(b) and parameters in Table 6.3.7.3.3(b).

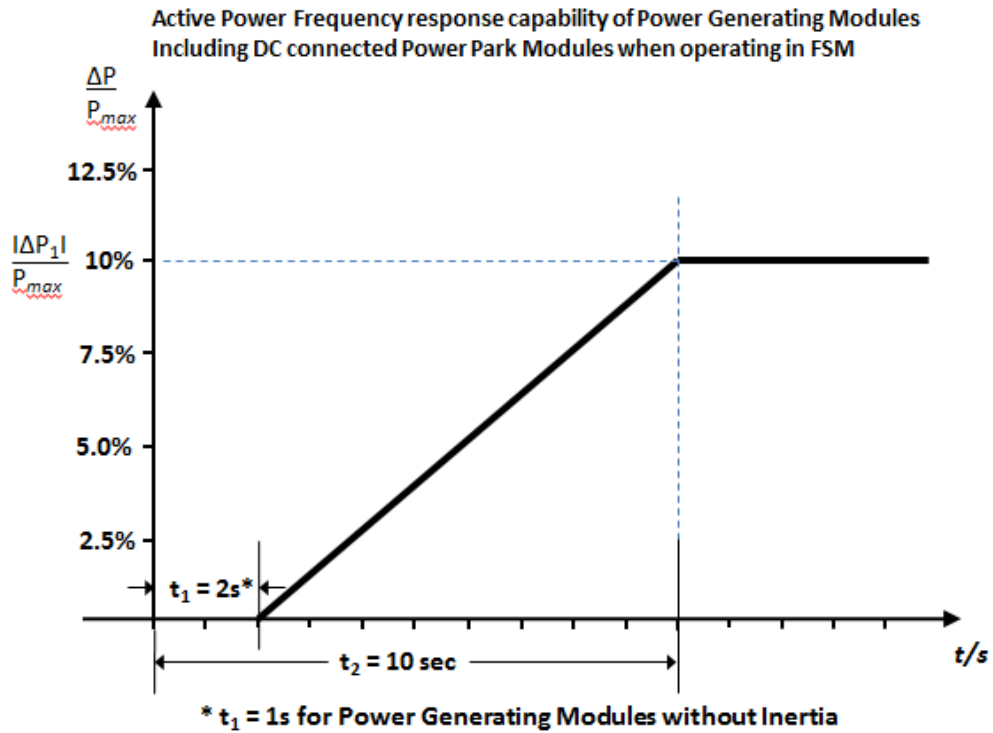

Figure 6.3.7.3.3(b) **Active Power Frequency Response** capability.

Parameter	Setting
Active Power as a percentage of Maximum Capacity (frequency response range) $(\frac{ \Delta P_1 }{P_{max}})$	10%
Maximum admissible initial delay t_1 for Power Generating Modules (including DC Connected Power Park Modules) with inertia unless justified as specified in ECC.6.3.7.3.3 (iv)	2 seconds
Maximum admissible initial delay t_1 for Power Generating Modules (including DC Connected Power Park Modules) which do not contribute to System inertia unless justified as specified in ECC.6.3.7.3.3 (iv)	1 second
Activation time t_2	10 seconds

Table 6.3.7.3.3(b) – Parameters for full activation of **Active Power Frequency** response resulting from a **Frequency** step change. Table 6.3.7.3.3(b) also includes the mathematical expressions used in Figure 6.3.7.3.3(b).

- (iv) The initial activation of **Active Power Primary Frequency** response shall not be unduly delayed. For **Type C** and **Type D Power Generating Modules** (including **DC Connected Power Park Modules**) with inertia the delay in initial **Active Power Frequency** response shall not be greater than 2 seconds. For **Type C** and **Type D Power Generating Modules** (including **DC Connected Power Park Modules**) without inertia, the delay in initial **Active Power Frequency** response shall not be greater than 1 second. If the **Generator** cannot meet this requirement they shall provide technical evidence to **The Company** demonstrating why a longer time is needed for the initial activation of **Active Power Frequency** response.
- (v) in the case of **Type C** and **Type D Power Generating Modules** (including **DC Connected Power Park Modules**) other than the **Steam Unit** within a **CCGT Module** the combined effect of the **Frequency Response Insensitivity** and **Frequency Response Deadband** of the **Frequency** control device (or speed governor) should be no greater than 0.03Hz (for the avoidance of doubt, $\pm 0.015\text{Hz}$). In the case of the **Steam Unit** within a **CCGT Module**, the **Frequency Response Deadband** should be set to an appropriate value consistent with the requirements of ECC.6.3.7.3.5(ii) and the requirements of BC3.7.2.2 for the provision of **LFSM-O** taking account of any **Frequency Response Insensitivity** of the Frequency control device (or speed governor);

ECC.6.3.7.3.4 **HVDC Systems** shall also meet the following minimum requirements:

- (i) **HVDC Systems** shall be capable of responding to **Frequency** deviations in each connected **AC System** by adjusting their **Active Power** import or export as shown in Figure 6.3.7.3.4(a) with the corresponding parameters in Table 6.3.7.3.4(a).

Active Power Frequency response capability of HVDC systems when operating in FSI

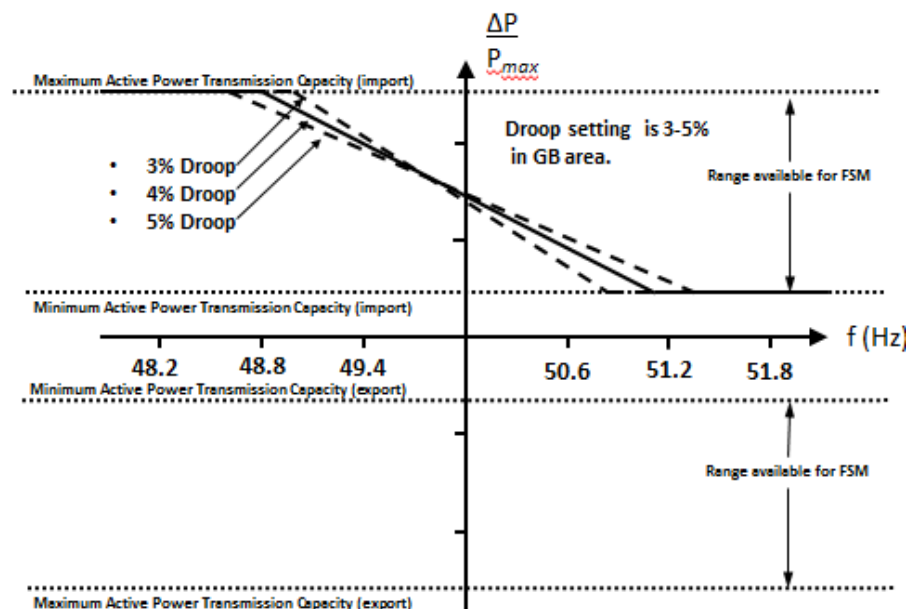

Figure 6.3.7.3.4(a) – **Active Power** frequency response capability of a **HVDC System** operating in **Frequency Sensitive Mode (FSM)**. ΔP is the change in active power output from the **HVDC System**.

Parameter	Setting
-----------	---------

Frequency Response Deadband	0
Droop S1 and S2 (upward and downward regulation) where S1=S2.	3 – 5%
Frequency Response Insensitivity	±15mHz

Table 6.3.7.3.4(a) – Parameters for **Active Power Frequency** response in **FSM** including the mathematical expressions in Figure 6.3.7.3.4.

- (ii) Each **HVDC System** shall be capable of adjusting the **Droop** for both upward and downward regulation and the **Active Power** range over which **Frequency Sensitive Mode** of operation is available as defined in ECC.6.3.7.3.4.
- (iii) In addition to the requirements in ECC.6.3.7.4(i) and ECC.6.3.7.4(ii) each **HVDC System** shall be capable of:-

delivering the response as soon as technically feasible

delivering the response on or above the solid line in Figure 6.3.7.3.4(b) in accordance with the parameters shown in Table 6.3.7.3.4(b)

initiating the delivery of **Primary Response** in no less than 0.5 seconds unless otherwise agreed with **The Company**. Where the initial delay time (t_1 – as shown in Figure 6.3.7.3.4(b)) is longer than 0.5 seconds the **HVDC Converter Station Owner** shall reasonably justify it to **The Company**.

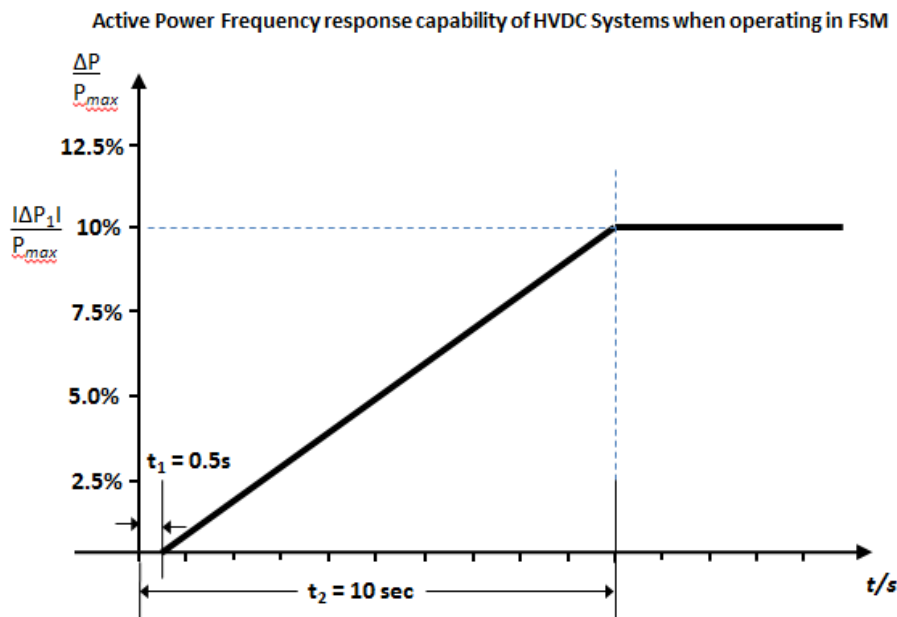

Figure 6.3.7.3.4(b) **Active Power Frequency Response** capability of a **HVDC System**. ΔP is the change in **Active Power** triggered by the step change in frequency

Parameter	Setting
Active Power as a percentage of Maximum Capacity (frequency response range) ($\frac{\Delta P_1}{P_{max}}$)	10%
Maximum admissible delay t_1	0.5 seconds

Maximum admissible time for full activation t_2 , unless longer activation times are agreed with The Company	10 seconds
-----------------------------------------------------------------------------------------------------------------------	------------

Table 6.3.7.3.4(b) – Parameters for full activation of **Active Power Frequency** response resulting from a **Frequency** step change.

- (iv) For **HVDC Systems** connecting various **Synchronous Areas**, each **HVDC System** shall be capable of adjusting the full **Active Power Frequency Response** when operating in **Frequency Sensitive Mode** at any time and for a continuous time period. In addition, the **Active Power** controller of each **HVDC System** shall not have any adverse impact on the delivery of frequency response.
- ECC.6.3.7.3.5 For **HVDC Systems** and **Type C** and **Type D Power Generating Modules** (including **DC Connected Power Park Modules**), other than the **Steam Unit** within a **CCGT Module** the combined effect of the **Frequency Response Insensitivity** and **Frequency Response Deadband** of the **Frequency** control device (or speed governor) should be no greater than 0.03Hz (for the avoidance of doubt, $\pm 0.015\text{Hz}$). In the case of the **Steam Unit** within a **CCGT Module**, the **Frequency Response Deadband** should be set to an appropriate value consistent with the requirements of ECC.6.3.7.3.5(ii) and the requirements of BC3.7.2.2 for the provision of **LFSM-O** taking account of any **Frequency Response Insensitivity** of the **Frequency** control device (or speed governor);
- (i) With regard to disconnection due to underfrequency, **EU Generators** responsible for **Type C** and **Type D Power Generating Modules** (including **DC Connected Power Park Modules**) capable of acting as a load, including but not limited to **Pumped Storage** and tidal **Power Generating Modules**, **HVDC Systems** and **Remote End HVDC Converter Stations**, shall be capable of disconnecting their load in case of underfrequency which will be agreed with **The Company**. For the avoidance of doubt this requirement does not apply to station auxiliary supplies; **EU Generators** in respect of **Type C** and **Type D Pumped Storage Power Generating Modules** should also be aware of the requirements in OC.6.6.6.
- (ii) Where a **Type C** or **Type D Power Generating Module**, **DC Connected Power Park Module** or **HVDC System** becomes isolated from the rest of the **Total System** but is still supplying **Customers**, the **Frequency** control device (or speed governor) must also be able to control **System Frequency** below 52Hz unless this causes the **Type C** or **Type D Power Generating Module** or **DC Connected Power Park Module** to operate below its **Minimum Regulating Level** or **Minimum Active Power Transmission Capacity** when it is possible that it may, as detailed in BC 3.7.3, trip after a time. For the avoidance of doubt **Power Generating Modules** (including **DC Connected Power Park Modules**) and **HVDC Systems** are only required to operate within the **System Frequency** range 47 - 52 Hz as defined in ECC.6.1.2 and for converter based technologies, the remaining island contains sufficient fault level for effective commutation;
- (iii) Each **Type C** and **Type D Power Generating Module** and **HVDC Systems** shall have the facility to modify the **Target Frequency** setting either continuously or in a maximum of 0.05Hz steps over at least the range $50 \pm 0.1\text{Hz}$ should be provided in the unit load controller or equivalent device.
- ECC.6.3.7.3.6 In addition to the requirements of ECC.6.3.7.3 each **Type C** and **Type D Power Generating Module** and **HVDC System** shall be capable of meeting the minimum **Frequency** response requirement profile subject to and in accordance with the provisions of Appendix A3.
- ECC.6.3.7.3.7 For the avoidance of doubt, the requirements of Appendix A3 do not apply to **Type A** and **Type B Power Generating Modules**.

- ECC.6.3.8 EXCITATION AND VOLTAGE CONTROL PERFORMANCE REQUIREMENTS
- ECC.6.3.8.1 Excitation Performance Requirements for Type B Synchronous Power Generating Modules
- ECC.6.3.8.1.1 Each **Synchronous Generating Unit** within a **Type B Synchronous Power Generating Module** shall be equipped with a permanent automatic excitation control system that shall have the capability to provide constant terminal voltage control at a selectable setpoint without instability over the entire operating range of the **Type B Synchronous Power Generating Module**.
- ECC.6.3.8.1.2 In addition to the requirements of ECC.6.3.8.1.1, **The Company** or the relevant **Network Operator** will specify if the control system of the **Type B Synchronous Power Generating Module** shall contribute to voltage control or **Reactive Power** control or **Power Factor** control at the **Grid Entry Point** or **User System Entry Point** (or other defined busbar). The performance requirements of the control system including slope (where applicable) shall be agreed between **The Company** and/or the relevant **Network Operator** and the **EU Generator**.
- ECC.6.3.8.2 Voltage Control Requirements for Type B Power Park Modules
- ECC.6.3.8.2.1 **The Company** or the relevant **Network Operator** will specify if the control system of the **Type B Power Park Module** shall contribute to voltage control or **Reactive Power** control or **Power Factor** control at the **Grid Entry Point** or **User System Entry Point** (or other defined busbar). The performance requirements of the control system including slope (where applicable) shall be agreed between **The Company** and/or the relevant **Network Operator** and the **EU Generator**.
- ECC.6.3.8.3 Excitation Performance Requirements for Type C and Type D Onshore Synchronous Power Generating Modules
- ECC.6.3.8.3.1 Each **Synchronous Generating Unit** within a **Type C** and **Type D Onshore Synchronous Power Generating Modules** shall be equipped with a permanent automatic excitation control system that shall have the capability to provide constant terminal voltage control at a selectable setpoint without instability over the entire operating range of the **Synchronous Power Generating Module**.
- ECC.6.3.8.3.2 The requirements for excitation control facilities are specified in ECC.A.6. Any site specific requirements shall be specified by **The Company** or the relevant **Network Operator**.
- ECC.6.3.8.3.3 Unless otherwise required for testing in accordance with OC5.A.2, the automatic excitation control system of an **Onshore Synchronous Power Generating Module** shall always be operated such that it controls the **Onshore Synchronous Generating Unit** terminal voltage to a value that is
- equal to its rated value: or
 - only where provisions have been made in the **Bilateral Agreement**, greater than its rated value.
- ECC.6.3.8.3.4 In particular, other control facilities including constant **Reactive Power** output control modes and constant **Power Factor** control modes (but excluding VAR limiters) are not required. However if present in the excitation or voltage control system they will be disabled unless otherwise agreed with **The Company** or the relevant **Network Operator**. Operation of such control facilities will be in accordance with the provisions contained in **BC2**.
- ECC.6.3.8.3.5 The excitation performance requirements for **Offshore Synchronous Power Generating Modules** with an **Offshore Grid Entry Point** shall be specified by **The Company**.
- ECC.6.3.8.4 Voltage Control Performance Requirements for Type C and Type D Onshore Power Park Modules, Onshore HVDC Converters and OTSUW Plant and Apparatus at the Interface Point

- ECC.6.3.8.4.1 Each **Type C** and **Type D Onshore Power Park Module, Onshore HVDC Converter** and **OTSDUW Plant and Apparatus** shall be fitted with a continuously acting automatic control system to provide control of the voltage at the **Grid Entry Point** or **User System Entry Point** (or **Interface Point** in the case of **OTSDUW Plant and Apparatus**) without instability over the entire operating range of the **Onshore Power Park Module, or Onshore HVDC Converter** or **OTSDUW Plant and Apparatus**. Any **Plant** or **Apparatus** used in the provisions of such voltage control within an **Onshore Power Park Module** may be located at the **Power Park Unit** terminals, an appropriate intermediate busbar or the **Grid Entry Point** or **User System Entry Point**. In the case of an **Onshore HVDC Converter** at a **HVDC Converter Station** any **Plant** or **Apparatus** used in the provisions of such voltage control may be located at any point within the **User's Plant and Apparatus** including the **Grid Entry Point** or **User System Entry Point**. **OTSDUW Plant and Apparatus** used in the provision of such voltage control may be located at the **Offshore Grid Entry Point** an appropriate intermediate busbar or at the **Interface Point**. When operating below 20% **Maximum Capacity** the automatic control system may continue to provide voltage control using any available reactive capability. If voltage control is not being provided, the automatic control system shall be designed to ensure a smooth transition between the shaded area below 20% of **Active Power** output and the non-shaded area above 20% of **Active Power** output in Figure ECC.6.3.2.4(c) and Figure ECC.6.3.2.6(b) The performance requirements for a continuously acting automatic voltage control system that shall be complied with by the **User** in respect of **Onshore Power Park Modules, Onshore HVDC Converters** at an **Onshore HVDC Converter Station, OTSDUW Plant and Apparatus** at the **Interface Point** are defined in ECC.A.7.
- ECC.6.3.8.4.3 In particular, other control facilities, including constant **Reactive Power** output control modes and constant **Power Factor** control modes (but excluding VAR limiters) are not required. However if present in the voltage control system they will be disabled unless otherwise agreed with **The Company** or the relevant **Network Operator**. Operation of such control facilities will be in accordance with the provisions contained in BC2. Where **Reactive Power** output control modes and constant **Power Factor** control modes have been fitted within the voltage control system they shall be required to satisfy the requirements of ECC.A.7.3 and ECC.A.7.4.
- ECC.6.3.8.5 Excitation Control Performance requirements applicable to AC Connected **Offshore Synchronous Power Generating Modules** and voltage control performance requirements applicable to AC connected **Offshore Power Park Modules, DC Connected Power Park Modules** and **Remote End HVDC Converters**
- ECC.6.3.8.5.1 A continuously acting automatic control system is required to provide control of **Reactive Power** (as specified in ECC.6.3.2.5 and ECC.6.3.2.6) at the **Offshore Grid Entry Point** (or **HVDC Interface Point** in the case of **Configuration 1 DC Connected Power Park Modules** and **Remote End HVDC Converters**) without instability over the entire operating range of the AC connected **Offshore Synchronous Power Generating Module** or **Configuration 1 AC connected Offshore Power Park Module** or **Configuration 1 DC Connected Power Park Modules** or **Remote End HVDC Converter**. The performance requirements for this automatic control system will be specified by **The Company** which would be consistent with the requirements of ECC.6.3.2.5 and ECC.6.3.2.6.
- ECC.6.3.8.5.2 A continuously acting automatic control system is required to provide control of **Reactive Power** (as specified in ECC.6.3.2.8) at the **Offshore Grid Entry Point** (or **HVDC Interface Point** in the case of **Configuration 2 DC Connected Power Park Modules**) without instability over the entire operating range of the **Configuration 2 AC connected Offshore Power Park Module** or **Configuration 2 DC Connected Power Park Modules**. otherwise the requirements of ECC.6.3.2.6 shall apply. The performance requirements for this automatic control system are specified in ECC.A.8
- ECC.6.3.8.5.3 In addition to ECC.6.3.8.5.1 and ECC.6.3.8.5.2 the requirements for excitation or voltage control facilities, including **Power System Stabilisers**, where these are necessary for system reasons, will be specified by **The Company**. Reference is made to on-load commissioning witnessed by **The Company** in BC2.11.2.

ECC.6.3.9 STEADY STATE LOAD INACCURACIES

ECC.6.3.9.1 The standard deviation of **Load** error at steady state **Load** over a 30 minute period must not exceed 2.5 per cent of a **Type C** or **Type D Power Generating Modules** (including a **DC Connected Power Park Module**) **Maximum Capacity**. Where a **Type C** or **Type D Power Generating Module** (including a **DC Connected Power Park Module**) is instructed to **Frequency** sensitive operation, allowance will be made in determining whether there has been an error according to the governor droop characteristic registered under the **PC**.

For the avoidance of doubt in the case of a **Power Park Module** (excluding a **Non-Synchronous Electricity Storage Module**) an allowance will be made for the full variation of mechanical power output.

In the case of an **Electricity Storage Module**, an allowance will be made for the storage reserve capability of the **Electricity Storage Module**.

ECC.6.3.10 NEGATIVE PHASE SEQUENCE LOADINGS

ECC.6.3.10.1 In addition to meeting the conditions specified in ECC.6.1.5(b), each **Synchronous Power Generating Module** will be required to withstand, without tripping, the negative phase sequence loading incurred by clearance of a close-up phase-to-phase fault, by **System Back-Up Protection** on the **National Electricity Transmission System** or **User System** located **Onshore** in which it is **Embedded**.

ECC.6.3.11 NEUTRAL EARTHING

ECC.6.3.11 At nominal **System** voltages of 110kV and above the higher voltage windings of a transformer of a **Power Generating Module** or **HVDC Equipment** or transformer resulting from **OTSDUW** must be star connected with the star point suitable for connection to earth. The earthing and lower voltage winding arrangement shall be such as to ensure that the **Earth Fault Factor** requirement of paragraph ECC.6.2.1.1 (b) will be met on the **National Electricity Transmission System** at nominal **System** voltages of 110kV and above.

ECC.6.3.12 FREQUENCY AND VOLTAGE DEVIATIONS

ECC.6.3.12.1 As stated in ECC.6.1.2, the **System Frequency** could rise to 52Hz or fall to 47Hz. Each **Power Generating Module** (including **DC Connected Power Park Modules**) must continue to operate within this **Frequency** range for at least the periods of time given in ECC.6.1.2 unless **The Company** has specified any requirements for combined **Frequency** and voltage deviations which are required to ensure the best use of technical capabilities of **Power Generating Modules** (including **DC Connected Power Park Modules**) if required to preserve or restore system security.- Notwithstanding this requirement, **EU Generators** should also be aware of the requirements of ECC.6.3.13.

ECC.6.3.13 FREQUENCY, RATE OF CHANGE OF FREQUENCY AND VOLTAGE PROTECTION SETTING ARRANGEMENTS

ECC.6.3.13.1 **EU Generators** (including in respect of **OTSDUW Plant and Apparatus**) and **HVDC System Owners** will be responsible for protecting all their **Power Generating Modules** (and **OTSDUW Plant and Apparatus**) or **HVDC Equipment** against damage should **Frequency** excursions outside the range 52Hz to 47Hz ever occur. Should such excursions occur, it is up to the **EU Generator** or **HVDC System Owner** to decide whether to disconnect their **Apparatus** for reasons of safety of **Apparatus, Plant** and/or personnel.

ECC.6.3.13.2 Each **Power Park Module** with a **Grid Forming Capability** as provided for in ECC.6.3.19, when connected and synchronised to the **System**, is required to be capable of withstanding without tripping a rate of change of **Frequency** up to and including 2 Hz per second as measured over a rolling 500 milliseconds period. All other **Power Generating Modules** when connected and synchronised to the **System**, shall be capable of withstanding without tripping a rate of change of **Frequency** up to and including 1 Hz per second as measured over a rolling 500 milliseconds period. Voltage dips may cause localised rate of change of **Frequency** values in excess of 1 Hz per second (or 2Hz/s in the case of **Power Park Modules** with a **Grid Forming Capability**) for short periods, and in these cases, the requirements under

ECC.6.3.15 (fault ride through) supersedes this clause. For the avoidance of doubt, this requirement relates to the capabilities of **Power Generating Modules** only and does not impose the need for rate of change of **Frequency** protection nor does it impose a specific setting for anti-islanding or loss-of-mains protection relays.

ECC.6.3.13.3 Each **HVDC System** and **Remote End HVDC Converter Station** when connected and synchronised to the **System**, shall be capable of withstanding without tripping a rate of change of **Frequency** up to and including ± 2.5 Hz per second as measured over the previous 1 second period. Voltage dips may cause localised rate of change of **Frequency** values in excess of ± 2.5 Hz per second for short periods, and in these cases, the requirements under ECC.6.3.15 (fault ride through) supersedes this clause. For the avoidance of doubt, this requirement relates to the capabilities of **HVDC Systems** and **Remote End HVDC Converter Stations** only and does not impose the need for rate of change of **Frequency** protection nor does it impose a specific setting for anti-islanding or loss-of-mains protection relays.

ECC.6.3.13.4 Each **DC Connected Power Park Module** when connected to the **System**, shall be capable of withstanding without tripping a rate of change of **Frequency** up to and including ± 2.0 Hz per second as measured over the previous 1 second period. **Voltage** dips may cause localised rate of change of **Frequency** values in excess of ± 2.0 Hz per second for short periods, and in these cases, the requirements under ECC.6.3.15 (fault ride through) supersedes this clause. For the avoidance of doubt, this requirement relates to the capabilities of **DC Connected Power Park Modules** only and does not impose the need for rate of change of **Frequency** protection nor does it impose a specific setting for anti-islanding or loss-of-mains protection relays.

ECC.6.3.13.5 As stated in ECC.6.1.2, the **System Frequency** could rise to 52Hz or fall to 47Hz and the **System** voltage at the **Grid Entry Point** or **User System Entry Point** could rise or fall within the values outlined in ECC.6.1.4. Each **Type C** and **Type D Power Generating Module** (including **DC Connected Power Park Modules**) or any constituent element must continue to operate within this **Frequency** range for at least the periods of time given in ECC.6.1.2 and voltage range as defined in ECC.6.1.4 unless **The Company** has agreed to any simultaneous overvoltage and underfrequency relays and/or simultaneous undervoltage and over frequency relays which will trip such **Power Generating Module** (including **DC Connected Power Park Modules**), and any constituent element within this **Frequency** or voltage range. In the case of **Grid Forming Plant**, **Grid Forming Plant Owners** are also required to satisfy the **System Frequency** and **System** voltage requirements as defined in ECC.6.3.19.

ECC.6.3.14 FAST START CAPABILITY

ECC.6.3.14.1 It may be agreed in the **Bilateral Agreement** that a **Genset** shall have a **Fast-Start Capability**. Such **Gensets** may be used for **Operating Reserve** and their **Start-Up** may be initiated by **Frequency**-level relays with settings in the range 49Hz to 50Hz as specified pursuant to **OC2**.

ECC.6.3.15 FAULT RIDE THROUGH

ECC.6.3.15.1 General **Fault Ride Through** requirements, principles and concepts applicable to **Type B**, **Type C** and **Type D Power Generating Modules** and **OTSDUW Plant and Apparatus** subject to faults up to 140ms in duration

ECC.6.3.15.1.1 ECC.6.3.15.1 – ECC.6.3.15.8 section sets out the **Fault Ride Through** requirements on **Type B**, **Type C** and **Type D Power Generating Modules**, **OTSDUW Plant and Apparatus** and **HVDC Equipment** that shall apply in the event of a fault lasting up to 140ms in duration.

ECC.6.3.15.1.2 Each **Power Generating Module, Power Park Module, HVDC Equipment and OTSDUW Plant and Apparatus** is required to remain connected and stable for any balanced and unbalanced fault where the voltage at the **Grid Entry Point** or **User System Entry Point** or (**HVDC Interface Point** in the case of **Remote End DC Converter Stations** or **Interface Point** in the case of **OTSDUW Plant and Apparatus**) remains on or above the heavy black line defined in sections ECC.6.3.15.2 – ECC.6.3.15.7 below. For up to 30 minutes following such a fault event each **Power Generating Module, Power Park Module, HVDC Equipment and OTSDUW Plant and Apparatus** is required to remain connected and stable provided **System** operating conditions have returned within those specified in ECC.6.1.

ECC.6.3.15.1.3 The voltage against time curves defined in ECC.6.3.15.2 – ECC.6.3.15.7 expresses the lower limit (expressed as the ratio of its actual value and its reference 1pu) of the actual course of the phase to phase voltage (or phase to earth voltage in the case of asymmetrical/unbalanced faults) on the **System** voltage level at the **Grid Entry Point** or **User System Entry Point** (or **HVDC Interface Point** in the case of **Remote End HVDC Converter Stations** or **Interface Point** in the case of **OTSDUW Plant and Apparatus**) during a symmetrical or asymmetrical/unbalanced fault, as a function of time before, during and after the fault.

ECC.6.3.15.2 Voltage against time curve and parameters applicable to **Type B Synchronous Power Generating Modules**

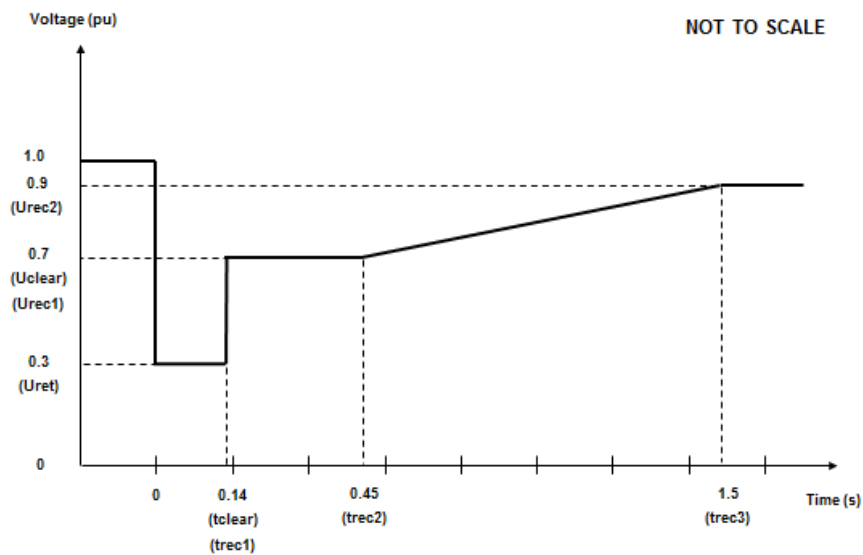

Figure ECC.6.3.15.2 - Voltage against time curve applicable to **Type B Synchronous Power Generating Modules**

Voltage parameters (pu)		Time parameters (seconds)	
Uret	0.3	tclear	0.14
Uclear	0.7	trec1	0.14
Urec1	0.7	trec2	0.45
Urec2	0.9	trec3	1.5

Table ECC.6.3.15.2 Voltage against time parameters applicable to **Type B Synchronous Power Generating Modules**

ECC.6.3.15.3 Voltage against time curve and parameters applicable to **Type C and D Synchronous Power Generating Modules** connected below 110kV

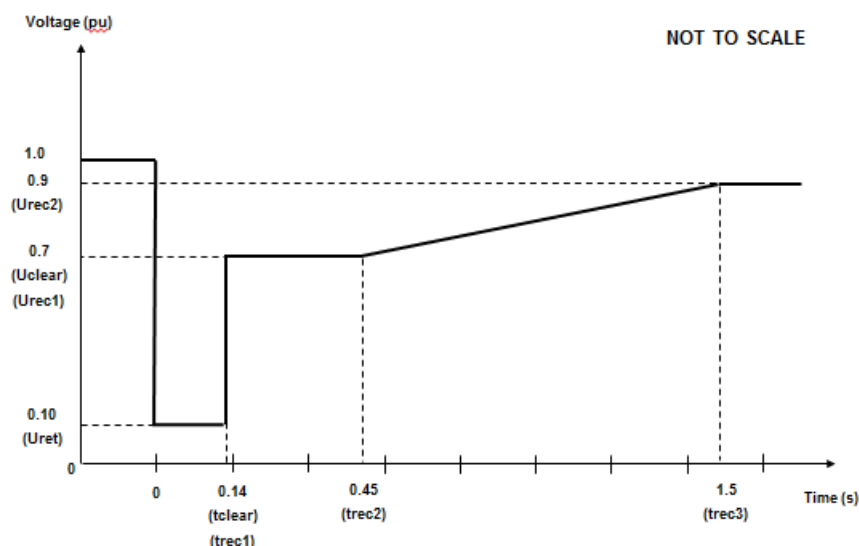

Figure ECC.6.3.15.3 - Voltage against time curve applicable to **Type C and D Synchronous Power Generating Modules** connected below 110kV

Voltage parameters (pu)		Time parameters (seconds)	
Uret	0.1	tclear	0.14
Uclear	0.7	trec1	0.14
Urec1	0.7	trec2	0.45
Urec2	0.9	trec3	1.5

Table ECC.6.3.15.3 Voltage against time parameters applicable to **Type C and D Synchronous Power Generating Modules** connected below 110kV

ECC.6.3.15.4 Voltage against time curve and parameters applicable to **Type D Synchronous Power Generating Modules** connected at or above 110kV

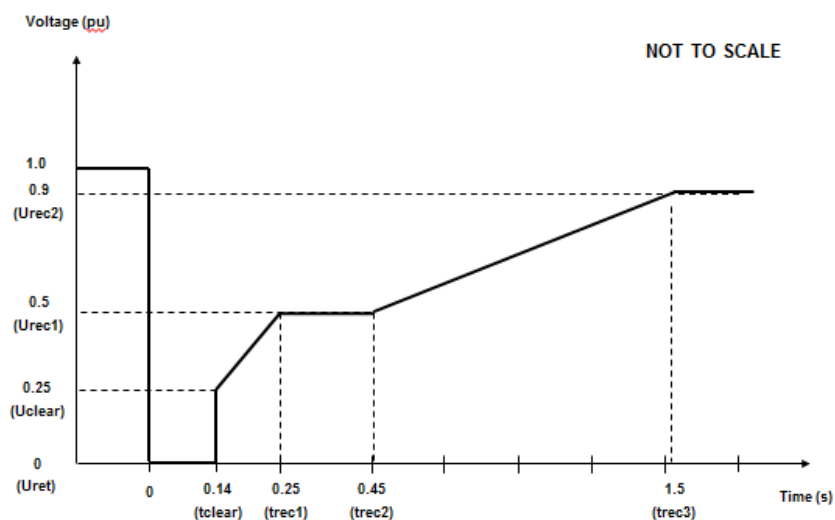

Figure ECC.6.3.15.4 - Voltage against time curve applicable to **Type D Synchronous Power Generating Modules** connected at or above 110kV

Voltage parameters (pu)		Time parameters (seconds)	
Uret	0	tclear	0.14
Uclear	0.25	trec1	0.25
Urec1	0.5	trec2	0.45
Urec2	0.9	trec3	1.5

Table ECC.6.3.15.4 Voltage against time parameters applicable to **Type D Synchronous Power Generating Modules** connected at or above 110kV

ECC.6.3.15.5 Voltage against time curve and parameters applicable to **Type B, C and D Power Park Modules** connected below 110kV

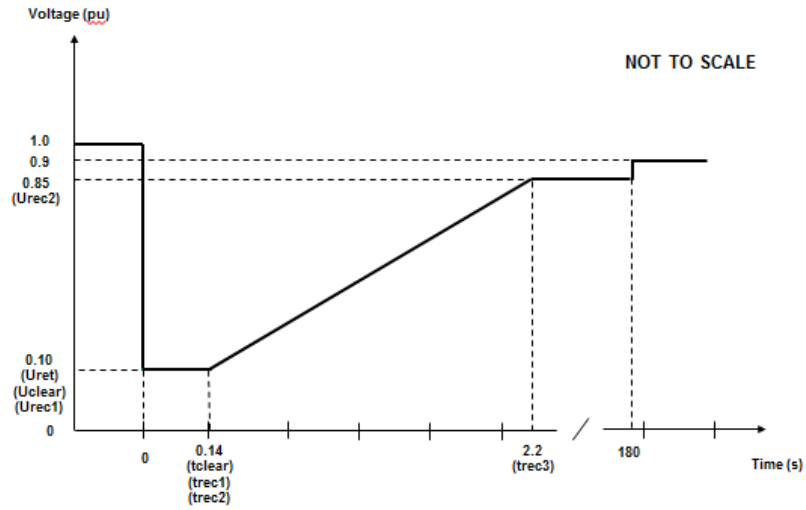

Figure ECC.6.3.15.5 - Voltage against time curve applicable to **Type B, C and D Power Park Modules** connected below 110kV

Voltage parameters (pu)		Time parameters (seconds)	
Uret	0.10	tclear	0.14
Uclear	0.10	trec1	0.14
Urec1	0.10	trec2	0.14
Urec2	0.85	trec3	2.2

Table ECC.6.3.15.5 Voltage against time parameters applicable to **Type B, C and D Power Park Modules** connected below 110kV

ECC.6.3.15.6 Voltage against time curve and parameters applicable to **Type D Power Park Modules** with a **Grid Entry Point** or **User System Entry Point** at or above 110kV, **DC Connected Power Park Modules** at the **HVDC Interface Point** or **OTSDUW Plant and Apparatus** at the **Interface Point**.

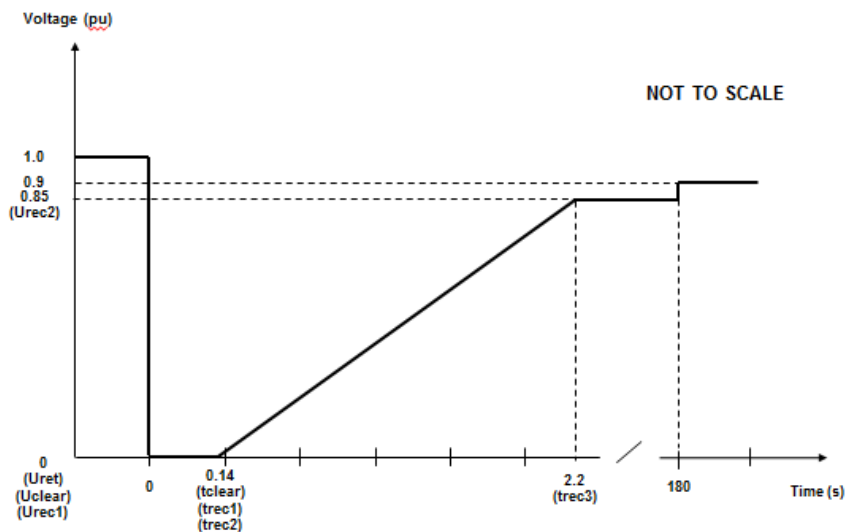

Figure ECC.6.3.15.6 - Voltage against time curve applicable to **Type D Power Park Modules** with a **Grid Entry Point** or **User System Entry Point** at or above 110kV, **DC Connected Power Park Modules** at the **HVDC Interface Point** or **OTSDUW Plant and Apparatus** at the **Interface Point**.

Voltage parameters (pu)		Time parameters (seconds)	
Uret	0	tclear	0.14
Uclear	0	trec1	0.14
Urec1	0	trec2	0.14
Urec2	0.85	trec3	2.2

Table ECC.6.3.15.6 Voltage against time parameters applicable to a **Type D Power Park Modules** with a **Grid Entry Point** or **User System Entry Point** at or above 110kV, **DC Connected Power Park Modules** at the **HVDC Interface Point** or **OTSDUW Plant and Apparatus** at the **Interface Point**.

ECC.6.3.15.7 Voltage against time curve and parameters applicable to HVDC Systems and Remote End HVDC Converter Stations

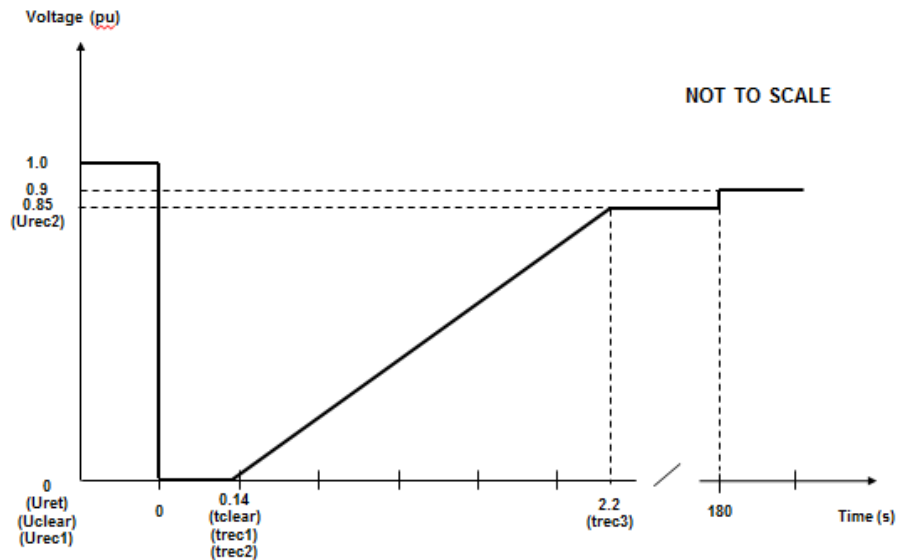

Figure ECC.6.3.15.7 - Voltage against time curve applicable to **HVDC Systems** and **Remote End HVDC Converter Stations**

Voltage parameters (pu)		Time parameters (seconds)	
Uret	0	tclear	0.14
Uclear	0	trec1	0.14
Urec1	0	trec2	0.14
Urec2	0.85	trec3	2.2

Table ECC.6.3.15.7 Voltage against time parameters applicable to **HVDC Systems** and **Remote End HVDC Converter Stations**

ECC.6.3.15.8 In addition to the requirements in ECC.6.3.15.1 – ECC.6.3.15.7:

- (i) Each **Type B, Type C and Type D Power Generating Module** at the **Grid Entry Point** or **User System Entry Point**, **HVDC Equipment** (or **OTSDUW Plant and Apparatus** at the **Interface Point**) shall be capable of satisfying the above requirements when operating at **Rated MW** output and maximum leading **Power Factor**.
- (ii) **The Company** will specify upon request by the **User** the pre-fault and post fault short circuit capacity (in MVA) at the **Grid Entry Point** or **User System Entry Point** (or **HVDC Interface Point** in the case of a remote end **HVDC Converter Stations** or **Interface Point** in the case of **OTSDUW Plant and Apparatus**).
- (iii) The pre-fault voltage shall be taken to be 1.0pu and the post fault voltage shall not be less than 0.9pu.
- (iv) To allow a **User** to model the **Fault Ride Through** performance of its **Type B, Type C and/or Type D Power Generating Modules** or **HVDC Equipment**, **The Company** will provide additional network data as may reasonably be required by the **EU Code User** to undertake such study work in accordance with PC.A.8. Alternatively, **The Company** may provide generic values derived from typical cases.
- (v) **The Company** will publish fault level data under maximum and minimum demand conditions in the **Electricity Ten Year Statement**.
- (vi) Each **EU Generator** (in respect of **Type B, Type C, Type D Power Generating Modules** and **DC Connected Power Park Modules**) and **HVDC System Owners** (in respect of **HVDC Systems**) shall satisfy the requirements in ECC.6.3.15.8(i) – (vii) unless the protection schemes and settings for internal electrical faults trips the **Type B, Type C and Type D Power Generating Module, HVDC Equipment** (or **OTSDUW Plant and Apparatus**) from the **System**. The protection schemes and settings should not jeopardise **Fault Ride Through** performance as specified in ECC.6.3.15.8(i) – (vii). The undervoltage protection at the **Grid Entry Point** or **User System Entry Point** (or **HVDC Interface Point** in the case of a **Remote End HVDC Converter Stations** or **Interface Point** in the case of **OTSDUW Plant and Apparatus**) shall be set by the **EU Generator** (or **HVDC System Owner** or **OTSDUA** in the case of **OTSDUW Plant and Apparatus**) according to the widest possible range unless **The Company** and the **EU Code User** have agreed to narrower settings. All protection settings associated with undervoltage protection shall be agreed between the **EU Generator** and/or **HVDC System Owner** with **The Company** and **Relevant Transmission Licensee's** and relevant **Network Operator** (as applicable).
- (vii) Each **Type B, Type C and Type D Power Generating Module, HVDC System** and **OTSDUW Plant and Apparatus** at the **Interface Point** shall be designed such that upon clearance of the fault on the **Onshore Transmission System** and within 0.5 seconds of restoration of the voltage at the **Grid Entry Point** or **User System Entry Point** or **HVDC Interface Point** in the case of a **Remote End HVDC Converter Stations** or **Interface Point** in the case of **OTSDUW Plant and Apparatus** to 90% of nominal voltage or greater, **Active Power** output (or **Active Power** transfer capability in the case of **OTSDW Plant and Apparatus** or **Remote End HVDC Converter Stations**) shall be restored to at least 90% of the level immediately before the fault. Once **Active Power** output (or **Active Power** transfer capability in the case of **OTSDUW Plant and Apparatus** or **Remote End HVDC Converter Stations**) has been restored to the required level, **Active Power** oscillations shall be acceptable provided that:
 - The total **Active Energy** delivered during the period of the oscillations is at least that which would have been delivered if the **Active Power** was constant
 - The oscillations are adequately damped.
 - In the event of power oscillations, **Power Generating Modules** shall retain steady state stability when operating at any point on the **Power Generating Module Performance Chart**.

For AC Connected **Onshore** and **Offshore Power Park Modules** comprising switched reactive compensation equipment (such as mechanically switched capacitors and reactors), such switched reactive compensation equipment shall be controlled such that it is not switched in or out of service during the fault but may act to assist in post fault voltage recovery.

ECC.6.3.15.9 General Fault Ride Through requirements for faults in excess of 140ms in duration.

ECC.6.3.15.9.1 General Fault Ride Through requirements applicable to HVDC Equipment and OTSDUW DC Converters subject to faults and voltage dips in excess of 140ms.

ECC.6.3.15.9.1.1 The requirements applicable to **HVDC Equipment** including **OTSDUW DC Converters** subject to faults and voltage disturbances at the **Grid Entry Point** or **User System Entry Point** or **Interface Point** or **HVDC Interface Point**, including **Active Power** transfer capability shall be specified in the **Bilateral Agreement**.

ECC.6.3.15.9.2 Fault Ride Through requirements for Type C and Type D Synchronous Power Generating Modules and Type C and Type D Power Park Modules and OTSDUW Plant and Apparatus subject to faults and voltage disturbances on the Onshore Transmission System in excess of 140ms

ECC.6.3.15.9.2.1 The **Fault Ride Through** requirements for **Type C** and **Type D Synchronous Power Generating Modules** subject to faults and voltage disturbances on the Onshore Transmission System in excess of 140ms are defined in ECC.6.3.15.9.2.1(a) and the **Fault Ride Through Requirements for Type C and Type D Power Park Modules and OTSDUW Plant and Apparatus** subject to faults and voltage disturbances on the Onshore Transmission System greater than 140ms in duration are defined in ECC.6.3.15.9.2.1(b).

(a) Requirements applicable to **Synchronous Power Generating Modules** subject to **Supergrid Voltage** dips on the **Onshore Transmission System** greater than 140ms in duration.

In addition to the requirements of ECC.6.3.15.1 – ECC.6.3.15.8 each **Synchronous Power Generating Module** shall:

(i) remain transiently stable and connected to the **System** without tripping of any **Synchronous Power Generating Module** for balanced **Supergrid Voltage** dips and associated durations on the **Onshore Transmission System** (which could be at the **Interface Point**) anywhere on or above the heavy black line shown in Figure ECC.6.3.15.9(a) Appendix 4 and Figures EA.4.3.2(a), (b) and (c) provide an explanation and illustrations of Figure ECC.6.3.15.9(a); and,

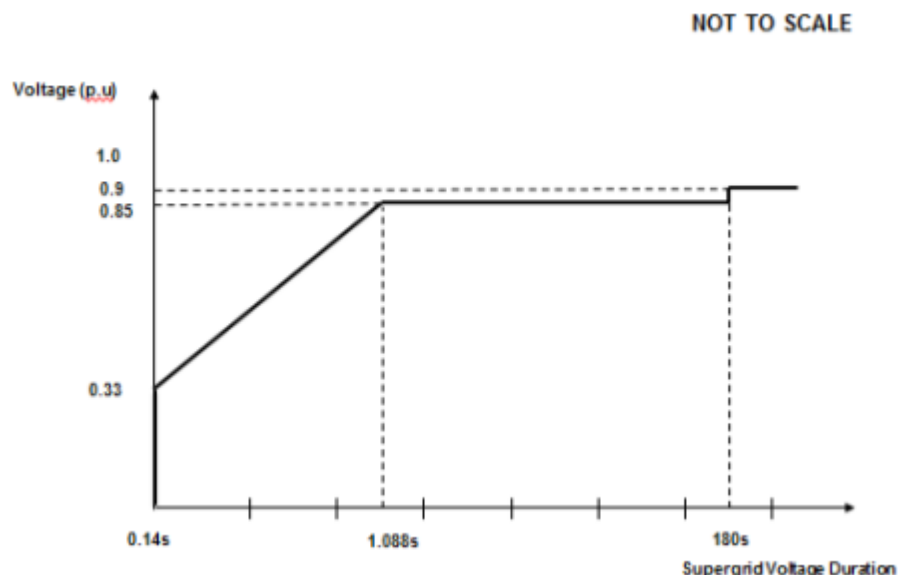

Figure ECC.6.3.15.9(a)

- (ii) provide **Active Power** output at the **Grid Entry Point**, during **Supergrid Voltage** dips on the **Onshore Transmission System** as described in Figure ECC.6.3.15.9(a), at least in proportion to the retained balanced voltage at the **Onshore Grid Entry Point** (for **Onshore Synchronous Power Generating Modules**) or **Interface Point** (for **Offshore Synchronous Power Generating Modules**) (or the retained balanced voltage at the **User System Entry Point if Embedded**) and shall generate maximum reactive current (where the voltage at the **Grid Entry Point** is outside the limits specified in ECC.6.1.4) without exceeding the transient rating limits of the **Synchronous Power Generating Module** and,
- (iii) restore **Active Power** output following **Supergrid Voltage** dips on the **Onshore Transmission System** as described in Figure ECC.6.3.15.9(a), within 1 second of restoration of the voltage to 1.0pu of the nominal voltage at the:

Onshore Grid Entry Point for directly connected **Onshore Synchronous Power Generating Modules** or,

Interface Point for **Offshore Synchronous Power Generating Modules**
or,

User System Entry Point for **Embedded Onshore Synchronous Power Generating Modules**

or,

User System Entry Point for **Embedded Medium Power Stations** not subject to a **Bilateral Agreement** which comprise **Synchronous Generating Units** and with an **Onshore User System Entry Point** (irrespective of whether they are located **Onshore** or **Offshore**)

to at least 90% of the level available immediately before the occurrence of the dip. Once the **Active Power** output has been restored to the required level, **Active Power** oscillations shall be acceptable provided that:

- the total **Active Energy** delivered during the period of the oscillations is at least that which would have been delivered if the **Active Power** was constant
- the oscillations are adequately damped.

For the avoidance of doubt a balanced **Onshore Transmission System Supergrid Voltage** meets the requirements of ECC.6.1.5 (b) and ECC.6.1.6.

(iv) For up to 30 minutes following such a **Supergrid Voltage** dip on the **Onshore Transmission System** each **Synchronous Power Generating Module** is required to remain connected and stable provided **System** operating conditions have returned within those specified in ECC.6.1

- (b) Requirements applicable to **Type C** and **Type D Power Park Modules** and **OTSDUW Plant and Apparatus** (excluding **OTSDUW DC Converters**) subject to **Supergrid Voltage** dips on the **Onshore Transmission System** greater than 140ms in duration.

In addition to the requirements of ECC.6.3.15.5, ECC.6.3.15.6 and ECC.6.3.15.8 (as applicable) each **OTSDUW Plant and Apparatus** or each **Power Park Module** and / or any constituent **Power Park Unit**, shall:

- (i) remain transiently stable and connected to the **System** without tripping of any **OTSDUW Plant and Apparatus**, or **Power Park Module** and / or any constituent **Power Park Unit**, for balanced **Supergrid Voltage** dips and associated durations on the **Onshore Transmission System** (which could be at the **Interface Point**) anywhere on or above the heavy black line shown in Figure ECC.6.3.15.9(b). Appendix 4 and Figures EA.4.3.4 (a), (b) and (c) provide an explanation and illustrations of Figure ECC.6.3.15.9(b) ; and,

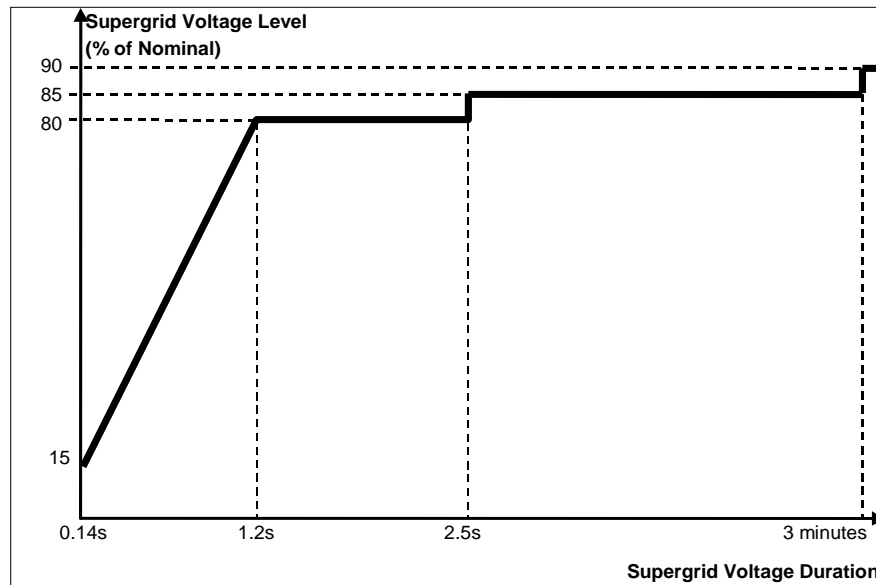

Figure ECC.6.3.15.9(b)

- (ii) be required to satisfy the requirements of ECC.6.3.16. In the case of a **Non-Synchronous Generating Unit** or **OTSDUW Plant and Apparatus** or **Power Park Module** where there has been a reduction in the **Intermittent Power Source** or in the case of **OTSDUW Active Power** transfer capability in the time range in Figure ECC.6.3.15.9(b) an allowance shall be made for the fall in input power and the corresponding reduction of real and reactive current.
- (iii) restore **Active Power** output (or, in the case of **OTSDUW, Active Power** transfer capability), following **Supergrid Voltage** dips on the **Onshore Transmission System** as described in Figure ECC.6.3.15.9(b), within 1 second of restoration of the voltage to 0.9 pu of the nominal voltage at the:

Onshore Grid Entry Point for directly connected **Onshore Power Park Modules** or,

Interface Point for **OTSDUW Plant and Apparatus** and **Offshore Power Park Modules** or,

User System Entry Point for **Embedded Onshore Power Park Modules** or ,

User System Entry Point for **Embedded Medium Power Stations** which comprise **Power Park Modules** not subject to a **Bilateral Agreement** and with an **Onshore User System Entry Point** (irrespective of whether they are located **Onshore** or **Offshore**)

to at least 90% of the level available immediately before the occurrence of the dip except in the case of a **Non-Synchronous Generating Unit, OTSDUW Plant and Apparatus** or **Power Park Module** where there has been a reduction in the **Intermittent Power Source** in the time range in Figure ECC.6.3.15.9(b) that restricts the **Active Power** output or, in the case of **OTSDUW, Active Power** transfer capability below this level. Once the **Active Power** output or, in the case of **OTSDUW, Active Power** transfer capability has been restored to the required level, **Active Power** oscillations shall be acceptable provided that:

- the total **Active Energy** delivered during the period of the oscillations is at least that which would have been delivered if the **Active Power** was constant
- the oscillations are adequately damped.

For the avoidance of doubt a balanced **Onshore Transmission System Supergrid Voltage** meets the requirements of ECC.6.1.5 (b) and ECC.6.1.6.

- (iv) For up to 30 minutes following such a **Supergrid Voltage** dip on the **Onshore Transmission System** each **Power Park Module** and / or any constituent **Power Park Unit** and **OTSDUW Plant and Apparatus** is required to remain connected and stable provided **System** operating conditions have returned within those specified in ECC.6.1.

ECC.6.3.15.10 Other Fault Ride Through Requirements

- (i) In the case of a **Power Park Module** (excluding **Non-Synchronous Electricity Storage Modules**), the requirements in ECC.6.3.15.9 do not apply when the **Power Park Module** (excluding **Non-Synchronous Electricity Storage Modules**) is operating at less than 5% of its **Rated MW** or during very high primary energy source conditions when more than 50% of the **Power Park Units** in a **Power Park Module** have been shut down or disconnected under an emergency shutdown sequence to protect **User's Plant and Apparatus**.
- (ii) In addition to meeting the conditions specified in ECC.6.1.5(b) and ECC.6.1.6, each **Non-Synchronous Generating Unit**, **OTSDUW Plant and Apparatus** or **Power Park Module** and any constituent **Power Park Unit** thereof will be required to withstand, without tripping, the negative phase sequence loading incurred by clearance of a close-up phase-to-phase fault, by **System Back-Up Protection** on the **Onshore Transmission System** operating at **Supergrid Voltage**.
- (iii) **Generators** in respect of **Type B**, **Type C** and **Type D Power Park Modules** and **HVDC System Owners** are required to confirm to **The Company**, their repeated ability to operate through balanced and unbalanced faults and **System** disturbances each time the voltage at the **Grid Entry Point** or **User System Entry Point** falls outside the limits specified in ECC.6.1.4. Demonstration of this capability would be satisfied by **EU Generators** and **HVDC System Owners** supplying the protection settings of their plant, informing **The Company** of the maximum number of repeated operations that can be performed under such conditions and any limiting factors to repeated operation such as protection or thermal rating; and
- (iv) Notwithstanding the requirements of ECC.6.3.15(v), **Power Generating Modules** shall be capable of remaining connected during single phase or three phase auto-reclosures to the **National Electricity Transmission System** and operating without power reduction as long as the voltage and frequency remain within the limits defined in ECC.6.1.4 and ECC.6.1.2; and
- (v) For the avoidance of doubt the requirements specified in ECC.6.3.15 do not apply to **Power Generating Modules** connected to either an unhealthy circuit and/or islanded from the **Transmission System** even for delayed auto reclosure times.
- (vi) To avoid unwanted island operation, **Non-Synchronous Generating Units** in Scotland (and those directly connected to a **Scottish Offshore Transmission System**), **Power Park Modules** in Scotland (and those directly connected to a **Scottish Offshore Transmission System**), or **OTSDUW Plant and Apparatus** with an **Interface Point** in Scotland shall be tripped for the following conditions:
 - (1) **Frequency** above 52Hz for more than 2 seconds
 - (2) **Frequency** below 47Hz for more than 2 seconds
 - (3) Voltage as measured at the **Onshore Connection Point** or **Onshore User System Entry Point** or **Offshore Grid Entry Point** or **Interface Point** in the case of **OTSDUW Plant and Apparatus** is below 80% for more than 2.5 seconds

Voltage as measured at the **Onshore Connection Point** or **Onshore User System Entry Point** or **Offshore Grid Entry Point** or **Interface Point** in the case of **OTSDUW Plant and Apparatus** is above 120% (115% for 275kV) for more than 1 second. The times in sections (1) and (2) are maximum trip times. Shorter times may be used to protect the **Non-Synchronous Generating Units**, or **OTSDUW Plant and Apparatus**.

ECC.6.3.15.11 HVDC System Robustness

ECC.6.3.15.11.1 The **HVDC System** shall be capable of finding stable operation points with a minimum change in **Active Power** flow and voltage level, during and after any planned or unplanned change in the **HVDC System** or **AC System** to which it is connected. **The Company** shall specify the changes in the System conditions for which the **HVDC Systems** shall remain in stable operation.

ECC.6.3.15.11.2 The **HVDC System** owner shall ensure that the tripping or disconnection of an **HVDC Converter Station**, as part of any multi-terminal or embedded **HVDC System**, does not result in transients at the **Grid Entry Point** or **User System Entry Point** beyond the limit specified by **The Company** in co-ordination with the **Relevant Transmission Licensee**.

ECC.6.3.15.11.3 The **HVDC System** shall withstand transient faults on HVAC lines in the network adjacent or close to the **HVDC System**, and shall not cause any of the equipment in the **HVDC System** to disconnect from the network due to autoreclosure of lines in the **System**.

ECC.6.3.15.11.4 The **HVDC System Owner** shall provide information to **The Company** on the resilience of the **HVDC System** to **AC System** disturbances.

ECC.6.3.16 FAST FAULT CURRENT INJECTION

ECC.6.3.16.1 General Fast Fault Current injection, principles and concepts applicable to Type B, Type C and Type D Power Park Modules and HVDC Equipment

ECC.6.3.16.1.1 In addition to the requirements of ECC.6.1.4, ECC.6.3.2, ECC.6.3.8 and ECC.A.7, each **Type B, Type C and Type D Power Park Module** or each **Power Park Unit** within a **Type B, Type C and Type D Power Park Module** or **HVDC Equipment** shall be required to satisfy the following requirements unless operating in a **Grid Forming Capability** mode in which case the requirements of ECC.6.3.19 shall apply instead. For the purposes of this requirement, current and voltage are assumed to be positive phase sequence values.

ECC.6.3.16.1.2 For any balanced fault which results in the positive phase sequence voltage falling below the voltage levels specified in ECC.6.1.4 at the **Grid Entry Point** or **User System Entry Point** (if **Embedded**), each **Type B, Type C and Type D Power Park Module** or each **Power Park Unit** within a **Type B, Type C and Type D Power Park Module** or **HVDC Equipment** shall, as a minimum (unless an alternative type registered solution has otherwise been agreed with **The Company**), be required to inject a reactive current above the heavy black line shown in Figure ECC.16.3.16(a)

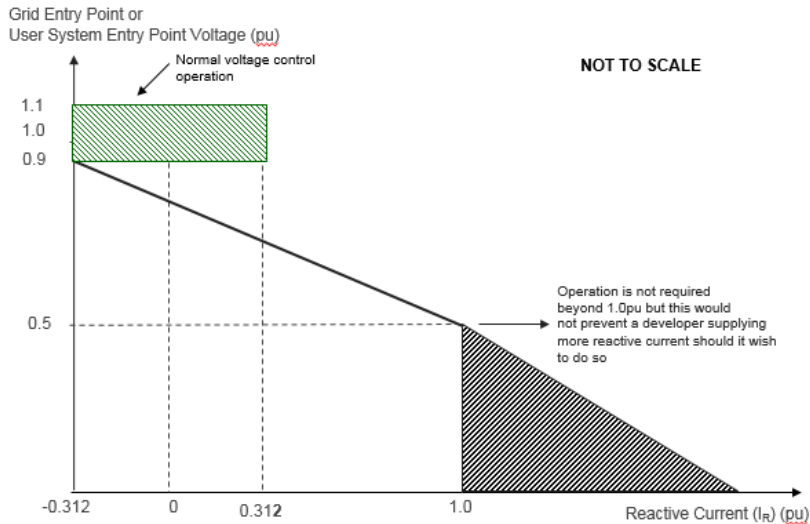

Figure ECC.6.3.16(a)

ECC.6.3.16.1.3 Figure ECC.6.3.16(a) defines the reactive current (I_R) to be supplied under a faulted condition which shall be dependent upon the pre-fault operating condition and the retained voltage at the **Grid Entry Point** or **User System Entry Point** voltage. For the avoidance of doubt, each **Power Park Module** (and any constituent element thereof) or **HVDC Equipment**, shall be required to inject a reactive current (I_R) which shall be not less than its pre-fault reactive current and which shall as a minimum increase with the fall in the retained voltage each time the voltage at the **Grid Entry Point** or **User System Entry Point** (if **Embedded**) falls below 0.9pu whilst ensuring the overall rating of the **Power Park Module** (or constituent element thereof) or **HVDC Equipment** shall not be exceeded.

ECC.6.3.16.1.4 In addition to the requirements of ECC.6.3.16.1.2 and ECC.6.3.16.1.3, each **Type B, Type C** and **Type D Power Park Module** or each **Power Park Unit** within a **Type B, Type C** and **Type D Power Park Module** or **HVDC Equipment** shall be required to inject reactive current above the shaded area shown in Figure ECC.6.3.16(b) and Figure ECC.6.3.16(c) which illustrates how the reactive current shall be injected over time from fault inception in which the value of I_R is determined from Figure ECC.6.3.16(a). In figures ECC.6.3.16(b) and ECC.6.3.16(c) ΔI_R is the value of the reactive current (I_R) less the pre-fault current. In this context fault inception is taken to be when the voltage at the **Grid Entry Point** or **User System Entry Point** falls below 0.9pu.

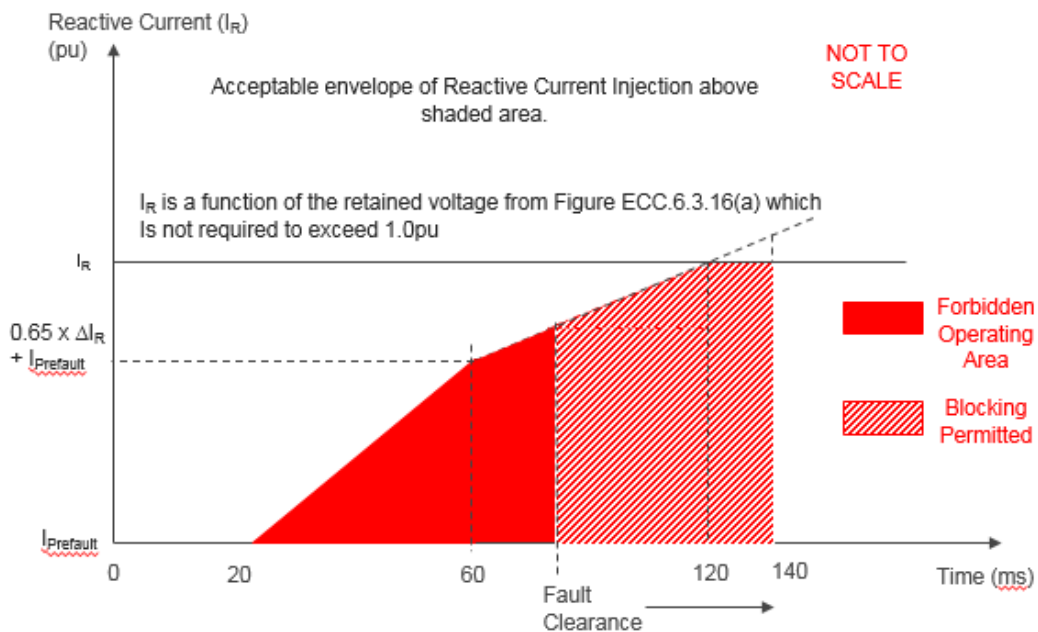

Figure ECC.16.3.16(b)

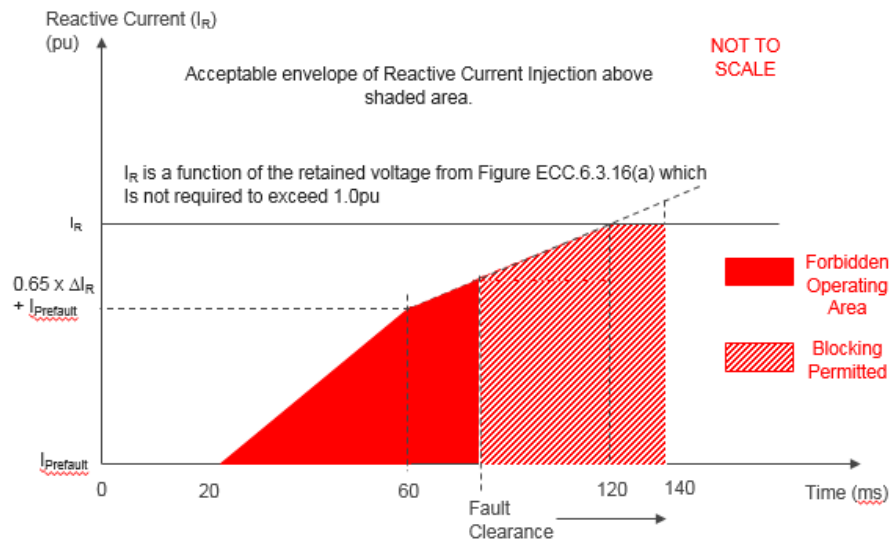

Figure ECC.16.3.16(c)

ECC.6.3.16.1.5 The injected reactive current (I_R) shall be above the shaded area shown in Figure ECC.6.3.16(b) and Figure ECC.6.3.16(c) with priority being given to reactive current injection with any residual capability being supplied as active current. Under any faulted condition, where the voltage falls outside the limits specified in ECC.6.1.4, there would be no requirement for each **Power Park Module** or constituent **Power Park Unit** or **HVDC Equipment** to exceed its transient or steady state rating of 1.0pu as defined in ECC.6.3.16.1.7.

ECC.6.3.16.1.6 For any planned or switching events (as outlined in ECC.6.1.7 of the Grid Code) or unplanned events which results in temporary power frequency over voltages (TOV's), each **Type B**, **Type C** and **Type D Power Generating Module** or each **Power Park Unit** within a **Type B**, **Type C** or **Type D Power Park Module** or **HVDC Equipment** will be required to satisfy the transient overvoltage limits specified in the **Bilateral Agreement**.

ECC.6.3.16.1.7 For the purposes of this requirement, the maximum rated current is taken to be the maximum current each **Power Park Module** (or the sum of the constituent **Power Park Units** which are connected to the **System** at the **Grid Entry Point** or **User System Entry Point**) or **HVDC Converter** is capable of supplying. In the case of a **Power Park Module** this would be the maximum rated current at the **Grid Entry Point** (or **User System Entry Point** if **Embedded**) when the **Power Park Module** is operating at rated **Active Power** and rated **Reactive Power** (as required under ECC.6.3.2) whilst operating over the nominal voltage range as required under ECC.6.1.4 at the **Grid Entry Point** (or **User System Entry Point** if **Embedded**). In the case of a **Power Park Unit** forming part of a **Type B**, **Type C** and **Type D Power Park Module**, the maximum rated current expected would be the maximum current supplied from each constituent **Power Park Unit** when the **Power Park Module** is operating at rated **Active Power** and rated **Reactive Power** over the nominal voltage operating range as defined in ECC.6.1.4 less the contribution from the reactive compensation equipment.

For example, in the case of a 100MW **Power Park Module** (consisting of 50 x 2MW Power Park Units and +10MVAR reactive compensation equipment) the **Rated Active Power** at the **Grid Entry Point** (or **User System Entry Point** if **Embedded**) would be taken as 100MW and the rated **Reactive Power** at the **Grid Entry Point** or (**User System Entry Point** if **Embedded**) would be taken as 32.8MVARs (ie **Rated MW** output operating at 0.95 **Power Factor** lead or 0.95 **Power Factor** lag as required under ECC.6.3.2.4). In this example, the maximum rating of each constituent **Power Park Unit** is obtained when the **Power Park Module** is operating at 100MW, and +32.8MVAR less 10MVAR equal to 22.8MVAR or - 32.8MVAR (less the reactive compensation equipment component of 10MVAR (ie - 22.8MVAR) when operating within the normal voltage operating range as defined under ECC.6.1.4 (allowing for any reactive compensation equipment or losses in the **Power Park Module** array network).

For the avoidance of doubt, the total current of 1.0pu would be assumed to be on the MVA rating of the **Power Park Module** or **HVDC Equipment** (less losses). Under all normal and abnormal conditions, the steady state or transient rating of the **Power Park Module** (or any constituent element including the **Power Park Units**) or **HVDC Equipment**, would not be required to exceed the locus shown in Figure 16.3.16(d).

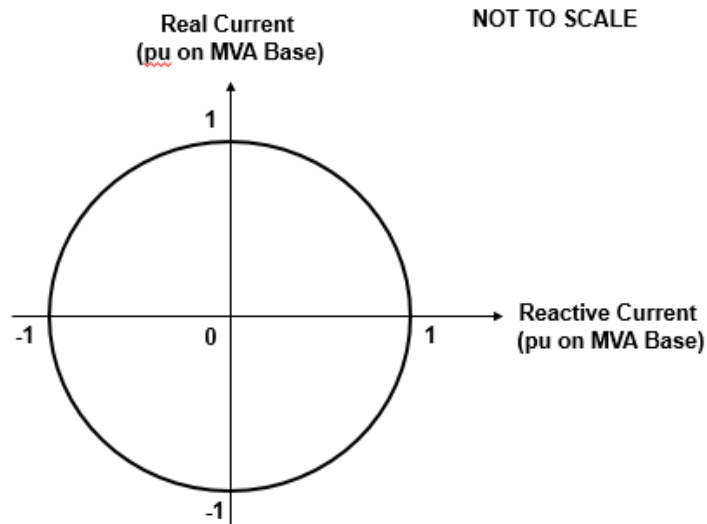

Figure ECC.16.3.16(d)

- ECC.6.3.16.1.7 Each **Type B, Type C** and **Type D Power Park Module** or **HVDC Equipment** shall be designed to ensure a smooth transition between voltage control mode and fault ride through mode in order to prevent the risk of instability which could arise in the transition between the steady state voltage operating range as defined under ECC.6.1.4 and abnormal conditions where the retained voltage falls below 90% of nominal voltage. Such a requirement is necessary to ensure adequate performance between the pre-fault operating condition of the **Power Park Module** or **HVDC Equipment** and its subsequent behaviour under faulted conditions. **EU Generators** and **HVDC System Owners** are required to both advise and agree with **The Company** the control strategy employed to mitigate the risk of such instability.
- ECC.6.3.16.1.8 Each **Type B, Type C** and **Type D Power Park Module** or **HVDC Equipment** shall be designed to reduce the risk of transient over voltage levels arising following clearance of the fault and in order to mitigate the risk of any form of instability which could result. **EU Generators** or **HVDC System Owners** shall be permitted to block or employ other means where the anticipated transient overvoltage would otherwise exceed the maximum permitted values specified in ECC.6.1.7. Figure ECC.16.3.16(b) and Figure ECC.16.3.16(c) shows the impact of variations in fault clearance time. For main protection operating times this would not exceed 140ms. The requirements for the maximum transient overvoltage withstand capability and associated time duration, shall be agreed between the **EU Code User** and **The Company** as part of the **Bilateral Agreement**. Where the **EU Code User** is able to demonstrate to **The Company** that blocking or other control strategies are required in order to prevent the risk of transient over voltage excursions as specified in ECC.6.3.16.1.5, **EU Generators** and **HVDC System Owners** are required to both advise and agree with **The Company** the control strategy, which must also include the approach taken to de-blocking

- ECC.6.3.16.1.9 In addition to the requirements of ECC.6.3.15, **Generators** in respect of **Type B, Type C and Type D Power Park Modules** or each **Power Park Unit** within a **Type B, Type C and Type D Power Park Module** or **DC Connected Power Park Modules** and **HVDC System Owners** in respect of **HVDC Systems** are required to confirm to **The Company**, their repeated ability to supply **Fast Fault Current** to the **System** each time the voltage at the **Grid Entry Point** or **User System Entry Point** falls outside the limits specified in ECC.6.1.4. **EU Generators** and **HVDC Equipment Owners** should inform **The Company** of the maximum number of repeated operations that can be performed under such conditions and any limiting factors to repeated operation such as protection or thermal rating.
- ECC.6.3.16.1.10 To permit additional flexibility for example from **Power Park Modules** made up of full converter machines, DFIG machines, induction generators or **HVDC Systems** or **Remote End HVDC Converters**, **The Company** will permit transient or marginal deviations below the shaded area shown in Figures ECC.16.3.16(b) or ECC.16.3.16(c) provided the injected reactive current supplied exceeds the area bound in Figure ECC.6.3.16(b) or ECC.6.3.16(c). Such agreement would be confirmed and agreed between **The Company** and **Generator**.
- ECC.6.3.16.1.11 In the case of a **Power Park Module** or **DC Connected Power Park Module**, where it is not practical to demonstrate the compliance requirements of ECC.6.3.16.1.1 to ECC.6.3.16.1.6 at the **Grid Entry Point** or **User System Entry Point**, **The Company** will accept compliance of the above requirements at the **Power Park Unit** terminals.
- ECC.6.3.16.1.12 For the avoidance of doubt, **Generators** in respect of **Type C and Type D Power Park Modules** and **OTSDUW Plant and Apparatus** are also required to satisfy the requirements of ECC.6.3.15.9.2.1(b) which specifies the requirements for fault ride through for voltage dips in excess of 140ms.
- ECC.6.3.16.1.13 In the case of an unbalanced fault, each **Type B, Type C and Type D Power Park Module** or each **Power Park Unit** within a **Type B, Type C and Type D Power Park Module** or **HVDC Equipment** shall be required to inject reactive current (I_R) which shall as a minimum increase with the fall in the retained unbalanced voltage up to its maximum reactive current without exceeding the transient rating of the **Power Park Module** (or constituent element thereof) or **HVDC Equipment**.
- ECC.6.3.16.1.14 In the case of a unbalanced fault, the **Generator** or **HVDC System Owner** shall confirm to **The Company** their ability to prevent transient overvoltages arising on the remaining healthy phases and the control strategy employed.
- ECC.6.3.17 SUBSYNCHRONOUS TORSIONAL INTERACTION DAMPING CAPABILITY, POWER OSCILLATION DAMPING CAPABILITY AND CONTROL FACILITIES FOR HVDC SYSTEMS
- ECC.6.3.17.1 Subsynchronous Torsional Interaction Damping Capability
- ECC.6.3.17.1.1 **HVDC System Owners**, or **Generators** in respect of **OTSDUW DC Converters** or **Network Operators** in the case of an **Embedded HVDC Systems** not subject to a **Bilateral Agreement** must ensure that any of their **Onshore HVDC Systems** or **OTSDUW DC Converters** will not cause a sub-synchronous resonance problem on the **Total System**. Each **HVDC System** or **OTSDUW DC Converter** is required to be provided with sub-synchronous resonance damping control facilities. **HVDC System Owners** and **EU Generators** in respect of **OTSDUW DC Converters** should also be aware of the requirements in ECC.6.1.9 and ECC.6.1.10.
- ECC.6.3.17.1.2 Where specified in the **Bilateral Agreement**, each **OTSDUW DC Converter** is required to be provided with power oscillation damping or any other identified additional control facilities.

- ECC.6.3.17.1.3 Each **HVDC System** shall be capable of contributing to the damping of power oscillations on the **National Electricity Transmission System**. The control system of the **HVDC System** shall not reduce the damping of power oscillations. **The Company** in coordination with the **Relevant Transmission Licensee** (as applicable) shall specify a frequency range of oscillations that the control scheme shall positively damp and the **System** conditions when this occurs, at least accounting for any dynamic stability assessment studies undertaken by the **Relevant Transmission Licensee** or **The Company** (as applicable) to identify the stability limits and potential stability problems on the **National Electricity Transmission System**. The selection of the control parameter settings shall be agreed between **The Company** in coordination with the **Relevant Transmission Licensee** and the **HVDC System Owner**.
- ECC.6.3.17.1.4 **The Company** shall specify the necessary extent of SSTI studies and provide input parameters, to the extent available, related to the equipment and relevant system conditions on the **National Electricity Transmission System**. The SSTI studies shall be provided by the **HVDC System Owner**. The studies shall identify the conditions, if any, where SSTI exists and propose any necessary mitigation procedure. The responsibility for undertaking the studies in accordance with these requirements lies with the **Relevant Transmission Licensee** in co-ordination with **The Company**. All parties shall be informed of the results of the studies.
- ECC.6.3.17.1.5 All parties identified by **The Company** as relevant to each **Grid Entry Point** or **User System Entry Point** (if **Embedded**), including the **Relevant Transmission Licensee**, shall contribute to the studies and shall provide all relevant data and models as reasonably required to meet the purposes of the studies. **The Company** shall collect this data and, where applicable, pass it on to the party responsible for the studies in accordance with **Retained EU Law** (Article 10 of Commission Regulation (EU) 2016/1447). Specific information relating to the interface schedules, input/output requirements, timing and submission of any studies or data would be agreed between the **User** and **The Company** and specified (where applicable) in the **Bilateral Agreement**.
- ECC.6.3.17.1.6 **The Company** in coordination with the **Relevant Transmission Licensee** shall assess the result of the SSTI studies. If necessary for the assessment, **The Company** in coordination with the **Relevant Transmission Licensee** may request that the **HVDC System Owner** perform further SSTI studies in line with this same scope and extent.
- ECC.6.3.17.1.7 **The Company** in coordination with the **Relevant Transmission Licensee** may review or replicate the study. The **HVDC System Owner** shall provide **The Company** with all relevant data and models that allow such studies to be performed. Submission of this data to **Relevant Transmission Licensee's** shall be in accordance with the requirements of **Retained EU Law** (Article 10 of Commission Regulation (EU) 2016/1447).
- ECC.6.3.17.1.8 Any necessary mitigating actions identified by the studies carried out in accordance with paragraphs ECC.6.3.17.1.4 or ECC.6.3.17.1.6, and reviewed by **The Company** in coordination with the **Relevant Transmission Licensees**, shall be undertaken by the **HVDC System Owner** as part of the connection of the new **HVDC Converter Station**.
- ECC.6.3.17.1.9 As part of the studies and data flow in respect of ECC.6.3.17.1 – ECC.6.3.17.8 the following data exchange would take place with the time scales being pursuant to the terms of the **Bilateral Agreement**.

Information supplied by **The Company** and **Relevant Transmission Licensees**

Studies provided by the **User**

User review

The Company review

Changes to studies and agreed updates between **The Company**, the **Relevant Transmission Licensee** and **User**

Final review

ECC.6.3.17.2 Interaction between **HVDC Systems** or other **User's Plant** and **Apparatus**

ECC.6.3.17.2.1 Notwithstanding the requirements of ECC6.1.9 and ECC.6.1.10, when several **HVDC Converter Stations** or other **User's Plant and Apparatus** are within close electrical proximity, **The Company** may specify that a study is required, and the scope and extent of that study, to demonstrate that no adverse interaction will occur. If adverse interaction is identified, the studies shall identify possible mitigating actions to be implemented to ensure compliance with the requirements of ECC.6.1.9

ECC.6.3.17.2.2 The studies shall be carried out by the connecting **HVDC System Owner** with the participation of all other **User's** identified by **The Company** in coordination with **Relevant Transmission Licensees** as relevant to each **Connection Point**.

ECC.6.3.17.2.3 All **User's** identified by **The Company** as relevant to the connection, and where applicable **Relevant Transmission Licensee's**, shall contribute to the studies and shall provide all relevant data and models as reasonably required to meet the purposes of the studies. **The Company** shall collect this input and, where applicable, pass it on to the party responsible for the studies in accordance with **Retained EU Law** (Article 10 of Commission Regulation (EU) 2016/1447). Specific information relating to the interface schedules, input/output requirements, timing and submission of any studies or data would be agreed between the **User** and **The Company** and specified (where applicable) in the **Bilateral Agreement**.

ECC.6.3.17.2.4 **The Company** in coordination with **Relevant Transmission Licensees** shall assess the result of the studies based on their scope and extent as specified in accordance with ECC.6.3.17.2.1. If necessary for the assessment, **The Company** in coordination with the **Relevant Transmission Licensee** may request the **HVDC System Owner** to perform further studies in line with the scope and extent specified in accordance with ECC.6.3.17.2.1.

ECC.6.3.17.2.5 **The Company** in coordination with the **Relevant Transmission Licensee** may review or replicate some or all of the studies. The **HVDC System Owner** shall provide **The Company** all relevant data and models that allow such studies to be performed.

ECC.6.3.17.2.6 The **EU Code User** and **The Company**, in coordination with the **Relevant Transmission Licensee**, shall agree any mitigating actions identified by the studies carried out following the site specific requirements and works, including any transmission reinforcement works and / or **User** works required to ensure that all sub-synchronous oscillations are sufficiently damped.

ECC.6.1.17.3 Fast Recovery from DC faults

ECC.6.1.17.3.1 **HVDC Systems**, including DC overhead lines, shall be capable of fast recovery from transient faults within the **HVDC System**. Details of this capability shall be subject to the **Bilateral Agreement** and the protection requirements specified in ECC.6.2.2 .

ECC.6.1.17.4 Maximum loss of Active Power

ECC.6.1.14.4.1 An **HVDC System** shall be configured in such a way that its loss of **Active Power** injection in the **GB Synchronous Area** shall be in accordance with the requirements of the **SQSS**.

ECC.6.3.18 SYSTEM TO GENERATOR OPERATIONAL INTERTRIPPING SCHEMES

ECC.6.3.18.1 **The Company** may require that a **System to Generator Operational Intertripping Scheme** be installed as part of a condition of the connection of the **EU Generator**. Scheme specific details shall be included in the relevant **Bilateral Agreement** and shall, include the following information:

- (1) the relevant category(ies) of the scheme (referred to as **Category 1 Intertripping Scheme, Category 2 Intertripping Scheme, Category 3 Intertripping Scheme** and **Category 4 Intertripping Scheme**);
- (2) the **Power Generating Module** to be either permanently armed or that can be instructed to be armed in accordance with BC2.8;
- (3) the time within which the **Power Generating Module** circuit breaker(s) are to be automatically tripped;

- (4) the location to which the trip signal will be provided by **The Company**. Such location will be provided by **The Company** prior to the commissioning of the **Power Generating Module**.

Where applicable, the **Bilateral Agreement** shall include the conditions on the **National Electricity Transmission System** during which **The Company** may instruct the **System to Generator Operational Intertripping Scheme** to be armed and the conditions that would initiate a trip signal.

ECC.6.3.18.2 The time within which the **Power Generating Module(s)** circuit breaker(s) need to be automatically tripped is determined by the specific conditions local to the **EU Generator**. This 'time to trip' (defined as the time from provision of the trip signal by **The Company** to the specified location, to circuit breaker main contact opening) can typically range from 100ms to 10sec. A longer time to trip may allow the initiation of an automatic reduction in the **Power Generating Module(s)** output prior to the automatic tripping of the **Power Generating Module(s)** circuit breaker. Where applicable **The Company** may provide separate trip signals to allow for either a longer or shorter 'time to trip' to be initiated.

ECC.6.3.19 **GRID FORMING CAPABILITY**

ECC.6.3.19.1 In order for the **National Electricity Transmission System** to satisfy the stability requirements defined in the **National Electricity Transmission System Security and Quality of Supply Standards**, it is an essential requirement that an appropriate volume of **Grid Forming Plant** is available and capable of providing a **Grid Forming Capability**.

ECC.6.3.19.2 **Grid Forming Capability** is not a mandatory requirement but one which will be delivered through market arrangements, the details of which shall be published on **The Company's Website**. **Grid Forming Capability** can be implemented by any technology including **Electronic Power Converters** with a **GBGF- I** ability, rotating **Synchronous Generating Units** or a combination of the two.

ECC.6.3.19.3 As noted in ECC.6.3.19.2, **Grid Forming Capability** is not a mandatory requirement, however where a **User** (be they a **GB Code User** or **EU Code User**) or **Non-CUSC Party** wishes to offer a **Grid Forming Capability**, then they will be required to ensure their **Grid Forming Plant** meets the following requirements.

- (i) The **Grid Forming Plant** must fully comply with the applicable requirements of the Grid Code including but not limited to the **Planning Code (PC)**, **Connection Conditions (CC's)** or **European Connection Conditions (ECC's)** (as applicable), **Compliance Processes (CP's)** or **European Compliance Processes (ECP's)** (as applicable), **Operating Codes (OC's)**, **Balancing Codes (BC's)** and **Data Registration Code (DRC)**.
- (ii) Each **GBGF-I** shall comprise an **Internal Voltage Source** and reactance. For the avoidance of doubt, the reactance between the **Internal Voltage Source** and **Grid Entry Point** or **User System Entry Point (if Embedded)** within the **Grid Forming Plant** can only be made by a combination of several physical discrete reactances. This could include the reactance of the **Synchronous Generating Unit** or **Power Park Unit** or **HVDC System** or **Electricity Storage Unit** or **Dynamic Reactive Compensation Equipment** and the electrical **Plant and Apparatus** connecting the **Synchronous Generating Unit** or **Power Park Unit** or **HVDC System** or **Electricity Storage Unit** (such as a transformer) to the **Grid Entry Point** or **User System Entry Point (if Embedded)**.
- (iii) In addition to meeting the requirements of CC.6.3.15 or ECC.6.3.15, each **Grid Forming Plant** is required to remain in synchronism with the **Total System** and maintain a **Load Angle** whose value can vary between 0 and 90 degrees ($\pi/2$ radians).

- (iv) When subject to a fault or disturbance, or **System Frequency** change, each **Grid Forming Plant** shall be capable of supplying **Active ROCOF Response Power**, **Active Phase Jump Power**, **Active Damping Power**, **Active Control Based Power**, **Control Based Reactive Power**, **Voltage Jump Reactive Power** and **GBGF Fast Fault Current Injection**.
- (v) Each **GBGF-I** shall be capable of:-
 - (a) Providing a symmetrical ability for importing and exporting **Active ROCOF Response Power**, **Active Phase Jump Power**, **Active Damping Power** and **Active Control Based Power** under both rising and falling **System Frequency** conditions. Such requirements will apply over the full **System Frequency** range as detailed in CC.6.1.2 and CC.6.1.3 or ECC.6.1.2 (as applicable). In satisfying these requirements, **User's** and **Non-CUSC Parties** should be aware of (but not limited to) the exclusions in CC.6.3.3, CC.6.3.7 and BC3.7.2.1 (as applicable for **GB Code User's**) or ECC.6.1.2, ECC.6.3.3, ECC.6.3.7 and BC3.7.2.1(b)(i) (as applicable for **EU Code User's** and **Non-CUSC Parties**) during **System Frequencies** between 47Hz – 52Hz, excluding CC.6.1.3 or ECC.6.1.2.1,2 for a **Grid Forming Plant** with time limited output ratings. For the avoidance of doubt, an asymmetrical response is permissible as agreed with **The Company** when required to protect **User's** and **Non-CUSC Parties Plant** and **Apparatus** or asymmetry in energy availability.
 - (b) Operating as a voltage source behind a real reactance.
 - (c) being designed so as not to cause any undue interactions which could cause damage to the **Total System** or other **User's Plant** and **Apparatus**.
 - (d) include an **Active Control Based Power** part of the control system that can respond to changes in the **Grid Forming Plant** or external signals from the **Total System** available at the **Grid Entry Point** or **User System Entry Point** but with a bandwidth below 5 Hz to avoid AC **System** resonance problems.
 - (e) meeting the requirements of ECC.6.3.13 irrespective of being owned or operated by a **GB Code User**, **EU Code User** or **Non-CUSC Party**.
 - (f) **GBGF-I** with an importing capability mode of operation such as **DC Converters**, **HVDC Systems** and **Electricity Storage Modules** are required to have a predefined frequency response operating characteristic over the full import and export range which is contained within the envelope defined by the red and blue lines shown in Figure ECC.6.3.19.3. This characteristic shall be submitted to **The Company**. For the avoidance of doubt, **Grid Forming Plants** which are only capable of exporting **Active Power** to the **Total System** are only required to operate over the exporting power region

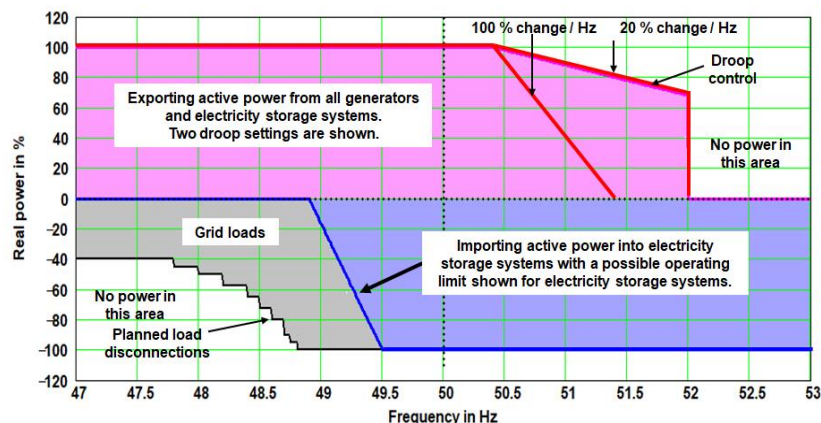

Figure ECC.6.3.19.3

- (vi) Each **User** or **Non-CUSC Party** shall design their **GBGF-I** system with an equivalent **Damping Factor** of between 0.2 and 5.0. It is down to the **User** or **Non-CUSC Party** to determine the **Damping Factor**, whose value shall be agreed with **The Company**. It is typical for the **Damping Factor** to be less than 1.0, though this will be dependent upon the parameters of the **Grid Forming Plant** and the equivalent **System** impedance at the **Grid Entry Point** or **User System Entry Point**.

The output of the **Grid Forming Plant** shall be designed such that following a disturbance on the **System**, the **Active Power** output and **Reactive Power** output shall be adequately damped. The damping shall be judged to be adequate if the corresponding **Active Power** response to a disturbance decays with a response that is in line with the response of second order system that has the same equivalent **Damping Factor**.

- (vii) Each **GBGF-I** shall be designed so as not to interact and affect the operation, performance, safety or capability of other **User's Plant** and **Apparatus** connected to the **Total System**. To achieve this requirement, each **User** and **Non-CUSC Party** shall be required to submit the data required in PC.A.5.8

ECC.6.3.19.4 In addition to the requirements of ECC.6.3.19.1 – ECC.6.3.19.3 each **Grid Forming Plant** shall also be capable of: -

- (i) satisfying the requirements of ECC.6.3.19.5.
- (ii) operating at a minimum short circuit level of zero MVA at the **Grid Entry Point** or **User System Entry Point**.
- (iii) providing any additional quality of supply requirements, including but not limited to reductions in the permitted frequency of Temporary Power **System** Over-voltage events (TOV's) and **System Frequency** bandwidth limitations, as agreed with **The Company**. Such requirements will be pursuant to the terms of the **Bilateral Agreement**. For the avoidance of doubt, this requirement is in addition to the minimum quality of supply requirements detailed in CC.6.1.5, CC.6.1.6 and CC.6.1.7 (as applicable) or ECC.6.1.5, ECC.6.1.6 and ECC.6.1.7 (as applicable),

ECC.6.3.19.5 **GBGF Fast Fault Current Injection**

ECC.6.3.19.5.1 For any balanced fault which results in the positive phase sequence voltage falling below the voltage levels specified in CC.6.1.4 or ECC.6.1.4 (as applicable) at the **Grid Entry Point** or **User System Entry Point** (if **Embedded**), a **Grid Forming Plant** shall, as a minimum be required to inject a reactive current of at least their **Peak Current Rating** when the voltage at the **Grid Entry Point** or **User System Entry Point** drops to zero. For intermediate retained voltages at the **Grid Entry Point** or **User System Entry Point**, the injected reactive current shall be on or above a line drawn from the bottom left hand corner of the normal voltage control operating zone (shown in the rectangular green shaded area of Figure ECC.6.3.19.5(a)) and the specified **Peak Current Rating** at a voltage of zero at the **Grid Entry Point** or **User System Entry Point** as shown in Figure ECC.16.3.19.5(a). Typical examples of limit lines are shown in Figure ECC.16.3.19.5(a) for a **Peak Current Rating** of 1.0pu where the injected reactive current must be on or above the black line and a **Peak Current Rating** of 1.5pu where injected reactive current must be on or above the red line.

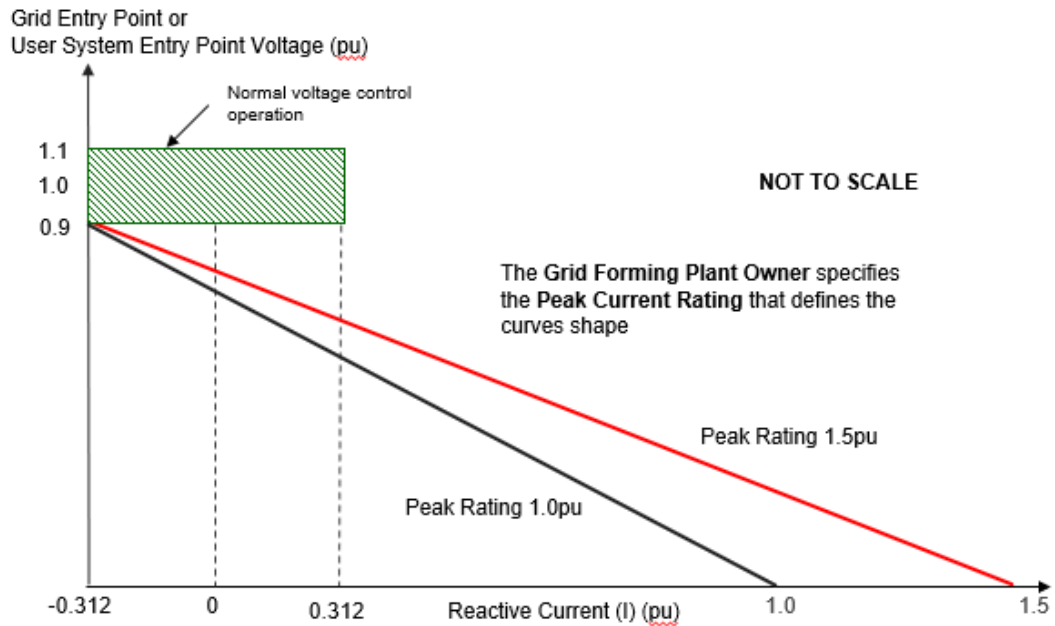

Figure ECC.6.3.19.5(a)

ECC.6.3.19.5.2 Figure ECC.6.3.19.5(a) defines the reactive current to be supplied under a faulted condition which shall be dependent upon the pre-fault operating condition and the retained voltage at the **Grid Entry Point** or **User System Entry Point** voltage. For the avoidance of doubt, each **Grid Forming Plant** (and any constituent element thereof), shall be required to inject a reactive current which shall be not less than its pre-fault reactive current and which shall as a minimum, increase each time the voltage at the **Grid Entry Point** or **User System Entry Point** (if **Embedded**) falls below 0.9pu whilst ensuring the overall rating of the **Grid Forming Plant** (or constituent element thereof) shall not be exceeded.

ECC.6.3.19.5.3 In addition to the requirements of ECC.6.3.19.5.1 and ECC.6.3.19.5.2, each **Grid Forming Plant** shall be required to inject reactive current above the shaded area shown in Figure ECC.6.3.19.5(b) when the retained voltage at the **Grid Entry Point** or **User System Entry Point** falls to 0pu. Where the retained voltage at the **Grid Entry Point** or **User System Entry Point** is below 0.9pu but above 0pu (for example when significant active current is drawn by loads and/or resistive components arising from both local and remote faults or disturbances from other **Plant** and **Apparatus** connected to the **Total System**) the injected reactive current component shall be in accordance with Figure ECC.6.3.19.5(a).

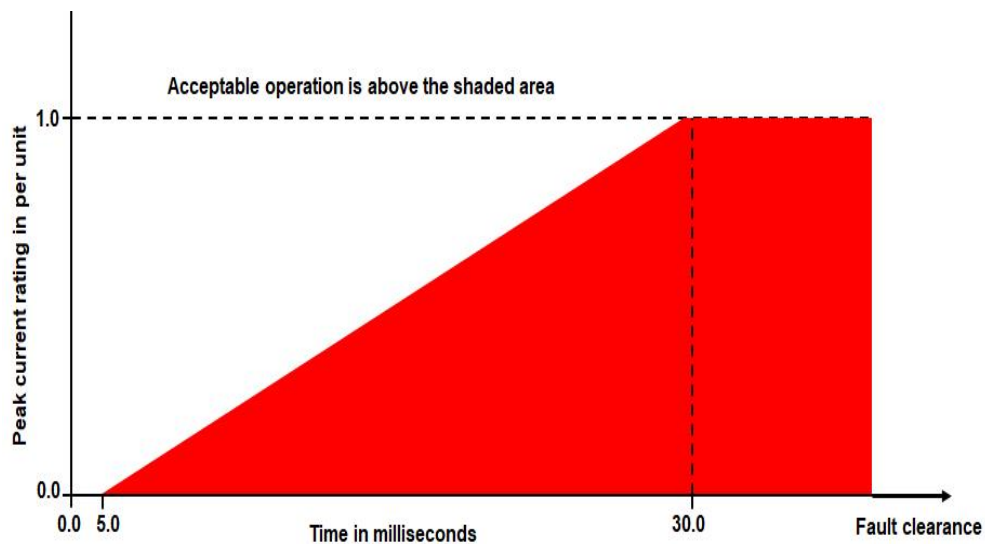

Figure ECC.6.3.19.5(b)

- ECC.6.3.19.5.4 The injected current shall be above the shaded area shown in Figure ECC.6.3.19.5(b) for the duration of the fault clearance time which for faults on the **Transmission System** cleared in **Main Protection** operating times shall be up to 140ms. Under any faulted condition, where the voltage falls outside the limits specified in CC.6.1.4 or ECC.6.1.4 (as applicable), there will be no requirement for each **Grid Forming Plant** or constituent part to exceed its transient or steady state rating as defined in Table PC.A.5.8.2.
- ECC.6.3.19.5.5 For any planned or switching events (as outlined in CC.6.1.7 or ECC.6.1.7 of the Grid Code) or unplanned events which results in Temporary Power **System** Over Voltages (TOV's), each **Grid Forming Plant** will be required to satisfy the transient overvoltage limits specified in the **Bilateral Agreement**.
- ECC.6.3.19.5.6 For the purposes of this requirement, the maximum rated current will be the **Peak Current Rating** declared by the **Grid Forming Plant Owner** in accordance with Table PC.A.5.8.2.
- ECC.6.3.19.5.7 Each **Grid Forming Plant** shall be designed to ensure a smooth transition between voltage control mode and **Fault Ride Through** mode in order to prevent the risk of instability which could arise in the transition between the steady state voltage operating range as defined under CC.6.1.4 or ECC.6.1.4 (as applicable) and abnormal conditions where the retained voltage falls below 90% of nominal voltage. Such a requirement is necessary to ensure adequate performance between the pre-fault operating condition of the **Grid Forming Plant** and its subsequent behaviour under faulted conditions. **Grid Forming Plant Owners** are required to both advise and agree with **The Company** the control strategy employed to mitigate the risk of such instability.
- ECC.6.3.19.5.8. Each **Grid Forming Plant** shall be designed to reduce the risk of transient over voltage levels arising following clearance of the fault and in order to mitigate the risk of any form of instability which could result. The requirements for the maximum transient overvoltage withstand capability and associated time duration, shall be agreed between the **User** or **Non-CUSC Party** and **The Company** as part of the **Bilateral Agreement**.
- ECC.6.3.19.5.9 In addition to the requirements of CC.6.3.15 or ECC.6.3.15, each **Grid Forming Plant Owner** is required to confirm to **The Company**, their repeated ability to supply **GBGF Fast Fault Current Injection** to the **System** each time the voltage at the **Grid Entry Point** or **User System Entry Point** falls outside the limits specified in CC.6.1.4 or ECC.6.1.4 (as applicable). **Grid Forming Plant Owners** should inform **The Company** of the maximum number of repeated operations that can be performed under such conditions and any limiting factors to repeated operation such as protection or thermal rating.

ECC.6.3.19.5.10 In the case of a **Power Park Module** or **DC Connected Power Park Module**, where it is not practical to demonstrate the compliance requirements of ECC.6.3.19.5.1 to ECC.6.3.19.5.5 at the **Grid Entry Point** or **User System Entry Point**, **The Company** will accept compliance of the above requirements at the **Power Park Unit** terminals.

ECC.6.3.19.5.11 In the case of an unbalanced fault, each **Grid Forming Plant**, shall be required to inject current which shall as a minimum increase with the fall in the unbalanced voltage without exceeding the transient **Peak Current Rating** of the **Grid Forming Plant** (or constituent element thereof).

ECC.6.3.19.5.12 In the case of an unbalanced fault, the **User** or **Non-CUSC Party** shall confirm to **The Company** their ability to prevent transient overvoltages arising on the remaining healthy phases and the control strategy employed.

ECC.6.4 General Network Operator And Non-Embedded Customer Requirements

ECC.6.4.1 This part of the **Grid Code** describes the technical and design criteria and performance requirements for **Network Operators** and **Non-Embedded Customers**.

Neutral Earthing

- ECC.6.4.2 At nominal **System** voltages of 132kV and above the higher voltage windings of three phase transformers and transformer banks connected to the **National Electricity Transmission System** must be star connected with the star point suitable for connection to earth. The earthing and lower voltage winding arrangement shall be such as to ensure that the **Earth Fault Factor** requirement of paragraph ECC.6.2.1.1 (b) will be met on the **National Electricity Transmission System** at nominal **System** voltages of 132kV and above.

Frequency Sensitive Relays

- ECC.6.4.3 As explained under **OC6**, each **Network Operator** and **Non Embedded Customer**, will make arrangements that will facilitate automatic low **Frequency Disconnection of Demand** (based on **Annual ACS Conditions**). ECC.A.5.5. of Appendix E5 includes specifications of the local percentage **Demand** that shall be disconnected at specific frequencies. The manner in which **Demand** subject to low **Frequency** disconnection will be split into discrete MW blocks is specified in OC6.6. Technical requirements relating to **Low Frequency Relays** are also listed in Appendix E5.

Operational Metering

- ECC.6.4.4 Where **The Company** can reasonably demonstrate that an **Embedded Medium Power Station** or **Embedded HVDC System** has a significant effect on the **National Electricity Transmission System**, it may require the **Network Operator** within whose **System** the **Embedded Medium Power Station** or **Embedded HVDC System** is situated to ensure that the operational metering equipment described in ECC.6.5.6 is installed such that **The Company** can receive the data referred to in ECC.6.5.6. In the case of an **Embedded Medium Power Station** subject to, or proposed to be subject to a **Bilateral Agreement**, **The Company** shall notify such **Network Operator** of the details of such installation in writing within 3 months of being notified of the application to connect under **CUSC** and in the case of an **Embedded Medium Power Station** not subject to, or not proposed to be subject to a **Bilateral Agreement** in writing as a **Site Specific Requirement** in accordance with the timescales in CUSC 6.5.5. In either case the **Network Operator** shall ensure that the data referred to in ECC.6.5.6 is provided to **The Company**.

- ECC.6.4.5 Reactive Power Requirements at each EU Grid Supply Point

- ECC.6.4.5.1 At each **EU Grid Supply Point**, **Non-Embedded Customers** and **Network Operators** who are **EU Code Users** shall ensure their **Systems** are capable of steady state operation within the **Reactive Power** limits as specified in ECC.6.4.5.1(a) and ECC.6.4.5.1(b). Where **The Company** requires a **Reactive Power** range which is broader than the limits defined in ECC.6.4.5.1(a) and ECC.6.4.5.1(b), this will be agreed as a reasonable requirement through joint assessment between the relevant **EU Code User** and **The Company** and justified in accordance with the requirements of ECC.6.4.5.1(c), (d), (e) and (f). For **Non-Embedded Customers** who are **EU Code Users**, the **Reactive Power** range at each **EU Grid Supply Point**, under both importing and exporting conditions, shall not exceed 48% of the larger of the **Maximum Import Capability** or **Maximum Export Capability** (0.9 **Power Factor** import or export of **Active Power**), except in situations where either technical or financial system benefits are demonstrated for **Non-Embedded Customers** and accepted by **The Company** in coordination with the **Relevant Transmission Licensee**.

- (a) For **Network Operators** who are **EU Code Users** at each **EU Grid Supply Point**, the **Reactive Power** range shall not exceed:
- (i) 48 percent (i.e. 0.9 **Power Factor**) of the larger of the **Maximum Import Capability** or **Maximum Export Capability** during **Reactive Power** import (consumption); and
 - (ii) 48 percent (i.e. 0.9 **Power Factor**) of the larger of the **Maximum Import Capability** or **Maximum Export Capability** during **Reactive Power** export (production);

Except in situations where either technical or financial system benefits are proved by **The Company** in coordination with the **Relevant Transmission Licensee** and the relevant **Network Operator** through joint analysis.

- (b) **The Company** in co-ordination with the **Relevant Transmission Licensee** shall agree with the **Network Operator** on the scope of the analysis, which shall determine the optimal solution for **Reactive Power** exchange between their **Systems** at each **EU Grid Supply Point**, taking adequately into consideration the specific **System** characteristics, variable structure of power exchange, bidirectional flows and the **Reactive Power** capabilities of the **Network Operator's System**. Any proposed solutions shall take the above issues into account and shall be agreed as a reasonable requirement through joint assessment between the relevant **Network Operator** or **Non-Embedded Customer** and **The Company** in coordination with the **Relevant Transmission Licensee**. In the event of a shared site between a **GB Code User** and **EU Code User**, the requirements would generally be allocated to each **User** on the basis of their **Demand** in the case of a **Network Operator** who is a **GB Code User** and applied on the basis of the **Maximum Import Capability** or **Maximum Export Capability** as specified in ECC.6.4.5.1 in the case of a **Network Operator** who is an **EU Code User**.
- (c) **The Company** in coordination with the **Relevant Transmission Licensee** may specify the **Reactive Power** capability range at the **EU Grid Supply Point** in another form other than **Power Factor**.
- (d) Notwithstanding the ability of **Network Operators** or **Non Embedded Customers** to apply for a derogation from ECC.6.4.5.1 (e), where an **EU Grid Supply Point** is shared between a **Power Generating Module** and a **Non-Embedded Customers System**, the **Reactive Power** range would be apportioned to each **EU Code User** at their **Connection Point**.

ECC.6.4.5.2 Where agreed with the **Network Operator** who is an **EU Code User** and justified through appropriate **System** studies, **The Company** may reasonably require the **Network Operator** not to export **Reactive Power** at the **EU Grid Supply Point** (at nominal voltage) at an **Active Power** flow of less than 25 % of the **Maximum Import Capability**. Where applicable, the **Authority** may require **The Company** in coordination with the **Relevant Transmission Licensee** to justify its request through a joint analysis with the relevant **Network Operator** and demonstrate that any such requirement is reasonable. If this requirement is not justified based on the joint analysis, **The Company** in coordination with the **Relevant Transmission Licensee** and the **Network Operator** shall agree on necessary requirements according to the outcomes of a joint analysis.

ECC.6.4.5.3 Notwithstanding the requirements of ECC.6.4.5.1(b) and subject to agreement between **The Company** and the relevant **Network Operator** there may be a requirement to actively control the exchange of **Reactive Power** at the **EU Grid Supply Point** for the benefit of the **Total System**. **The Company** and the relevant **Network Operator** shall agree on a method to carry out this control, to ensure the justified level of security of supply for both parties. Any such solution including joint study work and timelines would be agreed between **The Company** and the relevant **Network Operator** as reasonable, efficient and proportionate.

ECC.6.4.5.4 In accordance with ECC.6.4.5.3, the relevant **Network Operator** may require **The Company** to consider its **Network Operator's System** for **Reactive Power** management. Any such requirement would need to be agreed between **The Company** and the relevant **Network Operator** and justified by **The Company**.

ECC.6.5 Communications Plant

ECC.6.5.1 In order to ensure control of the **National Electricity Transmission System**, telecommunications between **Users** and **The Company** must (including in respect of any **OTSDUW Plant and Apparatus** at the **OTSUA Transfer Time**), if required by **The Company**, be established in accordance with the requirements set down below.

- ECC.6.5.2 Control Telephony and System Telephony
- ECC.6.5.2.1 **Control Telephony** provides secure point to point telephony for routine **Control Calls**, priority **Control Calls** and emergency **Control Calls**.
- ECC.6.5.2.2 **System Telephony** uses an appropriate public communications network to provide telephony for **Control Calls**, inclusive of emergency **Control Calls**. For the avoidance of doubt, **System Telephony** could include but shall not be limited to: an analogue or digital telephone line; a mobile telephone or an internet-based voice communication system, all of which would be connected to an appropriate public communications network.
- ECC.6.5.2.3 Calls made and received over **Control Telephony** and **System Telephony** may be recorded and subsequently replayed for commercial and operational reasons.
- ECC.6.5.3 Not Used
- ECC.6.5.4 Obligations in respect of Control Telephony and System Telephony
- ECC.6.5.4.1 Where **The Company** requires **Control Telephony**, **Users** are required to use the **Control Telephony** to communicate with **The Company** and / or the **Transmission Licensees'** in respect of all **Connection Points** with the **National Electricity Transmission System**, all **Embedded Large Power Stations**, **Embedded HVDC Systems** and **Network Operator's Control Centres** as appropriate. **The Company** shall provide **Control Telephony** interface equipment at the **User's Control Point** or the **Network Operators Control Centre** as appropriate. Where the **EU Code User's** or **Network Operators Control Centre** telephony equipment is not capable of providing the required facilities or is otherwise incompatible with the **Transmission Control Telephony** **The Company** shall provide a **Control Telephony** handset(s) Details of and relating to the **Control Telephony** requirements are contained in the **Bilateral Agreement** with **EU Code User's**.
- ECC.6.5.4.2 Where in **The Company's** sole opinion the installation of **Control Telephony** is not practicable at a **User's Control Point(s)**, **The Company** shall specify in the **Bilateral Agreement** whether **System Telephony** is required. Where **System Telephony** is required by **The Company**, the **User** shall ensure that **System Telephony** is installed.
- ECC.6.5.4.3 Where **System Telephony** is installed, **EU Code Users** are required to use the **System Telephony** for communication with **The Company** and the relevant **Transmission Licensees' Control Engineers** in respect of those **Control Point(s)** for which it has been installed. Details of and relating to the **System Telephony** required are contained in the **Bilateral Agreement**.
- ECC.6.5.4.4 Where **Control Telephony** or **System Telephony** is installed, routine testing of such facilities may be required by **The Company** (not normally more than once in any calendar month). The **User** and **The Company** shall use reasonable endeavours to agree a test programme and where **The Company** requests the assistance of the **User** in performing the agreed test programme the **User** shall provide such assistance. **The Company** requires the **EU Code User** to test the backup power supplies feeding its **Control Telephony** facilities at least once every 5 years.
- ECC.6.5.4.5 **Control Telephony** and **System Telephony** shall only be used for the purposes of operational voice communication between **The Company** and the relevant **User**.
- ECC.6.5.4.6 **Control Telephony** contains emergency calling functionality to be used for operational communication only under normal and emergency conditions. Functionality enables **The Company** and **Users** to utilise a priority call in the event of an emergency. **The Company** and **EU Code Users** shall only use such priority call functionality for urgent operational communications.
- ECC.6.5.5 Technical Requirements for Control Telephony and System Telephony

- ECC.6.5.5.1 Detailed information on the technical interfaces and support requirements for **Control Telephony** is provided in the **Control Telephony Electrical Standard** identified in the Annex to the **General Conditions**. Where additional information, or information in relation to **Control Telephony** applicable in Scotland, is requested by **Users**, this will be provided, where possible, by **The Company**.
- ECC.6.5.5.2 **System Telephony** shall consist of a dedicated telephone connected to an appropriate public communications network that shall be configured by the relevant **User**. **The Company** shall provide a dedicated free phone number (UK only), for the purposes of receiving incoming calls to **The Company**, which **Users** shall utilise for **System Telephony**. **System Telephony** shall only be utilised by **The Company's Control Engineer** and the **User's Responsible Engineer/Operator** for the purposes of operational communications.
- ECC.6.5.6 Operational Metering
- ECC.6.5.6.1 It is an essential requirement for **The Company** and **Network Operators** to have visibility of the real time output and status of indications of **User's Plant and Apparatus** so they can control the operation of the **System**.
- ECC.6.5.6.2 **Type B, Type C and Type D Power Park Modules, HVDC Equipment, Network Operators and Non Embedded Customers** are required to be capable of exchanging operational metering data with **The Company** and **Relevant Transmission Licensees** (as applicable) with time stamping. Time stamping would generally be to a sampling rate of 1 second or better unless otherwise specified by **The Company** in the **Bilateral Agreement**.
- ECC.6.5.6.3 **The Company** in coordination with the **Relevant Transmission Licensee** shall specify in the **Bilateral Agreement** the operational metering signals to be provided by the **EU Generator, HVDC System Owner, Network Operator or Non-Embedded Customer**. In the case of **Network Operators and Non-Embedded Customers**, detailed specifications relating to the operational metering standards at **EU Grid Supply Points** and the data required are published as **Electrical Standards** in the Annex to the **General Conditions**.
- ECC.6.5.6.4 (a) **The Company** or The **Relevant Transmission Licensee**, as applicable, shall provide system control and data acquisition (SCADA) outstation interface equipment., each **EU Code User** shall provide such voltage, current, **Frequency, Active Power and Reactive Power** measurement outputs and plant status indications and alarms to the **Transmission SCADA** outstation interface equipment as required by **The Company** in accordance with the terms of the **Bilateral Agreement**. In the case of **OTSDUW**, the **User** shall provide such SCADA outstation interface equipment and voltage, current, **Frequency, Active Power and Reactive Power** measurement outputs and plant status indications and alarms to the SCADA outstation interface equipment as required by **The Company** in accordance with the terms of the **Bilateral Agreement**.
- (b) For the avoidance of doubt, for **Active Power and Reactive Power** measurements, circuit breaker and disconnecter status indications from:
- (i) **CCGT Modules from Type B, Type C and Type D Power Generating Modules**, the outputs and status indications must each be provided to **The Company** on an individual **CCGT Unit** basis. In addition, where identified in the **Bilateral Agreement, Active Power and Reactive Power** measurements from **Unit Transformers** and/or **Station Transformers** must be provided.
 - (ii) For **Type B, Type C and Type D Power Park Modules** the outputs and status indications must each be provided to **The Company** on an individual **Power Park Module** basis. In addition, where identified in the **Bilateral Agreement, Active Power and Reactive Power** measurements from station transformers must be provided.
 - (iii) In respect of **OTSDUW Plant and Apparatus**, the outputs and status indications must be provided to **The Company** for each piece of electrical equipment. In addition, where identified in the **Bilateral Agreement, Active Power and Reactive**

Power measurements at the **Interface Point** must be provided.

- (c) For the avoidance of doubt, the requirements of ECC.6.5.6.4(a) in the case of a **Cascade Hydro Scheme** will be provided for each **Generating Unit** forming part of that **Cascade Hydro Scheme**. In the case of **Embedded Generating Units** forming part of a **Cascade Hydro Scheme** the data may be provided by means other than the SCADA outstation located at the **Power Station**, such as, with the agreement of the **Network Operator** in whose system such **Embedded Generating Unit** is located, from the **Network Operator's** SCADA system to **The Company**. Details of such arrangements will be contained in the relevant **Bilateral Agreements** between **The Company** and the **Generator** and the **Network Operator**.
- (d) In the case of a **Power Park Module**, additional energy input signals (e.g. wind speed, and wind direction) may be specified in the **Bilateral Agreement**. A **Power Available** signal will also be specified in the **Bilateral Agreement**. The signals would be used to establish the potential level of energy input from the **Intermittent Power Source** for monitoring pursuant to ECC.6.6.1 and **Ancillary Services** and will, in the case of a wind farm, be used to provide **The Company** with advanced warning of excess wind speed shutdown and to determine the level of **Headroom** available from **Power Park Modules** for the purposes of calculating response and reserve. For the avoidance of doubt, the **Power Available** signal would be automatically provided to **The Company** and represent the sum of the potential output of all available and operational **Power Park Units** within the **Power Park Module**. The refresh rate of the **Power Available** signal shall be specified in the **Bilateral Agreement**. In the case of an **Electricity Storage Module**, the requirement to provide a **Power Available Signal** when the **Plant** is in both an importing and exporting mode of operation would be specified in the **Bilateral Agreement**.
- (e) In the case of an **Electricity Storage Module**, additional input signals (e.g. state of energy (MWhr, and system availability) may be specified in the **Bilateral Agreement**. A **Power Available** signal will also be specified in the **Bilateral Agreement** in accordance with the requirements of ECC.6.5.6.4(d).

ECC.6.5.6.5 In addition to the requirements of the **Balancing Codes**, each **HVDC Converter** unit of an **HVDC system** shall be equipped with an automatic controller capable of receiving instructions from **The Company**. This automatic controller shall be capable of operating the **HVDC Converter** units of the **HVDC System** in a coordinated way. **The Company** shall specify the automatic controller hierarchy per **HVDC Converter** unit.

ECC.6.5.6.6 The automatic controller of the **HVDC System** referred to in paragraph ECC.6.5.6.5 shall be capable of sending the following signal types to **The Company** (where applicable) :

(a) operational metering signals, providing at least the following:

- (i) start-up signals;
- (ii) AC and DC voltage measurements;
- (iii) AC and DC current measurements;
- (iv) **Active and Reactive Power** measurements on the AC side;
- (v) DC power measurements;
- (vi) **HVDC Converter** unit level operation in a multi-pole type **HVDC Converter**;
- (vii) elements and topology status; and
- (viii) **Frequency Sensitive Mode, Limited Frequency Sensitive Mode Overfrequency and Limited Frequency Sensitive Mode Underfrequency Active Power** ranges (where applicable).

(b) alarm signals, providing at least the following:

- (i) emergency blocking;
- (ii) ramp blocking;

(iii) fast **Active Power** reversal (where applicable)

ECC.6.5.6.7 The automatic controller referred to in ECC.6.5.6.5 shall be capable of receiving the following signal types from **The Company** (where applicable) :

(a) operational metering signals, receiving at least the following:

- (i) start-up command;
- (ii) **Active Power** setpoints;
- (iii) **Frequency Sensitive Mode** settings;
- (iv) **Reactive Power**, voltage or similar setpoints;
- (v) **Reactive Power** control modes;
- (vi) power oscillation damping control; and

(b) alarm signals, receiving at least the following:

- (i) emergency blocking command;
- (ii) ramp blocking command;
- (iii) **Active Power** flow direction; and
- (iv) fast **Active Power** reversal command.

ECC.6.5.6.8 With regards to operational metering signals, the resolution and refresh rate required would be 1 second or better unless otherwise agreed with **The Company**

Instructor Facilities

ECC.6.5.7 The **User** shall accommodate **Instructor Facilities** provided by **The Company** for the receipt of operational messages relating to **System** conditions.

Electronic Data Communication Facilities

ECC.6.5.8 (a) All **BM Participants** must ensure that appropriate electronic data communication facilities are in place to permit the submission of data, as required by the **Grid Code**, to **The Company**.

(b) In addition,

(1) any **User** that wishes to participate in the **Balancing Mechanism**;

or

(2) any **BM Participant** in respect of its **BM Units** at a **Power Station** and the **BM Participant** is required to provide all **Part 1 System Ancillary Services** in accordance with ECC.8.1 (unless **The Company** has otherwise agreed)

must ensure that appropriate automatic logging devices are installed at the **Control Points** of its **BM Units** to submit data to and to receive instructions from **The Company**, as required by the **Grid Code**. For the avoidance of doubt, in the case of an **Interconnector User** the **Control Point** will be at the **Control Centre** of the appropriate **Externally Interconnected System Operator**.

(c) Detailed specifications of these required electronic facilities will be provided by **The Company** on request and they are listed as **Electrical Standards** in the Annex to the **General Conditions**.

Facsimile Machines

ECC.6.5.9 Each **User** and **The Company** shall provide a facsimile machine or machines:

- (a) in the case of **Generators**, at the **Control Point** of each **Power Station** and at its **Trading Point**;
- (b) in the case of **The Company** and **Network Operators**, at the **Control Centre(s)**; and
- (c) in the case of **Non-Embedded Customers** and **HVDC Equipment** owners at the **Control Point**.

Each **User** shall notify, prior to connection to the **System** of the **User's Plant and Apparatus**, **The Company** of its or their telephone number or numbers, and will notify **The Company** of any changes. Prior to connection to the **System** of the **User's Plant and Apparatus** **The Company** shall notify each **User** of the telephone number or numbers of its facsimile machine or machines and will notify any changes.

ECC.6.5.10 Busbar Voltage

The Relevant Transmission Licensee shall, subject as provided below, provide each **Generator** or **HVDC System Owner** at each **Grid Entry Point** where one of its **Power Stations** or **HVDC Systems** is connected with appropriate voltage signals to enable the **Generator** or **HVDC System** owner to obtain the necessary information to permit its **Power Generating Modules** (including **DC Connected Power Park Modules**) or **HVDC System** to be **Synchronised** to the **National Electricity Transmission System**. The term "**voltage signal**" shall mean in this context, a point of connection on (or wire or wires from) a relevant part of **Transmission Plant** and/or **Apparatus** at the **Grid Entry Point**, to which the **Generator** or **HVDC System Owner**, with **The Company's** agreement (not to be unreasonably withheld) in relation to the **Plant** and/or **Apparatus** to be attached, will be able to attach its **Plant** and/or **Apparatus** (normally a wire or wires) in order to obtain measurement outputs in relation to the busbar.

ECC.6.5.11 Bilingual Message Facilities

- (a) A Bilingual Message Facility is the method by which the **User's Responsible Engineer/Operator**, the **Externally Interconnected System Operator** and **The Company's Control Engineers** communicate clear and unambiguous information in two languages for the purposes of control of the **Total System** in both normal and emergency operating conditions.
- (b) A Bilingual Message Facility, where required, will provide up to two hundred pre-defined messages with up to five hundred and sixty characters each. A maximum of one minute is allowed for the transmission to, and display of, the selected message at any destination. The standard messages must be capable of being displayed at any combination of locations and can originate from any of these locations. Messages displayed in the UK will be displayed in the English language.
- (c) Detailed information on a Bilingual Message Facility and suitable equipment required for individual **User** applications will be provided by **The Company** upon request.

ECC.6.6 Monitoring

ECC.6.6.1 System Monitoring

ECC.6.6.1.1 Each **Type C** and **Type D Power Generating Module** including **DC Connected Power Park Modules** shall be equipped with a facility to provide fault recording and monitoring of dynamic system behaviour. These requirements are necessary to record conditions during **System** faults and detect poorly damped power oscillations. This facility shall record the following parameters:

- voltage,
- **Active Power**,
- **Reactive Power**, and
- **Frequency**.

- ECC.6.6.1.2 Detailed specifications for fault recording and dynamic system monitoring equipment including triggering criteria and sample rates are listed as **Electrical Standards** in the **Annex** to the **General Conditions**. For Dynamic System Monitoring, the specification for the communication protocol and recorded data shall also be included in the **Electrical Standard**.
- ECC.6.6.1.3 **The Company** in coordination with the **Relevant Transmission Licensee** shall specify any requirements for **Power Quality Monitoring** in the **Bilateral Agreement**. The power quality parameters to be monitored, the communication protocols for the recorded data and the time frames for compliance shall be agreed between **The Company**, the **Relevant Transmission Licensee** and **EU Generator**.
- ECC.6.6.1.4 **HVDC Systems** shall be equipped with a facility to provide fault recording and dynamic system behaviour monitoring of the following parameters for each of its **HVDC Converter Stations**:
- (a) AC and DC voltage;
 - (b) AC and DC current;
 - (c) **Active Power**;
 - (d) **Reactive Power**; and
 - (e) **Frequency**.
- ECC.6.6.1.5 **The Company** in coordination with the **Relevant Transmission Licensee** may specify quality of supply parameters to be complied with by the **HVDC System**, provided a reasonable prior notice is given.
- ECC.6.6.1.6 The particulars of the fault recording equipment referred to in ECC.6.6.1.4, including analogue and digital channels, the settings, including triggering criteria and the sampling rates, shall be agreed between the **HVDC System Owner** and **The Company** in coordination with the **Relevant Transmission Licensee**.
- ECC.6.6.1.7 All dynamic system behaviour monitoring equipment shall include an oscillation trigger, specified by **The Company**, in coordination with the **Relevant Transmission Licensee**, with the purpose of detecting poorly damped power oscillations.
- ECC.6.6.1.8 The facilities for quality of supply and dynamic system behaviour monitoring shall include arrangements for the **HVDC System Owner** and **The Company** and/or **Relevant Transmission Licensee** to access the information electronically. The communications protocols for recorded data shall be agreed between the **HVDC System Owner**, **The Company** and the **Relevant Transmission Licensee**.
- ECC.6.6.1.9 In order to accurately monitor the performance of a **Grid Forming Plant**, each **Grid Forming Plant** shall be equipped with a facility to accurately record the following parameters at a rate of 10ms : -
- **System Frequency** using a nominated algorithm as defined by **The Company**
 - The **ROCOF** rate using a nominated algorithm as defined by **The Company** based on a 500ms rolling average
 - A technique for recording the **Grid Phase Jump Angle** by using either a nominated algorithm as defined by **The Company** or an algorithm that records the time period of each half cycle with a time resolution of 10 microseconds. For a 50Hz **System**, a 1 degree phase jump is a time period change of 55.6 microseconds.
- ECC.6.6.1.10 Detailed specifications for **Grid Forming Capability Plant** dynamic performance including triggering criteria, sample rates, the communication protocol and recorded data shall be specified by **The Company** in the **Bilateral Agreement**.
- ECC.6.6.2 Frequency Response Monitoring
- ECC.6.6.2.1 Each **Type C** and **Type D Power Generating Module** including **DC Connected Power Park Modules** shall be fitted with equipment capable of monitoring the real time **Active Power** output of a **Power Generating Module** when operating in **Frequency Sensitive Mode**.

ECC.6.6.2.2

Detailed specifications of the **Active Power Frequency** response requirements including the communication requirements are listed as **Electrical Standards** in the **Annex** to the **General Conditions**.

ECC.6.6.2.3 **The Company** in co-ordination with the **Relevant Transmission Licensee** shall specify additional signals to be provided by the **EU Generator** by monitoring and recording devices in order to verify the performance of the **Active Power Frequency** response provision of participating **Power Generating Modules**.

ECC.6.6.3 Compliance Monitoring

ECC.6.6.3.1 For all on site monitoring by **The Company** of witnessed tests pursuant to the **CP** or **OC5** or **ECP** the **User** shall provide suitable test signals as outlined in either OC5.A.1 or **ECP.A.4** (as applicable).

ECC.6.6.3.2 The signals which shall be provided by the **User** to **The Company** for onsite monitoring shall be of the following resolution, unless otherwise agreed by **The Company**:

- (i) 1 Hz for reactive range tests
- (ii) 10 Hz for frequency control tests
- (iii) 100 Hz for voltage control tests
- (iv) 1 kHz for **Grid Forming Plant** signals including fast fault current measurements
- (v) 100Hz for the other **Grid Forming Plant** tests carried out in accordance with ECC.6.6.1.9

ECC.6.6.3.3 The **User** will provide all relevant signals for this purpose in the form of d.c. voltages within the range -10V to +10V. In exceptional circumstances some signals may be accepted as d.c. voltages within the range -60V to +60V with prior agreement between the **User** and **The Company**. All signals shall:

- (i) in the case of an **Onshore Power Generating Module** or **Onshore HVDC Converter Station**, be suitably terminated in a single accessible location at the **Generator** or **HVDC Converter Station** owner's site.
- (ii) in the case of an **Offshore Power Generating Module** and **OTSDUW Plant and Apparatus**, be transmitted onshore without attenuation, delay or filtering which would result in the inability to fully demonstrate the objectives of the test, or identify any potential safety or plant instability issues, and be suitably terminated in a single robust location normally located at or near the onshore **Interface Point** of the **Offshore Transmission System** to which it is connected.

ECC.6.6.3.4 All signals shall be suitably scaled across the range. The following scaling would (unless **The Company** notify the **User** otherwise) be acceptable to **The Company**:

- (a) 0MW to **Maximum Capacity** or **Interface Point Capacity** 0-8V dc
- (b) Maximum leading **Reactive Power** to maximum lagging **Reactive Power** -8 to 8V dc
- (c) 48 – 52Hz as -8 to 8V dc
- (d) Nominal terminal or connection point voltage -10% to +10% as -8 to 8V dc

ECC.6.6.3.5 The **User** shall provide to **The Company** a 230V power supply adjacent to the signal terminal location.

ECC.7 SITE RELATED CONDITIONS

ECC.7.1 Not used.

ECC.7.2 Responsibilities For Safety

- ECC.7.2.1 Any **User** entering and working on its **Plant** and/or **Apparatus** (including, until the **OTSUA Transfer Time**, any **OTSUA**) on a **Transmission Site** will work to the **Safety Rules** of the **Relevant Transmission Licensee**, as advised by **The Company**.
- ECC.7.2.2 For **User Sites**, **The Company** shall procure that the **Relevant Transmission Licensee** entering and working on **Transmission Plant** and/or **Apparatus** on a **User Site** will work to the **User's Safety Rules**.
- ECC.7.2.3 A **User** may, with a minimum of six weeks notice, apply to **The Company** for permission to work according to that **Users** own **Safety Rules** when working on its **Plant** and/or **Apparatus** on a **Transmission Site** rather than those set out in ECC.7.2.1. If **The Company** is of the opinion that the **User's Safety Rules** provide for a level of safety commensurate with those set out in ECC.7.2.1, **The Company** will notify the **User**, in writing, that, with effect from the date requested by the **User**, the **User** may use its own **Safety Rules** when working on its **Plant** and/or **Apparatus** on the **Transmission Site**. For a **Transmission Site**, in forming its opinion, **The Company** will seek the opinion of the **Relevant Transmission Licensee**. Until receipt of such written approval from **The Company**, the **User** will continue to use the **Safety Rules** as set out in ECC.7.2.1.
- ECC.7.2.4 In the case of a **User Site**, **The Company** may, with a minimum of six weeks notice, apply to a **User** for permission for the **Relevant Transmission Licensee** to work according to the **Relevant Transmission Licensee's Safety Rules** when working on **Transmission Plant** and/or **Apparatus** on that **User Site**, rather than the **User's Safety Rules**. If the **User** is of the opinion that the **Relevant Transmission Licensee's Safety Rules**, provide for a level of safety commensurate with that of that **User's Safety Rules**, it will notify **The Company**, in writing, that, with effect from the date requested by **The Company**, that the **Relevant Transmission Licensee** may use its own **Safety Rules** when working on its **Transmission Plant** and/or **Apparatus** on that **User's Site**. Until receipt of such written approval from the **User**, **The Company** shall procure that the **Relevant Transmission Licensee** shall continue to use the **User's Safety Rules**.
- ECC.7.2.5 For a **Transmission Site**, if **The Company** gives its approval for the **User's Safety Rules** to apply to the **User** when working on its **Plant** and/or **Apparatus**, that does not imply that the **User's Safety Rules** will apply to entering the **Transmission Site** and access to the **User's Plant** and/or **Apparatus** on that **Transmission Site**. Bearing in mind the **Relevant Transmission Licensee's** responsibility for the whole **Transmission Site**, entry and access will always be in accordance with the **Relevant Transmission Licensee's** site access procedures. For a **User Site**, if the **User** gives its approval for **Relevant Transmission Licensee Safety Rules** to apply to the **Relevant Transmission Licensee** when working on its **Plant** and **Apparatus**, that does not imply that the **Relevant Transmission Licensee's Safety Rules** will apply to entering the **User Site**, and access to the **Transmission Plant** and **Apparatus** on that **User Site**. Bearing in mind the **User's** responsibility for the whole **User Site**, entry and access will always be in accordance with the **User's** site access procedures.
- ECC.7.2.6 For **User Sites**, **Users** shall notify **The Company** of any **Safety Rules** that apply to the **Relevant Transmission Licensee's** staff working on **User Sites**. **The Company** shall procure that the **Relevant Transmission Licensee** shall notify **Users** of any **Safety Rules** that apply to the **User's** staff working on the **Transmission Site**.
- ECC.7.2.7 Each **Site Responsibility Schedule** must have recorded on it the **Safety Rules** which apply to each item of **Plant** and/or **Apparatus**.
- ECC.7.2.8 In the case of **OTSUA** a **User Site** or **Transmission Site** shall, for the purposes of this ECC.7.2, include a site at which there is an **Interface Point** until the **OTSUA Transfer Time** when it becomes part of the **National Electricity Transmission System**.
- ECC.7.3 Site Responsibility Schedules

- ECC.7.3.1 In order to inform site operational staff and **The Company's Control Engineers** of agreed responsibilities for **Plant** and/or **Apparatus** at the operational interface, a **Site Responsibility Schedule** shall be produced for **Connection Sites** (and in the case of **OTSUA**, until the **OTSUA Transfer Time, Interface Sites**) for **The Company**, the **Relevant Transmission Licensee** and **Users** with whom they interface.
- ECC.7.3.2 The format, principles and basic procedure to be used in the preparation of **Site Responsibility Schedules** are set down in Appendix 1.
- ECC.7.4 Operation And Gas Zone Diagrams
- Operation Diagrams
- ECC.7.4.1 An **Operation Diagram** shall be prepared for each **Connection Site** at which a **Connection Point** exists (and in the case of **OTSDUW Plant and Apparatus**, by **User's** for each **Interface Point**) using, where appropriate, the graphical symbols shown in Part 1A of Appendix 2. **Users** should also note that the provisions of **OC11** apply in certain circumstances.
- ECC.7.4.2 The **Operation Diagram** shall include all **HV Apparatus** and the connections to all external circuits and incorporate numbering, nomenclature and labelling, as set out in **OC11**. At those **Connection Sites** (or in the case of **OTSDUW Plant and Apparatus, Interface Points**) where gas-insulated metal enclosed switchgear and/or other gas-insulated **HV Apparatus** is installed, those items must be depicted within an area delineated by a chain dotted line which intersects gas-zone boundaries. The nomenclature used shall conform with that used on the relevant **Connection Site** and circuit (and in the case of **OTSDUW Plant and Apparatus, Interface Point** and circuit). The **Operation Diagram** (and the list of technical details) is intended to provide an accurate record of the layout and circuit interconnections, ratings and numbering and nomenclature of **HV Apparatus** and related **Plant**.
- ECC.7.4.3 A non-exhaustive guide to the types of **HV Apparatus** to be shown in the **Operation Diagram** is shown in Part 2 of Appendix 2, together with certain basic principles to be followed unless equivalent principles are approved by **The Company**.
- Gas Zone Diagrams
- ECC.7.4.4 A **Gas Zone Diagram** shall be prepared for each **Connection Site** at which a **Connection Point** (and in the case of **OTSDUW Plant and Apparatus**, by **User's** for an **Interface Point**) exists where gas-insulated switchgear and/or other gas-insulated **HV Apparatus** is utilised. They shall use, where appropriate, the graphical symbols shown in Part 1B of Appendix 2.
- ECC.7.4.5 The nomenclature used shall conform with that used in the relevant **Connection Site** and circuit (and in the case of **OTSDUW Plant and Apparatus**, relevant **Interface Point** and circuit).
- ECC.7.4.6 The basic principles set out in Part 2 of Appendix 2 shall be followed in the preparation of **Gas Zone Diagrams** unless equivalent principles are approved by **The Company**.
- Preparation of Operation and Gas Zone Diagrams for Users' Sites and Transmission Interface Sites
- ECC.7.4.7 In the case of a **User Site**, the **User** shall prepare and submit to **The Company**, an **Operation Diagram** for all **HV Apparatus** on the **User** side of the **Connection Point** (and in the case of **OTSDUW Plant and Apparatus**, on what will be the **Offshore Transmission** side of the **Connection Point** and the **Interface Point**) and **The Company** shall provide the **User** with an **Operation Diagram** for all **HV Apparatus** on the **Transmission** side of the **Connection Point** (and in the case of **OTSDUW Plant and Apparatus** on what will be the **Onshore Transmission** side of the **Interface Point**, in accordance with the timing requirements of the **Bilateral Agreement** and/or **Construction Agreement** prior to the **Completion Date** under the **Bilateral Agreement** and/or **Construction Agreement**.

ECC.7.4.8 The **User** will then prepare, produce and distribute, using the information submitted on the **User's Operation Diagram** and **The Company's Operation Diagram**, a composite **Operation Diagram** for the complete **Connection Site** (and in the case of **OTSDUW Plant and Apparatus, Interface Point**), also in accordance with the timing requirements of the **Bilateral Agreement** and/or **Construction Agreement** .

ECC.7.4.9 The provisions of ECC.7.4.7 and ECC.7.4.8 shall apply in relation to **Gas Zone Diagrams** where gas-insulated switchgear and/or other gas-insulated **HV Apparatus** is utilised.

Preparation of Operation and Gas Zone Diagrams for Transmission Sites

ECC.7.4.10 In the case of an **Transmission Site**, the **User** shall prepare and submit to **The Company** an **Operation Diagram** for all **HV Apparatus** on the **User** side of the **Connection Point**, in accordance with the timing requirements of the **Bilateral Agreement** and/or **Construction Agreement**.

ECC.7.4.11 **The Company** will then prepare, produce and distribute, using the information submitted on the **User's Operation Diagram**, a composite **Operation Diagram** for the complete **Connection Site**, also in accordance with the timing requirements of the **Bilateral Agreement** and/or **Construction Agreement** .

ECC.7.4.12 The provisions of ECC.7.4.10 and ECC.7.4.11 shall apply in relation to **Gas Zone Diagrams** where gas-insulated switchgear and/or other gas-insulated **HV Apparatus** is utilised.

ECC.7.4.13 Changes to Operation and Gas Zone Diagrams

ECC.7.4.13.1 When **The Company** has decided that it wishes to install new **HV Apparatus** or it wishes to change the existing numbering or nomenclature of **Transmission HV Apparatus** at a **Transmission Site**, **The Company** will (unless it gives rise to a **Modification** under the **CUSC**, in which case the provisions of the **CUSC** as to the timing apply) one month prior to the installation or change, send to each such **User** a revised **Operation Diagram** of that **Transmission Site**, incorporating the new **Transmission HV Apparatus** to be installed and its numbering and nomenclature or the changes, as the case may be. **OC11** is also relevant to certain **Apparatus**.

ECC.7.4.13.2 When a **User** has decided that it wishes to install new **HV Apparatus**, or it wishes to change the existing numbering or nomenclature of its **HV Apparatus** at its **User Site**, the **User** will (unless it gives rise to a **Modification** under the **CUSC**, in which case the provisions of the **CUSC** as to the timing apply) one month prior to the installation or change, send to **The Company** a revised **Operation Diagram** of that **User Site** incorporating the **EU Code User HV Apparatus** to be installed and its numbering and nomenclature or the changes as the case may be. **OC11** is also relevant to certain **Apparatus**.

ECC.7.4.13.3 The provisions of ECC.7.4.13.1 and ECC.7.4.13.2 shall apply in relation to **Gas Zone Diagrams** where gas-insulated switchgear and/or other gas-insulated **HV Apparatus** is installed.

Validity

ECC.7.4.14 (a) The composite **Operation Diagram** prepared by **The Company** or the **User**, as the case may be, will be the definitive **Operation Diagram** for all operational and planning activities associated with the **Connection Site**. If a dispute arises as to the accuracy of the composite **Operation Diagram**, a meeting shall be held at the **Connection Site**, as soon as reasonably practicable, between **The Company** and the **User**, to endeavour to resolve the matters in dispute.

(b) The composite **Operation Diagram** prepared by **The Company** or the **User**, as the case may be, will be the definitive **Operation Diagram** for all operational and planning activities associated with the **Interface Point** until the **OTSUA Transfer Time**. If a dispute arises as to the accuracy of the composite **Operation Diagram** prior to the **OTSUA Transfer Time**, a meeting shall be held at the **Interface Point**, as soon as reasonably practicable, between **The Company** and the **User**, to endeavour to resolve the matters in dispute.

(c) An equivalent rule shall apply for **Gas Zone Diagrams** where they exist for a **Connection Site**.

ECC.7.4.15 In the case of **OTSUA**, a **User Site** and **Transmission Site** shall, for the purposes of this ECC.7.4, include a site at which there is an **Interface Point** until the **OTSUA Transfer Time** when it becomes part of the **National Electricity Transmission System** and references to **HV Apparatus** in this ECC.7.4 shall include references to **HV OTSUA**.

ECC.7.5 Site Common Drawings

ECC.7.5.1 **Site Common Drawings** will be prepared for each **Connection Site** (and in the case of **OTSDUW**, each **Interface Point**) and will include **Connection Site** (and in the case of **OTSDUW**, **Interface Point**) layout drawings, electrical layout drawings, common **Protection/control** drawings and common services drawings.

Preparation of Site Common Drawings for a User Site and Transmission Interface Site

ECC.7.5.2 In the case of a **User Site**, **The Company** shall prepare and submit to the **User**, **Site Common Drawings** for the **Transmission** side of the **Connection Point** (and in the case of **OTSDUW Plant and Apparatus**, on what will be the **Onshore Transmission** side of the **Interface Point**), and the **User** shall prepare and submit to **The Company**, **Site Common Drawings** for the **User** side of the **Connection Point** (and in the case of **OTSDUW**, on what will be the **Offshore Transmission** side of the **Interface Point**) in accordance with the timing requirements of the **Bilateral Agreement** and/or **Construction Agreement**.

ECC.7.5.3 The **User** will then prepare, produce and distribute, using the information submitted on the **Transmission Site Common Drawings**, **Site Common Drawings** for the complete **Connection Site** (and in the case of **OTSDUW**, **Interface Point**) in accordance with the timing requirements of the **Bilateral Agreement** and/or **Construction Agreement**.

Preparation of Site Common Drawings for a Transmission Site

ECC.7.5.4 In the case of a **Transmission Site**, the **User** will prepare and submit to **The Company Site Common Drawings** for the **User** side of the **Connection Point** in accordance with the timing requirements of the **Bilateral Agreement** and/or **Construction Agreement**.

ECC.7.5.5 **The Company** will then prepare, produce and distribute, using the information submitted in the **User's Site Common Drawings**, **Site Common Drawings** for the complete **Connection Site** in accordance with the timing requirements of the **Bilateral Agreement** and/or **Construction Agreement**.

ECC.7.5.6 When a **User** becomes aware that it is necessary to change any aspect of the **Site Common Drawings** at a **Connection Site** (and in the case of **OTSDUW**, **Interface Point**) it will:

- (a) if it is a **User Site**, as soon as reasonably practicable, prepare, produce and distribute revised **Site Common Drawings** for the complete **Connection Site** (and in the case of **OTSDUW**, **Interface Point**); and
- (b) if it is a **Transmission Site**, as soon as reasonably practicable, prepare and submit to **The Company** revised **Site Common Drawings** for the **User** side of the **Connection Point** (and in the case of **OTSDUW**, **Interface Point**) and **The Company** will then, as soon as reasonably practicable, prepare, produce and distribute, using the information submitted in the **User's Site Common Drawings**, revised **Site Common Drawings** for the complete **Connection Site** (and in the case of **OTSDUW**, **Interface Point**).

In either case, if in the **User's** reasonable opinion the change can be dealt with by it notifying **The Company** in writing of the change and for each party to amend its copy of the **Site Common Drawings** (or where there is only one set, for the party holding that set to amend it), then it shall so notify and each party shall so amend. If the change gives rise to a **Modification** under the **CUSC**, the provisions of the **CUSC** as to timing will apply.

ECC.7.5.7 When **The Company** becomes aware that it is necessary to change any aspect of the **Site Common Drawings** at a **Connection Site**(and in the case of **OTSDUW**, **Interface Point**) it will:

- (a) if it is a **Transmission Site**, as soon as reasonably practicable, prepare, produce and distribute revised **Site Common Drawings** for the complete **Connection Site** (and in the case of **OTSDUW, Interface Point**); and
- (b) if it is a **User Site**, as soon as reasonably practicable, prepare and submit to the **User** revised **Site Common Drawings** for the **Transmission** side of the **Connection Point** (in the case of **OTSDUW, Interface Point**) and the **User** will then, as soon as reasonably practicable, prepare, produce and distribute, using the information submitted in the **Transmission Site Common Drawings**, revised **Site Common Drawings** for the complete **Connection Site** (and in the case of **OTSDUW, Interface Point**).

In either case, if in **The Company's** reasonable opinion the change can be dealt with by it notifying the **User** in writing of the change and for each party to amend its copy of the **Site Common Drawings** (or where there is only one set, for the party holding that set to amend it), then it shall so notify and each party shall so amend. If the change gives rise to a **Modification** under the **CUSC**, the provisions of the **CUSC** as to timing will apply.

Validity

- ECC.7.5.8 (a) The **Site Common Drawings** for the complete **Connection Site** prepared by the **User** or **The Company**, as the case may be, will be the definitive **Site Common Drawings** for all operational and planning activities associated with the **Connection Site**. If a dispute arises as to the accuracy of the **Site Common Drawings**, a meeting shall be held at the **Site**, as soon as reasonably practicable, between **The Company** and the **User**, to endeavour to resolve the matters in dispute.
- (b) The **Site Common Drawing** prepared by **The Company** or the **User**, as the case may be, will be the definitive **Site Common Drawing** for all operational and planning activities associated with the **Interface Point** until the **OTSUA Transfer Time**. If a dispute arises as to the accuracy of the composite **Operation Diagram** prior to the **OTSUA Transfer Time**, a meeting shall be held at the **Interface Point**, as soon as reasonably practicable, between **The Company** and the **User**, to endeavour to resolve the matters in dispute.
- ECC.7.5.9 In the case of **OTSUA**, a **User Site** and **Transmission Site** shall, for the purposes of this ECC.7.5, include a site at which there is an **Interface Point** until the **OTSUA Transfer Time** when it becomes part of the **National Electricity Transmission System**.

Access

ECC.7.6.1 The provisions relating to access to **Transmission Sites** by **Users**, and to **Users' Sites** by **Relevant Transmission Licensees**, are set out in each **Interface Agreement** (or in the case of **Interfaces Sites** prior to the **OTSUA Transfer Time** agreements in similar form) with, the **Relevant Transmission Licensee** and each **User**.

ECC.7.6.2 In addition to those provisions, where a **Transmission Site** contains exposed **HV** conductors, unaccompanied access will only be granted to individuals holding an **Authority for Access** issued by the **Relevant Transmission Licensee**.

ECC.7.6.3 The procedure for applying for an **Authority for Access** is contained in the **Interface Agreement**.

Maintenance Standards

ECC.7.7.1 It is the **User's** responsibility to ensure that all its **Plant** and **Apparatus** (including, until the **OTSUA Transfer Time**, any **OTSUA**) on a **Transmission Site** is tested and maintained adequately for the purpose for which it is intended, and to ensure that it does not pose a threat to the safety of any **Transmission Plant, Apparatus** or personnel on the **Transmission Site**. **The Company** will have the right to inspect the test results and maintenance records relating to such **Plant** and **Apparatus** at any time

ECC.7.7.2 For **User Sites**, **The Company** shall procure that the **Relevant Transmission Licensee** has a responsibility to ensure that all **Transmission Plant** and **Apparatus** on a **User Site** is tested and maintained adequately for the purposes for which it is intended and to ensure that it does not pose a threat to the safety of any **User's Plant, Apparatus** or personnel on the **User Site**.

The **User** will have the right to inspect the test results and maintenance records relating to such **Plant** and **Apparatus** on its **User Site** at any time.

ECC.7.8 Site Operational Procedures

ECC.7.8.1 Where there is an interface with **National Electricity Transmission System** **The Company** and **Users** must make available staff to take necessary **Safety Precautions** and carry out operational duties as may be required to enable work/testing to be carried out and for the operation of **Plant** and **Apparatus** (including, prior to the **OTSUA Transfer Time**, any **OTSUA**) connected to the **Total System**.

ECC.7.9 **Generators, HVDC System** owners and **BM Participants** (including **Virtual Lead Parties**) shall provide a **Control Point**.

- a) In the case of **EU Generators** and **HVDC System** owners, for each **Power Station** or **HVDC System** directly connected to the **National Electricity Transmission System** and for each **Embedded Large Power Station** or **Embedded HVDC System**, the **Control Point** shall receive and act upon instructions pursuant to OC7 and BC2 at all times that **Power Generating Modules** at the **Power Station** are generating or available to generate or **HVDC Systems** are importing or exporting or available to do so. In the case of all **BM Participants**, the **Control Point** shall be continuously staffed except where the **Bilateral Agreement** specifies that compliance with BC2 is not required, in which case the **Control Point** shall be staffed between the hours of 0800 and 1800 each day.
- b) In the case of **BM Participants**, the **BM Participant's Control Point** shall be capable of receiving and acting upon instructions from **The Company** and the relevant **Transmission Licensees' Control Engineers**.

The Company will normally issue instructions via automatic logging devices in accordance with the requirements of ECC.6.5.8(b).

Where the **BM Participant's Plant** and **Apparatus** does not respond to an instruction from **The Company** via automatic logging devices, or where it is not possible for **The Company** to issue the instruction via automatic logging devices, **The Company** shall issue the instruction by telephone.

In the case of **BM Participants** who own and/or operate a **Power Station** or **HVDC System** with an aggregated **Registered Capacity** or **BM Participants** with **BM Units** with an aggregated **Demand Capacity** per **Control Point** of less than 50MW, or, where a site is not part of a **Virtual Lead Party** as defined in the **BSC**, a **Registered Capacity** or **Demand Capacity** per site of less than 10MW

- a) where this situation arises, a representative of the **BM Participant** is required to be available to respond to instructions from **The Company** via the **Control Telephony** or **System Telephony** system, as provided for in ECC.6.5.4, between the hours of 0800-1800 each day.
- b) Outside the hours of 0800-1800 each day, the requirements of BC2.9.7 shall apply.

For the avoidance of doubt, **BM Participants** who are unable to provide **Control Telephony** and do not have a continuously staffed **Control Point** may be unable to act as a **Defence Service Provider** and shall be unable to act as a **Restoration Service Provider** or **Black Start Service Provider** where these require **Control Telephony** or a **Control Point** in respect of the specification of any such services falling into these categories.

ECC.7.10 Obligations on Users in respect of Critical Tools and Facilities

ECC.7.10.1 From 04/09/2024 **The Company**, each **Generator, HVDC System Owner, Network Operator, Non-Embedded Customer** and each **Restoration Service Provider** with a continuously staffed **Control Point** or **Control Centre** as provided for in ECC.7.9 shall:-

- (i) Ensure they have the appropriate **Critical Tools and Facilities**, necessary to control their assets for **Black Start**, from their **Control Point** or **Control Centre**, as appropriate, for a minimum period of 72 hours (or such longer period as agreed between the **Generator, HVDC System Owner, Network Operator, Non-Embedded Customer** and/or

Restoration Service Provider and The Company) following a **Total Shutdown** or **Partial Shutdown**.

- (ii) Ensure as far as reasonably practical that they have adequate control equipment redundancy in place so that in the event of a failure of one or more components of the control system its function is unimpaired.
- (iii) Report on the results of their management and testing for their **Critical Tools and Facilities** on request from **The Company**.

ECC.7.10.2 From 04/09/2023 each **BM Participant** including a **Virtual Lead Party** with a continuously staffed **Control Point** as provided for in ECC.7.9 (excluding those **BM Participants** covered by the requirements of ECC.7.10.1), shall:-

- (i) Ensure they have the appropriate **Critical Tools and Facilities** (as defined in clause (c) of the definition of **Critical Tools and Facilities** in the **Grid Code Glossary and Definitions**) for a minimum period of 72 hours (or such longer period as agreed between the **BM Participant** including a **Virtual Lead Party** and **The Company**) following a **Total Shutdown** or **Partial Shutdown**.
- (ii) Ensure as far as reasonably practical that they have adequate control equipment redundancy in place at their **Control Point** so that in the event of a failure of one or more components of their **Critical Tools and Facilities** its function is unimpaired.
- (iii) Report on the results of their management and testing for their **Critical Tools and Facilities** on request by **The Company**.

ECC.7.10.3 In the case of a **BM Participant** or **Virtual Lead Party** which has a **Black Start Contract** in respect of one or more of its aggregated **Plants**, the requirements of ECC.7.10.1 shall only apply between the **Control Point** of the **BM Participant** or **Virtual Lead Party** and that **Plant** with a **Black Start Contract**. For other non-contracted **Plants** under the control of the **BM Participant** or **Virtual Lead Party**, the requirements of ECC.7.10.2 shall continue to apply.

ECC.8 ANCILLARY SERVICES

ECC.8.1 System Ancillary Services

The **ECC** contain requirements for the capability for certain **Ancillary Services**, which are needed for **System** reasons ("**System Ancillary Services**"). There follows a list of these **System Ancillary Services**, together with the paragraph number of the **ECC** (or other part of the **Grid Code**) in which the minimum capability is required or referred to. The list is divided into two categories: Part 1 lists the **System Ancillary Services** which

- (a) **Generators** in respect of **Type C** and **Type D Power Generating Modules** (including **DC Connected Power Park Modules** and **Electricity Storage Modules**) are obliged to provide; and,
- (b) **HVDC System Owners** are obliged to have the capability to supply;
- (c) **Generators** in respect of **Medium Power Stations** (except **Embedded Medium Power Stations**) are obliged to provide in respect of **Reactive Power** only:

and Part 2 lists the **System Ancillary Services** which **Generators** will provide only if agreement to provide them is reached with **The Company**:

Part 1

- (a) **Reactive Power** supplied (in accordance with ECC.6.3.2)
- (b) **Frequency** Control by means of **Frequency** sensitive generation - ECC.6.3.7 and BC3.5.1

Part 2

- (c) **Frequency** Control by means of **Fast Start** - ECC.6.3.14

- (d) **Black Start Capability** - ECC.6.3.5
- (e) **System to Generator Operational Intertipping**

ECC.8.2 Commercial Ancillary Services

Other **Ancillary Services** are also utilised by **The Company** in operating the **Total System** if these have been agreed to be provided by a **User** (or other person) under an **Ancillary Services Agreement** or under a **Bilateral Agreement**, with payment being dealt with under an **Ancillary Services Agreement** or in the case of **Externally Interconnected System Operators** or **Interconnector Users**, under any other agreement (and in the case of **Externally Interconnected System Operators** and **Interconnector Users** includes ancillary services equivalent to or similar to **System Ancillary Services**) ("**Commercial Ancillary Services**"). The capability for these **Commercial Ancillary Services** is set out in the relevant **Ancillary Services Agreement** or **Bilateral Agreement** (as the case may be).

APPENDIX E1 - SITE RESPONSIBILITY SCHEDULES

FORMAT, PRINCIPLES AND BASIC PROCEDURE TO BE USED IN THE PREPARATION OF SITE RESPONSIBILITY SCHEDULES

ECC.A.1.1 Principles

Types of Schedules

ECC.A.1.1.1 At all **Complexes** (which in the context of this ECC shall include, **Interface Sites** until the **OTSUA Transfer Time**) the following **Site Responsibility Schedules** shall be drawn up using the relevant proforma attached or with such variations as may be agreed between **The Company** and **Users**, but in the absence of agreement the relevant proforma attached will be used. In addition, in the case of **OTSDUW Plant and Apparatus**, and in readiness for the **OTSUA Transfer Time**, the **User** shall provide **The Company** with the necessary information such that **Site Responsibility Schedules** in this form can be prepared by the **Relevant Transmission Licensees** for the **Transmission Interface Site**:

- (a) Schedule of **HV Apparatus**
- (b) Schedule of **Plant, LV/MV Apparatus**, services and supplies;
- (c) Schedule of telecommunications and measurements **Apparatus**.

Other than at **Power Generating Module** (including **DC Connected Power Park Modules**) and **Power Station** locations, the schedules referred to in (b) and (c) may be combined.

New Connection Sites

ECC.A.1.1.2 In the case of a new **Connection Site** each **Site Responsibility Schedule** for a **Connection Site** shall be prepared by **The Company** in consultation with relevant **Users** at least 2 weeks prior to the **Completion Date** (or, where the **OTSUA** is to become **Operational** prior to the **OTSUA Transfer Time**, an alternative date) under the **Bilateral Agreement** and/or **Construction Agreement** for that **Connection Site** (which may form part of a **Complex**). In the case of a new **Interface Site** where the **OTSUA** is to become **Operational** prior to the **OTSUA Transfer Time** each **Site Responsibility Schedule** for an **Interface Site** shall be prepared by **The Company** in consultation with relevant **Users** at least 2 weeks prior to the **Completion Date** under the **Bilateral Agreement** and/or **Construction Agreement** for that **Interface Site** (which may form part of a **Complex**) (and references to and requirements placed on "**Connection Site**" in this ECC shall also be read as "**Interface Site**" where the context requires and until the **OTSUA Transfer Time**). Each **User** shall, in accordance with the timing requirements of the **Bilateral Agreement** and/or **Construction Agreement**, provide information to **The Company** to enable it to prepare the **Site Responsibility Schedule**.

Sub-division

ECC.A.1.1.3 Each **Site Responsibility Schedule** will be subdivided to take account of any separate **Connection Sites** on that **Complex**.

Scope

ECC.A.1.1.4 Each **Site Responsibility Schedule** shall detail for each item of **Plant** and **Apparatus**:

- (a) **Plant/Apparatus** ownership;
- (b) Site Manager (Controller) (except in the case of **Plant/Apparatus** located in **SPT's Transmission Area**);
- (c) Safety issues comprising applicable **Safety Rules** and **Control Person** or other responsible person (**Safety Co-ordinator**), or such other person who is responsible for safety;
- (d) Operations issues comprising applicable **Operational Procedures** and control engineer;
- (e) Responsibility to undertake statutory inspections, fault investigation and maintenance.

Each **Connection Point** shall be precisely shown.

Detail

- ECC.A.1.1.5 (a) In the case of **Site Responsibility Schedules** referred to in ECC.A.1.1.1(b) and (c), with the exception of **Protection Apparatus** and **Intertrip Apparatus** operation, it will be sufficient to indicate the responsible **User** or **Transmission Licensee**, as the case may be.
- (b) In the case of the **Site Responsibility Schedule** referred to in ECC.A.1.1.1(a) and for **Protection Apparatus** and **Intertrip Apparatus**, the responsible management unit must be shown in addition to the **User** or **Transmission Licensee**, as the case may be.
- ECC.A.1.1.6 The **HV Apparatus Site Responsibility Schedule** for each **Connection Site** must include lines and cables emanating from or traversing¹ the **Connection Site**.

Issue Details

- ECC.A.1.1.7 Every page of each **Site Responsibility Schedule** shall bear the date of issue and the issue number.

Accuracy Confirmation

- ECC.A.1.1.8 When a **Site Responsibility Schedule** is prepared it shall be sent by **The Company** to the **Users** involved for confirmation of its accuracy.
- ECC.A.1.1.9 The **Site Responsibility Schedule** shall then be signed on behalf of **The Company** by its **Responsible Manager** (see ECC.A.1.1.16) and on behalf of each **User** involved by its **Responsible Manager** (see ECC.A.1.1.16), by way of written confirmation of its accuracy. The **Site Responsibility Schedule** will also be signed on behalf of the **Relevant Transmission Licensee** by its **Responsible Manager**.

Distribution and Availability

- ECC.A.1.1.10 Once signed, two copies will be distributed by **The Company**, not less than two weeks prior to its implementation date, to each **User** which is a party on the **Site Responsibility Schedule**, accompanied by a note indicating the issue number and the date of implementation.
- ECC.A.1.1.11 **The Company** and **Users** must make the **Site Responsibility Schedules** readily available to operational staff at the **Complex** and at the other relevant control points.

Alterations to Existing Site Responsibility Schedules

- ECC.A 1.1.12 Without prejudice to the provisions of ECC.A.1.1.15 which deals with urgent changes, when a **User** identified on a **Site Responsibility Schedule** becomes aware that an alteration is necessary, it must inform **The Company** immediately and in any event 8 weeks prior to any change taking effect (or as soon as possible after becoming aware of it, if less than 8 weeks remain when the **User** becomes aware of the change). This will cover the commissioning of new **Plant** and/or **Apparatus** at the **Connection Site**, whether requiring a revised **Bilateral Agreement** or not, de-commissioning of **Plant** and/or **Apparatus**, and other changes which affect the accuracy of the **Site Responsibility Schedule**.
- ECC.A 1.1.13 Where **The Company** has been informed of a change by a **User**, or itself proposes a change, it will prepare a revised **Site Responsibility Schedule** by not less than six weeks prior to the change taking effect (subject to it having been informed or knowing of the change eight weeks prior to that time) and the procedure set out in ECC.A.1.1.8 shall be followed with regard to the revised **Site Responsibility Schedule**.

¹ Details of circuits traversing the **Connection Site** are only needed from the date which is the earlier of the date when the **Site Responsibility Schedule** is first updated and 15th October 2004. In Scotland or **Offshore**, from a date to be agreed between **The Company** and the **Relevant Transmission Licensee**.

ECC.A.1.1.14 The revised **Site Responsibility Schedule** shall then be signed in accordance with the procedure set out in ECC.A.1.1.9 and distributed in accordance with the procedure set out in ECC.A.1.1.10, accompanied by a note indicating where the alteration(s) has/have been made, the new issue number and the date of implementation.

Urgent Changes

ECC.A.1.1.15 When a **User** identified on a **Site Responsibility Schedule**, or **The Company**, as the case may be, becomes aware that an alteration to the **Site Responsibility Schedule** is necessary urgently to reflect, for example, an emergency situation which has arisen outside its control, the **User** shall notify **The Company**, or **The Company** shall notify the **User**, as the case may be, immediately and will discuss:

- (a) what change is necessary to the **Site Responsibility Schedule**;
- (b) whether the **Site Responsibility Schedule** is to be modified temporarily or permanently;
- (c) the distribution of the revised **Site Responsibility Schedule**.

The Company will prepare a revised **Site Responsibility Schedule** as soon as possible, and in any event within seven days of it being informed of or knowing the necessary alteration. The **Site Responsibility Schedule** will be confirmed by **Users** and signed on behalf of **The Company** and **Users** and the **Relevant Transmission Licensee** (by the persons referred to in ECC.A.1.1.9) as soon as possible after it has been prepared and sent to **Users** for confirmation.

Responsible Managers

ECC.A.1.1.16 Each **User** shall, prior to the **Completion Date** under each **Bilateral Agreement** and/or **Construction Agreement**, supply to **The Company** a list of Managers who have been duly authorised to sign **Site Responsibility Schedules** on behalf of the **User** and **The Company** shall, prior to the **Completion Date** under each **Bilateral Agreement** and/or **Construction Agreement**, supply to that **User** the name of its **Responsible Manager** and the name of the **Relevant Transmission Licensee's Responsible Manager** and each shall supply to the other any changes to such list six weeks before the change takes effect where the change is anticipated, and as soon as possible after the change, where the change was not anticipated.

De-commissioning of Connection Sites

ECC.A.1.1.17 Where a **Connection Site** is to be de-commissioned, whichever of **The Company** or the **User** who is initiating the de-commissioning must contact the other to arrange for the **Site Responsibility Schedule** to be amended at the relevant time.

PROFORMA FOR SITE RESPONSIBILITY SCHEDULE

_____ AREA

COMPLEX: _____

SCHEDULE: _____

CONNECTION SITE: _____

ITEM OF PLANT/ APPARATUS	PLANT APPARATUS OWNER	SITE MANAGER	SAFETY		OPERATIONS		PARTY RESPONSIBLE FOR UNDERTAKING STATUTORY INSPECTIONS, FAULT INVESTIGATION & MAINTENANCE	REMARKS
			SAFETY RULES	CONTROL OR OTHER RESPONSIBLE PERSON (SAFETY CO-ORDINATOR)	OPERATIONAL PROCEDURES	CONTROL OR OTHER RESPONSIBLE ENGINEER		

--	--	--	--	--	--	--	--	--

PAGE: _____ ISSUE NO: _____ DATE: _____

PROFORMA FOR SITE RESPONSIBILITY SCHEDULE

AREA _____

COMPLEX: _____

SCHEDULE: _____

CONNECTION SITE: _____

ITEM OF PLANT/ APPARATUS	PLANT APPARATUS OWNER	SITE MANAGER	SAFETY		OPERATIONS		PARTY RESPONSIBLE FOR UNDERTAKING STATUTORY INSPECTIONS, FAULT INVESTIGATION & MAINTENANCE	REMARKS
			SAFETY RULES	CONTROL OR OTHER RESPONSIBLE PERSON (SAFETY CO-ORDINATOR)	OPERATIONAL PROCEDURES	CONTROL OR OTHER RESPONSIBLE ENGINEER		

NOTES:

SIGNATURE: _____ NAME: _____ COMPANY: _____ DATE: _____

SIGNE D:	_____	NAM E:	_____	COMPAN Y:	_____	DAT E:	_____
SIGNE D:	_____	NAM E:	_____	COMPAN Y:	_____	DAT E:	_____
SIGNE D:	_____	NAM E:	_____	COMPAN Y:	_____	DAT E:	_____

PAGE: _____ ISSUE NO: _____ DATE: _____

**SP TRANSMISSION Ltd
 SITE RESPONSIBILITY SCHEDULE
 OWNERSHIP, MAINTENANCE AND OPERATIONS OF EQUIPMENT
 IN JOINT USER SITUATIONS**

Sheet No. _____
 Revision: _____
 Date: _____

Network Area: _____

SECTION 'A' BUILDING AND SITE

OWNER	ACCESS REQUIRED:-	SECTION 'B' CUSTOMER OR OTHER PARTY NAME:-
LESSEE	SPECIAL CONDITIONS:-	
MAINTENANCE	LOCATION OF SUPPLY TERMINALS:-	
SAFETY		
SECURITY		

SECTION 'B' CUSTOMER OR OTHER PARTY

ADDRESS:-
TEL NO:-
SUB STATION:-
LOCATION:-

SECTION 'C' PLANT

ITEM Nos.	EQUIPMENT	IDENTIFICATION	OWNER	SAFETY RULES APPLICABLE	OPERATION			MAINTENANCE		FAULT INVESTIGATION		TESTING		RELAY SETTINGS	REMARKS
					Tripping	Closing	Isolating	Earthing	Primary Equip.	Protection Equip.	Primary Equip.	Protection Equip.	Trip and Alarm		

SECTION 'D' CONFIGURATION AND CONTROL

ITEM No.	CONFIGURATION RESPONSIBILITY	TELEPHONE NUMBER	REMARKS

ABBREVIATIONS:-

- D - SP AUTHORISED PERSON - DISTRIBUTION SYSTEM
- NGC - NATIONAL GRID COMPANY
- SPD - SP DISTRIBUTION Ltd
- SPPS - POWERSYSTEMS
- SPT - SP TRANSMISSION Ltd
- ST - SCOTTISH POWER TELECOMMUNICATIONS
- T - SP AUTHORISED PERSON - TRANSMISSION SYSTEM
- U - USER

SECTION 'E' ADDITIONAL INFORMATION

--

SIGNED _____ FOR SP Transmission DATE _____

SIGNED _____ FOR SP Distribution DATE _____

SIGNED _____ FOR PowerSystems/User DATE _____

APPENDIX E2 - OPERATION DIAGRAMS

PART 1A - PROCEDURES RELATING TO OPERATION DIAGRAMS

FIXED CAPACITOR		SWITCH DISCONNECTOR	
EARTH		SWITCH DISCONNECTOR WITH INCORPORATED EARTH SWITCH	
EARTHING RESISTOR		DISCONNECTOR (CENTRE ROTATING POST)	
LIQUID EARTHING RESISTOR		DISCONNECTOR (SINGLE BREAK DOUBLE ROTATING)	
ARC SUPPRESSION COIL		DISCONNECTOR (SINGLE BREAK DOUBLE ROTATING)	
FIXED MAINTENANCE EARTHING DEVICE		DISCONNECTOR (SINGLE BREAK)	
CARRIER COUPLING EQUIPMENT (WITHOUT VT)		DISCONNECTOR (NON-INTERLOCKED)	
CARRIER COUPLING EQUIPMENT (WITH VT ON ONE PHASE)		DISCONNECTOR (POWER OPERATED) NA - NON-AUTOMATIC A - AUTOMATIC SO - SEQUENTIAL OPERATION FI - FAULT INTERFERING OPERATION	
CARRIER COUPLING EQUIPMENT (WITH VT ON 3 PHASES)			
AC GENERATOR		EARTH SWITCH	
SYNCHRONOUS COMPENSATOR		FAULT THROWING SWITCH (PHASE TO PHASE)	
CIRCUIT BREAKER		FAULT THROWING SWITCH (EARTH FAULT)	
CIRCUIT BREAKER WITH DELAYED AUTO RECLOSE	DAR	SURGE ARRESTOR	
WITHDRAWABLE METALCLAD SWITCHGEAR		THYRISTOR	

TRANSFORMERS
(VECTORS TO INDICATE
WINDING CONFIGURATION)

TWO WINDING



THREE WINDING

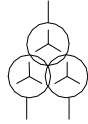

AUTO



AUTO WITH DELTA TERTIARY

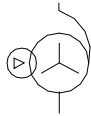

EARTHING OR AUX. TRANSFORMER

(-) INDICATE REMOTE SITE
IF APPLICABLE

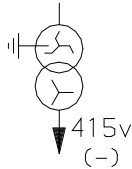

VOLTAGE TRANSFORMERS

SINGLE PHASE WOUND



THREE PHASE WOUND



SINGLE PHASE CAPACITOR



TWO SINGLE PHASE CAPACITOR

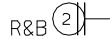

THREE PHASE CAPACITOR



* CURRENT TRANSFORMER
(WHERE SEPARATE PRIMARY
APPARATUS)



* COMBINED VT/CT UNIT
FOR METERING

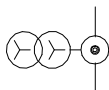

REACTOR



* BUSBARS



* OTHER PRIMARY CONNECTIONS



* CABLE & CABLE SEALING END

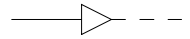

* THROUGH WALL BUSHING

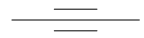

* BYPASS FACILITY



* CROSSING OF CONDUCTORS
(LOWER CONDUCTOR
TO BE BROKEN)

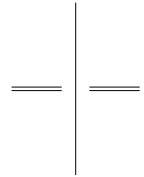

PREFERENTIAL ABBREVIATIONS

AUXILIARY TRANSFORMER	Aux T
EARTHING TRANSFORMER	ET
GAS TURBINE	Gas T
GENERATOR TRANSFORMER	Gen T
GRID TRANSFORMER	Gr T
SERIES REACTOR	Ser Reac
SHUNT REACTOR	Sh Reac
STATION TRANSFORMER	Stn T
SUPERGRID TRANSFORMER	SGT
UNIT TRANSFORMER	UT

* NON-STANDARD SYMBOL

PORTABLE MAINTENANCE
EARTH DEVICE



DISCONNECTOR
(PANTOGRAPH TYPE)



QUADRATURE BOOSTER

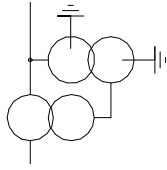

DISCONNECTOR
(KNEE TYPE)



SHORTING/DISCHARGE SWITCH

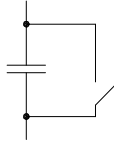

CAPACITOR
(INCLUDING HARMONIC FILTER)



SINGLE PHASE TRANSFORMER (BR)
NEUTRAL AND PHASE CONNECTIONS

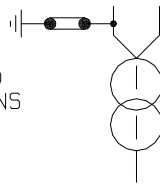

RESISTOR WITH INHERENT
NON-LINEAR VARIABILITY,
VOLTAGE DEPENDANT

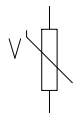

PART E1B - PROCEDURES RELATING TO GAS ZONE DIAGRAMS

GAS INSULATED
BUSBAR

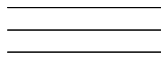

DOUBLE-BREAK
DISCONNECTOR

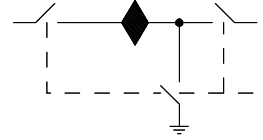

GAS BOUNDARY



EXTERNAL MOUNTED
CURRENT TRANSFORMER
(WHERE SEPARATE
PRIMARY APPARATUS)



GAS/GAS BOUNDARY



STOP VALVE
NORMALLY CLOSED



GAS/CABLE BOUNDARY



STOP VALVE
NORMALLY OPEN



GAS/AIR BOUNDARY



GAS MONITOR



GAS/TRANSFORMER BOUNDARY



FILTER



MAINTENANCE VALVE

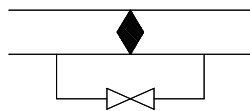

QUICK ACTING COUPLING



PART E2 - NON-EXHAUSTIVE LIST OF APPARATUS TO BE INCLUDED ON OPERATION DIAGRAMS

Basic Principles

- (1) Where practicable, all the **HV Apparatus** on any **Connection Site** shall be shown on one **Operation Diagram**. Provided the clarity of the diagram is not impaired, the layout shall represent as closely as possible the geographical arrangement on the **Connection Site**.
- (2) Where more than one **Operation Diagram** is unavoidable, duplication of identical information on more than one **Operation Diagram** must be avoided.
- (3) The **Operation Diagram** must show accurately the current status of the **Apparatus** e.g. whether commissioned or decommissioned. Where decommissioned, the associated switchbay will be labelled "spare bay".
- (4) Provision will be made on the **Operation Diagram** for signifying approvals, together with provision for details of revisions and dates.
- (5) **Operation Diagrams** will be prepared in A4 format or such other format as may be agreed with **The Company**.
- (6) The **Operation Diagram** should normally be drawn single line. However, where appropriate, detail which applies to individual phases shall be shown. For example, some **HV Apparatus** is numbered individually per phase.

Apparatus To Be Shown On Operation Diagram

- (1) Busbars
- (2) Circuit Breakers
- (3) Disconnecter (Isolator) and Switch Disconnecters (Switching Isolators)
- (4) Disconnectors (Isolators) - Automatic Facilities
- (5) Bypass Facilities
- (6) Earthing Switches
- (7) Maintenance Earths
- (8) Overhead Line Entries
- (9) Overhead Line Traps
- (10) Cable and Cable Sealing Ends
- (11) Generating Unit
- (12) Generator Transformers
- (13) Generating Unit Transformers, Station Transformers, including the lower voltage circuit-breakers.
- (14) Synchronous Compensators
- (15) Static Variable Compensators
- (16) Capacitors (including Harmonic Filters)
- (17) Series or Shunt Reactors (Referred to as "Inductors" at nuclear power station sites)
- (18) Supergrid and Grid Transformers
- (19) Tertiary Windings
- (20) Earthing and Auxiliary Transformers
- (21) Three Phase VT's

- (22) Single Phase VT & Phase Identity
- (23) High Accuracy VT and Phase Identity
- (24) Surge Arrestors/Diverter
- (25) Neutral Earthing Arrangements on HV Plant
- (26) Fault Throwing Devices
- (27) Quadrature Boosters
- (28) Arc Suppression Coils
- (29) Single Phase Transformers (BR) Neutral and Phase Connections
- (30) Current Transformers (where separate plant items)
- (31) Wall Bushings
- (32) Combined VT/CT Units
- (33) Shorting and Discharge Switches
- (34) Thyristor
- (35) Resistor with Inherent Non-Linear Variability, Voltage Dependent
- (36) Gas Zone

APPENDIX E3 - MINIMUM FREQUENCY RESPONSE CAPABILITY REQUIREMENT PROFILE AND OPERATING RANGE FOR POWER GENERATING MODULES AND HVDC EQUIPMENT

ECC.A.3.1 Scope

The frequency response capability is defined in terms of **Primary Response**, **Secondary Response** and **High Frequency Response**. In addition to the requirements defined in ECC.6.3.7 this appendix defines the minimum frequency response requirements for:-

- (a) each **Type C** and **Type D Power Generating Module**
- (b) each **DC Connected Power Park Module**
- (c) each **HVDC System**

For the avoidance of doubt, this appendix does not apply to **Type A** and **Type B Power Generating Modules**.

OTSDUW Plant and Apparatus should facilitate the delivery of frequency response services provided by **Offshore Generating Units** and **Offshore Power Park Units**.

The functional definition provides appropriate performance criteria relating to the provision of **Frequency** control by means of **Frequency** sensitive generation in addition to the other requirements identified in ECC.6.3.7.

In this Appendix 3 to the ECC, for a **Power Generating Module** including a **CCGT Module** or a **Power Park Module** or **DC Connected Power Park Module**, the phrase **Minimum Regulating Level** applies to the entire **CCGT Module** or **Power Park Module** or **DC Connected Power Park Module** operating with all **Generating Units Synchronised** to the **System**.

The minimum **Frequency** response requirement profile is shown diagrammatically in Figure ECC.A.3.1. The capability profile specifies the minimum required level of **Frequency Response** Capability throughout the normal plant operating range.

ECC.A.3.2 Plant Operating Range

The upper limit of the operating range is the **Maximum Capacity** of the **Power Generating Module** or **Generating Unit** or **CCGT Module** or **HVDC Equipment**.

The **Minimum Stable Operating Level** may be less than, but must not be more than, 65% of the **Maximum Capacity**. Each **Power Generating Module** and/or **Generating Unit** and/or **CCGT Module** and/or **Power Park Module** or **HVDC Equipment** must be capable of operating satisfactorily down to the **Minimum Regulating Level** as dictated by **System** operating conditions, although it will not be instructed to below its **Minimum Stable Operating Level**. If a **Power Generating Module** or **Generating Unit** or **CCGT Module** or **Power Park Module**, or **HVDC Equipment** is operating below **Minimum Stable Operating Level** because of high **System Frequency**, it should recover adequately to its **Minimum Stable Operating Level** as the **System Frequency** returns to **Target Frequency** so that it can provide **Primary** and **Secondary Response** from its **Minimum Stable Operating Level** if the **System Frequency** continues to fall. For the avoidance of doubt, under normal operating conditions steady state operation below the **Minimum Stable Operating Level** is not expected. The **Minimum Regulating Level** must not be more than 55% of **Maximum Capacity**.

In the event of a **Power Generating Module** or **Generating Unit** or **CCGT Module** or **Power Park Module** or **HVDC Equipment** load rejecting down to no less than its **Minimum Regulating Level** it should not trip as a result of automatic action as detailed in BC3.7. If the load rejection is to a level less than the **Minimum Regulating Level** then it is accepted that the condition might be so severe as to cause it to be disconnected from the **System**.

ECC.A.3.3 Minimum Frequency Response Requirement Profile

Figure ECC.A.3.1 shows the minimum **Frequency** response capability requirement profile diagrammatically for a 0.5 Hz change in **Frequency**. The percentage response capabilities and loading levels are defined on the basis of the **Maximum Capacity** of the **Power Generating Module** or **CCGT Module** or **Power Park Module** or **HVDC Equipment**. Each **Power Generating Module** or and/or **CCGT Module** or **Power Park Module** (including a **DC Connected Power Park Module**) and/or **HVDC Equipment** must be capable of operating in a manner to provide **Frequency** response at least to the solid boundaries shown in the figure. If the **Frequency** response capability falls within the solid boundaries, the **Power Generating Module** or **CCGT Module** or **Power Park Module** or **HVDC Equipment** is providing response below the minimum requirement which is not acceptable. Nothing in this appendix is intended to prevent a **Power Generating Module** or **CCGT Module** or **Power Park Module** or **HVDC Equipment** from being designed to deliver a **Frequency** response in excess of the identified minimum requirement.

The **Frequency** response delivered for **Frequency** deviations of less than 0.5 Hz should be no less than a figure which is directly proportional to the minimum **Frequency** response requirement for a **Frequency** deviation of 0.5 Hz. For example, if the **Frequency** deviation is 0.2 Hz, the corresponding minimum **Frequency** response requirement is 40% of the level shown in Figure ECC.A.3.1. The **Frequency** response delivered for **Frequency** deviations of more than 0.5 Hz should be no less than the response delivered for a **Frequency** deviation of 0.5 Hz.

Each **Power Generating Module** and/or **CCGT Module** and/or **Power Park Module** or **HVDC Equipment** must be capable of providing some response, in keeping with its specific operational characteristics, when operating between 95% to 100% of **Maximum Capacity** as illustrated by the dotted lines in Figure ECC.A.3.1.

At the **Minimum Stable Operating** level, each **Power Generating Module** and/or **CCGT Module** and/or **Power Park Module** and/or **HVDC Equipment** is required to provide high and low frequency response depending on the **System Frequency** conditions. Where the **Frequency** is high, the **Active Power** output is therefore expected to fall below the **Minimum Stable Operating** level.

The **Minimum Regulating Level** is the output at which a **Power Generating Module** and/or **CCGT Module** and/or **Power Park Module** and/or **HVDC Equipment** has no **High Frequency Response** capability. It may be less than, but must not be more than, 55% of the **Maximum Capacity**. This implies that a **Power Generating Module** or **CCGT Module** or **Power Park Module**) or **HVDC Equipment** is not obliged to reduce its output to below this level unless the **Frequency** is at or above 50.5 Hz (cf BC3.7).

ECC.A.3.4 Testing of Frequency Response Capability

The frequency response capabilities shown diagrammatically in Figure ECC.A.3.1 are measured by taking the responses as obtained from some of the dynamic step response tests specified by **The Company** and carried out by **Generators** and **HVDC System** owners for compliance purposes. The injected signal is a step of 0.5Hz from zero to 0.5 Hz **Frequency** change, and is sustained at 0.5 Hz **Frequency** change thereafter, the latter as illustrated diagrammatically in figures ECC.A.3.4 and ECC.A.3.5.

In addition to provide and/or to validate the content of **Ancillary Services Agreements** a progressive injection of a **Frequency** change to the plant control system (i.e. governor and load controller) is used. The injected signal is a ramp of 0.5Hz from zero to 0.5 Hz **Frequency** change over a ten second period, and is sustained at 0.5 Hz **Frequency** change thereafter, the latter as illustrated diagrammatically in figures ECC.A.3.2 and ECC.A.3.3. In the case of an **Embedded Medium Power Station** not subject to a **Bilateral Agreement** or **Embedded HVDC System** not subject to a **Bilateral Agreement**, **The Company** may require the **Network Operator** within whose System the **Embedded Medium Power Station** or **Embedded HVDC System** is situated, to ensure that the **Embedded Person** performs the dynamic response tests reasonably required by **The Company** in order to demonstrate compliance within the relevant requirements in the **ECC**.

The **Primary Response** capability (P) of a **Power Generating Module** or a **CCGT Module** or **Power Park Module** or **HVDC Equipment** is the minimum increase in **Active Power** output between 10 and 30 seconds after the start of the ramp injection as illustrated diagrammatically in Figure ECC.A.3.2. This increase in **Active Power** output should be released increasingly with time over the period 0 to 10 seconds from the time of the start of the **Frequency** fall as illustrated by the response from Figure ECC.A.3.2.

The **Secondary Response** capability (S) of a **Power Generating Module** or a **CCGT Module** or **Power Park Module** or **HVDC Equipment** is the minimum increase in **Active Power** output between 30 seconds and 30 minutes after the start of the ramp injection as illustrated diagrammatically in Figure ECC.A.3.2.

The **High Frequency Response** capability (H) of a **Power Generating Module** or a **CCGT Module** or **Power Park Module** or **HVDC Equipment** is the decrease in **Active Power** output provided 10 seconds after the start of the ramp injection and sustained thereafter as illustrated diagrammatically in Figure ECC.A.3.3. This reduction in **Active Power** output should be released increasingly with time over the period 0 to 10 seconds from the time of the start of the **Frequency** rise as illustrated by the response in Figure ECC.A.3.2.

ECC.A.3.5 Repeatability of Response

When a **Power Generating Module** or **CCGT Module** or **Power Park Module** or **HVDC Equipment** has responded to a significant **Frequency** disturbance, its response capability must be fully restored as soon as technically possible. Full response capability should be restored no later than 20 minutes after the initial change of **System Frequency** arising from the **Frequency** disturbance.

Figure ECC.A.3.1 - Minimum **Frequency** Response requirement profile for a 0.5 Hz frequency change from **Target Frequency**

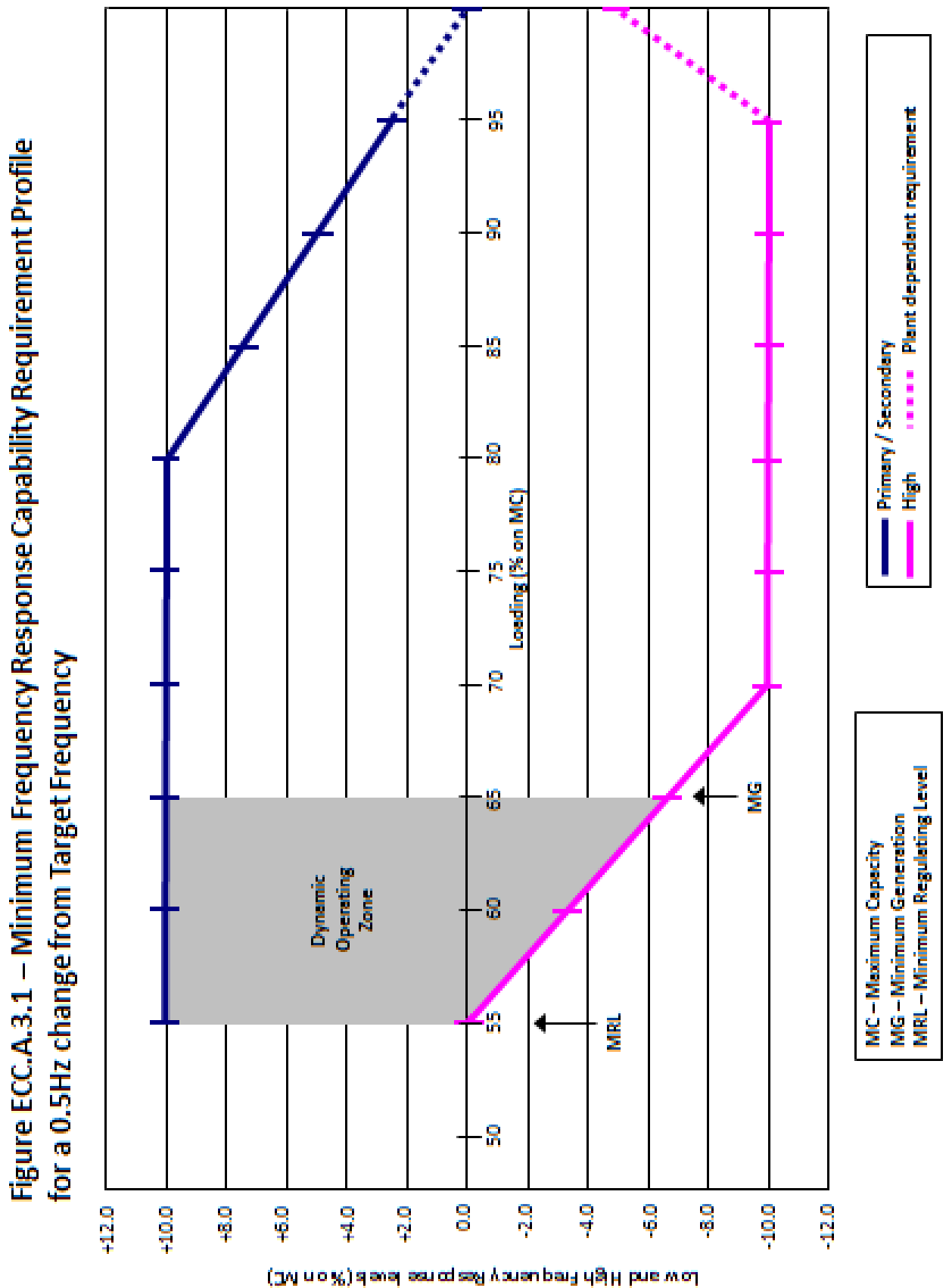

Figure ECC.A.3.2 – Interpretation of Primary and Secondary Response Service Values

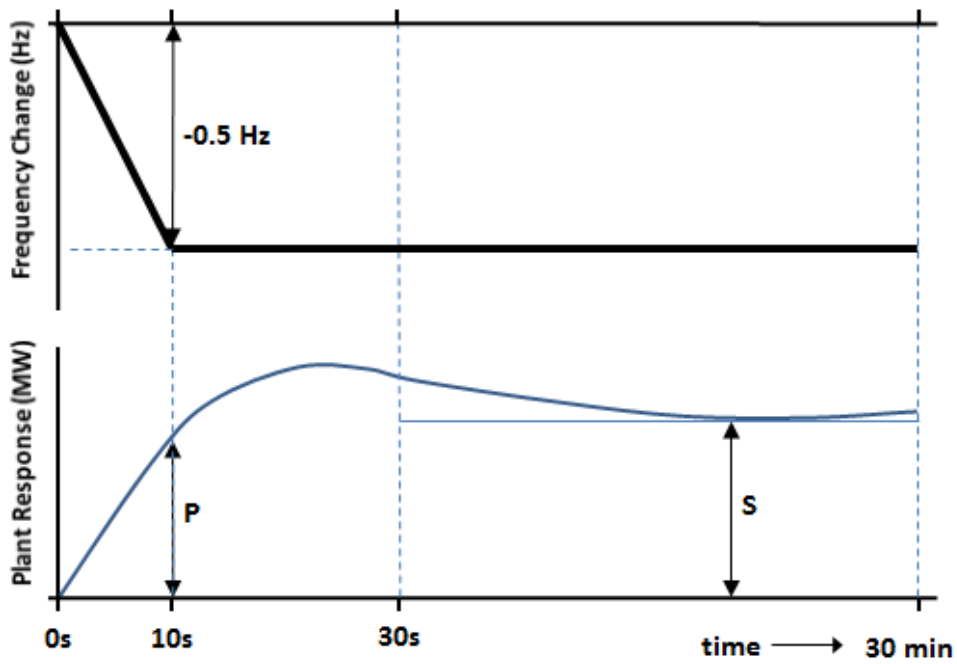

Figure ECC.A.3.3 – Interpretation of High Frequency Response Service Values

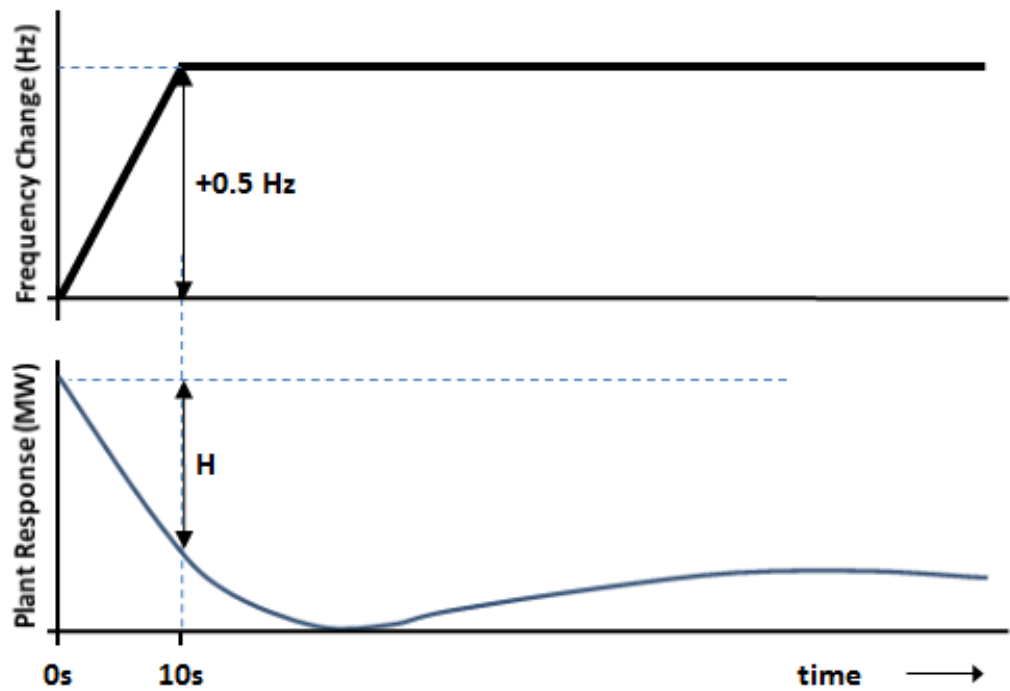

Figure ECC.A.3.4 – Interpretation of Low Frequency Response Capability Values

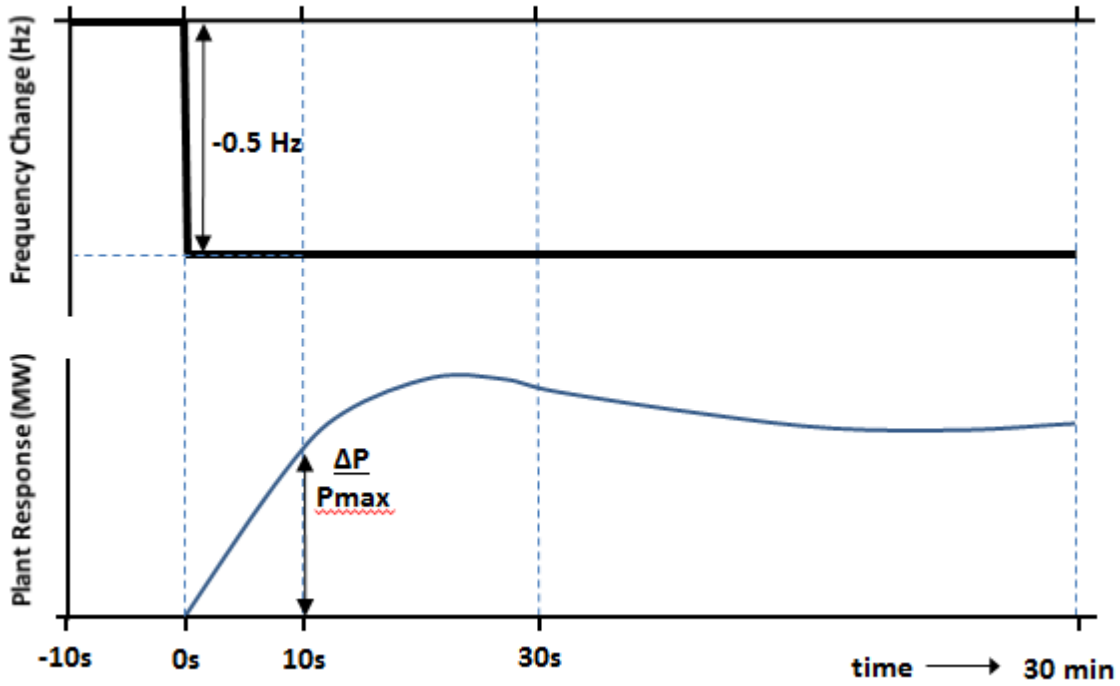
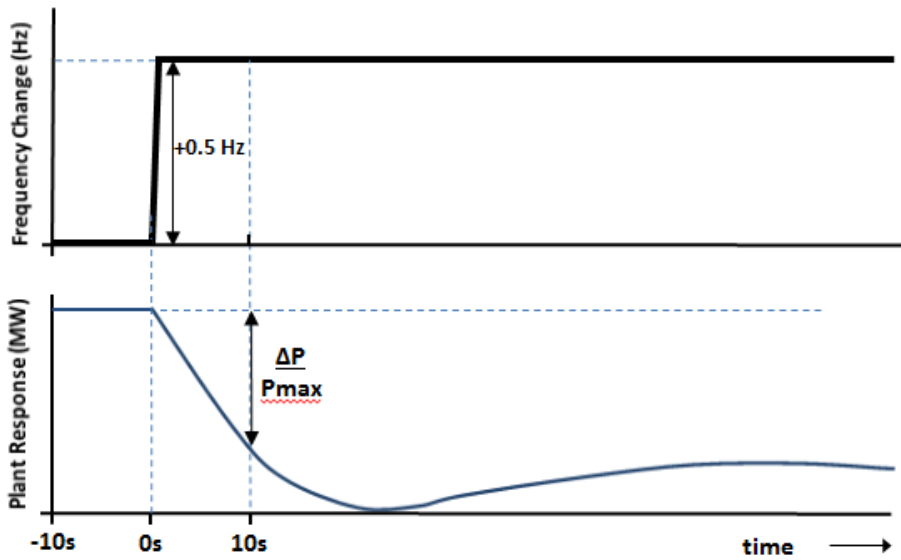

Figure ECC.A.3.5 – Interpretation of High Frequency Response Capability Values



ECC.4 - APPENDIX 4 - FAULT RIDE THROUGH REQUIREMENTS

FAULT RIDE THROUGH REQUIREMENTS FOR TYPE B, TYPE C AND TYPE D POWER GENERATING MODULES (INCLUDING OFFSHORE POWER PARK MODULES WHICH ARE EITHER AC CONNECTED POWER PARK MODULES OR DC CONNECTED POWER PARK MODULES), HVDC SYSTEMS AND OTSDUW PLANT AND APPARATUS

ECC.A.4A.1 Scope

The **Fault Ride Through** requirements are defined in ECC.6.3.15. This Appendix provides illustrations by way of examples only of ECC.6.3.15.1 to ECC.6.3.15.10 and further background and illustrations and is not intended to show all possible permutations.

ECC.A.4A.2 Short Circuit Faults At Supergrid Voltage On The Onshore Transmission System Up To 140ms In Duration

For short circuit faults at **Supergrid Voltage** on the **Onshore Transmission System** (which could be at an **Interface Point**) up to 140ms in duration, the **Fault Ride Through** requirement is defined in ECC.6.3.15. In summary any **Power Generating Module** (including a **DC Connected Power Park Module**) or **HVDC System** is required to remain connected and stable whilst connected to a healthy circuit. Figure ECC.A.4.A.2 illustrates this principle.

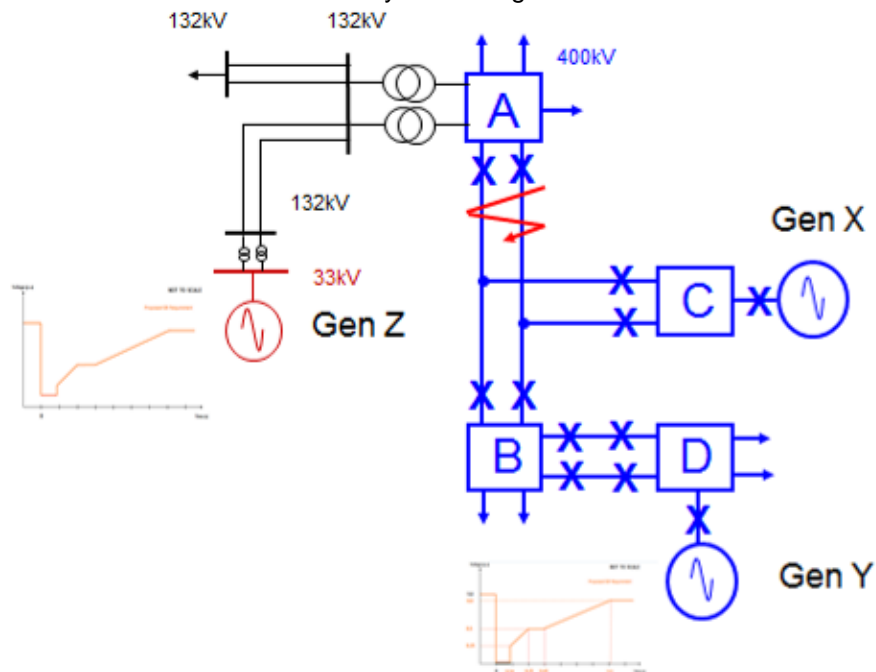

Figure ECC.A.4.A.2

In Figure ECC.A.4.A.2 a solid three phase short circuit fault is applied adjacent to substation A resulting in zero voltage at the point of fault. All circuit breakers on the faulty circuit (Lines ABC) will open within 140ms resulting in Gen X tripping. The effect of this fault, due to the low impedance of the network, will be the observation of a low voltage at each substation node across the **Total System** until the fault has been cleared. In this example, Gen Y and Gen Z (an Embedded Generator) would need to remain connected and stable as both are still connected to the **Total System** and remain connected to healthy circuits .

The criteria for assessment is based on a voltage against time curve at each **Grid Entry Point** or **User System Entry Point**. The voltage against time curve at the **Grid Entry Point** or **User System Entry Point** varies for each different type and size of **Power Generating Module** as detailed in ECC.6.3.15.2. – ECC.6.3.15.7.

The voltage against time curve represents the voltage profile at a **Grid Entry Point or User System Entry Point** that would be obtained by plotting the voltage at that **Grid Entry Point or User System Entry Point** before during and after the fault. This is not to be confused with a voltage duration curve (as defined under ECC.6.3.15.9) which represents a voltage level and associated time duration.

The post fault voltage at a **Grid Entry Point or User System Entry Point** is largely influenced by the topology of the network rather than the behaviour of the **Power Generating Module** itself. The **EU Generator** therefore needs to ensure each **Power Generating Module** remains connected and stable for a close up solid three phase short circuit fault for 140ms at the **Grid Entry Point or User System Entry Point**.

Two examples are shown in Figure EA.4.2(a) and Figure EA.4.2(b). In Figure EA.4.2(a) the post fault profile is above the heavy black line. In this case the **Power Generating Module** must remain connected and stable. In Figure EA.4.2(b) the post fault voltage dips below the heavy black line in which case the **Power Generating Module** is permitted to trip.

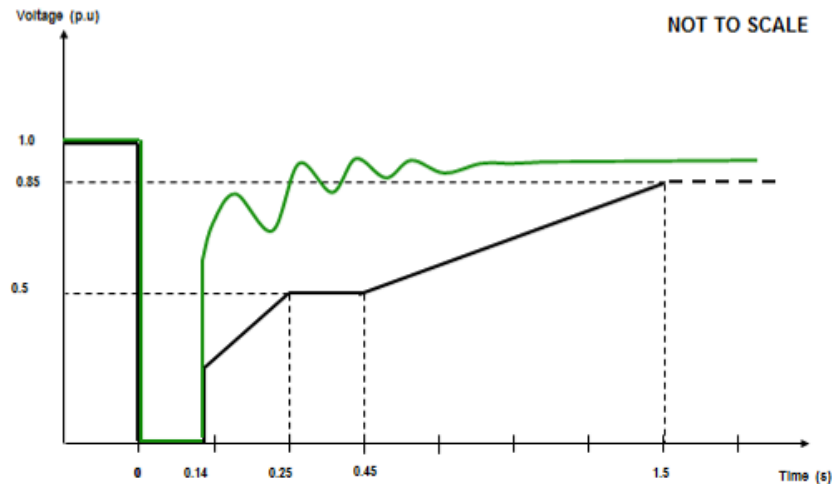

Figure EA.4.2(a)

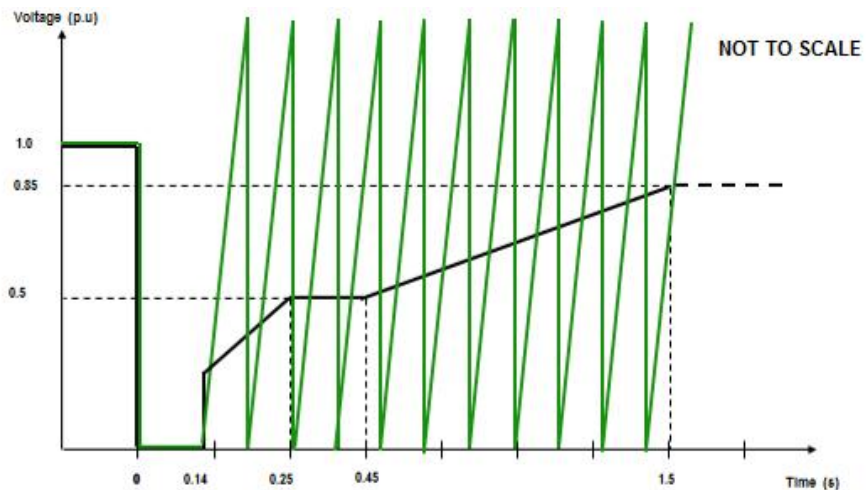

Figure EA.4.2(b)

The process for demonstrating **Fault Ride Through** compliance against the requirements of ECC.6.3.15 is detailed in ECP.A.3.5 and ECP.A.6.7 (as applicable).

ECC.A.4A.3 Supergrid Voltage Dips On The Onshore Transmission System Greater Than 140ms In Duration

ECC.A.4A3.1 Requirements applicable to **Synchronous Power Generating Modules** subject to **Supergrid Voltage** dips on the **Onshore Transmission System** greater than 140ms in duration.

For balanced **Supergrid Voltage** dips on the **Onshore Transmission System** having durations greater than 140ms and up to 3 minutes, the **Fault Ride Through** requirement is defined in ECC.6.3.15.9.2.1(a) and Figure ECC.6.3.15.9(a) which is reproduced in this Appendix as Figure EA.4.3.1 and termed the voltage–duration profile.

This profile is not a voltage-time response curve that would be obtained by plotting the transient voltage response at a point on the **Onshore Transmission System** (or **User System** if located **Onshore**) to a disturbance. Rather, each point on the profile (ie the heavy black line) represents a voltage level and an associated time duration which connected **Synchronous Power Generating Modules** must withstand or ride through.

Figures EA.4.3.2 (a), (b) and (c) illustrate the meaning of the voltage-duration profile for voltage dips having durations greater than 140ms.

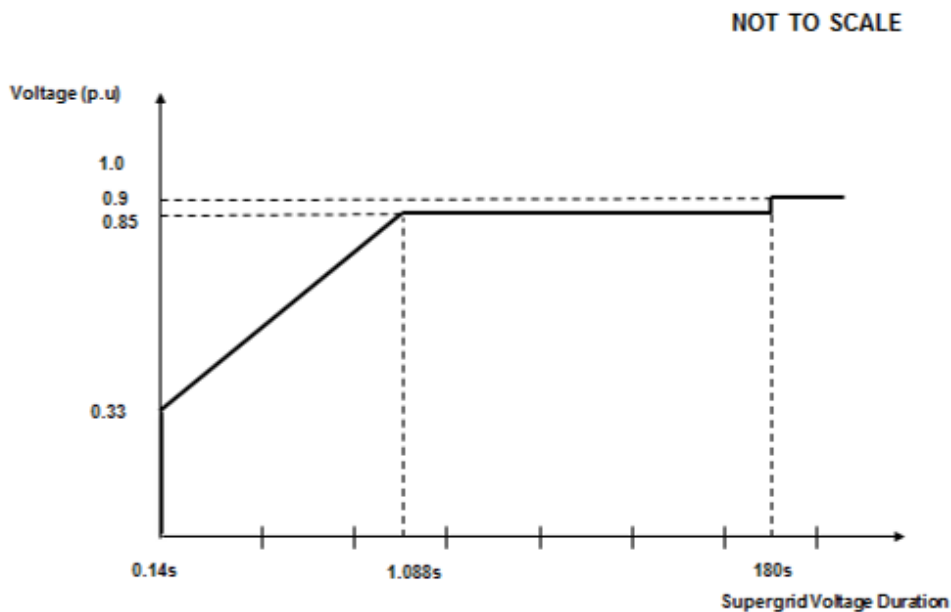

Figure EA.4.3.1

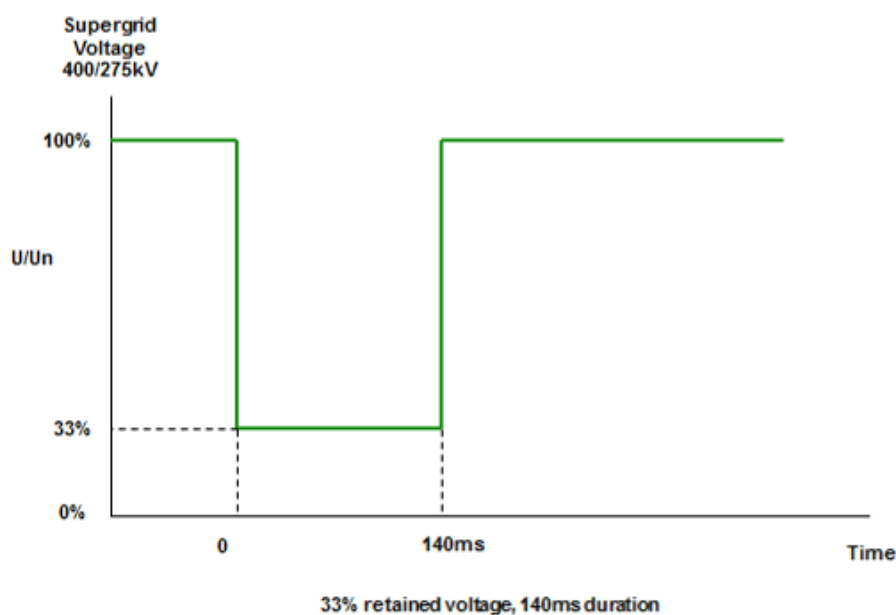

Figure EA.4.3.2 (a)

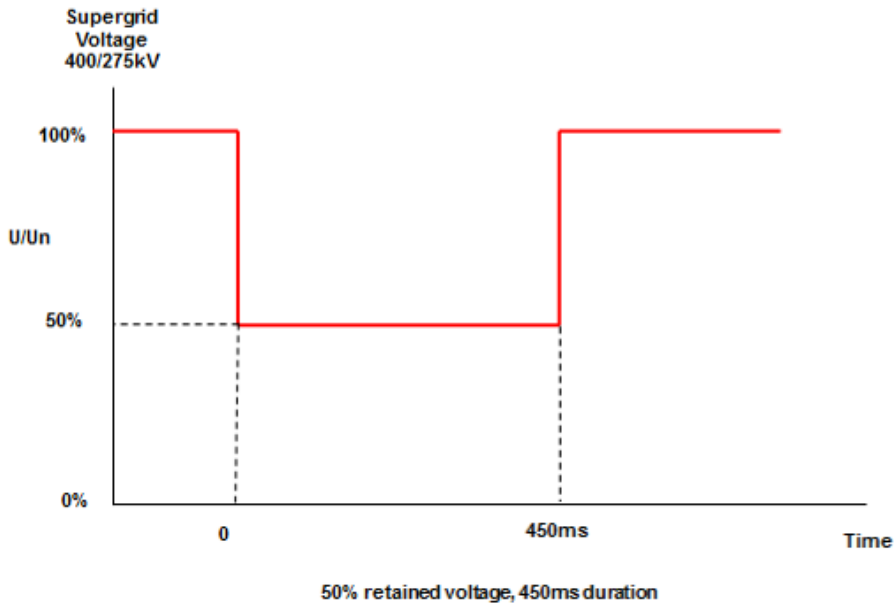

Figure EA.4.3.2 (b)

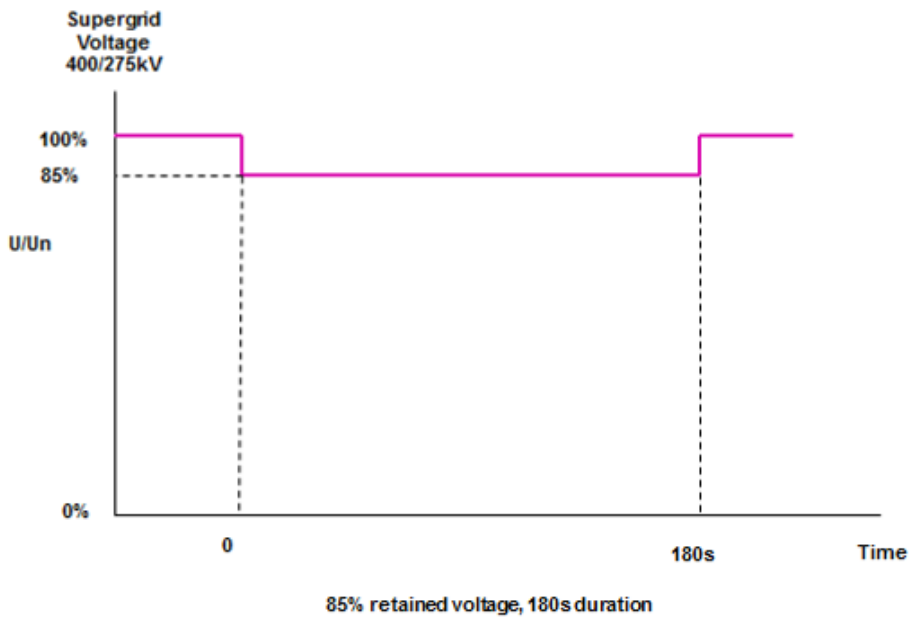

Figure EA.4.3.2 (c)

ECC.A.4A3.2 Requirements applicable to **Power Park Modules** or **OTSDUW Plant and Apparatus** subject to **Supergrid Voltage** dips on the **Onshore Transmission System** greater than 140ms in duration

For balanced **Supergrid Voltage** dips on the **Onshore Transmission System** (which could be at an **Interface Point**) having durations greater than 140ms and up to 3 minutes the **Fault Ride Through** requirement is defined in ECC.6.3.15.9.2.1(b) and Figure ECC.6.3.15.9(b) which is reproduced in this Appendix as Figure EA.4.3.3 and termed the voltage–duration profile.

This profile is not a voltage-time response curve that would be obtained by plotting the transient voltage response at a point on the **Onshore Transmission System** (or **User System** if located **Onshore**) to a disturbance. Rather, each point on the profile (ie the heavy black line) represents a voltage level and an associated time duration which connected **Power Park Modules** or **OTSDUW Plant and Apparatus** must withstand or ride through.

Figures EA.4.3.4 (a), (b) and (c) illustrate the meaning of the voltage-duration profile for voltage dips having durations greater than 140ms.

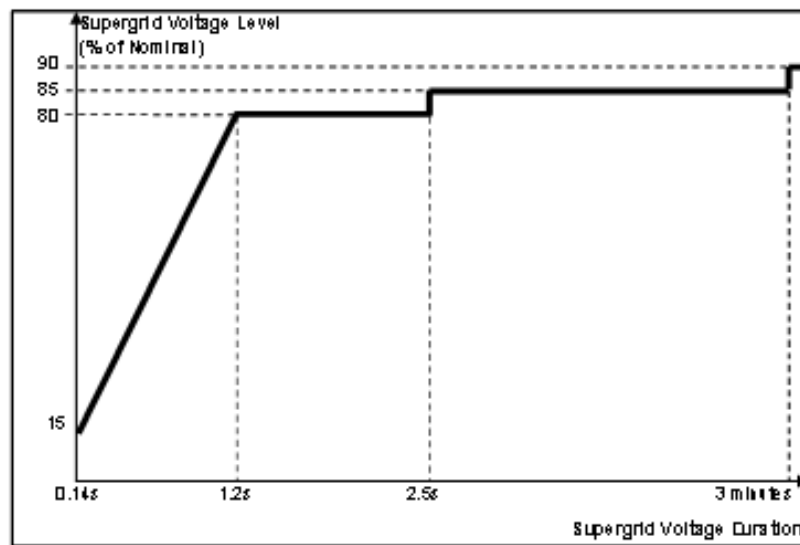
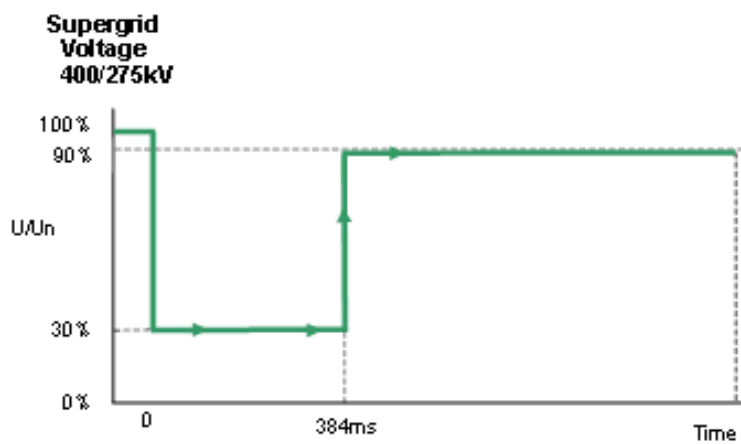

Figure EA.4.3.3



30 % retained voltage, 384ms duration

Figure EA.4.3.4(a)

**Supergrid
Voltage
400/275kV**

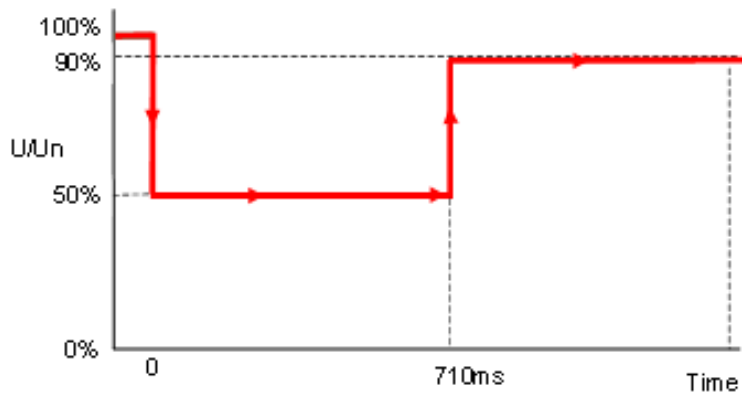

50% retained voltage, 710ms duration

Figure EA.4.3.4 (b)

**Supergrid
Voltage
400/275kV**

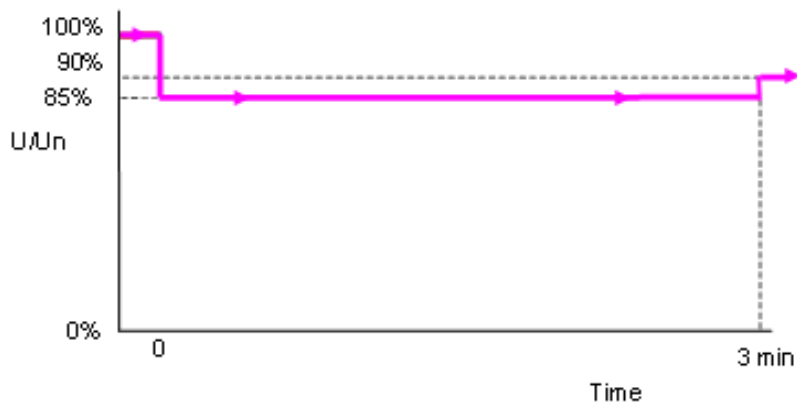

85% retained voltage, 3 minutes duration

Figure EA.4.3.4 (c)

**APPENDIX E5 - TECHNICAL REQUIREMENTS
LOW FREQUENCY RELAYS FOR THE AUTOMATIC
DISCONNECTION OF SUPPLIES AT LOW FREQUENCY**

ECC.A.5.1 Low Frequency Relays

ECC.A.5.1.1 The **Low Frequency Relays** to be used shall have a setting range of 47.0 to 50Hz and be suitable for operation from a nominal AC input of 63.5, 110 or 240V. The following parameters specify the requirements of approved **Low Frequency Relays**:

- (a) **Frequency** settings: 47-50Hz in steps of 0.05Hz or better, preferably 0.01Hz;
- (b) Operating time: Relay operating time shall not be more than 150 ms;
- (c) Voltage lock-out: Selectable within a range of 55 to 90% of nominal voltage;
- (d) Direction: Tripping interlock for forward or reverse power flow capable of being set in either position or off
- (e) Facility stages: One or two stages of **Frequency** operation;
- (f) Output contacts: Two output contacts per stage to be capable of repetitively making and breaking for 1000 operations:
- (g) Accuracy: 0.01 Hz maximum error under reference environmental and system voltage conditions.
0.05 Hz maximum error at 8% of total harmonic distortion
Electromagnetic Compatibility Level.

In the case of **Network Operators** who are **GB Code Users**, the above requirements only apply to a relay (if any) installed at the **EU Grid Supply Point**. **Network Operators** who are also **GB Code Users** should continue to satisfy the requirements for low frequency relays as specified in the **CCs** as applicable to their **System**.

ECC.A.5.2 Low Frequency Relay Voltage Supplies

ECC.A.5.2.1 It is essential that the voltage supply to the **Low Frequency Relays** shall be derived from the primary **System** at the supply point concerned so that the **Frequency** of the **Low Frequency Relays** input voltage is the same as that of the primary **System**. This requires either:

- (a) the use of a secure supply obtained from voltage transformers directly associated with the grid transformer(s) concerned, the supply being obtained where necessary via a suitable automatic voltage selection scheme; or
- (b) the use of the substation 240V phase-to-neutral selected auxiliary supply, provided that this supply is always derived at the supply point concerned and is never derived from a standby supply **Power Generating Module** or from another part of the **User System**.

ECC.A.5.3 Scheme Requirements

ECC.A.5.3.1 The tripping facility should be engineered in accordance with the following reliability considerations:

- (a) Dependability

Failure to trip at any one particular **Demand** shedding point would not harm the overall operation of the scheme. However, many failures would have the effect of reducing the amount of **Demand** under low **Frequency** control. An overall reasonable minimum requirement for the dependability of the **Demand** shedding scheme is 96%, i.e. the average probability of failure of each **Demand** shedding point should be less than 4%. Thus the **Demand** under low **Frequency** control will not be reduced by more than 4% due to relay failure.

(b) Outages

Low **Frequency Demand** shedding schemes will be engineered such that the amount of **Demand** under control is as specified in Table ECC.A.5.5.1a and is not reduced unacceptably during equipment outage or maintenance conditions.

ECC.A.5.3.2 The total operating time of the scheme, including circuit breakers operating time, shall where reasonably practicable, be less than 200 ms. For the avoidance of doubt, the replacement of plant installed prior to October 2009 will not be required in order to achieve lower total scheme operating times.

ECC.A.5.4 Low Frequency Relay Testing

ECC.A.5.4.1 **Low Frequency Relays** installed and commissioned after 1st January 2007 shall be type tested in accordance with and comply with the functional test requirements for **Frequency Protection** contained in Energy Networks Association Technical Specification 48-6-5 Issue 1 dated 2005 “**ENA Protection Assessment Functional Test Requirements – Voltage and Frequency Protection**”.

For the avoidance of doubt, **Low Frequency Relays** installed and commissioned before 1st January 2007 shall comply with the version of ECC.A.5.1.1 applicable at the time such **Low Frequency Relays** were commissioned.

ECC.A.5.4.2 Each **Non-Embedded Customer** shall aim to execute testing on its low frequency demand disconnection relays installed within its network and in service at least once every three years, although this may be extended to no more than every five years if considered to be required for operational purposes.

ECC.A.5.4.3 Each **Network Operator** and **Relevant Transmission Licensee** shall aim to execute testing on its low frequency demand disconnection relays installed within its network and in service at least once every three years, although this may be extended to no more than every five years if considered to be required for operational purposes.

ECC.A.5.5 Scheme Settings

ECC.A.5.5.1 Table CC.A.5.5.1a shows, for each **Transmission Area**, the percentage of **Demand** (based on **Annual ACS Conditions**) at the time of forecast **National Electricity Transmission System** peak **Demand** that each **Network Operator** whose **System** is connected to the **Onshore Transmission System** within such **Transmission Area** shall disconnect by **Low Frequency Relays** at a range of frequencies. Where a **Network Operator’s System** is connected to the **National Electricity Transmission System** in more than one **Transmission Area**, the settings for the **Transmission Area** in which the majority of the **Demand** is connected shall apply.

Frequency Hz	% Demand disconnection for each Network Operator in Transmission Area		
	NGET	SPT	SHETL
48.8	5		
48.75	5		

48.7	10		
48.6	7.5		10
48.5	7.5	10	
48.4	7.5	10	10
48.2	7.5	10	10
48.0	5	10	10
47.8	5		
Total % Demand	60	40	40

Table ECC.A.5.5.1a

Note – the percentages in table ECC.A.5.5.1a are cumulative such that, for example, should the frequency fall to 48.6 Hz in **NGET’s Transmission Area**, 27.5% of the total **Demand** connected to the **National Electricity Transmission System** in **NGET’s Transmission Area** shall be disconnected by the action of **Low Frequency Relays**.

The percentage **Demand** at each stage shall be allocated as far as reasonably practicable. The cumulative total percentage **Demand** is a minimum.

ECC.A.5.5.2 In the case of a **Non-Embedded Customer** (who is also an **EU Code User**) the percentage of **Demand** (based on **Annual ACS Conditions**) at the time of forecast **National Electricity Transmission System** peak **Demand** that each **Non-Embedded Customer** whose **System** is connected to the **Onshore Transmission System** which shall be disconnected by **Low Frequency Relays** shall be in accordance with OC6.6 and the **Bilateral Agreement**.

ECC.A.5.6 Connection and Reconnection

ECC.A.5.6.1 As defined under OC.6.6 once automatic low **Frequency Demand Disconnection** has taken place, the **Network Operator** on whose **User System** it has occurred, will not reconnect until **The Company** instructs that **Network Operator** to do so in accordance with OC6. The same requirement equally applies to **Non-Embedded Customers**.

ECC.A.5.6.2 Once **The Company** instructs the **Network Operator** or **Non Embedded Customer** to reconnect to the **National Electricity Transmission System** following operation of the **Low Frequency Demand Disconnection** scheme it shall do so in accordance with the requirements of ECC.6.2.3.10 and OC6.6.

ECC.A.5.6.3 **Network Operators** or **Non Embedded Customers** shall be capable of being remotely disconnected from the **National Electricity Transmission System** when instructed by **The Company**. Any requirement for the automated disconnection equipment for reconfiguration of the **National Electricity Transmission System** in preparation for block loading and the time required for remote disconnection shall be specified by **The Company** in accordance with the terms of the **Bilateral Agreement**.

**APPENDIX E6 - PERFORMANCE REQUIREMENTS FOR CONTINUOUSLY ACTING AUTOMATIC
EXCITATION CONTROL SYSTEMS FOR ONSHORE SYNCHRONOUS POWER GENERATING
MODULES,**

ECC.A.6.1 Scope

ECC.A.6.1.1 This Appendix sets out the performance requirements of continuously acting automatic excitation control systems for **Type C** and **Type D Onshore Synchronous Power Generating Modules** that must be complied with by the **User**. This Appendix does not limit any site specific requirements where in **The Company's** reasonable opinion these facilities are necessary for system reasons.

ECC.A.6.1.2 Where the requirements may vary the likely range of variation is given in this Appendix. It may be necessary to specify values outside this range where **The Company** identifies a system need, and notwithstanding anything to the contrary **The Company** may specify values outside of the ranges provided in this Appendix 6. The most common variations are in the on-load excitation ceiling voltage requirements and the response time required of the **Exciter**. Actual values will be included in the **Bilateral Agreement**.

ECC.A.6.1.3 Should an **EU Generator** anticipate making a change to the excitation control system it shall notify **The Company** under the **Planning Code** (PC.A.1.2(b) and (c)) as soon as the **EU Generator** anticipates making the change. The change may require a revision to the **Bilateral Agreement**.

ECC.A.6.2 Requirements

ECC.A.6.2.1 The **Excitation System** of a **Type C** or **Type D Onshore Synchronous Power Generating Module** shall include an excitation source (**Exciter**), and a continuously acting **Automatic Voltage Regulator (AVR)** and shall meet the following functional specification. **Type D Synchronous Power Generating Modules** are also required to be fitted with a **Power System Stabiliser** in accordance with the requirements of ECC.A.6.2.5.

ECC.A.6.2.3 Steady State Voltage Control

ECC.A.6.2.3.1 An accurate steady state control of the **Onshore Synchronous Power Generating Module** pre-set **Synchronous Generating Unit** terminal voltage is required. As a measure of the accuracy of the steady-state voltage control, the **Automatic Voltage Regulator** shall have static zero frequency gain, sufficient to limit the change in terminal voltage to a drop not exceeding 0.5% of rated terminal voltage, when the output of a **Synchronous Generating Unit** within an **Onshore Synchronous Power Generating Module** is gradually changed from zero to rated MVA output at rated voltage, **Active Power** and **Frequency**.

ECC.A.6.2.4 Transient Voltage Control

ECC.A.6.2.4.1 For a step change from 90% to 100% of the nominal **Onshore Synchronous Generating Unit** terminal voltage, with the **Onshore Synchronous Generating Unit** on open circuit, the **Excitation System** response shall have a damped oscillatory characteristic. For this characteristic, the time for the **Onshore Synchronous Generating Unit** terminal voltage to first reach 100% shall be less than 0.6 seconds. Also, the time to settle within 5% of the voltage change shall be less than 3 seconds.

ECC.A.6.2.4.2 To ensure that adequate synchronising power is maintained, when the **Onshore Power Generating Module** is subjected to a large voltage disturbance, the **Exciter** whose output is varied by the **Automatic Voltage Regulator** shall be capable of providing its achievable upper and lower limit ceiling voltages to the **Onshore Synchronous Generating Unit** field in a time not exceeding that specified in the **Bilateral Agreement**. This will normally be not less than 50 ms and not greater than 300 ms. The achievable upper and lower limit ceiling voltages may be dependent on the voltage disturbance.

ECC.A.6.2.4.3 The **Exciter** shall be capable of attaining an **Excitation System On Load Positive Ceiling Voltage** of not less than a value specified in the **Bilateral Agreement** that will be:

not less than 2 per unit (pu)
normally not greater than 3 pu
exceptionally up to 4 pu

of **Rated Field Voltage** when responding to a sudden drop in voltage of 10 percent or more at the **Onshore Synchronous Generating Unit** terminals. **The Company** may specify a value outside the above limits where **The Company** identifies a system need.

ECC.A.6.2.4.4 If a static type **Exciter** is employed:

- (i) the field voltage should be capable of attaining a negative ceiling level specified in the **Bilateral Agreement** after the removal of the step disturbance of ECC.A.6.2.4.3. The specified value will be 80% of the value specified in ECC.A.6.2.4.3. **The Company** may specify a value outside the above limits where **The Company** identifies a system need.
- (ii) the **Exciter** must be capable of maintaining free firing when the **Onshore Synchronous Generating Unit** terminal voltage is depressed to a level which may be between 20% to 30% of rated terminal voltage
- (iii) the **Exciter** shall be capable of attaining a positive ceiling voltage not less than 80% of the **Excitation System On Load Positive Ceiling Voltage** upon recovery of the **Onshore Synchronous Generating Unit** terminal voltage to 80% of rated terminal voltage following fault clearance. **The Company** may specify a value outside the above limits where **The Company** identifies a system need.
- (iv) the requirement to provide a separate power source for the **Exciter** will be specified if **The Company** identifies a **Transmission System** need.

ECC.A.6.2.5 Power Oscillations Damping Control

ECC.A.6.2.5.1 To allow **Type D Onshore Power Generating Modules** to maintain second and subsequent swing stability and also to ensure an adequate level of low frequency electrical damping power, the **Automatic Voltage Regulator** of each **Onshore Synchronous Generating Unit** within each **Type D Onshore Synchronous Power Generating Module** shall include a **Power System Stabiliser** as a means of supplementary control.

ECC.A.6.2.5.2 Whatever supplementary control signal is employed, it shall be of the type which operates into the **Automatic Voltage Regulator** to cause the field voltage to act in a manner which results in the damping power being improved while maintaining adequate synchronising power.

ECC.A.6.2.5.3 The arrangements for the supplementary control signal shall ensure that the **Power System Stabiliser** output signal relates only to changes in the supplementary control signal and not the steady state level of the signal. For example, if generator electrical power output is chosen as a supplementary control signal then the **Power System Stabiliser** output should relate only to changes in the **Synchronous Generating Unit** electrical power output and not the steady state level of power output. Additionally the **Power System Stabiliser** should not react to mechanical power changes in isolation for example during rapid changes in steady state load or when providing frequency response.

ECC.A.6.2.5.4 The output signal from the **Power System Stabiliser** shall be limited to not more than $\pm 10\%$ of the **Onshore Synchronous Generating Unit** terminal voltage signal at the **Automatic Voltage Regulator** input. The gain of the **Power System Stabiliser** shall be such that an increase in the gain by a factor of 3 shall not cause instability.

ECC.A.6.2.5.5 The **Power System Stabiliser** shall include elements that limit the bandwidth of the output signal. The bandwidth limiting must ensure that the highest frequency of response cannot excite torsional oscillations on other plant connected to the network. A bandwidth of 0-5Hz would be judged to be acceptable for this application.

- ECC.A.6.2.5.6 The **EU Generator** in respect of its **Type D Synchronous Power Generating Modules** will agree **Power System Stabiliser** settings with **The Company** prior to the on-load commissioning detailed in BC2.11.2(d). To allow assessment of the performance before on-load commissioning the **EU Generator** will provide to **The Company** a report covering the areas specified in ECP.A.3.2.1.
- ECC.A.6.2.5.7 The **Power System Stabiliser** must be active within the **Excitation System** at all times when **Synchronised** including when the **Under Excitation Limiter** or **Over Excitation Limiter** are active. When operating at low load when **Synchronising** or **De-Synchronising** an **Onshore Synchronous Generating Unit**, within a **Type D Synchronous Power Generating Module**, the **Power System Stabiliser** may be out of service.
- ECC.A.6.2.5.8 Where a **Power System Stabiliser** is fitted to a **Pumped Storage Unit** within a **Type D Synchronous Power Generating Module** it must function when the **Pumped Storage Unit** is in both generating and pumping modes. In addition, where a **Power System Stabiliser** is fitted to an **Electricity Storage Unit** within a **Type D Synchronous Electricity Storage Module**, it must function when the **Synchronous Electricity Storage Unit** is in both importing and exporting modes of operation.
- ECC.A.6.2.6 Overall **Excitation System** Control Characteristics
- ECC.A.6.2.6.1 The overall **Excitation System** shall include elements that limit the bandwidth of the output signal. The bandwidth limiting must be consistent with the speed of response requirements and ensure that the highest frequency of response cannot excite torsional oscillations on other plant connected to the network. A bandwidth of 0-5 Hz will be judged to be acceptable for this application.
- ECC.A.6.2.6.2 The response of the **Automatic Voltage Regulator** combined with the **Power System Stabiliser** shall be demonstrated by injecting similar step signal disturbances into the **Automatic Voltage Regulator** reference as detailed in ECPA.5.2 and ECPA.5.4. The **Automatic Voltage Regulator** shall include a facility to allow step injections into the **Automatic Voltage Regulator** voltage reference, with the **Onshore Type D Power Generating Module** operating at points specified by **The Company** (up to rated MVA output). The damping shall be judged to be adequate if the corresponding **Active Power** response to the disturbances decays within two cycles of oscillation.
- ECC.A.6.2.6.3 A facility to inject a band limited random noise signal into the **Automatic Voltage Regulator** voltage reference shall be provided for demonstrating the frequency domain response of the **Power System Stabiliser**. The tuning of the **Power System Stabiliser** shall be judged to be adequate if the corresponding **Active Power** response shows improved damping with the **Power System Stabiliser** in combination with the **Automatic Voltage Regulator** compared with the **Automatic Voltage Regulator** alone over the frequency range 0.3Hz – 2Hz.
- ECC.A.6.2.7 Under-Excitation Limiters
- ECC.A.6.2.7.1 The security of the power system shall also be safeguarded by means of MVAR **Under Excitation Limiters** fitted to the **Synchronous Power Generating Module Excitation System**. The **Under Excitation Limiter** shall prevent the **Automatic Voltage Regulator** reducing the **Synchronous Generating Unit** excitation to a level which would endanger synchronous stability. The **Under Excitation Limiter** shall operate when the excitation system is providing automatic control. The **Under Excitation Limiter** shall respond to changes in the **Active Power** (MW) the **Reactive Power** (MVAR) and to the square of the **Synchronous Generating Unit** voltage in such a direction that an increase in voltage will permit an increase in leading MVAR. The characteristic of the **Under Excitation Limiter** shall be substantially linear from no-load to the maximum **Active Power** output of the **Onshore Power Generating Module** at any setting and shall be readily adjustable.

- ECC.A.6.2.7.2 The performance of the **Under Excitation Limiter** shall be independent of the rate of change of the **Onshore Synchronous Power Generating Module** load and shall be demonstrated by testing as detailed in ECP.A.5.5. The resulting maximum overshoot in response to a step injection which operates the **Under Excitation Limiter** shall not exceed 4% of the **Onshore Synchronous Generating Unit** rated MVA. The operating point of the **Onshore Synchronous Generating Unit** shall be returned to a steady state value at the limit line and the final settling time shall not be greater than 5 seconds. When the step change in **Automatic Voltage Regulator** reference voltage is reversed, the field voltage should begin to respond without any delay and should not be held down by the **Under Excitation Limiter**. Operation into or out of the preset limit levels shall ensure that any resultant oscillations are damped so that the disturbance is within 0.5% of the **Onshore Synchronous Generating Unit** MVA rating within a period of 5 seconds.
- ECC.A.6.2.7.3 The **EU Generator** shall also make provision to prevent the reduction of the **Onshore Synchronous Generating Unit** excitation to a level which would endanger synchronous stability when the **Excitation System** is under manual control.
- ECC.A.6.2.8 Over-Excitation and Stator Current Limiters
- ECC.A.6.2.8.1 The settings of the **Over-Excitation Limiter** and stator current limiter, shall ensure that the **Onshore Synchronous Generating Unit** excitation is not limited to less than the maximum value that can be achieved whilst ensuring the **Onshore Synchronous Generating Unit** is operating within its design limits. If the **Onshore Synchronous Generating Unit** excitation is reduced following a period of operation at a high level, the rate of reduction shall not exceed that required to remain within any time dependent operating characteristics of the **Onshore Synchronous Power Generating Module**.
- ECC.A.6.2.8.2 The performance of the **Over-Excitation Limiter**, shall be demonstrated by testing as described in ECP.A.5.6. Any operation beyond the **Over-Excitation Limit** shall be controlled by the **Over-Excitation Limiter** or stator current limiter without the operation of any **Protection** that could trip the **Onshore Synchronous Power Generating Module**.
- ECC.A.6.2.8.3 The **EU Generator** shall also make provision to prevent any over-excitation restriction of the **Onshore Synchronous Generating Unit** when the **Excitation System** is under manual control, other than that necessary to ensure the **Onshore Power Generating Module** is operating within its design limits.

APPENDIX E7 - PERFORMANCE REQUIREMENTS FOR CONTINUOUSLY ACTING AUTOMATIC VOLTAGE CONTROL SYSTEMS FOR AC CONNECTED ONSHORE POWER PARK MODULES AND OTSDUW PLANT AND APPARATUS AT THE INTERFACE POINT HVDC SYSTEMS AND REMOTE END HVDC CONVERTER STATIONS

ECC.A.7.1 Scope

ECC.A.7.1.1 This Appendix sets out the performance requirements of continuously acting automatic voltage control systems for **Onshore Power Park Modules, Onshore HVDC Converters Remote End HVDC Converter Stations** and **OTSDUW Plant and Apparatus** at the **Interface Point** that must be complied with by the **User**. This Appendix does not limit any site specific requirements where in **The Company's** reasonable opinion these facilities are necessary for system reasons. The control performance requirements applicable to **Configuration 2 AC Connected Offshore Power Park Modules** and **Configuration 2 DC Connected Power Park Modules** are defined in Appendix E8.

ECC.A.7.1.2 Proposals by **EU Generators** or **HVDC System Owners** to make a change to the voltage control systems for **EU Generators** are required to be notified to **The Company** under the **Planning Code** (PC.A.1.2(b) and (c)) as soon as the **Generator** or **HVDC System Owner** anticipates making the change. The change may require a revision to the **Bilateral Agreement**.

ECC.A.7.1.3 In the case of a **Remote End HVDC Converter** at a **HVDC Converter Station**, the control performance requirements shall be specified in the **Bilateral Agreement**. These requirements shall be consistent with those specified in ECC.6.3.2.4. In the case where the **Remote End HVDC Converter** is required to ensure the zero transfer of **Reactive Power** at the **HVDC Interface Point** then the requirements shall be specified in the **Bilateral Agreement** which shall be consistent with those requirements specified in ECC.A.8. In the case where a wider reactive capability has been specified in ECC.6.3.2.4, then the requirements consistent with those specified in ECC.A.7.2 shall apply with any variations being agreed between the **User** and **The Company**.

ECC.A.7.2 Requirements

ECC.A.7.2.1 **The Company** requires that the continuously acting automatic voltage control system for the **Onshore Power Park Module, Onshore HVDC Converter** or **OTSDUW Plant and Apparatus** shall meet the following functional performance specification. If a **Network Operator** has confirmed to **The Company** that its network to which an **Embedded Onshore Power Park Module** or **Onshore HVDC Converter** or **OTSDUW Plant and Apparatus** is connected is restricted such that the full reactive range under the steady state voltage control requirements (ECC.A.7.2.2) cannot be utilised, **The Company** may specify alternative limits to the steady state voltage control range that reflect these restrictions. Where the **Network Operator** subsequently notifies **The Company** that such restriction has been removed, **The Company** may propose a **Modification** to the **Bilateral Agreement** (in accordance with the **CUSC** contract) to remove the alternative limits such that the continuously acting automatic voltage control system meets the following functional performance specification. All other requirements of the voltage control system will remain as in this Appendix.

ECC.A.7.2.2 Steady State Voltage Control

ECC.A.7.2.2.1 The **Onshore Power Park Module, Onshore HVDC Converter** or **OTSDUW Plant and Apparatus** shall provide continuous steady state control of the voltage at the **Onshore Grid Entry Point** (or **Onshore User System Entry Point** if **Embedded**) (or the **Interface Point** in the case of **OTSDUW Plant and Apparatus**) with a **Setpoint Voltage** and **Slope** characteristic as illustrated in Figure ECC.A.7.2.2a.

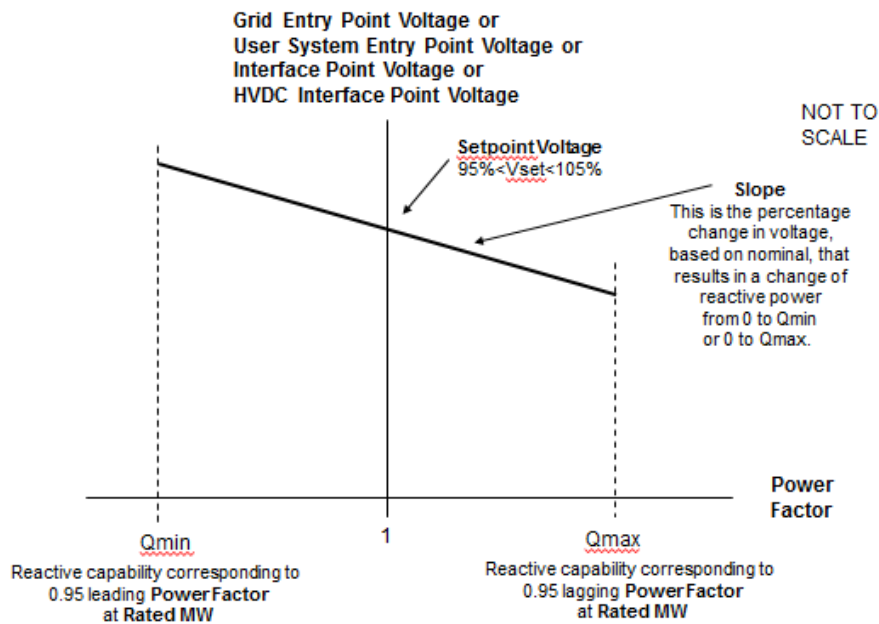

Figure ECC.A.7.2.2a

- ECC.A.7.2.2.2 The continuously acting automatic control system shall be capable of operating to a **Setpoint Voltage** between 95% and 105% with a resolution of 0.25% of the nominal voltage. For the avoidance of doubt values of 95%, 95.25%, 95.5% ... may be specified, but not intermediate values. The initial **Setpoint Voltage** will be 100%. The tolerance within which this **Setpoint Voltage** shall be achieved is specified in BC2.A.2.6. For the avoidance of doubt, with a tolerance of 0.25% and a Setpoint Voltage of 100%, the achieved value shall be between 99.75% and 100.25%. **The Company** may request the **EU Generator** or **HVDC System Owner** to implement an alternative **Setpoint Voltage** within the range of 95% to 105%. For **Embedded Generators** and **Embedded HVDC System Owners** the **Setpoint Voltage** will be discussed between **The Company** and the relevant **Network Operator** and will be specified to ensure consistency with ECC.6.3.4.
- ECC.A.7.2.2.3 The **Slope** characteristic of the continuously acting automatic control system shall be adjustable over the range 2% to 7% (with a resolution of 0.5%). For the avoidance of doubt values of 2%, 2.5%, 3% may be specified, but not intermediate values. The initial **Slope** setting will be 4%. The tolerance within which this **Slope** shall be achieved is specified in BC2.A.2.6. For the avoidance of doubt, with a tolerance of 0.5% and a **Slope** setting of 4%, the achieved value shall be between 3.5% and 4.5%. **The Company** may request the **EU Generator** or **HVDC System Owner** to implement an alternative slope setting within the range of 2% to 7%. For **Embedded Generators** and **Onshore Embedded HVDC Converter Station Owners** the **Slope** setting will be discussed between **The Company** and the relevant **Network Operator** and will be specified to ensure consistency with ECC.6.3.4.

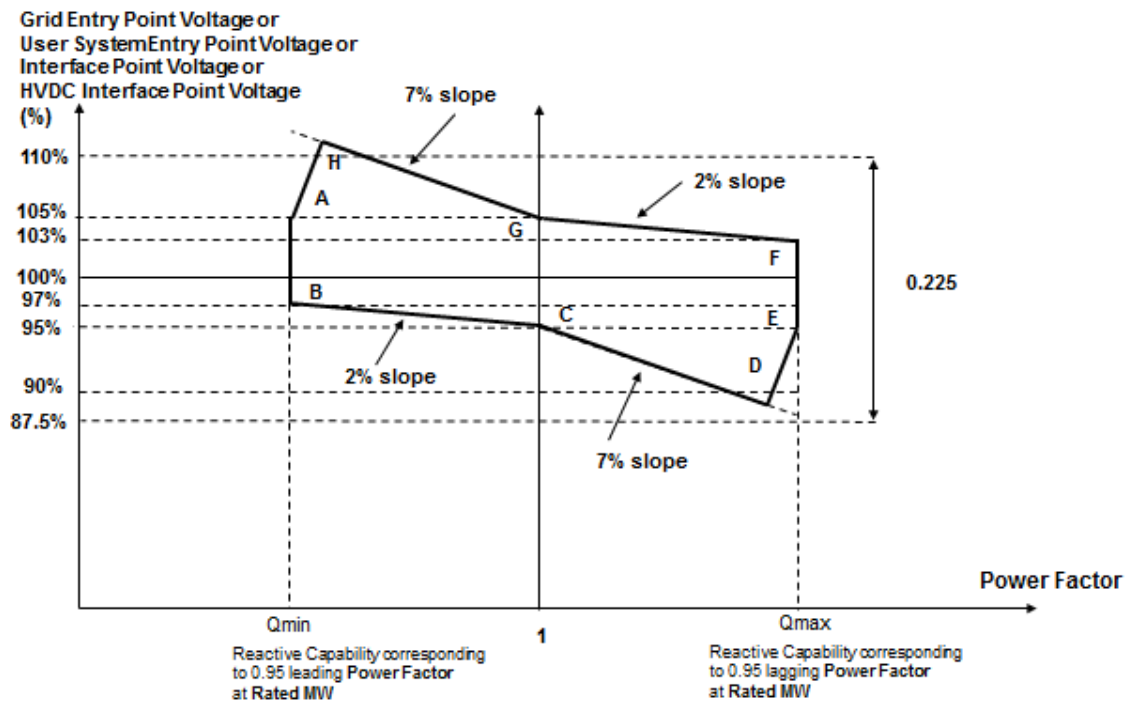

Figure ECC.A.7.2.2b

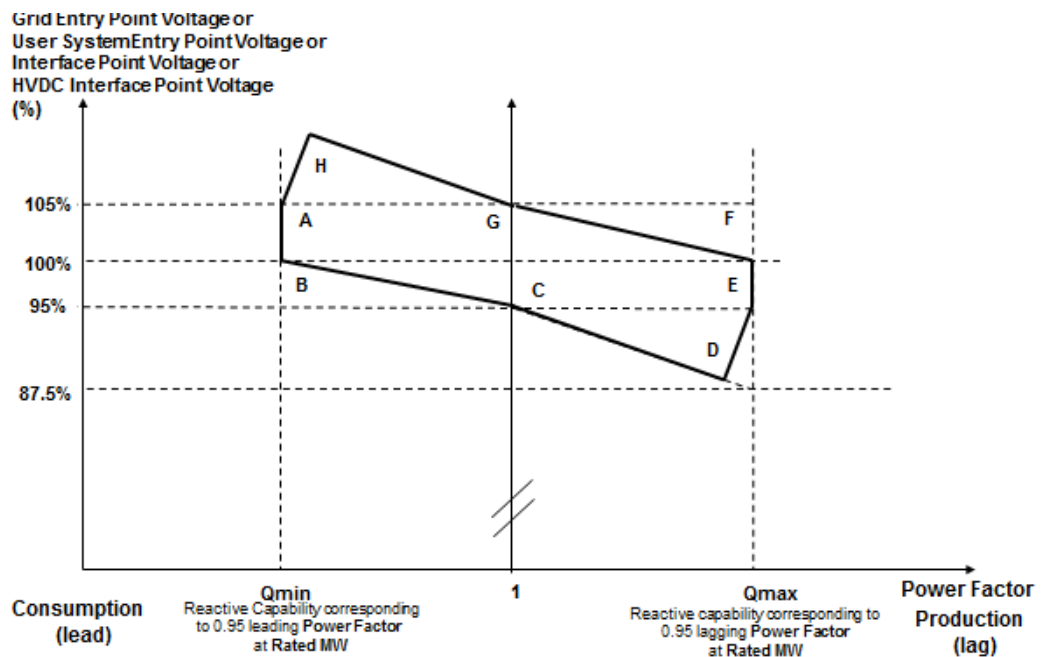

Figure ECC.A.7.2.2c

ECC.A.7.2.2.4 Figure ECC.A.7.2.2b shows the required envelope of operation for -, **OTSDUW Plant and Apparatus, Onshore Power Park Modules and Onshore HVDC Converters** except for those **Embedded** at 33kV and below or directly connected to the **National Electricity Transmission System** at 33kV and below. Figure ECC.A.7.2.2c shows the required envelope of operation for **Onshore Power Park Modules Embedded** at 33kV and below, or directly connected to the **National Electricity Transmission System** at 33kV and below. The enclosed area within points ABCDEFGH is the required capability range within which the **Slope** and **Setpoint Voltage** can be changed.

- ECC.A.7.2.2.5 Should the operating point of the **OTSDUW Plant and Apparatus** or **Onshore Power Park Module**, or **Onshore HVDC Converter** deviate so that it is no longer a point on the operating characteristic (figure ECC.A.7.2.2a) defined by the target **Setpoint Voltage** and **Slope**, the continuously acting automatic voltage control system shall act progressively to return the value to a point on the required characteristic within 5 seconds.
- ECC.A.7.2.2.6 Should the **Reactive Power** output of the **OTSDUW Plant and Apparatus** or **Onshore Power Park Module** or **Onshore HVDC Converter** reach its maximum lagging limit at a **Onshore Grid Entry Point** voltage (or **Onshore User System Entry Point** voltage if **Embedded** (or **Interface Point** in the case of **OTSDUW Plant and Apparatus**) above 95%, the **OTSDUW Plant and Apparatus** or **Onshore Power Park Module** or **HVDC System** shall maintain maximum lagging **Reactive Power** output for voltage reductions down to 95%. This requirement is indicated by the line EF in figures ECC.A.7.2.2b and ECC.A.7.2.2c as applicable. Should the **Reactive Power** output of the **OTSDUW Plant and Apparatus** or **Onshore Power Park Module**, or **Onshore HVDC Converter** reach its maximum leading limit at a **Onshore Grid Entry Point** voltage (or **Onshore User System Entry Point** voltage if **Embedded** or **Interface Point** in the case of **OTSDUW Plant and Apparatus**) below 105%, the **OTSDUW Plant and Apparatus** or **Onshore Power Park Module**, or **Onshore HVDC Converter** shall maintain maximum leading **Reactive Power** output for voltage increases up to 105%. This requirement is indicated by the line AB in figures ECC.A.7.2.2b and ECC.A.7.2.2c as applicable.
- ECC.A.7.2.2.7 For **Onshore Grid Entry Point** voltages (or **Onshore User System Entry Point** voltages if **Embedded** or **Interface Point** voltages) below 95%, the lagging **Reactive Power** capability of the **OTSDUW Plant and Apparatus** or **Onshore Power Park Module** or **Onshore HVDC Converters** should be that which results from the supply of maximum lagging reactive current whilst ensuring the current remains within design operating limits. An example of the capability is shown by the line DE in figures ECC.A.7.2.2b and ECC.A.7.2.2c. For **Onshore Grid Entry Point** voltages (or **User System Entry Point** voltages if **Embedded** or **Interface Point** voltages) above 105%, the leading **Reactive Power** capability of the **OTSDUW Plant and Apparatus** or **Onshore Power Park Module** or **Onshore HVDC System Converter** should be that which results from the supply of maximum leading reactive current whilst ensuring the current remains within design operating limits. An example of the capability is shown by the line AH in figures ECC.A.7.2.2b and ECC.A.7.2.2c as applicable. Should the **Reactive Power** output of the **OTSDUW Plant and Apparatus** or **Onshore Power Park Module** or **Onshore HVDC Converter** reach its maximum lagging limit at an **Onshore Grid Entry Connection Point** voltage (or **Onshore User System Entry Point** voltage if **Embedded** or **Interface Point** in the case of **OTSDUW Plant and Apparatus**) below 95%, the **Onshore Power Park Module**, **Onshore HVDC Converter** shall maintain maximum lagging reactive current output for further voltage decreases. Should the **Reactive Power** output of the **OTSDUW Plant and Apparatus** or **Onshore Power Park Module** or **Onshore HVDC Converter** reach its maximum leading limit at a **Onshore Grid Entry Point** voltage (or **User System Entry Point** voltage if **Embedded** or **Interface Point** voltage in the case of an **OTSDUW Plant and Apparatus**) above 105%, the **OTSDUW Plant and Apparatus** or **Onshore Power Park Module** or **Onshore HVDC Converter** shall maintain maximum leading reactive current output for further voltage increases.
- ECC.A.7.2.2.8 All **OTSDUW Plant and Apparatus** must be capable of enabling **EU Code Users** undertaking **OTSDUW** to comply with an instruction received from **The Company** relating to a variation of the **Setpoint Voltage** at the **Interface Point** within 2 minutes of such instruction being received.
- ECC.A.7.2.2.9 For **OTSDUW Plant and Apparatus** connected to a **Network Operator's System** where the **Network Operator** has confirmed to **The Company** that its **System** is restricted in accordance with ECC.A.7.2.1, clause ECC.A.7.2.2.8 will not apply unless **The Company** can reasonably demonstrate that the magnitude of the available change in **Reactive Power** has a significant effect on voltage levels on the **Onshore National Electricity Transmission System**.

ECC.A.7.2.3 Transient Voltage Control

ECC.A.7.2.3.1 For an on-load step change in **Onshore Grid Entry Point** or **Onshore User System Entry Point** voltage, or in the case of **OTSDUW Plant and Apparatus** an on-load step change in **Transmission Interface Point** voltage, the continuously acting automatic control system shall respond according to the following minimum criteria:

- (i) the **Reactive Power** output response of the, **OTSDUW Plant and Apparatus** or **Onshore Power Park Module** or **Onshore HVDC Converter** shall commence within 0.2 seconds of the application of the step. It shall progress linearly although variations from a linear characteristic shall be acceptable provided that the MVA_r seconds delivered at any time up to 1 second are at least those that would result from the response shown in figure ECC.A.7.2.3.1a.
- (ii) the response shall be such that 90% of the change in the **Reactive Power** output of the, **OTSDUW Plant and Apparatus** or **Onshore Power Park Module**, or **Onshore HVDC Converter** will be achieved within
 - 2 seconds, where the step is sufficiently large to require a change in the steady state **Reactive Power** output from its maximum leading value to its maximum lagging value or vice versa and
 - 1 second where the step is sufficiently large to require a change in the steady state **Reactive Power** output from zero to its maximum leading value or maximum lagging value as required by ECC.6.3.2 (or, if appropriate ECC.A.7.2.2.6 or ECC.A.7.2.2.7);
- (iii) the magnitude of the **Reactive Power** output response produced within 1 second shall vary linearly in proportion to the magnitude of the step change.
- (iv) within 5 seconds from achieving 90% of the response as defined in ECC.A.7.2.3.1 (ii), the peak to peak magnitude of any oscillations shall be less than 5% of the change in steady state maximum **Reactive Power**.
- (v) following the transient response, the conditions of ECC.A.7.2.2 apply.

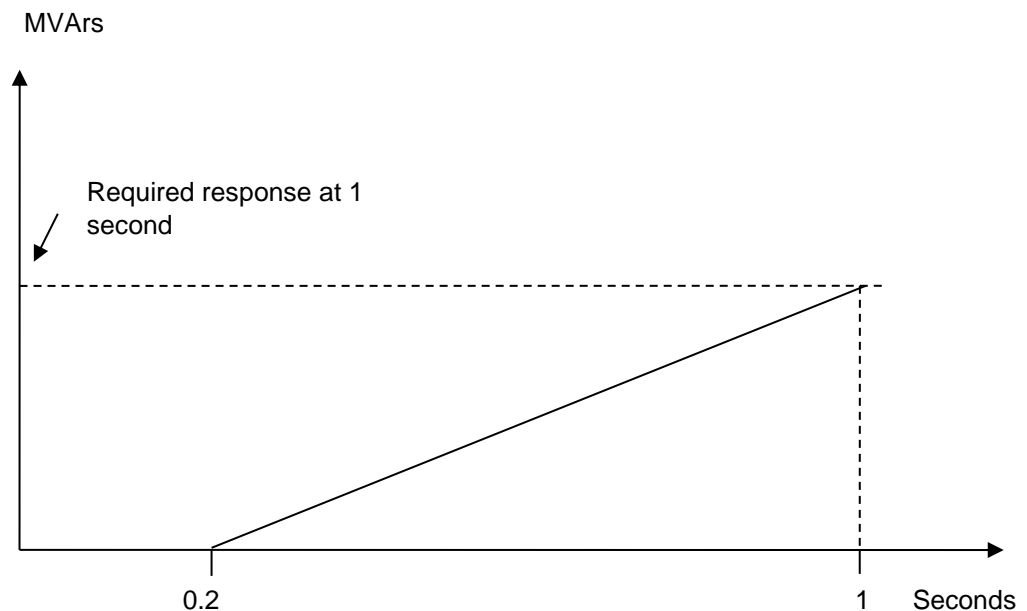

Figure ECC.A.7.2.3.1a

ECC.A.7.2.3.2 **OTSDUW Plant and Apparatus** or **Onshore Power Park Modules** or **Onshore HVDC Converters** shall be capable of

- (a) changing its **Reactive Power** output from its maximum lagging value to its maximum

leading value, or vice versa, then reverting back to the initial level of **Reactive Power** output once every 15 seconds for at least 5 times within any 5 minute period; and

- (b) changing its **Reactive Power** output from zero to its maximum leading value then reverting back to zero **Reactive Power** output at least 25 times within any 24 hour period and from zero to its maximum lagging value then reverting back to zero **Reactive Power** output at least 25 times within any 24 hour period. Any subsequent restriction on reactive capability shall be notified to **The Company** in accordance with BC2.5.3.2, and BC2.6.1.

In all cases, the response shall be in accordance to ECC.A.7.2.3.1 where the change in **Reactive Power** output is in response to an on-load step change in **Onshore Grid Entry Point** or **Onshore User System Entry Point** voltage, or in the case of **OTSDUW Plant and Apparatus** an on-load step change in **Transmission Interface Point** voltage.

ECC.A.7.2.4 Power Oscillation Damping

ECC.A.7.2.4.1 The requirement for the continuously acting voltage control system to be fitted with a **Power System Stabiliser (PSS)** shall be specified if, in **The Company's** view, this is required for system reasons. However if a **Power System Stabiliser** is included in the voltage control system its settings and performance shall be agreed with **The Company** and commissioned in accordance with BC2.11.2. To allow assessment of the performance before on-load commissioning the **Generator** will provide to **The Company** a report covering the areas specified in ECP.A.3.2.2.

ECC.A.7.2.5 Overall Voltage Control System Characteristics

ECC.A.7.2.5.1 The continuously acting automatic voltage control system is required to respond to minor variations, steps, gradual changes or major variations in **Onshore Grid Entry Point** voltage (or **Onshore User System Entry Point** voltage if **Embedded** or **Interface Point** voltage in the case of **OTSDUW Plant and Apparatus**).

ECC.A.7.2.5.2 The overall voltage control system shall include elements that limit the bandwidth of the output signal. The bandwidth limiting must be consistent with the speed of response requirements and ensure that the highest frequency of response cannot excite torsional oscillations on other plant connected to the network. A bandwidth of 0-5Hz would be judged to be acceptable for this application. All other control systems employed within the **OTSDUW Plant and Apparatus** or **Onshore Power Park Module** or **Onshore HVDC Converter** should also meet this requirement

ECC.A.7.2.5.3 The response of the voltage control system (including the **Power System Stabiliser** if employed) shall be demonstrated by testing in accordance with ECP.A.6.

ECC.A.7.3 Reactive Power Control

ECC.A.7.3.1 As defined in ECC.6.3.8.3.4, **Reactive Power** control mode of operation is not required in respect of **Onshore Power Park Modules** or **OTSDUW Plant and Apparatus** or **Onshore HVDC Converters** unless otherwise specified by **The Company** in coordination with the relevant **Network Operator**. However where there is a requirement for **Reactive Power** control mode of operation, the following requirements shall apply.

ECC.A.7.3.2 The **Onshore Power Park Module** or **OTSDUW Plant and Apparatus** or **Onshore HVDC Converter** shall be capable of setting the **Reactive Power** setpoint anywhere in the **Reactive Power** range as specified in ECC.6.3.2.4 with setting steps no greater than 5 MVAR or 5% (whichever is smaller) of full **Reactive Power**, controlling the reactive power at the **Grid Entry Point** or **User System Entry Point** if **Embedded** to an accuracy within plus or minus 5MVAR or plus or minus 5% (whichever is smaller) of the full **Reactive Power**.

ECC.A.7.3.3 Any additional requirements for **Reactive Power** control mode of operation shall be specified

by **The Company** in coordination with the relevant **Network Operator**..

ECC.A.7.4 **Power Factor Control**

ECC.A.7.4.1 As defined in ECC.6.3.8.4.3, **Power Factor** control mode of operation is not required in respect of **Onshore Power Park Modules** or **OTSDUW Plant and Apparatus** or **Onshore HVDC Converters** unless otherwise specified by **The Company** in coordination with the relevant **Network Operator**. However where there is a requirement for **Power Factor** control mode of operation, the following requirements shall apply.

ECC.A.7.4.2 The **Onshore Power Park Module** or **OTSDUW Plant and Apparatus** or **Onshore HVDC Converter** shall be capable of controlling the **Power Factor** at the **Grid Entry Point or User System Entry Point (if Embedded)** within the required **Reactive Power** range as specified in ECC.6.3.2.2.1 and ECC.6.3.2.4 to a specified target **Power Factor**. **The Company** shall specify the target **Power Factor** value (which shall be achieved within 0.01 of the set **Power Factor**), its tolerance and the period of time to achieve the target **Power Factor** following a sudden change of **Active Power** output. The tolerance of the target **Power Factor** shall be expressed through the tolerance of its corresponding **Reactive Power**. This **Reactive Power** tolerance shall be expressed by either an absolute value or by a percentage of the maximum **Reactive Power** of the **Onshore Power Park Module** or **OTSDUW Plant and Apparatus** or **Onshore HVDC Converter**. The details of these requirements being pursuant to the terms of the **Bilateral Agreement**.

ECC.A.7.4.3 Any additional requirements for **Power Factor** control mode of operation shall be specified by **The Company** in coordination with the relevant **Network Operator**.

APPENDIX E8 - PERFORMANCE REQUIREMENTS FOR CONTINUOUSLY ACTING AUTOMATIC VOLTAGE CONTROL SYSTEMS FOR CONFIGURATION 2 AC CONNECTED OFFSHORE POWER PARK MODULES AND CONFIGURATION 2 DC CONNECTED POWER PARK MODULES

ECC.A.8.1 Scope

ECC.A.8.1.1 This Appendix sets out the performance requirements of continuously acting automatic voltage control systems for **Configuration 2 AC Connected Offshore Power Park Modules** and **Configuration 2 DC Connected Power Park Modules** that must be complied with by the **EU Code User**. This Appendix does not limit any site specific requirements that may be specified where in **The Company's** reasonable opinion these facilities are necessary for system reasons.

ECC.A.8.1.2 These requirements also apply to **Configuration 2 DC Connected Power Park Modules**. In the case of a **Configuration 1 DC Connected Power Park Module** the technical performance requirements shall be specified by **The Company**. Where the **EU Generator** in respect of a **DC Connected Power Park Module** has agreed to a wider reactive capability range as defined under ECC.6.3.2.5 and ECC.6.2.3.6 then the requirements that apply will be specified by **The Company** and which shall reflect the performance requirements detailed in ECC.A.8.2 below but with different parameters such as droop and **Setpoint Voltage**.

ECC.A.8.1.3 Proposals by **EU Generators** to make a change to the voltage control systems are required to be notified to **The Company** under the **Planning Code** (PC.A.1.2(b) and (c)) as soon as the **Generator** anticipates making the change. The change may require a revision to the **Bilateral Agreement**.

ECC.A.8.2 Requirements

ECC.A.8.2.1 **The Company** requires that the continuously acting automatic voltage control system for the **Configuration 2 AC connected Offshore Power Park Module** and **Configuration 2 DC Connected Power Park Module** shall meet the following functional performance specification.

ECC.A.8.2.2 Steady State Voltage Control

ECC.A.8.2.2.1 The **Configuration 2 AC connected Offshore Power Park Module** and **Configuration 2 DC Connected Power Park Module** shall provide continuous steady state control of the voltage at the **Offshore Connection Point** with a **Setpoint Voltage** and **Slope** characteristic as illustrated in Figure ECC.A.8.2.2a.

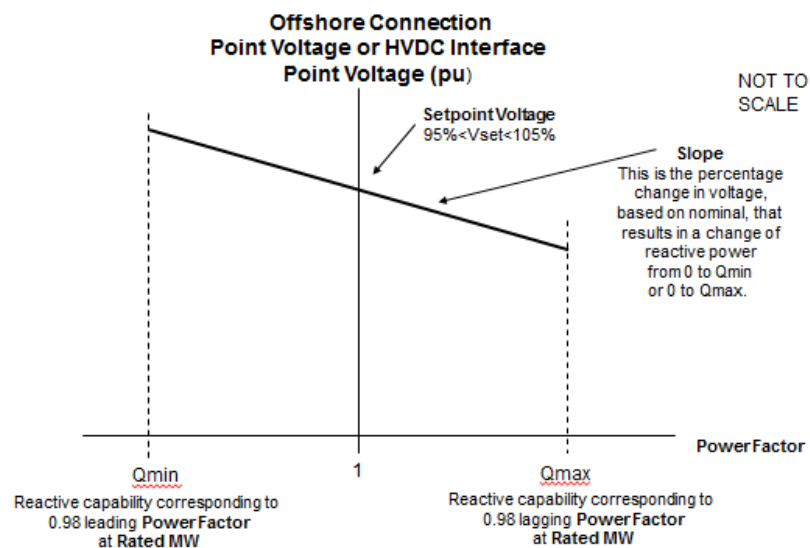

Figure ECC.A.8.2.2a

ECC.A.8.2.2.2 The continuously acting automatic control system shall be capable of operating to a **Setpoint Voltage** between 95% and 105% with a resolution of 0.25% of the nominal voltage. For the avoidance of doubt values of 95%, 95.25%, 95.5% ... may be specified, but not intermediate values. The initial **Setpoint Voltage** will be 100%. The tolerance within which this **Setpoint Voltage** shall be achieved is specified in BC2.A.2.6. For the avoidance of doubt, with a tolerance of 0.25% and a Setpoint Voltage of 100%, the achieved value shall be between 99.75% and 100.25%. **The Company** may request the **EU Generator** to implement an alternative **Setpoint Voltage** within the range of 95% to 105%.

ECC.A.8.2.2.3 The **Slope** characteristic of the continuously acting automatic control system shall be adjustable over the range 2% to 7% (with a resolution of 0.5%). For the avoidance of doubt values of 2%, 2.5%, 3% may be specified, but not intermediate values. The initial **Slope** setting will be 4%. The tolerance within which this **Slope** shall be achieved is specified in BC2.A.2.6. For the avoidance of doubt, with a tolerance of 0.5% and a **Slope** setting of 4%, the achieved value shall be between 3.5% and 4.5%. **The Company** may request the **EU Generator** to implement an alternative slope setting within the range of 2% to 7%.

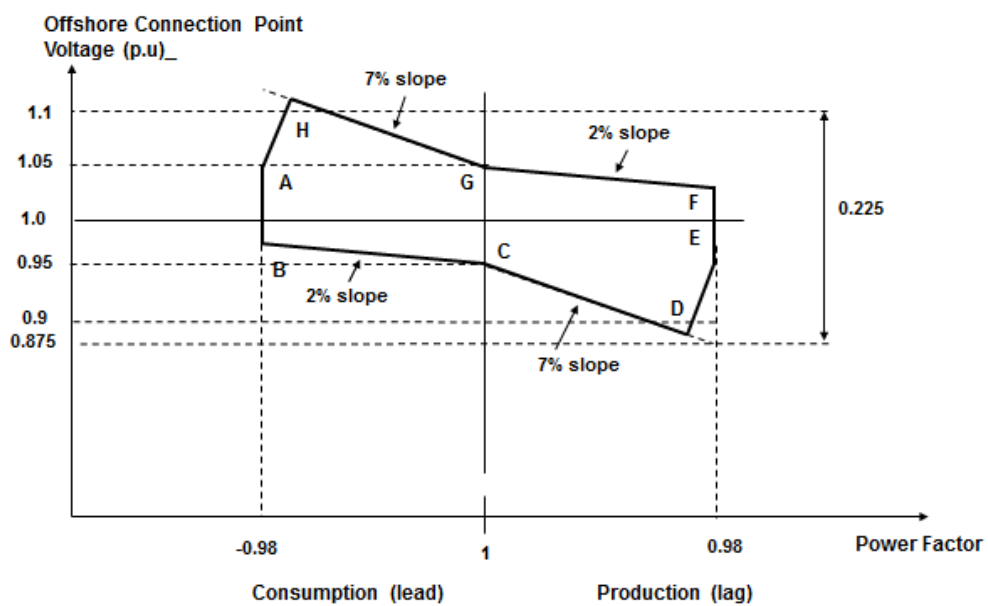

Figure ECC.A.8.2.2b

ECC.A.8.2.2.4 Figure ECC.A.8.2.2b shows the required envelope of operation for **Configuration 2 AC connected Offshore Power Park Module** and **Configuration 2 DC Connected Power Park Module**. The enclosed area within points ABCDEFGH is the required capability range within which the **Slope** and **Setpoint Voltage** can be changed.

ECC.A.8.2.2.5 Should the operating point of the **Configuration 2 AC connected Offshore Power Park or Configuration 2 DC Connected Power Park Module** deviate so that it is no longer a point on the operating characteristic (Figure ECC.A.8.2.2a) defined by the target **Setpoint Voltage** and **Slope**, the continuously acting automatic voltage control system shall act progressively to return the value to a point on the required characteristic within 5 seconds.

ECC.A.8.2.2.6 Should the **Reactive Power** output of the **Configuration 2 AC connected Offshore Power Park Module** or **Configuration 2 DC Connected Power Park Module** reach its maximum lagging limit at an **Offshore Grid Entry Point** or **Offshore User System Entry Point** or **HVDC Interface Point** voltage above 95%, the **Configuration 2 AC connected Offshore Power Park Module** or **Configuration 2 DC Connected Power Park Module** shall maintain maximum lagging **Reactive Power** output for voltage reductions down to 95%. This requirement is indicated by the line EF in figure ECC.A.8.2.2b. Should the **Reactive Power** output of the **Configuration 2 AC connected Offshore Power Park Module** or **Configuration 2 DC Connected Power Park Module** reach its maximum leading limit at the **Offshore Grid Entry Point** or **Offshore User System Entry Point** or **HVDC Interface Point** voltage below 105%, the **Configuration 2 AC connected Offshore Power Park Module** or **Configuration 2 DC Connected Power Park Module** shall maintain maximum leading **Reactive Power** output for voltage increases up to 105%. This requirement is indicated by the line AB in figures ECC.A.8.2.2b.

ECC.A.8.2.2.7 For **Offshore Grid Entry Point** or **User System Entry Point** or **HVDC Interface Point** voltages below 95%, the lagging **Reactive Power** capability of the **Configuration 2 AC connected Offshore Power Park Module** or **Configuration 2 DC Connected Power Park Module** should be that which results from the supply of maximum lagging reactive current whilst ensuring the current remains within design operating limits. An example of the capability is shown by the line DE in figures ECC.A.8.2.2b. For **Offshore Grid Entry Point** or **Offshore User System Entry Point** voltages or **HVDC Interface Point** voltages above 105%, the leading **Reactive Power** capability of the **Configuration 2 AC connected Offshore Power Park Module** or **Configuration 2 DC Connected Power Park Module** should be that which results from the supply of maximum leading reactive current whilst ensuring the current remains within design operating limits. An example of the capability is shown by the line AH in figures ECC.A.8.2.2b. Should the **Reactive Power** output of the **Configuration 2 AC connected Offshore Power Park Module** or **Configuration 2 DC Connected Power Park Module** reach its maximum lagging limit at an **Offshore Grid Entry Point** or **Offshore User System Entry Point** voltage or **HVDC Interface Point** voltage below 95%, the **Configuration 2 AC connected Offshore Power Park Module** or **Configuration 2 DC Connected Power Park Module** shall maintain maximum lagging reactive current output for further voltage decreases. Should the **Reactive Power** output of the **Configuration 2 AC connected Offshore Power Park Module** or **Configuration 2 DC Connected Power Park Module** reach its maximum leading limit at an **Offshore Grid Entry Point** or **Offshore User System Entry Point** voltage or **HVDC Interface Point** voltage above 105%, the **Configuration 2 AC connected Offshore Power Park Module** or **Configuration 2 DC Connected Power Park Module** shall maintain maximum leading reactive current output for further voltage increases.

ECC.A.8.2.3 Transient Voltage Control

ECC.A.8.2.3.1 For an on-load step change in **Offshore Grid Entry Point** or **Offshore User System Entry Point** voltage or **HVDC Interface Point** voltage, the continuously acting automatic control system shall respond according to the following minimum criteria:

- (i) the **Reactive Power** output response of the **Configuration 2 AC connected Offshore Power Park Module** or **Configuration 2 DC Connected Power Park Module** shall commence within 0.2 seconds of the application of the step. It shall progress linearly although variations from a linear characteristic shall be acceptable provided that the MVar seconds delivered at any time up to 1 second are at least those that would result from the response shown in figure ECC.A.8.2.3.1a.
- (ii) the response shall be such that 90% of the change in the **Reactive Power** output of the **Configuration 2 AC connected Offshore Power Park Module** or **Configuration 2 DC Connected Power Park Module** will be achieved within
 - 2 seconds, where the step is sufficiently large to require a change in the steady state **Reactive Power** output from its maximum leading value to its maximum lagging value or vice versa and

- 1 second where the step is sufficiently large to require a change in the steady state **Reactive Power** output from zero to its maximum leading value or maximum lagging value as required by ECC.6.3.2 (or, if appropriate ECC.A.8.2.2.6 or ECC.A.8.2.2.7);
- (iii) the magnitude of the **Reactive Power** output response produced within 1 second shall vary linearly in proportion to the magnitude of the step change.
- (iv) within 5 seconds from achieving 90% of the response as defined in ECC.A.8.2.3.1 (ii), the peak to peak magnitude of any oscillations shall be less than 5% of the change in steady state maximum **Reactive Power**.
- (v) following the transient response, the conditions of ECC.A.8.2.2 apply.

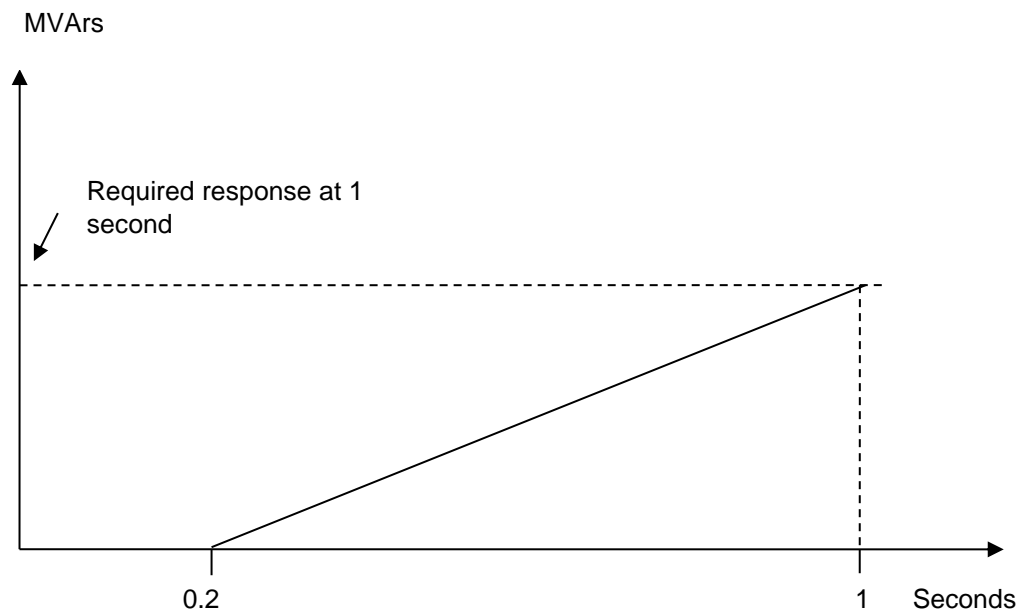

ECC.A.8.2.3.2 Configuration 2 AC connected Offshore Power Park Module or Configuration 2 DC Connected Power Park Module shall be capable of

- (a) changing their **Reactive Power** output from maximum lagging value to maximum leading value, or vice versa, then reverting back to the initial level of **Reactive Power** output once every 15 seconds for at least 5 times within any 5 minute period; and
- (b) changing **Reactive Power** output from zero to maximum leading value then reverting back to zero **Reactive Power** output at least 25 times within any 24 hour period and from zero to its maximum lagging value then reverting back to zero **Reactive Power** output at least 25 times within any 24 hour period. Any subsequent restriction on reactive capability shall be notified to **The Company** in accordance with BC2.5.3.2, and BC2.6.1.

In all cases, the response shall be in accordance to ECC.A.8.2.3.1 where the change in **Reactive Power** output is in response to an on-load step change in **Offshore Grid Entry Point** or **Offshore User System Entry Point** voltage or **HVDC Interface Point** voltage.

ECC.A.8.2.4 Power Oscillation Damping

- ECC.A.8.2.4.1 The requirement for the continuously acting voltage control system to be fitted with a **Power System Stabiliser (PSS)** shall be specified if, in **The Company's** view, this is required for system reasons. However if a **Power System Stabiliser** is included in the voltage control system its settings and performance shall be agreed with **The Company** and commissioned in accordance with BC2.11.2. To allow assessment of the performance before on-load commissioning the **Generator** or **HVDC System Owner** will provide to **The Company** a report covering the areas specified in ECP.A.3.2.2.
- ECC.A.8.2.5 Overall Voltage Control System Characteristics
- ECC.A.8.2.5.1 The continuously acting automatic voltage control system is required to respond to minor variations, steps, gradual changes or major variations in **Offshore Grid Entry Point** or **Offshore User System Entry Point** or **HVDC Interface Point** voltage.
- ECC.A.8.2.5.2 The overall voltage control system shall include elements that limit the bandwidth of the output signal. The bandwidth limiting must be consistent with the speed of response requirements and ensure that the highest frequency of response cannot excite torsional oscillations on other plant connected to the network. A bandwidth of 0-5Hz would be judged to be acceptable for this application. All other control systems employed within the **Configuration 2 AC connected Offshore Power Park Module** or **Configuration 2 DC Connected Power Park Module** should also meet this requirement
- ECC.A.8.2.5.3 The response of the voltage control system (including the **Power System Stabiliser** if employed) shall be demonstrated by testing in accordance with ECP.A.6.
- ECC.A.8.3 Reactive Power Control
- ECC.A.8.3.1 **Reactive Power** control mode of operation is not required in respect of **Configuration 2 AC connected Offshore Power Park Modules** or **Configuration 2 DC Connected Power Park Modules** unless otherwise specified by **The Company**. However where there is a requirement for **Reactive Power** control mode of operation, the following requirements shall apply.
- ECC.A.8.3.2 **Configuration 2 AC connected Offshore Power Park Modules** or **Configuration 2 DC Connected Power Park Modules** shall be capable of setting the **Reactive Power** setpoint anywhere in the **Reactive Power** range as specified in ECC.6.3.2.8.2 with setting steps no greater than 5 MVar or 5% (whichever is smaller) of full **Reactive Power**, controlling the **Reactive Power** at the **Offshore Grid Entry Point** or **Offshore User System Entry Point** or **HVDC Interface Point** to an accuracy within plus or minus 5MVar or plus or minus 5% (whichever is smaller) of the full **Reactive Power**.
- ECC.A.8.3.3 Any additional requirements for **Reactive Power** control mode of operation shall be specified by **The Company**.
- ECC.A.8.4 Power Factor Control
- ECC.A.8.4.1 **Power Factor** control mode of operation is not required in respect of **Configuration 2 AC connected Offshore Power Park Modules** or **Configuration 2 DC Connected Power Park Modules** unless otherwise specified by **The Company**. However where there is a requirement for **Power Factor** control mode of operation, the following requirements shall apply.
- ECC.A.8.4.2 **Configuration 2 AC connected Offshore Power Park Modules** or **Configuration 2 DC Connected Power Park Modules** shall be capable of controlling the **Power Factor** at the **Offshore Grid Entry Point** or **Offshore User System Entry Point** or **HVDC Interface Point** within the required **Reactive Power** range as specified in ECC.6.3.2.8.2 with a target **Power Factor**. **The Company** shall specify the target **Power Factor** (which shall be achieved to within 0.01 of the set **Power Factor**), its tolerance and the period of time to achieve the target **Power Factor** following a sudden change of **Active Power** output. The tolerance of the target **Power Factor** shall be expressed through the tolerance of its corresponding **Reactive Power**.

This **Reactive Power** tolerance shall be expressed by either an absolute value or by a percentage of the maximum **Reactive Power** of the **Configuration 2 AC connected Offshore Power Park Module** or **Configuration 2 DC Connected Power Park Module**. The details of these requirements being specified by **The Company**.

ECC.A.8.4.3 Any additional requirements for **Power Factor** control mode of operation shall be specified by **The Company**.

< END OF EUROPEAN CONNECTION CONDITIONS >

EUROPEAN COMPLIANCE PROCESSES

(ECP)

CONTENTS

(This contents page does not form part of the Grid Code)

Paragraph No/Title	Page No
ECP.1 INTRODUCTION	3
ECP.2 OBJECTIVE	4
ECP.3 SCOPE.....	5
ECP.4 CONNECTION PROCESS	5
ECP.5 ENERGISATION OPERATIONAL NOTIFICATION	7
ECP.6 OPERATIONAL NOTIFICATION PROCESSES	7
ECP.6.1 OPERATIONAL NOTIFICATION PROCESS (Type A)	7
ECP.6.2 INTERIM OPERATIONAL NOTIFICATION (Type B and Type C).....	9
ECP.6.3 INTERIM OPERATIONAL NOTIFICATION (Type D and HVDC Equipment).....	12
ECP.6.4 INTERIM OPERATIONAL NOTIFICATION (Network Operator's or Non- Embedded Customer's Plant and Apparatus).....	16
ECP.7 FINAL OPERATIONAL NOTIFICATION	18
ECP.8 COMPLIANCE REPEAT PLAN	21
ECP.9 LIMITED OPERATIONAL NOTIFICATION	22
ECP.10 PROCESSES RELATING TO DEROGATIONS.....	27
ECP.11 MANUFACTURER'S DATA & PERFORMANCE REPORT	27
APPENDIX 1	29
NOT USED	29
APPENDIX 2	30
USER SELF CERTIFICATION OF COMPLIANCE (Interim/Final)	30
APPENDIX 3	31
SIMULATION STUDIES.....	31
APPENDIX 4	50
ONSITE SIGNAL PROVISION FOR WITNESSING TESTS	50
APPENDIX 5	57
COMPLIANCE TESTING OF SYNCHRONOUS POWER GENERATING MODULES ..	57
ECP.A.5.2 Excitation System Open Circuit Step Response Tests	58
ECP.A.5.3 Open & Short Circuit Saturation Characteristics	58
ECP.A.5.6 Over-excitation Limiter Performance Test	61
ECP.A.5.8 Governor and Load Controller Response Performance	62
ECP.A.5.9 Compliance with ECC.6.3.3 Functionality Test.....	67

ECP

Page 1 of 99

APPENDIX 6	69
COMPLIANCE TESTING OF POWER PARK MODULES	69
APPENDIX 7	82
COMPLIANCE TESTING FOR HVDC EQUIPMENT	82
APPENDIX 8	92
SIMULATION STUDIES AND COMPLIANCE TESTING FOR NETWORK OPERATORS AND NON-EMBEDDED CUSTOMERS PLANT AND APPARATUS	92

EUROPEAN COMPLIANCE PROCESSES

ECP.1 INTRODUCTION

ECP.1.1 The **European Compliance Processes** ("ECP") specifies the compliance process in relation to directly connected and **Embedded Power Stations** (subject to a **Bilateral Agreement**), **HVDC Systems**, **Grid Forming Plant** and **Network Operator's** or **Non-Embedded Customer's Plant and Apparatus**. For the avoidance of doubt, the requirements of the **European Compliance Processes** do not apply to **Demand Response Providers** unless they are also an **EU Code User** and have entered into a **CUSC Contract** with **The Company**. **Generators** in respect of **Electricity Storage Modules** are required to meet the requirements of this **ECC** but are not required to satisfy the requirements of **Retained EU Law** (Commission Regulation (EU) 2016/631, Commission Regulation (EU) 2016/1388 or Commission Regulation (EU) 2016/1485). Any derogation in respect of **Electricity Storage Modules** would therefore be against the GB Grid Code as the requirements applicable to **Electricity Storage Modules** are not enforceable by EU Law:

(i) **Type A Power Generating Modules:**

the process for issuing and receiving an **Installation Document** which must be followed by **The Company** and any **User** with a **Type A Power Generating Module** to demonstrate its compliance with the **Grid Code** in relation to its **Plant** and **Apparatus** prior to the relevant **Plant** and **Apparatus** being energised.

(ii) **Type B, Type C or Type D Power Generating Modules and HVDC Systems:**

the process (leading to an **Energisation Operational Notification**) which must be followed by **The Company** and any **User** with a **Type B, Type C or Type D Power Generating Module** or **HVDC System** to demonstrate its compliance with the **Grid Code** in relation to its **Plant** and **Apparatus** (including **OTSUA**) prior to the relevant **Plant** and **Apparatus** (including any **OTSUA**) being energised.

the process (leading to an **Interim Operational Notification** and **Final Operational Notification**) which must be followed by **The Company** and any **User** with a **Type B, Type C or Type D Power Generating Module** or **HVDC System** or **HVDC System Owner** to demonstrate its compliance with the **Grid Code** in relation to its **Plant** and **Apparatus** (including and dynamically controlled **OTSUA**). This process shall be followed prior to and during the course of the relevant **Plant** and **Apparatus** (including **OTSUA**) being energised and **Synchronised**.

the process (leading to a **Limited Operational Notification**) which must be followed by **The Company** and each **User** with a **Type B, Type C or Type D Power Generating Module** or **HVDC System** where any of its **Plant** and/or **Apparatus** (including any **OTSUA**) becomes unable to comply with relevant provisions of the **Grid Code**, and where applicable with Appendices F1 to F5 of the **Bilateral Agreement** (and in the case of **OTSUA** Appendices OF1 to OF5 of the **Bilateral Agreement**). This process also includes when changes or **Modifications** are made to **Plant** and/or **Apparatus** (including **OTSUA**). This process applies to such **Plant** and/or **Apparatus** after the **Plant** and/or **Apparatus** has become **Operational** and until **Disconnected** from the **Total System**, (or until, in the case of

OTSUA, the **OTSUA Transfer Time**) when changes or **Modifications** are made.

(iii) **Network Operator's or Non-Embedded Customer's Plant and Apparatus:**

the process (leading to an **Energisation Operational Notification**) which must be followed by **The Company** and any **Network Operator** or **Non-Embedded Customer** to demonstrate its compliance with the **Grid Code** in relation to its **Plant and Apparatus** prior to the relevant **Plant and Apparatus** being energised.

the process (leading to an **Interim Operational Notification** and **Final Operational Notification**) which must be followed by **The Company** and any **Network Operator** or **Non-Embedded Customer** to demonstrate its compliance with the **Grid Code** in relation to its **Plant and Apparatus**. This process shall be followed prior to and during the course of the relevant **Plant and Apparatus** being energised and operated by using the grid connection.

the process (leading to a **Limited Operational Notification**) which must be followed by **The Company** and each **Network Operator** or **Non-Embedded Customer** where any of its **Plant** and/or **Apparatus** becomes unable to comply with relevant provisions of the **Grid Code**, and where applicable with Appendices F1 to F5 of the **Bilateral Agreement**. This process also includes changes or **Modifications** made to the **Plant** and/or **Apparatus**. This process applies to such **Plant** and/or **Apparatus** after the **Plant** and/or **Apparatus** has become operational and until **Disconnected** from the **Transmission System**.

ECP.1.2 As used in the **ECP**, references to **OTSUA** means **OTSUA** to be connected or connected to the **National Electricity Transmission System** prior to the **OTSUA Transfer Time**.

ECP.1.3 Where a **Generator** or **HVDC System Owner** and/or **The Company** are required to apply for a derogation to the **Authority**, this is not in respect of **OTSUA**.

ECP.1.4 In the case of an **Electricity Storage Plant** comprising of separate generating units and demand taking plant (eg a pump) then compliance would be assessed individually on the generating units and the demand taking elements.

ECP.2 OBJECTIVE

ECP.2.1 The objective of the **ECP** is to ensure that there is a clear and consistent process for demonstration of compliance by **Users** with the **European Connection Conditions** and **Bilateral Agreement** and will enable **The Company** to comply with its statutory and **Transmission Licence** obligations. For the avoidance of doubt, the requirements of the **European Compliance Processes** do not apply to **Demand Response Providers** unless they are also an **EU Code User** and have entered into a **CUSC Contract** with **The Company**.

ECP.2.2 Provisions of the **ECP** which apply in relation to **OTSDUW** and **OTSUA** shall (in any particular case) apply up to the **OTSUA Transfer Time**, whereupon such provisions shall (without prejudice to any prior non-compliance) cease to apply.

ECP.2.3 In relation to **OTSDUW**, provisions otherwise to be contained in a **Bilateral Agreement** may be contained in the **Construction Agreement**, and accordingly a reference in the **ECP** to a relevant **Bilateral Agreement** includes the relevant **Construction Agreement**.

ECP.3 SCOPE

ECP.3.1 The **ECP** applies to **The Company** and to **Users**, which in the **ECP** means:

- (a) **EU Generators** (other than in relation to **Embedded Power Stations** not subject to a **Bilateral Agreement**) including those undertaking **OTSDUW**.
- (b) **Network Operators** who are either;
 - (i) **EU Code Users** in respect of their entire distribution **System**; or
 - (ii) **GB Code Users** in respect of their **EU Grid Supply Points** only
- (c) **Non-Embedded Customers** who are **EU Code Users**;
- (d) **HVDC System Owners** (other than those which only have **Embedded HVDC Systems** not subject to a **Bilateral Agreement**).
- (e) **Grid Forming Plant Owners** who own and operate a **Grid Forming Plant** and intend to satisfy the requirements of ECC.6.3.19

ECP.3.2 The above categories of **User** will become bound by the **ECP** prior to them generating, distributing, supplying or consuming, or in the case of **OTSUA**, transmitting, as the case may be, and references to the various categories should, therefore, be taken as referring to them in that prospective role.

ECP.3.3 For the avoidance of doubt, **Demand Response Providers** do not need to satisfy the requirements of this **ECP** unless they are also defined as an **EU Code User** and have a **CUSC Contract** with **The Company**. Where a **Demand Response Provider** is not an **EU Code User** and does not have a **CUSC Contract** with **The Company**, the requirements of the **Demand Response Services Code** shall only apply.

ECP.3.4 For the avoidance of doubt, this **ECP** does not apply to **GB Code Users** other than in respect of **Network Operator's EU Grid Supply Points**.

ECP.4 CONNECTION PROCESS

ECP.4.1 The **CUSC Contract(s)** contain certain provisions relating to the procedure for connection to the **National Electricity Transmission System** or, in the case of **Embedded Power Stations** or **Embedded HVDC Systems**, becoming operational and include provisions to be complied with by **Users** prior to and during the course of **The Company** notifying the **User** that it has the right to become operational. In addition to such provisions, this **ECP** sets out in further detail the processes to be followed to demonstrate compliance. While this **ECP** does not expressly address the processes to be followed in the case of **OTSUA** connecting to a **Network Operator's User System** prior to **OTSUA Transfer Time**, the processes to be followed by **The Company** and the **Generator** in respect of the **OTSUA** in such circumstances shall be

consistent with those set out below by reference to **OTSUA** directly connected to the **National Electricity Transmission System**.

- ECP.4.2 The provisions contained in ECP.5 to ECP.7 detail the process to be followed in order for the **User's Plant** and **Apparatus** (including **OTSUA**) to become operational. This process includes
- (i) the acceptance of an **Installation Document** for a **Type A Power Generating Module**;
 - (ii) for energisation an **EON** for **Type B, Type C** or **Type D Power Generating Modules**, or **HVDC Equipment, Grid Forming Plant** or **Network Operator's** or **Non-Embedded Customer's Plant** and **Apparatus**;
 - (iii) for synchronising an **ION** for **Type B, Type C** or **Type D Power Generating Modules** or **HVDC Equipment**;
 - (iv) for operating by using the **Grid Supply Point** an **ION** for;
 - a. **Network Operators** who are **EU Code Users** in respect of their entire distribution **System**;
 - b. **Network Operators** who are **GB Code Users** in respect of their **EU Grid Supply Points** only; or
 - c. **Non-Embedded Customers** who are **EU Code Users**;
 - (v) for final certification a **FON**.
- ECP.4.2.1 The provisions contained in ECP.5 relate to the connection and energisation of **User's Plant** and **Apparatus** (including **OTSUA**) to the **National Electricity Transmission System** or where **Embedded**, to a **User's System**.
- ECP.4.2.2 The provisions contained in ECP.6 and ECP.7 provide the process for **Generators, HVDC System Owners, Grid Forming Plant Owners, Network Operators** and **Non-Embedded Customers** to demonstrate compliance with the **Grid Code** and with, where applicable, the **CUSC Contract(s)** prior to and during the course of such **Generator's, HVDC System Owner's** (including **OTSUA** up to the **OTSUA Transfer Time**), **Network Operator's** and **Non-Embedded Customer's Plant** and **Apparatus**) becoming operational.
- ECP.4.2.3 The provisions contained in ECP.8 detail the process to be followed to confirm continued compliance (the "Compliance Repeat Plan").
- ECP.4.2.4 The provisions contained in ECP.9 detail the process to be followed when:
- (a) a **Generator's** or **HVDC System Owner's**, or **Grid Forming Plant Owner's**, or **Network Operator's** or **Non-Embedded Customer's Plant** and/or **Apparatus** (including the **OTSUA**) is unable to comply with any provisions of the **Grid Code** and **Bilateral Agreement**; or,
 - (b) following any notification by a **Generator** or a **HVDC System Owner** or a **Grid Forming Plant Owner** or a **Network Operator** or a **Non-Embedded Customer** under the **PC** of any change to its **Plant** and **Apparatus** (including any **OTSUA**); or,
 - (c) a **Modification** to a **Generator's** or a **HVDC System Owner's** or a **Grid Forming Plant Owner's** or a **Network Operator's** or a **Non-Embedded Customer's Plant** and/or **Apparatus**.

- ECP.4.2.4 For **Grid Forming Plant Owners**, the **Operational Notification Process** of this **ECP** shall apply in relation to the type of **Plant** to which the **Grid Forming Capability** is provided (be it a **GBGF-S** or **GBGF-I**),
- ECP.4.3 **Embedded Medium Power Stations** not subject to a **Bilateral Agreement** and **Embedded HVDC Equipment** not subject to a **Bilateral Agreement**
- ECP.4.3.1 In the case of **Embedded Medium Power Stations** not subject to a **Bilateral Agreement** and **Embedded HVDC Systems** not subject to a **Bilateral Agreement**, ensuring the obligations of the **ECC** and Appendix E of the relevant **Bilateral Agreement** between **The Company** and the host **Network Operator** are performed and discharged by the relevant party. For the avoidance of doubt the process in this **ECP** does not apply to **Embedded Medium Power Stations** not subject to a **Bilateral Agreement** and **Embedded HVDC Equipment** not subject to a **Bilateral Agreement**.
- ECP.5 ENERGISATION OPERATIONAL NOTIFICATION
- ECP.5.1 The following provisions apply in relation to the issue of an **Energisation Operational Notification** in respect of a **Power Station** consisting of **Type B, Type C** or **Type D Power Generating Modules** or an **HVDC System** or a **Network Operator's** or a **Non-Embedded Customer's Plant** and **Apparatus**.
- ECP.5.1.1 Certain provisions relating to the connection and energisation of the **User's Plant** and **Apparatus** at the **Connection Site** and **OTSUA** at the **Transmission Interface Point** and in certain cases of **Embedded Plant** and **Apparatus** are specified in the **CUSC** and/or **CUSC Contract(s)**. For other **Embedded Plant** and **Apparatus**, the **Distribution Code**, the **DCUSA** and the **Embedded Development Agreement** for the connection specify equivalent provisions. Further detail on this is set out in ECP.5 below.
- ECP.5.2 The items for submission prior to the issue of an **Energisation Operational Notification** are set out in ECC.5.2.
- ECP.5.3 In the case of a **Generator** or **HVDC System Owner** the items referred to in ECC.5.2 shall be submitted using the **Power Generating Module Document** or **User Data File Structure** as applicable.
- ECP.5.4 Not less than 28 days, or such shorter period as may be acceptable in **The Company's** reasonable opinion, prior to the **User** wishing to energise its **Plant** and **Apparatus** (including passive **OTSUA**) for the first time, the **User** will submit to **The Company** a Certificate of Readiness to Energise **High Voltage** Equipment which specifies the items of **Plant** and **Apparatus** (including **OTSUA**) ready to be energised in a form acceptable to **The Company**.
- ECP.5.5 If the relevant obligations under the provisions of the **CUSC** and/or **CUSC Contract(s)** and the conditions of ECP.5 have been completed to **The Company's** reasonable satisfaction then **The Company** shall issue an **Energisation Operational Notification**. Any dynamically controlled reactive compensation **OTSUA** (including Statcoms or Static Var Compensators) shall not be **Energised** until the appropriate **Interim Operational Notification** has been issued in accordance with ECP.6.
- ECP.6 OPERATIONAL NOTIFICATION PROCESSES
- ECP.6.1 OPERATIONAL NOTIFICATION PROCESS (Type A)

- ECP.6.1.1 The following provisions apply in relation to the notification process in respect of a **Power Station** consisting of **Type A Power Generating Modules**.
- ECP.6.1.2 Not less than 7 days, or such shorter period as may be acceptable in **The Company's** reasonable opinion, prior to the **Generator** wishing to **Synchronise** its **Plant** and **Apparatus** for the first time, the **Generator** will:
- submit to **The Company**, a **Notification of the User's Intention to Connect**; and
- submit to **The Company** an **Installation Document** containing at least but not limited to the items referred to at ECP.6.1.3.
- ECP.6.1.3 Items for submission prior to connection.
- ECP.6.1.3.1 Prior to the issue of an acknowledgment to connect, the **Generator** must submit to **The Company**, to **The Company's** satisfaction, an **Installation Document** containing at least but not limited to:
- (i) The location at which the connection is made;
 - (ii) The date of the connection;
 - (iii) The **Maximum Capacity** of the installation in kW;
 - (iv) The type of primary energy source;
 - (v) The classification of the **Power Generating Module** as an emerging technology;
 - (vi) A list of references to **Equipment Certificates** issued by an authorised certifier or otherwise agreed with **The Company** used for equipment that is installed at the site or copies of the relevant **Equipment Certificates** issued by an **Authorised Certifier** or otherwise where these are relied upon as part of the evidence of compliance;
 - (vii) As regards equipment used, for which an **Equipment Certificate** has not been received, information shall be provided as directed by **The Company** or the **Relevant Network Operator**; and
 - (viii) The contact details of the **Generator** and the installer and their signatures.
- ECP.6.1.3.2 The items referred to in ECP.6.1.3 shall be submitted by the **Generator** in the form of an **Installation Document** for each applicable **Power Generating Module**.
- ECP.6.1.4 No **Power Generating Module** shall be **Synchronised** to the **Total System** until the later of:
- (a) the date specified by the **Generator** in the **Installation Document** issued in respect of each applicable **Power Generating Module(s)**; and,
 - (b) acknowledgement is received from **The Company** confirming receipt of the **Installation Document**.

- ECP.6.1.5 When the requirements of ECP.6.1.2 to ECP.6.1.4 have been met, **The Company** will notify the **Generator** that the **Power Generating Module** may (subject to the **Generator** having fulfilled the requirements of ECP.6.1.3 where that applies) be **Synchronised** to the **Total System**.
- ECP.6.1.6 Not less than 7 days, or such shorter period as may be acceptable in **The Company's** reasonable opinion, prior to the **Generator** wishing to decommission its **Plant** and **Apparatus**, the **Generator** will submit to **The Company** a **Notification of User's Intention to Disconnect**.
- ECP.6.2 INTERIM OPERATIONAL NOTIFICATION (Type B and Type C)
- ECP.6.2.1 The following provisions apply in relation to the issue of an **Interim Operational Notification** in respect of a **Power Station** consisting of **Type B** and/or **Type C Power Generating Modules**.
- ECP.6.2.2 Not less than 28 days, or such shorter period as may be acceptable in **The Company's** reasonable opinion, prior to the **Generator** wishing to **Synchronise** its **Plant** and **Apparatus** or dynamically controlled **OTSUA** for the first time the **Generator** or **HVDC Equipment** owner will:
- (i) submit to **The Company** a **Notification of User's Intention to Synchronise**; and
 - (ii) submit to **The Company** an initial **Power Generating Module Document** containing at least but not limited to the items referred to at ECP.6.2.3.
- ECP.6.2.3 Items for submission prior to issue of the **Interim Operational Notification**.
- ECP.6.2.3.1 Prior to the issue of an **Interim Operational Notification** in respect of the **EU Code User's Plant** and **Apparatus** or dynamically controlled **OTSUA**, the **Generator** must submit to **The Company** to **The Company's** satisfaction an **Interim Power Generating Module Document** containing at least but not limited to:
- (i) updated **Planning Code** data (both **Standard Planning Data** and **Detailed Planning Data**), with any estimated values assumed for planning purposes confirmed or, where practical, replaced by validated actual values and by updated estimates for the future and by updated forecasts for **Forecast Data** items such as **Demand**;
 - (ii) for **Type C Power Generating Modules** the simulation models;
 - (iii) details of any special **Power Generating Module(s)** protection as required by ECC.6.2.2.3. This may include Pole Slipping protection and islanding protection schemes as applicable;
 - (iv) simulation study provisions of Appendix ECP.A.3 and the results demonstrating compliance with **Grid Code** requirements of:
- PC.A.5.4.2
PC.A.5.4.3.2,
ECC.6.3.4,
ECC.6.3.7.3.1 to ECC.6.3.7.3.6,
ECC.6.3.15, ECC.6.3.16
ECC.A.6.2.5.6
ECC.A.7.2.3.1

as applicable to the **Power Generating Module(s)** or dynamically controlled **OTSUA** unless agreed otherwise by **The Company**;

- (v) a detailed schedule of the tests and the procedures for the tests required to be carried out by the **Generator** under ECP.7.2 to demonstrate compliance with relevant **Grid Code** requirements. Such schedule to be consistent with Appendix ECP.A.5 (in the case of a **Synchronous Power Generating Module**) or Appendix ECP.A.6 (in the case of a **Power Park Modules**) and **OTSUA** as applicable);
- (vi) copies of **Manufacturer's Test Certificates** or **Equipment Certificates** issued by an **Authorised Certifier** or equivalent as agreed with **The Company** where these are relied upon as part of the evidence of compliance; and
- (vii) a **Compliance Statement** and a **User Self Certification of Compliance** completed by the **EU Code User** (including any **Unresolved Issues**) against the relevant **Grid Code** requirements including details of any requirements that the **Generator** has identified that will not or may not be met or demonstrated.

ECP.6.2.3.2 The items referred to in ECP.6.2.3 shall be submitted by the **Generator** in the form of a **Power Generating Module Document (PGMD)** for each applicable **Power Generating Module**.

ECP.6.2.4 No **Generating Unit** or dynamically controlled **OTSUA** shall be **Synchronised** to the **Total System** (and for the avoidance of doubt, dynamically controlled **OTSUA** will not be able to transmit) until the later of:

- (a) the date specified by **The Company** in the **Interim Operational Notification** issued in respect of each applicable **Power Generating Module(s)** or dynamically controlled **OTSUA**; and,
- (b) in the case of **Synchronous Power Generating Module(s)** only after the date of receipt by the **Generator** of written confirmation from **The Company** that the **Synchronous Power Generating Module** or **CCGT Module** as applicable has completed the following tests to demonstrate compliance with the relevant provisions of the **Connection Conditions** to **The Company's** satisfaction:
 - (i) those tests required to establish the open and short circuit saturation characteristics of the **Synchronous Power Generating Module** (as detailed in Appendix ECP.A.4.3) to enable assessment of the short circuit ratio in accordance with ECC.6.3.2. Such tests may be carried out at a location other than the **Power Station** site and supplied in the form of an **Equipment Certificate** or as otherwise agreed by **The Company**; and
 - (ii) open circuit step response tests (as detailed in Appendix ECP.A.5.2) to demonstrate compliance with ECC.A.6.2.4.1.

ECP.6.2.5 **The Company** shall assess the schedule of tests submitted by the **Generator** with the **Notification of User's Intention to Synchronise** under ECP.6.2.3 and shall determine whether such schedule has been completed to **The Company's** satisfaction.

ECP.6.2.6 When the requirements of ECP.6.2.2 to ECP.6.2.5 have been met, **The Company** will notify the **Generator** that the:

**Synchronous Power Generating Module,
CCGT Module,
Power Park Module or
Dynamically controlled OTSUA**

as applicable may (subject to the **Generator** having fulfilled the requirements of ECP.6.2.3 where that applies) be **Synchronised** to the **Total System** through the issue of an **Interim Operational Notification**. Where the **Generator** is undertaking **OTSDUW** then the **Interim Operational Notification** will be in two parts, with the “**Interim Operational Notification Part A**” applicable to **OTSUA** and the **Interim Operational Notification Part B**” applicable to the **EU Code Users Plant and Apparatus**. For the avoidance of doubt, the “**Interim Operational Notification Part A**” and the “**Interim Operational Notification Part B**” can be issued together or at different times. In respect of an **Embedded Power Station** or **Embedded HVDC Equipment Station** (other than an **Embedded Medium Power Stations** not subject to a **Bilateral Agreement** and **Embedded HVDC Equipment Stations** not subject to a **Bilateral Agreement**), **The Company** will notify the **Network Operator** that an **Interim Operational Notification** has been issued.

ECP.6.2.6.1 The **Interim Operational Notification** will be time limited, the expiration date being specified at the time of issue. The **Interim Operational Notification** may be renewed by **The Company**.

ECP.6.2.6.2 The **Generator** must operate the **Power Generating Module** or **OTSUA** in accordance with the terms, arising from the **Unresolved Issues**, of the **Interim Operational Notification**. Where practicable, **The Company** will discuss such terms with the **Generator** prior to including them in the **Interim Operational Notification**.

ECP.6.2.6.3 The **Interim Operational Notification** will include the following limitations:

- (a) In the case of **OTSUA**, the **Interim Operational Notification Part A** permits **Synchronisation** of the dynamically controlled **OTSUA** to the **Total System** only for the purposes of active control of voltage and reactive power and not for the purpose of exporting **Active Power**.
- (b) In the case of a **Power Park Module** the **Interim Operational Notification** (and where **OTSDUW Arrangements** apply, this reference will be to the **Interim Operational Notification Part B**) will limit the proportion of the **Power Park Module** which can be simultaneously **Synchronised** to the **Total System** such that neither of the following figures is exceeded:
 - (i) 20% of the **Maximum Capacity** of the **Power Park Module** (or the output of a single **Power Park Unit** where this exceeds 20% of the **Power Station’s Maximum Capacity**)

until the **Generator** has completed the voltage control tests (detailed in ECP.A.6.2) (including in respect of any dynamically controlled **OTSUA**) to **The Company’s** reasonable satisfaction. Following successful completion of this test each additional **Power Park Unit** should be included in the voltage control scheme as soon as is technically possible (unless **The Company** agrees otherwise).

- (c) In the case of a **Synchronous Power Generating Module** employing a static **Excitation System** the **Interim Operational Notification** (and where **OTSDUW Arrangements** apply, this reference will be to the **Interim Operational Notification Part B**) may, if applicable, limit the

maximum **Active Power** output and **Reactive Power** output of the **Synchronous Power Generating Module** or **CCGT module** prior to the successful commissioning of the **Power System Stabiliser** to **The Company's** satisfaction, if applicable.

- ECP.6.2.6.4 Operation in accordance with the **Interim Operational Notification** whilst it is in force will meet the requirements for compliance by the **Generator** and **The Company** of all the relevant provisions of the **European Connection Conditions**.
- ECP.6.2.7 Other than **Unresolved Issues** that are subject to tests required under ECP.7.2 to be witnessed by **The Company**, the **Generator** must resolve any **Unresolved Issues** prior to the commencement of the tests, unless **The Company** agrees to a later resolution. The **Generator** must liaise with **The Company** in respect of such resolution. The tests that may be witnessed by **The Company** are specified in ECP.7.2.
- ECP.6.2.8 Not less than 28 days, or such shorter period as may be acceptable in **The Company's** reasonable opinion, prior to the **Generator** wishing to commence tests required under ECP.7 to be witnessed by **The Company**, the **Generator** will notify **The Company** that the **Power Generating Module(s)** as applicable is ready to commence such tests.
- ECP.6.2.9 The items referred to at ECP.7.3 shall be submitted by the **Generator** after successful completion of the tests required under ECP.7.2.
- ECP.6.3 INTERIM OPERATIONAL NOTIFICATION (Type D and HVDC Equipment)
- ECP.6.3.1 The following provisions apply in relation to the issue of an **Interim Operational Notification** in respect of a **Power Station** consisting of **Type D Power Generating Modules** or an **HVDC System**.
- ECP.6.3.2 Not less than 28 days, or such shorter period as may be acceptable in **The Company's** reasonable opinion, prior to the **Generator** or **HVDC System Owner** wishing to **Synchronise** its **Plant** and **Apparatus** or dynamically controlled **OTSUA** for the first time the **Generator** or **HVDC System Owner** will:
- i. submit to **The Company** a **Notification of User's Intention to Synchronise**; and
 - ii. submit to **The Company** the items referred to at ECP.6.3.3.
- ECP.6.3.3 Items for submission prior to issue of the **Interim Operational Notification**.
- ECP.6.3.3.1 Prior to the issue of an **Interim Operational Notification** in respect of the **EU Code User's Plant** and **Apparatus** or dynamically controlled **OTSUA** the **Generator** or **HVDC System Owner** must submit to **The Company** to **The Company's** satisfaction:
- (a) updated **Planning Code** data (both **Standard Planning Data** and **Detailed Planning Data**), with any estimated values assumed for planning purposes confirmed or, where practical, replaced by validated actual values and by updated estimates for the future and by updated forecasts for **Forecast Data** items such as **Demand**;
 - (b) details of any special **Power Generating Module(s)** or **HVDC Equipment** protection as applicable. This may include Pole Slipping protection and islanding protection schemes;

- (c) any items required by ECP.5.2, updated by the **EU Code User** as necessary;
- (d) simulation study provisions of Appendix ECP.A.3 and the results demonstrating compliance with **Grid Code** requirements of:

PC.A.5.4.2
 PC.A.5.4.3.2,
 ECC.6.3.4,
 ECC.6.3.7.3.1 to ECC.6.3.7.3.6,
 ECC.6.3.15, ECC.6.3.16
 ECC.A.6.2.5.6
 ECC.A.7.2.3.1

as applicable to the **Power Station, Synchronous Power Generating Module(s), Power Park Module(s), HVDC Equipment** or dynamically controlled **OTSUA** unless agreed otherwise by **The Company**;

- (e) a detailed schedule of the tests and the procedures for the tests required to be carried out by the **Generator** or **HVDC System Owner** under ECP.7.2 to demonstrate compliance with relevant **Grid Code** requirements. Such schedule to be consistent with Appendix ECP.A.5 (in the case of **Synchronous Power Generating Modules**) or Appendix ECP.A.6 (in the case of **Power Park** Modules and **OTSUA** as applicable) or Appendix ECP.A.7 (in the case of **HVDC Equipment**); and
- (f) an interim **Compliance Statement** and a **User Self Certification of Compliance** completed by the **EU Code User** (including any **Unresolved Issues**) against the relevant **Grid Code** requirements including details of any requirements that the **Generator** or **HVDC System Owner** has identified that will not or may not be met or demonstrated.

ECP.6.3.3.2 The items referred to in ECP.6.3.3 shall be submitted by the **Generator** or **HVDC System Owner** using the **User Data File Structure**.

ECP.6.3.4 No **Power Generating Module** or **HVDC Equipment** shall be **Synchronised** to the **Total System** (and for the avoidance of doubt, dynamically controlled **OTSUA** will not be able to transmit) until the later of:

- (a) the date specified by **The Company** in the **Interim Operational Notification** issued in respect of the **Power Generating Module(s)** or **HVDC Equipment** or dynamically controlled **OTSUA**; and,
- (b) if **Embedded**, the date of receipt of a confirmation from the **Network Operator** in whose **System** the **Plant and Apparatus** is connected that it is acceptable to the **Network Operator** that the **Plant and Apparatus** be connected and **Synchronised**; and,
- (c) in the case of **Synchronous Power Generating Module(s)** only after the date of receipt by **Generator** of written confirmation from **The Company** that the **Synchronous Power Generating Module** has completed the following tests to demonstrate compliance with the relevant provisions of the **Connection Conditions** to **The Company's** satisfaction:

- (i) those tests required to establish the open and short circuit saturation characteristics of the **Synchronous Power Generating Module** (as detailed in Appendix ECP.A.5.3) to enable assessment of the short circuit ratio in accordance with ECC.6.3.2. Such tests may be carried out at a location other than the **Power Station** site; and
- (ii) open circuit step response tests (as detailed in Appendix ECP.A.5.2) to demonstrate compliance with ECC.A.6.2.4.1.

ECP.6.3.5 **The Company** shall assess the schedule of tests submitted by the **Generator** or **HVDC System Owner** with the **Notification of User's Intention to Synchronise** under ECP.6.3.1 and shall determine whether such schedule has been completed to **The Company's** satisfaction.

ECP.6.3.6 When the requirements of ECP.6.3.2 to ECP.6.3.5 have been met, **The Company** will notify the **Generator** or **HVDC System Owner** that the:
Synchronous Power Generating Module,
CCGT Module,
Power Park Module
Dynamically controlled **OTSUA** or
HVDC Equipment,

as applicable may (subject to the **Generator** or **HVDC System Owner** having fulfilled the requirements of ECP.6.3.3 where that applies) be **Synchronised** to the **Total System** through the issue of an **Interim Operational Notification**. Where the **Generator** is undertaking **OTSDUW** then the **Interim Operational Notification** will be in two parts, with the "**Interim Operational Notification Part A**" applicable to **OTSUA** and the "**Interim Operational Notification Part B**" applicable to the **EU Code Users Plant and Apparatus**. For the avoidance of doubt, the "**Interim Operational Notification Part A**" and the "**Interim Operational Notification Part B**" can be issued together or at different times. In respect of an **Embedded Power Station or Embedded HVDC Equipment Station** (other than **Embedded Medium Power Stations** not subject to a **Bilateral Agreement** and **Embedded HVDC Equipment** not subject to a **Bilateral Agreement**), **The Company** will notify the **Network Operator** that an **Interim Operational Notification** has been issued.

ECP.6.3.6.1 The **Interim Operational Notification** will be time limited, the expiration date being specified at the time of issue. The **Interim Operational Notification** may be renewed by **The Company** for up to a maximum of 24 months from the date of the first issue of the **Interim Operational Notification**. **The Company** may only issue an extension to an **Interim Operational Notification** beyond 24 months provided the **Generator** or **HVDC System Owner** has applied for a derogation for any remaining **Unresolved Issues** to the **Authority** as detailed in ECP.10.

ECP.6.3.6.2 The **Generator** or **HVDC System Owner** must operate the **Power Generating Module** or **HVDC Equipment** in accordance with the terms, arising from the **Unresolved Issues**, of the **Interim Operational Notification**. Where practicable, **The Company** will discuss such terms with the **Generator** or **HVDC System Owner** prior to including them in the **Interim Operational Notification**.

ECP.6.3.6.3 The **Interim Operational Notification** will include the following limitations:

- (a) In the case of **OTSUA**, the **Interim Operational Notification Part A** permits **Synchronisation** of the dynamically controlled **OTSUA** to the

Total System only for the purposes of active control of voltage and **Reactive Power** and not for the purpose of exporting **Active Power**.

(b) In the case of a **Power Park Module** the **Interim Operational Notification** (and where **OTSDUW** Arrangements apply, this reference will be to the **Interim Operational Notification Part B**) will limit the proportion of the **Power Park Module** which can be simultaneously **Synchronised** to the **Total System** such that neither of the following figures is exceeded:

(i) 20% of the **Maximum Capacity** of the **Power Park Module** (or the output of a single **Power Park Unit** where this exceeds 20% of the **Power Station's Maximum Capacity**); nor

(ii) 50MW

until the **Generator** has completed the voltage control tests (detailed in ECP.A.6.3.2) to **The Company's** reasonable satisfaction. Following successful completion of this test, each additional **Power Park Unit** should be included in the voltage control scheme as soon as is technically possible (unless **The Company** agrees otherwise).

(c) In the case of a **Power Park Module** with a **Maximum Capacity** greater or equal to 100MW, the **Interim Operational Notification** (and where **OTSDUW** Arrangements apply, this reference will be to the **Interim Operational Notification Part B**) will limit the proportion of the **Power Park Module** which can be simultaneously **Synchronised** to the **Total System** to 70% of **Maximum Capacity** until the **Generator** has completed the **Limited Frequency Sensitive Mode (LFSM-O)** control tests with at least 50% of the **Maximum Capacity** of the **Power Park Module** in service (detailed in ECP.A.6.3.1) to **The Company's** reasonable satisfaction.

(d) In the case of a **Synchronous Power Generating Module** employing a static **Excitation System** or a **Power Park Module** employing a **Power System Stabiliser**, the **Interim Operational Notification** (and where **OTSDUW Arrangements** apply, this reference will be to the **Interim Operational Notification Part B**) may if applicable limit the maximum **Active Power** output and **Reactive Power** output of the **Synchronous Power Generating Module** or **CCGT module** prior to the successful commissioning of the **Power System Stabiliser** to **The Company's** satisfaction.

ECP.6.3.6.4 Operation in accordance with the **Interim Operational Notification** whilst it is in force will meet the requirements for compliance by the **Generator** or **HVDC System Owner** and **The Company** of all the relevant provisions of the **European Connection Conditions**.

ECP.6.3.7 Other than **Unresolved Issues** that are subject to tests required under ECP.7.2 to be witnessed by **The Company**, the **Generator** or **HVDC System Owner** must resolve any **Unresolved Issues** prior to the commencement of the tests, unless **The Company** agrees to a later resolution. The **Generator** or **HVDC System Owner** must liaise with **The Company** in respect of such resolution. The tests that may be witnessed by **The Company** are specified in ECP.7.2.

ECP.6.3.8 Not less than 28 days, or such shorter period as may be acceptable in **The Company's** reasonable opinion, prior to the **Generator** or **HVDC System Owner** wishing to commence tests required under ECP.7 to be witnessed by **The Company**, the **Generator** or **HVDC System Owner** will notify **The**

Company that the **Power Generating Module(s)** or **HVDC Equipment(s)** as applicable is ready to commence such tests.

ECP.6.3.9 The items referred to at ECP.7.3 shall be submitted by the **Generator** or the **HVDC System Owner** after successful completion of the tests required under ECP.7.2.

ECP.6.4 INTERIM OPERATIONAL NOTIFICATION (Network Operator's or Non-Embedded Customer's Plant and Apparatus)

ECP.6.4.1 The following provisions apply in relation to the issue of an **Interim Operational Notification** in respect of **Network Operator's** or **Non-Embedded Customer's Plant and Apparatus**.

ECP.6.4.2 Not less than 28 days, or such shorter period as may be acceptable in **The Company's** reasonable opinion, prior to the **Network Operator** or **Non-Embedded Customer** wishing to operate its **Plant and Apparatus** by using the **EU Grid Supply Point** for the first time, the **Network Operator** or **Non-Embedded Customer** will:

- i. submit to **The Company** a **Notification of User's Intention to Operate**; and
- ii. submit to **The Company** the items referred to at ECP.6.4.3.

ECP.6.4.3 Items for submission prior to issue of the **Interim Operational Notification**.

ECP.6.4.3.1 Prior to the issue of an **Interim Operational Notification** in respect of the **User's Plant and Apparatus** at an **EU Grid Supply Point**, the **Network Operator** or **Non-Embedded Customer** must submit to **The Company** to **The Company's** satisfaction:

- (a) updated **Planning Code** data (both **Standard Planning Data** and **Detailed Planning Data**), with any estimated values assumed for planning purposes confirmed or, where practical, replaced by validated actual values and by updated estimates for the future and by updated forecasts for **Forecast Data** items such as **Demand**;
- (b) details of any special protection as applicable;
- (c) any items required by ECP.5.2, updated as necessary;
- (d) data submission and results required by Appendix ECP.A.8 demonstrating compliance with **Grid Code** requirements of:

PC.A.2.2
PC.A.2.3
PC.A.2.4
PC.A.2.5.2
PC.A.2.5.3
PC.A.2.5.4
PC.A.2.5.6
PC.A.4
PC.A.6.1.3
PC.A.6.3
PC.A.6.7.1

as applicable to the **Network Operator's** or **Non-Embedded Customer's Plant and Apparatus** unless agreed otherwise by **The Company**;

- (e) a detailed schedule of the tests and the procedures for the tests required to be carried out by the **Network Operator** or **Non-Embedded Customer** under ECP.7.8 (or **Equipment Certificates** as relevant) to demonstrate compliance with relevant **Grid Code** requirements. Such schedule is to be consistent with Appendix ECP.A.8.
 - (f) an interim **Compliance Statement** and a **User Self Certification of Compliance** completed by the **User** (including any **Unresolved Issues**) against the relevant **Grid Code** requirements including details of any requirements that the **Network Operator** or **Non-Embedded Customer** has identified that will not or may not be met or demonstrated.
- ECP.6.4.4 No **Network Operator's** or **Non-Embedded Customer's Plant** and **Apparatus** shall be operated by using the **EU Grid Supply Point** until the date specified by **The Company** in the **Interim Operational Notification**.
- ECP.6.4.5 **The Company** shall assess the schedule of tests submitted by the **Network Operator** or **Non-Embedded Customer** with the **Notification of User's Intention to Operate** under ECP.6.4.1 and shall determine whether such schedule has been completed to **The Company's** satisfaction.
- ECP.6.4.6 When the requirements of ECP.6.4.2 to ECP.6.4.5 have been met, **The Company** will notify the **Network Operator** or **Non-Embedded Customer** that the **Plant** and **Apparatus** may (subject to the **Network Operator** or **Non-Embedded Customer** having fulfilled the requirements of ECP.6.4.3 where that applies) be operated by using the **EU Grid Supply Point** through the issue of an **Interim Operational Notification**.
- ECP.6.4.6.1 The **Interim Operational Notification** will be time limited, the expiration date being specified at the time of issue. The **Interim Operational Notification** may be renewed by **The Company** for up to a maximum of 24 months from the date of the first issue of the **Interim Operational Notification**. **The Company** may only issue an extension to an **Interim Operational Notification** beyond 24 months provided the **Network Operator** or **Non-Embedded Customer** has applied for a derogation for any remaining **Unresolved Issues** to the **Authority** as detailed in ECP.10.
- ECP.6.4.6.2 The **Network Operator** or **Non-Embedded Customer** must operate the **Plant** and **Apparatus** in accordance with the terms, arising from the **Unresolved Issues**, of the **Interim Operational Notification**. Where practicable, **The Company** will discuss such terms with the **Network Operator** or **Non-Embedded Customer** prior to including them in the **Interim Operational Notification**.
- ECP.6.4.7 The **Network Operator** or **Non-Embedded Customer** must resolve any **Unresolved Issues** prior to the commencement of the tests, unless **The Company** agrees to a later resolution. The **Network Operator** or **Non-Embedded Customer** must liaise with **The Company** in respect of such resolution.
- ECP.6.4.8 Not less than 28 days, or such shorter period as may be acceptable in **The Company's** reasonable opinion, prior to the **Network Operator** or **Non-Embedded Customer** wishing to commence tests required under ECP.7.8(e) and ECP.A.8 to be witnessed by **The Company** the **Network Operator** or **Non-Embedded Customer** will notify **The Company** that the **Network Operator** or **Non-Embedded Customer** as applicable is ready to commence such tests.

- ECP.7 FINAL OPERATIONAL NOTIFICATION
- Final Operational Notification in respect of Generators and HVDC System Owners
- ECP.7.1 The following provisions apply in relation to the issue of a **Final Operational Notification** in respect of a **Power Station** consisting of **Type B, Type C** and **Type D Power Generating Modules** or an **HVDC System**.
- ECP.7.2 Tests to be carried out prior to issue of the **Final Operational Notification**.
- ECP.7.2.1 Prior to the issue of a **Final Operational Notification** the **Generator** or **HVDC System Owner** must have completed the tests specified in this ECP.7.2.2 to **The Company's** satisfaction to demonstrate compliance with the relevant **Grid Code** provisions.
- ECP.7.2.2 In the case of any **Power Generating Module, OTSUA** (if applicable) or **HVDC Equipment** these tests will reflect the relevant technical requirements and will comprise one or more of the following:
- (a) Reactive capability tests to demonstrate that the **Power Generating Module, OTSUA** (if applicable) or **HVDC Equipment** can meet the requirements of ECC.6.3.2. These may be witnessed by **The Company** on site if there is no metering to **The Company** Control Centre.
 - (b) voltage control system tests to demonstrate that the **Power Generating Module, OTSUA** (if applicable) or **HVDC Equipment** can meet the requirements of ECC.6.3.6.3, ECC.6.3.8 and, in the case of a **Power Park Module, OTSUA** (if applicable) and **HVDC Equipment**, the requirements of ECC.A.7 or ECC.A.8 and, in the case of **Synchronous Power Generating Module** and **CCGT Module**, the requirements of ECC.A.6, and any terms specified in the **Bilateral Agreement** as applicable. These tests may also be used to validate the **Excitation System** model (PC.A.5.3) or voltage control system model (PC.A.5.4) as applicable. These tests may be witnessed by **The Company**.
 - (c) governor or frequency control system tests to demonstrate that the **Power Generating Module, OTSUA** (if applicable) or **HVDC Equipment** can meet the requirements of ECC.6.3.6.2, ECC.6.3.7, where applicable ECC.A.3, and BC.3.7. In the case of a **Type B Power Generating Module** only tests BC3 and BC4 in ECP.A.5.8 Figure 2 or ECP.A.6.6 Figure 2 must be completed. The results will also validate the **Mandatory Service Agreement** required by ECC.8.1. These tests may also be used to validate the governor model (PC.A.5.3) or frequency control system model (PC.A.5.4) as applicable. These tests may be witnessed by **The Company**.
 - (d) fault ride through tests in respect of a **Power Station** with a **Maximum Capacity** of 100MW or greater, comprised of one or more **Power Park Modules**, to demonstrate compliance with ECC.6.3.15, ECC.6.3.16 and ECC.A.4. Where test results from a **Manufacturers Data & Performance Report** as defined in ECP.11 have been accepted this test will not be required.

- (e) any further tests reasonably required by **The Company** and agreed with the **EU Code User** to demonstrate any aspects of compliance with the **Grid Code** and the **CUSC Contracts**.

ECP.7.2.3 **The Company's** preferred range of tests to demonstrate compliance with the **ECCs** are specified in Appendix ECP.A.5 (in the case of **Synchronous Power Generating Modules**) or Appendix ECP.A.6 (in the case of a **Power Park Modules** or **OTSUA** (if applicable)) or Appendix ECP.A.7 (in the case of **HVDC Equipment** and are to be carried out by the **EU Code User** with the results of each test provided to **The Company**. The **EU Code User** may carry out an alternative range of tests if this is agreed with **The Company**. **The Company** may agree a reduced set of tests where there is a relevant **Manufacturers Data & Performance Report** as detailed in ECP.10 or an applicable **Equipment Certificate** has been accepted.

ECP.7.2.4 In the case of **Offshore Power Park Modules** which do not contribute to **Offshore Transmission Licensee Reactive Power** capability as described in ECC.6.3.2.5 or ECC.6.3.2.6 or Voltage Control as described in ECC.6.3.8.5 the tests outlined in ECP.7.2.2 (a) and ECP.7.2.2 (b) are not required. However, the offshore **Reactive Power** transfer tests outlined in ECP.A.5.8 shall be completed in their place.

ECP.7.2.5 Following completion of each of the tests specified in this ECP.7.2, **The Company** will notify the **Generator** or **HVDC System Owner** whether, in the opinion of **The Company**, the results demonstrate compliance with the relevant **Grid Code** conditions. When the **Generator** or **HVDC System Owner** submits test results to **The Company**, the **Generator** or **HVDC System Owner** may request **The Company** to advise when the notification is expected to be provided. **The Company** should not unduly delay the notification.

ECP.7.2.6 The **Generator** or **HVDC System Owner** is responsible for carrying out the tests and retains the responsibility for safety and personnel during the test.

ECP.7.3 Items for submission prior to issue of the **Final Operational Notification**

ECP.7.3.1 Prior to the issue of a **Final Operational Notification** the **Generator** or **HVDC System Owner** must submit to **The Company** to **The Company's** satisfaction:

- (a) updated **Planning Code** data (both **Standard Planning Data** and **Detailed Planning Data**), with validated actual values and updated estimates for the future including **Forecast Data** items such as **Demand**;
- (b) any items required by ECP.5.2 and ECP.6.2.3 or ECP.6.3.3 as applicable, updated by the **EU Code User** as necessary;
- (c) evidence to **The Company's** satisfaction that demonstrates that the controller models and/or parameters (as required under PC.A.5.3.2(c) option 2, PC.A.5.3.2(d) option 2, PC.A.5.4.2, and/or PC.A.5.4.3.2) supplied to **The Company** provide a reasonable representation of the behaviour of the **EU Code User's Plant** and **Apparatus** and **OTSUA** if applicable;
- (d) copies of **Manufacturer's Test Certificates** or **Equipment Certificates** issued by an **Authorised Certifier** or equivalent where these are relied upon as part of the evidence of compliance;

- (e) results from the tests required in accordance with ECP.7.2 carried out by the **Generator** to demonstrate compliance with relevant **Grid Code** requirements including the tests witnessed by **The Company**; and
- (f) the final **Compliance Statement** and a **User Self Certification of Compliance** signed by the **EU Code User** and a statement of any requirements that the **Generator** or **HVDC System Owner** has identified that have not been met together with a copy of the derogation in respect of the same from the **Authority**.

ECP.7.3.2 The items in ECP.7.3 should be submitted by the **Generator** (including in respect of any **OTSUA** if applicable) or **HVDC System Owner** using the **User Data File Structure**.

ECP.7.4 If the requirements of ECP.7.2 and ECP.7.3 have been successfully met, **The Company** will notify the **Generator** or **HVDC System Owner** that compliance with the relevant **Grid Code** provisions has been demonstrated for the **Power Generating Module(s)**, **OTSUA** if applicable or **HVDC Equipment** as applicable through the issue of a **Final Operational Notification**. In respect of an **Embedded Power Station** or **Embedded HVDC Equipment** other than an **Embedded Medium Power Stations** not subject to a **Bilateral Agreement** and **Embedded HVDC Equipment** not subject to a **Bilateral Agreement**, **The Company** will notify the **Network Operator** that a **Final Operational Notification** has been issued, subject to the requirement to confirm continued compliance as per CP.8.2 as part of the Compliance Repeat Plan.

ECP.7.5 If a **Final Operational Notification** cannot be issued because the requirements of ECP.7.2 and ECP.7.3 have not been successfully met prior to the expiry of an **Interim Operational Notification** then the **Generator** or **HVDC System Owner** (where licensed in respect of its activities) and/or **The Company** shall apply to the **Authority** for a derogation. The provisions of ECP.10 shall then apply.

Final Operational Notification in respect of Network Operator's and Non-Embedded Customer's Plant and Apparatus

ECP.7.6 The following provisions apply in relation to the issue of a **Final Operational Notification** in respect of **Network Operators** and **Non-Embedded Customers Plant and Apparatus**.

ECP.7.7 Prior to the issue of a **Final Operational Notification** the **Network Operator** and **Non-Embedded Customer** must have addressed the **Unresolved Issues** to **The Company's** satisfaction to demonstrate compliance with the relevant **Grid Code** provisions.

ECP.7.8 Prior to the issue of a **Final Operational Notification** the **Network Operator** and **Non-Embedded Customer** must submit to **The Company** to **The Company's** satisfaction:

- (a) updated **Planning Code** data (both **Standard Planning Data** and **Detailed Planning Data**), with validated actual values and updated estimates for the future including **Forecast Data** items such as **Demand**;
- (b) any items required by ECP.5.2 and ECP.6.4 updated by the **User** as necessary;

- (c) evidence to **The Company's** reasonable satisfaction that demonstrates that the models and/or parameters as required under PC.A.2.2, PC.A.2.3, PC.A.2.4, PC.A.2.5, PC.A.4 and PC.A.6 (as applicable), supplied to **The Company** provide a reasonable representation of the behaviour of the **User's Plant and Apparatus**;
- (d) copies of **Manufacturer's Test Certificates** or **Equipment Certificates** issued by an **Authorised Certifier** or equivalent where these are relied upon as part of the evidence of compliance;
- (e) results from the tests and simulations required in accordance with ECP.A.8 carried out by the **Network Operator** or **Non-Embedded Customer** to demonstrate compliance with relevant **Grid Code** requirements including any tests witnessed by **The Company**; and
- (f) the final **Compliance Statement** and a **User Self Certification of Compliance** signed by the **User** and a statement of any requirements that the **Network Operator** or **Non-Embedded Customer** has identified that have not been met together with a copy of the derogation in respect of the same from the **Authority**.

ECP.7.9 The items referred to at ECP.7.8 shall be submitted by the **Network Operator** or **Non-Embedded Customer** after successful completion of the tests required under ECP.7.8.

ECP.7.10 If the requirements of ECP.7.8 have been successfully met, **The Company** will notify the **Network Operator** or **Non-Embedded Customer** that compliance with the relevant **Grid Code** provisions has been demonstrated for **Network Operators** or **Non-Embedded Customers Plant and Apparatus** as applicable through the issue of a **Final Operational Notification**.

ECP.7.11 If a **Final Operational Notification** cannot be issued because the requirements of ECP.7.8 have not been successfully met prior to the expiry of an **Interim Operational Notification**, then the **Network Operator** or **Non-Embedded Customer** and/or **The Company** shall apply to the **Authority** for a derogation. The provisions of ECP.10 shall then apply.

ECP.8 COMPLIANCE REPEAT PLAN

ECP.8.1 No later than 4 calendar years and 6 months after the issue of a **Final Operational Notification**, **The Company** will notify the **Generator** or **HVDC System Owner** that confirmation of continued compliance with the requirements of the Grid Code and/or the **Bilateral Agreement**.

ECP.8.2 No later than 5 calendar years after the issue of a **Final Operational Notification**, the **Generator** or **HVDC System Owner** shall confirm that the **Plant** and/or **Apparatus** (including **OTSUA** if applicable) is fully compliant with the requirements of the Grid Code and/or the **Bilateral Agreement**. The confirmation of compliance will include:

- (a) a **Compliance Statement** and a **User Self Certification of Compliance** signed by the **EU Code User** and a statement of any requirements that the **Generator** or **HVDC System Owner** has identified that have not been met together with a copy of the derogation in respect of the same from **The Authority**.

- (b) complete set of relevant **Planning Code** data (both **Standard Planning Data** and **Detailed Planning Data**), with validated actual values and updated estimates for the future including **Forecast Data** items such as **Demand**. Simulation Studies and results from tests detailed in Appendix ECP.A.3 – ECP.A.8 inclusive are not required as part of the Compliance Repeat Plan.

For the avoidance of doubt the **Generator** or **HVDC System Owner** is responsible for ensuring that **Plant** and/or **Apparatus** (including **OTSUA** if applicable) remains compliant with the relevant clauses of the Grid Code and/or the **Bilateral Agreement** and/or connection site conditions notified by **The Company**.

ECP.8.3 If the requirements of ECP.8.2 have been completed to **The Company's** satisfaction, **The Company** will notify the **Generator** or **HVDC System Owner** that compliance with the relevant Grid Code provisions has been demonstrated for the **Power Generating Module(s)**, including **DC Connected Power Park Module(s)** and **OTSUA**, if applicable or **HVDC Equipment** as applicable through the issue of a **Final Operational Notification** subject to Compliance Repeat Plan (ECP.8) no later than 5 years from the date of issue. In respect of an **Embedded Power Station** or **Embedded DC Converter Station** other than **Embedded Medium Power Stations** not subject to a **Bilateral Agreement** and **Embedded HVDC Systems** not subject to a **Bilateral Agreement**, **The Company** will notify the **Network Operator** that a **Final Operational Notification** has been issued.

ECP.8.4 If a **Final Operational Notification** cannot be issued because the requirements of ECP.8.2 have not been successfully met prior to 5 years from the date of issue of the **Final Operational Notification**, then **The Company** will issue the **Generator** or **HVDC System Owner** (where licensed in respect of its activities) a **Limited Operational Notification** with respect to the **Unresolved Issues**. The provisions of ECP.9 shall then apply.

ECP.9 LIMITED OPERATIONAL NOTIFICATION

ECP.9.1 Following the issue of a **Final Operational Notification** for a **Power Station** consisting of **Type B**, **Type C** or **Type D Power Generating Module** or an **HVDC System** or **Network Operators** or **Non-Embedded Customers Plant** and **Apparatus** if:

- (i) the **Generator** or **HVDC System Owner** or **Network Operator** or **Non-Embedded Customer** becomes aware, that its **Plant** and/or **Apparatus'** (including **OTSUA** if applicable) capability to meet any provisions of the **Grid Code**, or where applicable the **Bilateral Agreement** is not fully available then the **Generator** or **HVDC System Owner** or **Network Operator** or **Non-Embedded Customer** shall follow the process in ECP.9.2 to ECP.9.11; or,
- (ii) a **Network Operator** becomes aware, that the capability of **Plant** and/or **Apparatus** belonging to an **Embedded Power Station** or **Embedded HVDC Equipment Station** (other than **Embedded Medium Power Stations** not subject to a **Bilateral Agreement** and **Embedded HVDC Equipment Stations** not subject to a **Bilateral Agreement**) is failing to meet any provisions of the **Grid Code**, or where applicable the **Bilateral Agreement**, then the **Network Operator** shall inform **The Company** and **The Company** shall inform

the **Generator** or **HVDC System Owner** to then follow the process in ECP.9.2 to ECP.9.11; or,

- (iii) **The Company** becomes aware through monitoring as described in OC5.4, that a **Generator** or **HVDC System Owner Plant** and/or **Apparatus** (including **OTSUA** if applicable) capability to meet any provisions of the **Grid Code**, or where applicable the **Bilateral Agreement** is not fully available then **The Company** shall inform the other party. Where **The Company** and the **Generator** or **HVDC System Owner** cannot agree from the monitoring as described in OC5.4 whether the **Plant and/or Apparatus** (including **OTSUA** if applicable) is fully available and/or is compliant with the requirements of the **Grid Code** and where applicable the **Bilateral Agreement**, the parties shall first apply the process in OC5.5.1, before applying the process defined in ECP.9 (**LON**) if applicable. Where the testing instructed in accordance with OC.5.5.1 indicates that the **Plant** and/or **Apparatus** (including **OTSUA** if applicable) is not fully available and/or is not compliant with the requirements of the **Grid Code** and/or the **Bilateral Agreement**, or if the parties so agree, the process in ECP.9.2 to ECP.9.11 shall be followed.
- (iv) **The Company** becomes aware that a **Network Operator's** or **Non-Embedded Customer's Plant** and **Apparatus** capability to meet any provisions of the **Grid Code**, or where applicable the **Bilateral Agreement**, is not fully available then **The Company** shall inform the other party and the process in ECP.9.2 to ECP.9.11 shall be followed.

ECP.9.2 Immediately upon a **Generator, HVDC System Owner, Network Operator** or **Non-Embedded Customer** becoming aware that its **Power Generating Module, OTSUA** (if applicable), **HVDC Equipment** or **Plant** and **Apparatus**, as applicable may be unable to comply with certain provisions of the **Grid Code** or (where applicable) the **Bilateral Agreement**, the **Generator, HVDC System Owner, Network Operator** or **Non-Embedded Customer** shall notify **The Company** in writing. Additional details of any operating restrictions or changes in applicable data arising from the potential non-compliance and an indication of the date from when the restrictions will be removed and full compliance demonstrated shall be provided as soon as reasonably practical.

ECP.9.3 If the nature of any unavailability and/or potential non-compliance described in ECP.9.1 causes or can reasonably be expected to cause a material adverse effect on the business or condition of **The Company** or other **Users** or the **National Electricity Transmission System** or any **User Systems**, then **The Company** may, notwithstanding the provisions of this ECP.9, follow the provisions of Paragraph 5.4 of the **CUSC**.

ECP.9.4 Except where the provisions of ECP.9.3 apply, where the restriction notified in ECP.9.2 is not resolved in 28 days, then

- (i) the **Generator** or **HVDC System Owner** with input from and discussion of conclusions with **The Company**, and the **Network Operator** where the **Synchronous Power Generating Module, CCGT Module, Power Park Module** or **Power Station** as applicable is **Embedded**, shall undertake an investigation to attempt to determine the causes of and determine a solution to the non-compliance. Such investigation shall continue for no longer than 56 days. During such investigation, the **Generator** or **HVDC System Owner** shall provide to **The Company** the relevant data which has changed due to the restriction in respect of ECP.7.3.1 as notified to the **Generator** or

HVDC System Owner by **The Company** as being required to be provided; or

- (ii) the **Network Operator** or **Non-Embedded Customer** in discussion with **The Company**, shall undertake an investigation to attempt to determine the causes of and a solution to the non-compliance. Such investigation shall continue for no longer than 56 days. During such investigation the **Network Operator** or **Non-Embedded Customer** shall provide to **The Company** the relevant data which has changed due to the restriction in respect of ECP.7.8 as being required to be provided by **The Company**.

ECP.9.5 Issue and Effect of LON

ECP.9.5.1 Following the issue of a **Final Operational Notification**, **The Company** will issue to the **Generator**, **HVDC System Owner**, **Network Operator** or **Non-Embedded Customer** a **Limited Operational Notification** if:

- (a) by the end of the 56 day period referred to at ECP.9.4, the investigation has not resolved the non-compliance to **The Company's** satisfaction; or
- (b) **The Company** is notified by a **Generator**, **HVDC System Owner** (including **OTSUA** if applicable), **Network Operator** or **Non-Embedded Customer** of a **Modification** to its **Plant** and **Apparatus**; or
- (c) **The Company** receives a submission of data, or a statement from a **Generator**, **HVDC System Owner** (including **OTSUA** if applicable), **Network Operator** or **Non-Embedded Customer** indicating a change in **Plant** or **Apparatus** or settings (including but not limited to governor and excitation control systems) that may in **The Company's** reasonable opinion, acting in accordance with **Good Industry Practice** be expected to result in a material change of performance.

In the case of an **Embedded Generator** or **Embedded HVDC System Owner**, **The Company** will issue a copy of the **Limited Operational Notification** to the **Network Operator**.

ECP.9.5.2 The **Limited Operational Notification** will be time limited (in the case of **Type D Power Generating Modules**, **HVDC Systems**, **Network Operator's** or **Non-Embedded Customer's Plant** and **Apparatus** to expire no later than 12 months from the start of the non-compliance or restriction or from reconnection following a change). **The Company** may agree a longer duration in the case of a **Limited Operational Notification** following a **Modification** or whilst the **Authority** is considering the application for a derogation in accordance with ECP.10.1.

ECP.9.5.3 The **Limited Operational Notification** will notify the **Generator**, **HVDC System Owner**, **Network Operator** or **Non-Embedded Customer** of any restrictions on the operation of the **Synchronous Power Generating Module(s)**, **CCGT Module(s)**, **Power Park Module(s)**, **OTSUA** if applicable, **HVDC Equipment** or **Plant** and **Apparatus** and will specify the **Unresolved Issues**. The **Generator**, **HVDC System Owner**, **Network Operator** or **Non-Embedded Customer** must operate in accordance with any notified restrictions and must resolve the **Unresolved Issues**.

ECP.9.5.4 The **User** and **The Company** will be deemed compliant with all the relevant provisions of the **Grid Code** provided operation is in accordance with the **Limited Operational Notification**, whilst it is in force, and that the provisions of and referred to in ECP.9 are complied with.

ECP.9.5.5 The **Unresolved Issues** included in a **Limited Operational Notification** will show the extent that the provisions of ECP.7.2 (testing) and ECP.7.3 (final data submission) or ECP.7.8 (d) - (e) (testing) and ECP.7.8 (a) – (c) (data submission, as applicable, shall apply. In respect of selecting the extent of any tests which may in **The Company's** view reasonably be needed to demonstrate the restored capability and in agreeing the time period in which the tests will be scheduled, **The Company** shall, where reasonably practicable, take account of the **Generator** or **HVDC System Owner's** input to contain its costs associated with the testing.

ECP.9.5.6 In the case of a change or **Modification**, the **Limited Operational Notification** may specify that the affected **Plant** and **Apparatus** (including **OTSUA** if applicable) or associated **Synchronous Power Generating Module(s)** or **Power Park Unit(s)** must not be **Synchronised** or, in the case of **Network Operator's** or **Non-Embedded Customer's Plant** and **Apparatus**, operated until all of the following items, that in **The Company's** reasonable opinion are relevant, have been submitted to **The Company** to **The Company's** satisfaction:

- (a) updated **Planning Code** data (both **Standard Planning Data** and **Detailed Planning Data**);
- (b) details of any relevant special **Power Station**, **Synchronous Power Generating Module(s)**, **Power Park Module(s)**, **OTSUA** (if applicable), **HVDC Equipment Station(s)** or **Network Operator's** or **Non-Embedded Customer's Plant** and **Apparatus** protection as applicable. This may include Pole Slipping protection and islanding protection schemes; and
- (c) simulation study provisions of Appendix ECP.A.3 or Appendix ECP.A.8 as appropriate and the results demonstrating compliance with **Grid Code** requirements relevant to the change or **Modification** as agreed by **The Company**; and
- (d) a detailed schedule of the tests and the procedures for the tests required to be carried out by the **Generator**, **HVDC Equipment Station**, **Network Operator** or **Non-Embedded Customer** to demonstrate compliance with relevant **Grid Code** requirements as agreed by **The Company**. The schedule of tests shall be consistent with Appendix ECP.A.5, Appendix ECP.A.6 or Appendix ECP.A.8 as appropriate; and
- (e) an interim **Compliance Statement** and a **User Self Certification of Compliance** completed by the **User** (including any **Unresolved Issues**) against the relevant **Grid Code** requirements including details of any requirements that the **Generator**, **HVDC System Owner**, **Network Operator** or **Non-Embedded Customer** has identified that will not or may not be met or demonstrated; and
- (f) any other items specified in the **LON**.

ECP.9.5.7 The items referred to in ECP.9.5.6 shall be submitted by the **Generator** (including in respect of any **OTSUA** if applicable) or **HVDC System Owner** using the **User Data File Structure** or **Power Generation Module Document** as applicable.

ECP.9.5.8 In the case of **Synchronous Power Generating Module(s)** only, the **Unresolved Issues** of the **LON** may require that the **Generator** must complete the following tests to **The Company's** satisfaction to demonstrate compliance

with the relevant provisions of the **ECCs** prior to the **Synchronous Power Generating Module** being **Synchronised** to the **Total System**:

- (a) those tests required to establish the open and short circuit saturation characteristics of the **Synchronous Power Generating Module** (as detailed in Appendix ECP.A.5.3) to enable assessment of the short circuit ratio in accordance with ECC.6.3.2.3.4 or ECC.6.3.2.5. Such tests may be carried out at a location other than the **Power Station** site; and
- (b) open circuit step response tests (as detailed in Appendix ECP.A.5.2) to demonstrate compliance with ECC.A.6.2.4.1.

ECP.9.6 In the case of a change or **Modification**, not less than 28 days, or such shorter period as may be acceptable in **The Company's** reasonable opinion:

- (a) prior to the **Generator** or **HVDC System Owner** (including OTSUA if applicable) wishing to **Synchronise** its **Plant** and **Apparatus** for the first time following the change or **Modification**, the **Generator** or **HVDC System Owner** will:
 - (i) submit a **Notification of User's Intention to Synchronise**; and
 - (ii) submit to **The Company** the items referred to at ECP.9.5.6.
- (b) prior to the **Network Operator** or **Non-Embedded Customer** wishing to operate its **Plant** and **Apparatus** for the first time following the change or **Modification**, the **Network Operator** or **Non-Embedded Customer** will:
 - (i) submit a **Notification of User's intention to operate**; and
 - (ii) submit to **The Company** the items referred to at ECP.9.5.6

ECP.9.7 Other than **Unresolved Issues** that are subject to tests to be witnessed by **The Company**, the **Generator**, **HVDC System Owner**, **Network Operator** or **Non-Embedded Customer** must resolve any **Unresolved Issues** prior to the commencement of the tests, unless **The Company** agrees to a later resolution. The **Generator**, **HVDC System Owner**, **Network Operator** or **Non-Embedded Customer** must liaise with **The Company** in respect of such resolution. The tests that may be witnessed by **The Company** are specified in ECP.7.2.2.

ECP.9.8 Not less than 28 days, or such shorter period as may be acceptable in **The Company's** reasonable opinion, prior to the **Generator** or **HVDC System Owner** wishing to commence tests listed as **Unresolved Issues** to be witnessed by **The Company**, the **Generator** or **HVDC System Owner** will notify **The Company** that the **Synchronous Power Generating Module(s)**, **CCGT Module(s)**, **Power Park Module(s)**, **OTSUA** if applicable or **HVDC Equipment** as applicable is ready to commence such tests.

ECP.9.9 The items referred to at ECP.7.3 or ECP.7.8 as applicable and listed as **Unresolved Issues** shall be submitted by the **Generator**, **HVDC System Owner**, **Network Operator** or **Embedded Customer** after successful completion of the tests.

ECP.9.10 Where the **Unresolved Issues** have been resolved a **Final Operational Notification** will be issued to the **User**.

ECP.9.11 If a **Final Operational Notification** has not been issued by **The Company** as referred to at ECP.9.5.2 (or where agreed following a **Modification** by the

expiry time of the LON) then the **Generator, HVDC System Owner, Network Operator or Non-Embedded Customer** (where licensed in respect of its activities) and **The Company** shall apply to the **Authority** for a derogation.

ECP.10 PROCESSES RELATING TO DEROGATIONS

ECP.10.1 Whilst the **Authority** is considering the application for a derogation, the **Interim Operational Notification** or **Limited Operational Notification** will be extended to remain in force until the **Authority** has notified **The Company** and the **Generator, HVDC System Owner, Network Operator or Non-Embedded Customer** of its decision. Where the **Generator or HVDC System Owner** is not licensed, **The Company** may propose any necessary changes to the **Bilateral Agreement** with such unlicensed **Generator or HVDC System Owner**.

ECP.10.2 If the **Authority**:

- (a) grants a derogation in respect of the **Plant and/or Apparatus**, then **The Company** shall issue **Final Operational Notification** once all other **Unresolved Issues** are resolved; or
- (b) decides a derogation is not required in respect of the **Plant and/or Apparatus** then **The Company** will reconsider the relevant **Unresolved Issues** and may issue a **Final Operational Notification** once all other **Unresolved Issues** are resolved; or
- (c) decides not to grant any derogation in respect of the **Plant and/or Apparatus**, then there will be no **Operational Notification** in place and **The Company** and the **User** shall consider its rights pursuant to the **CUSC**.

ECP.10.3 Where an **Interim Operational Notification** or **Limited Operational Notification** is so conditional upon a derogation and such derogation includes any conditions (including any time limit to such derogation) the **Generator, HVDC System Owner, Network Operator or Non-Embedded Customer** will progress the resolution of any **Unresolved Issues** and / or progress and / or comply with any conditions upon such derogation and the provisions of ECP.6 to ECP.7.11 shall apply and shall be followed.

ECP.11 MANUFACTURER'S DATA & PERFORMANCE REPORT

ECP.11.1.1 Data and performance characteristics in respect of certain **Grid Code** requirements may be registered with **The Company** by **Power Park Unit** manufacturers in respect of specific models of **Power Park Units** by submitting information in the form of a **Manufacturer's Data and Performance Report** to **The Company**.

ECP.11.1.2 A **Generator** planning to construct a new **Power Station** containing the appropriate version of **Power Park Units** in respect of which a **Manufacturer's Data & Performance Report** has been submitted to **The Company** may reference the **Manufacturer's Data & Performance Report** in its submissions to **The Company**. Any **Generator** considering referring to a **Manufacturer's Data & Performance Report** for any aspect of its **Plant and Apparatus** may contact **The Company** to discuss the suitability of the relevant **Manufacturer's Data & Performance Report** to its project to determine if, and to what extent, the data included in the **Manufacturer's Data & Performance Report** contributes towards demonstrating compliance with those aspects of the **Grid Code** applicable to the **Generator**. **The Company** will inform the **Generator** if the reference to the **Manufacturer's Data & Performance Report** is not appropriate or not sufficient for its project.

- ECP.11.1.3 The process to be followed by **Power Park Unit** manufacturers submitting a **Manufacturer's Data & Performance Report** is agreed by **The Company**. ECP.11.2 indicates the specific **Grid Code** requirement areas in respect of which a **Manufacturer's Data & Performance Report** may be submitted.
- ECP.11.1.4 **The Company** will maintain and publish a register of those **Manufacturer's Data & Performance Reports** which **The Company** has received and accepted as being an accurate representation of the performance of the relevant **Plant** and / or **Apparatus**. Such register will identify the manufacturer, the model(s) of **Power Park Unit(s)** to which the report applies and the provisions of the **Grid Code** in respect of which the report contributes towards the demonstration of compliance. The inclusion of any report in the register does not in any way confirm that any **Power Park Modules** which utilise any **Power Park Unit(s)** covered by a report is or will be compliant with the **Grid Code**.
- ECP.11.2 A **Manufacturer's Data & Performance Report** in respect of **Power Park Units** may cover one (or part of one) or more of the following provisions of the **Grid Code**:
- (a) Fault Ride Through capability ECC.6.3.15, ECC.6.3.16.
 - (b) Power Park Module mathematical model PC.A.5.4.2.
- ECP.11.3 Reference to a **Manufacturer's Data & Performance Report** in a **EU Code User's** submissions does not by itself constitute compliance with the **Grid Code**.
- ECP.11.4 A **Generator** referencing a **Manufacturer's Data & Performance Report** should insert the relevant **Manufacturer's Data & Performance Report** reference in the appropriate place in the **DRC** data submission, **Power Generating Module Document** and / or in the **User Data File Structure**. **The Company** will consider the suitability of a **Manufacturer's Data & Performance Report**:
- (a) in place of **DRC** data submissions, a mathematical model suitable for representation of the entire **Power Park Module** as per ECP.A.3.4.4. For the avoidance of doubt only the relevant sections as specified in PC.A.2.5.5.7 apply. Site specific parameters will still need to be submitted by the **Generator**.
 - (b) Not Used.
 - (c) to reduce the scope of compliance site tests as follows;
 - (i) Where there is a **Manufacturer's Data & Performance Report** in respect of a **Power Park Unit** which covers Fault Ride Through, **The Company** may agree that no Fault Ride Through testing is required.
- ECP.11.5 It is the responsibility of the **EU Code User** to ensure that the correct reference for the **Manufacturer's Data & Performance Report** is used and the **EU Code User** by using that reference accepts responsibility for the accuracy of the information. The **EU Code User** shall ensure that the manufacturer has kept **The Company** informed of any relevant variations in plant specification since the submission of the relevant **Manufacturer's Data & Performance Report** which could impact on the validity of the information.

ECP.11.6 **The Company** may contact the **Power Park Unit** manufacturer directly to verify the relevance of the use of such **Manufacturer's Data & Performance Report**. If **The Company** believe the use some or all of such **Manufacturer's Data & Performance Report** information is incorrect or the referenced data is inappropriate, then the reference to the **Manufacturer's Data & Performance Report** may be declared invalid by **The Company**. Where, and to the extent possible, the data included in the **Manufacturer's Data & Performance Report** is appropriate, the compliance assessment process will be continued using the data included in the **Manufacturer's Data & Performance Report**.

ECP.11.7 In the case of a co-located site, for example **Electricity Storage Modules** or **Grid Forming Plant** connected within a new or existing **Power Station**, **The Company** will accept demonstration of compliance at the **Grid Entry Point** or **User System Entry Point** (if **Embedded**) through a combination of the capabilities of the **Power Generating Modules** and **Electricity Storage Modules** (which could include **Grid Forming Plant**) or **Electricity Storage Modules** and **Generating Units** or **Power Park Modules** (which could include **Grid Forming Plant**). **Generators** or **Grid Forming Plant Owners** should however be aware that for the purposes of compliance, full Grid Code compliance should be demonstrated when, for example, the **Electricity Storage Module** or **Grid Forming Plant** is out of service and the remaining **Power Generating Module** is in service or the **Electricity Storage Module** or **Grid Forming Plant** is in service and the **Power Generating Module** is out of service. Equally, **The Company** will accept **Manufacturer's Data & Performance Reports** for the purposes of proving compliance at co-located sites.

APPENDIX 1
NOT USED

APPENDIX 2

USER SELF CERTIFICATION OF COMPLIANCE (Interim/Final)

Power Station/ HVDC Equipment Station	[Name of Connection Site/site of connection]	User:	[Full User name]	Maximum Capacity (MW) of Plant:	
----------------------------------------------------------	----------------------------------------------------	--------------	------------------	------------------------------------------------	--

This **User Self Certification of Compliance** records the compliance by the **EU Code User** in respect of [NAME] **Power Station/HVDC Equipment Station** with the **Grid Code** and the requirements of the **Bilateral Agreement** and **Construction Agreement** dated [] with reference number []. It is completed by the **Power Station/HVDC System Owner** in the case of **Plant** and/or **Apparatus** connected to the **National Electricity Transmission System** and for **Embedded Plant**.

We have recorded our compliance against each requirement of the **Grid Code** which applies to the **Power Station/HVDC Equipment Station**, together with references to supporting evidence and a commentary where this is appropriate, and have provided this to **The Company**. A copy of the **Compliance Statement** is attached.

Supporting evidence, in the form of simulation results, test results, manufacturer’s data and other documentation, is attached in the **User Data File Structure**.

The **EU Code User** hereby certifies that, to the best of its knowledge and acting in accordance with **Good Industry Practice**, the **Power Station** is compliant with the **Grid Code** and the **Bilateral Agreement** in all aspects [with the following **Unresolved Issues***] [with the following derogation(s)**]:

Connection Condition	Requirement	Ref:	Issue

Compliance certified by:	Name:	Title:
	[PERSON]	[PERSON DESIGNATION]
	Signature:	Of
	[PERSON]	[User details]
	Date:	

* Include for Interim **User Self Certification of Compliance** ahead of **Interim Operational Notification**.

** Include for final **User Self Certification of Compliance** ahead of **Final Operational Notification** where derogation(s) have been granted. If no derogation(s) required delete wording and Table.

APPENDIX 3

SIMULATION STUDIES

ECP.A.3.1 SCOPE

- ECP.A.3.1.1 This Appendix sets out the simulation studies required to be submitted to **The Company** to demonstrate compliance with the **European Connection Conditions** unless otherwise agreed with **The Company**. This Appendix should be read in conjunction with ECP.6 with regard to the submission of the reports to **The Company**. Where there is any inconsistency in the technical requirements in respect of which compliance is being demonstrated by simulation in this Appendix and ECC.6.3 and the **Bilateral Agreement**, the provisions of the **Bilateral Agreement** and ECC.6.3 prevail. The studies specified in this Appendix will normally be sufficient to demonstrate compliance. However, **The Company** may agree an alternative set of studies proposed by the **Generator** or **HVDC System Owner** provided **The Company** deem the alternative set of studies sufficient to demonstrate compliance with the **Grid Code** and the **Bilateral Agreement**.
- ECP.A.3.1.2 The **Generator** or **HVDC System Owner** shall submit simulation studies in the form of a report to demonstrate compliance. In all cases the simulation studies must utilise models applicable to the **Synchronous Power Generating Module**, **HVDC Equipment** or **Power Park Module** with proposed or actual parameter settings. Reports should be submitted in English with all diagrams and graphs plotted clearly with legible axes and scaling provided to ensure any variations in plotted values is clear. In all cases, the simulation studies must be presented over a sufficient time period to demonstrate compliance with all applicable requirements.
- ECP.A.3.1.3 In the case of an **Offshore Power Station** where **OTSDUW Arrangements** apply simulation studies, the **Generator** should include the action of any relevant **OTSUA** where applicable to demonstrate compliance with the **Grid Code** and the **Bilateral Agreement** at the **Interface Point**.
- ECP.A.3.1.4 **The Company** will permit relaxation from the requirement ECP.A.3.2 to ECP.A.3.8 where an **Equipment Certificate** for the **Power Generating Module** or **HVDC Equipment** has been provided which details the characteristics from appropriate simulations on a representative installation with the same equipment and settings and the performance of the **Power Generating Module** or **HVDC Equipment** can, in **The Company's** opinion, reasonably represent that of the installed **Power Generating Module** or **HVDC Equipment**.
- ECP.A.3.1.5 For **Type B**, **Type C** and **Type D Power Generating Modules** the relevant **Equipment Certificate** must be supplied in the **Power Generating Module Document** or **Users Data File structure** as applicable. For **HVDC Equipment** the relevant **Equipment Certificates** must be supplied in the **Users Data File structure**.
- ECP.A.3.1.6 In the case of a co-located site, for example **Electricity Storage Modules** or **Grid Forming Plant** connected within a new or existing **Power Station**, **The Company** will accept simulation studies to demonstrate compliance at the **Grid Entry Point** or **User System Entry Point** (if **Embedded**) through a combination of the capabilities of the **Power Generating Modules** (which could include **Grid Forming Plant**) and **Electricity Storage Modules** or **Electricity Storage Modules** (which could include **Grid Forming Plant**) and **Generating Units** or **Power Park Modules**. **Generators** should however be aware that for the purposes of simulations, full **Grid Code** compliance should be demonstrated when, for example, the **Electricity Storage Module** or **Grid**

Forming Plant is out of service and the remaining **Power Generating Module** is in service or the **Electricity Storage Module** or **Grid Forming Plant** is in service and the **Power Generating Module** is out of service.

ECP.A.3.2 Power System Stabiliser Tuning

ECP.A.3.2.1 In the case of a **Synchronous Power Generating Module** with an **Excitation System Power System Stabiliser** the **Power System Stabiliser** tuning simulation study report required by ECC.A.6.2.5.6 or required by the **Bilateral Agreement** shall contain:

- (i) the **Excitation System** model including the **Power System Stabiliser** with settings as required under the **Planning Code** (PC.A.5.3.2(c)).
- (ii) open circuit time series simulation study of the response of the **Excitation System** to a +10% step change from 90% to 100% terminal voltage.
- (iii) on load time series dynamic simulation studies of the response of the **Excitation System** with and without the **Power System Stabiliser** to 2% and 10% steps in the reference voltage and a three phase short circuit fault applied to the higher voltage side of the **Synchronous Power Generating Module** transformer for 100ms. The simulation studies should be carried out with the **Synchronous Power Generating Module** operating at full **Active Power** and maximum leading **Reactive Power** import with the fault level at the **Supergrid** HV connection point at minimum or as otherwise agreed with **The Company**. The results should show the **Synchronous Power Generating Module** field voltage, terminal voltage, **Power System Stabiliser** output, **Active Power** and **Reactive Power** output.
- (iv) gain and phase Bode diagrams for the open loop frequency domain response of the **Synchronous Power Generating Module Excitation System** with and without the **Power System Stabiliser**. These should be in a suitable format to allow assessment of the phase contribution of the **Power System Stabiliser** and the gain and phase margin of the **Excitation System** with and without the **Power System Stabiliser** in service.
- (v) an eigenvalue plot to demonstrate that all modes remain stable when the **Power System Stabiliser** gain is increased by at least a factor of 3 from the designed operating value.
- (vi) gain Bode diagram for the closed loop on load frequency domain response of the **Synchronous Power Generating Module Excitation System** with and without the **Power System Stabiliser**. The **Synchronous Power Generating Module** operating at full load and at unity power factor. These diagrams should be in a suitable format to allow comparison of the **Active Power** damping across the frequency range specified in ECC.A.6.2.6.3 with and without the **Power System Stabiliser** in service.

In the case of a **Synchronous Power Generating Module** that may operate as **Demand** (e.g. **Pump Storage**) the on-load simulations (ii) to (vi) should also be carried out in both modes of operation.

ECP.A.3.2.2 In the case of **Onshore Non-Synchronous Power Generating Module, Onshore HVDC Equipment** and **Onshore Power Park Modules** and

OTSDUW Plant and Apparatus at the **Interface Point** the **Power System Stabiliser** tuning simulation study report required by ECC.A.7.2.4.1 or ECC.A.8.2.4 or required by the **Bilateral Agreement** shall contain:

- (i) the **Voltage Control System** model including the **Power System Stabiliser** with settings as required under the **Planning Code** (PC.A.5.4) and **Bilateral Agreement**.
- (ii) on load time series dynamic simulation studies of the response of the **Voltage Control System** with and without the **Power System Stabiliser** to 2% and 10% steps in the reference voltage and a three phase short circuit fault applied to the **Grid Entry Point** or the **Interface Point** in the case of **OTSDUW Plant and Apparatus** for 100ms. The simulation studies should be carried out operating at full **Active Power** and maximum leading **Reactive Power** import condition with the fault level at the **Supergrid** HV connection point at minimum or as otherwise agreed with **The Company**. The results should show appropriate signals to demonstrate the expected damping performance of the **Power System Stabiliser**.
- (iii) any other simulation as specified in the **Bilateral Agreement** or agreed between the **Generator** or **HVDC System Owner** or **Offshore Transmission Licensee** and **The Company**.

ECP.A.3.3 Reactive Capability across the Voltage Range

- ECP.A.3.3.1 (a) For a **Synchronous Power Generating Module**, the **Generator** shall supply simulation studies to demonstrate the capability to meet ECC.6.3.2 by submission of a report containing load flow simulation study results to demonstrate:
- (i) the maximum lagging **Reactive Power** capability at **Maximum Capacity** when the **Grid Entry Point** or **User System Entry Point** if **Embedded** or **Interface Point** (in the case of **OTSUA**) voltage is at 105% of nominal.
 - (ii) the maximum leading **Reactive Power** capability at **Maximum Capacity** when the **Grid Entry Point** or **User System Entry Point** if **Embedded** or **Interface Point** (in the case of **OTSUA**) voltage is at 95% of nominal.
 - (iii) the maximum lagging **Reactive Power** capability at the **Minimum Stable Operating Level** when the **Grid Entry Point** or **User System Entry Point** if **Embedded** or **Interface Point** (in the case of **OTSUA**) voltage is at 105% of nominal.
 - (iv) the maximum leading **Reactive Power** capability at the **Minimum Stable Operating Level** when the **Grid Entry Point** or **User System Entry Point** if **Embedded** or **Interface Point** (in the case of **OTSUA**) voltage is at 95% of nominal.
- (b) For an **OSTUA** with an **Interface Point** above 33kV or **Power Park Modules** with a **Grid Entry Point** or **User System Entry Point** above 33kV, the **Generator** shall demonstrate the capability to meet ECC.6.3.2 by submission of a report containing load flow simulation study results to demonstrate operation at points A, B, E and F in accordance with Figure ECC.A.7.2.2(b) or Figure ECC.A.8.2.2(b). The studies should be run with both the **OTSUA** and **Power Park Module** operating at **Maximum Capacity** and at the **Minimum Stable Operating Level**.

- (c) For an **OSTUA** with an **Interface Point** at or below 33kV or **Power Park Modules** with a **Grid Entry Point** or **User System Entry Point** at or below 33kV, a load flow simulation study results to demonstrate operation at points A, B, E and F in accordance with Figure ECC.A.7.2.2(c) or Figure ECC.A.8.2.2(b). The studies should be run with both the **OTSUA** and **Power Park Module** operating at **Maximum Capacity** and at the **Minimum Stable Operating Level**.
- (d) For an **HVDC system**, the **HVDC System Owner** shall supply simulation studies to demonstrate the capability to meet ECC.6.3.2 by submission of a report containing load flow simulation study results to demonstrate operation at points A, B, E and F in accordance with Figure ECC.A.7.2.2(b). The studies should be run with both the **HVDC System** operating at the **Maximum HVDC Active Power Transmission Capacity** and **Minimum HVDC Active Power Transmission Capacity**.

ECP.A.3.3.2 In the case of a **Synchronous Power Generating Module** the terminal voltage in the simulation should be the nominal voltage for the machine.

ECP.A.3.3.3 In the case of a **Power Park Module** where the load flow simulation studies show that the individual **Power Park Units** deviate from nominal voltage to meet the **Reactive Power** requirements then evidence must be provided from factory (e.g. in a **Manufacturer's Data & Performance Report**) or site testing that the **Power Park Unit** is capable of operating continuously at the operating points determined in the load flow simulation studies.

ECP.A.3.4 Voltage Control and Reactive Power Stability

ECP.A.3.4.1 This section applies to **HVDC Equipment**; and **Type C & Type D Power Park Modules** to demonstrate the voltage control capability and **Type B Power Park Modules** to demonstrate the voltage control capability if specified by **The Company**.

In the case of a **Power Station** containing **Power Park Modules** and/or **OTSUA**, the **Generator** shall provide a report to demonstrate the dynamic capability and control stability of the **Power Park Module**. The report shall contain:

- (i) a dynamic time series simulation study result of a sufficiently large negative step in **System** voltage to cause a change in **Reactive Power** from zero to the maximum lagging value at **Rated MW**.
- (ii) a dynamic time series simulation study result of a sufficiently large positive step in **System** voltage to cause a change in **Reactive Power** from zero to the maximum leading value at **Rated MW**.
- (iii) a dynamic time series simulation study result to demonstrate control stability at the lagging **Reactive Power** limit by application of a -2% voltage step while operating within 5% of the lagging **Reactive Power** limit.
- (iv) a dynamic time series simulation study result to demonstrate control stability at the leading **Reactive Power** limit by application of a +2% voltage step while operating within 5% of the leading **Reactive Power** limit.

- (v) a dynamic time series simulation study result of a sufficiently large negative step in **System** voltage to cause a change in **Reactive Power** from the maximum leading value to the maximum lagging value at **Rated MW**.

The **Generator** should also provide the voltage control study specified in ECP.A.3.7.4.

ECP.A.3.4.2 All the above studies should be completed with a network operating at the voltage applicable for zero **Reactive Power** transfer at the **Grid Entry Point** or **User System Entry Point** if **Embedded** or, in the case of **OTSUA, Interface Point** unless stated otherwise. The fault level at the HV connection point should be set at the minimum level as agreed with **The Company**.

ECP.A.3.5 Fault Ride Through and Fast Fault Current Injection

ECP.A.3.5.1 This section applies to **Type B, Type C and Type D Power Generating Modules** and **HVDC Equipment** to demonstrate the modules **Fault Ride Through** and **Fast Fault Current** injection capability.

The **Generator** or **HVDC System Owner** shall supply time series simulation study results to demonstrate the capability of **Synchronous Power Generating Module, HVDC Equipment, and Power Park Modules** and **OTSUA** to meet ECC.6.3.15 and ECC.6.3.16 by submission of a report containing:

- (i) a time series simulation study of a 140ms three phase short circuit fault with a retained voltage as detailed in table A.3.5.1 below applied at the **Grid Entry Point** or (**User System Entry Point** if **Embedded**) of the **Power Generating Module** or **HVDC Equipment** or **OTSUA**.
- (ii) a time series simulation study of 140ms unbalanced short circuit faults with a retained voltage as detailed in table 1 on the faulted phase(s) applied at the **Grid Entry Point** or (**User System Entry Point** if **Embedded**) of the **Power Generating Module** or **HVDC Equipment** or **OTSUA**. The unbalanced faults to be simulated are:
 1. a phase to phase fault
 2. a two phase to earth fault
 3. a single phase to earth fault.

Power Generating Module	Retained Voltage
Synchronous Power Generating Module	
Type B	30%
Type C or Type D with Grid connection point voltage <110kV	10%
Type D with connection point voltage >110kV	0%
Power Park Module	
Type B or Type C or Type D with connection point voltage < 110kV	10%
Type D with connection point voltage >110kV	0%
HVDC Equipment	0%

Table A.3.5.1

For a **Power Generating Module** or **HVDC Equipment** or **OTSUA** the simulation study should be completed with the **Power Generating Module** or **HVDC Equipment** or **OTSUA** operating at full **Active Power** and maximum leading **Reactive Power** and the fault level at

the **Supergrid** HV connection point at minimum or as otherwise agreed with **The Company** as detailed in ECC.6.3.15.8.

- (iii) time series simulation studies of balanced **Supergrid** voltage dips applied on the nearest point of the **National Electricity Transmission System** operating at **Supergrid** voltage to the **Synchronous Power Generating Module** or **OTSUA**. The simulation studies should include:

1. 50% retained voltage lasting 0.45 seconds
2. 70% retained voltage lasting 0.81 seconds
3. 80% retained voltage lasting 1.00 seconds
4. 85% retained voltage lasting 180 seconds.

For a **Synchronous Power Generating Module** or **OTSUA**, the simulation study should be completed with the **Synchronous Power Generating Module** or **OTSUA** operating at full **Active Power** and zero **Reactive Power** output and the fault level at the **Supergrid** HV connection point at minimum or as otherwise agreed with **The Company**. Where the **Synchronous Power Generating Module** is **Embedded**, the minimum **Network Operator's System** impedance to the **Supergrid HV Connection Point** shall be used which may be calculated from the maximum fault level at the **User System Entry Point**.

- (iv) time series simulation studies of balanced **Supergrid** voltage dips applied on the nearest point of the **National Electricity Transmission System** operating at **Supergrid** voltage to the **HVDC Equipment** or **Power Park Module**. The simulation studies should include:

1. 30% retained voltage lasting 0.384 seconds
2. 50% retained voltage lasting 0.71 seconds
3. 80% retained voltage lasting 2.5 seconds
4. 85% retained voltage lasting 180 seconds.

For **Power Park Modules** the simulation study should be completed with the **HVDC Equipment** or **Power Park Module** operating at full **Active Power** and zero **Reactive Power** output and the fault level at the **Supergrid HV Connection Point** at minimum or as otherwise agreed with **The Company**. Where the **Power Park Module** is **Embedded** the minimum **Network Operator's System** impedance to the **Supergrid HV Connection Point** shall be used which may be calculated from the maximum fault level at the **User System Entry Point**.

- (v) time series simulation studies of balanced **Supergrid** voltage dips applied on the nearest point of the **National Electricity Transmission System** operating at **Supergrid** voltage to the **HVDC Equipment**. The simulation studies should include:

1. 30% retained voltage
2. 50% retained voltage
3. 80% retained voltage
4. 85% retained voltage

For **HVDC Equipment** the simulation study should be completed with the **HVDC Equipment** operating at full **Active Power** transfer and zero **Reactive Power** output and the fault level at the **Supergrid** HV connection point at minimum or as otherwise agreed with **The Company**. Where the **HVDC Equipment** is **Embedded** the minimum **Network Operator's System** impedance to the **Supergrid** HV

connection point shall be used which may be calculated from the maximum fault level at the **User System Entry Point**.

For **HVDC Equipment** the duration of each voltage dip 1 to 4 above should demonstrate the requirements of the **Bilateral Agreement**.

- ECP.A.3.5.2 Not Used.
- ECP.A.3.5.3 In the case of a **Power Park Module** the studies detailed in ECP.A.3.5.1 should be repeated to demonstrate compliance during foreseeable running arrangements resulting from outages of major **Plant** and **Apparatus** (for example outage of the main export cable in the case of **OTSDUW** or module step up transformer where alternative export connections are possible). For these conditions, the **Power Park Module Active Power** output may be reduced to levels appropriate to the planned operating regime proposed by the **Generator**. The **Generator** shall consult **The Company** on alternative running arrangements and agree with **The Company** the running arrangements that will be studied prior to the **Generator** undertaking the studies. For the avoidance of doubt, compliance of a **Power Park Module** with **Fault Ride Through** requirements remains the responsibility of the **Generator** under all operating conditions.
- ECP.A.3.5.4 In the case of a **Power Park Module** with a **Registered Capacity** greater or equal to 100MW, the studies detailed in ECP.A.3.5.1 should be repeated with 50% of the **Power Park Units Synchronised** to the **Total System**. In the case of a **Power Station** containing multiple **Power Park Modules** or multiple **Offshore Power Park Modules** connected to an **Offshore Transmission System** or **OTSDUW** the study should include all **Power Park Modules** with 50% of the **Power Park Units Synchronised** to the **Total System**.
- ECP.A.3.5.5 In the case of **HVDC Equipment** the studies detailed in ECP.A.3.5.1 should be repeated to demonstrate compliance during foreseeable running arrangements resulting from outages of major **Plant** and **Apparatus** (for example outage of an HVDC cable or convertor. For these conditions, the **HVDC Equipment Active Power** transfer may be reduced to levels appropriate to the planned operating regime. The **Generator** or **HVDC System Owner** shall consult **The Company** on alternative running arrangements and agree with **The Company** the running arrangements that will be studied prior to the **Generator** or **HVDC System Owner** undertaking the studies. For the avoidance of doubt, compliance of **HVDC Equipment** with **Fault Ride Through** requirements remains the responsibility of the **Generator** or **HVDC System Owner** under all operating conditions.
- ECP.A.3.6 **Limited Frequency Sensitive Mode – Over Frequency (LFSM-O)**
- ECP.A.3.6.1 This section applies to **Type B, Type C and Type D Power Generating Modules, HVDC Equipment** to demonstrate the capability to modulate **Active Power** at high frequency as required by ECC6.3.7.3.5(ii).
- ECP.A.3.6.2 The simulation study should comprise of a **Power Generating Module** or **HVDC Equipment** connected to the total **System** with a local load shown as “X” in figure ECP.A.3.6.1. The load “X” is in addition to any auxiliary load of the **Power Station** connected directly to the **Power Generating Module** or **HVDC Equipment** and represents a small portion of the **System** to which the **Power Generating Module** or **HVDC Equipment** is attached. The value of “X” should be the minimum for which the **Power Generating Module** or **HVDC**

Equipment can control the power island **Frequency** to less than 52Hz consistent with ECC.6.3.7.3.5(ii). Where transient excursions above 52Hz occur the **Generator** or **HVDC Equipment Owner** should ensure that the duration above 52Hz is less than any high **Frequency** protection system applied to the **Power Generating Module** or **HVDC Equipment**.

ECP.A.3.6.3 For **HVDC Equipment** and **Power Park Modules** consisting of units connected wholly by power electronic devices the simulation methodology may be modified by the addition of a **Synchronous Power Generating Module** (G2) connected as indicated in Figure ECP.A.3.6.2. This additional **Synchronous Power Generating Module** should have an inertia constant of 3.5MWs/MVA, be initially operating at rated power output and unity **Power Factor**. The mechanical power of the **Synchronous Power Generating Module** (G2) should remain constant throughout the simulation.

ECP.A.3.6.4 At the start of the simulation study the **Power Generating Module** or **HVDC Equipment** will be operating maximum **Active Power** output. The **Power Generating Module** or **HVDC Equipment** will then be islanded from the **Total System** but still supplying load "X" by the opening of a breaker, which is not the **Power Generating Module** or **HVDC Equipment** connection circuit breaker (the governor should therefore, not receive any signals that the breaker has opened other than the reduction in load and subsequent increase in speed). A schematic arrangement of the simulation study is illustrated by Figure ECP.A.3.6.1.

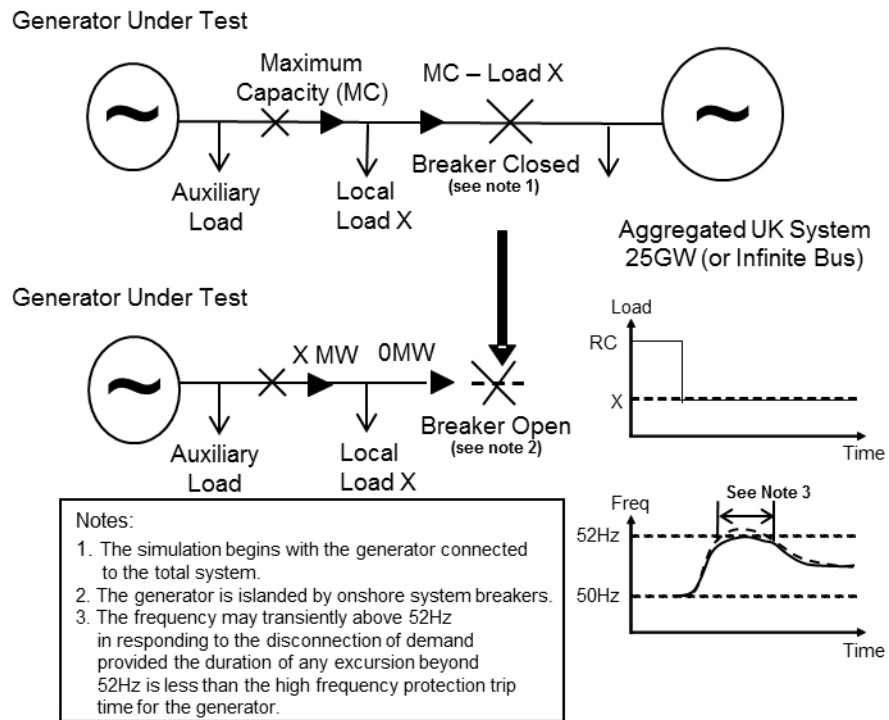

Figure ECP.A.3.6.1 – Diagram of Load Rejection Study

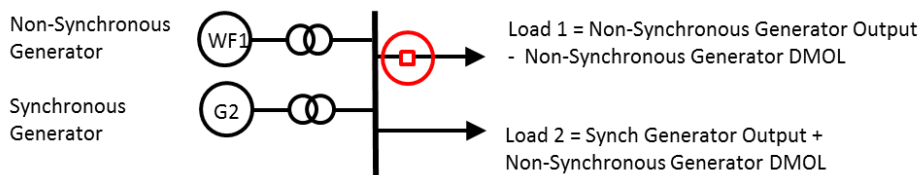

Figure ECP.A.3.6.2 – Addition of Generator G2 if applicable

- ECP.A.3.6.5 A simulation study shall be performed for **Type B, C & D Power Generating Modules** in **Limited Frequency Sensitive Mode (LFSM)** and **Frequency Sensitive Mode (FSM)** for **Type C & D Power Generating Modules**. The simulation study results should indicate **Active Power** and **Frequency**.
- ECP.A.3.6.6 To allow validation of the model used to simulate load rejection in accordance with ECC.6.3.7.3.5 as described, a further simulation study is required to represent the largest positive **Frequency** injection step or fast ramp (BC1 and BC3 of Figure 2) that will be applied as a test as described in ECP.A.5.8 and ECP.A.6.6.
- ECP.A.3.6.7 The above suite of simulation studies equally apply for **Electricity Storage Modules** when in an export mode of operation and should also demonstrate transition to an import mode of operation in line with the stated **Droop** characteristics of the **Electricity Storage Module** when in an import mode of operation. Three simulation studies need to be carried out:
- i) The **Electricity Storage Module** should initially be operating at zero **Active Power** output and have sufficient capability so that it is possible to operate the **Electricity Storage Module** at **Maximum Capacity** and **Maximum Import Power**. The above suite of simulation studies as detailed in ECP.A.3.6.1 – ECP.A.3.6.6 should then be conducted to ensure the **Electricity Storage Modules Active Power** output achieves its **Maximum Import Power** in line with the **Droop** and response time settings as declared by the **Generator**.
 - ii) The **Electricity Storage Module** should be operating at 50% of its **Maximum Import Power** and have sufficient capability so that it is possible to operate the **Electricity Storage Module** at **Maximum Capacity** and **Maximum Import Power**. The above suite of simulation studies should then be conducted to ensure the **Electricity Storage Modules Active Power** output achieves its **Maximum Import Power** in line with the **Droop** and response time settings as declared by the **Generator**.
 - iii) The **Electricity Storage Module** should be operating at its **Maximum Import Power**. The above suite of simulation studies should then be conducted to ensure the **Electricity Storage Modules Active Power** remains at its **Maximum Import Power**, unless it is in **Frequency Sensitive Mode** and the tested **Frequency** falls below 50.5Hz.

Limited Frequency Sensitive Mode – Under Frequency (LFSM-U)

- ECP.A.3.6.7 This section applies to:
Synchronous Power Generating Modules, Type C & D; or,
HVDC Equipment; or,
Power Park Modules, Type C & D to demonstrate the modules capability to modulate Active Power at low frequency.
- ECP.A.3.6.8 To demonstrate the **LFSM-U** low **Frequency** control when operating in **Limited Frequency Sensitive Mode** the **Generator** or **HVDC System Owner** shall submit a simulation study representing the response of the **Power Generating Module** or **HVDC Equipment** operating at 80% of **Maximum Capacity**. The simulation study event shall be equivalent to:
- (i) a sufficiently large reduction in the measured **System Frequency** ramped over 10 seconds to cause an increase in **Active Power** output to the **Maximum Capacity** followed by

- (ii) 60 seconds of steady state with the measured **System Frequency** depressed to the same level as in ECP.A.3.6.8.1 (i) as illustrated in Figure ECP.A.3.6.1 below.
- (iii) then increase of the measured **System Frequency** ramped over 10 seconds to cause a reduction in **Active Power** output back to the original **Active Power** level followed by at least 60 seconds of steady output.

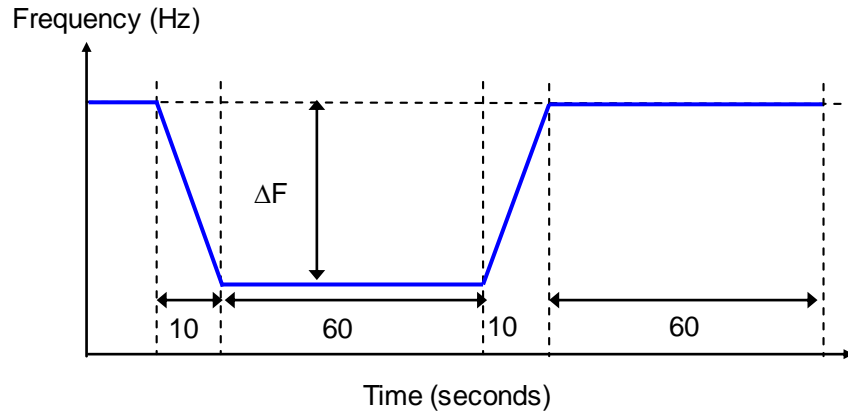

Figure ECP.A.3.6.1

Operation of **Electricity Storage Modules** in an import mode of operation during low **System Frequencies**

ECP.A.3.6.9 For **Generators** in respect of **Electricity Storage Modules** who are unable to deload from an import mode of operation to an export mode of operation during low **System Frequencies** as defined in ECC.6.3.7.2.3 and have agreed with **The Company** that they can comply with the requirements of OC6.6.6 as provided for in ECC.6.3.7.2.3.1, the simulation studies as detailed in ECP.A.3.6.10 shall apply.

For **Generators** in respect of **Electricity Storage Modules** who can satisfy the requirements of ECC.6.3.7.2.3 (except ECC.6.3.7.2.3.1 to which OC6.6.6 refers) the simulation studies as detailed in ECP.A.3.6.11 shall apply.

ECP.A.3.6.10 The **Generator** shall submit a simulation study representing the response of the **Electricity Storage Module** operating at **Maximum Import Power** followed by a simulated fall in **System Frequency**. The simulation study shall demonstrate that:-

- (i) For a sufficiently large reduction in the simulated **System Frequency** ramped over 10 seconds over the **Frequency** range 49.5 Hz to 48.85 Hz, the simulation shall be sufficient to demonstrate the tripping of each **Demand** block (as specified in the **Bilateral Agreement**).
- (ii) The simulation study shall demonstrate the tripping of each **Demand** block at the specified **Frequency** and time of disconnection following the **Frequency** excursion at the specified setting. The simulation study results shall be assessed against the settings in the **Bilateral Agreement**.

ECP.A.3.6.11 For **Generators** in respect of **Electricity Storage Modules** who can satisfy the **Droop** requirements of ECC.6.3.7.2.3, the **Generator** shall submit simulation studies representing the response of the **Electricity Storage Module**. The simulation studies shall comprise:-

- (i) Initial conditions where the **Electricity Storage Module** shall be operating at its **Maximum Import Power** with the **Electricity Storage Module** in **Limited Frequency Sensitive Mode**.
- (ii) A simulation signal shall be applied which ramps the **System Frequency** from 50Hz to 49.0Hz at a rate of 2Hz/s. The **System Frequency** shall be held at 49.0Hz for 60s and then ramped back to 50Hz in 10s as shown in Figure ECP.3.6.4.
- (iii) The simulated results should show a reduction in **Active Power** in accordance with the requirement of ECC.6.3.7.2.3.1. When the test injection signal is held at 49.0Hz, the **Active Power** output of the **Electricity Storage Module** should achieve a steady state operating point in no more than 10s and this should be maintained whilst the test frequency signal is held at 49.0Hz.
- (iv) The above simulation described (i) – (iii) above shall be repeated but the minimum test frequency applied shall be to 48.8Hz as shown in Figure ECP.3.6.5.
- (v) The above tests shall be repeated when the **Electricity Storage Module** is operating at 40% of its **Maximum Import Power**.

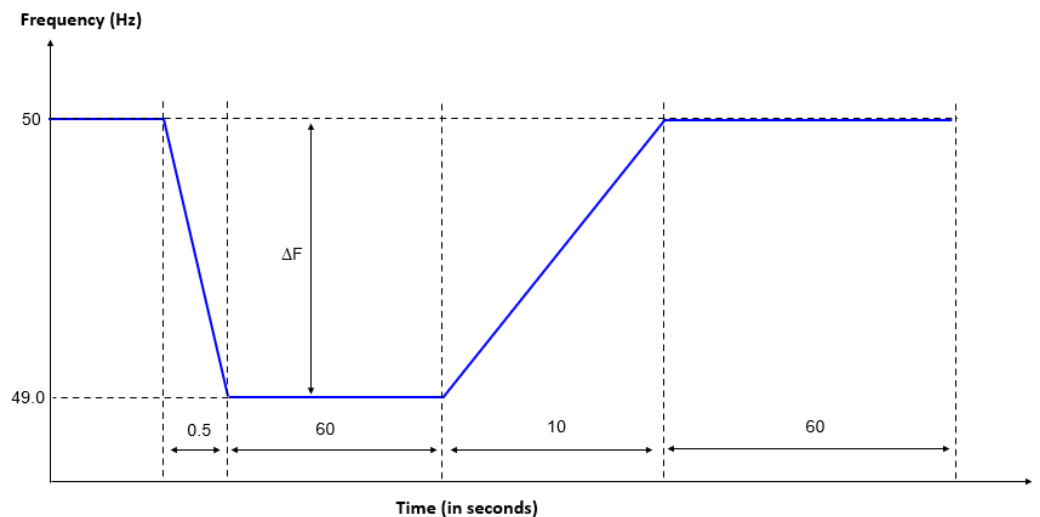

Figure ECP.A.3.6.4

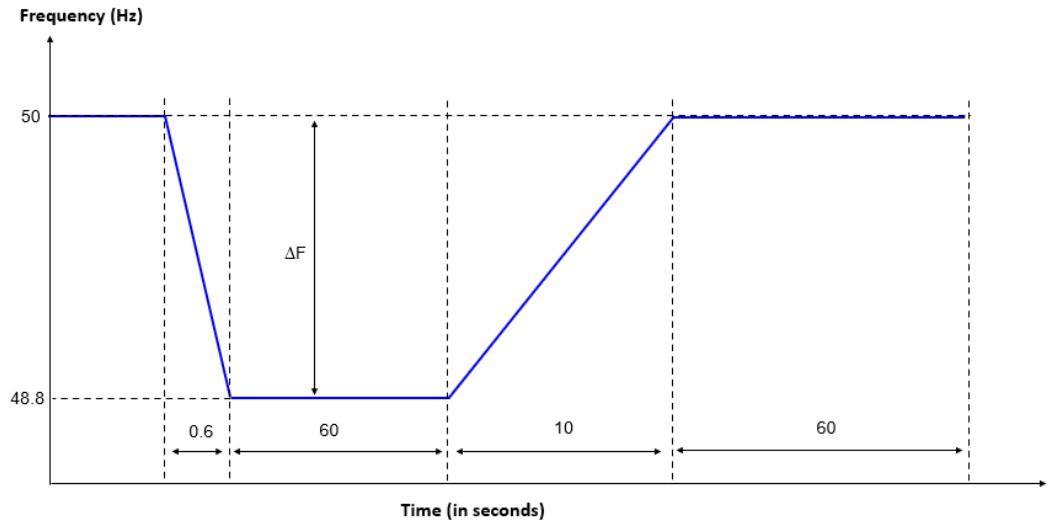

Figure ECP.A.3.6.5

ECP.A.3.6.12 In addition to the requirements of ECP.A.3.6.11 a set of simulation studies shall be submitted to demonstrate the performance of the **Electricity Storage Module** during extreme **Frequency** conditions. The simulated studies shall comprise:-

- (i) Initial conditions where the **Electricity Storage Module** shall be operating at its **Maximum Import Power** with the **Electricity Storage Module** in **Limited Frequency Sensitive Mode**.
- (ii) A simulation signal which ramps the **System Frequency** from 50Hz to 48.3Hz over 20s. The **System Frequency** shall be held at 48.3Hz for 60s and the then ramped back to 50Hz in 20s as shown in Figure ECP.3.6.6.
- (iii) The simulation shall demonstrate of the ability of the **Electricity Storage Module** to reach its **Maximum Capacity** (or otherwise) in accordance with the requirements of ECC.6.3.7.2.3. When the test injection signal is held at 48.3Hz, the **Active Power** output of the **Electricity Storage Module** should achieve a steady state operating point in no more than 10s and this should be maintained whilst the test frequency signal is held at 48.3Hz.
- (iv) An applied simulated signal which ramps from 48.3Hz to 50Hz over a 20s period. The **Electricity Storage Module** should return back to its **Maximum Import Power** at 49.5Hz in line with the performance requirements of ECC.6.3.7.2.3.

The above test shall be repeated with the **Electricity Storage Module** is operating at 50% of its **Maximum Import Power**.

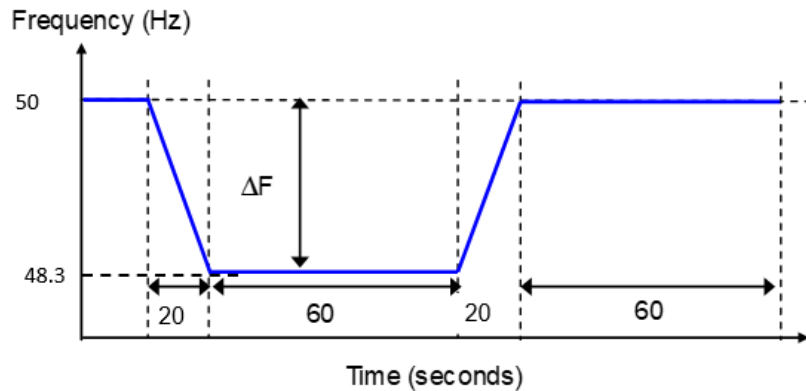

Figure ECP.A.3.6.6

ECP.A.3.7 Voltage and Frequency Controller Model Verification and Validation

ECP.A.3.7.1 For **Type C** and **Type D Synchronous Power Generating Modules, HVDC Equipment, OTSDUW Plant and Apparatus** or **Power Park Modules**, the **Generator** (including those undertaking **OTSDUW**) or **HVDC System Owner** shall provide simulation studies to verify that the proposed controller models supplied to **The Company** under the **Planning Code** are fit for purpose. These simulation study results shall be provided in the timescales stated in the **Planning Code**.

ECP.A.3.7.2 To demonstrate the **Frequency** control or governor/load controller/plant model the **Generator** or **HVDC System Owner** shall submit a simulation study representing the response of the **Synchronous Power Generating Module, HVDC Equipment** or **Power Park Module** operating at 80% of **Maximum Capacity**. The simulation study event shall be equivalent to:

- (i) a ramped reduction in the measured **System Frequency** of 0.5Hz in 10 seconds followed by
- (ii) 20 seconds of steady state with the measured **System Frequency** depressed by 0.5Hz followed by
- (iii) a ramped increase in measured **System Frequency** of 0.3Hz over 30 seconds followed by
- (iv) 60 seconds of steady state with the measured **System Frequency** depressed by 0.2Hz as illustrated in Figure ECP.A.3.7.2 below.

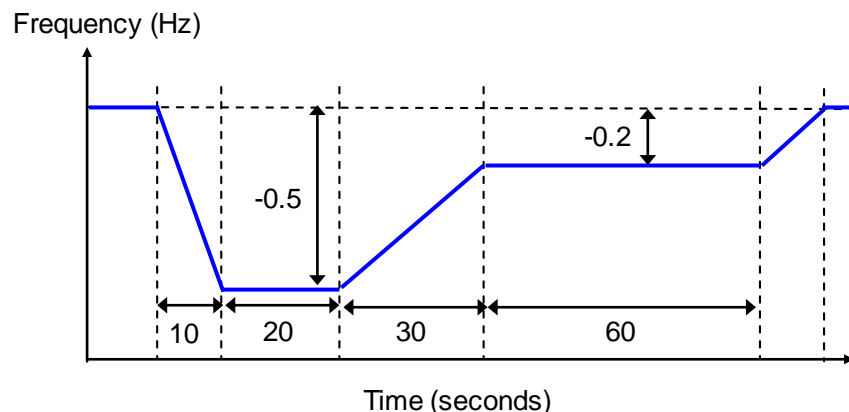

Figure ECP.A.3.7.2

The simulation study shall show **Active Power** output (MW) and the equivalent of **Frequency** injected.

ECP.A.3.7.3 To demonstrate the **Excitation System** model the **Generator** shall submit simulation studies representing the response of the **Synchronous Power Generating Module** as follows:

- (i) operating open circuit at rated terminal voltage and subjected to a 10% step increase in terminal voltage reference from 90% to 100%.
- (ii) operating at **Rated MW**, nominal terminal voltage and unity **Power Factor** subjected to a 2% step increase in the voltage reference. Where a **Power System Stabiliser** is included within the **Excitation System** this shall be in service.

The simulation study shall show the **Synchronous Power Generating Module** terminal voltage, field voltage, **Active Power**, **Reactive Power** and **Power System Stabiliser** output signal as appropriate.

ECP.A.3.7.4 To demonstrate the Voltage Controller model the **Generator** (including those undertaking **OTSDUW**) or **HVDC System Owner** shall submit a simulation study representing the response of the **HVDC Equipment, OTSDUW Plant and Apparatus** or **Power Park Module** operating at **Rated MW** and unity **Power Factor** at the connection point to a 2% step increase in the voltage reference. The simulation study shall show the terminal voltage, **Active Power**, **Reactive Power** and **Power System Stabiliser** output signal as appropriate.

ECP.A.3.7.5 To validate that the excitation and voltage control models submitted under the **Planning Code** are a reasonable representation of the dynamic behaviour of the **Synchronous Power Generating Module, OTSDUW Plant and Apparatus, HVDC Equipment** or **Power Park Module** as built, the **Generator** or **HVDC System Owner** shall repeat the simulation studies outlined above but using the operating conditions of the equivalent tests. The simulation study results shall be displayed overlaid on the actual test results.

ECP.A.3.7.6 For **Type C** and **Type D Synchronous Power Generating Modules** or **HVDC Equipment** to validate that the governor/load controller/plant or **Frequency** control models submitted under the **Planning Code** is a reasonable representation of the dynamic behaviour of the **Synchronous Power Generating Module** or **HVDC Equipment Station** as built, the **Generator** or **HVDC System Owner** shall repeat the simulation studies outlined above but using the operating conditions of the equivalent tests. The simulation study results shall be displayed overlaid on the actual test results.

ECP.A.3.8 Sub-synchronous Resonance control and Power Oscillation Damping control for HVDC System.

ECP.A.3.8.1 To demonstrate the compliance of the sub-synchronous control capability with ECC.6.3.17.1) and the terms of the **Bilateral Agreement**, the **HVDC System Owner** shall submit a simulation study report.

ECP.A.3.8.2 Where power oscillation damping control function is specified on a **HVDC Equipment** the **HVDC System Owner** shall submit a simulation study report to demonstrate the compliance with ECC.6.3.17.2 and the terms of the **Bilateral Agreement**.

ECP.A.3.8.3 The simulation studies should utilise the **HVDC Equipment** control system models including the settings as required under the **Planning Code**

(PC.A.5.3.2). The network conditions for the above simulation studies should be discussed with **The Company** prior to commencing any simulation studies.

ECP.A.3.9 **Grid Forming Plant** verification and validation

ECP.A.3.9.1 This section applies to **Users** and **Non-CUSC Parties** who own and operate **GBGF-I Plant** to demonstrate the ability of their **Grid Forming Plant** to satisfy the requirements of ECC.6.3.19. For the avoidance of doubt these requirements are not necessary from owner and operators of **GBGF-S Plant**.

ECP.A.3.9.2 For initial approval **Users** and **Non-CUSC Parties** are required to submit the following data of their **Grid Forming Plant** to **The Company**: -

- a) The representation of their **Grid Forming Plant** in a format either the same as Figure PC.A.5.8.1 of PC.A.5.8.1 or in an equivalent format.
- b) The data associated with their **Grid Forming Plant** as required in PC.A.5.8.1
- c) A linearised model and parameters of the **Grid Forming Plant** in the frequency domain in the same format as required in PC.A.5.8.1 or equivalent.
- d) A **Network Frequency Perturbation Plot** with a **Nichols Chart** demonstrating the equivalent **Damping Factor**.
- e) For the items a) to d) the **User** or **Non-CUSC Party** can submit the data in any equivalent format as agreed with **The Company**.

ECP.A.3.9.3 For **GBGF-I**, the **User** or **Non-CUSC Party** may be required to supply other versions of the **Network Frequency Perturbation Plot** for different input and output signals as defined by **The Company**.

ECP.A.3.9.4 For final approval, **Users** and **Non-CUSC Parties** are required to demonstrate that the **GBGF_I** model is capable of supplying **Active ROCOF Response Power**, and **Active Phase Jump Power**, and submit a full 3 phase simulation study in the time domain representing the response of the **Grid Forming Plant** over a range of operating conditions. The simulation study shall comprise of the following stages.

- i) A simulation study to the equivalent shown in Figure ECP.A.3.9.4.

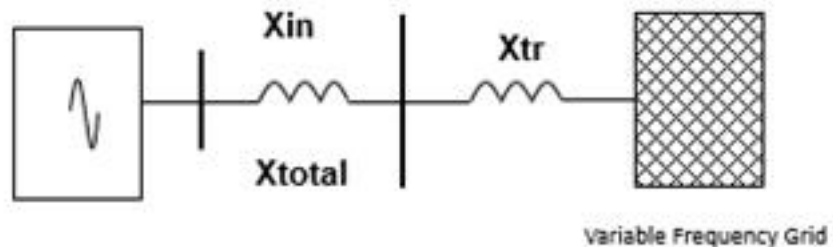

Figure ECP.A.3.9.4

- ii) The first simulation test is to demonstrate that the **GBGF-I** model is capable of supplying **Active ROCOF Response Power** to the **Total System** as a result of a **System Frequency** change. In this simulation, with the **Grid Forming Plant** initially running at **Registered Capacity** or **Maximum Capacity**, the **Grid System Frequency** is increased from 50Hz to 51Hz at a rate of 1Hz/s with measurements of

the **Grid Forming Plant's Active ROCOF Response Power, System Frequency** and time in (ms). The simulation is required to assess correct operation of the **Grid Forming Plant** without saturating. Repeat for 50Hz to 49Hz at 1Hz/s

- iii) The second simulation test is to demonstrate the **GBGF-I's** ability to supply **Active ROCOF Response Power** and assess its withstand capability under extreme **System Frequencies**. The **Grid System Frequency** is increased from 50Hz to 52Hz at a rate of 1Hz/s with measurements of the **Active ROCOF Response Power, System Frequency** and time in (ms). This is repeated when the **Grid System Frequency** is increased from 50Hz to 52Hz at a rate of 2 Hz/s with measurements of the **Active ROCOF Response Power, System Frequency** and time in (ms). Repeat for 50Hz to 48 Hz at 1 Hz/s and 50Hz to 48 Hz at 2 Hz/s.
- iv) The third simulation is to demonstrate the **Grid Forming Plant's** ability to supply **Active ROCOF Response Power** over the full **System Frequency** range.
- (a) With the **System Frequency** set to 50Hz, the **Grid Forming Plant** should be initially running at 75% **Maximum Capacity** or 75% **Registered Capacity**, zero MVar output and both **Limited Frequency Sensitive Mode** and **Frequency Sensitive Mode** disabled.
- (b) The **System Frequency** is then increased from 50Hz to 52Hz at a rate of 1Hz/s over a 2 second period. Allow conditions to stabilise for 5 seconds and then decrease the **System Frequency** from 52Hz to 47Hz at a rate of 1Hz/s over a 5 second period. Allow conditions to stabilise.
- (c) Record results of phase based **Active ROCOF Response Power, Reactive Power**, voltage and **System Frequency**.
- (d) The simulation now needs to be re-run in the opposite direction. The same initial conditions should be applied as per ECP.A.3.9.2iv) (a).
- (e) The **System Frequency** is then decreased from 50Hz to 47Hz at a rate of 1Hz/s over a 3 second period. Allow conditions to stabilise for 5 seconds and then increase the **System Frequency** from 47Hz to 52Hz at a rate of 1Hz/s over a 5 second period. Allow conditions to stabilise.
- (f) Record results of **Active ROCOF Response Power, Reactive Power**, voltage and **System Frequency**.
- (g) The simulation is required to ensure the **Grid Forming Plant** can deliver **Active ROCOF Response Power** without going into saturation and that a behaviour that is equivalent to pole slipping does not occur.
- v) The fourth simulation is to demonstrate the **Grid Forming Plant's** ability to supply **Active Phase Jump Power** under normal operation.
- (a) With the **System Frequency** set to 50Hz, the **Grid Forming Plant** should initially be running at **Maximum Capacity** or **Registered Capacity** or a suitable loading point to demonstrate **Grid Forming Capability** as agreed with **The Company**, zero MVar output and all control actions (e.g. **Limited Frequency Sensitive Mode, Frequency Sensitive Mode** and voltage control) disabled.
- (b) Apply a positive phase jump of the **Phase Jump Angle Limit** value at the **Grid Entry Point** or **User System Entry Point**.

- (c) Record traces of **Active Power**, **Reactive Power**, voltage, current and **System Frequency** for a period of 10 seconds after the step change in phase has been applied. Repeat with a negative phase jump.
- vi) The fifth simulation is to demonstrate the **Grid Forming Plant's** ability to supply **Active Phase Jump Power** under extreme conditions.
- (a) With the **System Frequency** set to 50Hz, the **Grid Forming Plant** should be initially running at its **Minimum Stable Operating Level** or **Minimum Stable Generation**, zero MVAR output and all control actions (e.g. **Limited Frequency Sensitive Mode**, **Frequency Sensitive Mode** and voltage control) disabled.
 - (b) Apply a phase jump equivalent to the positive **Phase Jump Angle Withstand** value at the **Grid**.
 - (c) Record traces of **Active Power**, **Reactive Power**, voltage, current and **System Frequency** for a period of 10 seconds after the step change in phase has been applied. Repeat with a negative phase jump.
 - (d) Repeat steps (a), (b) and (c) of ECP.A.3.9.4(vi) but on this occasion apply a phase jump equivalent to the positive **Phase Jump Angle Limit** at the **Grid**.
- vii) The sixth simulation is to demonstrate the **Grid Forming Plant's** ability to supply **Fault Ride Through** and **GBGF Fast Fault Current Injection** during a faulted condition
- (a) With the **System Frequency** set to 50Hz, the **Grid Forming Plant** should be initially running at its **Maximum Capacity** or **Registered Capacity**, zero MVAR output and all control actions (e.g., **Limited Frequency Sensitive Mode**, **Frequency Sensitive Mode**, **GBGF Fast Fault Current Injection**, **Fault Ride Through** and voltage control other than current limiters) disabled.
 - (b) Apply a solid three phase short circuit fault at the **Grid Entry Point** or **User System Entry Point** for 140ms.
 - (c) Record traces of **Active Power**, **Reactive Power**, voltage, current and **System Frequency** for a period of 10 seconds after the fault has been applied. The **GBGF-I's** current limit should be observed to operate.
 - (d) Repeat steps (a) to (c) but on this occasion with **Fault Ride Through**, **GBGF Fast Fault Current Injection**, **Limited Frequency Sensitive Mode** and voltage control switched into service.
 - (e) Record traces of **Active Power**, **Reactive Power**, voltage, current and **System Frequency** for a period of 10 seconds after the fault has been applied and confirm correct operation.

ECP.A.3.9.5 To demonstrate the **GBGF-I** model is capable of supplying **Active ROCOF Response Power** and **Active Phase Jump Power**, under extreme conditions the **Grid Forming Plant Owner** shall submit a simulation study representing the response of the **Grid Forming Plant**. To demonstrate the performance of the **Grid Forming Plant** under these conditions, the simulation study shall represent the following scenario.

- i) The **User** or **Non-CUSC Party** in respect of **GBGF-I** should supply a simulation study to **The Company** equivalent to Figure ECP.A.3.9.5.

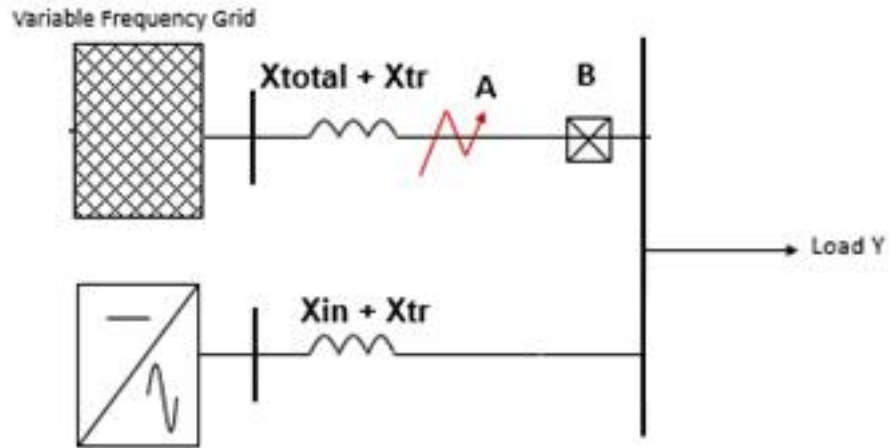

Figure ECP.A.3.9.5

- ii) In this simulation (as shown in Figure ECP.A.3.9.5) the parameters of the variable frequency Grid shall be supplied by **The Company**. The Load Y is also defined by **The Company**.
- iii) With the system running in steady state the **GBGF-I** and the variable frequency AC Grid should each be running at load Y/2 with the **System Frequency** of the test network being 50Hz. All control actions (e.g., **Limited Frequency Sensitive Mode**, **Frequency Sensitive Mode** and voltage control) should be disabled.
- iv) With the system in steady state, apply a solid (zero impedance) three phase short circuit fault at point A of Figure ECP.A.3.9.3 and then open circuit breaker B, 140ms after the fault has been applied.
- v) Record traces of **Active Power**, **Reactive Power**, voltage and **System Frequency** and record for a period of time after fault inception after allowing conditions to stabilise.

ECP.A.3.9.6 To demonstrate the **Grid Forming Plant** model is capable of contributing to **Active Damping Power**, the **GBGF-I** owner is required to supply a simulation study by injecting a **Test Signal** in the time domain into the model of the **GBGF-I**.

The **GBGF-I** model should take the equivalent form shown in either Figure ECP.A.3.9.6(a) or Figure ECP.A.3.9.6(b) as applicable. Each **User** or **Non-CUSC Party** can use their own design, that may be very different to Figures ECP.A.3.9.6(a) or ECP.A.3.9.6 (b) but should contain all relevant functions. In either case the following tests should be completed, and results supplied to

verify the following criteria: -

Typical simulation model 1

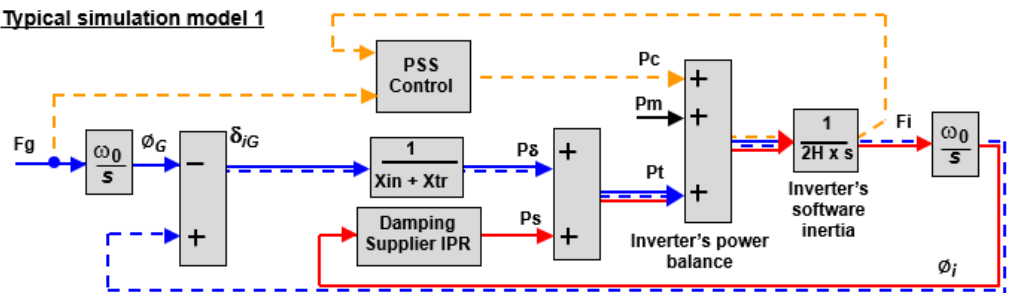

Figure ECP.A.3.9.6(a)

Typical simulation model 2

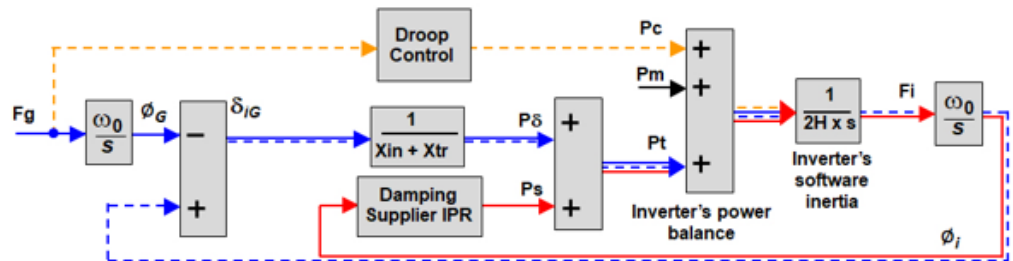

Figure ECP.A.3.9.6(b)

- i) Demonstration of **Damping** by injecting a **Test Signal** in the time domain at the **Grid Oscillation Value** and frequency into the model of the **GBGF-I**. An acceptable performance will be judged when the result matches the **NFP Plot** declared by the **Grid Forming Plant Owner** as submitted in PC.A.5.8.1(i)
- ii) Test i) is repeated with variations in the frequency of the **Test Signal**. An acceptable performance will be judged when the result matches the **NFP Plot** declared by the **Grid Forming Plant Owner** as submitted in PC.A.5.8.1(i).
- iii) Demonstration of phase based **Active Control Output Power** (or P_c) by injecting a **Test Signal** into the **Grid Forming Plant** controller to demonstrate that the **Active Control Based Power** output is supplied below the 5Hz bandwidth limit. An acceptable performance will be judged where the overshoot and decay matches the **Damping Factor** declared by the **Grid Forming Plant Owner** as submitted in PC.A.5.8.1 in addition to assessment against the requirements of CC.A.6.2.6.1 or ECC.A.6.2.6.1 or CC.A.7.2.2.5 or ECC.A.7.2.5.2 as applicable.

APPENDIX 4

ONSITE SIGNAL PROVISION FOR WITNESSING TESTS

ECP.A.4.1 During any tests witnessed on-site by **The Company**, the following signals shall be provided to **The Company** by the **Generator** undertaking **OTSDUW or HVDC System Owner** in accordance with ECC.6.6.3.

ECP.A.4.2 **Synchronous Power Generating Modules**

ECP.A.4.2(a) All Tests	<ul style="list-style-type: none"> • MW - Active Power at Synchronous Generating Unit terminals
ECP.A.4.2(b) Reactive & Excitation System	<ul style="list-style-type: none"> • MVar - Reactive Power at terminals • Vt - Synchronous Generating Unit terminal voltage • Efd- Synchronous Generating Unit field voltage and/or main exciter field voltage • Ifd – Synchronous Generating Unit Field current (where possible) • Power System Stabiliser output, where applicable. • Noise – Injected noise signal (where applicable and possible)
ECP.A.4.2(c) Governor System & Frequency Response	<ul style="list-style-type: none"> • Fsys - System Frequency • Finj - Injected Speed Setpoint • Logic - Stop / Start Logic Signal
	<p>For Gas Turbines:</p> <ul style="list-style-type: none"> • GT Fuel Demand • GT Fuel Valve Position • GT Inlet Guide Vane Position • GT Exhaust Gas Temperature
	<p>For Steam Turbines at >= 1Hz:</p> <ul style="list-style-type: none"> • Pressure before Turbine Governor Valves • Turbine Governor Valve Positions • Governor Oil Pressure* • Boiler Pressure Set Point * • Superheater Outlet Pressure * • Pressure after Turbine Governor Valves* • Boiler Firing Demand* <p>*Where applicable (typically not in CCGT module)</p>
ECP.A.4.2(d) Compliance with ECC.6.3.3	<ul style="list-style-type: none"> • Fsys - System Frequency • Finj - Injected Speed Setpoint • Appropriate control system parameters as agreed with The Company (See ECP.A.5.9)
ECP.A.4.2(e) Real Time on site or Down-loadable	<ul style="list-style-type: none"> • MW - Synchronous Power Generating Module Active Power at the Grid Entry Point or (User System Entry Point if Embedded). • MVar - Synchronous Power Generating Module Reactive Power at the Grid Entry Point or (User System Entry Point if Embedded).

	<ul style="list-style-type: none"> Line-line Voltage (kV) at the Grid Entry Point or (User System Entry Point if Embedded).
--	-----------------------------------------------------------------------------------------------------------------------------------------------------------------

ECP.A.4.3 **Power Park Modules, OTSDUA and HVDC Equipment**

	Each Power Park Module and HVDC Equipment at Grid Entry Point or User System Entry Point
ECP.A.4.3.1(a) Real Time on site.	<ul style="list-style-type: none"> Total Active Power (MW) Total Reactive Power (MVar) Line-line Voltage (kV) System Frequency (Hz)
ECP.A.4.3.1(b) Real Time on site or Down-loadable	<ul style="list-style-type: none"> Injected frequency signal (Hz) or test logic signal (Boolean) when appropriate Injected voltage signal (per unit voltage) or test logic signal (Boolean) when appropriate In the case of an Onshore Power Park Module the Onshore Power Park Module site voltage (MV) (kV) Power System Stabiliser output, where appropriate In the case of a Power Park Module or HVDC Equipment where the Reactive Power is provided by more than one Reactive Power source, the individual Reactive Power contributions from each source, as agreed with The Company. In the case of HVDC Equipment appropriate control system parameters as agreed with The Company (See ECP.A.7) In the case of an Offshore Power Park Module the Total Active Power (MW) and the Total Reactive Power (MVar) at the offshore Grid Entry Point
ECP.A.4.3.1(c) Real Time on site or Down-loadable	<ul style="list-style-type: none"> Available power for Power Park Module (MW) Power source speed for Power Park Module (e.g. wind speed) (m/s) when appropriate Power source direction for Power Park Module (degrees) when appropriate <p>See ECP.A.4.3.2</p>

ECP.A.4.3.2 **The Company** accept that the signals specified in ECP.A.4.3.1(c) may have lower effective sample rates than those required in ECC.6.6.3 although any signals supplied for connection to **The Company's** recording equipment which do not meet at least the sample rates detailed in ECC.6.6.3 should have the actual sample rates indicated to **The Company** before testing commences.

ECP.A.4.3.3 For all **The Company** witnessed testing either;

- (i) the **Generator** or **HVDC System Owner** shall provide to **The Company** all signals outlined in ECP.A.4.3.1 direct from the **Power Park Module** control system without any attenuation, delay or filtering which would result in the inability to fully demonstrate the objectives of the test, or identify any potential safety or plant instability issues, and with a signal update rate corresponding to ECC.6.6.3.2; or
- (ii) in the case of **Onshore Power Park Modules**, the **Generator** or **HVDC System Owner** shall provide signals ECP.A.4.3.1(a) direct from one or more transducer(s) connected to current and voltage transformers for monitoring in real time on site; or,

- (iii) In the case of **Offshore Power Park Modules** and **OTSDUA** signals ECP.A.4.3.1(a) will be provided at the **Interface Point** by the **Offshore Transmission Licensee** pursuant to the **STC** or by the **Generator** when **OTSDUW Arrangements** apply.

ECP.A.4.3.4 Options ECP.A.4.3.3 (ii) and (iii) will only be available on condition that;

- (a) all signals outlined in ECP.A.4.3.1 are recorded and made available to **The Company** by the **Generator** or **HVDC System Owner** from the **Power Park Module** or **OTSDUA** or **HVDC Equipment** control systems as a download once the testing has been completed; and
- (b) the full test results are provided by the **Generator HVDC System Owner** within 2 working days of the test date to **The Company** unless **The Company** agrees otherwise; and
- (c) all data is provided with a sample rate in accordance with ECC.6.6.3.3 unless **The Company** agrees otherwise; and
- (d) in **The Company's** reasonable opinion, the solution does not unreasonably add a significant delay between tests or impede the volume of testing which can take place on the day.

ECP.A.4.3.5 In the case of where transducers connected to current and voltage transformers are installed (ECP.A.4. 3.3(ii) and (iii)), the transducers shall meet the following specification

- (a) The transducer(s) shall be permanently installed to easily allow safe testing at any point in the future, and to avoid a requirement for recalibration of the current transformers and voltage transformers.
- (b) The transducer(s) should be directly connected to the metering quality current transformers and voltage transformers or similar.
- (c) The transducers shall either have a response time no greater than 50ms to reach 90% of output, or no greater than 300ms to reach 99.5%.

ECP.A.4.3.6 In the case of a **GBGF-I** system, the following signals shall be supplied to **The Company** by the **Grid Forming Plant Owner** in accordance with ECC.6.6.3. For the avoidance of doubt, **User's** and **Non-CUSC Parties** will also be required to undertake the necessary testing of their **Plant** in accordance with the requirements of ECC.A.4 and OC5 as applicable.

	Each Grid Forming Plant at the Grid Entry Point or User System Entry Point
ECP.A.4.3.6(a) Real Time Downloadable	Signals required shall be agreed with The Company in accordance with ECC.6.6.3.2(iv) and ECC.6.6.3.2(v)

ECP.A.4.3.7 Testing not witnessed by **The Company** on-site

ECP.A.4.3.7.1.1 Where **The Company** has decided not to witness testing on-site, the results shall be submitted to **The Company** in spreadsheet format with the signal data in columns arranged as follows. Signal data denoted by “#” is not essential but if not provided the column should remain in place but without values entered. Where two signal names are given in a column these are alternatives related to the type of plant under test.

ECP.A.4.3.7.1.2 Where **The Company** has requested addition signals to be recorded prior to the testing these signals shall be placed in columns to the right of the spreadsheet.

ECP.A.4.3.7.2.1 Onshore Synchronous Generating Unit Excitation System and Reactive Capability

	Col 1	Col 2	Col 3	Col 4	Col 5	Col 6	Col 7	Col 8
1	Time	Active Power	Reactive Power	Terminal Voltage	Speed /Frequency #	Freq Injection #	Logic / Test Start #	Field Voltage
	Col 9	Col 10	Col 11	Col 12	Col 13	Col 14	Col 15	Col 16
1	Field Current	PSS Output #	Noise Injection #					
# Columns may be left blank but the column must still be included in the files								

ECP.A.4.3.7.2.2 Onshore Synchronous Generating Unit Frequency Response and ECC.6.3.3

	Col 1	Col 2	Col 3	Col 4	Col 5	Col 6	Col 7	Col 8
1	Time	Active Power	Reactive Power #	Terminal Voltage #	Speed /Frequency	Freq Injection	Logic / Test Start	Fuel Demand
2								Guide Vane Setpoint
	Col 9	Col 10	Col 11	Col 12	Col 13	Col 14	Col 15	Col 16
1	Inlet Guide Vane	Exhaust Gas Temp	ST Valve Pos	Fuel Valve Pos	HP Steam Valve Pos	IP Steam Valve Pos	LP Steam Valve Pos	
2	Guide Vane Position	Head						
# Columns may be left blank but must still be included in the files								

ECP.A.4.3.7.3.1 Onshore Power Park Modules Voltage Control & Reactive Capability

	Col 1	Col 2	Col 3	Col 4	Col 5	Col 6	Col 7	Col 8
1	Time	Active Power	Reactive Power	Connection Point Voltage	Speed /Frequency #	Freq Injection #	Logic / Test Start #	Statcom or Windfarm Reactive Power #

	Col 9	Col 10	Col 11	Col 12	Col 13	Col 14	Col 15	Col 16
1	Power Available	Wind Speed	Wind Direction	Voltage Setpoint				
2	State of Charge							
# Columns may be left blank but the column must still be included in the files								

ECP.A.4.3.7.3.2 Offshore Power Park Modules Voltage Control & Reactive Capability

	Col 1	Col 2	Col 3	Col 4	Col 5	Col 6	Col 7	Col 8
1	Time	Onshore Interface Point Active Power	Onshore Interface Point Reactive Power	Onshore Interface Point Voltage	Speed /Frequency #	Freq Injection #	Logic / Test Start #	Statcom or Windfarm Reactive Power #
	Col 9	Col 10	Col 11	Col 12	Col 13	Col 14	Col 15	Col 16
1	Power Available	Wind Speed m/s	Wind Direction	Voltage Setpoint				
2	State of Charge							
# Columns may be left blank but the column must still be included in the files								

ECP.A.4.3.7.3.3 Power Park Module Frequency Control

	Col 1	Col 2	Col 3	Col 4	Col 5	Col 6	Col 7	Col 8
1	Time	GEP Active Power	GEP Reactive Power #	GEP Connection Voltage #	Speed /Frequency	Freq Injection	Logic / Test Start	Statcom or Windfarm Reactive Power #
	Col 9	Col 10	Col 11	Col 12	Col 13	Col 14	Col 15	Col 16
1	Power Available	Wind Speed m/s	Wind Direction					
2	State of Charge							
# Columns may be left blank but must still be included in the files								

ECP.A.4.3.8.1 Where test results are completed without the presence of **The Company** but are relied upon as evidence of the compliance they should be accompanied by a logsheet. This sheet should be legible, in English and detail the items as indicated below:

Time and Date of test;

Name of **Power Station** and **Power Generating Module** if applicable;
Name of Test engineer(s) and company name;
Name of **Users** representative(s) and company name;
Type of testing being undertake eg Voltage Control;
Ambient conditions eg. temperature, pressure, wind speed, wind direction;
and
Controller settings, eg voltage slope, frequency droop, voltage setpoint, UEL
& OEL settings

ECP.A.4.3.8.2 For each test the following items should be recorded as relevant to the type of test being undertaken. Where there is uncertainty on the information to be recorded this should be discussed with **The Company** in advance of the test.

ECP.A.4.3.8.2 .1 Voltage Control Tests

Start time of each test step;

Active Power;

Reactive Power;

Connection voltage;

Voltage Control Setpoint, if applicable or changed;

Voltage Control Slope, if applicable or changed;

Terminal Voltage if applicable;

Generator transformer tap position or grid transformer tap position, as applicable;

Number of **Power Park Units** in service in each **Power Park Module**, if applicable; and

For offshore connections **Offshore Grid Entry Point** voltage.

ECP.A.4.3.8.2.2 Reactive Power Capability Tests

Start time of test;

Active Power;

Reactive Power;

Connection Voltage;

Terminal Voltage if applicable;

Generating Unit transformer tap position or grid transformer tap position as applicable;

Number of **Power Park Units** in service in each **Power Park Module**, if applicable; and

For offshore connections **Offshore Grid Entry Point** voltage.

ECP.A.4.3.8.2.3 Frequency Response Capability Tests

Start time of test;

Active Power;

System Frequency;

For **CCGT Modules, Active Power** for the individual units (GT &ST);

For boiler plant, HP steam pressure;

Droop setting of controller if applicable;

Number of **Power Park Units** in service in each **Power Park Module**, if applicable; and

For offshore connections **Offshore Grid Entry Point Active Power** for each **Power Park Module**.

ECP.A.4.3.8.3 Material changes during the test period should be recorded e.g. **Generating Units** tripping / starting, changes to tapchange positions.

APPENDIX 5

COMPLIANCE TESTING OF SYNCHRONOUS POWER GENERATING MODULES

ECP.A.5.1 SCOPE

ECP.A.5.1.1 This Appendix sets out the tests contained therein to demonstrate compliance with the relevant clauses of the **European Connection Conditions** of the **Grid Code**. This Appendix shall be read in conjunction with the ECP with regard to the submission of the reports to **The Company**.

ECP.A.5.1.2 The tests specified in this Appendix will normally be sufficient to demonstrate compliance however **The Company** may:

- (i) agree an alternative set of tests provided **The Company** deem the alternative set of tests sufficient to demonstrate compliance with the **Grid Code** and **Bilateral Agreement**; and/or
- (ii) require additional or alternative tests if information supplied to **The Company** during the compliance process suggests that the tests in this Appendix will not fully demonstrate compliance with the relevant section of the **Grid Code** or **Bilateral Agreement**.
- (iii) Agree a reduced set of tests for subsequent **Synchronous Power Generating Module** following successful completion of the first **Synchronous Power Generating Module** tests in the case of a **Power Station** comprised of two or more **Synchronous Power Generating Modules** which **The Company** reasonably considers to be identical.

If:

- (a) the tests performed pursuant to ECP.A.5.1.2(iii) in respect of subsequent **Synchronous Power Generating Modules** do not replicate the full tests for the first **Synchronous Power Generating Module**, or
- (b) any of the tests performed pursuant to ECP.A.5.1.2(iii) do not fully demonstrate compliance with the relevant aspects of the **Grid Code**, **Ancillary Services Agreement** and / or **Bilateral Agreement**,

then notwithstanding the provisions above, the full testing requirements set out in this Appendix will be applied.

ECP.A.5.1.3 The **Generator** is responsible for carrying out the tests set out in and in accordance with this Appendix and the **Generator** retains the responsibility for the safety of personnel and plant during the test. **The Company** will witness all of the tests outlined or agreed in relation to this Appendix unless **The Company** decides and notifies the **Generator** otherwise. Reactive Capability tests may be witnessed by **The Company** remotely from **The Company** control centre. For all on site, **The Company** witnessed tests the **Generator** should ensure suitable representatives from the **Generator** and manufacturer (if appropriate) are available on site for the entire testing period. In all cases the **Generator** shall provide suitable monitoring equipment to record all relevant test signals as outlined below in ECP.A.6.1.5.

ECP.A.5.1.4 The **Generator** shall submit a schedule of tests to **The Company** in accordance with CP.4.3.1.

ECP.A.5.1.5 Prior to the testing of a **Synchronous Power Generating Module** the

Generator shall complete the **Integral Equipment Test** procedure in accordance with OC.7.5.

ECP.A.5.1.6 Full **Synchronous Power Generating Module** testing as required by CP.7.2 is to be completed as defined in ECP.A.5.2 through to ECP.A.5.9.

ECP.A.5.1.7 **The Company** will permit relaxation from the requirement ECP.A.5.2 to ECP.A.5.9 where an **Equipment Certificate** for the **Synchronous Power Generating Module** has been provided which details the characteristics from tests on a representative machine with the same equipment and settings and the performance of the **Synchronous Power Generating Module** can, in **The Company's** opinion, reasonably represent that of the installed **Synchronous Power Generating Module** at that site. For **Type B, Type C** and **Type D Power Generating Modules** the relevant **Equipment Certificate** must be supplied in the **Power Generating Module Document** or **Users Data File structure** as applicable.

ECP.A.5.1.8 In the case of a co-located site, for example **Electricity Storage Modules** or **Grid Forming Plant** connected within a new or existing **Power Station**, **The Company** will accept test results to demonstrate compliance at the **Grid Entry Point** or **User System Entry Point** (if **Embedded**) through a combination of the capabilities of the **Power Generating Modules** (which could include **Grid Forming Plant**) and **Electricity Storage Modules** or **Electricity Storage Modules** (which could include a **Grid Forming Plant**) and **Generating Units** or **Power Park Modules**. **Generators** should however be aware that for the purposes of testing, full Grid Code compliance should be demonstrated when, for example, the **Electricity Storage Module** or **Grid Forming Plant** is out of service and the remaining **Power Generating Module** is in service or the **Electricity Storage Module** or **Grid Forming Plant** is in service and the **Power Generating Module** is out of service. In the case of a **Synchronous Electricity Storage Module**, **The Company** would expect the full set of tests to be completed as detailed in ECP.A.5.2 to ECP.A.5.9.

ECP.A.5.2 Excitation System Open Circuit Step Response Tests

ECP.A.5.2.1 The open circuit step response of the **Excitation System** will be tested by applying a voltage step change from 90% to 100% of the nominal **Synchronous Power Generating Module** terminal voltage, with the **Synchronous Power Generating Module** on open circuit and at rated speed.

ECP.A.5.2.2 The test shall be carried out prior to synchronisation in accordance with CP.6.4. This is not witnessed by **The Company** unless specifically requested by **The Company**. Where **The Company** is not witnessing the tests, the **Generator** shall supply the recordings of the following signals to **The Company** in an electronic spreadsheet format:

Vt - **Synchronous Generating Unit** terminal voltage
Efd - **Synchronous Generating Unit** field voltage or main exciter field voltage
Ifd- **Synchronous Generating Unit** field current (where possible)
Step injection signal

ECP.A.5.2.3 Results shall be legible, identifiable by labelling, and shall have appropriate scaling.

ECP.A.5.3 Open & Short Circuit Saturation Characteristics

ECP.A.5.3.1 The test shall normally be carried out prior to synchronisation in accordance with ECP.6.2.4 or ECP.6.3.4 **Equipment Certificates** or **Manufacturer's Test Certificates** may be used where appropriate may be used if agreed by **The Company**.

- ECP.A.5.3.2 This is not witnessed by **The Company**. Graphical and tabular representations of the results in an electronic spreadsheet format showing per unit open circuit terminal voltage and short circuit current versus per unit field current shall be submitted to **The Company**.
- ECP.A.5.3.3 Results shall be legible, identifiable by labelling, and shall have appropriate scaling.
- ECP.A.5.4 **Excitation System On-Load Tests**
- ECP.A.5.4.1 The time domain performance of the **Excitation System** shall be tested by application of voltage step changes corresponding to 1% and 2% of the nominal terminal voltage.
- ECP.A.5.4.2 Where a **Power System Stabiliser** is present:
- (i) The **PSS** must only be commissioned in accordance with BC2.11.2. When a **PSS** is switched on for the first time as part of on-load commissioning or if parameters have been adjusted the **Generator** should consider reducing the **PSS** output gain by at least 50% and should consider reducing the limits on **PSS** output by at least a factor of 5 to prevent unexpected PSS action affecting the stability of the **Synchronous Generating Unit** or the **National Electricity Transmission System**.
 - (ii) The time domain performance of the **Excitation System** shall be tested by application of voltage step changes corresponding to 1% and 2% of the nominal terminal voltage, repeating with and without the **PSS** in service.
 - (iii) The frequency domain tuning of the **PSS** shall also be demonstrated by injecting a 0.2Hz-3Hz band limited random noise signal into the **Automatic Voltage Regulator** Setpoint with the **Synchronous Generating Unit** operating at points specified by **The Company** (up to rated MVA output).
 - (iv) The **PSS** gain margin shall be tested by increasing the **PSS** gain gradually to threefold and observing the **Synchronous Generating Unit** steady state **Active Power** output.
 - (v) The interaction of the **PSS** with changes in **Active Power** shall be tested by application of a +0.5Hz frequency injection to the governor while the **Synchronous Generating Unit** is selected to **Frequency Sensitive Mode**.
 - (vi) If the **Synchronous Power Generating Module** is of the **Pumped Storage** type then the step tests shall be carried out, with and without the **PSS**, in the pumping mode in addition to the generating mode. In the case of a **Synchronous Electricity Storage Module** the tests shall be carried out with and without the **PSS** in both importing and exporting modes of operation.
 - (vii) Where the **Bilateral Agreement** requires that the **PSS** is in service, at a specified loading level, additional testing witnessed by **The Company** will be required during the commissioning process before the **Synchronous Power Generating Module** may exceed this output level.
 - (viii) Where the **Excitation System** includes a **PSS**, the **Generator** shall provide a suitable noise source to facilitate noise injection testing.

ECP.A.5.4.3 The following typical procedure is provided to assist **Generators** in drawing up their own site specific procedures for **The Company** witnessed **PSS** Tests.

Test	Injection	Notes
	Synchronous Generating Unit running at Maximum Capacity , unity pf, PSS Switched Off	
1	<ul style="list-style-type: none"> Record steady state for 10 seconds Inject +1% step to AVR voltage setpoint and hold for at least 10 seconds until stabilised Remove step returning AVR voltage setpoint to nominal and hold for at least 10 seconds 	
2	<ul style="list-style-type: none"> Record steady state for 10 seconds Inject +2% step to AVR voltage setpoint and hold for at least 10 seconds until stabilised Remove step returning AVR voltage setpoint to nominal and hold for at least 10 seconds 	
3	<ul style="list-style-type: none"> Inject band limited (0.2-3Hz) random noise signal into voltage Setpoint and measure frequency spectrum of Real Power. Remove noise injection. 	
	• Switch On Power System Stabiliser	
4	<ul style="list-style-type: none"> Record steady state for 10 seconds Inject +1% step to AVR voltage setpoint and hold for at least 10 seconds until stabilised Remove step returning AVR voltage setpoint to nominal and hold for at least 10 seconds 	
5	<ul style="list-style-type: none"> Record steady state for 10 seconds Inject +2% step to AVR Voltage Setpoint and hold for at least 10 seconds until stabilised Remove step returning AVR Voltage Setpoint to nominal and hold for at least 10 seconds 	
6	<ul style="list-style-type: none"> Increase PSS gain at 30second intervals. i.e. x1 – x1.5 – x2 – x2.5 – x3 Return PSS gain to initial setting 	
7	<ul style="list-style-type: none"> Inject band limited (0.2-3Hz) random noise signal into voltage Setpoint and measure frequency spectrum of Real Power. Remove noise injection. 	
8	<ul style="list-style-type: none"> Select the governor to FSM Inject +0.5 Hz step into governor. Hold until generator MW output is stabilised Remove step 	

ECP.A.5.5 **Under-excitation Limiter Performance Test**

ECP.A.5.5.1 Initially the performance of the **Under-excitation Limiter** should be checked by moving the limit line close to the operating point of the **Synchronous Generating Unit** when operating close to unity **Power Factor**. The operating point of the **Synchronous Generating Unit** is then stepped into the limit by applying a 2% decrease in **Automatic Voltage Regulator** Setpoint voltage.

ECP.A.5.5.2 The final performance of the **Under-excitation Limiter** shall be demonstrated by testing its response to a step change corresponding to a 2% decrease in **Automatic Voltage Regulator Setpoint** voltage when the **Synchronous Generating Unit** is operating just off the limit line, at the designed setting as indicated on the **Performance Chart** [P-Q Capability Diagram] submitted to **The Company** under OC2.

ECP.A.5.5.3 Where possible the **Under-excitation Limiter** should also be tested by operating the tap- changer when the **Synchronous Generating Unit** is

operating just off the limit line, as set up.

ECP.A.5.5.4 The **Under-excitation Limiter** will normally be tested at low active power output and at maximum **Active Power** output.

ECP.A.5.5.5 The following typical procedure is provided to assist **Generators** in drawing up their own site specific procedures for **The Company** witnessed **Under-excitation Limiter Tests**.

Test	Injection	Notes
	Synchronous Generating Unit running at Maximum Capacity and unity Power Factor . Under-excitation limit temporarily moved close to the operating point of the Synchronous Generating Unit .	
1	<ul style="list-style-type: none"> • PSS on. • Inject -2% voltage step into AVR voltage setpoint and hold at least for 10 seconds until stabilised • Remove step returning AVR voltage setpoint to nominal and hold for at least 10 seconds 	
	Under-excitation limit moved to normal position. Synchronous Generating Unit running at Maximum Capacity and at leading Reactive Power close to Under-excitation limit.	
2	<ul style="list-style-type: none"> • PSS on. • Inject -2% voltage step into AVR voltage setpoint and hold at least for 10 seconds until stabilised • Remove step returning AVR voltage setpoint to nominal and hold for at least 10 seconds 	

ECP.A.5.6 Over-excitation Limiter Performance Test

ECP.A.5.6.1 The performance of the **Over-excitation Limiter**, where it exists, shall be demonstrated by testing its response to a step increase in the **Automatic Voltage Regulator Setpoint Voltage** that results in operation of the **Over-excitation Limiter**. Prior to application of the step the **Synchronous Generating Unit** shall be generating **Maximum Capacity** and operating within its continuous **Reactive Power** capability. The size of the step will be determined by the minimum value necessary to operate the **Over-excitation Limiter** and will be agreed by **The Company** and the **Generator**. The resulting operation beyond the **Over-excitation Limit** shall be controlled by the **Over-excitation Limiter** without the operation of any protection that could trip the **Synchronous Power Generating Module**. The step shall be removed immediately on completion of the test.

ECP.A.5.6.2 If the **Over-excitation Limiter** has multiple levels to account for heating effects, an explanation of this functionality will be necessary and if appropriate, a description of how this can be tested.

ECP.A.5.6.3 The following typical procedure is provided to assist **Generators** in drawing up their own site specific procedures for **The Company** witnessed **Under-excitation Limiter Tests**.

Test	Injection	Notes
	Synchronous Generating Unit running at Maximum Capacity and maximum lagging Reactive Power .	
	Over-excitation Limit temporarily set close to this operating point. PSS on.	
1	• Inject positive voltage step into AVR voltage setpoint and	

	hold <ul style="list-style-type: none"> • Wait until Over-excitation Limiter operates after sufficient time delay to bring back the excitation back to the limit. • Remove step returning AVR voltage setpoint to nominal. 	
	Over-excitation Limit restored to its normal operating value. PSS on.	

ECP.A.5.7 Reactive Capability

ECP.A.5.7.1 The **Reactive Power** capability on each **Synchronous Power Generating Module** will normally be demonstrated by:

- (a) operation of the **Synchronous Power Generating Module** at maximum lagging **Reactive Power** and **Maximum Capacity** for 1 hour
- (b) operation of the **Synchronous Power Generating Module** at maximum leading **Reactive Power** and **Maximum Capacity** for 1 hour.
- (c) operation of the **Synchronous Power Generating Module** at maximum lagging **Reactive Power** and **Minimum Stable Operating Level** for 1 hour
- (d) operation of the **Synchronous Power Generating Module** at maximum leading **Reactive Power** and **Minimum Stable Operating Level** for 1 hour.
- (e) operation of the **Synchronous Power Generating Module** at maximum lagging **Reactive Power** and a power output between **Maximum Capacity** and **Minimum Stable Operating Level**.
- (f) operation of the **Synchronous Power Generating Module** at maximum leading **Reactive Power** and a power output between **Maximum Capacity** and **Minimum Stable Operating Level**.

In the case of a **Synchronous Electricity Storage Module**, **The Company** shall have discretion to reduce the durations of the tests set out in ECP.A.5.7.1 (a) – (f), depending upon the capacity of the energy store.

ECP.A.5.7.2 In the case of an **Embedded Synchronous Power Generating Module** where distribution network considerations restrict the **Synchronous Power Generating Module Reactive Power** output, **The Company** will only require demonstration within the acceptable limits of the **Network Operator's System**.

ECP.A.5.7.3 The test procedure, time and date will be agreed with **The Company** and will be to the instruction of **The Company** control centre and shall be monitored and recorded at both **The Company** control centre and by the **Generator**.

ECP.A.5.7.4 Where the **Generator** is recording the voltage, **Active Power** and **Reactive Power** at the HV connection point the voltage for these tests **Active Power** and **Reactive Power** at the **Synchronous Power Generating Module** terminals may also be included. The results shall be supplied in an electronic spreadsheet format. Where applicable the **Synchronous Power Generating Module** transformer tapchanger position should be noted throughout the test period.

ECP.A.5.8 Governor and Load Controller Response Performance

ECP.A.5.8.1 The governor and load controller response performance will be tested by injecting simulated frequency deviations into the governor and load controller systems. Such simulated frequency deviation signals must be injected simultaneously at both speed governor and load controller setpoints. For **CCGT modules**, simultaneous injection into all gas turbines, steam turbine governors and module controllers is required.

ECP.A.5.8.2 Prior to witnessing the governor tests set out in ECP.A.5.8.6, **The Company** requires the **Generator** to conduct the preliminary tests detailed in ECP.A.5.8.4 and send the results to **The Company** for assessment unless agreed otherwise by **The Company**. The results should be supplied in an electronic spreadsheet format. These tests shall be completed at least two weeks prior to the witnessed governor response tests.

ECP.A.5.8.3 Where a **CCGT module** or **Synchronous Power Generating Module** is capable of operating on alternative fuels, tests will be required to demonstrate performance when operating on each fuel. **The Company** may agree a reduction from the tests listed in ECP.A.5.8.6 for demonstrating performance on the alternative fuel. This includes the case where a main fuel is supplemented by bio-fuel.

Preliminary Governor Frequency Response Testing

ECP.A.5.8.4 Prior to conducting the full set of tests as per ECP.A.5.8.6, **Generators** are required to conduct a preliminary set of tests below to confirm the frequency injection method is correct and the plant control performance is within expectation. The test numbers refer to Figure 1 below. With the plant running at 80% of full load, the following frequency injections shall be applied.

Test No (Figure1)	Frequency Injection	Notes
8	<ul style="list-style-type: none"> • Inject -0.5Hz frequency fall over 10 sec • Hold for a further 20 sec • At 30 sec from the start of the test, Inject a +0.3Hz frequency rise over 30 sec. • Hold until conditions stabilise • Remove the injected signal as a ramp over 10 seconds 	
13	<ul style="list-style-type: none"> • Inject - 0.5Hz frequency fall over 10 sec • Hold until conditions stabilise • Remove the injected signal as a ramp over 10 seconds 	
14	<ul style="list-style-type: none"> • Inject +0.5Hz frequency rise over 10 sec • Hold until conditions stabilise • Remove the injected signal as a ramp over 10 seconds 	
H	<ul style="list-style-type: none"> • Inject - 0.5Hz frequency fall as a stepchange • Hold until conditions stabilise • Remove the injected signal as a stepchange 	
I	<ul style="list-style-type: none"> • Inject +0.5Hz frequency rise as a stepchange • Hold until conditions stabilise • Remove the injected signal as a stepchange 	

ECP.A.5.8.5 The recorded results (e.g. Finj, MW and control signals) should be sampled at a minimum rate of 1 Hz to allow **The Company** to assess the plant performance from the initial transients (seconds) to the final steady state conditions (5-15 minutes depending on the plant design). This is not witnessed by **The Company**. The **Generator** shall supply the recordings including data to **The Company** in an electronic spreadsheet format. Results shall be legible, identifiable by labelling, and shall have appropriate scaling.

Full Frequency Response Testing Schedule Witnessed by **The Company**

ECP.A.5.8.6 The tests are to be conducted at a number of different Module Load Points (MLP). The load points are conducted as shown below unless agreed otherwise by **The Company**.

Module Load Point 6 (Maximum Export Limit)	100% MEL
Module Load Point 5	95% MEL
Module Load Point 4 (Mid-point of Operating Range)	80% MEL
Module Load Point 3	70% MEL
Module Load Point 2 (Lower of MRL+10% or Minimum Stable Operating Level)	MRL+10% or MSOL
Module Load Point 1 (Minimum Regulating Level)	MRL

ECP.A.5.8.7 The tests are divided into the following three types;

- (i) Frequency response compliance and volume tests as per ECP.A.5.8. Figure 1. These tests consist of frequency profile and ramp tests and adjustments to the target frequency setpoint as per ECP.5.8 Figure 3.
- (ii) System islanding and step response tests as shown by ECP.A.5.8. Figure 2.
- (iii) Frequency response tests in **Limited Frequency Sensitive Mode (LFSM)** to demonstrate **LFSM-O** and **LFSM-U** capability as shown by ECP.A.5.8 Figure 2.

ECP.A.5.8.8 There should be sufficient time allowed between tests for control systems to reach steady state. Where the diagram states 'HOLD' the current injection should be maintained until the **Active Power** (MW) output of the **Synchronous Power Generating Module** or **CCGT Module** has stabilised or 90 seconds, whichever is the longer. The frequency response capability test (see Figure 1) injection signal shall be returned to zero at the same rate at which it was applied. **The Company** may require repeat tests should the tests give unexpected results. When witnessed by **the Company** each test should be carried out as a separate injection, when not witnessed by **the Company** there must be sufficient time allowed between tests for the **Plant** to have reached a stable steady state operating condition or 90 seconds, whichever is the longer.

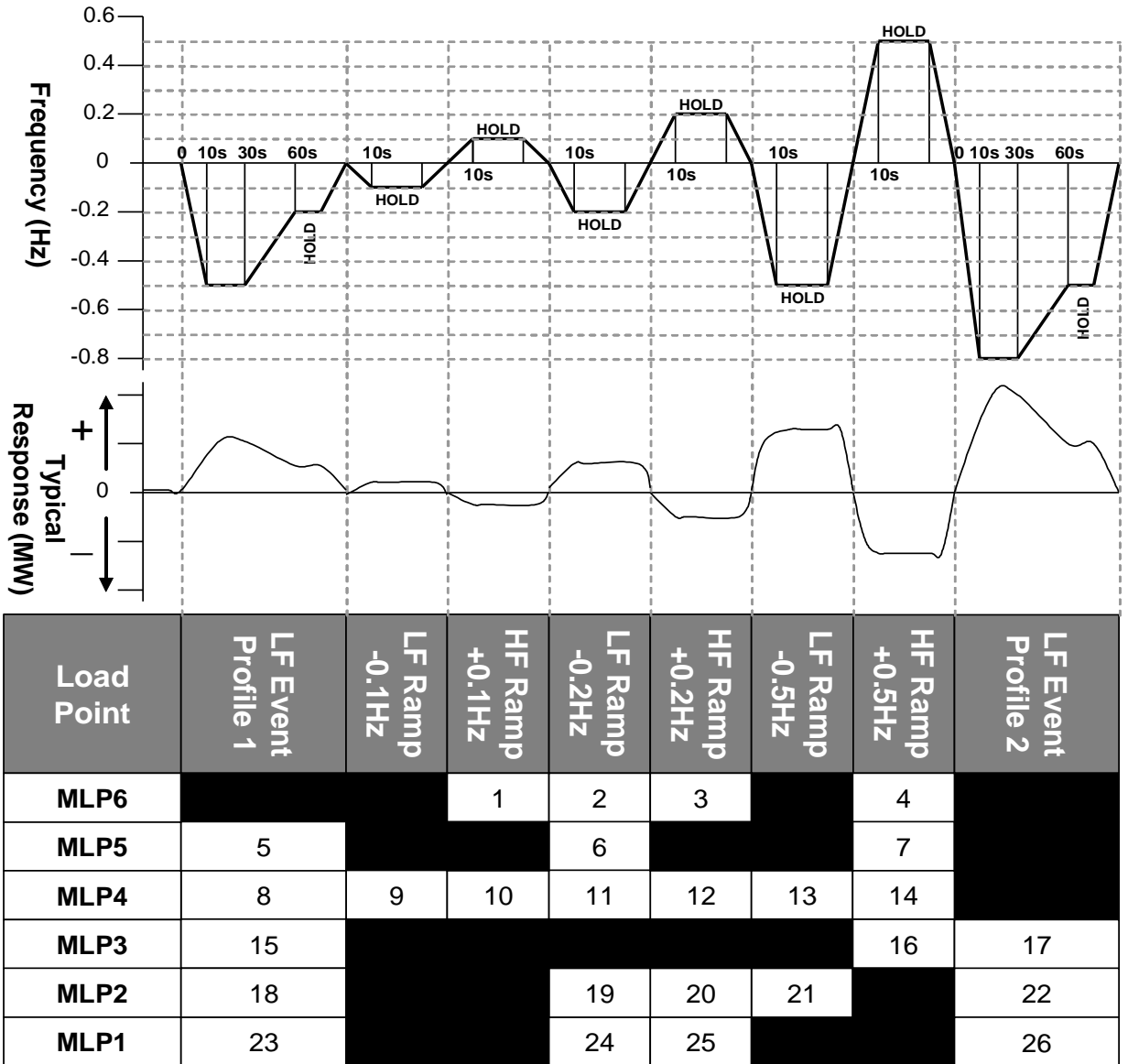

Figure 1: Frequency Response Capability FSM Ramp Response Tests

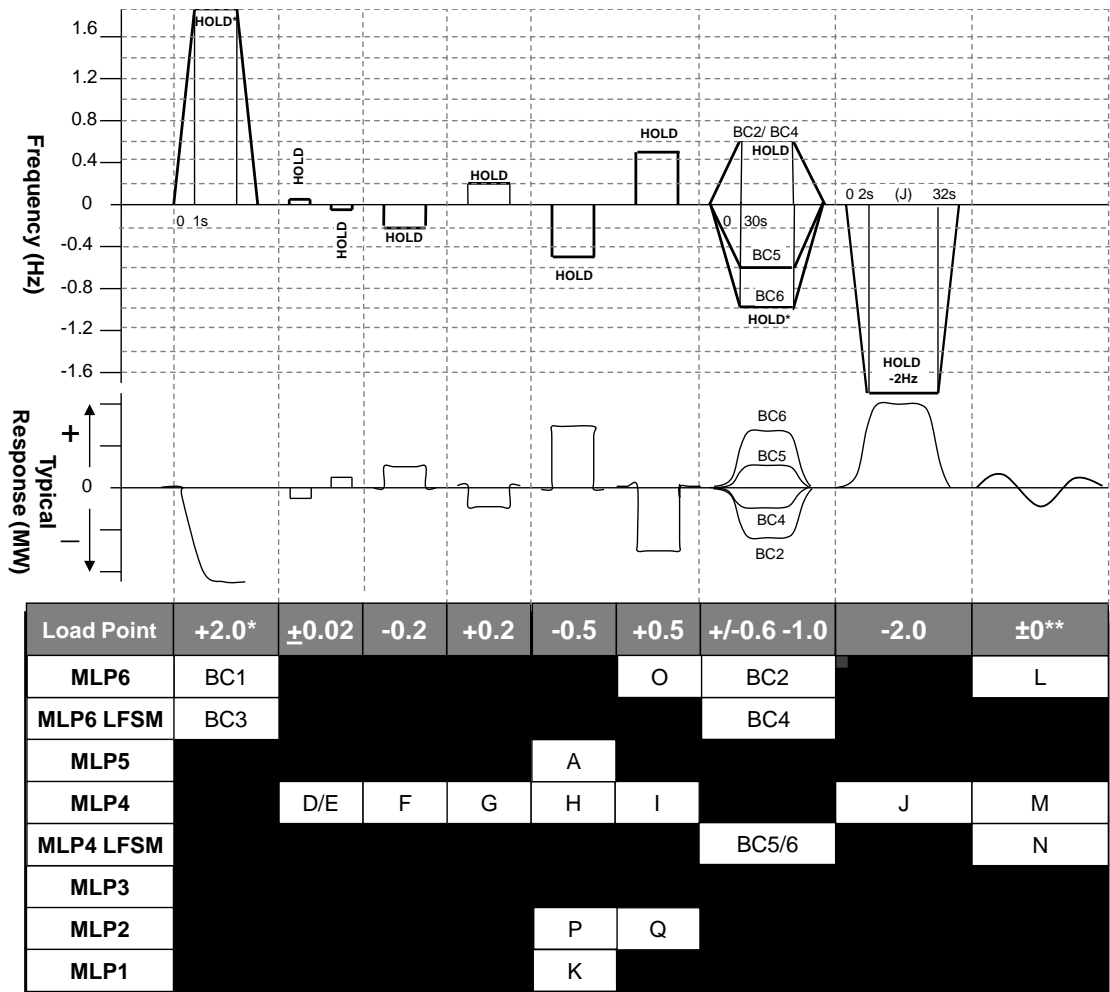

Figure 2: Frequency Response Capability LFSM-O, LFSM-U and FSM Step Response Tests

* This will generally be +2.0Hz unless an injection of this size causes a reduction in plant output that takes the operating point below the **Minimum Regulating Level** in which case an appropriate injection should be calculated in accordance with the following:

For example, 0.9Hz is needed to take an initial output 65% to a final output of 20%. If the initial output was not 65% and the **Minimum Regulating Level** is not 20% then the injected step should be adjusted accordingly as shown in the example given below

Initial Output 65%
Minimum Regulating Level 20%
 Frequency Controller Droop 4%
 Frequency to be injected = $(0.65-0.20) \times 0.04 \times 50 = 0.9\text{Hz}$

** Tests L and M in Figure 2 shall be conducted if in this range of tests the **System Frequency** feedback signal is replaced by the injection signal rather than the injection signal being added to the system frequency signal. The tests will consist of monitoring the **Synchronous Power Generating Module and CCGT Module** in **Frequency Sensitive Mode** during normal system frequency variations without applying any injection. Test N in figure 2 shall be

conducted in all cases. All three tests should be conducted for a period of at least 10 minutes.

ECP.A.5.8.9 The **Target Frequency** adjustment facility should be demonstrated from the normal control point within the range of 49.9Hz to 50.1Hz by step changes to the **Target Frequency** setpoint as indicated in ECP.A.5.8 Figure 3 while operating at MLP4.

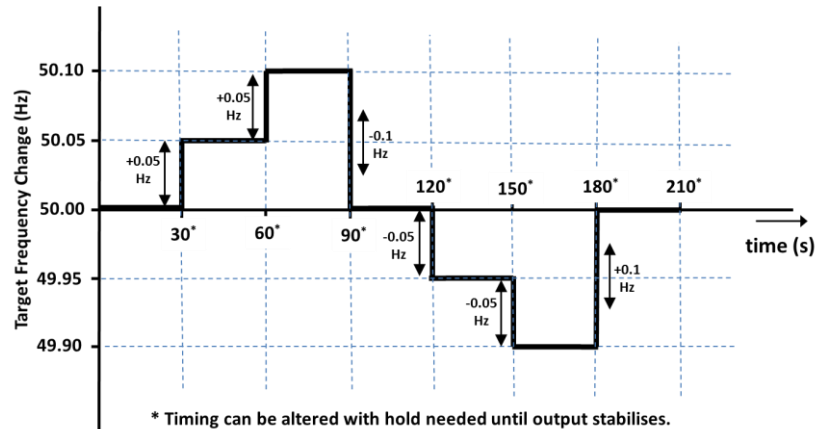

ECP.A.5.8 Figure 3 – Target Frequency setting changes

ECP.A.5.9 Compliance with ECC.6.3.3 Functionality Test

ECP.A.5.9.1 Where the plant design includes active control function or functions to deliver ECC.6.3.3 compliance, the **Generator** will propose and agree a test procedure with **The Company**, which will demonstrate how the **Synchronous Power Generating Module Active Power** output responds to changes in **System Frequency** and ambient conditions (e.g. by **Frequency** and temperature injection methods).

ECP.A.5.9.2 The **Generator** shall inform **The Company** if any load limiter control is additionally employed.

ECP.A.5.9.3 With the setpoint to the signals specified in ECP.A.4, **The Company** will agree with the **Generator** which additional control system parameters shall be monitored to demonstrate the functionality of ECC.6.3.3 compliance systems. Where **The Company** recording equipment is not used, results shall be supplied to **The Company** in an electronic spreadsheet format

ECP.A.5.10 Compliance of **Synchronous Electricity Storage Modules** during low **System Frequencies**

In order to assess the capability of the **Synchronous Electricity Storage Module** the following steps shall be undertaken:

- (i) Prior to the test, the **Synchronous Electricity Storage Module** shall be operating at its **Maximum Import Power** with the **Synchronous Electricity Storage Module** in **Limited Frequency Sensitive Mode**.
- (ii) A test signal shall be applied which ramps the **System Frequency** from 50Hz to 49.0Hz at a rate of 2Hz/s. The **System Frequency** shall be held at 49.0Hz for 60s and the then ramped back to 50Hz in 10s as shown in Figure 4.

- (iii) The test result shall demonstrate the ability of the **Electricity Storage Module** to meet the requirements of ECC.6.3.7.2.3. When the test injection signal is held at 49.0Hz, the **Active Power** output of the **Synchronous Electricity Storage Module** should achieve a steady state operating point in no more than 0.5 seconds and this should be maintained whilst the test **Frequency** signal is held at 49.0Hz.
- (iv) The above tests described (i) – (iii) above shall be repeated but the minimum test frequency applied shall be to 48.8Hz as shown in Figure 5.
- (v) The above tests shall be repeated when the **Synchronous Electricity Storage Module** is operating at 40% of its **Maximum Import Power**.

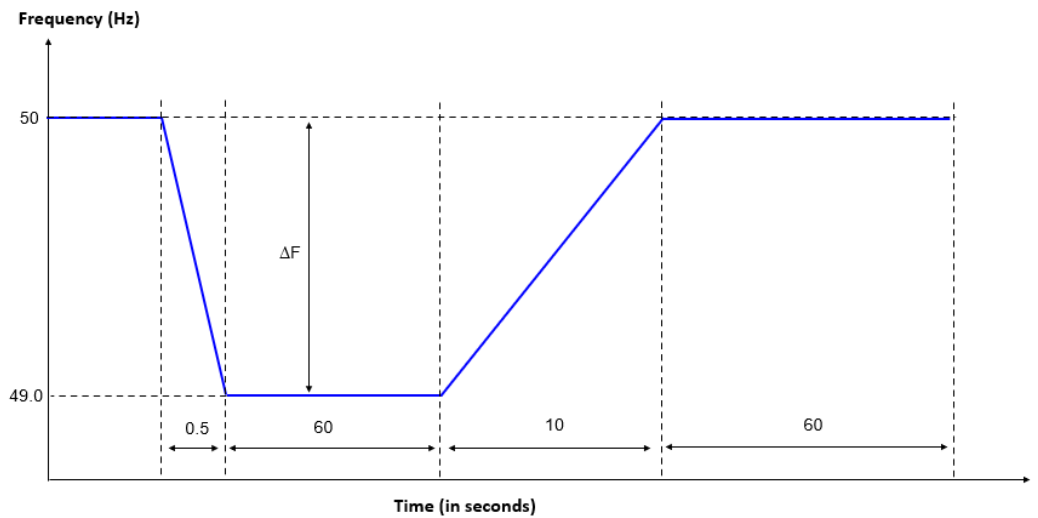

ECP.A.5.8 Figure 4

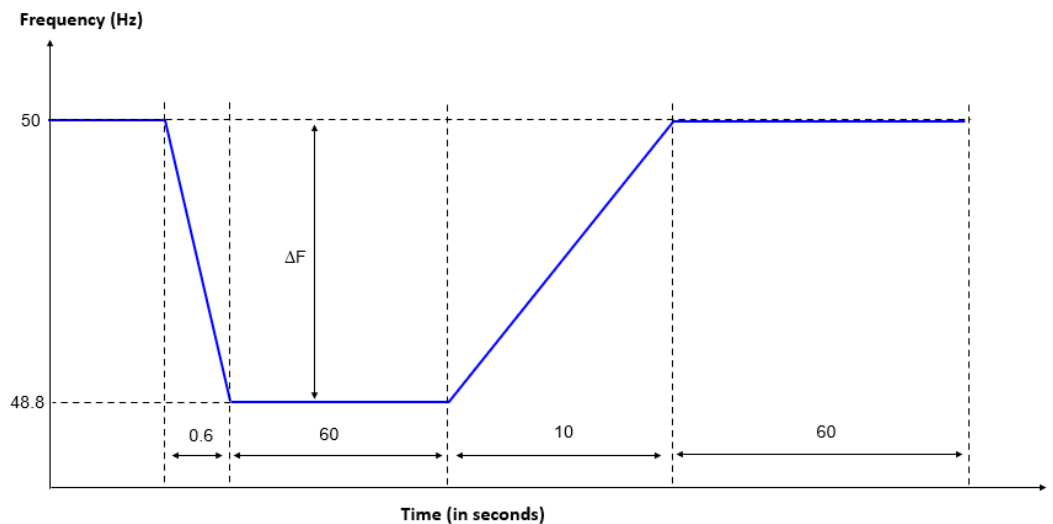

ECP.A.5.8 Figure 5

APPENDIX 6

COMPLIANCE TESTING OF POWER PARK MODULES

ECP.A.6.1 SCOPE

ECP.A.6.1.1 This Appendix outlines the general testing requirements for **Power Park Modules** and **OTSDUA** to demonstrate compliance with the relevant aspects of the **Grid Code, Ancillary Services Agreement** and **Bilateral Agreement**. The tests specified in this Appendix will normally be sufficient to demonstrate compliance however **The Company** may:

- i) agree an alternative set of tests provided **The Company** deem the alternative set of tests sufficient to demonstrate compliance with the **Grid Code, Ancillary Services Agreement** and **Bilateral Agreement**; and/or
- ii) require additional or alternative tests if information supplied to **The Company** during the compliance process suggests that the tests in this Appendix will not fully demonstrate compliance with the relevant section of the **Grid Code, Ancillary Services Agreement** or **Bilateral Agreement**; and/or
- iii) require additional tests if a **Power System Stabiliser** is fitted; and/or
- iv) agree a reduced set of tests if a relevant **Manufacturer's Data & Performance Report** has been submitted to and deemed to be appropriate by **The Company**; and/or
- v) agree a reduced set of tests for subsequent **Power Park Modules** or **OTSDUA** following successful completion of the first **Power Park Module** or **OTSDUA** tests in the case of a **Power Station** comprised of two or more **Power Park Modules** or **OTSDUA** which **The Company** reasonably considers to be identical.

If:

- (a) the tests performed pursuant to ECP.A.6.1.1(iv) do not replicate the results contained in the **Manufacturer's Data & Performance Report**, or
- (b) the tests performed pursuant to ECP.A.6.1.1(v) in respect of subsequent **Power Park Modules** or **OTSDUA** do not replicate the full tests for the first **Power Park Module** or **OTSDUA**, or
- (c) any of the tests performed pursuant to ECP.A.6.1.1(iv) or ECP.A.6.1.1(v) do not fully demonstrate compliance with the relevant aspects of the **Grid Code, Ancillary Services Agreement** and / or **Bilateral Agreement**,

then notwithstanding the provisions above, the full testing requirements set out in this Appendix will be applied.

ECP.A.6.1.2 The **Generator** is responsible for carrying out the tests set out in and in accordance with this Appendix and the **Generator** retains the responsibility for the safety of personnel and plant during the test. **The Company** will witness all of the tests outlined or agreed in relation to this Appendix unless **The Company** decides and notifies the **Generator** otherwise. Reactive Capability tests may be witnessed by **The Company** remotely from **The Company** control centre. For all on site **The Company** witnessed tests the **Generator**

must ensure suitable representatives from the **Generator** and / or **Power Park Module** manufacturer (if appropriate) and/or **OTSDUA** manufacturer (if appropriate) are available on site for the entire testing period. In all cases and in addition to any recording of signals conducted by **The Company**, the **Generator** shall record all relevant test signals as outlined in ECP.A.4.

- ECP.A.6.1.3 In addition to the dynamic signals supplied in ECP.A.4 the **Generator** shall inform **The Company** of the following information prior to the commencement of the tests and any changes to the following, if any values change during the tests:
- (i) All relevant transformer tap numbers; and
 - (ii) Number of **Power Park Units** in operation
- ECP.A.6.1.4 The **Generator** shall submit a detailed schedule of tests to **The Company** in accordance with CP.6.3.1, and this Appendix.
- ECP.A.6.1.5 Prior to the testing of a **Power Park Module** or **OTSDUA**, the **Generator** shall complete the **Integral Equipment Tests** procedure in accordance with OC.7.5.
- ECP.A.6.1.6 Partial **Power Park Module** or **OTSDUA** testing as defined in ECP.A.6.2 and ECP.A.6.3 is to be completed at the appropriate stage in accordance with ECP.6, ECP6.4A, ECP6.4B.
- ECP.A.6.1.7 Full **Power Park Module** or **OTSDUA** testing as required by CP.7.2 is to be completed as defined in ECP.A.6.4 through to ECP.A.6.7.
- ECP.A.6.1.8 Where **OTSDUW Arrangements** apply and prior to the **OTSUA Transfer Time** any relevant **OTSDUW Plant and Apparatus** shall be considered within the scope of testing described in this Appendix. Performance shall be assessed against the relevant Grid Code requirements for **OTSDUW Plant and Apparatus** at the **Interface Point** and other **Generator Plant and Apparatus** at the **Offshore Grid Entry Point**. This Appendix should be read accordingly.
- ECP.A.6.1.9 **The Company** will permit relaxation from the requirement ECP.A.6.2 to ECP.A.6.8 where an **Equipment Certificate** for the **Power Park Module** has been provided which details the characteristics from tests on a representative installation with the same equipment and settings and the performance of the **Power Park Module** can, in **The Company's** opinion, reasonably represent that of the installed **Power Park Module** at that site. For **Type B, Type C** and **Type D Power Park Modules**, the relevant **Equipment Certificate** must be supplied in the **Power Generating Module Document** or **Users Data File structure** as applicable.
- ECP.A.6.1.10 In the case of a co-located site, for example **Electricity Storage Modules** or **Grid Forming Plant** connected within a new or existing **Power Station**, **The Company** will accept test results to demonstrate compliance at the **Grid Entry Point** or **User System Entry Point** (if **Embedded**) through a combination of the capabilities of the **Power Generating Modules** (which could include a **Grid Forming Plant**) and **Electricity Storage Modules** or **Electricity Storage Modules** (which could include a **Grid Forming Plant**) and **Generating Units** or **Power Park Modules**. **Generators** should however be aware that for the purposes of testing, full Grid Code compliance should be demonstrated when, for example, the **Electricity Storage Module** or **Grid Forming Plant** is out of service and the remaining **Power Generating Module** is in service or the **Electricity Storage Module** or **Grid Forming Plant** is in service and the **Power Generating Module** is out of service. In the case of a **Non-Synchronous**

Electricity Storage Module, The Company would expect the full set of tests to be completed as detailed in ECP.A.6.2 to ECP.A.6.8.

ECP.A.6.2 Pre 20% (or <50MW) Synchronised Power Park Module Basic Voltage Control Tests

ECP.A.6.2.1 Before 20% of the **Power Park Module** (or 50MW if less) has commissioned, either voltage control test ECP.A.6.5.6(i) or (ii) must be completed in accordance with ECP.6, ECP.6A or ECP.6B. In the case of an **Offshore Power Park Module** the test must be completed by the **Generator** undertaking **OTSDUW** or the **Offshore Transmission Licensee** under STCP19-5.

ECP.A.6.2.2 In the case of an **Offshore Power Park Module** which provides all or a portion of the **Reactive Power** capability as described in ECC.6.3.2.5.2 or ECP.6.3.2.6.3 and / or voltage control requirements as described in ECC.6.3.8.5 to enable an **Offshore Transmission Licensee** to meet the requirements of **STC** Section K, the **Generator** is required to cooperate with the **Offshore Transmission Licensee** to conduct the 20% voltage control test. The results in relation to the **Offshore Power Park Module** will be assessed against the requirements in the **Bilateral Agreement**.

ECP.A.6.3 Power Park Modules with Maximum Capacity \geq 100MW Pre 70% Power Park Module Tests

ECP.A.6.3.1 Before 70% but with at least 50% of the **Power Park Module** commissioned the following **Limited Frequency Sensitive** tests as detailed in ECP.A.6.6.2 must be completed.

- (a) BC3
- (b) BC4

ECP.A.6.4 Reactive Capability Test

ECP.A.6.4.1 This section details the procedure for demonstrating the reactive capability of an **Onshore Power Park Module** or an **Offshore Power Park Module** or **OTSDUA** which provides all or a portion of the **Reactive Power** capability as described in ECC.6.3.2.5.2 or ECP.6.3.2.6.3 as applicable (for the avoidance of doubt, an **Offshore Power Park Module** which does not provide part of the **Offshore Transmission Licensee Reactive Power** capability as described in ECC.6.3.2.5.1 and ECP.6.3.2.6.1 should complete the **Reactive Power** transfer / voltage control tests as per section ECP.A.6.8). These tests should be scheduled at a time where there are at least 95% of the **Power Park Units** within the **Power Park Module** in service. There should be sufficient MW resource forecasted in order to generate at least 85% of **Maximum Capacity** of the **Power Park Module**.

ECP.A.6.4.2 The tests shall be performed by modifying the voltage set-point of the voltage control scheme of the **Power Park Module** or **OTSDUA** by the amount necessary to demonstrate the required reactive range. This is to be conducted for the operating points and durations specified in ECP.A.6.4.5.

ECP.A.6.4.3 An **Embedded Generator** or **Embedded Generator** undertaking **OTSDUW** should liaise with the relevant **Network Operator** to ensure the following tests will not have an adverse impact upon the **Network Operator's System** as per OC.7.5. In situations where the tests have an adverse impact upon the **Network Operator's System**, **The Company** will only require demonstration within the acceptable limits of the **Network Operator**. For the avoidance of doubt, these tests do not negate the requirement to produce a complete **Power Park Module** or **OTSDUA** performance chart as specified in OC2.4.2.1

ECP.A.6.4.4 In the case where the **Reactive Power** metering point is not at the same location as the **Reactive Power** capability requirement, then an equivalent **Reactive Power** capability for the metering point shall be agreed between the **Generator** and **The Company**.

ECP.A.6.4.5 The following tests shall be completed:

- (i) Operation in excess of 60% **Maximum Capacity** and maximum continuous lagging **Reactive Power** for 30 minutes. For the avoidance of doubt this test must start with **Active Power** output in excess of 85% of **Maximum Capacity** of the **Power Park Module** as ECP.A.6.4.1 and must not fall below 60% of **Maximum Capacity** of the **Power Park Module** during the 30 minutes.
- (ii) Operation in excess of 60% **Maximum Capacity** and maximum continuous leading **Reactive Power** for 30 minutes. For the avoidance of doubt this test must start with **Active Power** output in excess of 85% of **Maximum Capacity** of the **Power Park Module** as ECP.A.6.4.1 and must not fall below 60% of **Maximum Capacity** of the **Power Park Module** during the 30 minutes.
- (iii) Operation at 50% **Maximum Capacity** and maximum continuous leading **Reactive Power** for 30 minutes.
- (iv) Operation at 50% **Maximum Capacity** and maximum continuous lagging **Reactive Power** for 30 minutes.
- (v) Operation at 20% **Maximum Capacity** and maximum continuous leading **Reactive Power** for 60 minutes.
- (vi) Operation at 20% **Maximum Capacity** and maximum continuous lagging **Reactive Power** for 60 minutes.
- (vii) Operation at less than 20% **Maximum Capacity** and unity **Power Factor** for 5 minutes. This test only applies to systems which do not offer voltage control below 20% of **Maximum Capacity**.
- (viii) Operation at the lower of the **Minimum Regulating Level** or 0% **Maximum Capacity** and maximum continuous leading **Reactive Power** for 5 minutes. This test only applies to systems which offer voltage control below 20% and hence establishes actual capability rather than required capability.
- (ix) Operation at the lower of the **Minimum Regulating Level** or 0% **Maximum Capacity** and maximum continuous lagging **Reactive Power** for 5 minutes. This test only applies to systems which offer voltage control below 20% and hence establishes actual capability rather than required capability.

In the case of a **Non-Synchronous Electricity Storage Module**, **The Company** shall have discretion to reduce the duration of the tests required in ECP.A.6.4.5 (i) – (viii) depending upon the capability of the energy store.

ECP.A.6 Within this ECP, lagging **Reactive Power** is the export of **Reactive Power** from the **Power Park Module** to the **Total System** and leading **Reactive Power** is the import of **Reactive Power** from the **Total System** to the **Power Park Module** or **OTSDUA**.

ECP.A.6.5 Voltage Control Tests

- ECP.A.6.5.1 This section details the procedure for conducting voltage control tests on **Onshore Power Park Modules** or **OTSDUA** or an **Offshore Power Park Module** which provides all or a portion of the voltage control capability as described in ECC.6.3.8.5 (for the avoidance of doubt, **Offshore Power Park Modules** which do not provide part of the **Offshore Transmission Licensee** voltage control capability as described in CC6.3.8.5 should complete the **Reactive Power** transfer / voltage control tests as per section ECP.A.6.8). These tests should be scheduled at a time when there are at least 95% of the **Power Park Units** within the **Power Park Module** in service. There should be sufficient MW resource forecasted in order to generate at least 65% of **Maximum Capacity** of the **Onshore Power Park Module**. An **Embedded Generator** or **Embedded Generators** undertaking **OTSDUW** should also liaise with the relevant **Network Operator** to ensure all requirements covered in this section will not have a detrimental effect on the **Network Operator's System**.
- ECP.A.6.5.2 The voltage control system shall be perturbed with a series of step injections to the **Power Park Module** voltage setpoint, and where possible, multiple up-stream transformer taps. In the case of an **Offshore Power Park Module** providing part of the **Offshore Transmission Licensee** voltage control capability this may require a series of step injections to the voltage setpoint of the **Offshore Transmission Licensee** control system.
- ECP.A.6.5.3 For steps initiated using network tap changers, the **Generator** will need to coordinate with **The Company** or the relevant **Network Operator** as appropriate. The time between transformer taps shall be at least 10 seconds as per ECP.A.6.5 Figure 1.
- ECP.A.6.5.4 For a step injection into the **Power Park Module** or **OTSDUA** voltage setpoint, steps of $\pm 1\%$, $\pm 2\%$ and $\pm 4\%$ (or larger if required by **The Company**) shall be applied to the voltage control system setpoint summing junction. The injection shall be maintained for a minimum of 10 seconds as per ECP.A.6.5 Figure 2.
- ECP.A.6.5.5 Where the voltage control system comprises of discretely switched **Plant** and **Apparatus** (eg. mechanically switched shunt reactors or capacitors) additional tests will be required to demonstrate that overall performance of the voltage control system when switching these devices as part of the response is in accordance with **Grid Code** and **Bilateral Agreement** requirements.
- ECP.A.6.5.6 Tests to be completed:

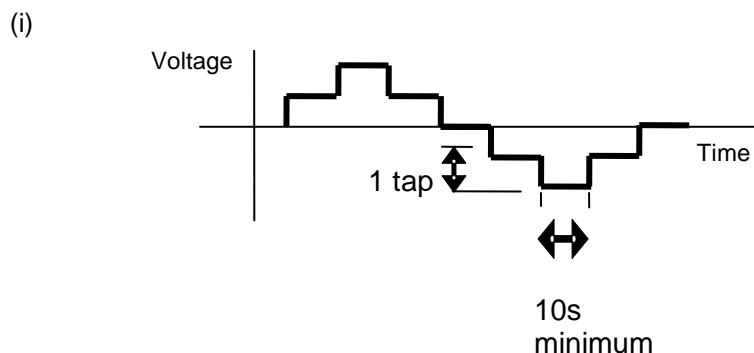

ECP.A.6.5 Figure 1 – Transformer tap sequence for voltage control tests

(ii)

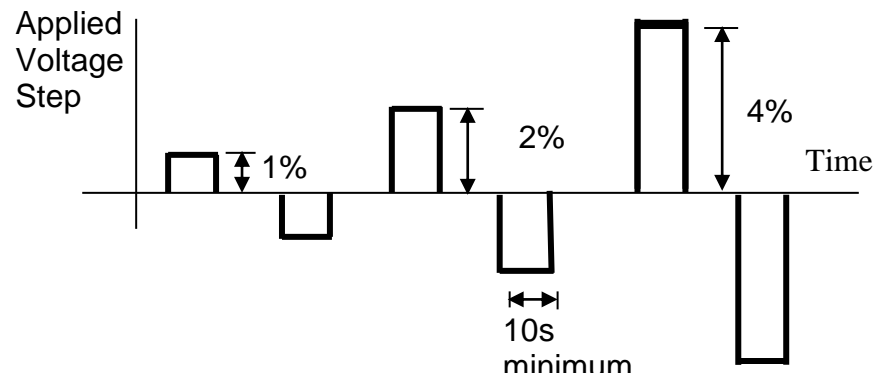

ECP.A.6.5 Figure 2 – Step injection sequence for voltage control tests

ECP.A.6.5.7 In the case of **OTSDUA**, where the **Bilateral Agreement** specifies additional damping facilities, additional testing to demonstrate these damping facilities may be required.

ECP.A.6.5.8 In the case of **Power Park Modules** that do not provide voltage control down to zero **Active Power** a test to demonstrate the smooth transition from voltage control mode to unity **Power Factor** shall be carried out. The **Power Park Module** voltage setpoint should be altered to produce lagging **Reactive Power** or absorbing leading **Reactive Power** at a low **Active Power** level where voltage control is provided. The **Power Park Module Active Power** should then be reduced to zero **Active Power** as a ramp over a short period (60 seconds is suggested).

ECP.A.6.6 Frequency Response Tests

ECP.A.6.6.1 This section describes the procedure for performing frequency response testing on a **Power Park Module**. These tests should be scheduled at a time where there are at least 95% of the **Power Park Units** within the **Power Park Module** in service. There should be sufficient MW resource forecasted in order to generate at least 65% of **Maximum Capacity** of the **Power Park Module**.

ECP.A.6.6.2 The frequency controller shall be in **Frequency Sensitive Mode** or **Limited Frequency Sensitive Mode** as appropriate for each test. Simulated frequency deviation signals shall be injected into the frequency controller setpoint/feedback summing junction. If the injected frequency signal replaces rather than sums with the real **System Frequency** signal then the additional tests outlined in ECP.A.6.6.6 shall be performed with the **Power Park Module** or **Power Park Unit** in normal **Frequency Sensitive Mode** monitoring actual **System Frequency**, over a period of at least 10 minutes. The aim of this additional test is to verify that the control system correctly measures the real **System Frequency** for normal variations over a period of time.

ECP.A.6.6.3 In addition to the frequency response requirements it is necessary to demonstrate the **Power Park Module** ability to deliver a requested steady state power output which is not impacted by power source variation as per ECC.6.3.9. This test shall be conducted in **Limited Frequency Sensitive Mode** at a part-loaded output for a period of 10 minutes as per ECP.A.6.6.6.

Preliminary Frequency Response Testing

ECP.A.6.6.4 Prior to conducting the full set of tests as per ECP.A.6.6.6, **Generators** are

required to conduct the preliminary set of tests below to confirm the frequency injection method is correct and the plant control performance is within expectation. The test numbers refer to Figure 1 below. The test should be conducted when sufficient MW resource is forecast in order to generate at least 65% of **Maximum Capacity** of the **Power Park Module**. The following frequency injections shall be applied when operating at module load point 4.

Test No (Figure1)	Frequency Injection	Notes
8	<ul style="list-style-type: none"> Inject -0.5Hz frequency fall over 10 sec Hold for a further 20 sec At 30 sec from the start of the test, Inject a +0.3Hz frequency rise over 30 sec. Hold until conditions stabilise Remove the injected signal as a ramp over 10 seconds 	
13	<ul style="list-style-type: none"> Inject - 0.5Hz frequency fall over 10 sec Hold until conditions stabilise Remove the injected signal as a ramp over 10 seconds 	
14	<ul style="list-style-type: none"> Inject +0.5Hz frequency rise over 10 sec Hold until conditions stabilise Remove the injected signal as a ramp over 10 seconds 	
H	<ul style="list-style-type: none"> Inject - 0.5Hz frequency fall as a stepchange Hold until conditions stabilise Remove the injected signal as a stepchange 	
I	<ul style="list-style-type: none"> Inject +0.5Hz frequency rise as a stepchange Hold until conditions stabilise Remove the injected signal as a stepchange 	

ECP.A.6.6.5 The recorded results (e.g. Finj, MW and control signals) should be sampled at a minimum rate of 1 Hz to allow **The Company** to assess the plant performance from the initial transients (seconds) to the final steady state conditions (5-15 minutes depending on the plant design). This is not witnessed by **The Company**. The **Generator** shall supply the recordings including data to **The Company** in an electronic spreadsheet format. Results shall be legible, identifiable by labelling, and shall have appropriate scaling.

Full Frequency Response Testing Schedule Witnessed by **The Company**.

ECP.A.6.6.6 The tests are to be conducted at a number of different Module Load Points (MLP). In the case of a **Power Park Module** the module load points are conducted as shown below unless agreed otherwise by **The Company**.

Module Load Point 6 (Maximum Export Limit)	100% MEL
Module Load Point 5	90% MEL
Module Load Point 4	80% MEL
Module Load Point 3	MRL+0.6 x (MEL – MRL)
Module Load Point 2 Lower of MRL + 0.3 x (MEL – MRL) or Minimum Stable Operating Level	MRL+0.3 X (MEL – MRL) or MSOL
Module Load Point 1 (Minimum Regulating Level)	MRL

ECP.A.6.6.7 The tests are divided into the following two types;

- (i) Frequency response compliance and volume tests as per ECP.A.6.6. Figure 1. These tests consist of frequency profile and ramp tests and adjustments to target frequency setpoint as per ECP.A.6.6 Figure 3.

- (ii) System islanding and step response tests as shown by ECP.A.6.6. Figure 2.
- (iii) Frequency response tests in **Limited Frequency Sensitive Mode (LFSM)** to demonstrate **LFSM-O** and **LFSM-U** capability as shown by ECP.A.6.6 Figure 2.

ECP.A.6.6.8 There should be sufficient time allowed between tests for control systems to reach steady state (depending on available power resource). Where the diagram states 'HOLD' the current injection should be maintained until the **Active Power (MW)** output of the **Power Park Module** has stabilised or 90 seconds, whichever is the longer. All frequency response tests should be removed over the same timescale for which they were applied. **The Company** may require repeat tests should the response volume be affected by the available power, or if tests give unexpected results. When witnessed by **The Company** each test should be carried out as a separate injection, when not witnessed by **The Company** there must be sufficient time allowed between tests for the **Active Power (MW)** output of the **Power Park Module** to have stabilised or 90 seconds, whichever is the longer.

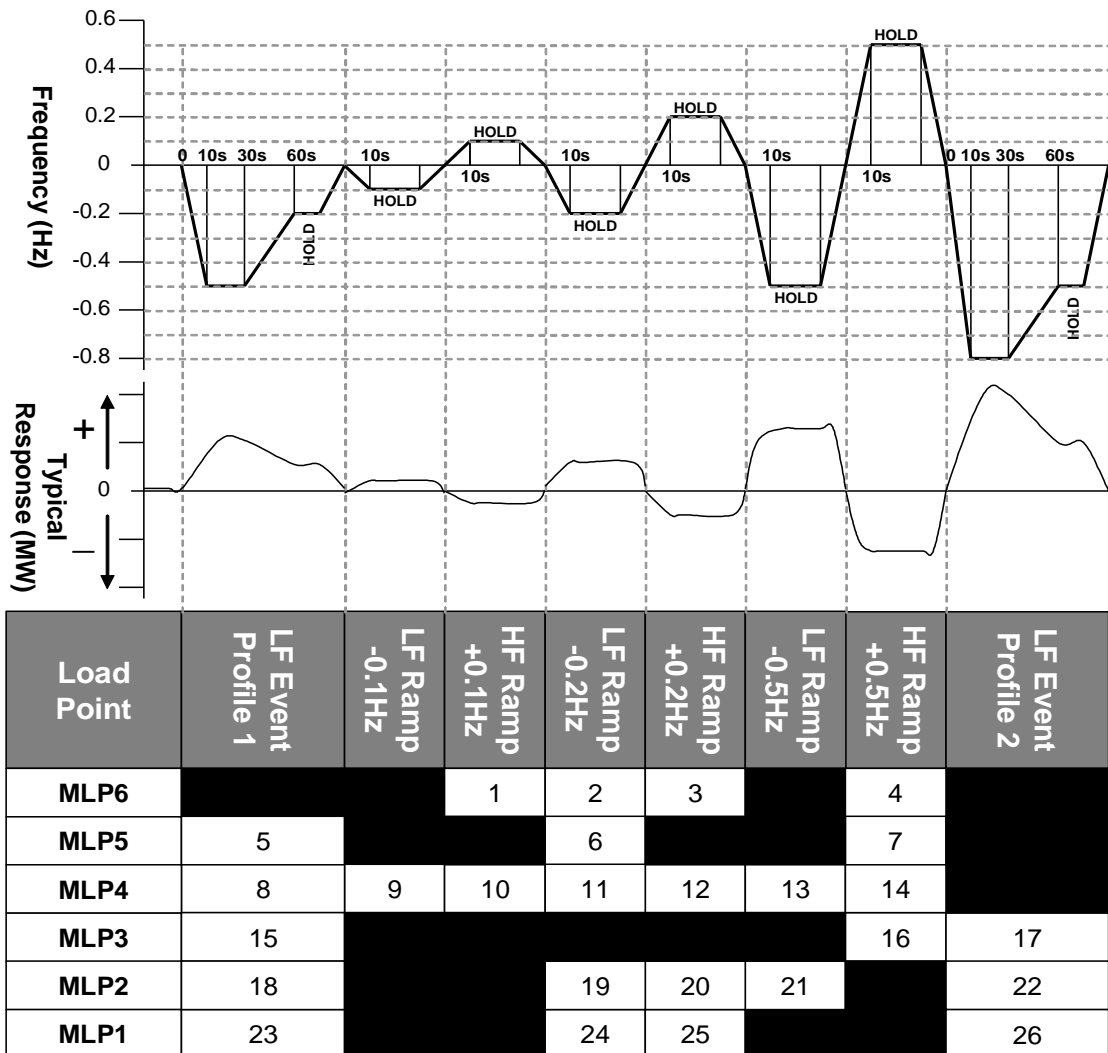

ECP.A.6.6. Figure 1 – Frequency Response Capability FSM Ramp Response tests

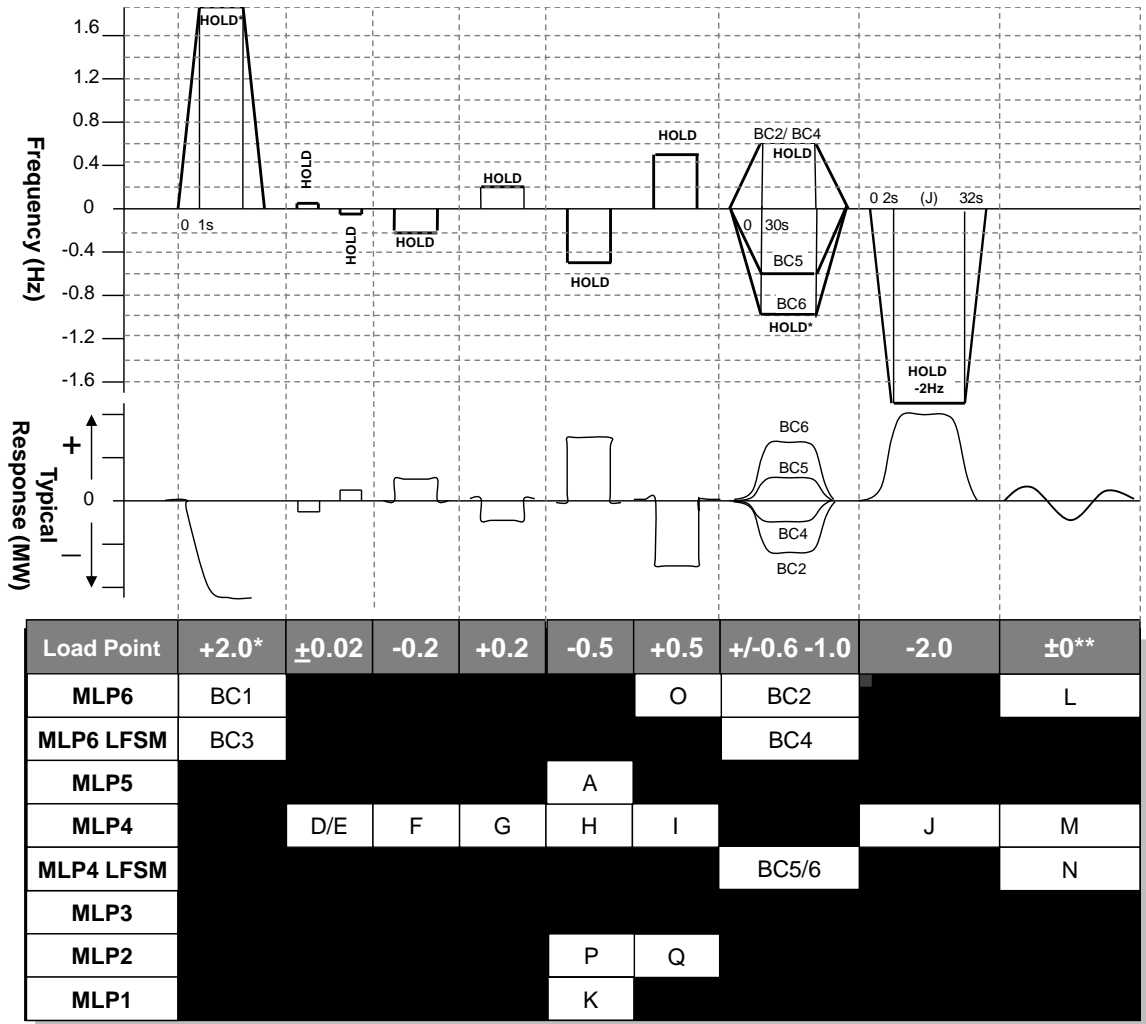

ECP.A.6.6. Figure 2 – Frequency Response Capability LFSM-O, LFSM-U, FSM Step Response tests

* This will generally be +2.0Hz unless an injection of this size causes a reduction in plant output that takes the operating point below the **Minimum Regulating Level** in which case an appropriate injection should be calculated in accordance with the following:

For example 0.9Hz is needed to take an initial output 65% to a final output of 20%. If the initial output was not 65% and the **Minimum Regulating Level** is not 20% then the injected step should be adjusted accordingly as shown in the example given below

Initial Output 65%
Minimum Regulating Level 20%
 Frequency Controller Droop 4%
 Frequency to be injected = $(0.65-0.20) \times 0.04 \times 50 = 0.9\text{Hz}$

** Tests L and M in Figure 2 shall be conducted if in this range of tests the **System Frequency** feedback signal is replaced by the injection signal rather than the injection signal being added to the system frequency signal. The tests will consist of monitoring the **Power Park Module** in **Frequency Sensitive Mode** during normal **System Frequency** variations without applying any injection. Test N in Figure 2 shall be conducted in all cases. All three tests should be conducted for a period of at least 10 minutes.

ECP.A.6.6.9 The **Target Frequency** adjustment facility should be demonstrated from the

normal control point within the range of 49.9Hz to 50.1Hz by step changes to the **Target Frequency** setpoint as indicated in ECP.A.6.6 Figure 3 while operating at MLP4.

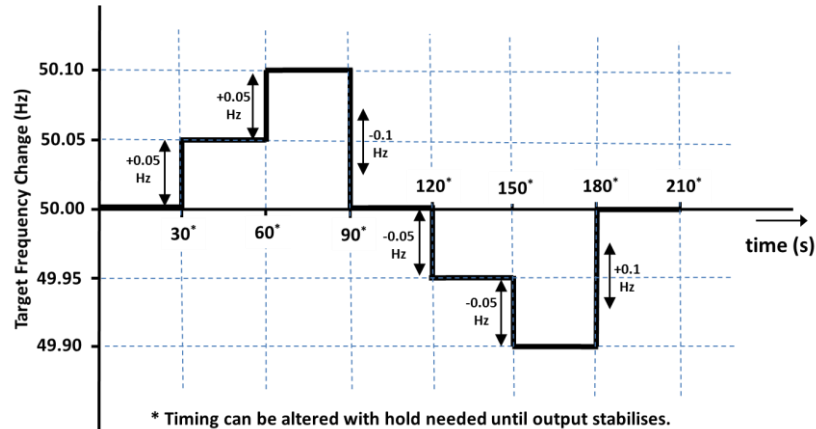

ECP.A.6.6. Figure 3 – **Target Frequency** setting changes

ECP.A.6.6.10 Compliance of **Non-Synchronous Electricity Storage Modules** during low **System Frequencies**

In order to assess the capability of the **Non-Synchronous Electricity Storage Module** the following steps shall be undertaken.

- (i) Prior to the test, the **Non-Synchronous Electricity Storage Module** shall be operating at its **Maximum Import Power** with the **Non-Synchronous Electricity Storage Module** in **Limited Frequency Sensitive Mode**.
- (ii) A test signal shall be applied which ramps the **System Frequency** from 50Hz to 49.0Hz at a rate of 2Hz/s. The **System Frequency** shall be held at 49.0Hz for 60s and the then ramped back to 50Hz in 10s as shown in Figure 4.
- (iii) The test result shall demonstrate the ability of the **Electricity Storage Module** to meet the requirements of ECC.6.3.7.2.3. When the test injection signal is held at 49.0Hz, the **Active Power** output of the **Non-Synchronous Electricity Storage Module** should achieve a steady state operating point in no more than 0.5 seconds and this should be maintained whilst the test **Frequency** signal is held at 49.0Hz.
- (iv) The above tests described (i) – (iii) above shall be repeated but the minimum test frequency applied shall be to 48.8Hz as shown in Figure 5.
- (v) The above tests shall be repeated when the **Non-Synchronous Electricity Storage Module** is operating at 40% of its **Maximum Import Power**.

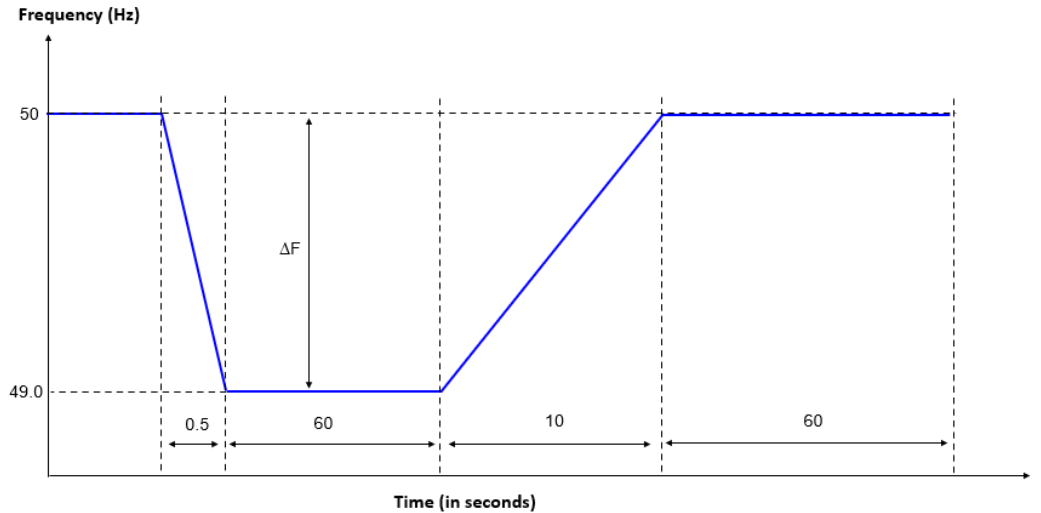

ECP.A.6.6 Figure 4

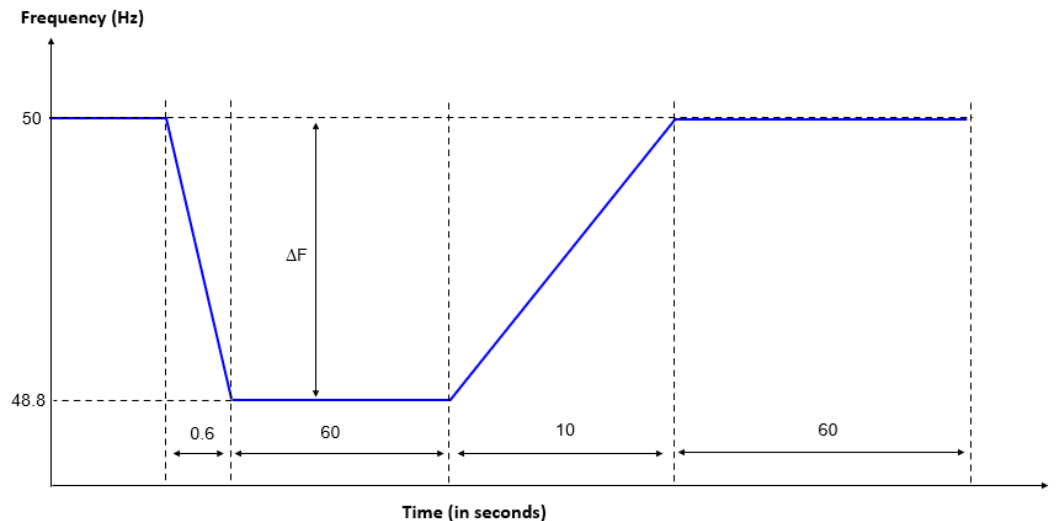

ECP.A.6.6 Figure 5

ECP.A.6.7 Fault Ride Through Testing

ECP.A.6.7.1 This section describes the procedure for conducting **Fault Ride Through** tests on a single **Power Park Unit** as required by ECP.7.2.2(d).

ECP.A.6.7.2 The test circuit will utilise the full **Power Park Unit** (e.g. in the case of a wind turbine it would include the full wind turbine nacelle structure, all inverters and converters along with step up transformer to medium voltage, all control systems including pitch control emulation) and shall be conducted with sufficient power input resource available to produce at least 95% of the **Maximum Capacity** of the **Power Park Unit**. The test will comprise of a number of controlled short circuits applied to a test network to which the **Power Park Unit** is connected, typically comprising of the **Power Park Unit** transformer and a test impedance or other decoupling equipment to shield the connected network from voltage dips at the **Power Park Unit** terminals.

- ECP.A.6.7.3 In each case, the tests should demonstrate the minimum voltage at the **Power Park Unit** terminals or **High Voltage** side of the **Power Park Unit** transformer which the **Power Park Unit** can withstand for the length of time specified in ECP.A.6.7.5. Any test results provided to **The Company** should contain sufficient data pre and post fault in order to determine steady state values of all signals, and the power recovery timescales.
- ECP.A.6.7.4 In addition to the signals outlined in ECP.A.4.2. the following signals from either the **Power Park Unit** terminals or **High Voltage** side of the **Power Park Unit** transformer should be provided for this test only:
- (i) Phase voltages
 - (ii) Positive phase sequence and negative phase sequence voltages
 - (iii) Phase currents
 - (iv) Positive phase sequence and negative phase sequence currents
 - (v) Estimate of **Power Park Unit** negative phase sequence impedance
 - (vi) MW – **Active Power** at the **Power Generating Module**.
 - (vii) MVar – **Reactive Power** at the **Power Generating Module**.
 - (viii) Mechanical Rotor Speed
 - (ix) Real / reactive, current / power Setpoint as appropriate
 - (x) **Fault Ride Through** protection operation (e.g. a crowbar in the case of a doubly fed induction generator)
 - (xi) Any other signals relevant to the control action of the **Fault Ride Through** control deemed applicable for model validation.

At a suitable frequency rate for fault ride through tests as agreed with **The Company**.

- ECP.A.6.7.5 The tests should be conducted for the times and fault types indicated in ECC.6.3.15 as applicable.

ECP.A.6.8 Reactive Power Transfer / Voltage Control Tests for **Offshore Power Park Modules**

- ECP.A.6.8.1 In the case of an **Offshore Power Park Module** which provides all or a portion of the **Reactive Power** capability as described in ECP.6.3.2.5.2 or ECP.6.3.6.3 and / or voltage control requirements as described in ECC.6.3.8.5 to enable an **Offshore Transmission Licensee** to meet the requirements of **STC** Section K, the testing, will comprise of the entire control system responding to changes at the onshore **Interface Point**. Therefore, the tests in this section ECP.A.6.8 will not apply. The **Generator** shall cooperate with the relevant **Offshore Transmission Licensee** to facilitate these tests as required by **The Company**. The testing may be combined with testing of the corresponding **Offshore Transmission Licensee** requirements under the **STC**. The results in relation to the **Offshore Power Park Module** will be assessed against the requirements in the **Bilateral Agreement**.

- ECP.A.6.8.2 In the case of an **Offshore Power Park Module** which does not provide part of the **Offshore Transmission Licensee Reactive Power** capability the following procedure for conducting **Reactive Power** transfer control tests on **Offshore Power Park Modules** and / or voltage control system as per ECC.6.3.2.5 and ECC.6.3.2.6 apply. These tests should be carried out prior to 20% of the **Power Park Units** within the **Offshore Power Park Module** being synchronised, and again when at least 95% of the **Power Park Units** within the **Offshore Power Park Module** in service. There should be sufficient power resource forecast to generate at least 85% of the **Maximum Capacity** of the **Offshore Power Park Module**.

- ECP.A.6.8.3 The **Reactive Power** control system shall be perturbed by a series of system voltage changes and changes to the **Active Power** output of the **Offshore Power Park Module**.
- ECP.A.6.8.4 **System** voltage changes should be created by a series of multiple upstream transformer taps. The **Generator** should coordinate with **The Company** or the relevant **Network Operator** in order to conduct the required tests. The time between transformer taps should be at least 10 seconds as per ECP.A.6.8 Figure 1.
- ECP.A.6.8.5 The **Active Power** output of the **Offshore Power Park Module** should be varied by applying a sufficiently large step to the frequency controller Setpoint/feedback summing junction to cause a 10% change in output of the **Maximum Capacity** of the **Offshore Power Park Module** in a time not exceeding 10 seconds. This test does not need to be conducted provided that the frequency response tests as outlined in ECP.A.6.6 are completed.
- ECP.A.6.8.6 The following diagrams illustrate the tests to be completed:

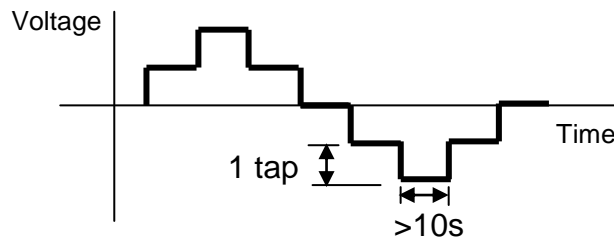

ECP.A.6.8 Figure 1 – Transformer tap sequence for reactive transfer tests

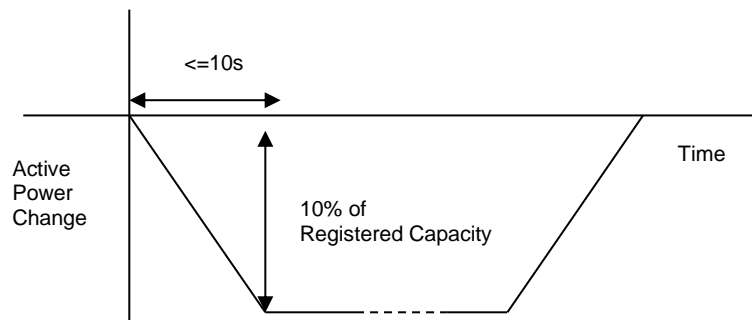

ECP.A.6.8 Figure 2 – **Active Power** ramp for reactive transfer tests

APPENDIX 7

COMPLIANCE TESTING FOR HVDC EQUIPMENT

ECP.A.7.1 SCOPE

ECP.A.7.1.1 This Appendix outlines the general testing requirements for **HVDC System Owners** to demonstrate compliance with the relevant aspects of the **Grid Code, Ancillary Services Agreement** and **Bilateral Agreement**. The tests specified in this Appendix will normally be sufficient to demonstrate compliance however **The Company** may:

- i) agree an alternative set of tests provided **The Company** deem the alternative set of tests sufficient to demonstrate compliance with the **Grid Code, Ancillary Services Agreement** and **Bilateral Agreement**; and/or
- ii) require additional or alternative tests if information supplied to **The Company** during the compliance process suggests that the tests in this Appendix will not fully demonstrate compliance with the relevant section of the **Grid Code, Ancillary Services Agreement** or **Bilateral Agreement**; and/or
- iii) require additional tests if control functions to improve damping of power system oscillations and/or subsynchronous resonance torsional oscillations required by the **Bilateral Agreement** or included in the control scheme and active; and/or
- iv) agree a reduced set of tests for subsequent **HVDC Equipment** following successful completion of the first **HVDC Equipment** tests in the case of an installation comprising of two or more **HVDC Systems** or **DC Connected Power Park Modules** which **The Company** reasonably considers to be identical.

If:

- (a) the tests performed pursuant to ECP.A.7.1.1(iv) in respect of subsequent **HVDC Systems** or **DC Connected Power Park Modules** do not replicate the full tests for the first **HVDC Equipment**, or
- (b) any of the tests performed pursuant to ECP.A.7.1.1(iv) do not fully demonstrate compliance with the relevant aspects of the **Grid Code, Ancillary Services Agreement** and / or **Bilateral**

ECP.A.7.1.2 The **HVDC System Owner** is responsible for carrying out the tests set out in and in accordance with this Appendix and the **HVDC System Owner** retains the responsibility for the safety of personnel and plant during the test. The **HVDC System Owner** is responsible for ensuring that suitable arrangements are in place with the **Externally Interconnected System Operator** to facilitate testing. **The Company** will witness all of the tests outlined or agreed in relation to this Appendix unless **The Company** decides and notifies the **HVDC System Owner** otherwise. Reactive Capability tests if required, may be witnessed by **The Company** remotely from **The Company** control centre. For all on site at **The Company** witnessed tests, the **HVDC System Owner** must ensure suitable representatives from the **HVDC System Owner** and / or **HVDC Equipment** manufacturer (if appropriate) are available on site for the entire testing period. In all cases and in addition to any recording of signals conducted by **The Company**, the **HVDC System Owner** shall record all relevant test signals as outlined in ECP.A.4.

- ECP.A.7.1.3 In addition to the dynamic signals supplied in ECP.A.4 the **HVDC System Owner** shall inform **The Company** of the following information prior to the commencement of the tests and any changes to the following, if any values change during the tests:
- (i) All relevant transformer tap numbers.
- ECP.A.7.1.4 The **HVDC System Owner** shall submit a detailed schedule of tests to **The Company** in accordance with CP.6.3.1, and this Appendix.
- ECP.A.7.1.5 Prior to the testing of **HVDC Equipment**, the **HVDC System Owner** shall complete the **Integral Equipment Tests** procedure in accordance with OC.7.5.
- ECP.A.7.1.6 Full **HVDC Equipment** testing as required by ECP.7.2 is to be completed as defined in ECP.A.7.2 through to ECP.A.7.5.
- ECP.A.7.1.7 **The Company** will permit relaxation from the requirement ECP.A.7.2 to ECP.A.7.5 where an **Equipment Certificate for HVDC Equipment** has been provided which details the characteristics from tests on a representative installation with the same equipment and settings and the performance of the **HVDC Equipment** can, in **The Company's** opinion, reasonably represent that of the installed **HVDC Equipment** at that site. The relevant **Equipment Certificate** must be supplied in the **Users Data File structure**.
- ECP.A.7.1.8 **The Company** may agree a reduction from the requirement ECP.A.7.2 to ECP.A.7.5 for on-site testing where suitable factory acceptance testing on a representative installation with the same equipment and settings of the **HVDC Equipment** that can, in **The Company's** opinion, reasonably represent the performance of the installed **HVDC Equipment** at that site. This is also conditional on **The Company** and the **DC Converter Station** owner agreeing sufficient on site testing of the fully commissioned **DC Converter Station** to demonstrate that the factory acceptance tests are valid. If in the reasonable opinion of **The Company**, the on-site testing does not demonstrate the factory acceptance tests are valid then the full set of on-site tests should be carried out.
- ECP.A.7.2 Reactive Capability Test
- ECP.A.7.2.1 This section details the procedure for demonstrating the reactive capability of **HVDC Equipment**. These tests should be scheduled at a time where there are sufficient MW resource forecasted in order to import and export full **Maximum Capacity** of the **HVDC Equipment**.
- ECP.A.7.2.2 The tests shall be performed by modifying the voltage set-point of the voltage control scheme of the **HVDC Equipment** by the amount necessary to demonstrate the required reactive range. This is to be conducted for the operating points and durations specified in ECP.A.7.2.5.
- ECP.A.7.2.3 **Embedded HVDC System Owners** should liaise with the relevant **Network Operator** to ensure the following tests will not have an adverse impact upon the **Network Operator's System** as per OC.7.5. In situations where the tests have an adverse impact upon the **Network Operator's System**, **The Company** will only require demonstration within the acceptable limits of the **Network Operator**. For the avoidance of doubt, these tests do not negate the requirement to produce a complete **HVDC Equipment** performance chart as specified in OC2.4.2.1
- ECP.A.7.2.4 In the case where the **Reactive Power** metering point is not at the same

location as the **Reactive Power** capability requirement, then an equivalent **Reactive Power** capability for the metering point shall be agreed between the **HVDC System Owner** and **The Company**.

ECP.A.7.2.5 The following tests shall be completed for both importing and exporting of **Active Power** for a **DC Converter**:

- (i) Operation at **Maximum Capacity** and maximum continuous lagging **Reactive Power** for 60 minutes.
- (ii) Operation at **Maximum Capacity** and maximum continuous leading **Reactive Power** for 60 minutes.
- (iii) Operation at 50% **Maximum Capacity** and maximum continuous leading **Reactive Power** for 60 minutes.
- (iv) Operation at 50% **Maximum Capacity** and maximum continuous lagging **Reactive Power** for 60 minutes.
- (v) Operation at **Minimum Capacity** and maximum continuous leading **Reactive Power** for 60 minutes.
- (vi) Operation at **Minimum Capacity** and maximum continuous lagging **Reactive Power** for 60 minutes.

ECP.A.7.2.6 For the avoidance of doubt, lagging **Reactive Power** is the export of **Reactive Power** from the **HVDC Equipment** to the **Total System** and leading **Reactive Power** is the import of **Reactive Power** from the **Total System** to the **HVDC Equipment**.

ECP.A.7.3 Not used

ECP.A.7.4 Voltage Control Tests

ECP.A.7.4.1 This section details the procedure for conducting voltage control tests on **HVDC Equipment**. These tests should be scheduled at a time where there is sufficient MW resource in order to import and export **Maximum Capacity** of the **HVDC Equipment**. An **Embedded HVDC System Owner** should also liaise with the relevant **Network Operator** to ensure all requirements covered in this section will not have a detrimental effect on the **Network Operator's System**.

ECP.A.7.4.2 The voltage control system shall be perturbed with a series of step injections to the **HVDC Equipment** voltage Setpoint, and where possible, multiple up-stream transformer taps.

ECP.A.7.4.3 For steps initiated using network tap changers the **HVDC System Owner** will need to coordinate with **The Company** or the relevant **Network Operator** as appropriate. The time between transformer taps shall be at least 10 seconds as per ECP.A.7.4 Figure 1.

ECP.A.7.4.4 For step injection into the **HVDC Equipment** voltage setpoint, steps of $\pm 1\%$, $\pm 2\%$ and $\pm 4\%$ shall be applied to the voltage control system setpoint summing junction. The injection shall be maintained for 10 seconds as per ECP.A.7.4 Figure 2.

ECP.A.7.4.5 Where the voltage control system comprises of discretely switched plant and apparatus, additional tests will be required to demonstrate that its performance is in accordance with **Grid Code** and **Bilateral Agreement** requirements.

ECP.A.7.4.6 Tests to be completed:

(i)

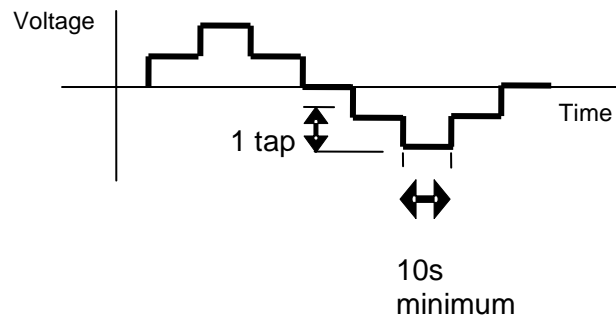

ECP.A.7.4 Figure 1 – Transformer tap sequence for voltage control tests

(ii)

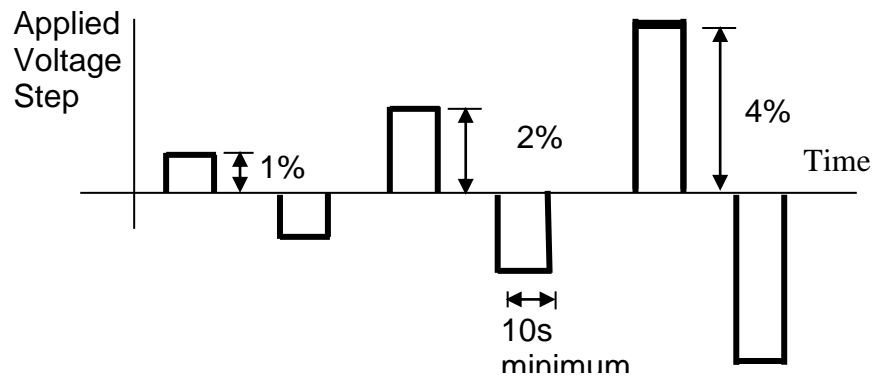

ECP.A.7.4 Figure 2 – Step injection sequence for voltage control tests

ECP.A.7.5 Frequency Response Tests

ECP.A.7.5.1 This section describes the procedure for performing frequency response testing on **HVDC Equipment**. These tests should be scheduled at a time where there is sufficient MW resource in order to import and export full **Maximum Capacity** of the **HVDC Equipment**. The **HVDC System Owner** is responsible for ensuring that suitable arrangements are in place with the **Externally Interconnected System Operator** to facilitate the **Active Power** changes required by these tests

ECP.A.7.5.2 The frequency controller shall be in **Frequency Sensitive Mode** or **Limited Frequency Sensitive Mode** as appropriate for each test. Simulated frequency deviation signals shall be injected into the frequency controller Setpoint/feedback summing junction. If the injected frequency signal replaces rather than sums with the real **System Frequency** signal, then the additional tests outlined in ECP.A.7.5.6 shall be performed with the **HVDC Equipment** in normal **Frequency Sensitive Mode** monitoring actual **System Frequency**, over a period of at least 10 minutes. The aim of this additional test is to verify that the control system correctly measures the real **System Frequency** for normal variations over a period of time.

ECP.A.7.5.3 In addition to the frequency response requirements, it is necessary to demonstrate the **HVDC Equipment** ability to deliver a requested steady state power output which is not impacted by power source variation as per ECC.6.3.9. This test shall be conducted in **Limited Frequency Sensitive Mode** at a part-loaded output for a period of 10 minutes as per ECP.A.7.5.6.

Preliminary Frequency Response Testing

ECP.A.7.5.4 Prior to conducting the full set of tests as per ECP.A.7.5.6, **HVDC System Owners** are required to conduct a preliminary set of tests below to confirm the frequency injection method is correct and the plant control performance is within expectation. The test numbers refer to Figure 1 below. These tests should be scheduled at a time where there is sufficient MW resource in order to export full **Maximum Capacity** from the **HVDC Equipment**. The following frequency injections shall be applied when operating at module load point 4.

Test No	Frequency Injection	Notes
---------	---------------------	-------

(Figure1)		
8	<ul style="list-style-type: none"> • Inject -0.5Hz frequency fall over 10 sec • Hold for a further 20 sec • At 30 sec from the start of the test, Inject a +0.3Hz frequency rise over 30 sec. • Hold until conditions stabilise • Remove the injected signal as a ramp over 10 seconds 	
13	<ul style="list-style-type: none"> • Inject - 0.5Hz frequency fall over 10 sec • Hold until conditions stabilise • Remove the injected signal as a ramp over 10 seconds 	
14	<ul style="list-style-type: none"> • Inject +0.5Hz frequency rise over 10 sec • Hold until conditions stabilise • Remove the injected signal as a ramp over 10 seconds 	
H	<ul style="list-style-type: none"> • Inject - 0.5Hz frequency fall as a stepchange • Hold until conditions stabilise • Remove the injected signal as a stepchange 	
I	<ul style="list-style-type: none"> • Inject +0.5Hz frequency rise as a stepchange • Hold until conditions stabilise • Remove the injected signal as a stepchange 	

ECP.A.7.5.5 The recorded results (e.g. Finj, MW and control signals) should be sampled at a minimum rate of 1Hz to allow **The Company** to assess the plant performance from the initial transients (seconds) to the final steady state conditions (5-15 minutes depending on the plant design). This is not witnessed by **The Company**. The **HVDC System Owner** shall supply the recordings including data to **The Company** in an electronic spreadsheet format. Results shall be legible, identifiable by labelling, and shall have appropriate scaling.

Full Frequency Response Testing Schedule Witnessed by **The Company**

ECP.A.7.5.6 The tests are to be conducted at a number of different Module Load Points (MLP). In the case of **HVDC Equipment** the load points are conducted as shown below unless agreed otherwise by **The Company**.

Module Load Point 6 (Maximum HVDC Active Power Transmission Capacity)	100% MaxHAPTC
Module Load Point 5	90% MaxHAPTC
Module Load Point 4	80% MaxHAPTC
Module Load Point 3	MinHAPTC+0.6 x (80% MaxHAPTC–MinHAPTC)
Module Load Point 2	MinHAPTC+0.3 x (80% MaxHAPTC–MinHAPTC)
Module Load Point 1 (Minimum HVDC Active Power Transmission Capacity)	MinHAPTC

ECP.A.7.5.7 The tests are divided into the following two types;

- (i) Frequency response compliance and volume tests as per ECP.A.7.5. Figure 1. These tests consist of frequency profile and ramp tests and adjustments to **Target Frequency** setpoint as per ECP.A.7.5 Figure 3.
- (ii) System islanding and step response tests as shown by ECP.A.7.5 Figure 2

ECP.A.7.5. Fig 1 and 2 are shown for the Importing of **Active Power**, simulated frequency polarity should be reversed when exporting **Active Power**.

ECP.A.7.5.8 There should be sufficient time allowed between tests for control systems to reach steady state (depending on available power resource). Where the diagram states 'HOLD' the current injection should be maintained until the **Active Power** (MW) output of the **HVDC Equipment** has stabilised or 90 seconds whichever is the longer. All frequency response tests should be removed over the same timescale for which they were applied. **The Company** may require repeat tests should the response volume be affected by the available power, or if tests give unexpected results. When witnessed by **The Company** each test should be carried out as a separate injection, when not witnessed by **The Company** there must be sufficient time allowed between tests for the **Active Power** (MW) output of the **HVDC Equipment** to have stabilised or 90 seconds, whichever is the longer.

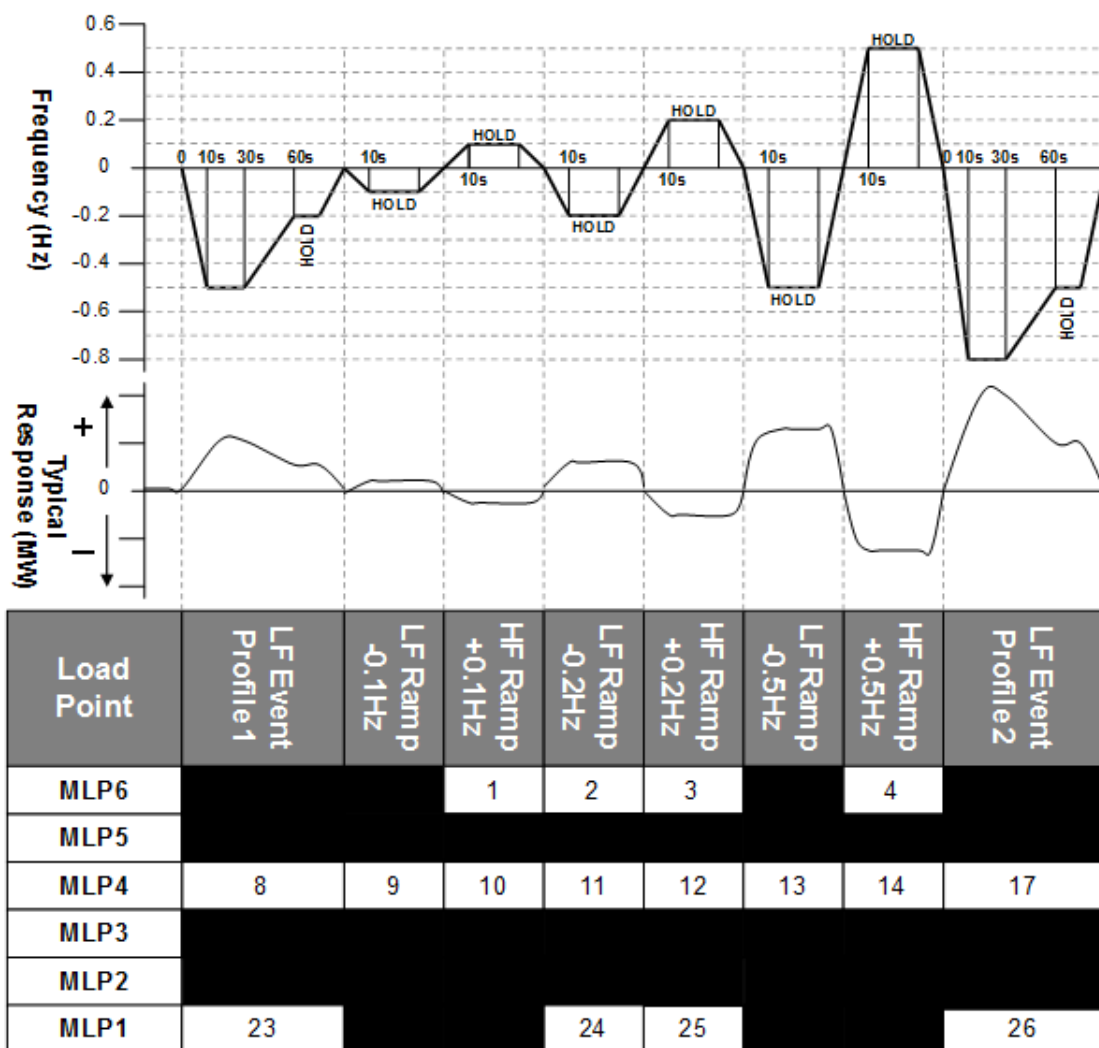

ECP.A.7.5. Figure 1 – Frequency Response Capability FSM Ramp Response tests

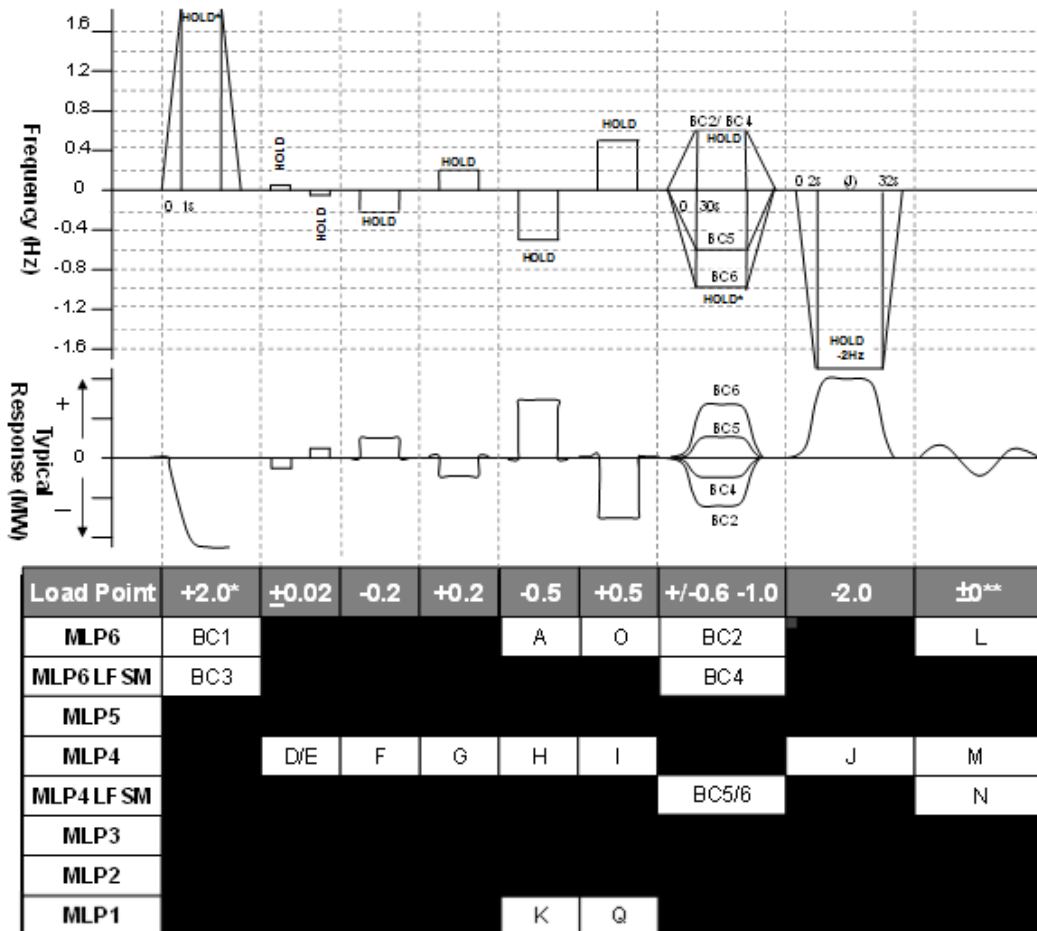

ECP.A.7.5. Figure 2 – Frequency Response Capability LFSM-O, LFSM-U, FSM Step Response tests

* This will generally be +2.0Hz unless an injection of this size causes a reduction in plant output that takes the operating point below the **Minimum Regulating Level** in which case an appropriate injection should be calculated in accordance with the following:

For example 0.9Hz is needed to take an initial output 65% to a final output of 20%. If the initial output was not 65% and the **Minimum Regulating Level** is not 20%, then the injected step should be adjusted accordingly as shown in the example given below

Initial Output		65%
Minimum Regulating Level	20%	
Frequency Controller Droop		4%
Frequency to be injected =		$(0.65-0.20) \times 0.04 \times 50 = 0.9\text{Hz}$

** Tests L and M in Figure 2 shall be conducted if in this range of tests the **System Frequency** feedback signal is replaced by the injection signal rather than the injection signal being added to the **System Frequency** signal. The tests will consist of monitoring the **HVDC Equipment in Frequency Sensitive Mode** during normal **System Frequency** variations without applying any injection. Test N in Figure 2 shall be conducted in all cases. All three tests should be conducted for a period of at least 10 minutes.

ECP.A.7.5.9 The target frequency adjustment facility should be demonstrated from the normal control point within the range of 49.9Hz to 50.1Hz by step changes to

the **Target Frequency** setpoint as indicated in ECP.A.7.5 Figure 3 while operating at MLP4.

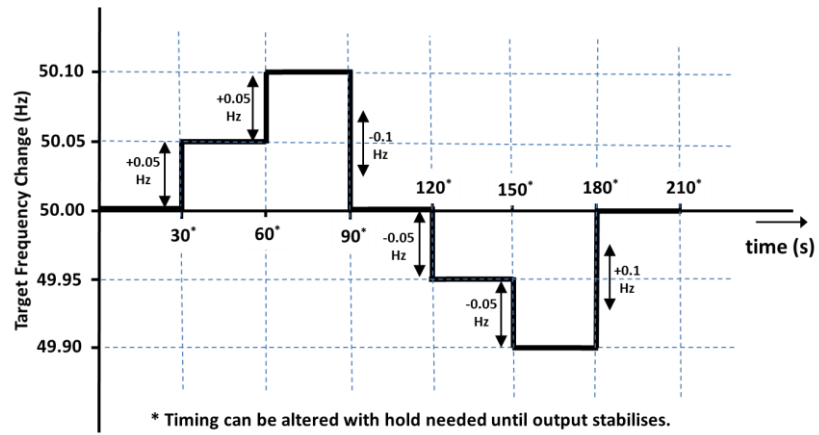

ECP.A.7.5. Figure 3 – Target Frequency setting changes

APPENDIX 8

SIMULATION STUDIES AND COMPLIANCE TESTING FOR NETWORK OPERATORS AND NON-EMBEDDED CUSTOMERS PLANT AND APPARATUS

- ECP.A.8.1 Compliance testing for disconnection and reconnection of Network Operator's Plant and Apparatus
- ECP.A.8.1.1 **Network Operators** shall comply with the following applicable requirements in respect of **EU Grid Supply Points**:
- (i) Demand disconnection schemes;
 - (ii) Synchronising; and/or
 - (iii) low frequency demand disconnection;
- ECP.A.8.1.2 The requirements for demand disconnection, other than low frequency demand disconnection, are pursuant to the requirements of the **Bilateral Agreement**. Any requirements for testing shall be agreed with the **User** where such requirements are applicable.
- ECP.A.8.1.3 The requirements for synchronising (where applicable) shall be pursuant to the requirements of the **Bilateral Agreement** and ECC.6.2.3.10. Any requirements for testing (as applicable) shall be agreed with the **User** and carried out during the commissioning process.
- ECP.A.8.1.4 **Network Operators** who are **EU Code Users** must demonstrate compliance with the low frequency demand disconnection requirements of ECC.6.4.3, ECC.A.5 and OC.6.6 for their entire distribution **System**.
- ECP.A.8.1.5 An equipment certificate may be submitted to **The Company** instead of part of the tests provided for in ECP.A.8.1.1.
- ECP.A.8.2 Compliance testing for operational metering at EU Grid Supply Points
- ECP.A.8.2.1 The requirements for operational metering (where required) shall be pursuant to the requirements of the **Bilateral Agreement** and ECC.6.5.6. Any applicable requirements for testing shall be agreed with the **User** and carried out during the commissioning process. An **Equipment Certificate** may be used for this purpose where agreed with **The Company**.
- ECP.A.8.3 Compliance testing for disconnection and reconnection of Non-Embedded Customers Plant and Apparatus
- ECP.A.8.3.1 **Non-Embedded Customers** shall comply with the following requirements where applicable:
- (i) Demand disconnection schemes;
 - (ii) Synchronising; and/or
 - (iii) low frequency demand disconnection;
- ECP.A.8.3.2 The requirements for demand disconnection, other than low frequency demand disconnection, are pursuant to the requirements of the **Bilateral Agreement**. Any requirements for testing shall be agreed with the **User**.
- ECP.A.8.3.3 The requirements for synchronising (where applicable) shall be pursuant to the requirements of the **Bilateral Agreement** and ECC.6.2.3.10. Any requirements for testing (as applicable) shall be agreed with the **User** and carried out during the commissioning process.

ECP.A.8.3.4 **Non-Embedded Customers** who are **EU Code Users** must demonstrate compliance with the low frequency demand disconnection requirements of ECC.6.4.3, ECC.A.5 and OC.6.6 of their **System**.

ECP.A.8.3.5 An equipment certificate may be submitted to **The Company** instead of part of the tests provided for in ECP.A.8.3.1.

ECP.A.8.4 Compliance testing for operational metering on Non-Embedded Customers Plant and Apparatus

ECP.A.8.4.1 The requirements for operational metering (where required)) shall be pursuant to the requirements of the **Bilateral Agreement** and ECC.6.5.6. Any applicable requirements for testing shall be agreed with the **User** and carried out during the commissioning process. An **Equipment Certificate** may be used for this purpose where agreed with **The Company**. ECP.A.8.5 Common Provisions on Compliance Simulations

ECP.A.8.5.1 **Users** are required to provide simulation studies or equivalent information to the satisfaction of **The Company** in the following circumstances.

- (i) a new connection to the **Transmission System** is required forming part of an **EU Grid Supply Point**;
- (ii) a **Substantial Modification** takes place at an **EU Grid Supply Point**
- (iii) **The Company** becomes aware of a potential non-compliance by the **Network Operator** or **Non-Embedded Customer** at an **EU Grid Supply Point**.

ECP.A.8.5.2 Notwithstanding the requirements of ECP.A.8.5.1, **The Company** shall be entitled to:-

- (a) Allow the **Network Operator** or **Non-Embedded Customer** to carry out an alternative set of simulations (or equivalent information) provided that they demonstrate that the **Network Operators** or **Non-Embedded Customers Plant and Apparatus** is capable of satisfying the applicable requirements of the **Data Registration Code**.
- (b) Require the **Network Operator** or **Non-Embedded Customer** to carry out additional or alternative simulations (or equivalent information) to those specified in ECP.A.8.5.1 where they would otherwise be insufficient to demonstrate compliance.
- (c) **The Company** may check that the **Network Operator** or **Non-Embedded Customer** complies with the requirements of the **Grid Code** by carrying out its own compliance simulations based on the simulation reports, models and test measurements submitted under the **Data Registration Code**.

ECP.A.8.5.3 **The Company** will supply (under PC.A.8) upon request to the **Network Operator** or **Non-Embedded Customer**, data to enable the **Network Operator** or **Non-Embedded Customer** to carry out the required simulations or supply the equivalent information required under the **Data Registration Code**.

ECP.A.8.6 Compliance simulations for EU Grid Supply Points

ECP.A.8.6.1 **Networks Operators** who are also **EU Code Users**, are required to provide simulation studies (or make available equivalent information) at each **EU Grid Supply Point** to demonstrate compliance with the **Reactive Power** capability requirements set out in ECC.6.4.5. The study or equivalent information provided shall include a steady state simulation model under both maximum

and minimum demand conditions. In addition, the model or equivalent information provided shall include the conditions when the **Reactive Power** export is at an **Active Power** flow of less than 25% of the **Maximum Import Capability** as detailed under ECC.6.4.5.2. In all cases the models or equivalent information submitted shall be agreed and approved with **The Company**.

ECP.A.8.7 Compliance simulations for Non-Embedded Customers Plant and Apparatus

ECP.A.8.7.1 **None Embedded Customers** who are also **EU Code Users** are required at each **EU Grid Supply Point** to provide simulation studies (or equivalent information) to demonstrate compliance with the **Reactive Power** capability requirements set out in ECC.6.4.5. The study or equivalent information provided shall include a steady state simulation model under both maximum and minimum demand conditions and with and without on-site generation. In all cases the models or equivalent information submitted shall be agreed and approved with **The Company**.

ECP.A.8.8 Compliance monitoring at EU Grid Supply Points

ECP.A.8.8.1 To satisfy the requirements of ECC.6.4.5, **EU Code Users** who are either **Network Operators** or **Non-Embedded Customers** shall ensure their **Plant** and **Apparatus** is equipped (where applicable), with the necessary equipment to measure the **Active Power** and **Reactive Power**, at each **EU Grid Supply Point**. The requirement for and time frame for compliance monitoring shall be agreed between **The Company** and the **EU Code User** for each **EU Grid Supply Point**.

APPENDIX 9
COMPLIANCE TESTING FOR GRID FORMING PLANT

ECP.A.9.1 SCOPE

ECP.A.9.1.1 This Appendix outlines the general testing requirements for **Users** or **Non-CUSC Parties** to demonstrate compliance with the relevant aspects of the **Grid Code, Ancillary Services Agreement** and **Bilateral Agreement**. The tests specified in this Appendix will normally be sufficient to demonstrate compliance of a **GBGF-I**, however **The Company** may:

- i) agree to an alternative set of tests provided **The Company** deem the alternative set of tests sufficient to demonstrate compliance with the **Grid Code, Ancillary Services Agreement** and **Bilateral Agreement**; and/or
- ii) require additional or alternative tests if information supplied to **The Company** during the compliance process suggests that the tests in this Appendix will not fully demonstrate compliance with the relevant section of the **Grid Code, Ancillary Services Agreement** or **Bilateral Agreement**; and/or
- iii) require additional tests if control functions to improve damping of power system oscillations or additional functions to prove the capability of the **GBGF-I** is required by the **Bilateral Agreement** or included in the control scheme; and/or
- iv) agree a reduced set of tests for the subsequent **GBGF-I** following successful completion of the first **Grid Forming** tests in the case of an installation comprising of two or more **GBGF-Is** which **The Company** reasonably considers to be identical if: -
 - (a) the tests performed pursuant to ECP.A.9.1.9 in respect of subsequent **GBGF-I Plants** do not replicate the full tests for the first **GBGF-I**; or
 - (b) any of the tests performed pursuant to ECP.A.9.1.9 do not fully demonstrate compliance with the relevant aspects of the **Grid Code, Ancillary Services Agreement** and / or **Bilateral Agreement**.

ECP.A.9.1.2 The **User or Non-CUSC Party** is responsible for carrying out the tests set out in and in accordance with this Appendix and the **User or Non-CUSC Party** retains the responsibility for the safety of personnel and plant during the test. **The Company** will witness all of the tests outlined or agreed in relation to this Appendix unless **The Company** decides and notifies the **User or Non-CUSC Party** otherwise. For all on site at **The Company** witnessed tests, the **User or Non-CUSC Party** must ensure suitable representatives from the **Grid Forming Plant's** manufacturer (if appropriate) are available on site for the entire testing period. In all cases and in addition to any recording of signals conducted by **The Company**, the **User or Non-CUSC Party** shall record all relevant test signals as outlined in ECP.A.4.

ECP.A.9.1.3 In addition to the dynamic signals supplied in ECP.A.4, the **User or Non-CUSC Party** shall inform **The Company** of the following information prior to the commencement of the tests and any changes to the following, if any values change during the tests:

- (i) All relevant transformer tap numbers, if used.
- (ii) Number of **Grid Forming Units** in operation.

ECP.A.9.1.4 The **User or Non-CUSC Party** shall submit a detailed schedule of tests to **The Company** in accordance with ECP.6.3.1, and this Appendix.

ECP.A.9.1.5 Prior to the testing of the **GBGF-I** the **User or Non-CUSC Party** shall complete

the **Integral Equipment Tests** procedure in accordance with OC.7.5.

- ECP.A.9.1.6 Full **GBGF-I** testing as required by ECP.7.2 is to be completed as defined in ECP.A.9.1.9.
- ECP.A.9.1.7 **The Company** will permit relaxation from the requirements in ECP.A.9.1.9 where an **Equipment Certificate** for **GBGF-I** has been provided which details the characteristics from tests on a representative installation with the same equipment and settings and the performance of the **GBGF-I** can, in **The Company's** opinion, reasonably represent that of the installed **GBGF-I** at that site. The relevant **Equipment Certificate** must be supplied in the **Users Data File Structure**.
- ECP.A.9.1.8 Prior to any **GBGF-I** tests taking place, the **User** or **Non-CUSC Party** shall have completed the relevant compliance tests on the **GBGF-I**, **Power Generating Module** or **Generating Unit** as required under ECP.A.5 or OC5. A.2 (as relevant) or **Power Park Module** as required under ECP.A.6 or OC5. A.3 (as applicable) or **HVDC Systems** or **DC Converters** as required under ECP.A.7 or OC5. A.4 (as applicable).
- ECP.A.9.1.9 Demonstration of **Grid Forming Capability**
- ECP.A.9.1.9.1 This section details the procedure for demonstrating **Active ROCOF Response Power**. Ideally if the test is being completed as part of a type test on an isolated network and it is possible to change the frequency of the isolated network then the tests should be completed using a variable network **Frequency**. **The Company** recognise that it is not possible in a large number of cases to adjust the network frequency of the network to which the **Grid Forming Plant** is connected. If a suitable test network is not available, performance of the **GBGF-I** will need to be demonstrated through online monitoring as detailed in CC.6.6 or ECC.6.6 and simulation studies as required under ECP.A.3.9.4 will be required during the **Interim Operational Notification Process** as provided for under CP.6 or ECP.6 (as applicable).
- ECP.A.9.1.9.2 In this test, with the **Grid Forming Plant** initially running at full load, the test network frequency is ideally increased from 50Hz to 51 Hz at a rate of 1Hz/s with measurements of the **Grid Forming Plant's Active ROCOF Response Power, System Frequency** and time in (ms). The test is required to assess correct operation of the **Grid Forming Plant** without saturating. This test is then repeated for a 50 Hz to 49 Hz at a rate of 1Hz/s.
- ECP.A.9.1.9.3 These tests are required to assess the **Grid Forming Plant's** withstand capabilities under extreme **System Frequencies**.
- (i) For **Grid Forming Plant** comprising a **GBGF-I** the frequency of the test network is increased from 50Hz to 52Hz at a rate of 2Hz/s with measurements of the **Grid Forming Plant's Active ROCOF Response Power, System Frequency** and time in (ms).
 - (ii) For a **Grid Forming Plant** comprising a **GBGF-I** the frequency of the test network is increased from 50Hz to 52Hz at a rate of 1Hz/s with measurements of the **Grid Forming Plant's Active ROCOF Response Power, System Frequency** and time in (ms).
 - (iii) For **Grid Forming Plant** comprising a **GBGF-I** the frequency of the test network is decreased from 50Hz to 47 Hz at a rate of 2Hz/s with measurements of the **Grid Forming Plant's Active ROCOF Response Power, System Frequency** and time in (ms).

- (iii) For **Grid Forming Plant** comprising a **GBGF-I** the frequency of the test network is decreased from 50Hz to 47 Hz at a rate of 1Hz/s with measurements of the **Grid Forming Plant's Active ROCOF Response Power, System Frequency** and time in (ms).

ECP.A.9.1.9.4 This test is to demonstrate the **Grid Forming Plant's** ability to supply **Active ROCOF Response Power** over the full **System Frequency** range.

- (a) With the frequency of the test network set to 50Hz, the **GBGF-I** should be initially running at 75% **Maximum Capacity** or **Registered Capacity**, zero MVA_r output and both **Limited Frequency Sensitive Mode** and **Frequency Sensitive Mode** disabled.
- (b) The frequency is then increased from 50Hz to 52Hz at a rate of 1Hz/s over a 2 second period. Allow conditions to stabilise for 5 seconds and then decrease the frequency from 52Hz to 47Hz at a rate of 1Hz/s over a 5 second period. Allow conditions to stabilise.
- (c) Record results of **Active ROCOF Response Power, Reactive Power**, voltage and frequency.
- (d) The test now needs to be re-run in the opposite direction. The same initial conditions should be applied as per ECP.A.9.1.9.4(a).
- (e) The frequency is then decreased from 50Hz to 47Hz at a rate of 1Hz/s over a 3 second period. Allow conditions to stabilise for 5 seconds and then increase the frequency from 47Hz to 52Hz at a rate of 1Hz/s over a 5 second period. Allow conditions to stabilise.
- (f) Record results of **Active ROCOF Response Power, Reactive Power**, voltage and frequency.

ECP.A.9.1.9.5 This test is to demonstrate the **Grid Forming Plant's** ability to supply **Active Phase Jump Power** under normal operation.

- (a) With the frequency of the test network set to 50Hz, the **GBGF-I** should be initially running at **Maximum Capacity** or **Registered Capacity** or at its agreed deloaded point, zero MVA_r output and all control actions (e.g. **Limited Frequency Sensitive Mode, Frequency Sensitive Mode** and voltage control) disabled.
- (b) Apply a positive phase jump of up to the **Phase Jump Angle Limit** at the **Grid Entry Point** or **User System Entry Point** (if **Embedded**).
- (c) This test can then be repeated by injecting the same angle into the **Grid Forming Plant's** control system (as indicatively shown in Figure ECP.A.9.1.9.5). This specific test can be repeated on site as required for a routine performance evaluation test. It should be noted that Figure ECP.A.9.1.9.5 is a simplified representation. Each **Grid Forming Plant Owner** can use their own design, that may be very different to Figure ECP.A.9.1.9.5 but should contain all relevant functions that can include test points and other equivalent data and documentation. Any additional signals, measurements, parameters and tests shall be agreed between the **Grid Forming Plant Owner** and **The Company**.
- (d) Repeat tests (b) and (c) with a negative injection up to the **Phase Jump Angle Limit**.
- (e) Record traces of **Active Power, Reactive Power**, voltage, current and frequency for a period of 10 seconds after the step change in phase has been applied.

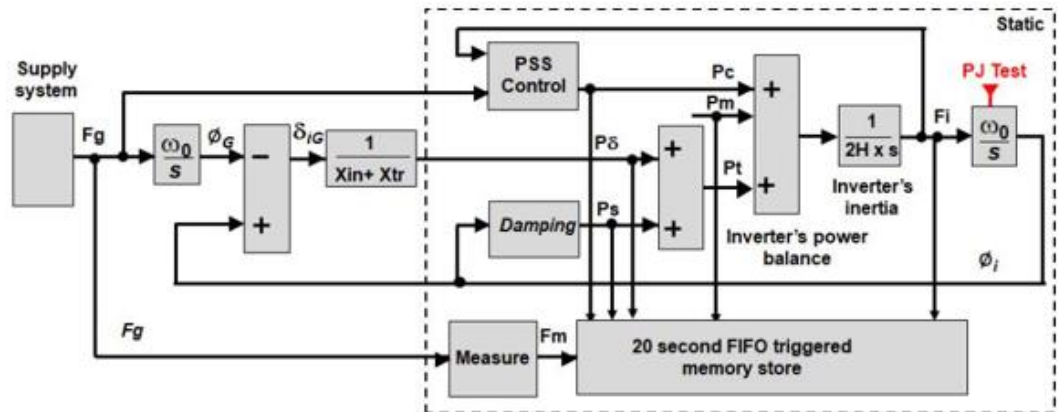

Figure ECP.A.9.1.9.5

As part of these tests, the corresponding **Active Power** change resulting from a phase shift will be a function of the local reactance and the location of where the phase shift is applied in addition to any additional upstream impedance between the **GBGF-I** and phase step location.

ECP.A.9.1.9.6 This test is to demonstrate the **Grid Forming Plant's** ability to supply **Active Phase Jump Power** under extreme conditions. Where it is not possible to undertake this test as part of a type test, **The Company** will accept demonstration through a combination of simulation studies as required under ECP.A.3.9.4(vi) and online monitoring as required under ECC.6.6.1.9.

- (a) With the frequency of the test network set to 50Hz, the **Grid Forming Plant** should be initially running at its **Minimum Stable Operating Level** or **Minimum Stable Generation**, zero MVAR output and all control actions (e.g., **Limited Frequency Sensitive Mode**, **Frequency Sensitive Mode** and voltage control) disabled.
- (b) Apply a phase jump of 60 degrees at the connection point of the **GBGF-I** or into the **Grid Forming Plant's** control system as shown in Figure ECP.A.9.1.9.5.
- (c) Record traces of **Active Power**, **Reactive Power**, voltage, current and frequency for a period of 10 seconds after the step change in phase has been applied.
- (d) Repeat steps (a), (b) and (c) of ECP.A.9.1.9.6 but on this occasion apply a phase jump equivalent to the positive **Phase Jump Angle Limit** at the Grid.

ECP.A.9.1.9.7 This test is to demonstrate the **GBGF-Is** ability to supply **Active Phase Jump Power**, **Fault Ride Through** and **GBGF Fast Fault Current Injection** during a faulted condition. Where it is not possible to undertake this test as part of a type test, **The Company** will accept demonstration through a combination of simulation studies as required under ECP.A.3.9.4(vii) and online monitoring as required under CC.6.6 and ECC.6.6.1.9.

- (a) With the frequency set to 50Hz, the **Grid Forming Plant** should be initially running at its **Maximum Capacity** or **Registered Capacity** or at an alternative loading point as agreed with **The Company**, zero MVAR output and all control actions (e.g., **Limited**

Frequency Sensitive Mode, Frequency Sensitive Mode and voltage control) disabled.

- (b) Apply a solid three phase short circuit fault at the connection point in the test network forming part of the type test for 140ms or alternatively the equivalent of a zero retained voltage for 140ms.
- (c) Record traces of **Active Power, Reactive Power**, voltage, current and frequency for a period of 10 seconds after the fault has been applied.
- (d) Repeat steps (a) to (c) but on this occasion with fault ride through, **GBGF Fast Fault Current Injection Limited Frequency Sensitive Mode** and voltage control switched into service.
- (e) Record traces of **Active Power, Reactive Power**, voltage, current and frequency for a period of 10 seconds after the step change in phase has been applied and confirm correct operation.

ECP.A.9.1.9.8 The final test required is to demonstrate the **GBGF-I** is capable of contributing to **Active Damping Power**. The **Grid Forming Plant Owner** should configure their **Grid Forming Plant** in form or equivalent (as agreed with **The Company**) as shown in Figure ECP.A.3.9.6(a) or Figure ECP.A.3.9.6(b) as applicable. Each **Grid Forming Plant Owner** can use their own design, that may be very different to Figures ECP.A.3.9.6(a) or ECP.A.3.9.6 (b) but should contain all relevant functions.

As part of this test, the **Grid Forming Plant Owner** is required to inject a signal into the **Grid Forming Plant** controller. The results supplied need to verify the following criteria:-

- i) Inject a **Test Signal** into the **Grid Forming Plant** controller to demonstrate the **Active Control Based Power** output is supplied below the 5Hz bandwidth limit. An acceptable performance will be judged where the overshoot or decay matches the **Damping Factor** declared by the **Grid Forming Plant Owner** as submitted in PC.A.5.8.1 in addition to assessment against the requirements of CC.A.6.2.6.1 or ECC.A.6.2.6.1 or CC.A.7.2.2.5 or ECC.A.7.2.5.2 as applicable.

<END OF ECP>

OPERATING CODE NO. 5

(OC5)

TESTING AND MONITORING

CONTENTS

(This contents page does not form part of the Grid Code)

<u>Paragraph No/Title</u>	<u>Page Number</u>
OC5.1 INTRODUCTION.....	2
OC5.2 OBJECTIVE	2
OC5.3 SCOPE.....	3
OC5.4 MONITORING	3
OC5.4.1 Parameters To Be Monitored	3
OC5.4.2 Procedure For Monitoring.....	3
OC5.5 PROCEDURE FOR TESTING	4
OC5.5.1 NGET Instruction For Testing	4
OC5.5.2 User Request For Testing	5
OC5.5.3 Conduct Of Test	6
OC5.5.4 Test And Monitoring Assessment	6
OC5.5.5 Test Failure / Re-test.....	10
OC5.5.6 Dispute Following Re-test	10
OC5.6 DISPUTE RESOLUTION	10
OC5.7.2 Procedure For A Black Start Test	12
OC5.8 PROCEDURES APPLYING TO EMBEDDED MEDIUM POWER STATION NOT SUBJECT TO A BILATERAL AGREEMENT AND EMBEDDED DC CONVERTER STATIONS NOT SUBJECT TO A BILATERAL AGREEMENT	14
APPENDIX 1 - ONSITE SIGNAL PROVISION FOR WITNESSING TESTS	17
APPENDIX 2 - COMPLIANCE TESTING OF SYNCHRONOUS PLANT	23
APPENDIX 3 - COMPLIANCE TESTING OF POWER PARK MODULES	34
APPENDIX 4 - COMPLIANCE TESTING FOR DC CONVERTERS AT A DC CONVERTER STATION	45

INTRODUCTION

Operating Code No. 5 ("OC5") specifies the procedures to be followed by **The Company** in carrying out:

- (a) monitoring
 - (i) of **BM Units** against their expected input or output;
 - (ii) of compliance by **Users** with the **CC** or **ECC** as applicable and in the case of response to **Frequency, BC3**; and
 - (iii) of the provision by **Users** of **Ancillary Services** which they are required or have agreed to provide; and
- (b) the following tests (which are subject to **System** conditions prevailing on the day):
 - (i) tests on **Gensets, CCGT Modules, Power Generating Modules, Power Park Modules, DC Converters, HVDC Equipment, OTSUA** (prior to the **OTSUA Transfer Time**) and **Generating Units** (excluding **Power Park Units**) to test that they have the capability to comply with the **CC** and **ECC**, and in the case of response to **Frequency, BC3** and to provide the **Ancillary Services** that they are either required or have agreed to provide;
 - (ii) tests on **BM Units**, to ensure that the **BM Units** are available in accordance with their submitted **Export and Import Limits** and **Dynamic Parameters**.

The **OC5** tests include the **Black Start Test** procedure.

OC5 also specifies in OC5.8 the procedures which apply to the monitoring and testing of **Embedded Medium Power Stations** not subject to a **Bilateral Agreement** and **Embedded DC Converter Stations** (or **Embedded HVDC Equipment**) not subject to a **Bilateral Agreement**.

In respect of a **Cascade Hydro Scheme** the provisions of **OC5** shall be applied as follows:

- (a) in respect of the **BM Unit** for the **Cascade Hydro Scheme** the parameters referred to at OC5.4.1 (a) and (c) in respect of **Commercial Ancillary Services** will be monitored and tested;
- (b) in respect of each **Genset** forming part of the **Cascade Hydro Scheme** the parameters referred to at OC5.4.1 (a), (b) and (c) will be tested and monitored. In respect of OC5.4.1 (a) the performance of the **Gensets** will be tested and monitored against their expected input or output derived from the data submitted under BC1.4.2(a)(2). Where necessary to give effect to the requirements for **Cascade Hydro Schemes** in the following provisions of **OC5**, the term **Genset** will be read and construed in the place of **BM Unit**.

In respect of **Embedded Exemptable Large Power Stations** the provisions of **OC5** shall be applied as follows:

- (a) where there is a **BM Unit** registered in the **BSC** in respect of **Generating Units** the provisions of **OC5** shall apply as written;
- (b) in all other cases, in respect of each **Power Generating Module**, and/or **Generating Unit** and **HVDC Equipment** the parameters referred to at OC5.4.1(a), (b) and (c) will be tested and monitored. In respect of OC5.4.1(a) the performance of the **Power Generating Module** and/or **Generating Unit** and **HVDC Equipment** will be tested and monitored against their expected input or output derived from the data submitted under BC1.4.2(a)(2). Where necessary to give effect to the requirements for such **Embedded Exemptable Large Power Stations** in the provisions of **OC5**, the term **Generating Unit** will be read and construed in place of **BM Unit**.

OBJECTIVE

The objectives of **OC5** are to establish:

- (a) that **Users** comply with the **CC** or **ECC** as applicable (including in the case of **OTSUA** prior to the **OTSUA Transfer Time**);

- (b) whether **BM Units** operate in accordance with their expected input or output derived from their **Final Physical Notification Data** and agreed **Bid-Offer Acceptances** issued under **BC2**;
- (c) whether each **BM Unit** is available as declared in accordance with its submitted **Export and Import Limits** and **Dynamic Parameters**; and
- (d) whether **Generators, DC Converter Station owners, HVDC Equipment Owners** and **Suppliers** can provide those **Ancillary Services** which they are either required or have agreed to provide.

In certain limited circumstances as specified in this **OC5**, the output of **CCGT Units** may be verified, namely the monitoring of the provision of **Ancillary Services** and the testing of **Reactive Power** and automatic **Frequency Sensitive Operation**.

OC5.3 SCOPE

OC5 applies to **The Company** and to **Users**, which in **OC5** means:

- (a) **Generators** (including those undertaking **OTSDUW**);
- (b) **Network Operators**;
- (c) **Non-Embedded Customers**;
- (d) **Suppliers**; and
- (e) **DC Converter Station owners or HVDC Equipment Owners**.

OC5.4 MONITORING

OC5.4.1 Parameters To Be monitored

The Company will monitor the performance of:

- (a) **BM Units** against their expected input or output derived from their **Final Physical Notification Data** and agreed **Bid-Offer Acceptances** issued under **BC2**;
- (b) compliance by **Users** with the **CC** or **ECC** as applicable; and
- (c) the provision by **Users** of **Ancillary Services** which they are required or have agreed to provide.

OC5.4.2 Procedure For Monitoring

OC5.4.2.1 In the event that a **BM Unit** fails persistently, in **The Company's** reasonable view, to follow, in any material respect, its expected input or output or a **User** fails persistently to comply with the **CC** or **ECC** as applicable, or fails to comply in the case of CC.6.3.15 or ECC 6.3.15 as applicable, and in the case of response to **Frequency, BC3** or to provide the **Ancillary Services** it is required, or has agreed, to provide, **The Company** shall notify the relevant **User** giving details of the failure and of the monitoring that **The Company** has carried out.

OC5.4.2.2 The relevant **User** will, as soon as possible, and in the case of a failure to comply with the requirements of CC.6.3.15 or ECC.6.3.15 as applicable, within 2 hours in respect of a notification to this effect under OC10 or a longer time period only where agreed by **The Company**, provide **The Company** with an explanation of the reasons for the failure and details of the action that it proposes to take to:

- (a) enable the **BM Unit** to meet its expected input or output or to provide the **Ancillary Services** it is required or has agreed to provide, within a reasonable period, or
- (b) in the case of a **Power Generating Module, Generating Unit** (excluding a **Power Park Unit**), **CCGT Module, Power Park Module, OTSUA** (prior to the **OTSUA Transfer Time**), **HVDC Equipment** or **DC Converter** to comply with the **CC** or **ECC** as applicable and in the case of response to **Frequency, BC3** or to provide the **Ancillary Services** it is required or has agreed to provide, within a reasonable period.

(c) in the case of a **Power Generating Module, Generating Unit** (excluding a **Power Park Unit**), **CCGT Module, Power Park Module, OTSUA** (prior to the **OTSUA Transfer Time**), **HVDC Equipment** or **DC Converter** which has tripped off or de-loaded coincident with a fault as described in CC.6.3.15 or ECC.6.3.15, resolve any non-compliance, within a reasonable period.

For the avoidance of doubt in the case of CC.6.3.15 or ECC.6.3.15 as applicable, the explanation may indicate that the **User** has complied with CC.6.3.15 or ECC.6.3.15 on the basis that:

- (i) the **User** had complied with CC.6.3.15 or ECC.6.3.15 as applicable on the basis that the **User** has provided recordings to show the voltage waveform during the fault was beyond the conditions specified in CC.6.3.15 or ECC.6.3.15 as applicable; or
- (ii) the **User's Connection Point** had been de-energised by receipt of an intertrip signal from the **National Electricity Transmission System**; or
- (iii) that other information has been shared between the **User** and **The Company** enabling agreement between them that compliance with CC.6.3.15 or ECC.6.3.15 as applicable has been confirmed.

Data relating to a fault on the **Transmission System** that **The Company** believes has led to **Users** to co-incidentally trip or de-load is to be provided by **The Company**, where available, in a file structure as agreed with the **User**. Where waveform data is available, this will be obtained from the recorder electrically closest to the **User's Connection Point**.

OC5.4.2.3 In the event of a **User** being notified under OC5.4.2.1 by **The Company** of a potential failure to comply with CC6.3.15 or ECC6.3.15 as applicable and where the **User** is required to provide an explanation as described in OC5.4.2.2(c), the **User** shall take action to restrict the output of their **Power Generating Module, Generating Unit** (excluding a **Power Park Unit**), **CCGT Module, Power Park Module, OTSUA** (prior to the **OTSUA Transfer Time**), **HVDC Equipment** or **DC Converter** to a level and for a period as agreed with **The Company** or until an explanation has been provided by the **User** and agreed between the **User** and **The Company** as set out under OC5.4.2.2(c).

OC5.4.2.4 **The Company** and the **User** will discuss any action the **User** proposes to take and will endeavour to reach agreement as to:

- (a) any short term operational measures necessary to protect other **Users**; and
- (b) the parameters which are to be submitted for the **BM Unit** and the effective time(s) and date(s) for the application of the agreed parameters. For the avoidance of doubt in the case of a failure to comply with CC.6.3.15 or ECC.6.3.15 as applicable which requires the **User** to provide an explanation as described in OC5.4.2.2(c), this may be to zero MW or another value if agreed between the **User** and **The Company**.

OC5.4.2.5 In the event that agreement cannot be reached within 10 days of notification of the failure by **The Company** to the **User**, **The Company** or the **User** shall be entitled to require a test, as set out in OC5.5 and OC5.6, to be carried out, except in respect of CC.6.3.15 or ECC.6.3.15, as applicable, where testing is impractical and OC.5.4.2.6 shall apply instead.

OC5.4.2.6 In the case of a **Power Generating Module, Generating Unit** (excluding a **Power Park Unit**), **CCGT Module, Power Park Module, OTSUA** (prior to the **OTSUA Transfer Time**), **HVDC Equipment** or **DC Converter** identifying their non-compliance with CC.6.3.15 or ECC.6.3.15 as applicable by completion of their report into this as set out in **OC10**, **The Company** will as soon as reasonably practicable, issue a **Limited Operational Notification** or amend any **Interim Operational Notification**.

OC5.5 PROCEDURE FOR TESTING

OC5.5.1 The Company's Instruction For Testing

- OC5.5.1.1 **The Company** may at any time (although not normally more than twice in any calendar year in respect of any particular **BM Unit**) issue an instruction requiring a **User** to carry out a test, provided **The Company** has reasonable grounds of justification based upon:
- (a) a failure to agree arising from the process in CP.8.1 or ECP.8.1; or
 - (b) monitoring carried out in accordance with OC5.4.2.
- OC5.5.1.2 The test, referred to in OC5.5.1.1 and carried out at a time no sooner than 48 hours from the time that the instruction was issued, on any one or more of the **User's BM Units** should only be to demonstrate that the relevant **BM Unit**:
- (a) if active in the **Balancing Mechanism**, meets the ability to operate in accordance with its submitted **Export and Import Limits** and **Dynamic Parameters** and achieve its expected input or output which has been monitored under OC5.4; and
 - (b) meets the requirements of the paragraphs in the **CC** and **ECC** which are applicable to such **BM Units**; and
- in the case of a **BM Unit** comprising a **Generating Unit**, a **CCGT Module**, a **Power Park Module**, a **Power Generating Module**, **HVDC System** or a **DC Converter** meets,
- (c) the requirements for operation in **Frequency Sensitive Mode** and compliance with the requirements for operation in **Limited Frequency Sensitive Mode** in accordance with CC.6.3.3, ECC.6.3.3, CC.6.3.7, ECC.6.3.7, BC3.5.2, BC.3.7.1 and BC3.7.2; or
 - (d) the terms of the applicable **Bilateral Agreement** agreed with the **Generator** to have a **Fast Start Capability**; or
 - (e) the **Reactive Power** capability registered with **The Company** under **OC2** which shall meet the requirements set out in CC.6.3.2 or ECC.6.3.2 as applicable. In the case of a test on a **Generating Unit** within a **CCGT Module** the instruction need not identify the particular **CCGT Unit** within the **CCGT Module** which is to be tested, but instead may specify that a test is to be carried out on one of the **CCGT Units** within the **CCGT Module**.
- OC5.5.1.3
- (a) The instruction referred to in OC5.5.1.1 may only be issued if the relevant **User** has submitted **Export and Import Limits** which notify that the relevant **BM Unit** is available in respect of the **Operational Day** current at the time at which the instruction is issued. The relevant **User** shall then be obliged to submit **Export and Import Limits** with a magnitude greater than zero for that **BM Unit** in respect of the time and the duration that the test is instructed to be carried out, unless that **BM Unit** would not then be available by reason of forced outage or **Planned Outage** expected prior to this instruction.
 - (b) In the case of a **CCGT Module** the **Export and Import Limits** data must relate to the same **CCGT Units** which were included in respect of the **Operational Day** current at the time at which the instruction referred to in OC5.5.1.1 is issued and must include, in relation to each of the **CCGT Units** within the **CCGT Module**, details of the various data set out in BC1.A.1.3 and BC1.A.1.5, which parameters **The Company** will utilise in instructing in accordance with this **OC5** in issuing **Bid-Offer Acceptances**. The parameters shall reasonably reflect the true operating characteristics of each **CCGT Unit**.
 - (c) The test referred to in OC5.5.1.1 will be initiated by the issue of instructions, which may be accompanied by a **Bid-Offer Acceptance**, under **BC2** (in accordance with the **Export and Import Limits** and **Dynamic Parameters** which have been submitted for the day on which the test was called, or in the case of a **CCGT Unit**, in accordance with the parameters submitted under OC5.5.1.3(b)). The instructions in respect of a **CCGT Unit** within a **CCGT Module** will be in respect of the **CCGT Unit**, as provided in BC2.
- OC5.5.2 User Request For Testing
- OC5.5.2.1 Where a **GB Code User** undertakes a test to demonstrate compliance with the **Grid Code** and **Bilateral Agreement** in accordance with CP.6 or CP.7 or CP.8 (other than a failure between **The Company** and a **GB Code User** to agree in CP.8.1 where OC5.5.1.1 applies) the **GB Code User** shall request permission to test using the process laid out in OC7.5.

- OC5.5.2.2 Where an **EU Code User** undertakes a test to demonstrate compliance with the **Grid Code** and **Bilateral Agreement** in accordance with ECP.6.1, ECP.6.2, ECP.6.3 or ECP.7 or ECP.8 (other than a failure between **The Company** and a **EU Code User** to agree in ECP.8.1 where OC5.5.1.1 applies) the **EU Code User** shall request permission to test using the process laid out in OC7.5.
- OC5.5.3 Conduct Of Test
- OC5.5.3.1 The performance of the **BM Unit** will be recorded at **Transmission Control Centres** notified by **The Company** with monitoring at site when necessary, from voltage and current signals provided by the **User** for each **BM Unit** under CC.6.6.1 or ECC.6.6.1 as applicable.
- OC5.5.3.2 If monitoring at site is undertaken, the performance of the **BM Unit** will be recorded on a suitable recorder (with measurements, in the case of a **Synchronous Generating Unit** (which could be part of a **Synchronous Power Generating Module**), taken on the **Generating Unit** stator terminals / on the **LV** side of the generator transformer) or in the case of a **Non-Synchronous Generating Unit** (excluding **Power Park Units**), **Power Generating Module**, **Power Park Module** or **HVDC Equipment** or **DC Converter** at the point of connection (including where the **OTSUA** is operational prior to the **OTSUA Transfer Time**, the **Transmission Interface Point**) in the relevant **User's Control Room**, in the presence of a reasonable number of representatives appointed and authorised by **The Company**. If **The Company** or the **User** requests, monitoring at site will include measurement of the parameters set out in OC5.A.1.2 or OC5.A.1.3 or ECP.A4.2 or ECP.A.4.3 as appropriate.
- OC5.5.3.3 The **User** is responsible for carrying out the test on their **Plant** and retains the responsibility for the safety of personnel and their **Plant** during the test.
- OC5.5.4 Test And Monitoring Assessment
- The criteria must be read in conjunction with the full text under the Grid Code reference. The **BM Unit**, **Power Generating Module**, **CCGT Module**, **Power Park Module** or **Generating Unit** (excluding **Power Park Units**), **HVDC Equipment** and **DC Converters** and **OTSUA** will pass the test the criteria below are met:

<u>Parameter to be Tested</u>		<u>Criteria against which the test results will be assessed by The Company.</u>
Voltage Quality	Harmonic Content	CC.6.1.5(a) or ECC.6.1.5(a) Measured harmonic emissions do not exceed the limits specified in the Bilateral Agreement or where no such limits are specified, the relevant planning level specified in Engineering Recommendation G5 .
	Phase Unbalance	CC.6.1.5(b) or ECC.6.1.5(b), The measured maximum Phase (Voltage) Unbalance on the National Electricity Transmission System should remain, in England and Wales, below 1% and, in Scotland, below 2% and Offshore will be defined in relevant Bilateral Agreement . CC.6.1.6 or ECC.6.1.6 In England and Wales, measured infrequent short duration peaks in Phase (Voltage) Unbalance should not exceed the maximum value stated in the Bilateral Agreement .
	Rapid Voltage Change	CC.6.1.7(a) or ECC.6.1.7(a) The measured Rapid Voltage Change at the Point of Common Coupling shall not exceed the Planning Levels specified in CC.6.1.7(a) or ECC 6.1.7.(i)
	Flicker Severity	CC.6.1.7(j) or ECC.6.1.7(j) The measured Flicker Severity at the Point of Common Coupling shall not exceed the limits specified in the table of CC.6.1.7(j) or ECC 6.1.7(j).
	Voltage Fluctuation	CC.6.1.8 or ECC.6.1.8 Offshore , measured voltage fluctuations at the Point of Common Coupling shall not exceed the limits set out in the Bilateral Agreement .
Fault Clearance	Fault Clearance Times	CC.6.2.2.2.2(a), CC.6.2.3.1.1(a), ECC.6.2.2.2.2(a), ECC.6.2.3.1.1(a), Bilateral Agreement
	Back Up Protection	CC.6.2.2.2.2(b), CC.6.2.3.1.1(b), ECC.6.2.2.2.2(a), ECC.6.2.3.1.1(a), Bilateral Agreement
	Circuit Breaker Fail Protection	CC.6.2.2.2.2(c), CC.6.2.3.1.1(c), ECC.6.2.2.2.2(c), ECC.6.2.3.1.1(c)

<u>Parameter to be Tested</u>		<u>Criteria against which the test results will be assessed by The Company.</u>
	Reactive Capability	<p>CC.6.3.2 or ECC.6.3.2 (and in the case of CC.6.3.2(e)(iii) and ECC.6.3.2.5 and ECC.6.3.2.6, the Bilateral Agreement), CC.6.3.4, Ancillary Services Agreement.</p> <p>For a test initiated under OC.5.5.1.1 the Power Generating Module, Generating Unit, HVDC Equipment, DC Converter or Power Park Module or (prior to the OTSUA Transfer Time) OTSUA will pass the test if it is within $\pm 5\%$ of the reactive capability registered with The Company under OC2. The duration of the test will be for a period of up to 60 minutes during which period the System voltage at the Grid Entry Point for the relevant Power Generating Module, Generating Unit, HVDC Equipment, DC Converter or Power Park Module or Interface Point in the case of OTSUA will be maintained by the Generator or HVDC System Owner, DC Converter Station owner at the voltage specified pursuant to BC2.8 by adjustment of Reactive Power on the remaining Power Generating Module, Generating Unit, HVDC Equipment, DC Converter or Power Park Modules or OTSUA, if necessary. Any test performed in respect of an Embedded Medium Power Station not subject to a Bilateral Agreement or, an Embedded DC Converter Station or Embedded HVDC System not subject to a Bilateral Agreement shall be as confirmed pursuant to OC5.8.3.</p> <p>Measurements of the Reactive Power output under steady state conditions should be consistent with Grid Code requirements i.e. fully available within the voltage range $\pm 5\%$ at all voltages.</p>
Governor / Frequency Control	Primary Secondary and High Frequency Response	<p>Ancillary Services Agreement, CC.6.3.7 and where applicable CC.A.3 or ECC.6.3.7 and where applicable ECC.A.3.</p> <p>For a test initiated under OC.5.5.1.1 the measured response in MW/Hz is within $\pm 5\%$ of the level of response specified in the Ancillary Services Agreement for that Genset.</p>
	Stability with Voltage	CC.6.3.4 or ECC.6.3.4
	Governor / Load / Frequency Controller System Compliance	CC.6.3.6(a), CC.6.3.7, CC.6.3.9, CC8.1, where applicable CC.A.3, BC3.5, BC3.6, BC3.7 or ECC.6.3.6, ECC.6.3.7, ECC.6.3.9, ECC8.1, where applicable ECC.A.3, BC3.5, BC3.6, BC3.7
	Output at Reduced System Frequency	CC.6.3.3 or ECC.6.3.3 - For variations in System Frequency exceeding 0.1Hz within a period of less than 10 seconds, the Active Power output is within $\pm 0.2\%$ of the requirements of CC.6.3.3 or ECC.6.3.3 when monitored at prevailing external air temperatures of up to 25°C., BC3.5.1

<u>Parameter to be Tested</u>		<u>Criteria against which the test results will be assessed by The Company.</u>
	Fast Start	Ancillary Services Agreement requirements
	Black Start	OC5.7
	Excitation/Voltage Control System	CC.6.3.6(b), CC.6.3.8, CC.A.6 or CC.A.7 as applicable, BC2.11.2, and the Bilateral Agreement or ECC.6.3.6, ECC.6.3.8, ECC.A.6 or ECC.A.7 or ECC.A.8 and the Bilateral Agreement as applicable
	Fault Ride Through and Fast Fault Current Injection	CC.6.3.15, CC.A.4.A or CC.A.4.B as applicable or ECC.6.3.15, ECC.6.3.16, ECC.A.4 as applicable
Dynamic Parameters	Export and Import Limits and Dynamic Parameters	BC2 The Export and Import Limits and Dynamic Parameters under test are within 2½% of the declared value being tested.
	Synchronisation time	BC2.5.2.3 Synchronisation takes place within ±5 minutes of the time it should have achieved Synchronisation .
	Run-up rates	BC2 Achieves the instructed output and, where applicable, the first and/or second intermediate breakpoints, each within ±3 minutes of the time it should have reached such output and breakpoints from Synchronisation (or break point, as the case may be), calculated from the run-up rates in its Dynamic Parameters .
	Run-down rates	BC2 Achieves the instructed output and, where applicable, the first and/or second intermediate breakpoints, each within ±5 minutes of the time it should have reached such output and breakpoints from Synchronisation (or break point, as the case may be), calculated from the run-up rates in its Dynamic Parameters .
	Demand Response	DRSC.11.7 Non-Embedded Customers and BM Participants who are also Demand Response Providers shall execute a demand modification test when requested as per DRSC.11.7 to ensure the requirements of the Ancillary Services agreement and Demand Response Services Code are satisfied.

- OC5.5.4.1 The duration of the **Dynamic Parameter** tests in the above table will be consistent with and sufficient to measure the relevant expected input or output derived from the **Final Physical Notification Data** and **Bid-Offer Acceptances** issued under **BC2** which are still in dispute following the procedure in OC5.4.2.
- OC5.5.4.2 Due account will be taken of any conditions on the **System** which may affect the results of the test. The relevant **User** must, if requested, demonstrate, to **The Company's** reasonable satisfaction, the reliability of the suitable recorders, disclosing calibration records to the extent appropriate.
- OC5.5.5 Test Failure / Re-test
- OC5.5.5.1 If the **BM Unit, Power Generating Module, CCGT Module, Power Park Module, OTSUA, or Generating Unit** (excluding **Power Park Units**), **HVDC Equipment** or **DC Converter Station** concerned fails to pass the test instructed by **The Company** under OC5.5.1.1, the **User** must provide **The Company** with a written report specifying in reasonable detail the reasons for any failure of the test so far as they are then known to the **User** after due and careful enquiry. This must be provided within five **Business Days** of the test.
- OC5.5.5.2 If in **The Company's** reasonable opinion, the failure to pass the test relates to compliance with the **CC** or **ECC** as applicable, then **The Company** may invoke the process detailed in CP.8.2 to CP.9, or ECP.8.2 to ECP.9
- OC5.5.5.3 If a dispute arises relating to the failure, **The Company** and the relevant **User** shall seek to resolve the dispute by discussion, and, if they fail to reach agreement, the **User** may by notice require **The Company** to carry out a re-test on 48 hours' notice which shall be carried out following the procedure set out in OC5.5.3 and OC5.5.4 and subject as provided in OC5.5.1.3, as if **The Company** had issued an instruction at the time of notice from the **User**.
- OC5.5.6 Dispute Following Re-Test
- If the **BM Unit, Power Generating Module, CCGT Module, Power Park Module, OTSUA, or Generating Unit** (excluding **Power Park Units**), **HVDC Equipment** or **DC Converter** in **The Company's** view fails to pass the re-test and a dispute arises on that re-test, either party may use the **Disputes Resolution Procedure** for a ruling in relation to the dispute, which ruling shall be binding.
- OC5.6 DISPUTE RESOLUTION
- OC5.6.1 If following the procedure set out in OC5.5 it is accepted that the **BM Unit, Power Generating Module, CCGT Module, Power Park Module, OTSUA** (prior to the **OTSUA Transfer Time**) or **Generating Unit** (excluding **Power Park Units**), **HVDC Equipment** or **DC Converter** has failed the test or re-test (as applicable), the **User** shall within 14 days, or such longer period as **The Company** may reasonably agree, following such failure, submit in writing to **The Company** for approval the date and time by which the **User** shall have brought the **BM Unit** concerned to a condition where it complies with the relevant requirement. **The Company** will not unreasonably withhold or delay its approval of the **User's** proposed date and time submitted. Should **The Company** not approve the **User's** proposed date or time (or any revised proposal), the **User** should amend such proposal having regard to any comments **The Company** may have made and re-submit it for approval.
- OC5.6.2 If a **BM Unit** fails the test, the **User** shall submit revised **Export and Import Limits** and/or **Dynamic Parameters**, or in the case of a **BM Unit** comprising a **Generating Unit, Power Generating Module, CCGT Module, HVDC Equipment, DC Converter, OTSUA** (prior to the **OTSUA Transfer Time**) or **Power Park Module**, the **User** may amend, with **The Company's** approval, the relevant registered parameters of that **Generating Unit, Power Generating Module, CCGT Module, HVDC Equipment, DC Converter, OTSUA** (prior to the **OTSUA Transfer Time**) or **Power Park Module**, as the case may be, relating to the criteria, for the period of time until the **BM Unit** can achieve the parameters previously registered, as demonstrated in a re-test.

OC5.6.3 Once the **User** has indicated to **The Company** the date and time that the **BM Unit, Power Generating Module, CCGT Module, Power Park Module, Generating Unit** (excluding **Power Park Units**) or **OTSUA** (prior to the **OTSUA Transfer Time**), **HVDC Equipment** or **DC Converter Station** can achieve the parameters previously registered or submitted, **The Company** shall either accept this information or require the **User** to demonstrate the restoration of the capability by means of a repetition of the test referred to in OC5.5.3 by an instruction requiring the **User** on 48 hours notice to carry out such a test. The provisions of this OC5.6 will apply to such further test.

OC5.7 BLACK START TESTING

OC5.7.1 General

- (a) **The Company** shall require a **Black Start Service Provider** to carry out a **Black Start Test** in order to demonstrate that a **Black Start Station** or **Black Start HVDC System** has a **Black Start Capability**.
- (i) In the case of a **Generator**, **The Company** shall require a **Generator** with a **Black Start Station** to carry out a test (either a "**Black Start Unit Test**" or a **Black Start Station Test**") in order to demonstrate that a **Black Start Station** has a **Black Start Capability**.
- (ii) In the case of an **HVDC System Owner** or **DC Converter Station Owner**, **The Company** shall require an **HVDC System Owner** or **DC Converter Station Owner** with a **Black Start HVDC System** to carry out a test (a "**Black Start HVDC Test**") on a **HVDC System** or **DC Converter**, in order to demonstrate that a **Black Start HVDC System** has a **Black Start Capability**.
- (iii) In the case of an **EU Generator**, **The Company** may also require a **Generator** with a **Black Start Station** to carry out a test (a **Quick Resynchronisation Unit Test**) in order to demonstrate that a **Black Start Station** has a **Quick Re-Synchronisation Capability**.
- (b) Where **The Company** requires a **Black Start Service Provider** to undertake testing, the following requirements shall apply:-
- (i) Where **The Company** requires a **Generator** with a **Black Start Station** to carry out a **Black Start Unit Test**, on each **Genset**, which has **Black Start Capability**, within such a **Black Start Station**, the **Generator** shall execute such a test at least once every three years. **The Company** shall not require the **Black Start Test Unit** to be carried out on more than one **Genset** at that **Black Start Station** at the same time, and would not, in the absence of exceptional circumstances, expect any of the other **Gensets** at the **Black Start Station** to be directly affected by the **Black Start Unit Test**.
- (ii) **The Company** may occasionally require the **Generator** to carry out a **Black Start Station Test** at any time (but will not require a **Black Start Station Test** to be carried out more than once in every three calendar years in respect of any particular **Genset** unless it can justify on reasonable grounds the necessity for further tests or unless the further test is a re-test). If successful, this **Black Start Station Test** shall count as a successful **Black Start Unit Test** for the **Genset** used in the test.
- (iii) **The Company** may require the **HVDC System Owner** or **DC Converter Station Owner** to carry out a **Black Start HVDC Test** at any time (but will not require such a test to be carried out more than once in every three calendar years unless it can justify on reasonable grounds the necessity for further tests or unless the further test is a re-test).
- (iv) **The Company** may occasionally require the **EU Generator** to carry out a **Quick Re-Synchronisation Test** at any time, but will generally only be required where the **EU Generator** has made a change to its **Plant** and **Apparatus** which has an impact on its **Houseload Operation** or after two unsuccessful tripping **Events** in the operational environment.

The above tests will be deemed a success where starting from **Shutdown** is achieved within a time frame specified by **The Company** and which may be agreed in the **Black Start Contract**.

- c) **The Company** may require a **Generator** to carry out a **Black Start Unit Test** at any time (but will not require a **Black Start Unit Test** to be carried out more than once in each calendar year in respect of any particular **Genset** unless it can justify on reasonable grounds the necessity for further tests or unless the further test is a re-test).
- (d) When **The Company** wishes a **Black Start Service Provider** to carry out a **Black Start Test**, it shall notify the relevant **Black Start Service Provider** at least 7 days prior to the time of the **Black Start Test** with details of the proposed **Black Start Test**.

OC5.7.2 Procedure for a Black Start Test

The following procedure will, so far as practicable, be carried out in the following sequence for **Black Start Tests**:

OC5.7.2.1 Black Start Unit Tests

- (a) The relevant **Generating Unit** shall be **Synchronised** and **Loaded**;
- (b) All the **Auxiliary Gas Turbines** and/or **Auxiliary Diesel Engines** in the **Black Start Station** in which that **Generating Unit** is situated, shall be **Shutdown**.
- (c) The **Generating Unit** shall be **De-Loaded** and **De-Synchronised** and all alternating current electrical supplies to its **Auxiliaries** shall be disconnected.
- (d) The **Auxiliary Gas Turbine(s)** or **Auxiliary Diesel Engine(s)** to the relevant **Generating Unit** shall be started, and shall re-energise the **Unit Board** of the relevant **Generating Unit**.
- (e) The **Auxiliaries** of the relevant **Generating Unit** shall be fed by the **Auxiliary Gas Turbine(s)** or **Auxiliary Diesel Engine(s)**, via the **Unit Board**, to enable the relevant **Generating Unit** to return to **Synchronous Speed**.
- (f) The relevant **Generating Unit** shall be **Synchronised** to the **System** but not **Loaded**, unless the appropriate instruction has been given by **The Company** under **BC2** which would also be in accordance with the requirements of the **Black Start Contract**.

- (g) In respect of **EU Generators**, the above tests defined in OC5.7.2.1(a) – (e) shall be in accordance with the requirements of ECC.6.3.5.3.

OC5.7.2.2 Black Start Station Test

- (a) All **Generating Units** at the **Black Start Station**, other than the **Generating Unit** on which the **Black Start Test** is to be carried out, and all the **Auxiliary Gas Turbines** and/or **Auxiliary Diesel Engines** at the **Black Start Station**, shall be **Shutdown**.
- (b) The relevant **Generating Unit** shall be **Synchronised** and **Loaded**.
- (c) The relevant **Generating Unit** shall be **De-Loaded** and **De-Synchronised**.
- (d) All external alternating current electrical supplies to the **Unit Board** of the relevant **Generating Unit**, and to the **Station Board** of the relevant **Black Start Station**, shall be disconnected.
- (e) An **Auxiliary Gas Turbine** or **Auxiliary Diesel Engine** at the **Black Start Station** shall be started, and shall re-energise either directly, or via the **Station Board**, the **Unit Board** of the relevant **Generating Unit**.
- (f) The provisions of OC5.7.2.1 (e) and (f) shall thereafter be followed.
- (g) In respect of **EU Generators**, the above tests defined in OC5.7.2.2(a) – (e) shall be in accordance with the requirements of ECC.6.3.5.3.

OC5.7.2.3 Procedure for a Black Start HVDC Test

- a) The **HVDC System** or **DC Converter Station** shall demonstrate its technical capability to energise the busbar of the de-energised AC substation to which it is connected, within the **GB Synchronous Area** within a timeframe specified by **The Company**. In the case of **HVDC Systems** this shall be in accordance with the requirements of ECC.6.3.5.4. As part of this test, all **Auxiliaries** are required to be derived from within the **HVDC System** or **DC Converter Station**.
- b) The test shall be carried out while the **HVDC System** or **DC Converter Station** starts from **Shutdown**;
- c) The test shall be deemed passed, provided that the following conditions are cumulatively fulfilled:
 - i) The **HVDC System Owner** has demonstrated its **HVDC System** or **DC Converter Station** is able to energise the busbar of the isolated AC-substation to which it is connected within the **GB Synchronous Area**
 - ii) The **HVDC System** or **DC Converter Station** can achieve a stable operating point at an agreed capacity as agreed with **The Company**. The relevant **HVDC System** or **DC Converter Station** can be connected to the **System** but not **Loaded**, unless appropriate instructions are given by **The Company** under **BC2** which would also be in accordance with the requirements of the **Black Start Contract**.
 - iii) In respect of **HVDC Systems** and **Remote End HVDC Converter Stations**, the above tests defined in OC5.7.2.3(a) – (c) shall be in accordance with the requirements of, ECC.6.1.2, ECC.6.1.4, ECC.6.2.2.9.4 and ECC.6.3.5.4.
 - iv) In respect of **DC Converter Stations**, the above tests defined in OC5.7.2.3(a) – (c) shall be in accordance with the requirements of, CC.6.1.2, CC.6.1.3 and CC.6.1.4.

OC5.7.2.4 All **Black Start Tests** shall be carried out at the time specified by **The Company** in the notice given under OC5.7.1 and shall be undertaken in the presence of a reasonable number of representatives appointed and authorised by **The Company**, who shall be given access to all information relevant to the **Black Start Test**.

OC5.7.2.5 Failure of a Black Start Test

A **Black Start Station** or **Black Start HVDC System** shall fail a **Black Start Test** if the **Black Start Test** shows that it does not have a **Black Start Capability** (ie. if the relevant **Generating Unit** or **HVDC System** or **DC Converter** fails to be **Synchronised** to the **System** within two hours of the **Auxiliary Gas Turbine(s)** or **Auxiliary Diesel Engine(s)** being required to start unless this is part of a **Local Joint Restoration Plan** where the times will be adjusted accordingly).

OC5.7.2.6 If a **Black Start Station** or **Black Start HVDC System** fails to pass a **Black Start Test** the **Black Start Service Provider** must provide **The Company** with a written report specifying in reasonable detail the reasons for any failure of the test so far as they are then known to the **Black Start Service Provider** after due and careful enquiry. This must be provided within five **Business Days** of the test. If a dispute arises relating to the failure, **The Company** and the relevant **Black Start Service Provider** shall seek to resolve the dispute by discussion, and if they fail to reach agreement, the **Black Start Service Provider** may require **The Company** to carry out a further **Black Start Test** on 48 hours notice which shall be carried out following the procedure set out in OC5.7.2.1 or OC5.7.2.2 or OC5.7.2.3 as the case may be, as if **The Company** had issued an instruction at the time of notice from the **Black Start Service Provider**.

OC5.7.2.7 If the **Black Start Station** or **Black Start HVDC System** concerned fails to pass the re-test and a dispute arises on that re-test, either party may use the **Disputes Resolution Procedure** for a ruling in relation to the dispute, which ruling shall be binding.

OC5.7.2.8 If following the procedure in OC5.7.2.6 and OC5.7.2.7 it is accepted that the **Black Start Station** or **Black Start HVDC System** has failed the **Black Start Test** (or a re-test carried out under OC5.7.2.5), within 14 days, or such longer period as **The Company** may reasonably agree, following such failure, the relevant **Black Start Service Provider** shall submit to **The Company** in writing for approval, the date and time by which that **Black Start Service Provider** shall have brought that **Black Start Station** or **Black Start HVDC System** to a condition where it has a **Black Start Capability** and would pass the **Black Start Test**, and **The Company** will not unreasonably withhold or delay its approval of the **Black Start Service Provider's** proposed date and time submitted. Should **The Company** not approve the **Black Start Service Provider's** proposed date and time (or any revised proposal) the **Black Start Service Provider** shall revise such proposal having regard to any comments **The Company** may have made and resubmit it for approval.

OC5.7.2.9 Once the **Black Start Service Provider** has indicated to **The Company** that the **Power Station** or **HVDC System** or **DC Converter Station** has a **Black Start Capability**, **The Company** shall either accept this information or require the **Black Start Service Provider** to demonstrate that the relevant **Black Start Station** or **Black Start HVDC System** has its **Black Start Capability** restored, by means of a repetition of the **Black Start Test** referred to in OC5.7.1(d) following the same procedure as for the initial **Black Start Test**. The provisions of this OC5.7.2 will apply to such test.

OC5.7.3 Quick Re-synchronisation UnitTest

(a) The relevant **Generating Unit** shall be **Synchronised** and **Loaded**;

(b) All the **Auxiliary Gas Turbines** and/or **Auxiliary Diesel Engines** in the **Black Start Station** in which that **Generating Unit** is situated, shall be **Shutdown**.

(c) The **Generating Unit** shall tripped to house load.

(d) The relevant **Generating Unit** shall be **Synchronised** to the **System** but not **Loaded**, unless the appropriate instruction has been given by **The Company** under **BC2** which would also be in accordance with the requirements of the **Black Start Contract**.

In respect of **EU Generators**, the above tests defined in OC5.7.2.3(a) – (e) shall be in accordance with the requirements of ECC.6.3.5.6.

OC5.8 PROCEDURES APPLYING TO EMBEDDED MEDIUM POWER STATIONS NOT SUBJECT TO A BILATERAL AGREEMENT AND EMBEDDED DC CONVERTER STATIONS NOT SUBJECT TO A BILATERAL AGREEMENT

OC5.8.1 Compliance Statement

Each **Network Operator** shall ensure that each **Embedded Person** provides to the **Network Operator** upon **The Company's** request:

(a) written confirmation that each such **Power Generating Module**, **Generating Unit**, **Power Park Module**, **HVDC Equipment**, or **DC Converter** complies with the requirements of the **CC** and **ECC**; and

(b) evidence, where requested, reasonably satisfactory to **The Company**, of such compliance. Such a request shall not normally be made by **The Company** more than twice in any calendar year in respect of any **Generator's Power Generating Module**, **Generating Unit** or **Power Park Module** or **HVDC System Owner's HVDC System**, or **DC Converter** owner's **DC Converter**.

The **Network Operator** shall provide the evidence or written confirmation required under OC5.8.1 (a) and (b) forthwith upon receipt to **The Company**.

OC5.8.2 Network Operator's Obligations To Facilitate Tests

If:

- (a) the **Network Operator** fails to procure the confirmation referred to at OC5.8.1(a); or
- (b) the evidence of compliance is not to **The Company's** reasonable satisfaction,

then, **The Company** shall be entitled to require the **Network Operator** to procure access upon terms reasonably satisfactory to **The Company** to enable **The Company** to witness the **Embedded Person** carrying out the tests referred to in OC5.8.3 in respect of the relevant **Embedded Medium Power Station** or **Embedded DC Converter Station** or **Embedded HVDC System**.

OC5.8.3 Testing Of Embedded Medium Power Stations Not Subject To A Bilateral Agreement Or Embedded DC Converter Stations Not Subject To A Bilateral Agreement or Embedded HVDC Equipment Not Subject To A Bilateral Agreement

The Company may, in accordance with the provisions of OC5.8.2, at any time (although not normally more than twice in any calendar year in respect of any particular **Embedded Medium Power Station** not subject to a **Bilateral Agreement** or **Embedded DC Converter Station** or **Embedded HVDC Equipment** not subject to a **Bilateral Agreement**) issue an instruction requiring the **Network Operator** within whose **System** the relevant **Medium Power Station** not subject to a **Bilateral Agreement** or **DC Converter Station** or **HVDC Equipment** not subject to a **Bilateral Agreement** is **Embedded**, to require the **Embedded Person** to carry out a test.

Such test shall be carried out at a time no sooner than 48 hours from the time that the instruction was issued, on any one or more of the **Generating Units, Power Generating Modules, Power Park Modules** or **DC Converters** or **HVDC Equipment** comprising part of the relevant **Embedded Medium Power Station** or **Embedded DC Converter Station** or **HVDC System** and should only be to demonstrate that:

- (a) the relevant **Generating Unit, Power Generating Module, Power Park Module** or **DC Converter** or **HVDC Equipment** meets the requirements of the paragraphs in the **CC** or **ECC** which are applicable to such **Generating Units, Power Generating Modules, Power Park Module** or **DC Converter** or **HVDC Equipment**;
- (b) the **Reactive Power** capability registered with **The Company** under **OC2** meets the requirements set out in **CC.6.3.2** or **ECC.6.3.2** as applicable.

The instruction may only be issued where, following consultation with the relevant **Network Operator**, **The Company** has:

- (c) confirmed to the relevant **Network Operator** the manner in which the test will be conducted, which shall be consistent with the principles established in OC5.5.3; and
- (d) received confirmation from the relevant **Network Operator** that the relevant **Generating Unit, Power Generating Module, Power Park Module** or **DC Converter** or **HVDC Equipment** would not then be unavailable by reason of forced outage or **Planned Outage** expected prior to the instruction.

The relevant **Network Operator** is responsible for ensuring the performance of any test so required by **The Company** and the **Network Operator** shall ensure that the **Embedded Person** retains the responsibility for ensuring the safety of personnel and plant during the test.

OC5.8.4 Test Failures/Re-Tests And Disputes

The relevant **Network Operator** shall:

- (a) ensure that provisions equivalent to OC5.5.5, OC5.5.6 and OC5.6 apply to **Embedded Medium Power Stations** not the subject of a **Bilateral Agreement**, **Embedded DC Converter Stations** not the subject of a **Bilateral Agreement** or **Embedded HVDC Equipment** not the subject of a **Bilateral Agreement** within its **System** in respect of test failures, re-tests and disputes as to test failures and re-tests;

- (b) ensure that the provisions equivalent to OC5.5.5, OC5.5.6 and OC5.6 referred to in OC5.8.4(a) are effective so that **The Company** may require, if it so wishes, the provision to it of any reports or other information equivalent to those or that to which **The Company** would be entitled in relation to test failures, re-tests and disputes as to test failures and re-tests under the provisions of OC5.5.5, OC5.5.6 and OC5.6; and
- (c) the provisions equivalent to OC5.5.5, OC5.5.6 and OC5.6 referred to in OC5.8.4(a) are effective to permit **The Company** to conduct itself and take decisions in such a manner in relation to test failures, re-tests and disputes as to test failures and re-tests in respect of **Embedded Medium Power Stations** not the subject of a **Bilateral Agreement**, **Embedded DC Converter Stations** not the subject of a **Bilateral Agreement** or **Embedded HVDC Equipment** not the subject of a **Bilateral Agreement** as it is able to conduct itself and take decisions in relation to test failures, re-tests and disputes as to test failures and re-tests under OC5.5.5, OC5.5.6 and OC5.6.

APPENDIX 1 - ONSITE SIGNAL PROVISION FOR WITNESSING TESTS

OC5.A.1.1 During tests witnessed on-site by **The Company**, the following signals shall be provided to **The Company** by the **GB Generator**, **GB Generator** undertaking **OTSDUW** or **DC Converter Station** owner in accordance with CC.6.6.2:

OC5.A.1.2 Synchronous Generating Units

(a) All Tests

- MW - **Active Power** at **Generating Unit** terminals

(b) Reactive & Excitation System

- MVA_r - **Reactive Power** at **Generating Unit** terminals
- V_t - **Generating Unit** terminal voltage
- E_{fd} - **Generating Unit** field voltage and/or main exciter field voltage
- I_{fd} – **Generating Unit** field current (where possible)
- **Power System Stabiliser** output, where applicable.
- Noise – Injected noise signal (where applicable and possible)

(c) Governor System & **Frequency** Response

- F_{sys} - **System Frequency**
- F_{inj} - Injected Speed Reference
- Logic - Stop / Start Logic Signal

For Gas Turbines:

- GT Fuel Demand
- GT Fuel Valve Position
- GT Inlet Guide Vane Position
- GT Exhaust Gas Temperature

For Steam Turbines at ≥ 1 Hz:

- Pressure before Turbine Governor Valves
- Turbine Governor Valve Positions
- Governor Oil Pressure*
- Boiler Pressure Set Point *
- Superheater Outlet Pressure *
- Pressure after Turbine Governor Valves*
- Boiler Firing Demand*

*Where applicable (typically not in **CCGT Module**)

For Hydro Plant:

- Speed Governor Demand Signal
- Actuator Output Signal
- Guide Vane / Needle Valve Position

(d) Compliance with
CC.6.3.3

- Fsys - **System Frequency**
- Finj - Injected Speed Reference
- Appropriate control system parameters as agreed with **The Company** (See OC5.A.2.9)

OC5.A.1.3 Power Park Modules, OTSUA and DC Converters

Each **Power Park Module** and **DC Converter** at a **Grid Entry Point** or **User System Entry Point**

(a) Real Time on site.

- Total **Active Power** (MW)
- Total **Reactive Power** (MVA_r)
- Line-line Voltage (kV)
- **System Frequency** (Hz)

(b) Real Time on site or Downloadable

- Injected frequency signal (Hz) or test logic signal (Boolean) when appropriate
- Injected voltage signal (per unit voltage) or test logic signal (Boolean) when appropriate
- In the case of an **Onshore Power Park Module** the **Onshore Power Park Module** site voltage (MV) (kV)
- **Power System Stabiliser** output, where appropriate
- In the case of a **Power Park Module** or **DC Converter** where the **Reactive Power** is provided from more than one **Reactive Power** source, the individual **Reactive Power** contributions from each source, as agreed with **The Company**.
- In the case of **DC Converters** appropriate control system parameters as agreed with **The Company** (See OC5.A.4)
- In the case of an **Offshore Power Park Module** the total **Active Power** (MW) and the total **Reactive Power** (MVA_r) at the **Offshore Grid Entry Point**

(c) Real Time on site or Downloadable

- Available power for **Power Park Module** (MW)
- Power source speed for **Power Park Module** (e.g. wind speed) (m/s) when appropriate
- Power source direction for **Power Park Module** (degrees) when appropriate

See OC5.A.1.3.1

OC5.A.1.3.1 **The Company** accept that the signals specified in OC5.A.1.3(c) may have lower effective sample rates than those required in CC.6.6.2 although any signals supplied for connection to **The Company's** recording equipment which do not meet at least the sample rates detailed in CC.6.6.2 should have the actual sample rates indicated to **The Company** before testing commences.

OC5.A.1.3.2 For all **The Company** witnessed testing either;

- (i) the **Generator** or **DC Converter Station** owner shall provide to **The Company** all signals outlined in OC5.A.1.3 direct from the **Power Park Module** control system without any attenuation, delay or filtering which would result in the inability to fully demonstrate the objectives of the test, or identify any potential safety or plant instability issues, and with a signal update rate corresponding to CC.6.6.2.1; or

- (ii) in the case of **Onshore Power Park Modules**, the **Generator** or **DC Converter Station** owner shall provide signals OC5.A.1.3(a) direct from one or more transducer(s) connected to current and voltage transformers for monitoring in real time on site; or,
- (iii) In the case of **Offshore Power Park Modules** and **OTSUA** signals OC5.A.1.3(a) will be provided at the **Interface Point** by the **Offshore Transmission Licensee** pursuant to the **STC** or by the **Generator** when **OTSDUW Arrangements** apply.

OC5.A.1.3.3 Options OC5.A.1.3.2 (ii) and (iii) will only be available on condition that;

- (a) all signals outlined in OC5.A.1.3 are recorded and made available to **The Company** by the **Generator** or **DC Converter Station** owner from the **Power Park Module** or **OTSUA** or **DC Converter** control systems as a download once the testing has been completed; and
- (b) the full test results are provided by the **Generator** or **DC Converter Station** owner within 2 working days of the test date to **The Company** unless **The Company** agrees otherwise; and
- (c) all data is provided with a sample rate in accordance with CC.6.6.2.2 or ECC.6.6.3.3 unless **The Company** agrees otherwise; and
- (d) in **The Company's** reasonable opinion the solution does not unreasonably add a significant delay between tests or impede the volume of testing which can take place on the day.

OC5.A.1.3.4 In the case of where transducers connected to current and voltage transformers are installed (OC5.A.1.3.3 (ii) and (iii)), the transducers shall meet the following specification

- (a) The transducer(s) shall be permanently installed to easily allow safe testing at any point in the future, and to avoid a requirement for recalibration of the current transformers and voltage transformers.
- (b) The transducer(s) should be directly connected to the metering quality current transformers and voltage transformers or similar.
- (c) The transducers shall either have a response time no greater than 50ms to reach 90% of output, or no greater than 300ms to reach 99.5%.

OC5.A.1.4 Testing not witnessed by **The Company** on-site

OC5.A.1.4.1.1 Where **The Company** has decided not to witness testing on-site, the results shall be submitted to **The Company** in spreadsheet format with the signal data in columns arranged as follows. Signal data denoted by “#” is not essential but if not provided the column should remain in place but without values entered. Where two signal names are given in a column these are alternatives related to the type of plant under test.

OC5.A.1.4.1.2. Where **The Company** has requested addition signals to be recorded prior to the testing these signals shall be placed in columns to the right of the spreadsheet.

OC5.A.1.4.2.1 Onshore Synchronous Generating Unit Excitation System and Reactive Capability

	Col 1	Col 2	Col 3	Col 4	Col 5	Col 6	Col 7	Col 8
1	Time	Active Power	Reactive Power	Terminal Voltage	Speed /Frequency #	Freq Injection #	Logic / Test Start #	Field Voltage
	Col 9	Col 10	Col 11	Col 12	Col 13	Col 14	Col 15	Col 16
1	Field Current	PSS Output #	Noise Injection #					
# Columns may be left blank but the column must still be included in the files								

OC5.A.1.4.2.2 Onshore Synchronous Generating Unit Frequency Response and CC.6.3.3

	Col 1	Col 2	Col 3	Col 4	Col 5	Col 6	Col 7	Col 8
1	Time	Active Power	Reactive Power #	Terminal Voltage #	Speed /Frequency	Freq Injection	Logic / Test Start	Fuel Demand
2								Guide Vane Setpoint
	Col 9	Col 10	Col 11	Col 12	Col 13	Col 14	Col 15	Col 16
1	Inlet Guide Vane	Exhaust Gas Temp	ST Valve Pos	Fuel Valve Pos	HP Steam Valve Pos	IP Steam Valve Pos	LP Steam Valve Pos	
2	Guide Vane Position	Head						
# Columns may be left blank but must still be included in the files								

OC5.A.1.4.3.1 Onshore Power Park Modules Voltage Control & Reactive Capability

	Col 1	Col 2	Col 3	Col 4	Col 5	Col 6	Col 7	Col 8
1	Time	Active Power	Reactive Power	Connection Point Voltage	Speed /Frequency #	Freq Injection #	Logic / Test Start #	Statcom or Windfarm Reactive Power #
	Col 9	Col 10	Col 11	Col 12	Col 13	Col 14	Col 15	Col 16
1	Power Available	Wind Speed	Wind Direction	Voltage Setpoint				
2	State of Charge							
# Columns may be left blank but the column must still be included in the files								

OC5.A.1.4.3.2 Offshore Power Park Modules Voltage Control & Reactive Capability

	Col 1	Col 2	Col 3	Col 4	Col 5	Col 6	Col 7	Col 8
1	Time	Onshore Interface Point Active Power	Onshore Interface Point Reactive Power	Onshore Interface Point Voltage	Speed /Frequency #	Freq Injection #	Logic / Test Start #	Statcom or Windfarm Reactive Power #
	Col 9	Col 10	Col 11	Col 12	Col 13	Col 14	Col 15	Col 16
1	Power Available	Wind Speed m/s	Wind Direction	Voltage Setpoint				
2	State of Charge							
# Columns may be left blank but the column must still be included in the files								

OC5.A.1.4.3.3 Power Park Modules Frequency Control

	Col 1	Col 2	Col 3	Col 4	Col 5	Col 6	Col 7	Col 8
1	Time	GEP Active Power	GEP Reactive Power #	GEP Connection Voltage #	Speed /Frequency	Freq Injection	Logic / Test Start	Statcom or Windfarm Output #
	Col 9	Col 10	Col 11	Col 12	Col 13	Col 14	Col 15	Col 16

1	Power Available	Wind Speed m/s	Wind Direction					
2	State of Charge							
# Columns may be left blank but must still be included in the files								

OC5.A.1.5.1 Where test results are completed without any presence of **The Company** but are relied upon as evidence of the compliance they should be accompanied by a logsheet. This sheet should be legible, in English and detail the items as indicated below:

- Time and date of test;
- Name of **Power Station** and module if applicable;
- Name of test engineer(s) and company name;
- Name of **User** representative(s) and company name;
- Type of testing being undertake eg voltage control;
- Ambient conditions eg. temperature, pressure, wind speed, wind direction; and
- Controller settings, eg voltage slope, frequency droop, voltage setpoint, UEL & OEL settings.

OC5.A.1.5.2 For each test the following items should be recorded as relevant to the type of test being undertaken. Where there is uncertainty on the information to be recorded this should be discussed with **The Company** in advance of the test.

OC5.A.1.5.2 .1 Voltage Control Tests

- Start time of each test step;
- **Active Power**;
- **Reactive Power**;
- Connection voltage;
- Voltage control setpoint, if applicable or changed;
- Voltage control slope, if applicable or changed;
- Terminal voltage if applicable;
- **Generating Unit** transformer tap position or grid transformer tap position, as applicable;
- Number of **Power Park Units** in service in each **Power Park Module**, if applicable; and
- For Offshore Connections, **Offshore Grid Entry Point** voltage.

OC5.A.1.5.2.2 Reactive Power Capability Tests

- Start time of test;
- **Active Power**;
- **Reactive Power**;
- Connection voltage;
- Terminal voltage if applicable;
- **Generating Unit** transformer tap position or grid transformer tap position as applicable;

- Number of **Power Park Units** in service in each **Power Park Module**, if applicable and
- For Offshore Connections, **Offshore Grid Entry Point** voltage.

OC5.A.1.5.2.3 Frequency Response Capability Tests

- Start time of test;
- **Active Power**;
- **System Frequency**;
- For **CCGT Modules, Active Power** for the individual units (GT &ST);
- For boiler plant, HP steam pressure;
- Droop setting of controller if applicable;
- Number of **Power Park Units** in service in each **Power Park Module**, if applicable.; and
- For Offshore Connections, **Offshore Grid Entry Point Active Power** for each Power Park Module.

OC5.A.1.5.3 Material changes during the test period should be recorded e.g. **Generating Units** tripping / starting, changes to tapchange positions.

APPENDIX 2 - COMPLIANCE TESTING OF SYNCHRONOUS PLANT

- OC5.A.2.1 Scope
- OC5.A.2.1.1 This Appendix sets out the tests contained therein to demonstrate compliance with the relevant clauses of the **Connection Conditions** of the Grid Code and apply only to **GB Generators**. This Appendix shall be read in conjunction with the **CP** with regard to the submission of the reports to **The Company**. The testing requirements applicable to **EU Generators** are specified in ECP.A.5.
- OC5.A.2.1.2 The tests specified in this Appendix will normally be sufficient to demonstrate compliance however **The Company** may:
- (i) agree an alternative set of tests provided **The Company** deem the alternative set of tests sufficient to demonstrate compliance with the **Grid Code** and **Bilateral Agreement**; and/or
 - (ii) require additional or alternative tests if information supplied to **The Company** during the compliance process suggests that the tests in this Appendix will not fully demonstrate compliance with the relevant section of the **Grid Code** or **Bilateral Agreement**.
 - (iii) Agree a reduced set of tests for subsequent **Generating Units** following successful completion of the first **Generating Unit** tests in the case of a **Power Station** comprised of two or more **Generating Units** which **The Company** reasonably considers to be identical.
- If:
- (a) the tests performed pursuant to OC5.A.2.1.2(iii) in respect of subsequent **Generating Units** do not replicate the full tests for the first **Generating Unit**, or
 - (b) any of the tests performed pursuant to OC5.A.2.1.2(iii) do not fully demonstrate compliance with the relevant aspects of the **Grid Code**, **Ancillary Services Agreement** and / or **Bilateral Agreement**,
- then notwithstanding the provisions above, the full testing requirements set out in this Appendix will be applied.
- OC5.A.2.1.3 The **Generator** is responsible for carrying out the tests set out in and in accordance with this Appendix and the **Generator** retains the responsibility for the safety of personnel and plant during the test. **The Company** will witness all of the tests outlined or agreed in relation to this Appendix unless **The Company** decides and notifies the **Generator** otherwise. Reactive Capability tests may be witnessed by **The Company** remotely from the **The Company** control centre. During **The Company** witnessed tests, the **Generator** should ensure suitable representatives from the **Generator** and manufacturer (if appropriate) are available on site for the entire testing period. In all cases the **Generator** shall provide suitable monitoring equipment to record all relevant test signals as outlined below in OC5.A.3.1.5.
- OC5.A.2.1.4 The **Generator** shall submit a schedule of tests to **The Company** in accordance with CP.4.3.1
- OC5.A.2.1.5 Prior to the testing of a **Generating Unit**, the **Generator** shall complete the **Integral Equipment Test** procedure in accordance with OC.7.5
- OC5.A.2.1.6 Full **Generating Unit** testing as required by CP.7.2 is to be completed as defined in OC5.A.2.2 through to OC5.A.2.9
- OC5.A.2.2 Excitation System Open Circuit Step Response Tests
- OC5.A.2.2.1 The open circuit step response of the **Excitation System** will be tested by applying a voltage step change from 90% to 100% of the nominal **Generating Unit** terminal voltage, with the **Generating Unit** on open circuit and at rated speed.

OC5.A.2.2.2 The test shall be carried out prior to synchronisation in accordance with CP.6.4. This is not witnessed by **The Company** unless specifically requested by **The Company**. Where **The Company** is not witnessing the tests, the **Generator** shall supply the recordings of the following signals to **The Company** in an electronic spreadsheet format:

Vt - **Generating Unit** terminal voltage

Efd - **Generating Unit** field voltage or main exciter field voltage

I_{fd} - **Generating Unit** field current (where possible)

Step injection signal

OC5.A.2.2.3 Results shall be legible, identifiable by labelling, and shall have appropriate scaling.

OC5.A.2.3 Open & Short Circuit Saturation Characteristics

OC5.A.2.3.1 The test shall normally be carried out prior to synchronisation in accordance with CP.6.4. Manufacturer factory test results may be used where appropriate or manufacturers factory type test results may be used if agreed by **The Company**.

OC5.A.2.3.2 This is not witnessed by **The Company**. Graphical and tabular representations of the results in an electronic spreadsheet format showing per unit open circuit terminal voltage and short circuit current versus per unit field current shall be submitted to **The Company**.

OC5.A.2.3.3 Results shall be legible, identifiable by labelling, and shall have appropriate scaling.

OC5.A.2.4 Excitation System On-Load Tests

OC5.A.2.4.1 The time domain performance of the **Excitation System** shall be tested by application of voltage step changes corresponding to 1% and 2% of the nominal terminal voltage.

OC5.A.2.4.2 Where a **Power System Stabiliser** is present:

- (i) The **PSS** must only be commissioned in accordance with BC2.11.2. When a **PSS** is switched on for the first time as part of on-load commissioning or if parameters have been adjusted, the **Generator** should consider reducing the **PSS** output gain by at least 50% and should consider reducing the limits on the **PSS** output by at least a factor of 5 to prevent unexpected **PSS** action affecting the stability of the **Generating Unit** or the **National Electricity Transmission System**.
- (ii) The time domain performance of the **Excitation System** shall be tested by application of voltage step changes corresponding to 1% and 2% of the nominal terminal voltage, repeating with and without the **PSS** in service.
- (iii) The frequency domain tuning of the **PSS** shall also be demonstrated by injecting a 0.2Hz-3Hz band limited random noise signal into the **Automatic Voltage Regulator** reference with the **Generating Unit** operating at points specified by **The Company** (up to rated MVA output).
- (iv) The **PSS** gain margin shall be tested by increasing the **PSS** gain gradually to threefold and observing the **Generating Unit** steady state **Active Power** output.
- (v) The interaction of the **PSS** with changes in **Active Power** shall be tested by application of a +0.5Hz frequency injection to the governor while the **Generating Unit** is selected to **Frequency Sensitive Mode**.
- (vi) If the **Generating Unit** is of the pump storage type, then the step tests shall be carried out, with and without the **PSS**, in the pumping mode in addition to the generating mode.
- (vii) Where the **Bilateral Agreement** requires that the **PSS** is in service at a specified loading level, additional testing witnessed by **The Company** will be required during the commissioning process before the **Generating Unit** or **CCGT Module** may exceed this output level.
- (viii) Where the **Excitation System** includes a **PSS**, the **Generator** shall provide a suitable noise source to facilitate noise injection testing.

OC5.A.2.4.3 The following typical procedure is provided to assist **Generators** in drawing up their own site specific procedures for the **The Company** witnessed **PSS** Tests.

Test	Injection	Notes
	Synchronous Generator running rated MW, unity pf, PSS Switched Off	
1	<ul style="list-style-type: none"> • Record steady state for 10 seconds • Inject +1% step to AVR Voltage Reference and hold for at least 10 seconds until stabilised • Remove step returning AVR Voltage Reference to nominal and hold for at least 10 seconds 	
2	<ul style="list-style-type: none"> • Record steady state for 10 seconds • Inject +2% step to AVR Voltage Reference and hold for at least 10 seconds until stabilised • Remove step returning AVR Voltage Reference to nominal and hold for at least 10 seconds 	
3	<ul style="list-style-type: none"> • Inject band limited (0.2-3Hz) random noise signal into voltage reference and measure frequency spectrum of Real Power. • Remove noise injection. 	
	Switch On Power System Stabiliser	
4	<ul style="list-style-type: none"> • Record steady state for 10 seconds • Inject +1% step to AVR Voltage Reference and hold for at least 10 seconds until stabilised • Remove step returning AVR Voltage Reference to nominal and hold for at least 10 seconds 	
5	<ul style="list-style-type: none"> • Record steady state for 10 seconds • Inject +2% step to AVR Voltage Reference and hold for at least 10 seconds until stabilised • Remove step returning AVR Voltage Reference to nominal and hold for at least 10 seconds 	
6	<ul style="list-style-type: none"> • Increase PSS gain at 30 second intervals. i.e. x1 – x1.5 – x2 – x2.5 – x3 • Return PSS gain to initial setting 	
7	<ul style="list-style-type: none"> • Inject band limited (0.2-3Hz) random noise signal into voltage reference and measure frequency spectrum of Real Power. • Remove noise injection. 	

8	<ul style="list-style-type: none"> • Select the governor to Frequency Sensitive Mode (FSM) • Inject +0.5 Hz step into governor. • Hold until generator MW output is stabilised • Remove step 	
---	-----------------------------------------------------------------------------------------------------------------------------------------------------------------------------------------------------------------------------------------------	--

OC5.A.2.5 Under-excitation Limiter Performance Test

OC5.A.2.5.1 Initially the performance of the **Under-excitation Limiter** should be checked by moving the limit line close to the operating point of the **Generating Unit** when operating close to unity power factor. The operating point of the **Generating Unit** is then stepped into the limit by applying a 2% decrease in **Automatic Voltage Regulator** reference voltage.

OC5.A.2.5.2 The final performance of the **Under-excitation Limiter** shall be demonstrated by testing its response to a step change corresponding to a 2% decrease in **Automatic Voltage Regulator** reference voltage when the **Generating Unit** is operating just off the limit line, at the designed setting as indicated on the **Performance Chart** submitted to **The Company** under OC2.

OC5.A.2.5.3 Where possible, the **Under-excitation Limiter** should also be tested by operating the tap-changer when the **Generating Unit** is operating just off the limit line, as set up.

OC5.A.2.5.4 The **Under-excitation Limiter** will normally be tested at low **Active Power** output and at maximum **Active Power** output (**Registered Capacity**).

OC5.A.2.5.5 The following typical procedure is provided to assist **Generators** in drawing up their own site specific procedures for the **The Company** witnessed **Under-excitation Limiter** Tests.

Test	Injection	Notes
	Synchronous generator running rated MW at unity Power Factor . Under-excitation limit temporarily moved close to the operating point of the generator.	
1	<ul style="list-style-type: none"> • PSS on. • Inject -2% voltage step into AVR voltage reference and hold at least for 10 seconds until stabilised • Remove step returning AVR Voltage Reference to nominal and hold for at least 10 seconds 	
	Under-excitation limit moved to normal position. Synchronous generator running at rated MW and at leading MVARs close to Under-excitation limit.	
2	<ul style="list-style-type: none"> • PSS on. • Inject -2% voltage step into AVR voltage reference and hold at least for 10 seconds until stabilised • Remove step returning AVR Voltage Reference to nominal and hold for at least 10 seconds 	

OC5.A.2.6 Over-excitation Limiter Performance Test

Description & Purpose of Test

- OC5.A.2.6.1 The performance of the **Over-excitation Limiter**, where it exists, shall be demonstrated by testing its response to a step increase in the **Automatic Voltage Regulator** reference voltage that results in operation of the **Over-excitation Limiter**. Prior to application of the step the **Generating Unit** shall be generating **Rated Active Power** and operating within its continuous **Reactive Power** capability. The size of the step will be determined by the minimum value necessary to operate the **Over-excitation Limiter** and will be agreed by **The Company** and the **Generator**. The resulting operation beyond the **Over-excitation Limit** shall be controlled by the **Over-excitation Limiter** without the operation of any protection that could trip the **Generating Unit**. The step shall be removed immediately on completion of the test.
- OC5.A.2.6.2 If the **Over-excitation Limiter** has multiple levels to account for heating effects, an explanation of this functionality will be necessary and if appropriate, a description of how this can be tested.
- OC5.A.2.6.3 The following typical procedure is provided to assist **Generators** in drawing up their own site specific procedures for the **The Company** witnessed **Under-excitation Limiter** Tests.

Test	Injection	Notes
	Synchronous Generator running Rated MW and maximum lagging MVA _r .	
	Over-excitation Limit temporarily set close to this operating point. PSS on.	
1	<ul style="list-style-type: none"> • Inject positive voltage step into AVR voltage reference and hold • Wait till Over-excitation Limiter operates after sufficient time delay to bring back the excitation back to the limit. • Remove step returning AVR Voltage Reference to nominal. 	
	Over-excitation Limit restored to its normal operating value. PSS on.	

OC5.A.2.7 Reactive Capability

- OC5.A.2.7.1 The leading and lagging **Reactive Power** capability on each **Generating Unit** will normally be demonstrated by operation of the **Generating Unit** at 0.85 power factor lagging for 1 hour and 0.95 power factor leading for 1 hour.
- OC5.A.2.7.2 In the case of an **Embedded Generating Unit** where distribution network considerations restrict the **Generating Unit Reactive Power** output then the maximum leading and lagging capability will be demonstrated without breaching the host network operators limits.
- OC5.A.2.7.3 The test procedure, time and date will be agreed with **The Company** and will be to the instruction of **The Company** control centre and shall be monitored and recorded at both the **The Company** control centre and by the **Generator**.
- OC5.A.2.7.4 Where the **Generator** is recording the voltage and **Reactive Power** at the **Generating Unit** terminals, the results shall be supplied in an electronic spreadsheet format.
- OC5.A.2.7.5 The ability of the **Generating Unit** to comply with the operational requirements specified in BC2.A.2.6 and CC.6.1.7 will normally be demonstrated by changing the tap position and, where agreed in the **Bilateral Agreement**, the **Generating Unit** terminal voltage.

OC5.A.2.8 Governor and Load Controller Response Performance

- OC5.A.2.8.1 The governor and load controller response performance will be tested by injecting simulated frequency deviations into the governor and load controller systems. Such simulated frequency deviation signals must be injected simultaneously at both speed governor and load controller references. For **CCGT modules**, simultaneous injection into all gas turbines, steam turbine governors and module controllers is required.
- OC5.A.2.8.2 Prior to witnessing the governor tests set out in OC5.A.2.8.6, **The Company** requires the **Generator** to conduct the preliminary tests detailed in OC5.A.2.8.4 and send the results to **The Company** for assessment unless agreed otherwise by **The Company**. The results should be supplied in an electronic spreadsheet format. These tests shall be completed at least two weeks prior to the witnessed governor response tests.
- OC5.A.2.8.3 Where a **CCGT Module** or **Generating Unit** is capable of operating on alternative fuels, tests will be required to demonstrate performance when operating on each fuel. **The Company** may agree a reduction from the tests listed in OC5.A.2.8.6 for demonstrating performance on the alternative fuel. This includes the case where a main fuel is supplemented by bio-fuel.

Preliminary Governor Frequency Response Testing

- OC5.A.2.8.4 Prior to conducting the full set of tests as per OC5.A.2.8.6, **Generators** are required to conduct a preliminary set of tests below to confirm the frequency injection method is correct and the plant control performance is within expectation. The test numbers refer to Figure 1 below. With the plant running at 80% of full load, the following frequency injections shall be applied.

Test No (Figure 1)	Frequency Injection	Notes
8	<ul style="list-style-type: none"> Inject - 0.5Hz frequency fall over 10 sec Hold until conditions stabilise Remove the injected signal 	
14	<ul style="list-style-type: none"> Inject +0.5Hz frequency rise over 10 sec Hold until conditions stabilise Remove the injected signal 	
13	<ul style="list-style-type: none"> Inject -0.5Hz frequency fall over 10 sec Hold for a further 20 sec At 30 sec from the start of the test, Inject a +0.3Hz frequency rise over 30 sec. Hold until conditions stabilise Remove the injected signal 	

- OC5.A.2.8.5 The recorded results (e.g. Finj, MW and control signals) should be sampled at a minimum rate of 1 Hz to allow **The Company** to assess the plant performance from the initial transients (seconds) to the final steady state conditions (5-15 minutes depending on the plant design). This is not witnessed by **The Company**. The **Generator** shall supply the recordings including data to **The Company** in an electronic spreadsheet format. Results shall be legible, identifiable by labelling, and shall have appropriate scaling.

Full Frequency Response Testing Schedule Witnessed by The Company

OC5.A.2.8.6 The tests are to be conducted at a number of different Module Load Points (MLP). The load points are conducted as shown below unless agreed otherwise by **The Company**.

Module Load Point 6 (Maximum Export Limit)	100% MEL
Module Load Point 5	95% MEL
Module Load Point 4 (Mid point of Operating Range)	80% MEL
Module Load Point 3	70% MEL
Module Load Point 2 (Minimum Generation)	MG
Module Load Point 1 (Design Minimum Operating Level)	DMOL

OC5.A.2.8.7 The tests are divided into the following two types;

- (i) **Frequency** response volume tests as per OC5.A.2.8. Figure 1. These tests consist of **Frequency** profile and ramp tests.
- (ii) **System** islanding and step response tests as shown by OC5.A.2.8. Figure 2.

OC5.A.2.8.8 There should be sufficient time allowed between tests for control systems to reach steady state. Where the diagram states 'HOLD' the current injection should be maintained until the **Active Power** (MW) output of the **Generating Unit** or **CCGT Module** has stabilised or 90 seconds, whichever is the longer. The frequency response capability test (see Figure 1) injection signal shall be returned to zero at the same rate at which it was applied. **The Company** may require repeat tests should the tests give unexpected results. When witnessed by **The Company** each test should be carried out as a separate injection; when not witnessed by **The Company** there must be sufficient time allowed between tests for the **Plant** to have reached a stable steady state operating condition or 90 seconds, whichever is the longer.

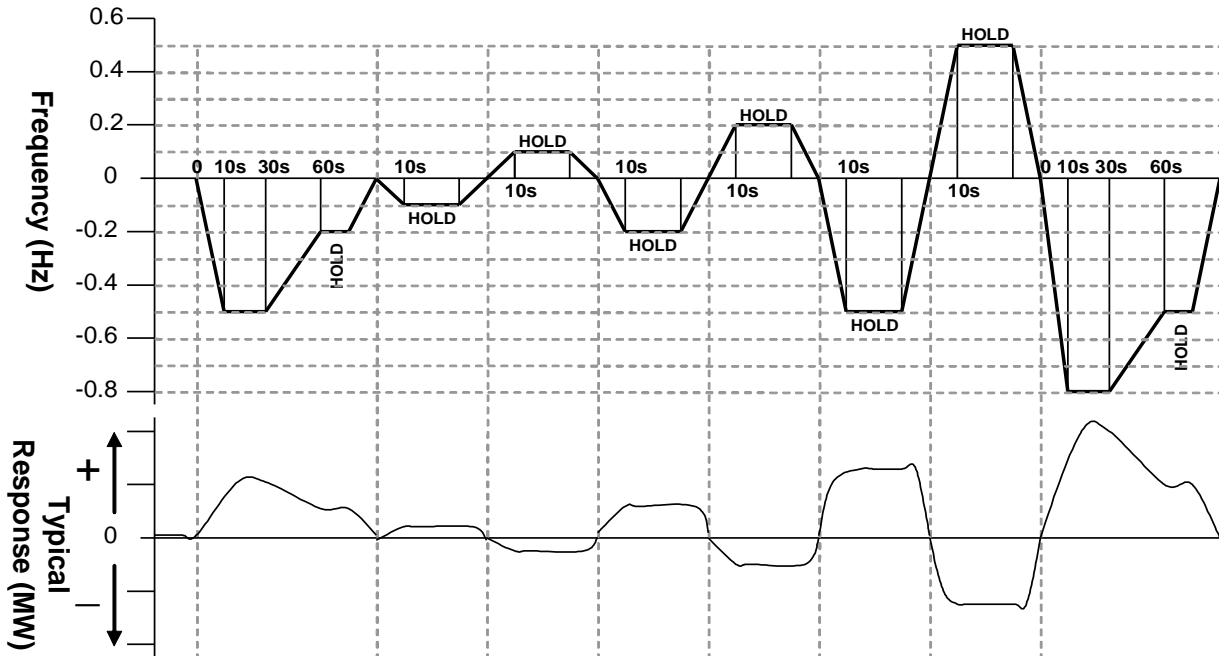

Load Point	LF Event Profile 1	LF Ramp -0.1Hz	HF Ramp +0.1Hz	LF Ramp -0.2Hz	HF Ramp +0.2Hz	LF Ramp -0.5Hz	HF Ramp +0.5Hz	LF Event Profile 2
MLP6			1	2	3		4	
MLP5	5			6			7	
MLP4	8	9	10	11	12	13	14	
MLP3	15						16	17
MLP2	18			19	20	21		22
MLP1	23			24	25			26

Figure 1: Frequency Response Capability Tests

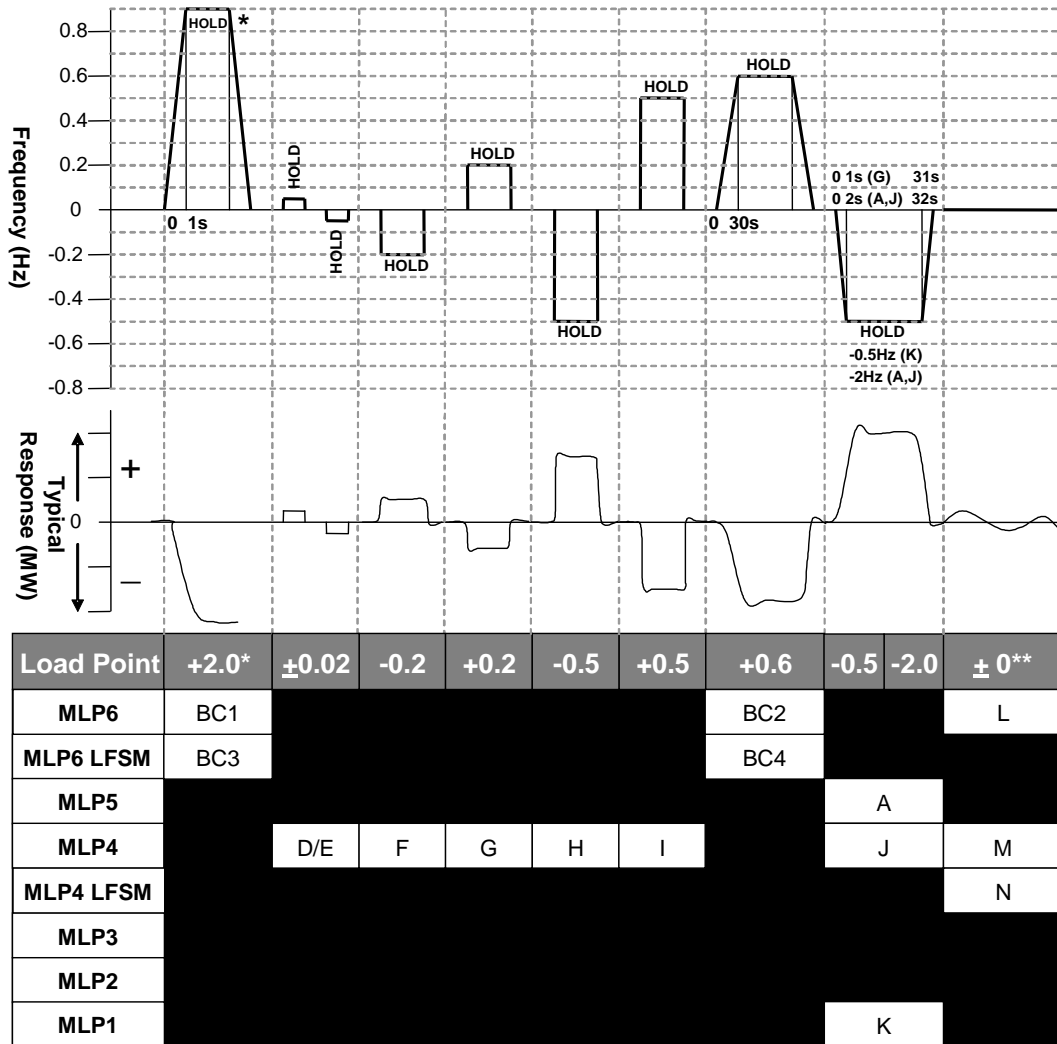

Figure 2: System islanding and step response tests

* This will generally be +2.0Hz unless an injection of this size causes a reduction in plant output that takes the operating point below **Designed Minimum Operating Level** in which case an appropriate injection should be calculated in accordance with the following:

For example, 0.9Hz is needed to take an initial output 65% to a final output of 20%. If the initial output was not 65% and the **Designed Minimum Operating Level** is not 20% then the injected step should be adjusted accordingly as shown in the example given below

Initial Output 65%

Designed Minimum Operating Level 20%

Frequency Controller Droop 4%

Frequency to be injected = $(0.65 - 0.20) \times 0.04 \times 50 = 0.9\text{Hz}$

** Tests L and M in Figure 2 shall be conducted if in this range of tests the **System Frequency** feedback signal is replaced by the injection signal rather than the injection signal being added to the **System Frequency** signal. The tests will consist of monitoring the **Generating Unit** and **CCGT Module** in **Frequency Sensitive Mode** during normal **System Frequency** variations without applying any injection. Test N in figure 2 shall be conducted in all cases. All three tests should be conducted for a period of at least 10 minutes.

OC5.A.2.8.9 The target frequency adjustment facility should be demonstrated from the normal **Control Point** within the range of 49.9Hz to 50.1Hz by step changes to the target frequency setpoint as indicated in OC5.A.2.8 Figure 3.

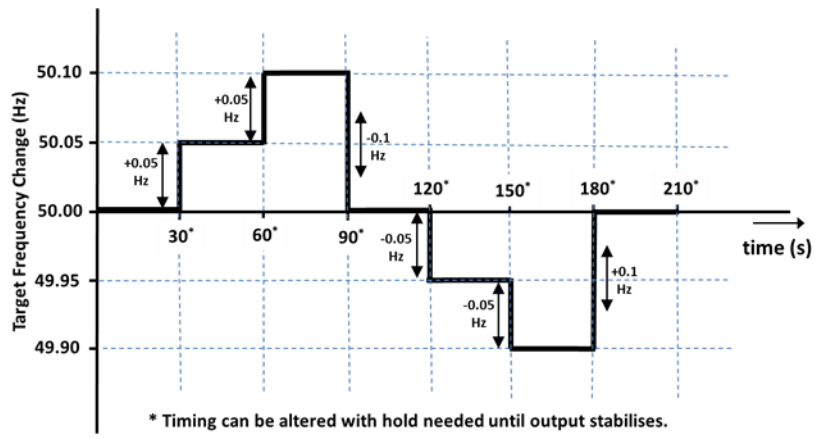

Figure 3 – Target Frequency setting changes

OC5.A.2.9 Compliance with CC.6.3.3 Functionality Test

OC5.A.2.9.1 Where the plant design includes active control function or functions to deliver CC.6.3.3 compliance, the **Generator** will propose and agree a test procedure with **The Company**, which will demonstrate how the **Generating Unit Active Power** output responds to changes in **System Frequency** and ambient conditions (e.g. by **Frequency** and temperature injection methods).

OC5.A.2.9.2 The **Generator** shall inform **The Company** if any load limiter control is additionally employed.

OC5.A.2.9.3 With reference to the signals specified in OC5.A.1, **The Company** will agree with the **Generator** which additional control system parameters shall be monitored to demonstrate the functionality of CC.6.3.3 compliance systems. Where **The Company** recording equipment is not used, results shall be supplied to **The Company** in an electronic spreadsheet format.

APPENDIX 3 - COMPLIANCE TESTING OF POWER PARK MODULES (AND OTSUA)

OC5.A.3.1 Scope

OC5.A.3.1.1 This Appendix outlines the general testing requirements for **Power Park Modules** and **OTSUA** to demonstrate compliance with the relevant aspects of the **Grid Code**, **Ancillary Services Agreement** and **Bilateral Agreement** and apply only to **GB Generators**. The testing requirements applicable to **EU Generators** are specified in ECP.A.6. The tests specified in this Appendix will normally be sufficient to demonstrate compliance however **The Company** may:

- (i) agree an alternative set of tests provided **The Company** deem the alternative set of tests sufficient to demonstrate compliance with the **Grid Code**, **Ancillary Services Agreement** and **Bilateral Agreement**; and/or
- (ii) require additional or alternative tests if information supplied to **The Company** during the compliance process suggests that the tests in this Appendix will not fully demonstrate compliance with the relevant section of the **Grid Code**, **Ancillary Services Agreement** or **Bilateral Agreement**; and/or
- (ii) require additional tests if a **Power System Stabiliser** is fitted; and/or
- (iv) agree a reduced set of tests if a relevant **Manufacturer's Data & Performance Report** has been submitted to and deemed to be appropriate by **The Company**; and/or
- (v) agree a reduced set of tests for subsequent **Power Park Modules** or **OTSUA** following successful completion of the first **Power Park Module** or **OTSUA** tests in the case of a **Power Station** comprised of two or more **Power Park Modules** or **OTSUA** which **The Company** reasonably considers to be identical.

If:

- (a) the tests performed pursuant to OC5.A.3.1.1(iv) do not replicate the results contained in the **Manufacturer's Data & Performance Report** or
- (b) the tests performed pursuant to OC5.A.3.1.1(v) in respect of subsequent **Power Park Modules** or **OTSUA** do not replicate the full tests for the first **Power Park Module** or **OTSUA**, or
- (c) any of the tests performed pursuant to OC5.A.3.1.1(iv) or OC5.A.3.1.1(v) do not fully demonstrate compliance with the relevant aspects of the **Grid Code**, **Ancillary Services Agreement** and / or **Bilateral Agreement**,

then notwithstanding the provisions above, the full testing requirements set out in this Appendix will be applied.

OC5.A.3.1.2 The **Generator** is responsible for carrying out the tests set out in and in accordance with this Appendix and the **Generator** retains the responsibility for the safety of personnel and plant during the test. **The Company** will witness all of the tests outlined or agreed in relation to this Appendix unless **The Company** decides and notifies the **Generator** owner otherwise. Reactive Capability tests may be witnessed by **The Company** remotely from the **The Company** control centre. For all on site during **The Company** witnessed tests, the **Generator** must ensure suitable representatives from the **Generator** and / or **Power Park Module** manufacturer (if appropriate) and/or **OTSUA** manufacturer (if appropriate) are available on site for the entire testing period. In all cases and in addition to any recording of signals conducted by **The Company**, the **Generator** shall record all relevant test signals as outlined in OC5.A.1.

OC5.A.3.1.3 In addition to the dynamic signals supplied in OC5.A.1, the **Generator** shall inform **The Company** of the following information prior to the commencement of the tests and any changes to the following, if any values change during the tests:

- (i) All relevant transformer tap numbers; and
- (ii) Number of **Power Park Units** in operation

- OC5.A.3.1.4 The **Generator** shall submit a detailed schedule of tests to **The Company** in accordance with CP.6.3.1, and this Appendix.
- OC5.A.3.1.5 Prior to the testing of a **Power Park Module** or **OTSUA**, the **Generator** shall complete the **Integral Equipment Tests** procedure in accordance with OC.7.5.
- OC5.A.3.1.6 Partial **Power Park Module** or **OTSUA** testing as defined in OC5.A.3.2 and OC5.A.3.3 is to be completed at the appropriate stage in accordance with CP.6.
- OC5.A.3.1.7 Full **Power Park Module** or **OTSUA** testing as required by CP.7.2 is to be completed as defined in OC5.A.3.4 through to OC5.A.3.7.
- OC5.A.3.1.8 Where **OTSDUW Arrangements** apply and prior to the **OTSUA Transfer Time**, any relevant **OTSDUW Plant and Apparatus** shall be considered within the scope of testing described in this Appendix. Performance shall be assessed against the relevant Grid Code requirements for **OTSDUW Plant and Apparatus** at the **Interface Point** and other **Generator Plant and Apparatus** at the **Offshore Grid Entry Point**. This Appendix should be read accordingly.
- OC5.A.3.2 Pre 20% (or <50MW) **Synchronised Power Park Module** basic Voltage Control Tests
- OC5.A.3.2.1 Before 20% of the **Power Park Module** (or 50MW if less) has commissioned, either voltage control test OC5.A.3.5.6(i) or (ii) must be completed in accordance with CP.6.
- OC5.A.3.2.2 In the case of an **Offshore Power Park Module** which provides all or a portion of the **Reactive Power** capability as described in CC.6.3.2(e)(iii) and / or voltage control requirements as described in CC.6.3.8(b)(ii) to enable an **Offshore Transmission Licensee** to meet the requirements of **STC** Section K, the **Generator** is required to cooperate with the **Offshore Transmission Licensee** to conduct the 20% voltage control test. The results in relation to the **Offshore Power Park Module** will be assessed against the requirements in the **Bilateral Agreement**. In the case of **OTSUA** prior to the **OTSUA Transfer Time**, the **Generator** shall conduct the testing by reference to the entire control system responding to changes at the **Interface Point**.
- OC5.A.3.3 Pre 70% Power Park Module Tests
- OC5.A.3.3.1 For **Power Park Modules** with **Registered Capacity** ≥100MW only. Before 70% but with at least 50% of the **Power Park Module** commissioned, the following **Limited Frequency Sensitive** tests as detailed in OC5.A.3.6.2 must be completed.
- (a) BC3
- (b) BC4
- OC5.A.3.4 Reactive Capability Test
- OC5.A.3.4.1 This section details the procedure for demonstrating the reactive capability of an **Onshore Power Park Module** or an **Offshore Power Park Module** or **OTSUA** which provides all or a portion of the **Reactive Power** capability as described in CC.6.3.2(e)(iii) (for the avoidance of doubt, an **Offshore Power Park Module** which does not provide part of the **Offshore Transmission Licensee Reactive Power** capability as described in CC6.3.2(e)(i) and CC6.3.2(e)(ii) should complete the reactive power transfer / voltage control tests as per section OC5.A.3.8). These tests should be scheduled at a time where there are at least 95% of the **Power Park Units** within the **Power Park Module** in service. There should be sufficient MW resource forecasted in order to generate at least 85% of **Registered Capacity** of the **Power Park Module**.
- OC5.A.3.4.2 The tests shall be performed by modifying the voltage set-point of the voltage control scheme of the **Power Park Module** or **OTSUA** by the amount necessary to demonstrate the required reactive range. This is to be conducted for the operating points and durations specified in OC5.A.3.4.5.
- OC5.A.3.4.3 **Embedded Generators** should liaise with the relevant **Network Operator** to ensure the following tests will not have an adverse impact upon the **Network Operator's System** as per OC.7.5. In situations where the tests have an adverse impact upon the **Network Operator's System**, **The Company** will only require demonstration within the acceptable limits of the **Network Operator**. For the avoidance of doubt, these tests do not negate the requirement to produce a complete **Power Park Module** performance chart as specified in OC2.4.2.1

- OC5.A.3.4.4 In the case where the **Reactive Power** metering point is not at the same location as the **Reactive Power** capability requirement, then an equivalent **Reactive Power** capability for the metering point shall be agreed between the **Generator** and **The Company**.
- OC5.A.3.4.5 The following tests shall be completed:
- (i) Operation in excess of 50% **Rated MW** and maximum continuous lagging **Reactive Power** for 60 minutes. For the avoidance of doubt this test must start with **Active Power** output in excess of 85% of **Registered Capacity** of the **Power Park Module** as OC5.A.3.4.1 and must not fall below 50% of **Registered Capacity** of the **Power Park Module** during the 60 minutes.
 - (ii) Operation in excess of 50% **Rated MW** and maximum continuous leading **Reactive Power** for 60 minutes. For the avoidance of doubt this test must start with **Active Power** output in excess of 85% of **Registered Capacity** of the **Power Park Module** as OC5.A.3.4.1 and must not fall below 50% of **Registered Capacity** of the **Power Park Module** during the 60 minutes.
 - (iii) Operation at 50% **Rated MW** and maximum continuous leading **Reactive Power** for 5 minutes.
 - (iv) Operation at 20% **Rated MW** and maximum continuous leading **Reactive Power** for 5 minutes.
 - (v) Operation at 20% **Rated MW** and maximum continuous lagging **Reactive Power** for 5 minutes.
 - (vi) Operation at less than 20% **Rated MW** and unity **Power Factor** for 5 minutes. This test only applies to systems which do not offer voltage control below 20% of **Rated MW**.
 - (vii) Operation at 0% **Rated MW** and maximum continuous leading **Reactive Power** for 5 minutes. This test only applies to systems which offer voltage control below 20% and hence establishes actual capability rather than required capability.
 - (viii) Operation at 0% **Rated MW** and maximum continuous lagging **Reactive Power** for 5 minutes. This test only applies to systems which offer voltage control below 20% and hence establishes actual capability rather than required capability.
- OC5.A.3.4.6 Within this **OC5** lagging **Reactive Power** is the export of **Reactive Power** from the **Power Park Module** to the **Total System** and leading **Reactive Power** is the import of **Reactive Power** from the **Total System** to the **Power Park Module** or **OTSUA**.
- OC5.A.3.5 Voltage Control Tests
- OC5.A.3.5.1 This section details the procedure for conducting voltage control tests on **Onshore Power Park Modules** or **OTSUA** or an **Offshore Power Park Module** which provides all or a portion of the voltage control capability as described in CC.6.3.8(b)(ii) (for the avoidance of doubt, **Offshore Power Park Modules** which do not provide part of the **Offshore Transmission Licensee** voltage control capability as described in CC6.3.8(b)(i) should complete the reactive power transfer / voltage control tests as per section OC5.A.3.8). These tests should be scheduled at a time when there are at least 95% of the **Power Park Units** within the **Power Park Module** in service. There should be sufficient MW resource forecasted in order to generate at least 65% of **Registered Capacity** of the **Onshore Power Park Module**. An **Embedded Generator** should also liaise with the relevant **Network Operator** to ensure all requirements covered in this section will not have a detrimental effect on the **Network Operator's System**.
- OC5.A.3.5.2 The voltage control system shall be perturbed with a series of step injections to the **Power Park Module** voltage reference, and where possible, multiple up-stream transformer taps. In the case of an **Offshore Power Park Module** providing part of the **Offshore Transmission Licensee** voltage control capability, this may require a series of step injections to the voltage reference of the **Offshore Transmission Licensee** control system.
- OC5.A.3.5.3 For steps initiated using network tap changers, the **Generator** will need to coordinate with **The Company** or the relevant **Network Operator** as appropriate. The time between transformer taps shall be at least 10 seconds as per OC5.A.3.5 Figure 1.

OC5.A.3.5.4 For step injections into the **Power Park Module** or **OTSUA** voltage reference, steps of $\pm 1\%$, $\pm 2\%$ and $\pm 4\%$ shall be applied to the voltage control system reference summing junction. The injection shall be maintained for a minimum of 10 seconds as per OC5.A.3.5 Figure 2.

OC5.A.3.5.5 Where the voltage control system comprises of discretely switched **Plant** and **Apparatus** (eg. mechanically switched shunt reactors or capacitors) additional tests will be required to demonstrate that the overall performance of the voltage control system when switching these devices as part of the response is in accordance with Grid Code and **Bilateral Agreement** requirements.

OC5.A.3.5.6 Tests to be completed:

(i)

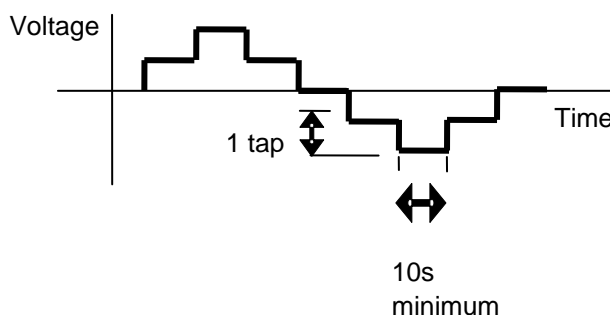

OC5.A.3.5 Figure 1 – Transformer tap sequence for voltage control tests

(ii)

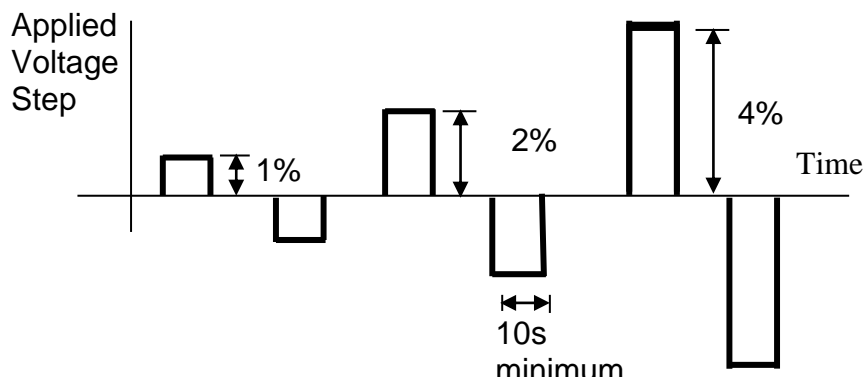

OC5.A.3.5 Figure 2 – Step injection sequence for voltage control tests

OC5.A.3.5.7 In the case of **OTSUA** where the **Bilateral Agreement** specifies additional damping facilities, additional testing to demonstrate these damping facilities may be required.

OC.A.3.5.8 In the case of **Power Park Modules** that do not provide voltage control down to zero **Active Power** a test to demonstrate the smooth transition from voltage control mode to unity **Power Factor** shall be carried out. The **Power Park Module** voltage setpoint should be altered to produce lagging **Reactive Power** or absorbing leading **Reactive Power** at a low **Active Power** level where voltage control is provided. The **Power Park Module Active Power** should then be reduced to zero **Active Power** as a ramp over a short period (60 seconds is suggested).

OC5.A.3.6 Frequency Response Tests

OC5.A.3.6.1 This section describes the procedure for performing frequency response testing on a **Power Park Module**. These tests should be scheduled at a time where there are at least 95% of the **Power Park Units** within the **Power Park Module** in service. There should be sufficient MW resource forecasted in order to generate at least 65% of **Registered Capacity** of the **Power Park Module**.

- OC5.A.3.6.2 The frequency controller shall be in **Frequency Sensitive Mode** or **Limited Frequency Sensitive Mode** as appropriate for each test. Simulated frequency deviation signals shall be injected into the frequency controller reference/feedback summing junction. If the injected frequency signal replaces rather than sums with the real **System Frequency** signal then the additional tests outlined in OC5.A.3.6.6 shall be performed with the **Power Park Module** or **Power Park Unit** in normal **Frequency Sensitive Mode** monitoring actual **System Frequency**, over a period of at least 10 minutes. The aim of this additional test is to verify that the control system correctly measures the real **System Frequency** for normal variations over a period of time.
- OC5.A.3.6.3 In addition to the frequency response requirements, it is necessary to demonstrate the **Power Park Module** ability to deliver a requested steady state power output which is not impacted by power source variation as per CC.6.3.9 or ECC.6.3.9. This test shall be conducted in **Limited Frequency Sensitive Mode** at a part-loaded output for a period of 10 minutes as per OC5.A.3.6.6.

Preliminary Frequency Response Testing

OC5.A.3.6.4 Prior to conducting the full set of tests as per OC5.A.3.6.6, **Generators** are required to conduct the preliminary set of tests below to confirm the frequency injection method is correct and the plant control performance is within expectation. The test numbers refer to Figure 1 below. The test should be conducted when sufficient MW resource is forecasted in order to generate at least 65% of **Registered Capacity** of the **Power Park Module**. The following frequency injections shall be applied when operating at module load point 4.

Test No (Figure 1)	Frequency Injection	Notes
8	<ul style="list-style-type: none"> Inject - 0.5Hz frequency fall over 10 sec Hold until conditions stabilise Remove the injected signal 	
14	<ul style="list-style-type: none"> Inject +0.5Hz frequency rise over 10 sec Hold until conditions stabilise Remove the injected signal 	
13	<ul style="list-style-type: none"> Inject -0.5Hz frequency fall over 10 sec Hold for a further 20 sec At 30 sec from the start of the test, Inject a +0.3Hz frequency rise over 30 sec. Hold until conditions stabilise Remove the injected signal 	

OC5.A.3.6.5 The recorded results (e.g. Finj, MW and control signals) should be sampled at a minimum rate of 1 Hz to allow **The Company** to assess the plant performance from the initial transients (seconds) to the final steady state conditions (5-15 minutes depending on the plant design). This is not witnessed by **The Company**. The **Generator** shall supply the recordings including data to **The Company** in an electronic spreadsheet format. Results shall be legible, identifiable by labelling, and shall have appropriate scaling.

Full Frequency Response Testing Schedule Witnessed by The Company

OC5.A.3.6.6 The tests are to be conducted at a number of different Module Load Points (MLP). In the case of a **Power Park Module** the module load points are conducted as shown below unless agreed otherwise by **The Company**.

Module Load Point 6 (Maximum Export Limit)	100% MEL
Module Load Point 5	90% MEL
Module Load Point 4 (Mid point of Operating Range)	80% MEL
Module Load Point 3	DMOL + 0.6 x (80% MEL – DMOL)
Module Load Point 2 (Minimum Generation)	DMOL + 0.3 x (80% MEL – DMOL)
Module Load Point 1 (Designed Minimum Operating Level)	DMOL

OC5.A.3.6.7 The tests are divided into the following two types;

- (i) Frequency response volume tests as per OC5.A.3.6. Figure 1. These tests consist of frequency profile and ramp tests.
- (ii) **System** islanding and step response tests as shown by OC5.A.3.6 Figure 2

OC5.A.3.6.8 There should be sufficient time allowed between tests for control systems to reach steady state (depending on available power resource). Where the diagram states ‘HOLD’ the current injection should be maintained until the **Active Power** (MW) output of the **Power Park Module** has stabilised or 90 seconds, which ever is the longer. All frequency response tests should be removed over the same timescale for which they were applied. **The Company** may require repeat tests should the response volume be affected by the available power, or if tests give unexpected results. When witnessed by **The Company** each test should be carried out as a separate injection; when not witnessed by **The Company** there must be sufficient time allowed between tests for the **Active Power** (MW) output of the **Power Park Module** to have stabilised or 90 seconds, whichever is the longer.

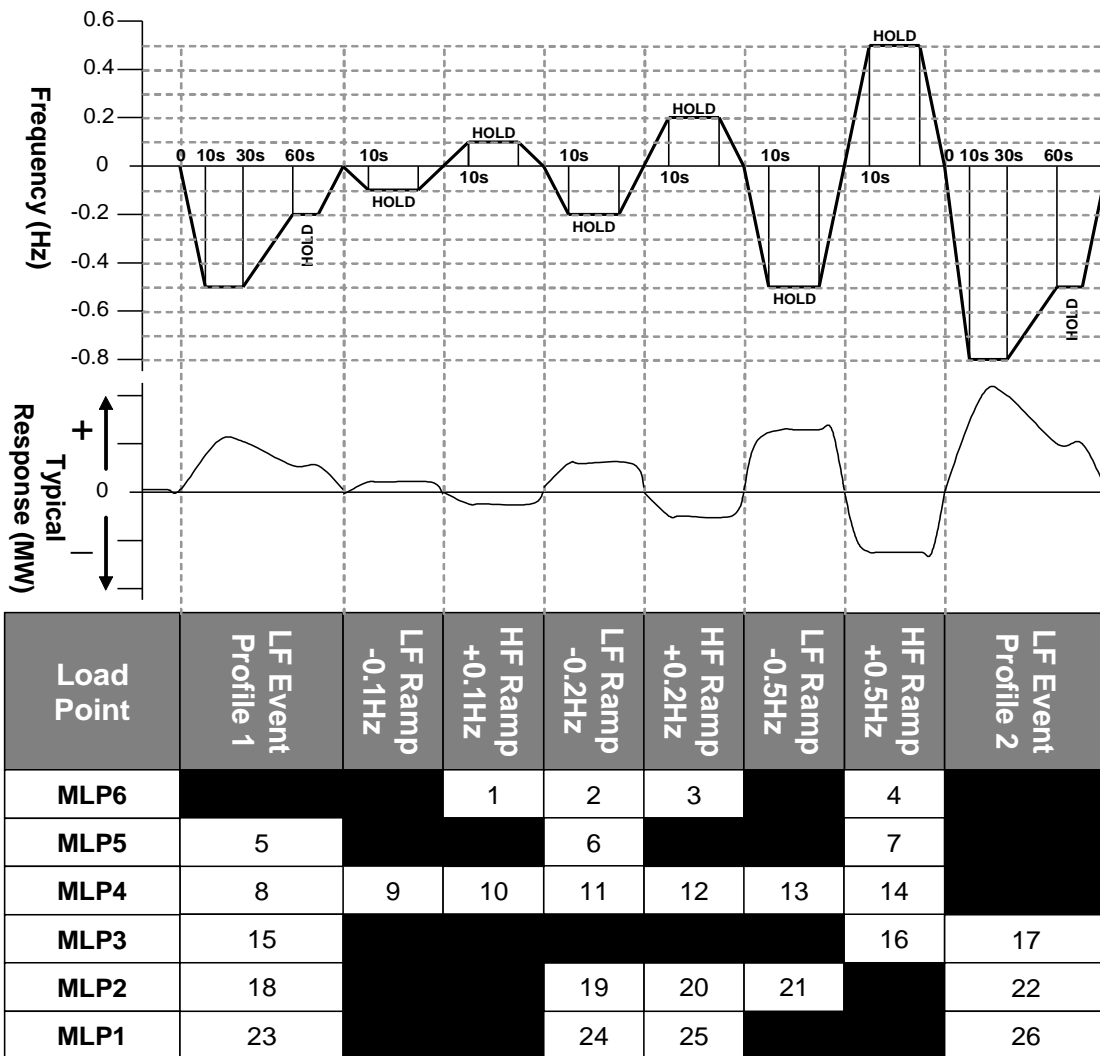

OC5.A.3.6. Figure 1 – Frequency response volume tests

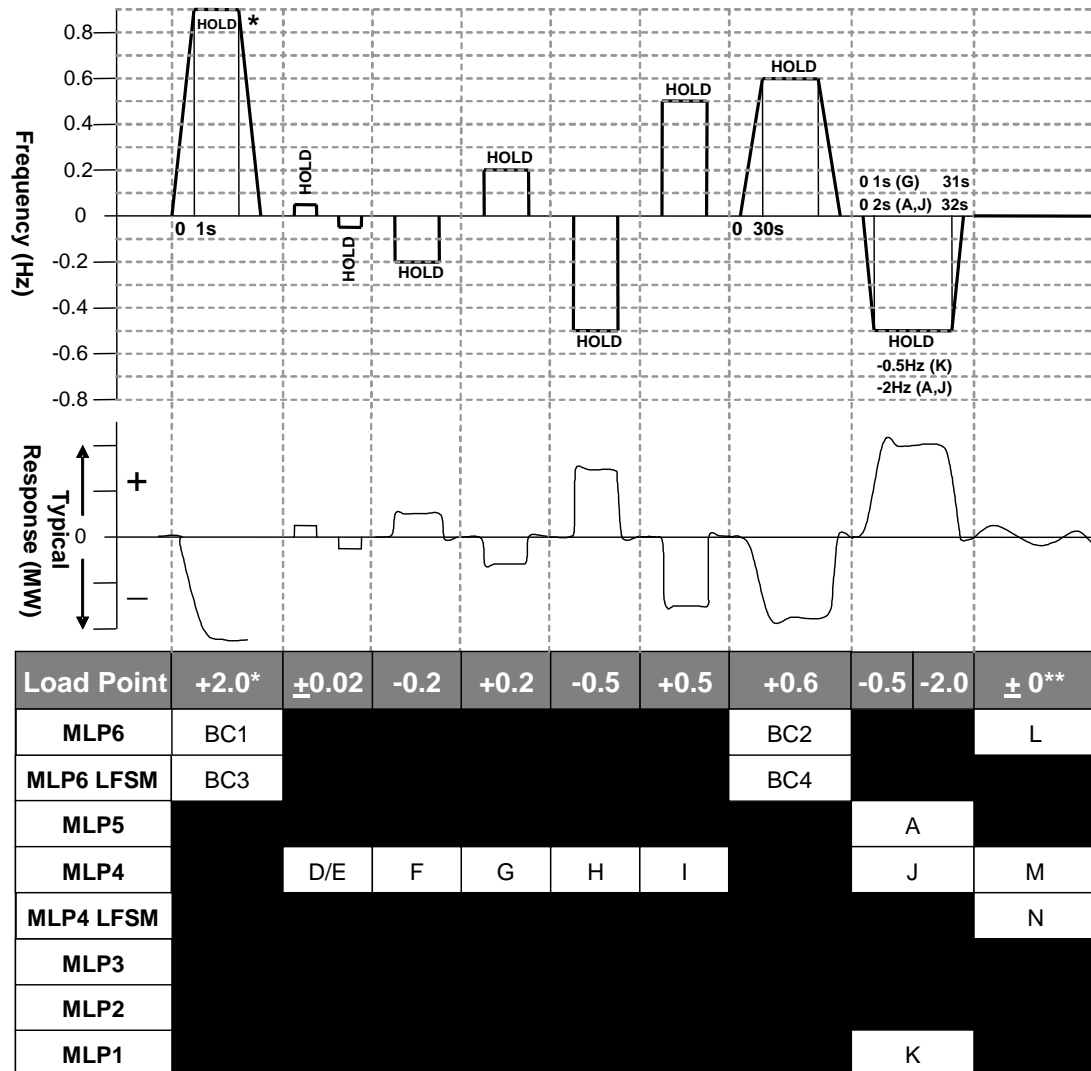

OC5.A.3.6. Figure 2 – System islanding and step response tests

* This will generally be +2.0Hz unless an injection of this size causes a reduction in plant output that takes the operating point below **Designed Minimum Operating Level** in which case an appropriate injection should be calculated in accordance with the following:

For example 0.9Hz is needed to take an initial output 65% to a final output of 20%. If the initial output was not 65% and the **Designed Minimum Operating Level** is not 20% then the injected step should be adjusted accordingly as shown in the example given below

Initial Output	65%
Designed Minimum Operating Level	20%
Frequency Controller Droop	4%
Frequency to be injected =	$(0.65 - 0.20) \times 0.04 \times 50 = 0.9\text{Hz}$

** Tests L and M in Figure 2 shall be conducted if in this range of tests the **System Frequency** feedback signal is replaced by the injection signal rather than the injection signal being added to the **System Frequency** signal. The tests will consist of monitoring the **Power Park Module** in **Frequency Sensitive Mode** during normal **System Frequency** variations without applying any injection. Test N in Figure 2 shall be conducted in all cases. All three tests should be conducted for a period of at least 10 minutes.

OC5.A.3.6.9 The **Target Frequency** adjustment facility should be demonstrated from the normal control point within the range of 49.9Hz to 50.1Hz by step changes to the **Target Frequency** setpoint as indicated in OC5.A.3.6 Figure 3.

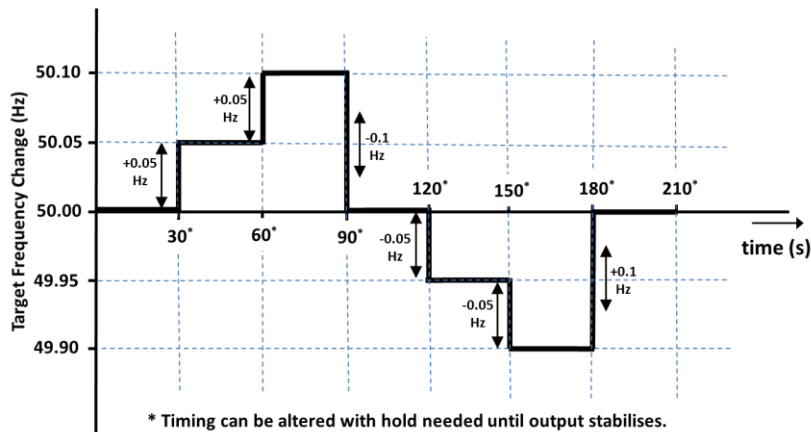

OC5.A.3.6. Figure 3 – Target Frequency setting changes

OC5.A.3.7 Fault Ride Through Testing

OC5.A.3.7.1 This section describes the procedure for conducting fault ride through tests on a single **Power Park Unit**.

OC5.A.3.7.2 The test circuit will utilise the full **Power Park Unit** (e.g. in the case of a wind turbine it would include the full wind turbine nacelle structure, all inverters and converters along with step up transformer to medium voltage, all control systems including pitch control emulation) and shall be conducted with sufficient power input resource available to produce at least 95% of the **Registered Capacity** of the **Power Park Unit**. The test will comprise of a number of controlled short circuits applied to a test network to which the **Power Park Unit** is connected, typically comprising of the **Power Park Unit** transformer and a test impedance or other decoupling equipment to shield the connected network from voltage dips at the **Power Park Unit** terminals.

OC5.A.3.7.3 In each case, the tests should demonstrate the minimum voltage at the **Power Park Unit** terminals or **High Voltage** side of the **Power Park Unit** transformer which the **Power Park Unit** can withstand for the length of time specified in OC5.A.3.7.5. Any test results provided to **The Company** should contain sufficient data pre and post fault in order to determine steady state values of all signals, and the power recovery timescales.

OC5.A.3.7.4 In addition to the signals outlined in OC5.A.1.2. the following signals from either the **Power Park Unit** terminals or **High Voltage** side of the **Power Park Unit** transformer should be provided for this test only:

- (i) Phase voltages
- (ii) Positive phase sequence and negative phase sequence voltages
- (iii) Phase currents
- (iv) Positive phase sequence and negative phase sequence currents
- (v) Estimate of **Power Park Unit** negative phase sequence impedance
- (vi) MW – **Active Power** at the generating unit.
- (vii) MVar – **Reactive Power** at the generating unit.
- (viii) Mechanical Rotor Speed
- (ix) Real / reactive, current / power reference as appropriate
- (x) Fault ride through protection operation (e.g. a crowbar in the case of a doubly fed induction generator)
- (xi) Any other signals relevant to the control action of the fault ride through control deemed applicable for model validation.

At a suitable frequency rate for fault ride through tests as agreed with **The Company**.

OC5.A.3.7.5 The tests should be conducted for the times and fault types indicated in OC5.A.3.7 Table 1.

3 Phase	Phase to Phase	2 Phase to Earth	1 Phase to Earth	Grid Code Ref
0.14s	0.14s	0.14s	0.14s	CC.6.3.15a
0.384s				CC.6.3.15b
0.710s				
2.5s				
180.0s				

OC5.A.3.7 Table 1 – Types of fault for fault ride through **testing**

OC5.A.3.8 Reactive Power Transfer / Voltage Control Tests for Offshore Power Park Modules

- OC5.A.3.8.1 In the case of an **Offshore Power Park Module** which provides all or a portion of the **Reactive Power** capability as described in CC.6.3.2(e)(iii) and / or voltage control requirements as described in CC.6.3.8(b)(ii) to enable an **Offshore Transmission Licensee** to meet the requirements of **STC** Section K, the testing, will comprise of the entire control system responding to changes at the onshore **Interface Point**. Therefore the tests in this section OC5.A.3.8 will not apply. The **Generator** shall cooperate with the relevant **Offshore Transmission Licensee** to facilitate these tests as required by **The Company**. The testing may be combined with testing of the corresponding **Offshore Transmission Licensee** requirements under the **STC**. The results in relation to the **Offshore Power Park Module** will be assessed against the requirements in the **Bilateral Agreement**.
- OC5.A.3.8.2 In the case of an **Offshore Power Park Module** which does not provide part of the **Offshore Transmission Licensee Reactive Power** capability the following procedure for conducting reactive power transfer control tests on **Offshore Power Park Modules** and / or voltage control system as per CC6.3.2(e)(i) and CC6.3.2(e)(ii) apply. These tests should be carried out prior to 20% of the **Power Park Units** within the **Offshore Power Park Module** being synchronised, and again when at least 95% of the **Power Park Units** within the **Offshore Power Park Module** in service. There should be sufficient power resource forecast to generate at least 85% of the **Registered Capacity** of the **Offshore Power Park Module**.
- OC5.A.3.8.3 The **Reactive Power** control system shall be perturbed by a series of system voltage changes and changes to the **Active Power** output of the **Offshore Power Park Module**.
- OC5.A.3.8.4 **System** voltage changes should be created by a series of multiple upstream transformer taps. The **Generator** should coordinate with **The Company** or the relevant **Network Operator** in order to conduct the required tests. The time between transformer taps should be at least 10 seconds as per OC5.A.3.8 Figure 1.
- OC5.A.3.8.5 The **Active Power** output of the **Offshore Power Park Module** should be varied by applying a sufficiently large step to the frequency controller reference/feedback summing junction to cause a 10% change in output of the **Registered Capacity** of the **Offshore Power Park Module** in a time not exceeding 10 seconds. This test does not need to be conducted provided that the frequency response tests as outlined in OC5.A.3.6 are completed.
- OC5.A.3.8.6 The following diagrams illustrate the tests to be completed:

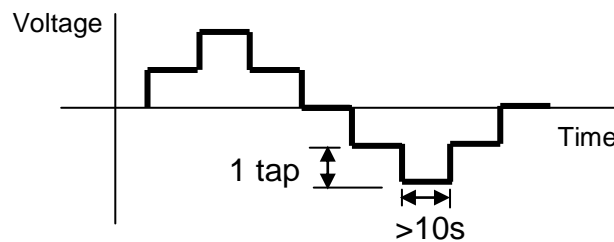

OC5.A.3.8 Figure 1 – Transformer tap sequence for reactive transfer tests

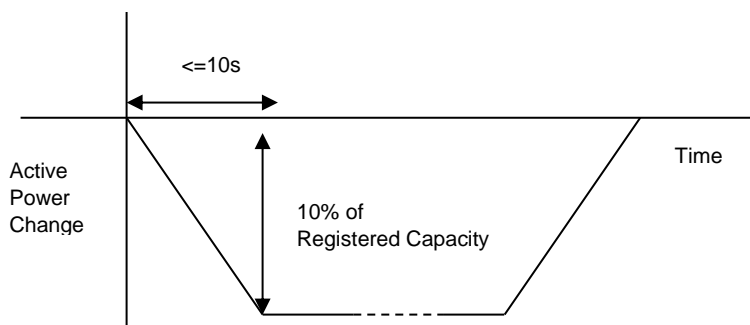

OC5.A.3.8 Figure 2 – Active Power ramp for reactive transfer tests

APPENDIX 4 - COMPLIANCE TESTING FOR DC CONVERTERS AT A DC CONVERTER STATION

OC5.A.4.1 Scope

OC5.A.4.1.1 This Appendix outlines the general testing requirements for **DC Converter Station** owners to demonstrate compliance with the relevant aspects of the **Grid Code**, **Ancillary Services Agreement** and **Bilateral Agreement** and apply only to **DC Converter Station** owners. The testing requirements applicable to **HVDC System Owners** are specified in ECP.A.7. The tests specified in this Appendix will normally be sufficient to demonstrate compliance however **The Company** may:

- (i) agree an alternative set of tests provided **The Company** deem the alternative set of tests sufficient to demonstrate compliance with the **Grid Code**, **Ancillary Services Agreement** and **Bilateral Agreement**; and/or
- (ii) require additional or alternative tests if information supplied to **The Company** during the compliance process suggests that the tests in this Appendix will not fully demonstrate compliance with the relevant section of the **Grid Code**, **Ancillary Services Agreement** or **Bilateral Agreement**; and/or
- (iii) require additional tests if control functions to improve damping of power system oscillations and/or subsynchronous resonance torsional oscillations required by the **Bilateral Agreement** or included in the control scheme and active; and/or
- (iv) agree a reduced set of tests for subsequent **DC Converters** following successful completion of the first **DC Converter** tests in the case of a **Power Station** comprised of two or more **DC Converters** which **The Company** reasonably considers to be identical.

If:

- (a) the tests performed pursuant to OC5.A.4.1.1(iv) in respect of subsequent **DC Converters** do not replicate the full tests for the first **DC Converter**, or
- (b) any of the tests performed pursuant to OC5.A.4.1.1(iv) do not fully demonstrate compliance with the relevant aspects of the **Grid Code**, **Ancillary Services Agreement** and / or **Bilateral Agreement**,

then notwithstanding the provisions above, the full testing requirements set out in this Appendix will be applied.

OC5.A.4.1.2 The **DC Converter Station** owner is responsible for carrying out the tests set out in and in accordance with this Appendix and the **DC Converter Station** owner retains the responsibility for the safety of personnel and plant during the test. The **DC Converter Station** owner is responsible for ensuring that suitable arrangements are in place with the **Externally Interconnected System Operator** to facilitate testing. **The Company** will witness all of the tests outlined or agreed in relation to this Appendix unless **The Company** decides and notifies the **DC Converter Station** owner otherwise. Reactive Capability tests if required, may be witnessed by **The Company** remotely from the **The Company** control centre. For all on site **The Company** witnessed tests the **DC Converter Station** owner must ensure suitable representatives from the **DC Converter Station** owner and / or **DC Converter** manufacturer (if appropriate) are available on site for the entire testing period. In all cases and in addition to any recording of signals conducted by **The Company** the **DC Converter Station** owner shall record all relevant test signals as outlined in OC5.A.1.

OC5.A.4.1.3 In addition to the dynamic signals supplied in OC5.A.1 the **DC Converter Station** owner shall inform **The Company** of the following information prior to the commencement of the tests and any changes to the following, if any values change during the tests:

- (i) All relevant transformer tap numbers.

OC5.A.4.1.4 The **DC Converter Station** owner shall submit a detailed schedule of tests to **The Company** in accordance with CP.6.3.1, and this Appendix.

- OC5.A.4.1.5 Prior to the testing of a **DC Converter** the **DC Converter Station** owner shall complete the **Integral Equipment Tests** procedure in accordance with OC.7.5
- OC5.A.4.1.6 Full **DC Converter** testing as required by CP.7.2 is to be completed as defined in OC5.A.4.2 through to OC5.A.4.5
- OC5.A.4.1.7 **The Company** may agree a reduction from the requirements set out in CP.A.7.2 to CP.A.7.5 for on-site testing where suitable factory acceptance testing on a representative installation with the same equipment and settings of the **HVDC Equipment** that can, in **The Company's** opinion, reasonably represent the performance of the installed **HVDC Equipment** at that site. This is also conditional on **The Company** and the **DC Converter Station** owner agreeing sufficient on site testing of the fully commissioned **DC Converter Station** to demonstrate that the factory acceptance tests are valid. If in the reasonable opinion of **The Company**, the on-site testing does not demonstrate the factory acceptance tests are valid then the full set of on-site tests should be carried out.
- OC5.A.4.2 Reactive Capability Test
- OC5.A.4.2.1 This section details the procedure for demonstrating the reactive capability of an **Onshore DC Converter**. These tests should be scheduled at a time where there are sufficient MW resource forecasted in order to import and export full **Registered Capacity** of the **DC Converter**.
- OC5.A.4.2.2 The tests shall be performed by modifying the voltage set-point of the voltage control scheme of the **DC Converter** by the amount necessary to demonstrate the required reactive range. This is to be conducted for the operating points and durations specified in OC5.A.4.2.5.
- OC5.A.4.2.3 **Embedded DC Converter Station** owner should liaise with the relevant **Network Operator** to ensure the following tests will not have an adverse impact upon the **Network Operator's System** as per OC.7.5. In situations where the tests have an adverse impact upon the **Network Operator's System**, **The Company** will only require demonstration within the acceptable limits of the **Network Operator**. For the avoidance of doubt, these tests do not negate the requirement to produce a complete **DC Converter** performance chart as specified in OC2.4.2.1.
- OC5.A.4.2.4 In the case where the **Reactive Power** metering point is not at the same location as the **Reactive Power** capability requirement, then an equivalent **Reactive Power** capability for the metering point shall be agreed between the **DC Converter Station** owner and **The Company**.
- OC5.A.4.2.5 The following tests shall be completed for both importing and exporting of **Active Power** for a **DC Converter** (excluding current source technology):
- (i) Operation at **Rated MW** and maximum continuous lagging **Reactive Power** for 60 minutes.
 - (ii) Operation at **Rated MW** and maximum continuous leading **Reactive Power** for 60 minutes.
 - (iii) Operation at 50% **Rated MW** and maximum continuous leading **Reactive Power** for 5 minutes.
 - (iv) Operation at 20% **Rated MW** and maximum continuous leading **Reactive Power** for 5 minutes.
 - (v) Operation at 20% **Rated MW** and maximum continuous lagging **Reactive Power** for 5 minutes.
 - (vi) Operation at less than 20% **Rated MW** and unity **Power Factor** for 5 minutes. This test only applies to systems which do not offer voltage control below 20% of **Rated MW**.
 - (vii) Operation at 0% **Rated MW** and maximum continuous leading **Reactive Power** for 5 minutes. This test only applies to systems which offer voltage control below 20% and hence establishes actual capability rather than required capability.
 - (viii) Operation at 0% **Rated MW** and maximum continuous lagging **Reactive Power** for 5 minutes. This test only applies to systems which offer voltage control below 20% and hence establishes actual capability rather than required capability.

OC5.A.4.2.6 For the avoidance of doubt, lagging **Reactive Power** is the export of **Reactive Power** from the **DC Converter** to the **Total System** and leading **Reactive Power** is the import of **Reactive Power** from the **Total System** to the **DC Converter**.

OC5.A.4.3 Reactive Control Testing For DC Converters (Current Source Technology)

OC5.A.4.3.1 The Reactive control testing for **DC Converters** employing current source technology shall be for both importing and exporting of **Active Power** and shall demonstrate that the **Reactive Power** transfer limits specified in the **Bilateral Agreement** are not exceeded. The **Reactive Power** control system shall be perturbed by a series of system voltage changes to the **Active Power** output of the **DC Converter** and changes of system voltage where possible. The **DC Converter Station** owner is responsible for ensuring that suitable arrangements are in place with the **Externally Interconnected System Operator** to facilitate the **Active Power** changes required by these tests

OC5.A.4.3.2 The **Active Power** output of the **DC Converter** should be varied by applying a sufficiently large step to the frequency controller reference/feedback summing junction to cause at least a 10% change in output of the **Registered Capacity** of the **DC Converter** in a time not exceeding 10 seconds. This test does not need to be conducted provided that the frequency response tests as outlined in OC5.A.4.3 are completed.

OC5.A.4.3.3 Where possible, **System** voltage changes should be created by a series of multiple upstream transformer taps. The **DC Converter station** owner should coordinate with **The Company** or the relevant **Network Operator** in order to conduct the required tests. The time between transformer taps should be at least 10 seconds as per OC5.A.4.3 Figure 1.

OC5.A.4.3.4 The following diagrams illustrate the tests to be completed:

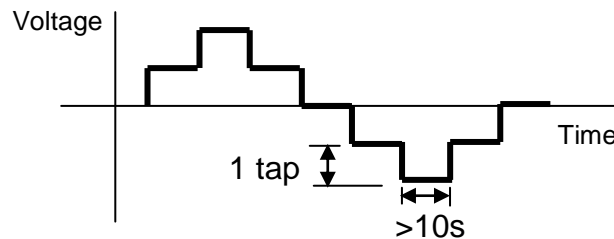

OC5.A.4.3 Figure 1 – Transformer tap sequence for reactive transfer tests

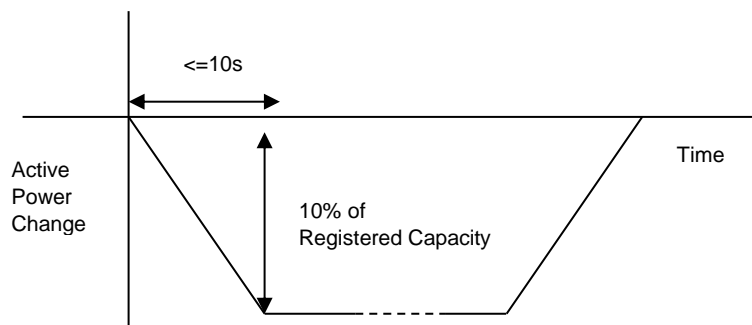

OC5.A.4.3 Figure 2 – Active Power ramp for reactive transfer tests

OC5.A.4.4 Voltage Control Tests

OC5.A.4.4.1 This section details the procedure for conducting voltage control tests on **DC Converters** (excluding current source technology). These tests should be scheduled at a time where there is sufficient MW resource in order to import and export full **Registered Capacity** of the **DC Converter**. An **Embedded DC Converter Station** owner should also liaise with the relevant **Network Operator** to ensure all requirements covered in this section will not have a detrimental effect on the **Network Operator's System**.

OC5.A.4.4.2 The voltage control system shall be perturbed with a series of step injections to the **DC Converter** voltage reference, and where possible, multiple up-stream transformer taps.

OC5.A.4.4.3 For steps initiated using network tap changers, the **DC Converter Station** owner will need to coordinate with **The Company** or the relevant **Network Operator** as appropriate. The time between transformer taps shall be at least 10 seconds as per OC5.A.4.4 Figure 1.

OC5.A.4.4.4 For step injections into the **DC Converter** voltage reference, steps of $\pm 1\%$, $\pm 2\%$ and $\pm 4\%$ shall be applied to the voltage control system reference summing junction. The injection shall be maintained for 10 seconds as per OC5.A.4.4 Figure 2.

OC5.A.4.4.5 Where the voltage control system comprises of discretely switched **Plant** and **Apparatus**, additional tests will be required to demonstrate that its performance is in accordance with **Grid Code** and **Bilateral Agreement** requirements.

OC5.A.4.4.6 Tests to be completed:

(i)

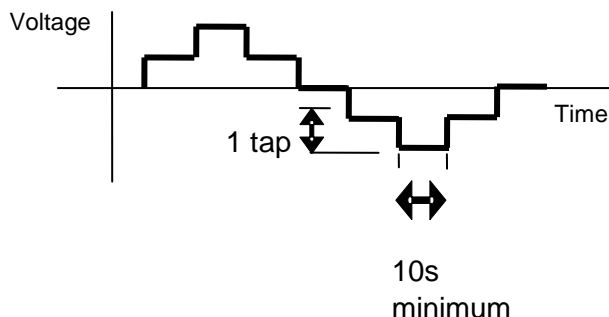

OC5.A.4.4 Figure 1 – Transformer tap sequence for voltage control tests

(ii)

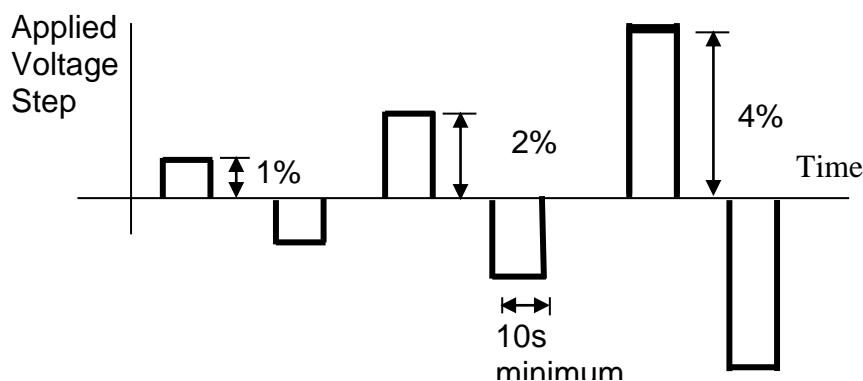

OC5.A.4.4 Figure 2 – Step injection sequence for voltage control tests

OC5.A.4.5 Frequency Response Tests

OC5.A.4.5.1 This section describes the procedure for performing frequency response testing on a **DC Converter**. These tests should be scheduled at a time where there is sufficient MW resource in order to import and export full **Registered Capacity** of the **DC Converter**. The **DC Converter Station** owner is responsible for ensuring that suitable arrangements are in place with the **Externally Interconnected System Operator** to facilitate the **Active Power** changes required by these tests

OC5.A.4.5.2 The frequency controller shall be in **Frequency Sensitive Mode** or **Limited Frequency Sensitive Mode** as appropriate for each test. Simulated frequency deviation signals shall be injected into the frequency controller reference/feedback summing junction. If the injected frequency signal replaces rather than sums with the real **System Frequency** signal then the additional tests outlined in OC5.A.4.5.6 shall be performed with the **DC Converter** in normal **Frequency Sensitive Mode** monitoring actual system frequency, over a period of at least 10 minutes. The aim of this additional test is to verify that the control system correctly measures the real **System Frequency** for normal variations over a period of time.

OC5.A.4.5.3 In addition to the frequency response requirements it is necessary to demonstrate the **DC Converter** ability to deliver a requested steady state power output which is not impacted by power source variation as per CC.6.3.9. This test shall be conducted in **Limited Frequency Sensitive Mode** at a part-loaded output for a period of 10 minutes as per OC5.A.4.5.6.

Preliminary Frequency Response Testing

OC5.A.4.5.4 Prior to conducting the full set of tests as per OC5.A.4.5.6, **DC Converter Station** owners are required to conduct a preliminary set of tests below to confirm the frequency injection method is correct and the plant control performance is within expectation. The test numbers refer to Figure 1 below. These tests should be scheduled at a time where there is sufficient MW resource in order to export full **Registered Capacity** from the **DC Converter**. The following frequency injections shall be applied when operating at module load point 4.

Test No (Figure 1)	Frequency Injection	Notes
8	<ul style="list-style-type: none"> Inject - 0.5Hz frequency fall over 10 sec Hold until conditions stabilise Remove the injected signal 	
14	<ul style="list-style-type: none"> Inject +0.5Hz frequency rise over 10 sec Hold until conditions stabilise Remove the injected signal 	
13	<ul style="list-style-type: none"> Inject -0.5Hz frequency fall over 10 sec Hold for a further 20 sec At 30 sec from the start of the test, Inject a +0.3Hz frequency rise over 30 sec. Hold until conditions stabilise Remove the injected signal 	

OC5.A.4.5.5 The recorded results (e.g. Finj, MW and control signals) should be sampled at a minimum rate of 1 Hz to allow **The Company** to assess the plant performance from the initial transients (seconds) to the final steady state conditions (5-15 minutes depending on the plant design). This is not witnessed by **The Company**. The **DC Converter Station** owner shall supply the recordings including data to **The Company** in an electronic spreadsheet format. Results shall be legible, identifiable by labelling, and shall have appropriate scaling.

Full Frequency Response Testing Schedule Witnessed by **The Company**

OC5.A.4.5.6 The tests are to be conducted at a number of different Module Load Points (MLP). In the case of a **DC Converter** the module load points are conducted as shown below unless agreed otherwise by **The Company**.

Module Load Point 6 (Maximum Export Limit)	100% MEL
Module Load Point 5	90% MEL
Module Load Point 4	80% MEL
Module Load Point 3	DMOL + 0.6 x (80% MEL – DMOL)
Module Load Point 2 (Minimum Generation)	DMOL + 0.3 x (80% MEL – DMOL)
Module Load Point 1 (Designed Minimum Operating Level)	DMOL

OC5.A.4.5.7

The tests are divided into the following two types;

- (i) **Frequency** response volume tests as per OC5.A.4.5. Figure 1. These tests consist of frequency profile and ramp tests.
- (ii) **System** islanding and step response tests as shown by OC5.A.4.5 Figure 2

OC5.A.4.5.8

There should be sufficient time allowed between tests for control systems to reach steady state (depending on available power resource). Where the diagram states ‘HOLD’ the current injection should be maintained until the **Active Power** (MW) output of the **DC Converter** has stabilised or 90 seconds whichever is the longer. All frequency response tests should be removed over the same timescale for which they were applied. **The Company** may require repeat tests should the response volume be affected by the available power, or if tests give unexpected results. When witnessed by **The Company** each test should be carried out as a separate injection, when not witnessed by **The Company** there must be sufficient time allowed between tests for the **Active Power** (MW) output of the **HVDC Equipment** to have stabilised or 90 seconds, whichever is the longer.

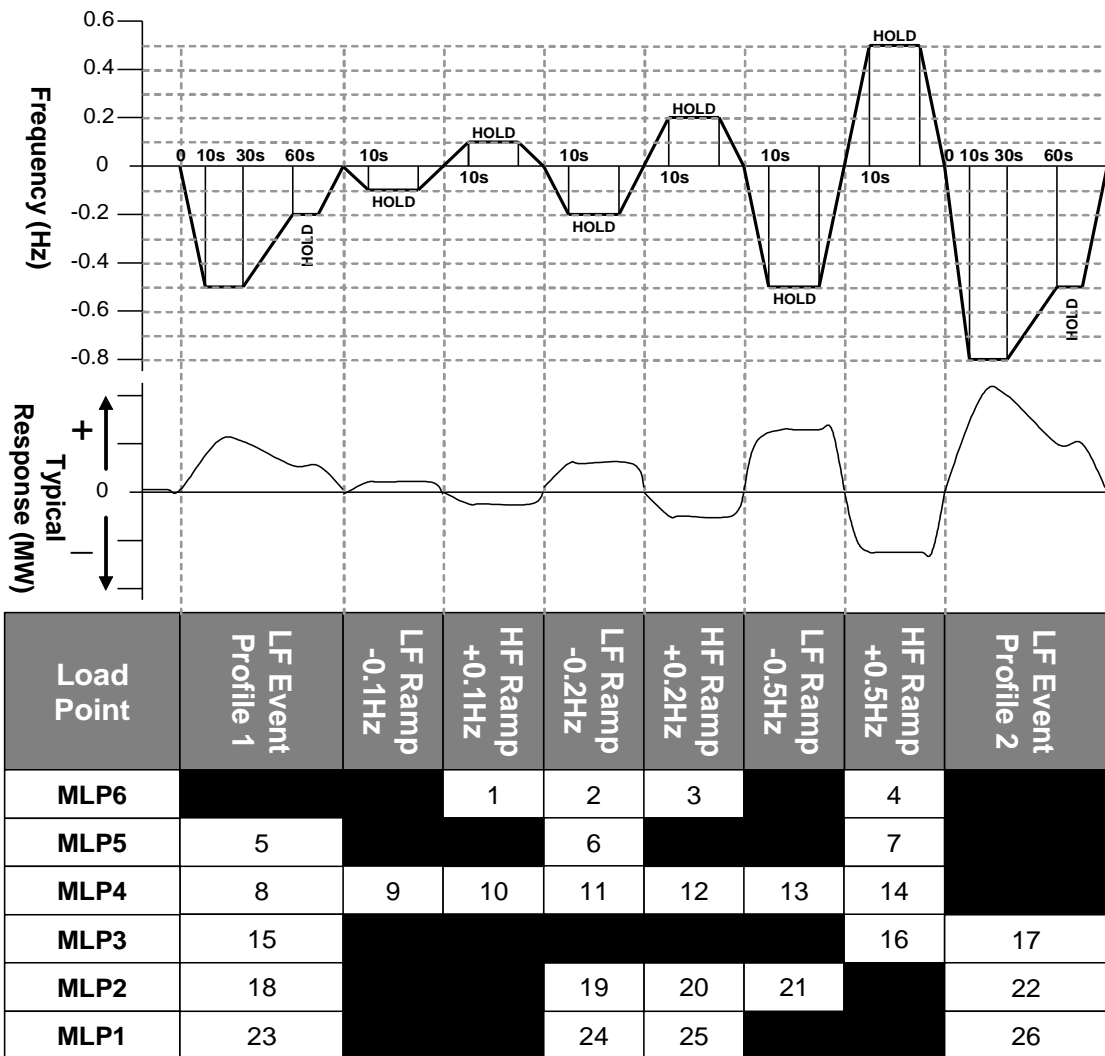

OC5.A.4.5. Figure 1 – Frequency response volume tests

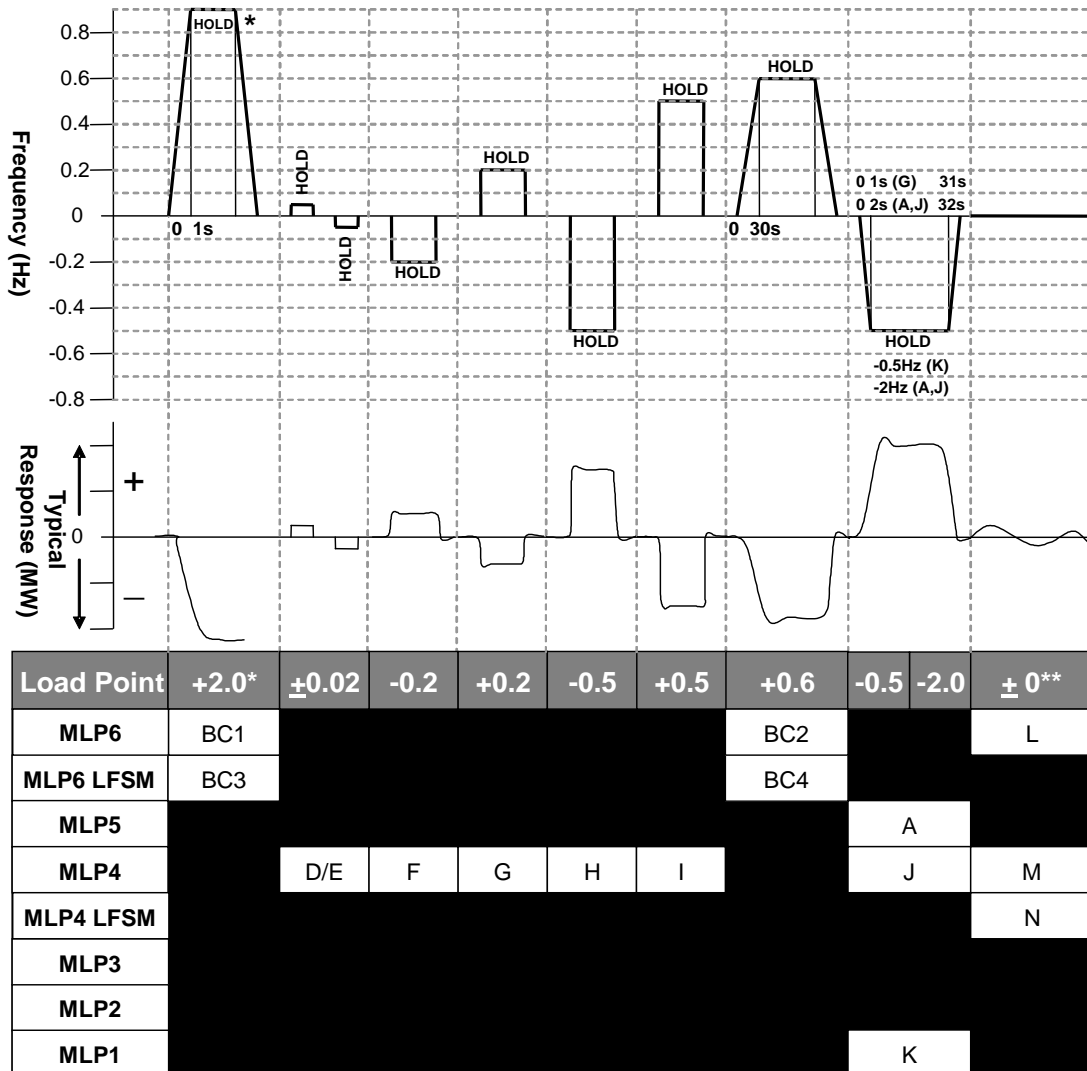

OC5.A.4.5. Figure 2 – System islanding and step response tests

* This will generally be +2.0Hz unless an injection of this size causes a reduction in plant output that takes the operating point below the **Designed Minimum Operating Level** in which case an appropriate injection should be calculated in accordance with the following:

For example 0.9Hz is needed to take an initial output of 65% to a final output of 20%. If the initial output was not 65% and the **Designed Minimum Operating Level** is not 20% then the injected step should be adjusted accordingly as shown in the example given below

Initial Output	65%
Designed Minimum Operating Level	20%
Frequency Controller Droop	4%
Frequency to be injected =	$(0.65 - 0.20) \times 0.04 \times 50 = 0.9\text{Hz}$

** Tests L and M in Figure 2 shall be conducted if in this range of tests the **System Frequency** feedback signal is replaced by the injection signal rather than the injection signal being added to the **System Frequency** signal. The tests will consist of monitoring the **DC Converter** in **Frequency Sensitive Mode** during normal **System Frequency** variations without applying any injection. Test N in Figure 2 shall be conducted in all cases. All three tests should be conducted for a period of at least 10 minutes.

OC5.A.4.6.9 The **Target Frequency** adjustment facility should be demonstrated from the normal **Control Point** within the range of 49.9Hz to 50.1Hz by step changes to the **Target Frequency** setpoint as indicated in OC5.A.4.6 Figure 3.

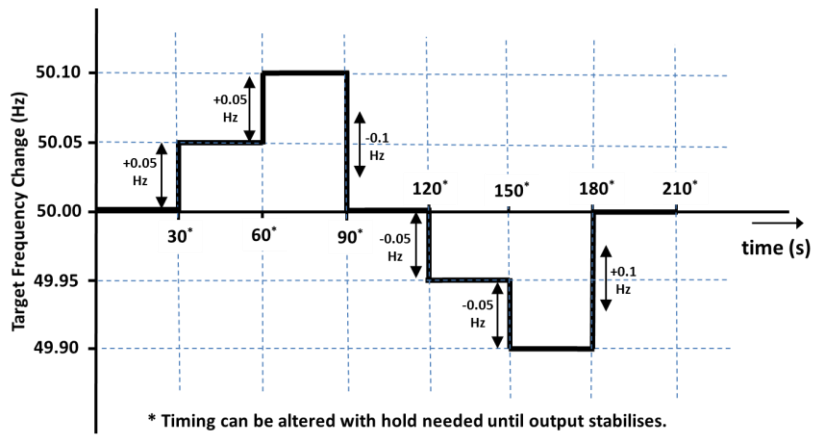

OC5.A.4.6. Figure 3 – Target Frequency setting changes

< END OF OPERATING CODE NO. 5 >

OPERATING CODE NO. 6

(OC6)

DEMAND CONTROL

CONTENTS

(This contents page does not form part of the Grid Code)

<u>Paragraph No/Title</u>	<u>Page Number</u>
OC6.1 INTRODUCTION.....	2
OC6.2 OBJECTIVE	3
OC6.3 SCOPE.....	3
OC6.4 PROCEDURE FOR THE NOTIFICATION OF DEMAND CONTROL INITIATED BY NETWORK OPERATORS	4
OC6.5 PROCEDURE FOR THE IMPLEMENTATION OF DEMAND CONTROL ON THE INSTRUCTIONS OF THE COMPANY	6
OC6.6 AUTOMATIC LOW FREQUENCY DEMAND DISCONNECTION	9
OC6.7 EMERGENCY MANUAL DISCONNECTION	10
OC6.8 OPERATION OF THE BALANCING MECHANISM DURING DEMAND CONTROL.....	11
APPENDIX 1 - EMERGENCY MANUAL DEMAND REDUCTION/DISCONNECTION SUMMARY SHEET	12

OC6.1 INTRODUCTION

OC6.1.1 **Operating Code No.6 ("OC6")** is concerned with the provisions to be made by **Network Operators**, and in relation to **Non-Embedded Customers** by **The Company**, to permit the reduction of **Demand** in the event of insufficient **Active Power** generation being available to meet **Demand**, or in the event of breakdown or operating problems (such as in respect of **System Frequency**, **System** voltage levels or **System** thermal overloads) on any part of the **National Electricity Transmission System**.

OC6.1.2 **OC6** deals with the following:

- (a) **Customer** voltage reduction initiated by **Network Operators** (other than following the instruction of **The Company**);
- (b) **Customer Demand** reduction by **Disconnection** initiated by **Network Operators** (other than following the instruction of **The Company**);
- (c) **Demand** reduction instructed by **The Company**;
- (d) automatic low frequency **Demand Disconnection**; and
- (e) emergency manual **Demand Disconnection**.

The term "**Demand Control**" is used to describe any or all of these methods of achieving a **Demand** reduction.

OC6.1.3 The procedure set out in **OC6** includes a system of warnings to give advance notice of **Demand Control** that may be required by **The Company** under this **OC6**.

OC6.1.4 Data relating to **Demand Control** should include details relating to MW

OC6.1.5 The Electricity Supply Emergency Code as reviewed and published from time to time by the appropriate government department for energy emergencies provides that in certain circumstances consumers are given a certain degree of "protection" when rota disconnections are implemented pursuant to a direction under the Energy Act 1976. No such protection can be given in relation to **Demand Control** under the **Grid Code**.

To invoke the Electricity Supply Emergency Code the Secretary of State will issue direction(s) to all **Network Operators** affected, exercising emergency powers under the Electricity Act 1989 or by virtue of an Order in Council under the Energy Act 1976. Following the issuance of such direction, **The Company** will act to coordinate the implementation of an agreed schedule of rota disconnections across all affected **Network Operators'** licence area(s) and to disseminate any information as necessary throughout the period of the emergency in accordance with the instructions **The Company** receives from the Secretary of State or those authorised on their behalf for this purpose.

OC6.1.6 Connections between **Large Power Stations** and the **National Electricity Transmission System** and between such **Power Stations** and a **User System** will not, as far as possible, be disconnected by **The Company** pursuant to the provisions of **OC6** insofar as that would interrupt supplies

- (a) for the purposes of operation of the **Power Station** (including **Start-Up** and shutting down);
- (b) for the purposes of keeping the **Power Station** in a state such that it could be Started-up when it is off-**Load** for ordinary operational reasons; or
- (c) for the purposes of compliance with the requirements of a Nuclear Site Licence.

Demand Control pursuant to this **OC6** therefore applies subject to this exception.

OC6.2 OBJECTIVE

OC6.2.1 The overall objective of **OC6** is to require the provision of facilities to enable **The Company** to achieve reduction in **Demand** that will either avoid or relieve operating problems on the **National Electricity Transmission System**, in whole or in part, and thereby to enable **The Company** to instruct **Demand Control** in a manner that does not unduly discriminate against, or unduly prefer, any one or any group of **Suppliers** or **Network Operators** or **Non-Embedded Customers**. It is also to ensure that **The Company** is notified of any **Demand Control** utilised by **Users** other than following an instruction from **The Company**.

OC6.2.2 For certain **Grid Supply Points** in Scotland it is recognised that it may not be possible to meet the requirements in OC6.4.5(b), OC6.5.3(b) (in respect of **Demand Disconnection** only), OC6.5.6 (ii), OC6.6.2 (c) and OC6.7.2 (b). In these circumstances **The Company** and the relevant **Network Operator(s)** will agree equivalent requirements covering a number of **Grid Supply Points**. If **The Company** and the relevant **Network Operator** fail to agree equivalent requirements covering a number of **Grid Supply Points**, then the relevant **Network Operator** will apply the provisions of OC6.4.5(b), OC6.5.3(b) (in respect of **Demand Disconnection** only), OC6.5.6(ii), OC6.6.2(c) and OC6.7.2(b) as evenly as reasonably practicable over the relevant **Network Operator's** entire **System**.

OC6.3 SCOPE

OC6.3.1 **OC6** applies to **The Company** and to **Users** which in **OC6** means:

- (a) **Generators**; and
- (b) **Network Operators**.

It also applies to **The Company** in relation to **Non-Embedded Customers**.

OC6.3.2 Explanation

OC6.3.2.1 (a) Although OC6 does not apply to **Suppliers**, the implementation of **Demand Control** may affect their **Customers**.

(b) In all situations envisaged in **OC6**, **Demand Control** is exercisable:

- (i) by reference to a **Network Operator's System**; or
- (ii) by **The Company** in relation to **Non-Embedded Customers**.

(c) **Demand Control** in all situations relates to the physical organisation of the **Total System**, and not to any contractual arrangements that may exist.

OC6.3.2.2 (a) Accordingly, **Demand Control** will be exercisable with reference to, for example, five per cent (or such other figure as may be utilised under OC6.5) tranches of **Demand** by a **Network Operator**.

(b) For a **Supplier**, whose **Customers** may be spread throughout a number of **User Systems** (and the **National Electricity Transmission System**), to split its **Customers** into five per cent (or such other figure as may be utilised under OC6.5) tranches of **Demand** would not result in **Demand Control** being implemented effectively on the **Total System**.

(c) Where **Demand Control** is needed in a particular area, **The Company** would not know which **Supplier** to contact and (even if it were to) the resulting **Demand Control** implemented, because of the diversity of contracts, may well not produce the required result.

OC6.3.2.3 (a) **Suppliers** should note, however, that, although implementation of **Demand Control** in respect of their **Customers** is not exercisable by them, their **Customers** may be affected by **Demand Control**.

- (b) This will be implemented by **Network Operators** where the **Customers** are within **User Systems** directly connected to the **National Electricity Transmission System** and by **The Company** where they are **Non-Embedded Customers**.
- (c) The contractual arrangements relating to **Customers** being supplied by **Suppliers** will, accordingly, need to reflect this.
- (d) The existence of a commercial arrangement for the provision of **Customer Demand Management** or **Commercial Ancillary Services** does not relieve a **Network Operator** from the **Demand Control** provisions of OC6.5, OC6.6 and OC6.7, which may be exercised from time to time.

OC6.4 PROCEDURE FOR THE NOTIFICATION OF DEMAND CONTROL INITIATED BY NETWORK OPERATORS (OTHER THAN FOLLOWING THE INSTRUCTION OF THE COMPANY)

OC6.4.1 Pursuant to the provisions of **OC1**, in respect of the time periods prior to 1100 hours each day, each **Network Operator** will notify **The Company** of all **Customer** voltage reductions and/or restorations and **Demand Disconnection** or reconnection, on a **Grid Supply Point** and half-hourly basis, which will or may, either alone or when aggregated with any other **Demand Control** planned by that **Network Operator**, result in a **Demand** change equal to or greater than the **Demand Control Notification Level** averaged over any half hour on any **Grid Supply Point**, which is planned to be instructed by the **Network Operator** other than following an instruction from **The Company** relating to **Demand** reduction.

OC6.4.2 Under **OC6**, each **Network Operator** will notify **The Company** in writing by 1100 hours each day (or such other time specified by **The Company** from time to time) for the next day (except that it will be for the next 3 days on Fridays and 2 days on Saturdays and may be longer (as specified by **The Company** at least one week in advance) to cover holiday periods) of **Customer** voltage reduction or **Demand Disconnection** which will or may result in a **Demand** change equal to or greater than the **Demand Control Notification Level** averaged over any half hour on any **Grid Supply Point**, (or which when aggregated with any other **Demand Control** planned by that **Network Operator** is equal to or greater than the **Demand Control Notification Level**), planned to take place during the next **Operational Day**.

OC6.4.3 When the **Customer** voltage reduction or **Demand Disconnection** which may result in a **Demand** change equal to or greater than the **Demand Control Notification Level** averaged over any half hour on any **Grid Supply Point** (or which when aggregated with any other **Demand Control** planned or implemented by that **Network Operator** is equal to or greater than the **Demand Control Notification Level**) is planned after 1100 hours, each **Network Operator** must notify **The Company** as soon as possible after the decision to implement has been made. If the **Customer** voltage reduction or **Demand Disconnection** is implemented immediately after the decision to implement is made, each **Network Operator** must notify **The Company** within five minutes of implementation.

OC6.4.4 Where, after **The Company** has been notified, whether pursuant to **OC1**, OC6.4.2 or OC6.4.3, the planned **Customer** voltage reduction or **Demand Disconnection** is changed, the **Network Operator** will notify **The Company** as soon as possible of the new plans, or if the **Customer** voltage reduction or **Demand Disconnection** implemented is different to that notified, the **Network Operator** will notify **The Company** of what took place within five minutes of implementation.

OC6.4.5 Any notification under OC6.4.2, OC6.4.3 or OC6.4.4 will contain the following information on a **Grid Supply Point** and half hourly basis:

- (a) the proposed (in the case of prior notification) and actual (in the case of subsequent notification) date, time and duration of implementation of the **Customer** voltage reduction or **Demand Disconnection**; and
- (b) the proposed reduction in **Demand** by use of the **Customer** voltage reduction or **Demand Disconnection**.

OC6.4.6

Pursuant to the provisions of OC1.5.6, each **Network Operator** will supply to **The Company** details of the amount of **Demand** reduction actually achieved by use of the **Customer** voltage reduction or **Demand Disconnection**.

OC6.5 PROCEDURE FOR THE IMPLEMENTATION OF DEMAND CONTROL ON THE INSTRUCTIONS OF THE COMPANY

OC6.5.1 A **National Electricity Transmission System Warning - High Risk of Demand Reduction** will, where possible, be issued by **The Company**, as more particularly set out in OC6.5.4, OC7.4.8 and BC1.5.4 when **The Company** anticipates that it will or may instruct a **Network Operator** to implement **Demand** reduction. It will, as provided in OC6.5.10 and OC7.4.8.2, also be issued to **Non-Embedded Customers**.

OC6.5.2 Where **The Company** expects to instruct **Demand** reduction within the following 30 minutes, **The Company** will where possible, issue a **National Electricity Transmission System Warning - Demand Control Imminent** in accordance with OC7.4.8.2(c) and OC7.4.8.6.

OC6.5.3 (a) Whether a **National Electricity Transmission System Warning - High Risk of Demand Reduction** or **National Electricity Transmission System Warning - Demand Control Imminent** has been issued or not:

(i) provided the instruction relates to not more than 20 per cent of its total **Demand** (measured at the time the **Demand** reduction is required); and

(ii) if the instruction relates to less than 20 per cent of its total **Demand**, is in

- two voltage reduction stages of between 2 and 4 percent, each of which can be expected to deliver around 1.5 percent **Demand** reduction; and
- up to three **Demand Disconnection** stages, each of which can reasonably be expected to deliver between four and six percent **Demand** reduction,

each **Network Operator** will abide by the instructions of **The Company**, which should specify whether a voltage reduction or **Demand Disconnection** stage is required; or

(iii) if the instruction relates to less than 20 per cent of its total **Demand**, is in four **Demand Disconnection** stages each of which can reasonably be expected to deliver between four and six per cent **Demand** reduction,

each **Network Operator** will abide by the instructions of **The Company** with regard to **Demand** reduction under OC6.5 without delay.

(b) The **Demand** reduction must be achieved within the **Network Operator's System** as far as possible uniformly across all **Grid Supply Points** (unless otherwise specified in the **National Electricity Transmission System Warning - High Risk of Demand Reduction**) either by **Customer** voltage reduction or by **Demand Disconnection**.

(c) **Demand Control** initiated by voltage reduction shall be initiated as soon as possible but in any event no longer than two minutes from the instruction being received from **The Company**, and completed within 10 minutes of the instruction being received from **The Company**.

(d) **Demand Control** initiated by **Demand Disconnection** shall be initiated as soon as possible but in any event no longer than two minutes from the instruction being received from **The Company**, and completed within five minutes of the instruction being received from **The Company**.

(e) Each **Network Operator** must notify **The Company** in writing by calendar week 24 each year, for the succeeding **Financial Year** onwards, whether **Demand Control** is to be implemented either:

i) by a combination of voltage reduction and **Demand Disconnection**; or

ii) **Demand Disconnection** alone;

together with the magnitude of the voltage reduction stages (where applicable) and for **Demand Disconnection** stages, the demand reduction anticipated. Thereafter, any changes must be notified in writing to **The Company** at least 10 **Business Days** prior to

the change coming into effect.

- OC6.5.4
- (a) Where **The Company** wishes to instruct a **Demand** reduction of more than 20 per cent of a **Network Operator's Demand** (measured at the time the **Demand** reduction is required), it shall, if it is able, issue a **National Electricity Transmission System Warning - High Risk of Demand Reduction** to the **Network Operator** by 1600 hours on the previous day. The warning will state the percentage level of **Demand** reduction that **The Company** may want to instruct (measured at the time the **Demand** reduction is required).
 - (b) The **National Electricity Transmission System Warning - High Risk of Demand Reduction** will specify the percentage of **Demand** reduction that **The Company** may require in integral multiples of the percentage levels notified by **Users** under OC6.5.3(c) up to (and including) 20 per cent and of five per cent above 20 per cent and will not relate to more than 40 per cent of **Demand** (measured at the time the **Demand** reduction is required) of the **Demand** on the **User System** of a **Network Operator**.
 - (c) If **The Company** has issued the **National Electricity Transmission System Warning - High Risk of Demand Reduction** by 1600 hours on the previous day, on receipt of it, the relevant **Network Operator** shall make available the percentage reduction in **Demand** specified for use within the period of the **National Electricity Transmission System Warning**.
 - (d) If **The Company** has not issued the **National Electricity Transmission System Warning - High Risk of Demand Reduction** by 1600 hours the previous day, but after that time, the **Network Operator** shall make available as much of the required **Demand** reduction as it is able, for use within the period of the **National Electricity Transmission System Warning**.

- OC6.5.5
- (a) If **The Company** has given a **National Electricity Transmission System Warning - High Risk of Demand Reduction** to a **Network Operator**, and has issued it by 1600 hours on the previous day, it can instruct the **Network Operator** to reduce its **Demand** by the percentage specified in the **National Electricity Transmission System Warning**.
 - (b) **The Company** accepts that if it has not issued the **National Electricity Transmission System Warning - High Risk of Demand Reduction** by 1600 hours on the previous day or if it has issued it by 1600 hours on the previous day, but it requires a further percentage of **Demand** reduction (which may be in excess of 40 per cent of the total **Demand** on the **User System** of the **Network Operator** (measured at the time the **Demand** reduction is required) from that set out in the **National Electricity Transmission System Warning**, it can only receive an amount that can be made available at that time by the **Network Operator**.
 - (c) Other than with regard to the proviso, the provisions of OC6.5.3 shall apply to those instructions.

- OC6.5.6
- Once a **Demand** reduction has been applied by a **Network Operator** at the instruction of **The Company**, the **Network Operator** may interchange the **Customers** to whom the **Demand** reduction has been applied provided that,
- (i) the percentage of **Demand** reduction at all times within the **Network Operator's System** does not change; and
 - (ii) at all times it is achieved within the **Network Operator's System** as far as possible uniformly across all **Grid Supply Points** (unless otherwise specified in the **National Electricity Transmission System Warning - High Risk of Demand Reduction** if one has been issued),

until **The Company** instructs that **Network Operator** in accordance with **OC6**.

- OC6.5.7 Each **Network Operator** will abide by the instructions of **The Company** with regard to the restoration of **Demand** under OC6.5 without delay. It shall not restore **Demand** until it has received such instruction. The restoration of **Demand** must be achieved as soon as possible and the process of restoration must begin within 2 minutes of the instruction being given by **The Company**.
- OC6.5.8 In circumstances of protracted shortage of generation or where a statutory instruction has been given (eg. a fuel security period) and when a reduction in **Demand** is envisaged by **The Company** to be prolonged, **The Company** will notify the **Network Operator** of the expected duration.
- OC6.5.9 The **Network Operator** will notify **The Company** in writing that it has complied with **The Company's** instruction under OC6.5, within five minutes of so doing, together with an estimation of the **Demand** reduction or restoration achieved, as the case may be.
- OC6.5.10 **The Company** may itself implement **Demand** reduction and subsequent restoration on **Non-Embedded Customers** as part of a **Demand Control** requirement and it will organise the **National Electricity Transmission System** so that it will be able to reduce **Demand** by **Disconnection** of, or **Customer** voltage reduction to, all or any **Non-Embedded Customers**. Equivalent provisions to those in OC6.5.4 shall apply to issuing a **National Electricity Transmission System Warning - High Risk of Demand Reduction** to **Non-Embedded Customers**, as envisaged in OC7.4.8.
- OC6.5.11 Pursuant to the provisions of OC1.5.6, the **Network Operator** will supply to **The Company** details of the amount of **Demand** reduction or restoration actually achieved.

OC6.6 AUTOMATIC LOW FREQUENCY DEMAND DISCONNECTION

OC6.6.1 Each **Network Operator** will make arrangements that will enable automatic low **Frequency Disconnection** of at least:

- (i) 60 per cent of its total **Demand** (based on **Annual ACS Conditions**) at the time of forecast **National Electricity Transmission System** peak **Demand** where such **Network Operator's System** is connected to the **National Electricity Transmission System** in **NGET's Transmission Area**
- (ii) 40 per cent of its total **Demand** (based on **Annual ACS Conditions**) at the time of forecast **National Electricity Transmission System** peak where such **Network Operator's System** is connected to the **National Electricity Transmission System** in either **SPT's** or **SHETL's Transmission Area**

in order to seek to limit the consequences of a major loss of generation or an **Event** on the **Total System** which leaves part of the **Total System** with a generation deficit. Where a **Network Operator's System** is connected to the **National Electricity Transmission System** in more than one **Transmission Area**, the figure above for the **Transmission Area** in which the majority of the **Network Operator's Demand** is connected shall apply.

- OC6.6.2
- (a) The **Demand** of each **Network Operator** which is subject to automatic low **Frequency Disconnection** will be split into discrete MW blocks.
 - (b) The number, size (% **Demand**) and the associated low **Frequency** settings of these blocks, will be as specified in Table CC.A.5.5.1a and Table ECC.A.5.5.1a. **The Company** will keep the settings under review.
 - (c) The distribution of the blocks will be such as to give a reasonably uniform **Disconnection** within the **Network Operator's System**, as the case may be, across all **Grid Supply Points**.
 - (d) Each **Network Operator** will notify **The Company** in writing by calendar week 24 each year of the details of the automatic low **Frequency Demand Disconnection** on its **User System**. The information provided should identify, for each **Grid Supply Point** at the date and time of the annual peak of the **National Electricity Transmission System Demand** at **Annual ACS Conditions** (as notified pursuant to OC1.4.2), the frequency settings at which **Demand Disconnection** will be initiated and the amount of **Demand** disconnected at each such setting.

OC6.6.3 Where conditions are such that, following automatic low **Frequency Demand Disconnection**, and the subsequent **Frequency** recovery, it is not possible to restore a large proportion of the total **Demand** so disconnected within a reasonable period of time, **The Company** may instruct a **Network Operator** to implement additional **Demand Disconnection** manually, and restore an equivalent amount of the **Demand** that had been disconnected automatically. The purpose of such action is to ensure that a subsequent fall in **Frequency** will again be contained by the operation of automatic low **Frequency Demand Disconnection**.

OC6.6.4 Once an automatic low **Frequency Demand Disconnection** has taken place, the **Network Operator** on whose **User System** it has occurred, will not reconnect until **The Company** instructs that **Network Operator** to do so in accordance with **OC6**.

OC6.6.5 Once the **Frequency** has recovered, each **Network Operator** will abide by the instructions of **The Company** with regard to reconnection under OC6.6 without delay. Reconnection must be achieved as soon as possible and the process of reconnection must begin within 2 minutes of the instruction being given by **The Company**.

OC6.6.6 (a) **Non-Embedded Customers** and **Pumped Storage Generators**, must provide automatic low **Frequency** disconnection, which shall be split into discrete blocks.

(b) The number and size of blocks and the associated low **Frequency** settings shall be as specified by **The Company** by week 24 each calendar year following discussion with the **Non-Embedded Customer** and **Pumped Storage Generator** in accordance with the relevant **Bilateral Agreement**.

(c) **Generators, Defence Service Providers, Restoration Service Providers** or **Non-Embedded Customers** in respect of **Electricity Storage Modules** who have agreed with **The Company** to satisfy the requirements of OC6.6.6 as provided for in ECC.6.3.7.2.3.1 must provide automatic low **Frequency** disconnection, which shall be split into discrete blocks. The number and size of blocks and the associated low **Frequency** settings will be specified by **The Company** by week 24 each calendar year following discussion with the relevant parties in accordance with the relevant **Bilateral Agreement** or other relevant **Ancillary Services** agreement.

OC6.6.7 (a) In addition, **Generators** may wish to disconnect **Power Generating Modules** and/or **Generating Units** from the **System**, either manually or automatically, should they be subject to **Frequency** levels which could result in **Power Generating Module** and/or **Generating Unit** damage.

(b) This **Disconnection** facility on such a **Power Generating Module** and/or **Generating Unit** directly connected to the **National Electricity Transmission System**, will be agreed with **The Company** in accordance with the **Bilateral Agreement**.

(c) Any **Embedded Power Stations** will need to agree this **Disconnection** facility with the relevant **User** to whose **System** that **Power Station** is connected, which will then need to notify **The Company** of this.

OC6.6.8 The **Network Operator** or **Non-Embedded Customer**, as the case may be, will notify **The Company** with an estimation of the **Demand** reduction which has occurred under automatic low **Frequency Demand Disconnection** and similarly notify the restoration, as the case may be, in each case within five minutes of the **Disconnection** or restoration.

OC6.6.9 Pursuant to the provisions of OC1.5.6 the **Network Operator** and **Non-Embedded Customer** will supply to **The Company** details of the amount of **Demand** reduction or restoration actually achieved.

OC6.6.10 (a) In the case of a **User**, it is not necessary for it to provide automatic low **Frequency** disconnection under OC6.6 only to the extent that it is providing, at the time it would be so needed, low **Frequency** disconnection at a higher level of **Frequency** as an **Ancillary Service**, namely if the amount provided as an **Ancillary Service** is less than that required under OC6.6 then the **User** must provide the balance required under OC6.6 at the time it is so needed.

(b) The provisions of OC7.4.8 relating to the use of **Demand Control** should be borne in mind by **Users**.

OC6.7 EMERGENCY MANUAL DISCONNECTION

OC6.7.1 Each **Network Operator** will make arrangements that will enable it, following an instruction from **The Company**, to disconnect **Customers** on its **User System** under emergency conditions irrespective of **Frequency** within 30 minutes. It must be possible to apply the **Demand Disconnections** to individual or specific groups of **Grid Supply Points**, as determined by **The Company**.

OC6.7.2 (a) Each **Network Operator** shall provide **The Company** in writing by week 24 in each calendar year, in respect of the next following year beginning week 24, on a **Grid Supply Point** basis, with the following information (which is set out in a tabular format in the Appendix):

(i) its total peak **Demand** (based on **Annual ACS Conditions**); and

(ii) the percentage value of the total peak **Demand** that can be disconnected (and

must include that which can also be reduced by voltage reduction, where applicable) within timescales of 5/10/15/20/25/30 minutes.

- (b) The information should include, in relation to the first 5 minutes, as a minimum, the 20% of **Demand** that must be reduced on instruction under OC6.5.

OC6.7.3 Each **Network Operator** will abide by the instructions of **The Company** with regard to **Disconnection** under OC6.7 without delay, and the **Disconnection** must be achieved as soon as possible after the instruction being given by **The Company**, and in any case, within the timescale registered in OC6.7. The instruction may relate to an individual **Grid Supply Point** and/or groups of **Grid Supply Points**.

OC6.7.4 **The Company** will notify a **Network Operator** who has been instructed under OC6.7, of what has happened on the **National Electricity Transmission System** to necessitate the instruction, in accordance with the provisions of **OC7** and, if relevant, **OC10**.

OC6.7.5 Once a **Disconnection** has been applied by a **Network Operator** at the instruction of **The Company**, that **Network Operator** will not reconnect until **The Company** instructs it to do so in accordance with **OC6**.

OC6.7.6 Each **Network Operator** will abide by the instructions of **The Company** with regard to reconnection under OC6.7 without delay, and shall not reconnect until it has received such instruction and reconnection must be achieved as soon as possible and the process of reconnection must begin within 2 minutes of the instruction being given by **The Company**.

OC6.7.7 **The Company** may itself disconnect manually and reconnect **Non-Embedded Customers** as part of a **Demand Control** requirement under emergency conditions.

OC6.7.8 If **The Company** determines that emergency manual **Disconnection** referred to in OC6.7 is inadequate, **The Company** may disconnect **Network Operators** and/or **Non-Embedded Customers** at **Grid Supply Points**, to preserve the security of the **National Electricity Transmission System**.

OC6.7.9 Pursuant to the provisions of OC1.5.6 the **Network Operator** will supply to **The Company** details of the amount of **Demand** reduction or restoration actually achieved.

OC6.8 OPERATION OF THE BALANCING MECHANISM DURING DEMAND CONTROL

Demand Control will constitute an **Emergency Instruction** in accordance with BC2.9 and it may be necessary to depart from normal **Balancing Mechanism** operation in accordance with BC2 in issuing **Bid-Offer Acceptances**. **The Company** will inform affected **BM Participants** in accordance with the provisions of **OC7**.

APPENDIX 1 - EMERGENCY MANUAL DEMAND REDUCTION/DISCONNECTION SUMMARY SHEET

(As set out in OC6.7)

NETWORK OPERATOR: _____ [YEAR] PEAK: _____

GRID SUPPLY POINT (Name)	PEAK MW	% OF GROUP DEMAND DISCONNECTION (AND/OR REDUCTION IN THE CASE OF THE FIRST 5 MINUTES) (CUMULATIVE)						REMARKS
		TIME (MINS)						
		5	10	15	20	25	30	

Notes:

1. Data to be provided annually by week 24 to cover the following year.

< END OF OPERATING CODE NO. 6 >

GENERAL CONDITIONS (GC)

CONTENTS

(This contents page does not form part of the Grid Code)

<u>Paragraph No/Title</u>	<u>Page Number</u>
GC.1 INTRODUCTION.....	2
GC.2 SCOPE.....	2
GC.3 UNFORESEEN CIRCUMSTANCES.....	2
GC.4 GRID CODE REVIEW PANEL.....	2
GC.5 COMMUNICATION BETWEEN NGET AND USERS.....	2
GC.6 MISCELLANEOUS.....	3
GC.7 OWNERSHIP OF PLANT AND/OR APPARATUS	3
GC.8 SYSTEM CONTROL.....	3
GC.9 EMERGENCY SITUATIONS	3
GC.10 MATTERS TO BE AGREED	4
GC.11 GOVERNANCE OF ELECTRICAL STANDARDS.....	4
GC.12 CONFIDENTIALITY	5
GC.13 RELEVANT TRANSMISSION LICENSEES	5
GC.14 BETTA TRANSITION ISSUES	6
GC.15 EMBEDDED EXEMPTABLE LARGE AND MEDIUM POWER STATIONS	6
GC.16 SIGNIFICANT CODE REVIEW.....	Error! Bookmark not defined.
ANNEX TO THE GENERAL CONDITIONS	9
APPENDIX TO THE GENERAL CONDITIONS	12

- GC.1 INTRODUCTION
- GC.1.1 The **General Conditions** contain provisions which are of general application to all provisions of the Grid Code. Their objective is to ensure, to the extent possible, that the various sections of the Grid Code work together and work in practice for the benefit of all **Users**.
- GC.2 SCOPE
- GC.2.1 The **General Conditions** apply to all **Users** (including, for the avoidance of doubt, **The Company**).
- GC.3 UNFORESEEN CIRCUMSTANCES
- GC.3.1 If circumstances arise which the provisions of the Grid Code have not foreseen, **The Company** shall, to the extent reasonably practicable in the circumstances, consult promptly and in good faith all affected **Users** in an effort to reach agreement as to what should be done. If agreement between **The Company** and those **Users** as to what should be done cannot be reached in the time available, **The Company** shall determine what is to be done. Wherever **The Company** makes a determination, it shall do so having regard, wherever possible, to the views expressed by **Users** and, in any event, to what is reasonable in all the circumstances. Each **User** shall comply with all instructions given to it by **The Company** following such a determination provided that the instructions are consistent with the then current technical parameters of the particular **User's System** registered under the Grid Code. **The Company** shall promptly refer all such unforeseen circumstances and any such determination to the **Panel** for consideration in accordance with GC.4.2(e).
- GC.4 NOT USED
- GC.5 COMMUNICATION BETWEEN THE COMPANY AND USERS
- GC.5.1 Unless otherwise specified in the Grid Code, all instructions given by **The Company** and communications (other than relating to the submission of data and notices) between **The Company** and **Users** (other than **Generators**, **DC Converter Station** owners or **Suppliers**) shall take place between the **The Company Control Engineer** based at the **Transmission Control Centre** notified by **The Company** to each **User** prior to connection, and the relevant **User Responsible Engineer/Operator**, who, in the case of a **Network Operator**, will be based at the **Control Centre** notified by the **Network Operator** to **The Company** prior to connection.
- GC.5.2 Unless otherwise specified in the Grid Code, all instructions given by **The Company** and communications (other than relating to the submission of data and notices) between **The Company** and **Generators** and/or **DC Converter Station** owners and/or **Suppliers**, shall take place between the **The Company Control Engineer** based at the **Transmission Control Centre** notified by **The Company** to each **Generator** or **DC Converter Station** owner prior to connection, or to each **Supplier** prior to submission of **BM Unit Data**, and either the relevant **Generator's** or **DC Converter Station** owner's or **Supplier's Trading Point** (if it has established one) notified to **The Company** or the **Control Point** of the **Supplier** or the **Generator's Power Station** or **DC Converter Station**, as specified in each relevant section of the Grid Code. In the absence of notification to the contrary, the **Control Point** of a **Generator's Power Station** will be deemed to be the **Power Station** at which the **Generating Units** or **Power Park Modules** are situated.
- GC.5.3 Unless otherwise specified in the Grid Code, all instructions given by **The Company** and communications (other than relating to the submission of data and notices) between **The Company** and **Users** will be given by means of the **Control Telephony** referred to in CC.6.5.2.

- GC.5.4 If the **Transmission Control Centre** notified by **The Company** to each **User** prior to connection, or the **User Control Centre**, notified in the case of a **Network Operator** to **The Company** prior to connection, is moved to another location, whether due to an emergency or for any other reason, **The Company** shall notify the relevant **User** or the **User** shall notify **The Company**, as the case may be, of the new location and any changes to the **Control Telephony** or **System Telephony** necessitated by such move, as soon as practicable following the move.
- GC.5.5 If any **Trading Point** notified to **The Company** by a **Generator** or **DC Converter Station** owner prior to connection, or by a **Supplier** prior to submission of **BM Unit Data**, is moved to another location or is shut down, the **Generator**, **DC Converter Station** owner or **Supplier** shall immediately notify **The Company**.
- GC.5.6 The recording (by whatever means) of instructions or communications given by means of **Control Telephony** or **System Telephony** will be accepted by **The Company** and **Users** as evidence of those instructions or communications.

GC.6 MISCELLANEOUS

GC.6.1 Data and Notices

- GC.6.1.1 Data and notices to be submitted either to **The Company** or to **Users** under the Grid Code (other than data which is the subject of a specific requirement of the Grid Code as to the manner of its delivery) shall be delivered in writing either by hand or sent by first-class pre-paid post, or by facsimile transfer or by electronic mail to a specified address or addresses previously supplied by **The Company** or the **User** (as the case may be) for the purposes of submitting that data or those notices.
- GC.6.1.2 References in the Grid Code to “in writing” or “written” include typewriting, printing, lithography, and other modes of reproducing words in a legible and non-transitory form and in relation to submission of data and notices includes electronic communications.
- GC.6.1.3 Data delivered pursuant to paragraph GC.6.1.1, in the case of data being submitted to **The Company**, shall be addressed to the **Transmission Control Centre** at the address notified by **The Company** to each **User** prior to connection, or to such other Department within **The Company** or address, as **The Company** may notify each **User** from time to time, and in the case of notices to be submitted to **Users**, shall be addressed to the chief executive of the addressee (or such other person as may be notified by the **User** in writing to **The Company** from time to time) at its address(es) notified by each **User** to **The Company** in writing from time to time for the submission of data and service of notices under the Grid Code (or failing which to the registered or principal office of the addressee).
- GC.6.1.4 All data items, where applicable, will be referenced to nominal voltage and **Frequency** unless otherwise stated.

GC.7 OWNERSHIP OF PLANT AND/OR APPARATUS

References in the Grid Code to **Plant** and/or **Apparatus** of a **User** include **Plant** and/or **Apparatus** used by a **User** under any agreement with a third party.

GC.8 SYSTEM CONTROL

Where a **User's System** (or part thereof) is, by agreement, under the control of **The Company**, then for the purposes of communication and co-ordination in operational timescales **The Company** can (for those purposes only) treat that **User's System** (or part thereof) as part of the **National Electricity Transmission System**, but, as between **The Company** and **Users**, it shall remain to be treated as the **User's System** (or part thereof).

GC.9 EMERGENCY SITUATIONS

Users should note that the provisions of the Grid Code may be suspended, in whole or in part, during a Security Period, as more particularly provided in the **Fuel Security Code**, or pursuant to any directions given and/or orders made by the **Secretary of State** under section 96 of the **Act** or under the Energy Act 1976.

GC.10 MATTERS TO BE AGREED

Save where expressly stated in the Grid Code to the contrary where any matter is left to **The Company** and **Users** to agree and there is a failure so to agree the matter shall not without the consent of both **The Company** and **Users** be referred to arbitration pursuant to the rules of the **Electricity Supply Industry Arbitration Association**.

GC.11 GOVERNANCE OF ELECTRICAL STANDARDS

GC.11.1 In relation to the **Electrical Standards** the following provisions shall apply.

GC.11.2 (a) If a **User**, or in respect of the **Electrical Standards** in (b) to the annex, **The Company**, or in respect of the **Electrical Standards** in (a) to the annex, or in respect of the **Electrical Standards** in (c) or (d) to the annex, the **Relevant Scottish Transmission Licensee**, wishes to:-

- (i) raise a change to an **Electrical Standard**;
- (ii) add a new standard to the list of **Electrical Standards**;
- (iii) delete a standard from being an **Electrical Standard**,

it shall activate the **Electrical Standards** procedure.

(b) The **Electrical Standards** procedure is the notification to the secretary to the **Panel** of the wish to so change, add or delete an **Electrical Standard**. That notification must contain details of the proposal, including an explanation of why the proposal is being made.

GC.11.3 Ordinary Electrical Standards Procedure

- (a) Unless it is identified as an urgent **Electrical Standards** proposal (in which case GC.11.4 applies) or unless the notifier requests that it be tabled at the next **Panel** meeting, as soon as reasonably practicable following receipt of the notification, the **Panel** secretary shall forward the proposal, with a covering paper, to **Panel Members**.
- (b) If no objections are raised within 20 Business Days of the date of the proposal, then it shall be deemed approved pursuant to the **Electrical Standards** procedure, and **The Company** shall make the change to the relevant **Electrical Standard** or the list of **Electrical Standards** contained in the Annex to this GC.11.
- (c) If there is an objection (or if the notifier had requested that it be tabled at the next **Panel** meeting rather than being dealt with in writing), then the proposal will be included in the agenda for the next following **Panel** meeting.
- (d) If there is broad consensus at the **Panel** meeting in favour of the proposal, **The Company** will make the change to the **Electrical Standard** or the list of **Electrical Standards** contained in the Annex to this GC.11.
- (e) If there is no such broad consensus, including where the **Panel** believes that further consultation is needed, **The Company** will establish a **Panel** working group if this was thought appropriate and in any event **The Company** shall undertake a consultation of **Authorised Electricity Operators** liable to be materially affected by the proposal.
- (f) Following such consultation, **The Company** will report back to **Panel Members**, either in writing or at a **Panel** meeting. If there was broad consensus in the consultation, then **The Company** will make the change to the **Electrical Standard** or the list of **Electrical Standards** contained in the Annex to this GC.11.

- (g) Where following such consultation there is no broad consensus, the matter will be referred to the **Authority** who will decide whether the proposal should be implemented and will notify **The Company** of its decision. If the decision is to so implement the change, **The Company** will make the change to the **Electrical Standard** or the list of **Electrical Standards** contained in the Annex to this GC.11.
- (h) In all cases where a change is made to the list of **Electrical Standards**, **The Company** will publish and circulate a replacement page for the Annex to this GC covering that list and reflecting the change.

GC.11.4 Urgent Electrical Standards Procedure

- (a) If the notification is marked as an urgent **Electrical Standards** proposal, the **Panel** secretary will contact **Panel Members** in writing to see whether a majority who are contactable agree that it is urgent and in that notification the secretary shall propose a timetable and procedure which shall be followed.
- (b) If such members do so agree, then the secretary will initiate the procedure accordingly, having first obtained the approval of the **Authority**.
- (c) If such members do not so agree, or if the **Authority** declines to approve the proposal being treated as an urgent one, the proposal will follow the ordinary **Electrical Standards** procedure as set out in GC.11.3 above.
- (d) If a proposal is implemented using the urgent **Electrical Standards** procedure, **The Company** will contact all **Panel Members** after it is so implemented to check whether they wish to discuss further the implemented proposal to see whether an additional proposal should be considered to alter the implementation, such proposal following the ordinary **Electrical Standards** procedure.

GC.12 CONFIDENTIALITY

GC.12.1 **Users** should note that although the Grid Code contains in certain sections specific provisions which relate to confidentiality, the confidentiality provisions set out in the **CUSC** apply generally to information and other data supplied as a requirement of or otherwise under the Grid Code. To the extent required to facilitate the requirements of the **EMR Documents**, **Users** that are party to the Grid Code but are not party to the **CUSC Framework Agreement** agree that the confidentiality provisions of the **CUSC** are deemed to be imported into the Grid Code.

GC.12.2 **The Company** has obligations under the **STC** to inform **Relevant Transmission Licensees** of certain data. **The Company** may pass on **User** data to a **Relevant Transmission Licensee** where:

- (a) **The Company** is required to do so under a provision of Schedule 3 of the **STC**; and/or
- (b) permitted in accordance with PC.3.4, PC.3.5 and OC2.3.2.

GC.12.3 **The Company** has obligations under the **EMR Documents** to inform **EMR Administrative Parties** of certain data. **The Company** may pass on **User** data to an **EMR Administrative Party** where **The Company** is required to do so under an **EMR Document**.

GC.12.4 **The Company** may use **User** data for the purpose of carrying out its **EMR Functions**.

GC.13 RELEVANT TRANSMISSION LICENSEES

- GC.13.1 It is recognised that the **Relevant Transmission Licensees** are not parties to the Grid Code. Accordingly, notwithstanding that Operating Code No. 8 Appendix 1 ("OC8A") and Appendix 2 ("OC8B"), OC7.6, OC9.4 and OC9.5 refer to obligations which will in practice be performed by the **Relevant Transmission Licensees** in accordance with relevant obligations under the **STC**, for the avoidance of doubt all contractual rights and obligations arising under OC8A, OC8B, OC7.6, OC9.4 and OC9.5 shall exist between **The Company** and the relevant **User** and in relation to any enforcement of those rights and obligations OC8A, OC8B, OC7.6, OC9.4 and OC9.5 shall be so read and construed. The **Relevant Transmission Licensees** shall enjoy no enforceable rights under OC8A, OC8B, OC7.6, OC9.4 and OC9.5 nor shall they be liable (other than pursuant to the **STC**) for failing to discharge any obligations under OC8A, OC8B, OC7.6, OC9.4 and OC9.5.
- GC.13.2 For the avoidance of doubt nothing in this Grid Code confers on any **Relevant Transmission Licensee** any rights, powers or benefits for the purpose of the Contracts (Rights of Third Parties) Act 1999.
- GC.14 BETTA TRANSITION ISSUES
- GC.14.1 The provisions of Part A of the Appendix to the **General Conditions** apply in relation to issues arising out of the transition associated with the designation of **GC Modification Proposals** by the **Secretary of State** in accordance with the provisions of the Energy Act 2004 for the purposes of Condition C14 of **The Company's Transmission Licence**.
- GC.15 EMBEDDED EXEMPTABLE LARGE AND MEDIUM POWER STATIONS
- GC.15.1 This GC.15.1 shall have an effect until and including 31st March 2007.
- (i) CC.6.3.2, CC.6.3.7, CC.8.1 and BC3.5.1; and
- (ii) Planning Code obligations and other Connection Conditions; shall apply to a **User** who owns or operates an **Embedded Exemptable Large Power Station**, or a **Network Operator** in respect of an **Embedded Exemptable Medium Power Station**, except where and to the extent that, in respect of that **Embedded Exemptable Large Power Station** or **Embedded Exemptable Medium Power Station**, **The Company** agrees or where the relevant **User** and **The Company** fail to agree, where and to the extent that the **Authority** consents.
- GC.16 SYSTEM DEFENCE PLAN, SYSTEM RESTORATION AND TEST PLAN
- GC.16.1 In relation to the **System Defence Plan**, **System Restoration Plan** and **Test Plan** the following provisions shall apply.
- GC.16.2 If a **User** or **The Company**, wishes to raise a change to the **System Defence Plan**, **System Restoration Plan** or **Test Plan**, they shall notify the **Panel Secretary** of the proposed change to the **System Defence Plan**, **System Restoration Plan** or **Test Plan**.
- In respect of the **System Defence Plan** the proposal shall not change the characteristics of the service to be provided or the conditions for aggregation, as any such changes that relate to the terms and conditions for **Defence Service Providers**; as set out in Article 4 paragraph 4 of **Retained EU Law** (Commission Regulation (EU) 2017/2196), as amended by Statutory Instrument 533 (2019); is subject to a separate change procedure. That notification must contain details of the proposal, including an explanation of why the proposal is being made.
- In respect of the **System Restoration Plan**, the proposal shall not change the characteristics of the service to be provided or conditions for aggregation or the target geographical distribution of power sources with **Black Start** and island operation capabilities, as any such changes that relate to the terms and conditions for **Restoration Service Providers**; as set out in Article 4 paragraph 4 of **Retained EU Law** (Commission Regulation (EU) 2017/2196), as amended by Statutory Instrument 533 (2019); is subject to a separate change procedure. That notification must contain details of the proposal, including an explanation of why the proposal is being made.

In respect of the **Test Plan**, the proposal shall include an explanation of why the proposal is being made.

Any such change proposals shall take into account the legitimate expectations, where necessary, of **User's, Defence Service Providers** or **Restoration Service Providers** based on the initially specified or agreed requirements or methodologies.

GC.16.3 Ordinary Procedure

- (a) Unless it is identified as an urgent proposal (in which case GC.16.4 applies) or unless the notifier requests that it be tabled at the next **Panel** meeting, as soon as reasonably practicable following receipt of the notification, the **Panel Secretary** shall forward the proposal, with a covering paper, to **Panel Members** and a consultation of not less than one month shall be undertaken.
- (b) For the **System Defence Plan** and the **System Restoration Plan** if no objections are raised following the consultation, then the modification shall be deemed approved, and **The Company** shall make the change to the **System Defence Plan** or the **System Restoration Plan**, and the **Panel Secretary** shall as soon as reasonably possible, publish it on **The Company's Website** and inform **Users** and other persons who may be interested.
- (c) If there is an objection (or if the notifier had requested that it be tabled at the next **Panel** meeting rather than being dealt with in writing), then the proposal to change the **System Defence Plan** or **System Restoration Plan** or **Test Plan** will be included on the agenda for the next **Panel** meeting.
- (d) For the **System Defence Plan** and the **System Restoration Plan** if there is a majority consensus at the **Panel** meeting in favour of the proposal, **The Company** will make the change to the **System Defence Plan** or the **System Restoration Plan** as soon as reasonably possible and the **Panel Secretary** shall publish it on **The Company's Website** and inform **Users** and other persons who may be interested.
- (e) If there is no such majority consensus in respect of the **System Defence Plan** or the **System Restoration Plan** or the **Test Plan**, **The Company** will request guidance from the **Panel** on an appropriate way forward. If the **Panel** decides a working group is required then the procedure under GR15 shall apply unless otherwise directed by **The Authority**.
- (f) In the case of a modification to the **Test Plan**, it shall be submitted to **The Authority** for approval. If approved **The Company** will make the change to the **Test Plan** as soon as reasonably possible and the **Panel Secretary** shall publish it on **The Company's Website** and inform **Users** and other persons who may be interested.

GC.16.4 Urgent Procedure

- (a) If the notification to change the **System Defence Plan** or **System Restoration Plan** is marked as an urgent proposal, the **Panel Secretary** will contact **Panel Members** in writing to see whether a majority who are contactable agree that it is urgent and in that case the **Panel Secretary** shall propose a timetable and procedure which shall be followed. The **Panel Secretary** shall as soon as reasonably possible, publish the proposal on **The Company's Website** and inform **User's** and other persons who may be interested.
- (b) If such **Panel Members** do so agree, then the **Panel Secretary** will initiate the procedure accordingly, having first obtained the approval of **The Authority** that urgency is warranted in accordance with the criteria set out in **The Authority's** published guidance.
- (c) If such **Panel Members** do not so agree, or if **The Authority** declines to approve the proposal being treated as an urgent one, the proposal will follow the ordinary procedure as set out in GC.16.3.

- (d) If a proposal to change the **System Defence Plan** or **System Restoration Plan** is developed using the urgent procedure, **The Company** will contact all **Panel Members** after it is agreed as being urgent to check whether they wish to discuss further the proposal to see whether an additional proposal should be considered to alter the implementation, such proposal following the ordinary procedure as provided for in GC.16.3 or, if agreed by **The Authority**, urgency as provided for in GC16.4.

ANNEX TO THE GENERAL CONDITIONS

The **Electrical Standards** are as follows:

(a) **Electrical Standards** applicable for **NGET's Transmission System**

The Relevant Electrical Standards Document (RES)		Reference	Issue	Date
Parts 1 to 3			3.0	March 2018
Part 4 – Specific Requirements				
1	Back-Up Protection Grading across NGET's and other Network Operator Interfaces	PS(T)044(RES)	1.0	September 2014
2	Ratings and General Requirements for Plant, Equipment, Apparatus and Services for the National Grid System and Connections Points to it.	TS 1 (RES)	1.0	February 2018
3	Substations	TS 2.01 (RES)	1.0	February 2018
4	Switchgear	TS 2.02 (RES)	1.0	October 2014
5	Substation Auxiliary Supplies	TS 2.12 (RES)	1.0	October 2014
6	Ancillary Light Current Equipment	TS 2.19 (RES)	1.0	October 2014
7	Substation Interlocking Schemes	TS 3.01.01 (RES)	1.0	February 2018
8	Earthing Requirements	TS 3.01.02 (RES)	1.0	October 2014
9	Circuit Breakers	TS 3.02.01 (RES)	2.0	February 2018
10	Disconnectors and Earthing Switches	TS 3.02.02 (RES)	1.0	October 2014
11	Current Transformers for Protection and General Use on the 132kV, 275kV and 400kV Systems	TS 3.02.04 (RES)	1.0	October 2014
12	Voltage Transformers	TS 3.02.05 (RES)	1.0	September 2016
13	Bushings	TS 3.02.07 (RES)	1.0	October 2014
14	Solid Core Post Insulators for Substations	TS 3.02.09 (RES)	1.0	October 2014
15	Voltage Dividers	TS 3.02.12 (RES)	1.0	September 2016
16	Gas Insulated Switchgear	TS 3.02.14 (RES)	1.0	October 2014
17	Environmental and Test Requirements for Electronic Equipment	TS 3.24.15 (RES)	1.0	October 2014
18	Busbar Protection	TS 3.24.34 (RES)	1.0	October 2014
19	Circuit Breaker Fail Protection	TS 3.24.39 (RES)	1.0	October 2014
20	Synchronising And Voltage Selection	TS.3.24.60 (RES)	2.0	January 2018
21	System Monitor – Dynamic System Monitoring (DSM)	TS 3.24.70 (RES)	2.0	February 2018
22	System Monitoring – Fault Recording	TS 3.24.71 (RES)	1.0	February 2018
23	Protection & Control for HVDC Systems	TS 3.24.90 (RES)	1.0	October 2014
24	Ancillary Services Business Monitoring	TS 3.24.95 (RES)	2.0	February 2018

25	Operational Data Transmission	TS 3.24.100 (RES)	1.0	February 2018
26	Guidance for Working in Proximity to Live Conductors	TGN(E)186 (RES)	1.0	October 2018
Additional Requirements				
Control Telephony Electrical Standard			1.0	17 th Sept 2007

(b) Electronic data communications facilities applicable in all **Transmission Areas**.

Communications Standards for Electronic Data Communication Facilities and Automatic Logging Devices	Issue 4	26 th Aug 2015
EDT Interface Specification	Issue 4	18 th Dec 2000
EDT Submitter Guidance Note	Issue 1	21 st Dec 2001
EDL Message Interface Specification	Issue 4	20 th Jun 2000
EDL Instruction Interface Valid Reason Codes	Issue 5	20 th Jan 2022
MODIS Interface Specification	Version 4	26 th May 2015

(c) Scottish **Electrical Standards** applicable for **SPT's Transmission System**.

RES-01-100	Relevant Electrical Standards for Plant, Equipment and Apparatus for connection to the SP Transmission System	Issue 1
------------	---------------------------------------------------------------------------------------------------------------	---------

(d) Scottish **Electrical Standards** applicable for **SHETL's Transmission System**.

1. NGTS 1: Rating and General Requirements for Plant, Equipment, Apparatus and Services for the National Grid System and Direct Connection to it. Issue 3 March 1999.
2. NGTS 2.1: Substations
Issue 2 May 1995
3. NGTS 3.1.1: Substation Interlocking Schemes.
Issue 1 October 1993.
4. NGTS 3.2.1: Circuit Breakers and Switches.
Issue 1 September 1992.
5. NGTS 3.2.2: Disconnectors and Earthing Switches.
Issue 1 March 1994.
6. NGTS 3.2.3: Metal-Oxide surge arresters for use on 132, 275 and 400kV systems.
Issue 2 May 1994.
7. NGTS 3.2.4: Current Transformers for protection and General use on the 132, 275 and 400kV systems.
Issue 1 September 1992.
8. NGTS 3.2.5: Voltage Transformers for use on the 132, 275 and 400 kV systems.
Issue 2 March 1994.
9. NGTS 3.2.6: Current and Voltage Measurement Transformers for Settlement Metering of 33, 66, 132, 275 and 400kV systems.
Issue 1 September 1992.
10. NGTS 3.2.7: Bushings for the Grid Systems.
Issue 1 September 1992.
11. NGTS 3.2.9: Post Insulators for Substations.
Issue 1 May 1996.
12. NGTS 2.6: Protection
Issue 2 June 1994.
13. NGTS 3.11.1: Capacitors and Capacitor Banks.
Issued 1 March 1993.

APPENDIX TO THE GENERAL CONDITIONS

PART A

GC.A.1 Introduction

GC.A.1.1 This Appendix Part A to the **General Conditions** deals with issues arising out of the transition associated with the designation of amendments to the Grid Code by the **Secretary of State** in accordance with the provisions of the Energy Act 2004 for the purposes of Condition C14 of **The Company's Transmission Licence** at that time. For the purposes of this Appendix to the **General Conditions**, the version of the Grid Code as amended by the changes designated by the **Secretary of State** and as further amended from time to time shall be referred to as the "GB Grid Code". The process and amendments referred to in this Appendix Part A took place before the separation of **The Company** from **NGET** and the introduction into the **Grid Code of Offshore Transmission Licencees** and this Part A shall be construed accordingly.

GC.A.1.2 The provisions of this Appendix Part A to the **General Conditions** shall only apply to **Users** (as defined in GC.A.1.4) and **The Company** after **Go-Live** for so long as is necessary for the transition requirements referred to in GC.A.1.1 and cut-over requirements (as further detailed in GC.A.3.1) to be undertaken.

GC.A.1.3 In this Appendix Part A to the **General Conditions**:

- (a) **Existing E&W Users** and **E&W Applicants** are referred to as "**E&W Users**";
- (b) **Users** who as at 1 January 2005 have entered into an agreement or have accepted an offer for connection to and/or use of the **Transmission System** of **NGET** are referred to as "**Existing E&W Users**";
- (c) **Users** (or prospective **Users**) other than **Existing E&W Users** who apply during the **Transition Period** for connection to and/or use of the **Transmission System** of **NGET** are referred to as "**E&W Applicants**";
- (d) Existing **Scottish Users** and **Scottish Applicants** are referred to as "**Scottish Users**";
- (e) **Users** who as at 1 January 2005 have entered into an agreement or have accepted an offer for connection to and/or use of the **Transmission System** of either **SPT** or **SHETL** are referred to as "**Existing Scottish Users**";
- (f) **Users** (or prospective **Users**) other than **Existing Scottish Users** who apply during the **Transition Period** for connection to and/or use of the **Transmission System** of either **SPT** or **SHETL** are referred to as "**Scottish Applicants**";
- (g) the term "**Transition Period**" means the period from **Go-Active** to **Go-Live** (unless it is provided to be different in relation to a particular provision), and is the period with which this Appendix Part A to the **General Conditions** deals;
- (h) the term "**Interim GB SYS**" means the document of that name referred to in Condition C11 of **The Company's Transmission Licence**;
- (i) the term "**Go-Active**" means the date on which the amendments designated by the **Secretary of State** to the Grid Code in accordance with the Energy Act 2004 come into effect; and
- (j) the term "**Go-Live**" means the date which the **Secretary of State** indicates in a direction shall be the **BETTA go-live** date.

GC.A.1.4 The provisions of GC.2.1 shall not apply in respect of this Appendix to the **General Conditions**, and in this Appendix Part A to the **General Conditions** the term "**Users**" means:

- (a) **Generators**;
- (b) **Network Operators**;
- (c) **Non-Embedded Customers**;
- (d) **Suppliers**;

- (e) **BM Participants;**
- (f) **Externally Interconnected System Operators;** and
- (g) **DC Converter Station** owners

to the extent that the provisions of this Appendix Part A to the **General Conditions** affect the rights and obligations of such **Users** under the other provisions of the GB Grid Code.

- GC.A.1.5 The GB Grid Code has been introduced with effect from **Go-Active** pursuant to the relevant licence changes introduced into **The Company's Transmission Licence**. **The Company** is required to implement and comply, and **Users** to comply, with the GB Grid Code subject as provided in this Appendix Part A to the **General Conditions**, which provides for the extent to which the GB Grid Code is to apply to **The Company** and **Users** during the **Transition Period**.
- GC.A.1.6 This Appendix Part A to the **General Conditions** comprises:
- (a) this Introduction;
 - (b) GB Grid Code transition issues; and
 - (c) Cut-over issues.
- GC.A.1.7 Without prejudice to GC.A.1.8, the failure of any **User** or **The Company** to comply with this Appendix Part A to the **General Conditions** shall not invalidate or render ineffective any part of this Appendix Part A to the **General Conditions** or actions undertaken pursuant to this Appendix to the **General Conditions**.
- GC.A.1.8 A **User** or **The Company** shall not be in breach of any part of this Appendix Part A to the **General Conditions** to the extent that compliance with that part is beyond its power by reason of the fact that any other **User** or **The Company** is in default of its obligations under this Appendix Part A to the **General Conditions**.
- GC.A.1.9 Without prejudice to any specific provision under this Appendix Part A to the **General Conditions** as to the time within which or the manner in which a **User** or **The Company** should perform its obligations under this Appendix to the **General Conditions**, where a **User** or **The Company** is required to take any step or measure under this Appendix Part A to the **General Conditions**, such requirement shall be construed as including any obligation to:
- (a) take such step or measure as quickly as reasonably practicable; and
 - (b) do such associated or ancillary things as may be necessary to complete such step or measure as quickly as reasonably practicable.
- GC.A.1.10 **The Company** shall use reasonable endeavours to identify any amendments it believes are needed to the GB Grid Code in respect of the matters referred to for the purposes of Condition C14 of **The Company's Transmission Licence** and in respect of the matters identified in GC.A.1.11, and, having notified the **Authority** of its consultation plans in relation to such amendments, **The Company** shall consult in accordance with the instructions of the **Authority** concerning such proposed amendments.
- GC.A.1.11 The following matters potentially require amendments to the GB Grid Code:
- (a) The specific detail of the obligations needed to manage implementation in the period up to and following (for a temporary period) **Go-Live** to achieve the change to operation under the GB Grid Code (to be included in GC.A.3).
 - (b) Information (including data) and other requirements under the GB Grid Code applicable to **Scottish Users** during the **Transition Period** (to be included in GC.A.2).
 - (c) The conclusions of Ofgem/DTI in relation to small and/or embedded generator issues under BETTA and allocation of access rights on a GB basis.
 - (d) Any arrangements required to make provision for operational liaison, including **Black Start** and islanding arrangements in Scotland.
 - (e) Any arrangements required to make provision for cascade hydro **BM Units**.

- (f) Any consequential changes to the safety co-ordination arrangements resulting from **STC** and **STC** procedure development.
- (g) Any arrangements required to reflect the **Electrical Standards** for the **Transmission Systems** of **SPT** and **SHETL**.
- (h) The conclusions of Ofgem/DTI in relation to planning and operating standards.

GC.A.1.12 **The Company** shall notify the **Authority** of any amendments that **The Company** identifies as needed pursuant to GC.A.1.10 and shall make such amendments as the **Authority** approves.

GC.A.2 GB Grid Code Transition

General Provisions

GC.A.2.1 The provisions of the GB Grid Code shall be varied or suspended (and the requirements of the GB Grid Code shall be deemed to be satisfied) by or in accordance with, and for the period and to the extent set out in this GC.A.2, and in accordance with the other applicable provisions in this Appendix Part A to the **General Conditions**.

GC.A.2.2 E&W Users:

In furtherance of the licence provisions referred to in GC.A.1.5, **E&W Users** shall comply with the GB Grid Code during the **Transition Period**, but shall comply with and be subject to it subject to this Appendix to the **General Conditions**, including on the basis that:

- (a) during the **Transition Period** the **Scottish Users** are only complying with the GB Grid Code in accordance with this Appendix Part A to the **General Conditions**; and
- (b) during the **Transition Period** the **National Electricity Transmission System** shall be limited to the **Transmission System** of **NGET**, and all rights and obligations of **E&W Users** in respect of the **National Electricity Transmission System** under the GB Grid Code shall only apply in respect of the **Transmission System** of **NGET**, and all the provisions of the GB Grid Code shall be construed accordingly.

GC.A.2.3 Scottish Users:

In furtherance of the licence provisions referred to in GC.A.1.5, **Scottish Users** shall comply with the GB Grid Code and the GB Grid Code shall apply to or in relation to them during the **Transition Period** only as provided in this Appendix Part A to the **General Conditions**.

GC.A.2.4 THE COMPANY:

In furtherance of the licence provisions referred to in GC.A.1.5, **The Company** shall implement and comply with the GB Grid Code during the **Transition Period**, but shall implement and comply with and be subject to it subject to, and taking into account, all the provisions of this Appendix Part A to the **General Conditions**, including on the basis that:

- (a) during the **Transition Period** **The Company's** rights and obligations in relation to **E&W Users** in respect of the **National Electricity Transmission System** under the GB Grid Code shall only apply in respect of the **Transmission System** of **NGET**, and all the provisions of the GB Grid Code shall be construed accordingly; and
- (b) during the **Transition Period** **The Company's** rights and obligations in relation to **Scottish Users** in respect of the **National Electricity Transmission System** under the GB Grid Code shall only be as provided in this Appendix Part A to the **General Conditions**.

Specific Provisions

GC.A.2.5 Definitions:

The provisions of the GB Grid Code **Glossary and Definitions** shall apply to and for the purposes of this Appendix Part A to the **General Conditions** except where provided to the contrary in this Appendix Part A to the **General Conditions**.

GC.A.2.6 Identification of Documents:

In the period beginning at **Go-Active**, **Scottish Users** will work with **The Company** to identify and agree with **The Company** any documents needed to be in place in accordance with the GB Grid Code, to apply from **Go-Live** or as earlier provided for under this Appendix Part A to the **General Conditions**, including (without limitation) **Site Responsibility Schedules**, **Gas Zone Diagrams** and **OC9 Desynchronised Island Procedures**.

GC.A.2.7 Data:

Each **Scottish User** must provide, or enable a **SPT** or **SHETL** to provide, **The Company**, as soon as reasonably practicable upon request, with all data which **The Company** needs in order to implement, with effect from **Go-Live**, the GB Grid Code in relation to Scotland. This data will include, without limitation, the data that a new **User** is required to submit to **The Company** under CC.5.2. **The Company** is also entitled to receive data on **Scottish Users** over **SPT** or **SHETL**'s SCADA links to the extent that **The Company** needs it for use in testing and in order to implement, with effect from **Go-Live**, the GB Grid Code in relation to Scotland. After **Go-Live** such data shall, notwithstanding GC.A.1.2, be treated as though it had been provided to **The Company** under the enduring provisions of the GB Grid Code.

GC.A.2.8 Verification of Data etc:

The Company shall be entitled to request from a **Scottish User** (which shall comply as soon as reasonably practicable with such a request) confirmation and verification of any information (including data) that has been received by **SPT** or **SHETL** under an existing Grid Code and passed on to **The Company** in respect of that **Scottish User**. After **Go-Live** such information (including data) shall, notwithstanding GC.A.1.2, be treated as though provided to **The Company** under the enduring provisions of the GB Grid Code.

GC.A.2.9 Grid Code Review Panel:

- (a) The individuals whose names are notified to **The Company** by the **Authority** prior to **Go-Active** as **Panel Members** (and **Alternate Members**, if applicable) are agreed by **Users** (including **Scottish Users**) and **The Company** to constitute the **Panel Members** and **Alternate Members** of the **Grid Code Review Panel** as at the first meeting of the **Grid Code Review Panel** after **Go-Active** as if they had been appointed as **Panel Members** (and **Alternate Members**) pursuant to the relevant provisions of the Constitution and Rules of the **Grid Code Review Panel** incorporating amendments equivalent to the amendments to GC.4.2 and GC.4.3 designated by the **Secretary of State** in accordance with the provisions of the Energy Act 2004 for the purposes of Condition C14 of **The Company's Transmission Licence**.
- (b) The provisions of GC.4 of the GB Grid Code shall apply to, and in respect of, **Scottish Users** from **Go-Active**.

GC.A.2.10 Interim GB SYS:

Where requirements are stated in, or in relation to, the GB Grid Code with reference to the **Seven Year Statement**, they shall be read and construed as necessary as being with reference to the **Interim GB SYS**.

GC.A.2.11 General Conditions:

The provisions of GC.4, GC.12 and GC.13.2 of the GB Grid Code shall apply to and be complied with by **Scottish Users** in respect of this Appendix Part A to the **General Conditions**.

GC.A.3 Cut-over

- GC.A.3.1 It is anticipated that it will be appropriate for arrangements to be put in place for final transition to BETTA in the period up to and following (for a temporary period) **Go-Live**, for the purposes of:

- (a) managing the transition from operations under the Grid Code as in force immediately prior to **Go-Active** to operations under the GB Grid Code and the **BSC** as in force on and after **Go-Active**;
- (b) managing the transition from operations under the existing Grid Code applicable to **Scottish Users** as in force immediately prior to **Go-Active** to operations under the GB Grid Code as in force on and after **Go-Active**;
- (c) managing the transition of certain data from operations under the existing grid code applicable to **Scottish Users** before and after **Go-Active**; and
- (d) managing GB Grid Code systems, processes and procedures so that they operate effectively at and from **Go-Live**.

GC.A.3.2

- (a) The provisions of **BC1** (excluding BC1.5.1, BC1.5.2 and BC1.5.3) shall apply to and be complied with by **Scottish Users** and by **The Company** in respect of such **Scottish Users** with effect from 11:00 hours on the day prior to **Go-Live**
- (b) Notwithstanding (a) above, **Scottish Users** may submit data for **Go-Live** 3 days in advance of **Go-Live** on the basis set out in the **Data Validation, Consistency and Defaulting Rules** which shall apply to **Scottish Users** and **The Company** in respect of such **Scottish Users** on that basis and for such purpose.
- (c) The **Operational Day** for the purposes of any submissions by **Scottish Users** prior to **Go-Live** under a) and b) above for the day of **Go-Live** shall be 00:00 hours on **Go Live** to 05:00 hours on the following day.
- (d) The provisions of **BC2** shall apply to and be complied with by **Scottish Users** and by **The Company** in respect of such **Scottish Users** with effect from 23:00 hours on the day prior to **Go-Live**.
- (e) The provisions of **OC7.4.8** shall apply to and be complied with by **Scottish Users** and by **The Company** in respect of such **Scottish Users** with effect from 11:00 hours on the day prior to **Go-Live**.
- (f) In order to facilitate cut-over, **Scottish Users** acknowledge and agree that **The Company** will exchange data submitted by such **Scottish Users** under **BC1** prior to Go-Live with the Scottish system operators to the extent necessary to enable the cut-over.
- (g) Except in the case of **Reactive Power**, **Scottish Users** should only provide **Ancillary Services** from **Go-Live** where they have been instructed to do so by **The Company**. In the case of **Reactive Power**, at **Go-Live** a **Scottish User's** MVA_r output will be deemed to be the level instructed by **The Company** under **BC2**, following this **Scottish Users** should operate in accordance with **BC2.A.2.6** on the basis that MVA_r output will be allowed to vary with system conditions.

PART B

GC.B.1

Introduction

GC.B.1.1

This Appendix Part B to the **General Conditions** deals with issues arising out of the transition associated with the approval and implementation of **Grid Code Modification Proposal GC0112** (Modifications relating to the separation of **System** operations and **Transmission Owner** roles).

GC.B.1.2

This Appendix Part B sets out the arrangements such that:

B.1.2.1 the **Post GC0112 Grid Code** reflects the **Transfer of the System Operator Role**;

B.1.2.2 certain amendments are made to **Grid Code Related Agreements/Documents** to

reflect the **Transfer of the System Operator Role**,

B.1.2.2 arrangements can be put in place prior to the **SO Transfer Date** to enable the transition of the operations with **NGET** under the **Pre GC0112 Grid Code** to operations with **The Company** under the **Post GC0112 Grid Code**; and

B.1.2.3 each **User** co-operates in relation to the transition.

GC.B.1.3 The provisions of the **Post GC0112 Grid Code** shall be suspended until the **SO Transfer Date** except for this Appendix Part B (and any related definitions within it) which will take immediate effect on the **Implementation Date** for **GC0112**.

GC.B.1.4 In this (and solely for the purposes of this) Appendix Part B the following terms have the following meaning:

B.1.4.1 the term "**Grid Code Related Agreements/Documents**" shall mean each or any of those agreements or documents entered into under or envisaged by the **Pre GC0112 Grid Code** prior to the **SO Transfer Date** which continue on and after the **SO Transfer Date**;

B.1.4.2 the term "**GC0112**" shall mean **Grid Code Modification Proposal 0112** (Amendments relating to the transfer of the system operator functions from **NGET** to **NGESO**);

B.1.4.3 the term "**NGET**" shall mean National Grid Electricity Transmission plc;

B.1.4.4 the term "**NGESO**" shall mean National Grid Electricity System Operator Limited;

B.1.4.5 the term "**Post GC0112 Grid Code**" means the version of the Grid Code as amended by **GC0112**;

B.1.4.6 the term "**Pre GC Grid Code**" means the version of the Grid Code prior to amendment by **GC0112**;

B.1.4.7 the term "**SO Transfer Date**" means the date on which **NGET's Transmission Licence** is transferred in part to **NGESO** to reflect the **Transfer of the System Operator Role**; and

B.1.4.8 the term "**Transfer of the System Operator Role**" means the the transfer, by means of the transfer in part of **NGET's Transmission Licence**, of the system operator role to **NGESO**.

GC.B.1.5 Without prejudice to any specific provision under this Appendix Part B as to the time within which or the manner in which any party should perform its obligations under this Appendix Part B, where a party is required to take any step or measure under this Appendix Part B, such requirement shall be construed as including any obligation to:

B.1.5.1 take such step or measure as quickly as reasonably practicable; and

B.1.5.2 do such associated or ancillary things as may be necessary to complete such step or measure as quickly as reasonably practicable.

GC.B.2 **GC0112: Amendments to Existing Agreements and Documents**

GC.B.2.1 Each **Grid Code Related Agreement/Document** in place or issued by a party in accordance with the terms of the **Pre GC0112 Grid Code** shall be read and construed, with effect from the **SO Transfer Date**, as if it (and any defined terms within it and the effect of it and those defined terms) recognise and reflect the **Transfer of the SO Functions** and as if any references in it to **NGET** in the context of its system operator role were references to **NGESO/The Company** as appropriate.

- GC.B.2.2 In the context of any **Site Responsibility Schedule** in existence at the **SO Transfer Date** and which would require, following the **Transfer of the System Operator Role**, the signature of either **NGESO** instead of **NGET** or both the signature of **NGESO** and **NGET**, **NGESO** and **NGET** acknowledge and the **Users** agree that the signature of **NGET** on such **Site Responsibility Schedule** shall be considered to be the signature of **NGESO** and/or **NGET** as appropriate.
- GC.B.3 **GC0112: Transition**
- GC.B.3.1 Each party shall take such steps and do such things in relation to the Grid Code and the **Grid Code Related Agreements/Documentation** as are within its power and as are reasonably necessary or appropriate in order to give full and timely effect to the **Transfer of the SO Role** and the transition of the operations, systems, process and procedures and the rights and obligations relating to the **Transfer of the SO Role** under the Grid Code from **NGET** to **NGESO**.
- GC. B.3.2 Each party agrees that (a) all things done by **NGET** pursuant to the Grid Code in its system operator role prior to the **SO Transfer Date** shall be deemed to have been done by **NGESO** and (b) all things received by **NGET** pursuant to the Grid Code in its system operator role (including but not limited to notices) shall be deemed to have been received by **NGESO** and (c) all things issued by **NGET** (including but not limited to notices) shall be deemed to have been issued by **NGESO**.
- GC.B.3.3 In particular:
- B.1.5.1 **Users** acknowledge and agree that **NGET** can exchange information and data submitted by **Users** under the Grid Code prior to the **SO Transfer Date** with **NGESO** to the extent necessary to enable the transition of the system operator role from **NGET** to **NGESO**;
- B.1.5.2 **NGET** will identify and publish as soon as practicable and in any event prior to 31 January 2019 any specific requirements (such requirements being reasonable and recognising the timescale) on **Users** necessary to manage the transition of the operations, systems, process and procedures and the rights and obligations relating to the **Transfer of the SO Role** under the Grid Code from **NGET** to **NGESO**;
- B.1.5.2 **Users** acknowledge that under the **Pre GC0112 Grid Code NGET** received certain data and information from **Users** which is no longer “live” data or information (“**Legacy Data**”) that if it was new data and information of that type would not be available to **NGET** as a **Relevant Transmisison Licence** from the **SO Transfer Date** consent to the retention of such **Legacy Data** by **NGET** where embedded in **NGET** systems or models.

< END OF GENERAL CONDITIONS >

REVISIONS

(R)

(This section does not form part of the Grid Code)

- R.1 **The Company's Transmission Licence** sets out the way in which changes to the Grid Code are to be made and reference is also made to **The Company's** obligations under the General Conditions.
- R.2 All pages re-issued have the revision number on the lower left hand corner of the page and date of the revision on the lower right hand corner of the page.
- R.3 The Grid Code was introduced in March 1990 and the first issue was revised 31 times. In March 2001 the New Electricity Trading Arrangements were introduced and Issue 2 of the Grid Code was introduced which was revised 16 times. At British Electricity Trading and Transmission Arrangements (BETTA) Go-Active Issue 3 of the Grid Code was introduced and subsequently revised 35 times. At Offshore Go-active Issue 4 of the Grid Code was introduced and has been revised 13 times since its original publication. Issue 5 of the Grid Code was published to accommodate the changes made by Grid Code Modification A/10 which has incorporated the **Generator** compliance process into the Grid Code, which was revised 47 times. Issue 6 was published to incorporate all the non-material amendments as a result of modification GC0136.
- R.4 This Revisions section provides a summary of the sections of the Grid Code changed by each revision to Issue 6.
- R.5 All enquiries in relation to revisions to the Grid Code, including revisions to Issues 1, 2, 3, 4 and 5 should be addressed to the Grid Code development team at the following email address:
Grid.Code@nationalgrideso.com

Revision	Section	Related Modification	Effective Date
0	Glossary Definitions	GC0136	05 March 2021
0	Planning Code	GC0136	05 March 2021
0	Connection Conditions	GC0136	05 March 2021
0	European Connection Conditions	GC0136	05 March 2021
0	Demand Response Services	GC0136	05 March 2021
0	Compliance Processes	GC0136	05 March 2021
0	Europeans Compliance Processes	GC0136	05 March 2021
0	Operating Code 1	GC0136	05 March 2021
0	Operating Code 2	GC0136	05 March 2021
0	Operating Code 5	GC0136	05 March 2021
0	Operating Code 6	GC0136	05 March 2021
0	Operating Code 7	GC0136	05 March 2021
0	Operating Code 8	GC0136	05 March 2021
0	Operating Code 8A	GC0136	05 March 2021
0	Operating Code 8B	GC0136	05 March 2021
0	Operating Code 9	GC0136	05 March 2021
0	Operating Code 11	GC0136	05 March 2021
0	Operating Code 12	GC0136	05 March 2021
0	Balancing Code 2	GC0136	05 March 2021

Revision	Section	Related Modification	Effective Date
0	Balancing Code 3	GC0136	05 March 2021
0	Balancing Code 4	GC0136	05 March 2021
0	Balancing Code 5	GC0136	05 March 2021
0	Data Registration Code	GC0136	05 March 2021
0	General Conditions	GC0136	05 March 2021
0	Governance Rules	GC0136	05 March 2021
1	Glossary Definitions	GC0130	18 March 2021
1	Operating Code 2	GC0130	18 March 2021
1	Data Registration Code	GC0130	18 March 2021
1	General Conditions	GC0130	18 March 2021
2	Glossary Definitions	GC0147	17 May 2021
2	Operating Code 6B	GC0147	17 May 2021
2	Operating Code 7	GC0147	17 May 2021
2	Balancing Code 1	GC0147	17 May 2021
2	Balancing Code 2	GC0147	17 May 2021
3	Balancing Code 2	GC0144	26 May 2021
3	Balancing Code 4	GC0144	26 May 2021
4	Preface	GC0149	03 August 2021
4	Glossary Definitions	GC0149	03 August 2021
4	Planning Code	GC0149	03 August 2021

Revision	Section	Related Modification	Effective Date
4	European Connection Conditions	GC0149	03 August 2021
4	European Compliance Processes	GC0149	03 August 2021
4	Demand Response Services Code	GC0149	03 August 2021
4	Operating Code 2	GC0149	03 August 2021
4	Balancing Code 4	GC0149	03 August 2021
4	Data Registration Code	GC0149	03 August 2021
4	Governance Rules	GC0149	03 August 2021
5	Operating Code 7	GC0109	23 August 2021
6	Connection Conditions	GC0134	01 September 2021
6	European Connection Conditions	GC0134	01 September 2021
6	Balancing Code 2	GC0134	01 September 2021
7	Operating Code 6B	GC0150	04 October 2021
8	Operating Code 2	GC0151	08 November 2021
8	Operating Code 3	GC0151	08 November 2021
8	Operating Code 5	GC0151	08 November 2021
9	Governance Rules	GC0152	29 December 2021
10	General Conditions	Electrical Standards - EDL Instruction Interface Valid Reason Codes	20 January 2022
11	Glossary Definitions	GC0137	14 February 2022
11	Planning Code	GC0137	14 February 2022

Revision	Section	Related Modification	Effective Date
11	Connection Conditions	GC0137	14 February 2022
11	European Connection Conditions	GC0137	14 February 2022
11	European Compliance Processes	GC0137	14 February 2022
11	Data Registration Code	GC0137	14 February 2022
12	Glossary Definitions	GC0153	09 March 2022
12	Connection Conditions	GC0153	09 March 2022
12	European Connection Conditions	GC0153	09 March 2022
12	Operating Code 6	GC0153	09 March 2022
12	Operating Code 8A	GC0153	09 March 2022
12	Operating Code 8B	GC0153	09 March 2022
12	Operating Code 12	GC0153	09 March 2022
12	Balancing Code 2	GC0153	09 March 2022
12	Governance Rules	GC0153	09 March 2022
13	Compliance Processes	GC0138	24 June 2022
13	European Compliance Processes	GC0138	24 June 2022
13	Operating Code 5	GC0138	24 June 2022
14	Glossary & Definitions	GC0157	06 October 2022
14	European Connection Conditions	GC0157	06 October 2022
14	Operating Code 2	GC0157	06 October 2022
14	Operating Code 5	GC0157	06 October 2022

Revision	Section	Related Modification	Effective Date
14	Data Registration Code	GC0157	06 October 2022
14	No changes to published Grid Code	GC0158	06 December 2022
15	Glossary & Definitions	GC0160	07 December 2022
15	Balancing Code 1	GC0160	07 December 2022
15	Balancing Code 2	GC0160	07 December 2022
16	Planning Code	GC0141	05 January 2023
16	Connection Conditions	GC0141	05 January 2023
16	European Connection Conditions	GC0141	05 January 2023
16	Compliance Processes	GC0141	05 January 2023
16	European Compliance Processes	GC0141	05 January 2023
17	Connection Conditions	GC0148	4 September 2023
17	European Compliance Processes	GC0148	4 September 2023
17	European Connection Conditions	GC0148	4 September 2023
17	General Conditions	GC0148	4 September 2023
17	Glossary & Definitions	GC0148	4 September 2023
17	Operating Code 5	GC0148	4 September 2023
17	Operating Code 6	GC0148	4 September 2023
17	Planning Code	GC0148	4 September 2023

< END OF REVISIONS >