

Network Options Assessment Methodology

Electricity System Operator

July 2023

Version	Issue 9.1
Date	31/07/2023

About this document

This document contains National Grid Electricity System Operator (ESO)'s Network Options Assessment (NOA) methodology established under the Electricity Transmission Licence Standard Condition C27 in respect of the financial year 2023/24. It covers the methodology on which National Grid ESO will base the 2023/24 NOA report to be published in 2023. As the methodology evolves due to experience and stakeholder feedback, the methodology statement will be revised for subsequent NOAs as required by Licence Condition C27.

Table of Contents

Contents

List of Abbreviations 2

Introduction 3

NOA Process Overview 9

Network Options Assessment for Interconnectors 26

Suitability for Third Party Delivery and Tendering Assessment 30

Pathfinders/ Network Services Procurement 38

Early development of options and interested persons’ process 64

Future Developments 69

List of Abbreviations

ACC	Attributable constraint costs
ACS	Average cold spell
ARW	Asset replacement works
BEIS	Department of Business Energy and Industrial Strategy
CATO	Competitively appointed transmission owner
CBA	Cost benefit analysis
CSNP	Centralised Strategic Network Planning
CUSC	Connection and Use of System Code
CWW	Connection Wider Works
DNO	Distribution network operator
EISD	Earliest in service date
ETNPR	Electricity Transmission Network Planning Review
ETYS	Electricity Ten-Year Statement
FACTS	Flexible AC transmission system
FES	Future Energy Scenarios
HEC	High efficiency co-generation
HND	Holistic Network Design
IWW	Incremental wider works
LOTI	Large Onshore Transmission Investment
LWR	Least worst regret
LWWR	Least worst weighted regret
MSIP	Medium Sized Investment Project
NDP	Network development plan
NETS	National Electricity Transmission System
OCP	Offshore Coordination Project
OTNR	Offshore Transmission Network Review
QB	Quad booster
RES	Renewable energy sources
RIIO	Revenue = incentives + innovation + outputs
SEW	Social economic welfare
SQSS	Security and Quality of Supply Standard
SRF	System Requirements Form
STC	System Operator Transmission Owner Code
STPR	Social Time Preference Rate
SWW	Strategic Wider Works
TO	Transmission Owner
WACC	Weighted average cost of capital

1

Introduction

1.1 Purpose

1. This document provides an overview of the aims of the onshore network options assessment and details the methodology which describes how the ESO assesses the required levels of network transfer, the options provided by the transmission owners to meet this requirement and recommends options for further development. It is important to note that whilst the ESO recommends progressing options to meet system needs, any investment decisions remain with the Onshore Transmission Owners (TOs) or other relevant parties, as appropriate.
2. This methodology describes the end-to-end process, from the analysis to the publication of the onshore network options assessment. The final onshore and offshore coordinated network design will be published in December 2023 within the transitional Centralised Strategic Network Plan (TCSNP) report.
3. The onshore Network Options Assessment (NOA) is prepared as per the C27 license requirement and presented alongside the offshore coordinated network design (which can be found [here](#)) to produce a holistic network design.
4. Appendix A of this methodology contains the roles and responsibilities of the ESO and TOs for this process.

1.2 How to read this document



1.3 Interaction of the TCSNP methodology with other reforms to network planning

1.3.1 Electricity Transmission Network Planning Review (ETNPR)

1. The Electricity Transmission Network Planning Review (ETNPR) is reviewing the existing Electricity Transmission network planning process and considering the need for improvements that will enable the GB transmission network to efficiently meet the anticipated future needs of the changing energy system to fulfil the decarbonisation targets.
2. The ETNPR introduces the concept of a Centralised Strategic Network Planning (CSNP) model which would take a GB-wide holistic view to develop an optimised plan for taking forward low regret Strategic Investments in the network (onshore and offshore). The CSNP will be developed and implemented over the next few years.
3. The purpose of the Centralised Strategic Network Plan (CSNP) is to facilitate the strategic development of an efficient, co-ordinated and economical system of electricity transmission and the development of whole energy system. This must be consistent with the National Electricity Transmission System Security and Quality of Supply Standard (NETS SQSS). At the same time, the CSNP process enables the development of the system in a manner that will achieve the Electricity System Operator (ESO)'s ambitions and government net zero targets.
4. The CSNP is to be delivered from 2024 however, in the interim the Electricity System Operator (ESO) is to deliver the transitional CSNP (TCSNP) which will incorporate the key outputs of the offshore transmission network review (OTNR) and expand the onshore Network Options Assessment (NOA).
5. This methodology is part of the Transitional Centralised Strategic Network Planning (TCSNP) which bridges the gap between the Network Options Assessment (NOA) and the CSNP. As part of this transition, this process includes new developments and iterations which will be further improved upon in the CSNP.

1.3.2 Holistic Network Design (HND)

1. Ofgem and DESNZ have initiated the Offshore Transmission Network Review (OTNR) project. One element of this work is the Pathway to 2030 workstream whereby NGESO, in collaboration with industry, is leading on the development of a Holistic Network Design (HND). HND has a strong focus on improvements to how we connect offshore generation to the onshore network and the overall coordination of network reinforcement to facilitate 2030 government offshore wind targets. The TCSNP is a key part of the HND and the NOA 2021/22 refresh report updated the analysis to reflect the onshore recommendations for 2021/22 and the impact of the coordinating in-scope offshore wind projects. The HND and a refreshed NOA 2021/22 publication were published in July 2022 providing an update to the NOA report published in January 2022.
2. The work being undertaken in the HND project will inform the development of the TCSNP and future CSNP.

Figure 1.1 - Overview of HND and NOA process

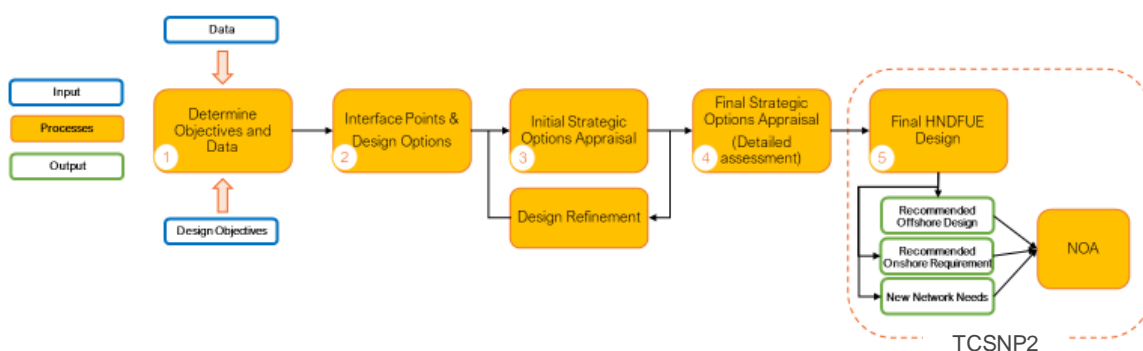

1.3.3 Impact of the Network Options Assessment and this methodology

1. There is significant development in the future network planning area. We strive to meet the Government's targets for offshore wind, net zero and other targets. You can read more about what we stand for on our website, [here](#).
2. We will consult with industry in developing the CSNP and we will review, update, and consult with the industry on our network planning methodologies.
3. The ESO continually reviews the operability requirements of the transmission network. Where it finds a new need that competitive services may meet, it develops a Network Services Procurement (formerly Pathfinder) project to test the need, the possible approaches, market engagement and interest.

1.4 Methodology review and stakeholder engagement

1. The ESO consults on the methodology of the onshore assessment of network options annually as part of meeting our licence condition. The methodology contains processes that operate at different times, notably the Network Services Procurement that are separate from the annual NOA process. We retain the option to separate out parts of the methodology in future years with Network Services Procurement being the most likely, while accommodating stakeholder feedback. The minimum duration of any TCSNP methodology consultation would be six weeks. The ESO considers feedback for a revised TCSNP methodology and submits the methodology to Ofgem by 1 August of that year.
2. The key consultation areas are the NOA methodology, form of the NOA report and the NOA report outputs and contents.
3. The ESO seeks approval from Ofgem on the NOA methodology and form of the TCSNP report as part of the annual stakeholder engagement process.
4. The ESO makes selected parts of the pre-release TCSNP report available to key stakeholders, particularly the relevant TOs, on a bilateral discussion basis to ensure confidentiality obligations. This is as the TCSNP report is being written based on assessment data, particularly economic data, becoming available. These discussions will occur as results become available and the report is being drafted. Just before publication, drafts are shared with the TOs and may be shared with Ofgem and Department of Energy Security and Net Zero. This provides a final opportunity for stakeholders to comment on the TCSNP report and raise any significant concerns. When a stakeholder expresses concern with the conclusions of the report, a comment is incorporated in the relevant section(s).
5. The ESO identifies and evaluates alternative options such as those based around commercial arrangements or reduced-build options in addition to those provided by the TOs. Appendix B/ Table B1 covers these alternative options in more detail.

1.5 Provision of information

1. The methodology for the assessment of onshore options and TCSNP report protects any confidential information provided by stakeholders or service providers, for example, balancing services contracts. For this reason, this methodology seeks to be as open and transparent as possible to withstand scrutiny and provide confidence in its outcomes, while maintaining confidentiality where necessary.
2. In accordance with Licence Condition C27 Part C, the ESO provides information to electricity transmission licensees, interconnector developers and to the Ofgem, if requested to do so. The ESO will assist TOs with cost-benefit analysis for LOTI or MSIP. Where appropriate the ESO can use the TCSNP results as part of a LOTI, MSIP or SWW initial Needs Case with the agreement of the relevant TO(s).

1.6 Key changes for 2023

1. Options considered in the background and HND integration

We will be focusing the scope of the CBA onto options that are required after 2030. Options previously studied in the NOA 2021/22 which have been classed as required for 2030 are not going to be re-assessed in the TCSNP options assessment and are assumed to be part of the network background that future options will build. The ESO believes that this is the strategic decision to streamline the delivery of works that are essential for GB over the next 7 years. Furthermore, the industry agreed with Ofgem to classify 10 critical projects as Accelerated Strategic Transmission Investment (ASTI) in 2022. These options will be handled on a project-by-project basis for their inclusion in the 2023 analysis.

2. Third party delivery and early competition

We have extended the chapter covering suitability for third party delivery and tendering assessment to include early competition assessments.

3. Recommendation changes from 2022 methodology being implemented in 2023

Following the consultation last year, we have amended the recommendations in the 2023 TCSNP report. We aim to support the TOs in delivering significant options in the most economic and efficient time. Therefore, we have revised the recommendations this year and this is explained in Chapter 2 section 2.4.

- a. Following discussions with Ofgem and DESNZ, the “Proceed – Maintain” recommendation will be given to options which are ‘Optimal’ within three years of the EISD, in at least two scenarios.

4. Interconnectors

We intend to develop NOA IC by building on the work undertaken for Ofgem’s Third Cap and Floor Window. This will include a focus on the impact of new interconnection at a regional level, covering thermal and other system operability costs, as well as social economic welfare, capital costs, carbon and RES integration costs.

5. Environmental and Community Assessment

As part of this analysis, we will be following the principles set out within the Pathway to 2030’s environmental assessment methodology. Further details of this can be found within the Environmental and Community assessment section within Chapter 2.

2

NOA Process Overview

2.1 Introduction

The Network Options Assessment (NOA) Methodology describes how we assess the required levels of power flow, evaluate the proposed options, and recommend network reinforcements for further development. These options are proposed by the TOs, Interested Persons and the ESO. The methodology describes the end-to-end process, from the analysis to the publication of the Transitional Centralised Strategic Network Plan (TCSNP), which contains the NOA outputs. It also outlines the roles and responsibilities of the Electricity System Operator (ESO), onshore Transmission Owners (TOs) and any interested persons (IP) that may participate in this.

In the transitional phase, the methodology also describes how the coordination of the offshore and onshore network design will happen.

Figure 2.1 - Overview of the NOA process

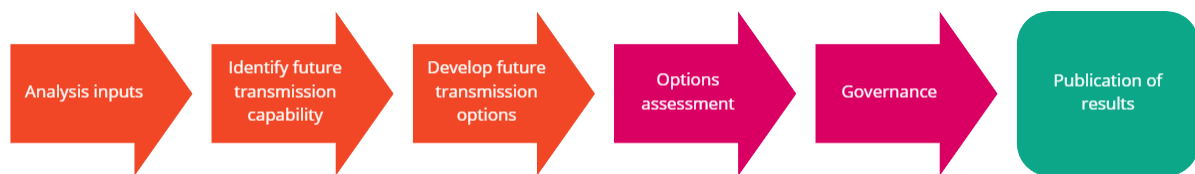

Note: The investment recommendations from our analysis are presented to the TCSNP Committee as an additional, transparent level of scrutiny to our recommendations.

2.2 Analysis inputs

2.2.1 FES generation and demand

1. The NOA process utilises the Future Energy Scenarios to form the background for the analysis. The FES model is subject to change based on stakeholder feedback received through the FES consultation process¹. The relevant set of scenarios as required by Electricity Transmission Standard Licence Condition C11, is used as the basis for each annual round of analysis. These provide self-consistent generation and demand scenarios which extend to 2050.
2. FES 2023 retains the scenario framework introduced for FES 2020 which reflects the UK net zero emissions target for 2050. As a result, it is based on the following scenarios which consider the rapid changes in the energy market. The last three achieve net zero by 2050 or earlier:
 - Falling Short
 - System Transformation
 - Consumer Transformation
 - Leading the Way

2.2.2 Offshore designs and the Holistic Network Design (HND)

1. The generation connections from the HND will be reflected through the scenarios used in this analysis, in the same manner as other generation.
2. Our analysis inherits the offshore design from the Pathway to 2030 outputs. The HND network will be deployed within each FES scenario differently in a similar way to offshore wind, for example.

1. ¹To keep up to date, please register for updates to the FES process.

2.2.3 GB modelling

1. The TOs submit power system models to the ESO for each year being modelled. The ESO uses these along with FES data to produce complete power system models of the GB network and shares these for analysis. Additional models and modelling information for different scenarios and network options are also submitted such that the ESO and TOs have adequate information to carry out the necessary option analysis.

2.2.4 Constraint cost modelling tool

1. The constraint cost modelling tool is used to forecast the constraint costs for different network states and scenarios. The high-level assumptions and inputs used in the tool are outlined in

Table 2.1 - Assumptions and input data for the constraint cost modelling tool

Input Data	Current Source	Description
Fuel price forecasts	FES	20-year forecast, varies by scenario
Carbon price	FES	20-year forecast
Plant efficiencies and season availabilities	FES	
Plant bid and offer costs	Historic data	See Long-term Market and Network Constraint Modelling ⁶
Renewable generation	FES	Wind, solar, and tidal profiles for zones around the UK
Demand data	FES	Annual peak and zonal demand
Demand profile	FES	Within year profiles
Maintenance outage patterns	Historic data - TO	Maintenance outage durations by boundary
System boundary capabilities	Power system studies - TO	See text
Reinforcement incremental capabilities	Power system studies - TO	See text

2. The model is set to simulate 365 days per year, 20 years into the future with an appropriate time resolution. The year in which an option is commissioned can be varied. The primary output from the tool for the cost-benefit analysis process is the annual transmission constraint forecast; there are further outputs that help the user identify which parts of the network require reinforcement.

2.3 Identify future transmission capability

2.3.1 Boundary capability assessment for options

1. The ESO and TOs complete boundary capability assessment studies to feed into the cost-benefit analysis process. The TOs submit the results of their boundary studies for their own areas with their SRFs. TOs study neighbouring areas to ensure TO coordination between base capabilities and options' uplifts for those that cross TO areas. The ESO may also perform studies of some of the same boundaries as the TO for the purpose of verification. For studies prior to the new SRF submission, the ESO studies reinforcements using information that the TO submitted the previous year. This assumes that many reinforcement proposals are the same or very similar from one year to the next. The TO will endeavour to provide any updates to the ESO on adjustments they make to their options that will allow the ESO to modify its studies. The ESO may perform studies concurrently with the TOs to cross-check some of the capability results, to the extent that the information on the options and any adjustments is available before the start of the economic analysis process. The ESO can ask the TOs for additional options if it finds that its studies highlight a need for further reinforcement.
2. The recommended HND and HND-FUE offshore network designs aligned to the FES generation background are to be included as part of in the background network. The capability of the offshore circuits is not to be added to the boundary capability as they will be included directly by the economic network assessment tools.

3. Thermal loading, voltage and stability boundary limitations are assessed to find the maximum boundary power transfer capability. The boundary capability is the greatest power transfer that can be achieved without breaching any NETS SQSS limitations. Sensitivities in background to represent different network conditions, such as interconnector flows, generation patterns or time of the year that may cause critical changes in boundary capability may be assessed separately.
4. Certain boundaries are classed as dynamic and have a capability that is dependent on the flow across an associated interconnector. The TO provides the boundary capability for each flow condition on this interconnector.
5. To minimise unnecessary repetition whilst maintaining robustness, winter peak network analysis is carried out under the scenario that will stress the transmission system the most. This scenario has the highest electrical load and generation and therefore gives us the required stress on the system to test our boundary capabilities. Where there are significant differences in network conditions, either between scenarios or in time, additional sensitivity analysis is undertaken where appropriate to understand any network capability impact. For the purposes of any stability analysis (where required), year-round demand conditions are considered. The secured events that are considered for these assessments are N-1-1, N-1 and N-D as appropriate in accordance with the NETS SQSS.
6. The analysis is done in accordance with the ETYS, NOA and TCSNP study guidelines which describes the constraint type, scenario, season, and the years for the network assessment. The ETYS, NOA and TCSNP study guidelines are governed by the STC.
7. For the boundary capability assessment, the baseline generation and demand dispatch conditions need to be altered to identify the maximum capability across the boundary. To make these changes, the generation and demand on either side of the boundary is scaled until the network cannot operate within the defined limits. The steady state flows across each of the boundary circuits prior to the secured event are summed to determine the maximum boundary capability.
8. The factors shown in Table 2.2 below are identified for each transmission solution to provide a basis on which to perform cost-benefit analysis at the next stage.

Table 2.2 - Transmission solution factors

Factor	Definition						
Output(s)	The calculated impact of the transmission solution on the boundary capabilities of all boundaries, the impact on network security						
Earliest in-service date (EISD)	The earliest year an option can be delivered and be operational.						
Cost	The forecast total cost for delivering the project, split to reflect the pre-construction and construction phases.						
Stage	The progress of the transmission solution through the development and delivery process. The stages are as follows: <table border="1" style="margin-left: 20px; width: 100%;"> <tr> <td colspan="3" style="text-align: center;"><i>Project not started</i></td> </tr> <tr> <td style="text-align: center;"><i>Pre-construction</i></td> <td style="text-align: center;"><i>Scoping</i></td> <td style="text-align: left;">Identification of broad Needs Case and consideration of number of design and reinforcement options to solve boundary constraint issues.</td> </tr> </table>	<i>Project not started</i>			<i>Pre-construction</i>	<i>Scoping</i>	Identification of broad Needs Case and consideration of number of design and reinforcement options to solve boundary constraint issues.
<i>Project not started</i>							
<i>Pre-construction</i>	<i>Scoping</i>	Identification of broad Needs Case and consideration of number of design and reinforcement options to solve boundary constraint issues.					

<i>Optioneering</i>	The Needs Case is firm; a number of design options being developed so that a preferred design solution can be identified.
<i>Design/ development and consenting</i>	Designing the preferred solution into greater levels of detail and preparing for the planning process including public consultation and stakeholder engagement.
<i>Planning / consenting</i>	Continuing with public consultation and adjusting the design as required all the way through the planning application process.
<i>Consents approved</i>	Consents obtained but construction has not started
<i>Construction</i>	Planning consent has been granted and the solution is under construction.

9. In order to assess the lead-time risk described in Table 2.2, the ESO will consider, for a project with significant consents and deliverability risks, both 'best view' and 'worst case' lead-times submitted by the TOs to establish the least regret for each likely project lead-time.
10. It is possible that alternative options are identified during each year and that the next iteration of the NOA process will need to consider these new developments alongside any updates to known transmission options, the scenarios, or commercial assumptions.
11. If the TOs decide that there are insufficient options to cover the boundary requirement, they initiate further work to identify reinforcement options. The TOs aim for at least three options for each boundary requirement. The TOs can submit long-term conceptual options to ensure that there are enough options. The long-term conceptual options are high level and are developed only as far as their boundary transfer benefits and initial estimate of costs. Power system analysis is not conducted on the conceptual options.
12. Where there are boundaries affecting more than one TO, the TOs should work together to determine the options for inclusion in the economic analysis and in the TCSNP outputs.
13. The TOs use their boundary capability results in the SRF Part D that they submit back to the ESO.
14. Where specific boundary capabilities are not provided for spring, summer, autumn, or outage conditions by the TOs the following winter adjustment factors, in Table 2.3, shall be used.

Table 2.3 - Seasonal boundary capability scaling.

Seasonal boundary capability scaling	
Spring and autumn thermal	85%
Summer thermal	80%
Summer outage thermal	70%
Summer outage voltage	90%

15. The ESO leads on commercial options in cooperation with the TOs. The economic analysis tool needs a MW value for the boundary capability which this analysis of commercial solutions must

provide. In addition, the ESO must provide ongoing costs for the economic analysis such as intertrip arming fees as well as any capital outlay such as the cost of designing/ installing the intertrip, if a commercial intertrip service is recommended to be developed.

2.4 Develop future transmission options

2.4.1 Major national electricity transmission system reinforcements

1. Standard Licence Condition C27 refers to '*Major National Electricity System Reinforcements*'. For this NOA Methodology statement, the definition, which has been agreed after consultation with the onshore TOs and the Ofgem is:
 - Major National Electricity Transmission System Reinforcements are defined by the ESO to consist of a 'project or projects in development to deliver additional boundary capacity or alternative system benefits as identified in the Electricity Ten Year Statement or equivalent document.'

2.4.2 Eligibility criteria for projects for inclusion or exclusion

1. The NOA report presents projects as options to reinforce the wider network that are defined by Major National Electricity System Reinforcements (see definition above).
2. The ESO provides a summary justification for any projects that are excluded from detailed NOA analysis.
3. Once a Medium Sized Investment Project (MSIP), Large Onshore Transmission Investment (LOTI) or Strategic Wider Work (SWW) needs case has been approved by Ofgem, the option is excluded from the NOA analysis although the report refers to it and it is included in the baseline. This is due to it being managed through the separate MSIP, LOTI or SWW process. Ofgem have agreed the approach of excluding options where they have already agreed the LOTI or SWW Needs Case. The NOA report will include analysis of options under construction that are funded through the incremental wider works (IWW) mechanism.
4. TCSNP will be focusing on the network needed for HNDFUE therefore, will be assessing projects that have an EISD of 2031 and beyond. The ESO will determine which projects will be reassessed and which ones will be excluded from the assessment, thus not changing their recommendation from the July 2022 NOA Refresh. Following approval from Ofgem these projects will be considered part of the base network.
5. All options with an EISD beyond 2031 will be reassessed unless they are part of the Acceleration of Strategic Transmission Investment (ASTI) framework. If a project is within the ASTI framework, the ESO will review on a project-by-project basis to determine if the option must be reassessed or excluded from this analysis.

2.4.3 Options development

1. All the high-level transmission reinforcement options which may provide additional capability across a system boundary requiring reinforcement (using "economic and security criteria") are identified, including a review of any options considered in previous years.
2. There might be variations in reinforcements for instance between different OHL routes where they could provide very different timescales and costs, due to planning and consents.
3. In response to the data on boundary capabilities and requirements, TOs identify and develop multiple credible options that deliver the required boundary capabilities. The ESO produces and circulates the SRF Part A (Appendix C/ Figure C1) to the TOs and publishes them on the ESO website for Interested Persons. In response to Part A, TOs provide high level details of credible reinforcement options that are expected to satisfy the requirements. Appendix C of this document provides detailed information about the SRF template. The SRF is split into six parts with a guideline on when the TO is required to complete and return each part.
4. The ESO can suggest concepts to the TOs to create new options to achieve the boundary requirements.
5. Interested Persons may also propose options for assessment through the Interested Persons' process. Further detail on this can be found in the Interested Persons' chapter 6 of this methodology.
6. As part of the process to identify future transmission options, the ESO will develop alternative options in collaboration with the relevant TO (and the relevant affected parties if applicable). The

ESO will provide information about network benefit of proposed alternative options and identify regions that might benefit from alternative options. Appendix B/ Table B1 provides examples of alternative options. The TOs can shadow the analysis performed by the ESO in their relevant networks. The ESO and TOs will agree a detailed assessment methodology appropriate to each option. To facilitate the development of these options, the TOs are expected to provide network information such as limiting trips and components, existing communication and control assets, and information on feasibility of alternative running arrangements.

7. As options develop, their level of detail and design confidence tends to increase. In the early stages, alternative options developed by the ESO will be high level based on the best available information and will not assume availability of market data. The assumptions for each option will be agreed with the relevant TO while developing the option. The assumptions regarding EISD, required infrastructure, cost and effectiveness will vary depending on the studied region. Similarly, 'build' and 'reduced-build' options at a very early development stage might lack detail due to uncertainty in detailed project design such as land and consents requirements.
8. If the alternative option proves beneficial in the cost-benefit analysis, the ESO will investigate the market to further develop the options. The ESO will use its existing Network Services Procurement projects or establish new ones, if necessary, to perform more detailed analysis to deliver these options. The ESO will share details of the technical and economic assessment approach with TOs, DNOs, and Third parties as we develop the Network Services Procurement projects. The TOs, DNOs, and third parties will collaborate with the ESO to undertake technical analysis of relevant solutions/options to confirm their effectiveness as well as to determine any works required on the TO/DNO network to facilitate these solutions. The TOs and DNOs will also provide the ESO with details of associated costs and programme details for TO and DNO works.
9. The TOs return certain draft SRF sections around a month before final versions according to the timeline described in Appendix D that's agreed between the ESO and TOs for the year's programme for the ETYS and NOA. The drafts' timing is to support the ESO's verification studies and cost checking process. The SRF sections form the key inputs to the cost-benefit analysis process.
10. Where an option affects an adjacent TO, the TOs and ESO coordinate their views on the reinforcement options and produce an agreed set of options by an agreed point in the year's programme. The ESO uses the agreed set of options in its economic analysis and might use the options in its verification studies. Where an option affects more than one TO and the TOs do not agree, the ESO decides which options it assesses.
11. Once the TOs have returned the SRF Parts A to E, the ESO reviews the data and understands the costs by discussing them with the TOs. Through engagement, the ESO presents the data that it plans to use in the economic studies.
12. The ESO and TOs agree the combinations of options that the ESO will use in the cost-benefit analysis.
13. A non-exhaustive list of potential transmission solutions is presented in Appendix B/ Table B1. A wide range of options is encouraged including, where relevant, any innovative solutions and options suggested by other interested persons.
14. It is intended that the range of options identified has some breadth and includes both small-scale reinforcements with short lead-times and larger-scale alternative reinforcements which are likely to have longer lead-times. The ESO applies a sense check in conjunction with the TOs and builds an understanding of the options and their practicalities. In this way, the ESO narrows down the options whilst allowing assessment of the most beneficial solution for consumers. Other than the application of economic tools and techniques, to refine a shortlist of options or identify a potential recommended option, the ESO relies on the TO for deliverability, planning and environmental factors.
15. TOs must submit the equipment outages required to deliver each reinforcement option in the SRF. The information required per option is:
 - a. the circuit or apparatus that needs to be on an outage and the required duration of the outages (in weeks) in each calendar year if the option is to be delivered on its EISD;
 - b. the number of distinct calendar years that the outage works take place in;
 - c. and clashes with other options.

The schemes will be assessed initially based on the outage schedule provided by the TOs. However, there will be a further optimisation of outage dates and EISD to ensure economic value.

16. When developing the outage requirements TOs must consider the results of the previous year's NOA report. The outage requirements of all the options need to be considered in a coordinated way such that the optimal years and the recommendations for the options that were found to be optimal in the previous year's NOA can be adhered to if possible.

2.4.4 Basis for the cost estimate provided for each option

1. The forecast cost is a central best view. By an agreed point some weeks before the SRF submissions and included in the year's plan, the TOs and ESO agree each year the cost basis to be used for NOA analysis. The information that will have to be agreed includes but is not limited to:
 - price base, that is the financial year of the prices and should be current year prices.
 - annual expenditure profile reflecting the options' earliest in service dates.
 - delay costs.
 - the TO's Weighted Average Cost of Capital (WACC).

2.4.5 Checks of the costs that the TOs submit

1. The ESO reviews the costs that the TOs submit via the SRF for each of their options and checks if they are reasonable. This is to ensure high quality data goes into the NOA process. The data is also used for assessing their eligibility for competition. Consenting costs are submitted through the same process but are made distinct from the construction costs.
2. The ESO checks the costs that the TOs submit against a range of data available. For similar plant and equipment, the ESO also uses knowledge gained from its own research using public resources. If any costs are outside of the range, the ESO will investigate it by asking more detailed information from the TO. If following discussions, the ESO still believes that the costs are outside of the expected range and will unduly affect the economic analysis, the ESO can omit the option from the economic analysis.
3. The costs check process the ESO follows is described in Appendix E.

2.4.6 Environmental and Community impacts and risks of options

1. As the TOs design and develop their options, their understanding of the environmental impacts of options improves. Where appropriate, the TO indicates options that are relatively immature, which helps to highlight where the environmental impact needs further development. The ESO gives a similar indication on options that it is leading. As the TSCNP is the first step in an analysis of the need for reinforcement of the national electricity transmission system, it cannot provide a final environmental assessment of those options. The TO will take any appropriate and timely environmental considerations into account as part of their investment process and according to relevant planning laws.
2. Different planning legislation and frameworks apply in Scotland from those in England and Wales and some reinforcements cross more than one planning framework. The TOs have the specialist knowledge for planning and consents and provide the relevant commentary.
3. The TOs provide views on the environmental impact of the options that they have proposed, in accordance with the ESO's onshore assessment methodology. The ESO uses this information to help understand the environmental, social and community challenges of proposed options, and while the information does not form part of the economic analysis, it's possible that an option (or specific combination of options) is omitted because of the assessment.
4. Both environmental and community impacts will be assessed together prior to and during the economic analysis to understand the overall impact of options. This can also be provided to the committee to help inform their decision, as detailed in section 2.6.
5. Options that have high certainty of environmental and community challenges will not be progressed in the analysis at this stage and the marginal options will be taken to the governance meetings to decide how they should be progressed.
6. As part of this analysis, we will be adopting the principles set out within the Pathway to 2030's environmental assessment methodology.

2.4.7 Deliverability and operability of options

1. The ESO is investigating a method of assessing the deliverability and operability of options within the NOA analysis.

2.4.8 ESO assessment of options' outage requirements

If the following criteria are met then the process below will be used for receiving detailed outage requirement data from the TOs and for identifying the resulting delivery interactions and restrictions:

- a) the detailed outage requirements of the assessed options (or a group of options) can be determined with a reasonable degree of confidence.
 - b) there is scope for the economic analysis to consider the impact of outages in the optimal years of the reinforcements and NOA recommendations.
1. ESO access planning assessment aims to identify the interactions that exist between the outage requirements of NOA options and other scheduled works or between the requirements of different NOA options. The assessment considers the NOA options' outage requirements submitted in SRF Part C together with the most recent long-term outage plan submitted by the TOs to the ESO Network Access Planning team. It takes place after the Final SRF Part C submission.
 2. In more detail, the assessment will identify the interactions a) between outages required for the delivery of customer connections projects, asset maintenance or other works, and b) between outages required for the delivery of the NOA options.
 3. The assessment will thus produce two sets of restrictions for each NOA option:
 - a. available years and;
 - b. NOA-to-NOA options outage conflicts.

The first term aims to capture the interaction between each NOA option, and the works specified in paragraph 2a. The second aims to capture interactions between the different NOA options.
 4. The default position during the assessment is that customer connection works take priority ahead of NOA works and that NOA works take priority ahead of asset maintenance or other works.
 5. ESO shares the output of the initial analysis with the TOs. The shared output is the identified interactions (paragraph 2) and the resulting restrictions (paragraph 3).
 6. TOs must review the identified interactions and the resulting restrictions and raise a query for any request for amends within two weeks. A separate query should be raised by the TO for each considered option.
 7. TOs must include in each query the justification for the requested amend. The justification can include any of the following but not limited to: why the TO believes that the identified interactions should be amended or why the identified interactions could be effectively resolved by the time construction for the option begins. TOs can also include revised outage requirements in their query.
 8. If no query is received for an option, the output of the ESO access planning analysis for that option will be used in the CBA.
 9. The ESO will examine each query separately and consider any amends to the identified interactions based on the data or justification provided by the TO. If applicable, the ESO will update the resulting restrictions for the considered options.
 10. Following any TO query and the response from the ESO no further change in outage requirements should be considered for the current NOA CBA cycle.
 11. The ESO will respond to all queries within two weeks of the date that the last TO query was received.

2.5 Options assessment

2.5.1 Cost-benefit analysis

1. Cost-benefit analysis compares forecast capital costs and monetised transmission benefits over the project's life to inform this investment recommendation.
2. The NOA provides investment recommendations based on the Single Year Regret Decision Making process. If the ESO's NOA recommendation is to "Proceed - Critical" and triggers a LOTI / MSIP for a RIIO Needs Case, the ESO will assist the TOs to produce a Needs Case by undertaking a more detailed cost-benefit analysis.
3. The purpose of the Single Year Regret Decision Making process is to inform investment recommendations regarding wider transmission works for the coming year. The main output of the process is a list of recommended wider works reinforcement options to receive either a "Proceed - Critical" recommendation or a "Proceed - Maintain" recommendation for the next year. A secondary output is an indicative list of which options would be proposed at present if each of the scenarios were to turn out.

4. The methodology for a LOTI cost-benefit analysis follows the Large Onshore Transmission Investments (LOTI) Re-opener Guidance document published by Ofgem⁴. A Needs Case is submitted by the TO that proposes the option to the regulator, and which includes a cost-benefit analysis section that outlines the financial case for the option. The output of this process is a recommendation for the option to progress.

2.5.2 Methodology

1. When the number of transmission system reinforcement options proposed is quite large, the country may be split into regions and each option is primarily allocated to one of the regions. The cost-benefit analysis process for each region is conducted in isolation. The annual boundary capability outside the region is fixed to a pre-determined value, which may vary by scenario. This is usually based upon the recommendations of the most recent NOA report. The size and extent of a region (that is where region dividing lines are drawn) may change from year to year.
2. All the scenarios are considered; it is usual for sensitivities to be considered as described previously. Each scenario is studied in isolation; Each scenario is studied, and the process is repeated (in parallel since there is no dependency) for the other scenarios. The process is iterative and involves adding a single reinforcement at a time and then evaluating the effect that this change has had on the transmission constraint cost forecast.
3. To begin the process, all proposed options within the region are disabled, the output of the model is analysed to determine which boundaries within the region require reinforcement and when the option is required, this simulation is referred to as the base case. It is used to determine which option(s) should be evaluated first. The option that has been selected to be evaluated next is then activated in the constraint cost modelling tool (see *Table 2.1* for a description) at its EISD. If a number of potential options have been identified as being candidates for the next option, then this process must be repeated with each option in turn. There are now two sets of constraint cost forecasts, the base case, and the reinforced case, which are compared using the Spackman⁵ methodology.
4. It is assumed that each transmission asset is to have a 40-year asset life. Since the constraint cost modelling tool only forecasts for the next 20 years the constraint costs for each year after that are assumed to be identical to the final simulated year (note that this limitation occurs because the scenarios do not contain detailed ranking orders beyond 20 years). Constraint cost forecasts are discounted using HM Treasury's Social Time Preferential Rate (STPR) to convert the forecasts into present values. The capital cost for the option is amortised over the asset life using the prevalent WACC and discounted using the STPR. This value is added to the constraint cost forecast for the reinforced case. The present value of the base-case GB transmission constraint cost is then compared to the present value of the reinforced-case constraint cost plus the amortised present value of the capital costs to give the net present value (NPV) for this option.
5. This cost-benefit analysis process is carried out in a separate comparison tool which also automatically calculates the NPVs if the option being evaluated were to be delayed by a number of years. This list of NPVs allows the optimum year for the option, for the current scenario, to be calculated. If a number of alternatives have been identified, then the option that has the earliest optimum year should usually be chosen. The chosen option is then added to the base case and another option is chosen for evaluation. The process is then repeated until further options produce a negative NPV (which would indicate that the capital cost of the option exceeds the saving in constraint costs). There may be an element of branching if it is not immediately obvious during the process which option should be chosen to be added to the base case at any given point.
6. The cost-benefit analysis considers the outage restrictions when deciding the optimal delivery years of the options. The delivery years are chosen so that the combined economic benefit of all the options that were found to be required in each scenario is maximised in the presence of the identified interactions and resulting outage restrictions.
7. The outcome of this process is a list of reinforcement options, for the current region and scenario, and the optimum year for each. This is referred to as a 'reinforcement profile'.

8. Once the reinforcement profile for each scenario within a region has been determined the 'critical' options for that region may be chosen. The definition of a 'critical' option has some flexibility, but the definition below must be considered.
9. An option's recommendation is 'critical' if its optimal year is in line with its earliest in-service date under at least one scenario.
10. To align with the Treasury Green book, the cost of carbon will be considered within the economic benefit for options that reduce carbon emissions, through the enablement of low-carbon generation. This could result in stronger recommendations for options which lower GB's carbon intensity.

2.5.3 Selection of recommended options

1. At this point, all the economic information available to assess the options is in place. The ESO then uses the Single Year Least Regret analysis methodology to determine which options will receive 'Proceed – Critical' or 'Proceed – Maintain' recommendation.

2.5.3.1 Single year least regret decision making

1. The single year least regret methodology is to facilitate the decision making for options critical in some scenarios but not in all scenarios. It involves evaluating every permutation of the critical options in the first year (the year beginning in April following publication of the NOA report). For each critical option, there are two possible recommendations:
 - a. "Proceed - Critical" recommendation for the option to be delivered on its EISD;
 - b. "Proceed - Maintain" recommendation for the option to be delivered up to three years after its EISD.
2. Critical options that are recommended to be delivered more than three years after it's EISD are given a 'Hold' recommendation.
3. Options that are not found to be optimal are given a 'Do not start' or 'Stop' recommendation. It is assumed that information will be revealed such that the optimal steps for a given scenario can be taken from year two onwards – so only the impact of decisions in the first year are evaluated. If there is more than one critical option in the region then the permutations of options increase; the number of permutations is equal to 2^n , where n is the number of critical options.
4. Each of the permutations has a series of cost implications. These are either additional capital and constraint costs if the option is delayed (and further additional costs if the option is restarted at a later date) or inefficient financing costs if the project is progressed too early.
5. For each permutation and scenario combination the present value is calculated, taking into account operational and capital costs. For each scenario one of the permutations will have the lowest present value cost; this is set as a reference point against which all the other permutations for that scenario are compared. The regret cost is calculated as the difference between the present value of the permutation for a scenario and the present value that is lowest of all permutations for the scenario. This results in one permutation having a zero-regret cost for each scenario.
6. The following section is a worked example of the least regret decision making process. Two options have been determined to be 'critical' in this region, the EISD for option 1 is 2023 and the EISD for option 2 is 2024. The optimum years for scenarios A, B and C are shown in Table 2.4 Note that the scenarios are colour-coded; this is used for clarity in the following tables.

Table 2.4 - Example of optimum years for two critical reinforcements

Scenario	Option 1	Option 2
A	2023	2024
B	2023	2025
C	2028	Not Required

Table 2.5 - Example decision tree

Permutation	Year 1 Recommendations	Completion Date	NPV	Regrets	Worst regret for each permutation
-------------	------------------------	-----------------	-----	---------	-----------------------------------

1	"Proceed - Critical" Option 1 & "Proceed - Maintain" Option 2	Option 1: 2023 Option 2: 2025	£149m	£51m	£51m
		Option 1: 2023 Option 2: 2025	£100m	£0m	
		Option 1: 2027 Option 2: Cancel	£145m	£5m	
2	"Proceed - Maintain" Option 1 & "Proceed - Critical" Option 2	Option 1: 2024 Option 2: 2024	£98m	£102m	£102m
		Option 1: 2024 Option 2: 2025	£65m	£35m	
		Option 1: 2028 Option 2: Cancel	£140m	£10m	
3	"Proceed - Critical" Option 1 & "Proceed - Critical" Option 2	Option 1: 2023 Option 2: 2024	£200m	£0m	£15m
		Option 1: 2023 Option 2: 2025	£98m	£2m	
		Option 1: 2028 Option 2: Cancel	£135m	£15m	
4	"Proceed - Maintain" Option 1 & "Proceed - Maintain" Option 2	Option 1: 2024 Option 2: 2025	£47m	£153m	£153m
		Option 1: 2024 Option 2: 2025	£68m	£32m	
		Option 1: 2027 Option 2: Cancel	£150m	£0m	

7. Table 2.5 is an example of a least regret decision tree, since there are two 'critical' options there are therefore four permutations. From Year 2 onwards for each of the permutations the options are commissioned as close to the optimum year for each option for each scenario. For each scenario one of the four permutations is the optimum and therefore there is one £0m value of regret for each scenario. The table's NPV column indicates the net present value for each of the permutations in each of the scenarios.
8. The causes of the regret costs vary depending upon the optimum year for the reinforcement and scenario:
 - If the option is delayed and cannot meet the optimum year, then additional constraint costs will be incurred.
 - If the option is delayed unnecessarily then there will be additional delay costs.
 - If the option is progressed too early, then there will be inefficient financing costs.
 - If the option is progressed and is not needed, then the investment will have been wasted.
9. The regret costs for each permutation under all scenarios are then compared to find the greatest regret cost for each permutation. This is referred to as the worst regret cost. The permutation with the least 'worst regret' cost is chosen as the recommended option and appears in the report's investment recommendation. In the example shown above the least 'worst regret' permutation is to give a "Proceed - Critical" to both options 1 and 2 which has a worst regret of £15m and is the least of the four permutations.
10. As the scenarios represent an envelope of credible outcomes it is possible that a reinforcement option is justified by just one scenario which doesn't always guarantee efficient and economic network planning if industry evolution were to follow a different path. In this event, the ESO would examine the single year regret analysis result to establish the drivers and then examine the scenario further. How we do this varies but an example would be to consider the sensitivity of the cost-benefit analysis to specific inputs. This informs our view on the robustness of the outcome and thus whether to make a recommendation based upon this scenario. The ESO supports all the TOs in this manner to optioneer and develop their projects to minimise the cost such as reducing any frontloading of expenditure if there is doubt about the need for the reinforcement option or downgrading the importance of the investment completely. The ESO

examines any sensitivity studies in the same way to ensure that none skew the results unfairly. For example, if a change in policy were to occur after the publication of the FES document, significant amounts of generation in the scenarios may be affected and their connection may then be delayed or unlikely to go ahead. We would flag this kind of background update and identify in the single scenario driven investments where this is likely to be creating a skewed outcome.

Figure 2.2 - Flow diagram of the decision tree for recommendations

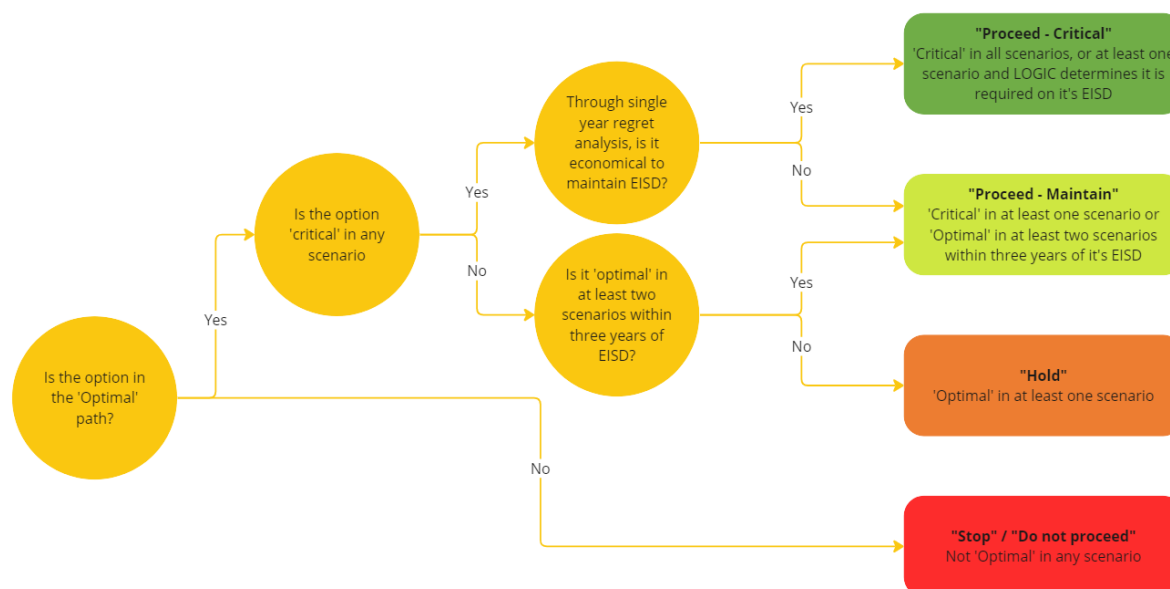

2.5.3.2 Probability Analysis - Least Worst Weighted Regret (LWWR)

1. The effect of varying the probability of each scenario occurring is also explored using the technique called Least Worst Weighted Regret (LWWR).
2. The LWR technique assumes that each scenario is equally likely to occur. The ESO does not assign probabilities to any of its scenarios, however, LWWR provides us with a technique to explore the effect of varying the probabilities. This is particularly useful when regrets between various options are close. This can be used to see how stable a solution is to changes in the probabilities occurring, and hence aid in the discussion of particular options.
3. The LWWR technique works by taking the initial LWR results, which have implicit 0.25 weighting for each scenario, then changing these weightings between 0 and 1 for each scenario individually and performing the LWR technique at every possible permutation of weightings. At each permutation the option with the least worst regret is found, allowing us to see which options provide the least regret at every possible combination of weightings.

2.5.4 Sensitivities

1. Sensitivities are used to enrich the analysis for particular boundaries to ensure that relevant boundary issues are captured, such as the sensitivity of boundary capability to the connection of a large generator or interconnector power flow condition. The ESO and TOs use a Joint Planning Committee subgroup as appropriate to coordinate sensitivities. This allows regional variations in generation activity and anticipated demand levels that still meet the scenario objectives to be appropriately considered.
2. For example, the contracted generation background on a national basis far exceeds the boundary requirements under the four main scenarios, but on a local basis, the possibility of the contracted generation occurring is credible and there is a need to ensure that we are able to meet customer requirements. A "one in, one out" rule is applied: any generation added in a region of concern is counter-balanced by the removal of a generation project of similar fuel type elsewhere to ensure that the scenario is kept whole in terms of the proportion of each generation type. This effectively creates sensitivities that still meet the underlying assumptions of the main scenarios but accounts for local sensitivities to the location of generation.
3. The inclusion of a local contracted scenario generally forms a high local generation case and allows the maximum regret associated with inefficient constraint costs to be assessed. In order to ensure that the maximum regret associated with inefficient financing costs and increased

risk of asset stranding is assessed; a low generation scenario where no new local generation connects is also considered. This is particularly important where the breadth of scenarios considered do not include a low generation case.

4. Interconnectors to elsewhere in Europe give rise to significant swings of power on the network due to their size and because they can act as both a generator (when importing energy into GB) and demand (when exporting energy out of GB). For example, when interconnectors in the South East are exporting to mainland Europe, this changes the loading on the transmission circuits in and around London and hence creates different boundary capabilities.
5. The ESO models interconnector power flows from economic simulation using a market model of forecast energy prices for GB and European markets. The interconnector market model covers full-year European market operation. The results of the market model are then used to inform which sensitivities are required for boundary capability modelling. Sensitivities may be eliminated for unlikely interconnector flow scenarios.
6. The ESO and TOs extend sensitivity studies to test credible conditions that may cause constraints. FES data tends to produce boundary flows in one direction, such as north to south. In some circumstances, flows may be reversed. The ESO develops relevant sensitivities in consultation with stakeholders to produce boundary capabilities for these sensitivity cases.
7. The resulting boundary capabilities from sensitivity studies are used by the constraint cost modelling tool to forecast the constraint costs for different network scenarios.
8. Storage, hydrogen electrolysis and other whole system solutions can also be considered as part sensitivity analysis by varying the volume and location of their deployment.

2.5.5 Options analysis outputs

1. Following Single Year Regret analysis, a list of investment recommendations for the region is presented.
2. The NOA process output recommendations are described below:
 - **“Proceed - Critical”**: This option is critical to our future planning. Investment should be made in the next financial year to ensure the option’s earliest in-service date remains on course.
 - **“Proceed – Maintain”**: This option is important and recommended soon after its earliest-in-service date. Investment can be made in the next financial year to maintain project momentum and ensure its earliest-in-service date is delayed by at most one year.
 - **“Hold”**: This option is important and recommended for the future, however it is not on the earliest-in-service date submitted to NOA. Therefore, the delivery date of this option can be delayed by at least one year and the option can be reviewed in the next NOA cycle.
 - **“Stop”**: This option is not currently recommended within the optimal path of any scenario; delivery should be stopped and not be continued.
 - **“Do not start”**: This option is not currently recommended within the optimal path of any scenario; delivery work should not begin.
3. If despite the process described in section 2.4.8, the optimal year for one or more options is primarily and adversely affected by the outage requirements the ESO will bring the options to the attention of the TCSNP committee. The ESO will present evidence to the Committee including: the outage interactions or restrictions that influenced the results; the expected economic impact and the steps taken during the process described in paragraphs 1 to 11 in Section 2.4.8 by the relevant TO if applicable. The ESO may request that the TO also provides evidence or technical details.
4. The ESO uses the output from the single year least worst regret analysis for the recommendation on whether a reinforcement option should receive a “Proceed - Critical” under the England and Wales Network Development Policy (NDP) framework.
5. If the investment signal triggers the TO’s Needs Case, the ESO will assist the TO in undertaking a more detailed cost-benefit analysis. The ESO reconciles the results of the regret analysis and any other drivers such as NETS SQSS, Chapter 4, as mentioned previously in the section on sensitivities before making a final recommendation.
6. If a TO does not follow a NOA recommendation, it must inform the ESO at the earliest opportunity and tell the ESO about the effect on the option’s EISD. If the TO has discretion over the change, it should fully involve the ESO in the decision process. The TCSNP Committee will monitor the process and the outcome.

2.5.6 Clean Energy Package

1. EU/2019/943 Article 13 paragraph 5 of the Clean Energy Package covers the proportion of renewable generation being dispatched and redispatched in each year. There are two routes to compliance:
 - Have total energy volumes of more than 50% renewables (including high efficiency cogeneration), or
 - Redispatch less than 5% renewable energy volumes (excluding high efficiency cogeneration).
 - We operate the NOA to meet this Clean Energy Package requirement as described below.
 - For each scenario, we extract from the constraint cost modelling tool the total energy volumes (TWh) for each year. We check the proportion of generation that meets the renewables criteria (under article 13, this includes high efficiency cogeneration, HEC) and record its value.
 - For years and scenarios where this value exceeds the 50% threshold, the network is compliant with article 13, paragraph 5.
 - For years and scenarios where the value falls below the 50% threshold, we take a further step described below.
 - For years and scenarios where the renewable volume (with HEC) falls below 50%, we extract the details of redispatched plant from the constraint cost modelling tool and record by fuel type. For years and scenarios where the redispatched volume comprises more than 5% renewables (this figure excludes HEC), we investigate the reinforcement profiles to see if changing the proposed reinforcements changes the plant and/or volume redispatched. The aim of this step is to bring the volume of redispatched renewables below the 5% threshold. We note the instances where amending the reinforcement profile is needed to meet the threshold in the NOA report. As compliance with article 13, paragraph 5 can also be achieved through mechanism outside of the NOA (broadly policy, or regulatory changes), and there may not be sufficient effective reinforcements in the NOA to achieve compliance, the situations where we do not meet the threshold will also be noted as appropriate in the NOA report. We will use the TCSNP Committee as our governance mechanism, as detailed in the Governance section (section 2.6).

2.5.7 Network competition

1. The ESO assesses options against early and late competition criteria that have “Proceed – Critical” recommendations and in some instances other recommendations. Chapter 4 of this methodology describes the ESO’s process to assess eligibility. The early competition eligibility process includes assessing the costs and benefits of tendering.

2.5.8 EISD Advancement Benefit

1. The EISD advancement benefit is to support a substantial reduction in network constraint costs and is an outcome of the 5-point plan Reinforcement options are shortlisted that would provide significant constraint cost savings from earliest in-service date (EISD) advancement. The purpose of this exercise is to stimulate early delivery, or at least highlight the importance of delivering schemes on their published earliest in service date. The results of the analysis are shared with the relevant TO but not included in the report.
2. The options for EISD advancement are selected individually by identifying bottlenecks to providing higher capability using our standard NOA toolset. These tools not only report boundary bottlenecks but also the cost associated with resolving these constraints. To be a candidate for advancement, the option being considered should have precursor reinforcements with earlier EISDs, such that bringing them forward poses no knock-on advancement of other options.
3. As an example, consider a path that has three reinforcements A, B, C, and A and B could be built in 2029, but C had an EISD of 2030, after B is built, we have to wait until 2030 before C can be built providing the next uplift. It is noted that C relieves several boundary constraints, causing constraint costs to decrease significantly. As such C would be identified as a potential candidate for advancement to 2029.
4. To establish the benefit of advancing schemes one or more years earlier than the EISD requires input including the capability that the scheme releases on boundaries and capital costs associated with delivering the scheme to this earlier year. To establish this for every scheme

requiring assessment would be resource intensive, and therefore a method that utilises existing data from the main TCSNP process was created. The following diagram highlights the main steps.

Figure 2.3 - Method for approximating EISD advancement benefit

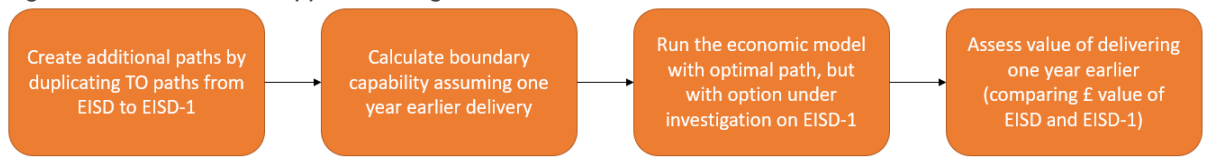

5. Additional paths are added representing the capability released on each boundary by a scheme. The capability values are obtained from the EISD year's capability value, essentially duplicating this to a year earlier. This method focusses on quantifying the approximate constraint cost saving, and therefore other factors are considered equal.
6. Using these updated capability values an economic market simulation is performed to determine constraint costs. The potential benefit of bringing an option forward by one year is then calculated as the difference between constraint cost where the option is delivered on its EISD versus delivery one year earlier.
7. The findings are then communicated to the relevant TO who can then use the evidence to either advance the option or to maintain an option on its EISD in the case where conflicting issues may cause delay.

2.6 Governance

1. The ESO has created the TCSNP Governance Committee to challenge the single year regret recommendations developed under this methodology. The Committee's remit is to allow the ESO to review the investment recommendations that are marginal, or risk being driven by a single scenario. This will seek to identify any 'false-positive' investment recommendations that could come about as a result of the single year regret process and ensure that the recommendations are justified. In addition, the Committee will ensure the recommendations are supported by the holistic needs of the system which include environment and community considerations as described in section 2.4.
2. The Committee consists of ESO senior management who will challenge the robustness of the investment recommendations as well as provide holistic energy industry insight and consider whole system needs to support or revise the marginal investment recommendations. Ofgem and DESNZ can also be present as observers to represent the consumers' interests and provide regulatory oversight, as well as understand the driving factors behind recommendations. In preparation for the Committee meeting, the ESO will discuss the single year regret outputs with internal stakeholders and the TOs to ensure the final recommendations are robust. The TOs are invited to attend the TCSNP Committee to provide supporting evidence as the committee requires while maintaining the necessary commercial confidentiality.
3. The guiding principle behind the TCSNP Governance Committee is that, on the marginal decisions the Committee reviews, the members should advise the investment recommendation they believe is most prudent, on the balance of evidence. This means that they believe, on the balance of probabilities, the recommendation ("Proceed - Critical", "Proceed - Maintain" or "Hold") is the best course of action for the GB consumer. This will take into consideration the many facets of the decision including, but not limited to: forecasted constraints in the scenario(s) advocating the option; the drivers behind the investment recommendation (e.g. specific generation build-up) and the latest market information on those drivers; what the regret is across the other scenarios; what next year's expenditure is acquiring and what it will achieve (e.g. will the expenditure allow the TOs to learn more about the option); what the implied scenario weight of the decision is (that is what probability would have to be placed on the driving scenario to make the same decision under expected net present value maximisation); wider system operability considerations including the availability of commercial solutions to congestion issues; and potential environmental and community impacts. The committee members should seek to have a risk-neutral outlook in their deliberations, that is they should

seek to make decisions dispassionately, and on the balance of evidence, bearing in mind as much as possible the likelihood of future events.

4. The Committee's aim is to reach a consensus on the marginal options. The outcomes will be recorded in minutes, and which will show the rationale behind the recommendations and highlight the challenges raised. The minutes will be made available to Ofgem and the TOs and published on the TCSNP webpage. Commercially sensitive information will be redacted from the published version.
5. Options that have high certainty of environmental and community challenges will not be progressed in the analysis at this stage and the marginal options will be taken to the governance meetings to decide how they should be progressed.
6. If deemed necessary, industry experts may be invited to consult on the committee process on specific topics.
7. Engagement on matters relating to TCSNP with other fora may be undertaken as agreed with DESNZ, Ofgem and the TOs. This will likely include engagement at a senior level for consideration of the results prior to publication. Where appropriate, Terms of Reference will be produced for these meetings.

2.7 Publication of results

1. The NOA report covers the recommendations from our analysis along with appropriate supporting background information and consideration of the HND network but maintains appropriate commercial confidentiality. We draft the report in accordance with the agreed timeline which includes governance. The form of the report is covered in Appendix F and is subject to consultation and to Ofgem approval.
2. The ESO will publish the TCSNP report by 31 December this year or as instructed otherwise by Ofgem.
8. On publication, the report is placed on the National Grid ESO website in a printable format. The ESO also provides a copy on request and free of charge to anyone who asks.
9. The NOA report includes the options that the TOs provide along with ESO alternatives such as commercial options.

3

Network Options Assessment for Interconnectors

3.1 Overview

1. This chapter provides an overview of the aims of the NOA with respect to interconnectors and details the methodology which the ESO will adopt for the analysis and publication within the TCSNP report (to be published in 2023).
2. Since the publication of the first NOA (2015/16), we have developed the NOA for Interconnector (NOA IC) methodology for each year. We wish to continue to develop the NOA IC methodology so that we produce an analysis that continues to be of increasing value for our stakeholders.
3. In August 2020, Ofgem launched an interconnector policy review (ICPR)², to review their regulatory policy and approach to new electricity interconnectors. Following a review of the consultation responses and additional evidence, Ofgem decided to open the Third Cap and Floor Window investment round in mid-2022.
4. Ofgem want future interconnector investment rounds to be more targeted than previous cap and floor application windows. This aims to incentivise projects that are most likely to be in the interest of consumers and have a high chance of deliverability.
5. To support Ofgem's Third Cap and Floor Window we have undertaken new forward-looking analysis on the system need for new interconnection, from a system operability perspective, on a regional basis across Great Britain. We plan to build on this analysis and incorporate some of the techniques into subsequent NOA for Interconnectors work, such as undertaking a regional analysis of the optimal location of new interconnection from a thermal and system operability perspective.
6. The primary purpose of NOA IC will continue to be to provide a market and network assessment of the optimal level of interconnection capacity to GB. This is undertaken by evaluating a range of factors, including socio-economic welfare, that is the overall benefit to society of a particular option, as well as constraint costs and capital expenditure costs. Carbon costs and Renewable Energy Sources (RES) curtailment levels will also be assessed.
7. NOA IC does not attempt to assess the viability of current or future projects: the final insights are largely independent of specific projects currently under development and NOA IC does not provide any project-specific results.
8. Previous NOA IC analyses only considered point to point interconnection between GB and potential European connecting countries. However, the potential for multi-purpose interconnectors (MPIs), or hybrid interconnectors, that may include connections to more than two countries and/or also incorporate connections to offshore windfarms in the North Sea or Irish Sea are also being proposed by developers. We will consider the impact of MPIs for NOA IC 2023.

3.2 Key changes for the 2023 methodology

1. Previous NOA ICs have used an iterative step by step process, that determines the optimal level of interconnection based on maximising the Net Present Value of SEW, constraint savings and CAPEX costs. For the new analysis undertaken for Ofgem's mid-2022 cap and floor window, we have developed a new process, which is not iterative. We intend subsequent NOA ICs under CSNP to build upon both sets of work.

3.3 Factors for the assessment of future interconnection

1. **Social and Economic Welfare (SEW), CAPEX and Attributable Constraint Costs (ACC)** – these are the most significant criteria for identifying the optimal level of interconnection. Constraint costs refer to GB network congestion costs borne by GB consumers as a result of interconnection. Therefore, these factors will be used in the analysis to determine the economically optimal level of interconnection.
2. **System Operability impacts** - this is an important area that we will be incorporating new analysis in NOA IC 2023. The services that we will analyse include frequency response, short circuit level and reactive response.
3. **Carbon costs:** modelling facilities allow for the extraction of total carbon emissions resulting from specific market states under different scenarios, thus the carbon savings or increases associated with various levels of interconnection can be presented with commentary.

² <https://www.ofgem.gov.uk/publications/interconnector-policy-review-decision>

4. **Renewable Energy Sources (RES) integration:** modelling facilities allow for the investigation of the impact of interconnection on renewable generation. This can be reviewed through investigating the reduction or increase in renewable generation curtailment driven by the optimal level of interconnection being in place in future years, rather than the currently forecast level.
5. Changes in carbon emissions and the use of RES will be analysed but will not be used to optimise the level of interconnection. This is due to the complexity of combining Carbon/ RES estimates with welfare costs, especially where modelled welfare is already influenced by such factors through RES incentives and the European Trading System capping carbon emissions.
6. Operational costs, environmental costs and other social benefits, such as local economy growth are outside the scope of this methodology.

3.4 Cost estimation for interconnection capacity

1. The cost of building interconnection capacity varies significantly between different projects - key drivers are converter technology, cable length and capacity of cable. Estimating costs for generic interconnectors between European markets and GB is therefore challenging. We will continue to use the latest publicly available data to update our cost assumptions.
2. Subsea cable costs will be identified by estimating the furthest and shortest realistic subsea cable length and taking the average distance for each market to GB zone permutation. The length of the cable will vary with the GB zone it is connecting to and the measurements will be taken between these to the nearest 5km.
3. Onshore connection costs will be excluded as the interconnector study cases are zone specific but not substation specific.
4. The converter station assumed value will be drawn from an average of known HVDC project costs in the public domain.
5. We will investigate sourcing data to enable generic MPIs to be modelled.
6. As connection costs can occur across a range of years, discounting is employed to standardise each cost in Present Value. This is done with the Social Time Preference Rate (STPR) of 3.5%. Additionally, the cost of capital is accounted for by using Weighted Average Cost of Capital (WACC) of 6.8% for interconnectors, drawn from a publicly available Grant Thornton report.³

3.5 Components of welfare benefits of interconnection

1. This section outlines the definition of socio-economic welfare. The purpose of this section is to give the theoretical background of assessing the impact of connected importing and exporting markets on consumers, producers and interconnectors triggered by another interconnector.

3.5.1 Socio-economic welfare

1. Socio-economic welfare (SEW) is a common indicator used in cost-benefit analysis of projects of public interest. It captures the overall benefit, in monetary terms, to society from a given course of action. It is important to understand it is an aggregate of different parties' benefits - so some groups within society may lose money as a result of the option taken. The society considered may be a single nation, GB, or the wider European society, in which case the benefits to European consumers and producers would be a part of the calculation. We intend to calculate SEW divided into GB and connecting country.
2. SEW benefits of an interconnector includes the following three components:
 - a. Consumer surplus, derived as an impact of market prices seen by the electricity consumers
 - b. Producer surplus, derived as the impact of market prices seen by the electricity producers
 - c. Interconnector revenue or congestion rents, derived as the impact on revenues of interconnectors between different markets.

3.5.2 Constraint cost implications of interconnection

1. The impact on constraint costs is dependent on the location of the interconnector on the GB network and the level of onshore reinforcement built to accommodate the interconnector.

³ <https://www.ofgem.gov.uk/ofgem-publications/51476/grant-thomton-interest-during-construction-offshore-transmission-assets.pdf>

Further detail regarding optimal locations to connect will be output based upon the constraint costs calculated on the network with the interconnectors under consideration.

2. Constraint costs are incurred on the network when power that is economically “in merit” is limited from outputting due to network restrictions. In this event, the ESO will incur balancing mechanism costs to turn down the generation which is not able to output and offer on generation elsewhere on the system to alleviate the constraint.

3.5.3 Modelling

1. We will use our pan-European market model to forecast the Socio-Economic Welfare (SEW) and the Attributable Constraint Costs (ACC).
2. It is an economic dispatch model which can simulate all ENTESO-E power markets simultaneously from the bottom up i.e., it can model individual power stations for example. It includes demand, supply and infrastructure and balances supply and demand on an hourly basis.
3. The GB electricity system is represented by a series of zones that are separated by boundaries. Generators are allocated to their relevant zone based on where they are located on the network, and then the appropriate demand is allocated to that zone. The boundaries, which represent the actual transmission circuits facilitating the zonal connectivity, have a maximum capability that restricts the amount of power which can be securely transferred across them.
4. The Socio-Economic Welfare is calculated by summing the producer surplus, consumer surplus and interconnector revenue. The consumer surplus is the difference between the value of lost load and the wholesale price. The producer surplus is calculated and summed per plant based upon their Short Run Marginal Cost and the wholesale price.

3.5.4 Options included in the assessment

1. The assessment is limited to interconnection to GB. The level of interconnection between European markets will remain fixed throughout the scenarios (though could vary across future years). These levels are defined by the FES European scenarios.

3.5.5 Interconnection assessment methodology

1. The starting point of the process will be National Grid ESO's FES 2023 which includes generation plant ranking orders and demand forecasts across Europe for each scenario.
2. The FES make forecasts of the future interconnection capacities in GB, per scenario. The FES level of interconnection is calculated on a project-by-project basis, reviewing all axioms from economic, political, environmental etc. An important distinction between the FES and this process, therefore, is that the NOA IC aims to find what would be economically optimal rather than being based on specific projects.
3. This year's NOA IC will use an iterative optimisation for each scenario. The iterative optimisation approach attempts to maximise present value, equal to SEW less CAPEX less Attributable Constraint Costs (ACC), using a search strategy. The whole process is repeated four times to arrive at an optimal development of capacity in each of the four FES. Based on strong stakeholder feedback, there will be no Least Worst Regret calculation at the end of each iterative step, resulting in four optimal paths: one per FES and hence a range for the optimal solution will be produced. We will also undertake a regional analysis of the optimal location of new interconnection from a thermal and system operability perspective.
4. Timing of capacity increases can affect the SEW generated and Attributable Constraint Costs (ACC) by the interconnection across the study window. Within each search step, therefore, timing combinations will be considered. The use of spot years will be necessary to allow a solution to converge, wherein the commissioning of additional projects would be evaluated only in a finite number of years. This means for each iteration, the welfare of the interconnectors in every spot year will be calculated.
5. In recent years the levels of interconnection within FES and NOA IC have started to converge. This is understandable as the FES scenarios are already partially optimised with respect to the levels of interconnection within each scenario. Each scenario within FES is modelled to ensure that a detailed within-day supply demand match can be achieved across all modelled years.

4

Suitability for Third Party Delivery and Tendering Assessment

4.1 Introduction

1. In preparation for the new competitive framework for electricity transmission, our licence condition C27 obliged the ESO to assess reinforcement options against criteria known as “late competition”. Subsequent work between the ESO, Ofgem and DESNZ (previously under Dept of BEIS) led to developing “early competition” criteria. The ESO’s role requires it to assess major network reinforcements against the competition criteria defined by Ofgem. This methodology describes the process for assessing both wider network reinforcement and connections against these criteria.
2. To support competition in onshore electricity transmission networks, the Government set out the framework to enable non-TO entities to deliver reinforcements in the Energy Bill. If passed in its current form, this legislation will enable Competitively Appointed Transmission Owners (CATOs) to compete to build, own and operate onshore transmission network. At the time of writing, the final criteria aren’t certain and there might be slight changes to how this methodology works.
3. In March 2022, Ofgem also confirmed its intention to implement an early model of competition (competition to design, build and own assets), as set out in the ESO’s Early Competition Plan. Ofgem asked the ESO to progress this implementation in their decision on the development of early competition in onshore electricity transmission networks.

4.2 Overview

1. The ESO assesses TCSNP wider network reinforcements and new connections or modification applications to existing connections against the criteria unless they’re exempted. For early competition, the exact criteria are expected to be finalised after the secondary legislation in the summer, so the criteria described in this chapter are based on information currently available but might change depending on subsequent guidance from Ofgem. The *competition Cost Benefit Analysis (CBA)* assesses the cost to consumers of delivering a particular project through the commercial model set out in the Early Competition Plan (ECP) versus a regulatory building block framework based on RIIO-T2 which is described on our Early Competition website. For late competition, the ESO assesses the suitability of these projects for competition in accordance with published tendering criteria⁴. Table 4.1 describes these criteria:

Table 4.1 - Early and late competition eligibility criteria

Criterion	Early competition	Late competition	Comments
Certainty	√	√	Certainty of the need: the projects that have a “Proceed - Critical”, “Proceed - Maintain” and “Hold” recommendations. Note that only options with a “Proceed – Critical” recommendation are assessed for “late competition”.
New	√	√	Completely new transmission assets or complete replacement of transmission assets,
Separable	√	√	Defined as ownership between these assets and other (existing) assets that can be clearly delineated.
High value		√	At or above £100m in value of the expected capital expenditure of the project.
Passes competition CBA	√		Where the benefits of tendering are found to outweigh disbenefits such as those resulting from the time taken to tender and hence costs.

⁴ https://www.ofgem.gov.uk/system/files/docs/2018/01/competition_update.pdf and https://www.ofgem.gov.uk/system/files/docs/2019/02/criteria_guidance.pdf

The TOs will provide information to the ESO via the SRF form (see Appendix C) for wider works which the ESO then uses for the following activities:

- Reviews the information provided for each option.
 - Assesses the options against the criteria for competition.
2. In addition to wider network reinforcement, the TCSNP also examines connections for eligibility for competition. For each TCSNP, the ESO assesses transmission connections against the same criteria as wider work options (described above) and publishes the conclusions in the TCSNP. The assessment does not mean that investments meeting the criteria will be subject to competitive tendering, for instance those exempted by agreement with Ofgem to meet 2030 targets.
 3. It should be noted that, in the current TCSNP, when the TOs submit the delivery dates for their wider transmission reinforcements or enabling works⁵ for connection projects, the time for the competitive tendering process for late competition is not considered.
 4. The ESO sorts reinforcement options into cost bands to give industry an indication of the value of reinforcements while maintaining confidentiality. It then includes them as appropriate in the TCSNP report. The assumptions are that land costs are included in the costs, but the cost of consents is excluded. The costs apply for new and separable elements only. Table 4.2 shows the cost bands that have been agreed.

Table 4.2 - Cost bands used in reporting competition eligibility assessments

Cost bands
£100m - £500m
£500m - £1000m
£1000m - £1500m
£1500m - £2000m
Greater than £2000m

4.3 Connections

1. Prospective users can apply at any time to connect to the transmission network or to modify a connection whereas the TCSNP process runs annually which allows the ESO to assess connection projects as it receives them. Some connection projects provide wider network benefits and hence are already included in the TCSNP process.
2. If the TO states that a project reinforces the wider network, it can use the SRF at the usual time in the TCSNP process to submit the information for the competition assessment process for TCSNP options.

4.4 Bundling or splitting of work packages

1. The first step in the ESO's competition assessment of larger projects, is to provide an opinion on bundling projects into larger packages, or splitting projects into smaller packages, to form a recommendation in the TCSNP. There are two aspects to the ESO's consideration of bundling and splitting as follows:
 - a. The costs and size of the component aspects of projects to ensure that they can be most appropriately packaged.
 - b. Where the ESO can identify opportunities or benefits from repackaging of projects.
2. The core process is to apply the competition criteria and checking for splitting or bundling beforehand is to investigate its relevance to the core process. However, recommendations to split or bundle do not prevent projects being assessed against the criteria. The check happens again at the end of the process if an option has met the criteria to see if changes for instance for separability have affected our earlier conclusions on splitting or bundling.

⁵ For the definition of 'enabling works', please refer to section 13 of the Connection and Use of System Code (CUSC) <https://www.nationalgrideso.com/document/91406/download>

3. If projects can be changed by splitting or bundling, they are assessed in the changed state. A comment about any change is included in the TCSNP report and is used in the tendering process.

4.5 Bundling

1. The ESO considers whether bundling projects into a single tender could be appropriate and whether it gives best value for consumers (e.g., economies of scale for procuring large quantities). Bundling might be worthwhile if the projects have common needs, drivers or it makes technical or commercial sense. For instance, you may be able to utilise economies of scale for procuring large quantities of materials. If the ESO believes that there is benefit from bundling, then each constituent project should meet the late competition high value threshold. Where work is bundled as part of this process, the component parts must each meet the competition criteria to be eligible.

4.6 Splitting

1. The ESO is expected to recommend splitting a project into more than one tender package if it is in the interest of consumers. For example, if a project constitutes new assets and refurbishment of existing assets, these could be split to enable the new assets to be competed. When it considers splitting a project, the ESO will consider the impact this could have on project delivery. Each resultant package should meet the high value threshold if these are to be competed where assessed against the late competition criteria.

4.7 Process for assessing against the competition criteria

1. Figure 4.1 below, shows the process for assessing whether reinforcement projects meet the early and the late model competition criteria. The process is carried out for options that meet the early competition “certainty” criteria or for late competition have the “Proceed – Critical” recommendation.
2. Process stages - the names of the process stages below match those in the diagram. The numbered stages below correspond to the boxes on the left side of the diagram. Note that some tests are repeated. Stages 2 and 4 test the high value criterion (for late competition only) and Stages 5 and 7 test the separable criterion. Stage 8, which tests the benefit of tendering, applies to early competition only.

Figure 4.1 – The process for assessing suitability for competition for options that meet certainty criteria.

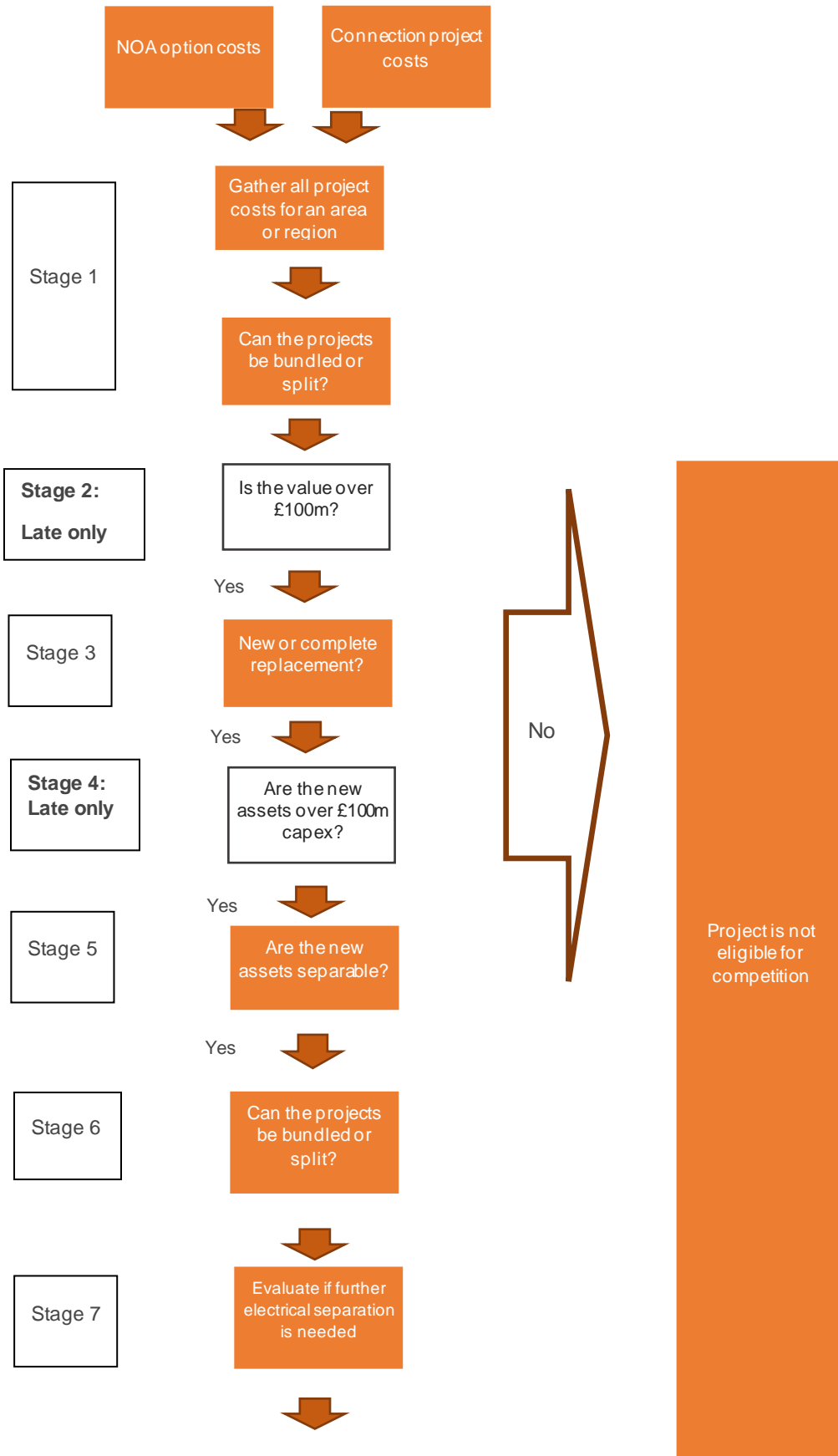

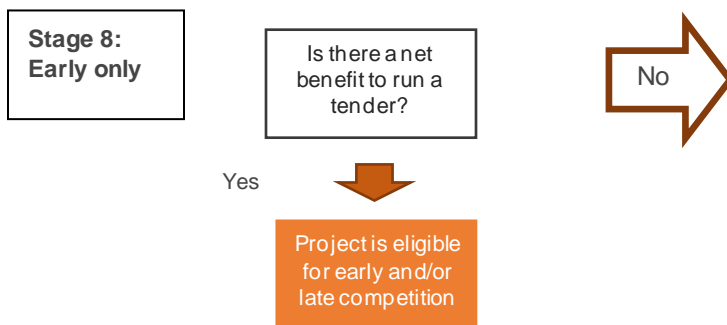

Note that the process applies only to options and projects that meet the certainty criteria for early competition, or for late competition, have received a “Proceed – Critical” recommendation.

4.7.1 Stage 1 – Can the projects be bundled or split?

1. Aim – to check that sensible packages of work are developed together by assessing the proposed work to see if it should be split (broken into more than one smaller bundle) or whether work across more than one project should be bundled together.
2. Considerations when assessing potential for splitting:
 - Does the project involve different technologies that suggests different skills and procurement are needed for the separate elements?
 - Is there a variety of works involved? For example:
 - Are there one or more new substations?
 - Does the proposed project comprise OHL and cable sections and how do they affect existing networks?
 - Are there one or more cable tunnels?
 - Are the project phases adjoining or in naturally separate timeframes?
 - Could the resulting work package lead to stranded investments?

Considerations when assessing the potential for bundling:

- Are there multiple projects with common needs / drivers?
- Are there several individual projects in a relatively self-contained area or corridor?
- Are there scheme works that are very similar?
- Is it one of several smaller projects that could be efficiently or more efficiently developed with other projects?

4.7.2 Stage 2 – Late Competition only

>=£100m capex (applies to late competition process only)

1. Aim – to assess whether the project or bundle of projects meets the late competition high value criteria and include only projects that exceed the threshold within a 10% margin for consideration at the next stage.

Criteria – this is the first of a two-stage process (the second, Stage 4, is below). The ESO uses the costs that the TOs have provided and conduct an independent cost checking (see Appendix E). For connection works the costs that appear in the connection contract are used to calculate the cost. The ESO will query any costs that cannot be explained with the TO. The trigger threshold is set at £90m to highlight projects that are marginally below the £100m figure. This produces a yes/ no output.

Table 4.3 – List of factors that the high value figure includes or excludes

The £100m capex 'high value' figure	
includes <ul style="list-style-type: none"> • costs of acquiring land • costs of complying with consents conditions 	excludes <ul style="list-style-type: none"> • costs of gaining consent

4.7.3 Stage 3 - New or complete replacement

1. Aim – to test the projects against whether they are new assets or complete replacement assets rather than refurbished assets, for example. This test has the practical benefit of checking for complicated examples. For example, where a new double circuit crosses an existing double circuit and because of routing and the existing circuits, the existing circuits need modification leading to new assets integrated into existing circuits. Often new double circuits employ sections of existing circuits for local reasons, such as, environment or amenity. Thus, the affected existing circuits would become a mix of old and new assets. The consenting process might also change a simple double circuit route into a complicated one that includes mixed ownership because of old and new assets being integrated. As the project will be assessed annually in the NOA process, this might lead to a change in the project's eligibility from one year's assessment to another. For example, some replacement work could become refurbishment as the project evolves, it might tip the project one way or the other over the value threshold.
2. Criteria – is a project delivering completely new assets or complete replacement assets that fulfil the same function as the assets to be removed or replaced? This produces a yes/ no output. For example: if an overhead line double circuit is completely rebuilt including towers and their foundations, it would count as complete replacement.

4.7.4 Stage 4 – Late Competition

Are the new assets >=£100m value (applies to late competition process only)?

1. Aim – to test whether the new assets reach or exceed the high value threshold.
2. Criteria – this is the second part of a two-stage process (the first, Stage 2 is above). If the project has a very high proportion of new assets and high value, the project will pass this stage. For more marginal projects (where the value of new assets is around the threshold), the ESO uses the breakdown of costs from the TO to calculate the value of the new assets. This produces a yes/ no output.

4.7.5 Stage 5 – Are the new assets separable?

1. Aim – to test whether the project details indicate that the new assets are readily separable from the existing assets.
2. Criteria – this is to check if the project already has points of connection to existing assets that can be clearly delineated, in other words, clearly identified. Disconnectors are obvious points that can be delineated but Ofgem suggest that other points such as clamps on busbars would also be acceptable as long as the point can be clearly identified. This produces a yes/no output.

4.7.6 Stage 6 – Can the projects be bundled or split?

1. Aim – having gone through the process to check for eligibility, this stage is a recheck that sensible packages of work are developed together. The eligibility process especially for separability sometimes changes a project package of works and this stage is to check if bundling or splitting is still appropriate or has become appropriate.
2. Criteria – these are the same as for Stage 1, above. Note that projects that are split must have component parts that meet or exceed the £100m value threshold.

4.7.7 Stage 7

Based on technical and cost-benefit analysis studies, is it appropriate for the ESO to recommend additional electrical separation for the projects that have met the competition criteria?

1. If the ESO concludes that the project proposals already have adequate electrical separation, it is not necessary to carry out this stage.
2. Aim – use cost-benefit analysis studies to test technical solutions and determine if it is worth extra investment in assets or amending the design to further delineate ownership boundaries to provide adequate electrical separability.
3. The ESO believes that the electrical separation assessment will be needed by exception only. As a result, the ESO treats any such instances on a case-by-case basis for options that pass the earlier stages and look likely to go to tender. The ESO will consider factors such as safety and operability as well as cost and record outcomes along with method used in a summary report.
4. The ESO maintains a log of connection projects that meet the competition criteria and liaises with the TOs about the outcomes of the competition eligibility assessments. This log forms the basis of the list that is published in the TCSNP.

4.7.8 Stage 8 – early competition

Is there a net benefit to run a tender (applies to early competition process only)?

1. Aim – to assess whether the benefits of running a competition tender outweigh the costs. The costs include the effect of the time taken to tender on key aspects such as constraints. An example is if there are extra constraint costs during the time taken to run a tender and those costs exceed the expected savings from a competition.
2. Criteria – the benefits of tendering outweigh the disbenefits of tendering. This is a complicated assessment process and is described in a separate methodology on early competition. At the time of writing the NOA methodology, the early *competition CBA* methodology for 2023 had not been published. You can read the 2022 publication [here](#). This produces a recommendation for Ofgem on whether to run a competition. Ofgem then have the final decision of whether this is taken to competition or not. This will be a separate process outside of the TCSNP.

5

Pathfinders/ Network Services Procurement

5.1 Introduction

This chapter outlines the scopes, principles and processes for the High Voltage, Stability and Constraint Management pathfinder projects.

5.1.1 Overview of the High Voltage and Stability Management Process

- High voltage and stability management are two separate processes with different technical assessments. However, they share a number of similarities in the economic assessment and tender processes. The objective of the process is to ensure economical and efficient options for high voltage and stability management to be available when required. This Electricity System Operator (ESO) led process is designed to identify high voltage and stability issues in the transmission system, the causes, requirements and the preferred options to solve these issues. The process is designed to work with all expected option providers including Transmission Owners (TO), Distribution Network Operator (DNO) and Commercial Service Providers. Figure 5.1 gives an overview of the high voltage and stability management process.

Figure 5.1 - Overview of the high voltage and stability management process²²

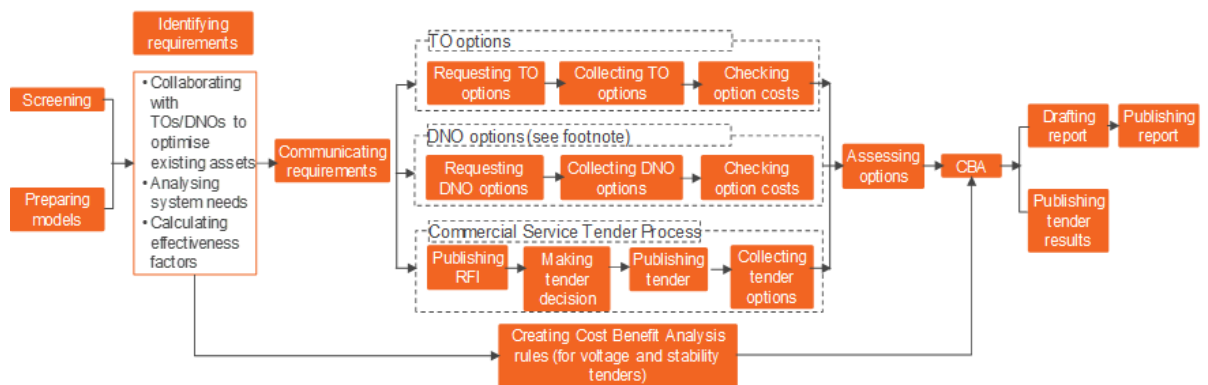

5.1.2 Overview of the Constraint Management Process

1. The NOA Constraint Management Pathfinder (CMP) looks for options to reduce the cost of managing constraints in various regions in the electricity system. Constraints can be of three types - thermal, voltage or stability on the transmission system. The CMP process is designed to develop commercial options in the NOA that could be used to relieve residual constraints depending on the need and delivery of network reinforcements. Figure 5.2 shows an overview of the CMP process. The detailed process is described in the Constraint Management Process in section 5.6.

Figure 5.2 - Overview of the constraint management process

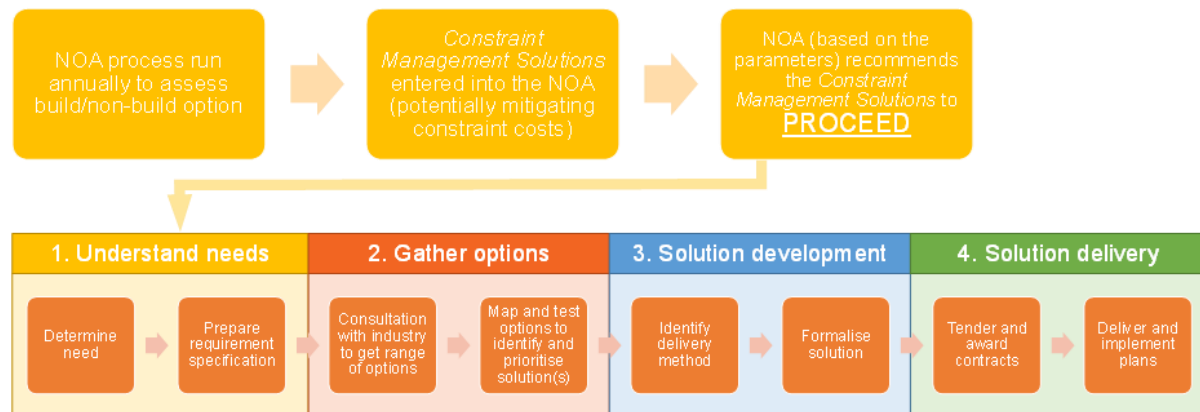

5.1.3 Programme

1. The ESO carries out the screening process annually. The ESO expects to carry out the screening process for high voltage and stability management after the annual technical analysis of boundary capabilities for ETYS & NOA. Constraint management solutions are assessed as part of the annual ETYS/NOA analysis, however the ESO only carries out more detailed CMP assessments in the regions with a “Proceed – Critical” recommendation from the constraint management NOA.
2. A detailed assessment of any prioritised regions will be initiated on demand and as agreed between the ESO and the relevant TOs and DNOs.
3. The timeline of the detailed assessment of any prioritised regions will vary depending on the complexity and the size of requirements. The ESO will agree the timeline with the relevant TOs and DNOs involved.
4. Appendix A3 contains roles and responsibilities for the ESO, TOs, DNOs and relevant service providers.

5.2 Principles of assessment for high voltage, stability issues and constraint related investment

1. The ESO plans, develops, and operates the transmission system so that voltage and frequency levels stay within the normal operating ranges defined within the National Electricity Transmission System Security and Quality of Supply Standards (NETS SQSS). The specific voltage and frequency limits used in planning and operating the transmission system can be found in chapter 6 of the NETS SQSS.
2. To ensure the ESO can plan the system to operate securely and safely while managing voltages and system stability both economically and efficiently, a Network Options Assessment (NOA) style methodology is proposed. This will facilitate the assessment of options to develop the electricity networks to meet future voltage and stability control requirements.

5.2.1 High Voltage Assessment

1. High voltage assessments seek to identify and address high voltages needs. This process currently runs in parallel to the existing NOA process which primarily focuses on thermal and low voltage issues that are typically seen when power transfer across the network is high. This is normally assessed at peak demand periods. High voltage issues are typically encountered during periods of light system loading or minimum demand.

2. Other voltage control concerns may be present at other periods of the year but to avoid increased complexity and delay they are not being addressed in this methodology. As the NOA methodology continues to evolve, the ESO will expand the methodology to cover further voltage control concerns in the future.
3. High voltage issues are typically localised and voltage control solutions are usually ineffective over long distances so the ESO will apply a regional approach to the assessment.
4. The ESO uses cost-benefit analysis (CBA) to provide investment recommendations. Cost-benefit analysis compares the cost of a proposed solution and the monetised benefits over the project's life to inform the investment recommendation. To effectively meet the future voltage control requirement, the ESO also considers system operability when recommendations are made. The two primary factors that will drive an ESO recommendation are:
 - a. **Monetised benefits** – when monetised benefits are higher than the forecast solution cost, this implies investing in the proposed solution will provide a more economical and efficient way to manage voltages. This is more beneficial in the long term, when compared to the ESO paying for reactive power service in real-time via the Balancing Mechanism (BM).

Justification based on monetised benefits

The monetised benefits are the cost savings achieved by investing in a proposed solution compared to using existing services such as Obligatory Reactive Power Services (ORPS)²⁶. The ESO currently relies heavily on the reactive power capabilities of generators for managing voltage. The ESO hopes to see savings on constraint costs and, in some cases, utilisation cost as well. To estimate this saving, the ESO forecasts the constraint and utilisation costs it will pay for accessing and using the ORPS via the BM.

Constraint cost refers to the bid and offer price the ESO pays (for the MW) to get a generator onto the system to provide reactive power support, together with another generator reducing its generation or turned off elsewhere on the system to maintain the balance of supply and demand. Utilisation cost refers to the payment the ESO makes (for the MVar) to generators for using their reactive power capabilities, the more being used the higher the cost.

The aim here is to find the solutions which deliver additional benefits to the consumers, in the form of net savings. This is achieved by replacing services which will need to be procured via the BM with lower cost proposed options. Figure 5.3 shows how proposed options replace services from the BM to meet the voltage control requirement. The ESO uses cost-benefit analysis (CBA) to compare forecast investment costs and monetised benefits over the duration of the system need to inform this investment recommendation.

Figure 5.3 - Proposed options replacing services from the BM to meet voltage control requirement

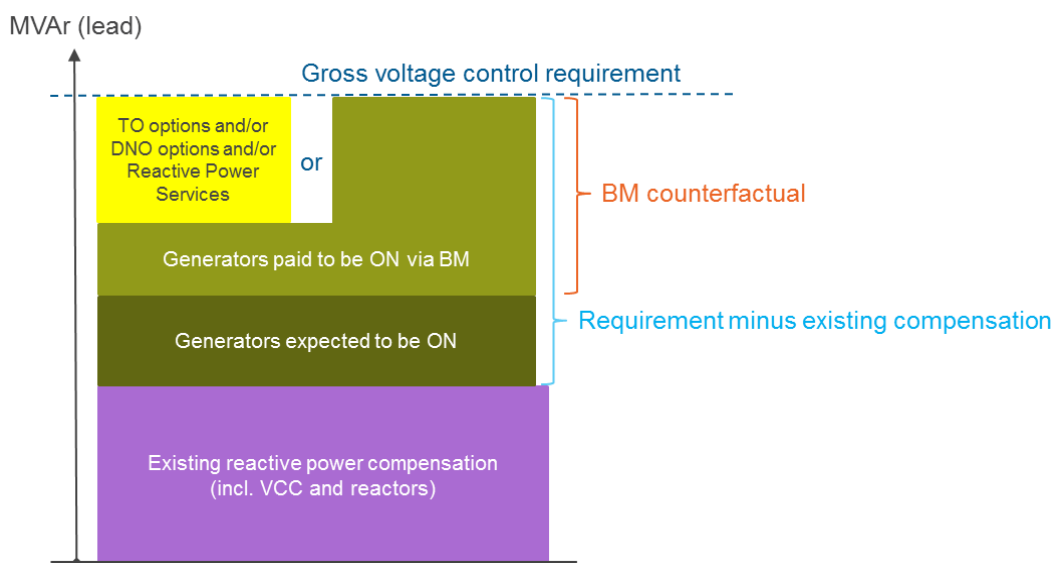

In this case, the ESO expects the remaining requirement (i.e., gross requirement minus existing compensation) can be satisfied by generators with mandatory service agreements (MSA) (or other contractual obligations).

Investment recommendations made in this case focus on the monetised benefits. It is possible for the ESO to secure Reactive Power services in real-time via the BM and ORPS. The aim is to explore potential solutions which provide overall savings to the consumers.

- b. **Operational security requirement** – applies when there are insufficient means to provide reactive power to contain high voltages and securely operate the network. This implies the forecast reactive power required in the future is higher than is forecast to be available via the BM or other means.

Justification based on security and operability

Given the rapid changes in generation and demand backgrounds, there may be times in the future where there will be insufficient reactive power compensation or services available to meet the voltage control requirements within a region. If such situation is observed in the analysis, the ESO will then focus on verifying the credibility of the assumptions leading to such a situation. If deemed credible, the most cost-effective solution to resolve the situation will be pursued. Figure 5.4 shows how proposed options provide the reactive power needed to meet voltage control requirement as sufficient services cannot be procured from the BM.

Figure 5.4 - Proposed options providing the reactive power needed to meet voltage control requirement as sufficient services cannot be procured from the BM

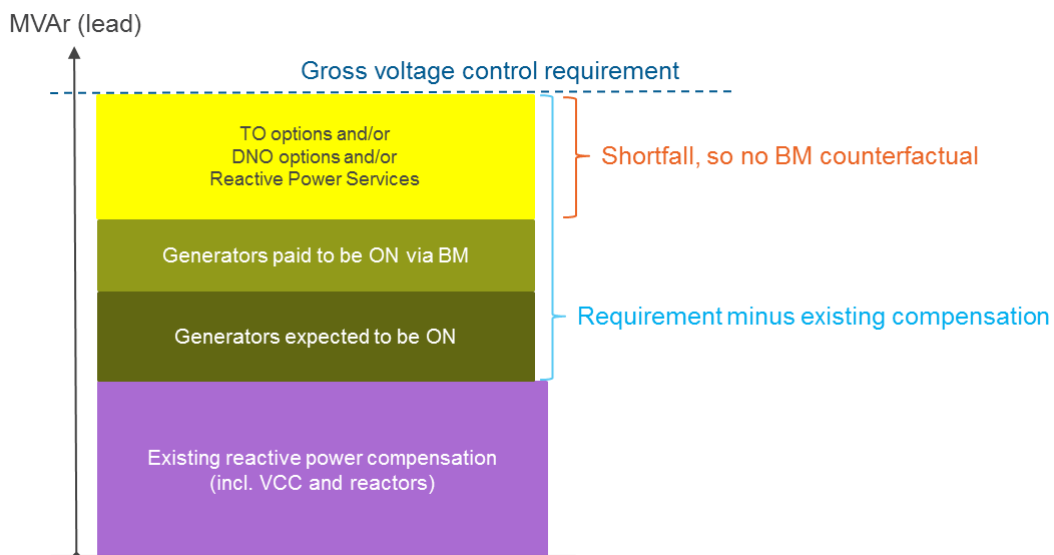

In this case, the ESO expects to have insufficient reactive power capability available and cannot satisfy the requirement by using generators with MSAs.

Investment recommendations made in this case focus on the operational security requirement. There is a risk that the system will be inoperable in real-time if nothing is available to provide the extra reactive power required to control the high voltages.

To meet the requirement (indicated as shortfall in the diagram), this may also mean that if generators who have MSAs wish to propose a reactive power service option, the ESO can only consider it if they are offering reactive power capability above their mandatory requirements in the tender process.

5.2.2 Stability Assessment

1. Voltage and frequency limits used in planning and operating of the transmission system are stated in the NETS SQSS. The GB Grid code defines performance requirements for different users connected the National Electricity System for different system conditions (e.g., fault ride through requirements, voltage and frequency withstand variations).

2. The ESO considers stability at national and regional levels. Where a solutions' ability to provide stability support is independent of its electrical location, it is considered at a national level. The ESO also considers stability on a regional basis where both the need and the solutions are location specific. There will be some interaction between these two types of needs that the ESO will manage in communicating the requirements.
 - At a national level, ESO maintains system frequency within limits by consideration of frequency response/reserve market products and maintains Rate of Change of Frequency (RoCoF) within limits by consideration of largest generation/ demand loss on the system and planning for national levels of inertia.
 - At a regional level, the distribution of regional inertia, short circuit level, dynamic voltage support can influence the stability of the local network and its users.
3. Similar to Voltage assessment, in order to ensure the system is planned in a way that it could be operated securely and safely while system stability is managed both economically and efficiently, a Network Options Assessment (NOA) style methodology is proposed. This will facilitate the assessment of options to develop the electricity networks to meet future stability requirements.
4. The ESO uses a cost-benefit analysis (CBA) to provide investment recommendations. The cost-benefit analysis compares the cost of a proposed solution and the monetised benefits over the length of the system need to inform the investment recommendation. The two primary factors that will drive an ESO recommendation are:
 - a. **Monetised benefits** – as stated earlier, when monetised benefits are higher than the forecast solution cost, this implies investing in the proposed solution will provide a more economical and efficient way to manage stability. This is more beneficial in the long term when compared to the ESO paying for the equivalent services in real-time via the Balancing Mechanism (BM).

Justification based on monetised benefits

The ESO currently relies on the inherent capabilities of synchronous generators participating in the BM to provide inertia, short circuit current and dynamic voltage support. The ESO takes actions in the BM to address any shortfall which would lead to system instability. The ESO hopes to see savings on constraint costs. To estimate this saving, the ESO forecasts the constraint and utilisation costs they will pay for accessing and using the short circuit level and inertia via the BM.

Constraint cost refers to the bid and offer price the ESO pays (for the MW) to get a generator onto the system to provide stability support, together with another generator reducing its generation or turned off elsewhere on the system to maintain the balance of supply and demand.

The aim here is to find the solutions which deliver additional benefits to the consumers, in the form of net savings. This is achieved by replacing services which will need to be procured via the BM with lower cost proposed options. In some future instances, the ESO expects a shortfall in the BM to procure for stability. Figure 5.5 shows how proposed options replace services from the BM to meet stability requirement. The ESO uses cost-benefit analysis (CBA) to compare forecast investment costs and monetised benefits over the solution's life to inform this investment recommendation.

Figure 5.5 - Proposed options replacing services from the BM to meet stability requirement

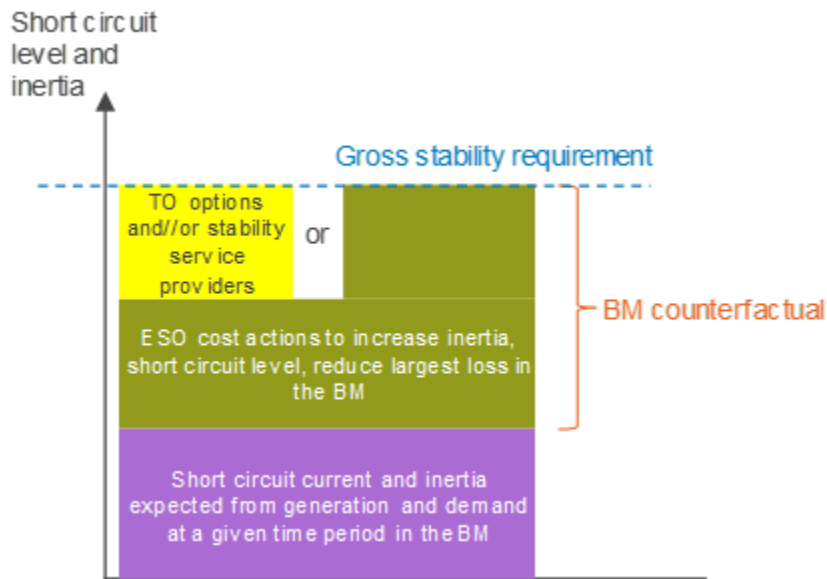

In this case, the ESO expects the remaining requirement (i.e., gross requirement minus existing compensation) can be satisfied by generators with mandatory service agreements (MSA) (or other contractual obligations).

Investment recommendations made in this case focuses on the monetised benefits. It is possible for the ESO to secure Stability Services in real-time via the BM. The aim is to explore potential solutions which provide overall savings to the consumers.

- b. **Operational security requirement** – applies when there are insufficient means to provide reactive power to contain high voltages and securely operate the network. This implies the forecast reactive power required in the future is higher than is forecast to be available via the BM or other means.

Justification based on security and operability

Given the rapid changes in generation and demand backgrounds, there may be times in the future where there will be insufficient BM services available to meet the stability requirements within a region. If such situation is observed in the analysis, the ESO will then focus on verifying the credibility of the assumptions leading to such a situation. If deemed credible, the most cost-effective solution to resolve the situation will be pursued. Figure 5.6 shows how proposed options provide the stability requirement as sufficient services cannot be procured from the BM.

Figure 5.6 - Proposed options providing the stability support needed to meet requirement as sufficient services cannot be procured from the BM

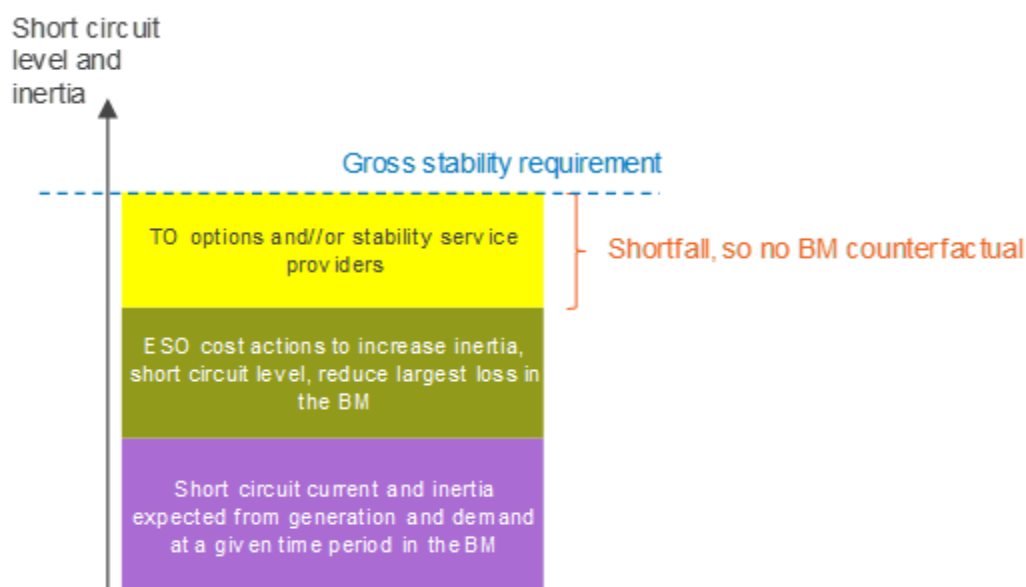

In this case, the ESO expects to have insufficient stability support available and cannot satisfy the requirement by using generators with MSAs.

Investment recommendations made in this case focus on the operational security requirement. There is a risk that the system will be inoperable in real-time if nothing is available to provide additional stability.

- Investment recommendations will be based on the above mentioned two primary factors. As a general principle, if there are several options which meet the requirements and satisfy either of the two primary factors, the CBA chooses the most economical and efficient options. This is described in more detail in the “cost benefit analysis” section.

5.2.3 Constraint Management Solutions Assessment

- The ESO must operate the system to the requirements set in the SQSS. When planning the network in operational timescales, the ESO Electricity National Control Centre (ENCC) would operate the system to a secure power transfer limit considering various network faults. If the transfer exceeds the capability, the ENCC must reduce the power flow pre-empting the worst network fault via Balancing Mechanism (BM) actions. Constraint costs are a factor of bid / offer prices and the amount of generation constrained.
- The NOA process annually assesses options to increase boundary transfer capabilities as per system needs outlined in the ETYS. Non-build constraint management solutions (e.g., system to generator intertrips) are assessed in the same way as asset-based options through the NOA process. The ESO uses cost-benefit analysis (CBA) to provide recommendations on balancing the costs of managing constraints and the cost of reinforcing the network. As constraint management solutions can be contracted flexibly and do not have a fixed asset life or duration, the NOA study assesses when to start commercial services to reduce constraint costs in short term and when to discontinue them considering delivery of asset-based reinforcements.
- For the constraint management solutions given with “Proceed – Critical” NOA recommendations, the associated regions are prioritised based on the constraint cost and year recommended to start the commercial services. From the NOA outcomes to date, thermal constraints are the most common type of constraint for the regions identified with needs of constraint management solutions.
- The ESO will select a priority region to carry out a regional constraint assessment by analysing technical and economic benefits of using commercial options. Constraint management solutions use operational measures from commercial providers to increase the volume of power that can be securely transferred across a boundary. For example, a commercial service enabling post-fault generation intertrip could be an effective way to relieve thermal constraints.

The constraint assessment seeks to identify constraint issues and reduce associated costs. In addition to assessing winter peak demand periods, the constraint assessment carries out sensitivity studies for the interested region to investigate various power transfer scenarios, including periods of light system loading or minimum demand when the system might have stability issues.

5. The ESO uses a cost-benefit analysis (CBA) to provide investment recommendations. The CBA compares the cost of a proposed solution to procure commercial services and the constraint savings over the length of the system need to inform the investment recommendation. Balancing mechanism actions to bid off or buy generation in operational time scale are used as the counterfactual measure to address constraints.

5.3 The High Voltage management process

5.3.1 Regional approach – determining the most economical and efficient solution for High Voltage management process

1. Voltage is a localised property of the system which means that requirements vary from one region to another. The voltage control requirements are determined by the configuration of the local network and the nature of generation and demand in that region. Since reactive power, unlike real power, cannot be sent across long distances due to the reactance of the transmission network, voltage control is most effective when applied close to the problem. Voltage issues can therefore be grouped into regions and assessment of each region conducted separately. The high voltage management process investigates the reactive power required for high voltage control on a regional basis.

5.3.2 Screening process – selecting and prioritising regions

1. The ESO uses a screening process to help identify and prioritise the region(s) which should be further explored through detailed power system and cost-benefit analysis. This should bring consumers the best value by ensuring that the secure, economical and efficient development of the network focuses on challenging regions first. The screening process considers four main factors which are in line with the NOA assessment principles – cost, network change, likelihood and lead time.
 - a. **Cost:** The focus is on the historic spend in each region to procure Commercial services for managing high voltages. A high historic spend in a region suggests heavy reliance on the BM and ORPS, which suggests potential benefits of conducting an assessment to evaluate the best options to provide future reactive support in the region.
 - b. **Network change:** This refers to any significant changes of the system in the future, including new generation (including embedded generation), major generator closures, commissioning of new cables etc. Regions which do not associate with a high historic spend, but which are set to see some significant changes that contribute to an increasing need for reactive support should be assessed.
 - c. **Likelihood:** This is an assessment about how likely the above two factors will materialise. For example, if the high historic spend was due to a routine maintenance outage, it will be considered more likely than spend due to a long outage caused by a fault.
 - d. **Lead time:** This refers to the length of time between the system need and the typical lead time to deliver an option in the region of interest. For example, if a compliance concern will arise soon after any options can be sourced to meet the requirements, there is an urgency to assess the region.
2. The ESO will request feedback from the TOs as to which region(s) they believe should be assessed. This includes any compliance concerns in their networks.
3. The ESO will discuss any compliance concerns raised by the TOs and agree a plan to assess these concerns. The discussion will consider when the compliance issue may materialise and the lead time of potential options to resolve the issue.
4. The four factors mentioned above, together with the TOs' feedback, will be used to help determine the region(s), as well as the backgrounds and conditions that the ESO will consider in the assessment. For example, conditions which are associated with high historic spend and are expected to persist or grow in severity will be analysed. The ESO will apply these conditions to future backgrounds which show similar characteristics to the system when those high historic spends arose.

5.3.3 Creating network models for analysis

1. In this high voltage Management Process, the ESO will use the GB system planning models produced in accordance with the SO-TO Code (STC). Future backgrounds based on Future Energy Scenarios (FES) and system conditions considered appropriate in accordance with the NETS SQSS will be applied to the models for assessment.
2. TOs and DNOs will provide relevant data to support the ESO in preparing the models for analysis.

5.3.4 Identifying requirement

5.3.4.1 Collaborating with TOs/ DNOs to explore options from existing assets

1. The ESO will collaborate with Network Owners, TOs and DNOs, to ensure a consistent methodology is applied when it comes to planning and developing the transmission system. TOs are obliged by their transmission license to plan and develop their transmission network in accordance with the NETS SQSS. DNOs have a key role in enabling a whole system approach to address some of the future requirements in the transmission system while maintaining compliance of their distribution system.
2. The ESO will share the initial view of areas of priority with the relevant TOs and DNOs. The ESO aims to ensure consistent methodology, models, backgrounds and sensitivities are considered across all analyses. TOs and DNOs provide feedback about their networks in the relevant areas. The feedback will help the ESO to optimise existing and planned assets prior to quantifying the system needs in those areas in details. To ensure the transmission system is planned and developed in an economical and efficient manner, the ESO should only proceed with new requirements once existing and planned network assets are optimised.
3. Where available, the ESO will engage with the system operator function of the distribution companies.

5.3.4.2 Analysing the size of the reactive power requirement

1. The ESO identifies the reactive power required to control voltage based on system analysis results. The requirement varies depending on the future backgrounds and system conditions. It is not practical to fully analyse all combinations of backgrounds and conditions. Hence, the ESO selects snapshots using historic records assisted by data mining techniques and engineering judgement to represent a reasonable number of variations of backgrounds and conditions. The same four factors, which were considered during the screening stage (i.e., cost, network change, likelihood and lead time), are used to help with the selection.
2. The ESO collaborates with the TOs and DNOs to identify the reactive power required for the transmission networks.
3. The diagram below illustrates how the analysis to identify the reactive power required may be structured. The example shows variation in demand assumptions. The selection of the specific study backgrounds and system conditions, which set out the analysis, however, depends on the characteristics of the region of interest.

Figure 5.7 - Example of backgrounds and conditions considered for analysis

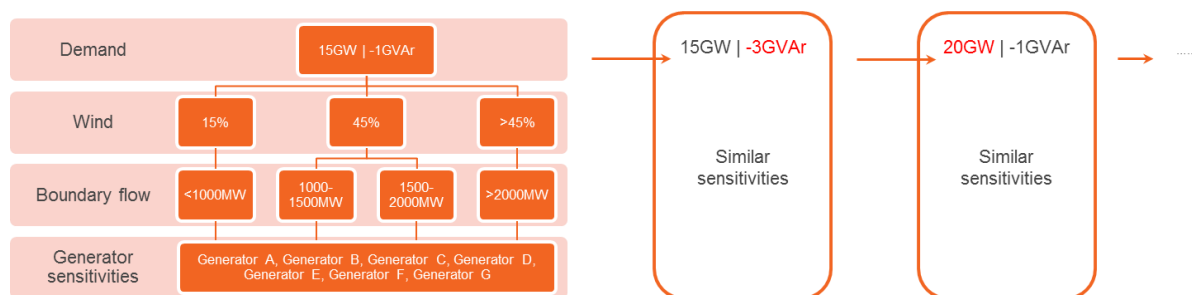

4. The reactive power required depends on what the ESO expects the system will need in the future to maintain voltages within the NETS SQSS limits. To determine the reactive power required for any region of the network the following steps are applied:
 1. Set up analysis with selected credible backgrounds and system conditions
 2. Analyse to check if the NETS SQSS requirement can be met with existing reactive power compensation and generators which are predicted to run

3. If the NETS SQSS requirement can be met, note the generators running in the region of interest and move on to the next sensitivity analysis
4. If the NETS SQSS requirement cannot be met
 - a. If applicable, consider using different combinations of generators in the region of interest which are accessible via the BM
 - i. Simulate constraint (bid and offer) actions until the voltage control requirement is satisfied
 - ii. Note the generators running in the region of interest
 - b. Consider suitable transmission solutions
 - i. Simulate investment in new transmission assets at different locations until the voltage control requirement is satisfied
 - ii. Note the size of new reactive power compensation plant(s) required and the location they are connected at. This is used to define the reactive power required and the most optimum location for solutions to meet the need in the region
 - c. Continue to the next analysis
5. The recorded generators running under each analysis will be used to formulate the voltage rules. This is described in more detail in the section “*Creating voltage rules*”.

5.3.4.3 Technical Assessment Approaches

1. Based on our latest pathfinder learning, we have found it necessary to adopt the technical assessment approach based on the unique characteristics of the relevant region.
 - **Effectiveness Factor Approach:** In regions where there is a single worst-case contingency, and a single electrically optimal site, we apply an effectiveness factor approach.
 - **Joint economic and technical optimisation approach:** In regions where there are several critical contingencies and solutions are required across multiple sites, we will apply a joint economic and technical optimisation approach.

The two approaches are described in the following sections:

5.3.4.4 Effectiveness factor approach

1. In some network areas, there is a single site which is optimal for the installation of reactive absorption. However, physical factors such as land availability or even the amount of compensation required mean that potentially only some or even none of the compensation may be delivered at that site. To allow fair comparison of all potential options across different sites and allow combined and single options to be assessed, effectiveness factors are used when the ESO assesses options.
2. The effectiveness of an option is directly linked to its point of connection and determines the amount of reactive power required to meet the requirement. This will change the total volume expected to be invested or procured. For example, if a unit A was assessed to be 50% effective and unit B 100% effective, to resolve the same issue the system would need to use twice as much reactive power from unit A than B. Unit A would need to be significantly cheaper to have the same benefits.
3. Effectiveness changes with certain system conditions, for example with certain outages. The ESO calculates effectiveness factors for each point of connection against consistent (set of) background to ensure all providers are treated equally.
4. The examples below are all aimed to be illustrative and provides approximations of potential differences in effectiveness. This will change when specific technical assessment for each region is completed. Provider A in green, Provider B in red and represent any appropriate technology that can satisfy the reactive power requirements.

Example 1

Provider A and B are connected at the same site. The site is run solid. The two different providers have similar reactive ranges.

The providers would likely have the same effectiveness factor.

Note: If the site is run split, the providers would likely have different effectiveness factors.

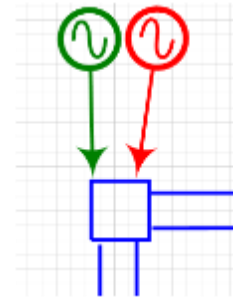

Figure 5.8

Example 2

Provider A and B are connected at different, adjacent, sites, but sites that are geographically close together.

The providers would likely have similar effectiveness factors.

Note: Distance in the diagram is indicative only.

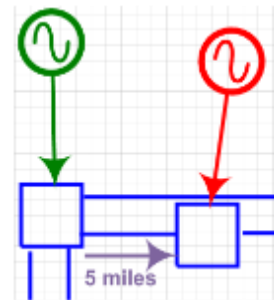

Figure 5.9

Example 3

Provider A and B are connected at different, adjacent, sites, but sites that are geographically far apart.

The providers would likely have different effectiveness factors.

Note: Distance in the diagram is indicative only.

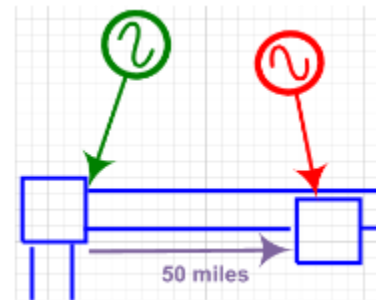

Figure 5.10

Example 4

Provider A and B are connected at different voltage levels. Provider B is connected at 132kV in the DNO network.

The ESO expects the options close to the source of the issue will have higher effectiveness factors.

If, for example, the source of the issue is at the transmission network, then Provider B that is connected at a 132kV voltage level is likely to be less effective than Provider A. Providers connected at lower voltages than 132kV, in this example, would be expected to be even less effective.

Alternatively, if, for example, the source of the issue is at the distribution network²⁷, then Provider B is likely to be as effective (or more effective in some cases) than Provider A.

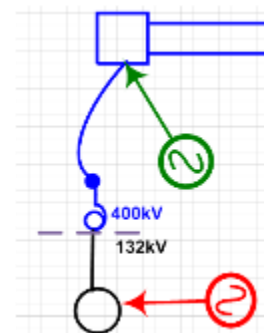

Figure 5.11

Example 5

The reactive power required is set specifically for a defined region. The region has been defined based on potential effectiveness.

Provider **A** is inside the defined region and Provider **B** is outside the defined region.

Providers outside the region are assessed as only being ineffective at resolving the issue.

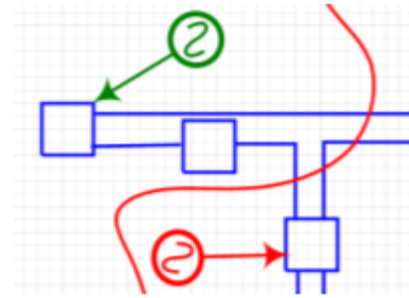
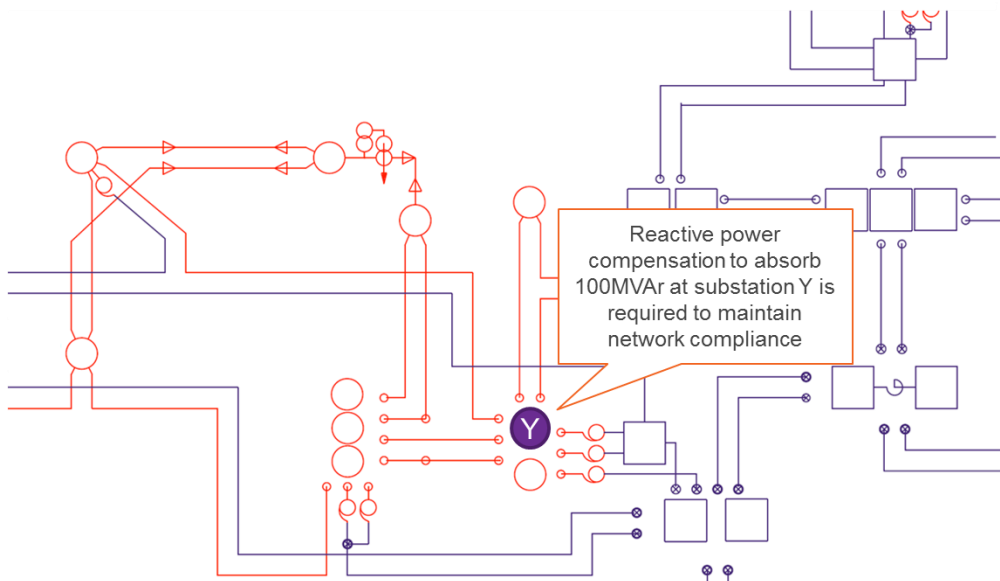

Figure 5.12

5. Many factors affect the effectiveness of an option, such as its size, where and how it will connect to the network. Effectiveness factors are relative to a reference point in the network. The ESO chooses reference point(s) in the network based on where it is most effective to implement reactive power compensation to meet the requirement of the region of interest. Through system analysis the ESO calculates the effectiveness of various available transmission-level connection points with respect to the reference point(s).
6. For distribution-level connection points, the ESO works with the relevant DNOs to calculate the effectiveness factor of an option. The DNO will calculate the impact of a distribution-connected option to the closest GSP(s). With this information, the ESO can then calculate the effectiveness factor of a distribution-connected option with respect to the reference point in the transmission network. Where available, the ESO engages with the system operator function of the distribution companies.
7. In an example below, system analysis suggests it is most effective to implement reactive power compensation at substation Y and that 100MVAR of reactive power absorption is required to meet the system requirement.

Figure 5.13 - Reactive Power Compensation



8. Next, the ESO calculates the effectiveness for options connecting at substation Z with substation Y as the reference point. The ESO models reactive power compensation to absorb 100MVAR at substation Z and test it with selected backgrounds and conditions. In this example, analysis results show that (on average) implementing a reactive power compensation to absorb 100MVAR at substation Z reduces the compensation required at substation Y from 100MVAR to 25MVAR.

Figure 5.14 - Reactive Power Compensation

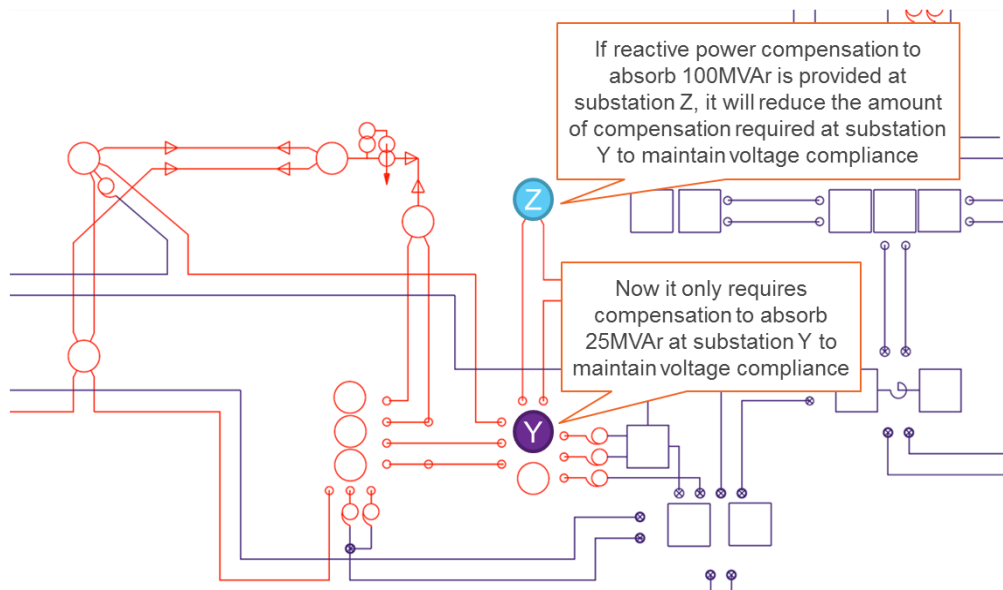

9. The ESO can then approximate the effectiveness for any options connecting at substation Z as $(100-25)/100 = 0.75$ with respect to the reference point.

$$Eff. Factor = \frac{Original\ Compensation\ at\ Ref.\ Point\ Y - Resulting\ Compensation\ at\ Ref.\ Point\ Y}{Size\ of\ Option\ at\ Z}$$

5.3.4.5 Joint Economic and Technical Optimisation approach

1. In some regions, it is not always possible to give a single effectiveness value for each site due to complexities in the network. In regions where there are several critical contingencies and solutions are required across multiple sites, we apply a joint economic and technical optimisation approach where combinations of all possible options must each be checked individually against the applicable criteria.
2. For cases where the requirement specifies any minimum criteria such as minimum amounts of MVar in a given region, the criteria will be applied when generating credible combinations.
3. The figure below illustrates an example process flow for a case where we have 2 regions under consideration (Region1 and Region2). In this example, technical analysis indicates some minimum requirements as follows.
 - Minimum MVar in Region 1 = 100MVar (Q Region1)
 - Minimum MVar in Region 2 = 200MVar (Q Region2)
 - Total minimum MVar across Region 1 & 2 = 500MVar
4. In order to meet the total requirement of 500MVar, all possible combinations of all the submitted options will be generated. The minimum criteria applicable across the individual regions would be applied to further refine the list of option. All remaining options will be ranked from lowest cost.
5. The joint optimisation seeks to identify the lowest cost combinations of options which meet the minimum (region) requirements by creating a cost stack of feasible solutions. Technical analysis is then completed for each option combination, starting with the lowest cost combination to confirm if they are technically valid and result in a compliant network across both regions. If the first combination tested is not valid, the next lowest cost combination which meets the requirements is found and checked, moving to the third, fourth, and so on until a valid combination is found.
6. The preferred solution will be the most cost-effective combination of options which resolves all the high voltage issues in the region.

Figure 5.15 - Example Joint technical and economic optimisation process

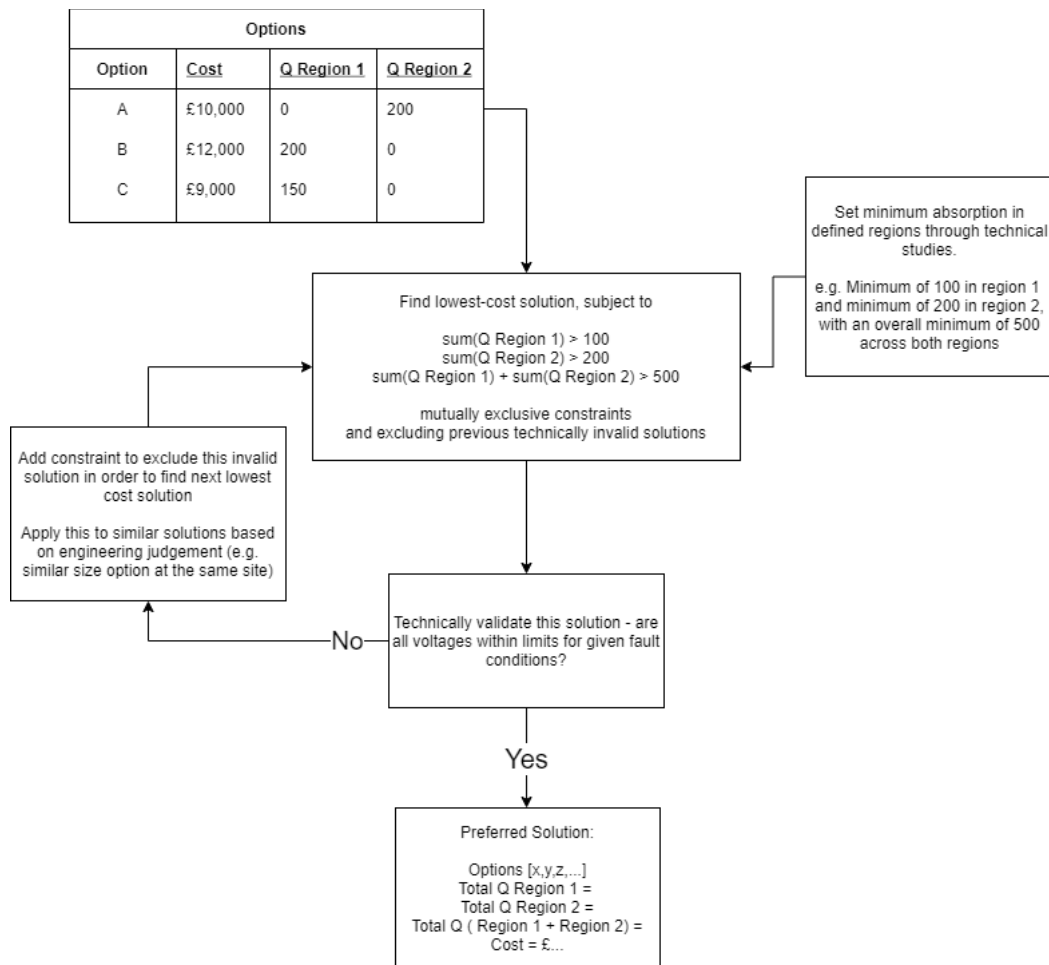

5.3.4.6 Communicating requirements

1. For regions where an Effectiveness Factor approach is applicable: The reactive power required to control voltage will be communicated to relevant parties in the form of “equivalent reactive power compensation to absorb X MVar at location Y”.
2. The ESO also provides information on the effectiveness of reactive power compensation or services installed away from location Y. This information could be presented in a heatmap. All effectiveness factors are relative to the same reference point(s). This is most likely to be the same reference point(s) stated in the requirement i.e., “location Y” for consistency.
3. For regions where a Joint Economic and Technical approach is applicable: The reactive power required to control voltage will be communicated with reference to the total volume required within the region, with additional supporting minimum criteria as deemed necessary to support tender participants to locate their solutions appropriately.
4. The ESO will provide the same information on requirement to all potential option providers. Such information will be provided to the TOs using the System Requirement Form – Voltage (SRF-V). This uses a similar format and structure as the SRF used in the current NOA for network boundary flow. The same information will be provided to the DNOs and Commercial service Providers via the Tender Process.
5. For the avoidance of doubt, this does not imply other information which the TOs and DNOs currently have access to in accordance with the likes of SO-TO Code (STC) or Connection and Use of System Code (CUSC) for network planning purposes will be provided to all parties due to confidentiality reasons.

5.3.4.7 Requesting & collecting options

1. The ESO will invite potential solution providers including TOs, DNOs and Commercial Service Providers to propose options to meet the reactive power for voltage control requirements.
2. The ESO will ensure that reasonable timescales are provided for participants to submit their options.

3. Any parties interested to have their options considered by the ESO should respond to the invitation to tender for proposed options.
4. The TOs should respond using the SRF-V while the DNOs and Commercial service Providers should respond via the Tender Process.
5. For the avoidance of doubt, all options received will be assessed against each other using the same criteria. The different submission process reflects the difference in funding mechanisms - TO options will be recovered via the present transmission regulatory framework, while DNO and Commercial service options will be paid via the Balancing Service Contract. The ESO considers and assesses all options in the same CBA. See the section “Cost-benefit analysis” for more details.
6. The option collection process for each party is as follows:

Branch 1 – TO options

The exchange of option information between the ESO and the TOs will be by means of the System Requirement Form – Voltage (SRF-V). The outline of the SRF-V structure is shown in Table 5.1.

Table 5.1 - Outline of System Requirement Form - Voltage

SRF-V Part	Section title	Details
A	Requirement	Information on requirement in SRF-V Part A will be the same as the information published as part of the Request for Information (see Branch 3 for more details).
B	TO proposed options	TOs provide the information on their proposed options.
C	Outage requirement	TOs provide the expected outages required to connect new assets associated with their proposed options.
D	Not applicable	N/A
E	Option costs	TOs provide the costs on their proposed options. Information should include, but is not limited to: Capital cost, annual breakdown of cost, operation & maintenance cost, WACC etc.
F	Publication information	TOs specify the information which they give consent to the ESO to publish. The ESO will request consent from the TOs to publish the same level of information consistent with the way information from a DNO option or a Commercial service option will be published when the Tender Process concludes.

7. System requirements are sent to the TOs using SRF-V Part A. Unless stated otherwise, this also acts as the prompt to the TOs to propose options.
8. TOs are expected to submit their options to the ESO using SRF-V Part B, Part C and Part E. All costs supplied in the submission should be in current financial year base prices. SRF-V Part D is not used in the high voltage and stability management process.
9. The SO reviews the costs that the TOs submit with their options and check that they are reasonable. The SO checks the costs that the TOs submit against a range of costs for plant and equipment that the ESO has gained from recent experience. If any costs are outside of the range, the SO discusses the costs with the relevant TO. If, following discussions the ESO still believes that the costs are outside of the expected range and will unduly affect the CBA, the ESO can omit the option from the CBA.

Branch 2 – DNO options

10. In the long term when a regulatory funding mechanism for DNO options is agreed, it is expected that DNO options will follow a similar route as TO options, but presently a suitable regulatory

funding mechanism is not in place for the DNO options. Until a suitable funding mechanism is established it is expected that the DNO options will be paid via the Balancing Service Contract; hence DNO options will follow the same route as Commercial service options in the short term. Therefore, DNOs who wish to propose options should respond via the Tender Process.

Branch 3 – Commercial Service Tender Process

11. The ESO publishes the requirements to inform potential Commercial service Providers as part of a Request for Information (RFI). This includes the technical requirements which a Commercial service must meet to participate in the Tender Process. The ESO uses the RFI to gather information about options that could relieve the high voltage and stability issues. Where applicable, the ESO may directly proceed with a tender process without an RFI. In general, the ESO would like to understand the following before a decision to tender is made:
 - The ability of the market to provide Commercial service options as alternatives to Network Owner options to control high voltage
 - The level of interest to provide a Commercial service to meet the identified long-term needs
 - The likelihood of achieving a more economical and efficient overall solution by considering a wider range of options
 - The delivery timescale of market-based options
 - Preferred contract options
12. The RFI information pack will include an indicative timeline for the Tender Process, including when a decision to tender will be made.
13. The ESO decides whether to tender based on the information received from the RFI. The decision will be published alongside a final timeline for the Tender Process.
14. If a decision is made to tender, the ESO will publish the Tender Process information pack with selected contract options. The ESO expects the requirements published in the Tender Process information pack to be the same as those published in the RFI information pack, and the assessment methodology to be consistent with this methodology document. Any exception will be stated in the Tender Process information pack. Details in the Tender Process information pack supersede the details from the RFI.
15. Any parties interested to have their Commercial service options considered by the ESO should respond to the Tender Process. Any responses should use the proforma published as part of the Tender Process information pack.

5.3.5 Creating voltage rules

1. Voltage rules are created to indicate the minimum number of generators required to meet voltage control requirements in a region. The voltage rules are formulated using system analysis results. This approach loosely simulates the close-to-real-time process for voltage management. Studies against generator sensitivities, as illustrated in the previous section, are carried out for each selected set of conditions to help determine the minimum number of generators required and define the voltage rules. Since generators differ in sizes, each generator will be assigned a size coefficient to reflect their different reactive power capabilities.
2. The ESO uses these voltage rules with the constraint cost modelling tool to simulate year-round system operation. The number of bid and offer actions required to maintain system voltages within the NETS SQSS can then be estimated.
3. The constraint cost saving for each proposed option can then be estimated. Representing those variations of study backgrounds and system conditions in the CBA is crucial to the credibility of the estimated constraint cost saving. These backgrounds and conditions will be built into the voltage rules and hence considered in the CBA.

5.3.6 Assessing options

1. When the ESO receives options from potential providers (TOs, DNOs, Commercial service Providers), these options need to be modelled and analysed so their actual impact to system voltages can be understood. The assessment often includes many options; and it may be necessary to group a few options together to create the solution which can meet the system requirement in a region. It may also be more economical and efficient to group options from various providers together i.e. combining TO, DNO and Commercial service options, to meet the requirement. It is however inefficient and impractical to always assess – model and analyse - all possible groups of options. Therefore, the assessment process set out below is used to keep the modelling and analysis at a practical level.

2. The ESO will assess the options selected in the CBA and ensure those options satisfy the service and technical requirements before the final recommendation is made and the Tender Process concludes.
3. The ESO intends to analyse as many options and combinations as practically possible. Only if the number of options available means there are too many possible combinations, the ESO will perform a pre-assessment selection. For the avoidance of doubt, this pre-assessment selection is designed to keep the assessment practical for the high voltage management Process; the overarching principle of finding the most economical and efficient solution still applies.

5.3.6.1 Pre-assessment (applicable when a high number of options are available)

1. The ESO bases the pre-assessment selection on two main factors - effectiveness and cost. The pre-assessment aims at reducing the number of options to keep the number of possible combinations practical.
2. The ESO first calculates the equivalent effective MVAR compensation each option provides with respect to the same (set of) reference point(s) (effective MVAR). The relevant effectiveness factor is applied to each option according to its point of connection and its effective MVAR is calculated.
3. The ESO then considers the cost of the option. As the process considers options from TOs, DNOs and Commercial service Providers, it is expected that the costs of options will cover a range of service terms. Hence the cost per year of each option is used for comparison. See the section "Cost-benefit analysis" for more details on calculating the cost per year for each option.
4. The ESO considers the effective MVAR and cost per year of each option. A cost-effectiveness factor will be calculated for each option in the format £/effective MVAR per year.
5. Options are then ranked according to their cost-effectiveness factors. The options with greatest cost-effectiveness will be selected for the CBA.
6. For the regions where the Joint Economic and Technical Optimisation Approach is applicable, no pre-assessment is required, and all options will be placed in a price stack for evaluation starting with the lowest cost combination as discussed in the earlier section.

5.3.6.2 Cost-benefit analysis

1. The cost-benefit analysis, as mentioned in previous sections, provides investment recommendation based on two primary factors – monetised benefits or security and operability. As a general principle, if there are several options which meet the requirement and satisfy either of the two primary factors, the CBA chooses the most economical and efficient options.

How does the ESO estimate constraint cost?

The ESO will use a pan-European economic dispatch tool to model the constraints in GB. More information on how we run the cost benefit analysis can be found in section 2 of the NOA Methodology.

The tool is used to work out constraint (bid and offer) actions required to maintain voltage compliance against future simulated scenarios. The criteria applied to evaluate constraint actions for high voltage control is different to those used by NOA to determine network boundary flow related constraint actions. The criteria are linked to the minimum number of local generators required on the system to maintain voltage compliance by means of voltage rules. This requirement is informed by analysis on credible future backgrounds and system conditions.

This tool will apply voltage rules to simulate the bid and offer actions required to maintain voltage compliance. The focus here is to represent the reactive power capability of generators while keeping the MW cost as low as possible, therefore the cost to move a plant to its minimum stable generation position is priced. Where applicable, footroom requirements will be considered.

The high-level process for estimating constraint cost is outlined below.

1. Run an economic market dispatch

The model is dispatched for each future energy scenario.

2. Run a network constrained re-dispatch

Apply the forecast boundary capabilities and constraints based on the latest FES database and NOA investment recommendations. Re-dispatch the network as per the previous step.

3. Extract hourly data for pertinent plants for the voltage rules

For the areas under consideration and according to the voltage rules determined from the technical studies, extract the hourly data relevant for all options under consideration.

4. Examine the hourly data to see what is required to fulfil the rules

For each option, examine in turn the hourly data to see whether the rules are complied with or what actions need to be taken for them to be complied with. This then creates a list of actions for each option which need to be taken for every hour for the validity of the rules and for each scenario.

5. Cost the actions required based on bid and offer prices and minimum stable generation

The cost of the bid and offer actions is taken from the assumptions made within the model and the actions required to meet the voltage rules costed.

How does the ESO estimate utilisation cost?

Utilisation cost will be dependent on a range of factors, such as the following:

- Rate: The ESO applies the current ORPS rate or the contracted rate where applicable.
- Point of connection: Utilisation varies depending on where an option is and the network topology at its point of connection.
- Service duration: Duration an option will be active i.e. how often the ESO expects an option will be required to control high voltages.
- Equipment used: The different equipment used to provide the Commercial services affects how often and how long an option will be used.
- System needs: For example, whether the reactive power capability is required pre-fault and/or post-fault will impact how often and how long an option will be used.

It is impractical to calculate utilisation based on fixed point system analysis as utilisation varies with system conditions. To fairly recognise the utilisation cost, the ESO estimates it based on how the BM units or newly proposed options are anticipated to be used.

1. The CBA considers various factors, including but not limited to:
 - System requirements for controlling high voltages
 - Point of connection of option
 - Effectiveness
 - Assessment period
 - MVAR capability provided by proposed option
 - Flexibility to offer only part of the MVAR capability of proposed option
 - Earliest-in-service date (EISD)
 - Costs including costs to cover outages requirements for unavailability of the provider, either due to their own outages or network outages
 - Cost of electrical losses
 - Credible events that could give rise to loss of multiple providers
2. In previous sections, system requirements, point of connection and effectiveness have already been discussed in detail.
3. Assessment period is defined as the years over which the future voltage control requirements are reasonably clear and certain. This should be the same as the period for which the Tender Process requests for options.
4. Options may provide different MVAR capability in each year.
5. In some cases, a provider who can offer only part of the MVAR capability of its proposed option may help achieve an overall solution of lower cost to consumers. The ESO considers this flexibility when they select options to form the most economical and efficient solution(s).
6. EISD refers to the earliest date when an option will be available to provide the required reactive power.
7. The cost to provide the service can be split into capital costs and operational costs. All costs submitted should be in current financial year base prices. Table 5.2 below provides the various element of costs to be included as the capital cost and operational cost in TO options, DNO options and Commercial service options.

Table 5.2 - Details of capital and operational costs for each type of providers

Option providers	Capital cost	Operational cost
TOs	<ul style="list-style-type: none"> • Cost of the new assets associated with an option • WACC to be applied to regulated assets 	<ul style="list-style-type: none"> • Maintenance • System access • Other ongoing operational cost associated to the option
DNOs	<ul style="list-style-type: none"> • In the short term while the DNO options will be paid via the Balancing Service Contract, the cost of DNO options should be submitted via the Tender Process and in the same format as required by the Tender Process. 	
Commercial service Providers	Cost of connecting any new assets associated with an option to the electricity system (transmission or distribution)	<ul style="list-style-type: none"> • As per contract, which may include: <ul style="list-style-type: none"> ○ Availability payment ○ Utilisation payment

8. The capital cost is any infrastructure cost that will be incurred by a Network Owner (TOs or DNOs). The ESO applies the weighted average cost of capital (WACC) to any network infrastructure costs that will be incurred due to an option. The ESO will seek this information directly from the relevant Network Owner(s). The capital cost should be submitted as a spend profile, which indicates the financial year in which the capital will be spent. Costs should be in a single, specified price base year which is consistent with the base year used for tender bids.

Table 5.3 - Example of spend profile

Year	2020/21	2021/22	2022/23
Cost £m	5	10	8

9. The operational cost should include any maintenance, system access and other ongoing costs. The operational cost will be applied for each year that the option is utilised. The operational cost submitted may vary by year.
10. The benefits that each option provides will be discounted at the social time preference rate as laid out in the Treasury Green Book. This process results in the present value (PV) of each cost and benefit.
11. The ESO first calculates the equivalent effective MVar compensation each option provides with respect to the same (set of) reference point(s) (effective MVar). The relevant effectiveness factor to each option is applied according to its point of connection and its effective MVar is calculated.
12. The ESO then calculates the cost of providing an effective MVar for each option. The operational cost per effective MVar will be calculated as the PV operational cost per year divided by the quantity of effective MVAr provided.

$$PV \text{ Op. Cost per Eff. MVar} = \frac{PV \text{ Operational Cost per Year}}{\text{eff. MVAr}}$$

13. The capital cost will be calculated as the PV capital cost divided by the product of the quantity of effective MVAr and the number of service years. Service years is defined as time that the option will be available and cost-effective within the assessment period.

$$PV \text{ Capital Cost per Eff. MVar} = \frac{PV \text{ Capital Cost per Year}}{\text{eff. MVAr} \times \text{Service Years}}$$

14. The sum of the operational and capital costs per effective MVAR will be the cost per effective MVAR for the option.

$$PV \text{ Cost per Eff. MVAR} = PV \text{ Op. Cost per Eff. MVAR} + PV \text{ Capital Cost per Eff. MVAR}$$

15. The goal of the CBA is to find the most economic and efficient solution(s) to the problem for the GB consumer. An optimisation will be carried out across all years within the assessment period simultaneously to find the cheapest solution(s). This is to take into account the capital cost of each option which is independent of the number of years that the option is considered optimum.
16. With the cost per effective MVAR calculated, the bids will be stacked, with the lowest cost per effective MVAR at the top, and the highest at the bottom. In general, bids will be selected from the top first until the system requirement for effective MVARS has been met. The stack order may be altered if more cost-effective combinations become apparent.
17. The ESO may conduct this process for every year individually or across the entire assessment period as deemed appropriate.
18. A provider may submit an optimal bid in one year, but this does not guarantee the bid will be optimal in subsequent years if lower cost options are available. The lowest cost solution(s) over the entire assessment period will be chosen. Note that in some cases this may result in a more flexible or smaller option that is more expensive per MVAR to be chosen.
19. Within each yearly stack, the ESO forecasts the cost of procuring the system voltage need through the BM. This will be done by modelling future GB electricity markets using the latest future energy scenarios and assessing within each settlement period which generators will be able to provide a solution to voltage issues. The BM costs for procuring the need will be again converted into a cost per effective MVAR which will be placed within each yearly stack to compete against the submitted options.
20. An example of the stacks and the selection of winning bids (highlighted green) is shown below in Table 5.4. Please note that the costs shown are not reflective of any forecast, they have simply been chosen for demonstration purposes.

Table 5.4 - Example of selection of options based on cost per effective MVAR to achieve a solution with most economical and efficient total cost

System need: 200MVAR

Provider name	Flexible?	Provider effective capability (MVAR)	Cost per effective MVAR (cost/MVAR)	Cost
Provider 1	Yes	50	10	500
Provider 2	Yes	100	14	1400
Provider 3	No	25	15	375
Provider 5	Yes	50 (25 procured)	18	450
Provider 4	No	50	17	
BM	Yes	200	22	
Provider 6	Yes	100	30	

21. The total cost in Table 5.4 is $500+1400+375+450=2725$. Note that Provider 5 is selected ahead of Provider 4 even though Provider 5 has a higher cost per MVAR. This is because Provider 5 is more flexible and allows the system need to be met exactly. Using Provider 4 would result in the system need being exceeded by 25MVAR and result in a higher total cost ($500 + 1400 + 375 + 850 = 3125$). There is a cheaper (although not the cheapest) solution where Provider 4 is selected ahead of Providers 3 and Provider 5. This solution has a cost of $500 + 1400 + 850 = 2750$ and exactly 200MVAR is procured. In some cases, the system operator may allow excess MVAR to be procured if this would result in a lower cost for the consumer and pose no operational issues.
22. The CBA recommends the options which should be taken forward. Given the size of the investments and the short lead times, these recommendations are a single lifetime decision.

This means that when an option is recommended, that recommendation persists until the asset or service contract expires. This is different to the normal annual NOA least-worst regret (LWR) recommendations which are reviewed annually. Where a recommendation is marginal, the decision may be to reassess at a later date when there is greater certainty of the need. This is only possible where the EISD of the option is ahead of the need and so the option can be delayed.

5.4 The Stability Management Process

5.4.1 Regional approach

1. At a regional level, the distribution of regional inertia, short circuit level, dynamic voltage support can influence the stability of the local network and its users. The regional stability requirements are determined by the configuration of the local network and the nature of generation and demand in that region. Since short circuit current and reactive power, unlike real power, cannot be sent across long distances due to the reactance of the transmission network, it is most effective when applied close to the problem. Stability issues can therefore be grouped into regions and assessment of each region conducted separately. The stability management process looks into the stability needs on a regional basis.

5.4.2 Screening process - selecting and prioritising regions

1. The ESO uses a screening process to help identify and prioritise the region(s) which should be further explored through detailed power system and cost-benefit analysis. This should bring consumers the best value by ensuring the secure, economical and efficient development focuses on challenging regions first. The screening process considers future trends of generation and demand and their potential impact of system operability due to decline in regional system strength (short circuit levels), regional inertia and regional dynamic voltage support.
2. The ESO will request feedback from the TOs as to which region(s) they believe should be assessed.

5.4.3 Creating network models for analysis

1. The ESO will start with the GB system planning models to produce and update elements within it to ensure the models are fit for this purpose. Future backgrounds based on Future Energy Scenarios (FES) and system conditions considered appropriate based on expected trends of decline in regional system strength (short circuit levels), regional inertia, regional dynamic voltage support will be applied to the models for assessment.

5.4.4 Identifying requirement

5.4.4.1 Collaborating with TOs/ DNOs to optimise existing assets

1. This part of the process is similar to the one from high voltage management project (please see Section 5.3.1 paragraph 1 and Section 5.3.2 paragraphs 1 and 2).

5.4.4.2 Analysing the size of the stability requirement

1. The ESO identifies the stability requirement based on system analysis. The requirement varies depending on the future backgrounds and system conditions. It is not practical to fully analyse all combinations of backgrounds and conditions. Hence, the ESO selects snapshots based on data mining techniques and engineering judgement to represent a fair number of variations of backgrounds and conditions. For stability analysis, the ESO considers future outlook of FES scenarios on regional short circuit level, regional inertia and regional dynamic voltage. This allows ESO to choose a generation and demand background to be studied in detail. The ESO determines the regional stability requirements by running time series fault simulations in an RMS tool for a selected generation and demand background. The ESO carries out sensitivity scenarios to complete its detailed analysis. The ESO also considers how often such a need could arise in future.
2. The regional stability needs are determined by understanding regional voltage and frequency behaviours within a period of a transmission system disturbance (transmission system faults can last for up to 140ms), at fault clearance and immediately after a fault clearance and for at least 500ms after fault clearance. The stability of voltage and frequency waveforms allows ESO to understand the risks on the transmission system and to quantify the stability requirements.

5.4.4.3 Collecting effectiveness factors

1. To allow a fair comparison to be made for all potential options, effectiveness factors are used when the ESO assesses options. The general principle used to calculate the effectiveness of an option is similar to the one in high voltage project (please see Section 5.3.4.1 paragraph 3 to Section 5.3.4.4 paragraph 2), instead of calculating effectiveness of options to provide reactive support, the effectiveness of option to provide short circuit current and/or dynamic reactive support is calculated for stability management process. More details will be published in any stability tender based on regional stability needs.

5.4.5 Communicating requirements

1. Communicating process for system requirement between ESO and stakeholders is similar to the one from high voltage process (please see Section 5.3.4.4 paragraph 9 to Section 5.3.4.5 paragraph 4), instead of using SRF-V, SRF-S is used to exchange data.

5.4.6 Requesting and collecting options

1. This part of the process is similar to the one from high voltage (please see Section 5.3.4.5 paragraph 5 to Section 5.3.4.7 paragraph 8), instead of using SRF-V, SRF-S is used to exchange data.

5.4.7 Assessing options

1. Process is again very similar to high voltage management (please Section 5.3.4.7 paragraphs 12 to 14), a cost-effective factor is calculated for each option in the format £/effective MVA per year (as opposed to the £/effective MVA_r per year used in high voltage management project) in order to compare and rank them in the CBA process later on.

5.4.8 Cost-benefit analysis

1. In principle, a similar methodology to high voltage is used (please see Section 5.3.6.1 paragraph 3). The stability cost benefit analysis will be dependent on drivers behind each region's stability requirements. For example, in Scotland the ESO's stability needs are primarily driven by low short circuit level, whereas in other areas of GB there may be different drivers. The stability cost benefit analysis will also take account of active power export for each option and discount providers due to the cost of balancing their active power elsewhere. The ESO will publish detailed assessment methodology applicable to a stability tender as part of a tender process.

5.5 High Voltage and Stability Process conclusion

1. Based on the results of the CBA, the ESO recommends the solution which should be taken forward. The recommended solution could consist of only TO option(s), only DNO option(s), only Commercial Service Provider option(s), or any combination of these three types of options. If the CBA concludes that none of the options proposed in the process provides benefits against forecast BM cost to control high voltages, the ESO may accept no Network Owner options and/or Commercial Service Provider options.
2. If the recommended solution consists of TO option(s), the ESO will write to the relevant TO(s) to inform them of the recommendation to support an investment case.
3. If the recommended solution consists of Commercial Service Provider option(s), the ESO will contact the relevant provider(s) after publishing the tender outcome and proceed with procuring the selected option(s) using the Balancing Service Contract.
4. If DNO option(s) are recommended, in the short term while the DNO options will be paid via the Balancing Service Contract, the ESO will proceed with the DNO option(s) in the same way as with any Commercial Service Provider options.

5.5.1 Tender outcome

1. Tender outcomes will be announced as soon as reasonably practicable once the analysis and other relevant verification and approval process conclude. Tender outcomes will be published on the ESO website.

5.5.2 Tender documentation

1. All tender related documentation will be published on our dedicated website throughout the process. This will include any pre-tender, tender and post-tender documentation. This will include the technical and commercial methodologies, technical specifications, feasibility study

guidelines, contractual terms and all other relevant data to support the tender activities. Tender outcomes will also be published on our website.

5.6 The Constraint Management Process

5.6.1 Annual NOA assessment of ESO constraint management solutions

1. As part of the NOA process, the ESO can propose alternative options to be assessed. Constraint management solutions are an example of the Automatic MW redistribution options described in Chapter 2 of this methodology.
2. The ESO initiates the development of constraint management solutions during the NOA process by assessing the need for constraint management solutions across constrained system boundaries. Solutions that receive a “Proceed – Critical” signal from the NOA are then progressed for further development.

5.6.2 Prioritising regions

1. The regions with “Proceed – Critical” ESO-led constraint management solutions are prioritised based on their forecasted constraint costs, and timing of the system need.
2. The ESO engages with the relevant TO(s) on which region(s) the ESO is planning to deliver constraint management solutions following NOA recommendations.

5.6.3 Understanding needs

1. At this stage, the ESO will carry out both economic and technical analyses to clearly define the system needs for the region(s) prioritised. The economic analysis forecasts the constraint costs over the next ten years while taking account of the NOA optimal reinforcement path. For the years with high constraint costs, the technical analysis conducts system studies to identify the causes of constraints, e.g., thermal, voltage or stability issues, under different operational scenarios.

5.6.3.1 Economic analysis

1. The ESO economic study uses the Plexos model and the FES background data to simulate the electricity market operation within the region. Following the NOA process outlined in Chapter 2, the study forecasts the number of periods in each year when the constraint is active, i.e., the boundary flow is higher than the boundary transfer capability. The study then calculates the associated constraint cost per year by taking balancing mechanism actions to re-dispatch generation to meet demand.
2. To demonstrate the business need of constraint management solutions, the economic study currently uses system to generator intertrip options with different MW volumes as a commercial service to increase the boundary transfer capability and alleviate constraints. An average effectiveness of commercial intertrip is used based on the technical analysis output. The economic analysis provides potential cost savings across the next ten years by taking account of the capital investment, arming fees and lead time of delivering intertrip services.

5.6.3.2 Technical analysis

1. The ESO study aims to define the technical requirement for a constraint management solution by assessing the thermal, voltage and stability criteria as per the NETS SQSS. In addition to the ETYS/ NOA boundary capability assessment, the analysis will:
 - a. focus on the earliest year expected to deliver a constraint management solution, which is usually the year when the constraint cost starts increasing significantly due to the high uptake of generation in the year as forecasted by the FES.
 - b. study a range of snapshot scenarios by taking a joint view of long-term network development and day-ahead planning. The scenarios cover winter peak and summer minimum demands with various generation and interconnector backgrounds.
 - c. utilise the latest NOA reinforcement options expected to be delivered in the region, and model intertrip as an example of constraint management solutions to resolve any thermal, voltage and stability issue encountered in each scenario.
2. The ESO will start with the GB system planning models to update and produce elements within it to ensure the models are fit for this purpose. Future backgrounds based on FES and system conditions considered appropriate in accordance with the NETS SQSS will be applied to the models for assessment.

3. The study calculates the effectiveness of using intertrip as a potential constraint management solution to relieve constraints. The effectiveness indicates how effectively tripping off generation helps increase the power flow through a constrained boundary, expressed as a percentage of the total volume of the intertrip service.

$$\text{Effectiveness} = \frac{\text{Change in the Boundary Transfer Capability (MW)}}{\text{Total Volume of Commercial Intertrip (MW)}} \times 100\%$$

For example, an effectiveness of 70% means allowing post-fault intertripping 1GW generation would increase the boundary transfer capability by 700MW. The effectiveness factors are calculated for all scenarios and provided to the economic analysis. The study also assesses the effectiveness of intertrip options with different amounts of active power, up to the largest infeed loss that can be securely tripped off the system without leading to instability or large disturbances on the network.

5.6.4 Gating options

1. Once the economic driver and technical requirements for a constraint management solution are defined, the ESO can decide whether to adopt an existing solution such as setting up a commercial intertrip market or request information from the market. The latter would be via Request for Information (RFI) to seek options that could better meet the need.
2. If a commercial intertrip service is being considered as an option, the ESO will collaborate with TO(s) to check the current status of any Operational Intertrip Scheme (OTS) that already exists in the region. Depending on the issues identified, the existing OTS (if any) might be able to be adopted for the commercial intertrip, or it needs to be upgraded with additional functionalities, e.g. fast reactive switching to help maintain post-fault system stability.

5.6.5 Solution development

1. Based on the options received, the ESO will validate the solutions to see how they fulfil the technical and commercial requirements. A cost-benefit analysis will be carried out to prioritise a solution or a range of solutions to progress.

5.6.5.1 Commercial Assessment/CBA

1. The ESO will conduct a cost-benefit analysis to commercially evaluate solutions. To assess the most economic solution, potential savings will be analysed. These will be calculated via simulating the costs of the balancing mechanism with the solution in place (which includes the boundary transfer capability of the intertrips) and comparing them to the ones of the counterfactual case. The cost of the solution will be then subtracted, and the result will be discounted using the rate provided by HM Treasury in the Green Book, resulting in the present value of the solution savings. In particular tenders, we may need to limit the number of options which can be awarded an agreement. The details will be part of the tender documentation, but this is likely to be by accepting a certain number of options or MW capability based on the lowest submitted prices.
2. If a commercial intertrip service is recommended to be developed, the ESO will launch a public consultation on the draft service requirement and contract, following with an Expression of Interest (EOI) to collect information on participants which are interested in offering an intertrip service. The ESO will conduct a feasibility study to assess the interested participants against the technical criteria of delivering the service. The feasibility study requires studies from TO(s) to confirm if the service providers could be connected to the existing OTS by the requested service period and hence can participate in the tender.
3. In the commercial tender stage, participants are expected to submit arming and utilisation (tripping) prices to the ESO. To determine the cheapest MW volume available to provide the service, the following process will be used:
 1. Identify all possible unit size combinations across the available number of channels in the intertrip scheme.
 2. If required, apply an average outturn factor to the submitted output capacity of the relevant units. This is important as a significant proportion of generation can come from wind, which rarely achieves 100% output. Therefore, the outturn factor helps to ensure that the MW volume is always achieved.

3. Filter and remove the combinations that do not meet the MW volume requirement. To ensure no single unit (N-1) being unavailable leaves the remaining MW volume under the requirement, the largest unit on a stack of generators shall be removed from the combination to see if the requirement is still met/exceeded.
4. The arming and utilisation (tripping) fees will be used to identify the lowest cost combination of units. The lowest priced combination will be awarded the contracts.
 - For the arming assessment, appropriate arming assumptions will be made. The ESO will assume H-hours (2H settlement periods) of arming per annum (units are expected but not guaranteed to be armed between H-hours a year).
 - The ESO expect the fault to be a rare occurrence. Subject to all involved units adhering to network policy for asset and maintenance and assumed historical weather conditions, the fault is expected to occur once every 25-years.
 - From the previous assumptions, the utilisation (tripping) fee will be calculated on a pro-rata basis and added to the arming fee per settlement period.

$$Combination\ Price = \sum_{i=1}^n \left(Arming\ Fee\ per\ SP + \left(\frac{Tripping\ Fee}{2H \times 25} \right) \right)$$

5.6.5.2 TO Feasibility studies

1. The ESO will initiate feasibility studies with the relevant Transmission Owner(s). The ESO will provide the EOI responses to the TOs who will thereafter advise the ESO:
 - If a service provider meets the ESO's requirements of the commercial intertrip service.
 - If the service provider can be connected to any existing OTS by the requested service start date.
 - The TOs will be looking to ensure that there is no disruption to another party connected behind the identified transmission circuit breaker. If another party is connected behind the same transmission circuit breaker or downstream of the interested party, then the outcome of the TO Feasibility Studies will be a failure if the other party is not in agreement with the conditions of being tripped off post fault or participating in the commercial intertrip service.

5.6.6 Solution deliver

1. A tender will be conducted at this stage to procure the constraint management solution.
2. The ESO will develop and publish the commercial assessment principles, service specification and contracts, tender platform with a clear timeline for delivery of the project.
3. Once contracts are awarded, the ESO will start to implement the infrastructure needed to deliver the solution, e.g., network, IT, training and resources. In the case of implementing a commercial intertrip service, the ESO will engage with the successful service providers and relevant TO(s) to commence the service.

5.6.7 Constraint Management Process Conclusion

1. Tender outcomes will be announced as soon as reasonably practicable once the analysis and other relevant verification and approval process conclude. Tender outcomes will be published on the ESO website.
2. The developed constraint management solution will be considered in background when assessing boundary capabilities in the next NOA annual process.
3. As constraint management solutions are currently being designed to be flexible around when the system needs emerge and decline, the contractual periods are expected to be short term. This allows flexibility for the ESO to revise the need and make improvements to deliver constraint management solutions that maximise consumer benefits.

6

Early development of options and interested persons' process

6.1 Introduction

1. This methodology section describes how the early development of options and the Interested person' processes work. The aim is to increase the breadth of options available for the NOA process to improve end consumer value. To support this, licence condition C27 obliges the ESO to undertake the early development of options (see paragraphs 23 and 24 of licence condition C27) and assess options from interested persons (see paragraph 16(a)(viii) of licence condition C27) among others.

6.1.1 Early development of options

1. The ESO undertakes the early development of options where early development is not carried out by another transmission licensee, or an option is suggested by other interested persons. The ESO will assess whether the option has demonstrable benefit. A demonstrable benefit would be where the mitigation of a constraint is in a credible range and at a competitive cost. The ESO might do development by, for example, modelling the network and/or options. The ESO must do the early development to such a standard that it can perform economic studies on the options to adequately compare the relative suitability of options.
2. The ESO publishes the System Requirements Form (SRF) that provides the information to the industry about system needs and hence opportunities for them to invest.
3. Note that early development of options is different from ESO-led options such as commercial solutions. A 'commercial solution' is a contract with a generator for the output of that unit to be reduced or disconnected following a system fault.
4. The ESO accepts that its limited capability to study options' costs and earliest in-service dates may limit the accuracy of its view of the costs of options it is developing. The consequence of this could be that an early development option has unduly favourable results at first which displaces and delays alternative options. The ESO may make its costs and earliest in-service dates available for scrutiny which could lead to it revising the data put into the NOA economic process.
5. Following the review of options submitted for the NOA process, the ESO will consider the following aspects when determining whether to undertake early development of options:
 - **Insufficient NOA Options:** Where there are not enough options to meet the requirements on each boundary, the ESO may undertake early development. We assess whether the options are sufficient by comparing the capabilities against unconstrained flows modelled in [our market model](#). This will be followed by initial screening to test if options are technically effective with some consideration of the cost.
 - **Abandoned Options:** If an option has been initially devised in NOA but then not re-submitted in a subsequent NOA, the ESO will seek to understand why the option has been abandoned and may/ may not decide to pursue the option.
 - **Options not progressed by relevant TO:** The ESO may develop an option that the TO or relevant party has declined to adopt and develop.

6.1.2 Interested Persons' Process

1. The purpose of Interested Persons' options is to increase the diversity of options considered within the NOA process through academic and industry participation. Options submitted through this process are required to be new and innovative and not currently assessed in [onshore network options](#).
2. Interested persons can suggest options and where they can give demonstrable evidence of benefit to meet system needs, the ESO, and TO as required, can support them with further analysis or studies. In some cases, the ESO might conclude that previous work, perhaps by a TO, has found that a particular option is impractical or not worthwhile in which case there is no further action.
3. The ESO will apply a screening stage to filter options from interested persons if there are many and it is clear that some are more beneficial than others. This may be found by engineering judgement based on the following factors:

- Genuine network need;
- Operability;
- Practicality, for instance delivery date;
- Understanding of the costs;
- Whether the same or similar option has been considered before and ruled out for good reason.

During the filtering process the ESO will also check to see if the Interested Persons option is better suited to alternative processes such as our voltage and stability procurement events or Innovation projects. If this is the case, the option may be recommended to be put forward to the alternative process.

4. When the ESO carries out early development of an option, it needs to be able to determine the option's benefit, for instance how much it improves boundary capability, the cost and also the earliest in-service date. These are the key factors in the cost-benefit studies. The ESO forms a view on these using the following considerations:
 - What the ESO's aim is, for example to improve capability when all other options have been exhausted. This introduces the nature of the option and the ESO's thinking, such as new reactive compensation and new circuits.
 - The existing parts of the network that are affected, such as connection points for new circuits as well as other network topology changes.
 - Technical parameters of the solution to allow technical studies of the option and determine, for instance, boundary capability and related effects such as fault levels. This might affect the overall benefit of the option as the net gain might be reduced or an investment like circuit breaker replacement might be needed elsewhere if fault levels exceed existing ratings. An estimate of the capital cost and earliest in service date based on public cost data and making certain assumptions such as the proportion of a new route that is cable. The ESO consults with the relevant TOs about such examples for their views about an option's practicality.
5. The early development of Interested Persons' options will be an ongoing collaborative process between the provider, NGESO and the incumbent TO, as appropriate. This will ensure proposed options are fully understood and sufficiently developed whereby it is demonstrated they can provide a benefit ahead of inclusion in the CBA. For an Interested Persons' option to be considered for the forthcoming CBA analysis, it must be considered technically competent, mature and submitted before the start of technical analysis.
6. Providers will be able to submit options year-round through a publicly available System Requirement Form (SRF).
7. Interested Persons' options must be a response to system needs and deemed sufficiently mature before the ESO will grant their inclusion for assessment in the CBA. Where deemed insufficiently mature, the option(s) will be developed in collaboration with the third party and incumbent TO until such time that all parties agree the option is ready for options assessment or until the need is met or no longer required. If an option's benefit cannot be clearly demonstrated, then the ESO can either work with the Interested Person if the ESO believes there could be some benefit or the ESO explains to the Interested Person why the option is being rejected.
8. At present, the Interested Persons process will not assess storage options, this includes pumped storage, battery storage, compressed air, and all other storage technologies. We are developing a process to assess storage for the enduring CSNP and builds on our Energy Storage Technical Feasibility Assessment which we investigated using storage to reduce constraint costs
9. The framework to enable non-TO entities to deliver reinforcements was set out as part of the Energy Bill. This would enable third parties to compete to become Competitively Appointed Transmission Owners (CATOs). The legislation to enable this is progressing and the ESO is establishing a tender process to run early competitions. These are competitions for the design,

build and operation of reinforcements. The ESO envisages that the interested person's process will evolve to enable third party input into the initial solution development for projects that may be completed.

10. In advance of the frameworks described above, it is anticipated that all successful non-ESO led Interested Persons' options will be developed and owned by the relevant TO. The development will require close collaboration with the Interested Persons.
11. The ESO may seek the input of the relevant TO(s) to help it understand the factors that might affect an option. The ESO will not undertake consenting engagement work on options – this will be carried out at the appropriate development stage, by the relevant party, following a "Proceed - Critical" recommendation. Following a "Proceed - Critical" signal from the TCSNP publication in December 2023, the Interested Persons' options will be delivered by the incumbent TO(s) or, if appropriate via the ESO, through standard procurement and regulatory frameworks. *Figure 6.1* shows the Interested Persons' process in a flowchart.
12. Year on year progression of Interested Persons' Options will be subject to continued "Proceed - Critical" signals in the annual CBA.

Figure 6.1 - Interested Persons' Process flowchart

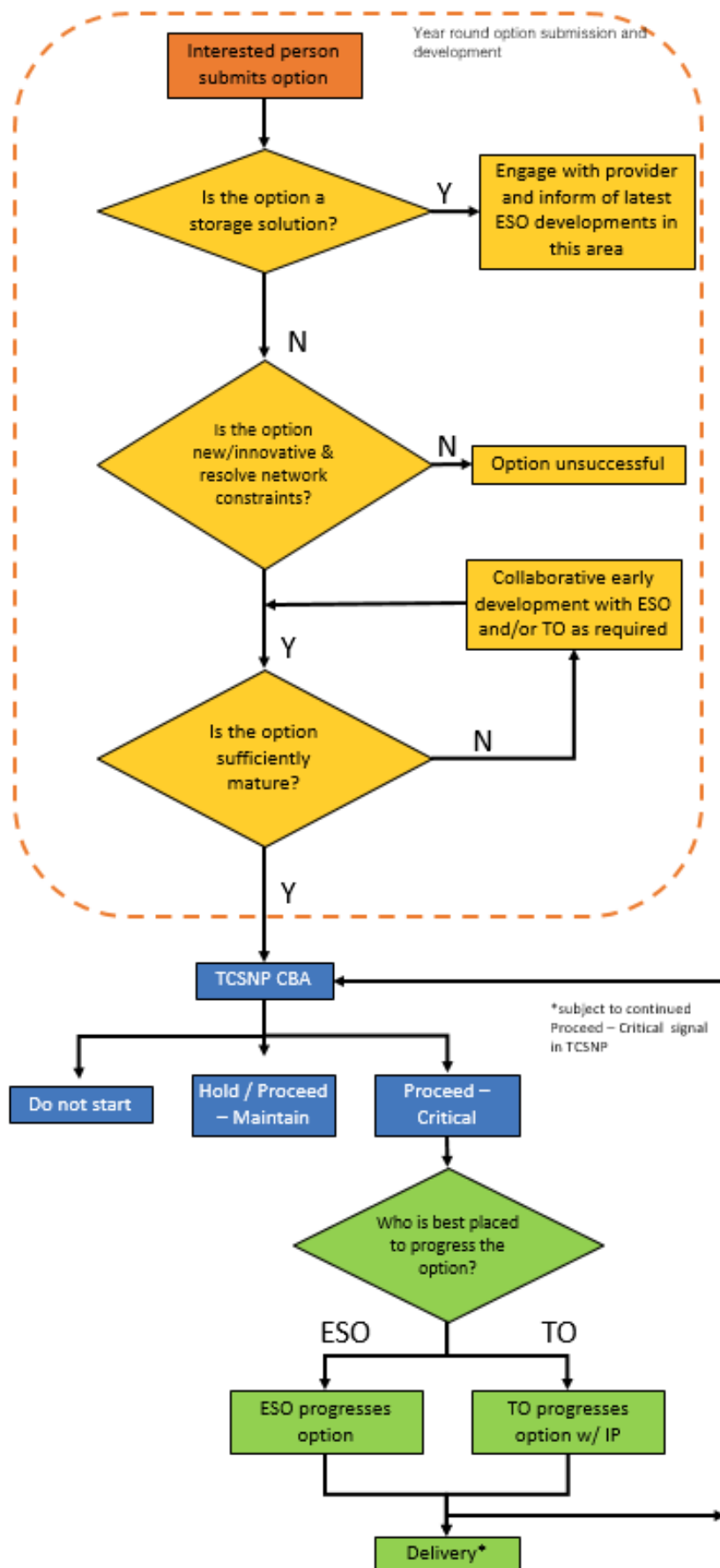

7

Future Developments

7.1 Future developments

1. The ESO expects to make the following changes to the TCSNP methodology:
 - a) Build on the Pathfinder projects to test distribution solutions as TCSNP options which include identifying non-MW requirements and the necessary cost-benefit analysis methodology.
 - b) The first iteration thermal probabilistic tool has been developed during 2021 and 2022. The methodology and findings have been discussed with our TO colleagues. Further discussion with the TOs will take place in 2023 and 2024 as we conduct continuous development and improvement.
 - c) Probabilistic tools that would facilitate:
 - i. Simulation analysis of full year network operation with variation in generation and demand profiles to identify both common and infrequent problems.
 - ii. Representation of typical operational optimisation actions such as control of powerflow controllable devices (e.g., Quad Boosters (QBs) and other similar Flexible AC Transmission System (FACTS) devices)
 - iii. Automation of study set-up and contingency analysis
 - iv. Automated data manipulation and results handling and filtering
 - v. Continuous assessment of individual circuit parameters instead of boundary representation.
 - vi. Benchmarking year-round circuit-based constraints representation in the economic assessment.
2. Our current work led to a thermal probabilistic case study. Through this we investigated the viability of using probabilistic tools for thermal studies during 2020 and 2021. We have successfully used the probabilistic circuit-based methodology for the ESO 5-point plan for constraint costs in 2021. This year we are going to validate the approach further and conclude our findings. Based on this we will propose the road map and methodology for the integration of a year-round probabilistic assessment within the TCSNP process in agreement with stakeholders. Having gained experience with thermal studies, which includes performance levels and validation, we envisage voltage, and any other elements would follow in the subsequent two years.
3. As part of our business plan obligations, A11, we have undertaken a tender exercise to review the economic assessment tool used in the TCSNP process. We have used BID3, supplied by AFRY up to NOA 2021/22 and NOA 2021/22 refresh. As a result of this competitive process, we selected Plexos, produced by Energy Exemplar as our new economic assessment tool. This tool will give us additional features including nodal modelling and more detailed constraint analysis. We are building up our model in Plexos and will undertake benchmarking activities against BID3 to ensure that the output is consistent.
4. We recognise the need to evaluate more Connection Wider Works (CWW) and Asset Replacement Works (ARW) in the TCSNP process in fulfilment of our Business Plan obligations, objective A9. We have been planning how to achieve this while we develop plans for the system wide review of network planning in the ETNPR. Our plan for ETNPR has been expanded to include CWW and ARW. Since this has a broader approach, it is expected that the outcomes will be stronger and more future proof than considering any topic in isolation.
5. Whilst developing our TCSNP methodology, we have also been working on what the enduring CSNP will look like by conducting an extensive review of our Network Planning processes. This is to ensure that the network design and investment processes in Great Britain are fit for the future. We will look to provide further information and engagement as we progress through our latest thinking.