

Annex 1 – Legal Text

Changes shown in red text

SECTION K: TECHNICAL, DESIGN AND OPERATIONAL CRITERIA AND PERFORMANCE REQUIREMENTS FOR OFFSHORE TRANSMISSION SYSTEMS

1. INTRODUCTION

1.1 This Section K sets out the minimum technical, design and operational criteria and performance criteria that Offshore Transmission Owners must ensure their Transmission System can satisfy in the following specific areas:

1.2 Section D Part One, clause 2.2.6 of the STC specifies that in planning and developing its Transmission System, each Transmission Owner (which includes Offshore Transmission Owners) shall ensure that its Transmission System complies with the minimum technical, design and operational criteria and performance requirements set out or referred to in Connection Conditions 6.1, 6.2, 6.3 and 6.4 as applicable to Type 1 Transmission Owners or European Connection Conditions 6.1, 6.2, 6.3 and 6.4 as applicable to Type 2 Transmission Owners and in Planning Code 6.2 and/or 6.3 as applicable or such other technical criteria or requirements as apply to any relevant part of its Transmission System by virtue of a current Transmission Derogation and in the case of an Offshore Transmission System, each Transmission Owner shall ensure that its Transmission System meets the minimum technical design and operational criteria and performance requirements set out or referred to in section K of this code.

1.3 Annex 1 of Section K of the STC applies to:-

Offshore Transmission Owner's who own an AC Offshore Transmission System and that AC Offshore Transmission System was first connected to the Onshore Transmission System before 27 April 2019 and the purchase contracts for its Plant and Apparatus forming the major part of that AC Offshore Transmission System had been concluded before 17th May 2018; or Offshore Transmission Owner's who own an Offshore Transmission System comprising a Transmission DC Converter and that Offshore Transmission System was first connected to the Onshore Transmission System before 8 September 2019 and the purchase contracts for the Main Plant and Apparatus forming that Offshore Transmission System comprising a Transmission DC Converter had been concluded before 28 September 2018;

1.4 Annex 2 of Section K of the STC applies to:-

Annex 1 – Legal Text

Changes shown in red text

Offshore Transmission Owner's who own an AC Offshore Transmission System and that AC Offshore Transmission System was first connected to the Onshore Transmission System on or after 27 April 2019 and the purchase contracts for the Plant and Apparatus forming the major part of that AC Offshore Transmission System had been concluded on or after 17th May 2018; or Offshore Transmission Owner's who own an Offshore Transmission System and that Offshore Transmission System comprises one or more Transmission DC Converters and that Offshore Transmission System was first connected to the Onshore Transmission System on or after 8 September 2019 and the purchase contracts for the Main Plant and Apparatus forming that Offshore DC Transmission System had been concluded on or after 28 September 2018. For the avoidance of doubt, an Offshore Transmission System comprising one of more Transmission DC Converters would be assumed to constitute an HVDC System.

ANNEX 1

- 1.1 Annex 1 of Section K sets out the minimum technical, design and operational criteria and performance criteria that applies to:- Offshore Transmission Owner's who own an AC Offshore Transmission System and that AC Offshore Transmission System was first connected to the Onshore Transmission System before 27 April 2019 and the purchase contracts for the Plant and Apparatus forming the major part of that AC Offshore Transmission System had been concluded before 17th May 2018; or
- 1.2 Section D Part One, clause 2.2.6 of the STC specifies that in planning and developing its Transmission System, each Transmission Owner (which includes Offshore Transmission Owner's) shall ensure that its Transmission System complies with the minimum technical, design and operational criteria and performance requirements set out or referred to in Connection Conditions 6.1, 6.2, 6.3 and 6.4 and in Planning Code 6.2 and/or 6.3 as applicable or such other technical criteria or requirements as apply to any relevant part of its Transmission System by virtue of a current Transmission Derogation. For the avoidance of doubt, Offshore Transmission Owners in respect of their Offshore Transmission System, would be expected to meet the same requirements as GB Generators undertaking OTSDUW Build in respect of their Offshore Transmission Systems which includes Transmission DC Converters.
- 1.3 In addition to the above requirements each Offshore Transmission Owner must ensure their Offshore Transmission System can satisfy in the following specific areas:
 - 1.4.1 the reactive power capability deliverable at the Interface Point;
 - 1.4.2 the performance requirements of voltage control systems;
 - 1.4.3 Fault Ride Through Capability;
 - 1.4.4 additional damping facilities for any Transmission DC Converters;

Annex 1 – Legal Text

Changes shown in red text

- 1.4.5 the provision of a **Frequency** signal to Users where necessary because of the use of Transmission DC Converters in an Offshore Transmission System;
 - 1.4.6 operation under a range of System Frequencies;
 - 1.4.7 earthing arrangements for transformers; and
 - 1.4.8 the power quality requirements applicable at the Interface Point.
- 1.5 This Section K also provides for the Offshore Transmission Owner and The Company to co-operate in relation to the assessment of compliance.

2. REACTIVE CAPABILITY AND VOLTAGE CONTROL

- 2.1 All Offshore Transmission Systems must be capable of delivering Reactive Power at the Interface Point as described in paragraphs 2.2, 2.3 and 2.4 of Section K below. The Reactive Power capability that an Offshore Transmission System must be able to provide at the Interface Point may be delivered using a combination of Plant owned by the Offshore Transmission Owner concerned and Plant owner by a Generator or Generators connected to that Offshore Transmission System. Where Generator Plant is out of service, these Reactive Power capability requirements will be reduced pro rata to the maximum Active Power capability of Generator Plant in service.
- 2.2 All Offshore Transmission Systems must be capable of enabling the Offshore Transmission Owner to comply with an instruction received from NGENSO relating to a variation of the voltage set point at the Interface Point within 2 minutes of such instruction being received.

For Offshore Transmission Systems connected to a Distribution System where the Network Operator has confirmed to NGENSO that its System is restricted in accordance with Section KB2, clause 2.2 will not apply unless NGENSO can reasonably demonstrate that the magnitude of the available change in Reactive Power has a significant effect on voltage levels on the Onshore National Electricity Transmission System.

- 2.3 All Offshore Transmission Systems must be capable of transmitting Active Power equivalent to the Interface Point Capacity at any point between the limits 0.95 Power Factor lagging and 0.95 Power Factor leading at the Interface Point. The Reactive Power limits defined at the Interface Point Capacity:
 - 2.3.1 at lagging Power Factor will apply to all Active Power transfer levels above 20% of the Interface Point Capacity as defined in Figure K1 below;

Annex 1 – Legal Text

Changes shown in *red text*

2.3.2 at leading Power Factor will apply at all Active Power transfer levels above 50% of the Interface Capacity as defined in Figure K1 below, and shall reduce linearly below 50% Active Power transfer as shown in figure K1 below unless the requirement to maintain the Reactive Power limits defined at the Interface Point Capacity at leading Power Factor down to 20% Active Power transfer is specified in the relevant Offshore TO Construction Agreement or Transmission Interface Site Specification.

2.4 When transferring Active Power equivalent to less than 20% of the Interface Point Capacity:

2.4.1 the automatic control system may continue to provide voltage control utilising any available reactive capability;

2.4.2 If voltage control is not being provided:

(a) the automatic control system shall be designed to be capable of a smooth transition between the shaded area bounded by CD and the non-shaded area bound by AB in Figure K1 below; and

(b) the Reactive Power delivered at the Interface Point shall be within a range of +/-5% of the Interface Point Capacity expressed in MVar.

Figure K1

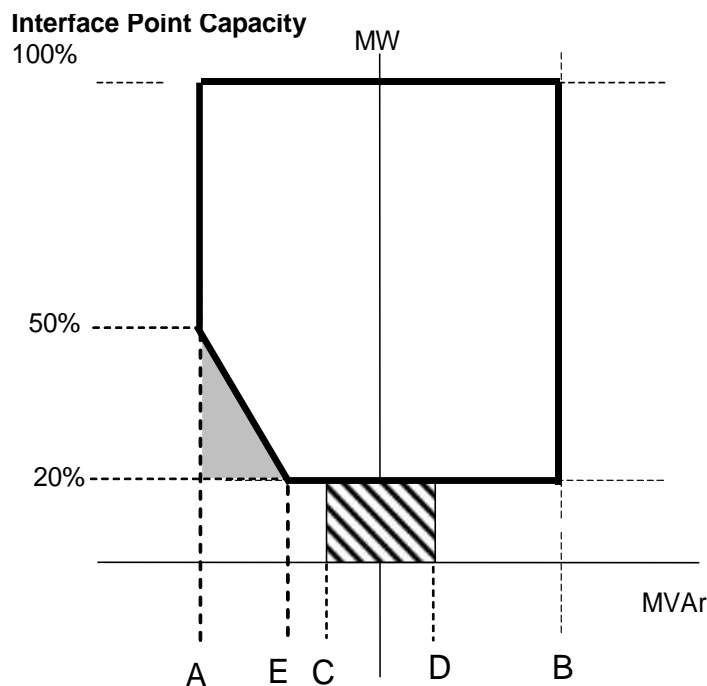

Point A is equivalent (in MVar) to 0.95 leading Power Factor at active power transfer equal to the Interface Point Capacity.

Annex 1 – Legal Text

Changes shown in red text

Point B is equivalent (in MVAR) to 0.95 lagging Power Factor active power transfer equal to the Interface Point Capacity.

Point C is equivalent (in MVAR) to -5% of active power transfer equal to the Interface Point Capacity.

Point D is equivalent (in MVAR) to +5% of active power transfer equal to the Interface Point Capacity.

Point E is equivalent (in MVAR) to -12% of active power transfer equal to the Interface Point Capacity.

- 2.5 Each Offshore Transmission System shall be capable of contribution to voltage control by continuous changes to the Reactive Power supplied at the Interface Point in accordance with the requirements specified in Appendix KB and without instability over the entire operating range of the Offshore Transmission System.
- 2.6 The requirement for additional voltage control facilities, including for example additional damping control facilities, where in NGESO's view these are necessary for system reasons will be specified in the relevant Offshore TO Construction Agreement or Transmission Interface Site Specification.
- 2.7 Other control facilities, including constant Reactive Power output control modes (but excluding VAR limiters) are not required. However, if present in the voltage control system they will be disabled unless recorded in the relevant Offshore TO Construction Agreement or Transmission Interface Site Specification. Where an Offshore Transmission Owner retains the responsibility for the operation of such facilities such operation will only be in accordance with instructions to direct the configuration of the National Electricity Transmission System as given by NGESO.
- 2.8 At the Interface Point the Active Power transfer from an Offshore Transmission System under steady state conditions should not be affected by voltage changes on the Onshore Transmission System in the Normal Operating Range by more than the change in Active Power losses at reduced or increased voltage. The Reactive Power output under steady state conditions should be fully available within the voltage range $\pm 5\%$ at 400kV, 275kV and 132kV.

3 FAULT RIDE THROUGH CAPABILITY

3.1 Fault Ride Through

- 3.1.1 For short circuit faults at Supergrid Voltage up to 140ms in duration:

Annex 1 – Legal Text

Changes shown in red text

- (a) each Offshore Transmission System shall remain connected to the remainder of the Total System at the Interface Point without tripping of any Plant and/or Apparatus comprising that Offshore Transmission System, for a close-up solid three-phase short circuit fault or any unbalanced short circuit fault on the Onshore Transmission System operating at Supergrid Voltages for a total fault clearance time of up to 140 ms. A solid three-phase or unbalanced earthed fault results in zero voltage on the faulted phase(s) at the point of fault. The duration of zero voltage is dependent on local protection and circuit breaker operating times. This duration and the fault clearance times will be specified in the relevant Offshore TO Construction Agreement or Transmission Interface Site Specification. Following fault clearance, recovery of the Supergrid Voltage to 90% on the Onshore Transmission System (which may include the Interface Point) may take longer than 140ms as illustrated in Appendix A Figures KA.1.1 (a) and (b);
- (b) each Offshore Transmission System shall be designed such that upon both clearance of the fault on the Onshore Transmission System as detailed in 3.1.1 (a) and within 0.5 seconds of the restoration of the voltage at the Interface Point to be within the Normal Operating Range Active Power transfer capability shall be restored to at least 90% of the level available immediately before the fault. During the period of the fault as detailed in 3.1.1 (a) each Offshore Transmission System shall generate maximum reactive current without exceeding the transient rating limit at the Interface Point;
- (c) Each Offshore Transmission System and any Plant and/or Apparatus comprising that Offshore Transmission System shall remain connected and stable for up to 30 minutes following fault clearance provided System operating conditions have returned within those specified in CC.6.1 of the Grid Code.

Annex 1 – Legal Text

Changes shown in *red* text

- (de) each Transmission DC Converter forming part of an Offshore Transmission System shall be designed to meet the Active Power recovery characteristics as specified in the relevant Offshore TO Construction Agreement Transmission Interface Site Specification upon clearance of the fault on the Onshore Transmission System as detailed in 3.1.1 (a).

3.1.2 For Supergrid Voltage dips greater than 140ms in duration, in addition to the requirements of 3.1.1 each Offshore Transmission System shall:

- (a) remain connected to the Onshore Transmission System without tripping of any Plant and/or Apparatus forming part of that Offshore Transmission System, for balanced Supergrid Voltage dips and associated durations on the Onshore Transmission System anywhere on or above the heavy black line shown in Figure K2. Appendix KA and Figures KA.1.3 (a), (b) and (c) provide an explanation and illustrations of Figure K2;

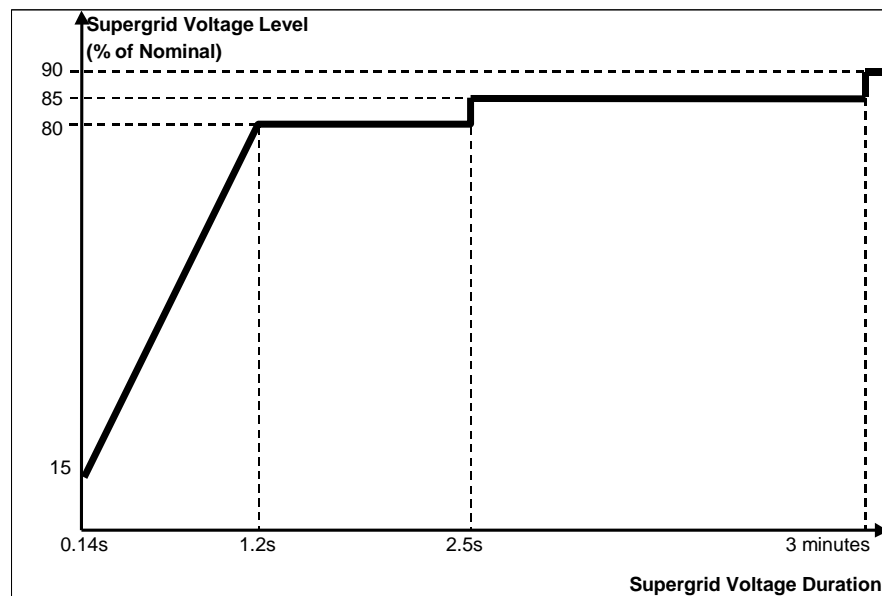

Figure K2

Annex 1 – Legal Text

Changes shown in red text

- (b) provide Active Power transfer capability, during Supergrid Voltage dips on the Onshore Transmission System as described in Figure K2, at least in proportion to the retained balanced voltage at the Interface Point except in the case where there has been a reduction in the Active Power transfer of the Offshore Transmission System in the time range in Figure K2, which has been caused by a reduction in the Active Power generated by any Generating Units connected to such an Offshore Transmission System. In addition, during the voltage dip, each Offshore Transmission System shall generate maximum reactive current at the Interface Point; and
- (c) restore Active Power transfer capability, following Supergrid Voltage dips on the Onshore Transmission System as described in Figure K2, within 1 second of restoration of the voltage at the Interface Point to be within the Normal Operating Range to at least 90% of the level available immediately before the occurrence of the dip except in the case of an Offshore Transmission System where there has been a reduction in the Intermittent Power Source of any Generating Units connected to such Offshore Transmission System in the time range in Figure K2 that restricts the Active Power transfer capability below this level.
- (d) Each Offshore Transmission System and any Plant and/or Apparatus comprising that Offshore Transmission System shall remain connected and stable for up to 30 minutes following the voltage dips defined in 3.1.2 (a) provided System operating conditions have returned within those specified in CC.6.1 of the Grid Code.

3.1.3 In addition to meeting the requirements of Grid Code CC.6.1.5 (b) and CC.6.1.6 at the Interface Point, each Offshore Transmission System will be required to withstand, without tripping, the negative phase sequence loading incurred by clearance of a close-up phase-to-phase fault, by System Back-Up Protection on the Onshore Transmission System operating at Supergrid Voltage.

3.1.4 To avoid unwanted island operation, Offshore Transmission Systems connected to Onshore Systems in Scotland shall be tripped for the following conditions:

- (a) frequency above 52Hz for more than 2 seconds;
- (b) frequency below 47Hz for more than 2 seconds;

Annex 1 – Legal Text

Changes shown in red text

- (c) voltage as measured at the Interface Point is below 80% for more than 2.5 seconds; and
- (d) voltage as measured at the Interface Point is above 120% (115% for 275kV) for more than 1 second.

The times stated in (a) and (b) above are maximum trip times. Shorter times may be used to protect the integrity of an Offshore Transmission System or Power Stations connected to it.

4 ADDITIONAL DAMPING CONTROL FACILITIES FOR TRANSMISSION DC CONVERTERS

- 4.1 Offshore Transmission Owners must ensure that any Transmission DC Converters do not cause a sub-synchronous resonance problem on the Total System. Each Transmission DC Converter shall to be provided with sub-synchronous resonance damping control facilities.
- 4.2 Where specified in the relevant Offshore TO Construction Agreement or Transmission Interface Site Specification, each Transmission DC Converter forming part of an Offshore Transmission System is required to be provided with power oscillation damping or any other identified additional control facilities.

5. FREQUENCY CAPABILITES AND SIGNALS

- 5.1 Each Offshore Transmission Owner which utilises a Transmission DC Converter as part of the Offshore Transmission System shall provide to each User, in respect of its Offshore Power Station(s) connected to and/or using such Offshore Transmission System, a continuous signal indicating the real-time Frequency measured at the Interface Point.
- 5.2 The Frequency signal referred to in 5.1 above shall be provided to the Offshore Power Station in a manner and in timescales notified to the Offshore Transmission Owner by NGESO through the relevant Offshore TO Construction Agreement or Transmission Interface Site Specification.
- 5.3 Each Offshore Transmission System which includes a Transmission DC Converter must be capable of:
 - (a) continuously maintaining constant Active Power transfer for System Frequency changes within the range 50.5 to 49.5 Hz; and

Annex 1 – Legal Text

Changes shown in red text

- (b) (subject to the provisions of Grid Code CC.6.1.3) maintaining its Active Power transfer at a level not lower than the figure determined by the linear relationship shown in Figure 2 for System Frequency changes within the range 49.5 to 47 Hz, such that if the System Frequency drops to 47 Hz the Active Power transfer does not decrease by more than 5%.

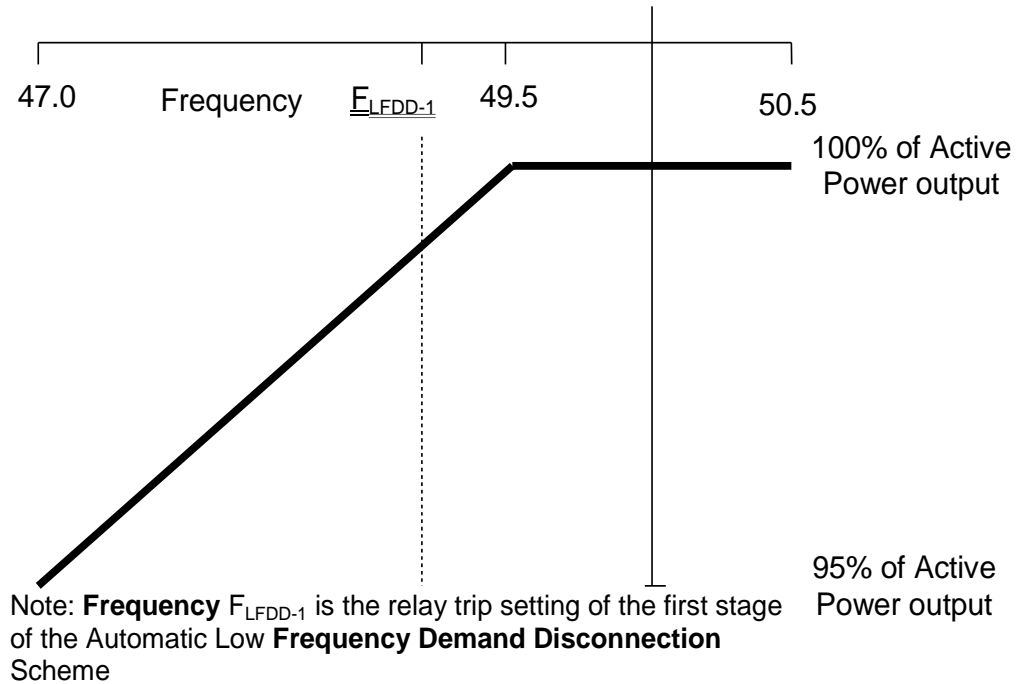

Figure K3

5.4 As stated in Grid Code CC.6.1.3, the System Frequency could rise to 52Hz or fall to 47Hz. Each Offshore Transmission System or any constituent element must be capable of:

5.4.1	<u>Frequency Range</u>	<u>Requirement</u>
	51.5Hz - 52Hz	Operation for a period of at least 15 minutes is required each time the Frequency is above 51.5Hz.
	51Hz - 51.5Hz	Operation for a period of at least 90 minutes is required each time the Frequency is above 51Hz.
	49.0Hz - 51Hz	Continuous operation is required
	47.5Hz - 49.0Hz	Operation for a period of at least 90 minutes is required each time the Frequency is below 49.0Hz.

Annex 1 – Legal Text

Changes shown in red text

- 5.4.2 47Hz - 47.5Hz Operation for a period of at least 20 seconds is required each occasion the Frequency is below 47.5Hz.

For the avoidance of doubt, disconnection, by frequency or speed based relays is not permitted within the frequency range 47.5Hz to 51.5Hz, unless NGESO has agreed to any Frequency-level relays and/or rate-of-change-of Frequency relays which will trip such Offshore Transmission System and any constituent element within this Frequency range, under the relevant Offshore TO Construction Agreement or Transmission Interface Site Specification.

- 5.5 Offshore Transmission Owners will be responsible for protecting all their Transmission DC Converters against damage should Frequency excursions outside the range 52Hz to 47Hz ever occur. Should such excursions occur, it is up to the Offshore Transmission Owner to decide whether to disconnect their Apparatus for reasons of safety of Apparatus, Plant and/or personnel.

6. NEUTRAL EARTHING

- 6.1 At nominal System voltages of 132kV and above the higher voltage windings of any transformer comprising part of an Offshore Transmission System must be star connected with the star point suitable for connection to earth. The earthing and lower voltage winding arrangement shall be such as to ensure that the Earth Fault Factor requirement of paragraph Grid Code CC.6.2.1.1 (b) will be met on the National Electricity Transmission System at nominal System voltages of 132kV and above.

7. POWER QUALITY REQUIREMENTS

- 7.1 Each Offshore Transmission Owner is required to ensure that its Offshore Transmission System complies with the criteria set out in Section D, Part One, paragraph 2.2.6 in respect of any Interface Points.
- 7.2 Each Offshore Transmission Owner will carry out a Voltage Waveform Quality Assessment when designing its Offshore Transmission System and proposing any changes to the design of its Offshore Transmission System in accordance with Section D.

8. COMPLIANCE ASSESSMENT

- 8.1 Each Offshore Transmission Owner shall provide to NGESO such information and assistance in relation to that Offshore Transmission Owner's Transmission System as required by NGESO to enable NGESO to undertake an assessment of the capability of the Offshore Transmission System to satisfy certain criteria as specified in this Section K. The Offshore Transmission Owner is responsible for carrying out any testing when requested by NGESO and retains the responsibility for the safety of personnel and plant during test.

Annex 1 – Legal Text
Changes shown in red text

Annex 1 – Legal Text

Changes shown in *red* text

APPENDIX KA

FAULT RIDE THROUGH REQUIREMENT FOR OFFSHORE TRANSMISSION SYSTEMS

KA.1 SCOPE

KA.1.1 The fault ride through requirement is defined in Section K paragraphs 3.1. This Appendix provides illustrations by way of examples only of Section K paragraph 3.1.1(a) and further background and illustrations to Section K paragraph 3.1.2(a) and is not intended to show all possible permutations.

KA.2 SHORT CIRCUIT FAULTS AT SUPERGRID VOLTAGE UP TO 140MS IN DURATION

KA.2.2 For short circuit faults at Supergrid Voltage up to 140ms in duration on the Onshore Transmission System, the fault ride through requirement is defined in Section K paragraph 3.1.1 (a). Figures KA.1.1 (a) and (b) illustrate two typical examples of voltage recovery for short-circuit faults cleared within 140ms by two circuit breakers (a) and three circuit breakers (b) respectively.

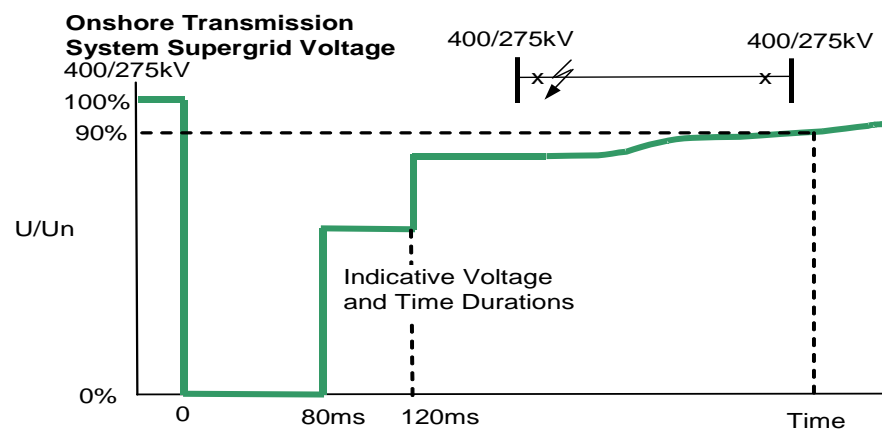

Figure KA.1.1 (a)

Annex 1 – Legal Text

Changes shown in red text

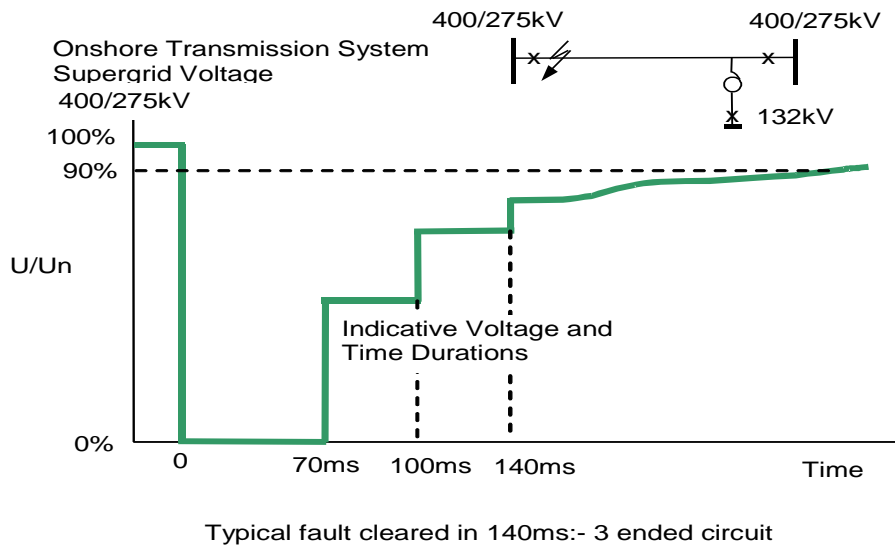

Figure KA.1.1 (b)

KA.3 SUPERGRID VOLTAGE DIPS GREATER THAN 140MS IN DURATION

KA.3.1 For balanced Supergrid voltage dips on the Onshore Transmission System having durations greater than 140ms and up to 3 minutes the fault ride through requirement is defined in Section K paragraph 3.1.2 (a) and Figure K2 which is reproduced in this Appendix as Figure KA.1.2 and termed the voltage–duration profile.

KA.3.2 This profile is not a voltage-time response curve that would be obtained by plotting the transient voltage response at a point on the Onshore Transmission System to a disturbance. Rather, each point on the profile (i.e. the heavy black line) represents a voltage level and an associated time duration which connected Offshore Transmission Systems must withstand or ride through.

KA.3.3 Figures KA.1.3 (a), (b) and (c) illustrate the meaning of the voltage-duration profile for voltage dips having durations greater than 140ms.

Annex 1 – Legal Text
 Changes shown in red text

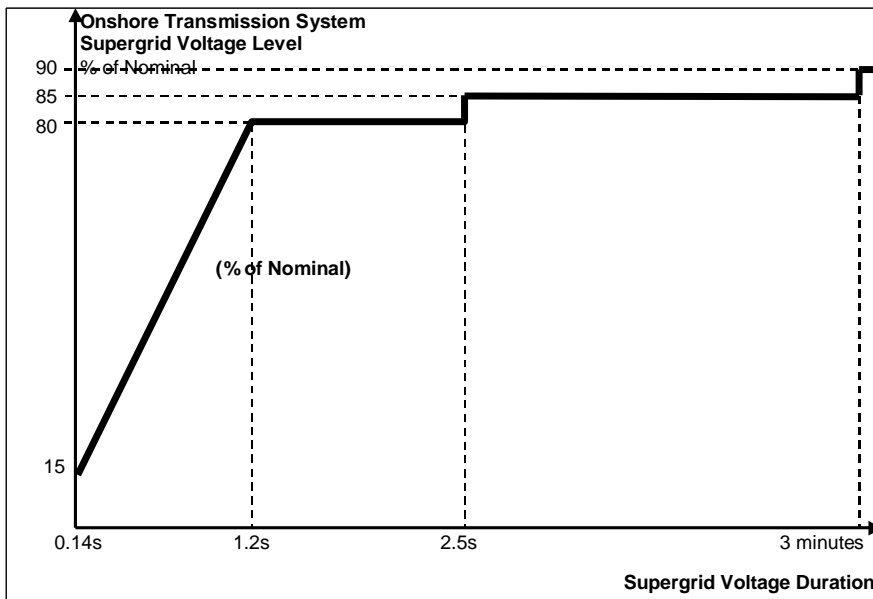
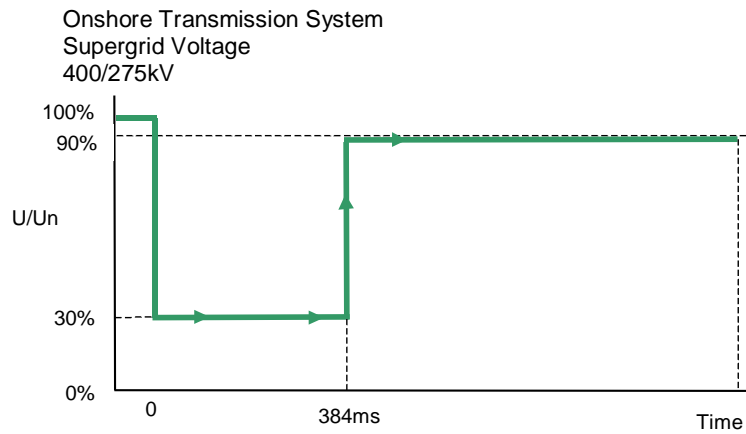

Figure KA.1.2



30% retained voltage, 384ms duration

Figure KA.1.3(a)

Annex 1 – Legal Text
Changes shown in red text

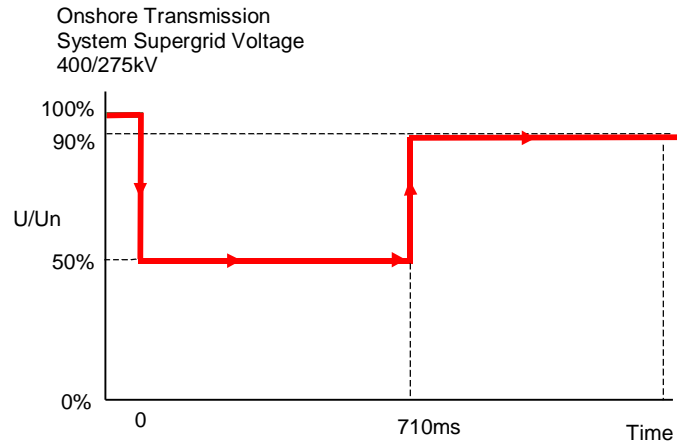

50% retained voltage, 710ms duration

Figure KA.1.3(b)

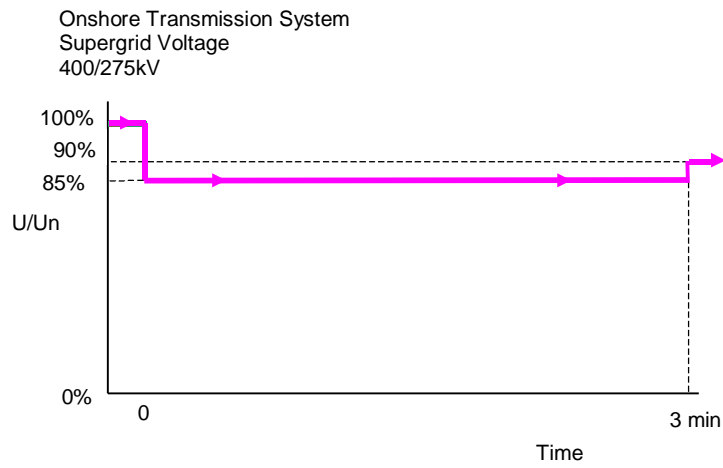

85% retained voltage, 3 minutes duration

Figure KA.1.3(c)

Annex 1 – Legal Text

Changes shown in red text

APPENDIX KB

PERFORMANCE REQUIREMENTS FOR CONTINUOUSLY ACTING AUTOMATIC VOLTAGE CONTROL SYSTEMS FOR OFFSHORE TRANSMISSION SYSTEMS

KB.1 SCOPE

KB.1.1 This Appendix sets out the performance requirements of continuously acting automatic voltage control systems for Offshore Transmission Systems that must be complied with by the owner of such an Offshore Transmission System. This Appendix does not limit any site specific requirements that may be included in an Offshore TO Construction Agreement or Transmission Interface Site Specification where in NGESO's reasonable opinion these facilities are necessary for system reasons.

KB.2 REQUIREMENTS

KB.2.1 NGESO requires that the continuously acting automatic voltage control system for the Offshore Transmission System shall meet the following functional performance specification. If a Network Operator has confirmed to NGESO that its network to which an Embedded Offshore Transmission System is connected is restricted such that the full reactive range under the steady state voltage control requirements (KB.3) cannot be utilised, NGESO may specify in the relevant TO Construction Agreement or Transmission Interface Site Specification alternative limits to the steady state voltage control range that reflect these restrictions.

KB.3 STEADY STATE VOLTAGE CONTROL

KB.3.1 The Offshore Transmission System shall provide continuous steady state control of the voltage at the Interface Point with a Setpoint Voltage and Slope characteristic as illustrated in Figure KB.3 (a).

Annex 1 – Legal Text

Changes shown in *red text*

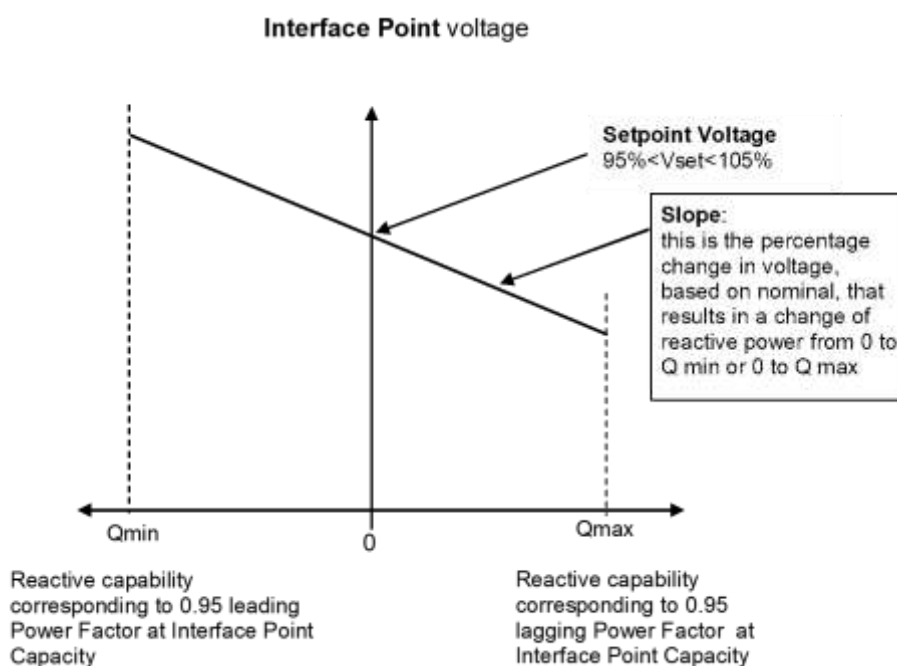

Figure KB.3 (a)

- KB.3.2 The continuously acting automatic control system shall be capable of operating to a Setpoint Voltage between 95% and 105% with a resolution of 0.25% of the nominal voltage. For the avoidance of doubt values of 95%, 95.25%, 95.5% ... may be specified, but not intermediate values. The initial Setpoint Voltage will be 100% which must be achievable to a tolerance of $\pm 0.25\%$. For the avoidance of doubt, with a tolerance of $\pm 0.25\%$ and a Setpoint Voltage of 100%, the achieved value shall be between 99.75% and 100.25%. NGESO may request the owner of the Offshore Transmission System to implement an alternative Setpoint Voltage within the range of 95% to 105%. For Embedded Offshore Transmission Systems the Setpoint Voltage will be discussed between NGESO and the relevant Network Operator.
- KB.3.3 The Slope characteristic of the continuously acting automatic control system shall be adjustable over the range 2% to 7% (with a resolution of 0.5%). For the avoidance of doubt values of 2%, 2.5%, 3% ... may be specified, but not intermediate values. The initial slope setting will be 4% which must be achievable to a tolerance of $\pm 0.5\%$. For the avoidance of doubt, with a tolerance of 0.5% and a Slope setting of 4%, the achieved value shall be between 3.5% and 4.5%. NGESO may request the owner of the Offshore Transmission System to implement an alternative slope setting within the range of 2% to 7%. For Embedded Offshore Transmission Systems the Slope setting will be discussed between NGESO and the relevant Network Operator.

Annex 1 – Legal Text
Changes shown in red text

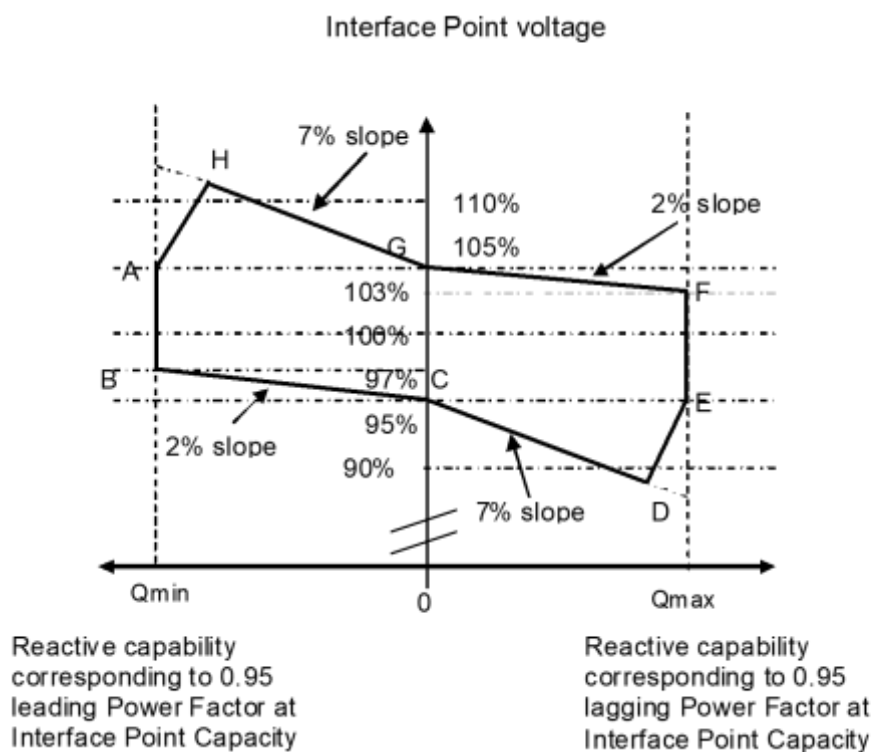

Figure KB.3 (b)

KB.3.4 Figure KB.3 (b) shows the required envelope of operation for Offshore Transmission Systems. The enclosed area within points ABCDEFGH is the required capability range within which the Slope and Setpoint Voltage can be changed.

KB.3.5 Should the operating point of the Offshore Transmission System deviate so that it is no longer a point on the operating characteristic (figure KB.3 (a)) defined by the target Setpoint Voltage and Slope, the continuously acting automatic voltage control system shall act progressively to return the value to a point on the required characteristic within 5 seconds.

KB.3.6 Should the Reactive Power output of the Offshore Transmission System reach its maximum lagging limit at an Interface Point voltage above 95%, the Offshore Transmission System shall maintain maximum lagging Reactive Power output for voltage reductions down to 95%. This requirement is indicated by the line EF in figure KB.3 (b). Should the Reactive Power output of the Offshore Transmission System reach its maximum leading limit at an Interface Point voltage below 105%, the Offshore Transmission System shall maintain maximum leading Reactive Power output for voltage increases up to 105%. This requirement is indicated by the line AB in figure KB.3 (b).

KB.3.7 For Interface Point voltages below 95%, the lagging Reactive Power capability of the Offshore Transmission System should be that which results from the supply of maximum lagging reactive current whilst ensuring the current remains within design operating limits. An example of the capability is shown by the line DE in figure KB.3 (b).

Annex 1 – Legal Text

Changes shown in red text

For Interface Point voltages above 105%, the leading Reactive Power capability of the Offshore Transmission System should be that which results from the supply of maximum leading reactive current whilst ensuring the current remains within design operating limits. An example of the capability is shown by the line AH in figure KB.3 (b). Should the Reactive Power output of the Offshore Transmission System reach its maximum lagging limit at an Interface Point voltage below 95%, the Offshore Transmission System shall maintain maximum lagging reactive current output for further voltage decreases. Should the Reactive Power output of the Offshore Transmission System reach its maximum leading limit at an Interface Point voltage above 105%, the Offshore Transmission System shall maintain maximum leading Reactive Power output for further voltage increases.

KB.4 TRANSIENT VOLTAGE CONTROL

KB.4.1 For an on-load step change in Interface Point voltage, the continuously acting automatic control system shall respond according to the following minimum criteria:

KB.4.1.1 the Reactive Power output response of the Offshore Transmission System shall commence within 0.2 seconds of the application of the step. It shall progress linearly although variations from a linear characteristic shall be acceptable provided that the MVar seconds delivered at any time up to 1 second are at least those that would result from the response shown in figure KB.4;

KB.4.1.2 the response shall be such that, for a sufficiently large step, 90% of the full reactive capability of the Offshore Transmission System, as required by Section K, paragraph 2.3 (or, if appropriate, KB.3.6 or KB.3.7), will be produced within 1 second

KB.4.1.3 the magnitude of the Reactive Power output response produced within 1 second shall vary linearly in proportion to the magnitude of the step change

KB.4.1.4 the settling time shall be no greater than 2 seconds from the application of the step change in voltage and the peak to peak magnitude of any oscillations shall be less than 5% of the change in steady state Reactive Power within this time.

KB.4.1.5 following the transient response, the conditions of KB3 apply.

Annex 1 – Legal Text

Changes shown in *red* text

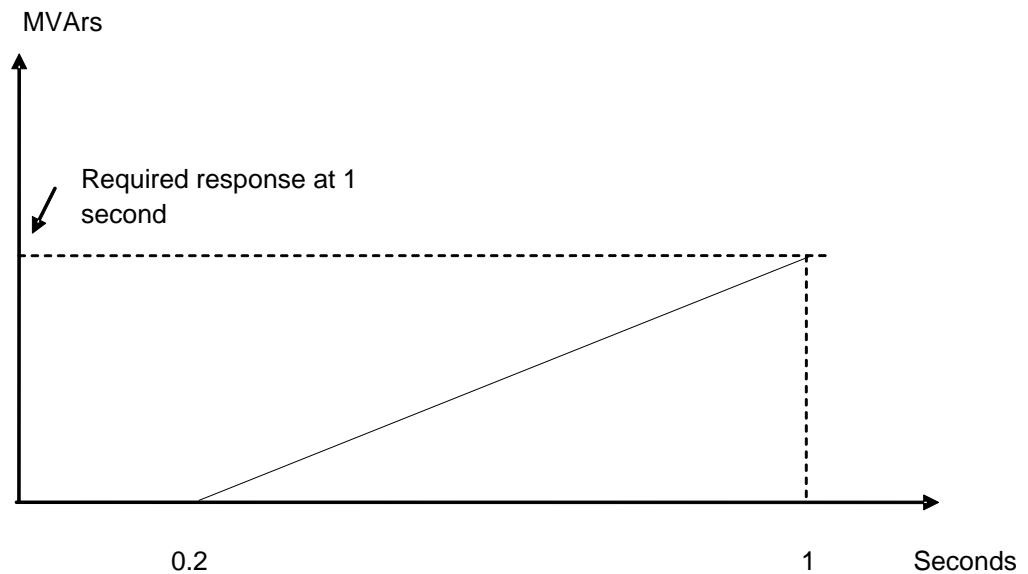

Figure KB.4

KB.5 POWER OSCILLATION DAMPING

KB.5.1 The requirement for the continuously acting voltage control system to be fitted with a Power System Stabiliser (PSS) shall be specified in the relevant Offshore TO Construction Agreement or Transmission Interface Site Specification if, in NGENSO's view, this is required for system reasons. However if a Power System Stabiliser is included in the voltage control system its settings and performance shall be agreed with NGENSO and commissioned in accordance with STCP19-4.

KB.6 OVERALL VOLTAGE CONTROL SYSTEM CHARACTERISTICS

KB.6.1 The continuously acting automatic voltage control system is required to respond to minor variations, steps, gradual changes or major variations in Interface Point voltage.

KB.6.2 The overall voltage control system shall include elements which provide a limited bandwidth output. The bandwidth limiting must be consistent with the speed of response requirements and ensure that the highest frequency of response cannot excite torsional oscillations on other plant connected to the network. A bandwidth of 0-5Hz would be judged to be acceptable for this application. All other control systems employed within the Offshore Transmission System should also meet this requirement

KB.6.3 The response of the voltage control system (including the Power System Stabiliser if employed) shall be demonstrated by applying suitable step disturbances into the voltage control system of the Offshore Transmission System, or by changing the actual

Annex 1 – Legal Text

Changes shown in red text

voltage at a suitable point as specified by NGENSO. The damping shall be judged to be adequate if the corresponding Active Power response to the disturbances decays within 2 seconds of the application of the step.

Annex 1 – Legal Text

Changes shown in red text

ANNEX 21.1 Annex 2 of Section K sets out the minimum technical, design and operational criteria and performance criteria that applies to:-

Offshore Transmission Owner's who own an AC Offshore Transmission System and that AC Offshore Transmission System was first connected to the Onshore Transmission System on or after 27 April 2019 and the purchase contracts for the Plant and Apparatus forming the major part of that AC Offshore Transmission System had been concluded on or after 17th May 2018; or

Offshore Transmission Owner's who own an Offshore Transmission System and that Offshore Transmission System comprises one or more Transmission DC Converters and that Offshore Transmission System was first connected to the Onshore Transmission System on or after 8 September 2019 and the purchase contracts for the Main Plant and Apparatus forming that Offshore DC Transmission System had been concluded on or after 28 September 2018. For the avoidance of doubt, an Offshore Transmission System comprising one or more Transmission DC Converters would be assumed to constitute an HVDC System.

1.2 Section D Part One, clause 2.2.6 of the STC specifies that in planning and developing its Transmission System, each Type 2 Transmission Owner (which includes Offshore Transmission Owner's) shall ensure that its Transmission System complies with the minimum technical, design and operational criteria and performance requirements set out or referred to in European Connection Conditions 6.1, 6.2, 6.3 and 6.4 and in Planning Code 6.2 and/or 6.3 as applicable or such other technical criteria or requirements as apply to any relevant part of its Transmission System by virtue of a current Transmission Derogation. For the avoidance of doubt, Offshore Transmission Owners in respect of their Offshore Transmission System, would be expected to meet the same requirements as EU Generators undertaking OTSDUW Build in respect of their Offshore Transmission Systems which includes Transmission DC Converters including HVDC Systems.

1.3 In addition to the above requirements each Offshore Transmission Owner must ensure their Offshore Transmission System can satisfy in the following specific areas:

1.3.1 In all cases, where an obligation is placed on a EU Generator undertaking OTSDUW Build (which includes those with Transmission DC Converters and HVDC Systems) any site specific requirements being pursuant to the Bilateral Agreement, to be placed upon the Offshore Transmission Owner would be specified in the Offshore Transmission Owner Construction Agreement or Transmission Interface Site Specification.

1.3.2 The Reactive Capability requirements at the Interface Point applicable to Offshore Transmission Licensees are the same as EU Generators undertaking OTSDUW Build as defined in ECC.6.3.2.4. The Reactive Power capability that an Offshore Transmission System must be able to provide at the Interface Point may be delivered

Annex 1 – Legal Text

Changes shown in red text

using a combination of Plant owned by the Offshore Transmission Owner concerned and Plant owned by a Generator or Generators connected to that Offshore Transmission System. Where Generator Plant is out of service, the Reactive Power capability requirements will be reduced pro-rata to the maximum Active Power capability of Generator Plant in service.

- 1.3.3 All Offshore Transmission Systems must be capable of enabling the Offshore Transmission Owner to comply with an instruction received from The Company relating to a variation on the voltage setpoint at the Interface Point within 2 minutes of such instruction being received.
- 1.3.4 Control facilities, including constant Reactive Power output control modes (but excluding VAR limiters) are not required. However, if present in the voltage control system they will be disabled unless recorded in the relevant Offshore TO Construction Agreement or Transmission Interface Site Specification. Where an Offshore Transmission Owner retains the responsibility for the operation of such facilities such operation will only be in accordance with instructions to direct the configuration of the National Electricity Transmission System as given by The Company.
- 1.3.5 Each Transmission Owner which utilises a Transmission DC Converter as part of the Offshore Transmission System shall provide to each User, in respect of its Offshore Power Station(s) connected to and/or using such Offshore Transmission System, a continuous signal indicating the real-time Frequency measured at the Interface Point as required under ECC.6.3.3 (f) of the Grid Code.
- 1.3.6 Each Transmission Owner which utilises a Transmission DC Converter as part of its Offshore Transmission System shall be required to satisfy the applicable requirements of ECC.6.3.6.1.2, ECC.6.3.7, ECC.6.3.12 and ECC.6.3.13 with any site specific requirements being specified in the Offshore Transmission Owner Construction Agreement or Transmission Interface Site Specification.
- 1.3.7 Each Transmission Owner which utilises a Transmission DC Converter as part of its Offshore Transmission System shall be required to satisfy the applicable requirements of ECC.6.3.17 with any site specific requirements being specified in the Offshore Transmission Owner Construction Agreement or Transmission Interface Site Specification.
- 1.3.8 Each Offshore Transmission System which includes a Transmission DC Converter (including and HVDC System) must be capable of:
- (a) continuously maintaining constant Active Power transfer for System Frequency changes within the range 50.5 to 49.5 Hz; and
 - (b) (subject to the provisions of Grid Code ECC.6.1.2) maintaining its Active Power transfer at a level not lower than the figure determined by the linear relationship shown in Figure K3 for System Frequency changes within the range 49.5 to 47 Hz,

Annex 1 – Legal Text

Changes shown in red text

such that if the System Frequency drops to 47 Hz the Active Power transfer does not decrease by more than 5%.

4

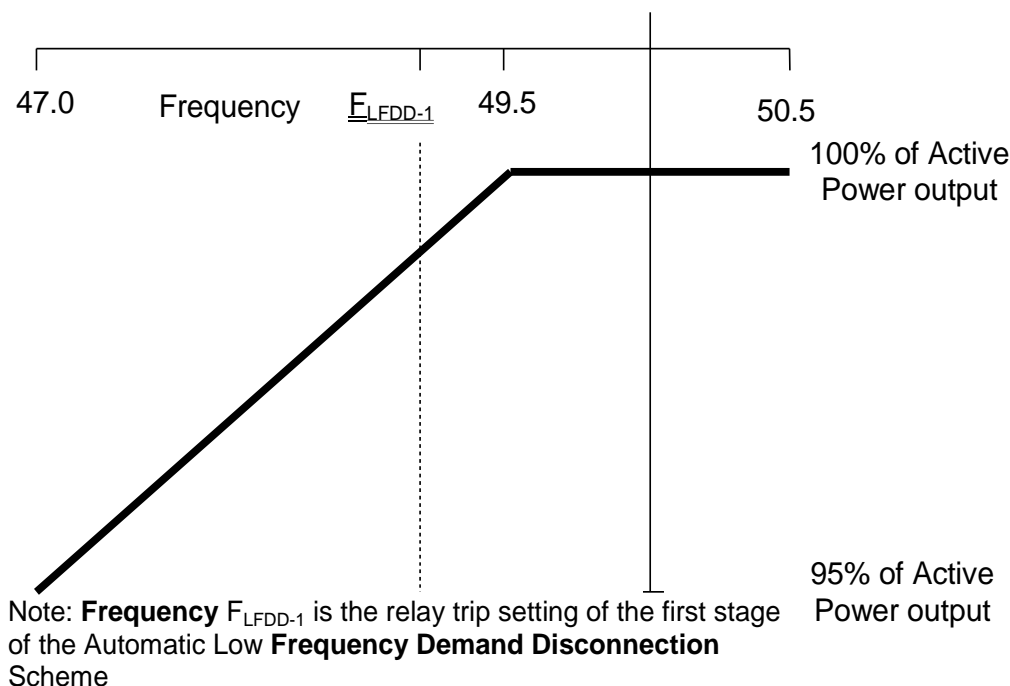

Figure K4

- 1.3.9 All Offshore Transmission Systems must be capable of enabling the Offshore Transmission Owner to comply with the requirements of ECC.6.5.6. In addition, Offshore Transmission Owners shall be required to satisfy the applicable requirements of ECC.6.6 with any detailed requirements being specified in the Offshore Transmission Owner Construction Agreement or Transmission Interface Site Specification.
- 1.4 Each Offshore Transmission Owner is required to comply with the requirements of the European Compliance Processes (ECP's) as applicable to EU Generators undertaking OTSDUW Build. For the avoidance of doubt, this would include Offshore Transmission Owners in respect of Transmission DC Converters including HVDC Systems as applicable. Each Offshore Transmission Owner shall provide to The Company such information and assistance in relation to that Offshore Transmission Owner's Transmission System as required by The Company to enable The Company to undertake an assessment of the capability of the Offshore Transmission System to satisfy certain criteria as specified in this section K.

Annex 1 – Legal Text
Changes shown in red text