

# Compliance Guidance Notes for NOA Stability Compensation Service Phase 2

**Version 1**  
November 2021



# Foreword

These Guidance Notes have been prepared by the National Grid Electricity System Operator (NGESO) to describe to potential Providers how the compliance with NOA Stability Compensation Service Phase 2 may be demonstrated.

These Guidance Notes are prepared, solely, for the assistance of service Providers for NOA Stability Compensation Service Phase 2. In the event of dispute, the Service Agreement will take precedence over these notes.

These Guidance Notes are based on the Grid Code, Issue 5, Revision 25, effective from the 07 September 2018. This version of the Grid Code also includes the major changes brought about to facilitate compliance with the European Connection Network Codes as approved by Ofgem in 2018.

Definitions for the terminology used this document can be found in the Grid Code.

Disclaimer: This document has been prepared for NOA Stability Compensation Service Phase 2 only and does not contain all the information needed to comply with the specific requirements of a Bilateral Connection Agreement or other stability or Ancillary services. Please note that whilst these guidance notes have been prepared with due care, National Grid ESO does not make any representation, warranty or undertaking, express or implied, in or in relation to the completeness and or accuracy of information contained in these guidance notes, and accordingly the contents should not be relied on as such.

© National Grid ESO 2021

# Contents

Foreword.....	1
Contents.....	2
Abbreviations .....	5
Definitions .....	8
Guidance Notes .....	13
Introduction .....	14
Definition of Grid Forming Plant .....	14
Manufacturer’s Data and Performance Report.....	15
<b>Simulation Studies .....</b>	<b>15</b>
Simulation Test 1 – Active RoCoF Response Power.....	17
Simulation Test 2 – Active Phase Jump Power .....	20
Simulation Test 3 – Short Circuit Events.....	21
Simulation Test 4 – Temporary Over Voltages .....	22
Simulation Test 5 – Multiple Fault Ride Through .....	23
Simulation Test 6 – Fast Fault Current Limitation for GBGF-I .....	23
Simulation Test 7 – Combined frequency and voltage events .....	24
Simulation Test 8 – Power Oscillation Damping (POD) .....	24
Simulation Test 9 – Further Tests for GBGF-I .....	26
Simulation Test 10 – Active RoCoF Response Power and Active Phase Jump Power, under extreme conditions for GBGF-I.....	27
<b>Validated Models .....</b>	<b>28</b>
<b>Compliance Tests .....</b>	<b>29</b>
<b>Grid Code Connections Compliance Process .....</b>	<b>30</b>
<b>Future Development of Compliance Testing .....</b>	<b>31</b>
<b>Factory Acceptance Tests (FAT) .....</b>	<b>31</b>
<b>Islanding Protection (Loss of Mains Protection) .....</b>	<b>31</b>
<b>Appendices .....</b>	<b>32</b>
<b>Appendix A Reactive Capability .....</b>	<b>33</b>
Grid Forming Synchronous Machine (GBGF-S) Reactive Capability Compliance Tests .....	33
Grid Forming Inverter Technology (GBGF-I) Reactive Capability Compliance Tests.....	33

<b>Appendix B Voltage Control and Testing .....</b>	<b>34</b>
Grid Forming Synchronous Machine (GBGF-S) .....	34
Grid Forming Converter (GBGF-I).....	34
<b>Appendix C Frequency Control .....</b>	<b>35</b>
<b>Appendix D Active RoCoF Response Power for GBGF-I.....</b>	<b>36</b>
<b>Appendix E Active Phase Jump Power for GBGF-I .....</b>	<b>38</b>
<b>Appendix F Active Damping Power for GBGF-I .....</b>	<b>40</b>
<b>Appendix G Fault Ride Through and Fast Fault Current Injection.....</b>	<b>41</b>
Grid Forming Synchronous Machine Technology (GBGF-S).....	41
Grid Forming Converter Technology (GBGF-I) .....	42
Generic Fault Ride Through Test Procedure .....	44
Fast Fault Current Injection (FFCI).....	46
<b>Appendix H Grid Forming Plant Performance Registration .....</b>	<b>47</b>
Scope .....	47
Background to Generic Grid Forming Plant Unit Type Validation.....	47
Confidentiality Provisions .....	48
Areas Suitable for Manufacturer’s Data and Performance Report.....	49
Submitting Data into the Register of Manufacturer’s Data and Performance Report .....	50
NGESO Register of Manufacturer’s Data and Performance Reports .....	50
<b>Appendix I Other Technical Information .....</b>	<b>51</b>
Calculating Equivalent Impedance for Fault Ride Through Studies.....	51
Positive Sequence Studies (PPS) .....	51
Negative Sequence Studies (NPS) .....	52
Equivalent Sequence Impedances for Calculating Unbalanced Short-Circuit Current.....	53
<b>Appendix J Compliance testing requirements .....</b>	<b>55</b>
Ongoing Monitoring .....	55
NGESO Data Recording Equipment .....	55
Interim Operation (if applicable) .....	55
Test Notification to Control Room .....	56
Compliance Testing of Grid Forming Technologies Comprised of Identical Modules .....	56
<b>Appendix K Test Signal Schedule and Log-sheet .....</b>	<b>57</b>
Compliance Test Signals.....	57
Compliance Test Signal Schedules.....	58
Compliance Test Log-sheet .....	59
<b>Appendix L List of tests and technical specification clauses .....</b>	<b>60</b>
<b>Appendix M Contacting NGESO .....</b>	<b>61</b>



# Abbreviations

This section includes a list of the abbreviations that may appear in this document.

<b>Abbreviation</b>	<b>Description</b>
AC	Alternating Current
AVC	Automatic Voltage Control (on transformers)
AVR	Automatic Voltage Regulator
BA / BCA	Bilateral Agreement / Bilateral Connection Agreement
BC	Balancing Code
BM / BMU	Balancing Mechanism / Balancing Mechanism Unit
CP	Compliance Processes
CSC	Current Sourced Converter
CUSC	Connection and Use of System Code
DC	Direct Current
DCS	Distributed Control System
DLL	Dynamic Link Library
DNO	Distribution Network Operator
DPD	Detailed Planning Data
DRC	Data Registration Code
ECC	European Connection Conditions
ECP	European Compliance Processes
EDL/EDT	Electronic Data Logging / Electronic Data Transfer
ELEXON	Balancing and Settlement Code Company
EMT	Electromagnetic Transient
FON	Final Operational Notification
FRT	Fault Ride Through
FSM	Frequency Sensitive Mode
GB	Great Britain
GBGF-I	Great Britain Grid Forming - Inverter
GBGF-S	Great Britain Grid Forming - Synchronous
GCRP	Grid Code Review Panel
GSU	Grid Step Up transformer
HVDC	High Voltage Direct Current
ION	Interim Operational Notification

LSFM(O)	Limited Frequency Sensitive Mode (Overfrequency)
LSFM(U)	Limited Frequency Sensitive Mode (Underfrequency)
LON	Limited Operational Notification
MC	Maximum Capacity
MEL	Maximum Export Limit
MG	Minimum Generation
MLP	Machine Load Point
MRL	Minimum Regulating Level
MSA	Mandatory Services Agreement
MSOL	Minimum Stable Operating Level
NETS	National Electricity Transmission System
NFP	Network Frequency Perturbation
NGESO	National Grid Electricity System Operator
NGET	National Grid Electricity Transmission
OC	Operating Code
OEM	Original Equipment Manufacturer
OFGEM	Office of Gas and Electricity Markets
OTSDUW	Offshore Transmission System Development User Works
PC	Planning Code
POD	Power Oscillation Damping
PSS	Power System Stabiliser
PSSE	Power System Simulator for Engineering software
RfG	Requirements for Generators (EU legislation)
RMS	Root Mean Square
RoCoF	Rate of Change of Frequency
SCL	Short Circuit Level
SEL	Stable Export limit
SO	System Operator (NGESO)
SPT	Scottish Power Transmission
SHET	Scottish Hydro Electric Transmission
STC	System Operator Transmission Owner Code
TGN	Technical Guidance Note
TO	Transmission Owner

TOGA	Transmission Outages, Generation Availability
TOV	Transient Over Voltage
UDFS	User Data File Structure
VSC	Voltage Source Converters



# Definitions

	Definitions
<b>Active Control Based Power</b>	<p>The Active Power output supplied by a Grid Forming Plant through controlled means (be it manual or automatic) of the positive phase sequence Root Mean Square Active Power produced at fundamental System Frequency by the control system of a Grid Forming Unit.</p> <p>For GBGF-I, this is equivalent to a Synchronous Generating Unit with a traditional governor coupled to its prime mover.</p> <p>Active Control Based Power includes Active Power changes that results from a change to the Grid Forming Plant Owners available set points that have a 5 Hz limit on the bandwidth of the provided response.</p> <p>Active Control Based Power also includes Active Power components produced by the normal operation of a Grid Forming Plant that comply with the Engineering Recommendation P28 limits. These Active Power components do not have a 5 Hz limit on the bandwidth of the provided response.</p> <p>Active Control Based Power does not include Active Power components proportional to System Frequency, slip or deviation that provide damping power to emulate the natural damping function provided by a real Synchronous Generating Unit.</p>
<b>Active Damping Power</b>	<p>Active Damping Power is the Active Power naturally injected or absorbed by a Grid Forming Plant to reduce Active Power oscillations in the Total System.</p> <p>More specifically, Active Damping Power is the damped response of a Grid Forming Plant to an oscillation between the voltage at the Grid Entry Point or User System Entry Point and the voltage of the Internal Voltage Source of the Grid Forming Plant.</p> <p>For the avoidance of doubt, Active Damping Power is an inherent capability of a Grid Forming Plant that starts to respond naturally, within less than 5ms to low frequency oscillations in the System Frequency.</p>
<b>Active Frequency Response Power</b>	<p>Active Frequency Response Power is the injection or absorption of Active Power by a Grid Forming Plant to and from the Total System during a deviation of the System Frequency away from the Target Frequency.</p> <p>For a GBGF-I Plant this is very similar to Primary Response but with a response time to achieve the declared service capability (which could be the Maximum Capacity or Registered Capacity) within 1 second.</p> <p>For GBGF-I Plant this can rapidly add extra Active Power in addition to the phase-based Active Inertia Power to provide a system with desirable NFP plot characteristics.</p> <p>The Active Frequency Response Power can be produced by any viable control technology.</p>
<b>Active Inertia Power or Inertia Power</b>	<p>Active Inertia Power or Inertia Power is the injection or absorption of Active Power by a Grid Forming Plant to and from the Total System during a System Frequency change.</p> <p>The amount of Active Power supplied or absorbed by the Grid Forming Plant is a function of the energy storage capability of the Internal Voltage Source and RoCoF or, in the case of an HVDC System, is a function of the Active Power provided by either the Remote End HVDC Converter Station or some extra Plant.</p> <p>For the avoidance of doubt, this includes the rotational inertial energy of the complete drive train of a synchronous machine Unit.</p> <p>Active Inertia Power is an inherent capability of a Grid Forming Plant to respond naturally, within less than 5ms, to changes in the System Frequency.</p>

	<b>Definitions</b>
	For the avoidance of doubt the Active Inertia Power has a slower frequency response compared with Active Phase Jump Power.
<b>Active RoCoF Response Power</b>	Active RoCoF Response Power is defined as the Active Inertia Power developed from a Grid Forming Plant plus the Active Frequency Response Power that can be supplied by a Grid Forming Plant when subject to a rate of change of the System Frequency. For avoidance of doubt, this is $\Delta P$ defined in the Service Agreement Schedule E Clause 1.1.2.
<b>Active Phase Jump Power</b>	Active Phase Jump Power is defined as the transient injection or absorption of Active Power transferred from a Grid Forming Plant to the Total System as a result of changes in the phase angle between the Internal Voltage Source of the Grid Forming Plant and the Grid Entry Point or User System Entry Point. In the event of a disturbance or fault on the Total System, a Grid Forming Plant will instantaneously inject supply or absorb Active Phase Jump Power to the Total System as a result of the phase angle change. For GBGF-I Plant as a minimum value this is up to the Phase Jump Angle Limit Power. Active Phase Jump Power is an inherent capability of a Grid Forming Plant that starts to respond naturally, within less than 5ms, and can have frequency components to over 1000Hz.
<b>Control Based Reactive Power</b>	Control Based Reactive Power is the Reactive Power supplied by a Grid Forming Plant through controlled means based on operator adjustment selectable setpoints (these may be manual or automatic).
<b>Damping Factor (<math>\zeta</math>)</b>	The ratio of the actual damping to critical damping. For a GBGF-I the open loop phase angle, for an open loop gain of one, is measured from the systems Nichols Chart. This angle is used to define the system's equivalent Damping Factor that is the same as the Damping Factor of a second order system with the same open loop phase angle. Alternatively, the Damping Factor refers to the damping of a specific oscillation mode that is associated with the second order system created by the power to angle transfer function as show in Figure 5 and Figure 6.
<b>Dynamic Reactive Compensation Equipment</b>	Plant capable of supplying or absorbing Reactive Power in a controlled manner which could include but not limited to a Synchronous Compensator, Static Var Compensator (SVC), or STATCOM.
<b>Facility</b>	The whole system which incorporates the Grid Forming Plant Modules.
<b>Grid Forming Capability</b>	Is the capability of (but not limited to) a Power Generating Module, HVDC Converter (which could form part of an HVDC System), Generating Unit, Power Park Module, DC Converter, OTSDUW Plant and Apparatus, Electricity Storage Module, Dynamic Reactive Compensation Equipment or any Plant and Apparatus (including a smart load) whose supplied Active Power is directly proportional to the difference between the magnitude and phase of its Internal Voltage Source and the magnitude and phase of the voltage at the Grid Entry Point or User System Entry Point and the sine of the Load Angle. As a consequence, a Plant which has a Grid Forming Capability is one where the frequency of the Internal Voltage Source is the same as the System Frequency for normal operation, with only the Load Angle defining the relative position between the two. In the case of a GBGF-I Plant a GBGF-I Unit forming part of a GBGF-I Plant shall be capable of sustaining a voltage at its terminals irrespective of the voltage at the Grid Entry Point or User System Entry Point for normal operating conditions.

	<b>Definitions</b>
	<p>For a GBGF-I Plant, the control system which determines the amplitude and phase of the Internal Voltage Source, shall have a response to the voltage and System Frequency at the Grid Entry Point or User System Entry Point with a bandwidth that is less than a defined value as shown by the control system's NFP Plot.</p> <p>Exceptions to this rule are only allowed during transients caused by System faults, voltage dips/surges and/or a step or ramp changes in the phase angle which are large enough to cause damage to the Grid Forming Plant via excessive currents.</p>
<b>Grid Forming Plant</b>	A Plant which is classified as either a GBGF-S or a GBGF-I.
<b>GBGF-S</b>	Is a Synchronous Power Generating Module, Synchronous Electricity Storage Module or Synchronous Generating Unit with a Grid Forming Capability.
<b>GBGF-I</b>	Is any Power Park Module, HVDC System, DC Converter, OTSDUW Plant and Apparatus, Non-Synchronous Electricity Storage Module, Dynamic Reactive Compensation Equipment or any Plant and Apparatus (including a smart load) which is connected or partly connected to the Total System via an Electronic Power Converter which has a Grid Forming Capability.
<b>Grid Forming Electronic Power Converter</b>	A Grid Forming Plant whose output is derived from a static solid-state Electronic Power Converter with a Grid Forming Capability.
<b>Grid Forming Active Power</b>	Grid Forming Active Power is the inherent Active Power produced by Grid Forming Plant that includes Active Inertia Power plus Active Phase Jump Power plus Active Damping Power.
<b>Grid Forming Unit</b>	A Power Park Unit or Electricity Storage Unit or a Synchronous Power Generating Unit or individual Load with a Grid Forming Capability
<b>Fast Fault Current Injection</b>	The ability of a Grid Forming Plant to supply reactive current, that starts to rise in less than 5ms, into the Total System when the voltage falls below 90% of its nominal value at the Grid Entry Point or User System Entry Point.
<b>Frequency Sensitive Mode</b>	A Genset, or Type C Power Generating Module or Type D Power Generating Module or DC Connected Power Park Module or HVDC System operating mode which will result in Active Power output changing, in response to a change in System Frequency, in a direction which assists in the recovery to Target Frequency, by operating so as to provide Primary Response and/or Secondary Response and/or High Frequency Response.
<b>Inertia Constant H</b>	<p>For a GBGF-S, the Inertia Constant H is measured in MW.seconds / MVA.</p> <p>For a GBGF- I, the Inertia Constant H is measured in MW.seconds / MVA and it is derived from the Active RoCoF Response Power when subject to a rate of change of the System Frequency.</p>
<b>Internal Voltage Source</b>	<p>For a GBGF-S, a real magnetic field, that rotates synchronously with the System Frequency under normal operating conditions, which as a consequence induces an Internal Voltage Source in the stationary generator winding that has a real physical impedance.</p> <p>In a GBGF-I, switched power electronic devices are used to produce a voltage waveform, with harmonics, that has a fundamental rotational component called the Internal Voltage source (IVS) that rotates synchronously with the System Frequency under normal operating conditions.</p> <p>For a GBGF-I Plant there must be a real physical impedance between the Internal Voltage Source and the Grid Entry Point or User System Entry Point.</p>

	<b>Definitions</b>
	For the avoidance of doubt a virtual impedance, is not permitted in GBGF-I Plant.
<b>Limited Frequency Sensitive Mode</b>	A mode whereby the operation of the Genset or Power Generating Module (or DC Converter at a DC Converter Station or HVDC Systems exporting Active Power to the Total System) is Frequency insensitive except when the System Frequency exceeds 50.4Hz, from which point Limited High Frequency Response must be provided. For Power Generating Modules (including DC Connected Power Park Modules) and HVDC Systems, operation in Limited Frequency Sensitive Mode would require Limited Frequency Sensitive Mode – Over-frequency (LFSM-O) capability and Limited Frequency Sensitive Mode – Underfrequency (LFSM-U) capability.
<b>Load Angle</b>	The angle in radians between the voltage of the Internal Voltage Source and the voltage at the Grid Entry Point or User System Entry Point.
<b>Maximum Capacity</b>	The maximum continuous Active Power which a Power Generating Module can supply to the Total System, less any demand associated solely with facilitating the operation of that Power Generating Module and not fed into the System. In the case of an Electricity Storage Module, the Maximum Capacity is the maximum continuous Active Power which an Electricity Storage Module can export to the Total System less any demand associated with facilitating the operation of that Electricity Storage Module when fully charged and operating in a mode analogous to Generation.
<b>Minimum Stable Operating Level or Minimum Stable Generation</b>	The minimum Active Power, as specified in the Bilateral Agreement or as agreed between The Company and the Generator, at which the Power Generating Module can be operated stably for an unlimited time.
<b>Network Frequency Perturbation (NFP) Plot</b>	<p>A form of Bode Plot which plots the amplitude (%) and phase (degrees) of the resulting output oscillation responding to an applied input oscillation across a frequency base. The plot will be used to assess the capability and performance of a Grid Forming Plant and to ensure that it does not pose a risk to other Plant and Apparatus connected to the Total System.</p> <p>For GBGF-I, these are used to provide data to The Company which together with the associated Nichols Chart (or equivalent) defines the effects on a GBGF-I for changes in the frequency of the applied input oscillation.</p> <p>The input is the applied as an input oscillation and the output is the resulting oscillations in the GBGF-I's Active Power.</p> <p>For the avoidance of doubt, Generators in respect of GBGF-S can provide their data using the existing formats and do not need to supply NFP plots.</p>
<b>Nichols Chart</b>	For a GBGF-I, a chart derived from the open loop Bode Plots that are used to produce an NFP Plot. The Nichols Chart plots open loop gain versus open loop phase angle. This enables the open loop phase for an open loop gain of 1 to be identified for use in defining the GBGF-I's equivalent Damping Factor
<b>Phase Jump Angle</b>	The Phase Jump Angle is the difference in the measured phase angle of the voltage at the Grid Entry Point or User System Entry Point (if Embedded) in a given mains half cycle compared with the measured phase angle of the voltage at the Grid Entry Point or User System Entry Point in the previous mains half cycle.
<b>Phase Jump Angle Limit</b>	The maximum Phase Jump Angle when applied to a GBGF-I Plant which will result in a linear controlled response without activating current

	<b>Definitions</b>
	limiting functions. This is specified for a System angle near to zero which will be considered to be the normal operating angle under steady state conditions.
<b>Phase Jump Angle Withstand</b>	The maximum Phase Jump Angle when applied to a GBGF-I Plant which will result in the GBGF-I Plant remaining in stable operation with current limiting functions activated. This is specified for a System angle near to zero which will be considered to be the normal operating angle under steady state conditions.
<b>Plant</b>	Solution and Plant are interchangeably used in this document. Solution or Plant refer to the project or Facility with which the Stability Compensation Service Agreement for NOA Stability Pathfinder Phase 2 will be signed.
<b>Point of Connection</b>	An electrical point of connection between the National Electricity Transmission System and a User's System.
<b>Point of Stability</b>	This is defined in the Service Agreement Schedule E as the point on the NETS (at 132kV or higher) where the Facility is directly or radially connected, being the point where, unless otherwise stated, NOA Stability Compensation Service Phase 2 must be delivered.
<b>Proving Tests</b>	A proving test or tests to verify that the Facility can provide the Stability Compensation Service in accordance with the Technical Performance Requirements stated in Schedule E of the Service Agreement, including the contracted Inertia, Short Circuit Level, and Reactive Power.
<b>Reactive Capability</b>	The ability of the Facility to absorb or produce Reactive Power range as specified in the Service Agreement.
<b>RoCoF</b>	Rate of Change of System Frequency.
<b>Service Agreement</b>	Refers to the commercial contract for NOA Stability Pathfinder Phase 2. It is also referenced as Stability Compensation Service Agreement in this document.
<b>Solution</b>	Solution and Plant are interchangeably used in this document. Solution or Plant refer to the project or Facility with which the Stability Compensation Service Agreement for NOA Stability Pathfinder Phase 2 will be signed.
<b>Total System</b>	The National Electricity Transmission System and all User Systems in the National Electricity Transmission System Operator Area.



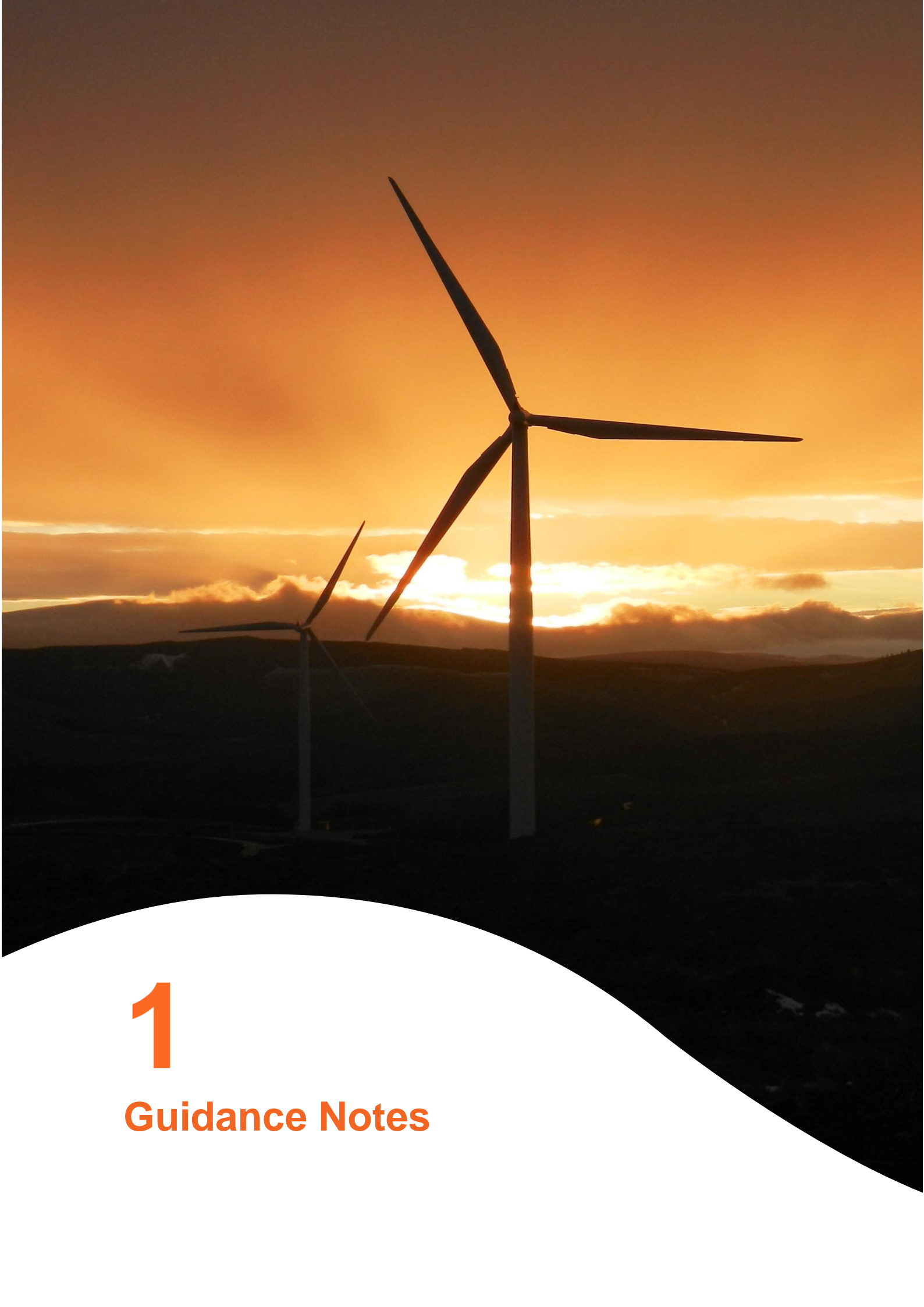

# 1

## Guidance Notes

## Introduction

This document provides description of the compliance and proving tests for NOA Stability Compensation Service Phase 2 which will be required ahead of the service commencement. This document is based on the European Compliance Processes (ECP) included in the Grid Code and the Grid Code modification process being progressed through GC0137 (<https://www.nationalgrideso.com/industry-information/codes/grid-code-old/modifications/gc0137-minimum-specification-required>).

To achieve Operational Notification, the Provider, the company owning and operating the Grid Forming Plant under NOA Stability Compensation Service Phase 2, must demonstrate compliance with the Grid Code as covered in its Bilateral Connection Agreement in addition to the requirements of the Service Agreement.

This guidance note has been written for NOA Stability Compensation Service Phase 2 Providers and covers the service compliance requirements for all Grid Forming technologies (including but not limited to synchronous condensers and grid forming converters).

Providers may, if they wish, suggest alternative tests or studies, which they believe will demonstrate compliance in accordance with the requirements placed on themselves and NGESO.

## Definition of Grid Forming Plant

A Grid Forming Plant is a Power Generating Module, HVDC System, Generating Unit, Power Park Module, DC Converter, OTSDUW Plant and Apparatus, Electricity Storage Module, Smart Load or Dynamic Reactive Compensation Equipment whose Active Power output is directly proportional to the magnitude and phase of its Internal Voltage Source, the magnitude and phase of the voltage at the Grid Entry Point or User System Entry Point and the sine of the Load Angle without any control actions occurring in the associated control system. Consequently, a Plant which has a Grid Forming Capability is one where the frequency of the Internal Voltage Source is the same as the System Frequency for normal operation, with only the Load Angle defining the relative position between the two.

NOA Stability Pathfinder Phase 2 technical specification in Schedule E of the Service Agreement covers the technical characteristics required.

Grid Forming Plant (defined as GBGF-S or GBGF-I in this report) can take many forms and can be a mixture of any of the technologies available. The list below indicates some typical Grid Forming technologies which are available, but this list is not exhaustive.

- Synchronous Condensers / Compensators with and without flywheels
- Synchronous Generators
- Grid Forming Converter storage systems
- Grid Forming Synchronous storage systems
- STATCOM Systems with an energy storage component

In addition, it is possible to mix the technologies to provide the overall Grid Forming package. It should be noted, that as part of this guidance, it is important that the Provider must test compliance of each Grid Forming Plant type which is proposing to use. In addition, at NGESO's discretion, the

Provider may need to test a combination of each technology at a single location to confirm service compliance and performance.

## Manufacturer's Data and Performance Report

Manufacturers are concerned with protecting their innovations and technologies employed in Grid Forming Technologies which if shared could compromise their competitive advantage. To facilitate the market, the power industry has agreed that mathematical simulation models and Fault Ride Through Capability can be supplied directly to NGENSO from manufacturers. The Grid Code (ECP.10) explains that NGENSO may receive manufacturer information and Providers can reference it as part of their compliance demonstration. Appendix D of these guidance notes provides additional information for manufacturers.

Providers should note that using registered manufacturer data does not guarantee Grid Code compliance for a Grid Forming Plant Module but does indicate that the Grid Forming Plant can achieve Grid Code compliance in the appropriate area. Any Provider wishing to use manufacturer data is advised to contact NGENSO early in the compliance process to determine if the information held in the Register of Manufacturer's Data and Performance Report is appropriate and sufficient in each case. This approach can be used for information relating to the dynamic model of a Grid Forming Plant or controller and the data and reports associated with fault ride through type tests.

While Providers may not see the Manufacturer's Data & Performance Report information, they must ensure that the correct reference is used as the same provisions will apply to this data as a normal Data Registration Code or a User Data File Structure submission. The Manufacturer's Data and Performance Report reference given by the Grid Forming Plant manufacturer will contain the following:

- Manufacturer name
- Grid Forming Plant type
- Date; and
- The relevant report version number

The User should then reference the document in the appropriate place in the User Data File Structure. For example, in case of fault ride through studies, assuming suitable fault ride through information is available in a Manufacturers Data and Performance report, the User can enter the following sentence:

*"This information has been submitted generically to NGENSO and can be found in the NGENSO Register of Manufacturer's Data and Performance Report under document reference "manufacturerX\_Planttype1\_22Aug21\_reportver001."*

## Simulation Studies

The simulation studies described in this document will allow demonstration of elements of the technical specification of the Service Agreement. However, if the study requirements specified in this document or in Provider's BCA are inappropriate, the Provider should contact NGENSO to discuss and agree an alternative program and success criteria. In general, simulation studies are required to

1. Demonstrate an expected compliant performance ahead of service commencement.



2. Demonstrate the model supplied is a true and accurate reflection of the Plant, as built.
3. Demonstrate capability where it is impractical through testing as the effects on other system Users would be unacceptable.

The simulations must be based on the validated models supplied to NGENSO in accordance with Schedule E Part D of the Service Agreement.

Unless otherwise stated in individual simulation tests, all simulation test results must be shown at the Point of Stability (as defined in the Service Agreement, Schedule E) and Grid Entry Point or User System Entry Point. Any equipment between the solution and the Point of Stability that impact the solution's performance (e.g., connection transformers/cables/transmission lines) must be explicitly modelled.

The simulation tests must be run for long enough to allow the system to settle to a steady state before any event is applied and long enough after the test to allow the system to return to steady state.

The following must be recorded for all simulation studies:

- Voltage magnitude and phase angle at the Point of Stability, the Grid Entry Point, and the terminals of the Grid Forming Plant
- Active Current, Reactive Current, and total current at the Point of Stability, the Grid Entry Point, and the terminals of the Grid Forming Plant
- Active Power and Reactive power at the Point of Stability, the Grid Entry Point, and the terminals of the Grid Forming Plant
- System Frequency and RoCoF at the Point of Stability

For EMT simulations, EMT and RMS quantities must be provided. The method adopted to compute RMS values must be clearly stated and explained. All RMS results must include positive, negative and zero sequence quantities.

All results must be recorded with step sizes not higher than 1ms.

The test model must be set up as following:

- The solution must be modelled in EMT for GBGF-I and Hybrid solutions. For GBGF-S solutions, RMS models run with EMT studies are preferable. However, for GBGF-S solutions, RMS simulations are acceptable if all simulations and results providing sufficient performance are provided. The models in all cases must accurately reflect the actual solution's performance and limitations.
- Any equipment (including protection settings) that impacts the performance at the Point of Stability must be modelled.
- The transmission network should be modelled using network short circuit levels and X/R ratios which will be provided by the NGENSO. The equivalent system impedance ( $Z_{sys}$ ) for each location can be calculated from the network SCL and X/R ratio provided by NGENSO.
- Nominal settings and ratings of assets should be used in the model and simulations.

- All simulation settings, model parameters, model settings and controllers' parameters must remain unchanged for all simulation tests. Any change in these settings and parameters, other than those requested by NGENSO (e.g., reactive power set point, frequency of the system, etc.) must be declared, justified, and agreed with NGENSO.
- For GBGF-I Plants, all converter limitations and associated protection settings must be modelled.
- Hybrid Plants must follow all tests described for GBGF-I Plants.

## Simulation Test 1 – Active RoCoF Response Power

Simulation Test 1 is required for all solutions.

The Provider is required to demonstrate that the Plant is capable of supplying Active Inertia Power, Active RoCoF Response Power, and Active Phase Jump Power, and submit a full 3 phase simulation study in the time domain representing the response of the Grid Forming Plant over a range of operating conditions.

The Provider must demonstrate that:

- The Plant can respond to a change in System Frequency with a change in Active Power output within 5ms.
- For GBGF-I,
  - Converter limits must be clearly explained and demonstrated that the Plant is not hitting converter limits for RoCoF events of 1 Hz/s in Table 2.
  - Demonstrate tendered Active RoCoF Response Power considering any stacking with other active power services and Plant's charging/discharging status.
  - Demonstrate stable and damped response.
  - Demonstrate delivery of Active RoCoF Response Power without going into saturation and a behaviour that is equivalent to pole slipping on synchronous machines does not occur.
  - Demonstrate that Active RoCoF Response Power value from all 1 Hz/s events must be equal to or higher than the tendered inertia value. Tendered inertia % availability must also be clearly explained.
- For GBGF-S,
  - Demonstrate tendered inertia values.
  - Demonstrate stable and damped response.
  - Show the manufacturer datasheet matches the calculated inertia values from simulations.

Simulation Test 1 should be done considering the network configuration shown in Figure 1. The frequency events must be modelled as a change in the ideal voltage source frequency.

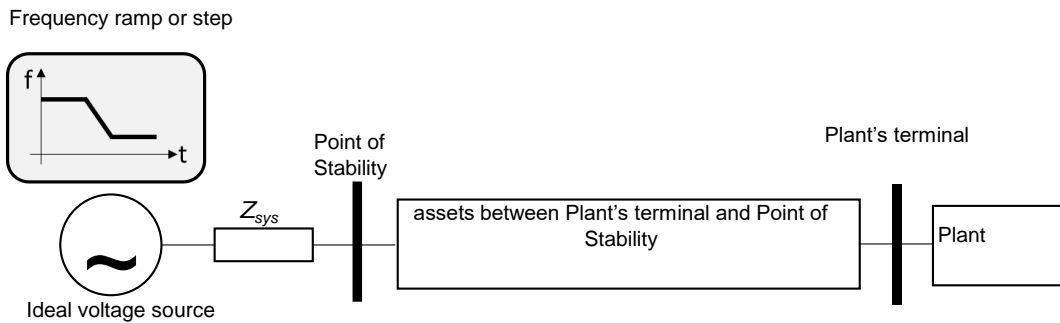

Figure 1: Simulation Test 1 network representation

Table 1: Initial Conditions for Simulations Tests 1-10

Initial Conditions for Simulation Tests	
Definitions	<p><b>Full Load Active Power Export</b> in this document, depending on the submission in the commercial tender, is defined as either 1) the maximum export / maximum discharged state of a GBGF-I asset or 2) the maximum Active Power Export based on participation in other services/BM. It must be clearly stated and explained.</p> <p><b>Full Load Active Power Import</b> in this document, depending on the submission in the commercial tender, is either 1) maximum import / maximum charging state of a GBGF-I asset or 2) maximum Active Power Import based on participation in other services/BM. It must be clearly stated and explained.</p>
Initial Condition 1	<p>GBGF-I Plant running at Full Load Active Power Export and Maximum Reactive Power Import.</p> <p>GBGF-S Plant running at 0 MW and Maximum Reactive Power Import.</p>
Initial Condition 2	<p>GBGF-I Plant running at Full Load Active Power Export and Maximum Reactive Power Export.</p> <p>GBGF-S Plant running at 0 MW and Maximum Reactive Power Export.</p>
Initial Condition 3	<p>GBGF-I Plant running at Full Load Active Power Import and Maximum Reactive Power Import.</p> <p>This Initial Condition is not applicable to GBGF-S Plant.</p>
Initial Condition 4	<p>GBGF-I Plant running at Full Load Active Power Import and Maximum Reactive Power Export.</p> <p>This Initial Condition is not applicable to GBGF-S Plant.</p>
Initial Condition 5	<p>GBGF-I Plant running at Full Load Active Power Export and 0 MVar Reactive Power.</p> <p>GBGF-S Plant running at 0 MW and 0 MVar Reactive Power.</p>
Initial Condition 6	<p>GBGF-I Plant running at Full Load Active Power Import and 0 MVar Reactive Power.</p> <p>This Initial Condition is not applicable to GBGF-S Plant.</p>

Table 2: Frequency and RoCoF tests for Active RoCoF Response Power

Steps	Simulation Event
	<p>With the System Frequency set to 50Hz, the Plant should have both Limited Frequency Sensitive Mode and Frequency Sensitive Mode disabled.</p> <p>Pre-event voltage at the Point of Stability equal to 1p.u.</p> <p>Record results for all parameters stated on Page 16 for all steps.</p>
1	<p>Simulate frequency event to increase from 50Hz to 50.5Hz RoCoF at 1Hz/s.</p> <p>For this step, use Initial Conditions 3, 4, and 6 from Table 1.</p>
2	<p>Simulate frequency event to drop from 50Hz to 49.2Hz RoCoF at 1Hz/s.</p>

Steps	Simulation Event
	For this step, use Initial Conditions 1, 2, and 5 from Table 1.
3	Simulate a frequency event to drop from 49.8Hz to 48.9Hz at 2Hz/s, restoring to 49.2Hz in 1 minute, to understand resilience to an extreme system event. For this step, use Initial Condition 1, 2, 3, and 4 from Table 1.
4	Simulate a frequency step change from 50Hz to 49Hz, lasting for 0.5 seconds. For this step, use Initial Condition 1 from Table 1.

For all solutions, the inertia values in MW.seconds should be calculated through Equations (1) and (2). For each event, the Active RoCoF Response Power in Equation (2) should be based on an average over the duration of the ramp event.

Equation 1

$$\text{Equation 1} \quad \text{Inertia} = H \times S_{rating}$$

$$\text{Equation 2} \quad H = \frac{\Delta P f_0}{2 S_{rating} RoCoF}$$

Equation 2

Where:

Inertia as defined in Equation 1 is in MW.seconds or MJ.

H (s) is the inertia constant as defined in Equation 2.

$S_{rating}$  (MVA) is the installed rating of the Grid Forming Plant.

$\Delta P$  (MW) is the solution's active power output for a frequency event which is referenced as Active RoCoF Response Power in this document.

RoCoF (Hz/s) is the rate of change of System Frequency.

$f_0$  (Hz) is the pre-fault System Frequency.

A table containing calculated Active RoCoF Response Power and inertia in MW.seconds or MJ from all steps in Table 2 must be provided.

For GFGF-I Plants, perform additional simulations in Table 3 to provide the solution's response under full System Frequency range.

Table 3: Performance under full System Frequency range test for GBGF-I

Steps	Simulation Events
	With the System Frequency set to 50Hz and both Limited Frequency Sensitive Mode and Frequency Sensitive Mode disabled. Pre-event voltage at the Point of Stability equal to 1p.u. Plant should be initially running at 0 MVar and Full Load Active Power Import value as defined in Table 1.
1	Simulate System Frequency to increase from 50Hz to 52Hz at a rate of 1Hz/s over a 2 second period. Allow conditions to stabilise for 5 seconds and then decrease the System Frequency from 52Hz to 47Hz at a rate of 1Hz/s over a 5 second period. Allow conditions to stabilise. Record results of Active Power, Reactive Power, Voltage, and System Frequency. Comment on the Plant's performance.
2	Repeat step 1 in reverse by simulating System Frequency to decrease from 50Hz to 47Hz at a rate of 1Hz/s over a 3 second period. Allow conditions to stabilise for 5 seconds and then increase the System Frequency from 47Hz to 52Hz at a rate of 1Hz/s over a 5 second period. Allow conditions to stabilise. Record results of Active Power, Reactive Power, Voltage, and System Frequency. Comment on the Plant's performance.
3	Repeat steps 1-2 with Plant running at Full Load Active Power Export value as defined in Table 1.

## Simulation Test 2 – Active Phase Jump Power

The purpose of this simulation test is to understand the ability of the solution to supply Active Phase Jump Power and withstand a phase jump of 60 degrees.

This test is required for all solutions.

Use network configuration shown in Figure 1 for this test. The voltage phase jump event must be modelled as a step change in the ideal voltage source.

All Grid Forming Plants are expected to demonstrate the capability to withstand a voltage phase jump of 60 degrees. A detailed explanation on the solution’s limitations must be provided.

GBGF-I Plant must be modelled in detail to capture limitations such as inverter blocking, controller saturation and protection tripping.

Any limitations and observations related to the solution’s performance must be noted.

Table 4: Phase Jump tests

Steps	Simulation Events
	Pre-event voltage at the Point of Stability equal to 1p.u. System Frequency set to 50Hz, and all control actions (e.g., Limited Frequency Sensitive Mode, Frequency Sensitive Mode and voltage control) disabled. Use Initial Conditions 1, 2, 3, and 4 from Table 1 for this test. Record results for all parameters stated on Page 16.
1	Simulate 60 degrees drop at the Point of Stability. Allow conditions to stabilise for at least 10 seconds, unless otherwise agreed with NGESO. Confirm correct operation of the Grid Forming Plant.

Additional tests defined in Table 5 must be undertaken by GBGF-I and hybrid Plants. Phase Jump Angle Withstand and Phase Jump Angle Limits must be clearly stated.

Table 5: Phase Jump tests at extreme conditions for GBGF-I

Steps	Simulation Event
	Pre-event voltage at the Point of Stability equal to 1p.u. With the System Frequency set to 50Hz, the Grid Forming Plant should initially be running at Minimum Stable Operating Level or Minimum Stable Generation, zero MVAR output and all control actions (e.g., Limited Frequency Sensitive Mode, Frequency Sensitive Mode and voltage control) disabled. Record results for all parameters stated on Page 16 for all steps.
1	Apply a phase jump equivalent to the positive Phase Jump Angle Limit value at the Point of Stability. Allow conditions to stabilise for at least 10 seconds.
2	Apply a phase jump equivalent to the negative Phase Jump Angle Limit value at the Point of Stability. Allow conditions to stabilise for at least 10 seconds.
3	Apply a phase jump equivalent to the positive Phase Jump Angle Withstand at the Point of Stability. Allow conditions to stabilise for at least 10 seconds.
4	Apply a phase jump equivalent to the negative Phase Jump Angle Withstand at the Point of Stability. Allow conditions to stabilise for at least 10 seconds.

## Simulation Test 3 – Short Circuit Events

This test is required for all solutions.

The purpose of this test is to demonstrate:

- Short Circuit Level (SCL) values used in the commercial tender assessment and the Service Agreement.
- Reactive current response initiation within 5 ms following a fault event.

Figure 2 and Figure 3 show the single-line diagrams of the system to be simulated.

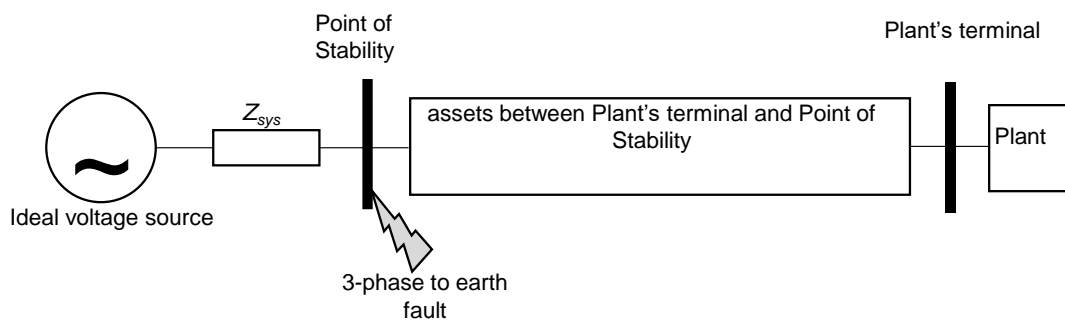

Figure 2: Simulation Test 3 Step 1 network representation

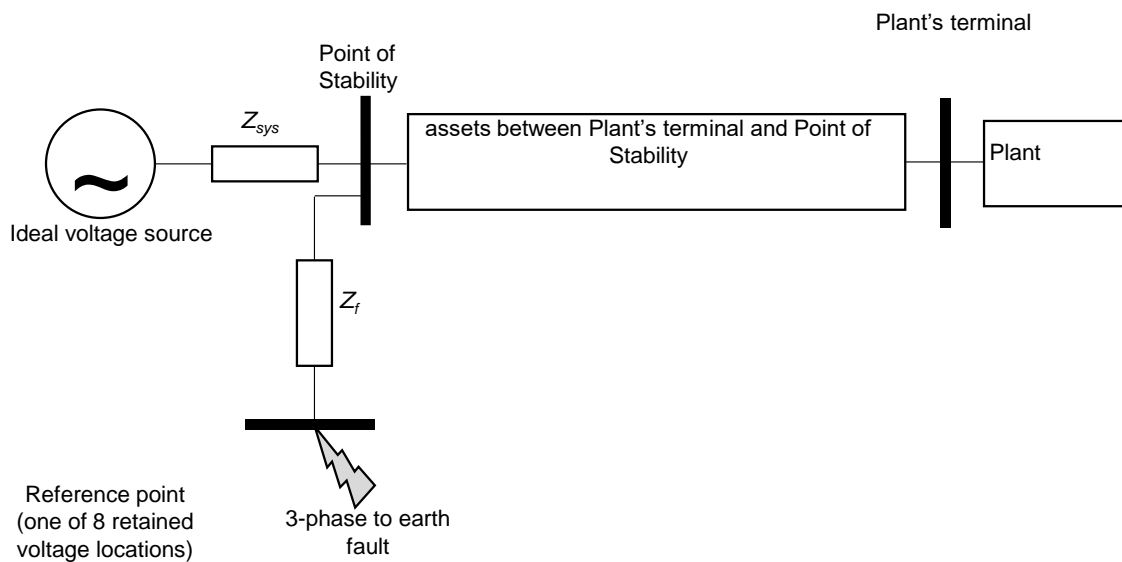

Figure 3: Simulation Test 3 Step 2 network representation

Table 6: Short circuit events

Steps	Simulation Events
	Pre-event voltage at the Point of Stability equal to 1p.u. With the System Frequency set to 50Hz, the Plant should have both Limited Frequency Sensitive Mode and Frequency Sensitive Mode disabled. Steps 1 – 2 must be carried out with all initial conditions stated in Table 1. Record results for all parameters stated on Page 16 for all steps.
1	Simulate a 3 phase to earth fault at the Point of Stability that is cleared at 140ms followed by a voltage rise to 1.1pu. The positive sequence RMS fault current at 100ms after fault initiation should be declared, measured in kA at the Point of Stability.
2	Simulate a 3 phase to earth with a fault impedance change set to achieve a retained voltage (without the Plant) based on the feasibility study submission at the Point of Stability. Fault impedance to achieve different retained voltage values must be modelled considering network's X/R ratio. The fault should be cleared at 140ms. The solution must be added, and the step is repeated. Carry out Step 2 for all 8 retained voltage values based on the retained voltage values from the tender feasibility study submissions. State positive sequence RMS fault current at 100ms after the fault initiation, measured in kA for each of these faults after the solution is added.

## Simulation Test 4 – Temporary Over Voltages

This test is required for all solutions. The purpose of this test is to demonstrate the withstand of an RMS overvoltage at the at the Grid Entry Point or User System Entry Point or Transmission Interface Point, of up to 1.4p.u. for 100ms after fault clearance followed by a reduction in over-voltage towards no more than 1.05pu as per the requirements of TGN(E)288. Use network configuration in Figure 2 for this test.

Table 7: Temporary Over Voltage test

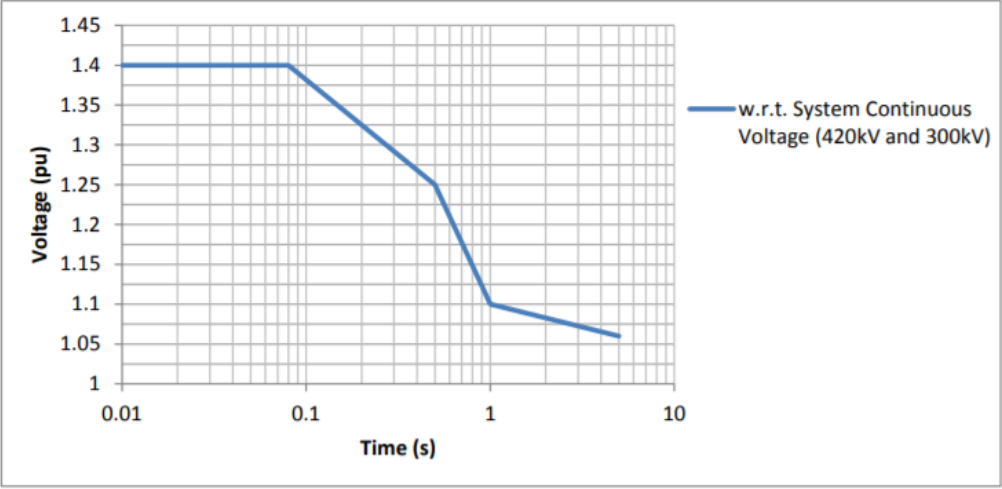
Steps	Simulation Event
	With the System Frequency set to 50Hz, the Grid Forming Plant should initially be running at the Minimum Stable Operating Level or Minimum Stable Generation, zero MVAR output and all control actions (e.g., Limited Frequency Sensitive Mode, Frequency Sensitive Mode and voltage control) disabled.
1	Simulate the following voltage profile as per <a href="#">TGN(E)288</a> at the Grid Entry Point or User System Entry Point or Transmission Interface Point. The voltage profile must be achieved by changing the ideal voltage source's magnitude. 

Steps	Simulation Event
	Record results for all parameters stated on Page 16. Comment on the solution's performance.

## Simulation Test 5 – Multiple Fault Ride Through

This test is required for all solutions.

The test should note any limitations and observations related to the solution's performance.

Use network configuration in Figure 2 for this test. In addition to the following simulations, provide any limitations with regards to clause 1.2.19 in Schedule E of the Service Agreement.

Table 8: Multiple fault ride through balanced faults

Steps	Simulation Event
1	This test must be carried out with all Initial Conditions from Table 1. Apply a 3 phase to earth fault at the point of study for 140ms before clearing the fault. Repeat the fault 5 times with 15 seconds between each two consecutive faults. Record results for all parameters stated on Page 16. Explain the Plant's behaviour and any observations.

Table 9: Multiple fault ride through unbalanced faults

Steps	Simulation Event
1	This test must be carried out with all Initial Conditions from Table 1. Apply a 2 phase to earth fault at the point of study for 140ms before clearing the fault. Repeat the fault 5 times with 15 seconds between each two consecutive faults. Record results for all parameters stated on Page 16. Explain the Plant's behaviour and any observations.

## Simulation Test 6 – Fast Fault Current Limitation for GBGF-I

This simulation test is required for GBGF-I and hybrid Plants.

The purpose of this test is to understand fast fault current limitations and note observations related to the solution's performance.

Use network configuration in Figure 2 for this test.

Table 10: Fast fault current limitations

Steps	Simulation Events
	Pre-event voltage at the Point of Stability equal to 1p.u. With the System Frequency set to 50Hz, the Grid Forming Plant should be initially running at its Maximum Active Power Export as defined in Table 1, zero MVAR output.
1	Disable all control actions (e.g., Limited Frequency Sensitive Mode, Frequency Sensitive Mode, Fast Fault Current Injection, Fault Ride Through and voltage control other than current limiters). Apply a solid three phase short circuit fault at the Point of Stability for 140ms. Record results for all parameters stated on Page 16 for a period of 10 seconds after the fault has been applied. The GBGF-I Plant's current limit should be observed to operate.
2	Enable all control actions (e.g., Limited Frequency Sensitive Mode, Frequency Sensitive Mode, Fast Fault Current Injection, Fault Ride Through and voltage control other than current limiters).



Steps	Simulation Events
	Apply a solid three phase short circuit fault at the Point of Stability for 140ms. Record results for all parameters stated on Page 16 for a period of 10 seconds after the fault has been applied and confirm correct operation.

## Simulation Test 7 – Combined frequency and voltage events

The purpose of this simulation test is to demonstrate a solution can support system voltage and frequency under combined frequency and voltage events. This simulation test is required all solutions.

Frequency event should be considered to start at the same time as the voltage event.

Use network configuration in Figure 2 for this test.

Table 11: Combined voltage and frequency events

Pre-event voltage at the Point of Stability equal to 1p.u.				
All combined voltage and frequency events must be carried out with Initial Conditions 1, 2, 3, and 4 from Table 1.				
Record results for all parameters stated on Page 16.				
Voltage Events	Frequency Events			
	Frequency fall from 50Hz to 49.2Hz at 0.5 Hz/s	Frequency fall from 50Hz to 47Hz at 1Hz/s	Frequency rise from 50Hz to 50.5Hz at 0.5 HZ/s	Frequency rise from 50Hz to 52Hz at 1Hz/s
3 phase to earth fault for 140ms followed by a step drop to 0.9pu				
3 phase to earth fault for 140ms followed by a step rise to 1.1pu				

## Simulation Test 8 – Power Oscillation Damping (POD)

This test will establish if the Grid Forming Plant is meeting the reactive and/or active power oscillation damping capability as specified in the Service Agreement.

GBGF-S Plant must be able to

1. Detect system voltage oscillations in the sub-synchronous frequency range 0.3-2Hz.
2. Upon detecting oscillations, inject reactive current adequately in antiphase to achieve a reduction in voltage oscillations at the grid entry point.
3. Change the amount of reactive current injection proportional to the amplitude of the oscillations.
4. Limit the influence of these subsidiary control functions at 10% of the primary function.
5. Achieve 1-4 whilst keeping the solution stable and not compromise other aspects of the technical specification.

GBGF-I Plant must be able to

1. Detect system voltage and active power oscillations in the sub-synchronous frequency range 0.3Hz to 2Hz.
2. Upon detecting voltage oscillations, inject/absorb reactive current adequately in antiphase to achieve a reduction in voltage oscillations at the grid entry point.
3. Upon detecting active power oscillations, inject/absorb active current adequately in antiphase to achieve a reduction in active power oscillations at the grid entry point.
4. Change the amount of reactive current injection proportional to the amplitude of the voltage oscillations.
5. Change the amount of active current injection proportional to the amplitude of the active power oscillations.
6. Limit the influence of these subsidiary control functions at 10% of the primary function.
7. Achieve 1-6 whilst keeping the solution stable and not compromise other aspects of the technical specification.

Hybrid solutions must follow same tests as GBGF-I.

For all Grid Forming Plants (GBGF-S or GBGF-I), NGENSO expects the Provider to contribute to damping over the frequency range 0.3Hz to 2 Hz. The report must include any limitations on damping over the frequency range 0.3Hz to 2 Hz based on the selected tuning.

The following procedure is provided to assist Providers in drawing up their own site-specific procedures.

Table 12: Power Oscillation Damping – Voltage oscillations

Steps	Simulation Events
	Plant running at 0 MVar and 0 MW. Equivalent system representation is shown in Figure 4.
1	Inject 0.3Hz oscillations in system voltage. The 0.3 Hz oscillations should be superimposed to the fundamental frequency (50 Hz) voltage. The amplitude of the oscillation must be 5% of the rated voltage at the Point of Stability. If 5% is not sufficiently large to demonstrated damping capability, increase further until able to demonstrate solution's contribution to damping. Record Active Power, Reactive Power, voltage and current from the Plant at the Point of Stability before and after the oscillation is applied. Observe differences with and without the oscillation on the Plant's performance and contribution to reactive power damping.
2	Repeat step 1 by increasing oscillation frequencies with steps of 0.1Hz up to 2Hz.

Additional tests defined in Table 13 must be undertaken by GBGF-I and hybrid Plants.

Table 13: Power Oscillation Damping – Active power oscillations

Steps	Simulation Events
	Plant running at 0 MVar and 0 MW. Equivalent system representation is shown in Figure 4.
1	Inject 0.3Hz oscillations in system frequency. The 0.3 Hz oscillations should be superimposed to the fundamental frequency (50 Hz) value. The amplitude of the oscillation must be 0.5% of the rated frequency at the Point of Stability. If 0.5% is not sufficiently large to demonstrated damping capability, increase further until able to demonstrate solution's contribution to damping whilst ensuring there is no risk to the Grid Forming Plant or wider System.

Steps	Simulation Events
	Record Active Power, Reactive Power, voltage and current from the Plant at the Point of Stability before and after the oscillation is applied. Observe differences with and without the oscillation on the Plant's performance and contribution to active power damping.
2	Repeat Step 1 for increasing oscillation frequencies with steps of 0.1Hz up to 2Hz.

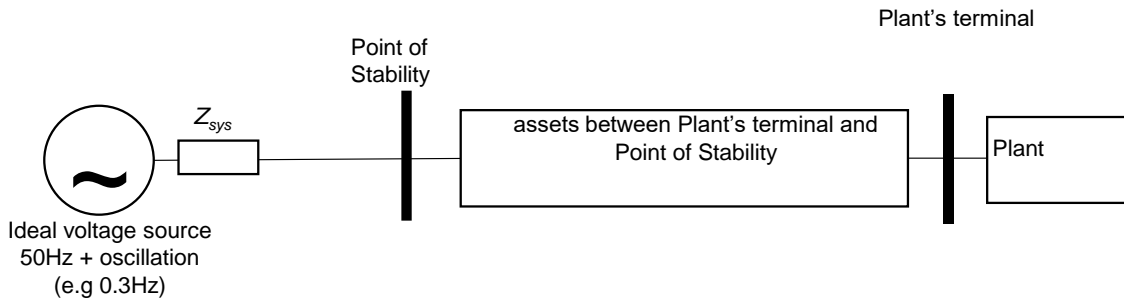

Figure 4: Power Oscillation Damping

If the unit has constant MVar mode, the Provider must show how POD performance is impacted by operating in MVar mode.

## Simulation Test 9 – Further Tests for GBGF-I

### Bode and NFP Plots

For GBGF-I Plant, simulation tests must confirm that the Plant does not cause undue interactions with the System or other User's Plant and Apparatus. This is requirement is achieved through tests, simulations, and the submission of Network Frequency Perturbation plots or an equivalent as agreed with The Company. This is to provide the following conditions:

- Active Power responses to frequency modulations
- Reactive Power responses to voltage modulations
- Cross Linkage of Active Power to voltage modulations
- Cross linkage to Reactive Power response to system frequency modulation

The Provider must demonstrate that the active and reactive output is supplied below the 5Hz bandwidth limit by supplying

- Bode plots
- Nichols Chart derived from the open loop Bode plot
- Or an equivalent as agreed with The Company

The transfer functions chosen to develop NFP plots must be explained and reflect the conditions a) to d) stated above. The block diagrams of the control system must be provided and clearly indicate the input and output signals specified to compute frequency domain analysis. For each condition, the Provider must explain performance and limitations with regards to 5Hz bandwidth limit.

The GBGF-I Plant model should take the equivalent form shown in either Figure 5 or Figure 6 below as applicable. The GBGF-I Plant Owner can use their own design, that may be very different to Figure 5 or Figure 6 but should contain all relevant functions.

**Typical simulation model 1**

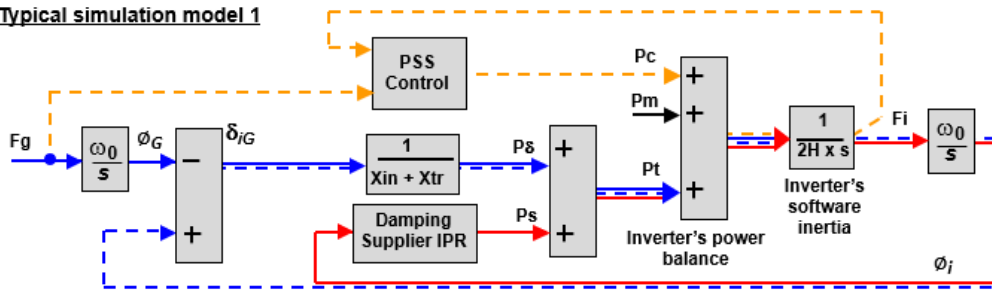

Figure 5: Typical control system simulation model 1

**Typical simulation model 2**

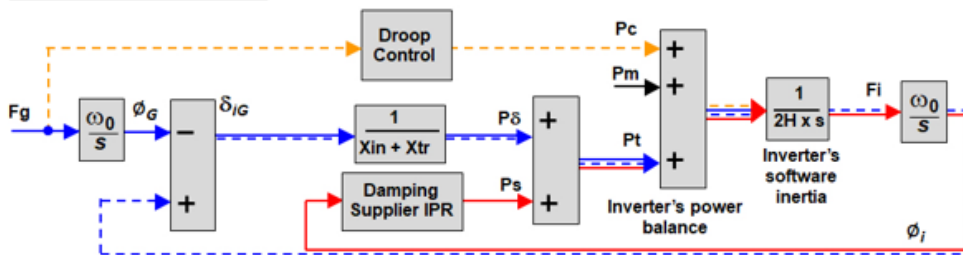

Figure 6: Typical control system simulation model 2

### Step Test to demonstrate overshoot and decay

Carry out a step change of 5% at a reference signal of the controller to demonstrate that the output signal's overshoot and decay are in line with the declared damping factor.

Record all parameters stated on Page 16.

### Simulation Test 10 – Active RoCoF Response Power and Active Phase Jump Power, under extreme conditions for GBGF-I

This test is required for GBGF-I and hybrid solutions to demonstrate that the Plant is capable of supplying Active RoCoF Response Power and Active Phase Jump Power, under extreme conditions. This test must be carried out with the network representation in Figure 7.

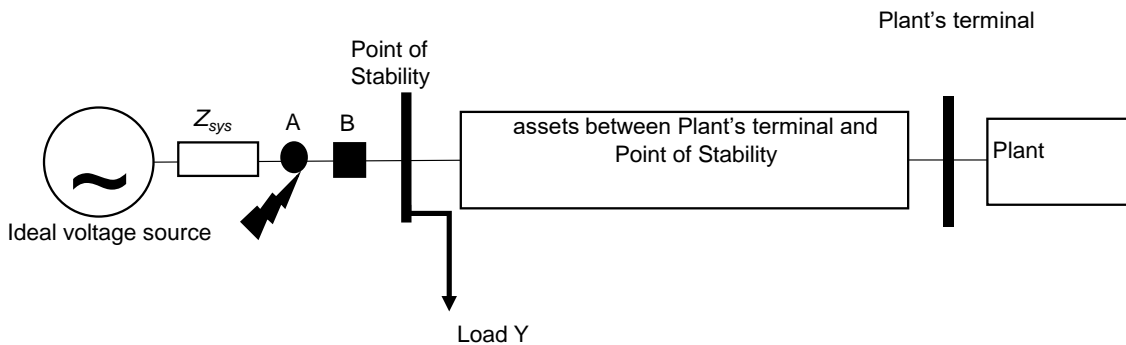

Figure 7: Network representation for Active RoCoF Response Power and Active Phase Jump Power extreme condition

In this test, the parameters of the ideal voltage source should be based on the network SCL and X/R ratio provided by NGESO. The Load Y will be defined by NGESO which will be within the range of GBGF-I Plant's rated capability.

Table 14: Extreme conditions for Active RoCoF Response Power and Active Phase Jump Power

Steps	Simulation Event
1	<p>With the system running in steady state the GBGF-I and the variable frequency AC Grid should each be running at load Y/2 with the system frequency of the test network being 50hz. All control actions (e.g Limited Frequency Sensitive Mode and voltage control) should be disabled.</p> <p>With the system in steady state, apply a solid (zero impedance) three phase short circuit fault at point A of Figure 7 and then open circuit breaker B, 140ms after the fault has been applied.</p> <p>Record traces of Active Power, Reactive Power, voltage, current and System Frequency for a period of 10 seconds after the fault has been applied and comment on the solution's performance.</p>

## Validated Models

The Provider is required to provide NGESO and the Transmission Owner with a model of their Grid Forming Plant as detailed in PC.A.5.3.2 c option 2 or PC.A.5.4.2 (a to h) of the Grid Code or as specified in Schedule E Part D of the Service Agreement. The model data is to be provided in a block diagram format, complete with Laplace equations and all associated parameters for the site in question. The electrical system is to be provided as a single line diagram.

The model structure and complexity must be suitable for NGESO to integrate into their power system analysis software (currently DlgSILENT). In cases where the model's functionality cannot be correctly or satisfactorily represented within NGESO's power system analysis software, the Provider may be required to liaise with NGESO to determine appropriate simplifications or changes in representation to produce an appropriate model. The model should not require integration time steps less than 10ms. Should a DlgSILENT PowerFactory model be supplied then it shall not contain DLL code or require calls to external routines or setup scripts. Please note that Grid Code modification GC0141, if approved, will require the provision of a DlgSILENT PowerFactory model

All model parameters must be identified along with units and site-specific values. A brief description of the model should ideally be provided as ultimately this will save time and money for both parties.

The model representation provided should be implemented on a power system analysis software package that is agreed with NGESO. In the event the model does not produce the correct output,

the data submission will be considered incorrect and not contractually compliant. NGENSO will confirm model accuracy using its power system analysis software for any issues which need to be addressed.

The model also needs to be suitable for integration into the power system analysis software used by the relevant Transmission Owner (if not NGENSO). Support may be required from the Provider to implement and, if necessary, modify the model representation for use on the Transmission Owner's power system analysis software (ordinarily this will not be the case if the model has already been satisfactorily implemented at NGENSO).

NGESO encourages developers to work with manufacturers to develop the use of standard models for each type of Grid Forming Plant. This information can be provided as a Manufacturers Data and Compliance Report in accordance with the Grid Code and this will minimise the work needed by all parties to validate Grid Forming Technologies models at each new site. See Appendix H for more information.

As specified in the Service Agreement Schedule E, the Provider must submit an EMT model in a software that is agreeable between The Company and the Provider if The Company requests before or after commissioning of the Facility. The Provider will submit a performance chart in accordance with OC2.4.2.1 of the Grid Code.

It is the responsibility of the Provider to provide information as described in the Planning Code, which enables NGENSO to model the National Electricity Transmission System.

## Compliance Tests

In addition to the simulation studies outlined in the previous section, compliance tests which are required are covered in Appendix A – Appendix G. Where appropriate, Appendices contain references to the existing Grid Code Connections Compliance tests. These tests are designed to demonstrate, where possible, that the relevant provisions of the Grid Code and Service Agreement have been met. However, if the tests described in the Appendices are at variance with the Bilateral Connection Agreement or the test requirements are not relevant to the Grid Forming Plant type, the Provider should contact NGENSO to discuss and agree an alternative test program and success criteria.

The Provider is responsible for drafting test procedures for the Grid Forming Plant as part of the compliance process prior to the issue of the Interim Operational Notification (ION). ECP.A.6 and the appendices of these guidance notes provide outline test schedules which may assist the Provider with this activity.

This Appendices outline the general testing requirements for the Provider to demonstrate compliance with the relevant aspects of the Grid Code, Ancillary Services Agreements and Bilateral Agreement. The tests specified will normally be sufficient to demonstrate compliance of a GBGF-I and/or GBGF-S Plant, however The Company may:

- Agree to an alternative set of tests provided The Company deem the alternative set of tests sufficient to demonstrate compliance with the Grid Code, Ancillary Services Agreements and Bilateral Agreement; and/or
- Require additional or alternative tests if information supplied to The Company during the compliance process suggests that the tests will not fully demonstrate compliance with the relevant section of the Grid Code, Ancillary Services Agreements or Bilateral Agreement; and/or

- Require additional tests if control functions to improve damping of power system oscillations or additional functions to prove the capability of the GBGF-I Plant is required by the Bilateral Agreement or included in the control scheme: and/or
- Agree a reduced set of tests for the subsequent GBGF-I Plant following successful completion of the first Grid Forming tests in the case of an installation comprising of two or more GBGF-I Plant's which The Company reasonably considers to be identical if: -
  - The tests performed in respect of subsequent Grid Forming Plants do not replicate the full tests for the first unit; or
  - Any of the tests performed do not fully demonstrate compliance with the relevant aspects of the Grid Code, Ancillary Services Agreement and / or Bilateral Agreement.

NGESO may require further compliance tests or evidence to confirm site-specific technical requirements (in line with the Bilateral Agreement) or to address compliance issues that are of particular concern. Additional compliance tests, if required, will be identified following NGESO's review of submissions of User Data File Structure (UDFS).

For testing and simulations, it is vital that fast timesteps and high-resolution recording samples are used as many of the characteristics occur almost instantaneously with many of the most important characteristics taking place in the first cycle.

Testing shall be in accordance with ECC.6.6.3. This will require further amendment for Grid Forming Converters. For voltage control tests a sampling rate of 100Hz is currently used (10ms).

For Grid Forming Converters events will be taking place within one cycle (20ms) and hence a minimum sampling rate of 1000Hz (1ms) will be required. Power Generating Modules of Type C and D are required to be fitted with Dynamic System Monitors which can record up to 256 samples in once cycle (12.8kHz).

In addition to the testing requirements as stated within Grid Code ECP.A.3 to ECP.A.7, additional tests are required for GBGF-I and Hybrid Plants. These are as follows.

- Active RoCoF Response Power
- Active Phase Jump Power
- Active Damping Power

The tests are carried out by the Provider, or by their agent, and not by NGESO. However, NGESO may witness some of the tests as indicated in ECP.A.6. Tests should be completed following the test procedures supplied in the UDFS prior to the issue of the ION unless otherwise agreed by NGESO.

The Provider should also provide suitable digital monitoring equipment as stated in the Service Agreement to record all relevant test signals needed to verify the Grid Forming Plant's performance in parallel with NGESO recording equipment.

## Grid Code Connections Compliance Process

Information on Grid Code connections compliance process can be found on National Grid ESO's website: <https://www.nationalgrideso.com/industry-information/connections/compliance-process>

Where required, Providers may need to enter a Mandatory Service Agreement (MSA).

## **Future Development of Compliance Testing**

At the time of writing, Grid Code modification GC0137 has been subject to both a Workgroup Consultation and Code Administrator Consultation and is shortly to be submitted to Ofgem for approval. This modification develops a high level non mandatory requirement for a Grid Forming capability from a whole range of plants and also provides the framework for a future stability market. Any new Grid Forming Plant which provides a GB Grid Forming Capability after the GC0137 modification has been approved by Ofgem would be required to meet the Grid Code requirements.

Following the Workgroup Consultation phase of the GC0137 modification, it was agreed that National Grid ESO would establish an Expert Group who would be responsible for the development of a GB Grid Forming Best Practice Guide. This aims to address many of the complex details highlighted as part of the GC0137 Workgroup which would include items such as testing, monitoring, simulation models, data submission, performance, worked examples and what would be considered to be a good performance or otherwise.

## **Factory Acceptance Tests (FAT)**

Factory Acceptance Tests, or FATs, are conducted at the manufacturer's site prior to delivery and installation and these tests help to identify any issues and correct them prior to shipment. FAT is not required or ruled out in the Grid Code however, FATs are beneficial not just for the NGENSO and Customers but for the manufacturer as well to simplify the process of on-site witness tests, the Compliance Engineers in ESO will be happy to discuss the FAT process, accept the FATs invitation and witness the part of test. Voltage Control, Frequency Control and Fault Ride Through tests can be witnessed in FAT. Following successful FATs of the voltage Control, Frequency Control and Fault Ride Through, the onsite test process may be simplified, and this should be discussed and agreed with the NGENSO compliance team in advance as part of the compliance process. Reactive Power Capability, Voltage Control, and Frequency Control tests are identified in Grid Code ECP.A.7.1. and the fault ride through tests will be agreed with NGENSO to demonstrate compliance with ECC.6.3.15, ECC.6.3.16 and ECP.A.3.5.

## **Islanding Protection (Loss of Mains Protection)**

If islanding protection is required, an intertripping scheme is recommended by G59/G99. If as an alternative, 'Rate of Change of Frequency' (ROCOF) trip relays are to be considered, there could be compliance implications which need to be discussed with NGENSO at the earliest opportunity. NGENSO does not require or desire Grid Forming Technologies to fit ROCOF protection but needs to be consulted on the settings of any such protections in service. Vector Shift protection is no longer accepted.





# A

## Appendices

# Appendix A Reactive Capability

The Stability Compensation Service Agreement will include the reactive range a Grid Forming Plant will deliver.

The reactive capability can be demonstrated with the existing Grid Code Compliance test for Reactive Capability for different Grid Code users. Compliance guidance for different users can be found on NGENSO website:

<https://www.nationalgrideso.com/industry-information/connections/compliance-process>

## Grid Forming Synchronous Machine (GBGF-S) Reactive Capability Compliance Tests

For synchronous generators, the provider should follow the tests mentioned in the compliance guidance notes for synchronous generators (Appendix for Reactive Capability).

For synchronous compensators, the provider should follow the tests mentioned in the compliance guidance notes for synchronous compensators (Appendix for Reactive Capability).

## Grid Forming Inverter Technology (GBGF-I) Reactive Capability Compliance Tests

For GBGF-I Plant treated as a Storage User in the BCA, the provider should follow the tests mentioned in the compliance guidance notes for Electricity Storage Modules (EU Code User) (Appendix for Reactive Capability).

For GBGF-I Plant treated as an HVDC System Owner or DC Converter Station Owner in the BCA, the provider should follow the tests mentioned in the compliance guidance notes for DC converter stations (EU Code User) (Appendix for Reactive Capability).

For GBGF-I Plant treated as Power Park Module in the BCA, the provider should follow the tests mentioned in the compliance guidance notes for Power Park Modules (EU Code User) (Appendix for Reactive Capability).

Additionally, for all Plants types, the following tests must be carried out where applicable.

For Constant Q mode if applicable:

Test	Description
1	Plant in Constant Q mode and maximum active power export (where applicable). Target Q (*) selected to generate a maximum continuous lagging Reactive Power for 60 minutes or maximum time limited by the storage capacity as applicable.
2	Plant in Constant Q Mode and maximum active power export (where applicable). Target Q (*) selected to generate a maximum continuous leading Reactive Power for 60 minutes or maximum time limited by the storage capacity as applicable.
3	Return Target Q to a value to achieve zero reactive power transfer.

Reactive Capability tests are not normally witnessed by NGENSO so where a Grid Forming Plant is recording the tests they should record details such as the HV system voltage and transformer tap position and equipment in service, as applicable, across the test period.

# Appendix B Voltage Control and Testing

The Service Agreement will include the voltage control requirements for a Grid Forming Plant.

The voltage control capability can be demonstrated with the existing Grid Code Compliance test for Voltage Control and Testing for different Grid Code users. Compliance guidance for different users can be found on NGENSO website:

<https://www.nationalgrideso.com/industry-information/connections/compliance-process>

## Grid Forming Synchronous Machine (GBGF-S)

For synchronous generators, providers should follow the tests mentioned in the compliance guidance notes for synchronous generators (Appendix for Voltage Control and Testing).

For synchronous compensators, providers should follow the tests mentioned in the compliance guidance notes for synchronous compensators (Appendix for Voltage Control and Testing).

### Constant MVar Mode Testing where applicable

For Plant in constant MVar mode, consideration should be given to devise a test to show behaviour during a voltage disturbance (2% step change). This may be achieved by tapping the Grid Step Up (GSU) transformer or a nearby network transformer.

## Grid Forming Converter (GBGF-I)

For GBGF-I Plant treated as a Storage User in the BCA, the provider should follow the tests mentioned in the compliance guidance notes for Electricity Storage Modules (EU Code User) (Appendix for Voltage Control and Testing).

For GBGF-I Plant treated as an HVDC System Owner or DC Converter Owner in the BCA, the provider should follow the tests mentioned in the compliance guidance notes for DC converter stations (EU Code User) (Appendix for Voltage Control and Testing).

For GBGF-I Plant treated as Power Park Modules in the BCA, the provider should follow the tests mentioned in the compliance guidance notes for Power Park Modules (EU Code User) (Appendix for Voltage Control and Testing).

Additionally, in all voltage step tests Provider must demonstrate that GBGF-I Plant's overshoot and decay match the declared damping factor.

# Appendix C Frequency Control

If a Plant participating in NOA Stability Compensation Service Phase 2 is also providing any frequency response services, it must demonstrate the relevant frequency control tests based on its Grid Code connection.

Information on Grid Code connections compliance process and guidance notes for different users can be found on National Grid ESO's website: <https://www.nationalgrideso.com/industry-information/connections/compliance-process>

Refer to the frequency control tests within the relevant Plant guidance.

# Appendix D Active RoCoF Response Power for GBGF-I

This section details the procedure for demonstrating Active ROCOF Response Power. Ideally this test should be completed as a type test on an isolated test network where it is possible to change the frequency of the isolated network. If a suitable test network is not available, performance of the GBGF-I will need to be demonstrated through online monitoring of network RoCoF events as detailed in the Service Agreement. The Interim Operational Notification process will require simulation studies prior to connection and online monitoring of network ROCOF events of suitable size to demonstrate compliance. This should be discussed and agreed with the NGENSO compliance team in advance of connection.

**Test 1:** The test is required to assess correct operation of the Grid Forming Plant without saturating. This test is then repeated for a 50 Hz to 49 Hz at a rate of 1Hz/s.

Test step	Description
	With the frequency of the test network set to 50Hz, the GBGF-I should be initially running at Full Load Active Power Export as defined in Table 1, zero MVAR output and both Limited Frequency Sensitive Mode and Frequency Sensitive Mode disabled. Record all measurements specified in Appendix K in all steps.
1	The test network frequency is increased from 50Hz to 51 Hz at a rate of 1Hz/s.
2	The test network frequency is decreased from 51Hz to 50 Hz at a rate of 1Hz/s.
3	The test network frequency is decreased from 50Hz to 49Hz at a rate of 1Hz/s.
4	The test network frequency is increased from 49Hz to 50Hz at a rate of 1Hz/s.
5	Repeat all test steps with Plant running at Full Load Active Power Import as defined in Table 1.

**Test 2:** This test is required to assess the Grid Forming Plant's withstand capabilities under extreme System Frequencies.

Test step	Description
	With the frequency of the test network set to 50Hz, the GBGF-I should be initially running at Full Load Active Power Export as defined in Table 1, zero MVAR output and both Limited Frequency Sensitive Mode and Frequency Sensitive Mode disabled. Record all measurements specified in Appendix K in all steps.
1	The frequency of the test network is increased from 50Hz to 52Hz at a rate of 2Hz/s.
2	The frequency of the test network is decreased from 52Hz to 50Hz at a rate of 2Hz/s.
3	The frequency of the test network is decreased from 50Hz to 47Hz at a rate of 2Hz/s.
4	The frequency of the test network is increased from 47Hz to 50Hz at a rate of 2Hz/s.
5	Repeat all test steps with Plant running at Full Load Active Power Import as defined in Table 1.

**Test 3:** This test is to demonstrate the Grid Forming Plant's ability to supply Active RoCoF Response Power over the full System Frequency range.

Test step	Description
	With the frequency of the test network set to 50Hz, the GBGF-I should be initially running at Full Load Active Power Export as defined in Table 1, zero MVAR output and both Limited Frequency Sensitive Mode and Frequency Sensitive Mode disabled. Record all measurements specified in Appendix K in all steps.
1	The frequency is then increased from 50Hz to 52Hz at a rate of 1Hz/s over a 2 second period. Allow conditions to stabilise for 5 seconds and then decrease the frequency from 52Hz to 47Hz at a rate of 1Hz/s over a 5 second period. Allow conditions to stabilise.
2	The test now needs to be re-run in the opposite direction. The frequency is decreased from 50Hz to 47Hz at a rate of 1Hz/s over a 3 second period. Allow conditions to stabilise for 5 seconds and then increase the system

Test step	Description
	frequency from 47Hz to 52Hz at a rate of 1Hz/s over a 5 second period. Allow conditions to stabilise.
3	Repeat all test steps with Plant running at Full Load Active Power Import as defined in Table 1.

# Appendix E Active Phase Jump Power for GBGF-I

This section details the procedure for demonstrating Active Phase Jump Power. Ideally this test should be completed as a type test on an isolated test network where it is possible to change the frequency of the isolated network. If a suitable test network is not available, performance of the GBGF-I will need to be demonstrated through online monitoring of network events as detailed in the Service Agreement. The Interim Operational Notification process will require simulation studies prior to connection and online monitoring of network events of suitable size to demonstrate compliance. This should be discussed and agreed with the NGESO compliance team in advance of connection.

**Test 1:** This test is to demonstrate the Grid Forming Plant’s ability to supply Active Phase Jump Power under normal operation.

Test Step	Description
	With the frequency of the test network set to 50Hz, the GBGF-I should be initially running at Maximum Capacity or Registered Capacity or at its agreed deloaded point, zero MVAR output and all control actions (e.g. Limited Frequency Sensitive Mode, Frequency Sensitive Mode and voltage control) disabled.
1	Apply a positive phase jump of up to the Phase Jump Angle Limit at the Grid Entry Point or User System Entry Point (if Embedded).
2	Repeat step 1 by injecting the same angle into the Grid Forming Plant’s control system (as indicatively shown below). This specific test can be repeated on site as required for a routine performance evaluation test. It should be noted that Figure below is a simplified representation. Each Grid Forming Plant Owner can use their own design, that may be very different to the Figure below but should contain all relevant functions that can include test points and other equivalent data and documentation. Any additional signals, measurements, parameters and tests shall be agreed between the Grid Forming Plant Owner and The Company.
3	Repeat steps 1-2 with a negative injection up to the Phase Jump Angle Limit.
	Record all measurements specified in Appendix K in all steps for a period of 10 seconds after the step change in phase has been applied for all steps. As part of these tests, the corresponding Active Power change resulting from a phase shift will be a function of the local reactance and the location of where the phase shift is applied in addition to any additional upstream impedance between the GBGF-I and phase step location.

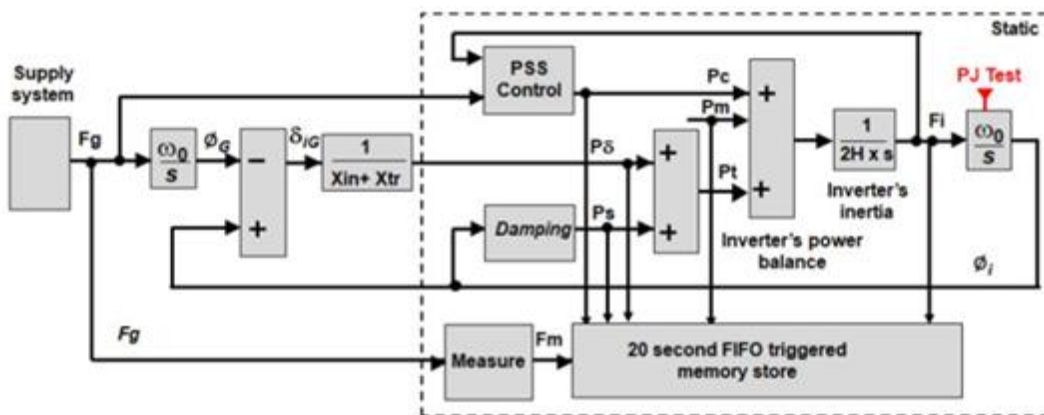

Figure 8:Active Phase Jump Power test system

**Test 2:** This test is to demonstrate the Grid Forming Plant’s ability to supply Active Phase Jump Power under extreme conditions.

Test Step	Description
	<p>With the frequency of the test network set to 50Hz, the Grid Forming Plant should be initially running at its Minimum Stable Operating Level or Minimum Stable Generation, zero MVAR output and all control actions (e.g., Limited Frequency Sensitive Mode, Frequency Sensitive Mode and voltage control) disabled.</p> <p>For all steps, record all measurements specified in Appendix K in all steps for a period of 10 seconds after the step change in phase has been applied.</p>
1	Apply a phase jump of 60 degrees at the connection point of the GBGF-I or into the Grid Forming Plant's control system as shown in Figure 8.
2	Repeat step 1 but on this occasion apply a phase jump equivalent to the positive Phase Jump Angle Limit at the Grid.

**Test 3:** This test is to demonstrate the GBGF-I Plant's ability to supply Active Phase Jump Power, Fault Ride Through and GBGF Fast Fault Current Injection during a faulted condition.

Test Step	Description
	<p>With the frequency set to 50Hz, the Grid Forming Plant should be initially running at its Maximum Capacity or Registered Capacity or at an alternative loading point as agreed with The Company, zero MVAR output and all control actions (e.g., Limited Frequency Sensitive Mode, Frequency Sensitive Mode and voltage control) disabled.</p> <p>For all steps, record all measurements specified in Appendix K in all steps for a period of 10 seconds after the step change in phase has been applied and confirm correct operation.</p>
1	Apply a solid three phase short circuit fault at the connection point in the test network forming part of the type test for 140ms or alternatively the equivalent of a zero retained voltage for 140ms.
2	Repeat Step 1 but on this occasion enable all control actions (e.g., Limited Frequency Sensitive Mode, Frequency Sensitive Mode, Fast Fault Current Injection, Fault Ride Through and voltage control other than current limiters).



# Appendix F Active Damping Power for GBGF-I

This test is required to demonstrate that the GBGF-I Plant is capable of contributing to Active Damping Power. The Grid Forming Plant Owner should configure their Grid Forming Plant in a form (as agreed with The Company) as shown in Figure 5 or Figure 6 or equivalent as applicable. Each Grid Forming Plant Owner can use their own design, that may be very different to Figure 5 or Figure 6 but should contain all relevant functions. If a suitable test network is not available, performance of the GBGF-I will need to be demonstrated through online monitoring as detailed in the Service Agreement and simulation studies will be required during the Interim Operational Notification Process (as applicable).

The suitability of the tuning of any POD is checked in both the time and frequency domains. In the time domain, testing is by small voltage step changes injected into the voltage control reference block. Comparisons are made between performance with and without the POD in service.

For analysis in the frequency domain, a bandwidth-limited (0.3Hz-2Hz) random noise injection should be made to the voltage control reference. The generator should provide a suitable band limited (300mHz-2Hz) noise source to facilitate noise injection testing. Any POD gain should be continuously controllable (i.e. not discrete components) during testing.

The stability of the POD gain setting will also be assessed by increasing the gain in stages to 3x the proposed setting. This increase is carried out gradually while monitoring the unit for any signs of instability. The tests will be regarded as supporting compliance of the POD if:

- POD gives improved damping following a step change in voltage.
- Any oscillations resulting from a 2% step to the voltage reference are damped out within 2 cycles of oscillation.
- The POD gives improved damping of frequencies in the band 300mHz – 2Hz.
- The gain margin test demonstrates no appreciable instability at 3x the proposed gain
- The interaction of POD to any changes in Active Power shows less than 2% difference in reactive power output.

The above guidance is based on PSS testing of synchronous generators provided in ECPA.5.4.3 although NGENSO will be happy to consider an alternative test procedure suggested by the GBGF-I Plant.

# Appendix G Fault Ride Through and Fast Fault Current Injection

All Plants under Stability Compensation Service must ride through voltage depressions at the Grid Entry Point or User System Entry Point or Transmission Interface Point of down to 0pu for up to 140ms. The Plant must also ride through the family of voltage depressions curves defined in ECC.6.3.15.

## Grid Forming Synchronous Machine Technology (GBGF-S)

A Fault Ride Through requirement is required of the GBGF-S. Each module is expected to remain connected and stable during fault conditions. To demonstrate this capability the user is required to provide simulation studies.

The Provider shall supply time series simulation study results to demonstrate the capability of GBGF-S units to meet the Fault Ride Through requirements by submission of a report containing. This is to confirm if the GBGF-S can provide the required fault contribution as would have been specified within the Service Agreement:

- 1) A time series simulation study of a 140ms three phase short circuit fault with a retained voltage as detailed in table below applied at the Grid Entry Point or (User System Entry Point if Embedded) of the GBGF-S unit.

Machine Technology Unit	Retained Voltage
Grid Entry Point Voltage	0%

- 2) A time series simulation study of 140ms unbalanced short circuit faults with a retained voltage as detailed in table 1 on the faulted phase(s) applied at the Grid Entry Point or (User System Entry Point if Embedded) of the GBGF-S Unit. The unbalanced faults to be simulated are:
  - Balanced three phase fault
  - A phase-to-phase fault
  - A two phase to earth fault
  - A single phase to earth fault

The simulation study should be completed with the GBGF-S operating at maximum leading Reactive Power and the fault level at the Supergrid HV connection point at minimum or as otherwise agreed with The Company as detailed in ECC.6.3.15.8.

- 3) Time series simulation studies of balanced Supergrid voltage dips applied on the nearest point of the National Electricity Transmission System operating at Supergrid voltage to the Grid Forming Machine Technology. The simulation studies should include:
  - 50% retained voltage lasting 0.45 seconds
  - 70% retained voltage lasting 0.81 seconds
  - 80% retained voltage lasting 1.00 seconds
  - 85% retained voltage lasting 180 seconds.

For GBGF-S, the simulation study should be completed with the unit operating at zero Reactive Power output and the fault level at the Supergrid HV connection point at minimum or as otherwise agreed with The Company. Where GBGF-S unit is embedded, the minimum Network Operator's System impedance to the Supergrid HV connection point shall be used which may be calculated from the maximum fault level at the User System Entry Point.

The above required simulated voltage changes are shown in Figures ECC.6.3.15.2 – ECC.6.3.15.7 and ECC.6.3.15.9 (a) of the European Code. The requirement and providing a Fault Ride through simulation study applies to all taking part in the Stability Compensation service.

These requirements can be referred to in the context of two separate fault modes, A & B, which are respectively covered by ECC.6.3.15.1.1 and ECC.6.3.15.9.2 of the Grid Code, where A applies to faults lasting 140ms and B to faults in excess of 140ms.

The details of the simulation studies required are based on the ECP.A.3.5.1 section of Grid Code. The simulation studies requirement for 140ms unbalanced fault is set out in ECP.A.3.5.1 (ii) of the Grid Code. The simulation needs to be carried out at Maximum Leading Reactive Power. The simulation studies requirement for faults lasting longer than 140ms is set out in ECP.A.3.5.1(iii).

## Grid Forming Converter Technology (GBGF-I)

### 'Mode A' Requirements - first 140msec of a fault

'Mode A' refers to the first 140msec of three-phase, phase to phase, two-phase to earth or single-phase to earth faults.

Throughout this period the GBGF-I Plant unit is required to remain transiently stable and connected for all Supergrid phase voltages down to a minimum of 0%. It should also generate the maximum possible reactive current without exceeding the transient rating limit of the GBGF-I Plant Module or any constituent element.

Within 0.5 seconds, following fault clearance and restoration of the Supergrid voltage to at least 90% of nominal, the GBGF-I Plant Module must restore the Active Power output to at least 90% of the level available immediately before the fault.

It is anticipated that in achieving this response the control system may be under damped. This will be considered acceptable provided any oscillations decay in a suitably short period and that whilst the oscillations are present the average Active Power delivered corresponds with the levels required were the oscillations not present.

Although the voltage will begin to recover upon fault clearance (within 140msec) it may not necessarily reach 90% voltage within the 140msec period as illustrated in the Appendix of the European Connection Conditions (ECC.A.4A.2). If the Supergrid Voltage has not restored to at least 90% within 140msec then the remaining fault period can be assumed to have a balanced retained voltage and that 'Mode B' requirements will then apply for the remainder of the fault period.

### 'Mode B' Requirements - fault period beyond the first 140msec

'Mode B' refers to a period of depressed voltages below nominal due to power system transients caused by remote faults or remote faults cleared in back up operating times.

Throughout this period the GBGF-I Plant Module is required to remain transiently stable and connected. During this period, it must remain connected and stable for any balanced Supergrid Voltage and provide fast fault current injection.

Within 1 second, following fault clearance and restoration of the Supergrid voltage to at least 90% of nominal, the GBGF-I Plant Module must restore the Active Power output to at least 90% of the level available immediately before the fault. Once again, appropriately damped active power oscillations shall be acceptable provided the total energy delivered during the period of the oscillation shall be 90% or more.

It is anticipated that in achieving this response the control system may be under damped. This will be considered acceptable provided any oscillations decay in a suitably short period.

### Fault Ride Through Testing

The manufacturer may demonstrate fault ride through using tests appropriate to the facilities available. However, a sufficiently large selection of results for balanced and unbalanced faults of varying duration must be provided to replicate the requirements.

NGESO expects the tests to replicate each fault type (3-phase, phase-phase, two-phase to earth and single-phase to earth) with varying magnitudes. The tests should illustrate any changes in characteristics or internal operating modes that depend upon fault severity.

Fault Ride Through testing involves applying simulated fault conditions, by applying short circuits, into known impedances to real systems. Compliance with fault ride through may be demonstrated by test conditions which are different to those specified in this sub section and different to the requirements specified in the Grid Code, provided:

- The test conditions are more severe.
- They encompass all the various fault scenarios covered by the Grid Code.
- They can be used in conjunction with the studies to demonstrate compliance.

A typical set of tests shown in the table below.

% Retained Supergrid Voltage*	3-phase	Phase phase	to 2-phase to Earth	1 phase to Earth	Grid Code Ref
0	0.14s	0.14s	0.14s	0.14s	ECC.6.3.15.1
30	0.384				ECC.6.3.15.9*
50	0.71s				
80	2.5s				
85	180s				

\*times quoted are for power park modules, refer to grid code section ECC.6.3.15 for specific technology types.

The purpose of the tests is to characterise the Grid Forming Plant Unit such that its limit of operation for retained voltage (at the terminals of the Grid Forming Plant Unit) is known. At the end of the test the results should indicate the level of voltage depression the unit can with stand for the times specified.

Ideally Grid Forming Plant Units will achieve the voltage levels and durations listed in the table above as this would indicate that the unit is fully compliant without the need for the study evidence. However, these levels are unlikely to occur at the Grid Forming Plant Unit terminals in practice because of the impedance between the fault location and the Grid Forming Plant Unit. Consequently, increased test voltage levels above those specified are typically acceptable for most circumstances but require further study evidence (on a case by case basis) to demonstrate that the levels which occur at the a particular Grid Forming Plant are greater than those which the Grid Forming Plant Units are capable of riding through.

The results should demonstrate the Grid Forming Plant Unit can survive at 0% retained volts for 140ms.

At the end of each of these tests the voltage should be returned to 90% until conditions have stabilised or for a minimum period of 180 seconds.

The tests should be performed on a single Grid Forming Plant using the test circuit shown below or using an isolated network driven by an inverter/converter to apply the required voltage profiles.

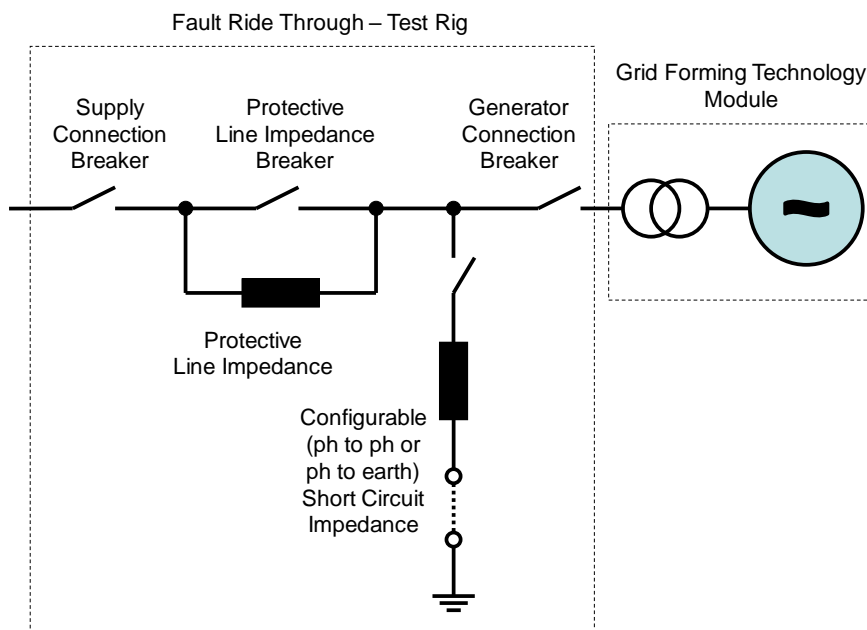

Figure G-2 – Fault ride through test rig single line diagram

## Generic Fault Ride Through Test Procedure

Since the fault ride through tests are to be arranged and conducted by the Provider, it is Provider's responsibility to propose a test programme to suit their site-specific requirements. A typical example of the test procedure based on Grid Code ECC.A.4 is given below.

Test	Description	Notes
1	<ul style="list-style-type: none"> <li>Operate the Grid Forming Plant Unit at nominal volts and appropriate output or input</li> <li>Apply a 3ph short reducing the volts to 0%</li> <li>Hold the voltage at 0% for 140ms</li> <li>Allow the voltage to recover to nominal volts</li> <li>Hold until conditions stabilise</li> <li>If the unit passes this test proceed to test 3 otherwise proceed to test 2</li> </ul>	Mode A
2	<ul style="list-style-type: none"> <li>Repeat test 1 to determine the minimum retained volts until the unit can operate at for a period of 140ms</li> </ul>	Mode A
3	<ul style="list-style-type: none"> <li>Operate the Grid Forming Plant Unit at nominal volts and appropriate output or input.</li> <li>Apply a 1ph to earth short circuit reducing the volts to 0%</li> <li>Hold the voltage at 0% for 140ms</li> </ul>	Mode A

Test	Description	Notes
4	<ul style="list-style-type: none"> <li>Allow the voltage to recover to nominal volts</li> <li>Hold until conditions stabilise</li> <li>If the unit passes this test proceed to test 5 otherwise proceed to test 4</li> </ul>	
	<ul style="list-style-type: none"> <li>Repeat test 3 to determine the minimum retained volts the unit can operate at for a period of 140ms</li> </ul>	<b>Mode A</b>
5	<ul style="list-style-type: none"> <li>Operate the Grid Forming Plant Unit at nominal volts and appropriate output or input.</li> <li>Apply a 2ph to earth short circuit reducing the volts to 0%</li> <li>Hold the voltage at 0% for 140ms</li> <li>Allow the voltage to recover to nominal volts</li> <li>Hold until conditions stabilise</li> <li>If the unit passes this test proceed to test 7 otherwise proceed to test 6</li> </ul>	<b>Mode A</b>
6	<ul style="list-style-type: none"> <li>Repeat test 5 to determine the minimum retained volts the unit can operate at for a period of 140ms</li> </ul>	<b>Mode A</b>

Test	Description	Notes
7	<ul style="list-style-type: none"> <li>Operate the Grid Forming Plant Unit at nominal volts and appropriate output or input.</li> <li>Apply a phase to phase short circuit reducing the volts to 0%</li> <li>Hold the voltage at 0% for 140ms</li> <li>Allow the voltage to recover to nominal volts</li> <li>Hold until conditions stabilise</li> <li>If the unit passes this test proceed to test 9 otherwise proceed to test 8</li> </ul>	<b>Mode A</b>
8	<ul style="list-style-type: none"> <li>Repeat test 7 to determine the minimum retained volts the unit can operate at for a period of 140ms</li> </ul>	<b>Mode A</b>
11	<ul style="list-style-type: none"> <li>Operate the Grid Forming Plant Unit at nominal volts and appropriate output or input.</li> <li>Apply a reduction in 3ph voltage to 30%</li> <li>Hold the voltage at 30% for 384ms</li> <li>Increase the voltage to 90%</li> <li>Hold until conditions stabilise or a minimum of 3 minutes</li> </ul>	<b>Mode B</b>
12	<ul style="list-style-type: none"> <li>Operate the Grid Forming Plant Unit at nominal volts and appropriate output or input.</li> <li>Apply a reduction in 3ph voltage to 50%</li> <li>Hold the voltage at 50% for 710ms</li> <li>Increase the voltage to 90%</li> <li>Hold until conditions stabilise or a minimum of 3 minutes</li> </ul>	<b>Mode B</b>
13	<ul style="list-style-type: none"> <li>Operate the Grid Forming Plant Unit at nominal volts and appropriate output or input.</li> <li>Apply a reduction in 3ph voltage to 80%</li> <li>Hold the voltage at 80% for 2.5 seconds</li> <li>Increase the voltage to 90%</li> <li>Hold until conditions stabilise or a minimum of 3 minutes</li> </ul>	<b>Mode B</b>
14	<ul style="list-style-type: none"> <li>Operate the Grid Forming Plant Unit at nominal volts and appropriate output or input.</li> <li>Apply a reduction in 3ph voltage to 85%</li> <li>Hold the voltage at 85% for 180 seconds</li> <li>Increase the voltage to 90%</li> <li>Hold until conditions stabilise or a minimum of 3 minutes</li> </ul>	<b>Mode B</b>

## Fast Fault Current Injection (FFCI)

The Grid Code requirement applies for Type B, Type C and Type D Plant and pathfinder technical specification Schedule E of the Service Agreement applies to all. The principles and details of the requirement are set out in ECC.6.3.16/19, and ECC.A.4EC1 of the Grid Code. Note fast fault current injection requirements for GBGF-I specified in the updated GC0137 legal text in ECC.6.3.19.5. The simulations and type tests will be used to confirm the status of FFCI compliance against that what is stated within Grid Code.

The Provider shall supply time series simulation study results to demonstrate the capability of the Grid Forming Plant Modules and OTSUA to meet ECC.6.3.16 and ECC.6.3.19.5 by submission of a report described in ECP.A.3.5.



# Appendix H Grid Forming Plant Performance Registration

## Scope

This Appendix is intended to provide guidance for Grid Forming Technologies Manufacturers rather than Providers on the direct submission of information and data to NGESO to assist in the demonstration of compliance. Generic Grid Forming Plant Unit Type Validation

Grid Forming Plant Modules generally comprise of many identical Grid Forming Units. Within manufacturing tolerances, the performance of a specific Grid Forming Plant Unit type is normally reasonably constant from unit to unit and at whichever site they are installed. It is therefore possible to register various aspects of this performance and the associated data once, and then reference this data for some or all the sites which use this particular type of equipment. The Grid Code recognises this by the provision of Manufacturer's Data and Performance Reports in ECP.10. The aim is to reduce the volume of work required by Users, Grid Forming Plant Unit manufacturers and NGESO in assessing the same information at different sites.

In addition, the Manufacturer's Data and Performance Reports can provide a route for detailed data that Grid Forming Plant Unit manufacturers regard as commercially sensitive to be sent directly to NGESO without publication to the User(s).

## Background to Generic Grid Forming Plant Unit Type Validation

To implement the provision of ECP.10 NGESO has developed the generic compliance process which allows manufacturers to work directly with NGESO in order to exchange information and evidence of compliance without data passing through a project chain. Figures H-1 to H-3 illustrate the differences in the two processes. Figure G1 demonstrates the conventional process where the data flow is always via the power station or power park developer.



Figure H-1 – The conventional compliance process data route.

Figure H-2 shows the one-time process to fill the generator equipment 'type' register. It may be that information only comes from the manufacturer although a developer may be involved by providing site test opportunities. The data will comprise of a report on one or more of the aspects outlined below.

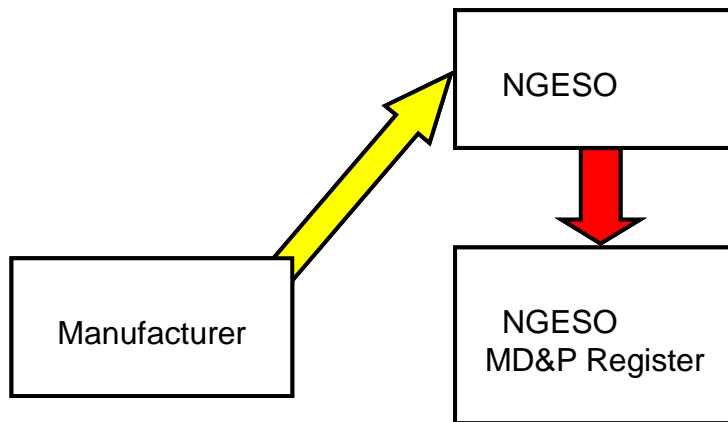

Figure H-2 – The Register of Manufacturer’s Data & Performance Report

Figure H-3 illustrates the process for referencing and using ‘generic’ data. Each project can, where appropriate, reference information held in the NGESO generator equipment Register of Manufacturer’s Data and Performance Report substituting information that they are required to submit before connecting to the National Electricity Transmission System and in lieu of some aspects of Grid Code testing. Developers will not have access to this information from NGESO and the only requirement is to obtain the correct reference from the manufacturer. If no relevant or insufficient data is held in the Register of Manufacturer’s Data and Performance Report, then the data must be provided in full by the developer.

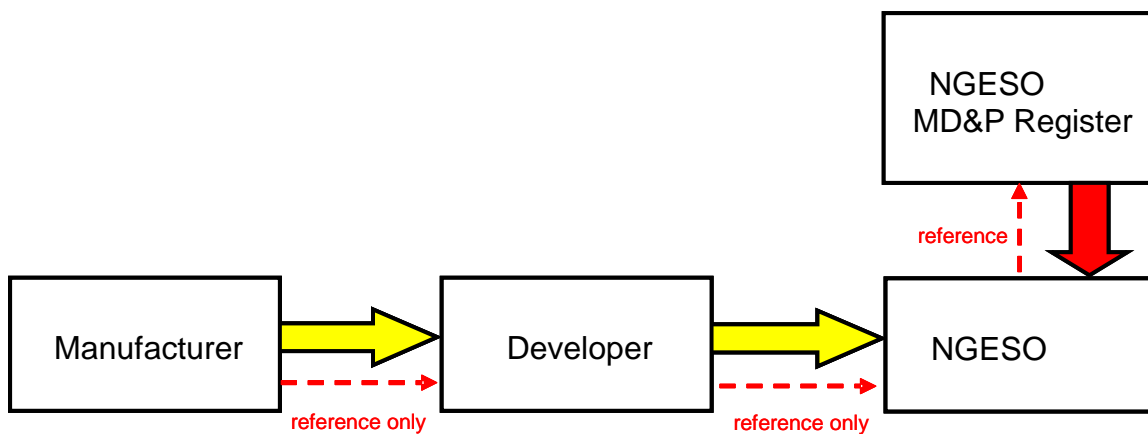

Figure H-3 – The generic data (red arrow) is referenced but cannot be seen by the developer.

## Confidentiality Provisions

Data submitted by Providers under the Data Registration Code (Grid Code) is protected by the confidentiality agreement contained in the Connection and Use of System Code (CUSC) and System Operator Transmission Owner Code (STC). This does not explicitly cover generic data sent from manufacturers directly to NGESO as it does not necessarily relate to a specific project. It is therefore recommended for manufacturers to sign a confidentiality agreement with NGESO prior to any exchange of information.

This process is currently under review as part of the grid code modification proposal GC0141.

Please note that NGENSO cannot sign individual manufacturer's confidentiality agreements as they may not cover the following aspects which are necessary to participate in the generic compliance process.

The following aspects are typical of the provisions of a confidentiality agreement between a manufacturer and NGENSO in relation to registering generic Manufacturers Data and Performance Reports information with NGENSO.

- This agreement has been written to reflect the confidentiality provisions in the CUSC which deals with the confidentiality of data as between NGENSO and Providers generally. NGENSO will NOT however be permitted to release this 'generic' information back to Providers (except for the generic information document reference as originally submitted) which is unlike data submissions received through the normal project chain.
- Some aspects of data must be passed to other Transmission System Operators and Owners in GB for system operation and design reasons as per the System Operator and Transmission Owner Code (STC).
- The 'Purpose' as defined in the Agreement reflects the purposes for which NGENSO do (and are permitted under the CUSC) to use information provided to NGENSO by developers through the normal project chain.
- The agreement is subject to the laws of England & Wales or Scotland because the entire framework within which this data will be used is structured around English law and if the data was directly provided by a Provider it would be subject to English law.
- Company Policy requires NGENSO business areas to adopt information and records management procedures that comply with all relevant legal requirements and are consistent with best practice as applied to their business needs. The records management procedure for this area provides that this data must be kept for 7 years after the data is last used. This therefore requires that the data should be kept for a period equating to the life of any Plant it refers to plus a period of 7 years. This is in line with normal project data submissions direct from developers.
- NGENSO may pass back information (e.g. computer models) to the manufacturer but does not accept any liability in respect of its accuracy.

If this agreement is not signed then the standard Grid Code data requirements apply and all data will need to be provided through the project chain. Failure to supply adequate data by either of these methods will result in non-compliance by the developer with the GB Grid Code and possible disconnection or denial of permission to connect to the GB transmission system.

## Areas Suitable for Manufacturer's Data and Performance Report

The Grid Code (ECP.10.2) allows the Fault Ride Through capability and the Grid Forming Plant Module mathematical model to be covered by a Manufacturer's Data and Performance Report. The manufacturer may choose to complete one or both of the above mentioned areas. In each case the manufacturer should submit a detailed report to NGENSO for approval and consequent submission into the Manufacturer's Data and Performance Report Register.

To achieve registration for Fault Ride Through capability, a series of tests and data submissions will be developed to demonstrate the performance characteristics of a single Grid Forming Plant Unit. Details of these tests and submissions are to be agreed between the Grid Forming Plant Unit manufacturer and NGESO. NGESO may wish to witness some or all of these tests.

To achieve registration for a Grid Forming Plant Module mathematical model, NGESO and the Grid Forming Plant Unit manufacturer will need to agree a series of simulations and data submissions in relation to a specific mathematical model of the Grid Forming Plant Unit and associated control systems in line with the requirements outlined in PC.A.5.4.2. In addition, the performance of this model should be validated against test results including faults, voltage steps and frequency changes as is deemed to be appropriate by NGESO.

## Submitting Data into the Register of Manufacturer's Data and Performance Report

Manufacturers considering registration should talk to NGESO early in their planning stage.

To be considered for registration, the Grid Forming Plant Unit manufacturer should submit a report to NGESO outlining the details and results as appropriate for its consideration. Each report should have an appropriate reference including manufacturer name, type of report (e.g. Fault Ride Through etc.), Grid Forming Plant Unit type, date, and report version number to permit referencing in future projects or for updates.

NGESO will, following submission of all required reports and data, confirm to the Grid Forming Plant Unit manufacturer in writing whether the Grid Forming Plant Unit report has been accepted. Once accepted the Manufacturer's Data and Performance Report Register status will be updated to indicate the acceptance in respect of the relevant Grid Code requirement.

## NGESO Register of Manufacturer's Data and Performance Reports

Users may wish to reference data held in the NGESO Register of Manufacturer's Data and Performance Reports to help to complete various parts of the compliance process (see previous section of this document). This can be achieved by placing the manufacturer document reference in the appropriate place in the Data Registration Code or User Data File Structure. This reference should be obtained by the User from the Grid Forming Plant manufacturer. Please note that it is the responsibility of the User to ensure that the correct reference is submitted to NGESO.

Even though different Grid Forming Plant Modules may be comprised of the same Grid Forming Plant Unit type, differences in performance can result. Submitting a Register of Manufacturer's Data and Performance Report reference can therefore not be a guarantee of compliance, and the suitability of the reference should be discussed with NGESO as part of the normal compliance process.

# Appendix I Other Technical Information

## Calculating Equivalent Impedance for Fault Ride Through Studies

The next two subsections describe a simplified method of determining the fault ride through capability where the Point of Connection is not the Supergrid. This method relies on substituting the network between the Supergrid and Point of Connection with an equivalent impedance. A reasonable value for the equivalent impedance needs to be determined. The worst-case scenario will be the minimum impedance. This minimum impedance can be derived from the maximum fault level at the connection point.

In some cases, however, the maximum fault level may include contributions from other generation embedded between the Point of Connection and the Supergrid. Consequently, the apparent impedance derived by the maximum fault level may be lower than the actual impedance. This will provide a worst-case scenario. The maximum fault level data at the point of connection is readily available and is therefore a reasonable place to start. If this conservative impedance estimate is too arduous more detailed work will be needed to obtain a better impedance estimate.

For Grid Forming Plant with a point of connection to the Supergrid, the technique described below is still appropriate however the equivalent impedance (described above) is removed.

## Positive Sequence Studies (PPS)

The simplified positive sequence network below will generally be accepted as satisfying the 'PPS' aspect of studies in Grid Code CP.A.3.5.

In this conservative and simplified case, the network beyond the point of connection is represented by, a controlled Thevenin source and equivalent impedance. The equivalent impedance is derived from the maximum fault level at the point of connection.

The type validation tests were based on benchmarking the Grid Forming Plant Unit at a node selected by the manufacturer. The impedance between the point of connection and the 'type validation node' must reflect the equivalent aggregated impedance of the Grid Forming Plant between the point of connection and the same node.

The remaining impedance is the impedance between the 'type validation node' and the point at which the model representation begins (model interface node). In some cases the type validation node and the model interface node will be the same point and this impedance will not be included.

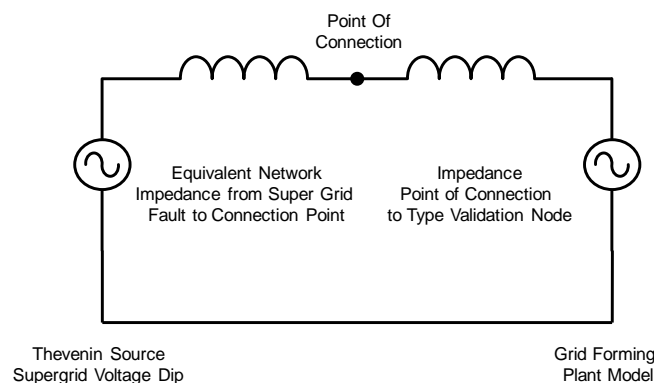

Figure I-1 – Simplified network diagram for PPS

This simplified network can be implemented in a power system analysis package of the Providers choice using the voltage dips specified in Studies 3.1 & 3.2. The results at node 'A' are then compared to the type validation results to confirm ride through capability. The validity of the Grid Forming Plant model's contribution to the retained voltage also needs to be confirmed by ensuring that the contribution at 'B' is comparable with the results obtained during the type validation tests for the equivalent profile at 'A'.

## Negative Sequence Studies (NPS)

Similarly, the simplified negative sequence network below will generally be accepted as satisfying the 'NPS' aspect of Grid Code CP.A.3.5.

The negative sequence network is identical to the positive sequence network except that the Grid Forming Plant model and the impedance between the 'type validation node' and the model interface node are replaced with an equivalent negative sequence estimate obtained during the type validation tests.

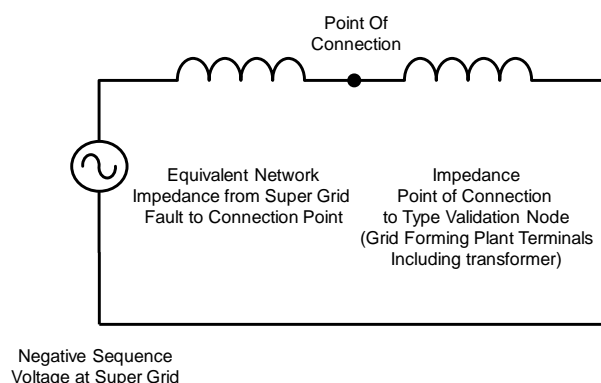

Figure I-2 – Simplified network diagram for NPS

Solving the load flow for the above network using a voltage source corresponding to the negative sequence magnitude at the Supergrid results in a negative sequence voltage estimate at the type validation node ('A'). The results at node 'A' are then compared to the type validation results to confirm ride through capability.

In the event that the type validation tests show that there is no single equivalent negative sequence impedance then the type validation will record a family of impedances equating to retained negative sequence voltages at the type validation node. The negative sequence studies will then be run iteratively, and the impedance value updated until reasonable convergence is obtained.

## Equivalent Sequence Impedances for Calculating Unbalanced Short-Circuit Current

The Provider is required to provide the fault infeed from the Grid Forming Plant Module into the public transmission/distribution network. The data should be submitted in Grid Code DRC Schedule 14.

The following transmission/distribution system equivalent sequence impedances may be used by Providers in calculating the unbalanced short-circuit current contribution from the Grid Forming Plant Module at the entry point unless site specific values have been given. The Provider should confirm the system equivalent sequence impedances that have been used in the submission.

**33kV:**             $Z1 = Z2 = 14.580\angle 88.091^\circ$  % on a 100 MVA base  
 $Z0 = 159.1\angle 26.565^\circ$  % on a 100 MVA base

These impedances are based on the following assumptions:

- The PPS and NPS X/R ratio of the 33kV system is equal to 30
- The ZPS X/R ratio of the 33kV system is equal to 0.5
- The short-circuit current contribution from the 33kV distribution system for a 3-phase fault at the entry point is approximately 12kA
- The short-circuit current contribution from the 33kV distribution system for a 1-phase fault at the entry point is approximately 3kA

**132kV:**             $Z1 = Z2 = 3.650\angle 84.289^\circ$  % on a 100 MVA base  
 $Z0 = 1.460\angle 84.289^\circ$  % on a 100 MVA base

These impedances are based on the following assumptions:

- The PPS, NPS and ZPS X/R ratio of the transmission/distribution system is 10.
- The short-circuit current contribution from the transmission/distribution system for a 3-phase fault at the entry point is approximately 12kA
- The short-circuit current contribution from the transmission/distribution system for a 1-phase fault at the entry point is approximately 15kA

**275kV:**             $Z1 = Z2 = 0.700\angle 85.236^\circ$  % on a 100 MVA base  
 $Z0 = 1.120\angle 85.236^\circ$  % on a 100 MVA base

These impedances are based on the following assumptions:

- The PPS, NPS and ZPS X/R ratio of the 275kV system is equal to 12
- The short-circuit current contribution from the 275kV transmission system for a 3-phase fault at the entry point is approximately 30kA



- The short-circuit current contribution from the 275kV transmission system for a 1-phase fault at the entry point is approximately 25kA

**400kV:**  $Z1 = Z2 = 0.361 \angle 85.914^\circ$  % on a 100 MVA base

$Z0 = 0.516 \angle 85.914^\circ$  % on a 100 MVA base

These impedances are based on the following assumptions:

- The PPS, NPS and ZPS X/R ratio of the 400kV system is equal to 14
- The short-circuit current contribution from the 400kV transmission system for a 3-phase fault at the entry point is approximately 40kA
- The short-circuit current contribution from the 400kV transmission system for a 1-phase fault at the entry point is approximately 35kA

# Appendix J Compliance testing requirements

## Ongoing Monitoring

Ongoing monitoring requirements for Stability Compensation Service are stated in Clause 7 - Monitoring of the Service Agreement.

There may be additional monitoring requirements as part of a Bilateral Connection Agreement or participation in other Ancillary Services. As part of the Compliance Process, in addition to simulation and testing, there is also a requirement for online monitoring to take place.

The signals which shall be provided for onsite monitoring and compliance testing and to have the following resolution, unless otherwise agreed:

- 1 Hz for reactive range tests
- 10 Hz for System Frequency control tests
- 100 Hz for voltage control tests
- 1 kHz for Grid Forming Plant signals including fast fault current measurements, Active RoCoF Response Power, Active Phase Jump Power, Active Damping Power measurements
- 100Hz for the other Grid Forming Plant tests carried out in accordance with the following:
  - To accurately monitor the performance of a Grid Forming Plant, each Grid Forming Plant shall be equipped with a facility to accurately record the following parameters at a rate of 10ms.
    - System Frequency using a nominated algorithm as defined by NGESO
    - The RoCoF rate using a nominated algorithm as defined by NGESO based on a 500ms rolling average
    - A technique for recording the Grid Phase Jump Angle by using either a nominated algorithm as defined by NGESO or an algorithm that records the time period of each half cycle with a time resolution of 10 microseconds. For a 50Hz System, a 1-degree phase jump is a time period change of 55.6 microseconds.

## NGESO Data Recording Equipment

Where NGESO is witnessing tests, further details of NGESO equipment can be found in the appropriate Grid Code Connections Compliance guidance notes.

## Interim Operation (if applicable)

As there may be a considerable period between commissioning the first and last power from the Grid Forming Plant when in modular format, the Grid Code European Compliance Processes (ECP) provides two capacity restrictions during commissioning. These restrictions are managed by items included in the Interim Operation Notification (ION). The Provider is required to complete basic voltage control and frequency response tests and have the results approved by NGESO to have the capacity restrictions released.

## Test Notification to Control Room

The Provider is responsible for notifying the 'NGESO Control Centre' of any tests to be carried out on their Plant, which could have a material effect on the National Electricity Transmission System. The procedures for planning and co-ordinating all Plant testing with the 'NGESO Control Centre' is detailed in OC7.5 of the Grid Code (i.e. Procedure in Relation to Integral Equipment Tests). For further details relating to this procedure, refer to "Integral Equipment Tests - Guidance Notes" which can be found on NGESO's Internet site in Grid Code, Associated Documents.

The Provider should be aware that this interface with NGESO transmission planning will normally be available in weekday working hours only. As best practice, the Generator should advise the 'NGESO Control Centre' and in Scotland the relevant Transmission Owner, or Distribution Network Operator (if embedded) of the times and nature of the proposed tests at the earliest stage possible and where possible with 28 days' notice. If there is insufficient notice or information provided by the Provider, then the proposed testing may not be allowed to proceed.

## Compliance Testing of Grid Forming Technologies Comprised of Identical Modules

Where the Grid Forming Plant is comprised of two or more identical units, NGESO may allow reduced compliance testing on the remaining unit(s) provided that the first unit successfully completed the full testing.

# Appendix K Test Signal Schedule and Log-sheet

## Compliance Test Signals

The Grid Code requires that several signals are provided from compliance tests to NGESO to allow assessment of the compliance. The list of these signals is set out in ECP.A.4 for EU Code Users.

Where these signals are provided to NGESO following witness tests or instead of witnessing there is a need to provide them in a consistent electronic format with a time stamp in a numerical format which can be interpreted in Excel. To facilitate efficient analysis the test results should include signals requested by NGESO set out in the columns order as indicated in the tables in this Appendix.

- Signals for non-witness tests should be provided in Excel format and in the order and format presented in next section of this Appendix unless otherwise agreed, in advance, with NGESO.
- Where any additional test signals to those indicated in the tables are presented these should only be added with the agreement of NGESO and be entered within the files as additional columns to the right of the required signals.
- Where a signal cannot be provided, and this has been agreed with NGESO in advance of the tests, a blank column should be retained within the data.
- Where additional signals are included, or the signals are presented but not in the arrangement detailed above the data may be rejected and the customer will be asked to resubmit the data in the agreed format.

In addition to the above, the following signals will need to be provided for GBGF-I and hybrid Plant to The Company in Real Time and recorded downloadable format.

- Rate of Change of System Frequency – this could be calculation based on frequency measurements
- RMS voltage angle measurements or calculations based on 3 phase voltage angle measurements
  - Internal voltage angle of the GBGF-I Plant
  - Voltage angle at the grid connection point
  - Load Angle
- Active RoCoF Response Power – calculated from active power values
- Protection signals as relevant
- Any other injected signals applied to the GBGF-I Plant

FAT results and additional signals for GBGF-I Plant to demonstrate Active RoCoF Response Power, Active Phase Jump Power, Active Damping Power in Appendices D-F compliance requirements will be acceptable to NGESO.

## Compliance Test Signal Schedules

For tests in Appendices A, B, C and G, all test signal schedule can be found within the relevant Grid Code Connections Compliance guidance notes which must be provided: <https://www.nationalgrideso.com/industry-information/connections/compliance-process>

For tests in Appendices D, E and F for GBGF-I Plant, additional signals stated in the previous section of this Appendix must be included as shown in the following table.

For GBGF-I Plant tests in Appendices D -F, information must be provided in the format below.

Any additional signals required to demonstrate the stated criteria in Appendices D – F should be added as additional columns in the table below.

Table Appendix D, E, F for GBGF-I								
	Col 1	Col 2	Col 3	Col 4	Col 5	Col 6	Col 7	Col 8
1	Time (10ms)	Active Power	Reactive Power	Connection Voltage	Speed /Frequency	Freq Injection #	Logic / Test Start #	Grid Forming Plant Output #
	Col 9	Col 10	Col 11	Col 12	Col 13	Col 14	Col 15	Col 16
1	Power Available #	Voltage Setpoint	Rate of Change of System Frequency	Internal voltage angle of the GBGF-I Plant	Voltage angle at the grid connection point	Load Angle	Active RoCoF Response Power	Input signal 1 (add signal name and units)
2	State of Charge #							
	Col 17	Col 18	Col 19	Col 20	Col 21	Col 22	Col 23	Col 24
1	Input signal 2 (add signal name and units)	Input signal 3 (add signal name and units)	Protection signal 1 (add signal name and units)	Protection signal 2 (add signal name and units)	Protection signal 3 (add signal name and units)			
# Columns may be left blank but the column must still be included in the files Additional signals relevant to the GBGF-I Plant may be added in column 22 and onwards.								

## Compliance Test Log-sheet

Where test results are completed without any NGESO presence but are relied upon as evidence of the compliance they should be accompanied by a log-sheet. This sheet should be legible, in English and detail the items set out below. Some of the items listed may not be relevant to all technology type addressed by guidance notes.

- Time and Date of test
- Name of Grid Forming Plant Station and module if applicable.
- Name of Test engineer(s) and company name.
- Name of Customer(s) representative and company name.
- Type of testing being undertake e.g. Voltage Control.
- Ambient Conditions e.g. Temperature, pressure, wind speed, wind direction.
- Controller settings, e.g. Voltage slope, Frequency droop, Voltage setpoint.

For each test the following items should be recorded as relevant to the type of test being undertaken. Where there is uncertainty on the information to be recorded this should be discussed with NGESO in advance of the test.

Refer to the [Grid Code Compliance Guidance notes](#) for details on specific tests.

### Example: Voltage Control Tests

- Start time of each test step.
- Active Power (if applicable).
- Reactive Power.
- Connection Voltage.
- Voltage Control Setpoint, if applicable or changed.
- Voltage Control Slope, if applicable or changed.
- Terminal Voltage if applicable.
- Generator tap position or Grid Transformer tap position, as applicable.
- Number of Grid Forming Plant Units in service in each Module, if applicable.

# Appendix L List of tests and technical specification clauses

<b>Service Agreement Schedule E Clause</b>	<b>Relevant tests are provided below for guidance</b>
<b>Part A- 1.1.1</b>	Simulation Test 3, 5, 6, 7 Appendices A, B, G
<b>Part A – 1.1.2</b>	Simulation Test 1 Appendix C Appendices D-E
<b>Part A – 1.2.1</b>	All tests
<b>Part A – 1.2.2</b>	All tests Additional activities as part of a Bilateral Connection Agreement
<b>Part A – 1.2.3</b>	Simulation Test 3, 4, 5, 6, 7 Appendix G
<b>Part A – 1.2.4</b>	All simulation tests Appendices A – G
<b>Part A – 1.2.5</b>	Simulation Test 1, 2, 7, 10 Appendix D
<b>Part A – 1.2.6</b>	Simulation Test 1, 2, 7, 10 Appendix D
<b>Part A – 1.2.7</b>	All tests
<b>Part A – 1.2.8</b>	Simulation Test 3, 5, 6, 7 Appendix G
<b>Part A – 1.2.9</b>	Simulation Test 4
<b>Part A – 1.2.10</b>	All tests
<b>Part A – 1.2.11</b>	All tests
<b>Part A – 1.2.12</b>	All tests
<b>Part A – 1.2.13</b>	Simulation Test 1, 7 Appendix D
<b>Part A – 1.2.14</b>	Simulation Test 3, 5, 6, 7 Appendix G
<b>Part A – 1.2.15</b>	Appendix G
<b>Part A – 1.2.16</b>	Simulation Test 1, 7 Appendices D
<b>Part A – 1.2.17</b>	Simulation Test 1, 7 Appendix D
<b>Part A – 1.2.18</b>	Simulation Test 4
<b>Part A – 1.2.19</b>	Simulation Test 5
<b>Part A – 1.2.20 – 1.2.21</b>	Simulation Test 8, 9 Appendix F
<b>Part B</b>	Appendix A Appendix B



# Appendix M Contacting NGENSO

There are several different departments within NGENSO that will be involved with this service. The initial point of contact for NGENSO will be your allocated Service Contract Manager.

For any correspondence relating to testing on the system following the Grid Code the IET process should be followed with notifications made to the '.Box.Tranreq' email address for England and Wales connections and '.Box.TR.Scotland' for all connections in Scotland.

## **Contact Address:**

National Grid ESO, Faraday House, Warwick Technology Park, Gallows Hill, Warwick CV34 6DA

Faraday House, Warwick Technology Park,  
Gallows Hill, Warwick, CV346DA

[nationalgrideso.com](http://nationalgrideso.com)

national**grid**ESO