

## Draft Final Modification Report

**GC0137:**

## Minimum Specification Required for Provision of GB Grid Forming (GBGF) Capability (formerly Virtual Synchronous Machine/VSM Capability)

**Overview:** This modification proposes to add a non-mandatory technical specification to the Grid Code, relating to GB Grid Forming Capability (which was formerly referred to as a Virtual Synchronous Machine (“VSM”) capability. The detail pertaining to its creation may be found in Section 3 “Why Change?” but the high-level overview is that the specification will enable parties to offer an additional grid stability service. This will be fundamental to ensuring future Grid Stability, facilitating the target of zero carbon System operation by 2025 and providing the opportunity to take part in a commercial market or become part of other market arrangements such as the stability pathfinder work and/or dynamic containment.

## Modification process &amp; timetable

1

**Proposal Form**

10 December 2019

2

**Workgroup Consultation**

31 March 2021 - 30 April 2021

3

**Workgroup Report**

29 July 2021

4

**Code Administrator Consultation**

03 September 2021 – 04 October 2021

5

**Draft Modification Report**

19 October 2021

6

**Final Modification Report**

09 November 2021

7

**Implementation**

TBC

**Have 5 minutes?** Read our [Executive summary](#)

**Have 20 minutes?** Read the full [Final Modification Report](#)

**Have 30 minutes?** Read the full Final Modification Report and Annexes.

**Status summary:** This report will be submitted to the Authority for them to decide whether this change should happen.

**Panel recommendation:** **The Panel recommendation vote to be held on 27 October 2021.**

**This modification is expected to have a: High impact** - National Grid ESO – successful implementation of this specification and the subsequent launch of a commercial market would result in the provision of additional stability services. The primary aim being the ability to run the entire electricity transmission system on low carbon generation sources that include nuclear power, whilst at the same time ensuring a safe, secure and economic system. Consequently, the likelihood would be a net-positive in terms of the ESO’s ability to balance the GB electrical grid and respond to unplanned interruptions to electricity supply. **Medium impact** - Generators Interconnectors and other “Providers” (in this context “Providers” include those parties which provide “Dynamic Compensation Equipment” or “Smart Loads”) – successful implementation of this specification and the subsequent launch of a commercial market would provide

Generators, Interconnectors and other “Providers” with a potential new revenue stream. In order to take part in such a market, Generators, Interconnectors and other “Providers” may wish to amend/modify their plant, or potentially amend or incorporate new software to enable them to satisfy the requirements of the specification if they wished to enter this future market. The purpose of this modification is simply to develop the minimum Grid Code technical specification for a GB Grid Forming Capability. The market arrangements will then be addressed as a separate piece of work once the specification and technical requirements are in place.

**Modification drivers:** Transmission System Need, New Generation, Interconnectors, Reactive Compensation Equipment Technologies and Smart Loads.

**Governance route** This modification has been assessed by a Workgroup and Ofgem will make the decision on whether it should be implemented.

<b>Who can I talk to about the change?</b>	<p><b>Proposer:</b> Antony Johnson, National Grid ESO <a href="mailto:Antony.Johnson@nationalgrideso.com">Antony.Johnson@nationalgrideso.com</a> <b>Phone:</b> 07966 734856</p>	<p><b>Code Administrator Chair:</b> Kavita Patel <a href="mailto:Kavita.patel@nationalgrideso.com">Kavita.patel@nationalgrideso.com</a> <b>Phone:</b> 07583 030425</p>
--	---	--

DRAFT

**Contents**

<b>Contents</b> .....	<b>3</b>
<b>Executive summary</b> .....	<b>4</b>
<b>What is the issue?</b> .....	<b>9</b>
<b>Background</b> .....	9
<b>Why change?</b> .....	10
<b>What is the solution?</b> .....	<b>16</b>
<b>Workgroup considerations</b> .....	<b>32</b>
<b>What is the impact of this change?</b> .....	<b>45</b>
<b>Proposer’s assessment against Code Objectives</b> .....	45
Workgroup vote .....	45
Code Administrator Consultation summary .....	46
Panel recommendation vote.....	47
Panel conclusion.....	49
<b>When will this change take place?</b> .....	<b>50</b>
Implementation date .....	50
Date decision required by .....	50
Implementation approach .....	50
<b>Interactions</b> .....	<b>50</b>
<b>Acronyms, key terms and reference material</b> .....	<b>51</b>
<b>Reference material</b> .....	51
<b>Annexes</b> .....	<b>54</b>

## Executive summary

This document draws on an extensive volume of material that has been in development for several years. The main body of the document itself simply covers the work of the GC0137 workgroup which includes an outline of the basic issue, the need for change, the proposal and a summary of the Grid Code meetings. The more detailed technical detail is therefore included in the Reference Section of this document or as additional Annexes.

### What is the issue?

In the Proposer's view electricity is the live blood of the modern economy. The principle method by which electricity has been supplied to the Grid has been through the use of the Synchronous Generator, a device which converts rotational kinetic energy into electrical energy. Its design has worked well and has been used for many decades in thermal and hydroelectric power stations which are generally based on a controllable primary energy source. In addition, the design and operational behaviour of Synchronous Generators together with their dominance in Grid supply applications has a fundamental influence upon the dynamical characteristics of the Electricity Transmission and Distribution System.

The overall reliability of supply for the National Electricity Transmission System during 2019-20 was 99.999967% [1]. These high levels of reliability have been achieved through decades of research, development, design, plant standards and industrial experience.

In GB, the technical requirements for User's plant (such as Generation, HVDC Systems and Demand) connected to the Transmission System are contained in the Grid Code [2] which also refers to numerous industry standards. In addition, the minimum requirements for the design and operation of the Transmission System are contained in the Security and Quality of Supply Standards (SQSS) [3] with the corresponding security of supply standard for distribution systems being contained in Engineering Recommendation P2/7 [4]. There are also obligations placed on Transmission Licensees under the System Operator Transmission Owner Code (STC) [5] and obligations on User's connecting to the Distribution System in the Distribution Code [6]. All of these codes and their associated documents have been developed to contribute to the overall reliability and robustness of the Transmission System, yet they also take into account the capability and characteristics of the component plant elements which make up the System.

In the 1990's, increasing concerns were being raised over environmental and climate change concerns. The electricity industry was seen as a potential solution to this problem where new technologies such as wind power could help cut the significant volumes of carbon dioxide emissions particularly from coal and oil fired power stations.

During the last 20 years, this trend has accelerated, additional environmental legislation has been introduced and future targets for net zero have been established. This drive has resulted in a substantial growth of new technologies such as wind power, solar power and storage so much so that there have been several weeks of zero coal operation. Within the ESO there is also a target to achieve zero carbon Transmission System operation by 2025 (i.e. the ability to operate the Transmission System in a safe, secure and economic manner using only low carbon generation sources). In other words, the ability to operate the Transmission System using low carbon sources but at the same level of robustness, reliability and cost we have grown accustomed to.

Unlike thermal plant however, renewable generation technologies such as wind, solar and storage do not rely on the synchronous generator but other technologies such as induction generators and power electronic converters. As noted above, the behaviour and operational characteristics of the Transmission System are largely a function of the type of generation and demand connected to it. As the volume of renewable plant increases, this continues to displace the more traditional carbon based thermal plant which in turn reduces the volume of synchronous generation connected to the System. Whilst numerous changes have been introduced to the industry codes over the last 15 years or so to facilitate ever growing volumes of renewable plant [7] and [8] and to maintain security of supply, we are now getting to the point where the decline in synchronous plant is resulting in significant changes to the dynamics and behaviour of the transmission system, so much so that the maintenance of stability and recovery following a credible fault becomes an increasing challenge. The effect of changing demand and load is also having a notable effect on the characteristics of the System. For example, the increase use of variable speed drives, LED lighting and an increasing dominance in the use of converter based power supplies is resulting in a reduction in Synchronous Loads and an increase in Constant Power Loads.

As far back as 2012, research was undertaken [9] which showed that once the volume of non-synchronous generation exceeded about 65% of the total generation capacity running, the Transmission System could not be secured against certain credible fault criteria under the SQSS. The cause of this stems from the fact that the more modern converter based plant, upon which many of the renewable technologies are so dependent, do not exhibit the same characteristics as their synchronous counterparts. It is still possible for the converter based plant to replace synchronous plant on a MW for MW basis, but it is their behaviour under fault conditions and the impact on the wider system which is more problematical.

Under a faulted condition, Synchronous Generators have the following key features: -

- They can supply inertia to the System (the ability to limit the rate of frequency rise or fall following the loss of a generator or load)
- They can instantaneously inject active power (MW) into the system as a result of a Grid Fault as a result of the corresponding phase change
- They can supply high fault currents (2 – 4 times) the continuous rating of the plant at the Grid Connection point. This is essential for the maintenance of post fault voltage profiles which is essential for adequate fault ride through performance
- They operate in synchronism, with each other, contribute to synchronising torque and help in limiting vector shift.
- They can supply damping power (MW) to the system to contribute to damping

All of these features are described in more detail within this report, its Annexes and References. Unfortunately, none of these features, apart from the last item in the list, are replicated in the current generation of converter based designs and it is the deficit of these features, which if left unchecked, could result in either significantly higher operating costs (at best) or insecure system operation and potential blackout (at worst). A summary of potential solutions to this issue are shown in Figure 1.0 based on initial studies and Figure 13 also gives the latest data on some of these possible solutions including the enhancements to the VSM0H solution.

Solution	Estimated Cost	RoCoF	Sync Torque/Power (Voltage Stability/Ref)	Prevent voltage collapse	Prevent Sub-Synch Osc/SG Compatible	Hi.Freq. Stability	RMS Modelling	Fault Level	Post Fault Over Volts	Harmonics & Imbalance	System Level Maturity	Notes
Constrain Asynchronous Generation	High	I	Yes	Yes	Yes	Yes	Yes	Yes	Yes	Yes	Proven	These technologies are or have the potential to be Grid Forming
Synchronous Compensation	High	I	Yes	Yes	Yes	Yes	Yes	Yes	Yes	Yes	Proven	
VSM	Medium	Yes	Yes	Yes	Yes	Yes	Yes	Yes	Yes	P	Modelled	
VSMOH	Low	No	Yes	Yes	Yes	Yes	Yes	Yes	Yes	P	Modelled	
Synthetic Inertia	Medium	Yes	No	No	P	No	No	No	No	No	Modelled	Has the potential to contribute but relies on above solutions
Other NG Projects	Low	Yes	P	Yes	No	No	No	P	P	No	Theoretical	

**Key**

Doesn't	
No	Resolve Issue
P	Potential
I	Improves
Yes	Resolves Issue

Figure 1.0

In the Proposer’s view two traditional approaches can be used to address this problem. The first is to constrain on synchronous plant and the second would be to use Synchronous Compensators. This would be expensive and may also be dependent upon the use of carbon based thermal plant which would make it difficult if not impossible to achieve the zero carbon operation by 2025 target and indeed the “Net Zero Ambition”. Notwithstanding this, there is no guarantee that there will be an abundance of synchronous plant available in the longer term future. The second approach would be to install synchronous compensators. These are effectively rotating electrical synchronous machines which rotate at the same speed as the grid frequency. They are not driven by a turbine and hence do not produce a continuous Active Power (MW) output, however by varying the magnetic field strength, they can contribute to reactive power control and hence Grid voltage control. The important point here is that under a faulted Grid condition, they exhibit similar characteristics to that of a synchronous generator (e.g. contribution to inertia, high fault currents, synchronising torque etc). This capability can further be enhanced by directly connected flywheels.

In the Proposer’s view a further solution which is the subject of this GC0137 Grid Code modification, is through the introduction of GB Grid Forming (formerly referred to as a Virtual Synchronous Machine). The aim here is to enhance the capability of conventional power electronic converter plant so it exhibits similar characteristics to that of synchronous plant. This technique has been available for some time, having been used in a number of other applications such as the marine industry but has not been widely utilised in utility Grid applications as there has been no real need based on the existing current background of synchronous generation. The technique can also be used for Smart Loads but also smaller scale storage systems such as electric vehicles. In particular, electric vehicles which have an import and export capability (V2G - Vehicle to Grid) provide a good fit for providing Grid Forming in so far that whilst the individual contribution may be modest, the cumulative effect on the Total System could be very significant whilst providing opportunities for Aggregators and Suppliers.

Grid Forming together with the other options mentioned can provide another solution to addressing the Grid Stability issue. The introduction of this additional technique is seen as a key enabler to achieving zero carbon operation by 2025 as well as helping to reduce cost.

The ESO recognise that the natural capabilities traditionally provided by synchronous generation in contributing to stability will no longer be available and in future will have to be paid for. The ESO are therefore running a number of initiatives including the Stability Pathfinder work [10]. The aim of this GC0137 work will complement the stability pathfinder work and will aim to develop a minimum GB Non-Mandatory Grid Forming specification into the Grid Code. This will then be used as the foundation for a future short stability market which will be undertaken as a separate piece of work and would sit alongside the Stability Pathfinder work and other Balancing Services such as Dynamic Containment.

### What is the solution and when will it come into effect?

Proposer's solution: In the Proposer's view this modification seeks to implement a minimum non-mandatory specification within the Grid Code for parties wishing to offer a Grid Forming capability – in that the affected plant provides the same type of performance from that traditionally associated with synchronous generators. Such plant would support the Grid during unplanned events/faults particularly in respect of: -

- i) limiting the rate of change of system frequency following the loss of a generating unit or load;
- ii) injecting instantaneous active power into the system at the time of a fault as a result of the corresponding phase change;
- iii) injecting instantaneous Fast Fault Current into the system at the time of a fault as a result of the corresponding voltage change;
- iv) Contributing to damping power;
- v) Limiting vector shift;
- vi) Contributing to synchronising torque;
- vii) Contributing to the maintenance of an improved voltage profile during a fault – a fundamental pre-requisite for fault ride through.

In the Proposer's view many of these features were provided as a natural capability of synchronous generators and therefore there was no need to explicitly define these technical performance requirements. Unfortunately, these characteristics are not an inherent feature of current power electronic converter based designs which use a Phase Locked Loop (PLL) as one of their primary controls that is used to stop the output power of current power electronic converter responding to changes in the phase angle of the AC grid.

In the Proposer's view the aim of this work is therefore to define a minimum non-mandatory specification in the Grid Code which would provide a framework for a future stability market. The market elements are a separate piece of work which will be addressed outside of this modification but would be designed to be flexible and transparent and open to any party with any technology so long as that technology is capable of meeting the requirements of the specification. Even if a developer owns and operates a plant with the required capability there is no requirement for them to enter the market if they do not wish to and equally there would be no requirement for older non-compliant plant to meet these requirements.

In the Proposer's view obtaining the inherent benefits of synchronous generating plant in an increasingly converter-based world is fundamental to achieving zero carbon operation by 2025. This approach together with other market initiatives such as the stability

pathfinder work, dynamic containment and other stacked Balancing Services is seen as the best method of securing a low carbon system in the most economical way.

New sections will be added to the Grid Code outlining the minimum Grid Forming specification. This will be open to all technologies be the new converter based plant, novel technologies, Smart Loads, Storage Systems which could even include large scale V2G schemes or even traditional synchronous generating plant which already have the capability to meet the proposed specification.

The proposed legal text to support this modification is included in Annex 19 of this document.

**Implementation date** It is envisaged that subject to approval by The Authority, the specification would be implemented within Grid Code during Q4 2021.

**Panel recommendation/determination:** The Panel has recommended **unanimously/by majority** that the Proposer's solution **should / should not be implemented**

### What is the impact if this change is made?

In the Proposer's view whilst subsequent market arrangements may affect the wider industry and commercial arrangements, this proposal relates only to the creation and implementation of the minimum specification itself and therefore the only change envisaged at present relates to the Grid Code.

### Interactions

Subject to the commentary in the section immediately above, it is understood that there should be no impact on any other codes.



## What is the issue?

### **Background**

In the Proposer's view electricity is the live blood of the modern economy. The roots of the electricity supply system date back to the Victorian period where local power stations fed local demand. Different system characteristics and regional variations eventually led to the need for significant industry change and standardisation which eventually resulted in the formation of the Central Electricity Board (CEB) in 1926. Whilst this had a substantial impact on the development of what was to become the National Grid, the principle method in which electricity is generated to the end consumer relied on a technology called the Synchronous Generator.

In the Proposer's view whilst there have been numerous developments to Synchronous Generators over the years, most notably in size (noting that in the 1920's a Synchronous Generator was in the region of 5MW, by the late 1960's and early 1970's this had grown to 660MW and today a single generating unit connecting to the GB Transmission System would be approaching somewhere in the region of 1700MW).

Apart from variations in size, the fundamental principle of a Synchronous Generator is based on magnetic field which rotates within a coil of wire which in turn generates an alternating voltage (EMF) whose electrical frequency is directly proportional to the speed of the rotating magnetic field or rotor. The term "Synchronous" comes from the fact that the Grid Frequency (nominally 50Hz (50 cycles per second) in GB) is therefore equivalent to the mechanical speed at which the generator rotor rotates which for a 2 pole machine would be 3000 revolutions per minute or 50 revolutions per second.

Synchronous Generators are ideal for the conversion of mechanical rotational energy into electrical energy. As a consequence, they find numerous applications where the fuel source is controllable and used to drive some form of turbine which in turn drives the synchronous generator. Synchronous generators are also ideal as their Active Power output is easy to regulate and Reactive Power output (a primary function used to regulate the voltage on the transmission system) can be adjusted through variation to their excitation system, in essence a method of adjusting the magnetic field strength of the Generator.

Against this background, the characteristics of synchronous generators have a very important impact on the behaviour and dynamics of the Transmission System which in turn led to the development of numerous standards resulting in the current high levels of reliability and security of supply.

By the 1990's, increasing concerns were being raised over environmental impact and climate change. This trend has continued, so much so that targets have now been set to achieve a landscape where carbon based generation is a thing of the past.

The increasing switch to renewable technologies over time has therefore resulted in the substantial displacement of conventional synchronous generating plant. As noted above, the characteristics of the transmission system are highly dependent upon the generation technologies connected to it. So much so that as the volume of synchronous plant falls away, the characteristics of the Transmission System starts to change. Putting this another way, it would be similar to comparing an electric vehicle and an internal combustion engine

vehicle. Both are designed as a mode of transport from one place to another, but they have very different characteristics and consideration needs to be given to what impact (if any) this could have on the road network.

The current Transmission Network is designed and operated to the requirements of the Security and Quality of Supply Standards (SQSS). Likewise, the Grid Code has evolved to define the design and operational requirements on User's Plant (e.g. Generation, HVDC Systems and Demand equipment) together with other standards and industry codes. These requirements which have been developed through many years of industrial experience and research which has enabled the GB Transmission System to become one of the most reliable in the world with a typical reliability of 99.999967% [1].

In the Proposer's view as converter based plant has started to displace synchronous generation, what has become increasingly apparent is the inherent features of synchronous plant which were a natural function of their physical operation – for example the contribution to system inertia, fault current infeed, contribution to fast fault current injection and the natural ability to operate in synchronism with each other is not a feature of converter based plant with the consequence that under certain operational conditions (particularly faults) the robustness and stability of the Transmission System can no longer be guaranteed against current standards of the SQSS [3].

In addition, the type of load connected to the System has also changed substantially which again has resulted in significant changes operational characteristics. The growth of LED lighting, solid state power supplies, variable speed drives and converter dominated appliances both at a retail and commercial level, not to mention changes in consumer habits has again resulted in significant changes, not least a reduction in Synchronous Loads and an increase in Constant Power Loads.

In the Proposer's view the purpose of this work therefore is to introduce non mandatory requirements into the Grid Code which will facilitate market arrangements for a wider short term stability market. This will run alongside existing market arrangements such as the stability pathfinder work and dynamic containment together with other Balancing Services with the aim to operate the system with 100% low carbon technologies. Having said that, whilst inertia, fault level and synchronising torque were all features which were provided free of charge, from the dominance of synchronous generation, these are now capabilities that will need to be paid for.

In the Proposer's view whilst these features will have to be paid for in future, it is believed that these can be most economically provided by a combination of different market arrangements.

### **Why change?**

The take up of renewable generation technologies over the last ten years has been significant and this trend will continue into the future. The recent Government Energy White Paper and 10 Point Plan [11] promotes the installation of 40GW of offshore wind by 2030 alone, aside from the other planned developments in renewable generation.

In recent years there has also been a significant drop in the volume of thermal plant (Coal and Gas Fired Powered Stations) using synchronous generators. By April 2017 there were operating days where coal fired power stations were not used to form part of the energy

mix (the first time since the Victorian era) and since then there have been increasing periods of time when coal has not been used. Based on the System Operability Framework [13] this trend will continue with falls in carbon based plant (most of which are based on synchronous generators) continuing to the point that in the future the remaining synchronous plant will either come from Nuclear or Hydro Power.

In the Proposer's view early signs on the impact of declining System inertia, synchronising power, and fault infeed etc have already started to be observed in several recent incidents. Transmission System faults have given rise to the loss of Embedded Generation even though there was no loss of directly connected generation. The Accelerated Loss of Mains Programme [13] has been putting measures in place to address this. The first measure has been to increase the settings used on Rate of Change of Frequency Relays which are used for detecting islanding conditions of Embedded Generation and the second has been to phase out the use of vector shift protection as a method of detecting islanding conditions. These measures provide an essential safety net to manage to the increasing volume of non-synchronous generation in the current climate, however in order to ensure the settings remain fit for purpose in the longer term future, there needs to be sufficient levels of system inertia, synchronising torque and fault infeed available from a number of sources.

As noted earlier in the Workgroup Report and provided through the references included in the "Reference Section" of this consultation paper, it *simply will not be possible to secure the Transmission System against the requirements of the SQSS [3] unless the characteristics traditionally provided for by synchronous generators are replaced by alternative means.*

In the Proposer's view this in part is already being addressed through the stability pathfinder work [10] and additional measures introduced through additional Balancing Services [14] such as Dynamic Containment. The challenge however is to achieve this in the most flexible and economic manner. It is also not clear that these measures alone will be sufficient and any additional tools available to manage this issue can only help in reduce the operating cost.

In the Proposer's view this modification is therefore being proposed to provide a Grid Code specification for a Grid Forming Capability which would form the basis of a future short term optional stability market. It will give certainty to developers of the requirements they would need to meet in a transparent way, and it would be consistent with the longer term stability pathfinder work. It would also enable providers to compete in other ESO Balancing Services.

The ESO are introducing this proposal as an additional key ingredient to achieve zero carbon operation of the Transmission System by 2025 and ensure the maintenance and security of supply. It is recognised that it is not the only stability initiative currently under development, but it is unique in providing the key foundation for a short term stability market. It is also recognised that as more tools become available to the industry in managing this issue the overall cost to the end consumer will be lower.

### **The Features of Synchronous Generators over Converter Based Plant**

This section of the report is to briefly cover the important benefits of synchronous generators compared to converter based plant at a high level as they form the basis of the solution. The more detailed aspects are covered in Annexes 3, 5, 8, 11 and particularly 18

of this document. It is also worth noting that this information has been presented to the workgroup.

As has been noted, a synchronous generator is one where the speed of rotation of the shaft is the same (or multiples thereof – depending on the number of poles) as the electrical system frequency of the Grid. The generator itself comprises an internal voltage source (which is an electromagnet rotating at synchronous speed) within a stator coil. The effect of this establishes a voltage at the terminals of the generating unit which is essentially equivalent to the EMF voltage (E) of the internal voltage source behind the reactance of the armature or stator winding.

The mechanical drive train of the generator in essence is magnetically coupled directly to the power system so the relative position of the rotor with respect to the equivalent position of the generated voltage is effectively the same but offset by the load angle. The load angle ( $\delta$ ) is effectively the relative angle between the position of the generator rotor (or rotating internal voltage source) and electrical system voltage as shown in Figure 2.0. Hence any change in the Grid will be seen by the generator and vice versa. Putting this another way, it would be like have two vehicles connected together via a bar acting like a very stiff spring. As one vehicle moves, the other follows it, both moving the same distance and at the same time – hence they are synchronised but there can be oscillations between the vehicles.

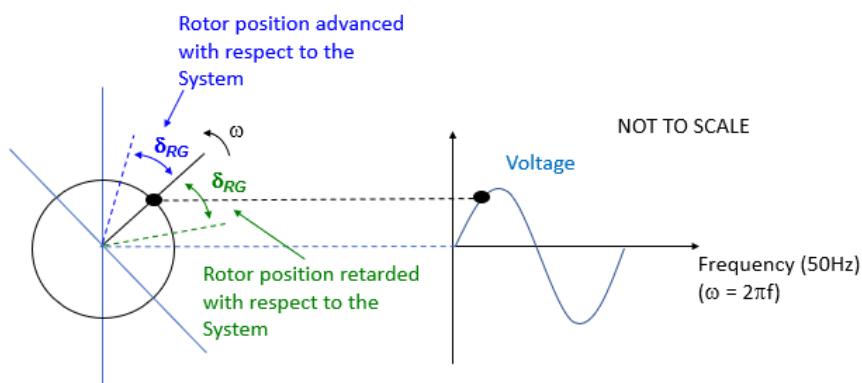

- Changing the load angle alters the power flow in the AC grid
- The load angle is the relative position between the position of the rotor and the point on the system voltage waveform

The power generated by a synchronous generator and the equivalent circuit is represented as shown in Figure 3.0.

$$P = \frac{EV}{X} \sin \delta_{RG}$$

Where: -

- P - is the Electrical Power Supplied by the Generator
- E – is the EMF Voltage of the rotor’s Internal Voltage Source
- V – is the terminal voltage (additional impedance would be seen at the at the Grid connection point through the inclusion of a Generator Transformer)

$X$  – is the Synchronous Reactance  
 $\delta_{RG}$  – Is the Load Angle between Rotor and Grid

Figure 3.0

In the Proposer's view this equation is very important as it represents the behaviour of a synchronous generator. It also demonstrates some very important features which are unique to synchronous machines. These can be categorised into three broad areas these being: -

- i) The equation in Figure 3.0 above shows that the power output is dependent upon the internal voltage ( $E$ ) and the terminal voltage ( $V$ ) both of which have a magnitude and phase. Hence, if there is a phase change at the connection point, (which can happen instantaneously) there will be an instantaneous change in power output and is referred to as "Phase Jump Power". In an AC Power System made up of Synchronous Generation, this contribution and benefit to the wider system is significant.
- ii) The second effect is that as noted in the above commentary, the rotor of the synchronous generator is magnetically coupled to the system. As the speed of a rotating body cannot change instantaneously (as a result of its inertia – this is effectively equivalent to a flywheel) any change in speed on the system (as a result of a load change or tripped generator) will be arrested by the stored kinetic energy in the rotating mass of the remaining generators and their respective drive trains which would include the rotor shaft and turbine shaft (a not insignificant spinning mass). This energy is slowly released to the power system and provides additional power into the system which helps arrest the Rate of Change of System Frequency (RoCoF). In summary it is this effect which prevents short term rapid system frequency changes. This is referred to as "Inertia Power". Inertia Power can be combined with the controlled output from a governor (a device used to supply more or less primary fuel to the turbine and hence drive the generator harder or less) to produce a controlled change in power output as system frequency changes.
- iii) The third benefit is that synchronous generators supply "Damping Power". Synchronous Generators are fitted with damper windings which effectively have no action when the generator is operating in steady state, however when there is a disturbance or change in rotor speed, a current flow in the damper windings which has the effect of contributing to braking or damping. This is again an important feature which delivers a further power contribution to the system under a disturbed condition. When combined with "Phase jump Power" plus "Inertia Power" this is referred to as "*Grid Forming Power*".

Figure 4.0 below shows the results of a generic study where a disturbance was applied which resulted a frequency fall as a result of a generating unit loss. The important point to note here is the instantaneous increase in power output of the remaining red, green and blue generators which is in essence the supplied "phase jump power". The area under the curve of the red, green and blue generators is effectively the power supplied from the stored energy in the rotating mass of the generators which amounts to the "Grid Forming Power".

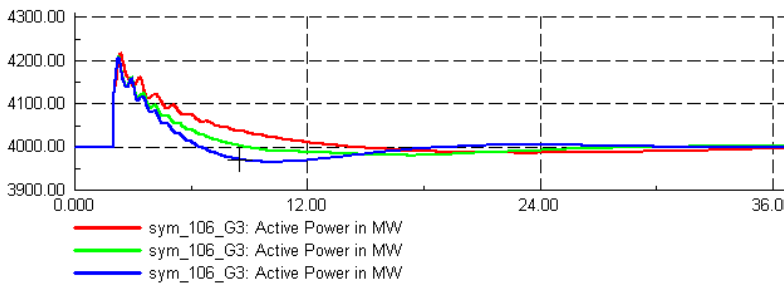

Figure 4.0

The full effects of “phase jump power”, “Inertia Power” and “Damping Power” are illustrated in Figure 5.0 which is taken from a real incident on the GB Transmission System.

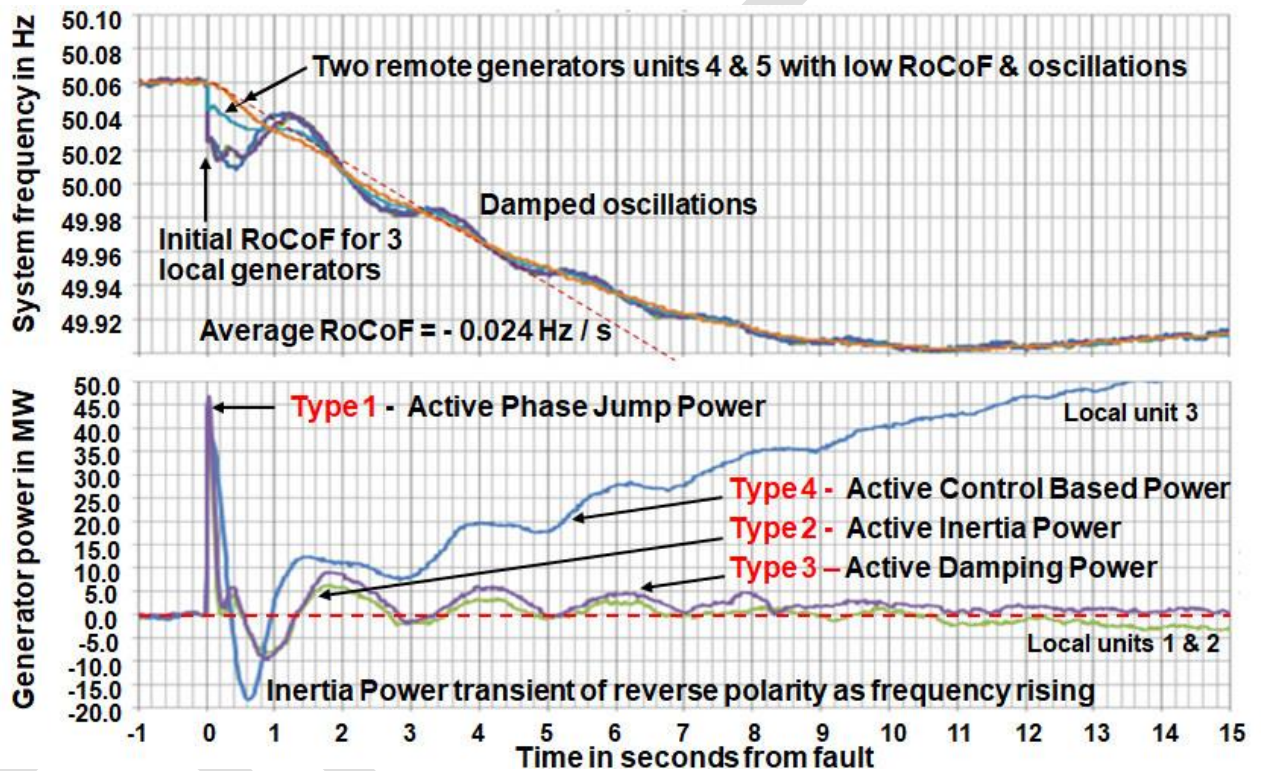

Figure 5.0 – Frequency and Power data for three 560MW Generating Units and two Remote Generating Units showing the effects of “Active Phase Jump Power”, “Active Inertia Power” and “Active Damping Power”. – This Figure is reproduced from Figure 8.2.1 in Annex 9.

In the Proposer’s view aside from these features, synchronous machines also have the capability to supply very high fault currents typically 2 - 4 times their steady state rating at the Grid connection point. This capability is important for fault detection and power system protection operation but the high currents that flow during the fault is important for maintaining a voltage profile across remaining parts of the system which is a fundamental prerequisite for fault ride through. This being essential for ensuring generation adjacent to a fault but connected to a healthy circuit is capable of withstanding disturbed conditions and hence prevents cascade tripping which would ultimately lead to a subsequent frequency collapse and a Blackout condition. As all synchronous plants operate in synchronism with each other their combined contribution in mitigating these effects has very significant system benefits.

In the Proposer's view unfortunately, these benefits are not replicated in converter based plant where the primary energy source is decoupled from the Power System. As such, the benefits of synchronous plant such as "Phase Jump Power", "Inertia Power", "Damping Power" and the contribution to Short Circuit Level are not replicated in the current design of converter based plants. A significant amount of work has been documented on this issue in the System Operability Framework [12] with Figure 6.0 below demonstrating the significant drop off in Short Circuit Level.

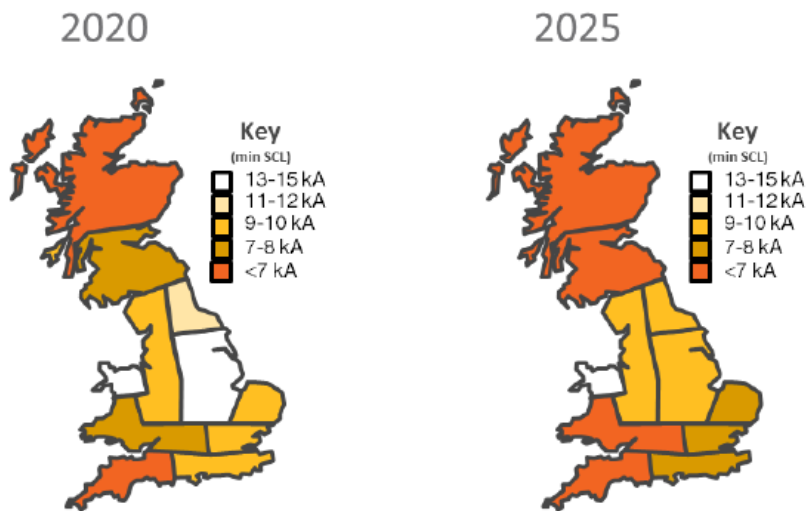

Figure 6.0 – Predicted decline in Regional Short Circuit Level in GB

These issues are covered in far more detail in Annex 18 of this document.

In the Proposer's view as a closing remark it is worth referring to the analogy used earlier. The synchronous generator can be compared to two vehicles coupled rigidly by a bar acting like a very stiff spring hinged at either end. As one vehicle moves the other follows it (moving by the same distance at exactly the same time) "phase jump power", on a hill, the vehicle following the front vehicle will benefit from engine braking as well as the braking system of the front vehicle "Inertia Power" and in the event the front vehicle goes over a road bump the second vehicle should provide some form of damping "Damping Power" due to the losses in the very stiff spring.

In the Proposer's view using the same analogy in the case of a converter-based plant it would be like having two vehicles tied together but, in this case, they are coupled using rope or chain. Hence as the first vehicle moves there will be a delay in the second vehicle moving until the slack and tension is taken up by the rope or chain. In the case of a hill there is the risk of the second vehicle running into the first vehicle. This illustrates the effect of a Phase Locked Loop (PLL) quite neatly, where the PLL will detect a change, makes some calculations and then applies appropriate control action. In the case of a vehicle going down a hill, the second vehicle detects slack in the rope or chain and then applies the brakes, but this action is a delayed control action and not in synchronism with the first vehicle. The last illustration is that where the first vehicle goes over a bump in the road a rope or chain will not contribute to damping due its flexible nature.

As noted above, in a Grid Following Converter, the Phase Locked Loop is used to measure the output of the plant, make some calculations and then provide a response. The response

of a PLL control loop is quite fast with the whole operation being completed in one cycle. Even so, a Grid Following Converter does not run in synchronism with the System and does not provide the same benefits as a Grid Forming Converter. Unfortunately Grid following inverters have a poor reputation due to PLL unlocking but it is important to note that a PLL used in the conventional way that changes the phase of the Internal Voltage Source (IVS) rapidly when a phase jump occurs in the Grid is not permitted. A PLL used for other purposes is however allowed in the control of a Grid Forming Converter.

Both Annex 11 and Annex 18 of this document provide a very good comparison between the performance of synchronous generation and converter-based Grid Forming Plant.

In the Proposer's view as a closing remark it is also worth referring to the change in load and the contribution that certain types of load can also make to Grid Forming. The reduction in synchronous load and increase in constant power loads will have a significant impact. Converter technology in loads and power factor correction make them look resistive at line frequency, but the impedance changes rapidly in the region below 10Hz with many loads becoming constant power for low frequency variations.

## What is the solution?

### **Proposer's solution:**

The proposer's solution is to introduce a non-mandatory specification into the Grid Code which will facilitate a short term future stability market. The aim is to ensure that any plant which offers this service is capable of providing the same characteristics inherently available from synchronous generation which are fundamental to the security and robustness of the transmission system.

### **Justification for Grid Forming / Virtual Synchronous Machine Technology**

In the Proposer's view the concept of Grid Forming is not new. It is a technique which was first considered in the mid 1990's finding applications in the marine industry. The ESO first considered the challenge of connecting large volumes of converter-based plant in 2013 finding that under certain operational conditions, only about 65% of total generation could comprise non- synchronous sources before significant issues arose under fault conditions [9].

Additional research was undertaken culminating in further papers published in 2016 [15]. These papers took the basic concept of adjusting the control architecture so that the converter behaves as voltage source behind an impedance in the same way as a synchronous generator. This has two substantial benefits – it i) enables the converter to instantaneously react to any change on the Grid system without any independent control action and ii) power electronic converters with this capability all operate in synchronism with each other in the same way as synchronous generation enabling wider system support during system disturbances. System studies included as part of the research papers [15] and [16] demonstrated a very substantial improvement in the results when the same studies as presented in 2013 [9] were rerun with the revised converter architecture.

In 2017 as part of the GC0100 work [8] it was initially proposed that Grid forming should be considered as an option for fast fault current injection. Again, this was based on detailed study work showing a substantial improvement in system performance when the improved converter architecture was used. At the time when this proposal was put forward,



workgroup members felt this approach was too ambitious and further work should be completed. On this basis in 2018, the ESO established a Virtual Synchronous Machine (VSM) Expert Group [17] whose main aim was to consider if VSM/Grid Forming was a viable technology worth progressing and to consider at a high level what the technical specification would look like.

In parallel with this work, the ESO published further papers in 2019 [18]. One of these papers included research undertaken in collaboration between the ESO and Nottingham University which trialled the successful demonstration of small scale VSM converter. In addition to this, Scottish Power Renewables in collaboration with Siemens Gamesa have also applied a Grid Forming architecture to the Dersaloch Wind Farm in Scotland [19], [25] and [26] with very promising results. In this case, Grid Forming technology has been applied to a full scale wind farm which was originally designed using classical converter technology and it has also demonstrated a Black Start capability [27].

References [18] and [19] clearly demonstrate the substantial research and development that has taken place into this subject and that Grid Forming/ Virtual Synchronous Machine technology is a viable solution in achieving a secure Grid System running on low carbon sources.

### **High Level Proposal**

As noted above, prior to the formation of this GC0137 Grid Code modification, substantial research and development work had already been undertaken into the concept of Grid Forming. The title was subsequently changed from Virtual Synchronous Machines or VSM to GB Grid Forming on the basis that VSM had been used in many different arena's and meant different things to different people. GB is also not unique in developing this technology as referred to in the "International Experience" section of this document but the GB Grid Forming proposals only relate to the GB Grid.

At the start of the work it was very clear that Grid Forming is a viable technology however any requirement specified within the Grid Code should take account of the following criteria.

- The requirements should not be mandatory and have the ability to form the basis of a wider commercial market.
- The specification should be transparent and enable any type of plant (e.g. synchronous plant, converter-based plant, compensation equipment, smart loads, storage (including V2G Systems) etc) which has the required capability to participate in a future market.
- The requirements should not mandate minimum overload ratings. This would present excessive costs to developers. The option should also enable developers to offer the service where their plant is de-loaded.
- The requirements would be consistent with the Stability Pathfinder work and equally enable developers the opportunity to offer additional Balancing Services (for example Dynamic Containment) provided this does not result in over declaration of capability.
- The specification has been developed to enable developers to declare the capability of their plant. This means that a full Grid Forming Capability could be offered which includes the VSM0H technology. VSM0H is a capability where the same capabilities as a synchronous machine are provided but the energy store (which would normally be reflected from the stored energy in the rotating mass

of the drive train) is substantially reduced. This technology does however provide substantial benefits in providing of synchronising torque, fault infeed, limiting vector shift and helping to maintain a stable voltage profile during disturbed conditions. Since Phase Jump Power is a very important element in stabilising the Grid, VSM0H is a very important technology.

- The ability for both new and existing providers to participate.

These features were considered following the feedback received from Stakeholders during the VSM Expert Group [17] and the dialogue received during the GC0137 workgroup itself. The specification itself comprises three main sections: -

- The technical performance requirements which define the plant capability.
- The plant data and modelling information. This is necessary to assess the capability of the plant and enable the model to be integrated into the ESO's software suite so its impact on the System can be established. It also includes the necessary data to ensure the plant does not cause any undue interactions on other User's plant or the wider Transmission System.
- Compliance which is to demonstrate that the plant as built is fully capable of meeting the requirements of the Grid Code specification. This would include both simulation and testing. The proposed legal drafting considers the potential need for type testing using an isolated test network.
- meeting the requirements of the Grid Code specification. This would include both simulation and testing. The proposed legal drafting considers the potential need for type testing using an isolated test network.

The following sections provide some more detail on each of these three main sections.

### **Technical Performance Requirements**

The Technical Performance requirements contain the following key requirements which are reflected in the legal drafting.

- New definitions in particular "Active ROCOF Response Power", "Active Phase Jump Power", "Active Damping Power", "Active Control Based Power", "Control Based Reactive Power", "Voltage Jump Reactive Power" and "Fast Fault Current Injection". These are key definitions which describe i) the plant and what is expected from it and ii) the type of "Power" output expected when subject to a disturbance. These definitions are described in more detail in Annex 18 and 19 but reflect similar performance requirements to that of a Synchronous Generator.

<p><b>Active Control Based Power</b></p>	<p>The <b>Active Power</b> output supplied by a <b>Grid Forming Plant</b> through controlled means (be it manual or automatic) of the positive phase sequence Root Mean Square <b>Active Power</b> produced at fundamental <b>System Frequency</b> by the control system of a <b>Grid Forming Unit</b>.</p> <p>For <b>GBGF-I</b>, this is equivalent to a <b>Synchronous Generating Unit</b> with a traditional governor coupled to its prime mover.</p> <p><b>Active Control Based Power</b> includes <b>Active Power</b> changes that results from a change to the <b>Grid Forming Plant Owners</b> available set points that have a 5 Hz limit on the bandwidth of the provided response.</p> <p><b>Active Control Based Power</b> also includes <b>Active Power</b> components produced by the normal operation of a <b>Grid Forming Plant</b> that comply with the <b>Engineering Recommendation P28</b> limits. These <b>Active Power</b> components do not have a 5 Hz limit on the bandwidth of the provided response.</p> <p><b>Active Control Based Power</b> does not include <b>Active Power</b> components proportional to <b>System Frequency</b>, slip or deviation that provide damping power to emulate the natural damping function provided by a real <b>Synchronous Generating Unit</b>.</p>
<p><b>Active Phase Jump Power</b></p>	<p>The transient injection or absorption of <b>Active Power</b> from a <b>Grid Forming Plant</b> to the <b>Total System</b> as a result of changes in the phase angle between the <b>Internal Voltage Source</b> of the <b>Grid Forming Plant</b> and the <b>Grid Entry Point</b> or <b>User System Entry Point</b>.</p> <p>In the event of a disturbance or fault on the <b>Total System</b>, a <b>Grid Forming Plant</b> will instantaneously (within 5ms) inject or absorb <b>Active Phase Jump Power</b> to the <b>Total System</b> as a result of the phase angle change.</p> <p>For <b>GBGF-I</b> as a minimum value this is up to the <b>Phase Jump Angle Limit Power</b>.</p> <p><b>Active Phase Jump Power</b> is an inherent capability of a <b>Grid Forming Plant</b> that starts to respond naturally, within less than 5 ms and can have frequency components of over 1000 Hz.</p>
<p><b>Active Damping Power</b></p>	<p>The <b>Active Power</b> naturally injected or absorbed by a <b>Grid Forming Plant</b> to reduce <b>Active Power</b> oscillations in the <b>Total System</b>.</p> <p>More specifically, <b>Active Damping Power</b> is the damped response of a <b>Grid Forming Plant</b> to an oscillation between the voltage at the <b>Grid Entry Point</b> or <b>User System Entry Point</b> and the voltage of the <b>Internal Voltage Source</b> of the <b>Grid Forming Plant</b>.</p> <p>For the avoidance of doubt, <b>Active Damping Power</b> is an inherent capability of a <b>Grid Forming Plant</b> that starts to respond naturally, within less than 5ms to low frequency oscillations in the <b>System Frequency</b>.</p>

<p><b>Active Inertia Power</b></p>	<p>The injection or absorption of <b>Active Power</b> by a <b>Grid Forming Plant</b> to or from the <b>Total System</b> during a <b>System Frequency</b> change.</p> <p>The transient injection or absorption of <b>Active Power</b> from a <b>Grid Forming Plant</b> to the <b>Total System</b> as a result of the <b>ROCOF</b> value at the <b>Grid Entry Point</b> or <b>User System Entry Point</b>. This requires a sufficient energy storage capacity of the <b>Grid Forming Plant</b> to meet the <b>Grid Forming Capability</b> requirements specified in ECC.6.3.19.</p> <p>For the avoidance of doubt, this includes the rotational inertial energy of the complete drive train of a <b>Synchronous Generating Unit</b>.</p> <p><b>Active Inertia Power</b> is an inherent capability of a <b>Grid Forming Plant</b> to respond naturally, within less than 5ms, to changes in the <b>System Frequency</b>.</p> <p>For the avoidance of doubt, the <b>Active Inertia Power</b> has a slower frequency response compared with <b>Active Phase Jump Power</b>.</p>
<p><b>Active ROCOF Response Power</b></p>	<p>The <b>Active Inertia Power</b> developed from a <b>Grid Forming Plant</b> plus the <b>Active Frequency Response Power</b> that can be supplied by a <b>Grid Forming Plant</b> when subject to a rate of change of the <b>System Frequency</b>.</p>
<p><b>Control Based Reactive Power</b></p>	<p>The <b>Reactive Power</b> supplied by a <b>Grid Forming Plant</b> through controlled means based on operator adjustment selectable setpoints (these may be manual or automatic).</p>
<p><b>GBGF Fast Fault Current Injection</b></p>	<p>The ability of a <b>Grid Forming Plant</b> to supply reactive current, that starts to be delivered into the <b>Total System</b> in less than 5ms when the voltage falls below 90% of its nominal value at the <b>Grid Entry Point</b> or <b>User System Entry Point</b>.</p>
<p><b>Grid Forming Active Power</b></p>	<p><b>Grid Forming Active Power</b> is the inherent <b>Active Power</b> produced by <b>Grid Forming Plant</b> that includes <b>Active Inertia Power</b> plus <b>Active Phase Jump Power</b> plus <b>Active Damping Power</b>.</p>

<p><b>Grid Forming Capability</b></p>	<p>Is (but not limited to) the capability a <b>Power Generating Module, HVDC Converter</b> (which could form part of an <b>HVDC System</b>), <b>Generating Unit, Power Park Module, DC Converter, OTSDUW Plant and Apparatus, Electricity Storage Module, Dynamic Reactive Compensation Equipment</b> or any <b>Plant and Apparatus</b> (including a smart load) whose supplied <b>Active Power</b> is directly proportional to the difference between the magnitude and phase of its <b>Internal Voltage Source</b> and the magnitude and phase of the voltage at the <b>Grid Entry Point</b> or <b>User System Entry Point</b> and the sine of the <b>Load Angle</b>. As a consequence, <b>Plant and Apparatus</b> which has a <b>Grid Forming Capability</b> has a frequency of rotation of the <b>Internal Voltage Source</b> which is the same as the <b>System Frequency</b> for normal operation, with only the <b>Load Angle</b> defining the relative position between the two. In the case of a <b>GBGF-I</b>, a <b>Grid Forming Unit</b> forming part of a <b>GBGF-I</b> shall be capable of sustaining a voltage at its terminals irrespective of the voltage at the <b>Grid Entry Point</b> or <b>User System Entry Point</b> for normal operating conditions.</p> <p>For <b>GBGF-I</b>, the control system, which determines the amplitude and phase of the <b>Internal Voltage Source</b>, shall have a response to the voltage and <b>System Frequency</b> at the <b>Grid Entry Point</b> or <b>User System Entry Point</b>) with a bandwidth that is less than a defined value as shown by the control system's <b>NFP Plot</b>. Exceptions to this requirement are only allowed during transients caused by <b>System</b> faults, voltage dips/surges and/or step or ramp changes in the phase angle which are large enough to cause damage to the <b>Grid Forming Plant</b> via excessive currents.</p>
<p><b>Voltage Jump Reactive Power</b></p>	<p>The transient <b>Reactive Power</b> injected or absorbed from a <b>Grid Forming Plant</b> to the <b>Total System</b> as a result of either a step or ramp change in the difference between the voltage magnitude and/or phase of the voltage of the <b>Internal Voltage Source</b> of the <b>Grid Forming Plant</b> and <b>Grid Entry Point</b> or <b>User System Entry Point</b>.</p> <p>In the event of a voltage magnitude and phase change at the <b>Grid Entry Point</b> or <b>User System Entry Point</b>, a <b>Grid Forming Plant</b> will instantaneously (within 5ms) supply <b>Voltage Jump Reactive Power</b> to the <b>Total System</b> as a result of the voltage magnitude change.</p>

- Grid Forming Plant has been subdivided into two parts GBGF-S (referring to a Grid Forming Plant derived from a Synchronous Generator) and GBGF-I

(referring to a Grid Forming Plant derived from a Power Electronic Converter). This has been necessary as some of the requirements between the two plant types are slightly different. It is not appropriate for example for owners of GBGF-S plant to undertake some of the tests or analysis as their dynamical performance characteristics are already understood and the proposer does not believe it is appropriate or efficient to undertake such tests.

- Any Plant Owner which wishes to provide a Black Start Service would need to have a Grid Forming Capability. This is important in providing additional market opportunities for owners and operators of plant to provide a Black Start service should they wish to do so.
- The technical performance requirements are non-mandatory but are open to any provider who owns and operates any form of plant so long as they can meet the minimum requirements. The ability to provide this service would also be open to Non-CUSC parties who traditionally would not be party to the Grid Code. For parties falling into this position, the relevant Grid Code obligations applicable to them would be set out as part of the qualification process for competing in a future Grid Forming market. For CUSC parties who are already caught by the requirements of the Grid Code, a condition of providing a Grid Forming Capability would also require them to meet other Grid Code requirements (for example the Planning Code, Connection Conditions / European Connection Conditions, Compliance Processes / European Compliance Processes), but these would already be a condition of being a CUSC Party.
- The basic structure of the Grid Forming Plant shall comprise an internal voltage source and impedance. The impedance would be real being made up of either one or a string of real impedances between the internal voltage source and connection point and would not comprise virtual impedances. It should be noted that it is not desirable to have any software which acts to control the Internal Voltage Source (IVS) to produce an equivalent to real impedance that we call synthetic impedance. The reason is that this requires high bandwidths which affects the Internal Voltage Source. If a supplier knows the actual real impedance values of the IVS they can be used in the equations
- Each Grid Forming Plant is required to be capable of supplying “Active ROCOF Response Power”, “Active Phase Jump Power”, “Active Damping Power”, “Active Control Based Power”, “Control Based Reactive Power”, “Voltage Jump Reactive Power” and “Fast Fault Current Injection” when subject to a network disturbance. These requirements also apply under both positive and negative frequency changes.
- The Figure 6.1 is a simulation of a GBGF- I System for a simultaneous occurrence of a 20 degree phase jump followed by a Rate of Change of Frequency (ROCOF) of  $-1 \text{ Hz / s}$ . This shows that the GBGF technology provides the required fast response to Grid transients. Figure 6.1 is for an Energy Storage System with no continuous Active Power rating and a current limit of 1 per unit. The phase jump was applied over 20 milliseconds to give a clear set of data without point on wave switching. This response cannot be achieved by any of the existing Grid Following power converter control systems based on PLL or similar technologies.

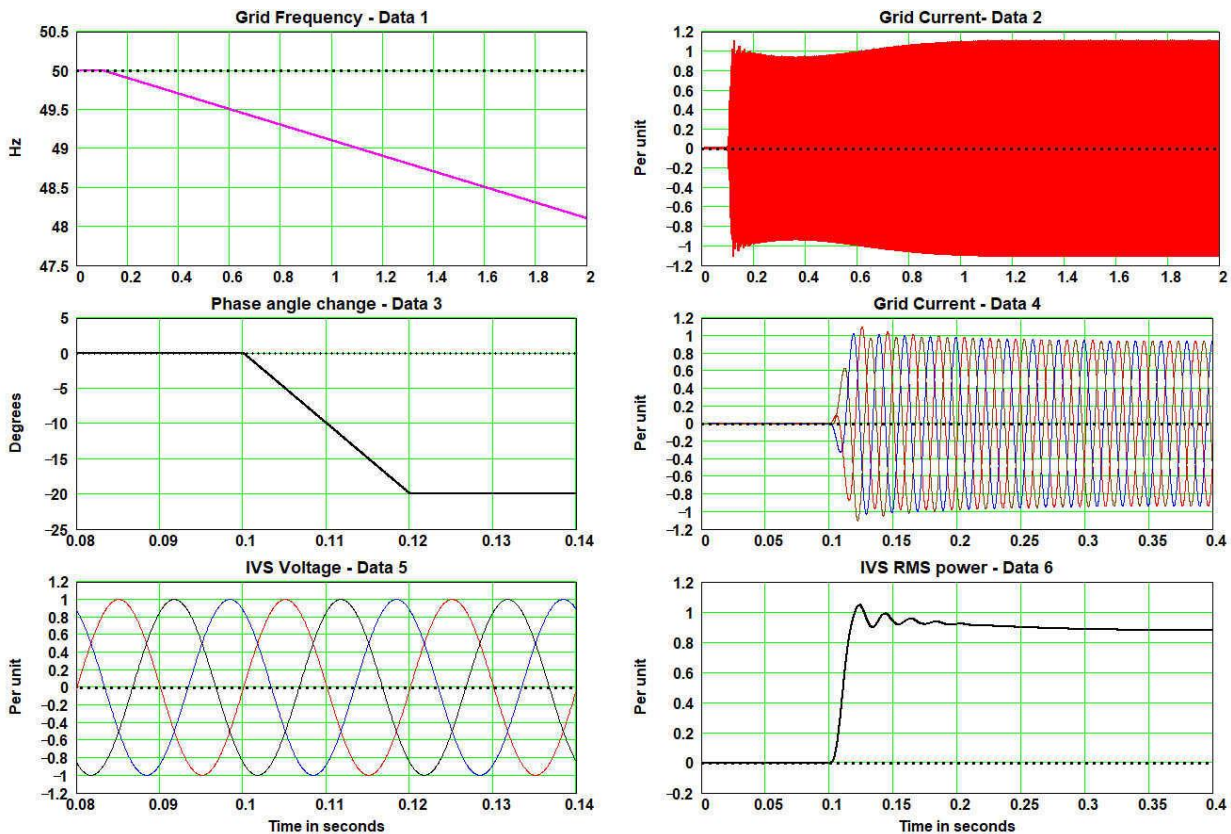

- Each Grid Forming Converter shall be designed so as not to cause any undue interactions with the wider System or other User's Plant and Apparatus.
- Each Grid Forming Converter shall include an Active Control Based Power part of the control system that can respond to changes in the Grid Forming Plant or external signals from the Total System available at the Grid Entry Point or User System Entry Point but with a bandwidth below 5 Hz to avoid AC System resonance problems.
- For Plants which have both an importing and Exporting Capability (for example an HVDC System or Energy Storage System), the Grid Forming Plant should have the capability to operate over the full import and export mode of operation.
- The Grid Forming Plant shall be designed to be adequately damped. A Damping Factor within a range of 0.2 – 5 is permitted with the specific value being agreed with the ESO as this will vary on a site specific basis.
- Each Grid Forming Plant should be capable of operating over a minimum short circuit level of zero MVA.
- Each directly connected Grid Forming Plant shall be capable of satisfying the applicable quality of supply requirements defined in CC/ECC.6.1.5, CC/ECC.6.1.6 and CC/ECC.6.1.7. Any additional requirements for enhanced quality of supply requirements (for example improvements in managing harmonic distortion) would be agreed bilaterally with the ESO and Relevant Transmission Licensee. The requirements for Temporary Overvoltage Assessment (TOV) for direct connections in England and Wales would generally be managed through compliance with TGN288 [20] and included as a requirement in the Bilateral Connection Agreement.
- A new requirement for fast fault current injection has been introduced. This is similar to the requirements of ECC.6.3.16 introduced through Grid Code modification GC0111 [21] but reflects the need for faster response times and the

peak rated current of the Grid Forming Plant. Following the Workgroup Meeting held in 28<sup>th</sup> May 2021 the voltage reactive current requirement (Figure 7(a) below) was updated to ensure consistency with Figure ECC.6.3.16(a) together with minor updates to the legal text to more clearly articulate the necessary requirements. In addition, following the Workgroup vote on 21 June 2021, a minor clarification was added to the legal text to clarify the main protection operating time (i.e. fault duration) would last for up to 140ms. The reactive current performance requirements are shown in Figures 7.0(a) and 7.0(b) below. The solid limit line of Figure 7.0(a) depends on the Grid Forming Plants current limit values and two examples are shown.

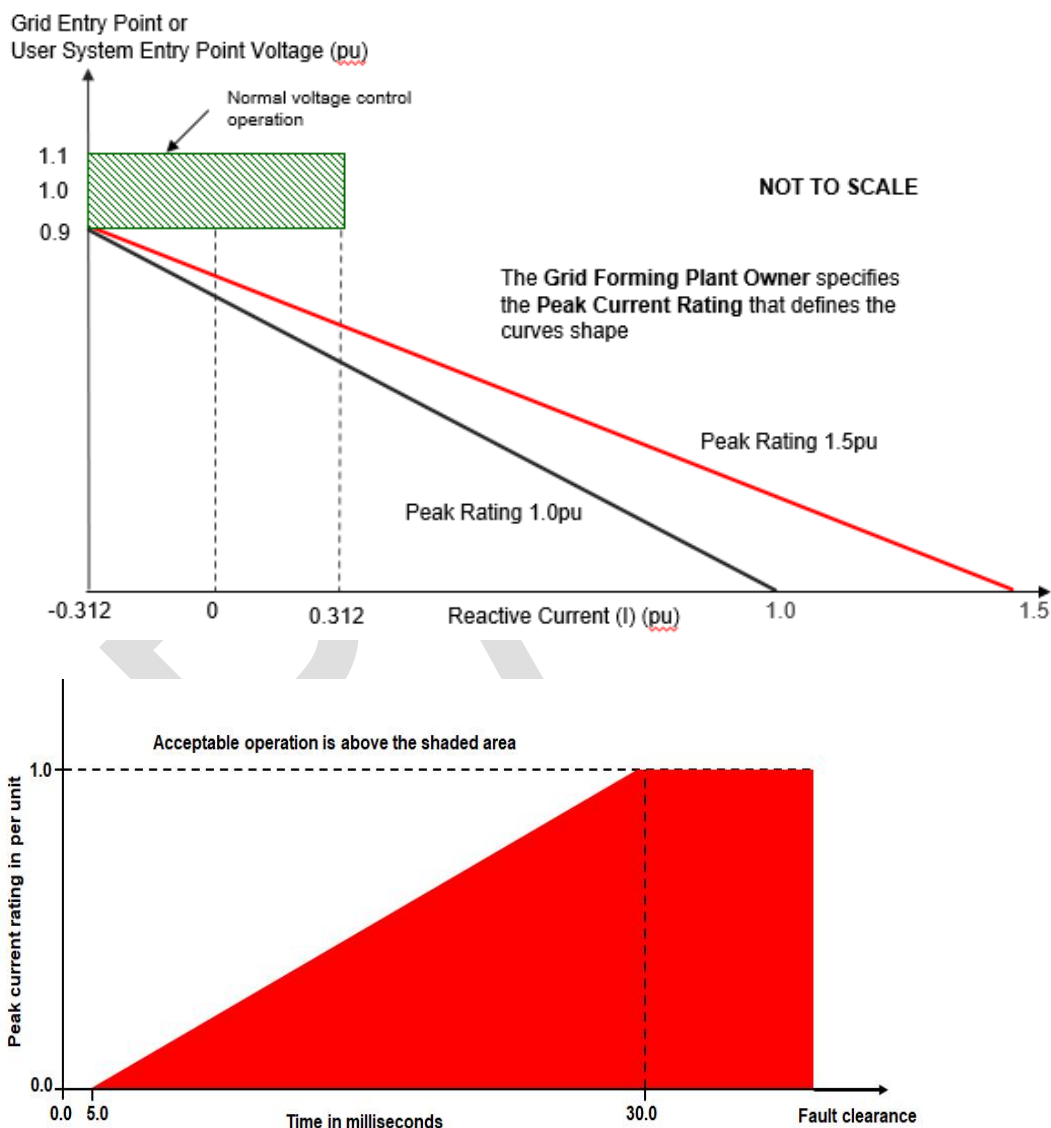

A new section has been introduced on monitoring. This will require either a new Electrical Standard or an amendment to the current Dynamic System Monitoring Standard (TS.3.24.70\_RES) [22]. This is an issue which will require further discussion as part of the GB Grid Forming Best Practice Expert Group. At the meeting on 28<sup>th</sup> May it was agreed that minor changes were needed to the improve the drafting, in particular relating to sample rates and flexibility to the monitoring methods.

Following the July 2021 Grid Code Review Panel, it was noted that the drafting of ECC.6.6.1.10 should be changed to reflect the fact that a Relevant Electrical Standard



relating the Dynamic System Monitoring requirements of Grid Forming Plant may not be available at the time the GC0137 modification is approved. It is therefore proposed to update ECC.6.1.10 as follows.

*ECC.6.6.1.10 Detailed specifications for **Grid Forming Capability Plant** dynamic performance including triggering criteria, sample rates, the communication protocol and recorded data shall be specified by **The Company** in the **Bilateral Agreement**.*

In the Proposer's view until the preparation of a Relevant Electrical Standard (as being developed by the Grid Forming Expert Group) it is proposed that Appendix F5 of Bilateral Connection Agreements should include words to the effect: -

*“If the User wishes to provide a Grid Forming Capability in accordance with the requirements of ECC.6.3.19, detailed specifications for Grid Forming Capability Plant dynamic performance including triggering criteria, sample rates, the communication protocol and recorded data shall be agreed between the User and The Company in the Detailed Design Phase”.*

### **Data Requirements**

The second part of the specification relates to the data and models which need to be supplied to the ESO. This is required for three principle reasons: -

- To ensure that a developer provides a true and accurate reflection of their Grid Forming Plant so that it can be replicated in the ESO's Power System Analysis software suite. This is to enable the ESO to continue to have an accurate understanding of how the Grid Forming Plant will affect the Transmission System.
- To enable the correct data to be submitted to facilitate the Future Grid Forming Market.
- To supply relevant data (Network Frequency Perturbation Plot and Nicols Charts or equivalent) so that the ESO can verify that the plant will not have any negative interactions with the Transmission System or other User's Plant and ensure an adequate level of damping.

For example, for a converter-based plant (GBGF-I Plant) the developer should supply i) a high level architecture of their plant (Figure 8.0), and ii) an equivalent simulation block diagram model as shown in Figure 9.0(a) or Figure 9.0(b).

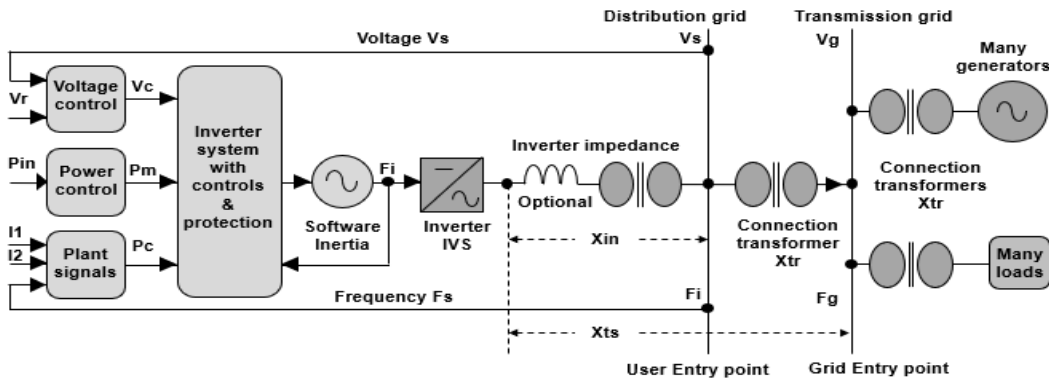

Figure 8.0

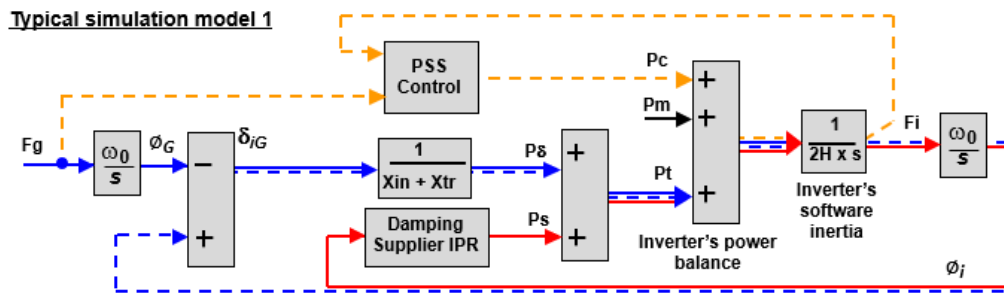

Figure 9.0(a) - Preferred simplified diagram of a **GBGF-I Plant** with a **Power System Stabiliser “PSS”** that can add damping to the **GBGF-I Plant’s** closed loop function shown by the solid red line and the dotted blue line.

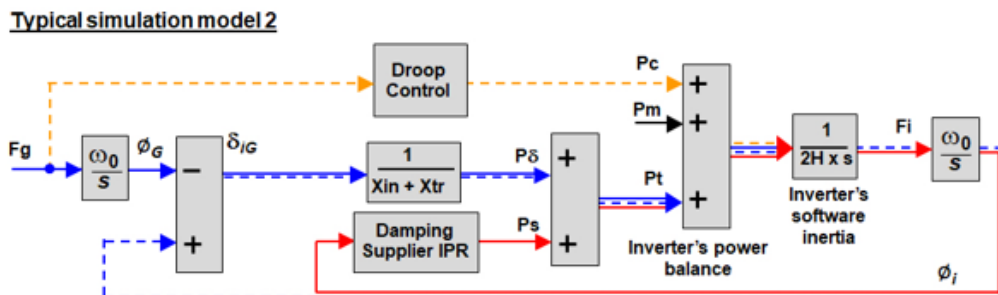

Figure 9.0(b) - Preferred simplified diagram of a system with a droop control ability that can add **Control-Based Active Droop Power**. This diagram does not add extra closed loop damping to the **GBGF-I Plant’s** closed loop function shown by the solid red line and the dotted blue line.

Table 1.0 below shows is an extract from the proposed Grid Code Legal drafting of the data that a developer would be expected to provide in respect of their Inverter based Grid Forming Plant. This would then be used to assess its benefit to the Transmission System and would also form the basis of a future Grid Forming Market.

Quantity	Units	Range (where Applicable)	User Defined Parameter

Type of <b>Grid Forming Plant</b> (e.g., <b>Generating Unit, Electricity Storage Module, Dynamic Reactive Compensation Equipment</b> etc.)	N/A		
Maximum Continuous Rating at <b>Registered Capacity</b> or <b>Maximum Capacity</b>	MVA		
Primary reactance $X_{in}$ or $X_{ts}$ (see Table PC.A.5.8.1)	pu on MVA		
Additional reactance $X_{tr}$ (See Table PC.A.5.8.1)	pu on MVA		
<b>Maximum Capacity</b>	MW		
<b>Active ROCOF Response Power</b> (MW) injected or absorbed at 1Hz/s <b>System Frequency</b> change (which is the maximum frequency change for linear operation of the <b>Grid Forming Plant</b> )	MW		
<b>Phase Jump Angle Withstand</b>	degrees		60 degrees specified
<b>Phase Jump Angle limit</b>	degrees		5 degrees recommended
<b>Phase Jump Power</b> (MW) at the rated angle	MW		
<b>Defined Active Damping Power</b> for a <b>Grid Oscillation Value</b> of 0.5 Hz peak to peak at 1 Hz	MW		
The cumulative energy delivered for a 1Hz/s <b>System Frequency</b> fall from 52 Hz to 47 Hz. This is the total <b>Active Power</b> transient output of the <b>Grid Forming Plant</b>	MWs or MJ		
<b>Inertia Constant (H)</b> using equation 1 or declared in accordance with the simulation results of ECP.A.3.9.4	MWs/MVA		
<b>Inertia Constant (He)</b> using equation 2 or declared in accordance with the simulation results of ECP.A.3.9.4	MWs/MVA		
Continuous Overload Capability	% on MVA		
Short Term duration Overload capability			

Duration of Short Term Overload Capability	s		
<b>Peak Current Rating</b>	pu		
Nominal <b>Grid Entry Point</b> or <b>User System Entry Point</b> voltage	kV		
<b>Grid Entry Point</b> or <b>User System Entry Point</b>	- Location		
Continuous or defined time duration MVA Rating	MVA		
Continuous or defined time duration MW Rating	MW		
For a <b>GBGF-I</b> the inverters maximum <b>Internal Voltage Source (IVS)</b> for the worst case condition – for example operation at maximum exporting <b>Reactive Power</b> at the maximum AC <b>System</b> voltage	pu		
Maximum Three Phase Short Circuit Infeed at <b>Grid Entry Point</b> or <b>User System Entry Point</b>	kA		
Maximum Single Phase Short Circuit Infeed at <b>Grid Entry Point</b> or <b>User System Entry Point</b>	kA		
Will the <b>Grid Forming Plant</b> contribute to any other form of commercial service – for example Dynamic Containment, Firm Frequency Response,	Details to be provided		
<b>Equivalent Damping Factor.</b>	Z		0.2 to 5.0 allowed

Where: -

Equation 1 is  $H = \text{Installed MWs} / \text{Rated installed MVA}$

Equation 2 is  $H_e = (\text{Active ROCOF Response Power at 1 Hz} / \text{s} \times \text{System Frequency}) / (\text{Installed MVA} \times 2)$

Table 1.0

In the Proposer's view it is important that any Grid Forming Plant connected to the Network does not cause any harmful or undue interactions with other User's Plant or the wider System itself. As part of the workgroup discussions, the Network Frequency Perturbation (NFP) Plot combined with the use of a Nichols Chart (to assess damping) has been suggested as a suitable approach for this application although the drafting has been written to allow other techniques to be used so long as they can demonstrate no harmful or undue interactions arise.

The Network Frequency Perturbation plot is essentially a form of Bode Plot which plots the amplitude (%) of the output oscillation and Phase (degrees) to the frequency of an applied input oscillation. The results from the Network Frequency Perturbation Plot is then used to construct a Nichols Chart from which the Damping Factor can be determined and hence establish if an appropriate level of performance is achieved. An example of an NFP Plot and Nichols Chart is shown for illustration purposes in Figure 10. This figure has an NFP plot with very low damping (dotted lines) provided by the real damping losses in the AC supply impedances and an NFP plot with added damping provided by the Supplier Damping Function shown on Figures 9(a) and 9(b)

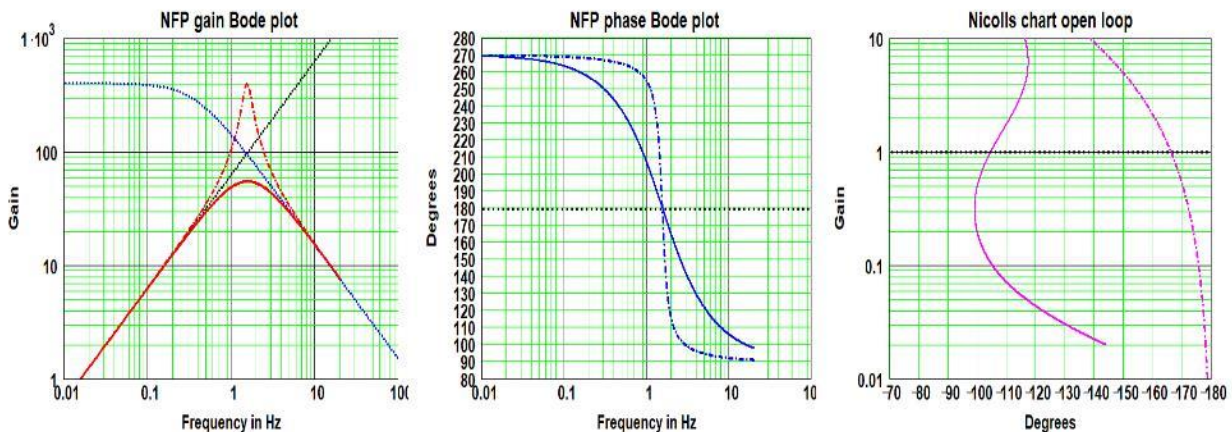

Figure 10 – NFP Plots and corresponding Nichols Charts – Reproduced with the kind permission of Enstore.

The data and analysis associated with the assessment and impact on the System is a complex area. Whilst the Grid Code proposal requires developers to submit an NFP Plot or equivalent, it is recognised that this is a complex area and therefore it is proposed that a separate Expert Group is established which will be tasked with developing a “Best Practice Guide”. The purpose of which will be to develop some guidance relating to what would be judged to be an acceptable level of performance and provide some worked examples. This work would sit outside this proposed GC0137 modification such that the Grid Code is sufficiently flexible to provide the minimum functional specification, but the Best Practice Guide would provide the detail necessary. It is also easier to subsequently update and amend a Best Practice Guide rather than the Grid Code.

### **Compliance Requirements**

The final part of the specification covers compliance which covers the following three main areas, these being: -

- Simulation
- Testing
- Online Monitoring

As noted earlier in this report the purpose of the Compliance Process to ensure that the plant as built is capable of meeting the full requirements of the Grid Code and Bilateral Agreement. All of these sections have been introduced into the legal drafting.

### **Simulation**

Simulation studies are a very important part of the compliance process in so far that i) they are necessary to ensure the data and models submitted are a true and accurate reflection of the plant as built and ii) to demonstrate that the plant behaves in the manner expected prior to any real tests being undertaken.

As part of this Grid Code modification, the following high level simulation studies are proposed. The first set of studies are run against the test network in Figure 11.0.

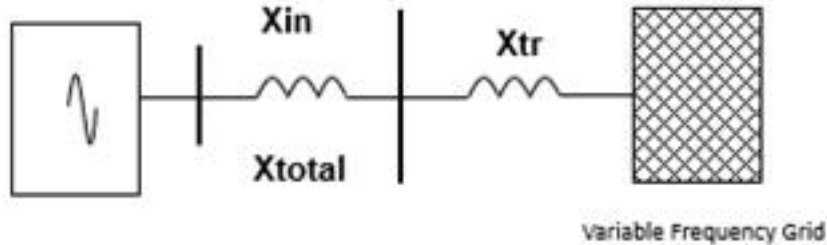

In the Proposer's view these simulations only need to be run for Grid Forming Plants comprising Power Electronic Converters. There is no requirement for them to be run for Grid Forming Plants which achieve the necessary requirements using Synchronous Generators as their capability has been demonstrated over many years of operation and industrial experience.

Simulations are first run by varying the frequency of the Grid to assess the supply of "Active ROCOF Response Power" performance under both slow and small frequency changes as well as under rapid and extreme frequency changes. This is to confirm the correct operation of the Grid Forming Plant in the linear operating region and also under extreme frequency changes when the plant saturates. The latter test is to ensure the plant can maintain its full expected saturated output when subject to extreme frequency conditions. These tests are repeated with the plant part loaded. The purpose is to assess the correct supply of "Active ROCOF Response Power" without going into saturation and that pole slipping does not occur.

The second set of simulations are required to demonstrate the ability of the Grid Forming Plant to supply Active Phase Jump Power. The simulations are run with the plant at full load or an agreed loading point, minimum load and a range of phase jumps applied at the connection point. A phase jump of up to the maximum phase jump limit is also to be applied. These tests are to demonstrate the plant can provide "Phase Jump Power" but also the Plant can withstand "Phase Jumps" up to the maximum "Phase Jump Angle Limit".

The third set of simulations are required to confirm and demonstrate the appropriate behaviour of the Grid Forming Plant during fault or depressed voltage conditions. In particular these are required to demonstrate fault ride through and fast fault current injection.

To demonstrate that the Grid Forming Converter can supply both Active ROCOF Response Power and Active Phase Jump Power at the same time, a simulation is required to be setup in accordance with the requirements of Figure 12.0.

Figure 12.0

In this simulation, the Grid Forming Plant's output is set to load  $Y/2$  and the variable frequency Grid is set to 50Hz with an export of  $Y/2$  as shown in Figure 12.0. The variable

frequency Grid is then subject to a fault at point A, followed by the opening of circuit breaker B, 140ms later. Results of Active Power, Reactive Power and Frequency are then recorded to demonstrate the capability of the Grid Forming Plant to supply “Active ROCOF Response Power” and “Active Phase Jump Power” simultaneously.

The next simulation test is required to demonstrate the ability of the Grid Forming Plant to supply Active Damping Power. This is initially achieved by injecting a Test Signal into the Grid Forming Plant model (see Figure 9.0(a) and Figure 9.0(b)) and comparing the results achieved match the quoted damping factor as derived from the Network Frequency Perturbation Plot as supplied by the Grid Forming Plant Owner. A range of simulation tests are repeated with different frequencies by injecting a Test Signal into the Grid Forming Plant Model. Again, damping is assessed against the Network Frequency Perturbation Plot as supplied by the Grid Forming Plant Owner.

The final simulation is to demonstrate “Active Control Output Power”. This is achieved by injecting a Test Signal into the Grid Forming Plant control system (see Figure 9.0(a) and Figure 9.0(b)) and ensuring that that “Active Control Output Power” which would be equivalent to the power output with governor action in operation is below the 5Hz bandwidth limit.

### **Testing**

In the Proposer’s view testing is required to ensure the actual Grid Forming plant is capable of meeting the requirements of the Grid Code, Bilateral Connection Agreement, Ancillary Services Agreement and to validate the data and models submitted.

The actual tests themselves are broadly the same as the simulation tests. Some of these tests will require a variable frequency supply and therefore will require specialist testing facilities. To address this issue the ESO will accept Type Tests and Equipment Certificates as demonstration of compliance and will also be open to accepting an alternative set of tests to those specified in the Grid Code Legal Text where it can be demonstrated that the Grid Forming Plant is fully capable of meeting the requirements of the Grid Code, Bilateral Agreement and Ancillary Services Agreement. Where such facilities or Equipment Certificates are not available, demonstration of compliance would need to be demonstrated during the Interim Operational Notification Process.

An Active Phase Jump Power test facility can be used to confirm the correct operation of a plant as it produces the same effect of a phase jump at the Grid Connection Point.

Some of the tests will require very fast sampling rates in order to see the behaviour of the Grid Forming Plant. This is particularly the case where a step change in the phase angle is applied at the connection point as it will result in an almost instantaneous change in the active power output of the Grid Forming Plant. Based on the analysis undertaken, the full supply of active power should be generated for a phase shift of 5 degrees. This value should be generated each time the phase shift exceeds 5 degrees up to a maximum phase withstand limit of 60 degrees. The resolutions required to record these events are small. A technique for recording the Grid Phase Jump Angle by using either a nominated algorithm as defined by National Grid ESO or an algorithm that records the time period of each half cycle with a time resolution of 10 microseconds. For a 50Hz System, a 1 degree phase jump is a time period change of 55.6 microseconds. There are instruments available capable of recording these values and the Grid Code legal text has been updated to include

this requirement. It is also expected that testing and monitoring will be considered in more detail as part of the Expert Group when the Best Practice Guide is developed.

### **Monitoring**

In addition to testing there will also be a requirement for online monitoring to be undertaken once the Grid Forming Plant has been commissioned. This would take the form of an enhanced Dynamic System Monitor where a new standard may need to be introduced within the Relevant Electrical Standards (RES). It is envisaged that this would be an adaptation to the current Dynamic System Monitoring Specification TS.3.24.70\_RES [22] which would require enhanced sampling and signal monitoring requirements. It is proposed that this standard is addressed as part of the Expert Group which is developing the Best Practice Guide.

One aim is that the monitoring system will capture data on either any significant grid phase jumps or any significant RoCoF transients for subsequent analysis of the plants performance. This has to be done at the plants location as these effects vary at different locations for any grid transient.

### **Code Structure**

In the Proposer's view as a final point, as the Grid Forming specification is a Non-Mandatory requirement, it was considered that the data requirements may more appropriately be suited to being included in the Grid Forming section of the European Connection Conditions rather than the more traditional location of the Planning Code. There are some options available here, these being the more traditional approach of placing the data requirements in the Planning Code, the technical requirements in the European Connection Conditions and the Compliance requirements in the European Compliance Processes. An alternative approach would be to create a new section of the Grid Code specifically aimed at "Grid Forming" which has been an approach used for previous Grid Code changes such as the "Demand Response Services Code". A consultation question was raised on this issue as part of the Workgroup Consultation and whilst there was support for both options, the overall majority promoted the traditional approach of placing the data in the Planning Code and Data Registration Code, the technical requirements in the European Connection Conditions and the Compliance Processes in the European Compliance Processes section of the Grid Code. The legal text has therefore been updated to reflect this option.

## **Workgroup considerations**

### **Meeting 1 – 9 April 2020**

The first workgroup meeting was held on 9th April 2020. Its aims were to discuss the Terms of Reference, introduce the modification and its reasoning, summarise the previous work that had been completed as part of the VSM Expert Group [17], discuss the draft specification that had been prepared prior to the first workgroup meeting. It was agreed that the draft specification discussed at that meeting should be reviewed and workgroup members should provide comments back to the ESO so they could be incorporated into the next iteration of the specification.

At this first meeting, the Chair took an action to update members on the progress of related Grid Code modifications GC0138 (Compliance process technical improvements) [23] and GC0141 (Compliance Processes and Modelling amendments following 9th August Power Disruption) [24] but noted that each modification needed to be considered on its own



merits. Annex 3 of this Workgroup Report contains the presentation material given at this meeting. The Terms of Reference of the GC0137 Workgroup are covered in Annex 2.

### **Meeting 2 – 22 September 2020**

The second meeting was held on 22 September 2020. Its aims were to discuss and address the actions raised at the previous meeting on 9 April 2020, address the comments that had been raised at the previous meeting and discuss the revised specification which had been prepared and circulated two weeks in advance of the meeting. Annex 5 of this Workgroup Report contains the presentation material.

It was at this meeting that it was agreed the name of the Workgroup should be changed from Virtual Synchronous Machines or VSM to GB Grid Forming. This was on the basis that VSM means different things to different people and the term has been used across various parts of the world with a potentially different context. On this basis it was agreed that the title of the Workgroup should be changed from “Minimum Specification Required for Provision of Virtual Synchronous Machine (VSM) Capability to the “Minimum Specification Required for Provision of GB Grid Forming (GBGF) Capability (formerly Virtual Synchronous Machine/VSM Capability)” It was agreed that this title better reflected the purpose of the modification which the Grid Code Review Panel also agreed to at their meeting on 24 September 2020.

At the second meeting the ESO also presented the developments which had taken place since the last meeting held on 9 April 2020. The topics discussed included the following: -

- Synchronous Machine Theory and how this relates to GB Grid Forming
- Synchronous Machines GB Grid Forming Static Power Converter (GBGFC with Inertia) and VSM0H (Grid Forming Static Power Converters with no inertia) and the comparison with conventional power electronic converter designs using Phase Locked Loops (PLL)
- Grid Forming Analysis, Specification and Development
- High level requirements
- Data submission and models
- Compliance Testing and Simulation
- Monitoring
- Determination of System Need

Between the first and second workgroup meetings, the ESO undertook some extensive discussion with some key stakeholders, notably Enstore and Siemens / Gamesa. The ESO is especially grateful to these stakeholders who covered some of the more detailed aspects of the design and equipment capability.

The second workgroup also discussed the revised specification which had been updated substantially since the first meeting and again further comments were requested from workgroup members on their views. This was also complemented by a “chat” session which was recorded at the meeting. At this stage the specification did not include requirements for fast fault current injection or the compliance simulation and testing requirements.

At the second meeting it was originally planned to launch the Workgroup consultation at the end of the year however in light of the additional significant comments that were subsequently received, and the further work required, it became clear that a further meeting

would be required ahead of issuing the consultation. One of the issues in particular is the need to ensure Grid Forming Plant does not cause undue interactions with the wider Transmission System or other User's Plant. A technique for managing this known as a Network Frequency Perturbation (NFP) Plot and it was agreed that this needed further development, particularly in respect of judging what would be considered to be an acceptable level of performance.

One point worthy of note is that between workgroup 1 and workgroup 2, the ESO came in for some criticism regarding the de-prioritisation of the GC0137 modification, especially as during the Summer of 2020 the Stability Pathfinder work [10] was requesting expressions of interest from developers. This was against the background of some developers preparing their own designs and requiring more certainty on the requirements. As part of this work, it is the Grid Code Review Panel that are responsible for the priority of work against the level of resource available. GC0137 is a modification that is seen as a strategic longer-term modification which while not having a critical requirement for an implementation date, it does make the operational costs for the System higher in the absence of a requirement and hence the availability of a shorter term stability market. This needs to be weighed against the other Grid Code modifications, some of which (GC0147 - Last Resort Disconnection of Embedded Generation – Enduring Solution) for example have an urgent need to be in place otherwise there is a risk to system security or other modifications which have an EU compliance deadline, so it is entirely understandable why the modification was de-prioritised. That said the ESO together with some key stakeholders worked very hard behind the scenes to keep the work moving despite only a few workgroup meetings. It is also seen that this is a very positive outcome when compared against leaving the modification in a dormant state.

Following the second meeting, the workgroup was asked for further comments. In addition, a formal response was provided to the recorded chat session held during the second meeting which was circulated to Workgroup members in early December 2020. This was released shortly after the technical guide issued by Enstore as many of the comments raised were addressed in the Enstore note. A copy of the recorded Chat and the response to these questions are covered in Annex 7. The Enstore Note entitled "Enstore's guide for GB Grid Forming Converters – V001" which describes the "Design of GB Grid Forming Converters" was updated prior to the release of the consultation document. In view of the substantial comments received after the consultation and to reflect the latest legal text, an updated version of the Enstore Guide is available in Annex 18.

### **Meeting 3 – 8 January 2021**

The third meeting was held on 8th January 2021. Its aims were to discuss and address the actions raised at the previous meeting on 22 September 2020, address the comments that had been raised at the previous meeting and discuss the revised specification which had been prepared and circulated in advance of the meeting. Annex 8 of this Workgroup Report contains the presentation material which included many substantial revisions including requirements for fast current injection, compliance testing and simulation.

At the third meeting the ESO, presented the developments which had taken place since the second meeting held on 22nd September. The topics discussed included the following:-

- Background
- Equivalent circuits and models
- Design Parameters

- Operating ranges (normal and abnormal)
- Fast Fault Current Injection
- Compliance Requirements
- Online Monitoring
- Arrangements for a Best Practice Expert Group

As noted above the main revisions to the specification included the requirements for fast fault current injection and a completely new section on compliance which covers simulation, testing and monitoring.

Two key issues were also raised during this meeting, these being: -

- The suggestion to issue the Workgroup Consultation in Mid-March 2021; and
- The proposal to establish a Grid Forming Best Practice Guide.

Prior to, during and following the meeting, a number of comments were received from the stakeholders and workgroup members on the presentation material and specification.

The second issue which was recognised later on in the workgroup process was the need to formulate an Expert Working Group who would be tasked with preparing a “GB Grid Forming Best Practice Guide”. This issue is discussed later in this Workgroup Report but in summary as the work developed it became clear that the Grid Code should simply define the high level specification, whereas some form of additional guidance is necessary to consider some of the more detailed aspects in particular what would be considered as an acceptable level of performance from a Grid Forming Plant and the tools and analysis techniques necessary to do this. It is also noted that a Best Practice Guide is easier to update in future unlike the Grid Code.

#### **Meeting 4 – 10 May 2021**

The fourth meeting was to discuss the feedback from the Workgroup Consultation which closed on the 30 April 2021 and agree next steps. A summary of the key issues raised is included in Annex 13.

At this meeting it was agreed that National Grid ESO would respond to Stakeholders comments and update the legal text.

#### **Meeting 5 – 28 May 2021**

The fifth meeting was arranged to discuss the revised legal text and National Grid ESO's responses to Stakeholders comments. A presentation was shared at the meeting outlining the work completed since the last meeting held on 10th May which is available on the GC0137 Workgroup Website <https://www.nationalgrideso.com/industry-information/codes/grid-code-old/modifications/gc0137-minimum-specification-required>.

At this meeting it was re-emphasised that the Grid Code defines a high level technical requirement with an intentional degree of flexibility and therefore it is not a detailed functional specification. Against this background, National Grid ESO sought views in particular on potential show stopping items noting that the detail would be picked up by the Expert Group through the development of a Best Practice Guide.

At the meeting there was overall agreement that the solution was appropriate, but some further minor work was required to the legal text in relation to some of the definitions,

frequency operating range, fast fault current injection, monitoring, simulation and testing and a minor change to the nomenclature.

The ESO agreed to re-issue the revised legal text to workgroup members at the beginning of June and also a reformatted version of the legal text (this being a version which did not change the technical solution but simply placed the correct items in the appropriate part of the Grid Code – for example the data elements being placed in the Planning Code and Data Registration Code, the technical requirements in the European Connection Conditions and the Compliance sections in the European Compliance Processes section). The revised legal text taking Workgroup members comments on board were circulated to the Workgroup on the 3 June 2021 and the reformatted version of the legal text was submitted to Workgroup Members on 14 June 2021.

### **Meeting 6 – 21 June 2021**

Meeting 6 was held on the 21 June 2021. The purpose of the meeting was to agree the proposed solution, agree the Workgroup had met the Terms of Reference (Annex 2) and hold the workgroup vote in respect of the updated legal text.

At that meeting it was agreed the Workgroup Report would need to be updated to reflect the proposed solution and ensure consistency with the revised Legal Text. It would also need to reflect the outcome of the voting.

So far as the legal text was concerned a couple of minor points were raised, one relating to fast fault current injection and the breaker operating time being set to 140ms and the other relating to points of clarification.

It was agreed that the updated Workgroup Report and the minor change to the legal text in relation to the fault clearance time would be issued by the Workgroup on 25 June and a further meeting to ensure the Workgroup were happy with the solution was proposed for 6 July.

### **Key areas of Discussion across all Meetings**

It is beyond the scope of this Workgroup Report to cover all the points raised, however a summary of the key issues raised are noted below. Further details of the comments raised are summarised in the “Chat” section of this Workgroup Report (Annex 7), Annex 9, Annex 18, the final legal text (Annex 19) and the material published on the GC0137 website (<https://www.nationalgrideso.com/industry-information/codes/grid-code-old/modifications/gc0137-minimum-specification-required>) reflects many of the comments raised.

### **Definitions**

In the Proposer’s view the definitions are a key part of the legal drafting and as the workgroup has progressed, they have constantly been reviewed and updated. The presentations included in the Appendices of this Workgroup Report together with the draft legal text convey the significant work that has taken place in this area.

### **VSM and VSM0H**

In the early discussions it was implied that VSM (a full GB Grid Forming Capability with an energy store capability) was the only technology viable to meet the proposed Grid Code

proposal and that a VSM0H (a GB Grid Forming Capability) with no energy store capability would not provide an acceptable solution.

This is absolutely not the case and both technologies are important in contributing to the overall stability of the Grid. Remembering that Grid Forming provides four important benefits these being: -

**Type i)** the ability to provide “*Active Phase Jump Power*” (the ability for the plant to instantaneously supply Active Power to the network following a phase change),

**Type ii)** is the ability to supply **Active Inertia Power** for **RoCoF** in the AC grid, which is one component of the **Active ROCOF Response Power**.

**Type iii)** is the ability to provide “*Active Damping Power*” (i.e. the ability of a Grid Forming Plant to naturally supply power as a result in the difference between oscillations in the Network when compared to the internal voltage source of the Grid Forming Plant).

**Type iv)** is the ability to supply is *Active Frequency Response Power* to produce extra generated power in the AC grid. Which is also one component of the *Active RoCoF Response Power*.

**The Active ROCOF (Rate of Change of Frequency) Response Power** is the “*Active Inertia Power* plus the *Active Frequency Response Power*” which is the additional power supplied through changes in system frequency which in the case of a Synchronous Generator the *Active Inertia Power* would be the additional power supplied through the stored energy in the rotating mass of the generator’s drive train and the *Active Frequency Response Power* is the power supplied as a result of Governor action.

In a full GB Grid Forming System **Items i), ii), iii) and iv)** are all supplied.

That said, as the proposed Grid Code text simply states that a developer should declare their capability and a price for that capability it should not preclude VSM0H systems from participating or indeed a plant with no additional energy store and also permit plants running at part load. It is through a large number of participants all providing a contribution which can make a difference to stabilising the system.

VSM0H systems also provide very important Grid benefits for contributing to system strength, limiting vector shift and thereby helping to maintain the system voltage profile during disturbances and faults which is a fundamental pre-requisite to fault ride through and overall system robustness.

Therefore, both systems are equally valuable and provide an important ingredient in managing the robustness of the system going forward as shown in Figure 13.

## Comparison of Converter Technology

Capability	GBGF-S	GBGF-I	Conventional
Phase Based Phase Jump Power in one cycle	Yes	Yes	No
RoCoF response Power	Yes	Yes	No
Damping Power	Yes	Yes	Yes
Operate in Synchronism with the System	Yes	Yes	Yes
Contribution to Fault infeed	Yes - High	Yes – As specified	Yes - Limited
Avoids producing current harmonics > 5 Hz	Yes	Yes	No

For the avoidance of doubt GBGF-I includes VSM0H converters

Figure 13

### 5Hz Bandwidth Limit

This issue has been raised on a number of occasions during the discussions. The 5Hz bandwidth issue originally stems from CC/ECC.A.6.2.6.1 which states “*The overall Excitation System shall include elements that limit the bandwidth of the output signal. The bandwidth limiting must be consistent with the speed of response requirements and ensure that the highest frequency of response cannot excite torsional oscillations on other plant connected to the network. A bandwidth of 0-5 Hz will be judged to be acceptable for this application*”. This clause is designed so as to ensure that the control system associated with the excitation system does not cause the risk of or encourage torsional oscillations on other plant. In the case of Synchronous generators where resonances can occur in the 10 – 15Hz range, a strict bandwidth limit is required to prevent the risk of this issue occurring. The same issue also applies to other supplementary control systems.

This issue was discussed at length on several occasions and it was agreed that the main concern relates to the risk of supplementary control systems (e.g. Governor, voltage control and damping control systems) fitted to the plant which may excite torsional oscillations on other User’s plant rather than the actual core of the Grid Forming Plant itself. The definitions in the legal text have therefore been updated to address this issue, in particular the definitions of “Grid Forming Capability” and “Active Control Based Power”.

### Modelling

The issue of modelling was discussed at length, particularly during the second Workgroup meeting. This aspect is also covered in more detail in Annex 9 and Annex 18 and also highlighted above in the proposer’s solution. In summary, the ESO requires a linearised model of the Grid Forming Plant from which the closed loop transfer function can be derived. This is then used to determine the Network Frequency Perturbation (NFP) Plot – see section below.

The model is also very necessary for the ESO for two reasons. These being i) so the model submitted is a true and accurate reflection of the plant as built so that it provides a good level of confidence of its behaviour and ii) so that the ESO can use the model in its power system analysis software for the ongoing design and operation of the Transmission System.

### Overall GB Grid Forming Plant Performance, Damping and System Interaction

This issue was discussed at length especially during the second and third meeting. A

technique to assess the overall performance of the GB Grid Forming Plant that has been proposed is a Network Frequency Perturbation (NFP) Plot. This is a form of bode plot which plots the amplitude (%) of the output oscillation and Phase (degrees) to the frequency of an applied input oscillation. The purpose of which is to assess the capability and performance of a Grid Forming Plant and to ensure it does not pose a risk to other Plant and Apparatus connected to the System. For a Converter based plant this can be used to provide data to the ESO together with a Nicolls Chart so the effect on the network and damping can be assessed. It is also helpful that the shape of the NFP Plot and Nicolls chart can also be used to assess what would be considered to be a good performance.

It is fully recognised that this area requires further work. The formation of an Expert Group who will be tasked with developing a “GB Grid Forming Best Practice Guide” will be looking into this area in more detail, in particular in assessing what would be an acceptable level of performance that is beneficial to the AC Grid in addition to developing some worked examples. The data in Annex 9 and Annex 18 has data on NFP plots with proposals for a possible set of acceptance levels that need to be reviewed by the Expert Group.

The Grid Code legal drafting has been developed to state that an equivalent to an NFP Plot can be submitted if this can demonstrate the performance of the plant and does not cause any undue interactions with the system or other User’s plant.

### **Compliance and Testing**

A considerable amount of time was spent on discussing the compliance simulations, tests and monitoring requirements. These were covered in particular in meetings 2 and 3 and form part of the proposed solution as discussed above.

### **Overall System Need**

As has been noted it is not within the remit of the GC0137 workgroup to develop the Grid Forming or short term Stability Market but simply to define the minimum specification.

At the outset, the basic requirement is to replace the capabilities traditionally provided by synchronous generators by other sources, including converter-based plant. The first part of that process is to develop a minimum specification. The Grid Code specification has been designed to be as flexible and as transparent as possible so that when a market is developed it will enable a wide range of providers to participate (should they wish to do so) and offer a range of capabilities. It does however need to be emphasised that where stability services were traditionally provided for free (as an inherent feature of synchronous generation) these services will in future need to be paid for as an additional service which would all be part and parcel of operating a safe, secure and economical transmission system.

Initial System studies indicate that in order to secure the system there is a need to i) have a minimum volume of Grid Forming capability at a National Level in order to limit rate of change of frequency (RoCoF) and ii) a minimum volume of Grid Forming Capability to limit local RoCoF, Vector Shift and maintain a sufficient post fault voltage profile. The volumes of Grid Forming will vary from operational condition to operational condition.

The work of the EFCC development has provided data on how the RoCoF rate varies at different locations during a power transient. Annex 9 and Annex 18 contains data on the maximum RoCoF rate that can occur on a local level versus the average grid level. This includes the evaluation of the required minimum inertia in a local zone and the local minimum rating of the local RoCoF response power and the local Phase jump power. This

data does not affect the issue of this document, but it is relevant to the associated SQSS standards.

As to how this would develop as a market is for further discussion through a separate piece of work, but one way it could develop is through the arrangement shown in Figure 14 below where the ESO determine the requirement for Grid Forming at the day ahead stage and then build up this requirement through a range of commercial arrangements.

This work also needs to consider the optimal way of implementing the GBGF technology for Offshore wind farms as providing the GBGF-I technology may be required on the land based grid connection point rather than in the offshore system. It is also noted that all forms of technology including Smart Loads and V2G systems are also able to participate in this market so long as they can meet the minimum technical requirements.

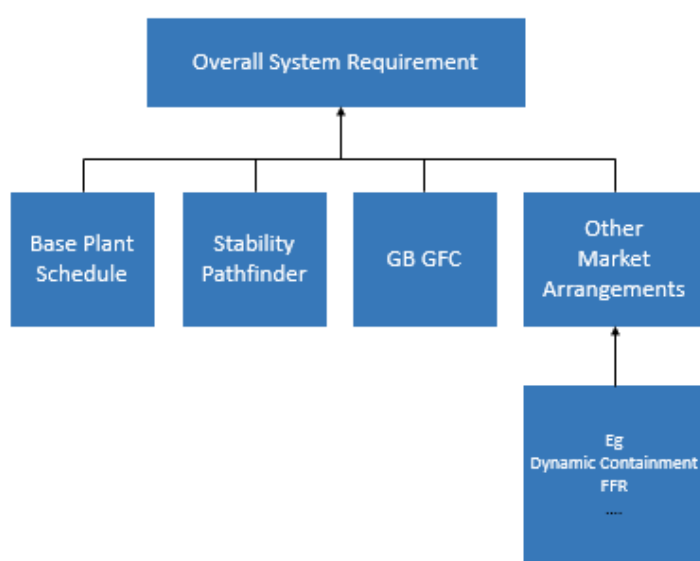

Figure 14

As part of the Workgroup Consultation one respondent noted that most converter based renewable generation cannot provide any sustained reserve power, unless their output is deliberately curtailed most of the time which is economically or environmentally inefficient. Greater use of fast demand side response services could provide an alternative grid stability service in case of unplanned loss of generation. We note this comment but would add several points. In GB there is currently a Frequency Response Market which rewards participants for providing frequency response and this provision allows market participants to factor in compensation arrangements when plant is de-loaded. In addition, the market arrangements are designed to be stacked so certain types of plant may only wish to provide certain types of Balancing Services. In the case of Grid Forming this is a non-mandatory requirement and therefore the provision of Grid Forming may be attractive to certain developers (e.g. a wind farm) during periods when the wind output is high and the demand is low, in which case provision of this service may be an attractive alternative to being curtailed. The choice will however very much depend on the developer and their plant type, solar plants with batteries for example may find the ability to provide Grid Forming a very attractive proposition.

### **Quality of Supply**

As part of the discussion it was noted that Grid Forming Plant's, especially those comprising Power Electronic Converters have the capability to improve power quality



rather than simply having to comply with a set of limits. So far as the legal drafting is concerned, a Grid Forming Plant would have to meet the existing Power Quality requirements defined in CC/ECC.6.1.5, 6.1.6 and 6.1.7 however an enhanced requirement could be specified in the Bilateral Agreement. It is noted that this provides an opportunity for enhanced power quality at a time when the number of switching devices are growing with ever higher switching frequencies. As this is an area requiring further work it is considered the current proposed approach of defining the minimum requirements in the Grid Code with an enhanced requirement in the Bilateral Agreement may be the most flexible approach, especially when the issue of Power Quality and improved performance could be picked up through the GB Grid Forming Expert Group who will be developing a “Best Practice Guide”.

One particular Quality of Supply standard that needs to be addressed is the harmonic standards between 5 kHz and 150 KHz as many GBGF-I systems emit harmonic currents in this frequency range and there is a lack of an emission standard in this frequency range.

### **Reactance**

A number of questions were raised regarding the reactance between the internal voltage source and the connection point. This issue stems from the initial drafting which included words to the effect “operating as a voltage source behind an effective reactance”. This caused some confusion as it did not make it clear whether this requirement could be made up from a virtual impedance implemented in software, a real impedance or series of impedances or a combination of the two. The legal text has been updated to clarify that this requirement should only be with respect to real impedances, so the text now states, “operating as a voltage source behind a real reactance”. As a condition of this specification, software which acts to control the Internal Voltage Source (IVS) to produce an equivalent to real impedance that we call synthetic impedance is not desirable as it requires high bandwidths which affects the Internal Voltage Source. As such the legal text was clarified to address this concern. If a developer knows the actual real impedance values of the IVS they can be used in the equations.

As part of this document, Enstore prepared a guide for GB Grid Forming Converters. A version issued with the Workgroup Consultation in March 2021 is included in Annex 9 and a more up to date version reflecting the terms used in the final legal drafting is included in Annex 18. The Enstore guide had several intended outcomes in mind:

- Includes technical details around the complexities and practical application of Grid Forming technologies, in particular Grid Forming technologies using power electronic converters.
- Provides data on GB Grid Forming converter design
- Provides an overview of the design requirements and why certain parameters are necessary from a Grid perspective including RoCoF events, ROCOF Response Power (including droop modes), Phase Jump Power and Damping Power.
- Provides details on fast fault current injection and phase withstand limits
- Compares VSM and VSMOH designs and the merits of the two
- Describes simulation models and analysis techniques
- Describes simulation, testing and monitoring
- Provides significant commentary on Network Frequency Perturbation Plots in terms of acceptable performance which will be invaluable for the Expert Group in developing the “Best Practice Guide”
- Clarifies queries raised during workgroup sessions (see Annex 7 “Chat Log” as the basis for much of this discussion) and improving the legal text developed at each stage of the GC0137 modification process.

### **Consideration of the proposer's solution**

The proposer's solution builds on an extensive volume of work but in principle the solution has been developed from the following sources: -

- The VSM Expert Group and associated research papers included in the Reference section of this document
- Grid Code Modification GC0100
- International Experience – see below
- Enstore's Guidance note
- Comments received from Stakeholders during the meeting and subsequently as part of the request for comments

### **GB Grid Forming Best Practice Expert Group**

In the Proposer's view although it will not form part of the solution being proposed within this modification (and therefore is only included for additional context), the Workgroup during its advanced stages identified a need for more technical information. This would generally take the form of "guidance" rather than the more functional requirements which typically would be included in the Grid Code. The advantage of this approach is that a guidance document has greater flexibility in taking developers through the thinking of the Grid Code specification and what is expected from them. It also offers the advantage of including worked examples as well as having the flexibility to be updated in the light of ongoing industrial experience. This provides the benefit that the Grid Code can remain relatively static and simply provide the functional specification and a guidance note can then contain further technical details.

The ESO has committed to establishing an Expert Group whose task will be to develop a GB Grid Forming Best Practice Guide. The group will be formed with the input of industry stakeholders and the ESO in order to provide guidance on examples of good performance relating to GB Grid Forming solutions. This is expected to include for example the derivation of Network Frequency Perturbation (NFP) Plots or an appropriate equivalent alternative together with worked examples and what would be judged to be an adequate level of performance.

### **The discussions will focus on:**

- Basic operation
- Models
- Data requirements and formats for submission
- Analysis techniques (e.g. NFP plots or otherwise)
- NFP plot features that are beneficial to the Grid
- NFP plot features that are incompatible with the Grid
- Timelines for producing the guidance document
- Monitoring and Testing
- Worked examples
- International Experience

It is intended that the best practice Expert Group will run slightly behind the GC0137 Grid Code work but in practical terms would be broadly in parallel. The important point here is that the GC0137 Modification is not contingent on the issue of the GB Grid Forming Best Practice Guide. The first Expert Group Meeting was held on 1 July 2021.

### **International experience**

GC0137 is just one part of a global push for new technology. The technology is being considered throughout the world and there are multiple other projects which are assessing the benefits of Grid Forming and Virtual Synchronous Machine technologies. Many other countries are at an advanced stage of addressing inertia-related challenges, but GB is making strong progress addressing wider issues such as fast fault current injection, limiting vector shift, ensuring adequate post fault voltage profiles and the management of short circuit levels. All these are very important in ensuring a stable Grid. In GB this is especially important bearing in mind the Transmission System is comparatively small when compared to other Systems such as the wider European System or that in the United States.

The reference section of this document provides some very useful references and reading. In addition to the list below indicates some of the international research that has been undertaken in this area.

### **European Projects**

- 1) EU - Project Migrate –  
<https://www.h2020-migrate.eu/about.html>
- 2) EU – ENTSO-E – High Penetration of Power Electronic Interfaced Power Sources and the Potential Contribution of Grid Forming Converters -  
<https://eepublicdownloads.entsoe.eu/clean-documents/Publications/SOC/High Penetration of Power Electronic Interfaced Power Sources and the Potential Contribution of Grid Forming Converters.pdf>
- 3) Fraunhofer Institute for Energy and Economics and Energy Technology IEE  
[https://www.iee.fraunhofer.de/content/dam/iee/energiesystemtechnik/en/documents/FactSheet\\_e/2018\\_FS\\_Grid\\_forming\\_inverter\\_pp\\_web.pdf](https://www.iee.fraunhofer.de/content/dam/iee/energiesystemtechnik/en/documents/FactSheet_e/2018_FS_Grid_forming_inverter_pp_web.pdf)

### **CIGRE**

- 4) CIGRE Study Committee B4.84  
Feasibility study and application of electric energy storage systems embedded in HVDC systems  
[https://b4.cigre.org/userfiles/files/TOR/TOR-WG%20B4\\_84\\_Approved.pdf](https://b4.cigre.org/userfiles/files/TOR/TOR-WG%20B4_84_Approved.pdf)
- 5) CIGRE Study Committee B4.87, “Voltage Sourced Converter (VSC) HVDC responses to disturbances and faults in AC systems with low synchronous generation”  
([https://b4.cigre.org/userfiles/files/TOR/TOR%20WG%20B4\\_87\\_Approved.pdf](https://b4.cigre.org/userfiles/files/TOR/TOR%20WG%20B4_87_Approved.pdf))
- 6) CIGRE Study Committee B4.77, “AC Fault response options for VSC HVDC Converters” – Task Force
- 7) CIGRE Study Committee B4.81, “Interaction between nearby VSC-HVDC converters, FACTS devices, HV power electronic devices and conventional AC equipment”  
([https://b4.cigre.org/userfiles/files/WG\\_Membership/WG\\_MEMBERSHIP\\_B4\\_81.pdf](https://b4.cigre.org/userfiles/files/WG_Membership/WG_MEMBERSHIP_B4_81.pdf))
- 8) CIGRE Study Committee C2.B4.38, “Capabilities and requirements definition for Power Electronics based technology for secure and efficient system operation and

control” ([https://b4.cigre.org/userfiles/files/TOR/TOR-JWG%20C2B4\\_38\\_Approved.pdf](https://b4.cigre.org/userfiles/files/TOR/TOR-JWG%20C2B4_38_Approved.pdf)) \*\*\*

- 9) CIGRE Study Committee C4.B4.52, “Guidelines for Sub-synchronous Oscillation studies in Power Electronics dominated power systems” ([https://b4.cigre.org/userfiles/files/TOR/TOR-JWG%20C4\\_B4\\_52\\_Approved.pdf](https://b4.cigre.org/userfiles/files/TOR/TOR-JWG%20C4_B4_52_Approved.pdf))
- 10) CIGRE Study Committee B4.64, “Impact of AC system characteristics on the performance of HVDC schemes” ([https://b4.cigre.org/userfiles/files/TOR/TOR%20B4-64\\_approved.pdf](https://b4.cigre.org/userfiles/files/TOR/TOR%20B4-64_approved.pdf))

### **United States**

- 11) IEEE – Draft Standard for Interconnection and Interoperability of Inverter-Based Resources (IBR) Interconnecting and Associated Transmission Electric Power Systems <https://standards.ieee.org/project/2800.html>
- 12) ESIG – Energy Systems Integration Group <https://www.esig.energy/event/2021-spring-technical-workshop/>
- 13) Reliability Guideline Performance, Modelling, and Simulations of BPS Connected Battery Energy Storage Systems and Hybrid Power Plants March 2021 NERC Document available at:- [Report \(nerc.com\)](https://www.nerc.com)

### **Consideration of other options**

As part of this work the ESO has tried very hard to incorporate stakeholders’ comments into this modification in addition to relying on the extensive range of research and material available.

As each meeting has progressed the specification has been updated and refined to reflect Stakeholders comments.

### **Further Considerations**

As noted, this GC0137 work aims to define a minimum specification for Grid Forming in Great Britain.

As part of this Workgroup, two points were raised which fall outside the “Terms of Reference” of this modification but need to reflect in other work areas. These are: -

- i) GB Grid Forming (GF) provides a number of benefits for the system operation that go beyond the usual recognised inertia capabilities. In order to incentivise the participation of a wider range of technologies, the remuneration incentive around GB GF should be flexible and remunerate each of these capabilities. Avoiding a black and white approach that may push back providers that are unable to fulfil the full extent of the specification will be critical for the success of the roll-out of GB GF. Whilst the specification has been designed to be a flexible as possible, so that developers supply the capability of their plant available to them this wider issue is something that will need to be addressed by the group tasked with designing and developing the market arrangements.
- ii) The treatment of Offshore Systems was noted, in particular the difficulties of Offshore Transmission Owners (OFTO’s) from owning Storage Systems. As part of the discussions, Workgroup Members are aware of the wider Offshore developments taking place and suggest this issue is taken away for the National

Grid ESO to take this away and discuss it more widely as part of the Offshore arena with Stakeholders in addition to BIES and Ofgem.

### **Legal text**

The final legal text for this change can be found in Annex 19.

## **What is the impact of this change?**

In the Proposer's view so far, it is understood that there should be no impact on any other codes although there is some scope that similar arrangements could be applied to the Distribution Code. That said, this issue is potentially limited as the arrangements are not mandatory and open to CUSC as well and Non-CUSC Parties. The requirement for a sufficient volume of Grid Forming Capability will be necessary on a regional level which will be equally applicable for distribution networks, particularly in managing issues such as vector shift, local RoCoF and the maintenance of post fault voltage profiles following a fault or disturbance.

In the Proposer's view whilst subsequent commercial arrangements are expected to eventually lead to a commercial market it is therefore likely that in the future there could be a change to the commercial codes or a separate commercial framework. For the time being however this modification is only looking to change the Grid Code in order facilitate a minimum Grid Forming specification, however this change is a fundamental to a much larger piece of work which will eventually lead to a short term Stability market which will be essential to achieving a target of zero carbon system operation by 2025 in an economic manner.

In the Proposer's view it is also worth noting that the technical detail will sit in a Best Practice Guidance Note which will be developed by a separate Expert Group.

### **Proposer's assessment against Code Objectives**

In the Proposer's view the principle benefit of the proposed changes within this modification is that it will provide the basis for the formation of a new market-based commercial arrangement. With the GB Grid Forming specification being relatively high-level as a minimum entry point, it will mean a broader range of prospective participants will find themselves presented with a new potential revenue-source to consider. The cost to the ESO should be kept to a necessary minimum, as the financial incentives for participants should drive the market to settle at its natural economically balanced point. Beyond these commercial considerations, a strong uptake of provision of Grid Forming Capability will add to the stability of the Grid through effectively replacing some of the traditional inertia with a viable and relatively future-proofed alternative. This, in turn, will enable the ESO to continue discharging its licensing obligations.

The proposal is designed to be flexible, enabling participation in both new and more traditional technologies whilst also enabling providers to participate in a number of other Balancing Services over and above other Grid Forming.

### **Workgroup vote**

The Workgroup met on 21 June 2021 to carry out their Workgroup vote in respect of the solution and legal text. The full Workgroup vote can be found in Annex 20. The table below

provides a summary of the Workgroup members view on the best option to implement this change.

The Workgroup concluded unanimously (17 out of 18 votes) that the Original better facilitated the Applicable Objectives than the Baseline.

## **Code Administrator Consultation summary**

The Code Administrator Consultation was issued on the 3 September 2021 and closed on 4 October 2021 and received 7 non-confidential responses. The full responses can be found in Annex 21. In summary:

- All 7 respondents supported the change with 3 of these respondents specifically noting this better facilitates Grid Code Objectives a, b and c than the current Grid Code.
- All 7 respondents either fully or partially supported the implementation approach. 3 of these respondents highlighted their support for this being non-mandatory as this would promote the use of market based arrangements. There were a number of general comments on some of the technical specifications that need to be developed further. We have since spoken to the Proposer and noted that there is a separate Expert Group, which would cover the more detailed aspects including testing, modelling, performance etc with the aim of which is to provide a Best Practice Guide as it is acknowledged that the Grid Code legal drafting is not a detailed functional specification.
- 1 respondent requested that the ESO also consider other equipment such as synchronous condensers to mitigate any localised inertia or low fault level issues. The Proposer has since contacted the respondent directly on this and noted that GC0137 specification does include synchronous condensers (Dynamic Reactive Compensation Equipment) as they would be considered to provide a Grid Forming Capability.
- 1 respondent provided some personal thoughts on the conclusions of the Workgroup but has since been notified that the Workgroup phase has concluded and, except for clear typographical changes, these thoughts will not be added to the body of this document.
- The following legal text changes were proposed:
  - In *Glossary and Definitions under Network Frequency Perturbation Plot* change “Apparent Power” to “Active Power”.
  - In *Part 5: OTSDUW Data and Information* change “aAnd” to “and”.
  - In *ECP.A.1.10*, change “aGrid” to “a Grid”.
  - Change reference at the bottom of the figure in section ECC.6.3.19.5 from “Figure ECC.16.3.19.5(b)” to “Figure ECC.6.3.19.5(b)”

These changes will be presented to Panel for them to agree next steps. Options available to Panel are:

- Agree that these changes are typographical and ask that legal text to be amended prior to sending the Final Modification Report to Ofgem; or
- Agree that some or all of these changes are not needed; or
- Direct the Workgroup to review the changes.

### **Panel recommendation vote**

The Panel met on the 27 October 2021 to carry out their recommendation vote. They assessed whether a change should be made to the Grid Code by assessing the proposed change and any alternatives against the Applicable Objectives.

**Vote 1:** Does the Original, facilitate the objectives better than the Baseline?

Panel Member: **Alan Creighton: Northern Power Grid**

	Better facilitates AO (a)?	Better facilitates AO (b)?	Better facilitates AO (c)?	Better facilitates AO (d)?	Better facilitates AO (e)?	Overall (Y/N)
Original						
Voting Statement						

**Vote 1:** Does the Original, facilitate the objectives better than the Baseline?

Panel Member: **Alastair Frew: Drax**

	Better facilitates AO (a)?	Better facilitates AO (b)?	Better facilitates AO (c)?	Better facilitates AO (d)?	Better facilitates AO (e)?	Overall (Y/N)
Original						
Voting Statement						

**Vote 1:** Does the Original, facilitate the objectives better than the Baseline?

Panel Member: **Christopher Smith: National Grid Viking Link**

	Better facilitates AO (a)?	Better facilitates AO (b)?	Better facilitates AO (c)?	Better facilitates AO (d)?	Better facilitates AO (e)?	Overall (Y/N)
Original						
Voting Statement						

**Vote 1:** Does the Original, facilitate the objectives better than the Baseline?

Panel Member: **Guy Nicholson: Statkraft**

	Better facilitates AO (a)?	Better facilitates AO (b)?	Better facilitates AO (c)?	Better facilitates AO (d)?	Better facilitates AO (e)?	Overall (Y/N)

Original						
Voting Statement						

**Vote 1:** Does the Original, facilitate the objectives better than the Baseline?

Panel Member: **John Harrower: SSE**

	Better facilitates AO (a)?	Better facilitates AO (b)?	Better facilitates AO (c)?	Better facilitates AO (d)?	Better facilitates AO (e)?	Overall (Y/N)
Original						
Voting Statement						

**Vote 1:** Does the Original, facilitate the objectives better than the Baseline?

Panel Member: **Rob Wilson: National Grid ESO**

	Better facilitates AO (a)?	Better facilitates AO (b)?	Better facilitates AO (c)?	Better facilitates AO (d)?	Better facilitates AO (e)?	Overall (Y/N)
Original						
Voting Statement						

**Vote 1:** Does the Original, facilitate the objectives better than the Baseline?

Panel Member: **Robert Longden: Cornwall Energy**

	Better facilitates AO (a)?	Better facilitates AO (b)?	Better facilitates AO (c)?	Better facilitates AO (d)?	Better facilitates AO (e)?	Overall (Y/N)
Original						
Voting Statement						

**Vote 1:** Does the Original, facilitate the objectives better than the Baseline?

Panel Member: **Roddy Wilson: SHE Transmission**

	Better facilitates AO (a)?	Better facilitates AO (b)?	Better facilitates AO (c)?	Better facilitates AO (d)?	Better facilitates AO (e)?	Overall (Y/N)
Original						
Voting Statement						



--

**Vote 1:** Does the Original, facilitate the objectives better than the Baseline?

Panel Member: **Sigrid Bolik: Siemens PLC**

	Better facilitates AO (a)?	Better facilitates AO (b)?	Better facilitates AO (c)?	Better facilitates AO (d)?	Better facilitates AO (e)?	Overall (Y/N)
Original						
Voting Statement						

**Vote 1:** Does the Original, facilitate the objectives better than the Baseline?

Panel Member: **Steve Cox: ENWL**

	Better facilitates AO (a)?	Better facilitates AO (b)?	Better facilitates AO (c)?	Better facilitates AO (d)?	Better facilitates AO (e)?	Overall (Y/N)
Original						
Voting Statement						

**Vote 2 – Which option is the best?**

Panel Member	BEST Option?	Which objectives does this option better facilitate? (If baseline not applicable).
Alan Creighton		
Alastair Frew		
Christopher Smith		
Guy Nicholson		
John Harrower		
Rob Wilson		
Robert Longden		
Roddy Wilson		
Sigrid Bolik		
Steve Cox		

### Panel conclusion

The Panel, **unanimously/ by majority** recommended that the Proposer's solution **should / should** not be implemented.

## When will this change take place?

### Implementation date

Q4 2021 – 10 working days after decision.

### Date decision required by

There is no critical date for the implementation of this modification but the longer it takes for the implementation to be approved, the longer it will take to implement technical solutions and the longer it will take to implement a stability market which in turn will increase operating costs for the system.

### Implementation approach

As currently proposed, there is no impact on systems or processes at the present time as this proposal is defining a minimum Grid Forming Capability. It is only later that there will be an impact on commercial systems when a Stability Market is formed.

## Interactions

Subject to the commentary in the section immediately above, it is understood that there should be no impact on any other codes.

DRAFT

## Acronyms, key terms and reference material

Acronym / key term	Meaning
BSC	Balancing and Settlement Code
CIGRE	Conseil International des Grands Réseaux Electriques
CMP	CUSC Modification Proposal
CUSC	Connection and Use of System Code
EBGL	Electricity Balancing Guideline
ESO	National Grid Electricity System Operator
FFCI	Fast Fault Current Injection
GBGF	Great Britain Grid Forming
GBGF-I	GB Grid Forming Inverter – As defined in the Grid Code Glossary and Definitions
GBGF-S	GB Grid Forming Synchronous – As defined in the Grid Code Glossary and Definitions
IEEE	Institute of Electrical and Electronics Engineers
PLL	Phase Locked Loop
ROCOF	Rate of Change of Frequency
SCL	Short Circuit Level
SQSS	Security and Quality of Supply Standards
STC	System Operator Transmission Owner Code
T&Cs	Terms and Conditions
V2G	Vehicle to Grid
VSM	Virtual Synchronous Machine

### Reference material

- [1] The 2019-2020 National Electricity Transmission System Performance Report  
<https://www.nationalgrideso.com/document/177156/download>
- [2] The Grid Code  
<https://www.nationalgrideso.com/industry-information/codes/grid-code/code-documents>
- [3] National Electricity Transmission System Security and Quality of Supply Standard  
<https://www.nationalgrideso.com/document/141056/download>
- [4] Engineering Recommendation P2/7  
[http://www.dcode.org.uk/assets/files/Qualifying%20Standards/ENA\\_EREC\\_P2\\_Issue%207\\_\(2019\).pdf](http://www.dcode.org.uk/assets/files/Qualifying%20Standards/ENA_EREC_P2_Issue%207_(2019).pdf)
- [5] System Operator Transmission Owner Code  
<https://www.nationalgrideso.com/industry-information/codes/system-operator-transmission-owner-code-stc>
- [6] Distribution Code  
[http://www.dcode.org.uk/assets/uploads/DCode\\_v45\\_20200612.pdf](http://www.dcode.org.uk/assets/uploads/DCode_v45_20200612.pdf)

- [7] Grid Code Modification H/04 - Grid Code Changes to Incorporate New Generation Technologies and DC Inter-connectors (Generic Provisions)
- [8] Grid Code Modification GC0100 – EU Connection Codes GB Implementation – Mod 1  
<https://www.nationalgrideso.com/industry-information/codes/grid-code/modifications/gc0100-eu-connection-codes-gb-implementation-mod>
- [9] H Urdal, A Dahresobh, R Ierna, C Ivanov, J Zhu, D Rostrom et al, System Strength Considerations in a converter Dominated Power System in 12th Wind Integration Workshop London 2013.
- [10] Stability Pathfinder work  
<https://www.nationalgrideso.com/future-of-energy/projects/pathfinders/stability>
- [11] Government White Energy White Paper  
<https://www.gov.uk/government/publications/energy-white-paper-powering-our-net-zero-future>
- [12] System Operability Framework  
<https://www.nationalgrideso.com/research-publications/system-operability-framework-sof>
- [13] Accelerated Loss of Mains Change Programme  
<https://www.ena-eng.org/ALoMCP/>
- [14] National Grid ESO Balancing Services  
<https://www.nationalgrideso.com/industry-information/balancing-services>
- [15] A.J.Roscoe, M.Yu, R.Ierna, H.Urdal, A. Dyško, C.Booth, J.Zhu, et al., “VSM (Virtual Synchronous Machine) Converter Control Model Suitable for RMS Studies for Resolving System Operator/Owner Challenges”, in 15th Wind Integration Workshop, Viena, Austria, 2016
- [16] R.Ierna, A.Roscoe, M. Yu, H. Urdal, A. Dyško, et al., “Effects of VSM Converter Control on Penetration Limits of Non-Synchronous Generation in the GB Power System”, in 15th Wind Integration Workshop, Viena, 2016.
- [17] VSM Expert Group  
<https://www.nationalgrid.com/uk/electricity/codes/grid-code/meetings/vsm-expert-workshop>
- [18] R Ierna, M Sumner, S Pholboon, C Li et al., “VSM (Virtual Synchronous Machine) Control System Design, Implementation, Performance, Models and Possible Implications for Grid Codes, in 18th Wind Integration Workshop, Dublin, 2019
- [19] Dersalloch Wind Farm – Video  
<https://www.youtube.com/watch?v=S2NJCbPg-9I>

- [20] TGN 288 - Limits for Temporary Overvoltages in England and Wales Network  
[https://www.nationalgrid.com/sites/default/files/documents/TGN%28E%29\\_288\\_0.pdf](https://www.nationalgrid.com/sites/default/files/documents/TGN%28E%29_288_0.pdf)
- [21] Grid Code Modification GC0111 – Fast Fault Current Injection Specification Text  
<https://www.nationalgrideso.com/codes/grid-code/modifications/gc0111-fast-fault-current-injection-specification-text>
- [22] National Grid Technical Specification – TS.3.24.70 – Dynamic System Monitoring (DSM)  
<https://www.nationalgrideso.com/document/33196/download>
- [23] Grid Code Modification GC0138 - Compliance process technical improvements  
<https://www.nationalgrideso.com/industry-information/codes/grid-code-old/modifications/gc0138-compliance-process-technical>
- [24] Grid Code Modification GC0141 - Compliance Processes and Modelling amendments following 9th August Power Disruption  
<https://www.nationalgrideso.com/industry-information/codes/grid-code-old/modifications/gc0141-compliance-processes-and-modelling>
- [25] Roscoe, A., Brogan, P., Elliott, D., *et al.*: 'Practical Experience of Operating a Grid Forming Wind Park and its Response to System Events', in '18th Wind Integration Workshop' (2019), p. 7  
<https://knowledge.rtds.com/hc/en-us/articles/360062289033-Practical-Experience-of-Operating-a-Grid-Forming-Wind-Park-and-its-Response-to-System-Events>
- [26] Roscoe, A.J., Brogan, P., Elliott, D., *et al.*: 'Response of a Grid Forming Wind Farm to System Events, and the Impact of External and Internal damping' *IET J. Renew. Power Gener.*, 2021.  
DOI 10.1049/iet-rpg.2020.0638  
<https://digital-library.theiet.org/content/journals/10.1049/iet-rpg.2020.0638>
- [27] Roscoe, A., Brogan, P., Elliott, D., *et al.*: 'Practical Experience of Providing Enhanced Grid Forming Services from an Onshore Wind Park', in '19th Wind Integration Workshop' (2020)

## Annexes

Annex	Information
Annex 1	Proposal form
Annex 2	Terms of reference
Annex 3	Workgroup Meeting 1 - Presentation
Annex 4	Workgroup Meeting 1 Summary
Annex 5	Workgroup Meeting 2 - Presentation
Annex 6	Workgroup Meeting 2 - Summary
Annex 7	Workgroup Meeting 2 – ESO Response to Workgroup Meeting 2 “Chat”
Annex 8	Workgroup Meeting 3 - Presentation
Annex 9	Enstore updated guide for GB Grid Forming Converters – V-004 dated 24 March 2021
Annex 10*	Not Used
Annex 11	SGRE Response to VSM Grid Code Spec V6_AJ010420 - Doc ID: GC0137 20200430 SGRE Response to VSG_Grid_Code_Draft_Specification_V6_AJ010420 R1.docx.docx
Annex 12	Non Confidential Workgroup Consultation Responses to the GC0137 Consultation
Annex 13	Summary of high level responses received following the GC0137 consultation
Annex 14	National Grid ESO’s detailed response to Stakeholders comments on the GC0137 Consultation
Annex 15	National Grid ESO’s detailed comments in response to SGRE (3 parts)
Annex 16*	Not Used
Annex 17*	Not Used
Annex 18	Enstore updated guide for GB Grid Forming Converters – V-005 dated 6 July 2021
Annex 19	Final Legal Text Dated 1 September 2021
Annex 20	Workgroup Vote
Annex 21	Code Administrator Consultation Responses

\*These Annexes contained earlier versions of Legal Text which were subsequently updated as the requirements became more clearly established. Rather than reformatting the report and to avoid confusion to the reader only one set of final legal text appears in this document.