All Recipients of the Serviced Grid Code

Rachel.Beaufoy@nationalgrideso.com
Mob: 07970 992890
www.nationalgrideso.com

03 August 2021

Dear Sir/Madam

THE SERVICED GRID CODE – ISSUE 6 REVISION 4

Issue 6 Revision 4 of the Grid Code has been approved by the Authority for implementation on **03 August 2021**.

In order to ensure your copy of the Grid Code remains up to date, you will need to replace the section affected with the revised version available on the National Grid Electricity System Operator website.

The revisions document provides an overview of the changes made to the Grid Code since the previous issue.

Yours faithfully

Rachel Beaufoy

Frameworks Officer

Code Administrator

Markets

nationalgridESO

M: 07970 992890

Faraday House, Warwick, CV34 6DA

THE GRID CODE – ISSUE 6 REVISION 4

INCLUSION OF REVISED SECTIONS

- Preface
- Glossary Definitions
- Planning Code
- European Connection Conditions
- European Compliance Processes
- Demand Response Services Code
- Operating Code 2
- Balancing Code 4
- Data Registration Code
- Governance Rules

SUMMARY OF CHANGES

The changes arise from the implementation of modifications proposed in the GC0149 Final Modification Report:

- **GC0149 - Grid Code changes to reflect the terms of the UK's departure from the EU**

Summary of GC0149 and Impact:

The proposal aims to ensure that retained EU law functions effectively in the context of the Grid Code following the UK-EU Trade and Cooperation Agreement and the end of the transition period. It will ensure that the Grid Code takes into account the provisions in the relevant Statutory Instruments prepared under the European Union (Withdrawal) Act 2018 (as amended by the European Union (Withdrawal Agreement) Act 2020).

Impact:

Low impact on all grid code parties

THE GRID CODE

ISSUE 6

REVISION 4

03 August 2021

© 2021 Copyright owned by National Grid Electricity System Operator Limited, all rights reserved.

No part of this publication may be reproduced in any material form (including photocopying and restoring in any medium or electronic means and whether or not transiently or incidentally) without the written permission of National Grid Electricity System Operator Limited, except:

1. to the extent that any party who is required to comply (or is exempt from complying) with the provisions under the Electricity Act 1989 reasonably needs to reproduce this publication to undertake its licence or statutory duties within Great Britain (or any agent appointed so to act on that party's behalf); and
2. in accordance with the provisions of the Copyright, Designs and Patents Act 1988.

PREFACE

(P)

(This section does not form part of the Grid Code)

P.1. The Grid Code sets out the operating procedures and principles governing the relationship between **The Company** and all Users of the **National Electricity Transmission System**, be they **Generators**, **DC Converter** owners, **Suppliers** or **Non-Embedded Customers**. The Grid Code specifies day-to-day procedures for both planning and operational purposes and covers both normal and exceptional circumstances.

P.2 The Grid Code is designed to:

- (i) permit the development, maintenance and operation of an efficient, coordinated and economical system for the transmission of electricity;
- (ii) facilitate competition in the generation and supply of electricity (and without limiting the foregoing, to facilitate the national electricity transmission system being made available to persons authorised to supply or generate electricity on terms which neither prevent nor restrict competition in the supply or generation of electricity);
- (iii) promote the security and efficiency of the electricity generation, transmission and distribution systems in the national electricity transmission system operator area taken as a whole; and
- (iv) efficiently discharge the obligations imposed upon the licensee by this license and to comply with the **Electricity Regulation** and any relevant **Legally Binding Decisions of the European Commission and/or the Agency**.

and is conceived as a statement of what is optimal (particularly from a technical point of view) for all **Users** and **The Company** itself in relation to the planning, operation and use of the **National Electricity Transmission System**. It seeks to avoid any undue discrimination between **Users** and categories of **Users**.

P.3 The Grid Code is divided into the following sections:

- (a) a **Planning Code** which provides generally for the supply of certain information by **Users** in order for **The Company** to undertake the planning and development of the **National Electricity Transmission System**;
- (b) the **Connection Conditions** which specify minimum technical, design and operational criteria which must be complied with by **The Company** at **Connection Sites** and by **Users** connected to or seeking connection with the **National Electricity Transmission System** or by **Generators** (other than in respect of **Small Power Stations**) or **DC Converter** owners, connected to or seeking connection to a **User's System**;
- (c) the **Compliance Processes** which specify the process that must be followed by **The Company** and any **Generator** or **DC Converter Station** owner to demonstrate its compliance with the Grid Code in relation to its **Plant** and **Apparatus**.

- (d) an **Operating Code**, which is split into a number of sections and deals with **Demand** forecasting (**OC1**); the co-ordination of the outage planning process in respect of **Large Power Stations**, the **National Electricity Transmission System** and **User Systems** for construction, repair and maintenance, and the provision of certain types of **Operating Margin** data (**OC2**); testing and monitoring of **Users** (**OC5**); different forms of reducing **Demand** (**OC6**); the reporting of scheduled and planned actions, and unexpected occurrences such as faults (**OC7**); the co-ordination, establishment and maintenance of **Isolation** and **Earthing** in order that work and/or testing can be carried out safely (**OC8**); certain aspects of contingency planning (**OC9**); the provision of written reports on occurrences such as faults in certain circumstances (**OC10**); the procedures for numbering and nomenclature of **HV Apparatus** at certain sites (**OC11**); and the procedures for the establishment of **System Tests** (**OC12**);
- (e) a **Balancing Code**, which is split into three sections and deals with the submission of **BM Unit Data** from **BM Participants**, and of certain other information, for the following day and ahead of **Gate Closure** (**BC1**); the post **Gate Closure** process (**BC2**); and the procedures and requirements in relation to **System Frequency** control (**BC3**);
- (f) a **Data Registration Code**, which sets out a unified listing of all data required by **The Company** from **Users**, and by **Users** from **The Company**, under the Grid Code;
- (g) **General Conditions**, which are intended to ensure, so far as possible, that the various sections of the Grid Code work together and work in practice and include provisions relating to the establishment of a **Grid Code Review Panel** and other provisions of a general nature.

P.4

This Preface is provided to **Users** and to prospective **Users** for information only and does not constitute part of the Grid Code.

< END OF PREFACE >

GLOSSARY & DEFINITIONS (GD)

GD.1 In the Grid Code the following words and expressions shall, unless the subject matter or context otherwise requires or is inconsistent therewith, bear the following meanings:

Access Group	<p>A group of Connection Points within which a User declares under the Planning Code</p> <p>(a) An interconnection and/or</p> <p>(b) A need to redistribute Demand between those Connection Points either pre-fault or post-fault</p> <p>Where a single Connection Point does not form part of an Access Group in accordance with the above, that single Connection Point shall be considered to be an Access Group in its own right.</p>
Access Period	<p>A period of time in respect of which each Transmission Interface Circuit is to be assessed as whether or not it is capable of being maintained as derived in accordance with PC.A.4.1.4. The period shall commence and end on specified calendar weeks.</p>
Act	<p>The Electricity Act 1989 (as amended by the Utilities Act 2000 and the Energy Act 2004).</p>
Active Energy	<p>The electrical energy produced, flowing or supplied by an electric circuit during a time interval, being the integral with respect to time of the instantaneous power, measured in units of watt-hours or standard multiples thereof, ie:</p> <p>1000 Wh = 1 kWh</p> <p>1000 kWh = 1 MWh</p> <p>1000 MWh = 1 GWh</p> <p>1000 GWh = 1 TWh</p>
Active Power	<p>The product of voltage and the in-phase component of alternating current measured in units of watts and standard multiples thereof, ie:</p> <p>1000 Watts = 1 kW</p> <p>1000 kW = 1 MW</p> <p>1000 MW = 1 GW</p> <p>1000 GW = 1 TW</p>

Additional BM Unit	Has the meaning as set out in the BSC
Affiliate	In relation to any person, any holding company or subsidiary of such person or any subsidiary of a holding company of such person, in each case within the meaning of Section 736, 736A and 736B of the Companies Act 1985 as substituted by section 144 of the Companies Act 1989 and, if that latter section is not in force at the Transfer Date , as if such section were in force at such date.
AF Rules	Has the meaning given to “allocation framework” in section 13(2) of the Energy Act 2013.
Agency	As defined in The Company’s Transmission Licence .
Aggregator	A BM Participant who controls one or more Additional BM Units or Secondary BM Units .
Aggregator Impact Matrix	Defined for an Additional BM Unit or a Secondary BM Unit . Provides data allowing The Company to model the result of a Bid-Offer Acceptance on each of the Grid Supply Points within the GSP Group over which the Additional BM Unit or Secondary BM Unit is defined.
Alternate Member	Shall mean an alternate member for the Panel Members elected or appointed in accordance with this GR.7.2(a) or (b).
Ancillary Service	A System Ancillary Service and/or a Commercial Ancillary Service , as the case may be. An Ancillary Service may include one or more Demand Response Services .
Ancillary Services Agreement	An agreement between a User and The Company for the payment by The Company to that User in respect of the provision by such User of Ancillary Services .
Annual Average Cold Spell Conditions or ACS Conditions	A particular combination of weather elements which gives rise to a level of peak Demand within a Financial Year which has a 50% chance of being exceeded as a result of weather variation alone.
Apparatus	Other than in OC8 , means all equipment in which electrical conductors are used, supported or of which they may form a part. In OC8 , it means High Voltage electrical circuits forming part of a System on which Safety Precautions may be applied to allow work and/or testing to be carried out on a System .
Apparent Power	The product of voltage and of alternating current measured in units of voltamperes and standard multiples thereof, ie: 1000 VA = 1 kVA 1000 kVA = 1 MVA
Approved Fast Track Proposal	Has the meaning given in GR.26.7, provided that no objection is received pursuant to GR.26.12.

Approved Grid Code Self-Governance Proposal	Has the meaning given in GR.24.10.
Approved Modification	Has the meaning given in GR.22.7
Authorised Certifier	An entity that issues Equipment Certificates and Power Generating Module Documents and whose accreditation is given by the United Kingdom Accreditation Service or such other body as may be established from time to time to carry out the function of accreditation.
Authorised Electricity Operator	Any person (other than The Company) who is authorised under the Act to generate, participate in the transmission of, distribute or supply electricity which shall include any Interconnector Owner or Interconnector User .
Authority-Led Modification	A Grid Code Modification Proposal in respect of a Significant Code Review , raised by the Authority pursuant to GR.17
Authority-Led Modification Report	Has the meaning given in GR.17.4.
Authority for Access	An authority which grants the holder the right to unaccompanied access to sites containing exposed HV conductors.
Authority, The	The Authority established by section 1 (1) of the Utilities Act 2000.
Automatic Voltage Regulator or AVR	The continuously acting automatic equipment controlling the terminal voltage of a Synchronous Generating Unit or Synchronous Power Generating Module by comparing the actual terminal voltage with a reference value and controlling by appropriate means the output of an Exciter , depending on the deviations.
Auxiliaries	Any item of Plant and/or Apparatus not directly a part of the boiler plant or Power Generating Module or Generating Unit or DC Converter or HVDC Equipment or Power Park Module , but required for the boiler plant's or Power Generating Module's or Generating Unit's or DC Converter's or HVDC Equipment's or Power Park Module's functional operation.
Auxiliary Diesel Engine	A diesel engine driving a Power Generating Module or Generating Unit which can supply a Unit Board or Station Board , which can start without an electrical power supply from outside the Power Station within which it is situated.
Auxiliary Gas Turbine	A Gas Turbine Unit , which can supply a Unit Board or Station Board , which can start without an electrical power supply from outside the Power Station within which it is situated.
Average Conditions	That combination of weather elements within a period of time which is the average of the observed values of those weather elements during equivalent periods over many years (sometimes referred to as normal weather).
Back-Up Protection	A Protection system which will operate when a system fault is not cleared by other Protection .

Balancing and Settlement Code or BSC	The code of that title as from time to time amended.
Balancing Code or BC	That portion of the Grid Code which specifies the Balancing Mechanism process.
Balancing Mechanism	Has the meaning set out in The Company's Transmission Licence
Balancing Mechanism Reporting Agent or BMRA	Has the meaning set out in the BSC .
Balancing Mechanism Reporting Service or BMRS	Has the meaning set out in the BSC .
Balancing Principles Statement	A statement prepared by The Company in accordance with Condition C16 of The Company's Transmission Licence .
Baseline Forecast	Has the meaning given to the term 'baseline forecast' in Section G of the BSC .
Bid-Offer Acceptance	(a) A communication issued by The Company in accordance with BC2.7; or (b) an Emergency Instruction to the extent provided for in BC2.9.2.3.
Bid-Offer Data	Has the meaning set out in the BSC .
Bilateral Agreement	Has the meaning set out in the CUSC .
Black Start	The procedure necessary for a recovery from a Total Shutdown or Partial Shutdown .
Black Start Capability	In the case of a Black Start Station , is the ability for at least one of its Gensets to Start-Up from Shutdown and to energise a part of the System and be Synchronised to the System upon instruction from The Company , within two hours, without an external electrical power supply. In the case of a Black Start HVDC System is the ability of an HVDC System to Start-Up from Shutdown and to energise a part of the System and be Synchronised to the System upon instruction from The Company , within two hours, without an external electrical power supply from the GB Synchronous Area .
Black Start Contract	An agreement between a Black Start Service Provider and The Company under which the Black Start Service Provider provides Black Start Capability and other associated services;
Black Start HVDC System	An HVDC System or DC Converter Station which are registered, pursuant to the Bilateral Agreement with a User , as having a Black Start Capability .
Black Start HVDC Test	A Black Start Test carried out by an HVDC System Owner or DC Converter Station Owner with a Black Start HVDC System while the Black Start HVDC System is disconnected from all external electrical power supplies from the GB Synchronous Area .
Black Start Service Provider	A Generator with a Black Start Station or an HVDC System Owner or DC Converter Station Owner with a Black Start HVDC System .

Black Start Stations	Power Stations which are registered, pursuant to the Bilateral Agreement with a User , as having a Black Start Capability .
Black Start Station Test	A Black Start Test carried out by a Generator with a Black Start Station while the Black Start Station is disconnected from all external electrical power supplies from the GB Synchronous Area .
Black Start Test	A Black Start Test carried out by a Black Start Service Provider on the instructions of The Company , in order to demonstrate that a Black Start Station or a Black Start HVDC System has a Black Start Capability . For the avoidance of doubt, a Black Start Test could comprise a Black Start Station Test , a Black Start Unit Test or Black Start HVDC Test .
Black Start Unit Test	A Black Start Test carried out on a Generating Unit or a CCGT Unit or a Power Generating Module , as the case may be, at a Black Start Station while the Black Start Station remains connected to an external alternating current electrical supply.
Block Loading Capability	The incremental Active Power steps, from no load to Rated MW , which a Generating Unit or Power Generating Module or Power Park Module or HVDC System or DC Converter Station can instantaneously supply without causing it to trip or go outside the Frequency range of 47.5Hz – 52Hz (or an otherwise agreed Frequency range). The time between each incremental step shall also be provided.
BM Participant	A person who is responsible for and controls one or more BM Units or where a Bilateral Agreement specifies that a User is required to be treated as a BM Participant for the purposes of the Grid Code. For the avoidance of doubt, it does not imply that they must be active in the Balancing Mechanism .
BM Unit	Has the meaning set out in the BSC , except that for the purposes of the Grid Code the reference to “Party” in the BSC shall be a reference to User .
BM Unit Data	The collection of parameters associated with each BM Unit , as described in Appendix 1 of BC1 .
Boiler Time Constant	Determined at Registered Capacity or Maximum Capacity (as applicable), the boiler time constant will be construed in accordance with the principles of the IEEE Committee Report "Dynamic Models for Steam and Hydro Turbines in Power System Studies" published in 1973 which apply to such phrase.
British Standards or BS	Those standards and specifications approved by the British Standards Institution.
BSCCo	Has the meaning set out in the BSC .
BSC Panel	Has meaning set out for “Panel” in the BSC .
Black Start Unit Test	A Black Start Test carried out on a Generating Unit or a CCGT Unit or a Power Generating Module , as the case may be, at a Black Start Station while the Black Start Station remains connected to an external alternating current electrical supply.

Business Day	Any week day (other than a Saturday) on which banks are open for domestic business in the City of London.
Cancellation of National Electricity Transmission System Warning	The notification given to Users when a National Electricity Transmission System Warning is cancelled.
Capacity Market Documents	The Capacity Market Rules , The Electricity Capacity Regulations 2014 and any other Regulations made under Chapter 3 of Part 2 of the Energy Act 2013 which are in force from time to time.
Capacity Market Rules	The rules made under section 34 of the Energy Act 2013 as modified from time to time in accordance with that section and The Electricity Capacity Regulations 2014.
Cascade Hydro Scheme	Two or more hydro-electric Generating Units , owned or controlled by the same Generator , which are located in the same water catchment area and are at different ordnance datums and which depend upon a common source of water for their operation, known as: <ul style="list-style-type: none"> (a) Moriston (b) Killin (c) Garry (d) Conon (e) Clunie (f) Beaully which will comprise more than one Power Station .
Cascade Hydro Scheme Matrix	The matrix described in Appendix 1 to BC1 under the heading Cascade Hydro Scheme Matrix .
Category 1 Intertripping Scheme	A System to Generator Operational Intertripping Scheme arising from a Variation to Connection Design following a request from the relevant User which is consistent with the criteria specified in the Security and Quality of Supply Standard .
Category 2 Intertripping Scheme	A System to Generator Operational Intertripping Scheme which is:- <ul style="list-style-type: none"> (i) required to alleviate an overload on a circuit which connects the Group containing the User's Connection Site to the National Electricity Transmission System; and (ii) installed in accordance with the requirements of the planning criteria of the Security and Quality of Supply Standard in order that measures can be taken to permit maintenance access for each transmission circuit and for such measures to be economically justified, and the operation of which results in a reduction in Active Power on the overloaded circuits which connect the User's Connection Site to the rest of the National Electricity Transmission System which is equal to the reduction in Active Power from the Connection Site (once any system losses or third party system effects are discounted).

Category 3 Intertripping Scheme	A System to Generator Operational Intertripping Scheme which, where agreed by The Company and the User , is installed to alleviate an overload on, and as an alternative to, the reinforcement of a third party system, such as the Distribution System of a Public Distribution System Operator .
Category 4 Intertripping Scheme	A System to Generator Operational Intertripping Scheme installed to enable the disconnection of the Connection Site from the National Electricity Transmission System in a controlled and efficient manner in order to facilitate the timely restoration of the National Electricity Transmission System .
Caution Notice	A notice conveying a warning against interference.
CENELEC	European Committee for Electrotechnical Standardisation.
Citizens Advice	Means the National Association of Citizens Advice Bureaux.
Citizens Advice Scotland	Means the Scottish Association of Citizens Advice Bureaux.
CfD Counterparty	A person designated as a “CfD counterparty” under section 7(1) of the Energy Act 2013.
CfD Documents	The AF Rules , The Contracts for Difference (Allocation) Regulations 2014, The Contracts for Difference (Definition of Eligible Generator) Regulations 2014 and The Contracts for Difference (Electricity Supplier Obligations) Regulations 2014 and any other regulations made under Chapter 2 of Part 2 of the Energy Act 2013 which are in force from time to time.
CfD Settlement Services Provider	means any person: <ul style="list-style-type: none"> (i) appointed for the time being and from time to time by a CfD Counterparty; or (ii) who is designated by virtue of Section C1.2.1B of the Balancing and Settlement Code, in either case to carry out any of the CFD settlement activities (or any successor entity performing CFD settlement activities).
CCGT Module Matrix	The matrix described in Appendix 1 to BC1 under the heading CCGT Module Matrix .
CCGT Module Planning Matrix	A matrix in the form set out in Appendix 3 of OC2 showing the combination of CCGT Units within a CCGT Module which would be running in relation to any given MW output.
Closed Distribution System or CDSO	A distribution system classified as a Closed Distribution System by the Authority which distributes electricity within a geographically confined industrial, commercial or shared services site and does not supply household Customers , without prejudice to incidental use by a small number of households located within the area served by the System and with employment or similar associations with the owner of the System .

CM Administrative Parties	The Secretary of State , the CM Settlement Body , and any CM Settlement Services Provider .
CM Settlement Body	the Electricity Settlements Company Ltd or such other person as may from time to time be appointed as Settlement Body under regulation 80 of the Electricity Capacity Regulations 2014.
CM Settlement Services Provider	any person with whom the CM Settlement Body has entered into a contract to provide services to it in relation to the performance of its functions under the Capacity Market Documents .
Code Administration Code of Practice	Means the code of practice approved by the Authority and: <ul style="list-style-type: none"> (a) developed and maintained by the code administrators in existence from time to time; and (b) amended subject to the Authority's approval from time to time; and (c) re-published from time to time;
Code Administrator	Means The Company carrying out the role of Code Administrator in accordance with the General Conditions.
Combined Cycle Gas Turbine Module or CCGT Module	A collection of Generating Units (registered as a CCGT Module (which could be within a Power Generating Module) under the PC) comprising one or more Gas Turbine Units (or other gas based engine units) and one or more Steam Units where, in normal operation, the waste heat from the Gas Turbines is passed to the water/steam system of the associated Steam Unit or Steam Units and where the component units within the CCGT Module are directly connected by steam or hot gas lines which enable those units to contribute to the efficiency of the combined cycle operation of the CCGT Module .
Combined Cycle Gas Turbine Unit or CCGT Unit	A Generating Unit within a CCGT Module .
Commercial Ancillary Services	Ancillary Services , other than System Ancillary Services , utilised by The Company in operating the Total System if a User (or other person such as a Demand Response Provider) has agreed to provide them under an Ancillary Services Agreement or under a Bilateral Agreement with payment being dealt with under an Ancillary Services Agreement or in the case of Externally Interconnected System Operators or Interconnector Users , under any other agreement (and in the case of Externally Interconnected System Operators and Interconnector Users includes Ancillary Services equivalent to or similar to System Ancillary Services).
Commercial Boundary	Has the meaning set out in the CUSC
Committed Level	The expected Active Power output from a BM Unit after accepting a Bid- Offer Acceptance or RR Instruction or a combination of Bid-Offer Acceptances and RR Instructions .
Committed Project Planning Data	Data relating to a User Development once the offer for a CUSC Contract is accepted.

Common Collection Busbar	A busbar within a Power Park Module to which the higher voltage side of two or more Power Park Unit generator transformers are connected.
Completion Date	Has the meaning set out in the Bilateral Agreement with each User to that term or in the absence of that term to such other term reflecting the date when a User is expected to connect to or start using the National Electricity Transmission System . In the case of an Embedded Medium Power Station or Embedded DC Converter Station or Embedded HVDC System having a similar meaning in relation to the Network Operator's System as set out in the Embedded Development Agreement .
Complex	A Connection Site together with the associated Power Station and/or Network Operator substation and/or associated Plant and/or Apparatus , as appropriate.
Compliance Processes or CP	That portion of the Grid Code which is identified as the Compliance Processes .
Compliance Statement	<p>A statement completed by the relevant User confirming compliance with each of the relevant Grid Code provisions, and the supporting evidence in respect of such compliance, of its:</p> <p>Generating Unit(s); or,</p> <p>Power Generating Modules (including DC Connected Power Park Modules and/or Electricity Storage Modules); or,</p> <p>CCGT Module(s); or,</p> <p>Power Park Module(s); or,</p> <p>DC Converter(s); or</p> <p>HVDC Systems; or</p> <p>Plant and Apparatus at an EU Grid Supply Point owned or operated by a Network Operator; or</p> <p>Network Operator's entire distribution System where such Network Operator's distribution System comprises solely of Plant and Apparatus procured on or after 7 September 2018 and was connected to the National Electricity Transmission System on or after 18 August 2019. In this case, all connections to the National Electricity Transmission System would comprise only of EU Grid Supply Points; or</p> <p>Plant and Apparatus at an EU Grid Supply Point owned or operated by a Non-Embedded Customer where such Non-Embedded Customer is defined as an EU Code User;</p> <p>In the form provided by The Company to the relevant User or another format as agreed between the User and The Company.</p>
Configuration 1 AC Connected Offshore Power Park Module	One or more Offshore Power Park Modules that are connected to an AC Offshore Transmission System and that AC Offshore Transmission System is connected to only one Onshore substation and which has one or more Transmission Interface Points .

Configuration 2 AC Connected Offshore Power Park Module	One or more Offshore Power Park Modules that are connected to a meshed AC Offshore Transmission System and that AC Offshore Transmission System is connected to two or more Onshore substations at its Transmission Interface Points .
Configuration 1 DC Connected Power Park Module	One or more DC Connected Power Park Modules that are connected to an HVDC System or Transmission DC Converter and that HVDC System or Transmission DC Converter is connected to only one Onshore substation and which has one or more Transmission Interface Points .
Configuration 2 DC Connected Power Park Module	One or more DC Connected Power Park Modules that are connected to an HVDC System or Transmission DC Converter and that HVDC System or Transmission DC Converter is connected to more than one Onshore substation at its Transmission Interface Points .
Connection Conditions or CC	That portion of the Grid Code which is identified as the Connection Conditions being applicable to GB Code Users .
Connection Entry Capacity	Has the meaning set out in the CUSC .
Connected Planning Data	Data which replaces data containing estimated values assumed for planning purposes by validated actual values and updated estimates for the future and by updated forecasts for Forecast Data items such as Demand .
Connection Point	A Grid Supply Point or Grid Entry Point , as the case may be.
Connection Site	A Transmission Site or User Site , as the case may be.
Construction Agreement	Has the meaning set out in the CUSC
Consumer Representative	Means the person appointed by the Citizens Advice or the Citizens Advice Scotland (or any successor body) representing all categories of customers, appointed in accordance with GR.4.2(b)
Contingency Reserve	The margin of generation over forecast Demand which is required in the period from 24 hours ahead down to real time to cover against uncertainties in Large Power Station availability and against both weather forecast and Demand forecast errors.
Control Calls	A telephone call whose destination and/or origin is a key on the control desk telephone keyboard at a Control Centre and which, for the purpose of Control Telephony , has the right to exercise priority over (ie. disconnect) a call of a lower status.
Control Centre	A location used for the purpose of control and operation of the National Electricity Transmission System or DC Converter Station owner's System or HVDC System Owner's System or a User System other than a Generator's System or an External System .
Control Engineer	A person nominated by the relevant party for the control of its Plant and Apparatus .
Control Person	The term used as an alternative to " Safety Co-ordinator " on the Site Responsibility Schedule only.

Control Phase	The Control Phase follows on from the Programming Phase and covers the period down to real time.
Control Point	<p>The point from which:-</p> <p>(a) A Non-Embedded Customer's Plant and Apparatus is controlled; or</p> <p>(b) A BM Unit at a Large Power Station or at a Medium Power Station or representing a Cascade Hydro Scheme or with a Demand Capacity with a magnitude of:</p> <p>(i) 50MW or more in NGET's Transmission Area; or</p> <p>(ii) 30MW or more in SPT's Transmission Area; or</p> <p>(iii) 10MW or more in SHETL's Transmission Area,</p> <p>(iv) 10MW or more which is connected to an Offshore Transmission System</p> <p>is physically controlled by a BM Participant; or</p> <p>(c) In the case of any other BM Unit or Generating Unit (which could be part of a Power Generating Module), data submission is co-ordinated for a BM Participant and instructions are received from The Company,</p> <p>as the case may be. For a Generator, this will normally be at a Power Station but may be at an alternative location agreed with The Company. In the case of a DC Converter Station or HVDC System, the Control Point will be at a location agreed with The Company. In the case of a BM Unit of an Interconnector User, the Control Point will be the Control Centre of the relevant Externally Interconnected System Operator.</p>
Control Telephony	The principal method by which a User's Responsible Engineer/Operator and The Company's Control Engineer(s) speak to one another for the purposes of control of the Total System in both normal and emergency operating conditions.
Core Industry Document	As defined in the Transmission Licence
Core Industry Document Owner	In relation to a Core Industry Document , the body(ies) or entity(ies) responsible for the management and operation of procedures for making changes to such document
CUSC	Has the meaning set out in The Company's Transmission Licence
CUSC Contract	<p>One or more of the following agreements as envisaged in Standard Condition C1 of The Company's Transmission Licence:</p> <p>(a) the CUSC Framework Agreement;</p> <p>(b) a Bilateral Agreement;</p> <p>(c) a Construction Agreement</p> <p>or a variation to an existing Bilateral Agreement and/or Construction Agreement;</p>

CUSC Framework Agreement	Has the meaning set out in The Company's Transmission Licence .
CUSC Party	As defined in the The Company's Transmission Licence and "CUSC Parties" shall be construed accordingly.
Customer	A person to whom electrical power is provided (whether or not he is the same person as the person who provides the electrical power).
Customer Demand Management	Reducing the supply of electricity to a Customer or disconnecting a Customer in a manner agreed for commercial purposes between a Supplier and its Customer .
Customer Demand Management Notification Level	The level above which a Supplier has to notify The Company of its proposed or achieved use of Customer Demand Management which is 12 MW in England and Wales and 5 MW in Scotland.
Customer Generating Plant	A Power Station or Generating Unit or Power Generating Module of a Customer to the extent that it operates the same exclusively to supply all or part of its own electricity requirements, and does not export electrical power to any part of the Total System .
Data Publisher	The person providing a reporting service, in relation to data which is submitted to the reporting service under OC2.4.2.3 or a Transmission Licensee , in relation to data which the Transmission Licensee is required to publish.
Data Registration Code or DRC	That portion of the Grid Code which is identified as the Data Registration Code .
Data Validation, Consistency and Defaulting Rules	The rules relating to validity and consistency of data, and default data to be applied, in relation to data submitted under the Balancing Codes , to be applied by The Company under the Grid Code as set out in the document "Data Validation, Consistency and Defaulting Rules" - Issue 8, dated 25 th January 2012. The document is available on the National Grid website or upon request from The Company .
DC Connected Power Park Module	A Power Park Module that is connected to one or more HVDC Interface Points .
DC Converter	Any Onshore DC Converter or Offshore DC Converter as applicable to GB Code User's .
DC Converter Station	An installation comprising one or more Onshore DC Converters connecting a direct current interconnector: to the National Electricity Transmission System ; or, (if the installation has a rating of 50MW or more) to a User System , and it shall form part of the External Interconnection to which it relates.
DC Network	All items of Plant and Apparatus connected together on the direct current side of a DC Converter or HVDC System .
DCUSA	The Distribution Connection and Use of System Agreement approved by the Authority and required to be maintained in force by each Electricity Distribution Licence holder.

Defence Service Provider	A User with a legal or contractual obligation to provide a service contributing to one or several measures of the System Defence Plan .
De-Load	The condition in which a Genset has reduced or is not delivering electrical power to the System to which it is Synchronised .
Δf	Deviation from Target Frequency
Demand	The demand of MW and MVA _r of electricity (i.e. both Active and Reactive Power), unless otherwise stated.
Demand Aggregation	A process where one or more Demand Facilities or Closed Distribution Systems can be controlled by a Demand Response Provider either as a single facility or Closed Distribution System for the purposes of offering one or more Demand Response Services .
Demand Capacity	Has the meaning as set out in the BSC .
Demand Control	Any or all of the following methods of achieving a Demand reduction: <ul style="list-style-type: none"> (a) Customer voltage reduction initiated by Network Operators (other than following an instruction from The Company); (b) Customer Demand reduction by Disconnection initiated by Network Operators (other than following an instruction from The Company); (c) Demand reduction instructed by The Company; (d) automatic low Frequency Demand Disconnection; (e) emergency manual Demand Disconnection.
Demand Control Notification Level	The level above which a Network Operator has to notify The Company of its proposed or achieved use of Demand Control which is 12 MW in England and Wales and 5 MW in Scotland.
Demand Facility	A facility which consumes electrical energy and is connected at one or more Grid Supply Points to the National Electricity Transmission System or connection points to a Network Operator's System . A Network Operator's System and/or auxiliary supplies of a Power Generating Module do not constitute a Demand Facility .
Demand Facility Owner	A person who owns or operates one or more Demand Units within a Demand Facility . A Demand Facility Owner who owns or operates a Demand Facility which is directly connected to the Transmission System shall be treated as a Non-Embedded Customer .
Demand Response Active Power Control	Demand within a Demand Facility or Closed Distribution System that is available for modulation by The Company or Network Operator or Relevant Transmission Licensee , which results in an Active Power modification.

Demand Response Provider	A party (other than The Company) who owns, operates, controls or manages Main Plant and Apparatus (excluding storage equipment) which was first connected to the Total System on or after 18 August 2019 and who had placed Purchase Contracts for its Main Plant and Apparatus on or after 7 September 2018 or is the subject of a Substantial Modification on or after 18 August 2019 and has an agreement with The Company to provide a Demand Response Service(s) . The party may be one or more Customers , a Network Operator or Non-Embedded Customer or EU Code User contracting bilaterally with The Company for the provision of services, or may be a third party providing Demand Aggregation from many individual Customers .
Demand Response Reactive Power Control	A Demand Response Service derived from Reactive Power or Reactive Power compensation devices in a Demand Facility or Closed Distribution System that are available for modulation by The Company or Network Operator or Relevant Transmission Licensee .
Demand Response Transmission Constraint Management	A Demand Response Service derived from Demand within a Demand Facility or Closed Distribution System that is available for modulation by The Company or Network Operator or Relevant Transmission Licensee to manage transmission constraints within the System .
Demand Response Service	<p>A Demand Response Service includes one of more of the following services:</p> <ul style="list-style-type: none"> (a) Demand Response Active Power Control; (b) Demand Response Reactive Power Control; (c) Demand Response Transmission Constraint Management; (d) Demand Response System Frequency Control; (e) Demand Response Very Fast Active Power Control. <p>The above Demand Response Services are not exclusive and do not preclude Demand Response Providers from negotiating other services for demand response capability with The Company. Where such services are negotiated they would still be treated as a Demand Response Service.</p>
Demand Response Services Code (DRSC)	That portion of the Grid Code which is identified as the Demand Response Services Code being applicable to Demand Response Providers .
Demand Response System Frequency Control	A Demand Response Service derived from a Demand within one or more Demand Facilities or Closed Distribution Systems that is available for the reduction or increase in response to Frequency fluctuations, made by an autonomous response from those Demand Facilities or Closed Distribution Systems to diminish these fluctuations.
Demand Response Unit Document (DRUD)	A document, issued either by the Non-Embedded Customer , Demand Facility Owner or the CDSO to The Company or the Network Operator (as the case may be) for Demand Units with demand response and providing a Demand Response Service which confirms the compliance of the Demand Unit with the technical requirements set out in the Grid Code and provides the necessary data and statements, including a statement of compliance.
Demand Response Very Fast Active Power Control	A Demand Response Service derived from a Demand within a Demand Facility or Closed Distribution System that can be modulated very fast in response to a Frequency deviation, which results in a very fast Active Power modification.

Demand Unit	An indivisible set of installations containing equipment which can be actively controlled at one or more sites by a Demand Response Provider, Demand Facility Owner, CDSO or by a Non Embedded Customer , either individually or commonly as part of Demand Aggregation through a third party who has agreed to provide Demand Response Services .
Designed Minimum Operating Level	The output (in whole MW) below which a Genset or a DC Converter at a DC Converter Station (in any of its operating configurations) has no High Frequency Response capability.
De-Synchronise	(a) The act of taking a Power Generating Module (including a DC Connected Power Park Module), Generating Unit, Power Park Module, HVDC System or DC Converter off a System to which it has been Synchronised , by opening any connecting circuit breaker; or (b) The act of ceasing to consume electricity at an importing BM Unit ; and the term " De-Synchronising " shall be construed accordingly.
De-synchronised Island(s)	Has the meaning set out in OC9.5.1(a).
Detailed Planning Data	Detailed additional data which The Company requires under the PC in support of Standard Planning Data , comprising DPD I and DPD II .
Detailed Planning Data Category I or DPD I	The Detailed Planning Data categorised as such in the DRC , and submitted in accordance with PC.4.4.2 or PC.4.4.4 as applicable.
Detailed Planning Data Category II or DPD II	The Detailed Planning Data categorised as such in the DRC , and submitted in accordance with PC.4.4.2 or PC.4.4.4 as applicable.
Disconnection	The physical separation of Users (or Customers) from the National Electricity Transmission System or a User System as the case may be.
Discrimination	The quality where a relay or protective system is enabled to pick out and cause to be disconnected only the faulty Apparatus .
Disputes Resolution Procedure	The procedure described in the CUSC relating to disputes resolution.
Distribution Code	The distribution code required to be drawn up by each Electricity Distribution Licence holder and approved by the Authority , as from time to time revised with the approval of the Authority .
Droop	The ratio of the per unit steady state change in speed (or Frequency), to the per unit steady state change in Active Power output. Whilst not mandatory, it is often common practice to express Droop in percentage terms.
Dynamic Parameters	Those parameters listed in Appendix 1 to BC1 under the heading BM Unit Data – Dynamic Parameters .
E&W Offshore Transmission System	An Offshore Transmission System with an Interface Point in England and Wales.

E&W Offshore Transmission Licensee	A person who owns or operates an E&W Offshore Transmission System pursuant to a Transmission Licence .
E&W Transmission System	Collectively NGET's Transmission System and any E&W Offshore Transmission Systems .
E&W User	A User in England and Wales or any Offshore User who owns or operates Plant and/or Apparatus connected (or which will at the OTSUA Transfer Time be connected) to an E&W Offshore Transmission System .
Earth Fault Factor	At a selected location of a three-phase System (generally the point of installation of equipment) and for a given System configuration, the ratio of the highest root mean square phase-to-earth power Frequency voltage on a sound phase during a fault to earth (affecting one or more phases at any point) to the root mean square phase-to-earth power Frequency voltage which would be obtained at the selected location without the fault.
Earthing	A way of providing a connection between conductors and earth by an Earthing Device which is either: <ul style="list-style-type: none"> (a) Immobilised and Locked in the earthing position. Where the Earthing Device is Locked with a Safety Key, the Safety Key must be secured in a Key Safe and the Key Safe Key must be, where reasonably practicable, given to the authorised site representative of the Requesting Safety Co-ordinator and is to be retained in safe custody. Where not reasonably practicable the Key Safe Key must be retained by the authorised site representative of the Implementing Safety Co-ordinator in safe custody; or (b) maintained and/or secured in position by such other method which must be in accordance with the Local Safety Instructions of NGET or the Safety Rules of the Relevant Transmission Licensee or that User, as the case may be.
Earthing Device	A means of providing a connection between a conductor and earth being of adequate strength and capability.
Elected Panel Members	Shall mean the following Panel Members elected in accordance with GR4.2(a): <ul style="list-style-type: none"> (a) the representative of the Suppliers; (b) the representative of the Onshore Transmission Licensees; (c) the representative of the Offshore Transmission Licensees; and (d) the representatives of the Generators
Electrical Standard	A standard listed in the Annex to the General Conditions .
Electricity Balancing Regulation	as defined in the CUSC .
Electricity Council	That body set up under the Electricity Act, 1957.

Electricity Distribution Licence	The licence granted pursuant to Section 6(1) (c) of the Act .
Electricity Regulation	As defined in the Transmission Licence .
Electricity Storage	The conversion of electrical energy into a form of energy which can be stored, the storing of that energy, and the subsequent reconversion of that energy back into electrical energy.
Electricity Storage Module	Is either one or more Synchronous Electricity Storage Unit(s) or Non-Synchronous Electricity Storage Unit(s) which could also be part of a Power Generating Module . For the avoidance of doubt, Non-Controllable Electricity Storage Equipment would not be considered to be classed as an Electricity Storage Module or as an Electricity Storage Unit .
Electricity Storage Unit	A Synchronous Electricity Storage Unit or Non-Synchronous Electricity Storage Unit .
Electricity Supply Industry Arbitration Association	The unincorporated members' club of that name formed inter alia to promote the efficient and economic operation of the procedure for the resolution of disputes within the electricity supply industry by means of arbitration or otherwise in accordance with its arbitration rules.
Electricity Supply Licence	The licence granted pursuant to Section 6(1) (d) of the Act .
Electromagnetic Compatibility Level	Has the meaning set out in Engineering Recommendation G5 .
Embedded	Having a direct connection to a User System or the System of any other User to which Customers and/or Power Stations are connected, such connection being either a direct connection or a connection via a busbar of another User or of a Relevant Transmission Licensee (but with no other connection to the National Electricity Transmission System).
Embedded Development	Has the meaning set out in PC.4.4.3(a).
Embedded Development Agreement	An agreement entered into between a Network Operator and an Embedded Person , identifying the relevant site of connection to the Network Operator's System and setting out other site specific details in relation to that use of the Network Operator's System .
Embedded Generation Control	Any or all of the following methods by which a Network Operator can achieve a reduction in the Active Power output of Embedded Power Stations to implement an instruction issued by The Company : (a) Embedded Generation De-energisation ; or (b) where this is achievable in a suitable timescale to comply with an instruction, arranging to reduce the Active Power output of Embedded Power Stations or Embedded Generator Unit(s) connected to their System .
Embedded Generation Deenergisation	The de-energisation by Network Operators of one or more Embedded Power Stations or Embedded Generating Units from their System as part of an Embedded Generation Control action.

Embedded Person	The party responsible for a Medium Power Station not subject to a Bilateral Agreement or DC Converter Station not subject to a Bilateral Agreement or HVDC System not subject to a Bilateral Agreement connected to or proposed to be connected to a Network Operator's System .
Emergency Deenergisation Instruction	An Emergency Instruction issued by The Company to De-Synchronise a Power Generating Module (including a DC Connected Power Park Module), Generating Unit , Power Park Module , HVDC System or DC Converter in circumstances specified in the CUSC .
Emergency Instruction	An instruction issued by The Company in emergency circumstances, pursuant to BC2.9, to the Control Point of a User . In the case of such instructions applicable to a BM Unit , it may require an action or response which is outside the Dynamic Parameters or Other Relevant Data , and may include an instruction to trip a Genset .
EMR Administrative Parties	Has the meaning given to “administrative parties” in The Electricity Capacity Regulations 2014 and each CfD Counterparty and CfD Settlement Services Provider .
EMR Documents	The Energy Act 2013, The Electricity Capacity Regulations 2014, the Capacity Market Rules , The Contracts for Difference (Allocation) Regulations 2014, The Contracts for Difference (Definition of Eligible Generator) Regulations 2014, The Contracts for Difference (Electricity Supplier Obligations) Regulations 2014, The Electricity Market Reform (General) Regulations 2014, the AF Rules and any other regulations or instruments made under Chapter 2 (contracts for difference), Chapter 3 (capacity market) or Chapter 4 (investment contracts) of Part 2 of the Energy Act 2013 which are in force from time to time.
EMR Functions	Has the meaning given to “EMR functions” in Chapter 5 of Part 2 of the Energy Act 2013.
Engineering Recommendations	The documents referred to as such and issued by the Energy Networks Association or the former Electricity Council.
Engineering Recommendation G5	Means Engineering Recommendation G5/5.
Energisation Operational Notification or EON	A notification (in respect of Plant and Apparatus (including OTSUA) which is directly connected to the National Electricity Transmission System) from The Company to a User confirming that the User can in accordance with the Bilateral Agreement and/or Construction Agreement , energise such User's Plant and Apparatus (including OTSUA) specified in such notification.
Equipment Certificate	A document issued by an Authorised Certifier for equipment used by a Power Generating Module , Demand Unit , Network Operators System , Non-Embedded Customers System , Demand Facility or HVDC System . The Equipment Certificate defines the scope of its validity at a national level. For the purpose of replacing specific parts of the compliance process, the Equipment Certificate may include models or equivalent information that have been verified against actual test results.

Estimated Registered Data	Those items of Standard Planning Data and Detailed Planning Data which either upon connection will become Registered Data , or which for the purposes of the Plant and/or Apparatus concerned as at the date of submission are Registered Data , but in each case which for the seven succeeding Financial Years will be an estimate of what is expected.
----------------------------------	--

<p>EU Code User</p>	<p>A User who is any of the following:-</p> <ul style="list-style-type: none"> (a) A Generator in respect of a Power Generating Module (excluding a DC Connected Power Park Module) or OTSDUA (in respect of an AC Offshore Transmission System) whose Main Plant and Apparatus is connected to the System on or after 27 April 2019 and who concluded Purchase Contracts for its Main Plant and Apparatus on or after 17 May 2018 (b) A Generator in respect of any Type C or Type D Power Generating Module which is the subject of a Substantial Modification which is effective on or after 27 April 2019. (c) A Generator in respect of any DC Connected Power Park Module whose Main Plant and Apparatus is connected to the System on or after 8 September 2019 and who had concluded Purchase Contracts for its Main Plant and Apparatus on or after 28 September 2018. (d) A Generator in respect of any DC Connected Power Park Module which is the subject of a Substantial Modification which is effective on or after 8 September 2019. (e) An HVDC System Owner or OTSDUA (in respect of a DC Offshore Transmission System including a Transmission DC Converter) whose Main Plant and Apparatus is connected to the System on or after 8 September 2019 and who had concluded Purchase Contracts for its Main Plant and Apparatus on or after 28 September 2018. (f) An HVDC System Owner or OTSDUA (in respect of a DC Offshore Transmission System including a Transmission DC Converter) whose HVDC System or DC Offshore Transmission System including a Transmission DC Converter) is the subject of a Substantial Modification on or after 8 September 2019. (g) A User which the Authority has determined should be considered as an EU Code User. (h) A Network Operator whose entire distribution System was first connected to the National Electricity Transmission System on or after 18 August 2019 and who had placed Purchase Contracts for its Main Plant and Apparatus in respect of its entire distribution System on or after 7 September 2018. For the avoidance of doubt, a Network Operator will be an EU Code User if its entire distribution System is connected to the National Electricity Transmission System at EU Grid Supply Points only. (i) A Non Embedded Customer whose Main Plant and Apparatus at each EU Grid Supply Point was first connected to the National Electricity Transmission System on or after 18 August 2019 and who had placed Purchase Contracts for its Main Plant and Apparatus at each EU Grid Supply Point on or after 7 September 2018 or is the subject of a Substantial Modification on or after 18 August 2019. (j) A Storage User in respect of an Electricity Storage Module whose Main Plant and Apparatus is connected to the System on or after 20 May 2020 and who concluded Purchase
----------------------------	--

	Contracts for its Main Plant and Apparatus on or after 20 May 2019.
EU Generator	A Generator or OTSDUA who is also an EU Code User .
EU Grid Supply Point	A Grid Supply Point where either:- <ul style="list-style-type: none"> (i) (a) the Network Operator or Non-Embedded Customer had placed Purchase Contracts for all of its Plant and Apparatus at that Grid Supply Point on or after 7 September 2018, and (b) All of the Network Operator's or Non-Embedded Customer's Plant and Apparatus at that Grid Supply Point was first connected to the Transmission System on or after 18 August 2019; or (ii) the Network Operator's or Non-Embedded Customer's Plant and Apparatus at a Grid Supply Point is the subject of a Substantial Modification which is effective on or after 18 August 2019.
EU Transparency Availability Data	Such relevant data as Customers and Generators are required to provide under Articles 7.1(a) and 7.1(b) and Articles 15.1(a), 15.1(b), 15.1(c), 15.1(d) of Retained EU Law (Commission Regulation (EU) 543/2013), and which also forms part of DRC Schedule 6 (Users' Outage Data).
European Compliance Processes or ECP	That portion of the Grid Code which is identified as the European Compliance Processes .
European Connection Conditions or ECC	That portion of the Grid Code which is identified as the European Connection Conditions being applicable to EU Code Users .
European Specification	A common technical specification, a British Standard implementing a European standard or a European technical approval. The terms "common technical specification", "European standard" and "European technical approval" shall have the meanings respectively ascribed to them in the Regulations .
Event	An unscheduled or unplanned (although it may be anticipated) occurrence on, or relating to, a System (including Embedded Power Stations) including, without limiting that general description, faults, incidents and breakdowns and adverse weather conditions being experienced.
Exciter	The source of the electrical power providing the field current of a synchronous machine.
Excitation System	The equipment providing the field current of a machine, including all regulating and control elements, as well as field discharge or suppression equipment and protective devices.
Excitation System No-Load Negative Ceiling Voltage	The minimum value of direct voltage that the Excitation System is able to provide from its terminals when it is not loaded, which may be zero or a negative value.

Excitation System Nominal Response	Shall have the meaning ascribed to that term in IEC 34-16-1:1991 [equivalent to British Standard BS4999 Section 116.1: 1992]. The time interval applicable is the first half-second of excitation system voltage response.
Excitation System On-Load Positive Ceiling Voltage	Shall have the meaning ascribed to the term 'Excitation system on load ceiling voltage' in IEC 34-16-1:1991 [equivalent to British Standard BS4999 Section 116.1: 1992].
Excitation System No-Load Positive Ceiling Voltage	Shall have the meaning ascribed to the term 'Excitation system no load ceiling voltage' in IEC 34-16-1:1991 [equivalent to British Standard BS4999 Section 116.1: 1992].
Exemptable	Has the meaning set out in the CUSC .
Existing AGR Plant	The following nuclear advanced gas cooled reactor plant (which was commissioned and connected to the Total System at the Transfer Date):- <ul style="list-style-type: none"> (a) Dungeness B (b) Hinkley Point B (c) Heysham 1 (d) Heysham 2 (e) Hartlepool (f) Hunterston B (g) Torness
Existing AGR Plant Flexibility Limit	In respect of each Genset within each Existing AGR Plant which has a safety case enabling it to so operate, 8 (or such lower number which when added to the number of instances of reduction of output as instructed by The Company in relation to operation in Frequency Sensitive Mode totals 8) instances of flexibility in any calendar year (or such lower or greater number as may be agreed by the Nuclear Installations Inspectorate and notified to The Company) for the purpose of assisting in the period of low System NRAPM and/or low Localised NRAPM provided that in relation to each Generating Unit each change in output shall not be required to be to a level where the output of the reactor is less than 80% of the reactor thermal power limit (as notified to The Company and which corresponds to the limit of reactor thermal power as contained in the "Operating Rules" or "Identified Operating Instructions" forming part of the safety case agreed with the Nuclear Installations Inspectorate).
Existing Gas Cooled Reactor Plant	Both Existing Magnox Reactor Plant and Existing AGR Plant .

Existing Magnox Reactor Plant	The following nuclear gas cooled reactor plant (which was commissioned and connected to the Total System at the Transfer Date):- (a) Calder Hall (b) Chapelcross (c) Dungeness A (d) Hinkley Point A (e) Oldbury-on-Severn (f) Bradwell (g) Sizewell A (h) Wylfa
Export and Import Limits	Those parameters listed in Appendix 1 to BC1 under the heading BM Unit Data – Export and Import Limits .
External Interconnection	Apparatus for the transmission of electricity to or from the National Electricity Transmission System or a User System into or out of an External System . For the avoidance of doubt, a single External Interconnection may comprise several circuits operating in parallel.
External Interconnection Circuit	Plant or Apparatus which comprises a circuit and which operates in parallel with another circuit and which forms part of the External Interconnection .
Externally Interconnected System Operator or EISO	A person who operates an External System which is connected to the National Electricity Transmission System or a User System by an External Interconnection .
External System	In relation to an Externally Interconnected System Operator means the transmission or distribution system which it owns or operates which is located outside the National Electricity Transmission System Operator Area any Apparatus or Plant which connects that system to the External Interconnection and which is owned or operated by such Externally Interconnected System Operator .
Fast Fault Current	A current delivered by a Power Park Module or HVDC System during and after a voltage deviation caused by an electrical fault within the System with the aim of identifying a fault by network Protection systems at the initial stage of the fault, supporting System voltage retention at a later stage of the fault and System voltage restoration after fault clearance.
Fault Current Interruption Time	The time interval from fault inception until the end of the break time of the circuit breaker (as declared by the manufacturers).
Fault Ride Through	The capability of Power Generating Modules (including DC Connected Power Park Modules) and HVDC Systems to be able to remain connected to the System and operate through periods of low voltage at the Grid Entry Point or User System Entry Point caused by secured faults.
Fast Start	A start by a Genset with a Fast Start Capability .
Fast Start Capability	The ability of a Genset to be Synchronised and Loaded up to full Load within 5 minutes.

Fast Track Criteria	A proposed Grid Code Modification Proposal that, if implemented, (a) would meet the Self-Governance Criteria ; and (b) is properly a housekeeping modification required as a result of some error or factual change, including but not limited to: (i) updating names or addresses listed in the Grid Code ; (ii) correcting any minor typographical errors; (iii) correcting formatting and consistency errors, such as paragraph numbering; or (iv) updating out of date references to other documents or paragraphs
Fault Current Interruption Time	The time interval from fault inception until the end of the break time of the circuit breaker (as declared by the manufacturers).
Fault Ride Through	The capability of Power Generating Modules (including DC Connected Power Park Modules) and HVDC Systems to be able to remain connected to the System and operate through periods of low voltage at the Grid Entry Point or User System Entry Point caused by secured faults.
Final Generation Outage Programme	An outage programme as agreed by The Company with each Generator and each Interconnector Owner at various stages through the Operational Planning Phase and Programming Phase which does not commit the parties to abide by it, but which at various stages will be used as the basis on which National Electricity Transmission System outages will be planned.
Final Operational Notification or FON	A notification from The Company to a Generator or DC Converter Station owner or HVDC System Owner or Network Operator or Non-Embedded Customer confirming that the User has demonstrated compliance: (a) with the Grid Code, (or where they apply, that relevant derogations have been granted), and (b) where applicable, with Appendices F1 to F5 of the Bilateral Agreement , in each case in respect of the Plant and Apparatus specified in such notification.
Final Physical Notification Data	Has the meaning set out in the BSC .
Final Report	A report prepared by the Test Proposer at the conclusion of a System Test for submission to The Company (if it did not propose the System Test) and other members of the Test Panel .
Financial Year	Bears the meaning given in Condition A1 (Definitions and Interpretation) of The Company's Transmission Licence .

Fixed Proposed Implementation Date	The proposed date(s) for the implementation of a Grid Code Modification Proposal or Workgroup Alternative Grid Code Modification such date to be a specific date by reference to an assumed date by which a direction from the Authority approving the Grid Code Modification Proposal or Workgroup Alternative Grid Code Modification is required in order for the Grid Code Modification Proposal or any Workgroup Alternative Grid Code Modification , if it were approved, to be implemented by the proposed date.
Flicker Severity (Long Term)	A value derived from 12 successive measurements of Flicker Severity (Short Term) (over a two hour period) and a calculation of the cube root of the mean sum of the cubes of 12 individual measurements, as further set out in Engineering Recommendation P28 as current at the Transfer Date .
Flicker Severity (Short Term)	A measure of the visual severity of flicker derived from the time series output of a flickermeter over a 10 minute period and as such provides an indication of the risk of Customer complaints.
Forecast Data	Those items of Standard Planning Data and Detailed Planning Data which will always be forecast.
Frequency	The number of alternating current cycles per second (expressed in Hertz) at which a System is running.
Frequency Containment Reserves (FCR)	means, in the context of Balancing Services , the Active Power reserves available to contain System Frequency after the occurrence of an imbalance.
Frequency Response Deadband	An interval used intentionally to make the Frequency control unresponsive. In the case of mechanical governor systems, the Frequency Response Deadband is the same as Frequency Response Insensitivity .
Frequency Response Insensitivity	The inherent feature of the control system specified as the minimum magnitude of change in the Frequency or input signal that results in a change of output power or output signal.
Frequency Restoration Reserves (FRR)	Means, in the context of Balancing Services , the Active Power reserves available to restore System Frequency to the nominal Frequency .
Frequency Sensitive AGR Unit	Each Generating Unit in an Existing AGR Plant for which the Generator has notified The Company that it has a safety case agreed with the Nuclear Installations Inspectorate enabling it to operate in Frequency Sensitive Mode , to the extent that such unit is within its Frequency Sensitive AGR Unit Limit . Each such Generating Unit shall be treated as if it were operating in accordance with BC3.5.1 provided that it is complying with its Frequency Sensitive AGR Unit Limit .

Frequency Sensitive AGR Unit Limit	<p>In respect of each Frequency Sensitive AGR Unit, 8 (or such lower number which when added to the number of instances of flexibility for the purposes of assisting in a period of low System or Localised NRAPM totals 8) instances of reduction of output in any calendar year as instructed by The Company in relation to operation in Frequency Sensitive Mode (or such greater number as may be agreed between The Company and the Generator), for the purpose of assisting with Frequency control, the level of operation of each Frequency Sensitive AGR Unit in Frequency Sensitive Mode shall not be outside that agreed by the Nuclear Installations Inspectorate in the relevant safety case.</p>
Frequency Sensitive Mode	<p>A Genset, or Type C Power Generating Module or Type D Power Generating Module or DC Connected Power Park Module or HVDC System operating mode which will result in Active Power output changing, in response to a change in System Frequency, in a direction which assists in the recovery to Target Frequency, by operating so as to provide Primary Response and/or Secondary Response and/or High Frequency Response.</p>
Fuel Security Code	<p>The document of that title designated as such by the Secretary of State, as from time to time amended.</p>
Gas Turbine Unit	<p>A Generating Unit driven by a gas turbine (for instance by an aero-engine).</p>
Gas Zone Diagram	<p>A single line diagram showing boundaries of, and interfaces between, gas-insulated HV Apparatus modules which comprise part, or the whole, of a substation at a Connection Site (or in the case of OTSDUW Plant and Apparatus, Transmission Interface Site), together with the associated stop valves and gas monitors required for the safe operation of the National Electricity Transmission System or the User System, as the case may be.</p>
Gate Closure	<p>Has the meaning set out in the BSC.</p>

GB Code User	<p>A User in respect of:-</p> <p>(a) A Generator or OTSDUA whose Main Plant and Apparatus (excluding a DC Connected Power Park Module) is connected to the System before 27 April 2019, or who had concluded Purchase Contracts for its Main Plant and Apparatus before 17 May 2018, or whose Plant and Apparatus is not the subject of a Substantial Modification which is effective on or after 27 April 2019; or</p> <p>(b) A DC Converter Station owner whose Main Plant and Apparatus is connected to the System before 8 September 2019, or who had concluded Purchase Contracts for its Main Plant and Apparatus before 28 September 2018, or whose Plant and Apparatus is not the subject of a Substantial Modification which is effective on or after 8 September 2019; or</p> <p>(c) A Non-Embedded Customer whose Main Plant and Apparatus was connected to the National Electricity Transmission System at a GB Grid Supply Point before 18 August 2019 or who had placed Purchase Contracts for its Main Plant and Apparatus before 7 September 2018 or that Non-Embedded Customer is not the subject of a Substantial Modification which is effective on or after 18 August 2019; or</p> <p>(d) A Network Operator whose entire distribution System was connected to the National Electricity Transmission System at one or more GB Grid Supply Points before 18 August 2019 or who had placed Purchase Contracts for its Main Plant and Apparatus in respect of its entire distribution System before 7 September 2018 or its entire distribution System is not the subject of a Substantial Modification which is effective on or after 18 August 2019. For the avoidance of doubt, a Network Operator would still be classed as a GB Code User where its entire distribution System was connected to the National Electricity Transmission System at one or more GB Grid Supply Points, even where that entire distribution System may have one or more EU Grid Supply Points but still comprises of GB Grid Supply Points.</p>
GB Generator	A Generator , or OTSDUA , who is also a GB Code User .
GB Grid Supply Point	A Grid Supply Point which is not an EU Grid Supply Point .
GB Synchronous Area	The AC power System in Great Britain which connects User's, Relevant Transmission Licensee's whose AC Plant and Apparatus is considered to operate in synchronism with each other at each Connection Point or User System Entry Point and at the same System Frequency .
GCDF	Means the Grid Code Development Forum.
General Conditions or GC	That portion of the Grid Code which is identified as the General Conditions .
Generating Plant Demand Margin	The difference between Output Usable and forecast Demand .

Generating Unit	An Onshore Generating Unit and/or an Offshore Generating Unit which could also be part of a Power Generating Module .
Generating Unit Data	The Physical Notification, Export and Import Limits and Other Relevant Data only in respect of each Generating Unit (which could be part of a Power Generating Module): <ul style="list-style-type: none"> (a) which forms part of the BM Unit which represents that Cascade Hydro Scheme; (b) at an Embedded Exemptable Large Power Station, where the relevant Bilateral Agreement specifies that compliance with BC1 and/or BC2 is required: <ul style="list-style-type: none"> (i) to each Generating Unit, or (ii) to each Power Park Module where the Power Station comprises Power Park Modules.
Generation Capacity	Has the meaning set out in the BSC .
Generation Planning Parameters	Those parameters listed in Appendix 2 of OC2 .
Generator	A person who generates electricity or undertakes Electricity Storage under licence or exemption under the Act , acting in its capacity as a generator in Great Britain or Offshore . The term Generator includes a EU Generator and a GB Generator .
Generator Performance Chart	A diagram which shows the MW and MVA _r capability limits within which a Generating Unit will be expected to operate under steady state conditions.
Genset	A Power Generating Module (including a DC Connected Power Park Module and/or Electricity Storage Module), Generating Unit , Power Park Module or CCGT Module at a Large Power Station or any Power Generating Module (including a DC Connected Power Park Module), Generating Unit , Power Park Module or CCGT Module which is directly connected to the National Electricity Transmission System .
Good Industry Practice	The exercise of that degree of skill, diligence, prudence and foresight which would reasonably and ordinarily be expected from a skilled and experienced operator engaged in the same type of undertaking under the same or similar circumstances.
Governance Rules or GR	That portion of the Grid Code which is identified as the Governance Rules .
Governor Deadband	An interval used intentionally to make the frequency control unresponsive.
Great Britain or GB	The landmass of England and Wales and Scotland, including internal waters.
Grid Code Fast Track Proposals	A proposal to modify the Grid Code which is raised pursuant to GR.26 and has not yet been approved or rejected by the Grid Code Review Panel .

Grid Code Modification Fast Track Report	A report prepared pursuant to GR.26
Grid Code Modification Register	Has the meaning given in GR.13.1.
Grid Code Modification Report	Has the meaning given in GR.22.1.
Grid Code Modification Procedures	The procedures for the modification of the Grid Code (including the implementation of Approved Modifications) as set out in the Governance Rules .
Grid Code Modification Proposal	A proposal to modify the Grid Code which is not yet rejected pursuant to GR.15.5 or GR.15.6 and has not yet been implemented.
Grid Code Modification Self- Governance Report	Has the meaning given in GR.24.5
Grid Code Objectives	Means the objectives referred to in Paragraph 1b of Standard Condition C14 of The Company's Transmission Licence .
Grid Code Review Panel or Panel	The panel with the functions set out in GR.1.2.
Grid Code Review Panel Recommendation Vote	The vote of Panel Members undertaken by the Panel Chairman in accordance with Paragraph GR.22.4 as to whether in their view they believe each proposed Grid Code Modification Proposal , or Workgroup Alternative Grid Code Modification would better facilitate achievement of the Grid Code Objective(s) and so should be made.
Grid Code Review Panel Self-Governance Vote	The vote of Panel Members undertaken by the Panel Chairman in accordance with GR.24.9 as to whether they believe each proposed Grid Code Modification Proposal, as compared with the then existing provisions of the Grid Code and any Workgroup Alternative Grid Code Modification set out in the Grid Code Modification Self-Governance Report , would better facilitate achievement of the Grid Code Objective(s) .
Grid Code Self-Governance Proposals	Grid Code Modification Proposals which satisfy the Self Governance Criteria .
Grid Entry Point	An Onshore Grid Entry Point or an Offshore Grid Entry Point .
Grid Supply Point	A point of supply from the National Electricity Transmission System to Network Operators or Non-Embedded Customers which could be a GB Grid Supply Point or an EU Grid Supply Point .
Group	Those National Electricity Transmission System sub-stations bounded solely by the faulted circuit(s) and the overloaded circuit(s) excluding any third party connections between the Group and the rest of the National Electricity Transmission System , the faulted circuit(s) being a Secured Event .
GSP Group	Has the meaning as set out in the BSC .

Headroom	The Power Available (in MW) less the actual Active Power exported from the Power Park Module (in MW).
High Frequency Response	An automatic reduction in Active Power output in response to an increase in System Frequency above the Target Frequency (or such other level of Frequency as may have been agreed in an Ancillary Services Agreement). This reduction in Active Power output must be in accordance with the provisions of the relevant Ancillary Services Agreement which will provide that it will be released increasingly with time over the period 0 to 10 seconds from the time of the Frequency increase on the basis set out in the Ancillary Services Agreement and fully achieved within 10 seconds of the time of the start of the Frequency increase and it must be sustained at no lesser reduction thereafter. The interpretation of the High Frequency Response to a + 0.5 Hz frequency change is shown diagrammatically in Figure CC.A.3.3 and Figure ECC.A.3.3.
High Voltage or HV	For E&W Transmission Systems , a voltage exceeding 650 volts. For Scottish Transmission Systems , a voltage exceeding 1000 volts.
Historic Frequency Data	System Frequency data at a maximum of one second intervals for the whole month, published by The Company as detailed in OC3.4.4.
Houseload Operation	Operation which ensures that a Power Station is able to continue to supply its in-house load in the event of System faults resulting in Power-Generating Modules being disconnected from the System and tripped onto their auxiliary supplies
HP Turbine Power Fraction	Ratio of steady state mechanical power delivered by the HP turbine to the total steady state mechanical power delivered by the total steam turbine at Registered Capacity or Maximum Capacity .
HV Connections	Apparatus connected at the same voltage as that of the National Electricity Transmission System , including Users' circuits, the higher voltage windings of Users' transformers and associated connection Apparatus .
HVDC Converter	Any EU Code User Apparatus used to convert alternating current electricity to direct current electricity, or vice versa. An HVDC Converter is a standalone operative configuration at a single site comprising one or more converter bridges, together with one or more converter transformers, reactors, converter control equipment, essential protective and switching devices and auxiliaries, if any, used for conversion. In a bipolar arrangement, an HVDC Converter represents the bipolar configuration.
HVDC Converter Station	Part of an HVDC System which consists of one or more HVDC Converters installed in a single location together with buildings, reactors, filters reactive power devices, control, monitoring, protective, measuring and auxiliary equipment.
HVDC Equipment	Collectively means an HVDC System and a DC Connected Power Park Module and a Remote End HVDC Converter Station .
HVDC Interface Point	A point at which HVDC Plant and Apparatus is connected to an AC System at which technical specifications affecting the performance of the Plant and Apparatus can be prescribed.
HVDC System	An electrical power system which transfers energy in the form of high voltage direct current between two or more alternating current (AC) buses and comprises at least two HVDC Converter Stations with DC Transmission lines or cables between the HVDC Converter Stations .

HVDC System Owner	A party who owns and is responsible for an HVDC System . For the avoidance of doubt a DC Connected Power Park Module owner would be treated as a Generator .
IEC	International Electrotechnical Commission.
IEC Standard	A standard approved by the International Electrotechnical Commission.
Implementation Date	Is the date and time for implementation of an Approved Modification as specified in accordance with Paragraph GR.25.3.
Implementing Safety Co-ordinator	The Safety Co-ordinator implementing Safety Precautions .
Import Usable	That portion of Registered Import Capacity which is expected to be available and which is not unavailable due to a Planned Outage .
Incident Centre	A centre established by The Company or a User as the focal point in The Company or in that User , as the case may be, for the communication and dissemination of information between the senior management representatives of The Company , or of that User , as the case may be, and the relevant other parties during a Joint System Incident in order to avoid overloading The Company's , or that User's , as the case may be, existing operational/control arrangements.
Independent Back-Up Protection	A Back-Up Protection system which utilises a discrete relay, different current transformers and an alternate operating principle to the Main Protection systems(s) such that it can operate autonomously in the event of a failure of the Main Protection .
Independent Main Protection	A Main Protection system which utilises a physically discrete relay and different current transformers to any other Main Protection .
Indicated Constraint Boundary Margin	The difference between a constraint boundary transfer limit and the difference between the sum of BM Unit Maximum Export Limits and the forecast of local Demand within the constraint boundary.
Indicated Imbalance	The difference between the sum of Physical Notifications for BM Units comprising Generating Units or CCGT Modules or Power Generating Modules and the forecast of Demand for the whole or any part of the System .
Indicated Margin	The difference between the sum of BM Unit Maximum Export Limits submitted and the forecast of Demand for the whole or any part of the System .
Installation Document	A simple structured document containing information about a Type A Power Generating Module or a Demand Unit , with demand response connected below 1000 V, and confirming its compliance with the relevant requirements
Instructor Facilities	A device or system which gives certain Transmission Control Centre instructions with an audible or visible alarm, and incorporates the means to return message acknowledgements to the Transmission Control Centre .

Integral Equipment Test or IET	A test on equipment, associated with Plant and/or Apparatus , which takes place when that Plant and/or Apparatus forms part of a Synchronised System and which, in the reasonable judgement of the person wishing to perform the test, may cause an Operational Effect .
Intellectual Property" or "IPRs	Patents, trade marks, service marks, rights in designs, trade names, copyrights and topography rights (whether or not any of the same are registered and including applications for registration of any of the same) and rights under licences and consents in relation to any of the same and all rights or forms of protection of a similar nature or having equivalent or similar effect to any of the same which may subsist anywhere in the world.
Interconnection Agreement	An agreement made between The Company and an Externally Interconnected System Operator and/or an Interconnector User and/or other relevant persons for the External Interconnection relating to an External Interconnection and/or an agreement under which an Interconnector User can use an External Interconnection .
Interconnector Export Capacity	In relation to an External Interconnection means the (daily or weekly) forecast value (in MW) at the time of the (daily or weekly) peak demand, of the maximum level at which the External Interconnection can export to the Grid Entry Point .
Interconnector Import Capacity	In relation to an External Interconnection means the (daily or weekly) forecast value (in MW) at the time of the (daily or weekly) peak demand of the maximum level at which the External Interconnection can import from the Grid Entry Point .
Interconnector Owner	Has the meaning given to the term in the Connection and Use of System Code .
Interconnector User	Has the meaning set out in the BSC .
Interface Agreement	Has the meaning set out in the CUSC .
Interface Point	As the context admits or requires either; (a) the electrical point of connection between an Offshore Transmission System and an Onshore Transmission System , or (b) the electrical point of connection between an Offshore Transmission System and a Network Operator's User System .
Interface Point Capacity	The maximum amount of Active Power transferable at the Interface Point as declared by a User under the OTSDUW Arrangements expressed in whole MW.
Interface Point Target Voltage/Power factor	The nominal target voltage/power factor at an Interface Point which a Network Operator requires The Company to achieve by operation of the relevant Offshore Transmission System .

Interim Operational Notification or ION	<p>A notification from The Company to a Generator or DC Converter Station owner or HVDC System Owner or Network Operator or Non-Embedded Customer acknowledging that the User has demonstrated compliance, except for the Unresolved Issues;</p> <p>(a) with the Grid Code, and</p> <p>(b) where applicable, with Appendices F1 to F5 of the Bilateral Agreement,</p> <p>in each case in respect of the Plant and Apparatus (including OTSUA) specified in such notification and provided that in the case of the OTSDUW Arrangements such notification shall be provided to a Generator in two parts dealing with the OTSUA and Generator’s Plant and Apparatus (called respectively “Interim Operational Notification Part A” or “ION A” and “Interim Operational Notification Part B” or “ION B”) as provided for in the CP or ECP.</p>
Intermittent Power Source	<p>The primary source of power for a Generating Unit or Power Generating Module that cannot be considered as controllable, e.g. wind, wave or solar. For the avoidance of doubt, the output from an Electricity Storage Module would not be considered to be an Intermittent Power Source.</p>
Intertripping	<p>(a) The tripping of circuit-breaker(s) by commands initiated from Protection at a remote location independent of the state of the local Protection; or</p> <p>(b) Operational Intertripping.</p>
Intertrip Apparatus	<p>Apparatus which performs Intertripping.</p>
IP Completion Day	<p>31 December 2020 as defined in Section 39 of the European Union (Withdrawal Agreement) Act 2020.</p>
IP Turbine Power Fraction	<p>Ratio of steady state mechanical power delivered by the IP turbine to the total steady state mechanical power delivered by the total steam turbine at Registered Capacity or Maximum Capacity.</p>
Isolating Device	<p>A device for achieving Isolation.</p>

<p>Isolation</p>	<p>The disconnection of HV Apparatus (as defined in OC8A.1.6.2 and OC8B.1.7.2) from the remainder of the System in which that HV Apparatus is situated by either of the following:</p> <ul style="list-style-type: none"> (a) an Isolating Device maintained in an isolating position. The isolating position must either be: <ul style="list-style-type: none"> (i) maintained by immobilising and Locking the Isolating Device in the isolating position and affixing a Caution Notice to it. Where the Isolating Device is Locked with a Safety Key, the Safety Key must be secured in a Key Safe and the Key Safe Key must be, where reasonably practicable, given to the authorised site representative of the Requesting Safety Co-Ordinator and is to be retained in safe custody. Where not reasonably practicable the Key Safe Key must be retained by the authorised site representative of the Implementing Safety Co-ordinator in safe custody; or (ii) maintained and/or secured by such other method which must be in accordance with the Local Safety Instructions or the Safety Rules of the Relevant Transmission Licensee or that User, as the case may be; or (b) an adequate physical separation which must be in accordance with and maintained by the method set out in the Local Safety Instructions or the Safety Rules of the Relevant Transmission Licensee or that User, as the case may be.
<p>Joint System Incident</p>	<p>An Event wherever occurring (other than on an Embedded Medium Power Station or an Embedded Small Power Station) which, in the opinion of The Company or a User, has or may have a serious and/or widespread effect, in the case of an Event on a User(s) System(s) (other than on an Embedded Medium Power Station or Embedded Small Power Station), on the National Electricity Transmission System, and in the case of an Event on the National Electricity Transmission System, on a User(s) System(s) (other than on an Embedded Medium Power Station or Embedded Small Power Station).</p>
<p>Key Safe</p>	<p>A device for the secure retention of keys.</p>
<p>Key Safe Key</p>	<p>A key unique at a Location capable of operating a lock, other than a control lock, on a Key Safe.</p>

<p>Large Power Station</p>	<p>A Power Station which is</p> <p>(a) directly connected to:</p> <ul style="list-style-type: none"> (i) NGET’s Transmission System where such Power Station has a Registered Capacity of 100MW or more; or (ii) SPT’s Transmission System where such Power Station has a Registered Capacity of 30MW or more; or (iii) SHETL’s Transmission System where such Power Station has a Registered Capacity of 10MW or more; or (iv) an Offshore Transmission System where such Power Station has a Registered Capacity of 10MW or more; <p>or,</p> <p>(b) Embedded within a User System (or part thereof) where such User System (or part thereof) is connected under normal operating conditions to:</p> <ul style="list-style-type: none"> (i) NGET’s Transmission System and such Power Station has a Registered Capacity of 100MW or more; or (ii) SPT’s Transmission System and such Power Station has a Registered Capacity of 30MW or more; or (iii) SHETL’s Transmission System and such Power Station has a Registered Capacity of 10MW or more; <p>or,</p> <p>(c) Embedded within a User System (or part thereof) where the User System (or part thereof) is not connected to the National Electricity Transmission System, although such Power Station is in:</p> <ul style="list-style-type: none"> (i) NGET’s Transmission Area where such Power Station has a Registered Capacity of 100MW or more; or (ii) SPT’s Transmission Area where such Power Station has a Registered Capacity of 30MW or more; or (iii) SHETL’s Transmission Area where such Power Station has a Registered Capacity of 10MW or more; <p>For the avoidance of doubt, a Large Power Station could comprise of Type A, Type B, Type C or Type D Power Generating Modules.</p>
<p>Legally Binding Decisions of the European Commission and/or the Agency</p>	<p>Any relevant legally binding decision or decisions of the European Commission and/or the Agency, but a binding decision does not include a decision that is not, or so much of a decision as is not, Retained EU Law.</p>
<p>Legal Challenge</p>	<p>Where permitted by law, a judicial review in respect of the Authority’s decision to approve or not to approve a Grid Code Modification Proposal.</p>
<p>Licence</p>	<p>Any licence granted to The Company or a Relevant Transmission Licensee or a User, under Section 6 of the Act.</p>

Licence Standards	Those standards set out or referred to in Condition C17 of The Company's Transmission Licence and/or Condition D3 and/or Condition E16 of a Relevant Transmission Licensee's Transmission Licence .
Limited Frequency Sensitive Mode	A mode whereby the operation of the Genset or Power Generating Module (or DC Converter at a DC Converter Station or HVDC Systems exporting Active Power to the Total System) is Frequency insensitive except when the System Frequency exceeds 50.4Hz, from which point Limited High Frequency Response must be provided. For Power Generating Modules (including DC Connected Power Park Modules) and HVDC Systems , operation in Limited Frequency Sensitive Mode would require Limited Frequency Sensitive Mode – Overfrequency (LFSM-O) capability and Limited Frequency Sensitive Mode – Underfrequency (LFSM-U) capability.
Limited Frequency Sensitive Mode – Overfrequency or LFSM-O	A Power Generating Module (including a DC Connected Power Park Module) or HVDC System operating mode which will result in Active Power output reduction in response to a change in System Frequency above a certain value.
Limited Frequency Sensitive Mode – Underfrequency or LFSM-U	A Power Generating Module (including a DC Connected Power Park Module) or HVDC System operating mode which will result in Active Power output increase in response to a change in System Frequency below a certain value.
Limited High Frequency Response	A response of a Genset (or DC Converter at a DC Converter Station exporting Active Power to the Total System) to an increase in System Frequency above 50.4Hz leading to a reduction in Active Power in accordance with the provisions of BC3.7.2.1.
Limited Membership Workgroup	<p>A Workgroup having less than five (5) but more than two (2) persons that have nominated themselves for membership in addition to the Code Administrator representative and the chair of the Workgroup.</p> <p>Members of a Limited Membership Workgroup where employed by companies that are considered to be an Affiliate of each other will be considered to be a single workgroup member for the purposes of fulfilling this minimum requirement.</p>
Limited Operational Notification or LON	<p>A notification from The Company to a Generator or DC Converter Station owner or HVDC System Owner or Network Operator or Non-Embedded Customer stating that the User's Plant and/or Apparatus specified in such notification may be, or is, unable to comply:</p> <p>(a) with the provisions of the Grid Code specified in the notice, and</p> <p>(b) where applicable, with Appendices F1 to F5 of the Bilateral Agreement ,</p> <p>and specifying the Unresolved Issues.</p>
Load	The Active, Reactive or Apparent Power , as the context requires, generated, transmitted or distributed.
Loaded	Supplying electrical power to the System .

Load Factor	The ratio of the actual output of a Generating Unit or Power Generating Module to the possible maximum output of that Generating Unit or Power Generating Module .
Load Management Block	A block of Demand controlled by a Supplier or other party through the means of radio teleswitching or by some other means.
Local Joint Restoration Plan	<p>A plan produced under OC9.4.7.12 detailing the agreed method and procedure by which a Black Start Service Provider will energise part of the Total System and meet complementary blocks of local Demand so as to form a Power Island.</p> <p>In Scotland, the plan may also: cover more than one Black Start Service Provider; including Gensets other than those at a Black Start Station and cover the creation of one or more Power Islands.</p>
Local Safety Instructions	For safety co-ordination in England and Wales, instructions on each User Site and Transmission Site , approved by NGET's or User's relevant manager, setting down the methods of achieving the objectives of NGET's or the User's Safety Rules , as the case may be, to ensure the safety of personnel carrying out work or testing on Plant and/or Apparatus on which his Safety Rules apply and, in the case of a User , any other document(s) on a User Site which contains rules with regard to maintaining or securing the isolating position of an Isolating Device , or maintaining a physical separation or maintaining or securing the position of an Earthing Device .
Local Switching Procedure	A procedure produced under OC7.6 detailing the agreed arrangements in respect of carrying out of Operational Switching at Connection Sites and parts of the National Electricity Transmission System adjacent to those Connection Sites .
Localised Negative Reserve Active Power Margin or Localised NRAPM	That margin of Active Power sufficient to allow transfers to and from a System Constraint Group (as the case may be) to be contained within such reasonable limit as The Company may determine.
Location	Any place at which Safety Precautions are to be applied.
Locked	A condition of HV Apparatus that cannot be altered without the operation of a locking device.
Locking	The application of a locking device which enables HV Apparatus to be Locked .
Low Frequency Relay	Has the same meaning as Under Frequency Relay .
Low Voltage or LV	For E&W Transmission Systems a voltage not exceeding 250 volts. For Scottish Transmission Systems , a voltage exceeding 50 volts but not exceeding 1000 volts.
LV Side of the Offshore Platform	Unless otherwise specified in the Bilateral Agreement , the busbar on the Offshore Platform (typically 33kV) at which the relevant Offshore Grid Entry Point is located.

Main Plant and Apparatus	<p>In respect of a Power Station (including Power Stations comprising of DC Connected Power Park Modules and Electricity Storage Modules) is one or more of the principal items of Plant or Apparatus required to convert or re-convert the primary source of energy into electricity.</p> <p>In respect of HVDC Systems or DC Converters or Transmission DC Converters is one of the principal items of Plant or Apparatus used to convert high voltage direct current to high voltage alternating current or vice versa.</p> <p>In respect of a Network Operator's equipment or a Non-Embedded Customer's equipment, is one of the principal items of Plant or Apparatus required to facilitate the import or export of Active Power or Reactive Power to or from a Network Operator's or Non-Embedded Customer's System.</p>
Main Protection	A Protection system which has priority above other Protection in initiating either a fault clearance or an action to terminate an abnormal condition in a power system.
Manufacturer's Data & Performance Report	A report submitted by a manufacturer to The Company relating to a specific version of a Power Park Unit demonstrating the performance characteristics of such Power Park Unit in respect of which The Company has evaluated its relevance for the purposes of the Compliance Processes .
Manufacturer's Test Certificates	A certificate prepared by a manufacturer which demonstrates that its Power Generating Module has undergone appropriate tests and conforms to the performance requirements expected by The Company in satisfying its compliance requirements and thereby satisfies the appropriate requirements of the Grid Code and Bilateral Agreement .
Market Operation Data Interface System (MODIS)	A computer system operated by The Company and made available for use by Customers connected to or using the National Electricity Transmission System for the purpose of submitting EU Transparency Availability Data to The Company .
Market Suspension Threshold	Has the meaning given to the term 'Market Suspension Threshold' in Section G of the BSC .
Material Effect	An effect causing The Company or a Relevant Transmission Licensee to effect any works or to alter the manner of operation of Transmission Plant and/or Transmission Apparatus at the Connection Site (which term shall, in this definition and in the definition of " Modification " only, have the meaning ascribed thereto in the CUSC) or the site of connection or a User to effect any works or to alter the manner of operation of its Plant and/or Apparatus at the Connection Site or the site of connection which in either case involves that party in expenditure of more than £10,000.
Materially Affected Party	Any person or class of persons designated by the Authority as such.
Maximum Export Capability	The maximum continuous Active Power that a Network Operator or Non-Embedded Customer can export to the Transmission System at the Grid Supply Point , as specified in the Bilateral Agreement .

Maximum Export Capacity	The maximum continuous Apparent Power expressed in MVA and maximum continuous Active Power expressed in MW which can flow from an Offshore Transmission System connected to a Network Operator's User System , to that User System .
Maximum Capacity or P_{max}	The maximum continuous Active Power which a Power Generating Module can supply to the Total System , less any demand associated solely with facilitating the operation of that Power Generating Module and not fed into the System . In the case of an Electricity Storage Module , the Maximum Capacity is the maximum continuous Active Power which an Electricity Storage Module can export to the Total System less any demand associated with facilitating the operation of that Electricity Storage Module when fully charged and operating in a mode analogous to Generation .
Maximum Generation Service or MGS	A service utilised by The Company in accordance with the CUSC and the Balancing Principles Statement in operating the Total System .
Maximum Generation Service Agreement	An agreement between a User and The Company for the payment by The Company to that User in respect of the provision by such User of a Maximum Generation Service .
Maximum HVDC Active Power Transmission Capacity (PHmax)	The maximum continuous Active Power which an HVDC System can exchange with the network at each Grid Entry Point or User System Entry Point as specified in the Bilateral Agreement or as agreed between The Company and the HVDC System Owner .
Maximum Import Capability	The maximum continuous Active Power that a Network Operator or Non-Embedded Customer can import from the Transmission System at the Grid Supply Point , as specified in the Bilateral Agreement .
Maximum Import Capacity	The maximum continuous Apparent Power expressed in MVA and maximum continuous Active Power expressed in MW which can flow to an Offshore Transmission System connected to a Network Operator's User System , from that User System .
Maximum Import Power	The maximum continuous Active Power which an Electricity Storage Module can import from the Total System , when fully discharged and operating in a mode analogous to Demand .

<p>Medium Power Station</p>	<p>A Power Station which is</p> <p>(a) directly connected to NGET's Transmission System where such Power Station has a Registered Capacity of 50MW or more but less than 100MW;</p> <p>or,</p> <p>(b) Embedded within a User System (or part thereof) where such User System (or part thereof) is connected under normal operating conditions to NGET's Transmission System and such Power Station has a Registered Capacity of 50MW or more but less than 100MW;</p> <p>or,</p> <p>(c) Embedded within a User System (or part thereof) where the User System (or part thereof) is not connected to the National Electricity Transmission System, although such Power Station is in NGET's Transmission Area and such Power Station has a Registered Capacity of 50MW or more but less than 100MW.</p> <p>For the avoidance of doubt a Medium Power Station could comprise of Type A, Type B, Type C or Type D Power Generating Modules.</p>
<p>Medium Voltage or MV</p>	<p>For E&W Transmission Systems a voltage exceeding 250 volts but not exceeding 650 volts.</p>
<p>Mills</p>	<p>Milling plant which supplies pulverised fuel to the boiler of a coal fired Power Station.</p>
<p>Minimum Generation</p>	<p>The minimum output (in whole MW) which a Genset can generate or DC Converter at a DC Converter Station or Electricity Storage Module can import or export to the Total System under stable operating conditions, as registered with The Company under the PC (and amended pursuant to the PC). For the avoidance of doubt, the output may go below this level as a result of operation in accordance with BC3.7.</p>
<p>Minimum Active Power Transmission Capacity (PHmin)</p>	<p>The minimum continuous Active Power which an HVDC System can exchange with the System at each Grid Entry Point or User System Entry Point as specified in the Bilateral Agreement or as agreed between The Company and the HVDC System Owner.</p>
<p>Minimum Import Capacity</p>	<p>The minimum input (in whole MW) into a DC Converter at a DC Converter Station or HVDC System at an HVDC Converter (in any of its operating configurations) at the Onshore Grid Entry Point (or in the case of an Embedded DC Converter or an Embedded HVDC Converter at the User System Entry Point) at which a DC Converter or HVDC Converter can operate in a stable manner, as registered with The Company under the PC (and amended pursuant to the PC).</p>
<p>Minimum Regulating Level</p>	<p>The minimum Active Power, as specified in the Bilateral Agreement or as agreed between The Company and the Generator or HVDC System Owner, down to which the Power Generating Module (including a DC Connected Power Park Module) or HVDC System can control Active Power.</p>

Minimum Stable Operating Level	The minimum Active Power , as specified in the Bilateral Agreement or as agreed between The Company and the Generator , at which the Power Generating Module can be operated stably for an unlimited time.
Modification	Any actual or proposed replacement, renovation, modification, alteration or construction by or on behalf of a User or The Company to either that User's Plant or Apparatus or Transmission Plant or Apparatus , as the case may be, or the manner of its operation which has or may have a Material Effect on The Company or a User , as the case may be, at a particular Connection Site .
Mothballed DC Connected Power Park Module	A DC Connected Power Park Module that has previously generated which the Generator plans not to use to generate for the remainder of the current Financial Year but which could be returned to service.
Mothballed DC Converter at a DC Converter Station	A DC Converter at a DC Converter Station that has previously imported or exported power which the DC Converter Station Owner plans not to use to import or export power for the remainder of the current Financial Year but which could be returned to service.
Mothballed HVDC System	An HVDC System that has previously imported or exported power which the HVDC System Owner plans not to use to import or export power for the remainder of the current Financial Year but which could be returned to service.
Mothballed HVDC Converter	An HVDC Converter which is part of an HVDC System that has previously imported or exported power which the HVDC System Owner plans not to use to import or export power for the remainder of the current Financial Year but which could be returned to service.
Mothballed Generating Unit	A Generating Unit that has previously generated which the Generator plans not to use to generate for the remainder of the current Financial Year but which could be returned to service. For the avoidance of doubt a Mothballed Generating Unit could be part of a Power Generating Module .
Mothballed Power Generating Module	A Power Generating Module that has previously generated which the Generator plans not to use to generate for the remainder of the current Financial Year but which could be returned to service.
Mothballed Power Park Module	A Power Park Module that has previously generated which the Generator plans not to use to generate for the remainder of the current Financial Year but which could be returned to service.
Multiple Point of Connection	A double (or more) Point of Connection , being two (or more) Points of Connection interconnected to each other through the User's System .
MSID	Has the meaning a set out in the BSC , covers Metering System Identifier.

<p>National Demand</p>	<p>The amount of electricity supplied from the Grid Supply Points plus:-</p> <ul style="list-style-type: none"> • that supplied by Embedded Large Power Stations, and • National Electricity Transmission System Losses, <p>minus:-</p> <ul style="list-style-type: none"> • the Demand taken by Station Transformers and, Pumped Storage Units’ and Electricity Storage Modules’. <p>and, for the purposes of this definition, does not include:-</p> <ul style="list-style-type: none"> • any exports from the National Electricity Transmission System across External Interconnections.
<p>National Electricity Transmission System</p>	<p>The Onshore Transmission System and, where owned by Offshore Transmission Licensees, Offshore Transmission Systems.</p>
<p>National Electricity Transmission System Demand</p>	<p>The amount of electricity supplied from the Grid Supply Points plus:-</p> <ul style="list-style-type: none"> • that supplied by Embedded Large Power Stations, and • exports from the National Electricity Transmission System across External Interconnections, and • National Electricity Transmission System Losses, <p>and, for the purposes of this definition, includes:-</p> <ul style="list-style-type: none"> • the Demand taken by Station Transformers and, Pumped Storage Units and Electricity Storage Modules’.
<p>National Electricity Transmission System Losses</p>	<p>The losses of electricity incurred on the National Electricity Transmission System.</p>
<p>National Electricity Transmission System Operator Area</p>	<p>Has the meaning set out in Schedule 1 of The Company's Transmission Licence.</p>
<p>National Electricity Transmission System Study Network Data File</p>	<p>A computer file produced by The Company which in The Company's view provides an appropriate representation of the National Electricity Transmission System for a specific point in time. The computer file will contain information and data on Demand on the National Electricity Transmission System and on Large Power Stations including Genset power output consistent with Output Usable and The Company's view of prevailing system conditions.</p>
<p>National Electricity Transmission System Warning</p>	<p>A warning issued by The Company to Users (or to certain Users only) in accordance with OC7.4.8.2, which provides information relating to System conditions or Events and is intended to:</p> <ol style="list-style-type: none"> (a) alert Users to possible or actual Plant shortage, System problems and/or Demand reductions; (b) inform of the applicable period; (c) indicate intended consequences for Users; and (d) enable specified Users to be in a state of readiness to receive instructions from The Company.

National Electricity Transmission System Warning - Demand Control Imminent	A warning issued by The Company , in accordance with OC7.4.8.7, which is intended to provide short term notice, where possible, to those Users who are likely to receive Demand reduction instructions from The Company within 30 minutes.
National Electricity Transmission System Warning - Electricity Margin Notice	A warning issued by The Company , in accordance with OC7.4.8.5, which is intended to invite a response from and to alert recipients to a decreased System Margin .
National Electricity Transmission System Warning – Embedded Generation Control Imminent	A warning issued by The Company , in accordance with OC7.4.8.12, which is intended to provide short term notice, where possible, to those Network Operators who are likely to receive Embedded Generation Control instructions from The Company within 30 minutes.
National Electricity Transmission System Warning - High Risk of Demand Reduction	A warning issued by The Company , in accordance with OC7.4.8.6, which is intended to alert recipients that there is a high risk of Demand reduction being implemented and which may normally result from an Electricity Margin Notice .
National Electricity Transmission System Warning - High Risk of Embedded Generation Reduction	A warning issued by The Company , in accordance with OC7.4.8.11, which is intended to alert recipients that there is a high risk of Embedded Generation Control being implemented and which may result from a National Electricity Transmission System Warning – System NRAPM .
National Electricity Transmission System Warning – Localised NRAPM	A warning issued by The Company , in accordance with OC.7.4.8.10, which is intended to invite a response from and to alert recipients to a decreased Localised NRAPM .
National Electricity Transmission System Warning - Risk of System Disturbance	A warning issued by The Company , in accordance with OC7.4.8.8, which is intended to alert Users of the risk of widespread and serious System disturbance which may affect Users .
National Electricity Transmission System Warning – System NRAPM	A warning issued by The Company , in accordance with OC.7.4.8.9, which is intended to invite a response from and to alert recipients to a decreased System NRAPM .
Network Data	The data to be provided by The Company to Users in accordance with the PC , as listed in Part 3 of the Appendix to the PC .
Network Operator	A person with a User System directly connected to the National Electricity Transmission System to which Customers and/or Power Stations (not forming part of the User System) are connected, acting in its capacity as an operator of the User System , but shall not include a person acting in the capacity of an Externally Interconnected System Operator or a Generator in respect of OTSUA .
NGET	National Grid Electricity Transmission plc (NO: 2366977) whose registered office is at 1-3 Strand, London, WC2N 5EH.
No-Load Field Voltage	Shall have the meaning ascribed to that term in IEC 34-16-1:1991 [equivalent to British Standard BS4999 Section 116.1 : 1992].

No System Connection	As defined in OC8A.1.6.2 and OC8B.1.7.2.
Non-Synchronous Electricity Storage Module	A Power Park Module comprising solely of one or more Non-Synchronous Electricity Storage Units .
Notification of User's Intention to Operate	A notification from a Network Operator or Non-Embedded Customer to The Company informing The Company of the date upon which any Network Operator's or Non-Embedded Customer's Plant and Apparatus at an EU Grid Supply Point will be ready to be connected to the Transmission System .
Notification of User's Intention to Synchronise	A notification from a Generator or DC Converter Station owner or HVDC System Owner to The Company informing The Company of the date upon which any OTSUA , a Generating Unit(s) , CCGT Module(s) , Power Park Module(s) , Power Generating Module(s) (including a DC Connected Power Park Module(s)), HVDC System or DC Converter(s) will be ready to be Synchronised to the Total System .
Non-Controllable Electricity Storage Equipment	An item of storage Plant , including but not limited to a Synchronous Flywheel or Synchronous Compensation Equipment or Regenerative Braking whose active output power cannot be independently controlled.
Non-Dynamic Frequency Response Service	A Demand Response Service in which the Demand is controlled through discrete switching rather than through continuous load changes in response to System Frequency changes.
Non-Embedded Customer	A Customer in Great Britain , except for a Network Operator acting in its capacity as such, receiving electricity direct from the Onshore Transmission System irrespective of from whom it is supplied.
Non-Synchronous Electricity Storage Module	A Power Park Module comprising solely of one or more Non-Synchronous Electricity Storage Units .
Non-Synchronous Electricity Storage Unit	A Power Park Unit which can produce electrical energy by converting or re-converting another source of energy such that the frequency of the generated voltage is not inherently in synchronism with the frequency of the System .
Non-Synchronous Generating Unit	An Onshore Non-Synchronous Generating Unit or Offshore Non-Synchronous Generating Unit which could form part of a Power Generating Module .
Normal CCGT Module	A CCGT Module other than a Range CCGT Module .
Novel Unit	A tidal, wave, wind, geothermal, or any similar, Generating Unit .
OC9 De-synchronised Island Procedure	Has the meaning set out in OC9.5.4.
Offshore	Means wholly or partly in Offshore Waters , and when used in conjunction with another term and not defined means that the associated term is to be read accordingly.

Offshore DC Converter	Any User Apparatus located Offshore used to convert alternating current electricity to direct current electricity, or vice versa. An Offshore DC Converter is a standalone operative configuration at a single site comprising one or more converter bridges, together with one or more converter transformers, converter control equipment, essential protective and switching devices and auxiliaries, if any, used for conversion.
Offshore HVDC Converter	Any User Apparatus located Offshore used to convert alternating current electricity to direct current electricity, or vice versa. An Offshore HVDC Converter is a standalone operative configuration at a single site comprising one or more converter bridges, together with one or more converter transformers, converter control equipment, essential protective and switching devices and auxiliaries, if any, used for conversion.
Offshore Development Information Statement	A statement prepared by The Company in accordance with Special Condition C4 of The Company's Transmission Licence .
Offshore Generating Unit	Unless otherwise provided in the Grid Code, any Apparatus located Offshore which produces electrical energy by converting or re-converting another source of energy, including, an Offshore Synchronous Generating Unit or Offshore Non-Synchronous Generating Unit which could also be part of a Power Generating Module or Electricity Storage Module
Offshore Grid Entry Point	In the case of:- (a) an Offshore Generating Unit or an Offshore Synchronous Power Generating Module or an Offshore DC Converter or an Offshore HVDC Converter , as the case may be, which is directly connected to an Offshore Transmission System , the point at which it connects to that Offshore Transmission System , or; (b) an Offshore Power Park Module which is directly connected to an Offshore Transmission System , the point where one Power Park String (registered by itself as a Power Park Module) or the collection of points where a number of Offshore Power Park Strings (registered as a single Power Park Module) connects to that Offshore Transmission System , or; (c) an External Interconnection which is directly connected to an Offshore Transmission System , the point at which it connects to that Offshore Transmission System .
Offshore Non-Synchronous Generating Unit	An Offshore Generating Unit that is not an Offshore Synchronous Generating Unit including for the avoidance of doubt a Power Park Unit or Non-Synchronous Electricity Storage Unit located Offshore .
Offshore Platform	A single structure comprising of Plant and Apparatus located Offshore which includes one or more Offshore Grid Entry Points .

Offshore Power Park Module	<p>A collection of one or more Offshore Power Park Strings (registered as a Power Park Module under the PC). There is no limit to the number of Power Park Strings within the Power Park Module, so long as they either:</p> <ul style="list-style-type: none"> (a) connect to the same busbar which cannot be electrically split; or (b) connect to a collection of directly electrically connected busbars of the same nominal voltage and are configured in accordance with the operating arrangements set out in the relevant Bilateral Agreement.
Offshore Power Park String	<p>A collection of Offshore Generating Units or Power Park Units or Non-Synchronous Electricity Storage Unit that are powered by an Intermittent Power Source, joined together by cables forming part of a User System with a single point of connection to an Offshore Transmission System. The connection to an Offshore Transmission System may include a DC Converter or HVDC Converter.</p>
Offshore Synchronous Generating Unit	<p>A Generating Unit or Synchronous Electricity Storage Unit located Offshore which could be part of an Offshore Synchronous Power Generating Module in which, under all steady state conditions, the rotor rotates at a mechanical speed equal to the electrical frequency of the National Electricity Transmission System divided by the number of pole pairs of the Generating Unit.</p>
Offshore Synchronous Power Generating Module	<p>A Synchronous Power Generating Module or Synchronous Electricity Storage Module located Offshore.</p>
Offshore Tender Process	<p>The process followed by the Authority to make, in prescribed cases, a determination on a competitive basis of the person to whom an offshore transmission licence is to be granted.</p>
Offshore Transmission Distribution Connection Agreement	<p>An agreement entered into by The Company and a Network Operator in respect of the connection to and use of a Network Operator's User System by an Offshore Transmission System.</p>
Offshore Transmission Licensee	<p>Such person in relation to whose Transmission Licence the standard conditions in Section E (offshore transmission owner standard conditions) of such Transmission Licence have been given effect, or any person in that prospective role who has acceded to the STC.</p>
Offshore Transmission System	<p>A system consisting (wholly or mainly) of high voltage electric lines and used for the transmission of electricity from one Power Station to a sub-station or to another Power Station or between sub-stations, and includes any Plant and Apparatus (including OTSUA) and meters in connection with the transmission of electricity but does not include any Remote Transmission Assets. An Offshore Transmission System extends from the Interface Point, or the Offshore Grid Entry Point(s) and may include Plant and Apparatus located Onshore and Offshore and, where the context permits, references to the Offshore Transmission System includes OTSUA.</p>

Offshore Transmission System Development User Works or OTSDUW	In relation to a particular User where the OTSDUW Arrangements apply, means those activities and/or works for the design, planning, consenting and/or construction and installation of the Offshore Transmission System to be undertaken by the User as identified in Part 2 of Appendix I of the relevant Construction Agreement .
Offshore Transmission System User Assets or OTSUA	OTSDUW Plant and Apparatus constructed and/or installed by a User under the OTSDUW Arrangements which form an Offshore Transmission System that once transferred to a Relevant Transmission Licensee under an Offshore Tender Process will become part of the National Electricity Transmission System .
Offshore Waters	Has the meaning given to “offshore waters” in Section 90(9) of the Energy Act 2004.
Offshore Works Assumptions	In relation to a particular User , means those assumptions set out in Appendix P of the relevant Construction Agreement as amended from time to time.
Onshore	Means within Great Britain , and when used in conjunction with another term and not defined means that the associated term is to be read accordingly.
Onshore DC Converter	Any User Apparatus located Onshore with a Completion Date after 1 st April 2005 used to convert alternating current electricity to direct current electricity, or vice versa. An Onshore DC Converter is a standalone operative configuration at a single site comprising one or more converter bridges, together with one or more converter transformers, converter control equipment, essential protective and switching devices and auxiliaries, if any, used for conversion. In a bipolar arrangement, an Onshore DC Converter represents the bipolar configuration.
Onshore Generating Unit	Unless otherwise provided in the Grid Code, any Apparatus located Onshore which produces electrical energy by converting or re-converting another source of energy, including, an Onshore Synchronous Generating Unit or Onshore Non-Synchronous Generating Unit which could also be part of a Power Generating Module or an Electricity Storage Module .
Onshore Grid Entry Point	A point at which a Onshore Generating Unit or a CCGT Module or a CCGT Unit or an Onshore Power Generating Module or a Onshore DC Converter or an Onshore HVDC Converter or a Onshore Power Park Module or an Onshore Electricity Storage Module or an External Interconnection , as the case may be, which is directly connected to the Onshore Transmission System connects to the Onshore Transmission System .
Onshore HVDC Converter	Any User Apparatus located Onshore used to convert alternating current electricity to direct current electricity, or vice versa. An Onshore HVDC Converter is a standalone operative configuration at a single site comprising one or more converter bridges, together with one or more converter transformers, converter control equipment, essential protective and switching devices and auxiliaries, if any, used for conversion. In a bipolar arrangement, an Onshore HVDC Converter represents the bipolar configuration.

Onshore Non-Synchronous Generating Unit	A Generating Unit located Onshore that is not a Synchronous Generating Unit or Synchronous Electricity Storage Unit including for the avoidance of doubt a Power Park Unit or Non-Synchronous Electricity Storage Unit located Onshore .
Onshore Power Park Module	A collection of Non-Synchronous Generating Units that are powered by an Intermittent Power Source or connected through power electronic conversion technology or Non-Synchronous Electricity Storage Units , joined together by a System (registered as a Power Park Module under the PC) with a single electrical point of connection directly to the Onshore Transmission System (or User System if Embedded) with no intermediate Offshore Transmission System connections. The connection to the Onshore Transmission System (or User System if Embedded) may include a DC Converter or HVDC Converter .
Onshore Synchronous Generating Unit	An Onshore Generating Unit or Onshore Synchronous Electricity Storage Unit (which could also be part of an Onshore Power Generating Module) including, for the avoidance of doubt, a CCGT Unit or Synchronous Electricity Storage Unit in which, under all steady state conditions, the rotor rotates at a mechanical speed equal to the electrical frequency of the National Electricity Transmission System divided by the number of pole pairs of the Generating Unit .
Onshore Synchronous Power Generating Module	A Synchronous Power Generating Module or Synchronous Electricity Storage Module located Onshore .
Onshore Transmission Licensee	NGET, SPT, or SHETL.
Onshore Transmission System	The system consisting (wholly or mainly) of high voltage electric lines owned or operated by Onshore Transmission Licensees or operated by The Company and used for the transmission of electricity from one Power Station to a substation or to another Power Station or between substations or to or from Offshore Transmission Systems or to or from any External Interconnection , and includes any Plant and Apparatus and meters owned or operated by any Onshore Transmission Licensee in connection with the transmission of electricity but does not include any Remote Transmission Assets .
On-Site Generator Site	A site which is determined by the BSC Panel to be a Trading Unit under the BSC by reason of having fulfilled the Class 1 or Class 2 requirements as such terms are used in the BSC .
Operating Code or OC	That portion of the Grid Code which is identified as the Operating Code .
Operating Margin	Contingency Reserve plus Operating Reserve .
Operating Reserve	The additional output from Large Power Stations or the reduction in Demand , which must be realisable in real-time operation to respond in order to contribute to containing and correcting any System Frequency fall to an acceptable level in the event of a loss of generation or a loss of import from an External Interconnection or mismatch between generation and Demand .
Operation	A scheduled or planned action relating to the operation of a System (including an Embedded Power Station).

Operational Data	Data required under the Operating Codes and/or Balancing Codes .
Operational Day	The period from 0500 hours on one day to 0500 on the following day.
Operation Diagrams	Diagrams which are a schematic representation of the HV Apparatus and the connections to all external circuits at a Connection Site (and in the case of OTSDUW, Transmission Interface Site), incorporating its numbering, nomenclature and labelling.
Operational Effect	Any effect on the operation of the relevant other System which causes the National Electricity Transmission System or the System of the other User or Users , as the case may be, to operate (or be at a materially increased risk of operating) differently to the way in which they would or may have operated in the absence of that effect.
Operational Intertripping	The automatic tripping of circuit-breakers to prevent abnormal system conditions occurring, such as over voltage, overload, System instability, etc. after the tripping of other circuit-breakers following power System fault(s) which includes System to Generating Unit , System to CCGT Module , System to Power Park Module , System to Electricity Storage Module , System to DC Converter , System to Power Generating Module , System to HVDC Converter and System to Demand intertripping schemes.
Operational Notifications	Any Energisation Operational Notification , Interim Operational Notification , Final Operational Notification or Limited Operational Notification issued from The Company to a User .
Operational Planning	Planning through various timescales the matching of generation output with forecast National Electricity Transmission System Demand together with a reserve of generation to provide a margin, taking into account outages of certain Generating Units or Power Generating Modules , of parts of the National Electricity Transmission System and of parts of User Systems to which Power Stations and/or Customers are connected, carried out to achieve, so far as possible, the standards of security set out in The Company's Transmission Licence , each Relevant Transmission Licensee's Transmission Licence or Electricity Distribution Licence , as the case may be.
Operational Planning Margin	An operational planning margin set by The Company .
Operational Planning Phase	The period from 8 weeks to the end of the 5 th year ahead of real time operation.
Operational Procedures	Management instructions and procedures, both in support of the Safety Rules and for the local and remote operation of Plant and Apparatus , issued in connection with the actual operation of Plant and/or Apparatus at or from a Connection Site .
Operational Switching	Operation of Plant and/or Apparatus to the instruction of the relevant Control Engineer . For the avoidance of doubt, the operation of Transmission Plant and/or Apparatus forming part of the National Electricity Transmission System will be to the instruction of the Relevant Transmission Licensee .

Other Relevant Data	The data listed in BC1.4.2(f) under the heading Other Relevant Data .
OTSDUW Arrangements	The arrangements whereby certain aspects of the design, consenting, construction, installation and/or commissioning of transmission assets are capable of being undertaken by a User prior to the transfer of those assets to a Relevant Transmission Licensee under an Offshore Tender Process .
OTSDUW Data and Information	The data and information to be provided by Users undertaking OTSDUW , to The Company in accordance with Appendix F of the Planning Code .
OTSDUW DC Converter	A Transmission DC Converter designed and/or constructed and/or installed by a User under the OTSDUW Arrangements and/or operated by the User until the OTSUA Transfer Time .
OTSDUW Development and Data Timetable	The timetable for both the delivery of OTSDUW Data and Information and OTSDUW Network Data and Information as referred to in Appendix F of the Planning Code and the development of the scope of the OTSDUW .
OTSDUW Network Data and Information	The data and information to be provided by The Company to Users undertaking OTSDUW in accordance with Appendix F of the Planning Code .
OTSDUW Plant and Apparatus	Plant and Apparatus , including any OTSDUW DC Converter , designed by the User under the OTSDUW Arrangements .
OTSUA Transfer Time	The time and date at which the OTSUA are transferred to a Relevant Transmission Licensee .
Out of Synchronism	The condition where a System or Generating Unit or Power Generating Module cannot meet the requirements to enable it to be Synchronised .
Output Usable or OU	<p>The (daily or weekly) forecast value (in MW), at the time of the (daily or weekly) peak demand, of the maximum level at which the Genset can export to the Grid Entry Point, or in the case of Embedded Power Stations, to the User System Entry Point. In addition, for a Genset powered by an Intermittent Power Source the forecast value is based upon the Intermittent Power Source being at a level which would enable the Genset to generate at Registered Capacity.</p> <p>For the purpose of OC2 only, the term Output Usable shall include the terms Interconnector Export Capacity and Interconnector Import Capacity where the term Output Usable is being applied to an External Interconnection.</p>
Over-excitation Limiter	Shall have the meaning ascribed to that term in IEC 34-16-1:1991 [equivalent to British Standard BS4999 Section 116.1: 1992].
Panel Chairman	A person appointed as such in accordance with GR.4.1.
Panel Member	Any of the persons identified as such in GR.4.
Panel Members' Recommendation	The recommendation in accordance with the " Grid Code Review Panel Recommendation Vote ".

Panel Secretary	A person appointed as such in accordance with GR.3.1.2(d).
Part 1 System Ancillary Services	Ancillary Services which are required for System reasons and which must be provided by Users in accordance with the Connection Conditions . An exhaustive list of Part 1 System Ancillary Services is included in that part of CC.8.1 or ECC.8.1 headed Part 1.
Part 2 System Ancillary Services	Ancillary Services which are required for System reasons and which must be provided by a User if the User has agreed to provide them under a Bilateral Agreement . A non-exhaustive list of Part 2 System Ancillary Services is included in that part of CC.8.1 or ECC.8.1 headed Part 2.
Part Load	The condition of a Genset , or Cascade Hydro Scheme which is Loaded but is not running at its Maximum Export Limit.
Permit for Work for proximity work	In respect of E&W Transmission Systems , a document issued by the Relevant E&W Transmission Licensee or an E&W User in accordance with its respective Safety Rules to enable work to be carried out in accordance with OC8A.8 and which provides for Safety Precautions to be applied and maintained. An example format of a Relevant E&W Transmission Licensee's permit for work is attached as Appendix E to OC8A . In respect of Scottish Transmission Systems , a document issued by a Relevant Scottish Transmission Licensee or a Scottish User in accordance with its respective Safety Rules to enable work to be carried out in accordance with OC8B.8 and which provides for Safety Precautions to be applied and maintained. Example formats of Relevant Scottish Transmission Licensees' permits for work are attached as Appendix E to OC8B .
Partial Shutdown	The same as a Total Shutdown except that all generation has ceased in a separate part of the Total System and there is no electricity supply from External Interconnections or other parts of the Total System to that part of the Total System and, therefore, that part of the Total System is shutdown, with the result that it is not possible for that part of the Total System to begin to function again without The Company's directions relating to a Black Start .
Pending Grid Code Modification Proposal	A Grid Code Modification Proposal in respect of which, at the relevant time, the Authority has not yet made a decision as to whether to direct such Grid Code Modification Proposal to be made pursuant to the Transmission Licence (whether or not a Grid Code Modification Report has been submitted in respect of such Grid Code Modification Proposal) or, in the case of a Grid Code Self Governance Proposals , in respect of which the Grid Code Review Panel has not yet voted whether or not to approve.
Phase (Voltage) Unbalance	The ratio (in percent) between the rms values of the negative sequence component and the positive sequence component of the voltage.
Physical Notification	Data that describes the BM Participant's best estimate of the expected input or output of Active Power of a BM Unit and/or (where relevant) Generating Unit , the accuracy of the Physical Notification being commensurate with Good Industry Practice .

Planning Code or PC	That portion of the Grid Code which is identified as the Planning Code .
Planned Maintenance Outage	An outage of The Company's electronic data communication facilities as provided for in CC.6.5.8 or ECC.6.5.8 and The Company's associated computer facilities of which normally at least 5 days notice is given, but in any event of which at least twelve hours notice has been given by The Company to the User and which is anticipated to last no longer than 2 hours. The length of such an outage may in exceptional circumstances be extended where at least 24 hours notice has been given by The Company to the User . It is anticipated that normally any planned outage would only last around one hour.
Planned Outage	An outage of a Large Power Station or of part of the National Electricity Transmission System , or of part of a User System , co-ordinated by The Company under OC2 .
Plant	Fixed and movable items used in the generation and/or supply and/or transmission of electricity, other than Apparatus .
Point of Common Coupling	That point on the National Electricity Transmission System electrically nearest to the User installation at which either Demands or Loads are, or may be, connected.
Point of Connection	An electrical point of connection between the National Electricity Transmission System and a User's System .
Point of Isolation	The point on Apparatus (as defined in OC8A.1.6.2 and OC8B.1.7.2) at which Isolation is achieved.
Post-Control Phase	The period following real time operation.
Power Available	A signal prepared in accordance with good industry practice, representing the instantaneous sum of the potential Active Power available from each individual Power Park Unit within the Power Park Module calculated using any applicable combination of electrical or mechanical or meteorological data (including wind speed) measured at each Power Park Unit at a specified time. Power Available shall be a value between 0MW and Registered Capacity or Maximum Capacity which is the sum of the potential Active Power available of each Power Park Unit within the Power Park Module . A unit that is not generating or supplying power will be considered as not available. For the avoidance of doubt, the Power Available signal would be the Active Power output that a Power Park Module could reasonably be expected to export at the Grid Entry Point or User System Entry Point taking all the above criteria into account including Power Park Unit constraints such as optimisation modes but would exclude a reduction in the Active Power export of the Power Park Module instructed by The Company (for example) for the purposes selecting a Power Park Module to operate in Frequency Sensitive Mode or when an Emergency Instruction has been issued.
Power Factor	The ratio of Active Power to Apparent Power .
Power-Generating Module	Either a Synchronous Power Generating Module , a Synchronous Electricity Storage Module , a Power Park Module or a Non-Synchronous Electricity Storage Module owned or operated by an EU Generator .

Power-Generating Module Document (PGMD)	A document provided by the Generator to The Company for a Type B or Type C Power Generating Module which confirms that the Power Generating Module's compliance with the technical criteria set out in the Grid Code has been demonstrated and provides the necessary data and statements, including a statement of compliance.
Power Generating Module Performance Chart	A diagram showing the Real Power (MW) and Reactive Power (MVar) capability limits within which a Synchronous Power Generating Module or Power Park Module at its Grid Entry Point or User System Entry Point will be expected to operate under steady state conditions.
Power Island	Gensets at an isolated Power Station , together with complementary local Demand . In Scotland a Power Island may include more than one Power Station .
Power Park Module	Any Onshore Power Park Module or Offshore Power Park Module .
Power Park Module Availability Matrix	The matrix described in Appendix 1 to BC1 under the heading Power Park Module Availability Matrix .
Power Park Module Planning Matrix	A matrix in the form set out in Appendix 4 of OC2 showing the combination of Power Park Units within a Power Park Module which would be expected to be running under normal conditions.
Power Park Unit	A Generating Unit within a Power Park Module .
Power Station	An installation comprising one or more Generating Units or Power Park Modules or Power Generating Modules or Electricity Storage Modules (even where sited separately) owned and/or controlled by the same Generator , which may reasonably be considered as being managed as one Power Station .
Power System Stabiliser or PSS	Equipment controlling the Exciter output via the voltage regulator in such a way that power oscillations of the synchronous machines are dampened. Input variables may be speed, frequency or power (or a combination of these).
Preface	The preface to the Grid Code (which does not form part of the Grid Code and therefore is not binding).
Preliminary Notice	A notice in writing, sent by The Company both to all Users identified by it under OC12.4.2.1 and to the Test Proposer , notifying them of a proposed System Test .
Preliminary Project Planning Data	Data relating to a proposed User Development at the time the User applies for a CUSC Contract but before an offer is made and accepted.

Primary Response	The automatic increase in Active Power output of a Genset or, as the case may be, the decrease in Active Power Demand in response to a System Frequency fall. This increase in Active Power output or, as the case may be, the decrease in Active Power Demand must be in accordance with the provisions of the relevant Ancillary Services Agreement which will provide that it will be released increasingly with time over the period 0 to 10 seconds from the time of the start of the Frequency fall on the basis set out in the Ancillary Services Agreement and fully available by the latter, and sustainable for at least a further 20 seconds. The interpretation of the Primary Response to a – 0.5 Hz frequency change is shown diagrammatically in Figure CC.A.3.2 and Figure ECC.A.3.2
Private Network	A network which connects to a Network Operator's System and that network belongs to a User who is not classified as a Generator, Network Operator or Non-Embedded Customer .
Programming Phase	The period between the Operational Planning Phase and the Control Phase . It starts at the 8 weeks ahead stage and finishes at 17:00 on the day ahead of real time.
Proposal Notice	A notice submitted to The Company by a User which would like to undertake a System Test .
Proposal Report	A report submitted by the Test Panel which contains: <ul style="list-style-type: none"> (a) proposals for carrying out a System Test (including the manner in which the System Test is to be monitored); (b) an allocation of costs (including un-anticipated costs) between the affected parties (the general principle being that the Test Proposer will bear the costs); and (c) such other matters as the Test Panel considers appropriate. The report may include requirements for indemnities to be given in respect of claims and losses arising from a System Test .
Proposed Implementation Date	The proposed date(s) for the implementation of a Grid Code Modification Proposal or Workgroup Alternative Grid Code Modification such date(s) to be either (i) described by reference to a specified period after a direction from the Authority approving the Grid Code Modification Proposal or Workgroup Alternative Grid Code Modification or (ii) a Fixed Proposed Implementation Date .
Proposer	In relation to a particular Grid Code Modification Proposal , the person who makes such Grid Code Modification Proposal .
Protection	The provisions for detecting abnormal conditions on a System and initiating fault clearance or actuating signals or indications.
Protection Apparatus	A group of one or more Protection relays and/or logic elements designated to perform a specified Protection function.
Pumped Storage	A hydro unit in which water can be raised by means of pumps and stored to be used for the generation of electrical energy;

Pumped Storage Generating Unit	A Generating Unit at a Pumped Storage Plant
Pumped Storage Generator	A Generator which owns and/or operates any Pumped Storage Plant .
Pumped Storage Plant	A Power Station comprising Pumped Storage Generating Units .
Pumped Storage Unit	A Generating Unit within a Pumped Storage Plant . For the avoidance of doubt, a Pumped Storage Unit is not considered to form part of an Electricity Storage Unit unless specifically declared by the Generator .
Purchase Contracts	A final and binding contract for the purchase of the Main Plant and Apparatus .
Q/Pmax	<p>The ratio of Reactive Power to the Maximum Capacity. The relationship between Power Factor and Q/Pmax is given by the formula:-</p> $\text{Power Factor} = \text{Cos} \left[\arctan \left[\frac{Q}{P_{max}} \right] \right]$ <p>For example, a Power Park Module with a Q/P value of +0.33 would equate to a Power Factor of $\text{Cos}(\arctan 0.33) = 0.95$ Power Factor lag.</p>
Quick Resynchronisation Capability	The capability of a Type C or Type D Power Generating Module as defined in ECC.6.3.5.6. For the avoidance of doubt this requirement only applies to EU Code Generators who own or operate a Type C or Type D Power Generating Module .
Quick Resynchronisation Unit Test	A test undertaken on Generating Unit forming part of a Type C or Type D Power Generating Module as detailed in OC5.7.1 and OC5.7.4 necessary to determine its ability to demonstrate a Quick Resynchronisation Capability .
Range CCGT Module	A CCGT Module where there is a physical connection by way of a steam or hot gas main between that CCGT Module and another CCGT Module or other CCGT Modules , which connection contributes (if open) to efficient modular operation, and which physical connection can be varied by the operator.
Rated Field Voltage	Shall have the meaning ascribed to that term in IEC 34-16-1:1991 [equivalent to British Standard BS4999 Section 116.1: 1992].

<p>Rated MW</p>	<p>The “rating-plate” MW output of a Power Generating Module, Generating Unit, Power Park Module, Electricity Storage Module, HVDC Converter or DC Converter, being:</p> <ul style="list-style-type: none"> (a) that output up to which the Generating Unit was designed to operate (Calculated as specified in British Standard BS EN 60034 – 1: 1995); or (b) the nominal rating for the MW output of a Power Park Module or Power Generating Module being the maximum continuous electric output power which the Power Park Module or Power Generating Module was designed to achieve under normal operating conditions; or (c) the nominal rating for the MW import capacity and export capacity (if at a DC Converter Station or HVDC Converter Station) of a DC Converter or HVDC Converter. (d) in an importing mode, is that input up to which an Electricity Storage Module was designed to operate being the maximum continuous electric input which the Electricity Storage Module was designed to achieve under normal operating conditions. In an exporting mode is:- <ul style="list-style-type: none"> (i) that output up to which the Synchronous Electricity Storage Unit was designed to operate (Calculated as specified in British Standard BS EN 60034 – 1: 1995); or (ii) the nominal rating for the MW output of a Non-Synchronous Electricity Storage Module being the maximum continuous electric output power which the Non-Synchronous Electricity Storage Module was designed to achieve under normal operating conditions.
<p>Reactive Despatch Instruction</p>	<p>Has the meaning set out in the CUSC.</p>
<p>Reactive Despatch Network Restriction</p>	<p>A restriction placed upon an Embedded Power Generating Module, Embedded Generating Unit, Embedded Power Park Module or DC Converter at an Embedded DC Converter Station or HVDC Converter at an Embedded HVDC Converter Station by the Network Operator that prevents the Generator or DC Converter Station owner or HVDC System Owner in question (as applicable) from complying with any Reactive Despatch Instruction with respect to that Power Generating Module, Generating Unit, Power Park Module or DC Converter at a DC Converter Station or HVDC Converter at a HVDC Converter Station, whether to provide MVAr over the range referred to in CC 6.3.2, ECC.6.3.2 or otherwise.</p>
<p>Reactive Despatch to Zero Mvar Network Restriction</p>	<p>A Reactive Despatch Network Restriction which prevents an Embedded Power Generating Module, an Embedded Generating Unit, Embedded Power Park Module, Embedded HVDC System, HVDC Converter at an Embedded HVDC Converter Station or DC Converter at an Embedded DC Converter Station from supplying power at zero MVAr at all Active Power output levels up to and including Rated MW at the Grid Entry Point (or User System Entry Point if Embedded).</p>
<p>Reactive Energy</p>	<p>The integral with respect to time of the Reactive Power.</p>

Reactive Power	<p>The product of voltage and current and the sine of the phase angle between them measured in units of voltamperes reactive and standard multiples thereof, ie:</p> <p>1000 VAr = 1 kVAr</p> <p>1000 kVAr = 1 MVar</p>
Record of Inter-System Safety Precautions or RISSP	<p>A written record of inter-system Safety Precautions to be compiled in accordance with the provisions of OC8.</p>
Regenerative Braking	<p>A method of braking in which energy is extracted from the parts braked, which may be returned directly to the System and the purpose of the braking is motion control.</p>

<p>Registered Capacity</p>	<p>(a) In the case of a Generating Unit other than that forming part of a CCGT Module or Power Park Module or Power Generating Module, the normal full load capacity of a Generating Unit as declared by the Generator, less the MW consumed by the Generating Unit through the Generating Unit's Unit Transformer when producing the same (the resultant figure being expressed in whole MW, or in MW to one decimal place).</p> <p>(b) In the case of a CCGT Module or Power Park Module owned or operated by a GB Generator, the normal full load capacity of the CCGT Module or Power Park Module (as the case may be) as declared by the GB Generator, being the Active Power declared by the GB Generator as being deliverable by the CCGT Module or Power Park Module at the Grid Entry Point (or in the case of an Embedded CCGT Module or Power Park Module, at the User System Entry Point), expressed in whole MW, or in MW to one decimal place. For the avoidance of doubt Maximum Capacity would apply to Power Generating Modules which form part of a Large, Medium or Small Power Station.</p> <p>(c) In the case of a Power Station, the maximum amount of Active Power deliverable by the Power Station at the Grid Entry Point (or in the case of an Embedded Power Station at the User System Entry Point), as declared by the Generator, expressed in whole MW, or in MW to one decimal place. The maximum Active Power deliverable is the maximum amount deliverable simultaneously by the Power Generating Modules and/or Generating Units and/or CCGT Modules and/or Power Park Modules less the MW consumed by the Power Generating Modules and/or Generating Units and/or CCGT Modules in producing that Active Power and forming part of a Power Station.</p> <p>(d) In the case of a DC Converter at a DC Converter Station or HVDC Converter at an HVDC Converter Station, the normal full load amount of Active Power transferable from a DC Converter or HVDC Converter at the Onshore Grid Entry Point (or in the case of an Embedded DC Converter Station or an Embedded HVDC Converter Station at the User System Entry Point), as declared by the DC Converter Station owner or HVDC System Owner, expressed in whole MW, or in MW to one decimal place.</p> <p>(e) In the case of a DC Converter Station or HVDC Converter Station, the maximum amount of Active Power transferable from a DC Converter Station or HVDC Converter Station at the Onshore Grid Entry Point (or in the case of an Embedded DC Converter Station or Embedded HVDC Converter Station at the User System Entry Point), as declared by the DC Converter Station owner or HVDC System Owner, expressed in whole MW, or in MW to one decimal place.</p> <p>(f) In the case of an Electricity Storage Module, the normal full load amount of Active Power transferable from an Electricity Storage Module at the Grid Entry Point (or in the case of an Embedded Electricity Storage Module at the User System Entry Point), as declared by the Generator, expressed in whole MW, or in MW to one decimal place.</p>
-----------------------------------	--

Registered Data	Those items of Standard Planning Data and Detailed Planning Data which upon connection become fixed (subject to any subsequent changes).
Registered Import Capability	<p>In the case of a DC Converter Station or HVDC Converter Station containing DC Converters or HVDC Converters connected to an External System, the maximum amount of Active Power transferable into a DC Converter Station or HVDC Converter Station at the Onshore Grid Entry Point (or in the case of an Embedded DC Converter Station or Embedded HVDC Converter Station at the User System Entry Point), as declared by the DC Converter Station owner or HVDC System Owner, expressed in whole MW.</p> <p>In the case of a DC Converter or HVDC Converter connected to an External System and in a DC Converter Station or HVDC Converter Station, the normal full load amount of Active Power transferable into a DC Converter or HVDC Converter at the Onshore Grid Entry Point (or in the case of an Embedded DC Converter Station or Embedded HVDC Converter Station at the User System Entry Point), as declared by the DC Converter owner or HVDC System Owner, expressed in whole MW.</p> <p>In the case of an Electricity Storage Module, the maximum amount of Active Power transferable into an Electricity Storage Module at the Grid Entry Point (or in the case of an Embedded Electricity Storage Module at the User System Entry Point), as declared by the Generator, expressed in whole MW.</p>
Regulations	The Utilities Contracts Regulations 1996, as amended from time to time.
Regulated Sections	Parts of the Grid Code that are referenced in Governance Rules Annex GR.B as amended from time to time with the approval of the Authority .
Reheater Time Constant	Determined at Registered Capacity , the reheater time constant will be construed in accordance with the principles of the IEEE Committee Report "Dynamic Models for Steam and Hydro Turbines in Power System Studies" published in 1973 which apply to such phrase.
Rejected Grid Code Modification Proposal	A Grid Code Modification Proposal in respect of which the Authority has decided not to direct The Company to modify the Grid Code pursuant to The Company's Transmission Licence in the manner set out herein or, in the case of a Grid Code Self Governance Proposals , in respect of which the Grid Code Review Panel has voted not to approve.
Related Person	Means, in relation to an individual, any member of his immediate family, his employer (and any former employer of his within the previous 12 months), any partner with whom he is in partnership, and any company or Affiliate of a company in which he or any member of his immediate family controls more than 20% of the voting rights in respect of the shares of the company;
Relevant E&W Transmission Licensee	As the context requires NGET and/or an E&W Offshore Transmission Licensee .
Relevant Party	Has the meaning given in GR15.10(a).

Relevant Scottish Transmission Licensee	As the context requires SPT and/or SHETL and/or a Scottish Offshore Transmission Licensee .
Relevant Transmission Licensee	Means National Grid Electricity Transmission plc (NGET) in its Transmission Area or SP Transmission plc (SPT) in its Transmission Area or Scottish Hydro-Electric Transmission Ltd (SHETL) in its Transmission Area or any Offshore Transmission Licensee in its Transmission Area .
Relevant Unit	As defined in the STC , Schedule 3.
Remote End HVDC Converter Station	An HVDC Converter Station which forms part of an HVDC System and is not directly connected to the AC part of the GB Synchronous Area .
Remote Transmission Assets	Any Plant and Apparatus or meters owned by NGET which: <ul style="list-style-type: none"> (a) are Embedded in a User System and which are not directly connected by Plant and/or Apparatus owned by NGET to a sub-station owned by NGET; and (b) are by agreement between NGET and such User operated under the direction and control of such User.
Replacement Reserves (RR)	Means, in the context of Balancing Services , the Active Power reserves available to restore or support the required level of FRR to be prepared for additional system imbalances, including generation reserves;
Requesting Safety Co-ordinator	The Safety Co-ordinator requesting Safety Precautions .
Responsible Engineer/ Operator	A person nominated by a User to be responsible for System control.
Responsible Manager	A manager who has been duly authorised by a User or a Relevant Transmission Licensee to sign Site Responsibility Schedules on behalf of that User or Relevant Transmission Licensee as the case may be.
Restoration Service Provider	A Black Start Service Provider or User with a legal or contractual obligation to provide a service contributing to one or several measures of the System Restoration Plan .
Re-synchronisation	The bringing of parts of the System which have become Out of Synchronism with any other System back into Synchronism , and like terms shall be construed accordingly.
Retained EU Law	31 December 2020 as defined in European Union (Withdrawal) Act 2018 as amended by the European Union (Withdrawal Agreement) Act 2020.
RR Acceptance	The results of the TERRE auction for each BM Participant .
Restricted	Applies to a TERRE Bid which has been marked so that it will be passed to the TERRE Central Platform but will not be used in the auction.

RR Instruction	Replacement Reserve Instruction – used for instructing BM Participants after the results of the TERRE auction. An RR Instruction has the same format as a Bid-Offer Acceptance but has type field indicating it is for TERRE .
Safety Co-ordinator	A person or persons nominated by a Relevant E&W Transmission Licensee and each E&W User in relation to Connection Points (or in the case of OTSUA operational prior to the OTSUA Transfer Time, Transmission Interface Points) on an E&W Transmission System and/or by the Relevant Scottish Transmission Licensee and each Scottish User in relation to Connection Points (or in the case of OTSUA operational prior to the OTSUA Transfer Time, Transmission Interface Points) on a Scottish Transmission System to be responsible for the co-ordination of Safety Precautions at each Connection Point (or in the case of OTSUA operational prior to the OTSUA Transfer Time, Transmission Interface Points) when work (which includes testing) is to be carried out on a System which necessitates the provision of Safety Precautions on HV Apparatus (as defined in OC8A.1.6.2 and OC8B.1.7.2), pursuant to OC8 .
Safety From The System	That condition which safeguards persons when work is to be carried out on or near a System from the dangers which are inherent in the System .
Safety Key	A key unique at the Location capable of operating a lock which will cause an Isolating Device and/or Earthing Device to be Locked .
Safety Log	A chronological record of messages relating to safety co-ordination sent and received by each Safety Co-ordinator under OC8 .
Safety Precautions	Isolation and/or Earthing .
Safety Rules	The rules of the Relevant Transmission Licensee or a User that seek to ensure that persons working on Plant and/or Apparatus to which the rules apply are safeguarded from hazards arising from the System .
Scottish Offshore Transmission System	An Offshore Transmission System with an Interface Point in Scotland.
Scottish Offshore Transmission Licensee	A person who owns or operates a Scottish Offshore Transmission System pursuant to a Transmission Licence .
Scottish Transmission System	Collectively SPT’s Transmission System and SHETL’s Transmission System and any Scottish Offshore Transmission Systems .
Scottish User	A User in Scotland or any Offshore User who owns or operates Plant and/or Apparatus connected (or which will at the OTSUA Transfer Time be connected) to a Scottish Offshore Transmission System .
Secondary BM Unit	Has the same meaning set out in the BSC .

Secondary Response	The automatic increase in Active Power output of a Genset or, as the case may be, the decrease in Active Power Demand in response to a System Frequency fall. This increase in Active Power output or, as the case may be, the decrease in Active Power Demand must be in accordance with the provisions of the relevant Ancillary Services Agreement which will provide that it will be fully available by 30 seconds from the time of the start of the Frequency fall and be sustainable for at least a further 30 minutes. The interpretation of the Secondary Response to a -0.5 Hz frequency change is shown diagrammatically in Figure CC.A.3.2 or Figure ECC.A.3.2.
Secretary of State	Has the same meaning as in the Act .
Secured Event	Has the meaning set out in the Security and Quality of Supply Standard .
Security and Quality of Supply Standard (SQSS)	The version of the document entitled 'Security and Quality of Supply Standard' established pursuant to the Transmission Licence in force at the time of entering into the relevant Bilateral Agreement .
Self-Governance Criteria	A proposed Modification that, if implemented, (a) is unlikely to have a material effect on: (i) existing or future electricity consumers; and (ii) competition in the generation, storage, distribution, or supply of electricity or any commercial activities connected with the generation, storage, distribution or supply of electricity; and (iii) the operation of the National Electricity Transmission System ; and (iv) matters relating to sustainable development, safety or security of supply, or the management of market or network emergencies; and (v) the Grid Code's governance procedures or the Grid Code's modification procedures, and (b) is unlikely to discriminate between different classes of Users. (c) other than where the modification meets the Fast Track Criteria , will not constitute an amendment to the Regulated Sections of the Grid Code.
Self-Governance Modifications	A Grid Code Modification Proposal that does not fall within the scope of a Significant Code Review and that meets the Self-Governance Criteria or which the Authority directs is to be treated as such any direction under GR.24.4.
Self-Governance Statement	The statement made by the Grid Code Review Panel and submitted to the Authority : (a) confirming that, in its opinion, the Self-Governance Criteria are met and the proposed Grid Code Modification Proposal is suitable for the Self-Governance route; and (b) providing a detailed explanation of the Grid Code Review Panel's reasons for that opinion.

Setpoint Voltage	The value of voltage at the Grid Entry Point , or User System Entry Point if Embedded , on the automatic control system steady state operating characteristic, as a percentage of the nominal voltage, at which the transfer of Reactive Power between a Power Park Module , DC Converter , HVDC Converter or Non-Synchronous Generating Unit and the Transmission System , or Network Operator's system if Embedded , is zero.
Settlement Period	A period of 30 minutes ending on the hour and half-hour in each hour during a day.
Seven Year Statement	A statement, prepared by The Company in accordance with the terms of The Company's Transmission Licence , showing for each of the seven succeeding Financial Years , the opportunities available for connecting to and using the National Electricity Transmission System and indicating those parts of the National Electricity Transmission System most suited to new connections and transport of further quantities of electricity.
SF₆ Gas Zone	A segregated zone surrounding electrical conductors within a casing containing SF ₆ gas.
SHETL	Scottish Hydro-Electric Transmission Limited.
Shutdown	In the case of a Generating Unit is the condition of a Generating Unit where the generator rotor is at rest or on barring. In the case of an HVDC System or DC Converter Station , is the condition of an HVDC System or DC Converter Station where the HVDC System or DC Converter Station is de-energised and therefore not importing or exporting Apparent Power to or from the Total System .
Significant Code Review	Means the period commencing on the start date of a Significant Code Review as stated in the notice issued by the Authority , and ending in the circumstances described in GR.16.6 or GR.16.7, as appropriate.
Significant Code Review Phase	Means the period commencing on the start date of a Significant Code Review as stated in the notice issued by the Authority , and ending in the circumstances described in GR.16.6 or GR.16.7, as appropriate.
Significant Event	An Event , as defined in OC3.4.1.
Significant Incident	An Event which either: (a) was notified by a User to The Company under OC7 , and which The Company considers has had or may have had a significant effect on the National Electricity Transmission System , and The Company requires the User to report that Event in writing in accordance with OC10 and notifies the User accordingly; or (b) was notified by The Company to a User under OC7 , and which that User considers has had or may have had a significant effect on that User's System , and that User requires The Company to report that Event in writing in accordance with the provisions of OC10 and notifies The Company accordingly.

Simultaneous Tap Change	A tap change implemented on the generator step-up transformers of Synchronised Gensets , effected by Generators in response to an instruction from The Company issued simultaneously to the relevant Power Stations . The instruction, preceded by advance notice, must be effected as soon as possible, and in any event within one minute of receipt from The Company of the instruction.
Single Intraday Coupling	The continuous process where collected orders are matched and cross-zonal capacity is allocated simultaneously for different bidding zones in the intraday market.
Single Line Diagram	A schematic representation of a three-phase network in which the three phases are represented by single lines. The diagram shall include (but not necessarily be limited to) busbars, overhead lines, underground cables, power transformers and reactive compensation equipment. It shall also show where Large Power Stations are connected, and the points at which Demand is supplied.
Single Point of Connection	A single Point of Connection , with no interconnection through the User's System to another Point of Connection .
Site Common Drawings	Drawings prepared for each Connection Site (and in the case of OTSDUW, Transmission Interface Site) which incorporate Connection Site (and in the case of OTSDUW, Transmission Interface Site) layout drawings, electrical layout drawings, common protection/ control drawings and common services drawings.
Site Responsibility Schedule	A schedule containing the information and prepared on the basis of the provisions set out in Appendix 1 of the CC and Appendix E1 of the ECC .
Slope	The ratio of the steady state change in voltage, as a percentage of the nominal voltage, to the steady state change in Reactive Power output, in per unit of Reactive Power capability. For the avoidance of doubt, the value indicates the percentage voltage reduction that will result in a 1 per unit increase in Reactive Power generation.
Small Participant	Has the meaning given in the CUSC .

<p>Small Power Station</p>	<p>A Power Station which is</p> <p>(a) directly connected to:</p> <ul style="list-style-type: none"> (i) NGET’s Transmission System where such Power Station has a Registered Capacity of less than 50MW; or (ii) SPT’s Transmission System where such Power Station has a Registered Capacity of less than 30MW; or (iii) SHETL’s Transmission System where such a Power Station has a Registered Capacity of less than 10 MW; or (iv) an Offshore Transmission System where such Power Station has a Registered Capacity of less than 10MW; <p>or,</p> <p>(b) Embedded within a User System (or part thereof) where such User System (or part thereof) is connected under normal operating conditions to:</p> <ul style="list-style-type: none"> (i) NGET’s Transmission System and such Power Station has a Registered Capacity of less than 50MW; or (ii) SPT’s Transmission System and such Power Station has a Registered Capacity of less than 30MW; or (iii) SHETL’s Transmission System and such Power Station has a Registered Capacity of less than 10MW; <p>or,</p> <p>(c) Embedded within a User System (or part thereof) where the User System (or part thereof) is not connected to the National Electricity Transmission System, although such Power Station is in:</p> <ul style="list-style-type: none"> (i) NGET’s Transmission Area and such Power Station has a Registered Capacity of less than 50MW; or (ii) SPT’s Transmission Area and such Power Station has a Registered Capacity of less than 30MW; or (iii) SHETL’s Transmission Area and such Power Station has a Registered Capacity of less than 10MW; <p>For the avoidance of doubt, a Small Power Station could comprise of Type A, Type B, Type C or Type D Power Generating Modules.</p>
<p>Speeder Motor Setting Range</p>	<p>The minimum and maximum no-load speeds (expressed as a percentage of rated speed) to which the turbine is capable of being controlled, by the speeder motor or equivalent, when the Generating Unit terminals are on open circuit.</p>
<p>SPT</p>	<p>SP Transmission Limited plc</p>
<p>Standard Contract Terms</p>	<p>The standard terms and conditions applicable to Ancillary Services provided by Demand Response Providers and published on the Website from time to time.</p>

Standard Modifications	A Grid Code Modification Proposal that does not fall within the scope of a Significant Code Review subject to any direction by the Authority pursuant to GR.16.3 and GR.16.4, nor meets the Self-Governance Criteria subject to any direction by the Authority pursuant to GR.24.4 and in accordance with any direction under GR.24.2. A Grid Code Modification Proposal that constitutes an amendment to the Regulated Sections of the Grid Code shall be a Standard Modification except where it is an Urgent Modification or where it meets the Fast Track Criteria .
Standard Planning Data	The general data required by The Company under the PC . It is generally also the data which The Company requires from a User in an application for a CUSC Contract , as reflected in the PC .
Standard Product	Means a harmonised balancing product defined by all EU TSOs for the exchange of balance services.
Specific Product	Means in the context of Balancing Services a product that is not a standard product.
Start Time	The time named as such in an instruction issued by The Company pursuant to the BC .
Start-Up	In the case of a Generating Unit is the action of bringing a Generating Unit from Shutdown to Synchronous Speed . In the case of an HVDC System or DC Converter Station , is the action of bringing the HVDC System or DC Converter Station from Shutdown to a state where it is energised.
Statement of Readiness	Has the meaning set out in the Bilateral Agreement and/or Construction Agreement .
Station Board	A switchboard through which electrical power is supplied to the Auxiliaries of a Power Station , and which is supplied by a Station Transformer . It may be interconnected with a Unit Board .
Station Transformer	A transformer supplying electrical power to the Auxiliaries of (a) a Power Station , which is not directly connected to the Generating Unit terminals (typical voltage ratios being 132/11kV or 275/11kV), or (b) a DC Converter Station or HVDC Converter Station .
STC Committee	The committee established under the STC .
Steam Unit	A Generating Unit whose prime mover converts the heat-energy in steam to mechanical energy.

Storage User	<p>A Generator who owns or operates one or more Electricity Storage Modules. For the avoidance of doubt:</p> <ul style="list-style-type: none"> (a) Retained EU Law (Commission Regulation (EU) 2016/631, Commission Regulation (EU) 2016/1388 and Commission Regulation (EU) 2016/1485) shall not apply to Storage Users; and (b) the European Connection Conditions (ECC's) shall apply to Storage Users on the basis set out in Paragraph ECC1.1(d).
Subtransmission System	The part of a User's System which operates at a single transformation below the voltage of the relevant Transmission System .
Substantial Modification	A Modification in relation to modernisation or replacement of the User's Main Plant and Apparatus which impacts its technical capabilities, which, following notification by the relevant User to The Company , results in substantial amendment to the Bilateral Agreement .
Supergrid Voltage	Any voltage greater than 200kV.
Supplier	<ul style="list-style-type: none"> (a) A person supplying electricity under an Electricity Supply Licence; or (b) A person supplying electricity under exemption under the Act; <p>in each case acting in its capacity as a supplier of electricity to Customers in Great Britain.</p>
Surplus	<p>A MW figure equal to the total Output Usable:</p> <ul style="list-style-type: none"> (a) minus the forecast of Active Power Demand, and (b) minus the Operational Planning Margin.
Synchronised	<ul style="list-style-type: none"> (a) The condition where an incoming Power Generating Module, Generating Unit or Power Park Module or DC Converter or HVDC Converter or System is connected to the busbars of another System so that the Frequencies and phase relationships of that Power Generating Module, Generating Unit, Power Park Module, DC Converter, HVDC Converter or System, as the case may be, and the System to which it is connected are identical, like terms shall be construed accordingly e.g. "Synchronism". (b) The condition where an importing BM Unit is consuming electricity.
Synchronous Electricity Storage Module	A Synchronous Power Generating Module which can convert or re-convert electrical energy from another source of energy such that the frequency of the generated voltage, the rotor speed and the frequency of network voltage are in a constant ratio and thus in synchronism. For the avoidance of doubt a Synchronous Electricity Storage Module could comprise of one or more Synchronous Electricity Storage Units .

Synchronous Electricity Storage Unit	A Synchronous Generating Unit which can supply or absorb electrical energy such that the frequency of the generated voltage, the rotor speed and the frequency of the equipment are in constant ratio and thus in synchronism with the network.
Synchronising Generation	The amount of MW (in whole MW) produced at the moment of synchronising.
Synchronising Group	A group of two or more Gensets) which require a minimum time interval between their Synchronising or De-Synchronising times.
Synchronous Area	An area covered by synchronously interconnected Transmission Licensees , such as the Synchronous Areas of Continental Europe, Great Britain, Ireland-Northern Ireland and Nordic and the power systems of Lithuania, Latvia and Estonia, together referred to as 'Baltic' which are part of a wider Synchronous Area ;
Synchronous Compensation	The operation of rotating synchronous Apparatus for the specific purpose of either the generation or absorption of Reactive Power .
Synchronous Compensation Equipment	Apparatus which has the function of providing Synchronous Compensation . For the avoidance of doubt, one or more Synchronous Compensation units would not constitute an Electricity Storage Module unless it could be operated in a controllable manner.
Synchronous Electricity Storage Module	A Synchronous Power Generating Module which can convert and reconvert electrical energy from another source of energy such that the frequency of the generated voltage, the rotor speed and the frequency of network voltage are in a constant ratio and thus in synchronism. For the avoidance of doubt a Synchronous Electricity Storage Module could comprise of one or more Synchronous Electricity Storage Units .
Synchronous Electricity Storage Unit	A Synchronous Generating Unit which can supply and absorb electrical energy such that the frequency of the generated voltage, the rotor speed and the frequency of the equipment are in constant ratio and thus in synchronism with the network.
Synchronous Flywheel	An item of synchronously rotating Plant for the specific purpose of contributing inertia to the System . One or more Synchronous Flywheels would not be considered to form an Electricity Storage Module unless it could be operated in a controllable manner for its AC input and output power.
Synchronous Generating Unit	Any Onshore Synchronous Generating Unit or Offshore Synchronous Generating Unit .
Synchronous Generating Unit Performance Chart	A diagram showing the Real Power (MW) and Reactive Power (MVA _r) capability limits within which a Synchronous Generating Unit at its stator terminals (which is part of a Synchronous Power Generating Module) will be expected to operate under steady state conditions.

Synchronous Power-Generating Module	An indivisible set of installations which can convert or re-convert electrical energy from another source of energy such that the frequency of the supplied voltage, the rotor speed and the frequency of network voltage are in a constant ratio and thus in synchronism. For the avoidance of doubt, a Synchronous Power Generating Module could comprise of one or more Synchronous Generating Units or one or more Synchronous Electricity Storage Units .
Synchronous Power Generating Module Matrix	The matrix described in Appendix 1 to BC1 under the heading Synchronous Power Generating Module Matrix .
Synchronous Power Generating Module Planning Matrix	A matrix in the form set out in Appendix 5 of OC2 showing the combination of Synchronous Generating Units within a Synchronous Power Generating Module which would be running in relation to any given MW output.
Synchronous Power Generating Unit	Has the same meaning as a Synchronous Generating Unit and would be considered to be part of a Power Generating Module .
Synchronous Speed	That speed required by a Generating Unit to enable it to be Synchronised to a System .
System	Any User System and/or the National Electricity Transmission System , as the case may be.
System Ancillary Services	Collectively Part 1 System Ancillary Services and Part 2 System Ancillary Services .
System Constraint	A limitation on the use of a System due to lack of transmission capacity or other System conditions.
System Constrained Capacity	That portion of Registered Capacity or Registered Import Capacity not available due to a System Constraint .
System Constraint Group	A part of the National Electricity Transmission System which, because of System Constraints , is subject to limits of Active Power which can flow into or out of (as the case may be) that part.
System Defence Plan	A document prepared by The Company , as published on its Website , outlining how the requirements of the “defence plan”, as provided for by Retained EU Law (Commission Regulation (EU) 2017/2196), has been implemented within the GB Synchronous Area .
System Fault Dependability Index or Dp	A measure of the ability of Protection to initiate successful tripping of circuit-breakers which are associated with a faulty item of Apparatus . It is calculated using the formula: $Dp = 1 - F_1/A$ Where: A = Total number of System faults F ₁ = Number of System faults where there was a failure to trip a circuit-breaker.
System Incidents Report	A report submitted to the GCRP on a monthly basis, containing, but not limited to, a list of Significant Events , as detailed in OC3.4.1.

System Margin	The margin in any period between (a) the sum of Maximum Export Limits and (b) forecast Demand and the Operating Margin , for that period.
System Negative Reserve Active Power Margin or System NRAPM	That margin of Active Power sufficient to allow the largest loss of Load at any time.
System Operator - Transmission Owner Code or STC	Has the meaning set out in The Company's Transmission Licence
System Restoration Plan	A document prepared by The Company , as published on its Website , outlining how the requirements of the "restoration plan", as defined in Retained EU Law (Commission Regulation (EU) 2017/2196), has been implemented within the GB Synchronous Area .
System Telephony	An alternative method by which a User's Responsible Engineer/Operator and The Company's Control Engineer(s) speak to one and another for the purposes of control of the Total System in both normal operating conditions and where practicable, emergency operating conditions.
System Tests	Tests which involve simulating conditions, or the controlled application of irregular, unusual or extreme conditions, on the Total System , or any part of the Total System , but which do not include commissioning or recommissioning tests or any other tests of a minor nature.
System to Demand Intertrip Scheme	An intertrip scheme which disconnects Demand when a System fault has arisen to prevent abnormal conditions occurring on the System .
System to Generator Operational Intertripping	A Balancing Service involving the initiation by a System to Generator Operational Intertripping Scheme of automatic tripping of the User's circuit breaker(s), or Relevant Transmission Licensee's circuit breaker(s) where agreed by The Company , the User and the Relevant Transmission Licensee , resulting in the tripping of BM Unit(s) or (where relevant) Generating Unit(s) comprised in a BM Unit to prevent abnormal system conditions occurring, such as over voltage, overload, System instability, etc, after the tripping of other circuit-breakers following power System fault(s).
System to Generator Operational Intertripping Scheme	A System to Generating Unit or System to CCGT Module or System to Power Park Module or System to Power Generating Module or System to Electricity Storage Module Intertripping Scheme forming a condition of connection and specified in Appendix F3 of the relevant Bilateral Agreement , being either a Category 1 Intertripping Scheme , Category 2 Intertripping Scheme , Category 3 Intertripping Scheme or Category 4 Intertripping Scheme .

Target Frequency	That Frequency determined by The Company , in its reasonable opinion, as the desired operating Frequency of the Total System . This will normally be 50.00Hz plus or minus 0.05Hz, except in exceptional circumstances as determined by The Company , in its reasonable opinion when this may be 49.90 or 50.10Hz. An example of exceptional circumstances may be difficulties caused in operating the System during disputes affecting fuel supplies.
Technical Specification	In relation to Plant and/or Apparatus , (a) the relevant European Specification ; or (b) if there is no relevant European Specification , other relevant standards which are in common use in the European Community.
TERRE	Trans European Replacement Reserves Exchange – a market covering the procurement of replacement reserves across Europe.
TERRE Activation Period	A period of time lasting 15 minutes and starting at either 0, 15, 30 or 45 minutes past the hour (e.g. 10:00 to 10:15). There are 4 TERRE Activation Periods in one TERRE Auction Period .
TERRE Auction Period	A period of time lasting one hour and starting and ending on the hour (e.g. from 10:00 to 11:00). Hence there are 24 TERRE Auction Periods in a day.
TERRE Bid	A submission by a BM Participant covering the price and MW deviation offered into the TERRE auction (please note – in the Balancing Mechanism the term bid has a different meaning – in this case a bid can be an upward or downward MW change).
TERRE Central Platform	An IT system which implements the TERRE auction.
TERRE Data Validation and Consistency Rules	A document produced by the central TERRE project detailing the correct format of submissions for TERRE .
TERRE Gate Closure	60 minutes before the start of the TERRE Auction Period (note still ongoing discussions if this may become 55 minutes).
TERRE Instruction Guide	Details specific rules for creating an RR Instruction from an RR Acceptance .
Test Co-ordinator	A person who co-ordinates System Tests .
Test Panel	A panel, whose composition is detailed in OC12 , which is responsible, inter alia, for considering a proposed System Test , and submitting a Proposal Report and a Test Programme .
Test Programme	A programme submitted by the Test Panel to The Company , the Test Proposer , and each User identified by The Company under OC12.4.2.1, which states the switching sequence and proposed timings of the switching sequence, a list of those staff involved in carrying out the System Test (including those responsible for the site safety) and such other matters as the Test Panel deems appropriate.
Test Proposer	The person who submits a Proposal Notice .

The Company	National Grid Electricity System Operator Limited (NO: 11014226) whose registered office is at 1-3 Strand, London, WC2N 5EH as the person whose Transmission Licence Section C of such Transmission Licence has been given effect.
The Company Control Engineer	The nominated person employed by The Company to direct the operation of the National Electricity Transmission System or such person as nominated by The Company .
The Company Operational Strategy	The Company's operational procedures which form the guidelines for operation of the National Electricity Transmission System .
Total Shutdown	The situation existing when all generation has ceased and there is no electricity supply from External Interconnections and, therefore, the Total System has shutdown with the result that it is not possible for the Total System to begin to function again without The Company's directions relating to a Black Start .
Total System	The National Electricity Transmission System and all User Systems in the National Electricity Transmission System Operator Area .
Trading Point	A commercial and, where so specified in the Grid Code, an operational interface between a User and The Company , which a User has notified to The Company .
Transfer Date	Such date as may be appointed by the Secretary of State by order under section 65 of the Act .
Transmission	Means, when used in conjunction with another term relating to equipment or a site, whether defined or not, that the associated term is to be read as being part of or directly associated with the National Electricity Transmission System , and not of or with the User System .
Transmission Area	Has the meaning set out in the Transmission Licence of a Transmission Licensee .
Transmission Connected Demand Facilities	A Demand Facility which has a Grid Supply Point to the National Electricity Transmission System .
Transmission DC Converter	Any Transmission Licensee Apparatus (or OTSUA that will become Transmission Licensee Apparatus at the OTSUA Transfer Time) used to convert alternating current electricity to direct current electricity, or vice versa. A Transmission Network DC Converter (which could include an HVDC System owned by an Offshore Transmission Licensee or Generator in respect of OTSUA) is a standalone operative configuration at a single site comprising one or more converter bridges, together with one or more converter transformers, converter control equipment, essential protective and switching devices and auxiliaries, if any, used for conversion.
Transmission Entry Capacity	Has the meaning set out in the CUSC .

Transmission Interface Circuit	In NGET's Transmission Area , a Transmission circuit which connects a System operating at a voltage above 132kV to a System operating at a voltage of 132kV or below In SHETL's Transmission Area and SPT's Transmission Area , a Transmission circuit which connects a System operating at a voltage of 132kV or above to a System operating at a voltage below 132kV.
Transmission Interface Point	Means the electrical point of connection between the Offshore Transmission System and an Onshore Transmission System .
Transmission Interface Site	The site at which the Transmission Interface Point is located.
Transmission Licence	A licence granted under Section 6(1)(b) of the Act .
Transmission Licensee	The Company and any Onshore Transmission Licensee or Offshore Transmission Licensee .
Transmission Site	Means a site owned (or occupied pursuant to a lease, licence or other agreement) by a Relevant Transmission Licensee in which there is a Connection Point . For the avoidance of doubt, a site owned by a User but occupied by the Relevant Transmission Licensee as aforesaid, is a Transmission Site .
Transmission System	Has the same meaning as the term "licensee's transmission system" in the Transmission Licence of a Transmission Licensee .
Turbine Time Constant	Determined at Registered Capacity , the turbine time constant will be construed in accordance with the principles of the IEEE Committee Report "Dynamic Models for Steam and Hydro Turbines in Power System Studies" published in 1973 which apply to such phrase.
Type A Power Generating Module	A Power-Generating Module (including an Electricity Storage Module) with a Grid Entry Point or User System Entry Point below 110 kV and a Maximum Capacity of 0.8 kW or greater but less than 1MW;
Type B Power Generating Module	A Power-Generating Module (including an Electricity Storage Module) with a Grid Entry Point or User System Entry Point below 110 kV and a Maximum Capacity of 1MW or greater but less than 10MW;
Type C Power Generating Module	A Power-Generating Module (including an Electricity Storage Module) with a Grid Entry Point or User System Entry Point below 110 kV and a Maximum Capacity of 10MW or greater but less than 50MW;
Type D Power Generating Module	A Power-generating Module : (including an Electricity Storage Module): with a Grid Entry Point or User System Entry Point at, or greater than, 110 kV; or with a Grid Entry Point or User System Entry Point below 110 kV and with Maximum Capacity of 50MW or greater
Unbalanced Load	The situation where the Load on each phase is not equal.
Under-excitation Limiter	Shall have the meaning ascribed to that term in IEC 34-16-1:1991 [equivalent to British Standard BS4999 Section 116.1: 1992].

Under Frequency Relay	An electrical measuring relay intended to operate when its characteristic quantity (Frequency) reaches the relay settings by a decrease in Frequency .
Unit Board	A switchboard through which electrical power is supplied to the Auxiliaries of a Generating Unit and which is supplied by a Unit Transformer . It may be interconnected with a Station Board .
Unit Transformer	A transformer directly connected to a Generating Unit's terminals, and which supplies power to the Auxiliaries of a Generating Unit . Typical voltage ratios are 23/11kV and 15/6.6kV.
Unit Load Controller Response Time Constant	The time constant, expressed in units of seconds, of the power output increase which occurs in the Secondary Response timescale in response to a step change in System Frequency .
Unresolved Issues	Any relevant Grid Code provisions or Bilateral Agreement requirements identified by The Company with which the relevant User has not demonstrated compliance to The Company's reasonable satisfaction at the date of issue of the Preliminary Operational Notification and/or Interim Operational Notification and/or Limited Operational Notification and which are detailed in such Preliminary Operational Notification and/or Interim Operational Notification and/or Limited Operational Notification .
Urgent Modification	A Grid Code Modification Proposal treated or to be treated as an Urgent Modification in accordance with GR.23.
User	A term utilised in various sections of the Grid Code to refer to the persons using the National Electricity Transmission System , as more particularly identified in each section of the Grid Code concerned. In the Preface and the General Conditions the term means any person to whom the Grid Code applies. The term User includes an EU Code User and a GB Code User .
User Data File Structure	The file structure given at DRC 18 which will be specified by The Company which a Generator or DC Converter Station owner or HVDC System Owner must use for the purposes of the CP or the ECP to submit DRC data Schedules and information demonstrating compliance with the Grid Code and, where applicable, with the CUSC Contract(s) , unless otherwise agreed by The Company .
User Development	In the PC means either User's Plant and/or Apparatus to be connected to the National Electricity Transmission System , or a Modification relating to a User's Plant and/or Apparatus already connected to the National Electricity Transmission System , or a proposed new connection or Modification to the connection within the User System .
User Self Certification of Compliance	A certificate, in the form attached at CP.A.2.(1) or ECP.A.2.(1) completed by a Generator or DC Converter Station owner or HVDC System Owner to which the Compliance Statement is attached which confirms that such Plant and Apparatus complies with the relevant Grid Code provisions and where appropriate, with the CUSC Contract(s) , as identified in the Compliance Statement and, if appropriate, identifies any Unresolved Issues and/or any exceptions to such compliance and details the derogation(s) granted in respect of such exceptions.

User Site	A site owned (or occupied pursuant to a lease, licence or other agreement) by a User in which there is a Connection Point . For the avoidance of doubt, a site owned by a Relevant Transmission Licensee but occupied by a User as aforesaid, is a User Site .
User System	Any system owned or operated by a User comprising:- (a) Power Generating Modules or Generating Units ; and/or (b) Systems consisting (wholly or mainly) of electric lines used for the distribution of electricity from Grid Supply Points or Generating Units or Power Generating Modules or other entry points to the point of delivery to Customers , or other Users ; and Plant and/or Apparatus (including prior to the OTSUA Transfer Time , any OTSUA) connecting:- (c) The system as described above; or (d) Non-Embedded Customers equipment; to the National Electricity Transmission System or to the relevant other User System , as the case may be. The User System includes any Remote Transmission Assets operated by such User or other person and any Plant and/or Apparatus and meters owned or operated by the User or other person in connection with the distribution of electricity but does not include any part of the National Electricity Transmission System .
User System Entry Point	A point at which a Power Generating Module , Generating Unit , a CCGT Module or a CCGT Unit or a Power Park Module , or an Electricity Storage Module or a DC Converter or an HVDC Converter , as the case may be, which is Embedded connects to the User System .
Water Time Constant	Bears the meaning ascribed to the term "Water inertia time" in IEC308.
Website	The site established by The Company on the World-Wide Web for the exchange of information among Users and other interested persons in accordance with such restrictions on access as may be determined from time to time by The Company .
Weekly ACS Conditions	Means that particular combination of weather elements that gives rise to a level of peak Demand within a week, taken to commence on a Monday and end on a Sunday, which has a particular chance of being exceeded as a result of weather variation alone. This particular chance is determined such that the combined probabilities of Demand in all weeks of the year exceeding the annual peak Demand under Annual ACS Conditions is 50%, and in the week of maximum risk the weekly peak Demand under Weekly ACS Conditions is equal to the annual peak Demand under Annual ACS Conditions .

WG Consultation Alternative Request	Any request from an Authorised Electricity Operator ; the Citizens Advice or the Citizens Advice Scotland , The Company or a Materially Affected Party for a Workgroup Alternative Grid Code Modification to be developed by the Workgroup expressed as such and which contains the information referred to at GR.20.16. For the avoidance of doubt, any WG Consultation Alternative Request does not constitute either a Grid Code Modification Proposal or a Workgroup Alternative Grid Code Modification .
Workgroup	A Workgroup established by the Grid Code Review Panel pursuant to GR.20.1;
Workgroup Consultation	As defined in GR.20.13, and any further consultation which may be directed by the Grid Code Review Panel pursuant to GR.20.20;
Workgroup Alternative Grid Code Modification	An alternative modification to the Grid Code Modification Proposal developed by the Workgroup under the Workgroup terms of reference (either as a result of a Workgroup Consultation or otherwise) and which is believed by a majority of the members of the Workgroup or by the chairman of the Workgroup to better facilitate the Grid Code Objectives than the Grid Code Modification Proposal or the current version of the Grid Code ;
Zonal System Security Requirements	That generation required, within the boundary circuits defining the System Zone , which when added to the secured transfer capability of the boundary circuits exactly matches the Demand within the System Zone .

A number of the terms listed above are defined in other documents, such as the **Balancing and Settlement Code** and the **Transmission Licence**. Appendix 1 sets out the current definitions from the other documents of those terms so used in the Grid Code and defined in other documents for ease of reference, but does not form part of the Grid Code.

GD.2 Construction of References

GD.2.1 In the Grid Code:

- (i) a table of contents, a Preface, a Revision section, headings, and the Appendix to this **Glossary and Definitions** are inserted for convenience only and shall be ignored in construing the Grid Code;
- (ii) unless the context otherwise requires, all references to a particular paragraph, sub-paragraph, Appendix or Schedule shall be a reference to that paragraph, sub-paragraph Appendix or Schedule in or to that part of the Grid Code in which the reference is made;
- (iii) unless the context otherwise requires, the singular shall include the plural and vice versa, references to any gender shall include all other genders and references to persons shall include any individual, body corporate, corporation, joint venture, trust, unincorporated association, organisation, firm or partnership and any other entity, in each case whether or not having a separate legal personality;
- (iv) references to the words "include" or "including" are to be construed without limitation to the generality of the preceding words;
- (v) unless there is something in the subject matter or the context which is inconsistent therewith, any reference to an Act of Parliament or any Section of or Schedule to, or other provision of an Act of Parliament shall be construed at the particular time, as including a reference to any modification, extension or re-enactment thereof then in force and to all instruments, orders and regulations then in force and made under or deriving validity from the relevant Act of Parliament;
- (vi) where the **Glossary and Definitions** refers to any word or term which is more particularly defined in a part of the Grid Code, the definition in that part of the Grid Code will prevail (unless otherwise stated) over the definition in the **Glossary & Definitions** in the event of any inconsistency;

- (vii) a cross-reference to another document or part of the Grid Code shall not of itself impose any additional or further or co-existent obligation or confer any additional or further or co-existent right in the part of the text where such cross-reference is contained;
- (viii) nothing in the Grid Code is intended to or shall derogate from **The Company's** statutory or licence obligations;
- (ix) a "holding company" means, in relation to any person, a holding company of such person within the meaning of section 736, 736A and 736B of the Companies Act 1985 as substituted by section 144 of the Companies Act 1989 and, if that latter section is not in force at the **Transfer Date**, as if such latter section were in force at such date;
- (x) a "subsidiary" means, in relation to any person, a subsidiary of such person within the meaning of section 736, 736A and 736B of the Companies Act 1985 as substituted by section 144 of the Companies Act 1989 and, if that latter section is not in force at the **Transfer Date**, as if such latter section were in force at such date;
- (xi) references to time are to London time; and
- (xii) (a) Save where (b) below applies, where there is a reference to an item of data being expressed in a whole number of MW, fractions of a MW below 0.5 shall be rounded down to the nearest whole MW and fractions of a MW of 0.5 and above shall be rounded up to the nearest whole MW;

(b) In the case of the definition of **Registered Capacity** or **Maximum Capacity**, fractions of a MW below 0.05 shall be rounded down to one decimal place and fractions of a MW of 0.05 and above shall be rounded up to one decimal place.
- (xiii) For the purposes of the Grid Code, physical quantities such as current or voltage are not defined terms as their meaning will vary depending upon the context of the obligation. For example, voltage could mean positive phase sequence root mean square voltage, instantaneous voltage, phase to phase voltage, phase to earth voltage. The same issue equally applies to current, and therefore the terms current and voltage should remain undefined with the meaning depending upon the context of the application. **Retained EU Law** (Commission Regulation (EU) 2016/631) defines requirements of current and voltage but they have not been adopted as part of EU implementation for the reasons outlined above.
- (xiv) Except where expressly stated to the contrary, reference to Commission Regulations means the Commission Regulation (EU) as it forms part of **Retained EU Law**, as such regulation may be amended.

< END OF GLOSSARY & DEFINITIONS >

PLANNING CODE

(PC)

CONTENTS

(This contents page does not form part of the Grid Code)

<u>Paragraph No/Title</u>	<u>Page Number</u>
PC.1 INTRODUCTION.....	2
PC.2 OBJECTIVE.....	3
PC.3 SCOPE.....	4
PC.4 PLANNING PROCEDURES.....	7
PC.5 PLANNING DATA.....	10
PC.6 PLANNING STANDARDS.....	13
PC.7 PLANNING LIAISON.....	14
PC.8 OTSDUW PLANNING LIAISON.....	15
APPENDIX A - PLANNING DATA REQUIREMENTS	16
PART 1 - STANDARD PLANNING DATA.....	20
PC.A.2 USER'S SYSTEM (AND OTSUA) DATA	20
PC.A.3 GENERATING UNIT AND DC CONVERTER DATA.....	28
PC.A.4 DEMAND AND ACTIVE ENERGY DATA	38
PART 2 - DETAILED PLANNING DATA.....	44
PC.A.5 POWER GENERATING MODULE, GENERATING UNIT, POWER PARK MODULE, DC CONVERTER AND OTSDUW PLANT AND APPARATUS DATA.....	44
PC.A.6 USERS' SYSTEM DATA.....	61
PC.A.7 ADDITIONAL DATA FOR NEW TYPES OF POWER STATIONS, DC CONVERTER STATIONS, OTSUA AND CONFIGURATIONS.....	65
PART 3 – DETAILED PLANNING DATA.....	66
APPENDIX B - SINGLE LINE DIAGRAMS	69
APPENDIX C - TECHNICAL AND DESIGN CRITERIA.....	72
PART 1 – SHETL's TECHNICAL AND DESIGN CRITERIA.....	72
PART 2 - SPT's TECHNICAL AND DESIGN CRITERIA	74
APPENDIX D - DATA NOT DISCLOSED TO A RELEVANT TRANSMISSION LICENSEE	75
APPENDIX E - OFFSHORE TRANSMISSION SYSTEM AND OTSDUW PLANT AND APPARATUS TECHNICAL AND DESIGN CRITERIA.....	77
APPENDIX F - OTSDUW DATA AND INFORMATION AND OTSDUW NETWORK DATA AND INFORMATION	78

PC.1 INTRODUCTION

PC.1.1 The **Planning Code ("PC")** specifies the technical and design criteria and procedures to be applied by **The Company** in the planning and development of the **National Electricity Transmission System** and to be taken into account by **Users** in the planning and development of their own **Systems**. In the case of **OTSUA**, the **PC** also specifies the technical and design criteria and procedures to be applied by the **User** in the planning and development of the **OTSUA**. It details information to be supplied by **Users** to **The Company**, and certain information to be supplied by **The Company** to **Users**. **The Company** has obligations under the **STC** to inform **Relevant Transmission Licensees** of data required for the planning of the **National Electricity Transmission System**. In respect of **PC** data, **The Company** may pass on **User** data to a **Relevant Transmission Licensee**, as detailed in PC.3.4 and PC.3.5.

PC.1.1A Provisions of the **PC** which apply in relation to **OTSDUW** and **OTSUA** shall apply up to the **OTSUA Transfer Time**, whereupon such provisions shall (without prejudice to any prior non-compliance) cease to apply, without prejudice to the continuing application of provisions of the **PC** applying in relation to the relevant **Offshore Transmission System** and/or **Connection Site**.

PC.1.1B As used in the **PC**:

- (a) **National Electricity Transmission System** excludes **OTSDUW Plant and Apparatus** (prior to the **OTSUA Transfer Time**) unless the context otherwise requires;
- (b) and User Development includes **OTSDUW** unless the context otherwise requires.

PC.1.2 The **Users** referred to above are defined, for the purpose of the **PC**, in PC.3.1.

PC.1.3 Development of the **National Electricity Transmission System**, involving its reinforcement or extension, will arise for a number of reasons including, but not limited to:

- (a) a development on a **User System** already connected to the **National Electricity Transmission System**;
- (b) the introduction of a new **Connection Site** or the **Modification** of an existing **Connection Site** between a **User System** and the **National Electricity Transmission System**;
- (c) the cumulative effect of a number of such developments referred to in (a) and (b) by one or more **Users**.

PC.1.4 Accordingly, the reinforcement or extension of the **National Electricity Transmission System** may involve work:

- (a) at a substation at a **Connection Site** where **User's Plant** and/or **Apparatus** is connected to the **National Electricity Transmission System** (or in the case of **OTSDUW**, at a substation at an **Interface Point**);
- (b) on transmission lines or other facilities which join that **Connection Site** (or in the case of **OTSDUW**, **Interface Point**) to the remainder of the **National Electricity Transmission System**;
- (c) on transmission lines or other facilities at or between points remote from that **Connection Site** (or in the case of **OTSDUW**, **Interface Point**).

PC.1.5 The time required for the planning and development of the **National Electricity Transmission System** will depend on the type and extent of the necessary reinforcement and/or extension work, the need or otherwise for statutory planning consent, the associated possibility of the need for a public inquiry and the degree of complexity in undertaking the new work while maintaining satisfactory security and quality of supply on the existing **National Electricity Transmission System**.

PC1.6 For the avoidance of doubt and the purposes of the Grid Code, **DC Connected Power Park Modules** are treated as belonging to **Generators**. **Generators** who own **DC Connected Power Park Modules** would therefore be expected to supply the same data as required under this **PC** in respect of **Power Stations** comprising **Power Park Modules** other than where specific references to **DC Connected Power Park Modules** are made.

PC1.7 As defined in the Glossary and Definitions, **Electricity Storage Modules** are treated as belonging to **Storage User's** who are a subset of **Generator's**. **Generators** who own or operate **Electricity Storage Modules** would therefore be expected to supply the same data as required under this **PC** in respect of **Power Stations**. In general, and notwithstanding the requirements of the Glossary and Definitions and the wider requirements specified in the **Planning Code**, **Generators** in respect of **Synchronous Electricity Storage Modules** would be expected to supply the same data as required from **Generators** in respect of **Synchronous Power Generating Modules** and **Generators** in respect of **Non-Synchronous Electricity Storage Modules** would be expected to supply the same data as required from **Generators** in respect of **Power Park Modules**.

PC.2 OBJECTIVE

PC.2.1 The objectives of the **PC** are:

- (a) to promote **The Company/User** interaction in respect of any proposed development on the **User System** which may impact on the performance of the **National Electricity Transmission System** or the direct connection with the **National Electricity Transmission System**;
- (b) to provide for the supply of information to **The Company** from **Users** in order that planning and development of the **National Electricity Transmission System** can be undertaken in accordance with the relevant **Licence Standards**, to facilitate existing and proposed connections, and also to provide for the supply of certain information from **The Company** to **Users** in relation to short circuit current contributions and **OTSUA**; and
- (c) to specify the **Licence Standards** which will be used in the planning and development of the **National Electricity Transmission System**; and
- (d) to provide for the supply of information required by **The Company** from **Users** in respect of the following to enable **The Company** to carry out its duties under the **Act** and the **Transmission Licence**:
 - (i) **Mothballed Generating Units, Mothballed Power Generating Modules**; and
 - (ii) capability of gas-fired **Synchronous Power Generating Modules** or **Generating Units** to run using alternative fuels.

The Company will use the information provided under PC.2.1(d) in providing reports to the **Authority** and the **Secretary of State** and, where directed by the **Authority** or the **Secretary of State** to do so, **The Company** may publish the information. Where it is known by **The Company** that such information is intended for wider publication the information provided under PC.2.1(d) shall be aggregated such that individual data items should not be identifiable.

- (e) in the case of **OTSUA**:
 - (i) to specify the minimum technical and design criteria and procedures to be applied by **Users** in the planning and development of **OTSUA**; and thereby
 - (ii) to ensure that the **OTSUA** can from the **OTSUA Transfer Time** be operated as part of the **National Electricity Transmission System**; and
 - (iii) to provide for the arrangements and supply of information and data between **The Company** and a **User** to ensure that the **User** is able to undertake **OTSDUW**; and
 - (iv) to promote **The Company/User** interaction and co-ordination in respect of any proposed development on the **National Electricity Transmission System** or the **OTSUA**, which may impact on the **OTSUA** or (as the case may be) the **National Electricity Transmission System**.

PC.3 SCOPE

PC.3.1 The **PC** applies to **The Company** and to **Users**, which in the **PC** means:

- (a) **Generators**;
- (b) **Generators** undertaking **OTSDUW**;
- (c) **Network Operators**;
- (d) **Non-Embedded Customers**;
- (e) **DC Converter Station** owners; and
- (f) **HVDC System Owners**.

The above categories of **User** will become bound by the **PC** prior to them generating, operating, or consuming or importing/exporting, as the case may be, and references to the various categories (or to the general category) of **User** should, therefore, be taken as referring to them in that prospective role as well as to **Users** actually connected.

PC.3.2 In the case of **Embedded Power Stations**, **Embedded DC Converter Stations** and **Embedded HVDC Systems**, unless provided otherwise, the following provisions apply with regard to the provision of data under this **PC**:

- (a) each **Generator** shall provide the data direct to **The Company** in respect of (i) **Embedded Large Power Stations**, (ii) **Embedded Medium Power Stations** subject to a **Bilateral Agreement** and (iii) **Embedded Small Power Stations** which form part of a **Cascade Hydro Scheme**;
- (b) each **DC Converter** owner or **HVDC System Owner** shall provide the data direct to **The Company** in respect of **Embedded DC Converter Stations** and **Embedded HVDC Systems** subject to a **Bilateral Agreement**;
- (c) each **Network Operator** shall provide the data to **The Company** in respect of each **Embedded Medium Power Station** not subject to a **Bilateral Agreement** or **Embedded DC Converter Station** not subject to a **Bilateral Agreement** or **Embedded HVDC System** not subject to a **Bilateral Agreement** connected, or proposed to be connected within such **Network Operator's System**;
- (d) although data is not normally required specifically on **Embedded Small Power Stations** or on **Embedded** installations of direct current converters which do not form a **DC Converter Station** or **HVDC System** under this **PC**, each **Network Operator** in whose **System** they are **Embedded** should provide the data (contained in the Appendix) to **The Company** in respect of **Embedded Small Power Stations** or **Embedded** installations of direct current converters which do not form a **DC Converter Station** or **Embedded** installations of **HVDC Systems** if:
 - (i) it falls to be supplied pursuant to the application for a **CUSC Contract** or in the **Statement of Readiness** to be supplied in connection with a **Bilateral Agreement** and/or **Construction Agreement**, by the **Network Operator**; or
 - (ii) it is specifically requested by **The Company** in the circumstances provided for under this **PC**.

PC.3.3 Certain data does not normally need to be provided in respect of certain **Embedded Power Stations**, **Embedded DC Converter Stations** or **Embedded HVDC Systems**, as provided in PC.A.1.12.

In summary, **Network Operators** are required to supply the following data in respect of **Embedded Medium Power Stations** not subject to a **Bilateral Agreement** or **Embedded DC Converter Stations** not subject to a **Bilateral Agreement** or **Embedded HVDC Systems** not subject to a **Bilateral Agreement** connected, or is proposed to be connected, within such **Network Operator's System**:

PC.A.2.1.1

PC.A.2.2.2
PC.A.2.5.5.2
PC.A.2.5.5.7
PC.A.2.5.6
PC.A.3.1.5
PC.A.3.2.2
PC.A.3.3.1
PC.A.3.4.1
PC.A.3.4.2
PC.A.5.2.2
PC.A.5.3.2
PC.A.5.4
PC.A.5.5.1
PC.A.5.6

For the avoidance of doubt **Network Operators** are required to supply the above data in respect of **Embedded Medium Power Stations** not subject to a **Bilateral Agreement** and **Embedded DC Converter Stations** not subject to a **Bilateral Agreement** and **Embedded HVDC Systems** not subject to a **Bilateral Agreement** which are located **Offshore** and which are connected or proposed to be connected within such **Network Operator's System**. This is because **Embedded Medium Power Stations** not subject to a **Bilateral Agreement** and **Embedded DC Converter Stations** not subject to a **Bilateral Agreement** and **Embedded HVDC Systems** not subject to a **Bilateral Agreement** are treated as **Onshore Generators** or **Onshore DC Converter Station** owners or **HVDC System Owners** connected to an **Onshore User System Entry Point**.

PC.3.4 **The Company** may provide to the **Relevant Transmission Licensees** any data which has been submitted to **The Company** by any **Users** pursuant to the following paragraphs of the **PC**. For the avoidance of doubt, **The Company** will not provide to the **Relevant Transmission Licensees**, the types of data specified in Appendix D. The **Relevant Transmission Licensees'** use of such data is detailed in the **STC**.

PC.A.2.2
PC.A.2.5
PC.A.3.1
PC.A.3.2.1
PC.A.3.2.2
PC.A.3.3
PC.A.3.4
PC.A.4
PC.A.5.1
PC.A.5.2
PC.A.5.3.1
PC.A.5.3.2
PC.A.5.4.1
PC.A.5.4.2
PC.A.5.4.3.1

PC.A.5.4.3.2

PC.A.5.4.3.3

PC.A.5.4.3.4

PC.A.7

(and in addition in respect of the data submitted in respect of the **OTSUA**)

PC.A.2.2

PC.A.2.3

PC.A.2.4

PC.A.2.5

PC.A.3.2.2

PC.A.3.3.1(d)

PC.A.4

PC.A.5.4.3.1

PC.A.5.4.3.2

PC.A.6.2

PC.A.6.3

PC.A.6.4

PC.A.6.5

PC.A.6.6

PC.A.7

PC.3.5 In addition to the provisions of PC.3.4, **The Company** may provide to the **Relevant Transmission Licensees** any data which has been submitted to **The Company** by any **Users** in respect of **Relevant Units** pursuant to the following paragraphs of the **PC**.

PC.A.2.3

PC.A.2.4

PC.A.5.5

PC.A.5.7

PC.A.6.2

PC.A.6.3

PC.A.6.4

PC.A.6.5

PC.A.6.6

PC.3.6 In the case of **Offshore Embedded Power Stations** connected to an **Offshore User System** which directly connects to an **Offshore Transmission System**, any additional data requirements in respect of such **Offshore Embedded Power Stations** may be specified in the relevant **Bilateral Agreement** with the **Network Operator** or in any **Bilateral Agreement** between **The Company** and such **Offshore Embedded Power Station**.

PC.3.7 In the case of a **Generator** undertaking **OTSDUW** connecting to an **Onshore Network Operator's System**, any additional requirements in respect of such **OTSDUW Plant and Apparatus** will be specified in the relevant **Bilateral Agreement** with the **Generator**. For the avoidance of doubt, requirements applicable to **Generators** undertaking **OTSDUW** and connecting to a **Network Operator's User System**, shall be consistent with those applicable requirements of **Generators** undertaking **OTSDUW** and connecting to a **Transmission Interface Point**.

PC.4 PLANNING PROCEDURES

PC.4.1 Pursuant to Condition C11 of **The Company's Transmission Licence**, the means by which **Users** and proposed **Users** of the **National Electricity Transmission System** are able to assess opportunities for connecting to, and using, the **National Electricity Transmission System** comprise two distinct parts, namely:

- (a) a statement, prepared by **The Company** under its **Transmission Licence**, showing for each of the seven succeeding **Financial Years**, the opportunities available for connecting to and using the **National Electricity Transmission System** and indicating those parts of the **National Electricity Transmission System** most suited to new connections and transport of further quantities of electricity (the "**Seven Year Statement**"); and
- (b) an offer, in accordance with its **Transmission Licence**, by **The Company** to enter into a **CUSC Contract**. A **Bilateral Agreement** is to be entered into for every **Connection Site** (and for certain **Embedded Power Stations** and **Embedded DC Converter Stations** and **Embedded HVDC Systems**) within the first two of the following categories and the existing **Bilateral Agreement** may be required to be varied in the case of the third category:
 - (i) existing **Connection Sites** (and for certain **Embedded Power Stations**) as at the **Transfer Date**;
 - (ii) new **Connection Sites** (and for certain **Embedded Power Stations**, **Embedded DC Converter Stations** and **Embedded HVDC Systems**) with effect from the **Transfer Date**;
 - (iii) a **Modification** at a **Connection Site** (or in relation to the connection of certain **Embedded Power Stations**, **Embedded DC Converter Stations** and **Embedded HVDC Systems** whether or not the subject of a **Bilateral Agreement**) (whether such **Connection Site** or connection exists on the **Transfer Date** or is new thereafter) with effect from the **Transfer Date**.

In this **PC**, unless the context otherwise requires, "connection" means any of these 3 categories.

PC.4.2 Introduction to Data

User Data

PC.4.2.1 Under the **PC**, two types of data to be supplied by **Users** are called for:

- (a) **Standard Planning Data**; and
- (b) **Detailed Planning Data**,

as more particularly provided in PC.A.1.4.

PC.4.2.2 The **PC** recognises that these two types of data, namely **Standard Planning Data** and **Detailed Planning Data**, are considered at three different levels:

- (a) **Preliminary Project Planning Data**;
- (b) **Committed Project Planning Data**; and
- (c) **Connected Planning Data**,

as more particularly provided in PC.5

PC.4.2.3 **Connected Planning Data** is itself divided into:

- (a) **Forecast Data**;
- (b) **Registered Data**; and
- (c) **Estimated Registered Data**,

as more particularly provided in PC.5.5

PC.4.2.4 Clearly, an existing **User** proposing a new **Connection Site** (or **Embedded Power Station** or **Embedded DC Converter Station** or **Embedded HVDC System**) in the circumstances outlined in PC.4.1) will need to supply data both in an application for a **Bilateral Agreement** and under the **PC** in relation to that proposed new **Connection Site** (or **Embedded Power Station** or **Embedded DC Converter Station** or **Embedded HVDC System** in the circumstances outlined in PC.4.1) and that will be treated as **Preliminary Project Planning Data** or **Committed Project Planning Data** (as the case may be), but the data it supplies under the **PC** relating to its existing **Connection Sites** will be treated as **Connected Planning Data**.

Network Data

PC.4.2.5 In addition, there is **Network Data** supplied by **The Company** in relation to short circuit current contributions and in relation to **OTSUA**.

PC.4.3 Data Provision

PC.4.3.1 Seven Year Statement

To enable the **Seven Year Statement** to be prepared, each **User** is required to submit to **The Company** (subject to the provisions relating to **Embedded Power Stations** and **Embedded DC Converter Stations** and **Embedded HVDC Systems** in PC.3.2) both the **Standard Planning Data** and the **Detailed Planning Data** as listed in parts 1 and 2 of the Appendix. This data should be submitted in calendar week 24 of each year (although **Network Operators** may delay the submission of data (other than that to be submitted pursuant to PC.3.2(c) and PC.3.2(d)) until calendar week 28) and should cover each of the seven succeeding **Financial Years** (and in certain instances, the current year). Where, from the date of one submission to another, there is no change in the data (or in some of the data) to be submitted, instead of re-submitting the data, a **User** may submit a written statement that there has been no change from the data (or in some of the data) submitted the previous time. In addition, **The Company** will also use the **Transmission Entry Capacity** and **Connection Entry Capacity** data from the **CUSC Contract**, and any data submitted by **Network Operators** in relation to an **Embedded Medium Power Station** not subject to a **Bilateral Agreement** or **Embedded DC Converter Station** not subject to a **Bilateral Agreement**, or **Embedded HVDC System** not subject to a **Bilateral Agreement** in the preparation of the **Seven Year Statement** and to that extent the data will not be treated as confidential.

PC.4.3.2 Network Data

To enable **Users** to model the **National Electricity Transmission System** in relation to short circuit current contributions, **The Company** is required to submit to **Users**, the **Network Data** as listed in Part 3 of the Appendix. The data will be submitted in week 42 of each year and will cover that **Financial Year**.

PC.4.3.3 To enable **Users** to model the **National Electricity Transmission System** in relation to **OTSUA**, **The Company** is required to submit to **Users** the **Network Data**, as listed in Part 3 of Appendix A and Appendix F. **The Company** shall provide the **Network Data** with the offer of a **CUSC Contract** in the case of the data in PC F2.1 and otherwise in accordance with the **OTSDUW Development and Data Timetable**.

PC.4.4 Offer of Terms for Connection

PC.4.4.1 CUSC Contract – Data Requirements/Offer Timing

The completed application form for a **CUSC Contract** to be submitted by a **User** when making an application for a **CUSC Contract** will include:

- (a) a description of the **Plant** and/or **Apparatus** (excluding **OTSDUW Plant and Apparatus**) to be connected to the **National Electricity Transmission System** or of the **Modification** relating to the **User's Plant** and/or **Apparatus** (and prior to the **OTSUA Transfer Time**, any **OTSUA**) already connected to the **National Electricity Transmission System** or, as the case may be, of the proposed new connection or **Modification** to the connection within the **User System** of the **User**, each of which shall be termed a "**User Development**" in the **PC**;

- (b) the relevant **Standard Planning Data** as listed in Part 1 of the Appendix (except in respect of any **OTSUA**); and
- (c) the desired **Completion Date** of the proposed **User Development**.
- (d) the desired **Connection Entry Capacity** and **Transmission Entry Capacity**.

The completed application form for a **CUSC Contract** will be sent to **The Company** as more particularly provided in the application form.

PC.4.4.2 Any offer of a **CUSC Contract** will provide that it must be accepted by the applicant **User** within the period stated in the offer, after which the offer automatically lapses. Except as provided in the **CUSC Contract**, acceptance of the offer renders the **National Electricity Transmission System** works relating to that **User Development**, reflected in the offer, committed and binds both parties to the terms of the offer. The User shall then provide the **Detailed Planning Data** as listed in Part 2 of the Appendix (and in the case of **OTSUA** the **Standard Planning Data** as listed in Part 1 of Appendix A within the timeline provided in PC.A.1.4). In respect of **DPD I** this shall generally be provided within 28 days (or such shorter period as **The Company** may determine, or such longer period as **The Company** may agree, in any particular case) of acceptance of the offer and in respect of **DPD II** this shall generally be provided at least two years (or such longer period as **The Company** may determine, or such shorter period as **The Company** may agree, in any particular case or in the case of **OTSUA** such shorter period as **The Company** shall require) prior to the **Completion Date** of the **User Development**.

PC.4.4.3 Embedded Development Agreement - Data Requirements

The **Network Operator** shall submit the following data in relation to an **Embedded Medium Power Station** not subject to, or proposed to be subject to, a **Bilateral Agreement** or **Embedded DC Converter Station** not subject to, or proposed to be subject to, a **Bilateral Agreement** as soon as reasonably practicable after receipt of an application from an **Embedded Person** to connect to its **System**:

- (a) details of the proposed new connection or variation (having a similar effect on the **Network Operator's System** as a **Modification** would have on the **National Electricity Transmission System**) to the connection within the **Network Operator's System**, each of which shall be termed an "**Embedded Development**" in the **PC** (where a **User Development** has an impact on the **Network Operator's System** details shall be supplied in accordance with PC.4.4 and PC.4.5);
- (b) the relevant **Standard Planning Data** as listed in Part 1 of the Appendix;
- (c) the proposed completion date (having a similar meaning in relation to the **Network Operator's System** as **Completion Date** would have in relation to the **National Electricity Transmission System**) of the **Embedded Development**; and
- (d) upon the request of **The Company**, the relevant **Detailed Planning Data** as listed in Part 2 of the Appendix.

PC.4.4.4 The **Network Operator** shall provide the **Detailed Planning Data** as listed in Part 2 of the Appendix. In respect of **DPD I**, this shall generally be provided within 28 days (or such shorter period as **The Company** may determine, or such longer period as **The Company** may agree, in any particular case) of entry into the **Embedded Development Agreement** and in respect to **DPD II** this shall generally be provided at least two years (or such longer period as **The Company** may determine, or such shorter period as **The Company** may agree, in any particular case) prior to the **Completion Date** of the **Embedded Development**.

PC.4.5 Complex Connections

- PC.4.5.1 The magnitude and complexity of any **National Electricity Transmission System** extension or reinforcement will vary according to the nature, location and timing of the proposed **User Development** which is the subject of the application and it may, in the event, be necessary for **The Company** to carry out additional more extensive system studies to evaluate more fully the impact of the proposed **User Development** on the **National Electricity Transmission System**. Where **The Company** judges that such additional more detailed studies are necessary the offer may indicate the areas that require more detailed analysis and before such additional studies are required, the **User** shall indicate whether it wishes **The Company** to undertake the work necessary to proceed to make a revised offer within the 3 month period normally allowed or, where relevant, the timescale consented to by the **Authority**.
- PC.4.5.2 To enable **The Company** to carry out any of the above mentioned necessary detailed system studies, the **User** may, at the request of **The Company**, be required to provide some or all of the **Detailed Planning Data** listed in part 2 of the Appendix in advance of the normal timescale referred in PC.4.4.2 provided that **The Company** can reasonably demonstrate that it is relevant and necessary.
- PC.4.5.3 To enable **The Company** to carry out any necessary detailed system studies, the relevant **Network Operator** may, at the request of **The Company**, be required to provide some or all of the **Detailed Planning Data** listed in Part 2 of the Appendix in advance of the normal timescale referred in PC.4.4.4 provided that **The Company** can reasonably demonstrate that it is relevant and necessary.
- PC.5 PLANNING DATA
- PC.5.1 As far as the **PC** is concerned, there are three relevant levels of data in relation to **Users**. These levels, which relate to levels of confidentiality, commitment and validation, are described in the following paragraphs.
- Preliminary Project Planning Data
- PC.5.2 At the time the **User** applies for a **CUSC Contract** but before an offer is made and accepted by the applicant **User**, the data relating to the proposed **User Development** will be considered as **Preliminary Project Planning Data**. Data relating to an **Embedded Development** provided by a **Network Operator** in accordance with PC.4.4.3, and PC.4.4.4 if requested, will be considered as **Preliminary Project Planning Data**. All such data will be treated as confidential within the scope of the provisions relating to confidentiality in the **CUSC**.
- PC.5.3 **Preliminary Project Planning Data** will normally only contain the **Standard Planning Data** unless the **Detailed Planning Data** is required in advance of the normal timescale to enable **The Company** to carry out additional detailed system studies as described in PC.4.5.
- Committed Project Planning Data
- PC.5.4 Once the offer for a **CUSC Contract** is accepted, the data relating to the **User Development** already submitted as **Preliminary Project Planning Data**, and subsequent data required by **The Company** under this **PC**, will become **Committed Project Planning Data**. Once an **Embedded Person** has entered into an **Embedded Development Agreement**, as notified to **The Company** by the **Network Operator**, the data relating to the **Embedded Development** already submitted as **Preliminary Project Planning Data**, and subsequent data required by **The Company** under the **PC**, will become **Committed Project Planning Data**. Such data, together with **Connection Entry Capacity** and **Transmission Entry Capacity** data from the **CUSC Contract** and other data held by **The Company** relating to the **National Electricity Transmission System** will form the background against which new applications by any **User** will be considered and against which planning of the **National Electricity Transmission System** will be undertaken. Accordingly, **Committed Project Planning Data**, **Connection Entry Capacity** and **Transmission Entry Capacity** data will not be treated as confidential to the extent that **The Company**:
- (a) is obliged to use it in the preparation of the **Seven Year Statement** and in any further information given pursuant to the **Seven Year Statement**;

- (b) is obliged to use it when considering and/or advising on applications (or possible applications) of other **Users** (including making use of it by giving data from it, both orally and in writing, to other **Users** making an application (or considering or discussing a possible application) which is, in **The Company's** view, relevant to that other application or possible application);
- (c) is obliged to use it for operational planning purposes;
- (d) is obliged under the terms of an **Interconnection Agreement** to pass it on as part of system information on the **Total System**;
- (e) is obliged to disclose it under the **STC**;
- (f) is obliged to use and disclose it in the preparation of the **Offshore Development Information Statement**;
- (g) is obliged to use it in order to carry out its **EMR Functions** or is obliged to disclose it under an **EMR Document**.

To reflect different types of data, **Preliminary Project Planning Data** and **Committed Project Planning Data** are themselves divided into:

- (a) those items of **Standard Planning Data** and **Detailed Planning Data** which will always be forecast, known as **Forecast Data**; and
- (b) those items of **Standard Planning Data** and **Detailed Planning Data** which relate to **Plant** and/or **Apparatus** which upon connection will become **Registered Data**, but which prior to connection, for the seven succeeding **Financial Years**, will be an estimate of what is expected, known as **Estimated Registered Data**.

Connected Planning Data

PC.5.5

The **PC** requires that, at the time that a **Statement of Readiness** is submitted under the **Bilateral Agreement** and/or **Construction Agreement**, any estimated values assumed for planning purposes are confirmed or, where practical, replaced by validated actual values and by updated estimates for the future and by updated forecasts for forecast data items such as **Demand**. In the case of an **Embedded Development** the relevant **Network Operator** will update any estimated values assumed for planning purposes with validated actual values as soon as reasonably practicable after energisation. This data is then termed **Connected Planning Data**.

To reflect the three types of data referred to above, **Connected Planning Data** is itself divided into:

- (a) those items of **Standard Planning Data** and **Detailed Planning Data** which will always be forecast data, known as **Forecast Data**; and
- (b) those items of **Standard Planning Data** and **Detailed Planning Data** which upon connection become fixed (subject to any subsequent changes), known as **Registered Data**; and
- (c) those items of **Standard Planning Data** and **Detailed Planning Data** which for the purposes of the **Plant** and/or **Apparatus** concerned as at the date of submission are **Registered Data** but which for the seven succeeding **Financial Years** will be an estimate of what is expected, known as **Estimated Registered Data**,

as more particularly provided in the Appendix.

PC.5.6

Connected Planning Data, together with **Connection Entry Capacity** and **Transmission Entry Capacity** data from the **CUSC Contract**, and other data held by **The Company** relating to the **National Electricity Transmission System**, will form the background against which new applications by any **User** will be considered and against which planning of the **National Electricity Transmission System** will be undertaken. Accordingly, **Connected Planning Data**, **Connection Entry Capacity** and **Transmission Entry Capacity** data will not be treated as confidential to the extent that **The Company**:

- (a) is obliged to use it in the preparation of the **Seven Year Statement** and in any further information given pursuant to the **Seven Year Statement**;
- (b) is obliged to use it when considering and/or advising on applications (or possible applications) of other **Users** (including making use of it by giving data from it, both orally and in writing, to other **Users** making an application (or considering or discussing a possible application) which is, in **The Company's** view, relevant to that other application or possible application);
- (c) is obliged to use it for operational planning purposes;
- (d) is obliged under the terms of an **Interconnection Agreement** to pass it on as part of system information on the **Total System**.
- (e) is obliged to disclose it under the **STC**;
- (f) is obliged to use it in order to carry out its **EMR Functions** or is obliged to disclose it under an **EMR Document**.

PC.5.7

Committed Project Planning Data and **Connected Planning Data** will each contain both **Standard Planning Data** and **Detailed Planning Data**.

PC.6 PLANNING STANDARDS

PC.6.1 **The Company** shall apply the **Licence Standards** relevant to it in the planning and development of the **National Electricity Transmission System**. **The Company** shall procure that each **Relevant Transmission Licensee** shall apply the **Licence Standards** relevant to planning and development, in the planning and development of the **Transmission System** of each **Relevant Transmission Licensee** and that a **User** shall apply the **Licence Standards** relevant to planning and development, in the planning and development of the **OTSUA**.

PC.6.2 In relation to Scotland, Appendix C lists the technical and design criteria applied in the planning and development of each **Relevant Transmission Licensee's Transmission System**. The criteria are subject to review in accordance with each **Relevant Transmission Licensee's Transmission Licence** conditions. Copies of these documents are available from **The Company** on request. **The Company** will charge an amount sufficient to recover its reasonable costs incurred in providing this service.

PC.6.3 In relation to **Offshore**, Appendix E lists the technical and design criteria applied in the planning and development of each **Offshore Transmission System**. The criteria are subject to review in accordance with each **Offshore Transmission Licensee's Transmission Licence** conditions. Copies of these documents are available from **The Company** on request. **The Company** will charge an amount sufficient to recover its reasonable costs incurred in providing this service.

PC.6.4 In planning and developing the **OTSUA**, the **User** shall comply with (and shall ensure that (as at the **OTSUA Transfer Time**) the **OTSUA** comply with):

- (a) the **Licence Standards**; and
- (b) the technical and design criteria in Appendix E.

PC.6.5 In addition the **User** shall, in the planning and development of the **OTSUA**, to the extent it is reasonable and practicable to do so, take into account the reasonable requests of **The Company** (in the context of its obligation to develop an efficient, co-ordinated and economical system) relating to the planning and development of the **National Electricity Transmission System**.

PC.6.6 In planning and developing the **OTSUA** the **User** shall take into account the **Network Data** provided to it by **The Company** under Part 3 of Appendix A and Appendix F, and act on the basis that the **Plant** and **Apparatus** of other **Users** complies with:

- (a) the minimum technical design and operational criteria and performance requirements set out in either CC.6.1, CC.6.2, CC.6.3 and CC.6.4 or ECC.6.1, ECC.6.2, ECC.6.3 and ECC.6.4 ; or
- (b) such other criteria or requirements as **The Company** may from time to time notify the **User** are applicable to specified **Plant** and **Apparatus** pursuant to PC.6.7.

PC.6.7 Where the **OTSUA** are likely to be materially affected by the design or operation of another **User's Plant** and **Apparatus** and **The Company**:

- (a) becomes aware that such other **User** has or is likely to apply for a derogation under the Grid Code;
- (b) is itself applying for a derogation under the Grid Code in relation to the **Connection Site** on which such other **User's Plant** and **Apparatus** is located or to which it otherwise relates; or
- (c) is otherwise notified by such other **User** that specified **Plant** or **Apparatus** is normally capable of operating at levels better than those set out in CC.6.1, CC.6.2, CC.6.3 and CC.6.4 or ECC.6.1, ECC.6.2, ECC.6.3 and ECC.6.4,

The Company shall notify the **User**.

PC.7 PLANNING LIAISON

PC.7.1 This PC.7 applies to **The Company** and **Users**, which in PC.7 means

- (a) **Network Operators**
- (b) **Non-Embedded Customers**

PC.7.2 As described in PC.2.1 (b) an objective of the **PC** is to provide for the supply of information to **The Company** by **Users** in order that planning and development of the **National Electricity Transmission System** can be undertaken in accordance with the relevant **Licence Standards**.

PC.7.3 **Grid Code** amendment B/07 (“Amendment B/07”) implemented changes to the **Grid Code** which included amendments to the datasets provided by both **The Company** and **Users** to inform the planning and development of the **National Electricity Transmission System**. The **Authority** has determined that these changes are to have a phased implementation. Consequently the provisions of Appendix A to the **PC** include specific years (ranging from 2009 to 2011) with effect from which certain of the specific additional obligations brought about by Amendment B/07 on **The Company** and **Users** are to take effect. Where specific provisions of paragraphs PC.A.4.1.4, PC.A.4.2.2 and PC.A.4.3.1 make reference to a year, then the obligation on **The Company** and the **Users** shall be required to be met by the relevant calendar week (as specified within such provision) in such year.

In addition to the phased implementation of aspects of Amendment B/07, **Users** must discuss and agree with **The Company** by no later than 31 March 2009 a more detailed implementation programme to facilitate the implementation of **Grid Code** amendment B/07.

It shall also be noted by **The Company** and **Users** that the dates set out in PC.A.4 are intended to be minimum requirements and are not intended to restrict a **User** and **The Company** from the earlier fulfilment of the new requirements prior to the specified years. Where **The Company** and a **User** wish to follow the new requirements from earlier dates than those specified, this will be set out in the more detailed implementation programme agreed between **The Company** and the **User**.

The following provisions of PC.7 shall only apply with effect from 1 January 2011.

PC.7.4 Following the submission of data by a **User** in or after week 24 of each year **The Company** will provide information to **Users** by calendar week 6 of the following year regarding the results of any relevant assessment that has been made by **The Company** based upon such data submissions to verify whether **Connection Points** are compliant with the relevant **Licence Standards**.

PC.7.5 Where the result of any assessment identifies possible future non-compliance with the relevant **Licence Standards**, **The Company** shall notify the relevant **User(s)** of this fact as soon as reasonably practicable and shall agree with **Users** any opportunity to resubmit data to allow for a reassessment in accordance with PC.7.6.

PC.7.6 Following any notification by **The Company** to a **User** pursuant to PC.7.5 and following any further discussions held between the **User** and **The Company**:

- (i) **The Company** and the **User** may agree revisions to the **Access Periods** for relevant **Transmission Interface Circuits**, such revisions shall not however permit an **Access Period** to be less than 4 continuous weeks in duration or to occur other than between calendar weeks 10 and 43 (inclusive); and/or,
- (ii) The **User** shall as soon as reasonably practicable
 - (a) submit further relevant data to **The Company** that is to **The Company’s** reasonable satisfaction; and/or,
 - (b) modify data previously submitted pursuant to this **PC**, such modified data to be to **The Company’s** reasonable satisfaction; and/or
 - (c) notify **The Company** that it is the intention of the **User** to leave the data as originally submitted to **The Company** to stand as its submission.

- PC.7.7 Where an **Access Period** is amended pursuant to PC.7.6 (i) **The Company** shall notify **The Authority** that it has been necessary to do so.
- PC.7.8 When it is agreed that any resubmission of data is unlikely to confirm future compliance with the relevant **Licence Standards** the **Modification** process in the **CUSC** may apply.
- PC.7.9 A **User** may at any time, in writing, request further specified **National Electricity Transmission System** network data in order to provide **The Company** with viable **User** network data (as required under this **PC**). Upon receipt of such request, **The Company** shall consider, and where appropriate provide such **National Electricity Transmission System** network data to the **User** as soon as reasonably practicable following the request.
- PC.8 OTSDUW PLANNING LIAISON
- PC.8.1 This PC.8 applies to **The Company** and **Users**, which in PC.8 means **Users** undertaking **OTSDUW**
- PC.8.2 As described in PC.2.1 (e) an objective of the **PC** is to provide for the supply of information between **The Company** and a **User** undertaking **OTSDUW** in order that planning and development of the **National Electricity Transmission System** can be co-ordinated.
- PC.8.3 Where the **OTSUA** also require works to be undertaken by any **Relevant Transmission Licensee** on its **Transmission System** **The Company** and the **User** shall throughout the construction and commissioning of such works:
- (a) co-operate and assist each other in the development of co-ordinated construction programmes or any other planning or, in the case of **The Company**, analysis it undertakes in respect of the works; and
 - (b) provide to each other all information relating to, in the case of the **User** its own works and, in the case of **The Company**, the works on the **Transmission Systems** reasonably necessary to assist each other in the performance of that other's part of the works, and shall use all reasonable endeavours to co-ordinate and integrate their respective part of the works; and
- the **User** shall plan and develop the **OTSUA**, taking into account to the extent that it is reasonable and practicable to do so the reasonable requests of **The Company** relating to the planning and development of the **National Electricity Transmission System**.
- PC.8.4 Where **The Company** becomes aware that changes made to the investment plans of any **Relevant Transmission Licensee** may have a material effect on the **OTSUA**, **The Company** shall notify the **User** and provide the **User** with the necessary information about the relevant **Transmission Systems** sufficient for the **User** to assess the impact on the **OTSUA**.

APPENDIX A - PLANNING DATA REQUIREMENTS

PC.A.1 INTRODUCTION

PC.A.1.1 The Appendix specifies data requirements to be submitted to **The Company** by **Users**, and in certain circumstances to **Users** by **The Company**.

PC.A.1.2 Submissions by Users

- (a) Planning data submissions by **Users** shall be:
- (i) with respect to each of the seven succeeding **Financial Years** (other than in the case of **Registered Data** which will reflect the current position and data relating to **Demand** forecasts which relates also to the current year);
 - (ii) provided by **Users** in connection with a **CUSC Contract** (PC.4.1, PC.4.4 and PC.4.5 refer);
 - (iii) provided by **Users** on a routine annual basis in calendar week 24 of each year to maintain an up-to-date data bank (although **Network Operators** may delay the submission of data (other than that to be submitted pursuant to PC.3.2(c) and PC.3.2(d)) until calendar week 28). In addition the structural data in DRC Schedule 5 Tables 5(a), 5(b), 5(d), 5(e), 5(f) and DRC Schedule 13 (Lumped system susceptance (PC.A.2.3) only) provided by **Network Operators** by calendar week 28 shall be updated by calendar week 50 of each year (again which may be delayed as above until week 2 of the following calendar year). Where from the date of one annual (or in the case of Schedule 5 or Schedule 13 the calendar week 50) submission to another there is no change in the data (or in some of the data) to be submitted, instead of re-submitting the data, a **User** may submit a written statement that there has been no change from the data (or some of the data) submitted the previous time; and
 - (iv) provided by **Network Operators** in connection with **Embedded Development** (PC.4.4 refers).
- (b) Where there is any change (or anticipated change) in **Committed Project Planning Data** or a significant change in **Connected Planning Data** in the category of **Forecast Data** or any change (or anticipated change) in **Connected Planning Data** in the categories of **Registered Data** or **Estimated Registered Data** supplied to **The Company** under the **PC**, notwithstanding that the change may subsequently be notified to **The Company** under the **PC** as part of the routine annual update of data (or that the change may be a **Modification** under the **CUSC**), the **User** shall, subject to PC.A.3.2.3 and PC.A.3.2.4, notify **The Company** in writing without delay.
- (c) The notification of the change will be in the form required under this **PC** in relation to the supply of that data and will also contain the following information:
- (i) the time and date at which the change became, or is expected to become, effective;
 - (ii) if the change is only temporary, an estimate of the time and date at which the data will revert to the previous registered form.
- (d) The routine annual update of data, referred to in (a)(iii) above, need not be submitted in respect of **Small Power Stations** or **Embedded** installations of direct current converters which do not form a **DC Converter Station** or **HVDC System** (except as provided in PC.3.2.(c)), or unless specifically requested by **The Company**, or unless otherwise specifically provided.

PC.A.1.3 Submissions by The Company

Network Data release by **The Company** shall be:

- (a) with respect to the current **Financial Year**;

- (b) provided by **The Company** on a routine annual basis in calendar week 42 of each year. Where from the date of one annual submission to another there is no change in the data (or in some of the data) to be released, instead of repeating the data, **The Company** may release a written statement that there has been no change from the data (or some of the data) released the previous time.

The three parts of the Appendix

PC.A.1.4

The data requirements listed in this Appendix are subdivided into the following four parts:

(a) Standard Planning Data

This data (as listed in Part 1 of the Appendix) is first to be provided by a **User** at the time of an application for a **CUSC Contract** or in accordance with PC.4.4.3. It comprises data which is expected normally to be sufficient for **The Company** to investigate the impact on the **National Electricity Transmission System** of any **User Development** or **Embedded Development** associated with an application by the **User** for a **CUSC Contract**. **Users** should note that the term **Standard Planning Data** also includes the information referred to in PC.4.4.1.(a) and PC.4.4.3.(a). In the case of **OTSUA**, this data is first to be provided by a **User** in accordance with the time line in Appendix F.

(b) Detailed Planning Data

This data (as listed in Part 2 of the Appendix) includes both **DPD I** and **DPD II** and is to be provided in accordance with PC.4.4.2 and PC.4.4.4. It comprises additional, more detailed, data not normally expected to be required by **The Company** to investigate the impact on the **National Electricity Transmission System** of any **User Development** associated with an application by the **User** for a **CUSC Contract** or **Embedded Development Agreement**. **Users** and **Network Operators** in respect of **Embedded Developments** should note that the term **Detailed Planning Data** also includes **Operation Diagrams** and **Site Common Drawings** produced in accordance with the **CC** and **ECC**.

The **User** may, however, be required by **The Company** to provide the **Detailed Planning Data** in advance of the normal timescale before **The Company** can make an offer for a **CUSC Contract**, as explained in PC.4.5.

(c) Network Data

The data requirements for **The Company** in this Appendix are in Part 3.

(d) Offshore Transmission System (OTSDUW) Data

Generators who are undertaking **OTSDUW** are required to submit data in accordance with Appendix A as summarised in Schedule 18 of the **Data Registration Code**.

Forecast Data, Registered Data and Estimated Registered Data

PC.A.1.5

As explained in PC.5.4 and PC.5.5, **Planning Data** is divided into:

- (i) those items of **Standard Planning Data** and **Detailed Planning Data** known as **Forecast Data**; and
- (ii) those items of **Standard Planning Data** and **Detailed Planning Data** known as **Registered Data**; and
- (iii) those items of **Standard Planning Data** and **Detailed Planning Data** known as **Estimated Registered Data**.

PC.A.1.6

The following paragraphs in this Appendix relate to **Forecast Data**:

3.2.2(b), (h), (i) and (j)

4.2.1

4.3.1

4.3.2

4.3.3

4.3.4

4.3.5

4.5

4.7.1

5.2.1

5.2.2

5.6.1

PC.A.1.7 The following paragraphs in this Appendix relate to **Registered Data** and **Estimated Registered Data**:

2.2.1

2.2.4

2.2.5

2.2.6

2.3.1

2.4.1

2.4.2

3.2.2(a), (c), (d), (e), (f), (g), (i)(part) and (j)

3.4.1

3.4.2

4.2.3

4.5(a)(i), (a)(iii), (b)(i) and (b)(iii)

4.6

5.3.2

5.4

5.4.2

5.4.3

5.5

5.6.3

6.2

6.3

PC.A.1.8 The data supplied under PC.A.3.3.1, although in the nature of **Registered Data**, is only supplied either upon application for a **CUSC Contract**, or in accordance with PC.4.4.3, and therefore does not fall to be **Registered Data**, but is **Estimated Registered Data**.

PC.A.1.9 **Forecast Data** must contain the **User's** best forecast of the data being forecast, acting as a reasonable and prudent **User** in all the circumstances.

- PC.A.1.10 **Registered Data** must contain validated actual values, parameters or other information (as the case may be) which replace the estimated values, parameters or other information (as the case may be) which were given in relation to those data items when they were **Preliminary Project Planning Data** and **Committed Project Planning Data**, or in the case of changes, which replace earlier actual values, parameters or other information (as the case may be). Until amended pursuant to the Grid Code, these actual values, parameters or other information (as the case may be) will be the basis upon which the **National Electricity Transmission System** is planned, designed, built and operated in accordance with, amongst other things, the **Transmission Licences**, the **STC** and the Grid Code, and on which **The Company** therefore relies. In following the processes set out in the **BC**, **The Company** will use the data which has been supplied to it under the **BC** and the data supplied under **OC2** in relation to **Gensets**, but the provision of such data will not alter the data supplied by **Users** under the **PC**, which may only be amended as provided in the **PC**.
- PC.A.1.11 **Estimated Registered Data** must contain the **User's** best estimate of the values, parameters or other information (as the case may be), acting as a reasonable and prudent **User** in all the circumstances.
- PC.A.1.12 Certain data does not need to be supplied in relation to **Embedded Power Stations** or **Embedded DC Converter Stations** or **Embedded HVDC Systems** where these are connected at a voltage level below the voltage level directly connected to the **National Electricity Transmission System** except in connection with a **CUSC Contract**, or unless specifically requested by **The Company**.
- PC.A.1.13 In the case of **OTSUA**, Schedule 18 of the **Data Registration Code** shall be construed in such a manner as to achieve the intent of such provisions by reference to the **OTSUA** and the **Interface Point** and all **Connection Points**.

PART 1 - STANDARD PLANNING DATA

PC.A.2 USER'S SYSTEM (AND OTSUA) DATA

PC.A.2.1 Introduction

PC.A.2.1.1 Each **User**, whether connected directly via an existing **Connection Point** to the **National Electricity Transmission System**, or seeking such a direct connection, or providing terms for connection of an **Offshore Transmission System** to its **User System** to **The Company**, shall provide **The Company** with data on its **User System** (and any **OTSUA**) which relates to the **Connection Site** (and in the case of **OTSUA**, the **Interface Point**) and/or which may have a system effect on the performance of the **National Electricity Transmission System**. Such data, current and forecast, is specified in PC.A.2.2 to PC.A.2.5. In addition each **Generator** in respect of its **Embedded Large Power Stations** and its **Embedded Medium Power Stations** subject to a **Bilateral Agreement** and each **Network Operator** in respect of **Embedded Medium Power Stations** within its **System** not subject to a **Bilateral Agreement** connected to the **Subtransmission System**, shall provide **The Company** with fault infeed data as specified in PC.A.2.5.5 and each **DC Converter** owner with **Embedded DC Converter Stations** subject to a **Bilateral Agreement** and **Embedded HVDC System Owner** subject to a **Bilateral Agreement**, or **Network Operator** in the case of **Embedded DC Converter Stations** not subject to a **Bilateral Agreement** or **Embedded HVDC Systems** not subject to a **Bilateral Agreement**, connected to the **Subtransmission System** shall provide **The Company** with fault infeed data as specified in PC.A.2.5.6.

PC.A.2.1.2 Each **User** must reflect the system effect at the **Connection Site(s)** of any third party **Embedded** within its **User System** whether existing or proposed.

PC.A.2.1.3 Although not itemised here, each **User** with an existing or proposed **Embedded Small Power Station**, **Embedded Medium Power Station**, **Embedded DC Converter Station** or **HVDC System** with a **Registered Capacity** of less than 100MW or an **Embedded** installation of direct current converters which does not form a **DC Converter Station** or **HVDC System** in its **User System** may, at **The Company's** reasonable discretion, be required to provide additional details relating to the **User's System** between the **Connection Site** and the existing or proposed **Embedded Small Power Station**, **Embedded Medium Power Station**, **Embedded DC Converter Station**, **Embedded HVDC System** or **Embedded** installation of direct current converters which does not form a **DC Converter Station** or **Embedded** installation which does not form an **HVDC System**.

PC.A.2.1.4 At **The Company's** reasonable request, additional data on the **User's System** (or **OTSUA**) will need to be supplied. Some of the possible reasons for such a request, and the data required, are given in PC.A.6.2, PC.A.6.4, PC.A.6.5 and PC.A.6.6.

PC.A.2.2 User's System (and OTSUA) Layout

PC.A.2.2.1 Each **User** shall provide a **Single Line Diagram**, depicting both its existing and proposed arrangement(s) of load current carrying **Apparatus** relating to both existing and proposed **Connection Points** (including in the case of **OTSUA**, **Interface Points**).

PC.A.2.2.2 The **Single Line Diagram** (three examples are shown in Appendix B) must include all parts of the **User System** operating at **Supergrid Voltage** throughout **Great Britain** and, in Scotland and **Offshore**, also all parts of the **User System** operating at 132kV or greater, and those parts of its **Subtransmission System** at any **Transmission Site**. In the case of **OTSDUW**, the **Single Line Diagram** must also include the **OTSUA**. In addition, the **Single Line Diagram** must include all parts of the **User's Subtransmission System** (and any **OTSUA**) throughout **Great Britain** operating at a voltage greater than 50kV, and, in Scotland and **Offshore**, also all parts of the **User's Subtransmission System** (and any **OTSUA**) operating at a voltage greater than 30kV, which, under either intact network or **Planned Outage** conditions:

- (a) normally interconnects separate **Connection Points**, or busbars at a **Connection Point** which are normally run in separate sections; or

- (b) connects **Embedded Large Power Stations**, or **Embedded Medium Power Stations**, or **Embedded DC Converter Stations**, or **Embedded HVDC Systems** or **Offshore Transmission Systems** connected to the **User's Subtransmission System**, to a **Connection Point** or **Interface Point**.

At the **User's** discretion, the **Single Line Diagram** can also contain additional details of the **User's Subtransmission System** (and any **OTSUA**) not already included above, and also details of the transformers connecting the **User's Subtransmission System** to a lower voltage. With **The Company's** agreement, the **Single Line Diagram** can also contain information about the **User's System** (and any **OTSUA**) at a voltage below the voltage of the **Subtransmission System**.

The **Single Line Diagram** for a **Power Park Module** (including **DC Connected Power Park Modules**) must include all parts of the System connecting generating equipment to the **Grid Entry Point** (or **User System Entry Point** if **Embedded**). As an alternative, the **User** may choose to submit a **Single Line Diagram** with the equipment between the equivalent **Power Park Unit** and the **Common Collection Busbar** reduced to an electrically equivalent network. The format for a **Single Line Diagram** for a **Power Park Module** (including **DC Connected Power Park Modules**) electrically equivalent system is shown in Appendix B.

The **Single Line Diagram** must include the points at which **Demand** data (provided under PC.A.4.3.4 and PC.A.4.3.5, or in the case of **Generators**, PC.A.5.) and fault infeed data (provided under PC.A.2.5) are supplied.

PC.A.2.2.3 The above-mentioned **Single Line Diagram** shall include:

- (a) electrical circuitry (i.e. overhead lines, identifying which circuits are on the same towers, underground cables, power transformers, reactive compensation equipment and similar equipment); and
- (b) substation names (in full or abbreviated form) with operating voltages.

In addition, for all load current carrying **Apparatus** operating at **Supergrid Voltage** throughout **Great Britain** and, in Scotland and **Offshore**, also at 132kV or greater, (and any **OTSUA**) the **Single Line Diagram** shall include:

- (a) circuit breakers
- (b) phasing arrangements.

PC.A.2.2.3.1 For the avoidance of doubt, the **Single Line Diagram** to be supplied is in addition to the **Operation Diagram** supplied pursuant to CC.7.4 or ECC.7.4.

PC.A.2.2.4 For each circuit shown on the **Single Line Diagram** provided under PC.A.2.2.1, each **User** shall provide the following details relating to that part of its **User System** and **OTSUA**:

Circuit Parameters:

Rated voltage (kV)

Operating voltage (kV)

Positive phase sequence reactance

Positive phase sequence resistance

Positive phase sequence susceptance

Zero phase sequence reactance (both self and mutual)

Zero phase sequence resistance (both self and mutual)

Zero phase sequence susceptance (both self and mutual)

In the case of a **Single Line Diagram** for a **Power Park Module** (including **DC Connected Power Park Modules**) electrically equivalent system the data should be on a 100MVA base. Depending on the equivalent system supplied an equivalent tap changer range may need to be supplied. Similarly mutual values, rated voltage and operating voltage may be inappropriate. Additionally in the case of **OTSUA**, seasonal maximum continuous ratings and circuit lengths are to be provided in addition to the data required under PC.A.2.2.4.

PC.A.2.2.5 For each transformer shown on the **Single Line Diagram** provided under PC.A.2.2.1, each **User** (including those undertaking **OTSDUW**) shall provide the following details:

Rated MVA

Voltage Ratio

Winding arrangement

Positive sequence reactance (max, min and nominal tap)

Positive sequence resistance (max, min and nominal tap)

Zero sequence reactance

PC.A.2.2.5.1. In addition, for all interconnecting transformers between the **User's Supergrid Voltage System** and the **User's Subtransmission System** throughout **Great Britain** and, in Scotland and **Offshore**, also for all interconnecting transformers operating at 132kV or greater between the **User's System** and the **User's Subtransmission System** (and any **OTSUA**) the **User** shall supply the following information:-

Tap changer range

Tap change step size

Tap changer type: on load or off circuit

Earthing method: Direct, resistance or reactance

Impedance (if not directly earthed)

PC.A.2.2.6 Each **User** shall supply the following information about the **User's** equipment installed at a **Transmission Site** (or in the case of **OTSUA**, all **OTSDUW Plant and Apparatus**):-

(a) Switchgear. For all circuit breakers:-

Rated voltage (kV)

Operating voltage (kV)

Rated 3-phase rms short-circuit breaking current, (kA)

Rated 1-phase rms short-circuit breaking current, (kA)

Rated 3-phase peak short-circuit making current, (kA)

Rated 1-phase peak short-circuit making current, (kA)

Rated rms continuous current (A)

DC time constant applied at testing of asymmetrical breaking abilities (secs)

In the case of **OTSDUW Plant and Apparatus** operating times for circuit breaker, **Protection**, trip relay and total operating time should be provided.

(b) Substation Infrastructure. For the substation infrastructure (including, but not limited to, switch disconnectors, disconnectors, current transformers, line traps, busbars, through bushings, etc):-

Rated 3-phase rms short-circuit withstand current (kA)

Rated 1-phase rms short-circuit withstand current (kA).

Rated 3-phase short-circuit peak withstand current (kA)

Rated 1- phase short-circuit peak withstand current (kA)

Rated duration of short circuit withstand (secs)

Rated rms continuous current (A)

A single value for the entire substation may be supplied, provided it represents the most restrictive item of current carrying apparatus.

PC.A.2.2.7 In the case of **OTSUA** the following should also be provided

- (a) Automatic switching scheme schedules including diagrams and an explanation of how the **System** will operate and what plant will be affected by the schemes **Operation**.
- (b) **Intertripping** schemes both Generation and **Demand**. In each case a diagram of the scheme and an explanation of how the **System** will operate and what **Plant** will be affected by the schemes **Operation**.

PC.A.2.3 Lumped System Susceptance

PC.A.2.3.1 For all parts of the **User's Subtransmission System** (and any **OTSUA**) which are not included in the **Single Line Diagram** provided under PC.A.2.2.1, each **User** shall provide the equivalent lumped shunt susceptance at nominal **Frequency**.

PC.A.2.3.1.1 This should include shunt reactors connected to cables which are not normally in or out of service independent of the cable (ie. they are regarded as part of the cable).

PC.A.2.3.1.2 This should not include:

- (a) independently switched reactive compensation equipment connected to the **User's System** specified under PC.A.2.4, or;
- (b) any susceptance of the **User's System** inherent in the **Demand (Reactive Power)** data specified under PC.A.4.3.1.

PC.A.2.4 Reactive Compensation Equipment

PC.A.2.4.1 For all independently switched reactive compensation equipment (including any **OTSUA**), including that shown on the **Single Line Diagram**, not operated by **The Company** and connected to the **User's System** at 132kV and above in England and Wales and 33kV and above in Scotland and **Offshore** (including any **OTSDUW Plant and Apparatus** operating at **High Voltage**), other than **Power Factor** correction equipment associated directly with **Customers' Plant and Apparatus**, the following information is required:

- (a) type of equipment (eg. fixed or variable);
- (b) capacitive and/or inductive rating or its operating range in MVAR;
- (c) details of any automatic control logic to enable operating characteristics to be determined;
- (d) the point of connection to the **User's System** (including **OTSUA**) in terms of electrical location and **System** voltage.
- (e) In the case of **OTSDUW Plant and Apparatus** the **User** should also provide:-
 - (i) Connection node, voltage, rating, power loss, tap range and connection arrangement.
 - (ii) A mathematical representation in block diagram format to model the control of any dynamic compensation plant. The model should be suitable for RMS dynamic stability type studies where each time constant should be no less than 10ms.
 - (iii) For Static Var Compensation equipment the **User** should provide:

HV Node

LV Node

Control Node

Nominal Voltage (kV)

Target Voltage (kV)

Maximum MVA_r at HV
Minimum MVA_r at HV
Slope %
Voltage dependant Q Limit
Normal Running Mode
Positive and zero phase sequence resistance and reactance
Transformer winding type
Connection arrangements

PC.A.2.4.2 **DC Converter Station** owners, **HVDC System Owners** (and a **User** where the **OTSUA** includes an **OTSDUW DC Converter**) are also required to provide information about the reactive compensation and harmonic filtering equipment required to ensure that their **Plant** and **Apparatus** (and the **OTSUA**) complies with the criteria set out in CC.6.1.5 or ECC.6.1.5 (as applicable).

PC.A.2.5 Short Circuit Contribution to National Electricity Transmission System

PC.A.2.5.1 General

- (a) To allow **The Company** to calculate fault currents, each **User** is required to provide data, calculated in accordance with **Good Industry Practice**, as set out in the following paragraphs of PC.A.2.5.
- (b) The data should be provided for the **User's System** with all **Generating Units** (including **Synchronous Generating Units**), **Power Park Units**, **HVDC Systems** and **DC Converters Synchronised** to that **User's System** (and any **OTSUA** where appropriate). The **User** must ensure that the pre-fault network conditions reflect a credible **System** operating arrangement.
- (c) The list of data items required, in whole or part, under the following provisions, is set out in PC.A.2.5.6. Each of the relevant following provisions identifies which data items in the list are required for the situation with which that provision deals.

The fault currents in sub-paragraphs (a) and (b) of the data list in PC.A.2.5.6 should be based on an a.c. load flow that takes into account any pre-fault current flow across the **Point of Connection** (and in the case of **OTSUA**, **Interface Points** and **Connection Points**) being considered.

Measurements made under appropriate **System** conditions may be used by the **User** to obtain the relevant data.

- (d) **The Company** may at any time, in writing, specifically request for data to be provided for an alternative **System** condition, for example minimum plant, and the **User** will, insofar as such request is reasonable, provide the information as soon as reasonably practicable following the request.

PC.A.2.5.2 **Network Operators** and **Non-Embedded Customers** are required to submit data in accordance with PC.A.2.5.4. **Generators**, **DC Converter Station** owners, **HVDC System Owners** and **Network Operators**, in respect of **Embedded Medium Power Stations** not subject to a **Bilateral Agreement** and **Embedded DC Converter Stations** not subject to a **Bilateral Agreement** and **Embedded HVDC Systems** within such **Network Operator's Systems** are required to submit data in accordance with PC.A.2.5.5.

PC.A.2.5.3 Where prospective short-circuit currents on **Transmission** equipment are close to the equipment rating, and in **The Company's** reasonable opinion more accurate calculations of the prospective short circuit currents are required, then **The Company** will request additional data as outlined in PC.A.6.6 below.

PC.A.2.5.4 Data from Network Operators and Non-Embedded Customers

PC.A.2.5.4.1 Data is required to be provided at each node on the **Single Line Diagram** provided under PC.A.2.2.1 at which motor loads and/or **Embedded Small Power Stations** and/or **Embedded Medium Power Stations** and/or **Embedded** installations of direct current converters which do not form a **DC Converter Station** or **HVDC System** are connected, assuming a fault at that location, as follows:-

The data items listed under the following parts of PC.A.2.5.6:-

(a) (i), (ii), (iii), (iv), (v) and (vi);

and the data items shall be provided in accordance with the detailed provisions of PC.A.2.5.6(c) - (f).

PC.A.2.5.4.2 **Network Operators** shall provide the following data items in respect of each **Interface Point** within their **User System**:

(a) **Maximum Export Capacity**;

(b) **Maximum Import Capacity**; and,

(c) **Interface Point Target Voltage/Power Factor**

Network Operators shall alongside these parameters include details of any manual or automatic post fault actions to be taken by the owner / operator of the **Offshore Transmission System** connected to such **Interface Point** that are required by the **Network Operator**.

PC.A.2.5.5 Data from **Generators** (including **Generators** undertaking **OTSDUW** and those responsible for **DC Connected Power Park Modules**), **DC Converter Station** owners, **HVDC System Owners** and from **Network Operators** in respect of **Embedded Medium Power Stations** not subject to a **Bilateral Agreement** and **Embedded DC Converter Stations** not subject to a **Bilateral Agreement** and **Embedded HVDC Systems** within such **Network Operator's Systems**.

PC.A.2.5.5.1 For each **Generating Unit** (including **Synchronous Generating Units** forming part of a **Synchronous Power Generating Module**) with one or more associated **Unit Transformers**, the **Generator**, or the **Network Operator** in respect of **Embedded Medium Power Stations** not subject to a **Bilateral Agreement** and **Embedded DC Converter Stations** not subject to a **Bilateral Agreement** and **Embedded HVDC Systems** within such **Network Operator's System** is required to provide values for the contribution of the **Power Station Auxiliaries** (including **Auxiliary Gas Turbines** or **Auxiliary Diesel Engines**) to the fault current flowing through the **Unit Transformer(s)**.

The data items listed under the following parts of PC.A.2.5.6(a) should be provided:-

(i), (ii) and (v);

(iii) if the associated **Generating Unit** (including **Synchronous Generating Units** forming part of a **Synchronous Power Generating Module**) step-up transformer can supply zero phase sequence current from the **Generating Unit** side to the **National Electricity Transmission System**;

(iv) if the value is not 1.0 p.u;

and the data items shall be provided in accordance with the detailed provisions of PC.A.2.5.6(c) - (f), and with the following parts of this PC.A.2.5.5.

PC.A.2.5.5.2 Auxiliary motor short circuit current contribution and any **Auxiliary Gas Turbine Unit** contribution through the **Unit Transformers** must be represented as a combined short circuit current contribution at the **Generating Unit's** (including **Synchronous Generating Units** forming part of a **Synchronous Power Generating Module**) terminals, assuming a fault at that location.

PC.A.2.5.5.3 If the **Power Station** or **HVDC System** or **DC Converter Station** (or **OTSDUW Plant and Apparatus** which provides a fault infeed) has separate **Station Transformers**, data should be provided for the fault current contribution from each transformer at its high voltage terminals, assuming a fault at that location, as follows:-

The data items listed under the following parts of PC.A.2.5.6

- (a) (i), (ii), (iii), (iv), (v) and (vi);

and the data items shall be provided in accordance with the detailed provisions of PC.A.2.5.6(b) - (f).

- PC.A.2.5.5.4 Data for the fault infeeds through both **Unit Transformers** and **Station Transformers** shall be provided for the normal running arrangement when the maximum number of **Generating Units** (including **Synchronous Generating Units** forming part of a **Synchronous Power Generating Module**) are **Synchronised** to the **System** or when all the **DC Converters** at a **DC Converter Station** or **HVDC Converters** within an **HVDC System** are transferring **Rated MW** in either direction. Where there is an alternative running arrangement (or transfer in the case of a **DC Converter Station** or **HVDC System**) which can give a higher fault infeed through the **Station Transformers**, then a separate data submission representing this condition shall be made.
- PC.A.2.5.5.5 Unless the normal operating arrangement within the **Power Station** is to have the **Station** and **Unit Boards** interconnected within the **Power Station**, no account should be taken of the interconnection between the **Station Board** and the **Unit Board**.
- PC.A.2.5.5.6 Auxiliary motor short circuit current contribution and any auxiliary **DC Converter Station** contribution or **HVDC System** contribution through the **Station Transformers** must be represented as a combined short circuit current contribution through the **Station Transformers**.
- PC.A.2.5.5.7 Where a **Manufacturer's Data & Performance Report** exists in respect of the model of the **Power Park Unit**, the **User** may opt to reference the **Manufacturer's Data & Performance Report** as an alternative to the provision of data in accordance with this PC.A.2.5.5.7. For the avoidance of doubt, all other data provision pursuant to the Grid Code shall still be provided including a Single Line Diagram and those data pertaining thereto.

For each **Power Park Module** (including **DC Connected Power Park Modules**) and each type of **Power Park Unit** (eg. a Doubly Fed Induction Generator) (and any **OTSDUW Plant and Apparatus** which provides a fault infeed), including any **Auxiliaries**, positive, negative and zero sequence root mean square current values are to be provided of the contribution to the short circuit current flowing at:

- (i) the **Power Park Unit** terminals, or the **Common Collection Busbar** if an equivalent **Single Line Diagram** and associated data as described in PC.A.2.2.2 is provided, and
- (ii) the **Grid Entry Point** (and in case of **OTSUA, Transmission Interface Point**), or **User System Entry Point** if **Embedded**

for the following solid faults at the **Grid Entry Point** (and in case of **OTSUA, Interface Point**), or **User System Entry Point** if **Embedded**:

- (i) a symmetrical three phase short circuit
- (ii) a single phase to earth short circuit
- (iii) a phase to phase short circuit
- (iv) a two phase to earth short circuit

For a **Power Park Module** (including **DC Connected Power Park Modules**) in which one or more of the **Power Park Units** utilise a protective control such as a crowbar circuit, the data should indicate whether the protective control will act in each of the above cases and the effects of its action shall be included in the data. For any case in which the protective control will act, the data for the fault shall also be submitted for the limiting case in which the protective circuit will not act, which may involve the application of a non-solid fault, and the positive, negative and zero sequence retained voltages at;

- (i) the **Power Park Unit** terminals, or the **Common Collection Busbar** if an equivalent **Single Line Diagram** and associated data is provided and
- (ii) the **Grid Entry Point**, or **User System Entry Point** if **Embedded**

in this limiting case shall be provided.

For each fault for which data is submitted, the data items listed under the following parts of PC.A.2.5.6(a) shall be provided:-

(iv), (vii), (viii), (ix), (x);

In addition, if an equivalent **Single Line Diagram** has been provided the data items listed under the following parts of PC.A.2.5.6(a) shall be provided:-

(xi), (xii), (xiii);

In addition, for a **Power Park Module** (including **DC Connected Power Park Modules**) in which one or more of the **Power Park Units** utilise a protective control such as a crowbar circuit:-

the data items listed under the following parts of PC.A.2.5.6(a) shall be provided:-

(xiv), (xv);

All of the above data items shall be provided in accordance with the detailed provisions of PC.A.2.5.6(c), (d), (f).

Should actual data in respect of fault infeeds be unavailable at the time of the application for a **CUSC Contract** or **Embedded Development Agreement**, a limited subset of the data, representing the maximum fault infeed that may result from all of the plant types being considered, shall be submitted. This data will, as a minimum, represent the root mean square of the positive, negative and zero sequence components of the fault current for both single phase and three phase solid faults at the **Grid Entry Point** (or **User System Entry Point** if **Embedded**) at the time of fault application and 50ms following fault application. Actual data in respect of fault infeeds shall be submitted to **The Company** as soon as it is available, in line with PC.A.1.2

PC.A.2.5.6

Data Items

- (a) The following is the list of data utilised in this part of the **PC**. It also contains rules on the data which generally apply:-
- (i) Root mean square of the symmetrical three-phase short circuit current infeed at the instant of fault, (I_1'');
 - (ii) Root mean square of the symmetrical three-phase short circuit current after the subtransient fault current contribution has substantially decayed, (I_1');
 - (iii) the zero sequence source resistance and reactance values of the **User's System** as seen from the node on the **Single Line Diagram** provided under PC.A.2.2.1 (or **Power Generating Module** or **Station Transformer** high voltage terminals or **Generating Unit** terminals or **DC Converter** terminals or **HVDC System** terminals, as appropriate) consistent with the infeed described in PC.A.2.5.1.(b);
 - (iv) root mean square of the pre-fault voltage at which the maximum fault currents were calculated;
 - (v) the positive sequence X/R ratio at the instant of fault;
 - (vi) the negative sequence resistance and reactance values of the **User's System** seen from the node on the **Single Line Diagram** provided under PC.A.2.2.1 (or **Power Generating Module** or **Station Transformer** high voltage terminals, or **Generating Unit** terminals or **DC Converter** terminals or **HVDC System** terminals as appropriate) if substantially different from the values of positive sequence resistance and reactance which would be derived from the data provided above;
 - (vii) A continuous trace and a table showing the root mean square of the positive, negative and zero sequence components of the short circuit current between zero and 140ms at 10ms intervals;

- (viii) The **Active Power** (or **Interface Point Capacity** being exported pre-fault by the **OTSDUW Plant and Apparatus**) being generated pre-fault by the **Power Park Module** (including **DC Connected Power Park Modules**) and by each type of **Power Park Unit**;
 - (ix) The reactive compensation shown explicitly on the **Single Line Diagram** that is switched in;
 - (x) The **Power Factor** of the **Power Park Module** (including **DC Connected Power Park Modules**) and of each **Power Park Unit** type;
 - (xi) The positive sequence X/R ratio of the equivalent at the **Common Collection Busbar** or **Interface Point** in the case of **OTSUA**;
 - (xii) The minimum zero sequence impedance of the equivalent seen from the **Common Collection Busbar** or **Interface Point** in the case of **OTSUA**;
 - (xiii) The number of **Power Park Units** represented in the equivalent **Power Park Unit**;
 - (xiv) The additional rotor resistance and reactance (if any) that is applied to the **Power Park Unit** under a fault condition;
 - (xv) A continuous trace and a table showing the root mean square of the positive, negative and zero sequence components of the retained voltage at the fault point and **Power Park Unit** terminals, or the **Common Collection Busbar** if an equivalent **Single Line Diagram** and associated data as described in PC.A.2.2.2 is provided or **Interface Point** in the case of **OTSUA**, representing the limiting case, which may involve the application of a non-solid fault, required to not cause operation of the protective control;
- (b) In considering this data, unless the **User** notifies **The Company** accordingly at the time of data submission, **The Company** will assume that the time constant of decay of the subtransient fault current corresponding to the change from I_1'' to I_1' , (T'') is not significantly different from 40ms. If that assumption is not correct in relation to an item of data, the **User** must inform **The Company** at the time of submission of the data.
 - (c) The value for the X/R ratio must reflect the rate of decay of the d.c. component that may be present in the fault current and hence that of the sources of the initial fault current. All shunt elements and loads must therefore be deleted from any system model before the X/R ratio is calculated.
 - (d) In producing the data, the **User** may use "time step analysis" or "fixed-point-in-time analysis" with different impedances.
 - (e) If a fixed-point-in-time analysis with different impedances method is used, then in relation to the data submitted under (a) (i) above, the data will be required for "time zero" to give I_1'' . The figure of 120ms is consistent with a decay time constant T'' of 40ms, and if that figure is different, then the figure of 120ms must be changed accordingly.
 - (f) Where a "time step analysis" is carried out, the X/R ratio may be calculated directly from the rate of decay of the d.c. component. The X/R ratio is not that given by the phase angle of the fault current if this is based on a system calculation with shunt loads, but from the Thévenin equivalent of the system impedance at the instant of fault with all non-source shunts removed.

PC.A.3 POWER GENERATING MODULE, GENERATING UNIT, HVDC SYSTEM AND DC CONVERTER DATA

PC.A.3.1 Introduction

Directly Connected

PC.A.3.1.1 Each **Generator, HVDC System Owner and DC Converter Station** owner (and a **User** where the **OTSUA** includes an **OTSDUW DC Converter**) with an existing, or proposed, **Power Station or DC Converter Station or HVDC System** directly connected, or to be directly connected, to the **National Electricity Transmission System** (or in the case of **OTSUA**, the **Interface Point**), shall provide **The Company** with data relating to that **Power Station or DC Converter Station or HVDC System**, both current and forecast, as specified in PC.A.3.2 to PC.A.3.4.

Embedded

- PC.A.3.1.2 (a) Each **Generator, HVDC System Owner and DC Converter Station** owner in respect of its existing, and/or proposed, **Embedded Large Power Stations** and/or **Embedded HVDC Systems** and/or **Embedded DC Converter Stations** and/or its **Embedded Medium Power Stations** subject to a **Bilateral Agreement** and each **Network Operator** in respect of its **Embedded Medium Power Stations** not subject to a **Bilateral Agreement** and/or **Embedded DC Converter Stations** not subject to a **Bilateral Agreement** and/or **Embedded HVDC Systems** not subject to a **Bilateral Agreement** within such **Network Operator's System** in each case connected to the **Subtransmission System**, shall provide **The Company** with data relating to that **Power Station or DC Converter Station or HVC System**, both current and forecast, as specified in PC.A.3.2 to PC.A.3.4.
- (b) No data need be supplied in relation to any **Small Power Station** or any **Medium Power Station** or installations of direct current converters which do not form a **DC Converter Station or HVDC System**, connected at a voltage level below the voltage level of the **Subtransmission System** except:-
- (i) in connection with an application for, or under, a **CUSC Contract**, or
 - (ii) unless specifically requested by **The Company** under PC.A.3.1.4.
- PC.A.3.1.3 (a) Each **Network Operator** shall provide **The Company** with the data specified in PC.A.3.2.2(c)(i) and (ii) and PC.A.3.2.2(i).
- (b) **Network Operators** need not submit planning data in respect of an **Embedded Small Power Station** unless required to do so under PC.A.1.2(b) or unless specifically requested under PC.A.3.1.4 below, in which case they will supply such data.
- PC.A.3.1.4 (a) PC.A.4.2.4(b) and PC.A.4.3.2(a) explain that the forecast **Demand** submitted by each **Network Operator** must be net of the output of all **Small Power Stations** and **Medium Power Stations** and **Customer Generating Plant** and all installations of direct current converters which do not form a **DC Converter Station or HVDC System**, **Embedded** within that **Network Operator's System**. The **Network Operator** must inform **The Company** of:
- (i) the number of such **Embedded Power Stations** and such **Embedded** installations of direct current converters (including the number of **Generating Units** or **Power Park Modules** (including **DC Connected Power Park Modules**) or **DC Converters** or **HVDC Systems**) together with their summated capacity; and
 - (ii) beginning from the 2015 Week 24 data submission, for each **Embedded Small Power Station** of registered capacity (as defined in the **Distribution Code**) of 1MW or more:
 - 1. A reference which is unique to each **Network Operator**;
 - 2. The production type as follows:
 - a) In the case of an **Embedded Small Power Station** first connected on or after 1 January 2015, the production type must be selected from the list below:
 - Biomass;
 - Fossil brown coal/lignite;
 - Fossil coal-derived gas;

- Fossil gas;
- Fossil hard coal;
- Fossil oil;
- Fossil oil shale;
- Fossil peat;
- Geothermal;
- Hydro pumped storage;
- Hydro run-of-river and poundage;
- Hydro water reservoir;
- Marine;
- Nuclear;
- Other renewable;
- Solar;
- Waste;
- Wind offshore;
- Wind onshore; or
- Other;

together with a statement as to whether the generation forms part of a CHP scheme;

(iii) beginning from the 2019 Week 24 data submission, for **Embedded Power Stations** with **Registered Capacity** of less than 1MW, their best estimate of the aggregated capacity of all such **Embedded Power Stations** per production type as defined in the list in PC.A.3.1.4 (a)(ii)(2)(a).

b) In the case of an **Embedded Small Power Station** first connected to the **Users' System** before 1 January 2015, as an alternative to the production type, the technology type(s) used, selected from the list set out at paragraph 2.23 in Version 2 of the Regulatory Instructions and Guidance relating to the distributed generation incentive, innovation funding incentive and registered power zones, reference 83/07, published by Ofgem in April 2007;

c) In the case of an **Embedded Small Power Station** comprising **Electricity Storage Modules** or **Electricity Storage Units** first connected the **User's System** on or after May 20 2020, the storage type must be selected from the list below:

- Chemical
 - Ammonia
 - Hydrogen
 - Synthetic Fuels
 - Drop-in Fuels
 - Methanol
 - Synthetic Natural Gas
- Electrical
 - Supercapacitors
 - Superconducting Magnetic ES (SMES)
- Mechanical
 - Adiabatic Compressed Air
 - Diabatic Compressed Air
 - Liquid Air Energy Storage
- Pumped Hydro
- Flywheels

- Thermal
 - Latent Heat Storage
 - Thermochemical Storage
 - Sensible Heat Storage
- Electrochemical
 - Classic Batteries
 - Lead Acid
 - Lithium Polymer (Li-Polymer)
 - Metal Air
 - Nickle Cadmium (Ni-Cd)
 - Sodium Nickle Chloride (Na-NiCl₂)
 - Lithium Ion (Li-ion)
 - Sodium Ion (Na-ion)
 - Lithium Sulphur (Li-S)
 - Sodium Sulphur(Na-S)
 - Nickle –Metal Hydride (Ni-MH)
 - Flow Batteries
 - Vanadium Red-Oxide
 - Zinc – Iron (Zn –Fe)
 - Zinc – Bromine (Zn –Br)
 - Other

together with a statement as to whether the storage forms part of a CHP scheme. Where this information is not held by the **Network Operator** it should provide its best view of the type of storage technology.

3. The registered capacity (as defined in the **Distribution Code**) in MW;
 4. The lowest voltage level node that is specified on the most up-to-date **Single Line Diagram** to which it connects or where it will export most of its power;
 5. Where it generates electricity from wind or PV, the geographical location using either latitude or longitude or grid reference coordinates of the primary or higher voltage substation to which it connects;
 6. The reactive power and voltage control mode, including the voltage set-point and reactive range, where it operates in voltage control mode, or the target **Power Factor**, where it operates in **Power Factor** mode;
 7. Details of the types of loss of mains **Protection** in place and their relay settings which in the case of **Embedded Small Power Stations** first connected to the **Users' System** before 1 January 2015 shall be provided on a reasonable endeavours basis.
- (b) On receipt of this data, the **Network Operator** or **Generator** (if the data relates to **Power Stations** referred to in PC.A.3.1.2) may be further required, at **The Company's** reasonable discretion, to provide details of **Embedded Small Power Stations** and **Embedded Medium Power Stations** and **Customer Generating Plant** and **Embedded** installations of direct current converters which do not form a **DC Converter Station** or **HVDC System**, both current and forecast, as specified in PC.A.3.2 to PC.A.3.4. Such requirement would arise where **The Company** reasonably considers that the collective effect of a number of such **Embedded Power Stations** and **Customer Generating Plants** and **Embedded** installations of direct current converters may have a significant system effect on the **National Electricity Transmission System**.

Busbar Arrangements

PC.A.3.1.5 Where **Generating Units**, which term includes **CCGT Units** and **Synchronous Generating Units** within a **Synchronous Power Generating Module** and **Power Park Modules** (including **DC Connected Power Park Modules**), and **DC Converters**, and **HVDC Systems** are connected to the **National Electricity Transmission System** via a busbar arrangement which is or is expected to be operated in separate sections, the section of busbar to which each **Generating Unit** (including **Synchronous Generating Units** within a **Synchronous Power Generating Module**), **DC Converter**, **HVDC System** or **Power Park Module** (including **DC Connected Power Park Modules**) is connected is to be identified in the submission.

PC.A.3.2 Output Data

PC.A.3.2.1 (a) **Large Power Stations and Gensets**

Data items PC.A.3.2.2 (a), (b), (c), (d), (e), (f) and (h) are required with respect to each **Large Power Station** and each **Generating Unit** (including **Synchronous Generating Units** within a **Synchronous Power Generating Module**) and **Power Park Module** (including **DC Connected Power Park Modules**) of each **Large Power Station** and for each **Genset** (although (a) is not required for **CCGT Units** and (b), (d) and (e) are not normally required for **CCGT Units** and (a), (b), (c), (d), (e), (f) and (h) are not normally required for **Power Park Units**).

(b) **Embedded Small Power Stations and Embedded Medium Power Stations**

Data item PC.A.3.2.2 (a) is required with respect to each **Embedded Small Power Station** and **Embedded Medium Power Station** and each **Generating Unit** (including **Synchronous Generating Units** within a **Synchronous Power Generating Module**) and **Power Park Module** (including **DC Connected Power Park Modules**) of each **Embedded Small Power Station** and **Embedded Medium Power Station** (although (a) is not required for **CCGT Units** or **Power Park Units**). In addition, data item PC.A.3.2.2(c)(ii) is required with respect to each **Embedded Medium Power Station**.

(c) **CCGT Units/Modules**

- (i) Data item PC.A.3.2.2 (g) is required with respect to each **CCGT Unit**;
- (ii) data item PC.A.3.2.2 (a) is required with respect to each **CCGT Module**; and
- (iii) data items PC.A.3.2.2 (b), (c), (d) and (e) are required with respect to each **CCGT Module** unless **The Company** informs the relevant **User** in advance of the submission that it needs the data items with respect to each **CCGT Unit** for particular studies, in which case it must be supplied on a **CCGT Unit** basis.

Where any definition utilised or referred to in relation to any of the data items does not reflect **CCGT Units**, such definition shall be deemed to relate to **CCGT Units** for the purposes of these data items. Any **Schedule** in the **DRC** which refers to these data items shall be interpreted to incorporate the **CCGT Unit** basis where appropriate;

(d) **Cascade Hydro Schemes**

Data item PC.A.3.2.2(i) is required with respect to each **Cascade Hydro Scheme**.

(e) **Power Park Units/Modules**

Data items PC.A.3.2.2 (k) is required with respect to each **Power Park Module** (including **DC Connected Power Park Modules**).

(f) **DC Converters and HVDC Systems**

Data items PC.A.3.2.2 (a), (b), (c), (d) (e) (f) (h) and (i) are required with respect of each **HVDC System**, each **DC Converter Station** and each **DC Converter** in each **DC Converter Station**. For installations of direct current converters which do not form a **DC Converter Station** only data item PC.A.3.2.2.(a) is required.

Items (a), (b), (d), (e), (f), (g), (h), (i), (j) and (k) are to be supplied by each **Generator, DC Converter Station owner, HVDC System Owner or Network Operator** (as the case may be) in accordance with PC.A.3.1.1, PC.A.3.1.2, PC.A.3.1.3 and PC.A.3.1.4. Items (a), and (f)(iv) are to be supplied (as applicable) by a **User** in the case of **OTSUA** which includes an **OTSDUW DC Converter**. Item (c) is to be supplied by each **Network Operator** in all cases:-

- (a) **Registered Capacity (MW), Maximum Capacity** (in the case of **Power Generating Modules** in addition to **Registered Capacity** on a **Power Station** basis) or **Interface Point Capacity** in the case of **OTSDUW**;
- (b) **Output Usable (MW)** on a monthly basis;
- (c) (i) **System Constrained Capacity (MW)** ie. any constraint placed on the capacity of the **Embedded Generating Unit** (including a **Synchronous Generating Unit** within a **Synchronous Power Generating Module**), **Embedded Power Park Module** (including **DC Connected Power Park Modules**) an **Offshore Transmission System** at an **Interface Point, Embedded HVDC System** or **DC Converter** at an **Embedded DC Converter Station** due to the **Network Operator's System** in which it is **Embedded**. Where **Generating Units** (which term includes **CCGT Units** and **Synchronous Generating Units** within a **Synchronous Power Generating Module**), **Power Park Modules** (including **DC Connected Power Park Modules**), **Offshore Transmission Systems** at an **Interface Point, HVDC Systems** or **DC Converters** are connected to a **Network Operator's User System** via a busbar arrangement which is or is expected to be operated in separate sections, details of busbar running arrangements and connected circuits at the substation to which the **Embedded Generating Unit** (including **Synchronous Generating Units** within an **Embedded Synchronous Power Generating Module**), **Embedded Power Park Module** (including **DC Connected Power Park Modules**), **Offshore Transmission System** at an **Interface Point, or Embedded HVDC System** or **Embedded DC Converter** is connected sufficient for **The Company** to determine where the MW generated by each **Generating Unit** (including **Synchronous Generating Units** within a **Synchronous Power Generating Module**), **Power Park Module** (including **DC Connected Power Park Modules**), **HVDC System** or **DC Converter** at that **Power Station** or **DC Converter Station** or **Offshore Transmission System** at an **Interface Point** would appear onto the **National Electricity Transmission System**;
- (ii) any **Reactive Despatch Network Restrictions**;
- (d) **Minimum Generation (MW)**, and in the case of **Power Generating Modules** only **Minimum Stable Operating Level (MW)** and **Minimum Regulating Level**;
- (e) MW obtainable from **Generating Units** (including **Synchronous Generating Units** within a **Synchronous Power Generating Module**), **Power Park Modules** (including **DC Connected Power Park Modules**), **HVDC Systems** or **DC Converters** at a **DC Converter Station** in excess of **Registered Capacity** or **Maximum Capacity**;
- (f) **Generator Performance Chart**:
 - (i) **GB Code User(s)** in respect of **Generating Units** shall provide a **Generator Performance Chart** and **EU Code Users** in respect of **Power Generating Modules** shall provide a **Power Generating Module Performance Chart** and a **Synchronous Generating Unit Performance Chart**.
 - (ii) at the electrical point of connection to the **Offshore Transmission System** for an **Offshore Synchronous Generating Unit** and **Offshore Synchronous Power Generating Module**.
 - (iii) at the electrical point of connection to the **National Electricity Transmission System** (or **User System** if **Embedded**) for a **Non Synchronous Generating Unit** (excluding a **Power Park Unit**), **Power Park Module** (including **DC Connected Power Park Modules**), **HVDC System** and **DC Converter** at a **DC Converter Station**;
 - (iv) at the **Interface Point** for **OTSDUW Plant and Apparatus**

Where a **Reactive Despatch Network Restriction** applies, its existence and details should be highlighted on the **Generator Performance Chart**, in sufficient detail for **The Company** to determine the nature of the restriction.

- (g) a list of the **CCGT Units** within a **CCGT Module**, identifying each **CCGT Unit**, and the **CCGT Module** of which it forms part, unambiguously. In the case of a **Range CCGT Module**, details of the possible configurations should also be submitted, together:-
 - (i) (in the case of a **Range CCGT Module** connected to the **National Electricity Transmission System**) with details of the single **Grid Entry Point** (there can only be one) at which power is provided from the **Range CCGT Module**;
 - (ii) (in the case of an **Embedded Range CCGT Module**) with details of the single **User System Entry Point** (there can only be one) at which power is provided from the **Range CCGT Module**;

Provided that, nothing in this sub-paragraph (g) shall prevent the busbar at the relevant point being operated in separate sections;

- (h) expected running regime(s) at each **Power Station, HVDC System** or **DC Converter Station** and type of **Power Generating Module** or **Generating Unit** (as applicable), eg. **Steam Unit, Gas Turbine Unit, Combined Cycle Gas Turbine Unit, Power Park Module** (including **DC Connected Power Park Modules**), **Novel Units** (specify by type), etc;
- (i) a list of **Power Stations** and **Generating Units** within a **Cascade Hydro Scheme**, identifying each **Generating Unit** (including **Synchronous Generating Units** within a **Synchronous Power Generating Module**) and **Power Station** and the **Cascade Hydro Scheme** of which each form part unambiguously. In addition:
 - (i) details of the **Grid Entry Point** at which **Active Power** is provided, or if **Embedded** the **Grid Supply Point(s)** within which the **Generating Unit** (including **Synchronous Generating Units** within a **Synchronous Power Generating Module**) is connected;
 - (ii) where the **Active Power** output of a **Generating Unit** is split between more than one **Grid Supply Points** the percentage that would appear under normal and outage conditions at each **Grid Supply Point**.
- (j) The following additional items are only applicable to **DC Converters** at **DC Converter Stations** and **HVDC Systems**.

Registered Import Capacity (MW);

Import Usable (MW) on a monthly basis;

Minimum Import Capacity (MW);

MW that may be absorbed by a **DC Converter** or **HVDC System** in excess of **Registered Import Capacity** and **Maximum HVDC Active Power Transmission Capacity** under importing conditions and the duration for which this is available;

- (k) the number and types of the **Power Park Units** within a **Power Park Module** (including **DC Connected Power Park Modules**), identifying each **Power Park Unit**, the **Power Park Module** of which it forms part and identifying the **BM Unit** of which each **Power Park Module** forms part, unambiguously. In the case of a **Power Station** directly connected to the **National Electricity Transmission System** with multiple **Power Park Modules** (including **DC Connected Power Park Modules**) where **Power Park Units** can be selected to run in different **Power Park Modules** and/or **Power Park Modules** can be selected to run in different **BM Units**, details of the possible configurations should also be submitted. In addition, for **Offshore Power Park Modules** (including **DC Connected Power Park Modules**), the number of **Offshore Power Park Strings** that are aggregated into one **Offshore Power Park Module** should also be submitted.

- (l) the number and types of the **Synchronous Generating Units** within a **Synchronous Power Generating Module**, identifying each **Synchronous Generating Unit**, the **Synchronous Power Generating Module** of which it forms part and identifying the **BM Unit** of which each **Synchronous Power Generating Module** forms part, unambiguously. In the case of a **Power Station** directly connected to the **National Electricity Transmission System** with multiple **Synchronous Power Generating Modules** where **Synchronous Generating Units** can be selected to run in different **Synchronous Power Generating Modules** and/or **Synchronous Power Generating Modules** can be selected to run in different **BM Units**, details of the possible configurations should also be submitted.

PC.A.3.2.3 Notwithstanding any other provision of this PC, the **CCGT Units** within a **CCGT Module**, details of which are required under paragraph (g) of PC.A.3.2.2, can only be amended in accordance with the following provisions:-

- (a) if the **CCGT Module** is a **Normal CCGT Module**, the **CCGT Units** within that **CCGT Module** can only be amended such that the **CCGT Module** comprises different **CCGT Units** if **The Company** gives its prior consent in writing. Notice of the wish to amend the **CCGT Units** within such a **CCGT Module** must be given at least 6 months before it is wished for the amendment to take effect;
- (b) if the **CCGT Module** is a **Range CCGT Module**, the **CCGT Units** within that **CCGT Module** and the **Grid Entry Point** at which the power is provided can only be amended as described in BC1.A1.6.4.

PC.A.3.2.4 Notwithstanding any other provision of this PC, the **Power Park Units** within a **Power Park Module** (including **DC Connected Power Park Modules**), and the **Power Park Modules** (including **DC Connected Power Park Modules**) within a **BM Unit**, details of which are required under paragraph (k) of PC.A.3.2.2, can only be amended in accordance with the following provisions:-

- (a) if the **Power Park Units** within that **Power Park Module** can only be amended such that the **Power Park Module** comprises different **Power Park Units** due to repair/replacement of individual **Power Park Units** if **The Company** gives its prior consent in writing. Notice of the wish to amend a **Power Park Unit** within such a **Power Park Module** (including **DC Connected Power Park Modules**) must be given at least 4 weeks before it is wished for the amendment to take effect;
- (b) if the **Power Park Units** within that **Power Park Module** (including **DC Connected Power Park Modules**) and/or the **Power Park Modules** (including **DC Connected Power Park Modules**) within that **BM Unit** can be selected to run in different **Power Park Modules** and/or **BM Units** as an alternative operational running arrangement the **Power Park Units** within the **Power Park Module**, the **BM Unit** of which each **Power Park Module** forms part, and the **Grid Entry Point** at which the power is provided can only be amended as described in BC1.A.1.8.4.

PC.A.3.2.5 Notwithstanding any other provision of this PC, the **Synchronous Generating Units** within a **Synchronous Power Generating Module**, and the **Synchronous Power Generating Modules** within a **BM Unit**, details of which are required under paragraph (l) of PC.A.3.2.2, can only be amended in accordance with the following provisions:-

- (a) if the **Synchronous Generating Units** within that **Synchronous Power Generating Module** can only be amended such that the **Synchronous Power Generating Module** comprises different **Synchronous Generating Units** due to repair/replacement of individual **Synchronous Generating Units** if **The Company** gives its prior consent in writing. Notice of the wish to amend a **Synchronous Generating Unit** within such a **Synchronous Power Generating Module** must be given at least 4 weeks before it is wished for the amendment to take effect;

- (b) if the **Synchronous Generating Units** within that **Synchronous Power Generating Module** and/or the **Synchronous Power Generating Modules** within that **BM Unit** can be selected to run in different **Synchronous Power Generating Modules** and/or **BM Units** as an alternative operational running arrangement the **Synchronous Generating Units** within the **Synchronous Power Generating Module**, the **BM Unit** of which each **Synchronous Power Generating Module** forms part, and the **Grid Entry Point** at which the power is provided can only be amended as described in BC1.A.1.9.4(c). The requirements of PC.A.3.2.5 need not be satisfied if **Generators** have already submitted data in respect of PC.A.3.2.3, PC.A.3.2.4 and PC.A.3.2.5 for the same **Power Generating Module**.

PC.A.3.3. Rated Parameters Data

PC.A.3.3.1 The following information is required to facilitate an early assessment, by **The Company**, of the need for more detailed studies;

- (a) for all **Generating Units** (excluding **Power Park Units**) and **Power Park Modules** (including **DC Connected Power Park Modules**):

Rated MVA

Rated MW;

- (b) for each **Synchronous Generating Unit** (including **Synchronous Generating Units** within a **Synchronous Power Generating Module**):

Short circuit ratio

Direct axis transient reactance;

Inertia constant (for whole machine), MWsecs/MVA;

- (c) for each **Synchronous Generating Unit** step-up transformer (including the step up transformer of a **Synchronous Generating Unit** within a **Synchronous Power Generating Module**):

Rated MVA

Positive sequence reactance (at max, min and nominal tap);

- (d) for each **DC Converter** at a **DC Converter Station, HVDC System, DC Converter** connecting a **Power Park Module** (including a **DC Connected Power Park Module**) and **Transmission DC Converter** (forming part of an **OTSUA**).

DC Converter or **HVDC Converter** type (e.g. current/voltage sourced)

Rated MW per pole for import and export

Number of poles and pole arrangement

Rated DC voltage/pole (kV)

Return path arrangement

Remote AC connection arrangement (excluding **OTSDUW DC Converters**)

Maximum HVDC Active Power Transmission Capacity

Minimum Active Power Transmission Capacity

- (e) for each type of **Power Park Unit** in a **Power Park Module** not connected to the **Total System** by a **DC Converter** or **HVDC System**:

Rated MVA

Rated MW

Rated terminal voltage

Inertia constant, (MWsec/MVA)

Additionally, for **Power Park Units** that are squirrel-cage or doubly-fed induction

generators driven by wind turbines:

Stator reactance.

Magnetising reactance.

Rotor resistance (at rated running)

Rotor reactance (at rated running)

The generator rotor speed range (minimum and maximum speeds in RPM) (for doubly-fed induction generators only)

Converter MVA rating (for doubly-fed induction generators only)

For a **Power Park Unit** consisting of a synchronous machine in combination with a back-to-back **DC Converter** or **HVDC Converter**, or for a **Power Park Unit** not driven by a wind turbine, the data to be supplied shall be agreed with **The Company** in accordance with PC.A.7.

This information should only be given in the data supplied in accordance with PC.4.4 and PC.4.5.

PC.A.3.4 General Generating Unit, Power Park Module (including **DC Connected Power Park Modules**), Power Generating Module, HVDC System and DC Converter Data

PC.A.3.4.1 The point of connection to the **National Electricity Transmission System** or the **Total System**, if other than to the **National Electricity Transmission System**, in terms of geographical and electrical location and system voltage is also required.

PC.A.3.4.2 (a) Type of **Generating Unit** (ie **Synchronous Power Generating Unit** within a **Power Generating Module, Synchronous Generating Unit, Non-Synchronous Generating Unit, DC Converter, Power Park Module (including DC Connected Power Park Modules)** or **HVDC System**).

(b) In the case of a **Synchronous Generating Unit** (including **Synchronous Generating Units** within a **Synchronous Power Generating Module**) details of the **Exciter** category, for example whether it is a rotating **Exciter** or a static **Exciter** or in the case of a **Non-Synchronous Generating Unit** the voltage control system.

(c) Whether a **Power System Stabiliser** is fitted.

PC.A.3.4.3 Each **Generator** shall supply **The Company** with the production type(s) used as the primary source of power in respect of each **Generating Unit** (including **Synchronous Generating Units** within a **Synchronous Power Generating Module**), selected from the list set out below:

- Biomass
- Fossil brown coal/lignite
- Fossil coal-derived gas
- Fossil gas
- Fossil hard coal
- Fossil oil
- Fossil oil shale
- Fossil peat
- Geothermal
- Hydro pumped storage
- Hydro run-of-river and poundage
- Hydro water reservoir
- Marine
- Nuclear

- Other renewable
- Solar
- Waste
- Wind offshore
- Wind onshore
- Other

PC.A.3.4.4 In the case of an **Electricity Storage Module** or **Electricity Storage Unit**, each **Generator** shall supply **The Company** with the production type(s) used as the primary **Electricity Storage** source (including **Synchronous Electricity Storage Units** within a **Synchronous Electricity Storage Module**), selected from the list set out below:

- Chemical
 - Ammonia
 - Hydrogen
 - Synthetic Fuels
 - Drop-in Fuels
 - Methanol
 - Synthetic Natural Gas
- Electrical
 - Supercapacitors
 - Superconducting Magnetic ES (SMES)
- Mechanical
 - Adiabatic Compressed Air
 - Diabatic Compressed Air
 - Liquid Air Energy Storage
 - Pumped Hydro
 - Flywheels
- Thermal
 - Latent Heat Storage
 - Thermochemical Storage
 - Sensible Heat Storage
- Electrochemical
 - Classic Batteries
 - Lead Acid
 - Lithium Polymer (Li-Polymer)
 - Metal Air
 - Nickle Cadmium (Ni-Cd)
 - Sodium Nickle Chloride (Na-NiCl₂)
 - Lithium Ion (Li-ion)
 - Sodium Ion (Na-ion)
 - Lithium Sulphur (Li-S)
 - Sodium Sulphur(Na-S)
 - Nickle –Metal Hydride (Ni-MH)
 - Flow Batteries
 - Vanadium Red-Oxide
 - Zinc – Iron (Zn –Fe)
 - Zinc – Bromine (Zn –Br)
 - Other

PC.A.4 DEMAND AND ACTIVE ENERGY DATA

PC.A.4.1 Introduction

PC.A.4.1.1 Each **User** directly connected to the **National Electricity Transmission System** with **Demand** shall provide **The Company** with the **Demand** data, historic, current and forecast, as specified in PC.A.4.2 and PC.A.4.3. Paragraphs PC.A.4.1.2 and PC.A.4.1.3 apply equally to **Active Energy** requirements as to **Demand** unless the context otherwise requires.

- PC.A.4.1.2 Data will need to be supplied by:
- (a) each **Network Operator**, in relation to **Demand** and **Active Energy** requirements on its **User System**;
 - (b) each **Non-Embedded Customer, Pumped Storage Generators** (with respect to Pumping **Demand**) and **Generators** in relation to **Electricity Storage Modules** in relation to their **Demand** and **Active Energy** requirements.
 - (c) each **DC Converter Station** owner or **HVDC System Owner** in relation to **Demand** and **Active Energy** transferred (imported) to its **DC Converter Station** or **HVDC System**.
 - (d) each **OTSDUW DC Converter** in relation to the Demand at each **Interface Point** and **Connection Point**.

Demand of **Power Stations** directly connected to the **National Electricity Transmission System** is to be supplied by the **Generator** under PC.A.5.2.

PC.A.4.1.3 References in this **PC** to data being supplied on a half hourly basis refer to it being supplied for each period of 30 minutes ending on the hour or half-hour in each hour.

PC.A.4.1.4 **Access Periods** and **Access Groups**

PC.A.4.1.4.1 Each **Connection Point** must belong to one, and only one, **Access Group**.

PC.A.4.1.4.2 Each **Transmission Interface Circuit** must have an **Access Period**.

PC.A.4.1.4.3 The **Access Period** shall

- (a) normally be a minimum of 8 continuous weeks and can occur in any one of three maintenance years during the period from calendar week 13 to calendar week 43 (inclusive) in each year; or,
- (b) exceptionally and provided that agreement is reached between **The Company** and the relevant **User(s)**, such agreement to be sought in accordance with PC.7, the **Access Period** may be of a period not less than 4 continuous weeks and can occur in any one of three maintenance years during the period from calendar week 10 to calendar week 43 (inclusive) in each year.

PC.A.4.1.4.4 **The Company** shall submit in writing no later than calendar week 6 in each year:

- (a) the calendar weeks defining the proposed start and finish of each **Access Period** for each **Transmission Interface Circuit**; and
- (b) the **Connection Points** in each **Access Group**.

The submission by **The Company** under PC.A.4.1.4.4 (a) above shall commence in 2010 and shall then continue each year thereafter. The submission by **The Company** under PC.A.4.1.4.4 (b) shall commence in 2009 and then continue each year thereafter.

PC.A.4.1.4.5 It is permitted for **Access Periods** to overlap in the same **Access Group** and in the same maintenance year. However, where possible **Access Periods** will be sought by **The Company** that do not overlap with any other **Access Period** within that **Access Group** for each maintenance year. Where it is not possible to avoid overlapping **Access Periods**, **The Company** will indicate to **Users** by calendar week 6 its initial view of which **Transmission Interface Circuits** will need to be considered out of service concurrently for the purpose of assessing compliance to **Licence Standards**. The obligation on **The Company** to indicate which **Transmission Interface Circuits** will need to be considered out of service concurrently for the purpose of assessing compliance to **Licence Standards** shall commence in 2010 and shall continue each year thereafter.

PC.A.4.1.4.6 Following the submission(s) by **The Company** by week 6 in each year and where required by either party, both **The Company** and the relevant **User(s)** shall use their reasonable endeavours to agree the appropriate **Access Group(s)** and **Access Period** for each **Transmission Interface Circuit** prior to week 17 in each year. The requirement on **The Company** and the relevant **User(s)** to agree, shall commence in respect of **Access Groups** only in 2010. This paragraph PC.A.4.1.4.6 shall apply in its entirety in 2011 and shall then continue each year thereafter.

PC.A.4.1.4.7 In exceptional circumstances, and with the agreement of all parties concerned, where a **Connection Point** is specified for the purpose of the **Planning Code** as electrically independent **Subtransmission Systems**, then data submissions can be on the basis of two (or more) individual **Connection Points**.

PC.A.4.2 User's User System Demand (Active Power) and Active Energy Data

PC.A.4.2.1 Forecast daily **Demand (Active Power)** profiles, as specified in (a), (b) and (c) below, in respect of each of the **User's User Systems** (each summated over all **Grid Supply Points** in each **User System**) are required for:

- (a) peak day on each of the **User's User Systems** (as determined by the **User**) giving the numerical value of the maximum **Demand (Active Power)** that in the **Users'** opinion could reasonably be imposed on the **National Electricity Transmission System**;
- (b) day of peak **National Electricity Transmission System Demand (Active Power)** as notified by **The Company** pursuant to PC.A.4.2.2;
- (c) day of minimum **National Electricity Transmission System Demand (Active Power)** as notified by **The Company** pursuant to PC.A.4.2.2.

In addition, the total **Demand (Active Power)** in respect of the time of peak **National Electricity Transmission System Demand** in the preceding **Financial Year** in respect of each of the **User's User Systems** (each summated over all **Grid Supply Points** in each **User System**) both outturn and weather corrected shall be supplied.

PC.A.4.2.2 No later than calendar week 17 each year, **The Company** shall notify each **Network Operator** and **Non-Embedded Customer** in writing of the following, for the current **Financial Year** and for each of the following seven **Financial Years**, which will, until replaced by the following year's notification, be regarded as the relevant specified days and times under PC.A.4.2.1:

- (a) the date and time of the annual peak of the **National Electricity Transmission System Demand**;
- (b) the date and time of the annual minimum of the **National Electricity Transmission System Demand**;
- (c) the relevant **Access Period** for each **Transmission Interface Circuit**; and,
- (d) concurrent **Access Periods** of two or more **Transmission Interface Circuits** (if any) that are situated in the same **Access Group**.

The submissions by **The Company** made under PC.A.4.2.1 (c) and PC.A.4.2.1 (d) above shall commence in 2010 and shall then continue in respect of each year thereafter.

PC.A.4.2.3 The total **Active Energy** used on each of the **Network Operators'** or **Non-Embedded Customers' User Systems** (each summated over all **Grid Supply Points** in each **User System**) in the preceding **Financial Year**, both outturn and weather corrected, together with a prediction for the current financial year, is required. Each **Active Energy** submission shall be subdivided into the following categories of **Customer** tariff:

- LV1
- LV2
- LV3
- HV
- EHV
- Traction
- Lighting

In addition, the total **User System** losses and the **Active Energy** provided by **Embedded Small Power Stations** and **Embedded Medium Power Stations** shall be supplied.

PC.A.4.2.4 All forecast **Demand (Active Power)** and **Active Energy** specified in PC.A.4.2.1 and PC.A.4.2.3 shall:

- (a) in the case of PC.A.4.2.1(a), (b) and (c), be such that the profiles comprise average **Active Power** levels in 'MW' for each time marked half hour throughout the day;
- (b) in the case of PC.A.4.2.1(a), (b) and (c), be that remaining after any deductions reasonably considered appropriate by the **User** to take account of the output profile of all **Embedded Small Power Stations** and **Embedded Medium Power Stations** and **Customer Generating Plant** and imports across **Embedded External Interconnections** including imports across **Embedded** installations of direct current converters which do not form a **DC Converter Station** or **HVDC System** and **Embedded DC Converter Stations** and **Embedded HVDC Systems** with a **Registered Capacity** or **HVDC Active Power Transmission Capacity** of less than 100MW;
- (c) be based upon **Annual ACS Conditions** for times that occur during week 44 through to week 12 (inclusive) and based on **Average Conditions** for weeks 13 to 43 (inclusive).

PC.A.4.3 Connection Point Demand (Active and Reactive Power)

PC.A.4.3.1 Forecast **Demand (Active Power)** and **Power Factor** (values of the **Power Factor** at maximum and minimum continuous excitation may be given instead where more than 95% of the total **Demand** at a **Connection Point** is taken by synchronous motors) to be met at each **Connection Point** within each **Access Group** is required for:

- (a) the time of the maximum **Demand (Active Power)** at the **Connection Point** (as determined by the **User**) that in the **User's** opinion could reasonably be imposed on the **National Electricity Transmission System**;
- (b) the time of peak **National Electricity Transmission System Demand** as provided by **The Company** under PC.A.4.2.2;
- (c) the time of minimum **National Electricity Transmission System Demand** as provided by **The Company** under PC.A.4.2.2;
- (d) the time of the maximum **Demand (Apparent Power)** at the **Connection Point** (as determined by the **User**) during the **Access Period** of each **Transmission Interface Circuit**;
- (e) at a time specified by either **The Company** or a **User** insofar as such a request is reasonable.

Instead of such forecast **Demand** to be met at each **Connection Point** within each **Access Group** the **User** may (subject to PC.A.4.3.4) submit such **Demand** at each node on the **Single Line Diagram**.

In addition, the **Demand** in respect of each of the time periods referred to in PC.A.4.3.1 (a) to (e) in the preceding **Financial Year** in respect of each **Connection Point** within each **Access Group** both outturn and weather corrected shall be supplied. The "weather correction" shall normalise outturn figures to **Annual ACS Conditions** for times that occur during calendar week 44 through to calendar week 12 (inclusive) or **Average Conditions** for the period calendar weeks 13 to calendar week 43 (inclusive) and shall be performed by the relevant **User** on a best endeavours basis.

The submission by a **User** pursuant to PC.A.4.3.1 (d) shall commence in 2011 and shall then continue each year thereafter.

PC.A.4.3.2 All forecast **Demand** specified in PC.A.4.3.1 shall:

- (a) be that remaining after any deductions reasonably considered appropriate by the **User** to take account of the output of all **Embedded Small Power Stations** and **Embedded Medium Power Stations** and **Customer Generating Plant** and imports across **Embedded External Interconnections**, including **Embedded** installations of direct current converters which do not form a **DC Converter Station**, **HVDC System** and **Embedded DC Converter Stations** and **Embedded HVDC Systems** and such deductions should be separately stated;
- (b) include any **User's System** series reactive losses but exclude any reactive compensation equipment specified in PC.A.2.4 and exclude any network susceptance specified in PC.A.2.3;

- (c) be based upon **Annual ACS Conditions** for times that occur during calendar week 44 through to calendar week 12 (inclusive) and based on **Average Conditions** for calendar weeks 13 to calendar week 43 (inclusive), both corrections being made on a best endeavours basis;
- (d) reflect the **User's** opinion of what could reasonably be imposed on the **National Electricity Transmission System**.

PC.A.4.3.3 The date and time of the forecast maximum **Demand (Apparent Power)** at the **Connection Point** as specified in PC.A.4.3.1 (a) and (d) is required.

PC.A.4.3.4 Each **Single Line Diagram** provided under PC.A.2.2.2 shall include the **Demand (Active Power)** and **Power Factor** (values of the **Power Factor** at maximum and minimum continuous excitation may be given instead where more than 95% of the **Demand** is taken by synchronous motors) at the time of the peak **National Electricity Transmission System Demand** (as provided under PC.A.4.2.2) at each node on the **Single Line Diagram**. These **Demands** shall be consistent with those provided under PC.A.4.3.1(b) above for the relevant year.

PC.A.4.3.5 The **Single Line Diagram** must represent the **User's User System** layout under the period specified in PC.A.4.3.1(b) (at the time of peak **National Electricity Transmission System Demand**). Should the **User's User System** layout during the other times specified in PC.A.4.3.1 be planned to be materially different from the **Single Line Diagram** submitted to **The Company** pursuant to PC.A.2.2.1 the **User** shall in respect of such other times submit:

- (i) an alternative **Single Line Diagram** that accurately reflects the revised layout and in such case shall also include appropriate associated data representing the relevant changes, or;
- (ii) submit an accurate and unambiguous description of the changes to the **Single Line Diagram** previously submitted for the time of peak **National Electricity Transmission System Demand**.

Where a **User** does not submit any changes, **The Company** will assume that the **Single Line Diagram** (and associated circuit and node data) provided at the time of peak **National Electricity Transmission System Demand** will be valid for all other times. In respect of such other times, where the **User** does not submit such nodal demands at the times defined in PC.A.4.3.1(a), (c), (d) and (e), the nodal demands will be pro-rata, to be consistent with the submitted **Connection Point Demands**.

PC.A.4.4 **The Company** will assemble and derive in a reasonable manner, the forecast information supplied to it under PC.A.4.2.1, PC.A.4.3.1, PC.A.4.3.4 and PC.A.4.3.5 above into a cohesive forecast and will use this in preparing **Forecast Demand** information in the **Seven Year Statement** and for use in **The Company's Operational Planning**. If any **User** believes that the cohesive forecast **Demand** information in the **Seven Year Statement** does not reflect its assumptions on **Demand**, it should contact **The Company** to explain its concerns and may require **The Company**, on reasonable request, to discuss these forecasts. In the absence of such expressions, **The Company** will assume that **Users** concur with **The Company's** cohesive forecast.

PC.A.4.5 Post Fault User System Layout

PC.A.4.5.1 Where for the purposes of **The Company** assessing against the Licence Standards an **Access Group**, the **User** reasonably considers it appropriate that revised post fault **User System** layouts should be taken into account by **The Company**, the following information is required to be submitted by the **User**:

- (i) the specified **Connection Point** assessment period (PC.A.4.3.1,(a)-(e)) that is being evaluated;
- (ii) an accurate and unambiguous description of the **Transmission Interface Circuits** considered to be switched out due to a fault;
- (iii) appropriate revised **Single Line Diagrams** and/or associated revised nodal **Demand** and circuit data detailing the revised **User System(s)** conditions;

- (iv) where the **User's** planned post fault action consists of more than one component, each component must be explicitly identified using the **Single Line Diagram** and associated nodal **Demand** and circuit data;
- (v) the arrangements for undertaking actions (eg the time taken, automatic or manual and any other appropriate information);.

The **User** must not submit any action that it does not have the capability or the intention to implement during the assessment period specified (subject to there being no further unplanned outages on the **User's User System**).

PC.A.4.6 Control of Demand or Reduction of Pumping Load Offered as Reserve

Magnitude of Demand or pumping load or Electricity Storage Module charging load which is tripped	MW
System Frequency at which tripping is initiated	Hz
Time duration of System Frequency below trip setting for tripping to be initiated	S
Time delay from trip initiation to tripping	S

PC.A.4.7 General Demand Data

PC.A.4.7.1 The following information is infrequently required and should be supplied (wherever possible) when requested by **The Company**:

- (a) details of any individual loads (including (as applicable) the load behaviour of an **Electricity Storage Module** when operating in a mode analogous to demand) which have characteristics significantly different from the typical range of Domestic, Commercial, **Electricity Storage** or Industrial loads supplied;
- (b) the sensitivity of the **Demand (Active and Reactive Power)** to variations in voltage and **Frequency** on the **National Electricity Transmission System** at the time of the peak **Demand (Active Power)**. The sensitivity factors quoted for the **Demand (Reactive Power)** should relate to that given under PC.A.4.3.1 and, therefore, include any **User's System** series reactive losses but exclude any reactive compensation equipment specified in PC.A.2.4 and exclude any network susceptance specified in PC.A.2.3;
- (c) details of any traction loads, e.g. connection phase pairs and continuous load variation with time;
- (d) the average and maximum phase unbalance, in magnitude and phase angle, which the **User** would expect its **Demand** to impose on the **National Electricity Transmission System**;
- (e) the maximum harmonic content which the **User** would expect its **Demand** to impose on the **National Electricity Transmission System**;
- (f) details of all loads which may cause **Demand** fluctuations greater than those permitted under **Engineering Recommendation P28 Issue 2, Stage 1** at a **Point of Common Coupling** including the **Flicker Severity Short Term** and the **Flicker Severity Long Term**.
- (g) In the case of **Electricity Storage Modules**, details of the **Maximum Capacity, Maximum Import Power, Registered Import Capability**, charge time, discharge time and operating periods.

PART 2 - DETAILED PLANNING DATA

PC.A.5 POWER GENERATING MODULE, GENERATING UNIT, POWER PARK MODULE (INCLUDING DC CONNECTED POWER PARK MODULES), DC CONVERTER, HVDC EQUIPMENT AND OTSDUW PLANT AND APPARATUS DATA

PC.A.5.1 Introduction

Directly Connected

PC.A.5.1.1 Each **Generator** (including those undertaking **OTSDUW**), with existing or proposed **Power Stations** directly connected, or to be directly connected, to the **National Electricity Transmission System**, shall provide **The Company** with data relating to that **Plant** and **Apparatus**, both current and forecast, as specified in PC.A.5.2, PC.A.5.3, PC.A.5.4 and PC.A.5.7 as applicable.

Each **DC Converter Station** owner or **HVDC System Owner**, with existing or proposed **DC Converter Stations** or **HVDC Systems** (including **Generators** undertaking **OTSDUW** which includes an **OTSDUW DC Converter**) directly connected, or to be directly connected, to the **National Electricity Transmission System**, shall provide **The Company** with data relating to that **Plant** and **Apparatus**, both current and forecast, as specified in PC.A.5.2 and PC.A.5.4.

GB Generators, DC Converter Station owners, **EU Generators** and **HVDC System Owners** shall ensure that the models supplied in respect of their **Plant** and **Apparatus** provide a true and accurate behaviour of the plant as built as required under PC.A.5.3.2(c), PC.A.5.4.2(a) and PC.A.5.4.3 and verified through the **Compliance Processes (CP)** or **European Compliance Processes (ECP)** as applicable.

Embedded

PC.A.5.1.2 Each **Generator**, in respect of its existing, or proposed, **Embedded Large Power Stations** and its **Embedded Medium Power Stations** subject to a **Bilateral Agreement** and each **Network Operator** in respect of **Embedded Medium Power Stations** not subject to a **Bilateral Agreement** within its **System** shall provide **The Company** with data relating to each of those **Large Power Stations** and **Medium Power Stations**, both current and forecast, as specified in PC.A.5.2, PC.A.5.3, PC.A.5.4 and PC.A.5.7 as applicable.

Each **DC Converter Station** owner or **HVDC System Owner**, or **Network Operator** in the case of an **Embedded DC Converter Station** or **Embedded HVDC System** not subject to a **Bilateral Agreement** within its **System** with existing or proposed **HVDC Systems** or **DC Converter Stations** shall provide **The Company** with data relating to each of those **HVDC Systems** or **DC Converter Stations**, both current and forecast, as specified in PC.A.5.2 and PC.A.5.4.

However, no data need be supplied in relation to those **Embedded Medium Power Stations** or **Embedded DC Converter Stations** or **Embedded HVDC Systems** if they are connected at a voltage level below the voltage level of the **Subtransmission System** except in connection with an application for, or under a, **CUSC Contract** or unless specifically requested by **The Company** under PC.A.5.1.4.

GB Generators, DC Converter Station owners, **EU Generators** and **HVDC System Owners** shall ensure that the models supplied in respect of their **Plant** and **Apparatus** provide a true and accurate behaviour of the plant as built as required under PC.A.5.3.2(c), PC.A.5.4.2(a) and PC.A.5.4.3 and verified through the **Compliance Processes (CP)** or **European Compliance Processes (ECP)** as applicable

PC.A.5.1.3 Each **Network Operator** need not submit **Planning Data** in respect of **Embedded Small Power Stations** unless required to do so under PC.A.1.2(b), PC.A.3.1.4 or unless specifically requested under PC.A.5.1.4 below, in which case they will supply such data.

PC.A.5.1.4 PC.A.4.2.4(b) and PC.A.4.3.2(a) explained that the forecast **Demand** submitted by each **Network Operator** must be net of the output of all **Medium Power Stations** and **Small Power Stations** and **Customer Generating Plant Embedded** within that **User's System**. In such cases, the **Network Operator** must provide **The Company** with the relevant information specified under PC.A.3.1.4 . On receipt of this data further details may be required at **The Company's** discretion as follows:

- (i) in the case of details required from the **Network Operator** for **Embedded Medium Power Stations** not subject to a **Bilateral Agreement** and **Embedded DC Converter Stations** not subject to a **Bilateral Agreement** and **Embedded HVDC Systems** not subject to a **Bilateral Agreement** and **Embedded Small Power Stations** and **Embedded DC Converters** and **Embedded HVDC Systems** in each case within such **Network Operator's System** and **Customer Generating Plant**; and
- (ii) in the case of details required from the **Generator** of **Embedded Large Power Stations** and **Embedded Medium Power Stations** subject to a **Bilateral Agreement**; and
- (iii) in the case of details required from the **DC Converter Station** owner of an **Embedded DC Converter** or **DC Converter Station** or **HVDC System Owner** of an **Embedded HVDC System Owner** subject to a **Bilateral Agreement**.

both current and forecast, as specified in PC.A.5.2 and PC.A.5.3. Such requirement would arise when **The Company** reasonably considers that the collective effect of a number of such **Embedded Small Power Stations**, **Embedded Medium Power Stations**, **Embedded DC Converter Stations**, **Embedded HVDC Systems**, **DC Converters** and **Customer Generating Plants** may have a significant system effect on the **National Electricity Transmission System**.

PC.A.5.1.5 DPD I and DPD II

The **Detailed Planning Data** described in this Part 2 of the Appendix comprises both **DPD I** and **DPD II**. The required data is listed and collated in the **Data Registration Code**. The **Users** need to refer to the **DRC** to establish whether data referred to here is **DPD I** or **DPD II**.

PC.A.5.2 Demand

PC.A.5.2.1 For each **Generating Unit** (including **Synchronous Generating Units** within a **Synchronous Power Generating Module**) which has an associated **Unit Transformer**, the value of the **Demand** supplied through this **Unit Transformer** when the **Generating Unit** is at **Rated MW** output is to be provided.

PC.A.5.2.2 Where the **Power Station** or **DC Converter Station** or **HVDC System** has associated **Demand** additional to the unit-supplied **Demand** of PC.A.5.2.1 which is supplied from either the **National Electricity Transmission System** or the **Generator's User System** the **Generator**, **DC Converter Station** owner, **HVDC System Owner** or the **Network Operator** (in the case of **Embedded Medium Power Stations** not subject to a **Bilateral Agreement** within its **System**), as the case may be, shall supply forecasts for each **Power Station** or **DC Converter Station** or **HVDC System** of:

- (a) the maximum **Demand** that, in the **User's** opinion, could reasonably be imposed on the **National Electricity Transmission System** or the **Generator's User System** as appropriate;
- (b) the **Demand** at the time of the peak **National Electricity Transmission System Demand**
- (c) the **Demand** at the time of minimum **National Electricity Transmission System Demand**.

PC.A.5.2.3 No later than calendar week 17 each year **The Company** shall notify each **Generator** in respect of its **Large Power Stations** and its **Medium Power Stations** and each **DC Converter** owner in respect of its **DC Converter Station** and each **HVDC System Owner** in respect of its **HVDC System** subject to a **Bilateral Agreement** and each **Network Operator** in respect of each **Embedded Medium Power Station** not subject to a **Bilateral Agreement** and each **Embedded DC Converter Station** or **Embedded HVDC System** not subject to a **Bilateral Agreement** within such **Network Operator's System** in writing of the following, for the current **Financial Year** and for each of the following seven **Financial Years**, which will be regarded as the relevant specified days and times under PC.A.5.2.2:

- (a) the date and time of the annual peak of the **National Electricity Transmission System Demand at Annual ACS Conditions**;
- (b) the date and time of the annual minimum of the **National Electricity Transmission System Demand at Average Conditions**.

PC.A.5.2.4 At its discretion, **The Company** may also request further details of the **Demand** as specified in PC.A.4.6

PC.A.5.2.5 In the case of **OTSDUW Plant and Apparatus** the following data shall be supplied:

- (a) The maximum **Demand** that could occur at the **Interface Point** and each **Connection Point** (in MW and MVA);
- (b) **Demand** at specified time of annual peak half hour of **National Electricity Transmission System Demand at Annual ACS Conditions** (in MW and MVA); and
- (c) **Demand** at specified time of annual minimum half-hour of **National Electricity Transmission System Demand** (in MW and MVA).

For the avoidance of doubt, **Demand** data associated with **Generators** undertaking **OTSDUW** which utilise an **OTSDUW DC Converter** should supply data under PC.A.4.

PC.A.5.3 Synchronous Power Generating Modules, Synchronous Generating Unit and Associated Control System Data

PC.A.5.3.1 The data submitted below are not intended to constrain any **Ancillary Services Agreement**

PC.A.5.3.2 The following **Synchronous Generating Unit** (including **Synchronous Generating Units** within a **Synchronous Power Generating Module**) and **Power Station** data should be supplied:

- (a) **Synchronous Generating Unit** Parameters

Rated terminal volts (kV)

Maximum terminal voltage set point (kV)

Terminal voltage set point step resolution – if not continuous (kV)

* Rated MVA

* **Rated MW**

* Minimum Generation MW

* Short circuit ratio

Direct axis synchronous reactance

* Direct axis transient reactance

Direct axis sub-transient reactance

Direct axis short-circuit transient time constant

Direct axis short-circuit sub-transient time constant

Quadrature axis synchronous reactance

Quadrature axis sub-transient reactance

Quadrature axis short-circuit sub-transient time constant.

Stator time constant

Stator leakage reactance

Armature winding direct-current resistance.

Note: The above data item relating to armature winding direct-current resistance need only be supplied with respect to **Generating Units** commissioned after 1st March 1996 and in cases where, for whatever reason, the **Generator** or the **Network Operator**, as the case may be is aware of the value of the relevant parameter.

- * Turbogenerator inertia constant (MWsec/MVA)

Rated field current (amps) at **Rated MW** and MVA_r output and at rated terminal voltage.

Field current (amps) open circuit saturation curve for **Generating Unit** terminal voltages ranging from 50% to 120% of rated value in 10% steps as derived from appropriate manufacturers test certificates.

- (b) Parameters for **Generating Unit** Step-up Transformers

- * Rated MVA

Voltage ratio

- * Positive sequence reactance (at max, min, & nominal tap)

Positive sequence resistance (at max, min, & nominal tap)

Zero phase sequence reactance

Tap changer range

Tap changer step size

Tap changer type: on load or off circuit

- (c) Excitation Control System parameters

Note: The data items requested under Option 1 below may continue to be provided in relation to **Generating Units** connected to the **System** at 09 January 1995 (in this paragraph, the "relevant date") or the new data items set out under Option 2 may be provided. **Generators** or **Network Operators**, as the case may be, must supply the data as set out under Option 2 (and not those under Option 1) for **Generating Unit** excitation control systems commissioned after the relevant date, those **Generating Unit** excitation control systems recommissioned for any reason such as refurbishment after the relevant date and **Generating Unit** excitation control systems where, as a result of testing or other process, the **Generator** or **Network Operator**, as the case may be, is aware of the data items listed under Option 2 in relation to that **Generating Unit**.

Option 1

DC gain of Excitation Loop

Rated field voltage

Maximum field voltage

Minimum field voltage

Maximum rate of change of field voltage (rising)

Maximum rate of change of field voltage (falling)

Details of Excitation Loop described in block diagram form showing transfer functions of individual elements.

Dynamic characteristics of **Over-excitation Limiter**

Option 2

Excitation System Nominal Response

Rated Field Voltage

No-Load Field Voltage

Excitation System On-Load Positive Ceiling Voltage

Excitation System No-Load Positive Ceiling Voltage

Excitation System No-Load Negative Ceiling Voltage

Stator Current Limiter (applicable only to **Synchronous Power Generating Modules**)

Details of **Excitation System** (including **PSS** if fitted) described in block diagram form showing transfer functions of individual elements.

Details of **Over-excitation Limiter** described in block diagram form showing transfer functions of individual elements.

Details of **Under-excitation Limiter** described in block diagram form showing transfer functions of individual elements.

The block diagrams submitted after 1 January 2009 in respect of the **Excitation System** (including the **Over-excitation Limiter** and the **Under-excitation Limiter**) for **Generating Units** with a **Completion date** after 1 January 2009 or subject to a **Modification** to the **Excitation System** after 1 January 2009, should have been verified as far as reasonably practicable by simulation studies as representing the expected behaviour of the system.

(d) Governor Parameters

Incremental **Droop** values (in %) are required for each **Generating Unit** at six MW loading points (MLP1 to MLP6) as detailed in PC.A.5.5.1 (this data item needs only be provided for **Large Power Stations**).

Note: The data items requested under Option 1 below may continue to be provided by **Generators** in relation to **Generating Units** on the **System** at 09 January 1995 (in this paragraph, the "relevant date") or they may provide the new data items set out under Option 2. **Generators** must supply the data as set out under Option 2 (and not those under Option 1) for **Generating Unit** governor control systems commissioned after the relevant date, those **Generating Unit** governor control systems recommissioned for any reason such as refurbishment after the relevant date and **Generating Unit** governor control systems where, as a result of testing or other process, the **Generator** is aware of the data items listed under Option 2 in relation to that **Generating Unit**. **EU Generators** are also required to submit the data as set out in option 2. Additional data required from **EU Generators** which own or operate **Type C** or **Type D Power Generating Modules** are marked in brackets with an asterisk (eg (*)). For the avoidance of doubt, items marked as (*) need not be supplied by **GB Generators**.

Option 1

(i) Governor Parameters (for Reheat **Steam Units**)

HP governor average gain MW/Hz

Speeder motor setting range

HP governor valve time constant

HP governor valve opening limits

HP governor valve rate limits

Reheater time constant (**Active Energy** stored in reheater)

IP governor average gain MW/Hz
IP governor setting range
IP governor valve time constant
IP governor valve opening limits
IP governor valve rate limits

Details of acceleration sensitive elements in HP & IP governor loop.

A governor block diagram showing transfer functions of individual elements.

(ii) Governor Parameters (for Non-Reheat **Steam Units** and **Gas Turbine Units**)

Governor average gain
Speeder motor setting range
Time constant of steam or fuel governor valve
Governor valve opening limits
Governor valve rate limits
Time constant of turbine
Governor block diagram

The following data items need only be supplied for **Large Power Stations**:

(iii) Boiler & Steam Turbine Data

Boiler Time Constant (Stored **Active Energy**) s
HP turbine response ratio:
proportion of **Primary Response** arising from HP turbine %
HP turbine response ratio:
proportion of High Frequency Response arising from HP turbine %

[End of Option 1]

Option 2

(i) Governor and associated prime mover Parameters - All **Generating Units** (including **Synchronous Generating Units** within a **Synchronous Power Generating Module**)

Governor Block Diagram showing transfer function of individual elements including acceleration sensitive elements.

Governor Time Constant (in seconds)

Speeder Motor Setting Range (%)

Average Gain (MW/Hz)

Governor Deadband need only be provided for **Large Power Stations** owned and operated by **GB Generators** (and both **Frequency Response Deadband** and **Frequency Response Insensitivity** should be supplied in respect of **Type C** and **D Power Generating Modules** within **Large Power Stations** and **Medium Power Stations** excluding **Embedded Medium Power Stations** not subject to a **Bilateral Agreement***) owned and operated by **EU Code Generators**.

- Maximum Setting \pm Hz
- Normal Setting \pm Hz
- Minimum Setting \pm Hz

Where the **Generating Unit** governor does not have a selectable **Governor Deadband** (or **Frequency Response Deadband** and **Frequency Response Insensitivity**)* facility as specified above, then the actual value of the **Governor Deadband** or (**Frequency Response Deadband** and **Frequency Response Insensitivity**)* need only be provided.

The block diagrams submitted after 1 January 2009 in respect of the governor system for **Generating Units** with a **Completion date** after 1 January 2009 or subject to a **Modification** to the governor system after 1 January 2009, should have been verified as far as reasonably practicable by simulation studies as representing the expected behaviour of the system.

(ii) Governor and associated prime mover Parameters - **Steam Units**

- HP Valve Time Constant (in seconds)
- HP Valve Opening Limits (%)
- HP Valve Opening Rate Limits (%/second)
- HP Valve Closing Rate Limits (%/second)
- HP Turbine Time Constant (in seconds)

- IP Valve Time Constant (in seconds)
- IP Valve Opening Limits (%)
- IP Valve Opening Rate Limits (%/second)
- IP Valve Closing Rate Limits (%/second)
- IP Turbine Time Constant (in seconds)

- LP Valve Time Constant (in seconds)
- LP Valve Opening Limits (%)
- LP Valve Opening Rate Limits (%/second)
- LP Valve Closing Rate Limits (%/second)
- LP Turbine Time Constant (in seconds)
- Reheater Time Constant (in seconds)
- Boiler Time Constant (in seconds)
- HP Power Fraction (%)
- IP Power Fraction (%)

(iii) Governor and associated prime mover Parameters - **Gas Turbine Units**

- Inlet Guide Vane Time Constant (in seconds)
- Inlet Guide Vane Opening Limits (%)
- Inlet Guide Vane Opening Rate Limits (%/second)
- Inlet Guide Vane Closing Rate Limits (%/second)
- Fuel Valve Constant (in seconds)
- Fuel Valve Opening Limits (%)

Fuel Valve Opening Rate Limits (%/second)
 Fuel Valve Closing Rate Limits (%/second)
 Waste Heat Recovery Boiler Time Constant (in seconds)

(iv) Governor and associated prime mover Parameters - Hydro Generating Units

Guide Vane Actuator Time Constant (in seconds)
 Guide Vane Opening Limits (%)
 Guide Vane Opening Rate Limits (%/second)
 Guide Vane Closing Rate Limits (%/second)
 Water Time Constant (in seconds)

(v) Governor Parameters – Synchronous Electricity Storage Units

For **Synchronous Electricity Storage Modules** which are derived from compressed air energy storage systems, the following data should be provided. For other **Synchronous Electricity Storage Modules**, data should be supplied as required by **The Company** in accordance with PC.A.7

Valve Actuator Time Constant (in seconds)
 Valve Opening Limits (%)
 Valve Opening Rate Limits (%/second)
 Valve Closing Rate Limits (%/second)

[End of Option 2]

(e) Unit Control Options

The following data items need only be supplied with respect to **Large Power Stations**:

Maximum Droop	%
Normal Droop	%
Minimum Droop	%
Maximum Governor Deadband or (maximum Frequency Response Deadband and maximum Frequency Response Insensitivity*)	±Hz
Normal Governor Deadband or (normal Frequency Response Deadband and normal Frequency Response Insensitivity*)	±Hz
Minimum Governor Deadband or (minimum Frequency Response Deadband and minimum Frequency Response Insensitivity*)	±Hz
Maximum output Governor Deadband (or maximum output Frequency Response Deadband and maximum Frequency Response Insensitivity*)	±MW
Normal output Governor Deadband (or normal output Frequency Response Deadband and normal output Frequency Response Insensitivity*)	±MW
Minimum output Governor Deadband or (minimum output Frequency Response Deadband and minimum output Frequency Response Insensitivity*)	±MW

Frequency settings between which Unit Load Controller **Droop** applies:

- Maximum	Hz
- Normal	Hz
- Minimum	Hz

State if sustained response is normally selected.

(* **GB Generators** which are not required to satisfy the requirements of the **European Connection Conditions** are not required to supply **Frequency Response Insensitivity** or **Frequency Response Deadband** data but should instead supply **Governor Deadband** data). For the avoidance of doubt, **EU Code Generators** in respect of **Type C** and **Type D Power Generating Modules** are required to supply **Frequency Response Deadband** and **Frequency Response Insensitivity** data).

(f) Plant Flexibility Performance

The following data items need only be supplied with respect to **Large Power Stations**, and should be provided with respect to each **Genset**:

- # Run-up rate to **Registered Capacity**,
- # Run-down rate from **Registered Capacity**,
- # **Synchronising Generation**,
Regulating range
Load rejection capability while still **Synchronised** and able to supply **Load**.

Data items marked with a hash (#) should be applicable to a **Genset** which has been **Shutdown** for 48 hours.

- * Data items marked with an asterisk are already requested under partx1, PC.A.3.3.1, to facilitate an early assessment by **The Company** as to whether detailed stability studies will be required before an offer of terms for a **CUSC Contract** can be made. Such data items have been repeated here merely for completeness and need not, of course, be resubmitted unless their values, known or estimated, have changed.

(g) Generating Unit Mechanical Parameters

It is occasionally necessary for **The Company** to assess the interaction between the **Total System** and the mechanical components of **Generating Units**. For **Generating Units** (including **Synchronous Generating Units** within a **Synchronous Power Generating Module**) with a **Completion Date** on or after 01 April 2015, the following data items should be supplied:

The number of turbine generator masses.

Diagram showing the Inertia and parameters for each turbine generator mass (kgm^2) and Stiffness constants and parameters between each turbine generator mass for the complete drive train (Nm/rad).

Number of poles.

Relative power applied to different parts of the turbine (%).

Torsional mode frequencies (Hz).

Modal damping decrement factors for the different mechanical modes.

PC.A.5.4 Power Park Module, Non-Synchronous Generating Unit and Associated Control System Data

PC.A.5.4.1 The data submitted below are not intended to constrain any **Ancillary Services Agreement**

PC.A.5.4.2 The following **Power Park Unit**, **Power Park Module** and **Power Station** data should be supplied in the case of a **Power Park Module** not connected to the **Total System** by a **DC Converter** or **HVDC System** (and in the case of PC.A.5.4.2(f) any **OTSUA**):

Where a **Manufacturer's Data & Performance Report** exists in respect of the model of the **Power Park Unit**, the **User** may subject to **The Company's** agreement, opt to reference the **Manufacturer's Data & Performance Report** as an alternative to the provision of data in accordance with PC.A.5.4.2 except for:

- (1) the section marked thus # at sub paragraph (b); and

- (2) all of the harmonic and flicker parameters required under sub paragraph (h); and
- (3) all of the site specific model parameters relating to the voltage or frequency control systems required under sub paragraphs (d) and (e),

which must be provided by the **User** in addition to the **Manufacturer's Data & Performance Report** reference.

(a) **Power Park Unit** model

A mathematical model of each type of **Power Park Unit** (including **Electricity Storage Units**) capable of representing its transient and dynamic behaviour under both small and large disturbance conditions. The model shall include non-linear effects and represent all equipment relevant to the dynamic performance of the **Power Park Unit** as agreed with **The Company**. The model shall be suitable for the study of balanced, root mean square, positive phase sequence time-domain behaviour, excluding the effects of electromagnetic transients, harmonic and sub-harmonic frequencies.

The model shall accurately represent the overall performance of the **Power Park Unit** over its entire operating range including that which is inherent to the **Power Park Unit** and that which is achieved by use of supplementary control systems providing either continuous or stepwise control. Model resolution should be sufficient to accurately represent **Power Park Unit** behaviour both in response to operation of **Transmission System** protection and in the context of longer-term simulations.

The overall structure of the model shall include:

- (i) any supplementary control signal modules not covered by (c), (d) and (e) below.
- (ii) any blocking, deblocking and protective trip features that are part of the **Power Park Unit** (e.g. "crowbar").
- (iii) any other information required to model the **Power Park Unit** behaviour to meet the model functional requirement described above.

The model shall be submitted in the form of a transfer function block diagram and may be accompanied by dynamic and algebraic equations.

This model shall display all the transfer functions and their parameter values, any non wind-up logic, signal limits and non-linearities.

The submitted **Power Park Unit** model and the supplementary control signal module models covered by (c), (d) and (e) below shall have been validated and this shall be confirmed by the **Generator**. The validation shall be based on comparing the submitted model simulation results against measured test results. Validation evidence shall also be submitted and this shall include the simulation and measured test results. The latter shall include appropriate short-circuit tests. In the case of an **Embedded Medium Power Station** not subject to a **Bilateral Agreement** the **Network Operator** will provide **The Company** with the validation evidence if requested by **The Company**. The validation of the supplementary control signal module models covered by (c), (d) and (e) below applies only to a **Power Park Module** with a **Completion Date** after 1 January 2009 or **Power Park Modules** within a **Power Generating Module**.

(b) **Power Park Unit** parameters

- * Rated MVA
- * **Rated MW**
- * Rated terminal voltage
- * Average site air density (kg/m^3), maximum site air density (kg/m^3) and minimum site air density (kg/m^3) for the year (as applicable)
Year for which the air density is submitted (as applicable)
Number of pole pairs (as applicable)

Blade swept area (m²) (as applicable)

Gear box ratio (as applicable)

Mechanical drive train (as applicable)

For each **Power Park Unit**, details of the parameters of the drive train (as applicable) represented as an equivalent two mass model should be provided. This model should accurately represent the behaviour of the complete drive train for the purposes of power system analysis studies and should include the following data items:-

Equivalent inertia constant (MWsec/MVA) of the first mass (e.g. wind turbine rotor and blades) at minimum, synchronous and rated speeds

Equivalent inertia constant (MWsec/MVA) of the second mass (e.g. generator rotor) at minimum, synchronous and rated speeds

Equivalent shaft stiffness between the two masses (Nm/electrical radian)

Additionally, for **Power Park Units** that are induction generators (e.g. squirrel cage, doubly-fed) driven by wind turbines:

- * Stator resistance
- * Stator reactance
- * Magnetising reactance.
- * Rotor resistance.(at starting)
- * Rotor resistance.(at rated running)
- * Rotor reactance (at starting)
- * Rotor reactance (at rated running)

Additionally for doubly-fed induction generators only:

The generator rotor speed range (minimum and maximum speeds in RPM)

The optimum generator rotor speed versus wind speed submitted in tabular format

Power converter rating (MVA)

The rotor power coefficient (C_p) versus tip speed ratio (λ) curves for a range of blade angles (where applicable) together with the corresponding values submitted in tabular format. The tip speed ratio (λ) is defined as $\Omega R/U$ where Ω is the angular velocity of the rotor, R is the radius of the wind turbine rotor and U is the wind speed.

The electrical power output versus generator rotor speed for a range of wind speeds over the entire operating range of the **Power Park Unit**, together with the corresponding values submitted in tabular format.

The blade angle versus wind speed curve together with the corresponding values submitted in tabular format.

The electrical power output versus wind speed over the entire operating range of the **Power Park Unit**, together with the corresponding values submitted in tabular format.

Transfer function block diagram, including parameters and description of the operation of the power electronic converter and fault ride through capability (where applicable).

For a **Power Park Unit** consisting of a synchronous machine in combination with a back to back **DC Converter** or **HVDC System**, or for a **Power Park Unit** not driven by a wind turbine, the data to be supplied shall be agreed with **The Company** in accordance with PC.A.7.

- (c) Torque / speed and blade angle control systems and parameters

For the type of **Power Park Unit** (as applicable), details of the torque / speed controller and blade angle controller in the case of a wind turbine and power limitation functions (where applicable) described in block diagram form showing transfer functions and parameters of individual elements.

- (d) Voltage/**Reactive Power/Power Factor** control system parameters

For the **Power Park Unit** and **Power Park Module** details of voltage/**Reactive Power/Power Factor** controller (and **PSS** if fitted) described in block diagram form showing transfer functions and parameters of individual elements.

- (e) **Frequency** control system parameters

For the **Power Park Unit** and **Power Park Module** details of the **Frequency** controller described in block diagram form showing transfer functions and parameters of individual elements.

- (f) **Protection**

Details of settings for the following **Protection** relays (to include): Under **Frequency**, over **Frequency**, under voltage, over voltage, rotor over current, stator over current, high wind speed shut down level.

- (g) Complete **Power Park Unit** model, parameters and controls

An alternative to PC.A.5.4.2 (a), (b), (c), (d), (e) and (f), is the submission of a single complete model that consists of the full information required under PC.A.5.4.2 (a), (b), (c), (d), (e) and (f) provided that all the information required under PC.A.5.4.2 (a), (b), (c), (d), (e) and (f) individually is clearly identifiable.

- (h) Harmonic and flicker parameters

When connecting a **Power Park Module**, it is necessary for **The Company** to evaluate the production of flicker and harmonics on the **National Electricity Transmission System** and **User's Systems**. At **The Company's** reasonable request, the **User** (a **Network Operator** in the case of an **Embedded Power Park Module** not subject to a **Bilateral Agreement**) is required to submit the following data (as defined in IEC 61400-21 (2001)) for each **Power Park Unit**:-

Flicker coefficient for continuous operation.

Flicker step factor.

Number of switching operations in a 10 minute window.

Number of switching operations in a 2 hour window.

Voltage change factor.

Current Injection at each harmonic for each **Power Park Unit** and for each **Power Park Module**.

* Data items marked with an asterisk are already requested under part 1, PC.A.3.3.1, to facilitate an early assessment by **The Company** as to whether detailed stability studies will be required before an offer of terms for a **CUSC Contract** can be made. Such data items have been repeated here merely for completeness and need not, of course, be resubmitted unless their values, known or estimated, have changed.

PC.A.5.4.3 DC Converter and HVDC Systems

PC.A.5.4.3.1 For a **DC Converter** at a **DC Converter Station** or an **HVDC System** connected to the **Total System** by a **DC Converter** or **HVDC System** (or in the case of **OTSUA** which includes an **OTSDUW DC Converter**) the following information for each **DC Converter**, **HVDC System** and **DC Network** should be supplied:

(a) **DC Converter** and **HVDC System** parameters

- * **Rated MW** per pole for transfer in each direction;
- * **DC Converter** type (i.e. current or voltage source (including a **HVDC Converter** in an **HVDC System**));
- * Number of poles and pole arrangement;
- * Rated DC voltage/pole (kV);
- * Return path arrangement;

(b) **DC Converter** and **HVDC System** transformer parameters

Rated MVA

Nominal primary voltage (kV);

Nominal secondary (converter-side) voltage(s) (kV);

Winding and earthing arrangement;

Positive phase sequence reactance at minimum, maximum and nominal tap;

Positive phase sequence resistance at minimum, maximum and nominal tap;

Zero phase sequence reactance;

Tap-changer range in %;

number of tap-changer steps;

(c) **DC Network** parameters

Rated DC voltage per pole;

Rated DC current per pole;

Single line diagram of the complete **DC Network** and **HVDC System**;

Details of the complete **DC Network**, including resistance, inductance and capacitance of all DC cables and/or DC lines and **HVDC System**;

Details of any DC reactors (including DC reactor resistance), DC capacitors and/or DC-side filters that form part of the **DC Network** and/or **HVDC System**;

(d) AC filter reactive compensation equipment parameters

Note: The data provided pursuant to this paragraph must not include any contribution from reactive compensation plant.

Total number of AC filter banks.

Type of equipment (e.g. fixed or variable)

Single line diagram of filter arrangement and connections;

Reactive Power rating for each AC filter bank, capacitor bank or operating range of each item of reactive compensation equipment, at rated voltage;

Performance chart showing **Reactive Power** capability of the **DC Converter** and **HVDC System**, as a function of MW transfer, with all filters and reactive compensation plant, belonging to the **DC Converter Station** or **HVDC System** working correctly.

Note: Details in PC.A.5.4.3.1 are required for each **DC Converter** connected to the **DC Network** and **HVDC System**, unless each is identical or where the data has already been submitted for an identical **DC Converter** or **HVDC System** at another **Connection Point**.

Note: For a **Power Park Module** and **DC Connected Power Park Module** connected to the **Grid Entry Point** or (**User System Entry Point** if **Embedded**) by a **DC Converter** or **HVDC System** the equivalent inertia and fault infeed at the **Power Park Unit** should be given.

DC Converter and HVDC System Control System Models

PC.A.5.4.3.2 The following data is required by **The Company** to represent **DC Converters** and associated **DC Networks** and **HVDC Systems** (and including **OTSUA** which includes an **OTSDUW DC Converter**) in dynamic power system simulations, in which the AC power system is typically represented by a positive sequence equivalent. **DC Converters** and **HVDC Systems** are represented by simplified equations and are not modelled to switching device level.

- (i) Static $V_{DC-I_{DC}}$ (DC voltage - DC current) characteristics, for both the rectifier and inverter modes for a current source converter. Static $V_{DC-P_{DC}}$ (DC voltage - DC power) characteristics, for both the rectifier and inverter modes for a voltage source converter. Transfer function block diagram including parameters representation of the control systems of each **DC Converter** and of the **DC Converter Station** and the **HVDC System**, for both the rectifier and inverter modes. A suitable model would feature the **DC Converter** or **HVDC Converter** firing angle as the output variable.
- (ii) Transfer function block diagram representation including parameters of the **DC Converter** or **HVDC Converter** transformer tap changer control systems, including time delays
- (iii) Transfer function block diagram representation including parameters of AC filter and reactive compensation equipment control systems, including any time delays.
- (iv) Transfer function block diagram representation including parameters of any **Frequency** and/or load control systems.
- (v) Transfer function block diagram representation including parameters of any small signal modulation controls such as power oscillation damping controls or sub-synchronous oscillation damping controls, that have not been submitted as part of the above control system data.
- (vi) Transfer block diagram representation of the **Reactive Power** control at converter ends for a voltage source converter.

In addition and where not provided for above, **HVDC System Owners** and **Generators** in respect of **OTSDUW DC Converters** who are also **EU Code Users** shall also provide the following dynamic simulation sub-models

- (i) **HVDC Converter** unit models
- (ii) AC component models
- (iii) DC Grid models
- (iv) Voltage and power controller
- (v) Special control features if applicable (eg power oscillation damping (POD) function, subsynchronous torsional interaction (SSTI) control;
- (vi) Multi terminal control, if applicable
- (vii) **HVDC System** protection models as agreed between **The Company** and the **HVDC System Owner**

HVDC System Owners are also required to supply an equivalent model of the control system when adverse control interactions may result with **HVDC Converter Stations** and other connections in close proximity if requested by **The Company**. The equivalent model shall contain all necessary data for the realistic simulation of the adverse control interactions.

Plant Flexibility Performance

- PC.A.5.4.3.3 The following information on plant flexibility and performance should be supplied (and also in respect of **OTSUA** which includes an **OTSDUW DC Converter**):
- (i) Nominal and maximum (emergency) loading rate with the **DC Converter** or **HVDC Converter** in rectifier mode.
 - (ii) Nominal and maximum (emergency) loading rate with the **DC Converter** or **HVDC Converter** in inverter mode.
 - (iii) Maximum recovery time, to 90% of pre-fault loading, following an AC system fault or severe voltage depression.
 - (iv) Maximum recovery time, to 90% of pre-fault loading, following a transient **DC Network** fault.

Harmonic Assessment Information

- PC.A.5.4.3.4 **DC Converter** owners and **HVDC System Owners** shall provide such additional further information as required by **The Company** in order that compliance with CC.6.1.5 or ECC.6.1.5 can be demonstrated.

* Data items marked with an asterisk are already requested under part 1, PC.A.3.3.1, to facilitate an early assessment by **The Company** as to whether detailed stability studies will be required before an offer of terms for a **CUSC Contract** can be made. Such data items have been repeated here merely for completeness and need not, of course, be resubmitted unless their values, known or estimated, have changed.

PC.A.5.5 Response Data For Frequency Changes

The information detailed below is required to describe the actual frequency response capability profile as illustrated in Figure CC.A.3.1 of the **Connection Conditions** or Figure ECC.A.3.1 of the **European Connection Conditions**, and need only be provided for each:

- (i) **Genset** at **Large Power Stations**; and
- (ii) **Generating Unit** (including **Synchronous Generating Units** within a **Synchronous Power Generating Module**), **Power Park Module** (including a **DC Connected Power Park Module**) or **CCGT Module** at a **Medium Power Station** or **DC Converter Station** or **HVDC System** that has agreed to provide **Frequency** response in accordance with a **CUSC Contract**.

In the case of (ii) above for the rest of this PC.A.5.5 where reference is made to **Gensets**, it shall include such **Generating Units** (including **Synchronous Generating Units** within a **Synchronous Power Generating Module**), **CCGT Modules**, **Power Park Modules** (including **DC Connected Power Park Modules**), **HVDC Systems** and **DC Converters** as appropriate, but excludes **OTSDUW Plant and Apparatus** utilising **OTSDUW DC Converters**.

In this PC.A.5.5, for a **CCGT Module** with more than one **Generating Unit**, the phrase **Minimum Generation** or **Minimum Regulating Level** applies to the entire **CCGT Module** operating with all **Generating Units** (including **Synchronous Generating Units** within a **Synchronous Power Generating Module**) **Synchronised** to the **System**. Similarly for a **Power Park Module** (including a **DC Connected Power Park Module**) with more than one **Power Park Unit**, the phrase **Minimum Generation** or **Minimum Regulating Level** applies to the entire **Power Park Module** operating with all **Power Park Units Synchronised** to the **System**.

PC.A.5.5.1 MW Loading Points At Which Data Is Required

Response values are required at six MW loading points (MLP1 to MLP6) for each **Genset**. **Primary** and **Secondary Response** values need not be provided for MW loading points which are below **Minimum Generation** or **Minimum Stable Operating Level**. MLP1 to MLP6 must be provided to the nearest MW.

Prior to the **Genset** being first **Synchronised**, the MW loading points must take the following values :

MLP1	Designed Minimum Operating Level or Minimum Regulating Level
MLP2	Minimum Generation or Minimum Stable Operating Level
MLP3	70% of Registered Capacity or Maximum Capacity
MLP4	80% of Registered Capacity or Maximum Capacity
MLP5	95% of Registered Capacity or Maximum Capacity
MLP6	Registered Capacity or Maximum Capacity

When data is provided after the **Genset** is first **Synchronised**, the MW loading points may take any value between the **Designed Minimum Operating Level** or **Minimum Regulating Level** and **Registered Capacity** or **Maximum Capacity** but the value of the **Designed Minimum Operating Level** or **Minimum Regulating Level** must still be provided if it does not form one of the MW loading points.

PC.A.5.5.2 Primary And Secondary Response To Frequency Fall

Primary and **Secondary Response** values for a -0.5Hz ramp are required at six MW loading points (MLP1 to MLP6) as detailed above

PC.A.5.5.3 High Frequency Response To Frequency Rise

High Frequency Response values for a +0.5Hz ramp are required at six MW loading points (MLP1 to MLP6) as detailed above.

PC.A.5.6 Mothballed Power Generating Module, Mothballed Generating Unit, Mothballed Power Park Module (including DC Connected Power Park Modules), Mothballed HVDC Systems or Mothballed DC Converter at a DC Converter Station And Alternative Fuel Information

Data identified under this section PC.A.5.6 must be submitted as required under PC.A.1.2 and at **The Company's** reasonable request.

In the case of **Embedded Medium Power Stations** not subject to a **Bilateral Agreement**, **Embedded HVDC Systems** not subject to a **Bilateral Agreement** and **Embedded DC Converter Stations** not subject to a **Bilateral Agreement**, upon request from **The Company** each **Network Operator** shall provide the information required in PC.A.5.6.1, PC.A.5.6.2, PC.A.5.6.3 and PC.A.5.6.4 on respect of such **Embedded Medium Power Stations** and **Embedded DC Converters Stations** and **Embedded HVDC Systems** with their **System**.

PC.A.5.6.1 Mothballed Generating Unit Information

Generators, HVDC System Owners and **DC Converter Station** owners must supply with respect to each **Mothballed Power Generating Module, Mothballed Generating Unit, Mothballed Power Park Module** (including a **DC Connected Power Park Module**), **Mothballed HVDC System** or **Mothballed DC Converter** at a **DC Converter Station** the estimated **MW** output which could be returned to service within the following time periods from the time that a decision to return was made:

- < 1 month;
- 1-2 months;
- 2-3 months;
- 3-6 months;
- 6-12 months; and
- >12 months.

The return to service time should be determined in accordance with **Good Industry Practice** assuming normal working arrangements and normal plant procurement lead times. The MW output values should be the incremental values made available in each time period as further described in the **DRC**.

PC.A.5.6.2 **Generators, HVDC System Owners and DC Converter Station** owners must also notify **The Company** of any significant factors which may prevent the **Mothballed Power Generating Module, Mothballed Generating Unit, Mothballed Power Park Module (including DC Connected Power Park Modules), Mothballed HVDC Systems or Mothballed DC Converter** at a **DC Converter Station** achieving the estimated values provided under PC.A.5.6.1 above, excluding factors relating to **Transmission Entry Capacity**.

PC.A.5.6.3 Alternative Fuel Information

The following data items must be supplied with respect to each **Generating Unit** (including **Synchronous Generating Units** within a **Synchronous Power Generating Module**) whose main fuel is gas.

For each alternative fuel type (if facility installed):

- (a) Alternative fuel type e.g. oil distillate, alternative gas supply
- (b) For the changeover from main to alternative fuel:
 - Time to carry out off-line and on-line fuel changeover (minutes).
 - Maximum output following off-line and on-line changeover (MW).
 - Maximum output during on-line fuel changeover (MW).
 - Maximum operating time at full load assuming typical and maximum possible stock levels (hours).
 - Maximum rate of replacement of depleted stocks (MWh electrical/day) on the basis of **Good Industry Practice**.
 - Is changeover to alternative fuel used in normal operating arrangements?
 - Number of successful changeovers carried out in the last of **The Company's Financial Year** (choice of 0, 1-5, 6-10, 11-20, >20).
- (c) For the changeover back to main fuel:
 - Time to carry out off-line and on-line fuel changeover (minutes).
 - Maximum output during on-line fuel changeover (MW).

PC.A.5.6.4 **Generators** must also notify **The Company** of any significant factors and their effects which may prevent the use of alternative fuels achieving the estimated values provided under PC.A.5.6.3 above (e.g. emissions limits, distilled water stocks etc.)

PC.A.5.7 Black Start Related Information

Data identified under this section PC.A.5.7 must be submitted as required under PC.A.1.2. This information may also be requested by **The Company** during a **Black Start** and should be provided by **Generators, HVDC System Owners and DC Converter Station Owners** where reasonably possible. For the avoidance of doubt, **Generators** in this section PC.A.5.7 means **Generators** only in respect of their **Large Power Stations**.

The following data items/text must be supplied, from each **Generator, HVDC System Owner and DC Converter Station Owner** to **The Company**. In the case of **Generators**, the data supplied should be with respect to each **BM Unit** at a **Large Power Station**. For the avoidance of doubt, the data required under PC.A.5.7 (a) and (b) below, does i) not need to be supplied in respect of **Generators** that are contracted to provide a **Black Start Capability** and ii), the data only needs to be supplied in respect of the **BM Unit** at a **Large Power Station** and does not need to include **Generating Unit** data;

- (a) Expected time for each **BM Unit** to be **Synchronised** following a **Total Shutdown** or **Partial Shutdown**. The assessment should include the **Power Station's** or **HVDC System's** or **DC Converter Station's** ability to re-synchronise all **BM Units**, if all were running immediately prior to the **Total Shutdown** or **Partial Shutdown**. Additionally this should highlight any specific issues (i.e. those that would impact on the **BM Unit's** time to be **Synchronised**) that may arise, as time progresses without external supplies being restored.

- (b) **Block Loading Capability.** This should be provided in either graphical or tabular format showing the estimated block loading capability from OMW to **Registered Capacity**. Any particular 'hold' points should also be identified. The data of each **BM Unit** should be provided for the condition of a **Generating Unit** (which is considered as both a 'hot' unit and cold unit) that was **Synchronised** just prior to the **Total Shutdown** or **Partial Shutdown**. In the case of an **HVDC System** or **DC Converter Station**, data should be provided when the **HVDC System** or **DC Converter Station** has been considered to have run immediately before the **Total Shutdown** or **Partial Shutdown** and equally when the **HVDC System** or **DC Converter Station** has been considered to have been **Shutdown** for a period of 48 hours or more. The block loading assessment should be done against a frequency variation of 49.5Hz – 50.5Hz.

PC.A.6 USERS' SYSTEM DATA

PC.A.6.1 Introduction

PC.A.6.1.1 Each **User**, whether connected directly via an existing **Connection Point** to the **National Electricity Transmission System** or seeking such a direct connection, or providing terms for connection of an **Offshore Transmission System** to its **User System** to **The Company** or undertaking **OTSDUW**, shall provide **The Company** with data on its **User System** or **OTSDUW Plant and Apparatus** which relates to the **Connection Site** containing the **Connection Point** (or **Interface Points** or **Connection Points** in the case of **OTSUA**) both current and forecast, as specified in PC.A.6.2 to PC.A.6.6.

PC.A.6.1.2 Each **User** must reflect the system effect at the **Connection Site(s)** of any third party **Embedded** within its **User System** whether existing or proposed.

PC.A.6.1.3 PC.A.6.2, and PC.A.6.4 to PC.A.6.7 consist of data which is only to be supplied to **The Company** at **The Company's** reasonable request. In the event that **The Company** identifies a reason for requiring this data, **The Company** shall write to the relevant **User(s)**, requesting the data, and explaining the reasons for the request. If the **User(s)** wishes, **The Company** shall also arrange a meeting at which the request for data can be discussed, with the objective of identifying the best way in which **The Company's** requirements can be met. In respect of **EU Code User(s)** only, **The Company** may request the need for electromagnetic transient simulations at **The Company's** reasonable request. **Users** with **EU Grid Supply Points** may be required to provide electromagnetic transient simulations in relation to those **EU Grid Supply Points** at **The Company's** reasonable request.

Where **The Company** makes a request to a **User** for dynamic models under PC.A.6.7, each relevant **User** shall ensure that the models supplied in respect of their **Plant** and **Apparatus** reflect the true and accurate behaviour of the **Plant** and **Apparatus** as built and verified through the **Compliance Processes (CP's)** or **European Compliance Processes (ECP)**.

PC.A.6.2 Transient Overvoltage Assessment Data

PC.A.6.2.1 It is occasionally necessary for **The Company** to undertake transient overvoltage assessments (e.g. capacitor switching transients, switchgear transient recovery voltages, etc). At **The Company's** reasonable request, each **User** is required to provide the following data with respect to the **Connection Site** (and in the case of **OTSUA**, **Interface Points** and **Connection Points**), current and forecast, together with a **Single Line Diagram** where not already supplied under PC.A.2.2.1, as follows:

- (a) busbar layout plan(s), including dimensions and geometry showing positioning of any current and voltage transformers, through bushings, support insulators, disconnectors, circuit breakers, surge arresters, etc. Electrical parameters of any associated current and voltage transformers, stray capacitances of wall bushings and support insulators, and grading capacitances of circuit breakers;
- (b) Electrical parameters and physical construction details of lines and cables connected at that busbar. Electrical parameters of all plant e.g., transformers (including neutral earthing impedance or zig-zag transformers, if any), series reactors and shunt compensation equipment connected at that busbar (or to the tertiary of a transformer) or by lines or cables to that busbar;

- (c) Basic insulation levels (BIL) of all **Apparatus** connected directly, by lines or by cables to the busbar;
- (d) characteristics of overvoltage **Protection** devices at the busbar and at the termination points of all lines, and all cables connected to the busbar;
- (e) fault levels at the lower voltage terminals of each transformer connected directly or indirectly to the **National Electricity Transmission System** (including **OTSUA** at each **Interface Point** and **Connection Point**) without intermediate transformation;
- (f) the following data is required on all transformers operating at **Supergrid Voltage** throughout **Great Britain** and, in Scotland and **Offshore**, also at 132kV or greater (including **OTSUA**): three or five limb cores or single phase units to be specified, and operating peak flux density at nominal voltage;
- (g) an indication of which items of equipment may be out of service simultaneously during **Planned Outage** conditions.

PC.A.6.3 User's Protection Data

PC.A.6.3.1 Protection

The following information is required which relates only to **Protection** equipment which can trip or inter-trip or close any **Connection Point** circuit-breaker or any **Transmission** circuit-breaker (or in the case of **OTSUA**, any **Interface Point** or **Connection Point** circuit breaker). This information need only be supplied once, in accordance with the timing requirements set out in PC.A.1.4(b), and need not be supplied on a routine annual basis thereafter, although **The Company** should be notified if any of the information changes;

- (a) a full description, including estimated settings, for all relays and **Protection** systems installed or to be installed on the **User's System**;
- (b) a full description of any auto-reclose facilities installed or to be installed on the **User's System**, including type and time delays;
- (c) a full description, including estimated settings, for all relays and **Protection** systems or to be installed on the generator, generator transformer, **Station Transformer** and their associated connections;
- (d) for **Generating Units** (including **Synchronous Generating Units** forming part of a **Synchronous Power Generating Module** but excluding **Power Park Units**) or **Power Park Modules** (including **DC Connected Power Park Modules**) or **HVDC Systems** or **DC Converters** at a **DC Converter Station** or **OTSDUW Plant and Apparatus** having (or intended to have) a circuit breaker at the generator terminal voltage, clearance times for electrical faults within the **Generating Unit** (including **Synchronous Generating Units** forming part of a **Synchronous Power Generating Module** but excluding a **Power Park Unit**) or **Power Park Module** (including **DC Connected Power Park Modules**) zone, or within the **OTSDUW Plant and Apparatus**;
- (e) the most probable fault clearance time for electrical faults on any part of the **User's System** directly connected to the **National Electricity Transmission System** including **OTSDUW Plant and Apparatus**; and
- (f) in the case of **OTSDUW Plant and Apparatus**, synchronisation facilities and delayed auto reclose sequence schedules (where applicable).

PC.A.6.4 Harmonic Studies

PC.A.6.4.1 It is occasionally necessary for **The Company** to evaluate the production/magnification of harmonic distortion on the **National Electricity Transmission System** and **User's Systems** (and **OTSUA**), especially when **The Company** is connecting equipment such as capacitor banks. At **The Company's** reasonable request, each **User** is required to submit data with respect to the **Connection Site** (and in the case of **OTSUA**, each **Interface Point** and **Connection Point**), current and forecast, and where not already supplied under PC.A.2.2.4 and PC.A.2.2.5, as follows:

PC.A.6.4.2 Overhead lines and underground cable circuits of the **User's Subtransmission System** must be differentiated and the following data provided separately for each type:

- Positive phase sequence resistance;
- Positive phase sequence reactance;
- Positive phase sequence susceptance;

and for all transformers connecting the **User's Subtransmission System** and **OTSDUW Plant and Apparatus** to a lower voltage:

- Rated MVA;
- Voltage Ratio;
- Positive phase sequence resistance;
- Positive phase sequence reactance;

and at the lower voltage points of those connecting transformers:

- Equivalent positive phase sequence susceptance;
- Connection voltage and MVA_r rating of any capacitor bank and component design parameters if configured as a filter;
- Equivalent positive phase sequence interconnection impedance with other lower voltage points;
- The minimum and maximum **Demand** (both MW and MVA_r) that could occur;
- Harmonic current injection sources in Amps at the Connection voltage points. Where the harmonic injection current comes from a diverse group of sources, the equivalent contribution may be established from appropriate measurements;
- Details of traction loads, eg connection phase pairs, continuous variation with time, etc;
- An indication of which items of equipment may be out of service simultaneously during **Planned Outage** conditions.

PC.A.6.5 Voltage Assessment Studies

It is occasionally necessary for **The Company** to undertake detailed voltage assessment studies (e.g., to examine potential voltage instability, voltage control co-ordination or to calculate voltage step changes). At **The Company's** reasonable request, each **User** is required to submit the following data where not already supplied under PC.A.2.2.4 and PC.A.2.2.5:

For all circuits of the User's Subtransmission System (and any OTSUA):-

- Positive Phase Sequence Reactance;
- Positive Phase Sequence Resistance;
- Positive Phase Sequence Susceptance;
- MVA_r rating of any reactive compensation equipment;

and for all transformers connecting the **User's Subtransmission System** to a lower voltage (and any **OTSUA**):

- Rated MVA;
- Voltage Ratio;
- Positive phase sequence resistance;
- Positive Phase sequence reactance;
- Tap-changer range;
- Number of tap steps;
- Tap-changer type: on-load or off-circuit;

AVC/tap-changer time delay to first tap movement;

AVC/tap-changer inter-tap time delay;

and at the lower voltage points of those connecting transformers (and any **OTSUA**):-

Equivalent positive phase sequence susceptance;

MVA_r rating of any reactive compensation equipment;

Equivalent positive phase sequence interconnection impedance with other lower voltage points;

The maximum **Demand** (both MW and MVA_r) that could occur;

Estimate of voltage insensitive (constant power) load content in % of total load at both winter peak and 75% off-peak load conditions.

PC.A.6.6 Short Circuit Analysis

PC.A.6.6.1 Where prospective short-circuit currents on **Transmission** equipment are greater than 90% of the equipment rating, and in **The Company's** reasonable opinion more accurate calculations of short-circuit currents are required, then at **The Company's** request each **User** is required to submit data with respect to the **Connection Site** (and in the case of **OTSUA**, each **Interface Point** and **Connection Point**), current and forecast, and where not already supplied under PC.A.2.2.4 and PC.A.2.2.5, as follows:

PC.A.6.6.2 For all circuits of the **User's Subtransmission System** (and any **OTSUA**):

Positive phase sequence resistance;

Positive phase sequence reactance;

Positive phase sequence susceptance;

Zero phase sequence resistance (both self and mutuals);

Zero phase sequence reactance (both self and mutuals);

Zero phase sequence susceptance (both self and mutuals);

and for all transformers connecting the **User's Subtransmission System** to a lower voltage (and any **OTSUA**):

Rated MVA;

Voltage Ratio;

Positive phase sequence resistance (at max, min and nominal tap);

Positive Phase sequence reactance (at max, min and nominal tap);

Zero phase sequence reactance (at nominal tap);

Tap changer range;

Earthing method: direct, resistance or reactance;

Impedance if not directly earthed;

and at the lower voltage points of those connecting transformers (and any **OTSUA**):

The maximum **Demand** (in MW and MVA_r) that could occur;

Short-circuit infeed data in accordance with PC.A.2.5.6 unless the **User's** lower voltage network runs in parallel with the **User's Subtransmission System**, when to prevent double counting in each node infeed data, a π equivalent comprising the data items of PC.A.2.5.6 for each node together with the positive phase sequence interconnection impedance between the nodes shall be submitted.

PC.A.6.7 Dynamic Models

PC.A.6.7.1 It is occasionally necessary for **The Company** to evaluate the dynamic performance of **User's Plant** and **Apparatus** at each **EU Grid Supply Point** or in the case of **EU Code Users**, their **System**. At **The Company's** reasonable request and as agreed between **The Company** and the relevant **Network Operator** or **Non-Embedded Customer**, each **User** is required to provide the following data. Where such data is required, **The Company** will work with the **Network Operator** or **Non-Embedded Customer** to establish the scope of the dynamic modelling work and share the required information where it is available:-

- (a) Dynamic model structure and block diagrams including parameters, transfer functions and individual elements (as applicable);
- (b) Power control functions and block diagrams including parameters, transfer functions and individual elements (as applicable);
- (c) Voltage control functions and block diagrams including parameters, transfer functions and individual elements (as applicable);
- (d) Converter control models and block diagrams including parameters, transfer functions and individual elements (as applicable).

PC.A.7 ADDITIONAL DATA FOR NEW TYPES OF POWER STATIONS, DC CONVERTER STATIONS, OTSUA AND CONFIGURATIONS

Notwithstanding the **Standard Planning Data** and **Detailed Planning Data** set out in this Appendix, as new types of configurations and operating arrangements of **Power Stations**, **HVDC Systems**, **DC Converter Stations** and **OTSUA** emerge in future, **The Company** may reasonably require additional data to represent correctly the performance of such **Plant** and **Apparatus** on the **System**, where the present data submissions would prove insufficient for the purpose of producing meaningful **System** studies for the relevant parties.

PART 3 - DETAILED PLANNING DATA

PC.A.8 To allow a **User** to model the **National Electricity Transmission System**, **The Company** will provide, upon request, the following **Network Data** to **Users**, calculated in accordance with **Good Industry Practice**:

To allow a **User** to assess undertaking **OTSDUW** and except where provided for in Appendix F, **The Company** will provide upon request the following **Network Data** to **Users**, calculated in accordance with **Good Industry Practice**:

PC.A.8.1 Single Point of Connection

For a **Single Point of Connection** to a **User's System** (and **OTSUA**), as a Transmission System voltage source, the data (as at the HV side of the **Point of Connection** (and in the case of **OTSUA**, each **Interface Point** and **Connection Point**) reflecting data given to **The Company** by **Users**) will be given to a **User** as follows:

The data items listed under the following parts of PC.A.8.3:

(a) (i), (ii), (iii), (iv), (v) and (vi) and the data items shall be provided in accordance with the detailed provisions of PC.A.8.3 (b) - (e).

PC.A.8.2 Multiple Point of Connection

For a **Multiple Point of Connection** to a **User's System** equivalents suitable for use in loadflow and fault level analysis shall be provided. These equivalents will normally be in the form of a π model or extension with a source (or demand for a loadflow equivalent) at each node and a linking impedance. The boundary nodes for the equivalent shall be either at the **Connection Point** (and in the case of **OTSDUW**, each **Interface Point** and **Connection Point**) or (where **The Company** agrees) at suitable nodes (the nodes to be agreed with the **User**) within the **National Electricity Transmission System**. The data at the **Connection Point** (and in the case of **OTSDUW**, each **Interface Point** and **Connection Point**) will be given to a **User** as follows:

The data items listed under the following parts of PC.A.8.3:-

(a) (i), (ii), (iv), (v), (vi), (vii), (viii), (ix), (x) and (xi)

and the data items shall be provided in accordance with the detailed provisions of PC.A.8.3 (b) - (e).

When an equivalent of this form is not required **The Company** will not provide the data items listed under the following parts of PC.A.8.3:-

(a) (vii), (viii), (ix), (x) and (xi)

PC.A.8.3 Data Items

(a) The following is a list of data utilised in this part of the **PC**. It also contains rules on the data which generally apply.

- (i) symmetrical three-phase short circuit current infeed at the instant of fault from the **National Electricity Transmission System**, (I_1'');
- (ii) symmetrical three-phase short circuit current from the **National Electricity Transmission System** after the subtransient fault current contribution has substantially decayed, (I_1');
- (iii) the zero sequence source resistance and reactance values at the **Point of Connection** (and in case of **OTSUA**, each **Interface Point** and **Connection Point**), consistent with the maximum infeed below;
- (iv) the pre-fault voltage magnitude at which the maximum fault currents were calculated;
- (v) the positive sequence X/R ratio at the instant of fault;
- (vi) the negative sequence resistance and reactance values of the **National Electricity Transmission System** seen from the **Point of Connection** (and in case of **OTSUA**, each **Interface Point** and **Connection Point**), if substantially different from the

- values of positive sequence resistance and reactance which would be derived from the data provided above;
- (vii) the initial positive sequence resistance and reactance values of the two (or more) sources and the linking impedance(s) derived from a fault study constituting the (π) equivalent and evaluated without the **User** network and load and where appropriate without elements of the **National Electricity Transmission System** between the **User** network and agreed boundary nodes (and in case of **OTSUA**, each **Interface Point** and **Connection Point**);
 - (viii) the positive sequence resistance and reactance values of the two (or more) sources and the linking impedance(s) derived from a fault study, considering the short circuit current contributions after the subtransient fault current contribution has substantially decayed, constituting the (π) equivalent and evaluated without the **User** network and load, and where appropriate without elements of the **National Electricity Transmission System** between the **User** network and agreed boundary nodes (and in case of **OTSUA**, each **Interface Point** and **Connection Point**);
 - (ix) the corresponding zero sequence impedance values of the (π) equivalent produced for use in fault level analysis;
 - (x) the **Demand** and voltage at the boundary nodes and the positive sequence resistance and reactance values of the linking impedance(s) derived from a loadflow study considering **National Electricity Transmission System** peak **Demand** constituting the (π) loadflow equivalent; and,
 - (xi) where the agreed boundary nodes are not at a **Connection Point** (and in case of **OTSUA**, **Interface Point** or **Connection Point**), the positive sequence and zero sequence impedances of all elements of the **National Electricity Transmission System** between the **User** network and agreed boundary nodes that are not included in the equivalent (and in case of **OTSUA**, each **Interface Point** and **Connection Point**).
- (b) To enable the model to be constructed, **The Company** will provide data based on the following conditions.
 - (c) The initial symmetrical three phase short circuit current and the transient period three phase short circuit current will normally be derived from the fixed impedance studies. The latter value should be taken as applying at times of 120ms and longer. Shorter values may be interpolated using a value for the subtransient time constant of 40ms. These fault currents will be obtained from a full **System** study based on load flow analysis that takes into account any existing flow across the point of connection being considered.
 - (d) **The Company** will provide the appropriate supergrid transformer data for the **National Electricity Transmission System** associated with equivalent voltage source data.
 - (e) The positive sequence X/R ratio and the zero sequence impedance value will correspond to **The Company's** source network only, that is with the section of network if any with which the equivalent is to be used excluded. These impedance values will be derived from the condition when all **Generating Units** (including **Synchronous Generating Units** forming part of a **Synchronous Power Generating Module**) are **Synchronised** to the **National Electricity Transmission System** or a **User's System** and will take account of active sources only including any contribution from the load to the fault current. The passive component of the load itself or other system shunt impedances should not be included.
 - (f) A **User** may at any time, in writing, specifically request for an equivalent to be prepared for an alternative **System** condition, for example where the **User's System** peak does not correspond to the **National Electricity Transmission System** peak, and **The Company** will, insofar as such request is reasonable, provide the information as soon as reasonably practicable following the request.

APPENDIX B - SINGLE LINE DIAGRAMS

PC.B.1

The diagrams below show three examples of single line diagrams, showing the detail that should be incorporated in the diagram. The first example is for an **Network Operator** connection, the second for a **Generator** connection, the third for a **Power Park Module** electrically equivalent system.

Network Operator Single Line Diagram

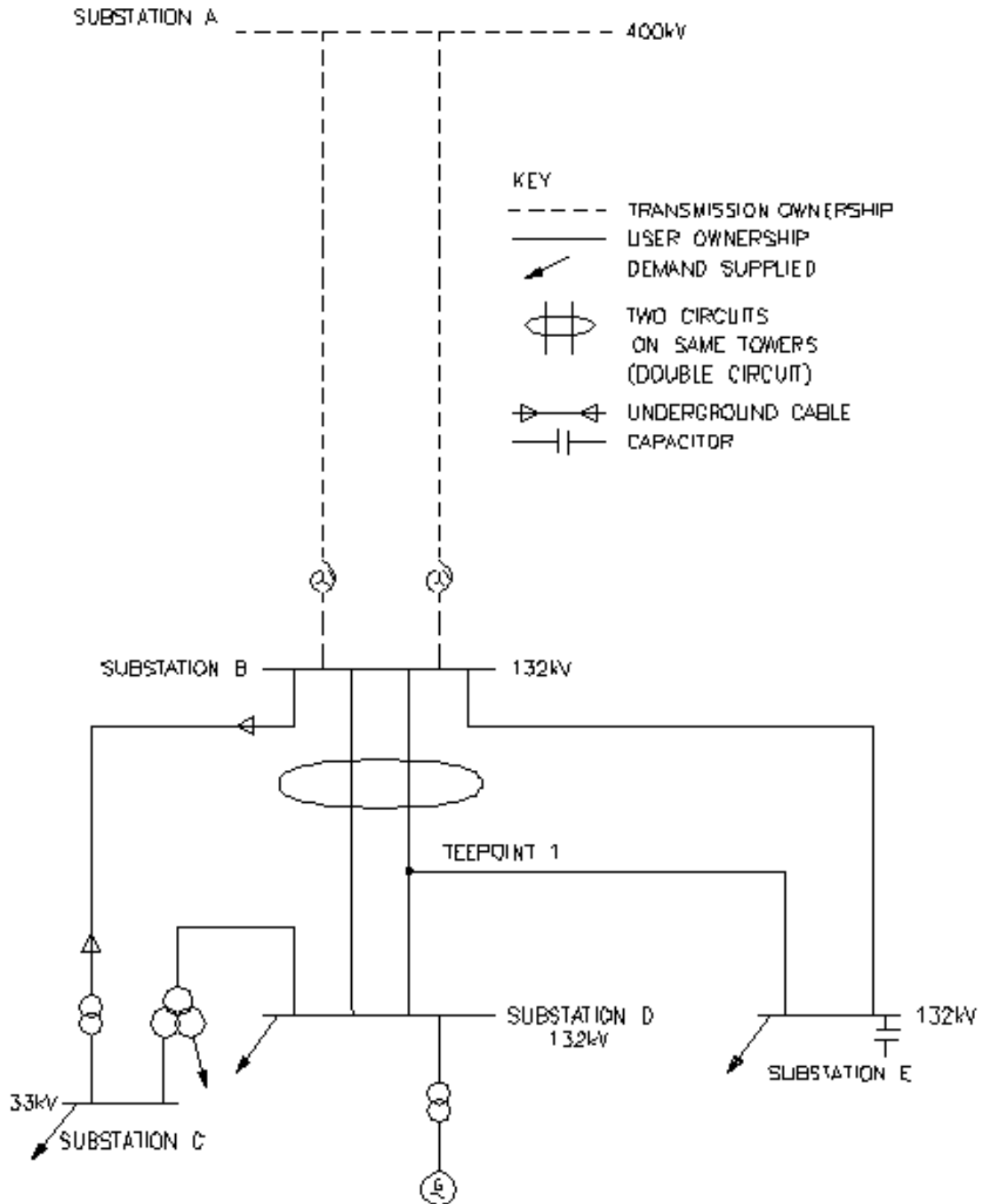

DISCLAIMER: THIS DOCUMENT IS THE PROPERTY OF THE NETWORK OPERATOR

ISS D
41/16826_1_1 29-07-04

Generator Single Line Diagram

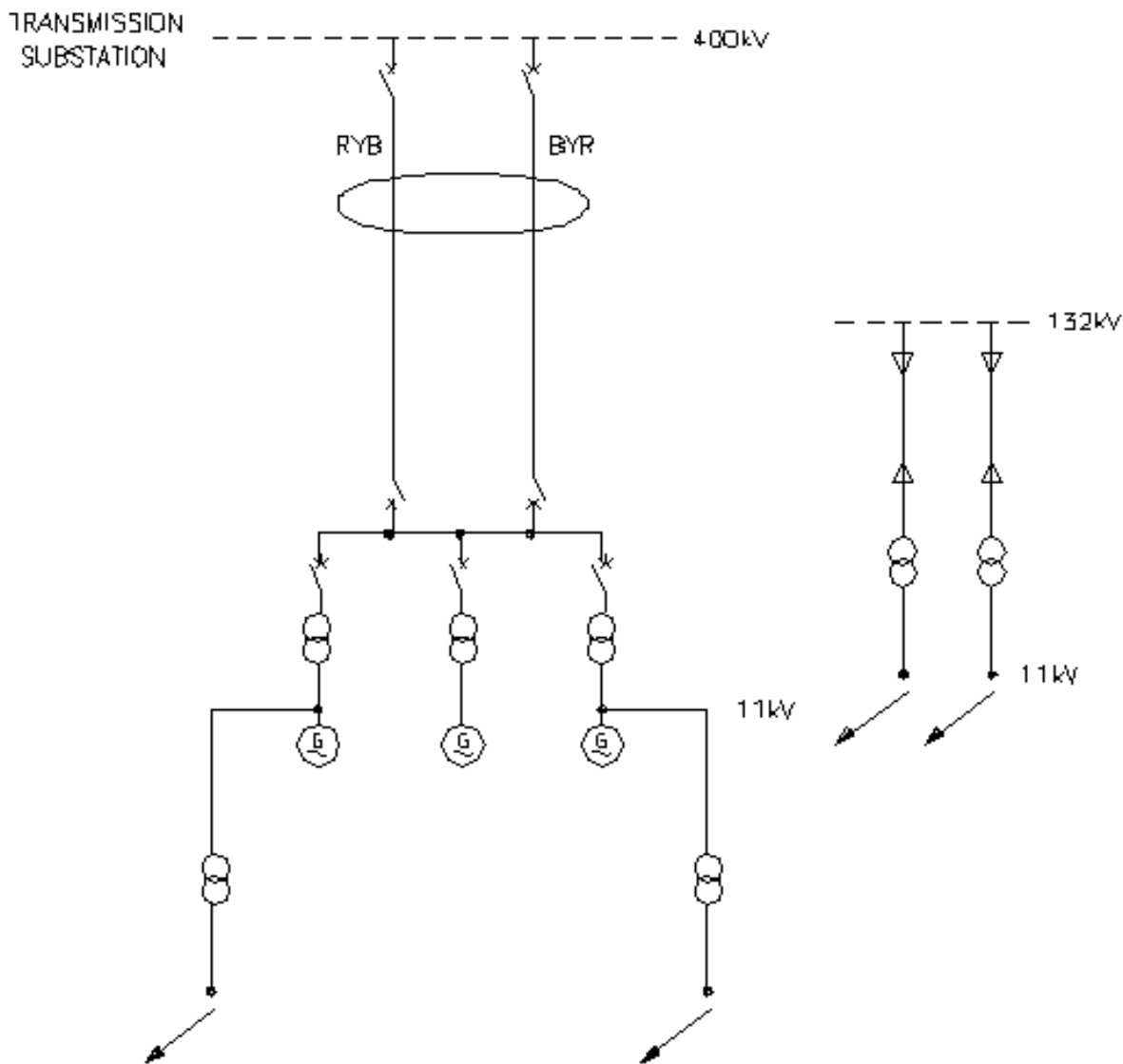

- KEY**
- TRANSMISSION OWNERSHIP
 - USER OWNERSHIP
 - ↙ DEMAND SUPPLIED
 - ⊖ TWO CIRCUITS ON SAME TOWERS (DOUBLE CIRCUIT)
 - ⚡ UNDERGROUND CABLE

TRANSMISSION OWNERSHIP
 NOT SHOWN IN
 THIS DIAGRAM

ISS D
 41/19468_1_1 29-07-04

Power Park Module Single Line Diagram

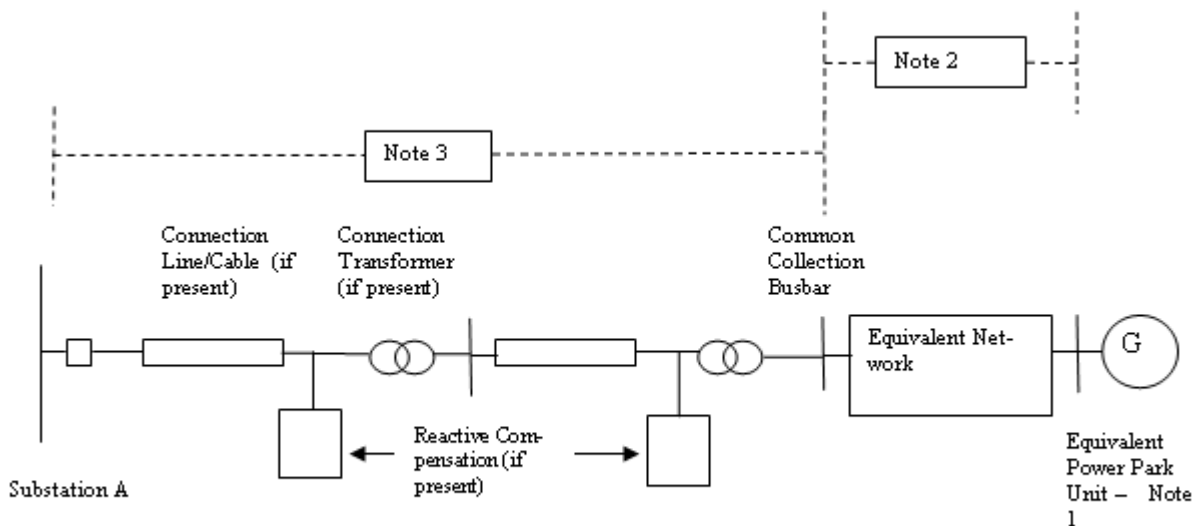

Notes:

- (1) The electrically equivalent **Power Park Unit** consists of a number of actual **Power Park Units** of the same type ie. any equipment external to the **Power Park Unit** terminals is considered as part of the equivalent network. **Power Park Units** of different types shall be included in separate electrically equivalent **Power Park Units**. The total number of equivalent **Power Park Units** shall represent all of the actual **Power Park Units** in the **Power Park Module** (which could be a **DC Connected Power Park Module**).
- (2) Separate electrically equivalent networks are required for each different type of electrically equivalent **Power Park Unit**. The electrically equivalent network shall include all equipment between the **Power Park Unit** terminals and the **Common Collection Busbar**.
- (3) All **Plant** and **Apparatus** including the circuit breakers, transformers, lines, cables and reactive compensation plant between the **Common Collection Busbar** and Substation A shall be shown.

APPENDIX C - TECHNICAL AND DESIGN CRITERIA

- PC.C.1 Planning and design of the **SPT** and **SHETL Transmission Systems** is based generally, but not totally, on criteria which evolved from joint consultation among various **Transmission Licensees** responsible for design of the **National Electricity Transmission System**.
- PC.C.2 The above criteria are set down within the standards, memoranda, recommendations and reports and are provided as a guide to system planning. It should be noted that each scheme for reinforcement or modification of the **Transmission System** is individually designed in the light of economic and technical factors associated with the particular system limitations under consideration.
- PC.C.3 The tables below identify the literature referred to above, together with the main topics considered within each document.

PART 1 – SHETL's TECHNICAL AND DESIGN CRITERIA

ITEM No.	DOCUMENT	REFERENCE No.
1	National Electricity Transmission System Security and Quality of Supply Standard	Version []
2	System Phasing	TPS 13/4
3	Not used	
4	Voltage fluctuations and the connection of disturbing equipment to transmission systems and distribution networks in the United Kingdom	EREC P28 Issue 2
5	EHV or HV Supplies to Induction Furnaces Voltage unbalance limits. Harmonic current limits.	ER P16 (Supported by ACE Report No.48)
6	Planning Levels for Harmonic Voltage Distortion and the Connection of Non-Linear Loads to Transmission Systems and Public Electricity Supply Systems in the United Kingdom Harmonic distortion (waveform). Harmonic voltage distortion. Harmonic current distortion. Stage 1 limits. Stage 2 limits. Stage 3 Limits Addition of Harmonics Short Duration Harmonics Site Measurements	ER G5 (Supported by ACE Report No.73)
7	AC Traction Supplies to British Rail Type of supply point to railway system. Estimation of traction loads. Nature of traction current. System disturbance estimation. Earthing arrangements.	ER P24

ITEM No.	DOCUMENT	REFERENCE No.
8	Operational Memoranda Main System operating procedure. Operational standards of security. Voltage and reactive control on main system. System warnings and procedures for instructed load reduction. Continuous tape recording of system control telephone messages and instructions. Emergency action in the event of an exceptionally serious breakdown of the main system.	(SOM) SOM 1 SOM 3 SOM 4 SOM 7 SOM 10 SOM 15
9	Planning Limits for Voltage Unbalance in the United Kingdom.	ER P29

PART 2 - SPT's TECHNICAL AND DESIGN CRITERIA

ITEM No.	DOCUMENT	REFERENCE No.
1	National Electricity Transmission System Security and Quality of Supply Standard	Version []
2	System Phasing	TDM 13/10,002 Issue 4
3	Not used	
4	Voltage fluctuations and the connection of disturbing equipment to transmission systems and distribution networks in the United Kingdom	EREC P28 Issue 2
5	EHV or HV Supplies to Induction Furnaces Voltage Unbalance limits. Harmonic current limits.	ER P16 (Supported by ACE Report No.48)
6	Planning Levels for Harmonic Voltage Distortion and the Connection of Non-Linear Loads to Transmission Systems and Public Electricity Supply Systems in the United Kingdom Harmonic distortion (waveform). Harmonic voltage distortion. Harmonic current distortion. Stage 1 limits. Stage 2 limits. Stage 3 Limits Addition of Harmonics Short Duration Harmonics Site Measurements	ER G5 (Supported by ACE Report No.73)
7	AC Traction Supplies to British Rail Type of supply point to railway system. Estimation of traction loads. Nature of traction current. System disturbance estimation. Earthing arrangements.	ER P24

APPENDIX D - DATA NOT DISCLOSED TO A RELEVANT TRANSMISSION LICENSEE

PC.D.1 Pursuant to PC.3.4, **The Company** will not disclose to a **Relevant Transmission Licensee** data items specified in the below extract:

PC REFERENCE	DATA DESCRIPTION	UNITS	DATA CATEGORY
PC.A.3.2.2 (f) (i)	<p>(i) For GB Code Users</p> <p>The Generator Performance Chart at the Generating Unit stator terminals</p> <p>(ii) For EU Code Users:-</p> <p>The Power Generating Module Performance Chart, and Synchronous Generating Unit Performance Chart;</p>		SPD
PC.A.3.2.2 (b)	Output Usable (on a monthly basis)	MW	SPD
PC.A.5.3.2 (d) Option 1 (iii)	<p>GOVERNOR AND ASSOCIATED PRIME MOVER PARAMETERS</p> <p>Option 1</p> <p>BOILER & STEAM TURBINE DATA</p> <p>Boiler time constant (Stored Active Energy)</p> <p>HP turbine response ratio: (Proportion of Primary Response arising from HP turbine)</p> <p>HP turbine response ratio: (Proportion of High Frequency Response arising from HP turbine)</p>	<p>S</p> <p>%</p> <p>%</p>	<p>DPD II</p> <p>DPD II</p> <p>DPD II</p>
Part of PC.A.5.3.2 (d) Option 2 (i)	<p>Option 2</p> <p>All Generating Units (including Synchronous Generating Units forming part of a Synchronous Power Generating Module)</p> <p>Governor Deadband or (Frequency Response Deadband and Frequency Response Insensitivity)*</p> <p>- Maximum Setting</p> <p>- Normal Setting</p> <p>- Minimum Setting</p> <p>*(Note GB Generators who are not required to satisfy the requirements of the European Connection Conditions do not need to supply Frequency Response Deadband or Frequency Response Insensitivity data).</p>	<p>±Hz</p> <p>±Hz</p> <p>±Hz</p>	<p>DPD II</p> <p>DPD II</p> <p>DPD II</p>
Part of PC.A.5.3.2 (d) Option 2 (ii)	Steam Units		

PC REFERENCE	DATA DESCRIPTION	UNITS	DATA CATEGORY
	Reheater Time Constant	sec	DPD II
	Boiler Time Constant	sec	DPD II
	HP Power Fraction	%	DPD II
	IP Power Fraction	%	DPD II
Part of PC.A.5.3.2 (d) Option 2 (iii)	Gas Turbine Units Waste Heat Recovery Boiler Time Constant		
Part of PC.A.5.3.2 (e)	UNIT CONTROL OPTIONS Maximum droop Minimum droop Maximum Governor Deadband or (Maximum Frequency Response Deadband and Maximum Frequency Response Insensitivity)* Normal Governor Deadband or (normal Frequency Response Deadband and normal Frequency Response Insensitivity)* Minimum Governor Deadband or (minimum Frequency Response Deadband and minimum Frequency Response Insensitivity)* Maximum Output Governor Deadband or (Maximum Output Frequency Response Deadband and Maximum Output Frequency Response Insensitivity)* Normal Output Governor Deadband or (Normal Output Frequency Response Deadband and Normal Output Frequency Response Insensitivity)* Minimum Output Governor Deadband or (Minimum Output Frequency Response Deadband and Minimum Output Frequency Response Insensitivity)* (Note Generators who are not required to satisfy the requirements of the European Connection Conditions do not need to supply Frequency Response Deadband and Frequency Response Insensitivity data). Frequency settings between which Unit Load Controller droop applies: Maximum Normal Minimum Sustained response normally selected	% % ±Hz ±Hz ±Hz ±MW ±MW ±MW Hz Hz Hz Yes/No	DPD II DPD II DPD II DPD II DPD II DPD II DPD II DPD II DPD II DPD II DPD II DPD II DPD II
PC.A.3.2.2 (f) (ii)	Performance Chart of a Power Park Modules (including DC Connected Power Park Modules) at the connection point		SPD

PC REFERENCE	DATA DESCRIPTION	UNITS	DATA CATEGORY
PC.A.3.2.2 (b)	Output Usable (on a monthly basis)	MW	SPD
PC.A.3.2.2 (e) and (j)	DC CONVERTER STATION AND HVDC SYSTEM DATA ACTIVE POWER TRANSFER CAPABILITY (PC.A.3.2.2) Import MW available in excess of Registered Import Capacity . Time duration for which MW in excess of Registered Import Capacity is available Export MW available in excess of Registered Capacity . Time duration for which MW in excess of Registered Capacity is available	MW Min MW Min	SPD SPD SPD SPD
Part of PC.A.5.4.3.3	LOADING PARAMETERS MW Export Nominal loading rate Maximum (emergency) loading rate MW Import Nominal loading rate Maximum (emergency) loading rate	MW MW/s MW/s MW/s MW/s	SPD DPD I DPD I DPD I DPD I

**APPENDIX E - OFFSHORE TRANSMISSION SYSTEM AND OTSDUW PLANT AND APPARATUS
TECHNICAL AND DESIGN CRITERIA**

PC.E.1 In the absence of any relevant **Electrical Standards, Offshore Transmission Licensees** and **Generators** undertaking **OTSDUW** are required to ensure that all equipment used in the construction of their network is:

- (i) Fully compliant and suitably designed to any relevant **Technical Specification**;
- (ii) Suitable for use and operation in an **Offshore** environment, where such parts of the **Offshore Transmission System** and **OTSDUW Plant and Apparatus** are located in **Offshore Waters** and are not installed in an area that is protected from that **Offshore** environment, and
- (iii) Compatible with any relevant **Electrical Standards** or **Technical Specifications** at the **Offshore Grid Entry Point** and **Interface Point**.

PC.E.2 The table below identifies the technical and design criteria that will be used in the design and development of an **Offshore Transmission System** and **OTSDUW Plant and Apparatus**.

ITEM No.	DOCUMENT	REFERENCE No.
1	National Electricity Transmission System Security and Quality of Supply Standard	Version []
2*	Voltage fluctuations and the connection of disturbing equipment to transmission systems and distribution networks in the United Kingdom	EREC P28 Issue 2
3*	Planning Levels for Harmonic Voltage Distortion and the Connection of Non-Linear Loads to Transmission Systems and Public Electricity Supply Systems in the United Kingdom	ER G5
4*	Planning Limits for Voltage Unbalance in the United Kingdom	ER P29

* Note:- Items 2, 3 and 4 above shall only apply at the **Interface Point**.

APPENDIX F - OTSDUW DATA AND INFORMATION AND OTSDUW NETWORK DATA AND INFORMATION

- PC.F.1 Introduction
- PC.F.1.1 Appendix F specifies data requirements to be submitted to **The Company** by **Users** and **Users** by **The Company** in respect of **OTSDUW**.
- PC.F.1.2 Such **User** submissions shall be in accordance with the **OTSDUW Development and Data Timetable** in a **Construction Agreement**.
- PC.F.1.3 Such submissions shall be issued to **The Company** with the offer of a **CUSC Contract** in the case of the data in Part 1 and otherwise in accordance with the **OTSDUW Development and Data Timetable** in a **Construction Agreement**.
- PC.F.2. OTSDUW Network Data and Information
- PC.F.2.1 With the offer of a **CUSC Contract** under the **OTSDUW Arrangements** **The Company** shall provide:
- (a) the site specific technical design and operational criteria for the **Connection Site**;
 - (b) the site specific technical design and operational criteria for the **Interface Point**, and
 - (c) details of **The Company's** preliminary identification and consideration of the options available for the **Interface Point** in the context of the **User's** application for connection or modification, the preliminary costs used by **The Company** in assessing such options and the **Offshore Works Assumptions** including the assumed **Interface Point** identified during these preliminary considerations.
- PC.F.2.2 In accordance with the **OTSDUW Development and Data Timetable** in a **Construction Agreement** **The Company** shall provide the following information and data to a **User**:
- (a) equivalent of the fault infeed or fault level ratings at the Interface Point (as identified in the **Offshore Works Assumptions**)
 - (b) notification of numbering and nomenclature of the **HV Apparatus** comprised in the **OTSDUW**;
 - (i) past or present physical properties, including both actual and designed physical properties, of **Plant** and **Apparatus** forming part of the **National Electricity Transmission System** at the Interface Point at which the **OTSUA** will be connected to the extent it is required for the design and construction of the **OTSDUW**, including but not limited to:
 - (ii) the voltage of any part of such **Plant** and **Apparatus**;
 - (iii) the electrical current flowing in or over such **Plant** and **Apparatus**;
 - (iv) the configuration of any part of such **Plant** and **Apparatus**
 - (v) the temperature of any part of such **Plant** and **Apparatus**;
 - (vi) the pressure of any fluid forming part of such **Plant** and **Apparatus**
 - (vii) the electromagnetic properties of such **Plant** and **Apparatus**; and
 - (viii) the technical specifications, settings or operation of any **Protection Systems** forming part of such **Plant** and **Apparatus**.
 - (c) information necessary to enable the **User** to harmonise the **OTSDUW** with construction works elsewhere on the **National Electricity Transmission System** that could affect the **OTSDUW**;
 - (d) information related to the current or future configuration of any circuits of the **Onshore Transmission System** with which the **OTSUA** are to connect;
 - (e) any changes which are planned on the **National Electricity Transmission System** in the current or following six **Financial Years** and which will materially affect the planning or development of the **OTSDUW**.

- PC.F.2.3 At the **Users** reasonable request, additional information and data in respect of the **National Electricity Transmission System** shall be provided.
- PC.F.2.4 OTSDUW Data And Information
- PC.F.2.4.1 In accordance with the **OTSDUW Development and Data Timetable** in a **Construction Agreement**, the **User** shall provide to **The Company**, the following information and data relating to the **OTSDUW Plant and Apparatus** in accordance with Appendix A of the **Planning Code**.

< END OF PLANNING CODE >

EUROPEAN CONNECTION CONDITIONS

(ECC)

CONTENTS

(This contents page does not form part of the Grid Code)

<u>Paragraph No/Title</u>	<u>Page Number</u>
ECC.1 INTRODUCTION	2
ECC.2 OBJECTIVE	3
ECC.3 SCOPE	3
ECC.4 PROCEDURE	5
ECC.5 CONNECTION.....	5
ECC.6 TECHNICAL, DESIGN AND OPERATIONAL CRITERIA	7
ECC.7 SITE RELATED CONDITIONS.....	81
ECC.8 ANCILLARY SERVICES.....	87
APPENDIX E1 - SITE RESPONSIBILITY SCHEDULES.....	88
PROFORMA FOR SITE RESPONSIBILITY SCHEDULE	91
APPENDIX E2 - OPERATION DIAGRAMS	97
PART 1A - PROCEDURES RELATING TO OPERATION DIAGRAMS	97
PART E1B - PROCEDURES RELATING TO GAS ZONE DIAGRAMS.....	100
PART E2 - NON-EXHAUSTIVE LIST OF APPARATUS TO BE INCLUDED ON OPERATION DIAGRAMS.....	101
APPENDIX E3 - MINIMUM FREQUENCY RESPONSE CAPABILITY REQUIREMENT PROFILE AND OPERATING RANGE FOR POWER GENERATING MODULES AND HVDC EQUIPMENT	103
APPENDIX 4 - FAULT RIDE THROUGH REQUIREMENTS.....	109
APPENDIX E5 - TECHNICAL REQUIREMENTS LOW FREQUENCY RELAYS FOR THE AUTOMATIC DISCONNECTION OF SUPPLIES AT LOW FREQUENCY	115
APPENDIX E6 - PERFORMANCE REQUIREMENTS FOR CONTINUOUSLY ACTING AUTOMATIC EXCITATION CONTROL SYSTEMS FOR ONSHORE SYNCHRONOUS GENERATING UNITS....	118
APPENDIX E7 - PERFORMANCE REQUIREMENTS FOR CONTINUOUSLY ACTING AUTOMATIC VOLTAGE CONTROL SYSTEMS FOR ONSHORE NON-SYNCHRONOUS GENERATING UNITS, ONSHORE DC CONVERTERS, ONSHORE POWER PARK MODULES AND OTSDUW PLANT AND APPARATUS AT THE INTERFACE POINT	122
APPENDIX E8 - PERFORMANCE REQUIREMENTS FOR CONTINUOUSLY ACTING AUTOMATIC VOLTAGE CONTROL SYSTEMS FOR CONFIGURATION 2 AC CONNECTED OFFSHORE POWER PARK MODULES AND CONFIGURATION 2 DC CONNECTED POWER PARK MODULES	129

ECC.1

INTRODUCTION

ECC.1.1

The **European Connection Conditions** ("**ECC**") specify both:

- (a) the minimum technical, design and operational criteria which must be complied with by:
 - (i) any **EU Code User** connected to or seeking connection with the **National Electricity Transmission System**, or
 - (ii) **EU Generators** or **HVDC System Owners** connected to or seeking connection to a **User's System** which is located in **Great Britain** or **Offshore**, or
 - (iii) **Network Operators** who are **EU Code Users**
 - (iv) **Network Operators** who are **GB Code Users** but only in respect of:-
 - (a) Their obligations in respect of **Embedded Medium Power Stations** not subject to a **Bilateral Agreement** for whom the requirements of ECC.3.1(b)(iii) apply alone; and/or
 - (b) The requirements of this **ECC** only in relation to each **EU Grid Supply Point. Network Operators** in respect of all other **Grid Supply Points** should continue to satisfy the requirements as specified in the **CCs**.
 - (v) **Non-Embedded Customers** who are **EU Code Users**
- (b) the minimum technical, design and operational criteria with which **The Company** will comply in relation to the part of the **National Electricity Transmission System** at the **Connection Site** with **Users**. In the case of any **OTSDUW Plant and Apparatus**, the **ECC** also specify the minimum technical, design and operational criteria which must be complied with by the **User** when undertaking **OTSDUW**.
- (c) The requirements of **Retained EU Law** (Commission Regulation (EU) 2016/631) shall not apply to
 - (i) **Power Generating Modules** that are installed to provide backup power and operate in parallel with the **Total System** for less than 5 minutes per calendar month while the **System** is in normal state. Parallel operation during maintenance or commissioning of tests of that **Power Generating Module** shall not count towards that five minute limit.
 - (ii) **Power Generating Modules** connected to the **Transmission System** or **Network Operators System** which are not operated in synchronism with a **Synchronous Area**.
 - (iii) **Power Generating Modules** that do not have a permanent **Connection Point** or **User System Entry Point** and used by **The Company** to temporarily provide power when normal **System** capacity is partly or completely unavailable.
 - (iv) **Electricity Storage Modules**.
- (d) **Storage Users** are required to comply with the entirety of the **ECC** but are not subject to the requirements of **Retained EU Law** (Commission Regulation (EU) 2016/631, Commission Regulation (EU) 2016/1388 and Commission Regulation (EU) 2016/1485). The requirements of the **ECC** shall therefore be enforceable against **Storage Users** under the Grid Code only (and not under any of the aforementioned **Retained EU Law**) and any derogation sought by a **Storage User** in respect of the **ECC** shall be deemed a derogation from the Grid Code only (and not from the aforementioned **Retained EU Law**).

ECC.2 OBJECTIVE

- ECC.2.1 The objective of the **ECC** is to ensure that by specifying minimum technical, design and operational criteria the basic rules for connection to the **National Electricity Transmission System** and (for certain **Users**) to a **User's System** are similar for all **Users** of an equivalent category and will enable **The Company** to comply with its statutory and **Transmission Licence** obligations and the applicable **Retained EU Law**.
- ECC.2.2 In the case of any **OTSDUW** the objective of the **ECC** is to ensure that by specifying the minimum technical, design and operational criteria the basic rules relating to an **Offshore Transmission System** designed and constructed by an **Offshore Transmission Licensee** and designed and/or constructed by a **User** under the **OTSDUW Arrangements** are equivalent.
- ECC.2.3 Provisions of the **ECC** which apply in relation to **OTSDUW** and **OTSUA**, and/or a **Transmission Interface Site**, shall (in any particular case) apply up to the **OTSUA Transfer Time**, whereupon such provisions shall (without prejudice to any prior non-compliance) cease to apply, without prejudice to the continuing application of provisions of the **ECC** applying in relation to the relevant **Offshore Transmission System** and/or **Connection Site**. It is the case therefore that in cases where the **OTSUA** becomes operational prior to the **OTSUA Transfer Time** that a **EU Generator** is required to comply with this **ECC** both as it applies to its **Plant** and **Apparatus** at a **Connection Site/Connection Point** and the **OTSUA** at the **Transmission Interface Site/Transmission Interface Point** until the **OTSUA Transfer Time** and this **ECC** shall be construed accordingly.
- ECC.2.4 In relation to **OTSDUW**, provisions otherwise to be contained in a **Bilateral Agreement** may be contained in the **Construction Agreement**, and accordingly a reference in the **ECC** to a relevant **Bilateral Agreement** includes the relevant **Construction Agreement**.

ECC.3 SCOPE

- ECC.3.1 The **ECC** applies to **The Company** and to **Users**, which in the **ECC** means:
- (a) **EU Generators** (other than those which only have **Embedded Small Power Stations**), including those undertaking **OTSDUW** including **Power Generating Modules**, and **DC Connected Power Park Modules**. For the avoidance of doubt, **Electricity Storage Modules** are included within the definition of **Power Generating Modules** for which the requirements of the **ECC** would be equally applicable.
 - (b) **Network Operators** but only in respect of:-
 - (i) **Network Operators** who are **EU Code Users**
 - (ii) **Network Operators** who only have **EU Grid Supply Points**
 - (iii) **Embedded Medium Power Stations** not subject to a **Bilateral Agreement** as provided for in ECC.3.2, ECC.3.3, EC3.4, EC3.5, ECC5.1, ECC.6.4.4 and ECA.3.4;
 - (iv) Notwithstanding the requirements of ECC3.1(b)(i)(ii) and (iii) , **Network Operators** who own and/or operate **EU Grid Supply Points**, are only required to satisfy the requirements of this **ECC** in relation to each **EU Grid Supply Point**. **Network Operators** in respect of all other **Grid Supply Points** should continue to satisfy the requirements as specified in the **CCs**.
 - (c) **Non-Embedded Customers** who are also **EU Code Users** ;
 - (d) **HVDC System Owners** who are also **EU Code Users**; and
 - (e) **BM Participants** and **Externally Interconnected System Operators** who are also **EU Code Users** in respect of ECC.6.5 only.

ECC.3.2 The above categories of **User** will become bound by the applicable sections of the **ECC** prior to them generating, distributing, storing, supplying or consuming, as the case may be, and references to the various categories should, therefore, be taken as referring to them in that prospective role.

ECC.3.3 **Embedded Medium Power Stations** not subject to a **Bilateral Agreement** and **Embedded HVDC Systems** not subject to a **Bilateral Agreement** Provisions.

The following provisions apply in respect of **Embedded Medium Power Stations** not subject to a **Bilateral Agreement** and **Embedded HVDC Systems** not subject to a **Bilateral Agreement**.

ECC.3.3.1 The obligations within the **ECC** that are expressed to be applicable to **EU Generators** in respect of **Embedded Medium Power Stations** not subject to a **Bilateral Agreement** and **HVDC System Owners** in respect of **Embedded HVDC Systems** not subject to a **Bilateral Agreement** (where the obligations are in each case listed in ECC.3.3.2) shall be read and construed as obligations that the **Network Operator** within whose **System** any such **Medium Power Station** or **HVDC System** is **Embedded** must ensure are performed and discharged by the **EU Generator** or the **HVDC Owner**. **Embedded Medium Power Stations** not subject to a **Bilateral Agreement** and **Embedded HVDC Systems** not subject to a **Bilateral Agreement** which are located **Offshore** and which are connected to an **Onshore User System** will be required to meet the applicable requirements of the Grid Code as though they are an **Onshore Generator** or **Onshore HVDC System Owner** connected to an **Onshore User System Entry Point**.

ECC.3.3.2 The **Network Operator** within whose **System** a **Medium Power Station** not subject to a **Bilateral Agreement** is **Embedded** or a **HVDC System** not subject to a **Bilateral Agreement** is **Embedded** must ensure that the following obligations in the **ECC** are performed and discharged by the **EU Generator** in respect of each such **Embedded Medium Power Station** or the **HVDC System Owner** in the case of an **Embedded HVDC System**:

ECC.5.1

ECC.5.2.2

ECC.5.3

ECC.6.1.3

ECC.6.1.5 (b)

ECC.6.3.2, ECC.6.3.3, ECC.6.3.4, ECC.6.3.6, ECC.6.3.7, ECC.6.3.8, ECC.6.3.9, ECC.6.3.10, ECC.6.3.12, ECC.6.3.13, ECC.6.3.15, ECC.6.3.16

ECC.6.4.4

ECC.6.5.6 (where required by ECC.6.4.4)

In respect of ECC.6.2.2.2, ECC.6.2.2.3, ECC.6.2.2.5, ECC.6.1.5(a), ECC.6.1.5(b) and ECC.6.3.11 equivalent provisions as co-ordinated and agreed with the **Network Operator** and **EU Generator** or **HVDC System Owner** may be required. Details of any such requirements will be notified to the **Network Operator** in accordance with ECC.3.5.

ECC.3.3.3 In the case of **Embedded Medium Power Stations** not subject to a **Bilateral Agreement** and **Embedded HVDC Systems** not subject to a **Bilateral Agreement** the requirements in:

ECC.6.1.6

ECC.6.3.8

ECC.6.3.12

ECC.6.3.15

ECC.6.3.16

ECC.6.3.17

that would otherwise have been specified in a **Bilateral Agreement** will be notified to the relevant **Network Operator** in writing in accordance with the provisions of the **CUSC** and the **Network Operator** must ensure such requirements are performed and discharged by the **Generator** or the **HVDC System** owner.

ECC.3.4 In the case of **Offshore Embedded Power Generating Modules** connected to an **Offshore User's System** which directly connects to an **Offshore Transmission System**, any additional requirements in respect of such **Offshore Embedded Power Generating Modules** may be specified in the relevant **Bilateral Agreement** with the **Network Operator** or in any **Bilateral Agreement** between **The Company** and such **Offshore Generator**.

ECC.3.5 In the case of a **Generator** undertaking **OTSDUW** connecting to an **Onshore Network Operator's System**, any additional requirements in respect of such **OTSDUW Plant and Apparatus** will be specified in the relevant **Bilateral Agreement** with the **EU Generator**. For the avoidance of doubt, requirements applicable to **EU Generators** undertaking **OTSDUW** and connecting to a **Network Operator's User System**, shall be consistent with those applicable requirements of **Generators** undertaking **OTSDUW** and connecting to a **Transmission Interface Point**.

ECC.3.6 The requirements of this **ECC** shall apply to **EU Code Users** in respect of **Power Generating Modules** (including **DC Connected Power Park Modules** and **Electricity Storage Modules**) and **HVDC Systems**.

ECC.4 PROCEDURE

ECC.4.1 The **CUSC** contains certain provisions relating to the procedure for connection to the **National Electricity Transmission System** or, in the case of **Embedded Power Stations** or **Embedded HVDC Systems**, becoming operational and includes provisions relating to certain conditions to be complied with by **EU Code Users** prior to and during the course of **The Company** notifying the **User** that it has the right to become operational. The procedure for an **EU Code User** to become connected is set out in the **Compliance Processes**.

ECC.5 CONNECTION

ECC.5.1 The provisions relating to connecting to the **National Electricity Transmission System** (or to a **User's System** in the case of a connection of an **Embedded Large Power Station** or **Embedded Medium Power Stations** or **Embedded HVDC System**) are contained in:

- (a) the **CUSC** and/or **CUSC Contract** (or in the relevant application form or offer for a **CUSC Contract**);
- (b) or, in the case of an **Embedded Development**, the relevant **Distribution Code** and/or the **Embedded Development Agreement** for the connection (or in the relevant application form or offer for an **Embedded Development Agreement**),

and include provisions relating to both the submission of information and reports relating to compliance with the relevant **European Connection Conditions** for that **EU Code User**, **Safety Rules**, commissioning programmes, **Operation Diagrams** and approval to connect (and their equivalents in the case of **Embedded Medium Power Stations** not subject to a **Bilateral Agreement** or **Embedded HVDC Systems** not subject to a **Bilateral Agreement**). References in the **ECC** to the "**Bilateral Agreement**" and/or "**Construction Agreement**" and/or "**Embedded Development Agreement**" shall be deemed to include references to the application form or offer therefor.

ECC.5.2 Items For Submission

ECC.5.2.1

Prior to the **Completion Date** (or, where the **EU Generator** is undertaking **OTSDUW**, any later date specified) under the **Bilateral Agreement** and/or **Construction Agreement**, the following is submitted pursuant to the terms of the **Bilateral Agreement** and/or **Construction Agreement**:

- (a) updated **Planning Code** data (both **Standard Planning Data** and **Detailed Planning Data**), with any estimated values assumed for planning purposes confirmed or, where practical, replaced by validated actual values and by updated estimates for the future and by updated forecasts for **Forecast Data** items such as **Demand**, pursuant to the requirements of the **Planning Code**;
- (b) details of the **Protection** arrangements and settings referred to in ECC.6;
- (c) copies of all **Safety Rules** and **Local Safety Instructions** applicable at **Users' Sites** which will be used at the **Transmission/User** interface (which, for the purpose of **OC8**, must be to **The Company's** satisfaction regarding the procedures for **Isolation** and **Earthing**. **The Company** will consult the **Relevant Transmission Licensee** when determining whether the procedures for **Isolation** and **Earthing** are satisfactory);
- (d) information to enable the preparation of the **Site Responsibility Schedules** on the basis of the provisions set out in Appendix 1;
- (e) an **Operation Diagram** for all **HV Apparatus** on the **User** side of the **Connection Point** as described in ECC.7;
- (f) the proposed name of the **User Site** (which shall not be the same as, or confusingly similar to, the name of any **Transmission Site** or of any other **User Site**);
- (g) written confirmation that **Safety Co-ordinators** acting on behalf of the **User** are authorised and competent pursuant to the requirements of **OC8**;
- (h) Such **RISSP** prefixes pursuant to the requirements of **OC8**. Such **RISSP** prefixes shall be circulated utilising a proforma in accordance with **OC8**;
- (i) a list of the telephone numbers for **Joint System Incidents** at which senior management representatives nominated for the purpose can be contacted and confirmation that they are fully authorised to make binding decisions on behalf of the **User**, pursuant to **OC9**;
- (j) a list of managers who have been duly authorised to sign **Site Responsibility Schedules** on behalf of the **User**;
- (k) information to enable the preparation of the **Site Common Drawings** as described in ECC.7;
- (l) a list of the telephone numbers for the **Users** facsimile machines referred to in ECC.6.5.9; and
- (m) for **Sites** in Scotland and **Offshore** a list of persons appointed by the **User** to undertake operational duties on the **User's System** (including any **OTSDUW** prior to the **OTSUA Transfer Time**) and to issue and receive operational messages and instructions in relation to the **User's System** (including any **OTSDUW** prior to the **OTSUA Transfer Time**); and an appointed person or persons responsible for the maintenance and testing of **User's Plant** and **Apparatus**.

ECC.5.2.2

Prior to the **Completion Date** the following must be submitted to **The Company** by the **Network Operator** in respect of an **Embedded Development**:

- (a) updated **Planning Code** data (both **Standard Planning Data** and **Detailed Planning Data**), with any estimated values assumed for planning purposes confirmed or, where practical, replaced by validated actual values and by updated estimates for the future and by updated forecasts for **Forecast Data** items such as **Demand**, pursuant to the requirements of the **Planning Code**;
- (b) details of the **Protection** arrangements and settings referred to in ECC.6;

- (c) the proposed name of the **Embedded Medium Power Station** or **Embedded HVDC System** (which shall be agreed with **The Company** unless it is the same as, or confusingly similar to, the name of other **Transmission Site** or **User Site**);
- ECC.5.2.3 Prior to the **Completion Date** contained within an **Offshore Transmission Distribution Connection Agreement** the following must be submitted to **The Company** by the **Network Operator** in respect of a proposed new **Interface Point** within its **User System**:
- (a) updated **Planning Code** data (both **Standard Planning Data** and **Detailed Planning Data**), with any estimated values assumed for planning purposes confirmed or, where practical, replaced by validated actual values and by updated estimates for the future and by updated forecasts for **Forecast Data** items such as **Demand**, pursuant to the requirements of the **Planning Code**;
- (b) details of the **Protection** arrangements and settings referred to in ECC.6;
- (c) the proposed name of the **Interface Point** (which shall not be the same as, or confusingly similar to, the name of any **Transmission Site** or of any other **User Site**);
- ECC.5.2.4 In the case of **OTSDUW Plant and Apparatus** (in addition to items under ECC.5.2.1 in respect of the **Connection Site**), prior to the **Completion Date** (or any later date specified) under the **Construction Agreement** the following must be submitted to **The Company** by the **User** in respect of the proposed new **Connection Point** and **Interface Point**:
- (a) updated **Planning Code** data (**Standard Planning Data**, **Detailed Planning Data** and **OTSDUW Data and Information**), with any estimated values assumed for planning purposes confirmed or, where practical, replaced by validated actual values and by updated estimates for the future and by updated forecasts for **Forecast Data** items such as **Demand**, pursuant to the requirements of the **Planning Code**;
- (b) details of the **Protection** arrangements and settings referred to in ECC.6;
- (c) information to enable preparation of the **Site Responsibility Schedules** at the **Transmission Interface Site** on the basis of the provisions set out in Appendix E1.
- (d) the proposed name of the **Interface Point** (which shall not be the same as, or confusingly similar to, the name of any **Transmission Site** or of any other **User Site**);
- ECC.5.3 (a) Of the items ECC.5.2.1 (c), (e), (g), (h), (k) and (m) need not be supplied in respect of **Embedded Power Stations** or **Embedded HVDC Systems**,
- (b) item ECC.5.2.1(i) need not be supplied in respect of **Embedded Small Power Stations** and **Embedded Medium Power Stations** or **Embedded HVDC Systems** with a **Registered Capacity** of less than 100MW, and
- (c) items ECC.5.2.1(d) and (j) are only needed in the case where the **Embedded Power Station** or the **Embedded HVDC System** is within a **Connection Site** with another **User**.

ECC.6 TECHNICAL, DESIGN AND OPERATIONAL CRITERIA

ECC.6.1 National Electricity Transmission System Performance Characteristics

ECC.6.1.1 **The Company** shall ensure that, subject as provided in the **Grid Code**, the **National Electricity Transmission System** complies with the following technical, design and operational criteria in relation to the part of the **National Electricity Transmission System** at the **Connection Site** with a **User** and in the case of **OTSDUW Plant and Apparatus**, a **Transmission Interface Point** (unless otherwise specified in ECC.6) although in relation to operational criteria **The Company** may be unable (and will not be required) to comply with this obligation to the extent that there are insufficient **Power Stations** or **User Systems** are not available or **Users** do not comply with **The Company's** instructions or otherwise do not comply with the **Grid Code** and each **User** shall ensure that its **Plant** and **Apparatus** complies with the criteria set out in ECC.6.1.5.

ECC.6.1.2 Grid Frequency Variations

ECC.6.1.2.1 Grid Frequency Variations

ECC.6.1.2.1.1 The **Frequency** of the **National Electricity Transmission System** shall be nominally 50Hz and shall be controlled within the limits of 49.5 - 50.5Hz unless exceptional circumstances prevail.

ECC.6.1.2.1.2 The **System Frequency** could rise to 52Hz or fall to 47Hz in exceptional circumstances. Design of **User's Plant and Apparatus** and **OTSDUW Plant and Apparatus** must enable operation of that **Plant and Apparatus** within that range in accordance with the following:

<u>Frequency Range</u>	<u>Requirement</u>
51.5Hz - 52Hz	Operation for a period of at least 15 minutes is required each time the Frequency is above 51.5Hz.
51Hz - 51.5Hz	Operation for a period of at least 90 minutes is required each time the Frequency is above 51Hz.
49.0Hz - 51Hz	Continuous operation is required
47.5Hz - 49.0Hz	Operation for a period of at least 90 minutes is required each time the Frequency is below 49.0Hz.
47Hz - 47.5Hz	Operation for a period of at least 20 seconds is required each time the Frequency is below 47.5Hz.

ECC.6.1.2.1.3 For the avoidance of doubt, disconnection, by frequency or speed based relays is not permitted within the frequency range 47.5Hz to 51.5Hz. **EU Generators** should however be aware of the combined voltage and frequency operating ranges as defined in ECC.6.3.12 and ECC.6.3.13.

ECC.6.1.2.1.4 **The Company** in co-ordination with the **Relevant Transmission Licensee** and/or **Network Operator** and a **User** may agree on wider variations in frequency or longer minimum operating times to those set out in ECC.6.1.2.1.2 or specific requirements for combined frequency and voltage deviations. Any such requirements in relation to **Power Generating Modules** shall be in accordance with ECC.6.3.12 and ECC.6.3.13. A **User** shall not unreasonably withhold consent to apply wider frequency ranges or longer minimum times for operation taking account of their economic and technical feasibility.

ECC.6.1.2.2 Grid Frequency variations for HVDC Systems and Remote End HVDC Converter Stations

ECC.6.1.2.2.1 **HVDC Systems** and **Remote End HVDC Converter Stations** shall be capable of staying connected to the **System** and remaining operable within the frequency ranges and time periods specified in Table ECC.6.1.2.2 below. This requirement shall continue to apply during the **Fault Ride Through** conditions defined in ECC.6.3.15

Frequency Range (Hz)	Time Period for Operation (s)
47.0 – 47.5Hz	60 seconds
47.5 – 49.0Hz	90 minutes and 30 seconds
49.0 – 51.0Hz	Unlimited
51.0 – 51.5Hz	90 minutes and 30 seconds
51.5Hz – 52 Hz	20 minutes

Table ECC.6.1.2.2 – Minimum time periods **HVDC Systems** and **Remote End HVDC Converter Stations** shall be able to operate for different frequencies deviating from a nominal value without disconnecting from the **National Electricity Transmission System**

ECC.6.1.2.2.2 **The Company** in coordination with the **Relevant Transmission Licensee** and a **HVDC System Owner** may agree wider frequency ranges or longer minimum operating times if required to preserve or restore system security. If wider frequency ranges or longer minimum times for operation are economically and technically feasible, the **HVDC System Owner** shall not unreasonably withhold consent.

ECC.6.1.2.2.3 Notwithstanding the requirements of ECC.6.1.2.2.1, an **HVDC System** or **Remote End HVDC Converter Station** shall be capable of automatic disconnection at frequencies specified by **The Company** and/or **Relevant Network Operator**.

ECC.6.1.2.2.4 In the case of **Remote End HVDC Converter Stations** where the **Remote End HVDC Converter Station** is operating at either nominal frequency other than 50Hz or a variable frequency, the requirements defined in ECC.6.1.2.2.1 to ECC.6.1.2.2.3 shall apply to the **Remote End HVDC Converter Station** other than in respect of the frequency ranges and time periods.

ECC.6.1.2.3 Grid Frequency Variations for DC Connected Power Park Modules

ECC.6.1.2.3.1 **DC Connected Power Park Modules** shall be capable of staying connected to the **Remote End DC Converter** network at the HVDC Interface Point and operating within the **Frequency** ranges and time periods specified in Table ECC.6.1.2.3 below. Where a nominal frequency other than 50Hz, or a **Frequency** variable by design is used as agreed with **The Company** and the **Relevant Transmission Licensee** the applicable **Frequency** ranges and time periods shall be specified in the **Bilateral Agreement** which shall (where applicable) reflect the requirements in Table ECC.6.1.2.3 .

Frequency Range (Hz)	Time Period for Operation (s)
47.0 – 47.5Hz	20 seconds
47.5 – 49.0Hz	90 minutes
49.0 – 51.0Hz	Unlimited
51.0 – 51.5Hz	90 minutes
51.5Hz – 52 Hz	15 minutes

Table ECC.6.1.2.3 – Minimum time periods a **DC Connected Power Park Module** shall be able to operate for different frequencies deviating from a nominal value without disconnecting from the **System**

ECC.6.1.2.3.2 **The Company** in coordination with the **Relevant Transmission Licensee** and a **Generator** may agree wider frequency ranges or longer minimum operating times if required to preserve or restore system security and to ensure the optimum capability of the **DC Connected Power Park Module**. If wider frequency ranges or longer minimum times for operation are economically and technically feasible, the **EU Generator** shall not unreasonably withhold consent.

ECC.6.1.3 Not used

ECC.6.1.4 Grid Voltage Variations

ECC.6.1.4.1 Grid Voltage Variations for Users excluding DC Connected Power Park Modules and Remote End HVDC Converters

The voltage on part of the **National Electricity Transmission System** operating at nominal voltages of greater than 300kV at each **Connection Site** with a **User** (and in the case of **OTSDUW Plant and Apparatus, a Transmission Interface Point, excluding DC Connected Power Park Modules and Remote End HVDC Converters**) will normally remain within $\pm 5\%$ of the nominal value unless abnormal conditions prevail. The minimum voltage is -10% and the maximum voltage is $+10\%$ unless abnormal conditions prevail, but voltages between $+5\%$ and $+10\%$ will not last longer than 15 minutes unless abnormal conditions prevail. For nominal voltages of 110kV and up to and including 300kV voltages on the parts of the **National Electricity Transmission System** at each **Connection Point** (and in the case of **OTSDUW Plant and Apparatus, a Transmission Interface Point**) will normally remain within the limits $\pm 10\%$ of the nominal value unless abnormal conditions prevail. At nominal **System** voltages below 110kV the voltage of the **National Electricity Transmission System** at each **Connection Site** with a **User** (and in the case of **OTSDUW Plant and Apparatus, a Transmission Interface Point**), excluding **Connection Sites for DC Connected Power Park Modules and Remote End HVDC Converters**) will normally remain within the limits $\pm 6\%$ of the nominal value unless abnormal conditions prevail. Under fault conditions, the voltage may collapse transiently to zero at the point of fault until the fault is cleared. The normal operating ranges of the **National Electricity Transmission System** are summarised below:

National Electricity Transmission System Nominal Voltage	Normal Operating Range		Time period for Operation
	Voltage (percentage of Nominal Voltage)	Pu (1pu relates to the Nominal Voltage)	
Greater than 300kV	V -10% to $+5\%$	0.90pu- 1.05pu	Unlimited
	V $+5\%$ to $+10\%$	1.05pu- 1.10pu	15 minutes
110kV up to 300kV	V $\pm 10\%$	0.90- 1.10pu	Unlimited
Below 110kV	$\pm 6\%$	0.94pu- 1.06pu	Unlimited

The **Company** and a **User** may agree greater variations or longer minimum time periods of operation in voltage to those set out above in relation to a particular **Connection Site**, and insofar as a greater variation is agreed, the relevant figure set out above shall, in relation to that **User** at the particular **Connection Site**, be replaced by the figure agreed.

ECC.6.1.4.2 Grid Voltage Variations for all DC Connected Power Park Modules

ECC.6.1.4.2.1 All **DC Connected Power Park Modules** shall be capable of staying connected to the **Remote End HVDC Converter Station** at the **HVDC Interface Point** and operating within the voltage ranges and time periods specified in Tables ECC.6.1.4.2(a) and ECC.6.1.4.2(b) below. The applicable voltage range and time periods specified are selected based on the reference 1pu voltage.

Voltage Range (pu)	Time Period for Operation (s)
0.85pu – 0.9pu	60 minutes
0.9pu – 1.1pu	Unlimited
1.1pu – 1.15pu	15 minutes

Table ECC.6.1.4.2(a) – Minimum time periods for which **DC Connected Power Park Modules** shall be capable of operating for different voltages deviating from reference 1pu without disconnecting from the network where the nominal voltage base is 110kV or above and less than 300kV.

Voltage Range (pu)	Time Period for Operation (s)
--------------------	-------------------------------

0.85pu – 0.9pu	60 minutes
0.9pu – 1.05pu	Unlimited
1.05pu – 1.15pu	15 minutes

Table ECC.6.1.4.2(b) – Minimum time periods for which **DC Connected Power Park Modules** shall be capable of operating for different voltages deviating from reference 1pu without disconnecting from the network where the nominal voltage base is from 300kV up to and including 400kV.

ECC.6.1.4.2.2 **The Company** and a **EU Generator** in respect of a **DC Connected Power Park Module** may agree greater voltage ranges or longer minimum operating times. If greater voltage ranges or longer minimum times for operation are economically and technically feasible, the **EU Generator** shall not unreasonably withhold any agreement.

ECC.6.1.4.2.3 For **DC Connected Power Park Modules** which have an **HVDC Interface Point** to the **Remote End HVDC Converter Station**, **The Company** in coordination with the **Relevant Transmission Licensee** may specify voltage limits at the **HVDC Interface Point** at which the **DC Connected Power Park Module** is capable of automatic disconnection.

ECC.6.1.4.2.4 For **HVDC Interface Points** which fall outside the scope of ECC.6.1.4.2.1, ECC.6.1.4.2.2 and ECC.6.1.4.2.3, **The Company** in coordination with the **Relevant Transmission Licensee** shall specify any applicable requirements at the **Grid Entry Point** or **User System Entry Point**.

ECC.6.1.4.2.5 Where the nominal frequency of the AC collector **System** which is connected to an **HVDC Interface Point** is at a value other than 50Hz, the voltage ranges and time periods specified by **The Company** in coordination with the **Relevant Transmission Licensee** shall be proportional to the values specified in Table ECC.6.1.4.2(a) and Table ECC.6.1.4.2(b)

ECC.6.1.4.3 Grid Voltage Variations for all Remote End HVDC Converters

ECC.6.1.4.3.1 All **Remote End HVDC Converter Stations** shall be capable of staying connected to the **HVDC Interface Point** and operating within the voltage ranges and time periods specified in Tables ECC.6.1.4.3(a) and ECC.6.1.4.3(b) below. The applicable voltage range and time periods specified are selected based on the reference 1pu voltage.

Voltage Range (pu)	Time Period for Operation (s)
0.85pu – 0.9pu	60 minutes
0.9pu – 1.1pu	Unlimited
1.1pu – 1.15pu	15 minutes

Table ECC.6.1.4.3(a) – Minimum time periods for which a **Remote End HVDC Converter** shall be capable of operating for different voltages deviating from reference 1pu without disconnecting from the network where the nominal voltage base is 110kV or above and less than 300kV.

Voltage Range (pu)	Time Period for Operation (s)
0.85pu – 0.9pu	60 minutes
0.9pu – 1.05pu	Unlimited
1.05pu – 1.15pu	15 minutes

Table ECC.6.1.4.3(b) – Minimum time periods for which a **Remote End HVDC Converter** shall be capable of operating for different voltages deviating from reference 1pu without disconnecting from the network where the nominal voltage base is from 300kV up to and including 400kV.

- ECC.6.1.4.3.2 **The Company** and a **HVDC System Owner** may agree greater voltage ranges or longer minimum operating times which shall be in accordance with the requirements of ECC.6.1.4.2.
- ECC.6.1.4.3.4 For **HVDC Interface Points** which fall outside the scope of ECC.6.1.4.3.1 **The Company** in coordination with the **Relevant Transmission Licensee** shall specify any applicable requirements at the **Grid Entry Point** or **User System Entry Point**.
- ECC.6.1.4.3.5 Where the nominal frequency of the AC collector **System** which is connected to an **HVDC Interface Point** is at a value other than 50Hz, the voltage ranges and time periods specified by **The Company** in coordination with the **Relevant Transmission Licensee** shall be proportional to the values specified in Table ECC.6.1.4.3(a) and Table ECC.6.1.4.3(b)

Voltage Waveform Quality

- ECC.6.1.5 All **Plant** and **Apparatus** connected to the **National Electricity Transmission System**, and that part of the **National Electricity Transmission System** at each **Connection Site** or, in the case of **OTSDUW Plant and Apparatus**, at each **Interface Point**, should be capable of withstanding the following distortions of the voltage waveform in respect of harmonic content and phase unbalance:

(a) Harmonic Content

The **Electromagnetic Compatibility Levels** for harmonic distortion on the **Onshore Transmission System** from all sources under both **Planned Outage** and fault outage conditions, (unless abnormal conditions prevail) shall comply with **Engineering Recommendation G5**. The **Electromagnetic Compatibility Levels** for harmonic distortion on an **Offshore Transmission System** will be defined in relevant **Bilateral Agreements**.

Engineering Recommendation G5 contains planning criteria which **The Company** will apply to the connection of non-linear **Load** to the **National Electricity Transmission System**, which may result in harmonic emission limits being specified for these **Loads** in the relevant **Bilateral Agreement**. The application of the planning criteria will take into account the position of existing **GB Code User's** and **EU Code Users' Plant and Apparatus** (and **OTSDUW Plant and Apparatus**) in relation to harmonic emissions. **EU Code Users** must ensure that connection of distorting loads to their **User Systems** do not cause any harmonic emission limits specified in the **Bilateral Agreement**, or where no such limits are specified, the relevant planning levels specified in **Engineering Recommendation G5** to be exceeded.

(b) Phase Unbalance

Under **Planned Outage** conditions, the weekly 95 percentile of **Phase (Voltage) Unbalance**, calculated in accordance with IEC 61000-4-30 and IEC 61000-3-13, on the **National Electricity Transmission System** for voltages above 150kV should remain, in England and Wales, below 1.5%, and in Scotland, below 2%, and for voltages of 150kV and below, across GB below 2%, unless abnormal conditions prevail and **Offshore** (or in the case of **OTSDUW, OTSDUW Plant and Apparatus**) will be defined in relevant **Bilateral Agreements**.

The Phase Unbalance is calculated from the ratio of root mean square (rms) of negative phase sequence voltage to rms of positive phase sequence voltage, based on 10-minute average values, in accordance with IEC 61000-4-30.

- ECC.6.1.6 Across GB, under the **Planned Outage** conditions stated in ECC.6.1.5(b) infrequent short duration peaks with a maximum value of 2% are permitted for **Phase (Voltage) Unbalance**, for voltages above 150kV, subject to the prior agreement of **The Company** under the **Bilateral Agreement** and in relation to **OTSDUW**, the **Construction Agreement**. **The Company** will only agree following a specific assessment of the impact of these levels on **Transmission Apparatus** and other **Users Apparatus** with which it is satisfied.

Voltage Fluctuations

ECC.6.1.7 Voltage changes at a **Point of Common Coupling** on the **Onshore Transmission System** shall not exceed:

(a) The limits specified in Table ECC.6.1.7(a) with the stated frequency of occurrence, where:

(i)

$$\% \Delta V_{\text{steadystate}} = \left| 100 \times \frac{\Delta V_{\text{steadystate}}}{V_n} \right| \quad \text{and}$$

$$\% \Delta V_{\text{max}} = 100 \times \frac{\Delta V_{\text{max}}}{V_n} ;$$

- (ii) V_n is the nominal system voltage;
- (iii) $V_{\text{steadystate}}$ is the voltage at the end of a period of 1 s during which the rate of change of system voltage over time is $\leq 0.5\%$;
- (iv) $\Delta V_{\text{steadystate}}$ is the difference in voltage between the initial steady state voltage prior to the RVC (V_0) and the final steady state voltage after the RVC (V_0');
- (v) ΔV_{max} is the absolute change in the system voltage relative to the initial steady state system voltage (V_0);
- (vi) All voltages are the r.m.s. of the voltage measured over one cycle refreshed every half a cycle as per BS EN 61000-4-30; and
- (vii) The applications in the 'Example Applicability' column are examples only and are not definitive.

Cat-egory	Title	Maximum number of occurrence	Limits %ΔV_{max} & %$\Delta V_{\text{steadystate}}$	Example Applicability
1	Frequent events	(see NOTE 1)	As per Figure ECC.6.1.7 (1)	Any single or repetitive RVC that falls inside Figure ECC.6.1.7 (1)
2	Infrequent events	4 events in 1 calendar month (see NOTE 2)	As per Figure ECC.6.1.7 (2) $ \% \Delta V_{\text{steadystate}} \leq 3\%$ For decrease in voltage: $ \% \Delta V_{\text{max}} \leq 10\%$ (see NOTE 3) For increase in voltage: $ \% \Delta V_{\text{max}} \leq 6\%$ (see NOTE 4)	Infrequent motor starting, transformer energisation, re-energisation (see NOTE 7)

3	Very infrequent events	1 event in 3 calendar months (see NOTE 2)	As per Figure ECC.6.1.7 (3) $ \% \Delta V_{\text{steadystate}} \leq 3\%$ For decrease in voltage: $ \% \Delta V_{\text{max}} \leq 12\%$ (see NOTE 5) For increase in voltage: $ \% \Delta V_{\text{max}} \leq 6\%$ (see NOTE 6)	Commissioning, maintenance & post fault switching (see NOTE 7)
<p>NOTE 1: $\pm 6\%$ is permissible for 100 ms reduced to $\pm 3\%$ thereafter as per Figure ECC.6.1.7 (1) . If the profile of repetitive voltage change(s) falls within the envelope given in Figure ECC.6.1.7 (1) , the assessment of such voltage change(s) shall be undertaken according to the recommendations for assessment of flicker <u>and</u> shall conform to the planning levels provided for flicker. If any part of the voltage change(s) falls outside the envelope given in Figure ECC.6.1.7(1), the assessment of such voltage changes, repetitive or not, shall be done according to the guidance and limits for RVCs.</p> <p>NOTE 2: No more than 1 event is permitted per day, consisting of up to 4 RVCs, each separated by at least 10 minutes with all switching completed within a two-hour window.</p> <p>NOTE 3: -10% is permissible for 100 ms reduced to -6% until 2 s then reduced to -3% thereafter as per Figure ECC.6.1.7 (2).</p> <p>NOTE 4: $+6\%$ is permissible for 0.8 s from the instant the event begins then reduced to $+3\%$ thereafter as per Figure ECC.6.1.7 (2).</p> <p>NOTE 5: -12% is permissible for 100 ms reduced to -10% until 2 s then reduced to -3% thereafter as per Figure ECC.6.1.7 (3).</p> <p>NOTE 6: $+6\%$ is permissible for 0.8 s from the instant the event begins then reduced to $+3\%$ thereafter as per Figure ECC.6.1.7 (3).</p> <p>NOTE 7: These are examples only. Customers may opt to conform to the limits of another category providing the frequency of occurrence is not expected to exceed the 'Maximum number of occurrence' for the chosen category.</p>				

Table ECC.6.1.7 (a) – Planning levels for RVC

- (b) The voltage change limit is the absolute maximum allowed of either the phase-to-earth voltage change or the phase-to-phase voltage change, whichever is the highest. The limits do not apply to single phasor equivalent voltages, e.g. positive phase sequence (PPS) voltages. For high impedance earthed systems, the maximum phase-to-phase, i.e. line voltage, should be used for assessment.
- (c) The RVCs in Category 2 and 3 should not exceed the limits depicted in the time dependent characteristic shown in Figure ECC.6.1.7 (2) and Figure ECC.6.1.7 (3) respectively. These limits do not apply to: 1) fault clearance operations; or 2) immediate operations in response to fault conditions; or 3) operations relating to post fault system restoration (for the avoidance of doubt this third exception pertains to a fault that is external to the **Users** plant and apparatus).
- (d) Any RVCs permitted in Category 2 and Category 3 should be at least 10 minutes apart.
- (e) The value of $V_{\text{steadystate}}$ should be established immediately prior to the start of a RVC. Following a RVC, the voltage should remain within the relevant envelope, as shown in Figures ECC.6.1.7 (1), ECC.6.1.7 (2), ECC.6.1.7 (3), until a $V_{\text{steadystate}}$ condition has been satisfied.

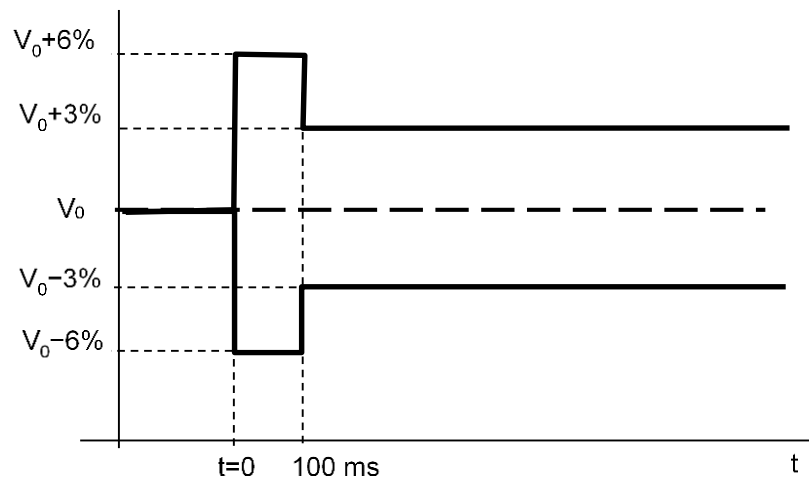

Figure ECC.6.1.7 (1) — Voltage characteristic for frequent events

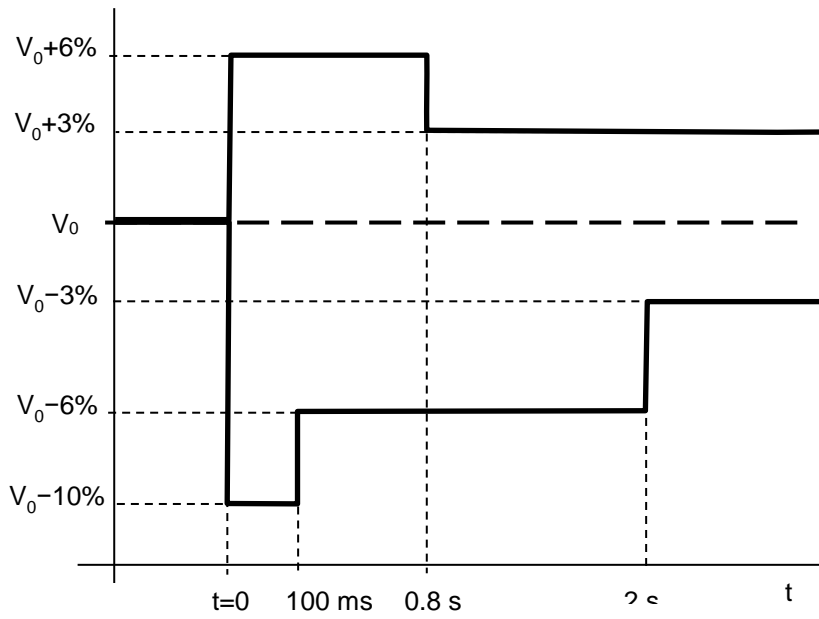

Figure ECC.6.1.7 (2) — Voltage characteristic for infrequent events

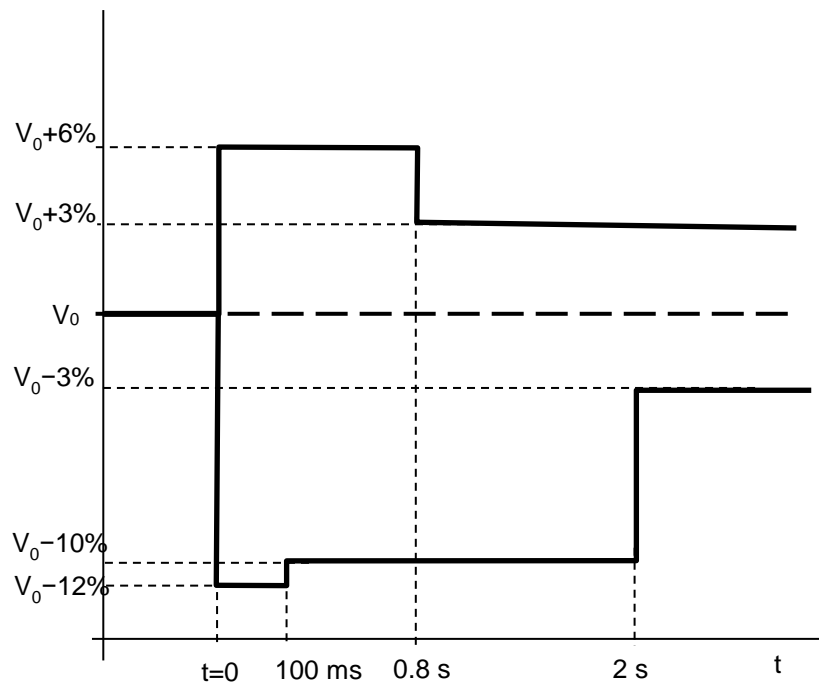

Figure ECC.6.1.7 (3) — Voltage characteristic for very infrequent events

- (f) The voltage change between two steady state voltage conditions should not exceed 3%. (The limit is based on 3% of the nominal voltage of the system (V_n) as measured at the PCC. The step voltage change as measured at the customer's supply terminals or equipment terminals could be greater. For example: The step voltage change limit stated in BS EN 61000-3-3 and BS EN 61000-3-11 is 3.3% when measured at the equipment terminals.)
- (g) The limits apply to voltage changes measured at the **Point of Common Coupling**.
- (h) Category 3 events that are planned should be notified to the Company in advance.
- (i) For connections where voltage changes would constitute a risk to the **National Electricity Transmission System** or, in **The Company's** view, the **System** of any **GB Code User, Bilateral Agreements** may include provision for **The Company** to reasonably limit the number of voltage changes in Category 2 or 3 to a lower number than specified in Table ECC.6.1.7(a) to ensure that the total number of voltage changes at the **Point of Common Coupling** across multiple **Users** remains within the limits of Table ECC.6.1.7(a).
- (j) The planning levels applicable to Flicker Severity Short Term (Pst) and Flicker Severity Long Term (Plt) are set out in Table ECC.6.1.7(b).

Supply system Nominal voltage	Planning level	
	Flicker Severity Short Term (Pst)	Flicker Severity Long Term (Plt)
Up to and including 33 kV	0.9	0.7
66kV and greater	0.8	0.6
NOTE 1: The magnitude of Pst is linear with respect to the magnitude of the voltage changes giving rise to it. NOTE 2: Extreme caution is advised in allowing any excursions of Pst and Plt above the planning level.		

Table ECC.6.7.1(b) — Planning levels for flicker

The values and figures referred to in this paragraph ECC.6.1.7 are derived from Engineering Recommendation P28 Issue 2.

ECC.6.1.8 Voltage fluctuations at a **Point of Common Coupling** with a fluctuating **Load** directly connected to an **Offshore Transmission System** (or in the case of **OTSDUW, OTSDUW Plant and Apparatus**) shall not exceed the limits set out in the **Bilateral Agreement**.

Sub-Synchronous Resonance and Sub-Synchronous Torsional Interaction (SSTI)

ECC.6.1.9 **The Company** shall ensure that **Users' Plant and Apparatus** will not be subject to unacceptable Sub-Synchronous Oscillation conditions as specified in the relevant **License Standards**.

ECC.6.1.10 **The Company** shall ensure where necessary, and in consultation with **Relevant Transmission Licensees** where required, that any relevant site specific conditions applicable at a **User's Connection Site**, including a description of the Sub-Synchronous Oscillation conditions considered in the application of the relevant **License Standards**, are set out in the **User's Bilateral Agreement**.

7

ECC.6.2 Plant and Apparatus relating to Connection Sites and Interface Points and HVDC Interface Points

The following requirements apply to **Plant** and **Apparatus** relating to the **Connection Point** and **OTSDUW Plant and Apparatus** relating to the **Interface Point** (until the **OTSUA Transfer Time**), **HVDC Interface Points** relating to **Remote End HVDC Converters** and **Connection Points** which (except as otherwise provided in the relevant paragraph) each **EU Code User** must ensure are complied with in relation to its **Plant** and **Apparatus** and which in the case of ECC.6.2.2.2.2, ECC.6.2.3.1.1 and ECC.6.2.1.1(b) only, **The Company** must ensure are complied with in relation to **Transmission Plant** and **Apparatus**, as provided in those paragraphs.

ECC.6.2.1 General Requirements

- ECC.6.2.1.1 (a) The design of connections between the **National Electricity Transmission System** and:
- (i) any **Power Generating Module Generating Unit** (other than a **CCGT Unit** or **Power Park Unit**) **HVDC Equipment**, **Power Park Module** or **CCGT Module**, or
 - (ii) any **Network Operator's User System**, or
 - (iii) **Non-Embedded Customers** equipment;
- will be consistent with the **Licence Standards**.

In the case of **OTSDUW**, the design of the **OTSUA's** connections at the **Interface Point** and **Connection Point** will be consistent with **Licence Standards**.

- (b) The **National Electricity Transmission System** (and any **OTSDUW Plant and Apparatus**) at nominal **System** voltages of 132kV and above is/shall be designed to be earthed with an **Earth Fault Factor** of, in England and Wales or **Offshore**, below 1.4 and in Scotland, below 1.5. Under fault conditions the rated **Frequency** component of voltage could fall transiently to zero on one or more phases or, in England and Wales, rise to 140% phase-to-earth voltage, or in Scotland, rise to 150% phase-to-earth voltage. The voltage rise would last only for the time that the fault conditions exist. The fault conditions referred to here are those existing when the type of fault is single or two phase-to-earth.
- (c) For connections to the **National Electricity Transmission System** at nominal **System** voltages of below 132kV the earthing requirements and voltage rise conditions will be advised by **The Company** as soon as practicable prior to connection and in the case of **OTSDUW Plant and Apparatus** shall be advised to **The Company** by the **EU Code User**.

ECC.6.2.1.2 Substation Plant and Apparatus

- (a) The following provisions shall apply to all **Plant** and **Apparatus** which is connected at the voltage of the **Connection Point** (and **OTSDUW Plant and Apparatus** at the **Interface Point**) and which is contained in equipment bays that are within the **Transmission** busbar **Protection** zone at the **Connection Point**. This includes circuit breakers, switch disconnectors, disconnectors, **Earthing Devices**, power transformers, voltage transformers, reactors, current transformers, surge arresters, bushings, neutral equipment, capacitors, line traps, coupling devices, external insulation and insulation co-ordination devices. Where necessary, this is as more precisely defined in the **Bilateral Agreement**.
- (i) Plant and/or Apparatus in respect of EU Code Users connecting to a new Connection Point (including OTSDUW Plant and Apparatus at the Interface Point)

Each item of such **Plant** and/or **Apparatus** installed in relation to a new **Connection Point** (or **OTSDUW Plant and Apparatus** at the **Interface Point** or **Remote End HVDC Converter Station** at the **HVDC Interface Point**) shall comply with the relevant **Technical Specifications** and any further requirements identified by **The Company**, acting reasonably, to reflect the options to be followed within the **Technical Specifications** and/or to complement if necessary the **Technical**

Specifications so as to enable **The Company** to comply with its obligations in relation to the **National Electricity Transmission System** or the **Relevant Transmission Licensee** to comply with its obligations in relation to its **Transmission System**. This information, including the application dates of the relevant **Technical Specifications**, will be as specified in the **Bilateral Agreement**.

- (ii) EU Code User's Plant and/or Apparatus connecting to an existing Connection Point (including OTSDUW Plant and Apparatus at the Interface Point)

Each new additional and/or replacement item of such **Plant** and/or **Apparatus** installed in relation to a change to an existing **Connection Point** (or **OTSDUW Plant and Apparatus** at the **Interface Point** and **Connection Point** or **Remote End HVDC Converter Stations** at the **HVDC Interface Point**)—shall comply with the standards/specifications applicable when the change was designed, or such other standards/specifications as necessary to ensure that the item of **Plant** and/or **Apparatus** is reasonably fit for its intended purpose having due regard to the obligations of **The Company**, the relevant **User** the **Relevant Transmission Licensee** under their respective **Licences**. Where appropriate this information, including the application dates of the relevant standards/specifications, will be as specified in the varied **Bilateral Agreement**.

- (iii) Used Plant and/or Apparatus being moved, re-used or modified

If, after its installation, any such item of **Plant** and/or **Apparatus** is subsequently:

- moved to a new location; or
- used for a different purpose; or
- otherwise modified;

then the standards/specifications as described in (i) or (ii) above as applicable will apply as appropriate to such **Plant** and/or **Apparatus**, which must be reasonably fit for its intended purpose having due regard to the obligations of **The Company**, the relevant **User** and the **Relevant Transmission Licensee** under their respective **Licences**.

- (b) **The Company** shall at all times maintain a list of those **Technical Specifications** and additional requirements which might be applicable under this ECC.6.2.1.2 and which may be referenced by **The Company** in the **Bilateral Agreement**. **The Company** shall provide a copy of the list upon request to any **EU Code User**. **The Company** shall also provide a copy of the list to any **EU Code User** upon receipt of an application form for a **Bilateral Agreement** for a new **Connection Point**.
- (c) Where the **EU Code User** provides **The Company** with information and/or test reports in respect of **Plant** and/or **Apparatus** which the **EU Code User** reasonably believes demonstrate the compliance of such items with the provisions of a **Technical Specification** then **The Company** shall promptly and without unreasonable delay give due and proper consideration to such information.
- (d) **Plant** and **Apparatus** shall be designed, manufactured and tested in premises with an accredited certificate in accordance with the quality assurance requirements of the relevant standard in the BS EN ISO 9000 series (or equivalent as reasonably approved by **The Company**) or in respect of test premises which do not include a manufacturing facility premises with an accredited certificate in accordance with BS EN 45001.
- (e) Each connection between a **User** and the **National Electricity Transmission System** must be controlled by a circuit-breaker (or circuit breakers) capable of interrupting the maximum short circuit current at the point of connection. The **Seven Year Statement** gives values of short circuit current and the rating of **Transmission** circuit breakers at existing and committed **Connection Points** for future years.

- (f) Each connection between a **Generator** undertaking **OTSDUW** or an **Onshore Transmission Licensee**, must be controlled by a circuit breaker (or circuit breakers) capable of interrupting the maximum short circuit current at the **Transmission Interface Point**. The **Seven Year Statement** gives values of short circuit current and the rating of **Transmission** circuit breakers at existing and committed **Transmission Interface Points** for future years.

ECC.6.2.2 Requirements at **Connection Points** or, in the case of **OTSDUW** at **Interface Points** that relate to **Generators** or **OTSDUW Plant and Apparatus**

ECC.6.2.2.1 Not Used.

ECC.6.2.2.2 **Power Generating Module, OTSDUW Plant and Apparatus, HVDC Equipment and Power Station Protection Arrangements**

ECC.6.2.2.2.1 Minimum Requirements

Protection of Power Generating Modules (other than **Power Park Units**), **HVDC Equipment, OTSDUW Plant and Apparatus** and their connections to the **National Electricity Transmission System** shall meet the requirements given below. These are necessary to reduce the impact on the **National Electricity Transmission System** of faults on **OTSDUW Plant and Apparatus** circuits or circuits owned by **Generators** (including **DC Connected Power Park Modules**) or **HVDC System Owners**.

ECC.6.2.2.2.2 Fault Clearance Times

- (a) The required fault clearance time for faults on the **Generator's** (including **DC Connected Power Park Modules**) or **HVDC System Owner's** equipment directly connected to the **National Electricity Transmission System** or **OTSDUW Plant and Apparatus** and for faults on the **National Electricity Transmission System** directly connected to the **EU Generator** (including **DC Connected Power Park Modules**) or **HVDC System Owner's** equipment or **OTSDUW Plant and Apparatus**, from fault inception to the circuit breaker arc extinction, shall be set out in the **Bilateral Agreement**. The fault clearance time specified in the **Bilateral Agreement** shall not be shorter than the durations specified below:

- (i) 80ms for connections operating at a nominal voltage of greater than 300kV
- (ii) 100ms for connections operating at a nominal voltage of greater than 132kV and up to 300kV
- (iii) 120ms for connections operating at a nominal voltage of 132kV and below

but this shall not prevent the **User** or **The Company** or the **Relevant Transmission Licensee** or the **EU Generator** (including in respect of **OTSDUW Plant and Apparatus** and **DC Connected Power Park Modules**) from selecting a shorter fault clearance time on their own **Plant** and **Apparatus** provided **Discrimination** is achieved.

A longer fault clearance time may be specified in the **Bilateral Agreement** for faults on the **National Electricity Transmission System**. A longer fault clearance time for faults on the **EU Generator** or **HVDC System Owner's** equipment or **OTSDUW Plant and Apparatus** may be agreed with **The Company** in accordance with the terms of the **Bilateral Agreement** but only if **System** requirements, in **The Company's** view, permit. The probability that the fault clearance time stated in the **Bilateral Agreement** will be exceeded by any given fault, must be less than 2%.

- (b) In the event that the required fault clearance time is not met as a result of failure to operate on the **Main Protection System(s)** provided, the **Generators** or **HVDC System Owners** or **Generators** in the case of **OTSDUW Plant and Apparatus** shall, except as specified below provide **Independent Back-Up Protection**. The **Relevant Transmission Licensee** will also provide **Back-Up Protection** and the **Relevant Transmission Licensee's** and the **User's Back-Up Protections** will be co-ordinated so as to provide **Discrimination**.

On a **Power Generating Module** (other than a **Power Park Unit**), **HVDC Equipment** or **OTSDUW Plant and Apparatus** and connected to the **National Electricity Transmission System** operating at a nominal voltage of greater than 132kV and where two **Independent Main Protections** are provided to clear faults on the **HV Connections** within the required fault clearance time, the **Back-Up Protection** provided by **EU Generators** (including in respect of **OTSDUW Plant and Apparatus** and **DC Connected Power Park Modules**) and **HVDC System Owners** shall operate to give a fault clearance time of no longer than 300ms at the minimum infeed for normal operation for faults on the **HV Connections**. Where two **Independent Main Protections** are installed the **Back-Up Protection** may be integrated into one (or both) of the **Independent Main Protection** relays.

On a **Power Generating Module** (other than a **Power Park Unit**), **HVDC Equipment** or **OTSDUW Plant and Apparatus** and connected to the **National Electricity Transmission System** at 132 kV and below and where only one **Main Protection** is provided to clear faults on the **HV Connections** within the required fault clearance time, the **Independent Back-Up Protection** provided by the **Generator** (including in respect of **OTSDUW Plant and Apparatus** and **DC Connected Power Park Modules**) and the **HVDC System Owner** shall operate to give a fault clearance time of no longer than 300ms at the minimum infeed for normal operation for faults on the **HV Connections**.

A Power Generating Module (other than a **Power Park Unit**), **HVDC Equipment** or **OTSDUW Plant and Apparatus**) with **Back-Up Protection** or **Independent Back-Up Protection** will also be required to withstand, without tripping, the loading incurred during the clearance of a fault on the **National Electricity Transmission System** by breaker fail **Protection** at a nominal voltage of greater than 132kV or of a fault cleared by **Back-Up Protection** where the **EU Generator** (including in the case of **OTSDUW Plant and Apparatus** or **DC Connected Power Park Module**) or **HVDC System** is connected at 132kV and below. This will permit **Discrimination** between the **Generator** in respect of **OTSDUW Plant and Apparatus** or **DC Connected Power Park Modules** or **HVDC System Owners' Back-Up Protection** or **Independent Back-Up Protection** and the **Back-Up Protection** provided on the **National Electricity Transmission System** and other **Users' Systems**.

- (c) When the **Power Generating Module** (other than **Power Park Units**), or the **HVDC Equipment** or **OTSDUW Plant and Apparatus** is connected to the **National Electricity Transmission System** operating at a nominal voltage of greater than 132kV, and in Scotland and **Offshore** also at 132kV, and a circuit breaker is provided by the **Generator** (including in respect of **OTSDUW Plant and Apparatus** or **DC Connected Power Park Modules**) or the **HVDC System** owner, or the **Relevant Transmission Licensee**, as the case may be, to interrupt fault current interchange with the **National Electricity Transmission System**, or **Generator's System**, or **HVDC System Owner's System**, as the case may be, circuit breaker fail **Protection** shall be provided by the **Generator** (including in respect of **OTSDUW Plant and Apparatus** or **DC Connected Power Park Modules**) or **HVDC System-Owner**, or the **Relevant Transmission Licensee**, as the case may be, on this circuit breaker. In the event, following operation of a **Protection** system, of a failure to interrupt fault current by these circuit-breakers within the **Fault Current Interruption Time**, the circuit breaker fail **Protection** is required to initiate tripping of all the necessary electrically adjacent circuit-breakers so as to interrupt the fault current within the next 200ms.
- (d) The target performance for the **System Fault Dependability Index** shall be not less than 99%. This is a measure of the ability of **Protection** to initiate successful tripping of circuit breakers which are associated with the faulty item of **Apparatus**.

ECC.6.2.2.3 Equipment including **Protection** equipment to be provided

The **Relevant Transmission Licensee** shall specify the **Protection** schemes and settings necessary to protect the **National Electricity Transmission System**, taking into account the characteristics of the **Power Generating Module** or **HVDC Equipment**.

The protection schemes needed for the **Power Generating Module** or **HVDC Equipment** and the **National Electricity Transmission System** as well as the settings relevant to the **Power Generating Module** and/or **HVDC Equipment** shall be coordinated and agreed between **The Company** and the **EU Generator** or **HVDC System Owner**. The agreed **Protection** schemes and settings will be specified in the **Bilateral Agreement**.

The protection schemes and settings for internal electrical faults must not prevent the **Power Generating Module** or **HVDC Equipment** from satisfying the requirements of the Grid Code although **EU Generators** should be aware of the requirements of ECC.6.3.13.1. ;

~~electrical~~ **Protection** of the **Power Generating Module** or **HVDC Equipment** shall take precedence over operational controls, taking into account the security of the **National Electricity Transmission System** and the health and safety of personnel, as well as mitigating any damage to the **Power Generating Module** or **HVDC Equipment**.

ECC.6.2.2.3.1 Protection of Interconnecting Connections

The requirements for the provision of **Protection** equipment for interconnecting connections will be specified in the **Bilateral Agreement**. In this **ECC** the term "interconnecting connections" means the primary conductors from the current transformer accommodation on the circuit side of the circuit breaker to the **Connection Point** or the primary conductors from the current transformer accommodation on the circuit side of the **OTSDUW Plant and Apparatus** of the circuit breaker to the **Transmission Interface Point**.

ECC.6.2.2.3.2 Circuit-breaker fail Protection

The **EU Generator** or **HVDC System Owner** will install circuit breaker fail **Protection** equipment in accordance with the requirements of the **Bilateral Agreement**. The **EU Generator** or **HVDC System Owner** will also provide a back-trip signal in the event of loss of air from its pressurised head circuit breakers, during the **Power Generating Module** (other than a **CCGT Unit** or **Power Park Unit**) or **HVDC Equipment** run-up sequence, where these circuit breakers are installed.

ECC.6.2.2.3.3 Loss of Excitation

The **EU Generator** must provide **Protection** to detect loss of excitation in respect of each of its **Generating Units** within a **Synchronous Power Generating Module** to initiate a **Generating Unit** trip.

ECC.6.2.2.3.4 Pole-Slipping Protection

Where, in **The Company's** reasonable opinion, **System** requirements dictate, **The Company** will specify in the **Bilateral Agreement** a requirement for **EU Generators** to fit pole-slipping **Protection** on their **Generating Units** within each **Synchronous Power Generating Module**.

ECC.6.2.2.3.5 Signals for Tariff Metering

EU Generators and **HVDC System Owners** will install current and voltage transformers supplying all tariff meters at a voltage to be specified in, and in accordance with, the **Bilateral Agreement**.

ECC.6.2.2.3.6 Commissioning of Protection Systems

No **EU Generator** or **HVDC System Owner** equipment shall be energised until the **Protection** settings have been finalised. The **EU Generator** or **HVDC System Owner** shall agree with **The Company** (in coordination with the **Relevant Transmission Licensee**) and carry out a combined commissioning programme for the **Protection** systems, and generally, to a minimum standard as specified in the **Bilateral Agreement**.

ECC.6.2.2.4 Work on Protection Equipment

No busbar **Protection**, mesh corner **Protection**, circuit-breaker fail **Protection** relays, AC or DC wiring (other than power supplies or DC tripping associated with the **Power Generating Module, HVDC Equipment** itself) may be worked upon or altered by the **EU Generator** or **HVDC System Owner** personnel in the absence of a representative of the **Relevant Transmission Licensee** or written authority from the **Relevant Transmission Licensee** to perform such work or alterations in the absence of a representative of the **Relevant Transmission Licensee**.

ECC.6.2.2.5 Relay Settings

Protection and relay settings will be co-ordinated (both on connection and subsequently) across the **Connection Point** in accordance with the **Bilateral Agreement** and in relation to **OTSDUW Plant and Apparatus**, across the **Interface Point** in accordance with the **Bilateral Agreement** to ensure effective disconnection of faulty **Apparatus**.

ECC.6.2.2.6 Changes to Protection Schemes and HVDC System Control Modes

ECC.6.2.2.6.1 Any subsequent alterations to the protection settings (whether by **The Company**, the **Relevant Transmission Licensee**, the **EU Generator** or the **HVDC System Owner**) shall be agreed between **The Company** (in co-ordination with the **Relevant Transmission Licensee**) and the **EU Generator** or **HVDC System Owner** in accordance with the Grid Code (ECC.6.2.2.5). No alterations are to be made to any protection schemes unless agreement has been reached between **The Company**, the **Relevant Transmission Licensee**, the **EU Generator** or **HVDC System Owner**.

ECC.6.2.2.6.2 The parameters of different control modes of the **HVDC System** shall be able to be changed in the **HVDC Converter Station**, if required by **The Company** in coordination with the **Relevant Transmission Licensee** and in accordance with ECC.6.2.2.6.4.

ECC.6.2.2.6.3 Any change to the schemes or settings of parameters of the different control modes and protection of the **HVDC System** including the procedure shall be agreed with **The Company** in coordination with the **Relevant Transmission Licensee** and the **HVDC System Owner**.

ECC.6.2.2.6.4 The control modes and associated set points shall be capable of being changed remotely, as specified by **The Company** in coordination with the **Relevant Transmission Licensee**.

ECC.6.2.2.7 Control Schemes and Settings

ECC.6.2.2.7.1 The schemes and settings of the different control devices on the **Power Generating Module** and **HVDC Equipment** that are necessary for **Transmission System** stability and for taking emergency action shall be agreed with **The Company** in coordination with the **Relevant Transmission Licensee** and the **EU Generator** or **HVDC System Owner**.

ECC.6.2.2.7.2 Subject to the requirements of ECC.6.2.2.7.1 any changes to the schemes and settings, defined in ECC.6.2.2.7.1, of the different control devices of the **Power Generating Module** or **HVDC Equipment** shall be coordinated and agreed between , the **Relevant Transmission Licensee**, the **EU Generator** and **HVDC System Owner**.

ECC.6.2.2.8 Ranking of Protection and Control

ECC.6.2.2.8.1 **The Company** in coordination with **Relevant Transmission Licensees**, shall agree and coordinate the protection and control devices of **EU Generators Plant and Apparatus** in accordance with the following general priority ranking (from highest to lowest):

- (i) The interface between the **National Electricity Transmission System** and the **Power Generating Module** or **HVDC Equipment Protection** equipment;
- (ii) frequency control (active power adjustment);
- (iii) power restriction; and
- (iv) power gradient constraint;

ECC.6.2.2.8.2 A control scheme, specified by the **HVDC System Owner** consisting of different control modes, including the settings of the specific parameters, shall be coordinated and agreed between **The Company** in coordination with the **Relevant Transmission Licensee** and the **HVDC System Owner**. These details would be specified in the **Bilateral Agreement**.

ECC.6.2.2.8.3 **The Company** in coordination with **Relevant Transmission Licensees**, shall agree and coordinate the protection and control devices of **HVDC System Owners Plant** and **Apparatus** in accordance with the following general priority ranking (from highest to lowest)

- (i) The interface between the **National Electricity Transmission System** and **HVDC System Protection** equipment;
- (ii) **Active Power** control for emergency assistance
- (iii) automatic remedial actions as specified in ECC.6.3.6.1.2.5
- (iv) **Limited Frequency Sensitive Mode** (LFSM) of operation;
- (v) **Frequency Sensitive Mode** of operation and **Frequency** control; and
- (vi) power gradient constraint.

ECC.6.2.2.9 Synchronising

ECC.6.2.2.9.1 For any **Power Generating Module** directly connected to the **National Electricity Transmission System** or **Type D Power Generating Module**, synchronisation shall be performed by the **EU Generator** only after instruction by **The Company** in accordance with the requirements of BC.2.5.2.

ECC.6.2.2.9.2 Each **Power Generating Module** directly connected to the **National Electricity Transmission System** or **Type D Power Generating Module** shall be equipped with the necessary synchronisation facilities. Synchronisation shall be possible within the range of frequencies specified in ECC.6.1.2.

ECC.6.2.2.9.3 The requirements for synchronising equipment shall be specified in accordance with the requirements in the **Electrical Standards** listed in the annex to the **General Conditions**. The synchronisation settings shall include the following elements below. Any variation to these requirements shall be pursuant to the terms of the **Bilateral Agreement**.

- (a) voltage
- (b) **Frequency**
- (c) phase angle range
- (d) phase sequence
- (e) deviation of voltage and **Frequency**

ECC.6.2.2.9.4 **HVDC Equipment** shall be required to satisfy the requirements of ECC.6.2.2.9.1 – ECC.6.2.2.9.3. In addition, unless otherwise specified by **The Company**, during the synchronisation of a **DC Connected Power Park Module** to the **National Electricity Transmission System**, any **HVDC Equipment** shall have the capability to limit any steady state voltage changes to the limits specified within ECC.6.1.7 or ECC.6.1.8 (as applicable) which shall not exceed 5% of the pre-synchronisation voltage. **The Company** in coordination with the **Relevant Transmission Licensee** shall specify any additional requirements for the maximum magnitude, duration and measurement of the voltage transients over and above those defined in ECC.6.1.7 and ECC.6.1.8 in the **Bilateral Agreement**.

ECC.6.2.2.9.5 **EU Generators** in respect of **DC Connected Power Park Modules** shall also provide output synchronisation signals specified by **The Company** in co-ordination with the **Relevant Transmission Licensee**.

ECC.6.2.2.9.6 In addition to the requirements of ECC.6.2.2.9.1 to ECC.6.2.2.9.5, **EU Generators** and **HVDC System Owners** should also be aware of the requirements of ECC.6.5.10 relating to busbar voltage

ECC.6.2.2.9.10 HVDC Parameters and Settings

ECC.6.2.2.9.10.1 The parameters and settings of the main control functions of an **HVDC System** shall be agreed between the **HVDC System** owner and **The Company**, in coordination with the **Relevant Transmission Licensee**. The parameters and settings shall be implemented within such a control hierarchy that makes their modification possible if necessary. Those main control functions are at least:

- (b) **Frequency Sensitive Modes** (FSM, LFSM-O, LFSM-U);
- (c) **Frequency** control, if applicable;
- (d) **Reactive Power** control mode, if applicable;
- (e) power oscillation damping capability;
- (f) subsynchronous torsional interaction damping capability,.

ECC.6.2.2.11 Automatic Reconnection

ECC.6.2.2.11.1 **EU Generators** in respect of **Type A, Type B, Type C** and **Type D Power Generating Modules** (including **DC Connected Power Park Modules**) which have signed a **CUSC Contract** with **The Company** are not permitted to automatically reconnect to the **Total System** without instruction from **The Company**. **The Company** will issue instructions for reconnection or re-synchronisation in accordance with the requirements of BC2.5.2. Where synchronising is permitted in accordance with BC2.5.2, the voltage and frequency at the **Grid Entry Point** or **User System Entry Point** shall be within the limits defined in ECC.6.1.2 and ECC.6.1.4 and the ramp rate limits pursuant to BC1.A.1.1. For the avoidance of doubt this requirement does not apply to **EU Generators** who are not required to satisfy the requirements of the Balancing Codes.

ECC.6.2.2.12 Automatic Disconnection

ECC.6.2.2.12.1 No **Power Generating Module** or **HVDC Equipment** shall disconnect within the frequency range or voltage range defined in ECC.6.1.2 and ECC.6.1.4.

ECC.6.2.2.13 Special Provisions relating to Power Generating Modules embedded within Industrial Sites which supply electricity as a bi-product of their industrial process

ECC.6.2.2.13.1 **Generators** in respect of **Power Generating Modules** which form part of an industrial network, where the **Power Generating Module** is used to supply critical loads within the industrial process shall be permitted to operate isolated from the **Total System** if agreed with **The Company** in the **Bilateral Agreement**.

ECC.6.2.2.13.2 Except for the requirements of ECC.6.3.3 and ECC.6.3.7.1, **Power Generating Modules** which are embedded within industrial sites are not required to satisfy the requirements of ECC.6.3.6.2.1 and ECC.6.3.9. In this case this exception would only apply to **Power Generating Modules** on industrial sites used for combined heat and power production which are embedded in the network of an industrial site where all the following criteria are met.

- (a) The primary purpose of these sites is to produce heat for production processes of the industrial site concerned,
- (b) Heat and power generation is inextricably interlinked, that is to say any change to heat generation results inadvertently in a change of active power generating and visa versa.
- (c) The **Power Generating Modules** are of **Type A, Type B** or **Type C**.
- (d) Combined heat and power generating facilities shall be assessed on the basis of their electrical **Maximum Capacity**.

ECC.6.2.3 Requirements at EU Grid Supply Points relating to Network Operators and Non-Embedded Customers

ECC.6.2.3.1 Protection Arrangements for EU Code Users in respect of Network Operators and Non-Embedded Customers

ECC.6.2.3.1.1 **Protection arrangements for EU Code Users** in respect of **Network Operators** and **Non-Embedded Customers User Systems** directly connected to the **National Electricity Transmission System**, shall meet the requirements given below:

Fault Clearance Times

(a) The required fault clearance time for faults on **Network Operator** and **Non-Embedded Customer** equipment directly connected to the **National Electricity Transmission System**, and for faults on the **National Electricity Transmission System** directly connected to the **Network Operator's** or **Non-Embedded Customer's** equipment, from fault inception to the circuit breaker arc extinction, shall be set out in each **Bilateral Agreement**. The fault clearance time specified in the **Bilateral Agreement** shall not be shorter than the durations specified below:

- (i) 80ms for connections operating at a nominal voltage of greater than 300kV
- (ii) 100ms for connections operating at a nominal voltage of greater than 132kV and up to 300kV
- (iii) 120ms for connections operating at a nominal voltage of greater than 132kV and below

but this shall not prevent the **User** or **The Company** or **Relevant Transmission Licensee** from selecting a shorter fault clearance time on its own **Plant** and **Apparatus** provided **Discrimination** is achieved.

For the purpose of establishing the **Protection** requirements in accordance with ECC.6.2.3.1.1 only, the point of connection of the **Network Operator** or **Non-Embedded Customer** equipment to the **National Electricity Transmission System** shall be deemed to be the low voltage busbars at an **EU Grid Supply Point**, irrespective of the ownership of the equipment at the **EU Grid Supply Point**.

A longer fault clearance time may be specified in the **Bilateral Agreement** for faults on the **National Electricity Transmission System**. A longer fault clearance time for faults on the **Network Operator** and **Non-Embedded Customers** equipment may be agreed with **The Company** in accordance with the terms of the **Bilateral Agreement** but only if **System** requirements in **The Company's** view permit. The probability that the fault clearance time stated in the **Bilateral Agreement** will be exceeded by any given fault must be less than 2%.

- (b) (i) For the event of failure of the **Protection** systems provided to meet the above fault clearance time requirements, **Back-Up Protection** shall be provided by the **Network Operator** or **Non-Embedded Customer** as the case may be.
- (ii) The **Relevant Transmission Licensee** will also provide **Back-Up Protection**, which will result in a fault clearance time longer than that specified for the **Network Operator** or **Non-Embedded Customer Back-Up Protection** so as to provide **Discrimination**.
- (iii) For connections with the **National Electricity Transmission System** at 132kV and below, it is normally required that the **Back-Up Protection** on the **National Electricity Transmission System** shall discriminate with the **Network Operator** or **Non-Embedded Customer's Back-Up Protection**.
- (iv) For connections with the **National Electricity Transmission System** operating at a nominal voltage greater than 132kV, the **Back-Up Protection** will be provided by the **Network Operator** or **Non-Embedded Customer**, as the case may be, with a fault clearance time not longer than 300ms for faults on the **Network Operator's** or **Non-Embedded Customer's Apparatus**.

- (v) Such **Protection** will also be required to withstand, without tripping, the loading incurred during the clearance of a fault on the **National Electricity Transmission System** by breaker fail **Protection** operating at a nominal voltage of greater than 132kV. This will permit **Discrimination** between **Network Operator's Back-Up Protection** or **Non-Embedded Customer's Back-Up Protection**, as the case may be, and **Back-Up Protection** provided on the **National Electricity Transmission System** and other **User Systems**. The requirement for and level of **Discrimination** required will be specified in the **Bilateral Agreement**.
- (c) (i) Where the **Network Operator** or **Non-Embedded Customer** is connected to part of the **National Electricity Transmission System** operating at a nominal voltage greater than 132kV and in Scotland also at 132kV, and a circuit breaker is provided by the **Network Operator** or **Non-Embedded Customer**, or the **Relevant Transmission Licensee**, as the case may be, to interrupt the interchange of fault current with the **National Electricity Transmission System** or the **System** of the **Network Operator** or **Non-Embedded Customer**, as the case may be, circuit breaker fail **Protection** will be provided by the **Network Operator** or **Non-Embedded Customer**, or the **Relevant Transmission Licensee**, as the case may be, on this circuit breaker.
 - (ii) In the event, following operation of a **Protection** system, of a failure to interrupt fault current by these circuit-breakers within the **Fault Current Interruption Time**, the circuit breaker fail **Protection** is required to initiate tripping of all the necessary electrically adjacent circuit-breakers so as to interrupt the fault current within the next 200ms.
- (d) The target performance for the **System Fault Dependability Index** shall be not less than 99%. This is a measure of the ability of **Protection** to initiate successful tripping of circuit breakers which are associated with the faulty items of **Apparatus**.

ECC.6.2.3.2 Fault Disconnection Facilities

- (a) Where no **Transmission** circuit breaker is provided at the **User's** connection voltage, the **User** must provide **The Company** with the means of tripping all the **User's** circuit breakers necessary to isolate faults or **System** abnormalities on the **National Electricity Transmission System**. In these circumstances, for faults on the **User's System**, the **User's Protection** should also trip higher voltage **Transmission** circuit breakers. These tripping facilities shall be in accordance with the requirements specified in the **Bilateral Agreement**.
- (b) **The Company** may require the installation of a **System to Generator Operational Intertripping Scheme** in order to enable the timely restoration of circuits following power **System** fault(s). These requirements shall be set out in the relevant **Bilateral Agreement**.

ECC.6.2.3.3 Automatic Switching Equipment

Where automatic reclosure of **Transmission** circuit breakers is required following faults on the **User's System**, automatic switching equipment shall be provided in accordance with the requirements specified in the **Bilateral Agreement**.

ECC.6.2.3.4 Relay Settings

Protection and relay settings will be co-ordinated (both on connection and subsequently) across the **Connection Point** in accordance with the **Bilateral Agreement** to ensure effective disconnection of faulty **Apparatus**.

ECC.6.2.3.5 Work on Protection equipment

Where a **Transmission Licensee** owns the busbar at the **Connection Point**, no busbar **Protection**, mesh corner **Protection** relays, AC or DC wiring (other than power supplies or DC tripping associated with the **Network Operator** or **Non-Embedded Customer's Apparatus** itself) may be worked upon or altered by the **Network Operator** or **Non-Embedded Customer** personnel in the absence of a representative of the **Relevant Transmission Licensee** or written authority from the **Relevant Transmission Licensee** to perform such work or alterations in the absence of a representative of the **Relevant Transmission Licensee**.

ECC.6.2.3.6 Equipment including Protection equipment to be provided

The Company in coordination with the **Relevant Transmission Licensee** shall specify and agree the **Protection** schemes and settings at each **EU Grid Supply Point** required to protect the **National Electricity Transmission System** in accordance with the characteristics of the **Network Operator's** or **Non Embedded Customer's System**. **The Company** in coordination with the **Relevant Transmission Licensee** and the **Network Operator** or **Non Embedded Customer** shall agree on the protection schemes and settings in respect of the busbar protection zone in respect of each **EU Grid Supply Point**.

Protection of the **Network Operator's** or **Non Embedded Customer's System** shall take precedence over operational controls whilst respecting the security of the **National Electricity Transmission System** and the health and safety of staff and the public.

ECC.6.2.3.6.1 Protection of Interconnecting Connections

The requirements for the provision of **Protection** equipment for interconnecting connections will be specified in the **Bilateral Agreement**.

ECC.6.2.3.7 Changes to Protection Schemes at EU Grid Supply Points

Any subsequent alterations to the busbar protection settings at the **EU Grid Supply Point** (whether by **The Company**, the **Relevant Transmission Licensee**, the **Network Operator** or the **Non Embedded Customer**) shall be agreed between **The Company** (in co-ordination with the **Relevant Transmission Licensee**) and the **Network Operator** or **Non Embedded Customer** in accordance with the Grid Code (ECC.6.2.3.4). No alterations are to be made to any busbar protection schemes unless agreement has been reached between **The Company**,

the **Relevant Transmission Licensee**, the **Network Operator** or **Non Embedded Customer**.

No **Network Operator** or **Non Embedded Customer** equipment shall be energised until the **Protection** settings have been agreed prior to commissioning. The **Network Operator** or **Non Embedded Customer** shall agree with **The Company** (in coordination with the **Relevant Transmission Licensee**) and carry out a combined commissioning programme for the **Protection** systems, and generally, to a minimum standard as specified in the **Bilateral Agreement**.

ECC.6.2.3.8 Control Requirements

ECC.6.2.3.8.1 **The Company** in coordination with the **Relevant Transmission Licensee** and the **Network Operator** or **Non Embedded Customer** shall agree on the control schemes and settings at each **EU Grid Supply Point** of the different control devices of the **Network Operator's** or **Non Embedded Customer's System** relevant for security of the **National Electricity Transmission System**. Such requirements would be pursuant to the terms of the **Bilateral Agreement** which shall also cover at least the following elements:

- (a) Isolated (**National Electricity Transmission System**) operation;
- (b) Damping of oscillations;
- (c) Disturbances to the **National Electricity Transmission System**;
- (d) Automatic switching to emergency supply and restoration to normal topology;
- (e) Automatic circuit breaker re-closure (on 1-phase faults).

ECC.6.2.3.8.2 Subject to the requirements of ECC.6.2.3.8.1 any changes to the schemes and settings, defined in ECC.6.2.3.8.1 of the different control devices of the **Network Operator's** or **Non-Embedded Customer's System** at the **EU Grid Supply Point** shall be coordinated and agreed between **The Company**, the **Relevant Transmission Licensee**, the **Network Operator** or **Non Embedded Customer**.

ECC.6.2.3.9 Ranking of Protection and Control

ECC.6.2.3.9.1 The **Network Operator** or the **Non Embedded Customer** who owns or operates an **EU Grid Supply Point** shall set the **Protection** and control devices of its **System**, in compliance with the following priority ranking, organised in decreasing order of importance:

- (a) **National Electricity Transmission System Protection**;
- (b) **Protection** equipment at each **EU Grid Supply Point**;
- (c) **Frequency** control (**Active Power** adjustment);
- (d) **Power** restriction.

ECC.6.2.3.10 Synchronising

ECC.6.2.3.10.1 Each **Network Operator** or **Non Embedded Customer** at each **EU Grid Supply Point** shall be capable of synchronisation within the range of frequencies specified in ECC.6.1.2 unless otherwise agreed with **The Company**.

ECC.6.2.3.10.2 **The Company** and the **Network Operator** or **Non Embedded Customer** shall agree on the settings of the synchronisation equipment at each **EU Grid Supply Point** prior to the **Completion Date**. **The Company** and the relevant **Network Operator** or **Non-Embedded Customer** shall agree the synchronisation settings which shall include the following elements.

- (a) Voltage;
- (b) **Frequency**;
- (c) phase angle range;
- (d) deviation of voltage and **Frequency**.

ECC.6.3 GENERAL POWER GENERATING MODULE, OTSDUW AND HVDC EQUIPMENT REQUIREMENTS

ECC.6.3.1 This section sets out the technical and design criteria and performance requirements for **Power Generating Modules** (which includes **Electricity Storage Modules**) and **HVDC Equipment** (whether directly connected to the **National Electricity Transmission System** or **Embedded**) and (where provided in this section) **OTSDUW Plant and Apparatus** which each **Generator** or **HVDC System Owner** must ensure are complied with in relation to its **Power Generating Modules**, **HVDC Equipment** and **OTSDUW Plant and Apparatus**. References to **Power Generating Modules**, **HVDC Equipment** in this ECC.6.3 should be read accordingly. For the avoidance of doubt, the requirements applicable to **Synchronous Power Generating Modules** also apply to **Synchronous Electricity Storage Modules** and the requirements applicable to **Power Park Modules** apply to **Non-Synchronous Electricity Storage Modules**. In addition, the requirements applicable to **Electricity Storage Modules** also apply irrespective of whether the **Electricity Storage Module** operates in such a mode as to import or export power from the **Total System**.

Plant Performance Requirements

ECC.6.3.2 REACTIVE CAPABILITY

ECC.6.3.2.1 Reactive Capability for Type B Synchronous Power Generating Modules

ECC.6.3.2.1.1 When operating at **Maximum Capacity**, all **Type B Synchronous Power Generating Modules** must be capable of continuous operation at any points between the limits of 0.95 **Power Factor** lagging and 0.95 **Power Factor** leading at the **Grid Entry Point** or **User System Entry Point** unless otherwise agreed with **The Company** or relevant **Network Operator**. At **Active Power** output levels other than **Maximum Capacity**, all **Generating Units** within a **Type B Synchronous Power Generating Module** must be capable of continuous operation at any point between the **Reactive Power** capability limits identified on the **HV Generator Performance Chart** unless otherwise agreed with **The Company** or relevant **Network Operator**.

ECC.6.3.2.2 Reactive Capability for Type B Power Park Modules

ECC.6.3.2.2.1 When operating at **Maximum Capacity** all **Type B Power Park Modules** must be capable of continuous operation at any points between the limits of 0.95 **Power Factor** lagging and 0.95 **Power Factor** leading at the **Grid Entry Point** or **User System Entry Point** unless otherwise agreed with **The Company** or relevant **Network Operator**. At **Active Power** output levels other than **Maximum Capacity**, each **Power Park Module** must be capable of continuous operation at any point between the **Reactive Power** capability limits identified on the **HV Generator Performance Chart** unless otherwise agreed with **The Company** or **Network Operator**.

ECC.6.3.2.3 Reactive Capability for Type C and D Synchronous Power Generating Modules

ECC.6.3.2.3.1 In addition to meeting the requirements of ECC.6.3.2.3.2 – ECC.6.3.2.3.5, **EU Generators** which connect a **Type C** or **Type D Synchronous Power Generating Module(s)** to a **Non Embedded Customers System** or private network, may be required to meet additional reactive compensation requirements at the point of connection between the **System** and the **Non Embedded Customer** or private network where this is required for **System** reasons.

ECC.6.3.2.3.2 All **Type C** and **Type D Synchronous Power Generating Modules** shall be capable of satisfying the **Reactive Power** capability requirements at the **Grid Entry Point** or **User System Entry Point** as defined in Figure ECC.6.3.2.3 when operating at **Maximum Capacity**.

ECC.6.3.2.3.3

At **Active Power** output levels other than **Maximum Capacity**, all **Generating Units** within a **Synchronous Power Generating Module** must be capable of continuous operation at any point between the **Reactive Power** capability limit identified on the **HV Generator Performance Chart** at least down to the **Minimum Stable Operating Level**. At reduced **Active Power** output, **Reactive Power** supplied at the **Grid Entry Point** (or **User System Entry Point** if **Embedded**) shall correspond to the **HV Generator Performance Chart** of the **Synchronous Power Generating Module**, taking the auxiliary supplies and the **Active Power** and **Reactive Power** losses of the **Generating Unit** transformer or **Station Transformer** into account.

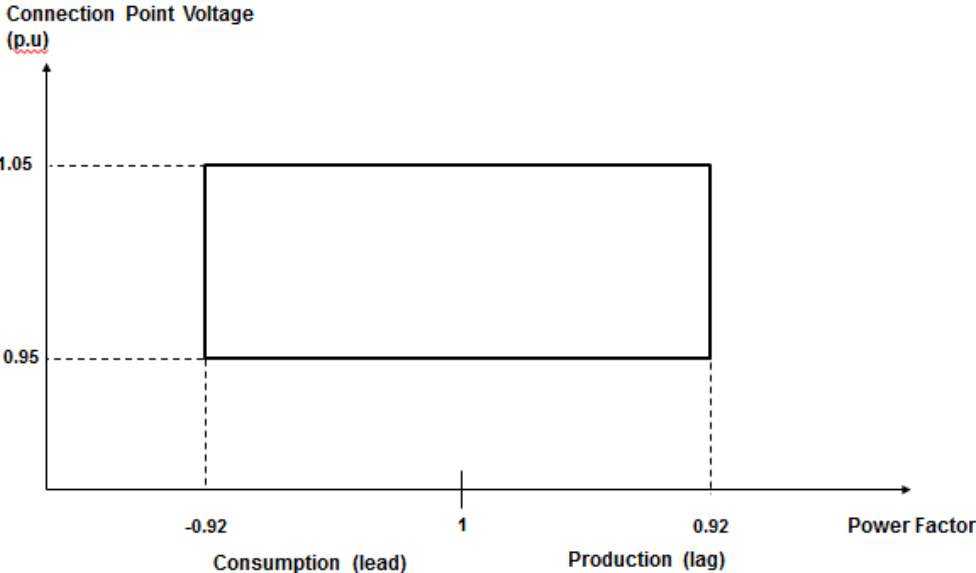

Figure ECC.6.3.2.3

ECC.6.3.2.3.4

In addition, to the requirements of ECC.6.3.2.3.1 – ECC.6.3.2.3.3 the short circuit ratio of all **Onshore Synchronous Generating Units** with an **Apparent Power** rating of less than 1600MVA shall not be less than 0.5. The short circuit ratio of **Onshore Synchronous Generating Units** with a rated **Apparent Power** of 1600MVA or above shall be not less than 0.4.

ECC.6.3.2.4

Reactive Capability for Type C and D Power Park Modules, HVDC Equipment and OTSDUW Plant and Apparatus at the Interface Point

ECC.6.3.2.4.1

EU Generators or **HVDC System Owners** which connect an **Onshore Type C** or **Onshore Type D Power Park Module** or **HVDC Equipment** to a **Non Embedded Customers System** or private network, may be required to meet additional reactive compensation requirements at the point of connection between the **System** and the **Non Embedded Customer** or private network where this is required for **System** reasons.

ECC.6.3.2.4.2

All **Onshore Type C Power Park Modules** and **Onshore Type D Power Park Modules** or **HVDC Converters** at an **HVDC Converter Station** with a **Grid Entry Point** or **User System Entry Point** voltage above 33kV, or **Remote End HVDC Converters** with an **HVDC Interface Point** voltage above 33kV, or **OTSDUW Plant and Apparatus** with an **Interface Point** voltage above 33kV shall be capable of satisfying the **Reactive Power** capability requirements at the **Grid Entry Point** or **User System Entry Point** (or **Interface Point** in the case of **OTSDUW Plant and Apparatus**, or **HVDC Interface Point** in the case of a **Remote End HVDC Converter Station**) as defined in Figure ECC.6.3.2.4(a) when operating at **Maximum Capacity** (or **Interface Point Capacity** in the case of **OTSUW Plant and Apparatus**). In the case of **Remote End HVDC Converters** and **DC Connected Power Park Modules**, **The Company** in co-ordination with the **Relevant Transmission Licensee** may agree to alternative reactive capability requirements to those specified in Figure ECC.6.3.2.4(a), where it is demonstrated that it is uneconomic and inefficient to do so, for example in the case of new technologies or advanced control strategies. For the avoidance of doubt, the requirements for **Offshore Power Park Modules** and **DC Connected Power Park Modules** are defined in ECC.6.3.2.5 and ECC.6.3.2.6.

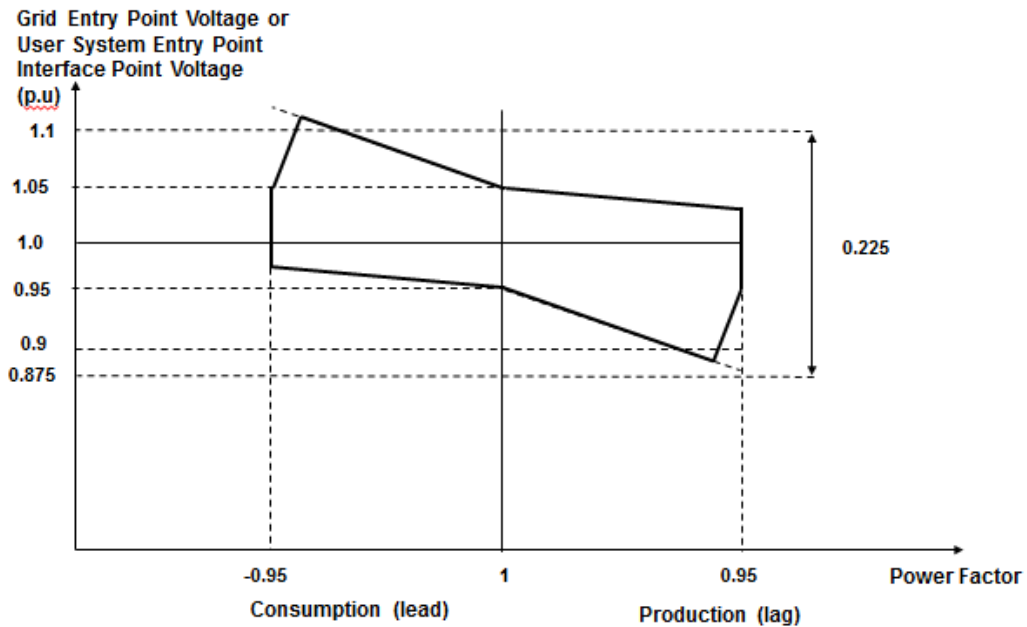

Figure ECC.6.3.2.4(a)

ECC.6.3.2.4.3

All **Onshore Type C** or **Type D Power Park Modules** or **HVDC Converters** at a **HVDC Converter Station** with a **Grid Entry Point** or **User System Entry Point** voltage at or below 33kV or **Remote End HVDC Converter Station** with an **HVDC Interface Point Voltage** at or below 33kV shall be capable of satisfying the **Reactive Power** capability requirements at the **Grid Entry Point** or **User System Entry Point** as defined in Figure ECC.6.3.2.4(b) when operating at **Maximum Capacity**. In the case of **Remote End HVDC Converters** **The Company** in co-ordination with the **Relevant Transmission Licensee** may agree to alternative reactive capability requirements to those specified in Figure ECC.6.3.2.4(b), where it is demonstrated that it is uneconomic and inefficient to do so, for example in the case of new technologies or advanced control strategies. For the avoidance of doubt, the requirements for **Offshore Power Park Modules** and **DC Connected Power Park Modules** are defined in ECC.6.3.2.5 and ECC.6.3.2.6.

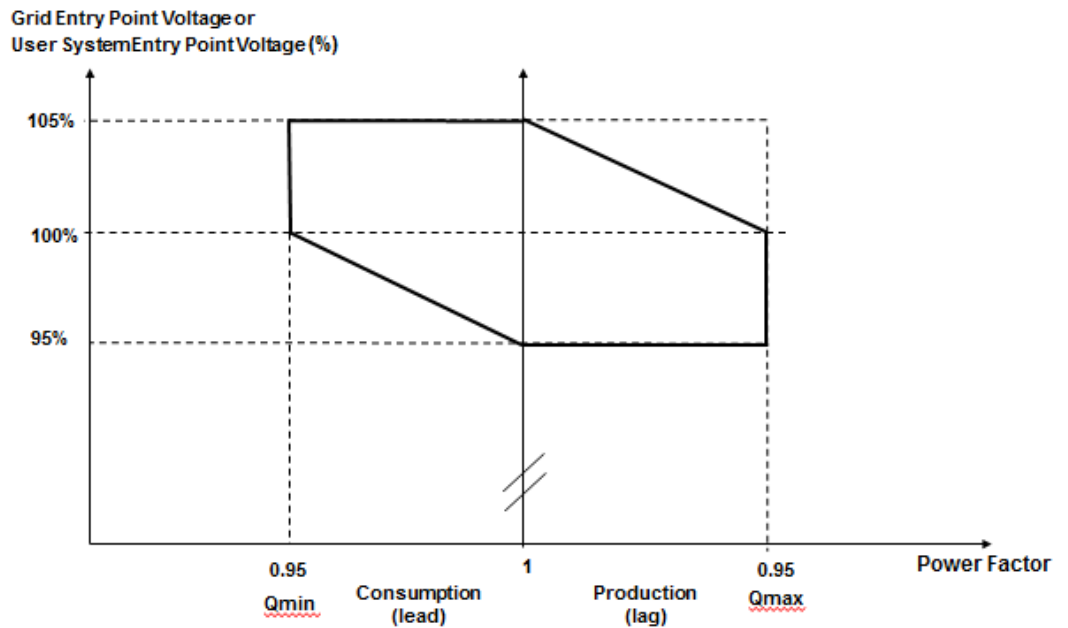

Figure ECC.6.3.2.4(b)

ECC.6.3.2.4.4 All **Type C** and **Type D Power Park Modules, HVDC Converters** at a **HVDC Converter Station** including **Remote End HVDC Converters** or **OTSDUW Plant and Apparatus**, shall be capable of satisfying the **Reactive Power** capability requirements at the **Grid Entry Point** or **User System Entry Point** (or **Interface Point Capacity** in the case of **OTSUW Plant and Apparatus** or **HVDC Interface Point** in the case of **Remote End HVDC Converter Stations**) as defined in Figure ECC.6.3.2.4(c) when operating below **Maximum Capacity**. With all **Plant** in service, the **Reactive Power** limits will reduce linearly below 50% **Active Power** output as shown in Figure ECC.6.3.2.4(c) unless the requirement to maintain the **Reactive Power** limits defined at **Maximum Capacity** (or **Interface Point Capacity** in the case of **OTSDUW Plant and Apparatus**) under absorbing **Reactive Power** conditions down to 20% **Active Power** output has been specified by **The Company**. These **Reactive Power** limits will be reduced pro rata to the amount of **Plant** in service. In the case of **Remote End HVDC Converters**, **The Company** in co-ordination with the **Relevant Transmission Licensee** may agree to alternative reactive capability requirements to those specified in Figure ECC.6.3.2.4(a), where it is demonstrated that it is uneconomic and inefficient to do so, for example in the case of new technologies or advanced control strategies. For the avoidance of doubt, the requirements for **Offshore Power Park Modules** and **DC Connected Power Park Modules** are defined in ECC.6.3.2.5 and ECC.6.3.2.6.

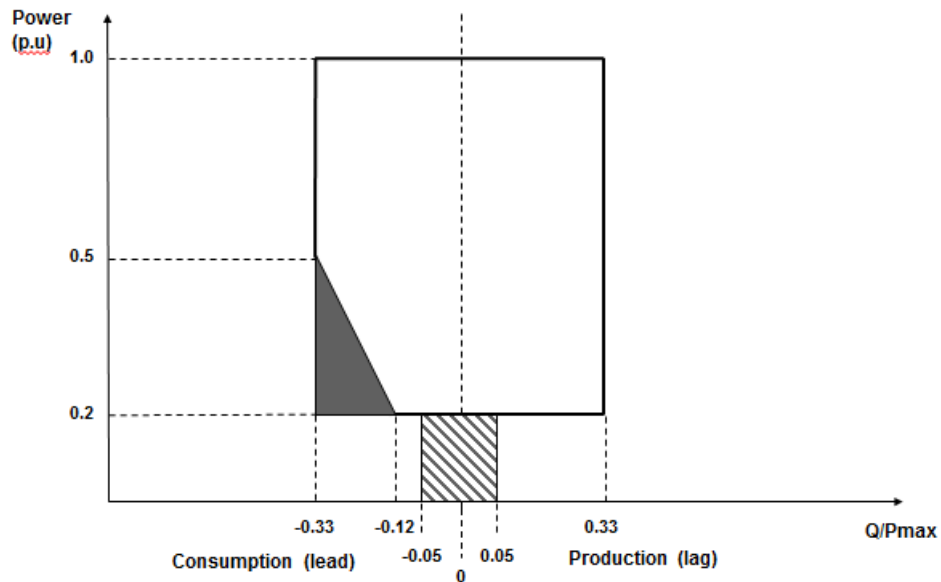

Figure ECC.6.3.2.4(c)

ECC.6.3.2.5 Reactive Capability for Offshore Synchronous Power Generating Modules, Configuration 1 AC connected Offshore Power Park Modules and Configuration 1 DC Connected Power Park Modules.

ECC.6.3.2.5.1 The short circuit ratio of any **Offshore Synchronous Generating Units** within a **Synchronous Power Generating Module** shall not be less than 0.5. All **Offshore Synchronous Generating Units, Configuration 1 AC connected Offshore Power Park Modules or Configuration 1 DC Connected Power Park Modules** must be capable of maintaining zero transfer of **Reactive Power** at the **Offshore Grid Entry Point**. The steady state tolerance on **Reactive Power** transfer to and from an **Offshore Transmission System** expressed in **MVar** shall be no greater than 5% of the **Maximum Capacity**.

ECC.6.3.2.5.2 For the avoidance of doubt if an **EU Generator** (including those in respect of **DC Connected Power Park Modules**) wishes to provide a **Reactive Power** capability in excess of the minimum requirements defined in ECC.6.3.2.5.1 then such capability (including steady state tolerance) shall be agreed between the **Generator, Offshore Transmission Licensee and The Company** and/or the relevant **Network Operator**.

ECC.6.3.2.6 Reactive Capability for Configuration 2 AC Connected Offshore Power Park Modules and Configuration 2 DC Connected Power Park Modules.

ECC.6.3.2.6.1 All **Configuration 2 AC connected Offshore Power Park Modules and Configuration 2 DC Connected Power Park Modules** shall be capable of satisfying the minimum **Reactive Power** capability requirements at the **Offshore Grid Entry Point** as defined in Figure ECC.6.3.2.6(a) when operating at **Maximum Capacity**. **The Company** in co-ordination with the **Relevant Transmission Licensee** may agree to alternative reactive capability requirements to those specified in Figure ECC.6.3.2.6(a), where it is demonstrated that it is uneconomic and inefficient to do so, for example in the case of new technologies or advanced control strategies.

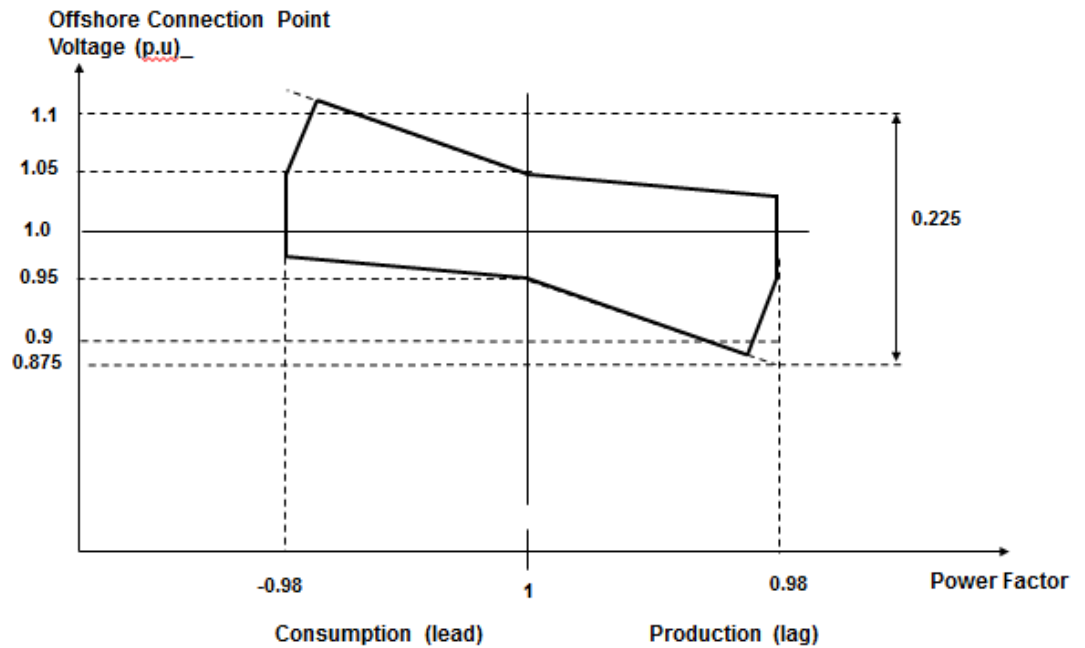

Figure ECC.6.3.2.6(a)

ECC.6.3.2.6.2 All **AC Connected Configuration 2 Offshore Power Park Modules** and **Configuration 2 DC Connected Power Park Modules** shall be capable of satisfying the **Reactive Power** capability requirements at the **Offshore Grid Entry Point** as defined in Figure ECC.6.3.2.6(b) when operating below **Maximum Capacity**. With all **Plant** in service, the **Reactive Power** limits will reduce linearly below 50% **Active Power** output as shown in Figure ECC.6.3.2.6(b) unless the requirement to maintain the **Reactive Power** limits defined at **Maximum Capacity** (or **Interface Point Capacity** in the case of **OTSDUW Plant and Apparatus**) under absorbing **Reactive Power** conditions down to 20% **Active Power** output has been specified with **The Company**. These **Reactive Power** limits will be reduced pro rata to the amount of **Plant** in service. **The Company** in co-ordination with the **Relevant Transmission Licensee** may agree to alternative reactive capability requirements to those specified in Figure ECC.6.3.2.6(b), where it is demonstrated that it is uneconomic and inefficient to do so, for example in the case of new technologies or advanced control strategies.

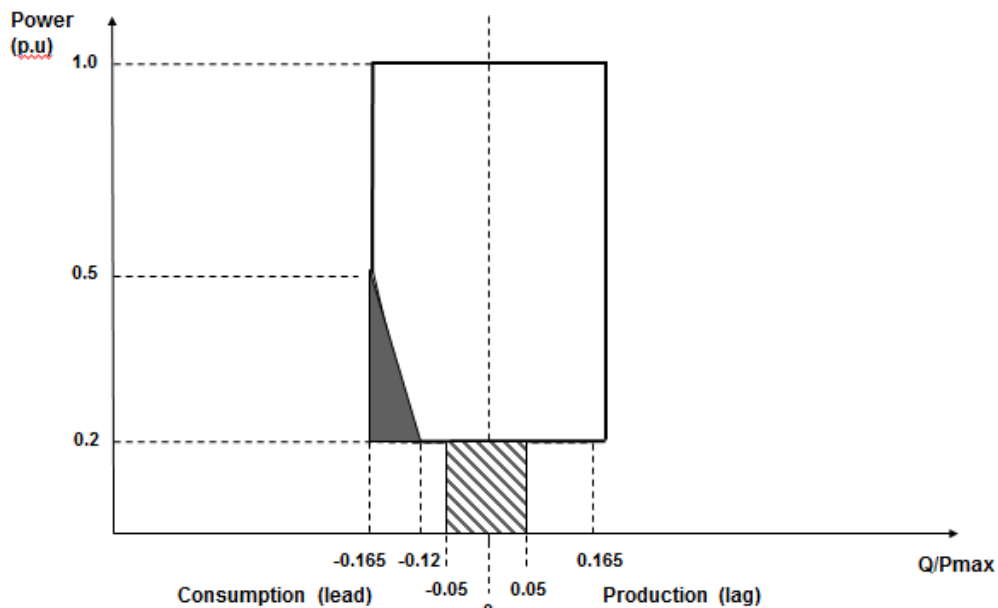

Figure ECC.6.3.2.6(b)

ECC.6.3.2.6.3 For the avoidance of doubt if an **EU Generator** (including **Generators** in respect of **DC Connected Power Park Modules** referred to in ECC.6.3.2.6.2) wishes to provide a **Reactive Power** capability in excess of the minimum requirements defined in ECC.6.3.2.6.1 then such capability (including any steady state tolerance) shall be between the **EU Generator, Offshore Transmission Licensee** and **The Company** and/or the relevant **Network Operator**.

ECC.6.3.3 OUTPUT POWER WITH FALLING FREQUENCY

ECC.6.3.3.1 Output power with falling frequency for **Power Generating Modules** and **HVDC Equipment**

ECC.6.3.3.1.1 Each **Power Generating Module** and **HVDC Equipment** must be capable of:

- (a) continuously maintaining constant **Active Power** output for **System Frequency** changes within the range 50.5 to 49.5 Hz; and
- (b) (subject to the provisions of ECC.6.1.2) maintaining its **Active Power** output at a level not lower than the figure determined by the linear relationship shown in Figure ECC.6.3.3(a) for **System Frequency** changes within the range 49.5 to 47 Hz for all ambient temperatures up to and including 25⁰C, such that if the **System Frequency** drops to 47 Hz the **Active Power** output does not decrease by more than 5%. In the case of a **CCGT Module**, the above requirement shall be retained down to the **Low Frequency Relay** trip setting of 48.8 Hz, which reflects the first stage of the **Automatic Low Frequency Demand Disconnection** scheme notified to **Network Operators** under OC6.6.2. For **System Frequency** below that setting, the existing requirement shall be retained for a minimum period of 5 minutes while **System Frequency** remains below that setting, and special measure(s) that may be required to meet this requirement shall be kept in service during this period. After that 5 minutes period, if **System Frequency** remains below that setting, the special measure(s) must be discontinued if there is a materially increased risk of the **Gas Turbine** tripping. The need for special measure(s) is linked to the inherent **Gas Turbine Active Power** output reduction caused by reduced shaft speed due to falling **System Frequency**. Where the need for special measures is identified in order to maintain output in line with the level identified in Figure ECC.6.3.3(a) these measures should be still continued at ambient temperatures above 25⁰C maintaining as much of the **Active Power** achievable within the capability of the plant. For the avoidance of doubt, **Generators** in respect of **Pumped Storage Plant** and **Electricity Storage Modules** shall also be required to satisfy the requirements of OC6.6.6.

Figure ECC.6.3.3(a) **Active Power** Output with falling frequency for **Power Generating Modules** and **HVDC Systems** and **Electricity Storage Modules** when operating in an exporting mode of operation

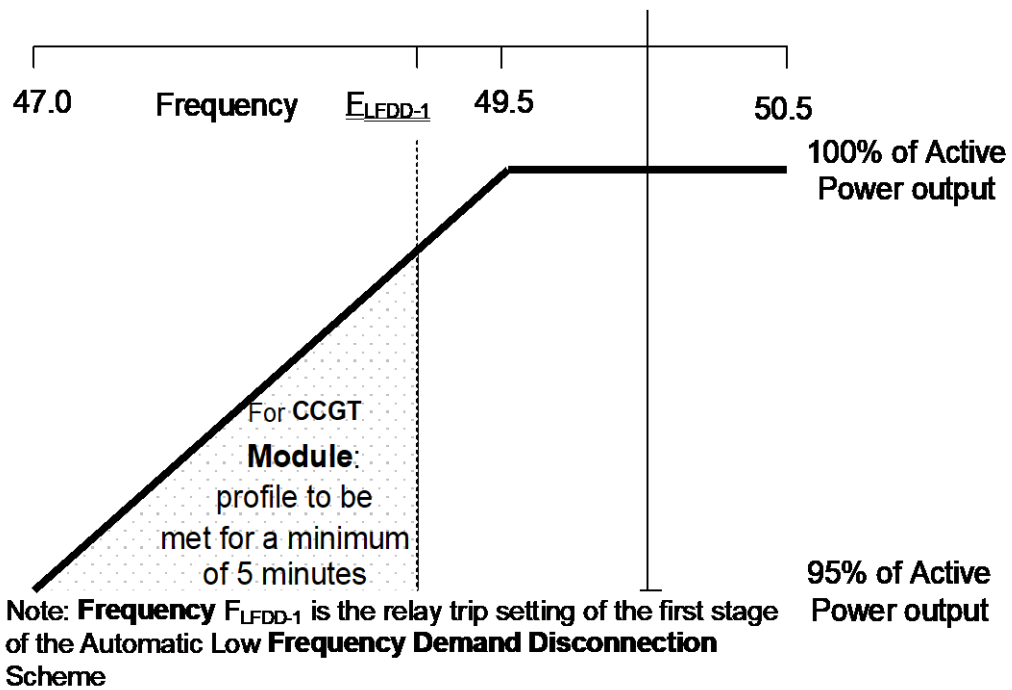

- (c) For the avoidance of doubt, in the case of a **Power Generating Module** including a **DC Connected Power Park Module** using an **Intermittent Power Source** where the mechanical power input will not be constant over time, the requirement is that the **Active Power** output shall be independent of **System Frequency** under (a) above and should not drop with **System Frequency** by greater than the amount specified in (b) above.
- (d) An **HVDC System** must be capable of maintaining its **Active Power** input (i.e. when operating in a mode analogous to **Demand**) from the **National Electricity Transmission System** (or **User System** in the case of an **Embedded HVDC System**) at a level not greater than the figure determined by the linear relationship shown in Figure ECC.6.3.3(b) for **System Frequency** changes within the range 49.5 to 47 Hz, such that if the **System Frequency** drops to 47.8 Hz the **Active Power** input decreases by more than 60%.

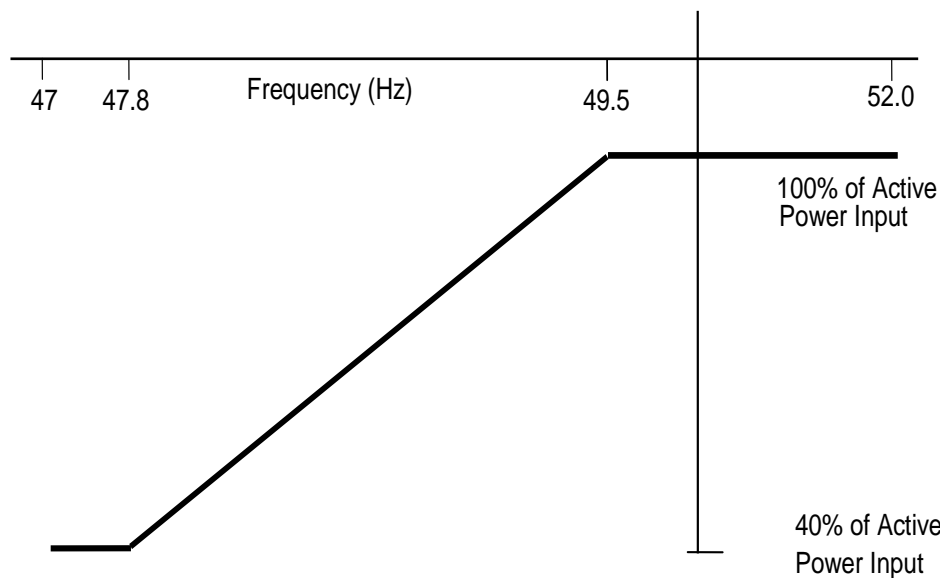

Figure ECC.6.3.3(b) **Active Power** input with falling frequency for **HVDC Systems**

- (e) In the case of an **Offshore Generating Unit** or **Offshore Power Park Module** or **DC Connected Power Park Module** or **Remote End HVDC Converter** or **Transmission DC Converter**, the **EU Generator** shall comply with the requirements of ECC.6.3.3. **EU Generators** should be aware that Section K of the **STC** places requirements on **Offshore Transmission Licensees** which utilise a **Transmission DC Converter** as part of their **Offshore Transmission System** to make appropriate provisions to enable **EU Generators** to fulfil their obligations.
- (f) **Transmission DC Converters** and **Remote End HVDC Converters** shall provide a continuous signal indicating the real time frequency measured at the **Interface Point** to the **Offshore Grid Entry Point** or **HVDC Interface Point** for the purpose of **Offshore Generators** or **DC Connected Power Park Modules** to respond to changes in **System Frequency** on the Main Interconnected **Transmission System**. A **DC Connected Power Park Module** or **Offshore Power Generating Module** shall be capable of receiving and processing this signal within 100ms.

ECC.6.3.4 ACTIVE POWER OUTPUT UNDER SYSTEM VOLTAGE VARIATIONS

ECC.6.3.4.1 At the **Grid Entry Point** or **User System Entry Point**, the **Active Power** output under steady state conditions of any **Power Generating Module** or **HVDC Equipment** directly connected to the **National Electricity Transmission System** or in the case of **OTSDUW**, the **Active Power** transfer at the **Interface Point**, under steady state conditions of any **OTSDUW Plant and Apparatus** should not be affected by voltage changes in the normal operating range specified in paragraph ECC.6.1.4 by more than the change in **Active Power** losses at reduced or increased voltage.

ECC.6.3.5 BLACK START

ECC.6.3.5.1 **Black Start** is not a mandatory requirement, however **EU Code Users** may wish to notify **The Company** of their ability to provide a **Black Start** facility and the cost of the service. **The Company** will then consider whether it wishes to contract with the **EU Code User** for the provision of a **Black Start** service which would be specified via a **Black Start Contract**. Where an **EU Code User** does not offer to provide a cost for the provision of a **Black Start Capability**, **The Company** may make such a request if it considers **System** security to be at risk due to a lack of **Black Start** capability.

ECC.6.3.5.2 It is an essential requirement that the **National Electricity Transmission System** must incorporate a **Black Start Capability**. This will be achieved by agreeing a **Black Start Capability** at a number of strategically located **Power Stations** and **HVDC Systems**. For each **Power Station** or **HVDC System**, **The Company** will state in the **Bilateral Agreement** whether or not a **Black Start Capability** is required.

ECC.6.3.5.3 Where an **EU Code User** has entered into a **Black Start Contract** to provide a **Black Start Capability** in respect of a **Type C Power Generating Module** or **Type D Power Generating Module** (including **DC Connected Power Park Modules**) the following requirements shall apply.

- (i) The **Power-Generating Module** or **DC Connected Power Park Module** shall be capable of starting from shutdown without any external electrical energy supply within a time frame specified by **The Company** in the **Black Start Contract**.
- (ii) Each **Power Generating Module** or **DC Connected Power Park Module** shall be able to synchronise within the frequency limits defined in ECC.6.1. and, where applicable, voltage limits specified in ECC.6.1.4;
- (iii) The **Power Generating Module** or **DC Connected Power Park Module** shall be capable of connecting on to an unenergised **System**.
- (iv) The **Power-Generating Module** or **DC Connected Power Park Module** shall be capable of automatically regulating dips in voltage caused by connection of demand;
- (v) The **Power Generating Module** or **DC Connected Power Park Module** shall:
 - be capable of **Block Load Capability**,

be capable of operating in **LFSM-O** and **LFSM-U**, as specified in ECC.6.3.7.1 and ECC.6.3.7.2

control **Frequency** in case of overfrequency and underfrequency within the whole **Active Power** output range between the **Minimum Regulating Level** and **Maximum Capacity** as well as at houseload operation levels

be capable of parallel operation of a few **Power Generating Modules** including **DC Connected Power Park Modules** within an isolated part of the **Total System** that is still supplying **Customers**, and control voltage automatically during the system restoration phase;

ECC.6.3.5.4 Each **HVDC System** or **Remote End HVDC Converter Station** which has a **Black Start Capability** shall be capable of energising the busbar of an AC substation to which the another **HVDC Converter Station** is connected. The timeframe after shutdown of the **HVDC System** prior to energisation of the AC substation shall be pursuant to the terms of the **Black Start Contract**. The **HVDC System** shall be able to synchronise within the **Frequency** limits defined in ECC.6.1.2.1.2 and voltage limits defined in ECC.6.1.4.1 unless otherwise specified in the **Black Start Contract**. Wider **Frequency** and voltage ranges can be specified in the **Black Start Contract** in order to restore **System** security.

ECC.6.3.5.5 With regard to the capability to take part in operation of an isolated part of the **Total System** that is still supplying **Customers**:

(b) **Power Generating Modules** including **DC Connected Power Park Modules** shall be capable of taking part in island operation if specified in the **Black Start Contract** required by **The Company** and:

the **Frequency** limits for island operation shall be those specified in ECC.6.1.2,

the voltage limits for island operation shall be those defined in ECC.6.1.4;

(i) **Power Generating Modules** including **DC Connected Power Park Modules** shall be able to operate in **Frequency Sensitive Mode** during island operation, as specified in ECC.6.3.7.3. In the event of a power surplus, **Power Generating Modules** including **DC Connected Power Park Modules** shall be capable of reducing the **Active Power** output from a previous operating point to any new operating point within the **Power Generating Module Performance Chart**. **Power Generating Modules** including **DC Connected Power Park Modules** shall be capable of reducing **Active Power** output as much as inherently technically feasible, but to at least 55 % of **Maximum Capacity**;

(iii) The method for detecting a change from interconnected system operation to island operation shall be agreed between the **EU Generator**, **The Company** and the **Relevant Transmission Licensee**. The agreed method of detection must not rely solely on **The Company**, **Relevant Transmission Licensee's** or **Network Operators** switchgear position signals;

(iv) **Power Generating Modules** including **DC Connected Power Park Modules** shall be able to operate in **LFSM-O** and **LFSM-U** during island operation, as specified in ECC.6.3.7.1 and ECC.6.3.7.2;

ECC.6.3.5.6 With regard to quick re-synchronisation capability:

(b) In case of disconnection of the **Power Generating Module** including **DC Connected Power Park Modules** from the **System**, the **Power Generating Module** shall be capable of quick re-synchronisation in line with the **Protection** strategy agreed between **The Company** and/or **Network Operator** in co-ordination with the **Relevant Transmission Licensee** and the **Generator**;

- (i) A **Power Generating Module** including a **DC Connected Power Park Module** with a minimum re-synchronisation time greater than 15 minutes after its disconnection from any external power supply must be capable of **Houseload Operation** from any operating point on its **Power Generating Module Performance Chart**. In this case, the identification of **Houseload Operation** must not be based solely on the **Total System's** switchgear position signals;
- (ii) **Power Generating Modules** including **DC Connected Power Park Modules** shall be capable of **Houseload Operation**, irrespective of any auxiliary connection to the **Total System**. The minimum operation time shall be specified by **The Company**, taking into consideration the specific characteristics of prime mover technology.

ECC.6.3.6 CONTROL ARRANGEMENTS

ECC.6.3.6.1 ACTIVE POWER CONTROL

ECC.6.3.6.1.1 Active Power control in respect of Power Generating Modules including DC Connected Power Park Modules

ECC.6.3.6.1.1.1 **Type A Power Generating Modules** shall be equipped with a logic interface (input port) in order to cease **Active Power** output within five seconds following receipt of a signal from **The Company**. **The Company** shall specify the requirements for such facilities, including the need for remote operation, in the **Bilateral Agreement** where they are necessary for **System** reasons .

ECC.6.3.6.1.1.2 **Type B Power Generating Modules** shall be equipped with an interface (input port) in order to be able to reduce **Active Power** output following receipt of a signal from **The Company**. **The Company** shall specify the requirements for such facilities, including the need for remote operation, in the **Bilateral Agreement** where they are necessary for **System** reasons.

ECC.6.3.6.1.1.3 **Type C and Type D Power Generating Modules and DC Connected Power Park Modules** shall be capable of adjusting the **Active Power** setpoint in accordance with instructions issued by **The Company**.

ECC.6.3.6.1.2 Active Power control in respect of HVDC Systems and Remote End HVDC Converter Stations

ECC.6.3.6.1.2.1 **HVDC Systems** shall be capable of adjusting the transmitted **Active Power** upon receipt of an instruction from **The Company** which shall be in accordance with the requirements of BC2.6.1.

ECC.6.3.6.1.2.2 The requirements for fast **Active Power** reversal (if required) shall be specified by **The Company**. Where **Active Power** reversal is specified in the **Bilateral Agreement**, each **HVDC System** and **Remote End HVDC Converter Station** shall be capable of operating from maximum import to maximum export in a time which is as fast as technically feasible or in a time that is no greater than 2 seconds except where a **HVDC Converter Station Owner** has justified to **The Company** that a longer reversal time is required.

ECC.6.3.6.1.2.3 Where an **HVDC System** connects various **Control Areas** or **Synchronous Areas**, each **HVDC System** or **Remote End HVDC Converter Station** shall be capable of responding to instructions issued by **The Company** under the **Balancing Code** to modify the transmitted **Active Power** for the purposes of cross-border balancing.

ECC.6.3.6.1.2.4 An **HVDC System** shall be capable of adjusting the ramping rate of **Active Power** variations within its technical capabilities in accordance with instructions issued by **The Company** . In case of modification of **Active Power** according to ECC.6.3.15 and ECC.6.3.6.1.2.2, there shall be no adjustment of ramping rate.

ECC.6.3.6.1.2.5 If specified by **The Company**, in coordination with the **Relevant Transmission Licensees**, the control functions of an **HVDC System** shall be capable of taking automatic remedial actions including, but not limited to, stopping the ramping and blocking FSM, LFSM-O, LFSM-U and **Frequency** control. The triggering and blocking criteria shall be specified by **The Company**.

ECC.6.3.6.2 MODULATION OF ACTIVE POWER

ECC.6.3.6.2.1 Each **Power Generating Module** (including **DC Connected Power Park Modules**) and **Onshore HVDC Converters** at an **Onshore HVDC Converter Station** must be capable of contributing to **Frequency** control by continuous modulation of **Active Power** supplied to the **National Electricity Transmission System**. For the avoidance of doubt each **Onshore HVDC Converter** at an **Onshore HVDC Converter Station** and/or **OTSDUW DC Converter** shall provide each **EU Code User** in respect of its **Offshore Power Stations** connected to and/or using an **Offshore Transmission System** a continuous signal indicating the real time **Frequency** measured at the **Transmission Interface Point**. A **DC Connected Power Park Module** or **Offshore Power Generating Module** shall be capable of receiving and processing this signal within 100ms.

ECC.6.3.6.3 MODULATION OF REACTIVE POWER

ECC.6.3.6.3.1 Notwithstanding the requirements of ECC.6.3.2, each **Power Generating Module** or **HVDC Equipment** (and **OTSDUW Plant and Apparatus** at a **Transmission Interface Point** and **Remote End HVDC Converter** at an **HVDC Interface Point**) (as applicable) must be capable of contributing to voltage control by continuous changes to the **Reactive Power** supplied to the **National Electricity Transmission System** or the **User System** in which it is **Embedded**.

ECC.6.3.7 FREQUENCY RESPONSE

ECC.6.3.7.1 Limited Frequency Sensitive Mode – Overfrequency (LFSM-O)

ECC.6.3.7.1.1 Each **Power Generating Module** (including **DC Connected Power Park Modules**) and **HVDC Systems** shall be capable of reducing **Active Power** output in response to **Frequency** on the **Total System** when this rises above 50.4Hz. For the avoidance of doubt, the provision of this reduction in **Active Power** output is not an **Ancillary Service**. Such provision is known as **Limited High Frequency Response**. The **Power Generating Module** (including **DC Connected Power Park Modules**) or **HVDC Systems** shall be capable of operating stably during **LFSM-O** operation. However for a **Power Generating Module** (including **DC Connected Power Park Modules**) or **HVDC Systems** operating in **Frequency Sensitive Mode** the requirements of **LFSM-O** shall apply when the frequency exceeds 50.5Hz.

- ECC.6.3.7.1.2
- (i) The rate of change of **Active Power** output must be at a minimum a rate of 2 percent of output per 0.1 Hz deviation of **System Frequency** above 50.4Hz (ie a **Droop** of 10%) as shown in Figure ECC.6.3.7.1 below. This would not preclude a **EU Generator** or **HVDC System Owner** from designing their **Power Generating Module** with a **Droop** of less than 10% but in all cases the **Droop** should be 2% or greater.
 - (ii) The reduction in **Active Power** output must be continuously and linearly proportional, as far as is practicable, to the excess of **Frequency** above 50.4 Hz and must be provided increasingly with time over the period specified in (iii) below.
 - (iii) As much as possible of the proportional reduction in **Active Power** output must result from the frequency control device (or speed governor) action and must be achieved within 10 seconds of the time of the **Frequency** increase above 50.4 Hz. The **Power Generating Module** (including **DC Connected Power Park Modules**) or **HVDC Systems** shall be capable of initiating a power **Frequency** response with an initial delay that is as short as possible. If the delay exceeds 2 seconds the **EU Generator** or **HVDC System Owner** shall justify the variation, providing technical evidence to **The Company**.
 - (iii) The residue of the proportional reduction in **Active Power** output which results from automatic action of the **Power Generating Module** (including **DC Connected Power**

Park Modules) or **HVDC System** output control devices other than the frequency control devices (or speed governors) must be achieved within 3 minutes for the time of the **Frequency** increase above 50.4Hz.

- (iv) For the avoidance of doubt, the **LFSM-O** response must be reduced when the **Frequency** falls again and, when to a value less than 50.4Hz, as much as possible of the increase in **Active Power** must be achieved within 10 seconds.
- (v) For **Type A** and **Type B Power Generating Modules** which are not required to have **Frequency Sensitive Mode (FSM)** as described in ECC.6.3.7.3 for deviations in **Frequency** up to 50.9Hz at least half of the proportional reduction in **Active Power** output must be achieved in 10 seconds of the time of the **Frequency** increase above 50.4Hz. For deviations in **Frequency** beyond 50.9Hz the measured rate of change of **Active Power** reduction must exceed 0.5%/sec of the initial output. The **LFSM-O** response must be reduced when the **Frequency** subsequently falls again and when to a value less than 50.4Hz, at least half the increase in **Active Power** must be achieved in 10 seconds. For a **Frequency** excursion returning from beyond 50.9Hz the measured rate of change of **Active Power** increase must exceed 0.5%/second.

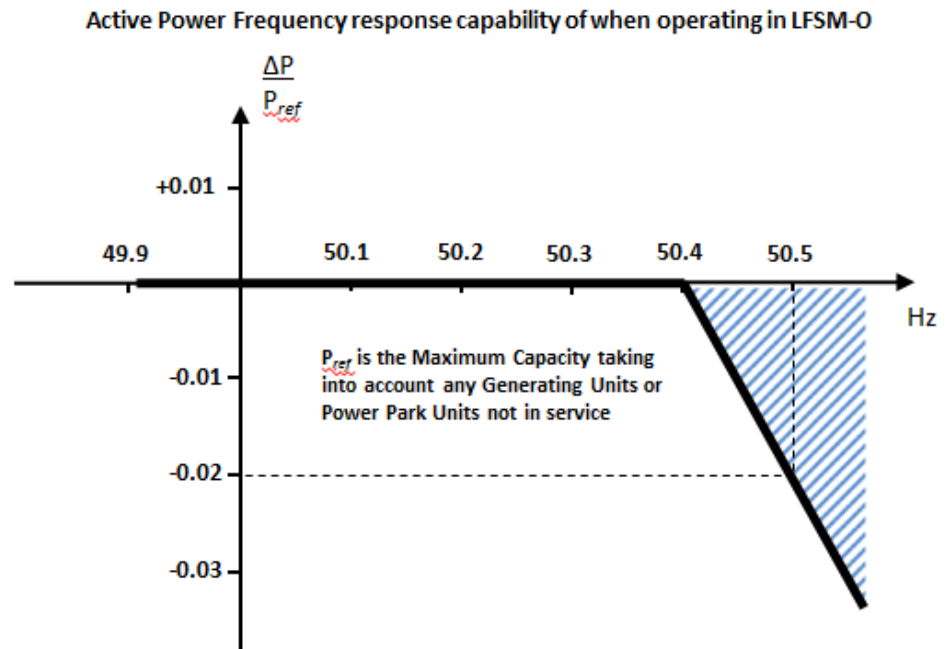

Figure ECC.6.3.7.1 – P_{ref} is the reference **Active Power** to which ΔP is related and ΔP is the change in **Active Power** output from the **Power Generating Module** (including **DC Connected Power Park Modules**) or **HVDC System**. The **Power Generating Module** (including **DC Connected Power Park Modules** or **HVDC Systems**) has to provide a negative **Active Power** output change with a droop of 10% or less based on P_{ref} .

ECC.6.3.7.1.3 Each **Power Generating Module** (including **DC Connected Power Park Modules**) or **HVDC Systems** which is providing **Limited High Frequency Response (LFSM-O)** must continue to provide it until the **Frequency** has returned to or below 50.4Hz or until otherwise instructed by **The Company**. **EU Generators** in respect of **Gensets** and **HVDC Converter Station Owners** in respect of an **HVDC System** should also be aware of the requirements in BC.3.7.2.2.

ECC.6.3.7.1.4 Steady state operation below the **Minimum Stable Operating Level** in the case of **Power Generating Modules** including **DC Connected Power Park Modules** or **Minimum Active Power Transmission Capacity** in the case of **HVDC Systems** is not expected but if **System** operating conditions cause operation below the **Minimum Stable Operating Level** or **Minimum Active Power Transmission Capacity** which could give rise to operational

difficulties for the **Power Generating Module** including a **DC Connected Power Park Module** or **HVDC Systems** then the **EU Generator** or **HVDC System Owner** shall be able to return the output of the **Power Generating Module** including a **DC Connected Power Park Module** to an output of not less than the **Minimum Stable Operating Level** or **HVDC System** to an output of not less than the **Minimum Active Power Transmission Capacity**.

ECC.6.3.7.1.5 All reasonable efforts should in the event be made by the **EU Generator** or **HVDC System Owner** to avoid such tripping provided that the **System Frequency** is below 52Hz in accordance with the requirements of ECC.6.1.2. If the **System Frequency** is at or above 52Hz, the requirement to make all reasonable efforts to avoid tripping does not apply and the **EU Generator** or **HVDC System Owner** is required to take action to protect its **Power Generating Modules** including **DC Connected Power Park Modules** or **HVDC Converter Stations**.

ECC.6.3.7.2 Limited Frequency Sensitive Mode – Underfrequency (LFSM-U)

ECC.6.3.7.2.1 Each **Type C Power Generating Module** and **Type D Power Generating Module** (including **DC Connected Power Park Modules**) or **HVDC Systems** operating in **Limited Frequency Sensitive Mode** shall be capable of increasing **Active Power** output in response to **System Frequency** when this falls below 49.5Hz. For the avoidance of doubt, the provision of this increase in **Active Power** output is not a mandatory **Ancillary Service** and it is not anticipated **Power Generating Modules** (including **DC Connected Power Park Modules**) or **HVDC Systems** are operated in an inefficient mode to facilitate delivery of **LFSM-U** response, but any inherent capability (where available) should be made without undue delay. The **Power Generating Module** (including **DC Connected Power Park Modules**) or **HVDC Systems** shall be capable of stable operation during **LFSM-U Mode**. For example, a **EU Generator** which is operating with no headroom (eg it is operating at maximum output or is de-loading as part of a run down sequence and has no headroom) would not be required to provide **LFSM-U**.

ECC.6.3.7.2.2 (i) The rate of change of **Active Power** output must be at a minimum a rate of 2 percent of output per 0.1 Hz deviation of **System Frequency** below 49.5Hz (ie a **Droop** of 10%) as shown in Figure ECC.6.3.7.2.2 below. This requirement only applies if the **Power Generating Module** has headroom and the ability to increase **Active Power** output. In the case of a **Power Park Module** or **DC Connected Power Park Module** the requirements of Figure ECC.6.3.7.2.2 shall be reduced pro-rata to the amount of **Power Park Units** in service and available to generate. For the avoidance of doubt, this would not preclude an **EU Generator** or **HVDC System Owner** from designing their **Power Generating Module** with a lower **Droop** setting, for example between 3 – 5%.

(ii) As much as possible of the proportional increase in **Active Power** output must result from the **Frequency** control device (or speed governor) action and must be achieved for **Frequencies** below 49.5 Hz. The **Power Generating Module** (including **DC Connected Power Park Modules**) or **HVDC Systems** shall be capable of initiating a power **Frequency** response with minimal delay. If the delay exceeds 2 seconds the **EU Generator** or **HVDC System Owner** shall justify the delay, providing technical evidence to **The Company**).

(iii) The actual delivery of **Active Power Frequency Response** in **LFSM-U** mode shall take into account

The ambient conditions when the response is to be triggered

The operating conditions of the **Power Generating Module** (including **DC Connected Power Park Modules**) or **HVDC Systems** in particular limitations on operation near **Maximum Capacity** or **Maximum HVDC Active Power Transmission Capacity** at low frequencies and the respective impact of ambient conditions as detailed in ECC.6.3.3.

The availability of primary energy sources.

- (iv) In **LFSM_U Mode**, the **Power Generating Module** (including **DC Connected Power Park Modules**) and **HVDC Systems**, shall be capable of providing a power increase up to its **Maximum Capacity** or **Maximum HVDC Active Power Transmission Capacity** (as applicable).

Active Power Frequency response capability of when operating in LFSM-U

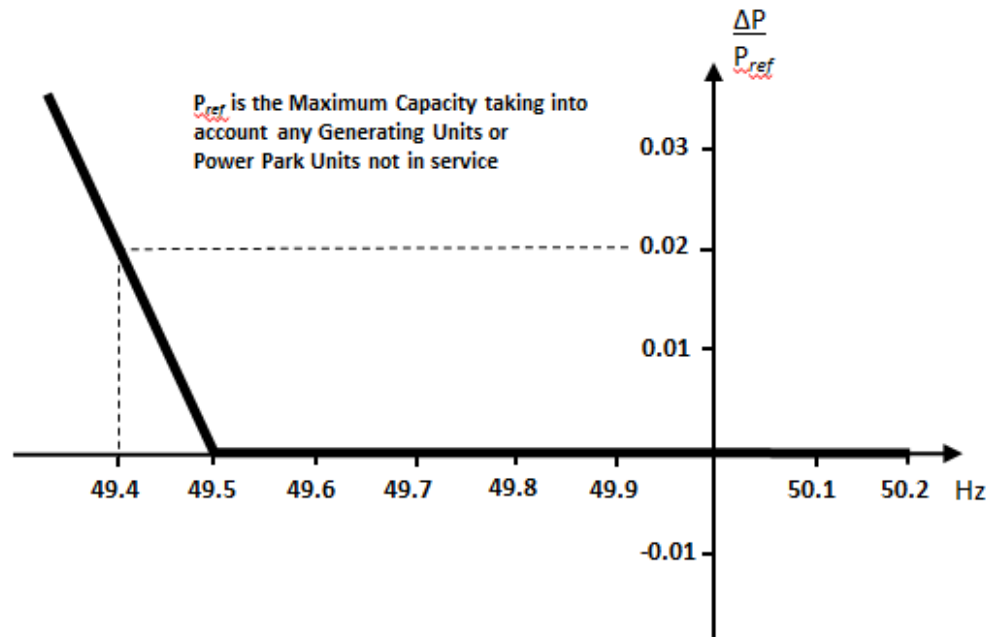

Figure ECC.6.3.7.2.2 – P_{ref} is the reference **Active Power** to which ΔP is related and ΔP is the change in **Active Power** output from the **Power Generating Module** (including **DC Connected Power Park Modules**) or **HVDC System**. The **Power Generating Module** (including **DC Connected Power Park Modules** or **HVDC Systems**) has to provide a positive **Active Power** output change with a droop of 10% or less based on P_{ref} .

ECC.6.3.7.3 Frequency Sensitive Mode – (FSM)

ECC.6.3.7.3.1 In addition to the requirements of ECC.6.3.7.1 and ECC.6.3.7.2 each **Type C Power Generating Module** and **Type D Power Generating Module** (including **DC Connected Power Park Modules**) or **HVDC Systems** must be fitted with a fast acting proportional **Frequency** control device (or turbine speed governor) and unit load controller or equivalent control device to provide **Frequency** response under normal operational conditions in accordance with **Balancing Code 3 (BC3)**. In the case of a **Power Park Module** including a **DC Connected Power Park Module**, the **Frequency** or speed control device(s) may be on the **Power Park Module** (including a **DC Connected Power Park Module**) or on each individual **Power Park Unit** (including a **Power Park Unit** within a **DC Connected Power Park Module**) or be a combination of both. The **Frequency** control device(s) (or speed governor(s)) must be designed and operated to the appropriate:

- (i) **European Specification:** or
- (ii) in the absence of a relevant **European Specification**, such other standard which is in common use within the European Community (which may include a manufacturer specification);

as at the time when the installation of which it forms part was designed or (in the case of modification or alteration to the **Frequency** control device (or turbine speed governor)) when the modification or alteration was designed.

The **European Specification** or other standard utilised in accordance with sub paragraph ECC.6.3.7.3.1 (a) (ii) will be notified to **The Company** by the **EU Generator** or **HVDC System Owner**:

- (i) as part of the application for a **Bilateral Agreement**; or
- (ii) as part of the application for a varied **Bilateral Agreement**; or
- (iii) in the case of an Embedded Development, within 28 days of entry into the Embedded Development Agreement (or such later time as agreed with **The Company**) or
- (iv) as soon as possible prior to any modification or alteration to the **Frequency** control device (or governor); and

ECC.6.3.7.3.2 The **Frequency** control device (or speed governor) in co-ordination with other control devices must control each **Type C Power Generating Module** and **Type D Power Generating Module** (including **DC Connected Power Park Modules**) or **HVDC Systems Active Power Output** or **Active Power** transfer capability with stability over the entire operating range of the **Power Generating Module** (including **DC Connected Power Park Modules**) or **HVDC Systems** ; and

ECC.6.3.7.3.3 **Type C** and **Type D Power Generating Modules** and **DC Connected Power Park Modules** shall also meet the following minimum requirements:

- (i) capable of providing **Active Power Frequency** response in accordance with the performance characteristic shown in Figure 6.3.7.3.3(a) and parameters in Table 6.3.7.3.3(a)

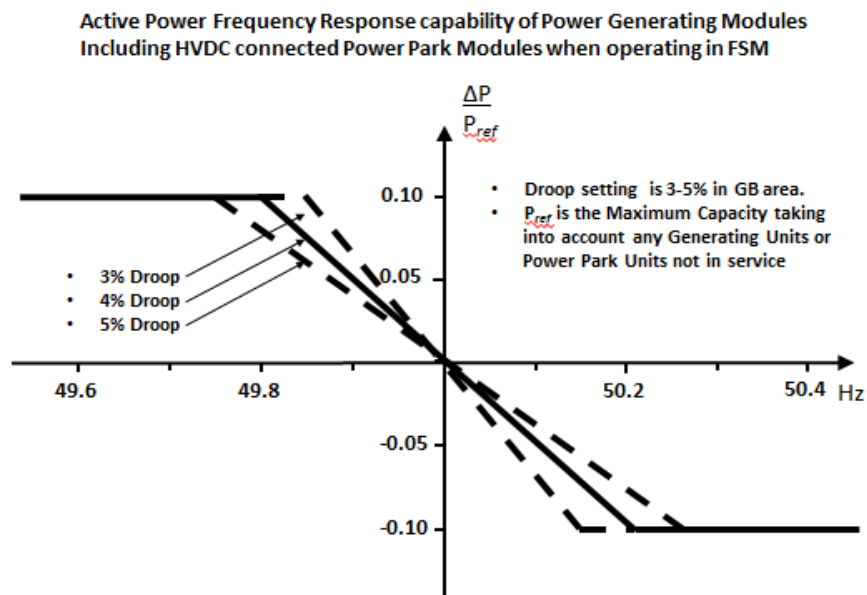

Figure 6.3.7.3.3(a) – **Frequency Sensitive Mode** capability of **Power Generating Modules** and **DC Connected Power Park Modules**

Parameter	Setting
Nominal System Frequency	50Hz
Active Power as a percentage of Maximum Capacity ($\frac{ \Delta P_1 }{P_{max}}$)	10%
Frequency Response Insensitivity in mHz ($ \Delta f_i $)	±15mHz

Frequency Response Insensitivity as a percentage of nominal frequency ($\frac{ \Delta f_i }{f_n}$)	±0.03%
Frequency Response Deadband in mHz	0 (mHz)
Droop (%)	3 – 5%

Table 6.3.7.3.3(a) – Parameters for **Active Power Frequency** response in **Frequency Sensitive Mode** including the mathematical expressions in Figure 6.3.7.3.3(a).

- (ii) In satisfying the performance requirements specified in ECC.6.3.7.3(i) **EU Generators** in respect of each **Type C** and **Type D Power Generating Modules and DC Connected Power Park Module** should be aware:-

in the case of overfrequency, the **Active Power Frequency** response is limited by the **Minimum Regulating Level**,

in the case of underfrequency, the **Active Power Frequency** response is limited by the **Maximum Capacity**,

the actual delivery of **Active Power** frequency response depends on the operating and ambient conditions of the **Power Generating Module** (including **DC Connected Power Park Modules**) when this response is triggered, in particular limitations on operation near **Maximum Capacity** at low **Frequencies** as specified in ECC.6.3.3 and available primary energy sources.

The frequency control device (or speed governor) must also be capable of being set so that it operates with an overall speed **Droop** of between 3 – 5%. The **Frequency Response Deadband** and **Droop** must be able to be reselected repeatedly. For the avoidance of doubt, in the case of a **Power Park Module** (including **DC Connected Power Park Modules**) the speed **Droop** should be equivalent of a fixed setting between 3% and 5% applied to each **Power Park Unit** in service.

- (iii) In the event of a **Frequency** step change, each **Type C** and **Type D Power Generating Module** and **DC Connected Power Park Module** shall be capable of activating full and stable **Active Power Frequency** response (without undue power oscillations), in accordance with the performance characteristic shown in Figure 6.3.7.3.3(b) and parameters in Table 6.3.7.3.3(b).

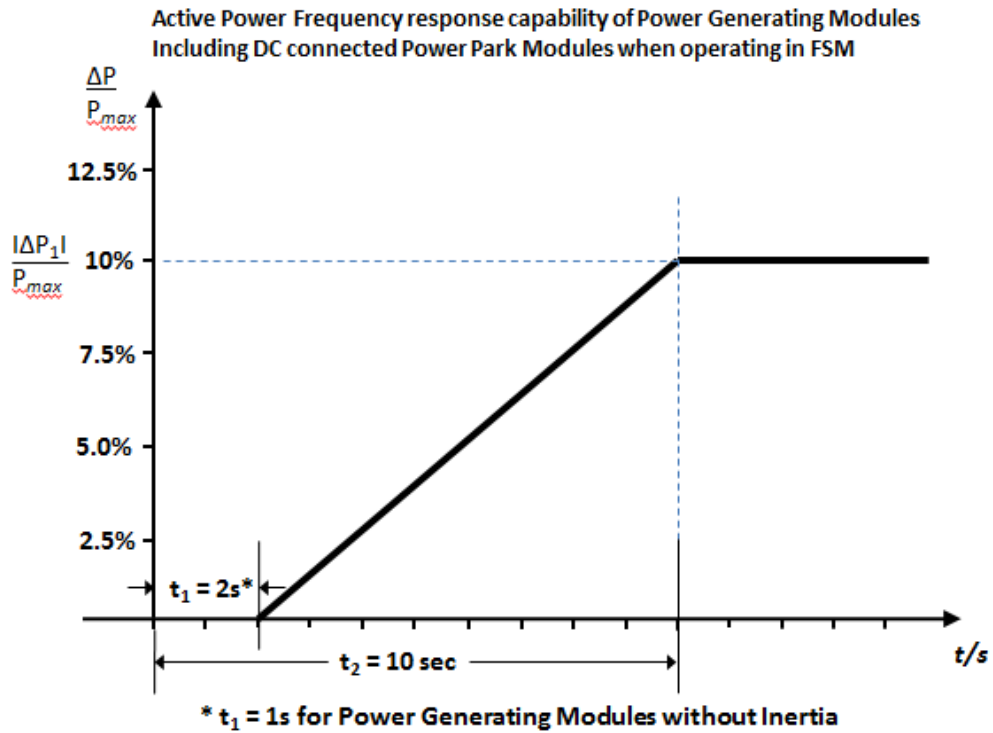

Figure 6.3.7.3.3(b) **Active Power Frequency Response** capability.

Parameter	Setting
Active Power as a percentage of Maximum Capacity (frequency response range) $\left(\frac{ \Delta P_1 }{P_{max}}\right)$	10%
Maximum admissible initial delay t_1 for Power Generating Modules (including DC Connected Power Park Modules) with inertia unless justified as specified in ECC.6.3.7.3.3 (iv)	2 seconds
Maximum admissible initial delay t_1 for Power Generating Modules (including DC Connected Power Park Modules) which do not contribute to System inertia unless justified as specified in ECC.6.3.7.3.3 (iv)	1 second
Activation time t_2	10 seconds

Table 6.3.7.3.3(b) – Parameters for full activation of **Active Power Frequency** response resulting from a **Frequency** step change. Table 6.3.7.3.3(b) also includes the mathematical expressions used in Figure 6.3.7.3.3(b).

- (iv) The initial activation of **Active Power Primary Frequency** response shall not be unduly delayed. For **Type C** and **Type D Power Generating Modules** (including **DC Connected Power Park Modules**) with inertia the delay in initial **Active Power Frequency** response shall not be greater than 2 seconds. For **Type C** and **Type D Power Generating Modules** (including **DC Connected Power Park Modules**) without inertia, the delay in initial **Active Power Frequency** response shall not be greater than 1 second. If the **Generator** cannot meet this requirement they shall provide technical evidence to **The Company** demonstrating why a longer time is needed for the initial activation of **Active Power Frequency** response.
- (v) in the case of **Type C** and **Type D Power Generating Modules** (including **DC Connected Power Park Modules**) other than the **Steam Unit** within a **CCGT Module** the combined effect of the **Frequency Response Insensitivity** and **Frequency Response Deadband** of the **Frequency** control device (or speed governor) should be no greater than 0.03Hz (for the avoidance of doubt, $\pm 0.015\text{Hz}$). In the case of the **Steam Unit** within a **CCGT Module**, the **Frequency Response Deadband** should be set to an appropriate value consistent with the requirements of ECC.6.3.7.3.5(ii) and the requirements of BC3.7.2.2 for the provision of **LFSM-O** taking account of any **Frequency Response Insensitivity** of the Frequency control device (or speed governor);

ECC.6.3.7.3.4 **HVDC Systems** shall also meet the following minimum requirements:

- (i) **HVDC Systems** shall be capable of responding to **Frequency** deviations in each connected **AC System** by adjusting their **Active Power** import or export as shown in Figure 6.3.7.3.4(a) with the corresponding parameters in Table 6.3.7.3.4(a).

Active Power Frequency response capability of HVDC systems when operating in FSI

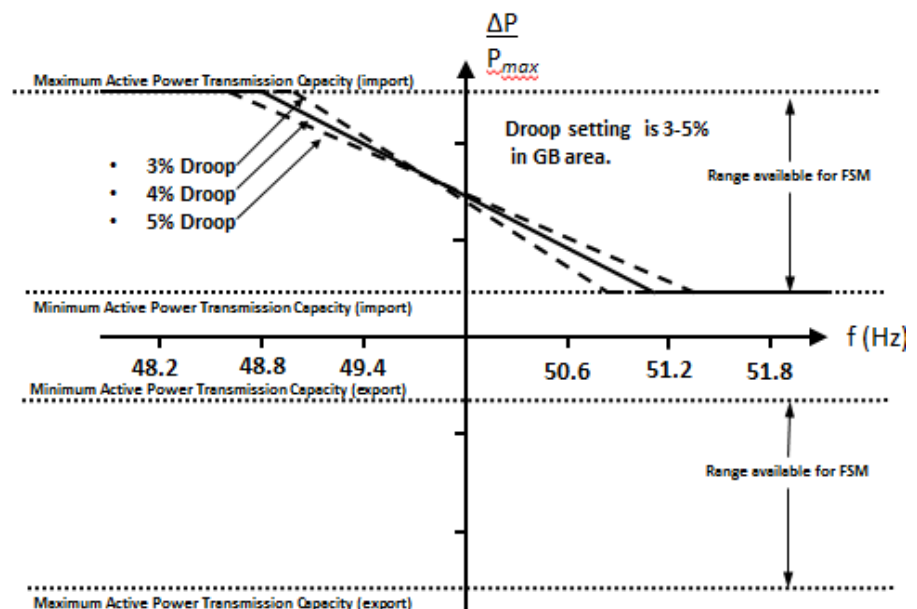

Figure 6.3.7.3.4(a) – **Active Power** frequency response capability of a **HVDC System** operating in **Frequency Sensitive Mode (FSM)**. ΔP is the change in active power output from the **HVDC System**.

Parameter	Setting
-----------	---------

Frequency Response Deadband	0
Droop S1 and S2 (upward and downward regulation) where S1=S2.	3 – 5%
Frequency Response Insensitivity	±15mHz

Table 6.3.7.3.4(a) – Parameters for **Active Power Frequency** response in **FSM** including the mathematical expressions in Figure 6.3.7.3.4.

- (ii) Each **HVDC System** shall be capable of adjusting the **Droop** for both upward and downward regulation and the **Active Power** range over which **Frequency Sensitive Mode** of operation is available as defined in ECC.6.3.7.3.4.
- (iii) In addition to the requirements in ECC.6.3.7.4(i) and ECC.6.3.7.4(ii) each **HVDC System** shall be capable of:-

delivering the response as soon as technically feasible

delivering the response on or above the solid line in Figure 6.3.7.3.4(b) in accordance with the parameters shown in Table 6.3.7.3.4(b)

initiating the delivery of **Primary Response** in no less than 0.5 seconds unless otherwise agreed with **The Company**. Where the initial delay time (t_1 – as shown in Figure 6.3.7.3.4(b)) is longer than 0.5 seconds the **HVDC Converter Station Owner** shall reasonably justify it to **The Company**.

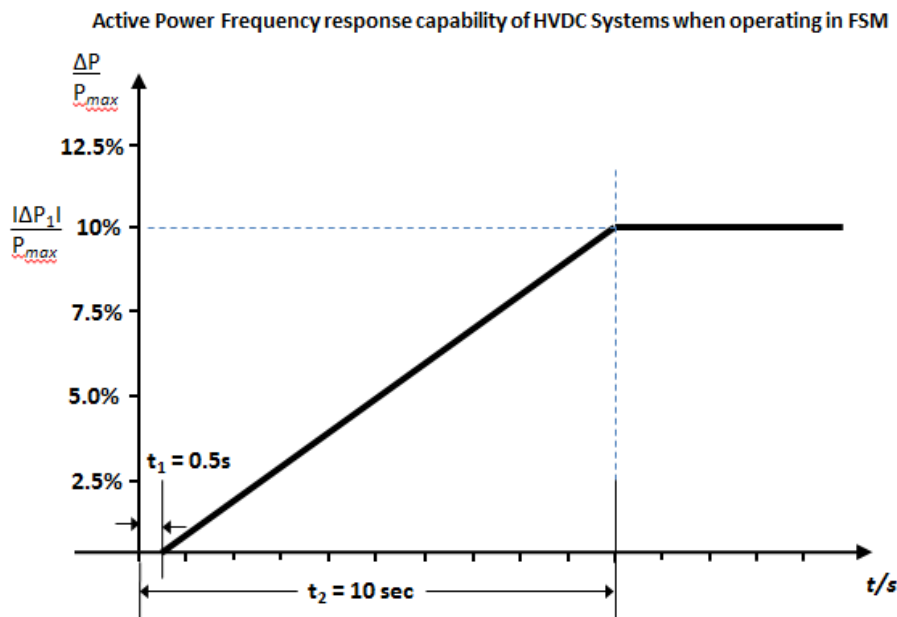

Figure 6.3.7.3.4(b) **Active Power Frequency Response** capability of a **HVDC System**. ΔP is the change in **Active Power** triggered by the step change in frequency

Parameter	Setting
Active Power as a percentage of Maximum Capacity (frequency response range) ($\frac{\Delta P_1}{P_{max}}$)	10%
Maximum admissible delay t_1	0.5 seconds

Maximum admissible time for full activation t_2 , unless longer activation times are agreed with The Company	10 seconds
---	------------

Table 6.3.7.3.4(b) – Parameters for full activation of **Active Power Frequency** response resulting from a **Frequency** step change.

- (iv) For **HVDC Systems** connecting various **Synchronous Areas**, each **HVDC System** shall be capable of adjusting the full **Active Power Frequency Response** when operating in **Frequency Sensitive Mode** at any time and for a continuous time period. In addition, the **Active Power** controller of each **HVDC System** shall not have any adverse impact on the delivery of frequency response.
- ECC.6.3.7.3.5 For **HVDC Systems** and **Type C** and **Type D Power Generating Modules** (including **DC Connected Power Park Modules**), other than the **Steam Unit** within a **CCGT Module** the combined effect of the **Frequency Response Insensitivity** and **Frequency Response Deadband** of the **Frequency** control device (or speed governor) should be no greater than 0.03Hz (for the avoidance of doubt, $\pm 0.015\text{Hz}$). In the case of the **Steam Unit** within a **CCGT Module**, the **Frequency Response Deadband** should be set to an appropriate value consistent with the requirements of ECC.6.3.7.3.5(ii) and the requirements of BC3.7.2.2 for the provision of **LFSM-O** taking account of any **Frequency Response Insensitivity** of the **Frequency** control device (or speed governor);
- (i) With regard to disconnection due to underfrequency, **EU Generators** responsible for **Type C** and **Type D Power Generating Modules** (including **DC Connected Power Park Modules**) capable of acting as a load, including but not limited to **Pumped Storage** and tidal **Power Generating Modules**, **HVDC Systems** and **Remote End HVDC Converter Stations**, shall be capable of disconnecting their load in case of underfrequency which will be agreed with **The Company**. For the avoidance of doubt this requirement does not apply to station auxiliary supplies; **EU Generators** in respect of **Type C** and **Type D Pumped Storage Power Generating Modules** should also be aware of the requirements in OC.6.6.6.
- (ii) Where a **Type C** or **Type D Power Generating Module**, **DC Connected Power Park Module** or **HVDC System** becomes isolated from the rest of the **Total System** but is still supplying **Customers**, the **Frequency** control device (or speed governor) must also be able to control **System Frequency** below 52Hz unless this causes the **Type C** or **Type D Power Generating Module** or **DC Connected Power Park Module** to operate below its **Minimum Regulating Level** or **Minimum Active Power Transmission Capacity** when it is possible that it may, as detailed in BC 3.7.3, trip after a time. For the avoidance of doubt **Power Generating Modules** (including **DC Connected Power Park Modules**) and **HVDC Systems** are only required to operate within the **System Frequency** range 47 - 52 Hz as defined in ECC.6.1.2 and for converter based technologies, the remaining island contains sufficient fault level for effective commutation;
- (iii) Each **Type C** and **Type D Power Generating Module** and **HVDC Systems** shall have the facility to modify the **Target Frequency** setting either continuously or in a maximum of 0.05Hz steps over at least the range $50 \pm 0.1\text{Hz}$ should be provided in the unit load controller or equivalent device.
- ECC.6.3.7.3.6 In addition to the requirements of ECC.6.3.7.3 each **Type C** and **Type D Power Generating Module** and **HVDC System** shall be capable of meeting the minimum **Frequency** response requirement profile subject to and in accordance with the provisions of Appendix A3.
- ECC.6.3.7.3.7 For the avoidance of doubt, the requirements of Appendix A3 do not apply to **Type A** and **Type B Power Generating Modules**.

ECC.6.3.8	<u>EXCITATION AND VOLTAGE CONTROL PERFORMANCE REQUIREMENTS</u>
ECC.6.3.8.1	<u>Excitation Performance Requirements for Type B Synchronous Power Generating Modules</u>
ECC.6.3.8.1.1	Each Synchronous Generating Unit within a Type B Synchronous Power Generating Module shall be equipped with a permanent automatic excitation control system that shall have the capability to provide constant terminal voltage control at a selectable setpoint without instability over the entire operating range of the Type B Synchronous Power Generating Module .
ECC.6.3.8.1.2	In addition to the requirements of ECC.6.3.8.1.1, The Company or the relevant Network Operator will specify if the control system of the Type B Synchronous Power Generating Module shall contribute to voltage control or Reactive Power control or Power Factor control at the Grid Entry Point or User System Entry Point (or other defined busbar). The performance requirements of the control system including slope (where applicable) shall be agreed between The Company and/or the relevant Network Operator and the EU Generator .
ECC.6.3.8.2	<u>Voltage Control Requirements for Type B Power Park Modules</u>
ECC.6.3.8.2.1	The Company or the relevant Network Operator will specify if the control system of the Type B Power Park Module shall contribute to voltage control or Reactive Power control or Power Factor control at the Grid Entry Point or User System Entry Point (or other defined busbar). The performance requirements of the control system including slope (where applicable) shall be agreed between The Company and/or the relevant Network Operator and the EU Generator .
ECC.6.3.8.3	<u>Excitation Performance Requirements for Type C and Type D Onshore Synchronous Power Generating Modules</u>
ECC.6.3.8.3.1	Each Synchronous Generating Unit within a Type C and Type D Onshore Synchronous Power Generating Modules shall be equipped with a permanent automatic excitation control system that shall have the capability to provide constant terminal voltage control at a selectable setpoint without instability over the entire operating range of the Synchronous Power Generating Module .
ECC.6.3.8.3.2	The requirements for excitation control facilities are specified in ECC.A.6. Any site specific requirements shall be specified by The Company or the relevant Network Operator .
ECC.6.3.8.3.3	Unless otherwise required for testing in accordance with OC5.A.2, the automatic excitation control system of an Onshore Synchronous Power Generating Module shall always be operated such that it controls the Onshore Synchronous Generating Unit terminal voltage to a value that is <ul style="list-style-type: none"> - equal to its rated value: or - only where provisions have been made in the Bilateral Agreement, greater than its rated value.
ECC.6.3.8.3.4	In particular, other control facilities including constant Reactive Power output control modes and constant Power Factor control modes (but excluding VAR limiters) are not required. However if present in the excitation or voltage control system they will be disabled unless otherwise agreed with The Company or the relevant Network Operator . Operation of such control facilities will be in accordance with the provisions contained in BC2 .
ECC.6.3.8.3.5	The excitation performance requirements for Offshore Synchronous Power Generating Modules with an Offshore Grid Entry Point shall be specified by The Company .
ECC.6.3.8.4	<u>Voltage Control Performance Requirements for Type C and Type D Onshore Power Park Modules, Onshore HVDC Converters and OTSUW Plant and Apparatus at the Interface Point</u>

- ECC.6.3.8.4.1 Each **Type C** and **Type D Onshore Power Park Module**, **Onshore HVDC Converter** and **OTSDUW Plant and Apparatus** shall be fitted with a continuously acting automatic control system to provide control of the voltage at the **Grid Entry Point** or **User System Entry Point** (or **Interface Point** in the case of **OTSDUW Plant and Apparatus**) without instability over the entire operating range of the **Onshore Power Park Module**, or **Onshore HVDC Converter** or **OTSDUW Plant and Apparatus**. Any **Plant** or **Apparatus** used in the provisions of such voltage control within an **Onshore Power Park Module** may be located at the **Power Park Unit** terminals, an appropriate intermediate busbar or the **Grid Entry Point** or **User System Entry Point**. In the case of an **Onshore HVDC Converter** at a **HVDC Converter Station** any **Plant** or **Apparatus** used in the provisions of such voltage control may be located at any point within the **User's Plant and Apparatus** including the **Grid Entry Point** or **User System Entry Point**. **OTSDUW Plant and Apparatus** used in the provision of such voltage control may be located at the **Offshore Grid Entry Point** an appropriate intermediate busbar or at the **Interface Point**. When operating below 20% **Maximum Capacity** the automatic control system may continue to provide voltage control using any available reactive capability. If voltage control is not being provided, the automatic control system shall be designed to ensure a smooth transition between the shaded area below 20% of **Active Power** output and the non-shaded area above 20% of **Active Power** output in Figure ECC.6.3.2.5(c) and Figure ECC.6.3.2.7(b) The performance requirements for a continuously acting automatic voltage control system that shall be complied with by the **User** in respect of **Onshore Power Park Modules**, **Onshore HVDC Converters** at an **Onshore HVDC Converter Station**, **OTSDUW Plant and Apparatus** at the **Interface Point** are defined in ECC.A.7.
- ECC.6.3.8.4.3 In particular, other control facilities, including constant **Reactive Power** output control modes and constant **Power Factor** control modes (but excluding VAR limiters) are not required. However if present in the voltage control system they will be disabled unless otherwise agreed with **The Company** or the relevant **Network Operator**. Operation of such control facilities will be in accordance with the provisions contained in BC2. Where **Reactive Power** output control modes and constant **Power Factor** control modes have been fitted within the voltage control system they shall be required to satisfy the requirements of ECC.A.7.3 and ECC.A.7.4.
- ECC.6.3.8.5 Excitation Control Performance requirements applicable to AC Connected **Offshore Synchronous Power Generating Modules** and voltage control performance requirements applicable to AC connected **Offshore Power Park Modules**, **DC Connected Power Park Modules** and **Remote End HVDC Converters**
- ECC.6.3.8.5.1 A continuously acting automatic control system is required to provide control of **Reactive Power** (as specified in ECC.6.3.2.5 and ECC.6.3.2.6) at the **Offshore Grid Entry Point** (or **HVDC Interface Point** in the case of **Configuration 1 DC Connected Power Park Modules** and **Remote End HVDC Converters**) without instability over the entire operating range of the AC connected **Offshore Synchronous Power Generating Module** or **Configuration 1 AC connected Offshore Power Park Module** or **Configuration 1 DC Connected Power Park Modules** or **Remote End HVDC Converter**. The performance requirements for this automatic control system will be specified by **The Company** which would be consistent with the requirements of ECC.6.3.2.5 and ECC.6.3.2.6.
- ECC.6.3.8.5.2 A continuously acting automatic control system is required to provide control of **Reactive Power** (as specified in ECC.6.3.2.8) at the **Offshore Grid Entry Point** (or **HVDC Interface Point** in the case of **Configuration 2 DC Connected Power Park Modules**) without instability over the entire operating range of the **Configuration 2 AC connected Offshore Power Park Module** or **Configuration 2 DC Connected Power Park Modules**. otherwise the requirements of ECC.6.3.2.6 shall apply. The performance requirements for this automatic control system are specified in ECC.A.8
- ECC.6.3.8.5.3 In addition to ECC.6.3.8.5.1 and ECC.6.3.8.5.2 the requirements for excitation or voltage control facilities, including **Power System Stabilisers**, where these are necessary for system reasons, will be specified by **The Company**. Reference is made to on-load commissioning witnessed by **The Company** in BC2.11.2.

ECC.6.3.9 STEADY STATE LOAD INACCURACIES

ECC.6.3.9.1 The standard deviation of **Load** error at steady state **Load** over a 30 minute period must not exceed 2.5 per cent of a **Type C** or **Type D Power Generating Modules** (including a **DC Connected Power Park Module**) **Maximum Capacity**. Where a **Type C** or **Type D Power Generating Module** (including a **DC Connected Power Park Module**) is instructed to **Frequency** sensitive operation, allowance will be made in determining whether there has been an error according to the governor droop characteristic registered under the **PC**.

For the avoidance of doubt in the case of a **Power Park Module** (excluding a **Non-Synchronous Electricity Storage Module**) an allowance will be made for the full variation of mechanical power output.

In the case of an **Electricity Storage Module**, an allowance will be made for the storage reserve capability of the **Electricity Storage Module**.

ECC.6.3.10 NEGATIVE PHASE SEQUENCE LOADINGS

ECC.6.3.10.1 In addition to meeting the conditions specified in ECC.6.1.5(b), each **Synchronous Power Generating Module** will be required to withstand, without tripping, the negative phase sequence loading incurred by clearance of a close-up phase-to-phase fault, by **System Back-Up Protection** on the **National Electricity Transmission System** or **User System** located **Onshore** in which it is **Embedded**.

ECC.6.3.11 NEUTRAL EARTHING

ECC.6.3.11 At nominal **System** voltages of 110kV and above the higher voltage windings of a transformer of a **Power Generating Module** or **HVDC Equipment** or transformer resulting from **OTSDUW** must be star connected with the star point suitable for connection to earth. The earthing and lower voltage winding arrangement shall be such as to ensure that the **Earth Fault Factor** requirement of paragraph ECC.6.2.1.1 (b) will be met on the **National Electricity Transmission System** at nominal **System** voltages of 110kV and above.

ECC.6.3.12 FREQUENCY AND VOLTAGE DEVIATIONS

ECC.6.3.12.1 As stated in ECC.6.1.2, the **System Frequency** could rise to 52Hz or fall to 47Hz. Each **Power Generating Module** (including **DC Connected Power Park Modules**) must continue to operate within this **Frequency** range for at least the periods of time given in ECC.6.1.2 unless **The Company** has specified any requirements for combined **Frequency** and voltage deviations which are required to ensure the best use of technical capabilities of **Power Generating Modules** (including **DC Connected Power Park Modules**) if required to preserve or restore system security.- Notwithstanding this requirement, **EU Generators** should also be aware of the requirements of ECC.6.3.13.

ECC.6.3.13 FREQUENCY, RATE OF CHANGE OF FREQUENCY AND VOLTAGE PROTECTION SETTING ARRANGEMENTS

ECC.6.3.13.1 **EU Generators** (including in respect of **OTSDUW Plant and Apparatus**) and **HVDC System Owners** will be responsible for protecting all their **Power Generating Modules** (and **OTSDUW Plant and Apparatus**) or **HVDC Equipment** against damage should **Frequency** excursions outside the range 52Hz to 47Hz ever occur. Should such excursions occur, it is up to the **EU Generator** or **HVDC System Owner** to decide whether to disconnect his **Apparatus** for reasons of safety of **Apparatus, Plant** and/or personnel.

ECC.6.3.13.2 Each **Power Generating Module** when connected and synchronised to the **System**, shall be capable of withstanding without tripping a rate of change of **Frequency** up to and including 1 Hz per second as measured over a rolling 500 milliseconds period. Voltage dips may cause localised rate of change of **Frequency** values in excess of 1 Hz per second for short periods, and in these cases, the requirements under ECC.6.3.15 (fault ride through) supersedes this clause. For the avoidance of doubt, this requirement relates to the capabilities of **Power Generating Modules** only and does not impose the need for rate of change of **Frequency** protection nor does it impose a specific setting for anti-islanding or loss-of-mains protection relays.

- ECC.6.3.13.3 Each **HVDC System** and **Remote End HVDC Converter Station** when connected and synchronised to the **System**, shall be capable of withstanding without tripping a rate of change of **Frequency** up to and including ± 2.5 Hz per second as measured over the previous 1 second period. Voltage dips may cause localised rate of change of **Frequency** values in excess of ± 2.5 Hz per second for short periods, and in these cases, the requirements under ECC.6.3.15 (fault ride through) supersedes this clause. For the avoidance of doubt, this requirement relates to the capabilities of **HVDC Systems** and **Remote End HVDC Converter Stations** only and does not impose the need for rate of change of **Frequency** protection nor does it impose a specific setting for anti-islanding or loss-of-mains protection relays.
- ECC.6.3.13.4 Each **DC Connected Power Park Module** when connected to the **System**, shall be capable of withstanding without tripping a rate of change of **Frequency** up to and including ± 2.0 Hz per second as measured over the previous 1 second period. **Voltage** dips may cause localised rate of change of **Frequency** values in excess of ± 2.0 Hz per second for short periods, and in these cases, the requirements under ECC.6.3.15 (fault ride through) supersedes this clause. For the avoidance of doubt, this requirement relates to the capabilities of **DC Connected Power Park Modules** only and does not impose the need for rate of change of **Frequency** protection nor does it impose a specific setting for anti-islanding or loss-of-mains protection relays.
- ECC.6.3.13.5 As stated in ECC.6.1.2, the **System Frequency** could rise to 52Hz or fall to 47Hz and the **System** voltage at the **Grid Entry Point** or **User System Entry Point** could rise or fall within the values outlined in ECC.6.1.4. Each **Type C** and **Type D Power Generating Module** (including **DC Connected Power Park Modules**) or any constituent element must continue to operate within this **Frequency** range for at least the periods of time given in ECC.6.1.2 and voltage range as defined in ECC.6.1.4 unless **The Company** has agreed to any simultaneous overvoltage and underfrequency relays and/or simultaneous undervoltage and over frequency relays which will trip such **Power Generating Module** (including **DC Connected Power Park Modules**), and any constituent element within this **Frequency** or voltage range.
- ECC.6.3.14 FAST START CAPABILITY
- ECC.6.3.14.1 It may be agreed in the **Bilateral Agreement** that a **Genset** shall have a **Fast-Start Capability**. Such **Gensets** may be used for **Operating Reserve** and their **Start-Up** may be initiated by **Frequency**-level relays with settings in the range 49Hz to 50Hz as specified pursuant to **OC2**.
- ECC.6.3.15 FAULT RIDE THROUGH
- ECC.6.3.15.1 General Fault Ride Through requirements, principles and concepts applicable to Type B, Type C and Type D Power Generating Modules and OTSDUW Plant and Apparatus subject to faults up to 140ms in duration
- ECC.6.3.15.1.1 ECC.6.3.15.1 – ECC.6.3.15.8 section sets out the **Fault Ride Through** requirements on **Type B, Type C and Type D Power Generating Modules, OTSDUW Plant and Apparatus** and **HVDC Equipment** that shall apply in the event of a fault lasting up to 140ms in duration.
- ECC.6.3.15.1.2 Each **Power Generating Module, Power Park Module, HVDC Equipment** and **OTSDUW Plant and Apparatus** is required to remain connected and stable for any balanced and unbalanced fault where the voltage at the **Grid Entry Point** or **User System Entry Point** or (**HVDC Interface Point** in the case of **Remote End DC Converter Stations** or **Interface Point** in the case of **OTSDUW Plant and Apparatus**) remains on or above the heavy black line defined in sections ECC.6.3.15.2 – ECC.6.3.15.7 below.

ECC.6.3.15.1.3 The voltage against time curves defined in ECC.6.3.15.2 – ECC.6.3.15.7 expresses the lower limit (expressed as the ratio of its actual value and its reference 1pu) of the actual course of the phase to phase voltage (or phase to earth voltage in the case of asymmetrical/unbalanced faults) on the **System** voltage level at the **Grid Entry Point** or **User System Entry Point** (or **HVDC Interface Point** in the case of **Remote End HVDC Converter Stations** or **Interface Point** in the case of **OTSDUW Plant and Apparatus**) during a symmetrical or asymmetrical/unbalanced fault, as a function of time before, during and after the fault.

ECC.6.3.15.2 Voltage against time curve and parameters applicable to **Type B Synchronous Power Generating Modules**

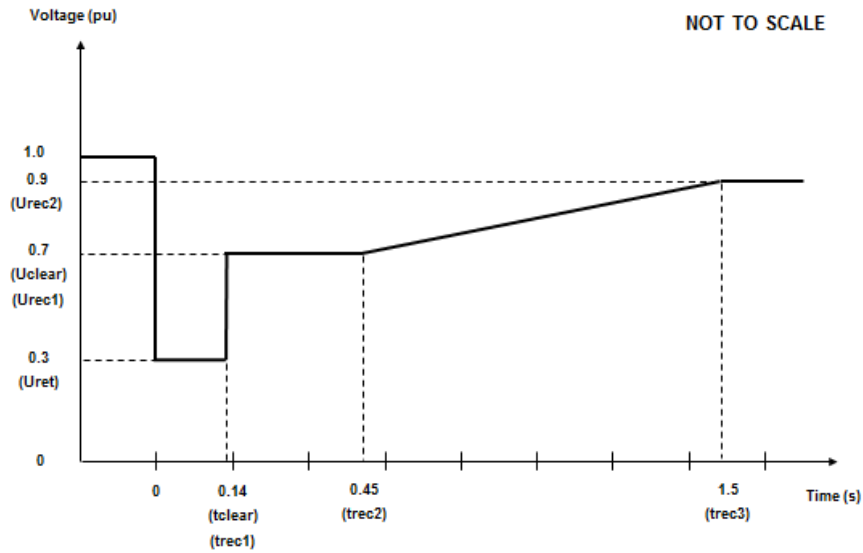

Figure ECC.6.3.15.2 - Voltage against time curve applicable to **Type B Synchronous Power Generating Modules**

Voltage parameters (pu)		Time parameters (seconds)	
Uret	0.3	tclear	0.14
Uclear	0.7	trec1	0.14
Urec1	0.7	trec2	0.45
Urec2	0.9	trec3	1.5

Table ECC.6.3.15.2 Voltage against time parameters applicable to **Type B Synchronous Power Generating Modules**

ECC.6.3.15.3 Voltage against time curve and parameters applicable to **Type C and D Synchronous Power Generating Modules** connected below 110kV

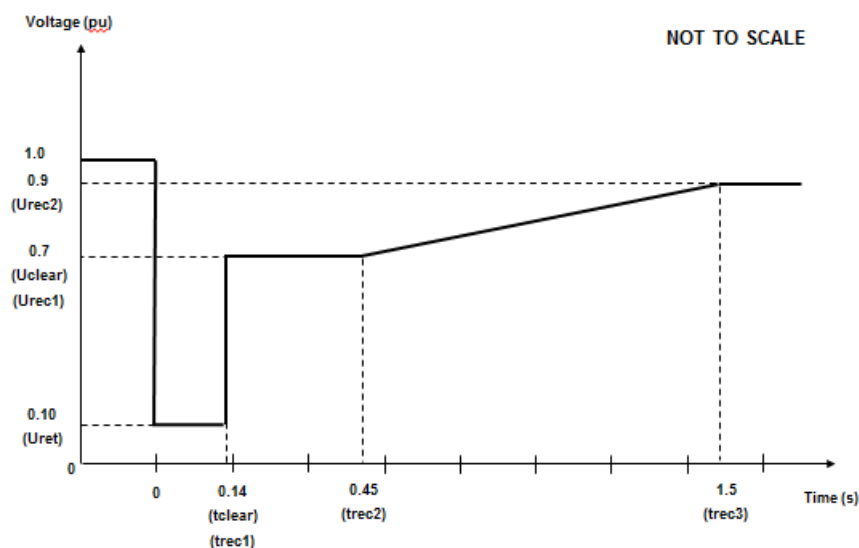

Figure ECC.6.3.15.3 - Voltage against time curve applicable to **Type C and D Synchronous Power Generating Modules** connected below 110kV

Voltage parameters (pu)		Time parameters (seconds)	
Uret	0.1	tclear	0.14
Uclear	0.7	trec1	0.14
Urec1	0.7	trec2	0.45
Urec2	0.9	trec3	1.5

Table ECC.6.3.15.3 Voltage against time parameters applicable to **Type C and D Synchronous Power Generating Modules** connected below 110kV

ECC.6.3.15.4 Voltage against time curve and parameters applicable to **Type D Synchronous Power Generating Modules** connected at or above 110kV

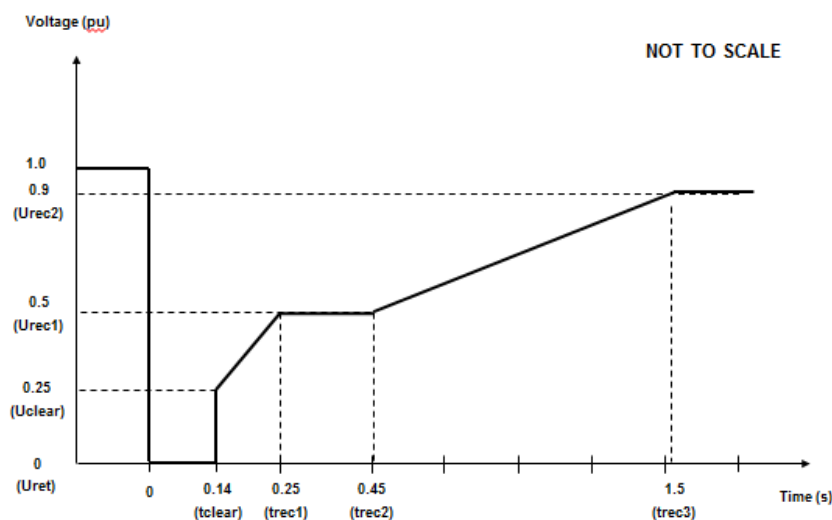

Figure ECC.6.3.15.4 - Voltage against time curve applicable to **Type D Synchronous Power Generating Modules** connected at or above 110kV

Voltage parameters (pu)		Time parameters (seconds)	
Uret	0	tclear	0.14
Uclear	0.25	trec1	0.25
Urec1	0.5	trec2	0.45
Urec2	0.9	trec3	1.5

Table ECC.6.3.15.4 Voltage against time parameters applicable to **Type D Synchronous Power Generating Modules** connected at or above 110kV

ECC.6.3.15.5 Voltage against time curve and parameters applicable to **Type B, C and D Power Park Modules** connected below 110kV

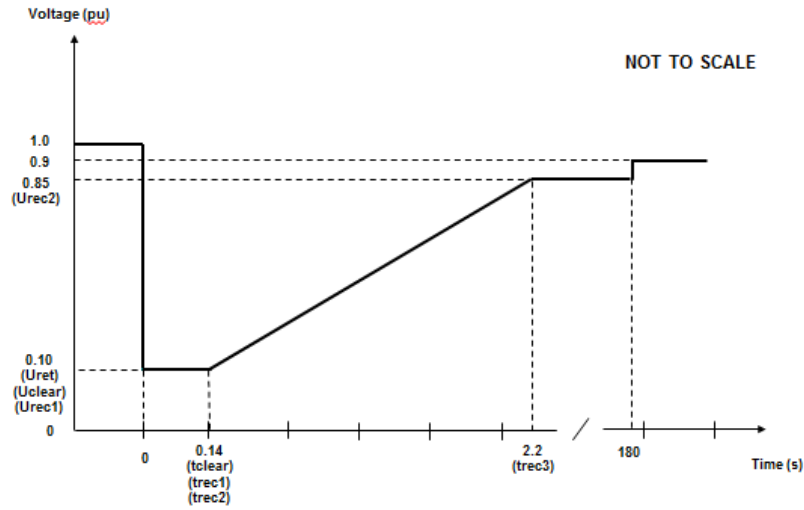

Figure ECC.6.3.15.5 - Voltage against time curve applicable to **Type B, C and D Power Park Modules** connected below 110kV

Voltage parameters (pu)		Time parameters (seconds)	
Uret	0.10	tclear	0.14
Uclear	0.10	trec1	0.14
Urec1	0.10	trec2	0.14
Urec2	0.85	trec3	2.2

Table ECC.6.3.15.5 Voltage against time parameters applicable to **Type B, C and D Power Park Modules** connected below 110kV

ECC.6.3.15.6 Voltage against time curve and parameters applicable to **Type D Power Park Modules** with a **Grid Entry Point** or **User System Entry Point** at or above 110kV, **DC Connected Power Park Modules** at the **HVDC Interface Point** or **OTSDUW Plant and Apparatus** at the **Interface Point**.

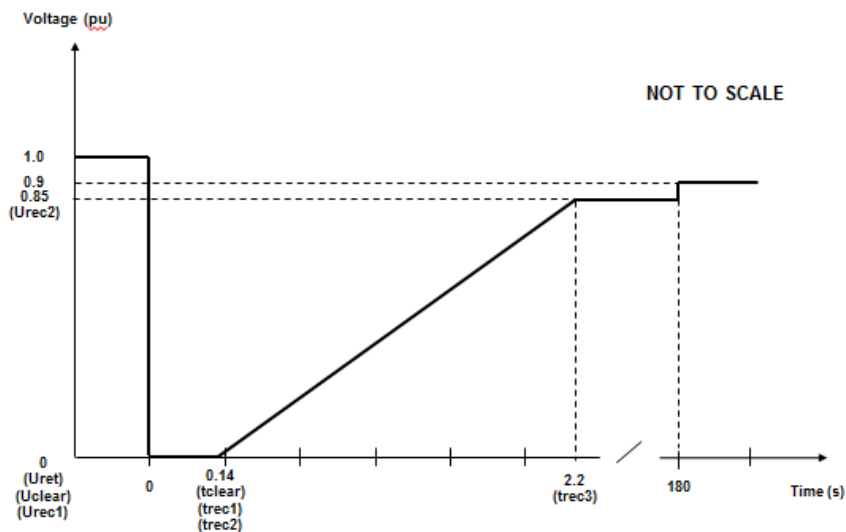

Figure ECC.6.3.15.6 - Voltage against time curve applicable to **Type D Power Park Modules** with a **Grid Entry Point** or **User System Entry Point** at or above 110kV, **DC Connected Power Park Modules** at the **HVDC Interface Point** or **OTSDUW Plant and Apparatus** at the **Interface Point**.

Voltage parameters (pu)		Time parameters (seconds)	
Uret	0	tclear	0.14
Uclear	0	trec1	0.14
Urec1	0	trec2	0.14
Urec2	0.85	trec3	2.2

Table ECC.6.3.15.6 Voltage against time parameters applicable to a **Type D Power Park Modules** with a **Grid Entry Point** or **User System Entry Point** at or above 110kV, **DC Connected Power Park Modules** at the **HVDC Interface Point** or **OTSDUW Plant and Apparatus** at the **Interface Point**.

ECC.6.3.15.7 Voltage against time curve and parameters applicable to HVDC Systems and Remote End HVDC Converter Stations

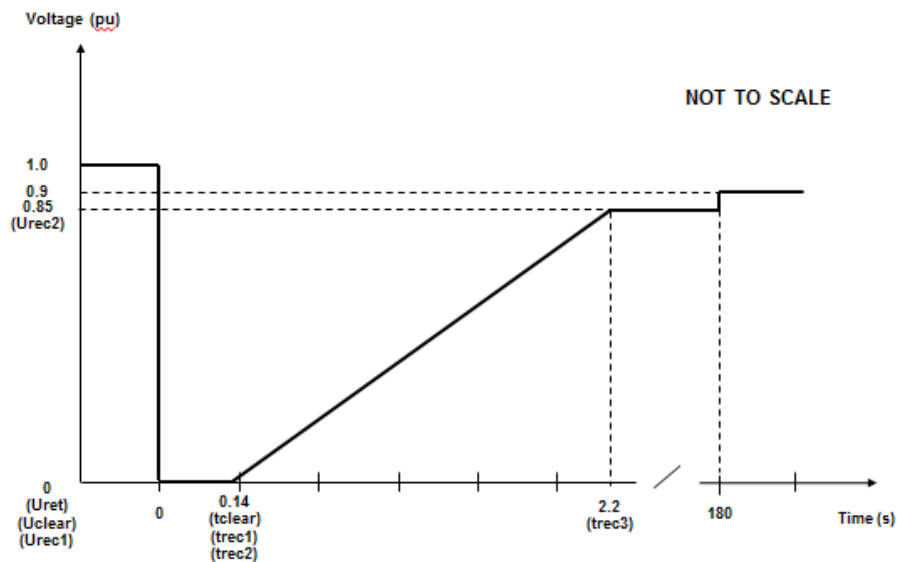

Figure ECC.6.3.15.7 - Voltage against time curve applicable to **HVDC Systems** and **Remote End HVDC Converter Stations**

Voltage parameters (pu)		Time parameters (seconds)	
Uret	0	tclear	0.14
Uclear	0	trec1	0.14
Urec1	0	trec2	0.14
Urec2	0.85	trec3	2.2

Table ECC.6.3.15.7 Voltage against time parameters applicable to **HVDC Systems** and **Remote End HVDC Converter Stations**

ECC.6.3.15.8 In addition to the requirements in ECC.6.3.15.1 – ECC.6.3.15.7:

- (i) Each **Type B, Type C and Type D Power Generating Module** at the **Grid Entry Point** or **User System Entry Point**, **HVDC Equipment** (or **OTSDUW Plant and Apparatus** at the **Interface Point**) shall be capable of satisfying the above requirements when operating at **Rated MW** output and maximum leading **Power Factor**.
- (ii) **The Company** will specify upon request by the **User** the pre-fault and post fault short circuit capacity (in MVA) at the **Grid Entry Point** or **User System Entry Point** (or **HVDC Interface Point** in the case of a remote end **HVDC Converter Stations** or **Interface Point** in the case of **OTSDUW Plant and Apparatus**).
- (iii) The pre-fault voltage shall be taken to be 1.0pu and the post fault voltage shall not be less than 0.9pu.
- (iv) To allow a **User** to model the **Fault Ride Through** performance of its **Type B, Type C and/or Type D Power Generating Modules** or **HVDC Equipment**, **The Company** will provide additional network data as may reasonably be required by the **EU Code User** to undertake such study work in accordance with PC.A.8. Alternatively, **The Company** may provide generic values derived from typical cases.
- (v) **The Company** will publish fault level data under maximum and minimum demand conditions in the **Electricity Ten Year Statement**.
- (vi) Each **EU Generator** (in respect of **Type B, Type C, Type D Power Generating Modules** and **DC Connected Power Park Modules**) and **HVDC System Owners** (in respect of **HVDC Systems**) shall satisfy the requirements in ECC.6.3.15.8(i) – (vii) unless the protection schemes and settings for internal electrical faults trips the **Type B, Type C and Type D Power Generating Module, HVDC Equipment** (or **OTSDUW Plant and Apparatus**) from the **System**. The protection schemes and settings should not jeopardise **Fault Ride Through** performance as specified in ECC.6.3.15.8(i) – (vii). The undervoltage protection at the **Grid Entry Point** or **User System Entry Point** (or **HVDC Interface Point** in the case of a **Remote End HVDC Converter Stations** or **Interface Point** in the case of **OTSDUW Plant and Apparatus**) shall be set by the **EU Generator** (or **HVDC System Owner** or **OTSDUA** in the case of **OTSDUW Plant and Apparatus**) according to the widest possible range unless **The Company** and the **EU Code User** have agreed to narrower settings. All protection settings associated with undervoltage protection shall be agreed between the **EU Generator** and/or **HVDC System Owner** with **The Company** and **Relevant Transmission Licensee's** and relevant **Network Operator** (as applicable).
- (vii) Each **Type B, Type C and Type D Power Generating Module, HVDC System** and **OTSDUW Plant and Apparatus** at the **Interface Point** shall be designed such that upon clearance of the fault on the **Onshore Transmission System** and within 0.5 seconds of restoration of the voltage at the **Grid Entry Point** or **User System Entry Point** or **HVDC Interface Point** in the case of a **Remote End HVDC Converter Stations** or **Interface Point** in the case of **OTSDUW Plant and Apparatus** to 90% of nominal voltage or greater, **Active Power** output (or **Active Power** transfer capability in the case of **OTSDW Plant and Apparatus** or **Remote End HVDC Converter Stations**) shall be restored to at least 90% of the level immediately before the fault. Once **Active Power** output (or **Active Power** transfer capability in the case of **OTSDUW Plant and Apparatus** or **Remote End HVDC Converter Stations**) has been restored to the required level, **Active Power** oscillations shall be acceptable provided that:
 - The total **Active Energy** delivered during the period of the oscillations is at least that which would have been delivered if the **Active Power** was constant
 - The oscillations are adequately damped.
 - In the event of power oscillations, **Power Generating Modules** shall retain steady state stability when operating at any point on the **Power Generating Module Performance Chart**.

For AC Connected **Onshore** and **Offshore Power Park Modules** comprising switched reactive compensation equipment (such as mechanically switched capacitors and reactors), such switched reactive compensation equipment shall be controlled such that it is not switched in or out of service during the fault but may act to assist in post fault voltage recovery.

ECC.6.3.15.9.1 General Fault Ride Through requirements applicable to HVDC Equipment and OTSDUW DC Converters subject to faults and voltage dips in excess of 140ms.

ECC.6.3.15.9.1.1 The requirements applicable to **HVDC Equipment** including **OTSDUW DC Converters** subject to faults and voltage disturbances at the **Grid Entry Point** or **User System Entry Point** or **Interface Point** or **HVDC Interface Point**, including **Active Power** transfer capability shall be specified in the **Bilateral Agreement**.

ECC.6.3.15.9.2 Fault Ride Through requirements for Type C and Type D Synchronous Power Generating Modules and Type C and Type D Power Park Modules and OTSDUW Plant and Apparatus subject to faults and voltage disturbances on the Onshore Transmission System in excess of 140ms

ECC.6.3.15.9.2.1 The **Fault Ride Through** requirements for **Type C** and **Type D Synchronous Power Generating Modules** subject to faults and voltage disturbances on the Onshore Transmission System in excess of 140ms are defined in ECC.6.3.15.9.2.1(a) and the **Fault Ride Through Requirements** for **Type C** and **Type D Power Park Modules** and **OTSDUW Plant and Apparatus** subject to faults and voltage disturbances on the Onshore Transmission System greater than 140ms in duration are defined in ECC.6.3.15.9.2.1(b).

(a) Requirements applicable to **Synchronous Power Generating Modules** subject to **Supergrid Voltage** dips on the **Onshore Transmission System** greater than 140ms in duration.

In addition to the requirements of ECC.6.3.15.1 – ECC.6.3.15.8 each **Synchronous Power Generating Module** shall:

(i) remain transiently stable and connected to the **System** without tripping of any **Synchronous Power Generating Module** for balanced **Supergrid Voltage** dips and associated durations on the **Onshore Transmission System** (which could be at the **Interface Point**) anywhere on or above the heavy black line shown in Figure ECC.6.3.15.9(a) Appendix 4 and Figures EA.4.3.2(a), (b) and (c) provide an explanation and illustrations of Figure ECC.6.3.15.9(a); and,

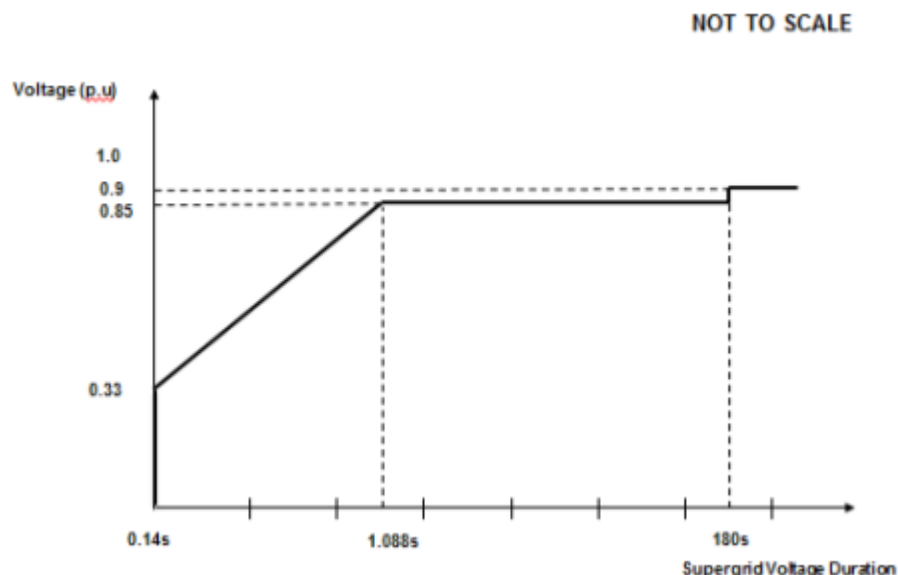

Figure ECC.6.3.15.9(a)

- (ii) provide **Active Power** output at the **Grid Entry Point**, during **Supergrid Voltage** dips on the **Onshore Transmission System** as described in Figure ECC.6.3.15.9(a), at least in proportion to the retained balanced voltage at the **Onshore Grid Entry Point** (for **Onshore Synchronous Power Generating Modules**) or **Interface Point** (for **Offshore Synchronous Power Generating Modules**) or the retained balanced voltage at the **User System Entry Point if Embedded**) and shall generate maximum reactive current (where the voltage at the **Grid Entry Point** is outside the limits specified in ECC.6.1.4) without exceeding the transient rating limits of the **Synchronous Power Generating Module** and,
- (iii) restore **Active Power** output following **Supergrid Voltage** dips on the **Onshore Transmission System** as described in Figure ECC.6.3.15.9(a), within 1 second of restoration of the voltage to 1.0pu of the nominal voltage at the:

Onshore Grid Entry Point for directly connected **Onshore Synchronous Power Generating Modules** or,

Interface Point for **Offshore Synchronous Power Generating Modules**
or,

User System Entry Point for **Embedded Onshore Synchronous Power Generating Modules**

or,

User System Entry Point for **Embedded Medium Power Stations** not subject to a **Bilateral Agreement** which comprise **Synchronous Generating Units** and with an **Onshore User System Entry Point** (irrespective of whether they are located **Onshore** or **Offshore**)

to at least 90% of the level available immediately before the occurrence of the dip. Once the **Active Power** output has been restored to the required level, **Active Power** oscillations shall be acceptable provided that:

- the total **Active Energy** delivered during the period of the oscillations is at least that which would have been delivered if the **Active Power** was constant
- the oscillations are adequately damped.

For the avoidance of doubt a balanced **Onshore Transmission System Supergrid Voltage** meets the requirements of ECC.6.1.5 (b) and ECC.6.1.6.

- (b) Requirements applicable to **Type C** and **Type D Power Park Modules** and **OTSDUW Plant and Apparatus** (excluding **OTSDUW DC Converters**) subject to **Supergrid Voltage** dips on the **Onshore Transmission System** greater than 140ms in duration.

In addition to the requirements of ECC.6.3.15.5, ECC.6.3.15.6 and ECC.6.3.15.8 (as applicable) each **OTSDUW Plant and Apparatus** or each **Power Park Module** and / or any constituent **Power Park Unit**, shall:

- (i) remain transiently stable and connected to the **System** without tripping of any **OTSDUW Plant and Apparatus**, or **Power Park Module** and / or any constituent **Power Park Unit**, for balanced **Supergrid Voltage** dips and associated durations on the **Onshore Transmission System** (which could be at the **Interface Point**) anywhere on or above the heavy black line shown in Figure ECC.6.3.15.9(b). Appendix 4 and Figures EA.4.3.4 (a), (b) and (c) provide an explanation and illustrations of Figure ECC.6.3.15.9(b) ; and,

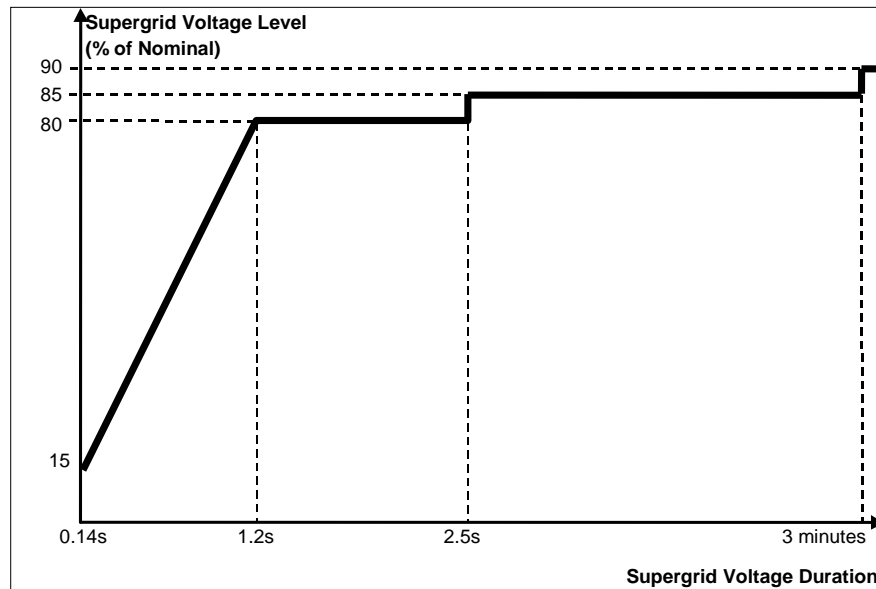

Figure ECC.6.3.15.9(b)

- (ii) be required to satisfy the requirements of ECC.6.3.16. In the case of a **Non-Synchronous Generating Unit** or **OTSDUW Plant and Apparatus** or **Power Park Module** where there has been a reduction in the **Intermittent Power Source** or in the case of **OTSDUW Active Power** transfer capability in the time range in Figure ECC.6.3.15.9(b) an allowance shall be made for the fall in input power and the corresponding reduction of real and reactive current.
- (iii) restore **Active Power** output (or, in the case of **OTSDUW, Active Power** transfer capability), following **Supergrid Voltage** dips on the **Onshore Transmission System** as described in Figure ECC.6.3.15.9(b), within 1 second of restoration of the voltage to 0.9 pu of the nominal voltage at the:

Onshore Grid Entry Point for directly connected **Onshore Power Park Modules** or,

Interface Point for **OTSDUW Plant and Apparatus** and **Offshore Power Park Modules** or,

User System Entry Point for **Embedded Onshore Power Park Modules** or ,

User System Entry Point for **Embedded Medium Power Stations** which comprise **Power Park Modules** not subject to a **Bilateral Agreement** and with an **Onshore User System Entry Point** (irrespective of whether they are located **Onshore** or **Offshore**)

to at least 90% of the level available immediately before the occurrence of the dip except in the case of a **Non-Synchronous Generating Unit, OTSDUW Plant and Apparatus** or **Power Park Module** where there has been a reduction in the **Intermittent Power Source** in the time range in Figure ECC.6.3.15.9(b) that restricts the **Active Power** output or, in the case of **OTSDUW, Active Power** transfer capability below this level. Once the **Active Power** output or, in the case of **OTSDUW, Active Power** transfer capability has been restored to the required level, **Active Power** oscillations shall be acceptable provided that:

- the total **Active Energy** delivered during the period of the oscillations is at least that which would have been delivered if the **Active Power** was constant
- the oscillations are adequately damped.

For the avoidance of doubt a balanced **Onshore Transmission System Supergrid Voltage** meets the requirements of ECC.6.1.5 (b) and ECC.6.1.6.

- (i) In the case of a **Power Park Module** (excluding **Non-Synchronous Electricity Storage Modules**), the requirements in ECC.6.3.15.9 do not apply when the **Power Park Module** (excluding **Non-Synchronous Electricity Storage Modules**) is operating at less than 5% of its **Rated MW** or during very high primary energy source conditions when more than 50% of the **Power Park Units** in a **Power Park Module** have been shut down or disconnected under an emergency shutdown sequence to protect **User's Plant** and **Apparatus**.
- (ii) In addition to meeting the conditions specified in ECC.6.1.5(b) and ECC.6.1.6, each **Non-Synchronous Generating Unit, OTSDUW Plant and Apparatus** or **Power Park Module** and any constituent **Power Park Unit** thereof will be required to withstand, without tripping, the negative phase sequence loading incurred by clearance of a close-up phase-to-phase fault, by **System Back-Up Protection** on the **Onshore Transmission System** operating at **Supergrid Voltage**.
- (iii) **Generators** in respect of **Type B, Type C** and **Type D Power Park Modules** and **HVDC System Owners** are required to confirm to **The Company**, their repeated ability to operate through balanced and unbalanced faults and **System** disturbances each time the voltage at the **Grid Entry Point** or **User System Entry Point** falls outside the limits specified in ECC.6.1.4. Demonstration of this capability would be satisfied by **EU Generators** and **HVDC System Owners** supplying the protection settings of their plant, informing **The Company** of the maximum number of repeated operations that can be performed under such conditions and any limiting factors to repeated operation such as protection or thermal rating; and
- (iv) Notwithstanding the requirements of ECC.6.3.15(v), **Power Generating Modules** shall be capable of remaining connected during single phase or three phase auto-reclosures to the **National Electricity Transmission System** and operating without power reduction as long as the voltage and frequency remain within the limits defined in ECC.6.1.4 and ECC.6.1.2; and
- (v) For the avoidance of doubt the requirements specified in ECC.6.3.15 do not apply to **Power Generating Modules** connected to either an unhealthy circuit and/or islanded from the **Transmission System** even for delayed auto reclosure times.
- (vi) To avoid unwanted island operation, **Non-Synchronous Generating Units** in Scotland (and those directly connected to a **Scottish Offshore Transmission System**), **Power Park Modules** in Scotland (and those directly connected to a **Scottish Offshore Transmission System**), or **OTSDUW Plant and Apparatus** with an **Interface Point** in Scotland shall be tripped for the following conditions:
 - (1) **Frequency** above 52Hz for more than 2 seconds
 - (2) **Frequency** below 47Hz for more than 2 seconds
 - (3) Voltage as measured at the **Onshore Connection Point** or **Onshore User System Entry Point** or **Offshore Grid Entry Point** or **Interface Point** in the case of **OTSDUW Plant and Apparatus** is below 80% for more than 2.5 seconds

Voltage as measured at the **Onshore Connection Point** or **Onshore User System Entry Point** or **Offshore Grid Entry Point** or **Interface Point** in the case of **OTSDUW Plant and Apparatus** is above 120% (115% for 275kV) for more than 1 second. The times in sections (1) and (2) are maximum trip times. Shorter times may be used to protect the **Non-Synchronous Generating Units**, or **OTSDUW Plant and Apparatus**.

ECC.6.3.15.11 HVDC System Robustness

ECC.6.3.15.11.1 The **HVDC System** shall be capable of finding stable operation points with a minimum change in **Active Power** flow and voltage level, during and after any planned or unplanned change in the **HVDC System** or **AC System** to which it is connected. **The Company** shall specify the changes in the System conditions for which the **HVDC Systems** shall remain in stable operation.

ECC.6.3.15.11.2 The **HVDC System** owner shall ensure that the tripping or disconnection of an **HVDC Converter Station**, as part of any multi-terminal or embedded **HVDC System**, does not result in transients at the **Grid Entry Point** or **User System Entry Point** beyond the limit specified by **The Company** in co-ordination with the **Relevant Transmission Licensee**.

ECC.6.3.15.11.3 The **HVDC System** shall withstand transient faults on HVAC lines in the network adjacent or close to the **HVDC System**, and shall not cause any of the equipment in the **HVDC System** to disconnect from the network due to autoreclosure of lines in the **System**.

ECC.6.3.15.11.4 The **HVDC System Owner** shall provide information to **The Company** on the resilience of the **HVDC System** to AC **System** disturbances.

ECC.6.3.16 FAST FAULT CURRENT INJECTION

ECC.6.3.16.1 General Fast Fault Current injection, principles and concepts applicable to Type B, Type C and Type D Power Park Modules and HVDC Equipment

ECC.6.3.16.1.1 In addition to the requirements of ECC.6.1.4, ECC.6.3.2, ECC.6.3.8 and ECC.A.7, each **Type B, Type C and Type D Power Park Module** or each **Power Park Unit** within a **Type B, Type C and Type D Power Park Module** or **HVDC Equipment** shall be required to satisfy the following requirements. For the purposes of this requirement, current and voltage are assumed to be positive phase sequence values.

ECC.6.3.16.1.2 For any balanced fault which results in the positive phase sequence voltage falling below the voltage levels specified in ECC.6.1.4 at the **Grid Entry Point** or **User System Entry Point** (if **Embedded**), each **Type B, Type C and Type D Power Park Module** or each **Power Park Unit** within a **Type B, Type C and Type D Power Park Module** or **HVDC Equipment** shall, as a minimum (unless an alternative type registered solution has otherwise been agreed with **The Company**), be required to inject a reactive current above the heavy black line shown in Figure ECC.16.3.16(a)

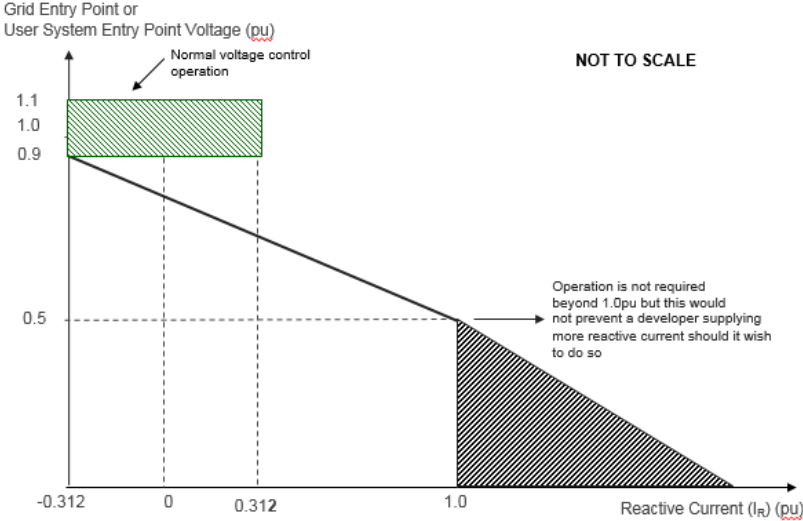

Figure ECC.6.3.16(a)

ECC.6.3.16.1.3 Figure ECC.6.3.16(a) defines the reactive current (I_R) to be supplied under a faulted condition which shall be dependent upon the pre-fault operating condition and the retained voltage at the **Grid Entry Point** or **User System Entry Point** voltage. For the avoidance of doubt, each **Power Park Module** (and any constituent element thereof) or **HVDC Equipment**, shall be required to inject a reactive current (I_R) which shall be not less than its pre-fault reactive current and which shall as a minimum increase with the fall in the retained voltage each time the voltage at the **Grid Entry Point** or **User System Entry Point** (if **Embedded**) falls below 0.9pu whilst ensuring the overall rating of the **Power Park Module** (or constituent element thereof) or **HVDC Equipment** shall not be exceeded.

ECC.6.3.16.1.4 In addition to the requirements of ECC.6.3.16.1.2 and ECC.6.3.16.1.3, each **Type B, Type C** and **Type D Power Park Module** or each **Power Park Unit** within a **Type B, Type C** and **Type D Power Park Module** or **HVDC Equipment** shall be required to inject reactive current above the shaded area shown in Figure ECC.6.3.16(b) and Figure ECC.6.3.16(c) which illustrates how the reactive current shall be injected over time from fault inception in which the value of I_R is determined from Figure ECC.6.3.16(a). In figures ECC.6.3.16(b) and ECC.6.3.16(c) ΔI_R is the value of the reactive current (I_R) less the pre-fault current. In this context fault inception is taken to be when the voltage at the **Grid Entry Point** or **User System Entry Point** falls below 0.9pu.

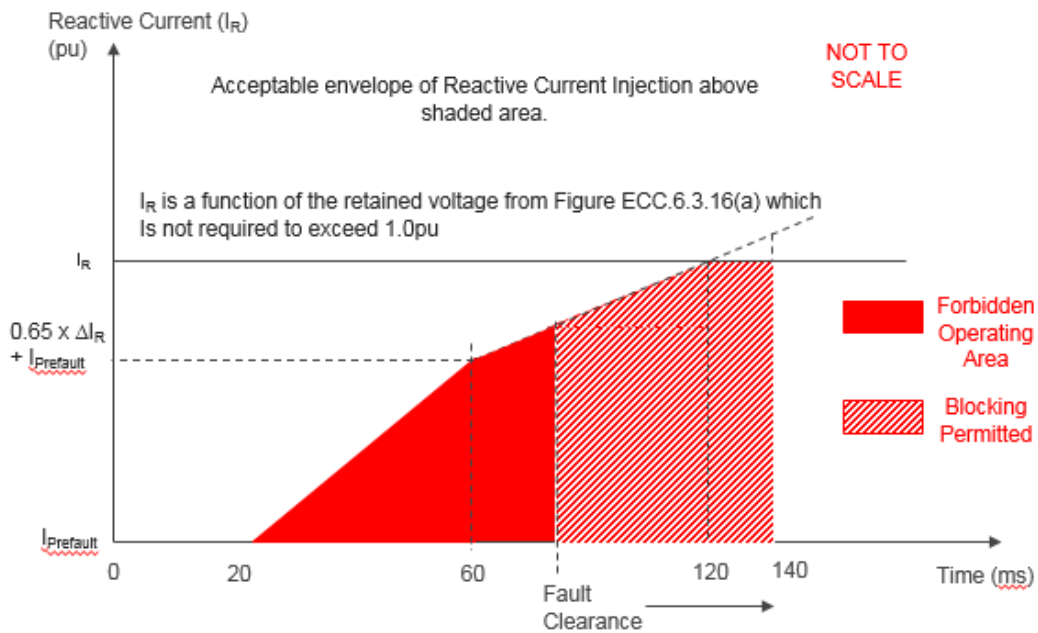

Figure ECC.16.3.16(b)

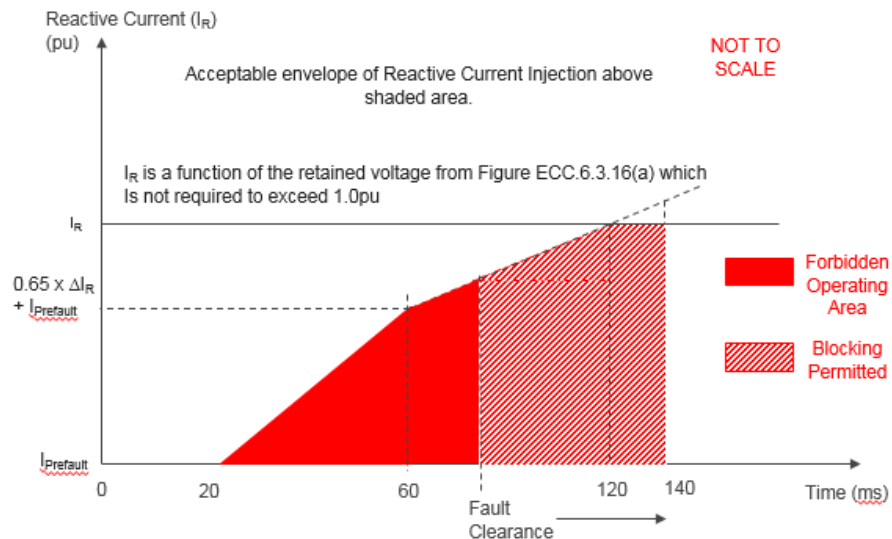

Figure ECC.16.3.16(c)

ECC.6.3.16.1.5 The injected reactive current (I_R) shall be above the shaded area shown in Figure ECC.6.3.16(b) and Figure ECC.6.3.16(c) with priority being given to reactive current injection with any residual capability being supplied as active current. Under any faulted condition, where the voltage falls outside the limits specified in ECC.6.1.4, there would be no requirement for each **Power Park Module** or constituent **Power Park Unit** or **HVDC Equipment** to exceed its transient or steady state rating of 1.0pu as defined in ECC.6.3.16.1.7.

ECC.6.3.16.1.6 For any planned or switching events (as outlined in ECC.6.1.7 of the Grid Code) or unplanned events which results in temporary power frequency over voltages (TOV's), each **Type B**, **Type C** and **Type D Power Generating Module** or each **Power Park Unit** within a **Type B**, **Type C** or **Type D Power Park Module** or **HVDC Equipment** will be required to satisfy the transient overvoltage limits specified in the **Bilateral Agreement**.

ECC.6.3.16.1.7 For the purposes of this requirement, the maximum rated current is taken to be the maximum current each **Power Park Module** (or the sum of the constituent **Power Park Units** which are connected to the **System** at the **Grid Entry Point** or **User System Entry Point**) or **HVDC Converter** is capable of supplying. In the case of a **Power Park Module** this would be the maximum rated current at the **Grid Entry Point** (or **User System Entry Point** if **Embedded**) when the **Power Park Module** is operating at rated **Active Power** and rated **Reactive Power** (as required under ECC.6.3.2) whilst operating over the nominal voltage range as required under ECC.6.1.4 at the **Grid Entry Point** (or **User System Entry Point** if **Embedded**). In the case of a **Power Park Unit** forming part of a **Type B**, **Type C** and **Type D Power Park Module**, the maximum rated current expected would be the maximum current supplied from each constituent **Power Park Unit** when the **Power Park Module** is operating at rated **Active Power** and rated **Reactive Power** over the nominal voltage operating range as defined in ECC.6.1.4 less the contribution from the reactive compensation equipment.

For example, in the case of a 100MW **Power Park Module** (consisting of 50 x 2MW Power Park Units and +10MVAR reactive compensation equipment) the **Rated Active Power** at the **Grid Entry Point** (or **User System Entry Point** if **Embedded**) would be taken as 100MW and the rated **Reactive Power** at the **Grid Entry Point** or (**User System Entry Point** if **Embedded**) would be taken as 32.8MVAr (ie **Rated MW** output operating at 0.95 **Power Factor** lead or 0.95 **Power Factor** lag as required under ECC.6.3.2.4). In this example, the maximum rating of each constituent **Power Park Unit** is obtained when the **Power Park Module** is operating at 100MW, and +32.8MVAr less 10MVAr equal to 22.8MVAr or - 32.8MVAr (less the reactive compensation equipment component of 10MVAr (ie - 22.8MVAr) when operating within the normal voltage operating range as defined under ECC.6.1.4 (allowing for any reactive compensation equipment or losses in the **Power Park Module** array network).

For the avoidance of doubt, the total current of 1.0pu would be assumed to be on the MVA rating of the **Power Park Module** or **HVDC Equipment** (less losses). Under all normal and abnormal conditions, the steady state or transient rating of the **Power Park Module** (or any constituent element including the **Power Park Units**) or **HVDC Equipment**, would not be required to exceed the locus shown in Figure 16.3.16(d).

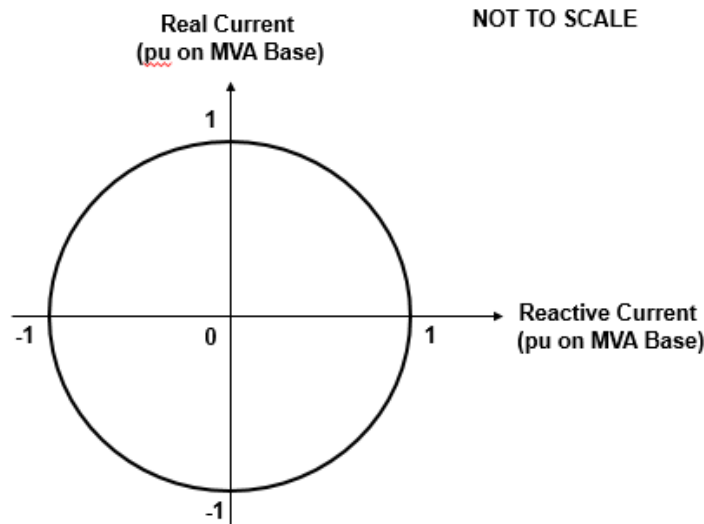

Figure ECC.16.3.16(d)

- ECC.6.3.16.1.7 Each **Type B, Type C** and **Type D Power Park Module** or **HVDC Equipment** shall be designed to ensure a smooth transition between voltage control mode and fault ride through mode in order to prevent the risk of instability which could arise in the transition between the steady state voltage operating range as defined under ECC.6.1.4 and abnormal conditions where the retained voltage falls below 90% of nominal voltage. Such a requirement is necessary to ensure adequate performance between the pre-fault operating condition of the **Power Park Module** or **HVDC Equipment** and its subsequent behaviour under faulted conditions. **EU Generators** and **HVDC System Owners** are required to both advise and agree with **The Company** the control strategy employed to mitigate the risk of such instability.
- ECC.6.3.16.1.8 Each **Type B, Type C** and **Type D Power Park Module** or **HVDC Equipment** shall be designed to reduce the risk of transient over voltage levels arising following clearance of the fault and in order to mitigate the risk of any form of instability which could result. **EU Generators** or **HVDC System Owners** shall be permitted to block or employ other means where the anticipated transient overvoltage would otherwise exceed the maximum permitted values specified in ECC.6.1.7. Figure ECC.16.3.16(b) and Figure ECC.16.3.16(c) shows the impact of variations in fault clearance time. For main protection operating times this would not exceed 140ms. The requirements for the maximum transient overvoltage withstand capability and associated time duration, shall be agreed between the **EU Code User** and **The Company** as part of the **Bilateral Agreement**. Where the **EU Code User** is able to demonstrate to **The Company** that blocking or other control strategies are required in order to prevent the risk of transient over voltage excursions as specified in ECC.6.3.16.1.5, **EU Generators** and **HVDC System Owners** are required to both advise and agree with **The Company** the control strategy, which must also include the approach taken to de-blocking

- ECC.6.3.16.1.9 In addition to the requirements of ECC.6.3.15, **Generators** in respect of **Type B, Type C and Type D Power Park Modules** or each **Power Park Unit** within a **Type B, Type C and Type D Power Park Module** or **DC Connected Power Park Modules** and **HVDC System Owners** in respect of **HVDC Systems** are required to confirm to **The Company**, their repeated ability to supply **Fast Fault Current** to the **System** each time the voltage at the **Grid Entry Point** or **User System Entry Point** falls outside the limits specified in ECC.6.1.4. **EU Generators** and **HVDC Equipment Owners** should inform **The Company** of the maximum number of repeated operations that can be performed under such conditions and any limiting factors to repeated operation such as protection or thermal rating.
- ECC.6.3.16.1.10 To permit additional flexibility for example from **Power Park Modules** made up of full converter machines, DFIG machines, induction generators or **HVDC Systems** or **Remote End HVDC Converters**, **The Company** will permit transient or marginal deviations below the shaded area shown in Figures ECC.16.3.16(b) or ECC.16.3.16(c) provided the injected reactive current supplied exceeds the area bound in Figure ECC.6.3.16(b) or ECC.6.3.16(c). Such agreement would be confirmed and agreed between **The Company** and **Generator**.
- ECC.6.3.16.1.11 In the case of a **Power Park Module** or **DC Connected Power Park Module**, where it is not practical to demonstrate the compliance requirements of ECC.6.3.16.1.1 to ECC.6.3.16.1.6 at the **Grid Entry Point** or **User System Entry Point**, **The Company** will accept compliance of the above requirements at the **Power Park Unit** terminals.
- ECC.6.3.16.1.12 For the avoidance of doubt, **Generators** in respect of **Type C and Type D Power Park Modules** and **OTSDUW Plant and Apparatus** are also required to satisfy the requirements of ECC.6.3.15.9.2.1(b) which specifies the requirements for fault ride through for voltage dips in excess of 140ms.
- ECC.6.3.16.1.13 In the case of an unbalanced fault, each **Type B, Type C and Type D Power Park Module** or each **Power Park Unit** within a **Type B, Type C and Type D Power Park Module** or **HVDC Equipment** shall be required to inject reactive current (I_R) which shall as a minimum increase with the fall in the retained unbalanced voltage up to its maximum reactive current without exceeding the transient rating of the **Power Park Module** (or constituent element thereof) or **HVDC Equipment**.
- ECC.6.3.16.1.14 In the case of a unbalanced fault, the **Generator** or **HVDC System Owner** shall confirm to **The Company** their ability to prevent transient overvoltages arising on the remaining healthy phases and the control strategy employed.
- ECC.6.3.17 SUBSYNCHRONOUS TORSIONAL INTERACTION DAMPING CAPABILITY, POWER OSCILLATION DAMPING CAPABILITY AND CONTROL FACILITIES FOR HVDC SYSTEMS
- ECC.6.3.17.1 Subsynchronous Torsional Interaction Damping Capability
- ECC.6.3.17.1.1 **HVDC System Owners**, or **Generators** in respect of **OTSDUW DC Converters** or **Network Operators** in the case of an **Embedded HVDC Systems** not subject to a **Bilateral Agreement** must ensure that any of their **Onshore HVDC Systems** or **OTSDUW DC Converters** will not cause a sub-synchronous resonance problem on the **Total System**. Each **HVDC System** or **OTSDUW DC Converter** is required to be provided with sub-synchronous resonance damping control facilities. **HVDC System Owners** and **EU Generators** in respect of **OTSDUW DC Converters** should also be aware of the requirements in ECC.6.1.9 and ECC.6.1.10.
- ECC.6.3.17.1.2 Where specified in the **Bilateral Agreement**, each **OTSDUW DC Converter** is required to be provided with power oscillation damping or any other identified additional control facilities.

- ECC.6.3.17.1.3 Each **HVDC System** shall be capable of contributing to the damping of power oscillations on the **National Electricity Transmission System**. The control system of the **HVDC System** shall not reduce the damping of power oscillations. **The Company** in coordination with the **Relevant Transmission Licensee** (as applicable) shall specify a frequency range of oscillations that the control scheme shall positively damp and the **System** conditions when this occurs, at least accounting for any dynamic stability assessment studies undertaken by the **Relevant Transmission Licensee** or **The Company** (as applicable) to identify the stability limits and potential stability problems on the **National Electricity Transmission System**. The selection of the control parameter settings shall be agreed between **The Company** in coordination with the **Relevant Transmission Licensee** and the **HVDC System Owner**.
- ECC.6.3.17.1.4 **The Company** shall specify the necessary extent of SSTI studies and provide input parameters, to the extent available, related to the equipment and relevant system conditions on the **National Electricity Transmission System**. The SSTI studies shall be provided by the **HVDC System Owner**. The studies shall identify the conditions, if any, where SSTI exists and propose any necessary mitigation procedure. The responsibility for undertaking the studies in accordance with these requirements lies with the **Relevant Transmission Licensee** in co-ordination with **The Company**. All parties shall be informed of the results of the studies.
- ECC.6.3.17.1.5 All parties identified by **The Company** as relevant to each **Grid Entry Point** or **User System Entry Point** (if **Embedded**), including the **Relevant Transmission Licensee**, shall contribute to the studies and shall provide all relevant data and models as reasonably required to meet the purposes of the studies. **The Company** shall collect this data and, where applicable, pass it on to the party responsible for the studies in accordance with **Retained EU Law** (Article 10 of Commission Regulation (EU) 2016/1447). Specific information relating to the interface schedules, input/output requirements, timing and submission of any studies or data would be agreed between the **User** and **The Company** and specified (where applicable) in the **Bilateral Agreement**.
- ECC.6.3.17.1.6 **The Company** in coordination with the **Relevant Transmission Licensee** shall assess the result of the SSTI studies. If necessary for the assessment, **The Company** in coordination with the **Relevant Transmission Licensee** may request that the **HVDC System Owner** perform further SSTI studies in line with this same scope and extent.
- ECC.6.3.17.1.7 **The Company** in coordination with the **Relevant Transmission Licensee** may review or replicate the study. The **HVDC System Owner** shall provide **The Company** with all relevant data and models that allow such studies to be performed. Submission of this data to **Relevant Transmission Licensee's** shall be in accordance with the requirements of **Retained EU Law** (Article 10 of Commission Regulation (EU) 2016/1447).
- ECC.6.3.17.1.8 Any necessary mitigating actions identified by the studies carried out in accordance with paragraphs ECC.6.3.17.1.4 or ECC.6.3.17.1.6, and reviewed by **The Company** in coordination with the **Relevant Transmission Licensees**, shall be undertaken by the **HVDC System Owner** as part of the connection of the new **HVDC Converter Station**.
- ECC.6.3.17.1.9 As part of the studies and data flow in respect of ECC.6.3.17.1 – ECC.6.3.17.8 the following data exchange would take place with the time scales being pursuant to the terms of the **Bilateral Agreement**.

Information supplied by **The Company** and **Relevant Transmission Licensees**

Studies provided by the **User**

User review

The Company review

Changes to studies and agreed updates between **The Company**, the **Relevant Transmission Licensee** and **User**

Final review

ECC.6.3.17.2 Interaction between **HVDC Systems** or other **User's Plant** and **Apparatus**

ECC.6.3.17.2.1 Notwithstanding the requirements of ECC6.1.9 and ECC.6.1.10, when several **HVDC Converter Stations** or other **User's Plant and Apparatus** are within close electrical proximity, **The Company** may specify that a study is required, and the scope and extent of that study, to demonstrate that no adverse interaction will occur. If adverse interaction is identified, the studies shall identify possible mitigating actions to be implemented to ensure compliance with the requirements of ECC.6.1.9

ECC.6.3.17.2.2 The studies shall be carried out by the connecting **HVDC System Owner** with the participation of all other **User's** identified by **The Company** in coordination with **Relevant Transmission Licensees** as relevant to each **Connection Point**.

ECC.6.3.17.2.3 All **User's** identified by **The Company** as relevant to the connection, and where applicable **Relevant Transmission Licensee's**, shall contribute to the studies and shall provide all relevant data and models as reasonably required to meet the purposes of the studies. **The Company** shall collect this input and, where applicable, pass it on to the party responsible for the studies in accordance with **Retained EU Law** (Article 10 of Commission Regulation (EU) 2016/1447). Specific information relating to the interface schedules, input/output requirements, timing and submission of any studies or data would be agreed between the **User** and **The Company** and specified (where applicable) in the **Bilateral Agreement**.

ECC.6.3.17.2.4 **The Company** in coordination with **Relevant Transmission Licensees** shall assess the result of the studies based on their scope and extent as specified in accordance with ECC.6.3.17.2.1. If necessary for the assessment, **The Company** in coordination with the **Relevant Transmission Licensee** may request the **HVDC System Owner** to perform further studies in line with the scope and extent specified in accordance with ECC.6.3.17.2.1.

ECC.6.3.17.2.5 **The Company** in coordination with the **Relevant Transmission Licensee** may review or replicate some or all of the studies. The **HVDC System Owner** shall provide **The Company** all relevant data and models that allow such studies to be performed.

ECC.6.3.17.2.6 The **EU Code User** and **The Company**, in coordination with the **Relevant Transmission Licensee**, shall agree any mitigating actions identified by the studies carried out following the site specific requirements and works, including any transmission reinforcement works and / or **User** works required to ensure that all sub-synchronous oscillations are sufficiently damped.

ECC.6.1.17.3 Fast Recovery from DC faults

ECC.6.1.17.3.1 **HVDC Systems**, including DC overhead lines, shall be capable of fast recovery from transient faults within the **HVDC System**. Details of this capability shall be subject to the **Bilateral Agreement** and the protection requirements specified in ECC.6.2.2 .

ECC.6.1.17.4 Maximum loss of Active Power

ECC.6.1.14.4.1 An **HVDC System** shall be configured in such a way that its loss of **Active Power** injection in the **GB Synchronous Area** shall be in accordance with the requirements of the **SQSS**.

ECC.6.3.18 SYSTEM TO GENERATOR OPERATIONAL INTERTRIPPING SCHEMES

ECC.6.3.18.1 **The Company** may require that a **System to Generator Operational Intertripping Scheme** be installed as part of a condition of the connection of the **EU Generator**. Scheme specific details shall be included in the relevant **Bilateral Agreement** and shall, include the following information:

- (1) the relevant category(ies) of the scheme (referred to as **Category 1 Intertripping Scheme, Category 2 Intertripping Scheme, Category 3 Intertripping Scheme** and **Category 4 Intertripping Scheme**);
- (2) the **Power Generating Module** to be either permanently armed or that can be instructed to be armed in accordance with BC2.8;
- (3) the time within which the **Power Generating Module** circuit breaker(s) are to be automatically tripped;

- (4) the location to which the trip signal will be provided by **The Company**. Such location will be provided by **The Company** prior to the commissioning of the **Power Generating Module**.

Where applicable, the **Bilateral Agreement** shall include the conditions on the **National Electricity Transmission System** during which **The Company** may instruct the **System to Generator Operational Intertripping Scheme** to be armed and the conditions that would initiate a trip signal.

ECC.6.3.18.2 The time within which the **Power Generating Module(s)** circuit breaker(s) need to be automatically tripped is determined by the specific conditions local to the **EU Generator**. This 'time to trip' (defined as the time from provision of the trip signal by **The Company** to the specified location, to circuit breaker main contact opening) can typically range from 100ms to 10sec. A longer time to trip may allow the initiation of an automatic reduction in the **Power Generating Module(s)** output prior to the automatic tripping of the **Power Generating Module(s)** circuit breaker. Where applicable **The Company** may provide separate trip signals to allow for either a longer or shorter 'time to trip' to be initiated.

ECC.6.4 General Network Operator And Non-Embedded Customer Requirements

ECC.6.4.1 This part of the **Grid Code** describes the technical and design criteria and performance requirements for **Network Operators** and **Non-Embedded Customers**.

Neutral Earthing

ECC.6.4.2 At nominal **System** voltages of 132kV and above the higher voltage windings of three phase transformers and transformer banks connected to the **National Electricity Transmission System** must be star connected with the star point suitable for connection to earth. The earthing and lower voltage winding arrangement shall be such as to ensure that the **Earth Fault Factor** requirement of paragraph ECC.6.2.1.1 (b) will be met on the **National Electricity Transmission System** at nominal **System** voltages of 132kV and above.

Frequency Sensitive Relays

ECC.6.4.3 As explained under **OC6**, each **Network Operator** and **Non Embedded Customer**, will make arrangements that will facilitate automatic low **Frequency Disconnection of Demand** (based on **Annual ACS Conditions**). ECC.A.5.5. of Appendix E5 includes specifications of the local percentage **Demand** that shall be disconnected at specific frequencies. The manner in which **Demand** subject to low **Frequency** disconnection will be split into discrete MW blocks is specified in OC6.6. Technical requirements relating to **Low Frequency Relays** are also listed in Appendix E5.

Operational Metering

ECC.6.4.4 Where **The Company** can reasonably demonstrate that an **Embedded Medium Power Station** or **Embedded HVDC System** has a significant effect on the **National Electricity Transmission System**, it may require the **Network Operator** within whose **System** the **Embedded Medium Power Station** or **Embedded HVDC System** is situated to ensure that the operational metering equipment described in ECC.6.5.6 is installed such that **The Company** can receive the data referred to in ECC.6.5.6. In the case of an **Embedded Medium Power Station** subject to, or proposed to be subject to a **Bilateral Agreement**, **The Company** shall notify such **Network Operator** of the details of such installation in writing within 3 months of being notified of the application to connect under **CUSC** and in the case of an **Embedded Medium Power Station** not subject to, or not proposed to be subject to a **Bilateral Agreement** in writing as a **Site Specific Requirement** in accordance with the timescales in CUSC 6.5.5. In either case the **Network Operator** shall ensure that the data referred to in ECC.6.5.6 is provided to **The Company**.

ECC.6.4.5 Reactive Power Requirements at each EU Grid Supply Point

ECC.6.4.5.1 At each **EU Grid Supply Point**, **Non-Embedded Customers** and **Network Operators** who are **EU Code Users** shall ensure their **Systems** are capable of steady state operation within the **Reactive Power** limits as specified in ECC.6.4.5.1(a) and ECC.6.4.5.1(b). Where **The Company** requires a **Reactive Power** range which is broader than the limits defined in ECC.6.4.5.1(a) and ECC.6.4.5.1(b), this will be agreed as a reasonable requirement through joint assessment between the relevant **EU Code User** and **The Company** and justified in accordance with the requirements of ECC.6.4.5.1(c), (d), (e) and (f). For **Non-Embedded Customers** who are **EU Code Users**, the **Reactive Power** range at each **EU Grid Supply Point**, under both importing and exporting conditions, shall not exceed 48% of the larger of the **Maximum Import Capability** or **Maximum Export Capability** (0.9 **Power Factor** import or export of **Active Power**), except in situations where either technical or financial system benefits are demonstrated for **Non-Embedded Customers** and accepted by **The Company** in coordination with the **Relevant Transmission Licensee**.

(a) For **Network Operators** who are **EU Code Users** at each **EU Grid Supply Point**, the **Reactive Power** range shall not exceed:

- (i) 48 percent (i.e. 0.9 **Power Factor**) of the larger of the **Maximum Import Capability** or **Maximum Export Capability** during **Reactive Power** import (consumption); and
- (ii) 48 percent (i.e. 0.9 **Power Factor**) of the larger of the **Maximum Import Capability** or **Maximum Export Capability** during **Reactive Power** export (production);

Except in situations where either technical or financial system benefits are proved by **The Company** in coordination with the **Relevant Transmission Licensee** and the relevant **Network Operator** through joint analysis.

- (b) **The Company** in co-ordination with the **Relevant Transmission Licensee** shall agree with the **Network Operator** on the scope of the analysis, which shall determine the optimal solution for **Reactive Power** exchange between their **Systems** at each **EU Grid Supply Point**, taking adequately into consideration the specific **System** characteristics, variable structure of power exchange, bidirectional flows and the **Reactive Power** capabilities of the **Network Operator's System**. Any proposed solutions shall take the above issues into account and shall be agreed as a reasonable requirement through joint assessment between the relevant **Network Operator** or **Non-Embedded Customer** and **The Company** in coordination with the **Relevant Transmission Licensee**. In the event of a shared site between a **GB Code User** and **EU Code User**, the requirements would generally be allocated to each **User** on the basis of their **Demand** in the case of a **Network Operator** who is a **GB Code User** and applied on the basis of the **Maximum Import Capability** or **Maximum Export Capability** as specified in ECC.6.4.5.1 in the case of a **Network Operator** who is an **EU Code User**.
- (c) **The Company** in coordination with the **Relevant Transmission Licensee** may specify the **Reactive Power** capability range at the **EU Grid Supply Point** in another form other than **Power Factor**.
- (d) Notwithstanding the ability of **Network Operators** or **Non Embedded Customers** to apply for a derogation from ECC.6.4.5.1 (e), where an **EU Grid Supply Point** is shared between a **Power Generating Module** and a **Non-Embedded Customers System**, the **Reactive Power** range would be apportioned to each **EU Code User** at their **Connection Point**.

ECC.6.4.5.2 Where agreed with the **Network Operator** who is an **EU Code User** and justified through appropriate **System** studies, **The Company** may reasonably require the **Network Operator** not to export **Reactive Power** at the **EU Grid Supply Point** (at nominal voltage) at an **Active Power** flow of less than 25 % of the **Maximum Import Capability**. Where applicable, the **Authority** may require **The Company** in coordination with the **Relevant Transmission Licensee** to justify its request through a joint analysis with the relevant **Network Operator** and demonstrate that any such requirement is reasonable. If this requirement is not justified based on the joint analysis, **The Company** in coordination with the **Relevant Transmission Licensee** and the **Network Operator** shall agree on necessary requirements according to the outcomes of a joint analysis.

ECC.6.4.5.3 Notwithstanding the requirements of ECC.6.4.5.1(b) and subject to agreement between **The Company** and the relevant **Network Operator** there may be a requirement to actively control the exchange of **Reactive Power** at the **EU Grid Supply Point** for the benefit of the **Total System**. **The Company** and the relevant **Network Operator** shall agree on a method to carry out this control, to ensure the justified level of security of supply for both parties. Any such solution including joint study work and timelines would be agreed between **The Company** and the relevant **Network Operator** as reasonable, efficient and proportionate.

ECC.6.4.5.4 In accordance with ECC.6.4.5.3, the relevant **Network Operator** may require **The Company** to consider its **Network Operator's System** for **Reactive Power** management. Any such requirement would need to be agreed between **The Company** and the relevant **Network Operator** and justified by **The Company**.

ECC.6.5 Communications Plant

ECC.6.5.1 In order to ensure control of the **National Electricity Transmission System**, telecommunications between **Users** and **The Company** must (including in respect of any **OTSDUW Plant and Apparatus** at the **OTSUA Transfer Time**), if required by **The Company**, be established in accordance with the requirements set down below.

- ECC.6.5.2 Control Telephony and System Telephony
- ECC.6.5.2.1 **Control Telephony** is the principle method by which a **User's Responsible Engineer/Operator** and **The Company's Control Engineers** speak to one another for the purposes of control of the **Total System** in both normal and emergency operating conditions. **Control Telephony** provides secure point to point telephony for routine **Control Calls**, priority **Control Calls** and emergency **Control Calls**.
- ECC.6.5.2.2 **System Telephony** is an alternate method by which a **User's Responsible Engineer/Operator** and **The Company's Control Engineers** speak to one another for the purposes of control of the **Total System** in both normal operating conditions and where practicable, emergency operating conditions. **System Telephony** uses the Public Switched Telephony Network to provide telephony for **Control Calls**, inclusive of emergency **Control Calls**.
- ECC.6.5.2.3 Calls made and received over **Control Telephony** and **System Telephony** may be recorded and subsequently replayed for commercial and operational reasons.
- ECC.6.5.3 Supervisory Tones
- ECC.6.5.3.1 **Control Telephony** supervisory tones indicate to the calling and receiving parties dial, engaged, ringing, secondary engaged (signifying that priority may be exercised) and priority disconnect tones.
- ECC.6.5.3.2 **System Telephony** supervisory tones indicate to the calling and receiving parties dial, engaged and ringing tones.
- ECC.6.5.4 Obligations in respect of Control Telephony and System Telephony
- ECC.6.5.4.1 Where **The Company** requires **Control Telephony**, **Users** are required to use the **Control Telephony** with **The Company** in respect of all **Connection Points** with the **National Electricity Transmission System** and in respect of all **Embedded Large Power Stations** and **Embedded HVDC Systems**. **The Company** will have **Control Telephony** installed at the **User's Control Point** where the **User's** telephony equipment is not capable of providing the required facilities or is otherwise incompatible with the **Transmission Control Telephony**. Details of and relating to the **Control Telephony** required are contained in the **Bilateral Agreement**.
- ECC.6.5.4.2 Where in **The Company's** sole opinion the installation of **Control Telephony** is not practicable at a **User's Control Point(s)**, **The Company** shall specify in the **Bilateral Agreement** whether **System Telephony** is required. Where **System Telephony** is required by **The Company**, the **User** shall ensure that **System Telephony** is installed.
- ECC.6.5.4.3 Where **System Telephony** is installed, **Users** are required to use the **System Telephony** with **The Company** in respect of those **Control Point(s)** for which it has been installed. Details of and relating to the **System Telephony** required are contained in the **Bilateral Agreement**.
- ECC.6.5.4.4 Where **Control Telephony** or **System Telephony** is installed, routine testing of such facilities may be required by **The Company** (not normally more than once in any calendar month). The **User** and **The Company** shall use reasonable endeavours to agree a test programme and where **The Company** requests the assistance of the **User** in performing the agreed test programme the **User** shall provide such assistance. **The Company** requires the **EU Code User** to test the backup power supplies feeding its **Control Telephony** facilities at least once every 5 years.
- ECC.6.5.4.5 **Control Telephony** and **System Telephony** shall only be used for the purposes of operational voice communication between **The Company** and the relevant **User**.
- ECC.6.5.4.6 **Control Telephony** contains emergency calling functionality to be used for urgent operational communication only. Such functionality enables **The Company** and **Users** to utilise a priority call in the event of an emergency. **The Company** and **Users** shall only use such priority call functionality for urgent operational communications.

ECC.6.5.5 Technical Requirements for Control Telephony and System Telephony

ECC.6.5.5.1 Detailed information on the technical interfaces and support requirements for **Control Telephony** is provided in the **Control Telephony Electrical Standard** identified in the Annex to the **General Conditions**. Where additional information, or information in relation to **Control Telephony** applicable in Scotland, is requested by **Users**, this will be provided, where possible, by **The Company**.

ECC.6.5.5.2 **System Telephony** shall consist of a dedicated Public Switched Telephone Network telephone line that shall be installed and configured by the relevant **User**. **The Company** shall provide a dedicated free phone number (UK only), for the purposes of receiving incoming calls to **The Company**, which **Users** shall utilise for **System Telephony**. **System Telephony** shall only be utilised by **The Company's Control Engineer** and the **User's Responsible Engineer/Operator** for the purposes of operational communications.

ECC.6.5.6 Operational Metering

ECC.6.5.6.1 It is an essential requirement for **The Company** and **Network Operators** to have visibility of the real time output and status of indications of **User's Plant and Apparatus** so they can control the operation of the **System**.

ECC.6.5.6.2 **Type B, Type C and Type D Power Park Modules, HVDC Equipment, Network Operators and Non Embedded Customers** are required to be capable of exchanging operational metering data with **The Company** and **Relevant Transmission Licensees** (as applicable) with time stamping. Time stamping would generally be to a sampling rate of 1 second or better unless otherwise specified by **The Company** in the **Bilateral Agreement**.

ECC.6.5.6.3 **The Company** in coordination with the **Relevant Transmission Licensee** shall specify in the **Bilateral Agreement** the operational metering signals to be provided by the **EU Generator, HVDC System Owner, Network Operator or Non-Embedded Customer**. In the case of **Network Operators and Non-Embedded Customers**, detailed specifications relating to the operational metering standards at **EU Grid Supply Points** and the data required are published as **Electrical Standards** in the Annex to the **General Conditions**.

ECC.6.5.6.4 (a) **The Company** or The **Relevant Transmission Licensee**, as applicable, shall provide system control and data acquisition (SCADA) outstation interface equipment., each **EU Code User** shall provide such voltage, current, **Frequency, Active Power and Reactive Power** measurement outputs and plant status indications and alarms to the **Transmission SCADA outstation interface equipment** as required by **The Company** in accordance with the terms of the **Bilateral Agreement**. In the case of **OTSDUW**, the **User** shall provide such SCADA outstation interface equipment and voltage, current, **Frequency, Active Power and Reactive Power** measurement outputs and plant status indications and alarms to the SCADA outstation interface equipment as required by **The Company** in accordance with the terms of the **Bilateral Agreement**.

(b) For the avoidance of doubt, for **Active Power and Reactive Power** measurements, circuit breaker and disconnector status indications from:

(i) **CCGT Modules** from **Type B, Type C and Type D Power Generating Modules**, the outputs and status indications must each be provided to **The Company** on an individual **CCGT Unit** basis. In addition, where identified in the **Bilateral Agreement**, **Active Power and Reactive Power** measurements from **Unit Transformers** and/or **Station Transformers** must be provided.

(ii) For **Type B, Type C and Type D Power Park Modules** the outputs and status indications must each be provided to **The Company** on an individual **Power Park Module** basis. In addition, where identified in the **Bilateral Agreement**, **Active Power and Reactive Power** measurements from station transformers must be provided.

(iii) In respect of **OTSDUW Plant and Apparatus**, the outputs and status indications must be provided to **The Company** for each piece of electrical equipment. In

addition, where identified in the **Bilateral Agreement**, **Active Power** and **Reactive Power** measurements at the **Interface Point** must be provided.

- (c) For the avoidance of doubt, the requirements of ECC.6.5.6.4(a) in the case of a **Cascade Hydro Scheme** will be provided for each **Generating Unit** forming part of that **Cascade Hydro Scheme**. In the case of **Embedded Generating Units** forming part of a **Cascade Hydro Scheme** the data may be provided by means other than the SCADA outstation located at the **Power Station**, such as, with the agreement of the **Network Operator** in whose system such **Embedded Generating Unit** is located, from the **Network Operator's** SCADA system to **The Company**. Details of such arrangements will be contained in the relevant **Bilateral Agreements** between **The Company** and the **Generator** and the **Network Operator**.
- (d) In the case of a **Power Park Module**, additional energy input signals (e.g. wind speed, and wind direction) may be specified in the **Bilateral Agreement**. A **Power Available** signal will also be specified in the **Bilateral Agreement**. The signals would be used to establish the potential level of energy input from the **Intermittent Power Source** for monitoring pursuant to ECC.6.6.1 and **Ancillary Services** and will, in the case of a wind farm, be used to provide **The Company** with advanced warning of excess wind speed shutdown and to determine the level of **Headroom** available from **Power Park Modules** for the purposes of calculating response and reserve. For the avoidance of doubt, the **Power Available** signal would be automatically provided to **The Company** and represent the sum of the potential output of all available and operational **Power Park Units** within the **Power Park Module**. The refresh rate of the **Power Available** signal shall be specified in the **Bilateral Agreement**. In the case of an **Electricity Storage Module**, the requirement to provide a **Power Available Signal** when the **Plant** is in both an importing and exporting mode of operation would be specified in the **Bilateral Agreement**.
- (e) In the case of an **Electricity Storage Module**, additional input signals (e.g. state of energy (MWhr, and system availability) may be specified in the **Bilateral Agreement**. A **Power Available** signal will also be specified in the **Bilateral Agreement** in accordance with the requirements of ECC.6.5.6.4(d).

ECC.6.5.6.5 In addition to the requirements of the **Balancing Codes**, each **HVDC Converter** unit of an **HVDC system** shall be equipped with an automatic controller capable of receiving instructions from **The Company**. This automatic controller shall be capable of operating the **HVDC Converter** units of the **HVDC System** in a coordinated way. **The Company** shall specify the automatic controller hierarchy per **HVDC Converter** unit.

ECC.6.5.6.6 The automatic controller of the **HVDC System** referred to in paragraph ECC.6.5.6.5 shall be capable of sending the following signal types to **The Company** (where applicable) :

- (a) operational metering signals, providing at least the following:
 - (i) start-up signals;
 - (ii) AC and DC voltage measurements;
 - (iii) AC and DC current measurements;
 - (iv) **Active** and **Reactive Power** measurements on the AC side;
 - (v) DC power measurements;
 - (vi) **HVDC Converter** unit level operation in a multi-pole type **HVDC Converter**;
 - (vii) elements and topology status; and
 - (viii) **Frequency Sensitive Mode**, **Limited Frequency Sensitive Mode Overfrequency** and **Limited Frequency Sensitive Mode Underfrequency Active Power** ranges (where applicable).
- (b) alarm signals, providing at least the following:
 - (i) emergency blocking;

- (ii) ramp blocking;
- (iii) fast **Active Power** reversal (where applicable)

ECC.6.5.6.7 The automatic controller referred to in ECC.6.5.6.5 shall be capable of receiving the following signal types from **The Company** (where applicable) :

(a) operational metering signals, receiving at least the following:

- (i) start-up command;
- (ii) **Active Power** setpoints;
- (iii) **Frequency Sensitive Mode** settings;
- (iv) **Reactive Power**, voltage or similar setpoints;
- (v) **Reactive Power** control modes;
- (vi) power oscillation damping control; and

(b) alarm signals, receiving at least the following:

- (i) emergency blocking command;
- (ii) ramp blocking command;
- (iii) **Active Power** flow direction; and
- (iv) fast **Active Power** reversal command.

ECC.6.5.6.8 With regards to operational metering signals, the resolution and refresh rate required would be 1 second or better unless otherwise agreed with **The Company**

Instructor Facilities

ECC.6.5.7 The **User** shall accommodate **Instructor Facilities** provided by **The Company** for the receipt of operational messages relating to **System** conditions.

Electronic Data Communication Facilities

ECC.6.5.8 (a) All **BM Participants** must ensure that appropriate electronic data communication facilities are in place to permit the submission of data, as required by the **Grid Code**, to **The Company**.

(b) In addition,

(1) any **User** that wishes to participate in the **Balancing Mechanism**;

or

(2) any **BM Participant** in respect of its **BM Units** at a **Power Station** and the **BM Participant** is required to provide all **Part 1 System Ancillary Services** in accordance with ECC.8.1 (unless **The Company** has otherwise agreed)

must ensure that appropriate automatic logging devices are installed at the **Control Points** of its **BM Units** to submit data to and to receive instructions from **The Company**, as required by the **Grid Code**. For the avoidance of doubt, in the case of an **Interconnector User** the **Control Point** will be at the **Control Centre** of the appropriate **Externally Interconnected System Operator**.

(c) Detailed specifications of these required electronic facilities will be provided by **The Company** on request and they are listed as **Electrical Standards** in the Annex to the **General Conditions**.

Facsimile Machines

ECC.6.5.9 Each **User** and **The Company** shall provide a facsimile machine or machines:

- (a) in the case of **Generators**, at the **Control Point** of each **Power Station** and at its **Trading Point**;
- (b) in the case of **The Company** and **Network Operators**, at the **Control Centre(s)**; and
- (c) in the case of **Non-Embedded Customers** and **HVDC Equipment** owners at the **Control Point**.

Each **User** shall notify, prior to connection to the **System** of the **User's Plant and Apparatus**, **The Company** of its or their telephone number or numbers, and will notify **The Company** of any changes. Prior to connection to the **System** of the **User's Plant and Apparatus** **The Company** shall notify each **User** of the telephone number or numbers of its facsimile machine or machines and will notify any changes.

ECC.6.5.10 Busbar Voltage

The Relevant Transmission Licensee shall, subject as provided below, provide each **Generator** or **HVDC System Owner** at each **Grid Entry Point** where one of its **Power Stations** or **HVDC Systems** is connected with appropriate voltage signals to enable the **Generator** or **HVDC System** owner to obtain the necessary information to permit its **Power Generating Modules** (including **DC Connected Power Park Modules**) or **HVDC System** to be **Synchronised** to the **National Electricity Transmission System**. The term "**voltage signal**" shall mean in this context, a point of connection on (or wire or wires from) a relevant part of **Transmission Plant** and/or **Apparatus** at the **Grid Entry Point**, to which the **Generator** or **HVDC System Owner**, with **The Company's** agreement (not to be unreasonably withheld) in relation to the **Plant** and/or **Apparatus** to be attached, will be able to attach its **Plant** and/or **Apparatus** (normally a wire or wires) in order to obtain measurement outputs in relation to the busbar.

ECC.6.5.11 Bilingual Message Facilities

- (a) A Bilingual Message Facility is the method by which the **User's Responsible Engineer/Operator**, the **Externally Interconnected System Operator** and **The Company's Control Engineers** communicate clear and unambiguous information in two languages for the purposes of control of the **Total System** in both normal and emergency operating conditions.
- (b) A Bilingual Message Facility, where required, will provide up to two hundred pre-defined messages with up to five hundred and sixty characters each. A maximum of one minute is allowed for the transmission to, and display of, the selected message at any destination. The standard messages must be capable of being displayed at any combination of locations and can originate from any of these locations. Messages displayed in the UK will be displayed in the English language.
- (c) Detailed information on a Bilingual Message Facility and suitable equipment required for individual **User** applications will be provided by **The Company** upon request.

ECC.6.6 Monitoring

ECC.6.6.1 System Monitoring

ECC.6.6.1.1 Each **Type C** and **Type D Power Generating Module** including **DC Connected Power Park Modules** shall be equipped with a facility to provide fault recording and monitoring of dynamic system behaviour. These requirements are necessary to record conditions during **System** faults and detect poorly damped power oscillations. This facility shall record the following parameters:

- voltage,
- **Active Power**,
- **Reactive Power**, and
- **Frequency**.

- ECC.6.6.1.2 Detailed specifications for fault recording and dynamic system monitoring equipment including triggering criteria and sample rates are listed as **Electrical Standards** in the **Annex** to the **General Conditions**. For Dynamic System Monitoring, the specification for the communication protocol and recorded data shall also be included in the **Electrical Standard**.
- ECC.6.6.1.3 **The Company** in coordination with the **Relevant Transmission Licensee** shall specify any requirements for **Power Quality Monitoring** in the **Bilateral Agreement**. The power quality parameters to be monitored, the communication protocols for the recorded data and the time frames for compliance shall be agreed between **The Company**, the **Relevant Transmission Licensee** and **EU Generator**.
- ECC.6.6.1.4 **HVDC Systems** shall be equipped with a facility to provide fault recording and dynamic system behaviour monitoring of the following parameters for each of its **HVDC Converter Stations**:
- (a) AC and DC voltage;
 - (b) AC and DC current;
 - (c) **Active Power**;
 - (d) **Reactive Power**; and
 - (e) **Frequency**.
- ECC.6.6.1.5 **The Company** in coordination with the **Relevant Transmission Licensee** may specify quality of supply parameters to be complied with by the **HVDC System**, provided a reasonable prior notice is given.
- ECC.6.6.1.6 The particulars of the fault recording equipment referred to in ECC.6.6.1.4, including analogue and digital channels, the settings, including triggering criteria and the sampling rates, shall be agreed between the **HVDC System Owner** and **The Company** in coordination with the **Relevant Transmission Licensee**.
- ECC.6.6.1.7 All dynamic system behaviour monitoring equipment shall include an oscillation trigger, specified by **The Company**, in coordination with the **Relevant Transmission Licensee**, with the purpose of detecting poorly damped power oscillations.
- ECC.6.6.1.8 The facilities for quality of supply and dynamic system behaviour monitoring shall include arrangements for the **HVDC System Owner** and **The Company** and/or **Relevant Transmission Licensee** to access the information electronically. The communications protocols for recorded data shall be agreed between the **HVDC System Owner**, **The Company** and the **Relevant Transmission Licensee**.
- ECC.6.6.2 Frequency Response Monitoring
- ECC.6.6.2.1 Each **Type C** and **Type D Power Generating Module** including **DC Connected Power Park Modules** shall be fitted with equipment capable of monitoring the real time **Active Power** output of a **Power Generating Module** when operating in **Frequency Sensitive Mode**.
- ECC.6.6.2.2 Detailed specifications of the **Active Power Frequency** response requirements including the communication requirements are listed as **Electrical Standards** in the **Annex** to the **General Conditions**.
- ECC.6.6.2.3 **The Company** in co-ordination with the **Relevant Transmission Licensee** shall specify additional signals to be provided by the **EU Generator** by monitoring and recording devices in order to verify the performance of the **Active Power Frequency** response provision of participating **Power Generating Modules**.
- ECC.6.6.3 Compliance Monitoring
- ECC.6.6.3.1 For all on site monitoring by **The Company** of witnessed tests pursuant to the **CP** or **OC5** or **ECP** the **User** shall provide suitable test signals as outlined in either OC5.A.1 or **ECP.A.4** (as applicable).

- ECC.6.6.3.2 The signals which shall be provided by the **User** to **The Company** for onsite monitoring shall be of the following resolution, unless otherwise agreed by **The Company**:
- (i) 1 Hz for reactive range tests
 - (ii) 10 Hz for frequency control tests
 - (iii) 100 Hz for voltage control tests
- ECC.6.6.3.3 The **User** will provide all relevant signals for this purpose in the form of d.c. voltages within the range -10V to +10V. In exceptional circumstances some signals may be accepted as d.c. voltages within the range -60V to +60V with prior agreement between the **User** and **The Company**. All signals shall:
- (i) in the case of an **Onshore Power Generating Module** or **Onshore HVDC Converter Station**, be suitably terminated in a single accessible location at the **Generator** or **HVDC Converter Station** owner's site.
 - (ii) in the case of an **Offshore Power Generating Module** and **OTSDUW Plant and Apparatus**, be transmitted onshore without attenuation, delay or filtering which would result in the inability to fully demonstrate the objectives of the test, or identify any potential safety or plant instability issues, and be suitably terminated in a single robust location normally located at or near the onshore **Interface Point** of the **Offshore Transmission System** to which it is connected.
- ECC.6.6.3.4 All signals shall be suitably scaled across the range. The following scaling would (unless **The Company** notify the **User** otherwise) be acceptable to **The Company**:
- (a) 0MW to **Maximum Capacity** or **Interface Point Capacity** 0-8V dc
 - (b) Maximum leading **Reactive Power** to maximum lagging **Reactive Power** -8 to 8V dc
 - (c) 48 – 52Hz as -8 to 8V dc
 - (d) Nominal terminal or connection point voltage -10% to +10% as -8 to 8V dc
- ECC.6.6.3.5 The **User** shall provide to **The Company** a 230V power supply adjacent to the signal terminal location.

ECC.7 SITE RELATED CONDITIONS

ECC.7.1 Not used.

ECC.7.2 Responsibilities For Safety

ECC.7.2.1 Any **User** entering and working on its **Plant** and/or **Apparatus** (including, until the **OTSUA Transfer Time**, any **OTSUA**) on a **Transmission Site** will work to the **Safety Rules** of the **Relevant Transmission Licensee**, as advised by **The Company**.

ECC.7.2.2 For **User Sites**, **The Company** shall procure that the **Relevant Transmission Licensee** entering and working on **Transmission Plant** and/or **Apparatus** on a **User Site** will work to the **User's Safety Rules**.

ECC.7.2.3 A **User** may, with a minimum of six weeks notice, apply to **The Company** for permission to work according to that **Users** own **Safety Rules** when working on its **Plant** and/or **Apparatus** on a **Transmission Site** rather than those set out in ECC.7.2.1. If **The Company** is of the opinion that the **User's Safety Rules** provide for a level of safety commensurate with those set out in ECC.7.2.1, **The Company** will notify the **User**, in writing, that, with effect from the date requested by the **User**, the **User** may use its own **Safety Rules** when working on its **Plant** and/or **Apparatus** on the **Transmission Site**. For a **Transmission Site**, in forming its opinion, **The Company** will seek the opinion of the **Relevant Transmission Licensee**. Until receipt of such written approval from **The Company**, the **User** will continue to use the **Safety Rules** as set out in ECC.7.2.1.

- ECC.7.2.4 In the case of a **User Site**, **The Company** may, with a minimum of six weeks notice, apply to a **User** for permission for the **Relevant Transmission Licensee** to work according to the **Relevant Transmission Licensee's Safety Rules** when working on **Transmission Plant** and/or **Apparatus** on that **User Site**, rather than the **User's Safety Rules**. If the **User** is of the opinion that the **Relevant Transmission Licensee's Safety Rules**, provide for a level of safety commensurate with that of that **User's Safety Rules**, it will notify **The Company**, in writing, that, with effect from the date requested by **The Company**, that the **Relevant Transmission Licensee** may use its own **Safety Rules** when working on its **Transmission Plant** and/or **Apparatus** on that **User's Site**. Until receipt of such written approval from the **User**, **The Company** shall procure that the **Relevant Transmission Licensee** shall continue to use the **User's Safety Rules**.
- ECC.7.2.5 For a **Transmission Site**, if **The Company** gives its approval for the **User's Safety Rules** to apply to the **User** when working on its **Plant** and/or **Apparatus**, that does not imply that the **User's Safety Rules** will apply to entering the **Transmission Site** and access to the **User's Plant** and/or **Apparatus** on that **Transmission Site**. Bearing in mind the **Relevant Transmission Licensee's** responsibility for the whole **Transmission Site**, entry and access will always be in accordance with the **Relevant Transmission Licensee's** site access procedures. For a **User Site**, if the **User** gives its approval for **Relevant Transmission Licensee Safety Rules** to apply to the **Relevant Transmission Licensee** when working on its **Plant** and **Apparatus**, that does not imply that the **Relevant Transmission Licensee's Safety Rules** will apply to entering the **User Site**, and access to the **Transmission Plant** and **Apparatus** on that **User Site**. Bearing in mind the **User's** responsibility for the whole **User Site**, entry and access will always be in accordance with the **User's** site access procedures.
- ECC.7.2.6 For **User Sites**, **Users** shall notify **The Company** of any **Safety Rules** that apply to the **Relevant Transmission Licensee's** staff working on **User Sites**. **The Company** shall procure that the **Relevant Transmission Licensee** shall notify **Users** of any **Safety Rules** that apply to the **User's** staff working on the **Transmission Site**.
- ECC.7.2.7 Each **Site Responsibility Schedule** must have recorded on it the **Safety Rules** which apply to each item of **Plant** and/or **Apparatus**.
- ECC.7.2.8 In the case of **OTSUA** a **User Site** or **Transmission Site** shall, for the purposes of this ECC.7.2, include a site at which there is an **Interface Point** until the **OTSUA Transfer Time** when it becomes part of the **National Electricity Transmission System**.
- ECC.7.3 Site Responsibility Schedules
- ECC.7.3.1 In order to inform site operational staff and **The Company's Control Engineers** of agreed responsibilities for **Plant** and/or **Apparatus** at the operational interface, a **Site Responsibility Schedule** shall be produced for **Connection Sites** (and in the case of **OTSUA**, until the **OTSUA Transfer Time, Interface Sites**) for **The Company**, the **Relevant Transmission Licensee** and **Users** with whom they interface.
- ECC.7.3.2 The format, principles and basic procedure to be used in the preparation of **Site Responsibility Schedules** are set down in Appendix 1.
- ECC.7.4 Operation And Gas Zone Diagrams
Operation Diagrams
- ECC.7.4.1 An **Operation Diagram** shall be prepared for each **Connection Site** at which a **Connection Point** exists (and in the case of **OTSDUW Plant and Apparatus**, by **User's** for each **Interface Point**) using, where appropriate, the graphical symbols shown in Part 1A of Appendix 2. **Users** should also note that the provisions of **OC11** apply in certain circumstances.

ECC.7.4.2 The **Operation Diagram** shall include all **HV Apparatus** and the connections to all external circuits and incorporate numbering, nomenclature and labelling, as set out in **OC11**. At those **Connection Sites** (or in the case of **OTSDUW Plant and Apparatus, Interface Points**) where gas-insulated metal enclosed switchgear and/or other gas-insulated **HV Apparatus** is installed, those items must be depicted within an area delineated by a chain dotted line which intersects gas-zone boundaries. The nomenclature used shall conform with that used on the relevant **Connection Site** and circuit (and in the case of **OTSDUW Plant and Apparatus, Interface Point** and circuit). The **Operation Diagram** (and the list of technical details) is intended to provide an accurate record of the layout and circuit interconnections, ratings and numbering and nomenclature of **HV Apparatus** and related **Plant**.

ECC.7.4.3 A non-exhaustive guide to the types of **HV Apparatus** to be shown in the **Operation Diagram** is shown in Part 2 of Appendix 2, together with certain basic principles to be followed unless equivalent principles are approved by **The Company**.

Gas Zone Diagrams

ECC.7.4.4 A **Gas Zone Diagram** shall be prepared for each **Connection Site** at which a **Connection Point** (and in the case of **OTSDUW Plant and Apparatus, by User's** for an **Interface Point**) exists where gas-insulated switchgear and/or other gas-insulated **HV Apparatus** is utilised. They shall use, where appropriate, the graphical symbols shown in Part 1B of Appendix 2.

ECC.7.4.5 The nomenclature used shall conform with that used in the relevant **Connection Site** and circuit (and in the case of **OTSDUW Plant and Apparatus, relevant Interface Point** and circuit).

ECC.7.4.6 The basic principles set out in Part 2 of Appendix 2 shall be followed in the preparation of **Gas Zone Diagrams** unless equivalent principles are approved by **The Company**.

Preparation of Operation and Gas Zone Diagrams for Users' Sites and Transmission Interface Sites

ECC.7.4.7 In the case of a **User Site**, the **User** shall prepare and submit to **The Company**, an **Operation Diagram** for all **HV Apparatus** on the **User** side of the **Connection Point** (and in the case of **OTSDUW Plant and Apparatus**, on what will be the **Offshore Transmission** side of the **Connection Point** and the **Interface Point**) and **The Company** shall provide the **User** with an **Operation Diagram** for all **HV Apparatus** on the **Transmission** side of the **Connection Point** (and in the case of **OTSDUW Plant and Apparatus** on what will be the **Onshore Transmission** side of the **Interface Point**, in accordance with the timing requirements of the **Bilateral Agreement** and/or **Construction Agreement** prior to the **Completion Date** under the **Bilateral Agreement** and/or **Construction Agreement**.

ECC.7.4.8 The **User** will then prepare, produce and distribute, using the information submitted on the **User's Operation Diagram** and **The Company's Operation Diagram**, a composite **Operation Diagram** for the complete **Connection Site** (and in the case of **OTSDUW Plant and Apparatus, Interface Point**), also in accordance with the timing requirements of the **Bilateral Agreement** and/or **Construction Agreement** .

ECC.7.4.9 The provisions of ECC.7.4.7 and ECC.7.4.8 shall apply in relation to **Gas Zone Diagrams** where gas-insulated switchgear and/or other gas-insulated **HV Apparatus** is utilised.

Preparation of Operation and Gas Zone Diagrams for Transmission Sites

ECC.7.4.10 In the case of an **Transmission Site**, the **User** shall prepare and submit to **The Company** an **Operation Diagram** for all **HV Apparatus** on the **User** side of the **Connection Point**, in accordance with the timing requirements of the **Bilateral Agreement** and/or **Construction Agreement**.

ECC.7.4.11 **The Company** will then prepare, produce and distribute, using the information submitted on the **User's Operation Diagram**, a composite **Operation Diagram** for the complete **Connection Site**, also in accordance with the timing requirements of the **Bilateral Agreement** and/or **Construction Agreement** .

ECC.7.4.12 The provisions of ECC.7.4.10 and ECC.7.4.11 shall apply in relation to **Gas Zone Diagrams** where gas-insulated switchgear and/or other gas-insulated **HV Apparatus** is utilised.

ECC.7.4.13 Changes to Operation and Gas Zone Diagrams

ECC.7.4.13.1 When **The Company** has decided that it wishes to install new **HV Apparatus** or it wishes to change the existing numbering or nomenclature of **Transmission HV Apparatus** at a **Transmission Site**, **The Company** will (unless it gives rise to a **Modification** under the **CUSC**, in which case the provisions of the **CUSC** as to the timing apply) one month prior to the installation or change, send to each such **User** a revised **Operation Diagram** of that **Transmission Site**, incorporating the new **Transmission HV Apparatus** to be installed and its numbering and nomenclature or the changes, as the case may be. **OC11** is also relevant to certain **Apparatus**.

ECC.7.4.13.2 When a **User** has decided that it wishes to install new **HV Apparatus**, or it wishes to change the existing numbering or nomenclature of its **HV Apparatus** at its **User Site**, the **User** will (unless it gives rise to a **Modification** under the **CUSC**, in which case the provisions of the **CUSC** as to the timing apply) one month prior to the installation or change, send to **The Company** a revised **Operation Diagram** of that **User Site** incorporating the **EU Code User HV Apparatus** to be installed and its numbering and nomenclature or the changes as the case may be. **OC11** is also relevant to certain **Apparatus**.

ECC.7.4.13.3 The provisions of ECC.7.4.13.1 and ECC.7.4.13.2 shall apply in relation to **Gas Zone Diagrams** where gas-insulated switchgear and/or other gas-insulated **HV Apparatus** is installed.

Validity

ECC.7.4.14 (a) The composite **Operation Diagram** prepared by **The Company** or the **User**, as the case may be, will be the definitive **Operation Diagram** for all operational and planning activities associated with the **Connection Site**. If a dispute arises as to the accuracy of the composite **Operation Diagram**, a meeting shall be held at the **Connection Site**, as soon as reasonably practicable, between **The Company** and the **User**, to endeavour to resolve the matters in dispute.

(b) The composite **Operation Diagram** prepared by **The Company** or the **User**, as the case may be, will be the definitive **Operation Diagram** for all operational and planning activities associated with the **Interface Point** until the **OTSUA Transfer Time**. If a dispute arises as to the accuracy of the composite **Operation Diagram** prior to the **OTSUA Transfer Time**, a meeting shall be held at the **Interface Point**, as soon as reasonably practicable, between **The Company** and the **User**, to endeavour to resolve the matters in dispute.

(c) An equivalent rule shall apply for **Gas Zone Diagrams** where they exist for a **Connection Site**.

ECC.7.4.15 In the case of **OTSUA**, a **User Site** and **Transmission Site** shall, for the purposes of this ECC.7.4, include a site at which there is an **Interface Point** until the **OTSUA Transfer Time** when it becomes part of the **National Electricity Transmission System** and references to **HV Apparatus** in this ECC.7.4 shall include references to **HV OTSUA**.

ECC.7.5 Site Common Drawings

ECC.7.5.1 **Site Common Drawings** will be prepared for each **Connection Site** (and in the case of **OTSDUW**, each **Interface Point**) and will include **Connection Site** (and in the case of **OTSDUW**, **Interface Point**) layout drawings, electrical layout drawings, common **Protection/control** drawings and common services drawings.

Preparation of Site Common Drawings for a User Site and Transmission Interface Site

ECC.7.5.2 In the case of a **User Site**, **The Company** shall prepare and submit to the **User**, **Site Common Drawings** for the **Transmission** side of the **Connection Point** (and in the case of **OTSDUW Plant and Apparatus**, on what will be the **Onshore Transmission** side of the **Interface Point**.) and the **User** shall prepare and submit to **The Company**, **Site Common Drawings** for the **User** side of the **Connection Point** (and in the case of **OTSDUW**, on what will be the **Offshore Transmission** side of the **Interface Point**) in accordance with the timing requirements of the **Bilateral Agreement** and/or **Construction Agreement**.

ECC.7.5.3 The **User** will then prepare, produce and distribute, using the information submitted on the **Transmission Site Common Drawings**, **Site Common Drawings** for the complete **Connection Site** (and in the case of **OTSDUW**, **Interface Point**) in accordance with the timing requirements of the **Bilateral Agreement** and/or **Construction Agreement** .

Preparation of Site Common Drawings for a Transmission Site

ECC.7.5.4 In the case of a **Transmission Site**, the **User** will prepare and submit to **The Company Site Common Drawings** for the **User** side of the **Connection Point** in accordance with the timing requirements of the **Bilateral Agreement** and/or **Construction Agreement**.

ECC.7.5.5 **The Company** will then prepare, produce and distribute, using the information submitted in the **User's Site Common Drawings**, **Site Common Drawings** for the complete **Connection Site** in accordance with the timing requirements of the **Bilateral Agreement** and/or **Construction Agreement**.

ECC.7.5.6 When a **User** becomes aware that it is necessary to change any aspect of the **Site Common Drawings** at a **Connection Site** (and in the case of **OTSDUW**, **Interface Point**) it will:

- (a) if it is a **User Site**, as soon as reasonably practicable, prepare, produce and distribute revised **Site Common Drawings** for the complete **Connection Site** (and in the case of **OTSDUW**, **Interface Point**); and
- (b) if it is a **Transmission Site**, as soon as reasonably practicable, prepare and submit to **The Company** revised **Site Common Drawings** for the **User** side of the **Connection Point** (and in the case of **OTSDUW**, **Interface Point**) and **The Company** will then, as soon as reasonably practicable, prepare, produce and distribute, using the information submitted in the **User's Site Common Drawings**, revised **Site Common Drawings** for the complete **Connection Site** (and in the case of **OTSDUW**, **Interface Point**).

In either case, if in the **User's** reasonable opinion the change can be dealt with by it notifying **The Company** in writing of the change and for each party to amend its copy of the **Site Common Drawings** (or where there is only one set, for the party holding that set to amend it), then it shall so notify and each party shall so amend. If the change gives rise to a **Modification** under the **CUSC**, the provisions of the **CUSC** as to timing will apply.

ECC.7.5.7 When **The Company** becomes aware that it is necessary to change any aspect of the **Site Common Drawings** at a **Connection Site**(and in the case of **OTSDUW**, **Interface Point**) it will:

- (a) if it is a **Transmission Site**, as soon as reasonably practicable, prepare, produce and distribute revised **Site Common Drawings** for the complete **Connection Site** (and in the case of **OTSDUW**, **Interface Point**); and
- (b) if it is a **User Site**, as soon as reasonably practicable, prepare and submit to the **User** revised **Site Common Drawings** for the **Transmission** side of the **Connection Point** (in the case of **OTSDUW**, **Interface Point**) and the **User** will then, as soon as reasonably practicable, prepare, produce and distribute, using the information submitted in the **Transmission Site Common Drawings**, revised **Site Common Drawings** for the complete **Connection Site** (and in the case of **OTSDUW**, **Interface Point**).

In either case, if in **The Company's** reasonable opinion the change can be dealt with by it notifying the **User** in writing of the change and for each party to amend its copy of the **Site Common Drawings** (or where there is only one set, for the party holding that set to amend it), then it shall so notify and each party shall so amend. If the change gives rise to a **Modification** under the **CUSC**, the provisions of the **CUSC** as to timing will apply.

Validity

- ECC.7.5.8 (a) The **Site Common Drawings** for the complete **Connection Site** prepared by the **User** or **The Company**, as the case may be, will be the definitive **Site Common Drawings** for all operational and planning activities associated with the **Connection Site**. If a dispute arises as to the accuracy of the **Site Common Drawings**, a meeting shall be held at the **Site**, as soon as reasonably practicable, between **The Company** and the **User**, to endeavour to resolve the matters in dispute.
- (b) The **Site Common Drawing** prepared by **The Company** or the **User**, as the case may be, will be the definitive **Site Common Drawing** for all operational and planning activities associated with the **Interface Point** until the **OTSUA Transfer Time**. If a dispute arises as to the accuracy of the composite **Operation Diagram** prior to the **OTSUA Transfer Time**, a meeting shall be held at the **Interface Point**, as soon as reasonably practicable, between **The Company** and the **User**, to endeavour to resolve the matters in dispute.
- ECC.7.5.9 In the case of **OTSUA**, a **User Site** and **Transmission Site** shall, for the purposes of this ECC.7.5, include a site at which there is an **Interface Point** until the **OTSUA Transfer Time** when it becomes part of the **National Electricity Transmission System**.
- ECC.7.6 Access
- ECC.7.6.1 The provisions relating to access to **Transmission Sites** by **Users**, and to **Users' Sites** by **Relevant Transmission Licensees**, are set out in each **Interface Agreement** (or in the case of **Interfaces Sites** prior to the **OTSUA Transfer Time** agreements in similar form) with, the **Relevant Transmission Licensee** and each **User**.
- ECC.7.6.2 In addition to those provisions, where a **Transmission Site** contains exposed **HV** conductors, unaccompanied access will only be granted to individuals holding an **Authority for Access** issued by the **Relevant Transmission Licensee**.
- ECC.7.6.3 The procedure for applying for an **Authority for Access** is contained in the **Interface Agreement**.
- ECC.7.7 Maintenance Standards
- ECC.7.7.1 It is the **User's** responsibility to ensure that all its **Plant** and **Apparatus** (including, until the **OTSUA Transfer Time**, any **OTSUA**) on a **Transmission Site** is tested and maintained adequately for the purpose for which it is intended, and to ensure that it does not pose a threat to the safety of any **Transmission Plant, Apparatus** or personnel on the **Transmission Site**. **The Company** will have the right to inspect the test results and maintenance records relating to such **Plant** and **Apparatus** at any time
- ECC.7.7.2 For **User Sites**, **The Company** shall procure that the **Relevant Transmission Licensee** has a responsibility to ensure that all **Transmission Plant** and **Apparatus** on a **User Site** is tested and maintained adequately for the purposes for which it is intended and to ensure that it does not pose a threat to the safety of any **User's Plant, Apparatus** or personnel on the **User Site**.
- The **User** will have the right to inspect the test results and maintenance records relating to such **Plant** and **Apparatus** on its **User Site** at any time.
- ECC.7.8 Site Operational Procedures
- ECC.7.8.1 Where there is an interface with **National Electricity Transmission System** **The Company** and **Users** must make available staff to take necessary **Safety Precautions** and carry out operational duties as may be required to enable work/testing to be carried out and for the operation of **Plant** and **Apparatus** (including, prior to the **OTSUA Transfer Time**, any **OTSUA**) connected to the **Total System**.

ECC.7.9 **Generators** and **HVDC System** owners shall provide a **Control Point** in respect of each **Power Station** directly connected to the **National Electricity Transmission System** and **Embedded Large Power Station** or **HVDC System** to receive and act upon instructions pursuant to OC7 and BC2 at all times that **Power Generating Modules** at the **Power Station** are generating or available to generate or **HVDC Systems** are importing or exporting or available to do so. The **Control Point** shall be continuously manned except where the **Bilateral Agreement** in respect of such **Embedded Power Station** specifies that compliance with BC2 is not required, where the **Control Point** shall be manned between the hours of 0800 and 1800 each day.

ECC.8 ANCILLARY SERVICES

ECC.8.1 System Ancillary Services

The **ECC** contain requirements for the capability for certain **Ancillary Services**, which are needed for **System** reasons ("**System Ancillary Services**"). There follows a list of these **System Ancillary Services**, together with the paragraph number of the **ECC** (or other part of the **Grid Code**) in which the minimum capability is required or referred to. The list is divided into two categories: Part 1 lists the **System Ancillary Services** which

- (a) **Generators** in respect of **Type C** and **Type D Power Generating Modules** (including **DC Connected Power Park Modules** and **Electricity Storage Modules**) are obliged to provide; and,
- (b) **HVDC System Owners** are obliged to have the capability to supply;
- (c) **Generators** in respect of **Medium Power Stations** (except **Embedded Medium Power Stations**) are obliged to provide in respect of **Reactive Power** only:

and Part 2 lists the **System Ancillary Services** which **Generators** will provide only if agreement to provide them is reached with **The Company**:

Part 1

- (a) **Reactive Power** supplied (in accordance with ECC.6.3.2)
- (b) **Frequency** Control by means of **Frequency** sensitive generation - ECC.6.3.7 and BC3.5.1

Part 2

- (c) **Frequency** Control by means of **Fast Start** - ECC.6.3.14
- (d) **Black Start Capability** - ECC.6.3.5
- (e) **System to Generator Operational Intertripping**

ECC.8.2 Commercial Ancillary Services

Other **Ancillary Services** are also utilised by **The Company** in operating the **Total System** if these have been agreed to be provided by a **User** (or other person) under an **Ancillary Services Agreement** or under a **Bilateral Agreement**, with payment being dealt with under an **Ancillary Services Agreement** or in the case of **Externally Interconnected System Operators** or **Interconnector Users**, under any other agreement (and in the case of **Externally Interconnected System Operators** and **Interconnector Users** includes ancillary services equivalent to or similar to **System Ancillary Services**) ("**Commercial Ancillary Services**"). The capability for these **Commercial Ancillary Services** is set out in the relevant **Ancillary Services Agreement** or **Bilateral Agreement** (as the case may be).

APPENDIX E1 - SITE RESPONSIBILITY SCHEDULES

FORMAT, PRINCIPLES AND BASIC PROCEDURE TO BE USED IN THE PREPARATION OF SITE RESPONSIBILITY SCHEDULES

ECC.A.1.1 Principles

Types of Schedules

ECC.A.1.1.1 At all **Complexes** (which in the context of this ECC shall include, **Interface Sites** until the **OTSUA Transfer Time**) the following **Site Responsibility Schedules** shall be drawn up using the relevant proforma attached or with such variations as may be agreed between **The Company** and **Users**, but in the absence of agreement the relevant proforma attached will be used. In addition, in the case of **OTSDUW Plant and Apparatus**, and in readiness for the **OTSUA Transfer Time**, the **User** shall provide **The Company** with the necessary information such that **Site Responsibility Schedules** in this form can be prepared by the **Relevant Transmission Licensees** for the **Transmission Interface Site**:

- (a) Schedule of **HV Apparatus**
- (b) Schedule of **Plant, LV/MV Apparatus**, services and supplies;
- (c) Schedule of telecommunications and measurements **Apparatus**.

Other than at **Power Generating Module** (including **DC Connected Power Park Modules**) and **Power Station** locations, the schedules referred to in (b) and (c) may be combined.

New Connection Sites

ECC.A.1.1.2 In the case of a new **Connection Site** each **Site Responsibility Schedule** for a **Connection Site** shall be prepared by **The Company** in consultation with relevant **Users** at least 2 weeks prior to the **Completion Date** (or, where the **OTSUA** is to become **Operational** prior to the **OTSUA Transfer Time**, an alternative date) under the **Bilateral Agreement** and/or **Construction Agreement** for that **Connection Site** (which may form part of a **Complex**). In the case of a new **Interface Site** where the **OTSUA** is to become **Operational** prior to the **OTSUA Transfer Time** each **Site Responsibility Schedule** for an **Interface Site** shall be prepared by **The Company** in consultation with relevant **Users** at least 2 weeks prior to the **Completion Date** under the **Bilateral Agreement** and/or **Construction Agreement** for that **Interface Site** (which may form part of a **Complex**) (and references to and requirements placed on "**Connection Site**" in this **ECC** shall also be read as "**Interface Site**" where the context requires and until the **OTSUA Transfer Time**). Each **User** shall, in accordance with the timing requirements of the **Bilateral Agreement** and/or **Construction Agreement**, provide information to **The Company** to enable it to prepare the **Site Responsibility Schedule**.

Sub-division

ECC.A.1.1.3 Each **Site Responsibility Schedule** will be subdivided to take account of any separate **Connection Sites** on that **Complex**.

Scope

ECC.A.1.1.4 Each **Site Responsibility Schedule** shall detail for each item of **Plant** and **Apparatus**:

- (a) **Plant/Apparatus** ownership;
- (b) Site Manager (Controller) (except in the case of **Plant/Apparatus** located in **SPT's Transmission Area**);
- (c) Safety issues comprising applicable **Safety Rules** and **Control Person** or other responsible person (**Safety Co-ordinator**), or such other person who is responsible for safety;
- (d) Operations issues comprising applicable **Operational Procedures** and control engineer;
- (e) Responsibility to undertake statutory inspections, fault investigation and maintenance.

Each **Connection Point** shall be precisely shown.

Detail

- ECC.A.1.1.5 (a) In the case of **Site Responsibility Schedules** referred to in ECC.A.1.1.1(b) and (c), with the exception of **Protection Apparatus** and **Intertrip Apparatus** operation, it will be sufficient to indicate the responsible **User** or **Transmission Licensee**, as the case may be.
- (b) In the case of the **Site Responsibility Schedule** referred to in ECC.A.1.1.1(a) and for **Protection Apparatus** and **Intertrip Apparatus**, the responsible management unit must be shown in addition to the **User** or **Transmission Licensee**, as the case may be.
- ECC.A.1.1.6 The **HV Apparatus Site Responsibility Schedule** for each **Connection Site** must include lines and cables emanating from or traversing¹ the **Connection Site**.

Issue Details

- ECC.A.1.1.7 Every page of each **Site Responsibility Schedule** shall bear the date of issue and the issue number.

Accuracy Confirmation

- ECC.A.1.1.8 When a **Site Responsibility Schedule** is prepared it shall be sent by **The Company** to the **Users** involved for confirmation of its accuracy.
- ECC.A.1.1.9 The **Site Responsibility Schedule** shall then be signed on behalf of **The Company** by its **Responsible Manager** (see ECC.A.1.1.16) and on behalf of each **User** involved by its **Responsible Manager** (see ECC.A.1.1.16), by way of written confirmation of its accuracy. The **Site Responsibility Schedule** will also be signed on behalf of the **Relevant Transmission Licensee** by its **Responsible Manager**.

Distribution and Availability

- ECC.A.1.1.10 Once signed, two copies will be distributed by **The Company**, not less than two weeks prior to its implementation date, to each **User** which is a party on the **Site Responsibility Schedule**, accompanied by a note indicating the issue number and the date of implementation.
- ECC.A.1.1.11 **The Company** and **Users** must make the **Site Responsibility Schedules** readily available to operational staff at the **Complex** and at the other relevant control points.

Alterations to Existing Site Responsibility Schedules

- ECC.A.1.1.12 Without prejudice to the provisions of ECC.A.1.1.15 which deals with urgent changes, when a **User** identified on a **Site Responsibility Schedule** becomes aware that an alteration is necessary, it must inform **The Company** immediately and in any event 8 weeks prior to any change taking effect (or as soon as possible after becoming aware of it, if less than 8 weeks remain when the **User** becomes aware of the change). This will cover the commissioning of new **Plant** and/or **Apparatus** at the **Connection Site**, whether requiring a revised **Bilateral Agreement** or not, de-commissioning of **Plant** and/or **Apparatus**, and other changes which affect the accuracy of the **Site Responsibility Schedule**.
- ECC.A.1.1.13 Where **The Company** has been informed of a change by a **User**, or itself proposes a change, it will prepare a revised **Site Responsibility Schedule** by not less than six weeks prior to the change taking effect (subject to it having been informed or knowing of the change eight weeks prior to that time) and the procedure set out in ECC.A.1.1.8 shall be followed with regard to the revised **Site Responsibility Schedule**.

¹ Details of circuits traversing the **Connection Site** are only needed from the date which is the earlier of the date when the **Site Responsibility Schedule** is first updated and 15th October 2004. In Scotland or **Offshore**, from a date to be agreed between **The Company** and the **Relevant Transmission Licensee**.

ECC.A.1.1.14 The revised **Site Responsibility Schedule** shall then be signed in accordance with the procedure set out in ECC.A.1.1.9 and distributed in accordance with the procedure set out in ECC.A.1.1.10, accompanied by a note indicating where the alteration(s) has/have been made, the new issue number and the date of implementation.

Urgent Changes

ECC.A.1.1.15 When a **User** identified on a **Site Responsibility Schedule**, or **The Company**, as the case may be, becomes aware that an alteration to the **Site Responsibility Schedule** is necessary urgently to reflect, for example, an emergency situation which has arisen outside its control, the **User** shall notify **The Company**, or **The Company** shall notify the **User**, as the case may be, immediately and will discuss:

- (a) what change is necessary to the **Site Responsibility Schedule**;
- (b) whether the **Site Responsibility Schedule** is to be modified temporarily or permanently;
- (c) the distribution of the revised **Site Responsibility Schedule**.

The Company will prepare a revised **Site Responsibility Schedule** as soon as possible, and in any event within seven days of it being informed of or knowing the necessary alteration. The **Site Responsibility Schedule** will be confirmed by **Users** and signed on behalf of **The Company** and **Users** and the **Relevant Transmission Licensee** (by the persons referred to in ECC.A.1.1.9) as soon as possible after it has been prepared and sent to **Users** for confirmation.

Responsible Managers

ECC.A.1.1.16 Each **User** shall, prior to the **Completion Date** under each **Bilateral Agreement** and/or **Construction Agreement**, supply to **The Company** a list of Managers who have been duly authorised to sign **Site Responsibility Schedules** on behalf of the **User** and **The Company** shall, prior to the **Completion Date** under each **Bilateral Agreement** and/or **Construction Agreement**, supply to that **User** the name of its **Responsible Manager** and the name of the **Relevant Transmission Licensee's Responsible Manager** and each shall supply to the other any changes to such list six weeks before the change takes effect where the change is anticipated, and as soon as possible after the change, where the change was not anticipated.

De-commissioning of Connection Sites

ECC.A.1.1.17 Where a **Connection Site** is to be de-commissioned, whichever of **The Company** or the **User** who is initiating the de-commissioning must contact the other to arrange for the **Site Responsibility Schedule** to be amended at the relevant time.

PROFORMA FOR SITE RESPONSIBILITY SCHEDULE

AREA _____

COMPLEX: _____

SCHEDULE: _____

CONNECTION SITE: _____

ITEM OF PLANT/ APPARATUS	PLANT APPARATUS OWNER	SITE MANAGER	SAFETY		OPERATIONS		PARTY RESPONSIBLE FOR UNDERTAKING STATUTORY INSPECTIONS, FAULT INVESTIGATION & MAINTENANCE	REMARKS
			SAFETY RULES	CONTROL OR OTHER RESPONSIBLE PERSON (SAFETY CO-ORDINATOR)	OPERATIONAL PROCEDURES	CONTROL OR OTHER RESPONSIBLE ENGINEER		

--	--	--	--	--	--	--	--	--

PAGE: _____ ISSUE NO: _____ DATE: _____

PROFORMA FOR SITE RESPONSIBILITY SCHEDULE

AREA _____

COMPLEX: _____

SCHEDULE: _____

CONNECTION SITE: _____

ITEM OF PLANT/ APPARATUS	PLANT APPARATUS OWNER	SITE MANAGER	SAFETY		OPERATIONS		PARTY RESPONSIBLE FOR UNDERTAKING STATUTORY INSPECTIONS, FAULT INVESTIGATION & MAINTENANCE	REMARKS
			SAFETY RULES	CONTROL OR OTHER RESPONSIBLE PERSON (SAFETY CO-ORDINATOR)	OPERATIONAL PROCEDURES	CONTROL OR OTHER RESPONSIBLE ENGINEER		

NOTES:

SIGNATURE: _____ NAME: _____ COMPANY: _____ DATE: _____

SIGNE D: _____	NAM E: _____	COMPAN Y: _____	DAT E: _____
SIGNE D: _____	NAM E: _____	COMPAN Y: _____	DAT E: _____
SIGNE D: _____	NAM E: _____	COMPAN Y: _____	DAT E: _____

PAGE: _____ ISSUE NO: _____ DATE: _____

**SP TRANSMISSION Ltd
SITE RESPONSIBILITY SCHEDULE
OWNERSHIP, MAINTENANCE AND OPERATIONS OF EQUIPMENT
IN JOINT USER SITUATIONS**

Sheet No. _____
Revision: _____
Date: _____

Network Area: _____

SECTION 'A' BUILDING AND SITE

OWNER	ACCESS REQUIRED:-	SECTION 'B' CUSTOMER OR OTHER PARTY NAME:-
LESSEE	SPECIAL CONDITIONS:-	
MAINTENANCE	LOCATION OF SUPPLY	
SAFETY	TERMINALS:-	
SECURITY		

SECTION 'C' PLANT

ITEM Nos.	EQUIPMENT	IDENTIFICATION	OWNER	SAFETY RULES APPLICABLE	OPERATION			MAINTENANCE		FAULT INVESTIGATION		TESTING		RELAY SETTINGS	REMARKS
					Tripping	Closing	Isolating	Earthing	Primary Equip.	Protection Equip.	Primary Equip.	Protection Equip.	Trip and Alarm		

SECTION 'D' CONFIGURATION AND CONTROL

ITEM Nos.	CONFIGURATION RESPONSIBILITY	TELEPHONE NUMBER	REMARKS

ABBREVIATIONS:

- D - SP AUTHORISED PERSON - DISTRIBUTION SYSTEM
- NGC - NATIONAL GRID COMPANY
- SPD - SP DISTRIBUTION LTD
- SPPS - POWERSYSTEMS
- SPT - SP TRANSMISSION LTD
- ST - SCOTTISH POWER TELECOMMUNICATIONS
- T - SP AUTHORISED PERSON - TRANSMISSION SYSTEM
- U - USER

SECTION 'E' ADDITIONAL INFORMATION

SIGNED _____ FOR _____ SP Transmission DATE _____

SIGNED _____ FOR _____ SP Distribution DATE _____

SIGNED _____ FOR _____ PowerSystems/User DATE _____















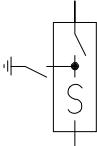





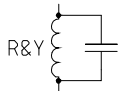

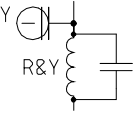

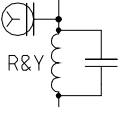

Scottish Hydro-Electric Transmission Limited

Site Responsibility Schedule

Substation Type			Number:			Revision:			
Equipment	Owner	Controller	Maintainer	Responsible System User	Responsible Management Unit	Control Authority	Safety Rules	Operational Procedures	Notes

APPENDIX E2 - OPERATION DIAGRAMS

PART 1A - PROCEDURES RELATING TO OPERATION DIAGRAMS

FIXED CAPACITOR		SWITCH DISCONNECTOR	
EARTH			
EARTHING RESISTOR		SWITCH DISCONNECTOR WITH INCORPORATED EARTH SWITCH	
LIQUID EARTHING RESISTOR			
ARC SUPPRESSION COIL		DISCONNECTOR (CENTRE ROTATING POST)	
FIXED MAINTENANCE EARTHING DEVICE		DISCONNECTOR (SINGLE BREAK DOUBLE ROTATING)	
CARRIER COUPLING EQUIPMENT (WITHOUT VT)		DISCONNECTOR (SINGLE BREAK)	
CARRIER COUPLING EQUIPMENT (WITH VT ON ONE PHASE)		DISCONNECTOR (NON-INTERLOCKED)	
CARRIER COUPLING EQUIPMENT (WITH VT ON 3 PHASES)		DISCONNECTOR (POWER OPERATED) NA - NON-AUTOMATIC A - AUTOMATIC SO - SEQUENTIAL OPERATION FI - FAULT INTERFERING OPERATION	
AC GENERATOR		EARTH SWITCH	
SYNCHRONOUS COMPENSATOR			
CIRCUIT BREAKER		FAULT THROWING SWITCH (PHASE TO PHASE)	
CIRCUIT BREAKER WITH DELAYED AUTO RECLOSE	DAR 	FAULT THROWING SWITCH (EARTH FAULT)	
		SURGE ARRESTOR	
WITHDRAWABLE METALCLAD SWITCHGEAR		THYRISTOR	

TRANSFORMERS
(VECTORS TO INDICATE
WINDING CONFIGURATION)

TWO WINDING



THREE WINDING

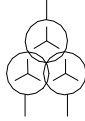

AUTO



AUTO WITH DELTA TERTIARY

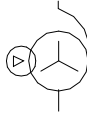

EARTHING OR AUX. TRANSFORMER

(-) INDICATE REMOTE SITE
IF APPLICABLE

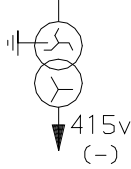

VOLTAGE TRANSFORMERS

SINGLE PHASE WOUND



THREE PHASE WOUND



SINGLE PHASE CAPACITOR



TWO SINGLE PHASE CAPACITOR

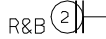

THREE PHASE CAPACITOR



* CURRENT TRANSFORMER
(WHERE SEPARATE PRIMARY
APPARATUS)



* COMBINED VT/CT UNIT
FOR METERING

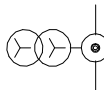

REACTOR



* BUSBARS



* OTHER PRIMARY CONNECTIONS



* CABLE & CABLE SEALING END

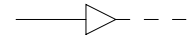

* THROUGH WALL BUSHING



* BYPASS FACILITY



* CROSSING OF CONDUCTORS
(LOWER CONDUCTOR
TO BE BROKEN)

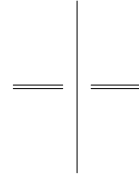

PREFERENTIAL ABBREVIATIONS

AUXILIARY TRANSFORMER	Aux T
EARTHING TRANSFORMER	ET
GAS TURBINE	Gas T
GENERATOR TRANSFORMER	Gen T
GRID TRANSFORMER	Gr T
SERIES REACTOR	Ser Reac
SHUNT REACTOR	Sh Reac
STATION TRANSFORMER	Stn T
SUPERGRID TRANSFORMER	SGT
UNIT TRANSFORMER	UT

* NON-STANDARD SYMBOL

PORTABLE MAINTENANCE
EARTH DEVICE

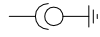

DISCONNECTOR
(PANTOGRAPH TYPE)



QUADRATURE BOOSTER

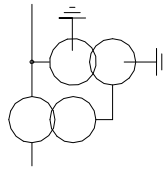

DISCONNECTOR
(KNEE TYPE)



SHORTING/DISCHARGE SWITCH

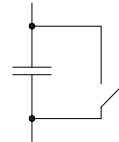

CAPACITOR
(INCLUDING HARMONIC FILTER)



SINGLE PHASE TRANSFORMER (BR)
NEUTRAL AND PHASE CONNECTIONS

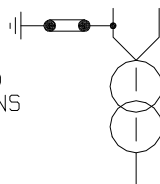

RESISTOR WITH INHERENT
NON-LINEAR VARIABILITY,
VOLTAGE DEPENDANT

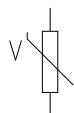

PART E1B - PROCEDURES RELATING TO GAS ZONE DIAGRAMS

GAS INSULATED
BUSBAR

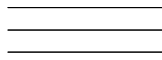

DOUBLE-BREAK
DISCONNECTOR

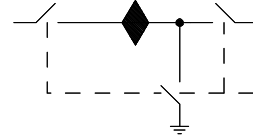

GAS BOUNDARY



EXTERNAL MOUNTED
CURRENT TRANSFORMER
(WHERE SEPARATE
PRIMARY APPARATUS)

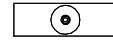

GAS/GAS BOUNDARY



STOP VALVE
NORMALLY CLOSED



GAS/CABLE BOUNDARY



STOP VALVE
NORMALLY OPEN



GAS/AIR BOUNDARY



GAS MONITOR



GAS/TRANSFORMER BOUNDARY



FILTER



MAINTENANCE VALVE

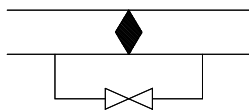

QUICK ACTING COUPLING



PART E2 - NON-EXHAUSTIVE LIST OF APPARATUS TO BE INCLUDED ON OPERATION DIAGRAMS

Basic Principles

- (1) Where practicable, all the **HV Apparatus** on any **Connection Site** shall be shown on one **Operation Diagram**. Provided the clarity of the diagram is not impaired, the layout shall represent as closely as possible the geographical arrangement on the **Connection Site**.
- (2) Where more than one **Operation Diagram** is unavoidable, duplication of identical information on more than one **Operation Diagram** must be avoided.
- (3) The **Operation Diagram** must show accurately the current status of the **Apparatus** e.g. whether commissioned or decommissioned. Where decommissioned, the associated switchbay will be labelled "spare bay".
- (4) Provision will be made on the **Operation Diagram** for signifying approvals, together with provision for details of revisions and dates.
- (5) **Operation Diagrams** will be prepared in A4 format or such other format as may be agreed with **The Company**.
- (6) The **Operation Diagram** should normally be drawn single line. However, where appropriate, detail which applies to individual phases shall be shown. For example, some **HV Apparatus** is numbered individually per phase.

Apparatus To Be Shown On Operation Diagram

- (1) Busbars
- (2) Circuit Breakers
- (3) Disconnecter (Isolator) and Switch Disconnecters (Switching Isolators)
- (4) Disconnectors (Isolators) - Automatic Facilities
- (5) Bypass Facilities
- (6) Earthing Switches
- (7) Maintenance Earths
- (8) Overhead Line Entries
- (9) Overhead Line Traps
- (10) Cable and Cable Sealing Ends
- (11) Generating Unit
- (12) Generator Transformers
- (13) Generating Unit Transformers, Station Transformers, including the lower voltage circuit-breakers.
- (14) Synchronous Compensators
- (15) Static Variable Compensators
- (16) Capacitors (including Harmonic Filters)
- (17) Series or Shunt Reactors (Referred to as "Inductors" at nuclear power station sites)
- (18) Supergrid and Grid Transformers
- (19) Tertiary Windings
- (20) Earthing and Auxiliary Transformers
- (21) Three Phase VT's

- (22) Single Phase VT & Phase Identity
- (23) High Accuracy VT and Phase Identity
- (24) Surge Arrestors/Diverter
- (25) Neutral Earthing Arrangements on HV Plant
- (26) Fault Throwing Devices
- (27) Quadrature Boosters
- (28) Arc Suppression Coils
- (29) Single Phase Transformers (BR) Neutral and Phase Connections
- (30) Current Transformers (where separate plant items)
- (31) Wall Bushings
- (32) Combined VT/CT Units
- (33) Shorting and Discharge Switches
- (34) Thyristor
- (35) Resistor with Inherent Non-Linear Variability, Voltage Dependent
- (36) Gas Zone

APPENDIX E3 - MINIMUM FREQUENCY RESPONSE CAPABILITY REQUIREMENT PROFILE AND OPERATING RANGE FOR POWER GENERATING MODULES AND HVDC EQUIPMENT

ECC.A.3.1 Scope

The frequency response capability is defined in terms of **Primary Response**, **Secondary Response** and **High Frequency Response**. In addition to the requirements defined in ECC.6.3.7 this appendix defines the minimum frequency response requirements for:-

- (a) each **Type C** and **Type D Power Generating Module**
- (b) each **DC Connected Power Park Module**
- (c) each **HVDC System**

For the avoidance of doubt, this appendix does not apply to **Type A** and **Type B Power Generating Modules**.

OTSDUW Plant and Apparatus should facilitate the delivery of frequency response services provided by **Offshore Generating Units** and **Offshore Power Park Units**.

The functional definition provides appropriate performance criteria relating to the provision of **Frequency** control by means of **Frequency** sensitive generation in addition to the other requirements identified in ECC.6.3.7.

In this Appendix 3 to the ECC, for a **Power Generating Module** including a **CCGT Module** or a **Power Park Module** or **DC Connected Power Park Module**, the phrase **Minimum Regulating Level** applies to the entire **CCGT Module** or **Power Park Module** or **DC Connected Power Park Module** operating with all **Generating Units Synchronised** to the **System**.

The minimum **Frequency** response requirement profile is shown diagrammatically in Figure ECC.A.3.1. The capability profile specifies the minimum required level of **Frequency Response** Capability throughout the normal plant operating range.

ECC.A.3.2 Plant Operating Range

The upper limit of the operating range is the **Maximum Capacity** of the **Power Generating Module** or **Generating Unit** or **CCGT Module** or **HVDC Equipment**.

The **Minimum Stable Operating Level** may be less than, but must not be more than, 65% of the **Maximum Capacity**. Each **Power Generating Module** and/or **Generating Unit** and/or **CCGT Module** and/or **Power Park Module** or **HVDC Equipment** must be capable of operating satisfactorily down to the **Minimum Regulating Level** as dictated by **System** operating conditions, although it will not be instructed to below its **Minimum Stable Operating Level**. If a **Power Generating Module** or **Generating Unit** or **CCGT Module** or **Power Park Module**, or **HVDC Equipment** is operating below **Minimum Stable Operating Level** because of high **System Frequency**, it should recover adequately to its **Minimum Stable Operating Level** as the **System Frequency** returns to **Target Frequency** so that it can provide **Primary** and **Secondary Response** from its **Minimum Stable Operating Level** if the **System Frequency** continues to fall. For the avoidance of doubt, under normal operating conditions steady state operation below the **Minimum Stable Operating Level** is not expected. The **Minimum Regulating Level** must not be more than 55% of **Maximum Capacity**.

In the event of a **Power Generating Module** or **Generating Unit** or **CCGT Module** or **Power Park Module** or **HVDC Equipment** load rejecting down to no less than its **Minimum Regulating Level** it should not trip as a result of automatic action as detailed in BC3.7. If the load rejection is to a level less than the **Minimum Regulating Level** then it is accepted that the condition might be so severe as to cause it to be disconnected from the **System**.

ECC.A.3.3 Minimum Frequency Response Requirement Profile

Figure ECC.A.3.1 shows the minimum **Frequency** response capability requirement profile diagrammatically for a 0.5 Hz change in **Frequency**. The percentage response capabilities and loading levels are defined on the basis of the **Maximum Capacity** of the **Power Generating Module** or **CCGT Module** or **Power Park Module** or **HVDC Equipment**. Each **Power Generating Module** or and/or **CCGT Module** or **Power Park Module** (including a **DC Connected Power Park Module**) and/or **HVDC Equipment** must be capable of operating in a manner to provide **Frequency** response at least to the solid boundaries shown in the figure. If the **Frequency** response capability falls within the solid boundaries, the **Power Generating Module** or **CCGT Module** or **Power Park Module** or **HVDC Equipment** is providing response below the minimum requirement which is not acceptable. Nothing in this appendix is intended to prevent a **Power Generating Module** or **CCGT Module** or **Power Park Module** or **HVDC Equipment** from being designed to deliver a **Frequency** response in excess of the identified minimum requirement.

The **Frequency** response delivered for **Frequency** deviations of less than 0.5 Hz should be no less than a figure which is directly proportional to the minimum **Frequency** response requirement for a **Frequency** deviation of 0.5 Hz. For example, if the **Frequency** deviation is 0.2 Hz, the corresponding minimum **Frequency** response requirement is 40% of the level shown in Figure ECC.A.3.1. The **Frequency** response delivered for **Frequency** deviations of more than 0.5 Hz should be no less than the response delivered for a **Frequency** deviation of 0.5 Hz.

Each **Power Generating Module** and/or **CCGT Module** and/or **Power Park Module** or **HVDC Equipment** must be capable of providing some response, in keeping with its specific operational characteristics, when operating between 95% to 100% of **Maximum Capacity** as illustrated by the dotted lines in Figure ECC.A.3.1.

At the **Minimum Stable Operating** level, each **Power Generating Module** and/or **CCGT Module** and/or **Power Park Module** and/or **HVDC Equipment** is required to provide high and low frequency response depending on the **System Frequency** conditions. Where the **Frequency** is high, the **Active Power** output is therefore expected to fall below the **Minimum Stable Operating** level.

The **Minimum Regulating Level** is the output at which a **Power Generating Module** and/or **CCGT Module** and/or **Power Park Module** and/or **HVDC Equipment** has no **High Frequency Response** capability. It may be less than, but must not be more than, 55% of the **Maximum Capacity**. This implies that a **Power Generating Module** or **CCGT Module** or **Power Park Module**) or **HVDC Equipment** is not obliged to reduce its output to below this level unless the **Frequency** is at or above 50.5 Hz (cf BC3.7).

ECC.A.3.4 Testing of Frequency Response Capability

The frequency response capabilities shown diagrammatically in Figure ECC.A.3.1 are measured by taking the responses as obtained from some of the dynamic step response tests specified by **The Company** and carried out by **Generators** and **HVDC System** owners for compliance purposes. The injected signal is a step of 0.5Hz from zero to 0.5 Hz **Frequency** change, and is sustained at 0.5 Hz **Frequency** change thereafter, the latter as illustrated diagrammatically in figures ECC.A.3.4 and ECC.A.3.5.

In addition to provide and/or to validate the content of **Ancillary Services Agreements** a progressive injection of a **Frequency** change to the plant control system (i.e. governor and load controller) is used. The injected signal is a ramp of 0.5Hz from zero to 0.5 Hz **Frequency** change over a ten second period, and is sustained at 0.5 Hz **Frequency** change thereafter, the latter as illustrated diagrammatically in figures ECC.A.3.2 and ECC.A.3.3. In the case of an **Embedded Medium Power Station** not subject to a **Bilateral Agreement** or **Embedded HVDC System** not subject to a **Bilateral Agreement**, **The Company** may require the **Network Operator** within whose System the **Embedded Medium Power Station** or **Embedded HVDC System** is situated, to ensure that the **Embedded Person** performs the dynamic response tests reasonably required by **The Company** in order to demonstrate compliance within the relevant requirements in the **ECC**.

The **Primary Response** capability (P) of a **Power Generating Module** or a **CCGT Module** or **Power Park Module** or **HVDC Equipment** is the minimum increase in **Active Power** output between 10 and 30 seconds after the start of the ramp injection as illustrated diagrammatically in Figure ECC.A.3.2. This increase in **Active Power** output should be released increasingly with time over the period 0 to 10 seconds from the time of the start of the **Frequency** fall as illustrated by the response from Figure ECC.A.3.2.

The **Secondary Response** capability (S) of a **Power Generating Module** or a **CCGT Module** or **Power Park Module** or **HVDC Equipment** is the minimum increase in **Active Power** output between 30 seconds and 30 minutes after the start of the ramp injection as illustrated diagrammatically in Figure ECC.A.3.2.

The **High Frequency Response** capability (H) of a **Power Generating Module** or a **CCGT Module** or **Power Park Module** or **HVDC Equipment** is the decrease in **Active Power** output provided 10 seconds after the start of the ramp injection and sustained thereafter as illustrated diagrammatically in Figure ECC.A.3.3. This reduction in **Active Power** output should be released increasingly with time over the period 0 to 10 seconds from the time of the start of the **Frequency** rise as illustrated by the response in Figure ECC.A.3.2.

ECC.A.3.5

Repeatability Of Response

When a **Power Generating Module** or **CCGT Module** or **Power Park Module** or **HVDC Equipment** has responded to a significant **Frequency** disturbance, its response capability must be fully restored as soon as technically possible. Full response capability should be restored no later than 20 minutes after the initial change of **System Frequency** arising from the **Frequency** disturbance.

Figure ECC.A.3.1 - Minimum **Frequency** Response requirement profile for a 0.5 Hz frequency change from **Target Frequency**

Figure ECC.A.3.1 – Minimum Frequency Response Capability Requirement Profile for a 0.5Hz change from Target Frequency

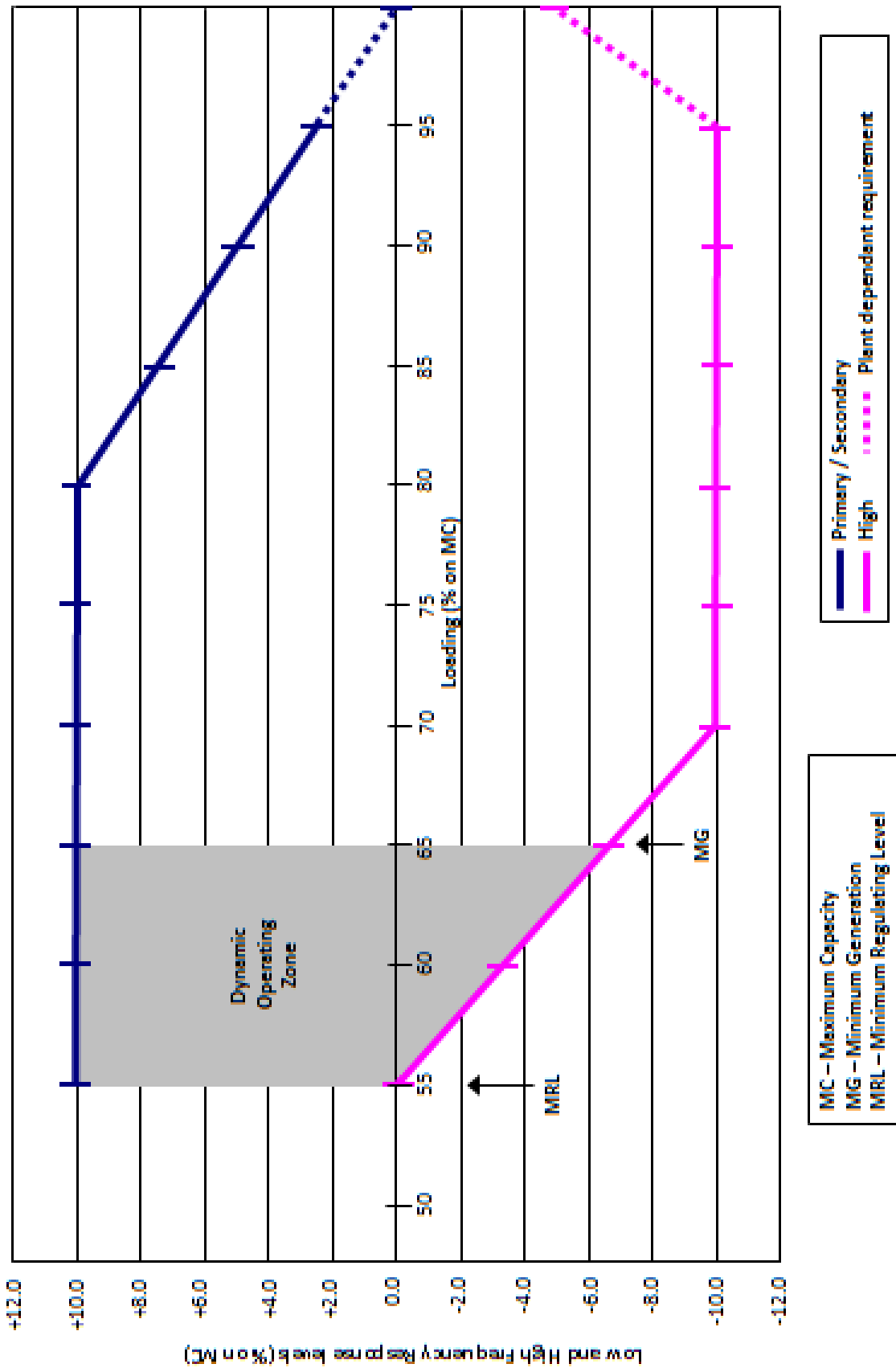

Figure ECC.A.3.2 – Interpretation of Primary and Secondary Response Service Values

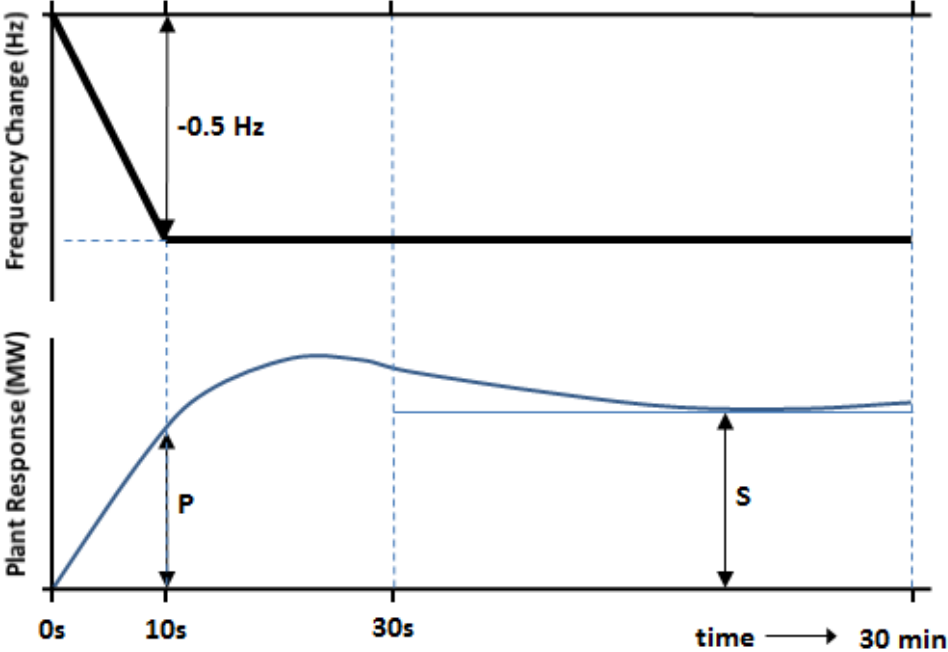

Figure ECC.A.3.3 – Interpretation of High Frequency Response Service Values

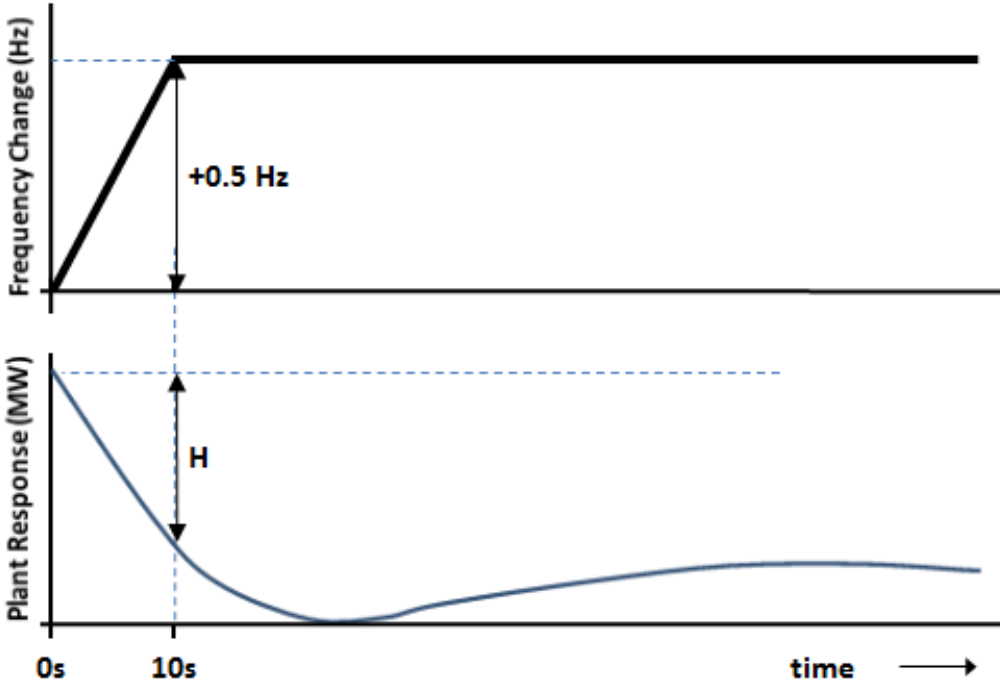

Figure ECC.A.3.4 – Interpretation of Low Frequency Response Capability Values

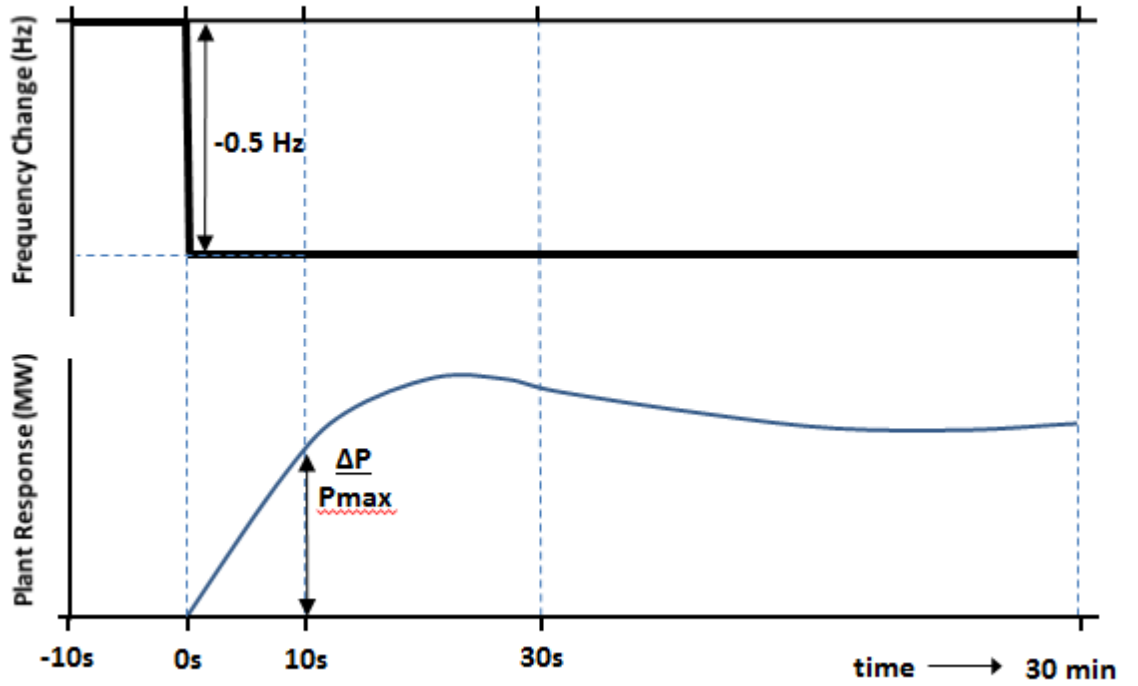
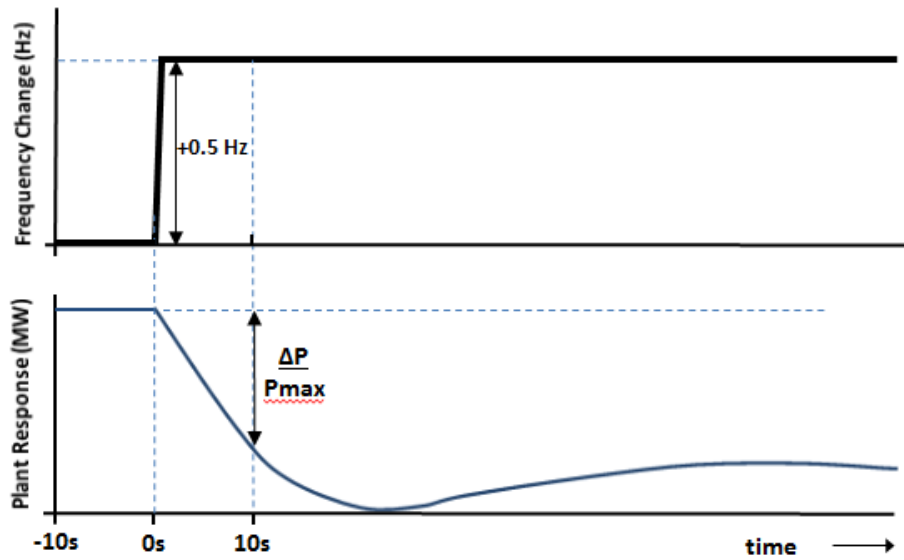

Figure ECC.A.3.5 – Interpretation of High Frequency Response Capability Values



ECC.4 - APPENDIX 4 - FAULT RIDE THROUGH REQUIREMENTS

FAULT RIDE THROUGH REQUIREMENTS FOR TYPE B, TYPE C AND TYPE D POWER GENERATING MODULES (INCLUDING OFFSHORE POWER PARK MODULES WHICH ARE EITHER AC CONNECTED POWER PARK MODULES OR DC CONNECTED POWER PARK MODULES), HVDC SYSTEMS AND OTSDUW PLANT AND APPARATUS

ECC.A.4A.1 Scope

The **Fault Ride Through** requirements are defined in ECC.6.3.15. This Appendix provides illustrations by way of examples only of ECC.6.3.15.1 to ECC.6.3.15.10 and further background and illustrations and is not intended to show all possible permutations.

ECC.A.4A.2 Short Circuit Faults At Supergrid Voltage On The Onshore Transmission System Up To 140ms In Duration

For short circuit faults at **Supergrid Voltage** on the **Onshore Transmission System** (which could be at an **Interface Point**) up to 140ms in duration, the **Fault Ride Through** requirement is defined in ECC.6.3.15. In summary any **Power Generating Module** (including a **DC Connected Power Park Module**) or **HVDC System** is required to remain connected and stable whilst connected to a healthy circuit. Figure ECC.A.4.A.2 illustrates this principle.

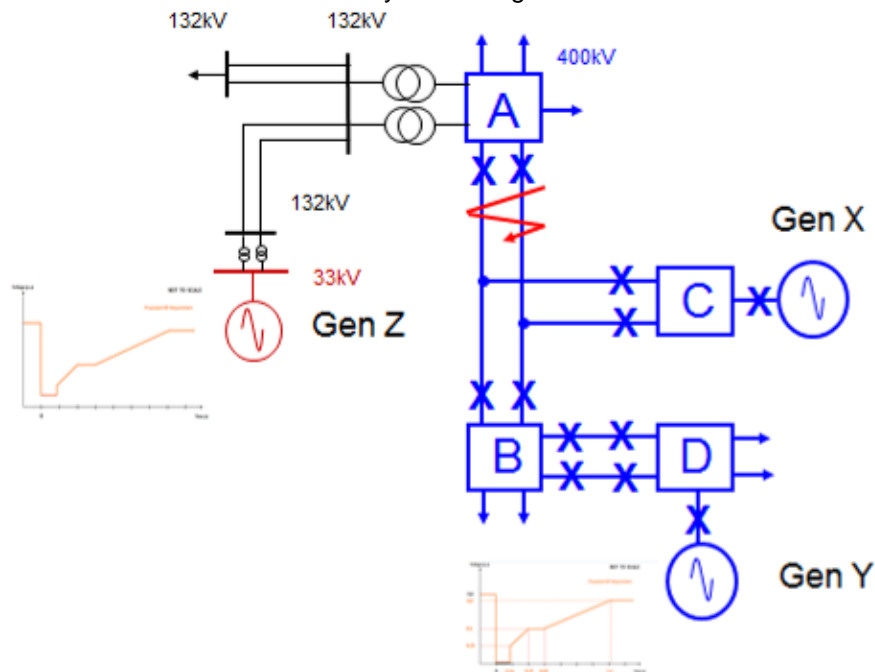

Figure ECC.A.4.A.2

In Figure ECC.A.4.A.2 a solid three phase short circuit fault is applied adjacent to substation A resulting in zero voltage at the point of fault. All circuit breakers on the faulty circuit (Lines ABC) will open within 140ms resulting in Gen X tripping. The effect of this fault, due to the low impedance of the network, will be the observation of a low voltage at each substation node across the **Total System** until the fault has been cleared. In this example, Gen Y and Gen Z (an Embedded Generator) would need to remain connected and stable as both are still connected to the **Total System** and remain connected to healthy circuits .

The criteria for assessment is based on a voltage against time curve at each **Grid Entry Point** or **User System Entry Point**. The voltage against time curve at the **Grid Entry Point** or **User System Entry Point** varies for each different type and size of **Power Generating Module** as detailed in ECC.6.3.15.2. – ECC.6.3.15.7.

The voltage against time curve represents the voltage profile at a **Grid Entry Point** or **User System Entry Point** that would be obtained by plotting the voltage at that **Grid Entry Point** or **User System Entry Point** before during and after the fault. This is not to be confused with a voltage duration curve (as defined under ECC.6.3.15.9) which represents a voltage level and associated time duration.

The post fault voltage at a **Grid Entry Point** or **User System Entry Point** is largely influenced by the topology of the network rather than the behaviour of the **Power Generating Module** itself. The **EU Generator** therefore needs to ensure each **Power Generating Module** remains connected and stable for a close up solid three phase short circuit fault for 140ms at the **Grid Entry Point** or **User System Entry Point**.

Two examples are shown in Figure EA.4.2(a) and Figure EA.4.2(b). In Figure EA.4.2(a) the post fault profile is above the heavy black line. In this case the **Power Generating Module** must remain connected and stable. In Figure EA.4.2(b) the post fault voltage dips below the heavy black line in which case the **Power Generating Module** is permitted to trip.

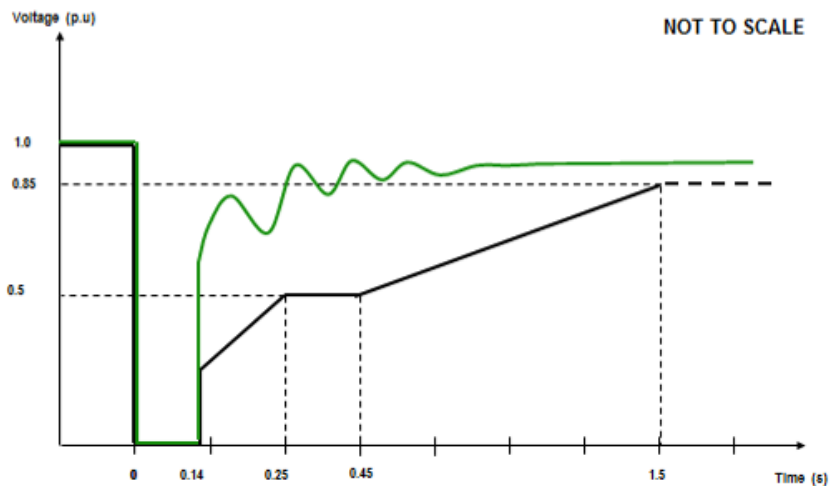

Figure EA.4.2(a)

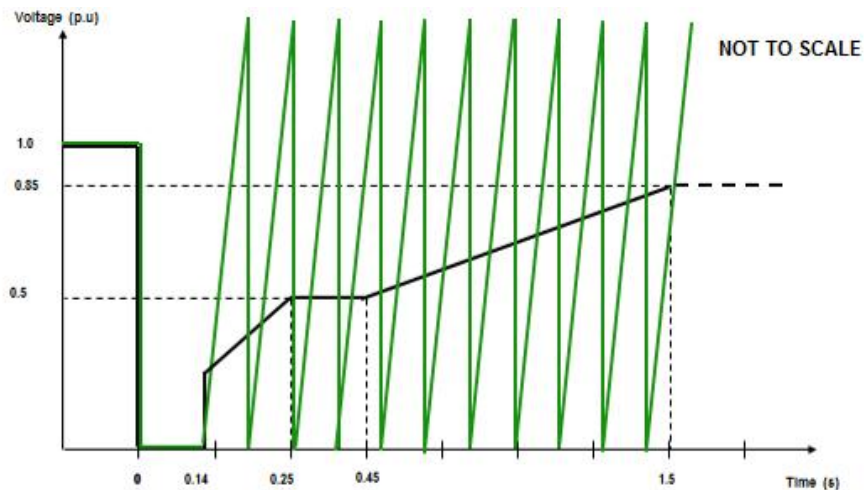

Figure EA.4.2(b)

The process for demonstrating **Fault Ride Through** compliance against the requirements of ECC.6.3.15 is detailed in ECP.A.3.5 and ECP.A.6.7 (as applicable).

ECC.A.4A.3 Supergrid Voltage Dips On The Onshore Transmission System Greater Than 140ms In Duration

ECC.A.4A3.1 Requirements applicable to **Synchronous Power Generating Modules** subject to **Supergrid Voltage** dips on the **Onshore Transmission System** greater than 140ms in duration.

For balanced **Supergrid Voltage** dips on the **Onshore Transmission System** having durations greater than 140ms and up to 3 minutes, the **Fault Ride Through** requirement is defined in ECC.6.3.15.9.2.1(a) and Figure ECC.6.3.15.9(a) which is reproduced in this Appendix as Figure EA.4.3.1 and termed the voltage–duration profile.

This profile is not a voltage-time response curve that would be obtained by plotting the transient voltage response at a point on the **Onshore Transmission System** (or **User System** if located **Onshore**) to a disturbance. Rather, each point on the profile (ie the heavy black line) represents a voltage level and an associated time duration which connected **Synchronous Power Generating Modules** must withstand or ride through.

Figures EA.4.3.2 (a), (b) and (c) illustrate the meaning of the voltage-duration profile for voltage dips having durations greater than 140ms.

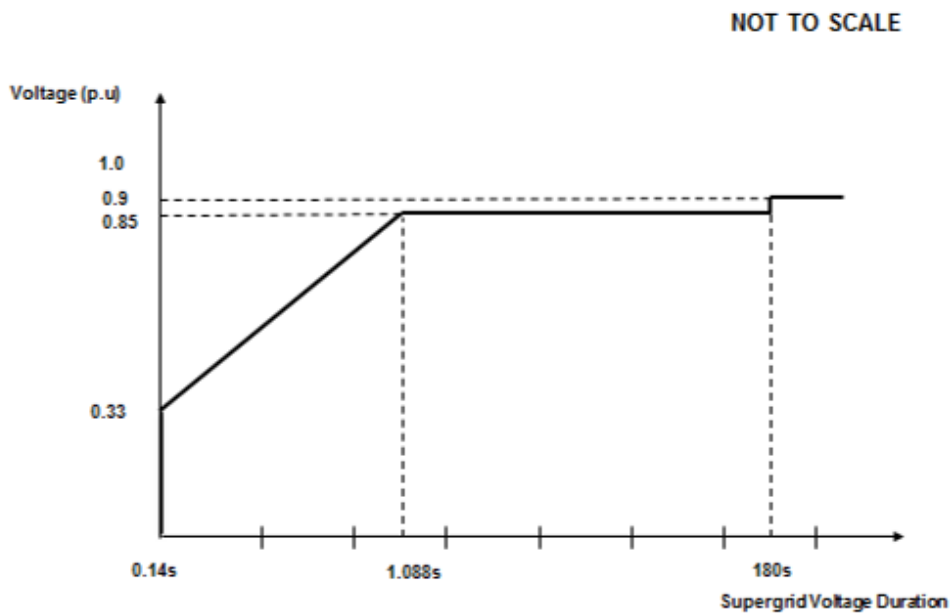

Figure EA.4.3.1

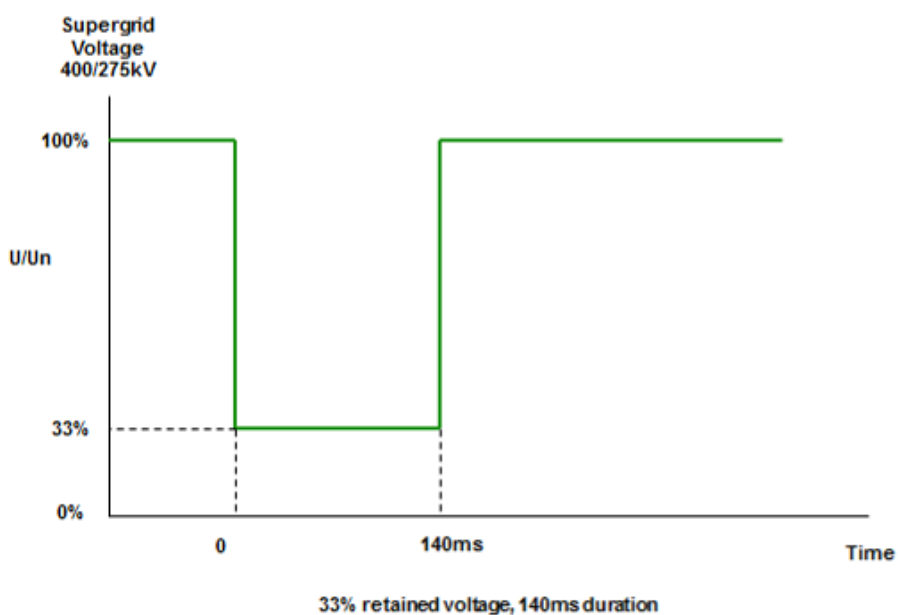

Figure EA.4.3.2 (a)

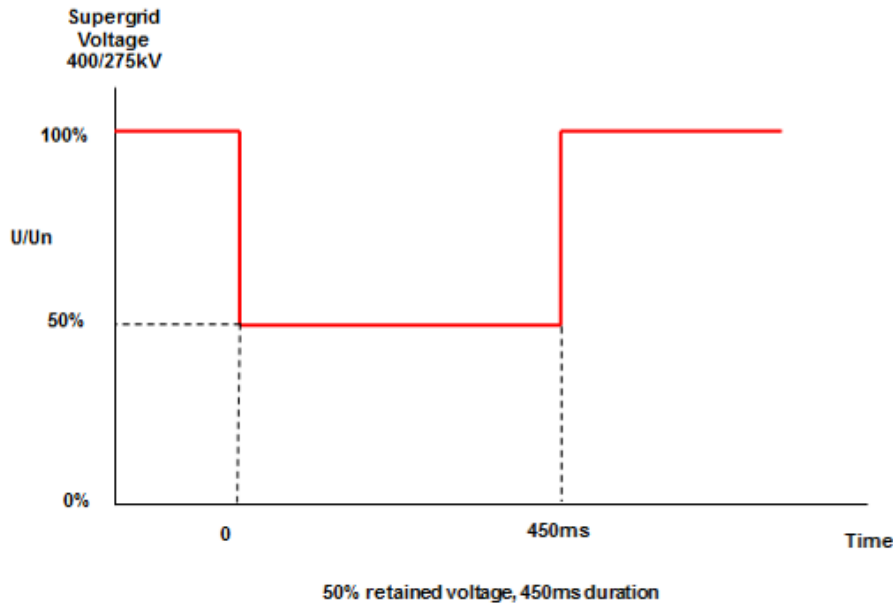

Figure EA.4.3.2 (b)

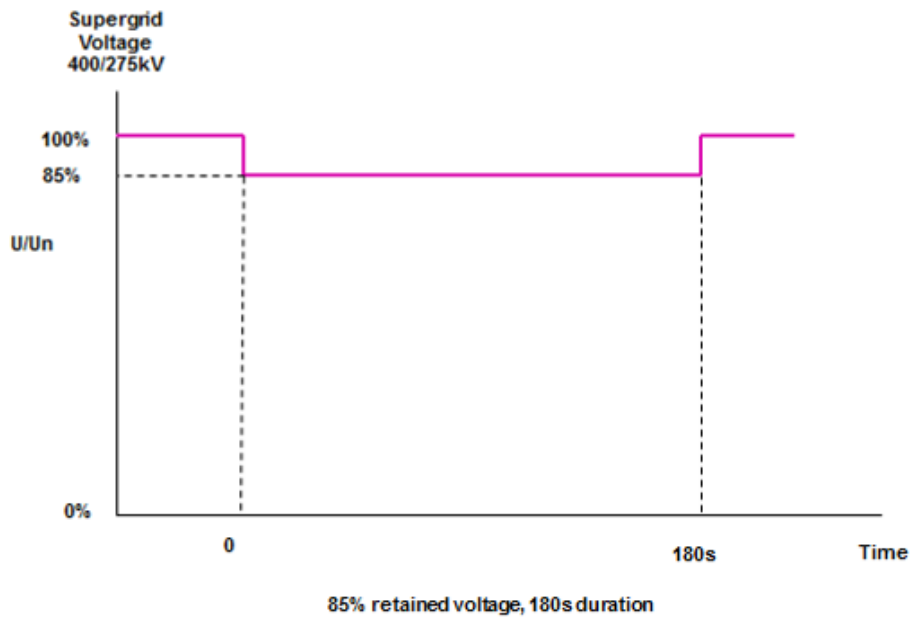

Figure EA.4.3.2 (c)

ECC.A.4A3.2 Requirements applicable to **Power Park Modules** or **OTSDUW Plant and Apparatus** subject to **Supergrid Voltage** dips on the **Onshore Transmission System** greater than 140ms in duration

For balanced **Supergrid Voltage** dips on the **Onshore Transmission System** (which could be at an **Interface Point**) having durations greater than 140ms and up to 3 minutes the **Fault Ride Through** requirement is defined in ECC.6.3.15.9.2.1(b) and Figure ECC.6.3.15.9(b) which is reproduced in this Appendix as Figure EA.4.3.3 and termed the voltage–duration profile.

This profile is not a voltage–time response curve that would be obtained by plotting the transient voltage response at a point on the **Onshore Transmission System** (or **User System** if located **Onshore**) to a disturbance. Rather, each point on the profile (ie the heavy black line) represents a voltage level and an associated time duration which connected **Power Park Modules** or **OTSDUW Plant and Apparatus** must withstand or ride through.

Figures EA.4.3.4 (a), (b) and (c) illustrate the meaning of the voltage-duration profile for voltage dips having durations greater than 140ms.

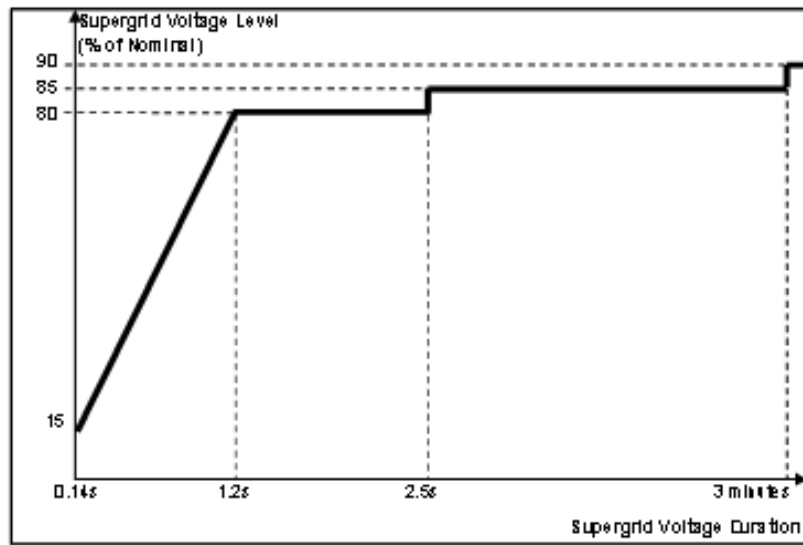
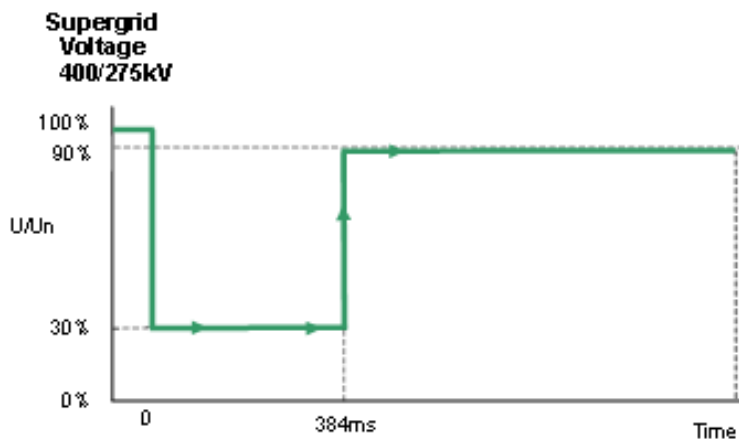

Figure EA.4.3.3



30 % retained voltage, 384ms duration

Figure EA.4.3.4(a)

**Supergrid
Voltage
400/275kV**

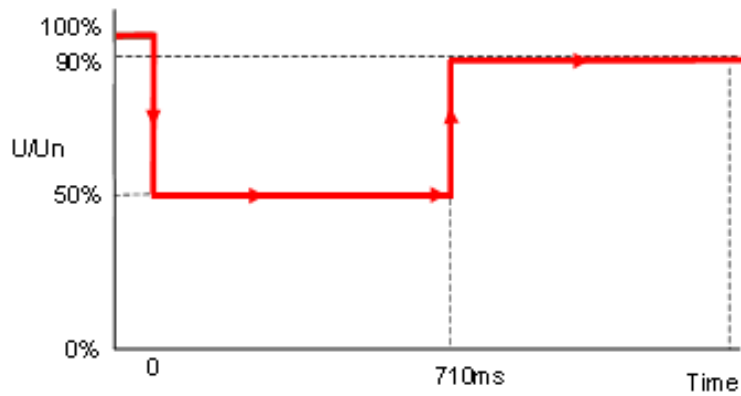

50% retained voltage, 710ms duration

Figure EA.4.3.4 (b)

**Supergrid
Voltage
400/275kV**

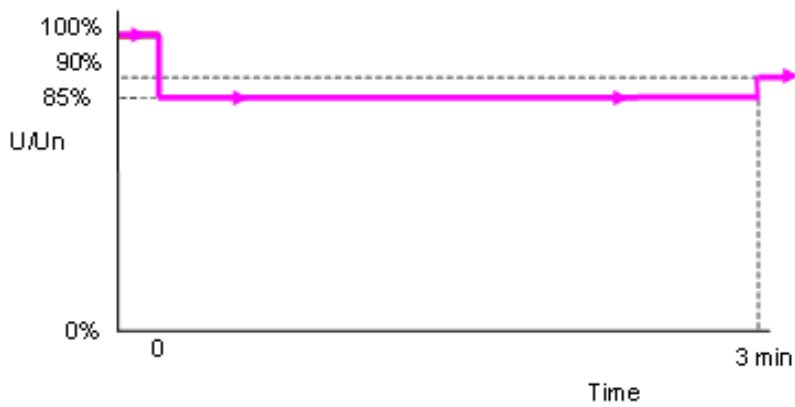

85% retained voltage, 3 minutes duration

Figure EA.4.3.4 (c)

**APPENDIX E5 - TECHNICAL REQUIREMENTS
LOW FREQUENCY RELAYS FOR THE AUTOMATIC
DISCONNECTION OF SUPPLIES AT LOW FREQUENCY**

ECC.A.5.1 Low Frequency Relays

ECC.A.5.1.1 The **Low Frequency Relays** to be used shall have a setting range of 47.0 to 50Hz and be suitable for operation from a nominal AC input of 63.5, 110 or 240V. The following parameters specify the requirements of approved **Low Frequency Relays**:

- (a) **Frequency** settings: 47-50Hz in steps of 0.05Hz or better, preferably 0.01Hz;
- (b) Operating time: Relay operating time shall not be more than 150 ms;
- (c) Voltage lock-out: Selectable within a range of 55 to 90% of nominal voltage;
- (d) Direction: Tripping interlock for forward or reverse power flow capable of being set in either position or off
- (e) Facility stages: One or two stages of **Frequency** operation;
- (f) Output contacts: Two output contacts per stage to be capable of repetitively making and breaking for 1000 operations:
- (g) Accuracy: 0.01 Hz maximum error under reference environmental and system voltage conditions.
0.05 Hz maximum error at 8% of total harmonic distortion
Electromagnetic Compatibility Level.

In the case of **Network Operators** who are **GB Code Users**, the above requirements only apply to a relay (if any) installed at the **EU Grid Supply Point**. **Network Operators** who are also **GB Code Users** should continue to satisfy the requirements for low frequency relays as specified in the **CCs** as applicable to their **System**.

ECC.A.5.2 Low Frequency Relay Voltage Supplies

ECC.A.5.2.1 It is essential that the voltage supply to the **Low Frequency Relays** shall be derived from the primary **System** at the supply point concerned so that the **Frequency** of the **Low Frequency Relays** input voltage is the same as that of the primary **System**. This requires either:

- (a) the use of a secure supply obtained from voltage transformers directly associated with the grid transformer(s) concerned, the supply being obtained where necessary via a suitable automatic voltage selection scheme; or
- (b) the use of the substation 240V phase-to-neutral selected auxiliary supply, provided that this supply is always derived at the supply point concerned and is never derived from a standby supply **Power Generating Module** or from another part of the **User System**.

ECC.A.5.3 Scheme Requirements

ECC.A.5.3.1 The tripping facility should be engineered in accordance with the following reliability considerations:

- (a) Dependability

Failure to trip at any one particular **Demand** shedding point would not harm the overall operation of the scheme. However, many failures would have the effect of reducing the amount of **Demand** under low **Frequency** control. An overall reasonable minimum requirement for the dependability of the **Demand** shedding scheme is 96%, i.e. the average probability of failure of each **Demand** shedding point should be less than 4%. Thus the **Demand** under low **Frequency** control will not be reduced by more than 4% due to relay failure.

(b) Outages

Low **Frequency Demand** shedding schemes will be engineered such that the amount of **Demand** under control is as specified in Table ECC.A.5.5.1a and is not reduced unacceptably during equipment outage or maintenance conditions.

ECC.A.5.3.2 The total operating time of the scheme, including circuit breakers operating time, shall where reasonably practicable, be less than 200 ms. For the avoidance of doubt, the replacement of plant installed prior to October 2009 will not be required in order to achieve lower total scheme operating times.

ECC.A.5.4 Low Frequency Relay Testing

ECC.A.5.4.1 **Low Frequency Relays** installed and commissioned after 1st January 2007 shall be type tested in accordance with and comply with the functional test requirements for **Frequency Protection** contained in Energy Networks Association Technical Specification 48-6-5 Issue 1 dated 2005 “**ENA Protection Assessment Functional Test Requirements – Voltage and Frequency Protection**”.

For the avoidance of doubt, **Low Frequency Relays** installed and commissioned before 1st January 2007 shall comply with the version of ECC.A.5.1.1 applicable at the time such **Low Frequency Relays** were commissioned.

ECC.A.5.4.2 Each **Non-Embedded Customer** shall aim to execute testing on its low frequency demand disconnection relays installed within its network and in service at least once every three years, although this may be extended to no more than every five years if considered to be required for operational purposes.

ECC.A.5.4.3 Each **Network Operator** and **Relevant Transmission Licensee** shall aim to execute testing on its low frequency demand disconnection relays installed within its network and in service at least once every three years, although this may be extended to no more than every five years if considered to be required for operational purposes.

ECC.A.5.5 Scheme Settings

ECC.A.5.5.1 Table CC.A.5.5.1a shows, for each **Transmission Area**, the percentage of **Demand** (based on **Annual ACS Conditions**) at the time of forecast **National Electricity Transmission System** peak **Demand** that each **Network Operator** whose **System** is connected to the **Onshore Transmission System** within such **Transmission Area** shall disconnect by **Low Frequency Relays** at a range of frequencies. Where a **Network Operator’s System** is connected to the **National Electricity Transmission System** in more than one **Transmission Area**, the settings for the **Transmission Area** in which the majority of the **Demand** is connected shall apply.

Frequency Hz	% Demand disconnection for each Network Operator in Transmission Area		
	NGET	SPT	SHETL
48.8	5		
48.75	5		

48.7	10		
48.6	7.5		10
48.5	7.5	10	
48.4	7.5	10	10
48.2	7.5	10	10
48.0	5	10	10
47.8	5		
Total % Demand	60	40	40

Table ECC.A.5.5.1a

Note – the percentages in table ECC.A.5.5.1a are cumulative such that, for example, should the frequency fall to 48.6 Hz in **NGET’s Transmission Area**, 27.5% of the total **Demand** connected to the **National Electricity Transmission System** in **NGET’s Transmission Area** shall be disconnected by the action of **Low Frequency Relays**.

The percentage **Demand** at each stage shall be allocated as far as reasonably practicable. The cumulative total percentage **Demand** is a minimum.

ECC.A.5.5.2 In the case of a **Non-Embedded Customer** (who is also an **EU Code User**) the percentage of **Demand** (based on **Annual ACS Conditions**) at the time of forecast **National Electricity Transmission System** peak **Demand** that each **Non-Embedded Customer** whose **System** is connected to the **Onshore Transmission System** which shall be disconnected by **Low Frequency Relays** shall be in accordance with OC6.6 and the **Bilateral Agreement**.

ECC.A.5.6 Connection and Reconnection

ECC.A.5.6.1 As defined under OC.6.6 once automatic low **Frequency Demand Disconnection** has taken place, the **Network Operator** on whose **User System** it has occurred, will not reconnect until **The Company** instructs that **Network Operator** to do so in accordance with OC6. The same requirement equally applies to **Non-Embedded Customers**.

ECC.A.5.6.2 Once **The Company** instructs the **Network Operator** or **Non Embedded Customer** to reconnect to the **National Electricity Transmission System** following operation of the **Low Frequency Demand Disconnection** scheme it shall do so in accordance with the requirements of ECC.6.2.3.10 and OC6.6.

ECC.A.5.6.3 **Network Operators** or **Non Embedded Customers** shall be capable of being remotely disconnected from the **National Electricity Transmission System** when instructed by **The Company**. Any requirement for the automated disconnection equipment for reconfiguration of the **National Electricity Transmission System** in preparation for block loading and the time required for remote disconnection shall be specified by **The Company** in accordance with the terms of the **Bilateral Agreement**.

APPENDIX E6 - PERFORMANCE REQUIREMENTS FOR CONTINUOUSLY ACTING AUTOMATIC EXCITATION CONTROL SYSTEMS FOR ONSHORE SYNCHRONOUS POWER GENERATING MODULES,

ECC.A.6.1 Scope

ECC.A.6.1.1 This Appendix sets out the performance requirements of continuously acting automatic excitation control systems for **Type C** and **Type D Onshore Synchronous Power Generating Modules** that must be complied with by the **User**. This Appendix does not limit any site specific requirements where in **The Company's** reasonable opinion these facilities are necessary for system reasons.

ECC.A.6.1.2 Where the requirements may vary the likely range of variation is given in this Appendix. It may be necessary to specify values outside this range where **The Company** identifies a system need, and notwithstanding anything to the contrary **The Company** may specify values outside of the ranges provided in this Appendix 6. The most common variations are in the on-load excitation ceiling voltage requirements and the response time required of the **Exciter**. Actual values will be included in the **Bilateral Agreement**.

ECC.A.6.1.3 Should an **EU Generator** anticipate making a change to the excitation control system it shall notify **The Company** under the **Planning Code** (PC.A.1.2(b) and (c)) as soon as the **EU Generator** anticipates making the change. The change may require a revision to the **Bilateral Agreement**.

ECC.A.6.2 Requirements

ECC.A.6.2.1 The **Excitation System** of a **Type C** or **Type D Onshore Synchronous Power Generating Module** shall include an excitation source (**Exciter**), and a continuously acting **Automatic Voltage Regulator (AVR)** and shall meet the following functional specification. **Type D Synchronous Power Generating Modules** are also required to be fitted with a **Power System Stabiliser** in accordance with the requirements of ECC.A.6.2.5.

ECC.A.6.2.3 Steady State Voltage Control

ECC.A.6.2.3.1 An accurate steady state control of the **Onshore Synchronous Power Generating Module** pre-set **Synchronous Generating Unit** terminal voltage is required. As a measure of the accuracy of the steady-state voltage control, the **Automatic Voltage Regulator** shall have static zero frequency gain, sufficient to limit the change in terminal voltage to a drop not exceeding 0.5% of rated terminal voltage, when the output of a **Synchronous Generating Unit** within an **Onshore Synchronous Power Generating Module** is gradually changed from zero to rated MVA output at rated voltage, **Active Power** and **Frequency**.

ECC.A.6.2.4 Transient Voltage Control

ECC.A.6.2.4.1 For a step change from 90% to 100% of the nominal **Onshore Synchronous Generating Unit** terminal voltage, with the **Onshore Synchronous Generating Unit** on open circuit, the **Excitation System** response shall have a damped oscillatory characteristic. For this characteristic, the time for the **Onshore Synchronous Generating Unit** terminal voltage to first reach 100% shall be less than 0.6 seconds. Also, the time to settle within 5% of the voltage change shall be less than 3 seconds.

ECC.A.6.2.4.2 To ensure that adequate synchronising power is maintained, when the **Onshore Power Generating Module** is subjected to a large voltage disturbance, the **Exciter** whose output is varied by the **Automatic Voltage Regulator** shall be capable of providing its achievable upper and lower limit ceiling voltages to the **Onshore Synchronous Generating Unit** field in a time not exceeding that specified in the **Bilateral Agreement**. This will normally be not less than 50 ms and not greater than 300 ms. The achievable upper and lower limit ceiling voltages may be dependent on the voltage disturbance.

ECC.A.6.2.4.3 The **Exciter** shall be capable of attaining an **Excitation System On Load Positive Ceiling Voltage** of not less than a value specified in the **Bilateral Agreement** that will be:

not less than 2 per unit (pu)

normally not greater than 3 pu

exceptionally up to 4 pu

of **Rated Field Voltage** when responding to a sudden drop in voltage of 10 percent or more at the **Onshore Synchronous Generating Unit** terminals. **The Company** may specify a value outside the above limits where **The Company** identifies a system need.

ECC.A.6.2.4.4 If a static type **Exciter** is employed:

- (i) the field voltage should be capable of attaining a negative ceiling level specified in the **Bilateral Agreement** after the removal of the step disturbance of ECC.A.6.2.4.3. The specified value will be 80% of the value specified in ECC.A.6.2.4.3. **The Company** may specify a value outside the above limits where **The Company** identifies a system need.
- (ii) the **Exciter** must be capable of maintaining free firing when the **Onshore Synchronous Generating Unit** terminal voltage is depressed to a level which may be between 20% to 30% of rated terminal voltage
- (iii) the **Exciter** shall be capable of attaining a positive ceiling voltage not less than 80% of the **Excitation System On Load Positive Ceiling Voltage** upon recovery of the **Onshore Synchronous Generating Unit** terminal voltage to 80% of rated terminal voltage following fault clearance. **The Company** may specify a value outside the above limits where **The Company** identifies a system need.
- (iv) the requirement to provide a separate power source for the **Exciter** will be specified if **The Company** identifies a **Transmission System** need.

ECC.A.6.2.5 Power Oscillations Damping Control

ECC.A.6.2.5.1 To allow **Type D Onshore Power Generating Modules** to maintain second and subsequent swing stability and also to ensure an adequate level of low frequency electrical damping power, the **Automatic Voltage Regulator** of each **Onshore Synchronous Generating Unit** within each **Type D Onshore Synchronous Power Generating Module** shall include a **Power System Stabiliser** as a means of supplementary control.

ECC.A.6.2.5.2 Whatever supplementary control signal is employed, it shall be of the type which operates into the **Automatic Voltage Regulator** to cause the field voltage to act in a manner which results in the damping power being improved while maintaining adequate synchronising power.

ECC.A.6.2.5.3 The arrangements for the supplementary control signal shall ensure that the **Power System Stabiliser** output signal relates only to changes in the supplementary control signal and not the steady state level of the signal. For example, if generator electrical power output is chosen as a supplementary control signal then the **Power System Stabiliser** output should relate only to changes in the **Synchronous Generating Unit** electrical power output and not the steady state level of power output. Additionally the **Power System Stabiliser** should not react to mechanical power changes in isolation for example during rapid changes in steady state load or when providing frequency response.

ECC.A.6.2.5.4 The output signal from the **Power System Stabiliser** shall be limited to not more than $\pm 10\%$ of the **Onshore Synchronous Generating Unit** terminal voltage signal at the **Automatic Voltage Regulator** input. The gain of the **Power System Stabiliser** shall be such that an increase in the gain by a factor of 3 shall not cause instability.

ECC.A.6.2.5.5 The **Power System Stabiliser** shall include elements that limit the bandwidth of the output signal. The bandwidth limiting must ensure that the highest frequency of response cannot excite torsional oscillations on other plant connected to the network. A bandwidth of 0-5Hz would be judged to be acceptable for this application.

- ECC.A.6.2.5.6 The **EU Generator** in respect of its **Type D Synchronous Power Generating Modules** will agree **Power System Stabiliser** settings with **The Company** prior to the on-load commissioning detailed in BC2.11.2(d). To allow assessment of the performance before on-load commissioning the **EU Generator** will provide to **The Company** a report covering the areas specified in ECP.A.3.2.1.
- ECC.A.6.2.5.7 The **Power System Stabiliser** must be active within the **Excitation System** at all times when **Synchronised** including when the **Under Excitation Limiter** or **Over Excitation Limiter** are active. When operating at low load when **Synchronising** or **De-Synchronising** an **Onshore Synchronous Generating Unit**, within a **Type D Synchronous Power Generating Module**, the **Power System Stabiliser** may be out of service.
- ECC.A.6.2.5.8 Where a **Power System Stabiliser** is fitted to a **Pumped Storage Unit** within a **Type D Synchronous Power Generating Module** it must function when the **Pumped Storage Unit** is in both generating and pumping modes. In addition, where a **Power System Stabiliser** is fitted to an **Electricity Storage Unit** within a **Type D Synchronous Electricity Storage Module**, it must function when the **Synchronous Electricity Storage Unit** is in both importing and exporting modes of operation.
- ECC.A.6.2.6 Overall **Excitation System** Control Characteristics
- ECC.A.6.2.6.1 The overall **Excitation System** shall include elements that limit the bandwidth of the output signal. The bandwidth limiting must be consistent with the speed of response requirements and ensure that the highest frequency of response cannot excite torsional oscillations on other plant connected to the network. A bandwidth of 0-5 Hz will be judged to be acceptable for this application.
- ECC.A.6.2.6.2 The response of the **Automatic Voltage Regulator** combined with the **Power System Stabiliser** shall be demonstrated by injecting similar step signal disturbances into the **Automatic Voltage Regulator** reference as detailed in ECPA.5.2 and ECPA.5.4. The **Automatic Voltage Regulator** shall include a facility to allow step injections into the **Automatic Voltage Regulator** voltage reference, with the **Onshore Type D Power Generating Module** operating at points specified by **The Company** (up to rated MVA output). The damping shall be judged to be adequate if the corresponding **Active Power** response to the disturbances decays within two cycles of oscillation.
- ECC.A.6.2.6.3 A facility to inject a band limited random noise signal into the **Automatic Voltage Regulator** voltage reference shall be provided for demonstrating the frequency domain response of the **Power System Stabiliser**. The tuning of the **Power System Stabiliser** shall be judged to be adequate if the corresponding **Active Power** response shows improved damping with the **Power System Stabiliser** in combination with the **Automatic Voltage Regulator** compared with the **Automatic Voltage Regulator** alone over the frequency range 0.3Hz – 2Hz.
- ECC.A.6.2.7 Under-Excitation Limiters
- ECC.A.6.2.7.1 The security of the power system shall also be safeguarded by means of MVar **Under Excitation Limiters** fitted to the **Synchronous Power Generating Module Excitation System**. The **Under Excitation Limiter** shall prevent the **Automatic Voltage Regulator** reducing the **Synchronous Generating Unit** excitation to a level which would endanger synchronous stability. The **Under Excitation Limiter** shall operate when the excitation system is providing automatic control. The **Under Excitation Limiter** shall respond to changes in the **Active Power** (MW) the **Reactive Power** (MVar) and to the square of the **Synchronous Generating Unit** voltage in such a direction that an increase in voltage will permit an increase in leading MVar. The characteristic of the **Under Excitation Limiter** shall be substantially linear from no-load to the maximum **Active Power** output of the **Onshore Power Generating Module** at any setting and shall be readily adjustable.

- ECC.A.6.2.7.2 The performance of the **Under Excitation Limiter** shall be independent of the rate of change of the **Onshore Synchronous Power Generating Module** load and shall be demonstrated by testing as detailed in ECP.A.5.5. The resulting maximum overshoot in response to a step injection which operates the **Under Excitation Limiter** shall not exceed 4% of the **Onshore Synchronous Generating Unit** rated MVA. The operating point of the **Onshore Synchronous Generating Unit** shall be returned to a steady state value at the limit line and the final settling time shall not be greater than 5 seconds. When the step change in **Automatic Voltage Regulator** reference voltage is reversed, the field voltage should begin to respond without any delay and should not be held down by the **Under Excitation Limiter**. Operation into or out of the preset limit levels shall ensure that any resultant oscillations are damped so that the disturbance is within 0.5% of the **Onshore Synchronous Generating Unit** MVA rating within a period of 5 seconds.
- ECC.A.6.2.7.3 The **EU Generator** shall also make provision to prevent the reduction of the **Onshore Synchronous Generating Unit** excitation to a level which would endanger synchronous stability when the **Excitation System** is under manual control.
- ECC.A.6.2.8 Over-Excitation and Stator Current Limiters
- ECC.A.6.2.8.1 The settings of the **Over-Excitation Limiter** and stator current limiter, shall ensure that the **Onshore Synchronous Generating Unit** excitation is not limited to less than the maximum value that can be achieved whilst ensuring the **Onshore Synchronous Generating Unit** is operating within its design limits. If the **Onshore Synchronous Generating Unit** excitation is reduced following a period of operation at a high level, the rate of reduction shall not exceed that required to remain within any time dependent operating characteristics of the **Onshore Synchronous Power Generating Module**.
- ECC.A.6.2.8.2 The performance of the **Over-Excitation Limiter**, shall be demonstrated by testing as described in ECP.A.5.6. Any operation beyond the **Over-Excitation Limit** shall be controlled by the **Over-Excitation Limiter** or stator current limiter without the operation of any **Protection** that could trip the **Onshore Synchronous Power Generating Module**.
- ECC.A.6.2.8.3 The **EU Generator** shall also make provision to prevent any over-excitation restriction of the **Onshore Synchronous Generating Unit** when the **Excitation System** is under manual control, other than that necessary to ensure the **Onshore Power Generating Module** is operating within its design limits.

APPENDIX E7 - PERFORMANCE REQUIREMENTS FOR CONTINUOUSLY ACTING AUTOMATIC VOLTAGE CONTROL SYSTEMS FOR AC CONNECTED ONSHORE POWER PARK MODULES AND OTSDUW PLANT AND APPARATUS AT THE INTERFACE POINT HVDC SYSTEMS AND REMOTE END HVDC CONVERTER STATIONS

ECC.A.7.1 Scope

ECC.A.7.1.1 This Appendix sets out the performance requirements of continuously acting automatic voltage control systems for **Onshore Power Park Modules, Onshore HVDC Converters Remote End HVDC Converter Stations and OTSDUW Plant and Apparatus** at the **Interface Point** that must be complied with by the **User**. This Appendix does not limit any site specific requirements where in **The Company's** reasonable opinion these facilities are necessary for system reasons. The control performance requirements applicable to **Configuration 2 AC Connected Offshore Power Park Modules and Configuration 2 DC Connected Power Park Modules** are defined in Appendix E8.

ECC.A.7.1.2 Proposals by **EU Generators** or **HVDC System Owners** to make a change to the voltage control systems are required to be notified to **The Company** under the **Planning Code** (PC.A.1.2(b) and (c)) as soon as the **Generator** or **HVDC System Owner** anticipates making the change. The change may require a revision to the **Bilateral Agreement**.

ECC.A.7.1.3 In the case of a **Remote End HVDC Converter** at a **HVDC Converter Station**, the control performance requirements shall be specified in the **Bilateral Agreement**. These requirements shall be consistent with those specified in ECC.6.3.2.4. In the case where the **Remote End HVDC Converter** is required to ensure the zero transfer of **Reactive Power** at the **HVDC Interface Point** then the requirements shall be specified in the **Bilateral Agreement** which shall be consistent with those requirements specified in ECC.A.8 . In the case where a wider reactive capability has been specified in ECC.6.3.2.4, then the requirements consistent with those specified in ECC.A.7.2 shall apply with any variations being agreed between the **User** and **The Company**.

ECC.A.7.2 Requirements

ECC.A.7.2.1 **The Company** requires that the continuously acting automatic voltage control system for the **Onshore Power Park Module, Onshore HVDC Converter** or **OTSDUW Plant and Apparatus** shall meet the following functional performance specification. If a **Network Operator** has confirmed to **The Company** that its network to which an **Embedded Onshore Power Park Module** or **Onshore HVDC Converter** or **OTSDUW Plant and Apparatus** is connected is restricted such that the full reactive range under the steady state voltage control requirements (ECC.A.7.2.2) cannot be utilised, **The Company** may specify alternative limits to the steady state voltage control range that reflect these restrictions. Where the **Network Operator** subsequently notifies **The Company** that such restriction has been removed, **The Company** may propose a **Modification** to the **Bilateral Agreement** (in accordance with the **CUSC** contract) to remove the alternative limits such that the continuously acting automatic voltage control system meets the following functional performance specification. All other requirements of the voltage control system will remain as in this Appendix.

ECC.A.7.2.2 Steady State Voltage Control

ECC.A.7.2.2.1 The **Onshore Power Park Module, Onshore HVDC Converter** or **OTSDUW Plant and Apparatus** shall provide continuous steady state control of the voltage at the **Onshore Grid Entry Point** (or **Onshore User System Entry Point** if **Embedded**) (or the **Interface Point** in the case of **OTSDUW Plant and Apparatus**) with a **Setpoint Voltage** and **Slope** characteristic as illustrated in Figure ECC.A.7.2.2a.

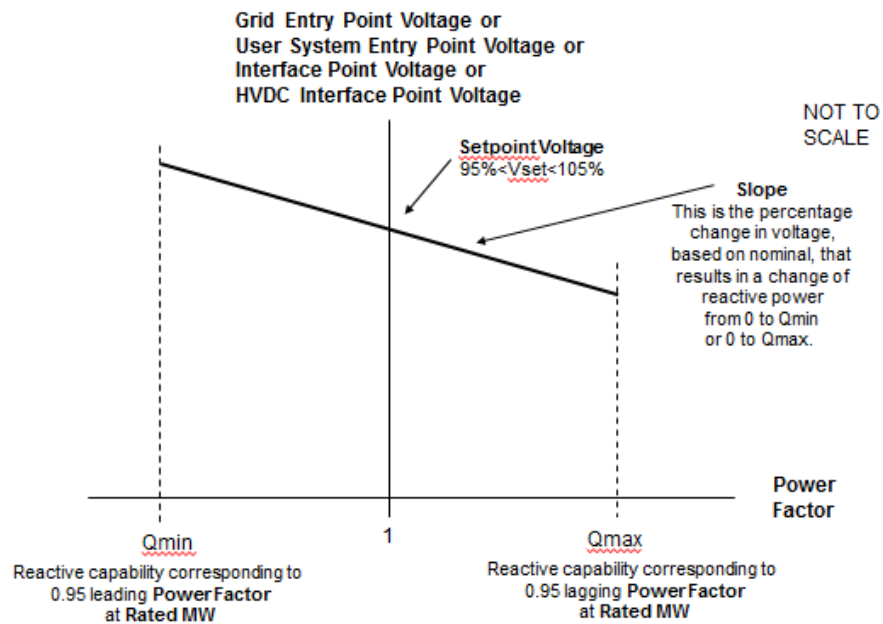

Figure ECC.A.7.2.2a

ECC.A.7.2.2.2 The continuously acting automatic control system shall be capable of operating to a **Setpoint Voltage** between 95% and 105% with a resolution of 0.25% of the nominal voltage. For the avoidance of doubt values of 95%, 95.25%, 95.5% ... may be specified, but not intermediate values. The initial **Setpoint Voltage** will be 100%. The tolerance within which this **Setpoint Voltage** shall be achieved is specified in BC2.A.2.6. For the avoidance of doubt, with a tolerance of 0.25% and a Setpoint Voltage of 100%, the achieved value shall be between 99.75% and 100.25%. **The Company** may request the **EU Generator** or **HVDC System Owner** to implement an alternative **Setpoint Voltage** within the range of 95% to 105%. For **Embedded Generators** and **Embedded HVDC System Owners** the **Setpoint Voltage** will be discussed between **The Company** and the relevant **Network Operator** and will be specified to ensure consistency with ECC.6.3.4.

ECC.A.7.2.2.3 The **Slope** characteristic of the continuously acting automatic control system shall be adjustable over the range 2% to 7% (with a resolution of 0.5%). For the avoidance of doubt values of 2%, 2.5%, 3% may be specified, but not intermediate values. The initial **Slope** setting will be 4%. The tolerance within which this **Slope** shall be achieved is specified in BC2.A.2.6. For the avoidance of doubt, with a tolerance of 0.5% and a **Slope** setting of 4%, the achieved value shall be between 3.5% and 4.5%. **The Company** may request the **EU Generator** or **HVDC System Owner** to implement an alternative slope setting within the range of 2% to 7%. For **Embedded Generators** and **Onshore Embedded HVDC Converter Station Owners** the **Slope** setting will be discussed between **The Company** and the relevant **Network Operator** and will be specified to ensure consistency with ECC.6.3.4.

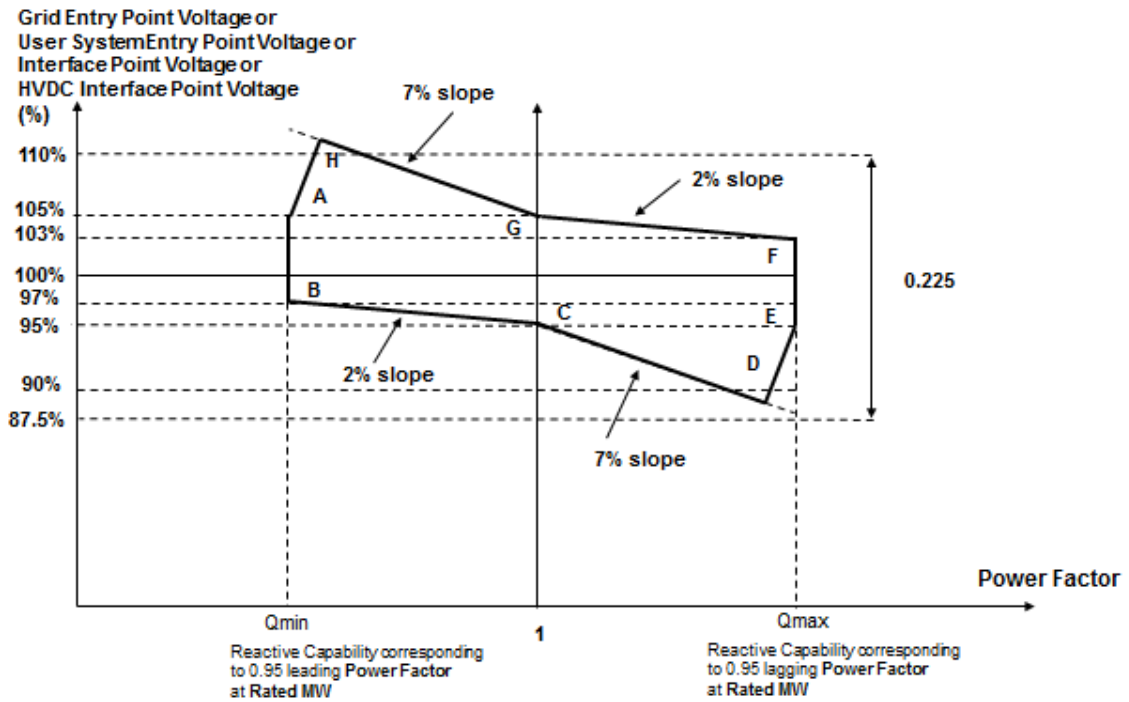

Figure ECC.A.7.2.2b

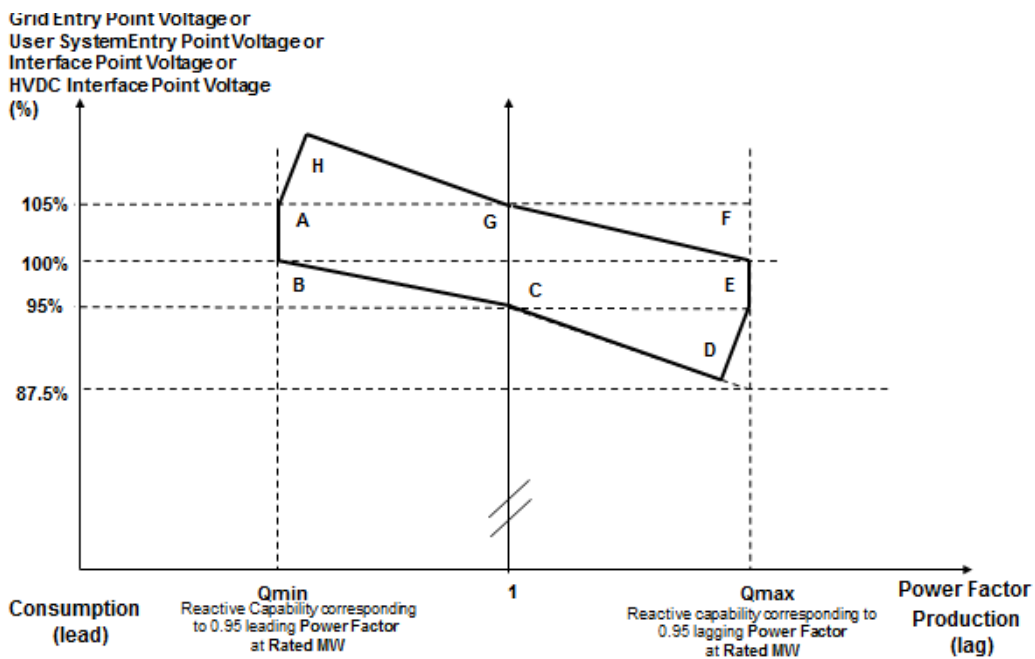

Figure ECC.A.7.2.2c

ECC.A.7.2.2.4 Figure ECC.A.7.2.2b shows the required envelope of operation for -, **OTSDUW Plant and Apparatus, Onshore Power Park Modules and Onshore HVDC Converters** except for those **Embedded** at 33kV and below or directly connected to the **National Electricity Transmission System** at 33kV and below. Figure ECC.A.7.2.2c shows the required envelope of operation for **Onshore Power Park Modules Embedded** at 33kV and below, or directly connected to the **National Electricity Transmission System** at 33kV and below. The enclosed area within points ABCDEFGH is the required capability range within which the **Slope** and **Setpoint Voltage** can be changed.

- ECC.A.7.2.2.5 Should the operating point of the, **OTSDUW Plant and Apparatus** or **Onshore Power Park Module**, or **Onshore HVDC Converter** deviate so that it is no longer a point on the operating characteristic (figure ECC.A.7.2.2a) defined by the target **Setpoint Voltage** and **Slope**, the continuously acting automatic voltage control system shall act progressively to return the value to a point on the required characteristic within 5 seconds.
- ECC.A.7.2.2.6 Should the **Reactive Power** output of the **OTSDUW Plant and Apparatus** or **Onshore Power Park Module** or **Onshore HVDC Converter** reach its maximum lagging limit at a **Onshore Grid Entry Point** voltage (or **Onshore User System Entry Point** voltage if **Embedded** (or **Interface Point** in the case of **OTSDUW Plant and Apparatus**) above 95%, the **OTSDUW Plant and Apparatus** or **Onshore Power Park Module** or **HVDC System** shall maintain maximum lagging **Reactive Power** output for voltage reductions down to 95%. This requirement is indicated by the line EF in figures ECC.A.7.2.2b and ECC.A.7.2.2c as applicable. Should the **Reactive Power** output of the **OTSDUW Plant and Apparatus** or **Onshore Power Park Module**, or **Onshore HVDC Converter** reach its maximum leading limit at a **Onshore Grid Entry Point** voltage (or **Onshore User System Entry Point** voltage if **Embedded** or **Interface Point** in the case of **OTSDUW Plant and Apparatus**) below 105%, the **OTSDUW Plant and Apparatus** or **Onshore Power Park Module**, or **Onshore HVDC Converter** shall maintain maximum leading **Reactive Power** output for voltage increases up to 105%. This requirement is indicated by the line AB in figures ECC.A.7.2.2b and ECC.A.7.2.2c as applicable.
- ECC.A.7.2.2.7 For **Onshore Grid Entry Point** voltages (or **Onshore User System Entry Point** voltages if **Embedded** or **Interface Point** voltages) below 95%, the lagging **Reactive Power** capability of the **OTSDUW Plant and Apparatus** or **Onshore Power Park Module** or **Onshore HVDC Converters** should be that which results from the supply of maximum lagging reactive current whilst ensuring the current remains within design operating limits. An example of the capability is shown by the line DE in figures ECC.A.7.2.2b and ECC.A.7.2.2c. For **Onshore Grid Entry Point** voltages (or **User System Entry Point** voltages if **Embedded** or **Interface Point** voltages) above 105%, the leading **Reactive Power** capability of the **OTSDUW Plant and Apparatus** or **Onshore Power Park Module** or **Onshore HVDC System Converter** should be that which results from the supply of maximum leading reactive current whilst ensuring the current remains within design operating limits. An example of the capability is shown by the line AH in figures ECC.A.7.2.2b and ECC.A.7.2.2c as applicable. Should the **Reactive Power** output of the **OTSDUW Plant and Apparatus** or **Onshore Power Park Module** or **Onshore HVDC Converter** reach its maximum lagging limit at an **Onshore Grid Entry Connection Point** voltage (or **Onshore User System Entry Point** voltage if **Embedded** or **Interface Point** in the case of **OTSDUW Plant and Apparatus**) below 95%, the **Onshore Power Park Module**, **Onshore HVDC Converter** shall maintain maximum lagging reactive current output for further voltage decreases. Should the **Reactive Power** output of the **OTSDUW Plant and Apparatus** or **Onshore Power Park Module** or **Onshore HVDC Converter** reach its maximum leading limit at a **Onshore Grid Entry Point** voltage (or **User System Entry Point** voltage if **Embedded** or **Interface Point** voltage in the case of an **OTSDUW Plant and Apparatus**) above 105%, the **OTSDUW Plant and Apparatus** or **Onshore Power Park Module** or **Onshore HVDC Converter** shall maintain maximum leading reactive current output for further voltage increases.
- ECC.A.7.2.2.8 All **OTSDUW Plant and Apparatus** must be capable of enabling **EU Code Users** undertaking **OTSDUW** to comply with an instruction received from **The Company** relating to a variation of the **Setpoint Voltage** at the **Interface Point** within 2 minutes of such instruction being received.
- ECC.A.7.2.2.9 For **OTSDUW Plant and Apparatus** connected to a **Network Operator's System** where the **Network Operator** has confirmed to **The Company** that its **System** is restricted in accordance with ECC.A.7.2.1, clause ECC.A.7.2.2.8 will not apply unless **The Company** can reasonably demonstrate that the magnitude of the available change in **Reactive Power** has a significant effect on voltage levels on the **Onshore National Electricity Transmission System**.

ECC.A.7.2.3 Transient Voltage Control

ECC.A.7.2.3.1 For an on-load step change in **Onshore Grid Entry Point** or **Onshore User System Entry Point** voltage, or in the case of **OTSDUW Plant and Apparatus** an on-load step change in **Transmission Interface Point** voltage, the continuously acting automatic control system shall respond according to the following minimum criteria:

- (i) the **Reactive Power** output response of the, **OTSDUW Plant and Apparatus** or **Onshore Power Park Module** or **Onshore HVDC Converter** shall commence within 0.2 seconds of the application of the step. It shall progress linearly although variations from a linear characteristic shall be acceptable provided that the MVA_r seconds delivered at any time up to 1 second are at least those that would result from the response shown in figure ECC.A.7.2.3.1a.
- (ii) the response shall be such that 90% of the change in the **Reactive Power** output of the, **OTSDUW Plant and Apparatus** or **Onshore Power Park Module**, or **Onshore HVDC Converter** will be achieved within
 - 2 seconds, where the step is sufficiently large to require a change in the steady state **Reactive Power** output from its maximum leading value to its maximum lagging value or vice versa and
 - 1 second where the step is sufficiently large to require a change in the steady state **Reactive Power** output from zero to its maximum leading value or maximum lagging value as required by ECC.6.3.2 (or, if appropriate ECC.A.7.2.2.6 or ECC.A.7.2.2.7);
- (iii) the magnitude of the **Reactive Power** output response produced within 1 second shall vary linearly in proportion to the magnitude of the step change.
- (iv) within 5 seconds from achieving 90% of the response as defined in ECC.A.7.2.3.1 (ii), the peak to peak magnitude of any oscillations shall be less than 5% of the change in steady state maximum **Reactive Power**.
- (v) following the transient response, the conditions of ECC.A.7.2.2 apply.

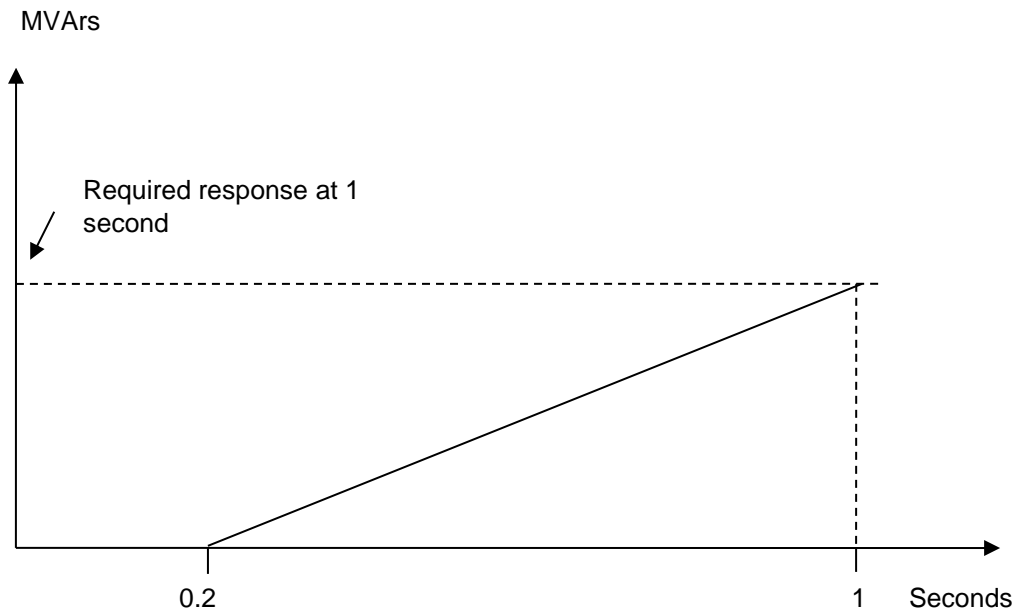

Figure ECC.A.7.2.3.1a

ECC.A.7.2.3.2 **OTSDUW Plant and Apparatus** or **Onshore Power Park Modules** or **Onshore HVDC Converters** shall be capable of

- (a) changing its **Reactive Power** output from its maximum lagging value to its maximum

leading value, or vice versa, then reverting back to the initial level of **Reactive Power** output once every 15 seconds for at least 5 times within any 5 minute period; and

- (b) changing its **Reactive Power** output from zero to its maximum leading value then reverting back to zero **Reactive Power** output at least 25 times within any 24 hour period and from zero to its maximum lagging value then reverting back to zero **Reactive Power** output at least 25 times within any 24 hour period. Any subsequent restriction on reactive capability shall be notified to **The Company** in accordance with BC2.5.3.2, and BC2.6.1.

In all cases, the response shall be in accordance to ECC.A.7.2.3.1 where the change in **Reactive Power** output is in response to an on-load step change in **Onshore Grid Entry Point** or **Onshore User System Entry Point** voltage, or in the case of **OTSDUW Plant and Apparatus** an on-load step change in **Transmission Interface Point** voltage.

ECC.A.7.2.4 Power Oscillation Damping

ECC.A.7.2.4.1 The requirement for the continuously acting voltage control system to be fitted with a **Power System Stabiliser (PSS)** shall be specified if, in **The Company's** view, this is required for system reasons. However if a **Power System Stabiliser** is included in the voltage control system its settings and performance shall be agreed with **The Company** and commissioned in accordance with BC2.11.2. To allow assessment of the performance before on-load commissioning the **Generator** will provide to **The Company** a report covering the areas specified in ECP.A.3.2.2.

ECC.A.7.2.5 Overall Voltage Control System Characteristics

ECC.A.7.2.5.1 The continuously acting automatic voltage control system is required to respond to minor variations, steps, gradual changes or major variations in **Onshore Grid Entry Point** voltage (or **Onshore User System Entry Point** voltage if **Embedded** or **Interface Point** voltage in the case of **OTSDUW Plant and Apparatus**).

ECC.A.7.2.5.2 The overall voltage control system shall include elements that limit the bandwidth of the output signal. The bandwidth limiting must be consistent with the speed of response requirements and ensure that the highest frequency of response cannot excite torsional oscillations on other plant connected to the network. A bandwidth of 0-5Hz would be judged to be acceptable for this application. All other control systems employed within the **OTSDUW Plant and Apparatus** or **Onshore Power Park Module** or **Onshore HVDC Converter** should also meet this requirement

ECC.A.7.2.5.3 The response of the voltage control system (including the **Power System Stabiliser** if employed) shall be demonstrated by testing in accordance with ECP.A.6.

ECC.A.7.3 Reactive Power Control

ECC.A.7.3.1 As defined in ECC.6.3.8.3.4, **Reactive Power** control mode of operation is not required in respect of **Onshore Power Park Modules** or **OTSDUW Plant and Apparatus** or **Onshore HVDC Converters** unless otherwise specified by **The Company** in coordination with the relevant **Network Operator**. However where there is a requirement for **Reactive Power** control mode of operation, the following requirements shall apply.

ECC.A.7.3.2 The **Onshore Power Park Module** or **OTSDUW Plant and Apparatus** or **Onshore HVDC Converter** shall be capable of setting the **Reactive Power** setpoint anywhere in the **Reactive Power** range as specified in ECC.6.3.2.4 with setting steps no greater than 5 MVAR or 5% (whichever is smaller) of full **Reactive Power**, controlling the reactive power at the **Grid Entry Point** or **User System Entry Point** if **Embedded** to an accuracy within plus or minus 5MVAR or plus or minus 5% (whichever is smaller) of the full **Reactive Power**.

ECC.A.7.3.3 Any additional requirements for **Reactive Power** control mode of operation shall be specified

by **The Company** in coordination with the relevant **Network Operator**..

ECC.A.7.4 **Power Factor Control**

- ECC.A.7.4.1 As defined in ECC.6.3.8.4.3, **Power Factor** control mode of operation is not required in respect of **Onshore Power Park Modules** or **OTSDUW Plant and Apparatus** or **Onshore HVDC Converters** unless otherwise specified by **The Company** in coordination with the relevant **Network Operator**. However where there is a requirement for **Power Factor** control mode of operation, the following requirements shall apply.
- ECC.A.7.4.2 The **Onshore Power Park Module** or **OTSDUW Plant and Apparatus** or **Onshore HVDC Converter** shall be capable of controlling the **Power Factor** at the **Grid Entry Point** or **User System Entry Point (if Embedded)** within the required **Reactive Power** range as specified in ECC.6.3.2.2.1 and ECC.6.3.2.4 to a specified target **Power Factor**. **The Company** shall specify the target **Power Factor** value (which shall be achieved within 0.01 of the set **Power Factor**), its tolerance and the period of time to achieve the target **Power Factor** following a sudden change of **Active Power** output. The tolerance of the target **Power Factor** shall be expressed through the tolerance of its corresponding **Reactive Power**. This **Reactive Power** tolerance shall be expressed by either an absolute value or by a percentage of the maximum **Reactive Power** of the **Onshore Power Park Module** or **OTSDUW Plant and Apparatus** or **Onshore HVDC Converter**. The details of these requirements being pursuant to the terms of the **Bilateral Agreement**.
- ECC.A.7.4.3 Any additional requirements for **Power Factor** control mode of operation shall be specified by **The Company** in coordination with the relevant **Network Operator**.

APPENDIX E8 - PERFORMANCE REQUIREMENTS FOR CONTINUOUSLY ACTING AUTOMATIC VOLTAGE CONTROL SYSTEMS FOR CONFIGURATION 2 AC CONNECTED OFFSHORE POWER PARK MODULES AND CONFIGURATION 2 DC CONNECTED POWER PARK MODULES

ECC.A.8.1 Scope

ECC.A.8.1.1 This Appendix sets out the performance requirements of continuously acting automatic voltage control systems for **Configuration 2 AC Connected Offshore Power Park Modules** and **Configuration 2 DC Connected Power Park Modules** that must be complied with by the **EU Code User**. This Appendix does not limit any site specific requirements that may be specified where in **The Company's** reasonable opinion these facilities are necessary for system reasons.

ECC.A.8.1.2 These requirements also apply to **Configuration 2 DC Connected Power Park Modules**. In the case of a **Configuration 1 DC Connected Power Park Module** the technical performance requirements shall be specified by **The Company**. Where the **EU Generator** in respect of a **DC Connected Power Park Module** has agreed to a wider reactive capability range as defined under ECC.6.3.2.5 and ECC.6.2.3.6 then the requirements that apply will be specified by **The Company** and which shall reflect the performance requirements detailed in ECC.A.8.2 below but with different parameters such as droop and **Setpoint Voltage**.

ECC.A.8.1.3 Proposals by **EU Generators** to make a change to the voltage control systems are required to be notified to **The Company** under the **Planning Code** (PC.A.1.2(b) and (c)) as soon as the **Generator** anticipates making the change. The change may require a revision to the **Bilateral Agreement**.

ECC.A.8.2 Requirements

ECC.A.8.2.1 **The Company** requires that the continuously acting automatic voltage control system for the **Configuration 2 AC connected Offshore Power Park Module** and **Configuration 2 DC Connected Power Park Module** shall meet the following functional performance specification.

ECC.A.8.2.2 Steady State Voltage Control

ECC.A.8.2.2.1 The **Configuration 2 AC connected Offshore Power Park Module** and **Configuration 2 DC Connected Power Park Module** shall provide continuous steady state control of the voltage at the **Offshore Connection Point** with a **Setpoint Voltage** and **Slope** characteristic as illustrated in Figure ECC.A.8.2.2a.

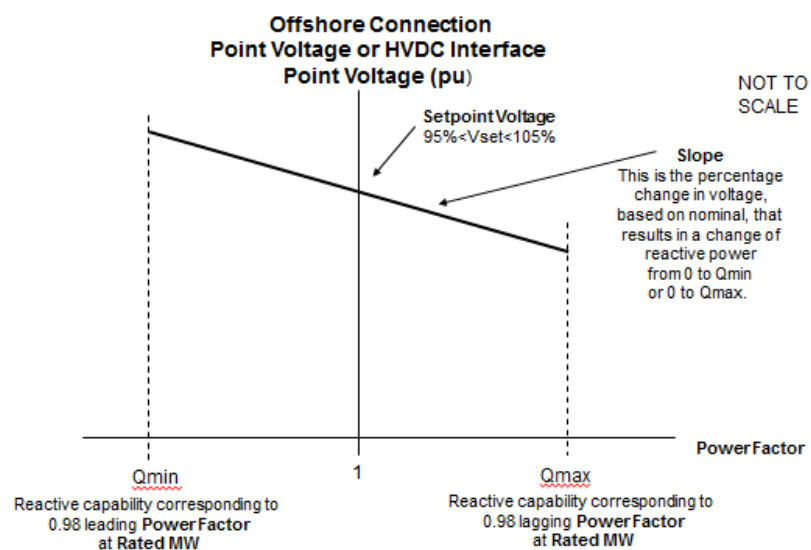

Figure ECC.A.8.2.2a

ECC.A.8.2.2.2 The continuously acting automatic control system shall be capable of operating to a **Setpoint Voltage** between 95% and 105% with a resolution of 0.25% of the nominal voltage. For the avoidance of doubt values of 95%, 95.25%, 95.5% ... may be specified, but not intermediate values. The initial **Setpoint Voltage** will be 100%. The tolerance within which this **Setpoint Voltage** shall be achieved is specified in BC2.A.2.6. For the avoidance of doubt, with a tolerance of 0.25% and a Setpoint Voltage of 100%, the achieved value shall be between 99.75% and 100.25%. **The Company** may request the **EU Generator** to implement an alternative **Setpoint Voltage** within the range of 95% to 105%.

ECC.A.8.2.2.3 The **Slope** characteristic of the continuously acting automatic control system shall be adjustable over the range 2% to 7% (with a resolution of 0.5%). For the avoidance of doubt values of 2%, 2.5%, 3% may be specified, but not intermediate values. The initial **Slope** setting will be 4%. The tolerance within which this **Slope** shall be achieved is specified in BC2.A.2.6. For the avoidance of doubt, with a tolerance of 0.5% and a **Slope** setting of 4%, the achieved value shall be between 3.5% and 4.5%. **The Company** may request the **EU Generator** to implement an alternative slope setting within the range of 2% to 7%.

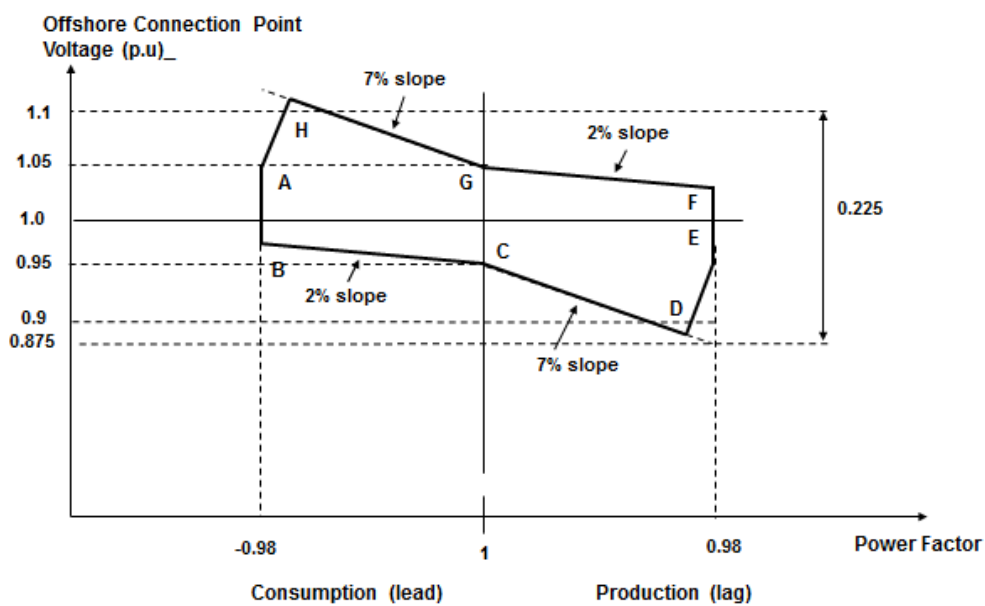

Figure ECC.A.8.2.2b

ECC.A.8.2.2.4 Figure ECC.A.8.2.2b shows the required envelope of operation for **Configuration 2 AC connected Offshore Power Park Module** and **Configuration 2 DC Connected Power Park Module**. The enclosed area within points ABCDEFGH is the required capability range within which the **Slope** and **Setpoint Voltage** can be changed.

ECC.A.8.2.2.5 Should the operating point of the **Configuration 2 AC connected Offshore Power Park or Configuration 2 DC Connected Power Park Module** deviate so that it is no longer a point on the operating characteristic (Figure ECC.A.8.2.2a) defined by the target **Setpoint Voltage** and **Slope**, the continuously acting automatic voltage control system shall act progressively to return the value to a point on the required characteristic within 5 seconds.

ECC.A.8.2.2.6 Should the **Reactive Power** output of the **Configuration 2 AC connected Offshore Power Park Module** or **Configuration 2 DC Connected Power Park Module** reach its maximum lagging limit at an **Offshore Grid Entry Point** or **Offshore User System Entry Point** or **HVDC Interface Point** voltage above 95%, the **Configuration 2 AC connected Offshore Power Park Module** or **Configuration 2 DC Connected Power Park Module** shall maintain maximum lagging **Reactive Power** output for voltage reductions down to 95%. This requirement is indicated by the line EF in figure ECC.A.8.2.2b. Should the **Reactive Power** output of the **Configuration 2 AC connected Offshore Power Park Module** or **Configuration 2 DC Connected Power Park Module** reach its maximum leading limit at the **Offshore Grid Entry Point** or **Offshore User System Entry Point** or **HVDC Interface Point** voltage below 105%, the **Configuration 2 AC connected Offshore Power Park Module** or **Configuration 2 DC Connected Power Park Module** shall maintain maximum leading **Reactive Power** output for voltage increases up to 105%. This requirement is indicated by the line AB in figures ECC.A.8.2.2b.

ECC.A.8.2.2.7 For **Offshore Grid Entry Point** or **User System Entry Point** or **HVDC Interface Point** voltages below 95%, the lagging **Reactive Power** capability of the **Configuration 2 AC connected Offshore Power Park Module** or **Configuration 2 DC Connected Power Park Module** should be that which results from the supply of maximum lagging reactive current whilst ensuring the current remains within design operating limits. An example of the capability is shown by the line DE in figures ECC.A.8.2.2b. For **Offshore Grid Entry Point** or **Offshore User System Entry Point** voltages or **HVDC Interface Point** voltages above 105%, the leading **Reactive Power** capability of the **Configuration 2 AC connected Offshore Power Park Module** or **Configuration 2 DC Connected Power Park Module** should be that which results from the supply of maximum leading reactive current whilst ensuring the current remains within design operating limits. An example of the capability is shown by the line AH in figures ECC.A.8.2.2b. Should the **Reactive Power** output of the **Configuration 2 AC connected Offshore Power Park Module** or **Configuration 2 DC Connected Power Park Module** reach its maximum lagging limit at an **Offshore Grid Entry Point** or **Offshore User System Entry Point** voltage or **HVDC Interface Point** voltage below 95%, the **Configuration 2 AC connected Offshore Power Park Module** or **Configuration 2 DC Connected Power Park Module** shall maintain maximum lagging reactive current output for further voltage decreases. Should the **Reactive Power** output of the **Configuration 2 AC connected Offshore Power Park Module** or **Configuration 2 DC Connected Power Park Module** reach its maximum leading limit at an **Offshore Grid Entry Point** or **Offshore User System Entry Point** voltage or **HVDC Interface Point** voltage above 105%, the **Configuration 2 AC connected Offshore Power Park Module** or **Configuration 2 DC Connected Power Park Module** shall maintain maximum leading reactive current output for further voltage increases.

ECC.A.8.2.3 Transient Voltage Control

ECC.A.8.2.3.1 For an on-load step change in **Offshore Grid Entry Point** or **Offshore User System Entry Point** voltage or **HVDC Interface Point** voltage, the continuously acting automatic control system shall respond according to the following minimum criteria:

- (i) the **Reactive Power** output response of the **Configuration 2 AC connected Offshore Power Park Module** or **Configuration 2 DC Connected Power Park Module** shall commence within 0.2 seconds of the application of the step. It shall progress linearly although variations from a linear characteristic shall be acceptable provided that the MVAR seconds delivered at any time up to 1 second are at least those that would result from the response shown in figure ECC.A.8.2.3.1a.
- (ii) the response shall be such that 90% of the change in the **Reactive Power** output of the **Configuration 2 AC connected Offshore Power Park Module** or **Configuration 2 DC Connected Power Park Module** will be achieved within
 - 2 seconds, where the step is sufficiently large to require a change in the steady state **Reactive Power** output from its maximum leading value to its maximum lagging value or vice versa and

- 1 second where the step is sufficiently large to require a change in the steady state **Reactive Power** output from zero to its maximum leading value or maximum lagging value as required by ECC.6.3.2 (or, if appropriate ECC.A.8.2.2.6 or ECC.A.8.2.2.7);
- (iii) the magnitude of the **Reactive Power** output response produced within 1 second shall vary linearly in proportion to the magnitude of the step change.
- (iv) within 5 seconds from achieving 90% of the response as defined in ECC.A.8.2.3.1 (ii), the peak to peak magnitude of any oscillations shall be less than 5% of the change in steady state maximum **Reactive Power**.
- (v) following the transient response, the conditions of ECC.A.8.2.2 apply.

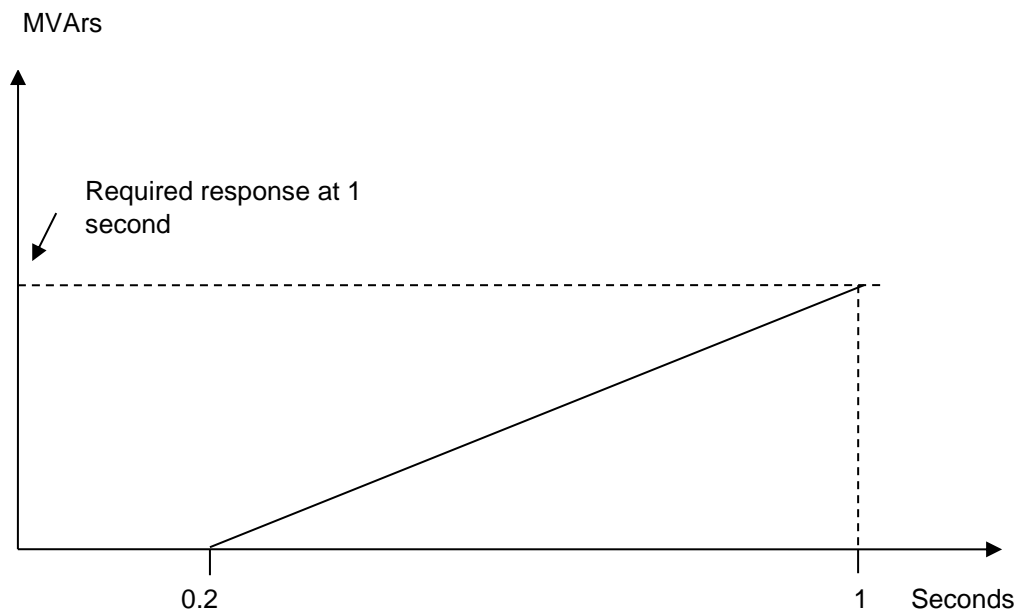

ECC.A.8.2.3.2 Configuration 2 AC connected Offshore Power Park Module or Configuration 2 DC Connected Power Park Module shall be capable of

- (a) changing their **Reactive Power** output from maximum lagging value to maximum leading value, or vice versa, then reverting back to the initial level of **Reactive Power** output once every 15 seconds for at least 5 times within any 5 minute period; and
- (b) changing **Reactive Power** output from zero to maximum leading value then reverting back to zero **Reactive Power** output at least 25 times within any 24 hour period and from zero to its maximum lagging value then reverting back to zero **Reactive Power** output at least 25 times within any 24 hour period. Any subsequent restriction on reactive capability shall be notified to **The Company** in accordance with BC2.5.3.2, and BC2.6.1.

In all cases, the response shall be in accordance to ECC.A.8.2.3.1 where the change in **Reactive Power** output is in response to an on-load step change in **Offshore Grid Entry Point** or **Offshore User System Entry Point** voltage or **HVDC Interface Point** voltage.

ECC.A.8.2.4 Power Oscillation Damping

- ECC.A.8.2.4.1 The requirement for the continuously acting voltage control system to be fitted with a **Power System Stabiliser (PSS)** shall be specified if, in **The Company's** view, this is required for system reasons. However if a **Power System Stabiliser** is included in the voltage control system its settings and performance shall be agreed with **The Company** and commissioned in accordance with BC2.11.2. To allow assessment of the performance before on-load commissioning the **Generator** or **HVDC System Owner** will provide to **The Company** a report covering the areas specified in ECP.A.3.2.2.
- ECC.A.8.2.5 Overall Voltage Control System Characteristics
- ECC.A.8.2.5.1 The continuously acting automatic voltage control system is required to respond to minor variations, steps, gradual changes or major variations in **Offshore Grid Entry Point** or **Offshore User System Entry Point** or **HVDC Interface Point** voltage.
- ECC.A.8.2.5.2 The overall voltage control system shall include elements that limit the bandwidth of the output signal. The bandwidth limiting must be consistent with the speed of response requirements and ensure that the highest frequency of response cannot excite torsional oscillations on other plant connected to the network. A bandwidth of 0-5Hz would be judged to be acceptable for this application. All other control systems employed within the **Configuration 2 AC connected Offshore Power Park Module** or **Configuration 2 DC Connected Power Park Module** should also meet this requirement
- ECC.A.8.2.5.3 The response of the voltage control system (including the **Power System Stabiliser** if employed) shall be demonstrated by testing in accordance with ECP.A.6.
- ECC.A.8.3 Reactive Power Control
- ECC.A.8.3.1 **Reactive Power** control mode of operation is not required in respect of **Configuration 2 AC connected Offshore Power Park Modules** or **Configuration 2 DC Connected Power Park Modules** unless otherwise specified by **The Company**. However where there is a requirement for **Reactive Power** control mode of operation, the following requirements shall apply.
- ECC.A.8.3.2 **Configuration 2 AC connected Offshore Power Park Modules** or **Configuration 2 DC Connected Power Park Modules** shall be capable of setting the **Reactive Power** setpoint anywhere in the **Reactive Power** range as specified in ECC.6.3.2.8.2 with setting steps no greater than 5 MVar or 5% (whichever is smaller) of full **Reactive Power**, controlling the **Reactive Power** at the **Offshore Grid Entry Point** or **Offshore User System Entry Point** or **HVDC Interface Point** to an accuracy within plus or minus 5MVar or plus or minus 5% (whichever is smaller) of the full **Reactive Power**.
- ECC.A.8.3.3 Any additional requirements for **Reactive Power** control mode of operation shall be specified by **The Company**.
- ECC.A.8.4 Power Factor Control
- ECC.A.8.4.1 **Power Factor** control mode of operation is not required in respect of **Configuration 2 AC connected Offshore Power Park Modules** or **Configuration 2 DC Connected Power Park Modules** unless otherwise specified by **The Company**. However where there is a requirement for **Power Factor** control mode of operation, the following requirements shall apply.
- ECC.A.8.4.2 **Configuration 2 AC connected Offshore Power Park Modules** or **Configuration 2 DC Connected Power Park Modules** shall be capable of controlling the **Power Factor** at the **Offshore Grid Entry Point** or **Offshore User System Entry Point** or **HVDC Interface Point** within the required **Reactive Power** range as specified in ECC.6.3.2.8.2 with a target **Power Factor**. **The Company** shall specify the target **Power Factor** (which shall be achieved to within 0.01 of the set **Power Factor**), its tolerance and the period of time to achieve the target **Power Factor** following a sudden change of **Active Power** output. The tolerance of the target **Power Factor** shall be expressed through the tolerance of its corresponding **Reactive Power**.

This **Reactive Power** tolerance shall be expressed by either an absolute value or by a percentage of the maximum **Reactive Power** of the **Configuration 2 AC connected Offshore Power Park Module** or **Configuration 2 DC Connected Power Park Module**. The details of these requirements being specified by **The Company**.

ECC.A.8.4.3 Any additional requirements for **Power Factor** control mode of operation shall be specified by **The Company**.

< END OF EUROPEAN CONNECTION CONDITIONS >

**DEMAND RESPONSE SERVICES CODE
(DRSC)**

CONTENTS

(This contents page does not form part of the Grid Code)

<u>Paragraph No/Title</u>	<u>Page Number</u>
DRSC.1 INTRODUCTION	2
DRSC.2 OBJECTIVE	2
DRSC.3 SCOPE	2
DRSC.4 GENERAL PROVISIONS	3
DRSC.5 SPECIFIC PROVISIONS FOR DEMAND UNITS WITH DEMAND RESPONSE ACTIVE POWER CONTROL AND TRANSMISSION CONSTRAINT MANAGEMENT	3
DRSC.6 SPECIFIC PROVISIONS FOR DEMAND UNITS WITH DEMAND RESPONSE FREQUENCY CONTROL	4
DRSC.7 SPECIFIC PROVISIONS FOR DEMAND UNITS WITH DEMAND RESPONSE VERY FAST ACTIVE POWER CONTROL	4
DRSC.8 DATA REQUIRED BY THE COMPANY FROM DEMAND RESPONSE PROVIDER'S	5
DRSC.9 OPERATIONAL METERING REQUIREMENTS	5
DRSC.10 INSTRUCTIONS ISSUED TO DEMAND RESPONSE PROVIDER'S	5
DRSC.11 OPERATIONAL NOTIFICATION PROCEDURE	5
DRSC.11.1 GENERAL PROVISIONS	5
DRSC 11.2 OPERATIONAL NOTIFICATION PROCEDURES FOR DEMAND RESPONSE PROVIDERS	6
DRSC.11.3 COMPLIANCE	6
DRSC.11.4 COMPLIANCE TESTING	7
DRSC.11.5 COMPLIANCE TESTING FOR DEMAND RESPONSE PROVIDER'S WITH DEMAND RESPONSE ACTIVE POWER CONTROL, REACTIVE POWER CONTROL AND TRANSMISSION CONSTRAINT MANAGEMENT	8
DRSC.11.6 COMPLIANCE SIMULATION	9
APPENDIX I - DRSC.A.2 - DEMAND RESPONSE UNIT DOCUMENT (DRUD) STATEMENT OF COMPLIANCE FOR DEMAND RESPONSE PROVIDER'S	10

PART I

DRSC.1 INTRODUCTION

DRSC.1.1 The **Demand Response Services Code** is concerned with **Demand Response Providers** who contract with **The Company** for the provision of **Ancillary Services**.

DRSC.1.2 **Ancillary Services** are non-mandatory services used by **The Company** in operating the **System**. They are provided by **Demand Response Providers** with payment being dealt with under the terms of the relevant agreement for the **Ancillary Service**.

DRSC.1.3 Where a **Demand Response Provider** is interested in offering an **Ancillary Service** to **The Company**, then further details and additional information of the **Ancillary Services** are available from the Balancing Services section of the **Website**.

DRSC.1.4 Where **The Company** and a **Demand Response Provider** enter into an **Ancillary Services** agreement, it shall be in accordance with **Transmission Licence** condition C16 and the **Standard Contract Terms**.

DRSC 1.5 **The Demand Response Services Code** which would form part of an **Ancillary Services** agreement between a **Demand Response Provider** and **The Company** and to discharge the obligations under **Retained EU Law** (Commission Regulation (EU) 2016/1388). The **Ancillary Services** agreement will include an obligation on the **Demand Response Provider** to satisfy the applicable requirements of this **Demand Response Services Code**.

DRSC.1.6 The **Demand Response Services Code** applies only to **Demand Response Providers** who have entered into an agreement with **The Company** to provide an **Ancillary Service**. This **Demand Response Services Code** does not apply to **Users** who are not **Demand Response Providers**.

DRSC.1.7 For the avoidance of doubt, **Network Operators** and **Non Embedded Customers** in respect of **EU Grid Supply Points** are required to satisfy the compliance requirements in section DRSC.11 of this code in addition to the **European Compliance Processes** only if they are also a **Demand Response Provider**.

DRSC.2 OBJECTIVE

The objectives of the **DRSC** are to

DRSC.2.1 Ensure the obligations of **Retained EU Law** (Commission Regulation (EU) 2016/1388) have been discharged; and

DRSC.2.2 Complement the requirements of the **Ancillary Services** agreement between **The Company** and a **Demand Response Provider**; and

DRSC.2.3 Define the minimum technical and compliance requirements **Demand Response Providers** are required to satisfy if they provide a **Demand Response Service** to **The Company** under an **Ancillary Services** agreement.

DRSC.3 SCOPE

DRSC.3.1 The **DRSC** applies to any **Demand Response Provider** who has entered into an agreement to provide **Ancillary Services** with **The Company**.

DRSC.3.2 The **DRSC** does not apply to **Users**, **BM Participants** or other parties unless they are also a **Demand Response Provider**.

DRSC.4 GENERAL PROVISIONS

DRSC.4.1 **Demand Response Services** shall be based on the following categories.

(a) Controlled by instruction from **The Company**

(i) **Demand Response Active Power Control**

(ii) **Demand Response Reactive Power Control**

(iii) **Demand Response Transmission Constraint Management**

(b) Automatic operation once the facility has been instructed into operation upon instruction from **The Company** pursuant to the terms of the **Ancillary Services** agreement.

(i) **Demand Response System Frequency Control**

(ii) **Demand Response Very Fast Active Power Control**

DRSC.4.2 **Demand Response Providers** who own, operate, control or manage **Plant** and **Apparatus** or **Demand Unit(s)** within a **Demand Facility** and/or **Closed Distribution System(s)** or on an aggregated basis may provide **Demand Response Services** to **The Company**. **Demand Response Providers** can offer **Demand Response Services** on an individual or collective basis and increase or decrease their **Demand** in accordance with the terms of their **Ancillary Services** agreement.

DRSC.4.3 The **Demand Response Services** specified in DRSC.4.1 are not exclusive and do not preclude **Demand Response Providers** from negotiating other services with **The Company**. These services would be pursuant to the terms of the **Ancillary Services** agreement.

DRSC.5 SPECIFIC PROVISIONS FOR DEMAND UNITS WITH DEMAND RESPONSE ACTIVE POWER CONTROL AND TRANSMISSION CONSTRAINT MANAGEMENT

DRSC.5.1 Where a **Demand Response Provider** provides **Demand Response Active Power Control**, **Demand Response Reactive Power Control** or **Demand Response Transmission Constraint Management** to **The Company**, then the following requirements as detailed below shall apply. For the avoidance of doubt, these requirements shall apply either individually or where it is not part of a **Demand Facility**, collectively as part of a **Demand Aggregation** scheme through a **Demand Response Provider**. **Demand Response Providers** shall ensure that any **Demand Unit** which they own, operate, control or manage and which is used to provide **Demand Response Services** shall:-

- (a) Be capable of satisfying the **Frequency** range requirements as specified in ECC.6.1.2.1.
- (b) Be capable of satisfying the voltage range requirements as specified in ECC.6.1.4.1.
- (c) Be capable of controlling the power consumption from the **Total System** in accordance with the terms of the **Ancillary Services** agreement.
- (d) Be capable of receiving instructions from **The Company** either directly or through a third party to modify their demand in accordance with the **Demand Response Service** they have agreed to provide..
- (e) Be capable of adjusting its **Real Power** or **Reactive Power** flow within a time period pursuant to the terms of the **Ancillary Services** agreement.
- (f) Be capable of full execution of an instruction issued by **The Company** to modify its power flow.
- (g) Be capable of further demand changes as instructed by **The Company**, following the execution of a previous instruction issued by **The Company** in accordance with the **Ancillary Services** agreement. Any such instruction shall not exceed the normal safe operating conditions of the **Demand Response Provider's Plant** and **Apparatus** or **Demand Unit(s)** which could cause such equipment to trip. Instructions to modify **Active Power** or **Reactive Power** flow may have immediate or delayed effects but in any event would need to comply with the requirements of the **Ancillary Services** agreement.
- (h) Notify **The Company** of any change in the available capacity in accordance with the relevant **Ancillary Services** agreement.
- (i) Be capable of withstanding a rate of change of **System Frequency** of up to a maximum of 1Hz/s measured over a 500ms time frame.

- DRSC.5.2 In addition to the requirements of DRSC.5.1, where a **Demand Response Provider** automatically modifies its **Demand** in response to changes in **System Frequency** or **System voltage** or both, **The Company** will have previously instructed the **Demand Response Provider** to switch these facilities into service in accordance with the terms of the **Ancillary Services** agreement prior to any automatic action taking place. The ability for **The Company** to issue instructions, receive acknowledgement of those instructions and receive operational metering data (for example voltage, current, **Active Power** and **Reactive Power** signals) from the **Demand Response Provider** will be dependent upon the type of **Demand Response Service** provided and shall be defined in the **Ancillary Services** agreement which shall be pursuant to the **Standard Contract Terms**.
- DRSC.5.3 **Non Embedded Customers** who are also **Demand Response Provider's** shall be capable of providing **Demand Response Reactive Power Control** by switching static compensation equipment into or out of service.
- DRSC.6 SPECIFIC PROVISIONS FOR DEMAND UNITS WITH DEMAND RESPONSE FREQUENCY CONTROL
- DRSC.6.1 Where a **Demand Response Provider** provides **Demand Response System Frequency Control** to **The Company**, then the following requirements as detailed below shall apply. For the avoidance of doubt, these requirements apply either individually or where it is not part of a **Demand Facility**, collectively as part of a **Demand Aggregation** scheme through a **Demand Response Provider**. **Demand Response Providers** shall ensure that any **Plant** and **Apparatus** or **Demand Unit(s)** which they own, operate, control or manage, and which is used to provide **Demand Response System Frequency Control** shall:-
- (a) Be capable of satisfying the **Frequency** range requirements as specified in ECC.6.1.2.1.
 - (b) Be capable of satisfying the voltage range requirements as specified in ECC.6.1.4.1.
 - (c) Be fitted with a deadband facility no greater than 0.03Hz unless otherwise specified in the **Ancillary Services** agreement. This requirement shall not apply to **Demand Response Providers** where only a **Non-Dynamic Frequency Response Service** is provided.
 - (d) The envelope of operation of the **Demand Response System Frequency Control** shall be in accordance with the terms of the **Ancillary Services** agreement. For the avoidance of doubt, continuous operation would not be required in respect of a static **Frequency** response service.
 - (e) Be fitted with a control system which is capable of responding to changes in **System Frequency** outside the nominal value of 50Hz. A deadband either side of nominal **Frequency** shall be permitted which shall be in accordance with the requirement of the **Ancillary Services** agreement.
 - (f) Be equipped with a controller that measures the actual **System Frequency**. The refresh rate for this controller shall be no longer than 0.2 seconds.
 - (g) Be able to detect a change in **System Frequency** of 0.01Hz. Each **Demand Unit** owned, operated, controlled or managed by a **Demand Response Provider** shall be capable of a rapid detection and respond to changes in **System Frequency** which shall be pursuant to the terms of the **Ancillary Services** agreement. An offset in the steady state measurement of **Frequency** shall be acceptable up to 0.05Hz. **Frequency** measurements must be recorded at each **Demand Facility** and must not be derived on an aggregated basis.
- DRSC.7 SPECIFIC PROVISIONS FOR DEMAND UNITS WITH DEMAND RESPONSE VERY FAST ACTIVE POWER CONTROL
- DRSC.7.1 Where a **Demand Response Provider** provides **Demand Response Very Fast Active Power Control** to **The Company**, then the applicable requirements shall be pursuant to the terms of the **Ancillary Services** agreement which shall specify:-
- (a) The relationship between the change in **Active Power** and the rate of change of **System Frequency** over the **Demand** range of the **Demand Response Provider's Demand Unit(s)** which they own, operate, control or manage.

- (b) The operating principles of the **Demand Response Very Fast Active Power Control** and associated performance parameters.
- (c) The response time of the **Demand Response Very Fast Active Power Control** which shall be no longer than 2 seconds from the inception of the **System Frequency** change.

DRSC.8 DATA REQUIRED BY THE COMPANY FROM DEMAND RESPONSE PROVIDER'S

DRSC.8.1 The data required to be submitted to **The Company** by a **Demand Response Provider** will vary depending upon the type of **Demand Response Service** provided and will be set out in the **Ancillary Services** agreement.

DRSC.9 OPERATIONAL METERING REQUIREMENTS

DRSC.9.1 The operational metering data required to be submitted to **The Company** will vary depending upon the type of **Demand Response Service** provided. **Demand Response Providers** may be required to install such operational metering equipment in accordance with the **Ancillary Services** agreement.

DRSC.10 INSTRUCTIONS ISSUED TO DEMAND RESPONSE PROVIDER'S

DRSC.10.1 **Demand Response Providers** may be required to be fitted with communication and instruction facilities to enable **The Company** to instruct them in the operational timeframe. These requirements will vary depending upon the type of **Demand Response Service** provided and will be set out in the **Ancillary Services** agreement.

PART II

COMPLIANCE REQUIREMENTS FOR DEMAND RESPONSE SERVICES

DRSC.11 OPERATIONAL NOTIFICATION PROCEDURE

DRSC.11.1 General Provisions

DRSC.11.1.1 **Demand Response Providers** who enter into an agreement with **The Company** to provide **Ancillary Services** are required to undertake a compliance process to ensure the **Plant** and **Apparatus** or **Demand Unit(s)** which they own, operate, control or manage, satisfies the requirements of the **Ancillary Services** agreement and the **Demand Response Services Code**. For the avoidance of doubt, **Demand Response Providers** who are also **EU Code Users**, will also be required to satisfy the requirements of the applicable requirements of the **European Compliance Processes (ECP's)**.

DRSC.11.1.2 Each **Demand Response Provider**, shall confirm to **The Company** its ability to comply with the requirements of the **Ancillary Services** agreement.

DRSC.11.1.3 Each **Demand Response Provider** shall notify **The Company** of any change to the **Plant** or **Apparatus** which they own, operate, control or manage such they are no longer able to satisfy the conditions specified in the **Ancillary Services** agreement and/or the relevant provisions of the **DRSC**. Such changes shall be notified to **The Company** in accordance with the terms of the **Ancillary Services** agreement.

DRSC.11.2 Operational Notification Procedures for Demand Response Providers

DRSC.11.2.1 All **Demand Response Providers** are required to undertake an **Operational Notification** procedure which shall comprise a **Demand Response Unit Document (DRUD)**.

DRSC.11.2.2 The format of the **Demand Response Unit Document (DRUD)** shall take the form shown

in DRSC.A.1 and shall provide sufficient information to demonstrate the **Plant and Apparatus** or **Demand Unit(s)** which a **Demand Response Provider** owns, operates, controls or manages, is capable of satisfying the full requirements of the **Ancillary Services** agreement and the applicable requirements of the **DRSC**. The compliance requirements can be simplified to a single operational notification stage as well as be reduced as agreed with **The Company**. **Demand Response Providers** shall be required to submit a new **DRUD** for each subsequent **Demand Unit** added to its portfolio.

DRSC.11.2.3 When the **Demand Response Provider** has submitted a final **DRUD** to the satisfaction of **The Company**, which clearly demonstrates full compliance with the **Ancillary Services** agreement, **The Company** shall issue a **Final Operational Notification** to the **Demand Response Provider**.

DRSC.11.3 COMPLIANCE

DRSC.11.3.1 Responsibility of the Demand Response Provider

DRSC.11.3.1.1 **Demand Response Providers** are required to satisfy the requirements of the **Ancillary Services** agreement which shall include satisfying the applicable requirements of this **Demand Response Services Code**.

DRSC.11.3.1.2 Should the **Demand Response Provider** wish to modify the technical capability of the **Plant and Apparatus** or **Demand Unit(s)** which it owns, operates, controls or manages and which affects its compliance with the **Ancillary Services** agreement, it should notify and agree any timescales for the change with **The Company** prior to making any change.

DRSC.11.3.1.3 Any operational incidents or failure of the **Plant and Apparatus** or **Demand Unit(s)** owned, operated, controlled or managed by the **Demand Response Provider** which impacts its ability to satisfy the compliance requirements detailed in this **Demand Response Services Code** shall be notified to **The Company** as soon as possible after occurrence of the incident.

DRSC.11.3.1.4 Any planned test schedules and procedures to verify compliance of the **Plant and Apparatus** or **Demand Unit(s)** owned, operated, controlled or managed by the **Demand Response Provider** shall be submitted to **The Company** in advance of the tests. **The Company** shall assess the test schedules and procedures in a timely manner prior to agreeing that the **Demand Response Provider** can carry out the tests.

DRSC.11.3.1.5 **The Company** may witness such tests and record the performance of the **Plant and Apparatus** owned, operated, controlled or managed by the **Demand Response Provider** to verify compliance with the **Ancillary Services** agreement and the **Demand Response Services Code**.

DRSC.11.3.2 Role of The Company

DRSC.11.3.2.1 **The Company** shall assess the compliance of the **Demand Response Provider** and shall undertake monitoring throughout the life time of the **Plant and Apparatus** or **Demand Unit(s)** owned, operated, controlled or managed by the **Demand Response Provider** to ensure compliance with the requirements of the **Ancillary Services** agreement. **The Company** shall inform the **Demand Response Provider** of the outcome of such assessment.

DRSC.11.3.2.2 **The Company** may require **Demand Response Providers** to carry out compliance tests and simulations according to a repeat plan or general scheme or replacement of equipment which may have an impact on the compliance of the **Plant and Apparatus** or **Demand Units** owned, operated, controlled or managed by the **Demand Response Provider** as detailed in DRSC.11.3.1.3 and DRSC.11.3.1.4. **The Company** shall inform the **Demand Response Provider** of the results of these tests.

- DRSC.11.3.2.3 As part of this compliance process, the **Demand Response Provider** shall provide the following items:-
- (a) Relevant documentation and certificates associated with the compliance process.
 - (b) Details of the technical data required to ensure compliance with the **Ancillary Services** agreement.
 - (c) Steady state and dynamic models (as applicable) of their **Demand Units** or **Plant** and **Apparatus** (or equivalent) as required and agreed with **The Company**.
 - (d) Timelines for the submission of system data required to perform **System** studies.
 - (e) Study results showing the expected steady state and dynamic performance of the **Plant** and **Apparatus** or **Demand Unit(s)** or the performance of their **Demand Response Service** on an aggregated basis as required and agreed with **The Company**.
 - (f) Submission of registered **Equipment Certificates** or otherwise as agreed with **The Company**.
 - (g) Conditions and procedures for the use of relevant **Equipment Certificates** issued by an **Authorised Certifier** to a **Demand Response Provider** or equivalent to the satisfaction of **The Company**.
- DRSC.11.3.2.4 If compliance tests or simulations cannot be carried out as agreed between the **Demand Response Provider** and **The Company** due to reasons attributable to **The Company**, then **The Company** shall not unreasonably withhold the **Operational Notification** referred to in DRSC.11.2.3.
- DRSC.11.4 Compliance Testing
- DRSC.11.4.1 Common Provisions for Compliance Testing
- DRSC.11.4.1.1 The purpose of compliance testing is to ensure that the **Plant** and **Apparatus** or **Demand Unit(s)** owned, operated, controlled or managed by a **Demand Response Provider** is capable of satisfying the requirements of the **Ancillary Services** agreement and applicable sections of this **Demand Response Services Code** in addition to verifying that the models and data submitted provide a true and accurate representation of the **Plant** as built.
- DRSC.11.4.1.2 Notwithstanding the minimum requirements for compliance testing detailed in DRSC.11.4 of this **Demand Response Services Code**, **The Company** shall:-
- (a) Allow the **Demand Response Provider** to carry out an alternative set of tests provided that they are efficient and sufficient to demonstrate that the **Plant** and **Apparatus** or **Demand Unit(s)** owned, operated, controlled or managed by a **Demand Response Provider** is capable of satisfying the requirements of the **Ancillary Services** agreement and the applicable sections of the **Demand Response Services Code**.
 - (b) Require the **Demand Response Provider** to carry out additional or alternative tests (where reasonable) to those specified in DRSC.11.5 where they would otherwise be insufficient to demonstrate compliance with the **Ancillary Services** agreement.
 - (c) Require the **Demand Response Provider** to be responsible for carrying out the tests in accordance with the requirements specified in DRSC.11.4 and DRSC.11.5 of the **Demand Response Services Code**. **The Company** shall cooperate with the **Demand Response Provider** and will not unduly delay the scheduling of the tests.
- DRSC.11.4.1.3 **The Company** may witness such tests (either on site or remotely from **The Company's** control room) to record the performance of the **Demand Response Providers**

capability to verify compliance with the **Ancillary Services** agreement and the **Demand Response Services Code**. Where **The Company** witnesses the tests remotely, the **Demand Response Provider** shall provide the monitoring equipment necessary to record all relevant test signals and measurements in addition to ensuring that necessary representatives from the **Demand Response Provider** are available on site for the entire testing period. Signals specified by **The Company** shall be provided, if for selected tests, **The Company** wishes to use its own equipment to record performance. **The Company** will inform the **Demand Response Provider** if it wishes to witness the tests.

DRSC.11.5 Compliance Testing for Demand Response Providers with Demand Response Active Power Control, Reactive Power Control and Transmission Constraint Management.

DRSC.11.5.1 Demand Modification Tests

DRSC.11.5.1.1 **Demand Response Providers** who have signed an **Ancillary Services** agreement with **The Company** to provide **Demand Response Active Power Control, Demand Response Reactive Power Control** or **Demand Response Transmission Constraint Management**, are required to demonstrate (through site tests) the capability of the **Plant and Apparatus** or **Demand Unit(s)** they own, operate, control or manage to satisfy the requirements of the **Ancillary Services** agreement and the applicable requirements of DRSC.5. The site tests should demonstrate the capability of the **Demand Response Providers** ability to operate with instruction over the agreed timeframes, **Demand** range and duration pursuant to the terms of the **Ancillary Services** agreement. The tests can be completed individually or as part of a **Demand** aggregation scheme.

DRSC.11.5.1.2 The tests shall be carried out either by instruction from **The Company's Control Centre** or by site tests through injections applied to the **Plant and Apparatus** or **Demand Unit(s)** owned, operated, controlled or managed by the **Demand Response Provider**.

DRSC.11.5.1.3 The test shall be deemed as passed if the requirements of the **Ancillary Services** agreement have been satisfied and the applicable requirements of DRSC.5 demonstrated to the satisfaction of **The Company**.

DRSC.11.5.1.4 A list of references to **Equipment Certificates** issued by an **Authorised Certifier** (or otherwise) as agreed with **The Company**, which can be supplied by the **Demand Response Provider** to demonstrate part of the evidence of compliance;

DRSC.11.5.2 Disconnection and Reconnection of Static Compensation Facilities

DRSC.11.5.2.1 **Demand Response Providers** who have signed an **Ancillary Services** agreement with **The Company** to provide **Demand Response Active Power Control, Demand Response Reactive Power Control** or **Demand Response Transmission Constraint Management** and have also agreed to disconnect or reconnect (or both) static compensation facilities when receiving an instruction from **The Company** in accordance with the requirements of the **Ancillary Services** agreement and DRSC.5.3, shall be required to demonstrate the performance of the **Plant and Apparatus** or **Demand Unit(s)** they own, operate, control or manage to satisfy these requirements. These requirements can be demonstrated individually or collectively as part of a demand aggregation scheme.

DRSC.11.5.2.2 The tests shall be carried out either by instruction from **The Company's Control Centre** or by site tests resulting in the disconnection and subsequent re-connection of the static compensation facilities.

DRSC.11.5.2.3 The test shall be deemed as passed if the requirements of the **Ancillary Services** agreement have been satisfied and the applicable requirements of DRSC.5.3 demonstrated to the satisfaction of **The Company**.

DRSC.11.6 Compliance Simulation

DRSC.11.6.1 Common Provisions on Compliance Simulations

DRSC.11.6.1.1 **Demand Response Providers** who agree to provide **Demand Response Very Fast Active Power Control** are required to demonstrate their ability to satisfy the requirements of the **Ancillary Services** agreement and DRSC.7 through necessary simulation studies to the satisfaction of **The Company**.

DRSC.11.6.1.2 **Demand Response Providers** who have contracted to provide a **Demand Response Very Fast Active Power Control** service, are required to submit further simulation studies where there has been a development, replacement or modernisation of the **Plant and Apparatus** or **Demand Unit(s)** owned, operated, controlled or managed by the **Demand Response Provider**, or **The Company** has identified a non-compliance with the **Demand Response Provider's** ability to satisfy the requirements of the **Ancillary Services** agreement or DRSC.7.

DRSC.11.6.1.3 Notwithstanding the requirements of DRSC.11.6.1.1 and DRSC.11.6.1.2 **The Company** shall be entitled to:-

- (a) Allow the **Demand Response Provider** to carry out an alternative set of simulations provided that they are efficient and sufficient to demonstrate that the **Plant and Apparatus** or **Demand Unit(s)** owned, operated, controlled or managed by the **Demand Response Provider** is capable of satisfying the requirements of the **Ancillary Services** agreement and the applicable sections of the **Demand Response Services Code**.
- (b) Require the **Demand Response Provider** to carry out additional or alternative simulations to those specified in DRSC.11.6.1.1 and DRSC.11.6.1.28 where they would otherwise be insufficient to demonstrate compliance with the **Ancillary Services** agreement.

DRSC.11.6.1.4 **The Company** may check that the **Demand Response Provider** complies with the requirements of the **Ancillary Services** agreement and the applicable sections of the **Demand Response Services Code** by carrying out its own compliance simulations based on the simulation reports, models and test measurements.

DRSC.11.6.1.5 **The Company** will supply upon request from the **Demand Response Provider**, data to enable the **Demand Response Provider** to carry out the required simulations in accordance with the requirements of the **Ancillary Services** agreement and DRSC.11.6.

DRSC.11.7 Additional Testing requirements for Non-Embedded Customers and CUSC Parties who are also Demand Response Providers

DRSC.11.7.1 **Non-Embedded Customers** and **CUSC Parties** who are also **Demand Response Providers** shall be required to execute a demand modification test after two consecutive unsuccessful responses in the operational environment or at least every year as agreed with **The Company**.

DRSC.11.7.2 Each **Non-Embedded Customer** and **CUSC Party** who are also **Demand Response Providers** and provide demand response low frequency demand disconnection shall execute a low frequency demand disconnection test at least once every three years.

APPENDIX I – DRSC.A.1

Format of the **Demand Response Unit Document (DRUD)**

**Demand Response Unit Document (DRUD)
Statement of Compliance for Demand Response Providers**

Contract company details

Contracted company name	
Primary contact name	
Contact number /s	
Email address	

Demand Response Service Details

Contract ID	
Type of Demand Response Service type,	
Asset type,	
Unit make up	
Aggregation methodology (if appropriate)	
Maximum capacity of the Demand Response Service (MW)	
Equipment Certificates (as applicable)_	
Unit location/ connection point / ID	
Contract signed date	
Service start date	
Desired test date	

Compliance Requirements

DRSC Requirement	Compliance Y/N	Demand Response Provider Statement
All documentation and certificates demonstrating compliance with the DRSC .		
Details of the technical data required to ensure compliance with the Ancillary Services agreement.		
Steady state and dynamic models (or equivalent information) of Plant and Apparatus or Demand Unit(s) .		
Timelines for the submission of system studies or equivalent data.		
Study results showing the expected steady state and dynamic performance of the Plant and Apparatus or Demand Unit(s)		
Conditions and procedures including the scope for registering Equipment Certificates or otherwise as agreed with The Company .		
Conditions and procedures for the use of relevant Equipment Certificates issued by an Authorised Certifier to a Demand Response Provider .		
Operational Metering Data to be submitted in accordance with Ancillary Services agreement.		
Ability to receive instructions to and from The Company accordance with the Ancillary Services agreement.		

DRSC Requirement	Compliance Y/N	Demand Response Provider Statement
Ability to operate over Frequency range as specified in DRSC.5.1(a).		
Ability to operate over voltage range as specified in DRSC.5.1(b).		
Ability to withstand a rate of change of system frequency up to a maximum of 1Hz per second as measured over a 500ms timeframe as specified in DRSC.5.1(i).		
Non-Embedded Customers who are also Demand Response Providers ability to switch static compensation equipment into or out of service in accordance with DRSC5.3 as applicable.		
Deadband settings as applicable.		
Control system block diagrams, parameters and settings as applicable.		

Declaration
Declaration – to be completed by Customer or the Demand Response Provider's appointed technical representative
I declare that for all the Demand Response Provider's information associated with this contract: 1. Compliance with the requirements of the Demand Response Services Code is achieved. 2. The commissioning checks have been successfully completed.
Name:
Signature:
Company Name:
Position:
Declaration – to be completed by The Company Witnessing Representative if applicable. Delete if not witnessed by the The Company .
I confirm that I have witnessed the commissioning checks in this document on behalf of _____ and that the results are an accurate record of the checks
Name:
Signature:
Company Name:

< END OF DEMAND RESPONSE SERVICES CODE >

EUROPEAN COMPLIANCE PROCESSES

(ECP)

CONTENTS

(This contents page does not form part of the Grid Code)

Paragraph No/Title	Page No
ECP.1 INTRODUCTION	3
ECP.2 OBJECTIVE	4
ECP.3 SCOPE.....	5
ECP.4 CONNECTION PROCESS	5
ECP.5 ENERGISATION OPERATIONAL NOTIFICATION	7
ECP.6 OPERATIONAL NOTIFICATION PROCESSES	7
ECP.6.1 OPERATIONAL NOTIFICATION PROCESS (Type A)	7
ECP.6.2 INTERIM OPERATIONAL NOTIFICATION (Type B and Type C).....	8
ECP.6.3 INTERIM OPERATIONAL NOTIFICATION (Type D and HVDC Equipment).....	12
ECP.7. FINAL OPERATIONAL NOTIFICATION	17
ECP.8 LIMITED OPERATIONAL NOTIFICATION	21
ECP.9 PROCESSES RELATING TO DEROGATIONS.....	25
ECP.10 MANUFACTURER'S DATA & PERFORMANCE REPORT	26
APPENDIX 1	28
NOT USED	28
APPENDIX 2	29
USER SELF CERTIFICATION OF COMPLIANCE (Interim/Final)	29
APPENDIX 3	30
SIMULATION STUDIES.....	30
APPENDIX 4	41
ONSITE SIGNAL PROVISION FOR WITNESSING TESTS	41
APPENDIX 5	44
COMPLIANCE TESTING OF SYNCHRONOUS POWER GENERATING MODULES ..	44
ECP.A.5.2 Excitation System Open Circuit Step Response Tests	45
ECP.A.5.3 Open & Short Circuit Saturation Characteristics	45
ECP.A.5.6 Over-excitation Limiter Performance Test	48
ECP.A.5.8 Governor and Load Controller Response Performance	50
ECP.A.5.9 Compliance with ECC.6.3.3 Functionality Test.....	54
APPENDIX 6	55
COMPLIANCE TESTING OF POWER PARK MODULES	55
APPENDIX 7	67

COMPLIANCE TESTING FOR HVDC EQUIPMENT	67
APPENDIX 8	76
SIMULATION STUDIES AND COMPLIANCE TESTING FOR NETWORK OPERATORS AND NON-EMBEDDED CUSTOMERS PLANT AND APPARATUS	76

EUROPEAN COMPLIANCE PROCESSES

ECP.1 INTRODUCTION

ECP.1.1 The **European Compliance Processes** ("ECP") specifies the compliance process in relation to directly connected and **Embedded Power Stations** (subject to a **Bilateral Agreement**), **HVDC Systems**, and **Network Operator's** or **Non-Embedded Customer's Plant and Apparatus**. For the avoidance of doubt, the requirements of the **European Compliance Processes** do not apply to **Demand Response Providers** unless they are also an **EU Code User** and have entered into a **CUSC Contract** with **The Company**. **Generators** in respect of **Electricity Storage Modules** are required to meet the requirements of this **ECC** but are not required to satisfy the requirements of **Retained EU Law** (Commission Regulation (EU) 2016/631, Commission Regulation (EU) 2016/1388 or Commission Regulation (EU) 2016/1485). Any derogation in respect of **Electricity Storage Modules** would therefore be against the GB Grid Code as the requirements applicable to **Electricity Storage Modules** are not enforceable by EU Law:

(i) **Type A Power Generating Modules:**

the process for issuing and receiving an **Installation Document** which must be followed by **The Company** and any **User** with a **Type A Power Generating Module** to demonstrate its compliance with the **Grid Code** in relation to its **Plant** and **Apparatus** prior to the relevant **Plant** and **Apparatus** being energised.

(ii) **Type B, Type C or Type D Power Generating Modules and HVDC Systems:**

the process (leading to an **Energisation Operational Notification**) which must be followed by **The Company** and any **User** with a **Type B, Type C or Type D Power Generating Module** or **HVDC System** to demonstrate its compliance with the **Grid Code** in relation to its **Plant** and **Apparatus** (including **OTSUA**) prior to the relevant **Plant** and **Apparatus** (including any **OTSUA**) being energised.

the process (leading to an **Interim Operational Notification** and **Final Operational Notification**) which must be followed by **The Company** and any **User** with a **Type B, Type C or Type D Power Generating Module** or **HVDC System** or **HVDC System Owner** to demonstrate its compliance with the **Grid Code** in relation to its **Plant** and **Apparatus** (including and dynamically controlled **OTSUA**). This process shall be followed prior to and during the course of the relevant **Plant** and **Apparatus** (including **OTSUA**) being energised and **Synchronised**.

the process (leading to a **Limited Operational Notification**) which must be followed by **The Company** and each **User** with a **Type B, Type C or Type D Power Generating Module** or **HVDC System** where any of its **Plant** and/or **Apparatus** (including any **OTSUA**) becomes unable to comply with relevant provisions of the **Grid Code**, and where applicable with Appendices F1 to F5 of the **Bilateral Agreement** (and in the case of **OTSUA** Appendices OF1 to OF5 of the **Bilateral Agreement**). This process also includes when changes or **Modifications** are made to **Plant** and/or **Apparatus** (including **OTSUA**). This process applies to such **Plant** and/or **Apparatus** after the **Plant** and/or **Apparatus** has become **Operational** and until **Disconnected** from the **Total System**, (or until, in the case of

OTSUA, the **OTSUA Transfer Time**) when changes or **Modifications** are made.

(iii) **Network Operator's or Non-Embedded Customer's Plant and Apparatus:**

the process (leading to an **Energisation Operational Notification**) which must be followed by **The Company** and any **Network Operator** or **Non-Embedded Customer** to demonstrate its compliance with the **Grid Code** in relation to its **Plant** and **Apparatus** prior to the relevant **Plant** and **Apparatus** being energised.

the process (leading to an **Interim Operational Notification** and **Final Operational Notification**) which must be followed by **The Company** and any **Network Operator** or **Non-Embedded Customer** to demonstrate its compliance with the **Grid Code** in relation to its **Plant** and **Apparatus**. This process shall be followed prior to and during the course of the relevant **Plant** and **Apparatus** being energised and operated by using the grid connection.

the process (leading to a **Limited Operational Notification**) which must be followed by **The Company** and each **Network Operator** or **Non-Embedded Customer** where any of its **Plant** and/or **Apparatus** becomes unable to comply with relevant provisions of the **Grid Code**, and where applicable with Appendices F1 to F5 of the **Bilateral Agreement**. This process also includes changes or **Modifications** made to the **Plant** and/or **Apparatus**. This process applies to such **Plant** and/or **Apparatus** after the **Plant** and/or **Apparatus** has become operational and until **Disconnected** from the **Transmission System**.

ECP.1.2 As used in the **ECP**, references to **OTSUA** means **OTSUA** to be connected or connected to the **National Electricity Transmission System** prior to the **OTSUA Transfer Time**.

ECP.1.3 Where a **Generator** or **HVDC System Owner** and/or **The Company** are required to apply for a derogation to the **Authority**, this is not in respect of **OTSUA**.

ECP.1.4 In the case of an **Electricity Storage Plant** comprising of separate generating units and demand taking plant (eg a pump) then compliance would be assessed individually on the generating units and the demand taking elements.

ECP.2 OBJECTIVE

ECP.2.1 The objective of the **ECP** is to ensure that there is a clear and consistent process for demonstration of compliance by **Users** with the **European Connection Conditions** and **Bilateral Agreement** and will enable **The Company** to comply with its statutory and **Transmission Licence** obligations. For the avoidance of doubt, the requirements of the **European Compliance Processes** do not apply to **Demand Response Providers** unless they are also an **EU Code User** and have entered into a **CUSC Contract** with **The Company**.

ECP.2.2 Provisions of the **ECP** which apply in relation to **OTSDUW** and **OTSUA** shall (in any particular case) apply up to the **OTSUA Transfer Time**, whereupon such provisions shall (without prejudice to any prior non-compliance) cease to apply.

ECP.2.3 In relation to **OTSDUW**, provisions otherwise to be contained in a **Bilateral Agreement** may be contained in the **Construction Agreement**, and accordingly a reference in the **ECP** to a relevant **Bilateral Agreement** includes the relevant **Construction Agreement**.

ECP.3 SCOPE

ECP.3.1 The **ECP** applies to **The Company** and to **Users**, which in the **ECP** means:

- (a) **EU Generators** (other than in relation to **Embedded Power Stations** not subject to a **Bilateral Agreement**) including those undertaking **OTSDUW**.
- (b) **Network Operators** who are either;
 - (i) **EU Code Users** in respect of their entire distribution **System**; or
 - (ii) **GB Code Users** in respect of their **EU Grid Supply Points** only
- (c) **Non-Embedded Customers** who are **EU Code Users**;
- (d) **HVDC System Owners** (other than those which only have **Embedded HVDC Systems** not subject to a **Bilateral Agreement**).

ECP.3.2 The above categories of **User** will become bound by the **ECP** prior to them generating, distributing, supplying or consuming, or in the case of **OTSUA**, transmitting, as the case may be, and references to the various categories should, therefore, be taken as referring to them in that prospective role.

ECP.3.3 For the avoidance of doubt, **Demand Response Providers** do not need to satisfy the requirements of this **ECP** unless they are also defined as an **EU Code User** and have a **CUSC Contract** with **The Company**. Where a **Demand Response Provider** is not an **EU Code User** and does not have a **CUSC Contract** with **The Company**, the requirements of the **Demand Response Services Code** shall only apply.

ECP.3.4 For the avoidance of doubt, this **ECP** does not apply to **GB Code Users** other than in respect of **Network Operator's EU Grid Supply Points**.

ECP.4 CONNECTION PROCESS

ECP.4.1 The **CUSC Contract(s)** contain certain provisions relating to the procedure for connection to the **National Electricity Transmission System** or, in the case of **Embedded Power Stations** or **Embedded HVDC Systems**, becoming operational and include provisions to be complied with by **Users** prior to and during the course of **The Company** notifying the **User** that it has the right to become operational. In addition to such provisions, this **ECP** sets out in further detail the processes to be followed to demonstrate compliance. While this **ECP** does not expressly address the processes to be followed in the case of **OTSUA** connecting to a **Network Operator's User System** prior to **OTSUA Transfer Time**, the processes to be followed by **The Company** and the **Generator** in respect of the **OTSUA** in such circumstances shall be consistent with those set out below by reference to **OTSUA** directly connected to the **National Electricity Transmission System**.

- ECP.4.2 The provisions contained in ECP.5 to ECP.7 detail the process to be followed in order for the **User's Plant** and **Apparatus** (including **OTSUA**) to become operational. This process includes
- (i) the acceptance of an **Installation Document** for a **Type A Power Generating Module**;
 - (ii) for energisation an **EON** for **Type B, Type C** or **Type D Power Generating Modules**, or **HVDC Equipment** or **Network Operator's** or **Non-Embedded Customer's Plant** and **Apparatus**;
 - (iii) for synchronising an **ION** for **Type B, Type C** or **Type D Power Generating Modules** or **HVDC Equipment**;
 - (iv) for operating by using the **Grid Supply Point** an **ION** for;
 - a. **Network Operators** who are **EU Code Users** in respect of their entire distribution **System**;
 - b. **Network Operators** who are **GB Code Users** in respect of their **EU Grid Supply Points** only; or
 - c. **Non-Embedded Customers** who are **EU Code Users**;
 - (v) for final certification a **FON**.
- ECP.4.2.1 The provisions contained in ECP.5 relate to the connection and energisation of **User's Plant** and **Apparatus** (including **OTSUA**) to the **National Electricity Transmission System** or where **Embedded**, to a **User's System**.
- ECP.4.2.2 The provisions contained in ECP.6 and ECP.7 provide the process for **Generators, HVDC System Owners, Network Operators** and **Non-Embedded Customers** to demonstrate compliance with the **Grid Code** and with, where applicable, the **CUSC Contract(s)** prior to and during the course of such **Generator's, HVDC System Owner's** (including **OTSUA** up to the **OTSUA Transfer Time**), **Network Operator's** and **Non-Embedded Customer's Plant** and **Apparatus**) becoming operational.
- ECP.4.2.3 The provisions contained in ECP.8 detail the process to be followed when:
- (a) a **Generator's** or **HVDC System Owner's**, or **Network Operator's** or **Non-Embedded Customer's Plant** and/or **Apparatus** (including the **OTSUA**) is unable to comply with any provisions of the **Grid Code** and **Bilateral Agreement**; or,
 - (b) following any notification by a **Generator** or a **HVDC System Owner** or a **Network Operator** or a **Non-Embedded Customer** under the **PC** of any change to its **Plant** and **Apparatus** (including any **OTSUA**); or,
 - (c) a **Modification** to a **Generator's** or a **HVDC System Owner's** or a **Network Operator's** or a **Non-Embedded Customer's Plant** and/or **Apparatus**.
- ECP.4.3 **Embedded Medium Power Stations not subject to a Bilateral Agreement and Embedded HVDC Equipment not subject to a Bilateral Agreement**
- ECP.4.3.1 In the case of **Embedded Medium Power Stations** not subject to a **Bilateral Agreement** and **Embedded HVDC Systems** not subject to a **Bilateral Agreement**, ensuring the obligations of the **ECC** and Appendix E of the relevant **Bilateral Agreement** between **The Company** and the host **Network Operator** are performed and discharged by the relevant party. For the avoidance of doubt the process in this **ECP** does not apply to **Embedded**

Medium Power Stations not subject to a **Bilateral Agreement** and **Embedded HVDC Equipment** not subject to a **Bilateral Agreement**.

ECP.5 ENERGISATION OPERATIONAL NOTIFICATION

ECP.5.1 The following provisions apply in relation to the issue of an **Energisation Operational Notification** in respect of a **Power Station** consisting of **Type B, Type C or Type D Power Generating Modules** or an **HVDC System** or a **Network Operator's** or a **Non-Embedded Customer's Plant and Apparatus**.

ECP.5.1.1 Certain provisions relating to the connection and energisation of the **User's Plant and Apparatus** at the **Connection Site** and **OTSUA** at the **Transmission Interface Point** and in certain cases of **Embedded Plant and Apparatus** are specified in the **CUSC** and/or **CUSC Contract(s)**. For other **Embedded Plant and Apparatus**, the **Distribution Code**, the **DCUSA** and the **Embedded Development Agreement** for the connection specify equivalent provisions. Further detail on this is set out in ECP.5 below.

ECP.5.2 The items for submission prior to the issue of an **Energisation Operational Notification** are set out in ECC.5.2.

ECP.5.3 In the case of a **Generator** or **HVDC System Owner** the items referred to in ECC.5.2 shall be submitted using the **Power Generating Module Document** or **User Data File Structure** as applicable.

ECP.5.4 Not less than 28 days, or such shorter period as may be acceptable in **The Company's** reasonable opinion, prior to the **User** wishing to energise its **Plant and Apparatus** (including passive **OTSUA**) for the first time, the **User** will submit to **The Company** a Certificate of Readiness to Energise **High Voltage** Equipment which specifies the items of **Plant and Apparatus** (including **OTSUA**) ready to be energised in a form acceptable to **The Company**.

ECP.5.5 If the relevant obligations under the provisions of the **CUSC** and/or **CUSC Contract(s)** and the conditions of ECP.5 have been completed to **The Company's** reasonable satisfaction then **The Company** shall issue an **Energisation Operational Notification**. Any dynamically controlled reactive compensation **OTSUA** (including Statcoms or Static Var Compensators) shall not be **Energised** until the appropriate **Interim Operational Notification** has been issued in accordance with ECP.6.

ECP.6 OPERATIONAL NOTIFICATION PROCESSES

ECP.6.1 OPERATIONAL NOTIFICATION PROCESS (Type A)

ECP.6.1.1 The following provisions apply in relation to the notification process in respect of a **Power Station** consisting of **Type A Power Generating Modules**.

ECP.6.1.2 Not less than 7 days, or such shorter period as may be acceptable in **The Company's** reasonable opinion, prior to the **Generator** wishing to **Synchronise** its **Plant and Apparatus** for the first time, the **Generator** will:

submit to **The Company**, a **Notification of the User's Intention to Connect**; and

submit to **The Company** an **Installation Document** containing at least but not limited to the items referred to at ECP.6.1.3.

- ECP.6.1.3 Items for submission prior to connection.
- ECP.6.1.3.1 Prior to the issue of an acknowledgment to connect, the **Generator** must submit to **The Company**, to **The Company's** satisfaction, an **Installation Document** containing at least but not limited to:
- (i) The location at which the connection is made;
 - (ii) The date of the connection;
 - (iii) The **Maximum Capacity** of the installation in kW;
 - (iv) The type of primary energy source;
 - (v) The classification of the **Power Generating Module** as an emerging technology;
 - (vi) A list of references to **Equipment Certificates** issued by an authorised certifier or otherwise agreed with **The Company** used for equipment that is installed at the site or copies of the relevant **Equipment Certificates** issued by an **Authorised Certifier** or otherwise where these are relied upon as part of the evidence of compliance;
 - (vii) As regards equipment used, for which an **Equipment Certificate** has not been received, information shall be provided as directed by **The Company** or the **Relevant Network Operator**; and
 - (viii) The contact details of the **Generator** and the installer and their signatures.
- ECP.6.1.3.2 The items referred to in ECP.6.1.3 shall be submitted by the **Generator** in the form of an **Installation Document** for each applicable **Power Generating Module**.
- ECP.6.1.4 No **Power Generating Module** shall be **Synchronised** to the **Total System** until the later of:
- (a) the date specified by the **Generator** in the **Installation Document** issued in respect of each applicable **Power Generating Module(s)**; and,
 - (b) acknowledgement is received from **The Company** confirming receipt of the **Installation Document**.
- ECP.6.1.5 When the requirements of ECP.6.1.2 to ECP.6.1.4 have been met, **The Company** will notify the **Generator** that the **Power Generating Module** may (subject to the **Generator** having fulfilled the requirements of ECP.6.1.3 where that applies) be **Synchronised** to the **Total System**.
- ECP.6.1.6 Not less than 7 days, or such shorter period as may be acceptable in **The Company's** reasonable opinion, prior to the **Generator** wishing to decommission its **Plant** and **Apparatus**, the **Generator** will submit to **The Company** a **Notification of User's Intention to Disconnect**.
- ECP.6.2 INTERIM OPERATIONAL NOTIFICATION (Type B and Type C)
- ECP.6.2.1 The following provisions apply in relation to the issue of an **Interim Operational Notification** in respect of a **Power Station** consisting of **Type B** and/or **Type C Power Generating Modules**.

ECP.6.2.2 Not less than 28 days, or such shorter period as may be acceptable in **The Company's** reasonable opinion, prior to the **Generator** wishing to **Synchronise** its **Plant** and **Apparatus** or dynamically controlled **OTSUA** for the first time the **Generator or HVDC Equipment** owner will:

- (i) submit to **The Company** a **Notification of User's Intention to Synchronise**; and
- (ii) submit to **The Company** an initial **Power Generating Module Document** containing at least but not limited to the items referred to at ECP.6.2.3.

ECP.6.2.3 Items for submission prior to issue of the **Interim Operational Notification**.

ECP.6.2.3.1 Prior to the issue of an **Interim Operational Notification** in respect of the **EU Code User's Plant** and **Apparatus** or dynamically controlled **OTSUA**, the **Generator** must submit to **The Company** to **The Company's** satisfaction an Interim **Power Generating Module Document** containing at least but not limited to:

- (i) updated **Planning Code** data (both **Standard Planning Data** and **Detailed Planning Data**), with any estimated values assumed for planning purposes confirmed or, where practical, replaced by validated actual values and by updated estimates for the future and by updated forecasts for **Forecast Data** items such as **Demand**;
- (ii) for **Type C Power Generating Modules** the simulation models;
- (iii) details of any special **Power Generating Module(s)** protection as required by ECC.6.2.2.3. This may include Pole Slipping protection and islanding protection schemes as applicable;
- (iv) simulation study provisions of Appendix ECP.A.3 and the results demonstrating compliance with **Grid Code** requirements of:

PC.A.5.4.2
PC.A.5.4.3.2,
ECC.6.3.4,
ECC.6.3.7.3.1 to ECC.6.3.7.3.6,
ECC.6.3.15, ECC.6.3.16
ECC.A.6.2.5.6
ECC.A.7.2.3.1

as applicable to the **Power Generating Module(s)** or dynamically controlled **OTSUA** unless agreed otherwise by **The Company**;

- (v) a detailed schedule of the tests and the procedures for the tests required to be carried out by the **Generator** under ECP.7.2 to demonstrate compliance with relevant **Grid Code** requirements. Such schedule to be consistent with Appendix ECP.A.5 (in the case of a **Synchronous Power Generating Module**) or Appendix ECP.A.6 (in the case of a **Power Park Modules**) and **OTSUA** as applicable);
- (vi) copies of **Manufacturer's Test Certificates** or **Equipment Certificates** issued by an **Authorised Certifier** or equivalent as agreed with **The Company** where these are relied upon as part of the evidence of compliance; and

- (vii) a **Compliance Statement** and a **User Self Certification of Compliance** completed by the **EU Code User** (including any **Unresolved Issues**) against the relevant **Grid Code** requirements including details of any requirements that the **Generator** has identified that will not or may not be met or demonstrated.

ECP.6.2.3.2 The items referred to in ECP.6.2.3 shall be submitted by the **Generator** in the form of a **Power Generating Module Document (PGMD)** for each applicable **Power Generating Module**.

ECP.6.2.4 No **Generating Unit** or dynamically controlled **OTSUA** shall be **Synchronised** to the **Total System** (and for the avoidance of doubt, dynamically controlled **OTSUA** will not be able to transmit) until the later of:

- (a) the date specified by **The Company** in the **Interim Operational Notification** issued in respect of each applicable **Power Generating Module(s)** or dynamically controlled **OTSUA**; and,

- (b) in the case of **Synchronous Power Generating Module(s)** only after the date of receipt by the **Generator** of written confirmation from **The Company** that the **Synchronous Power Generating Module** or **CCGT Module** as applicable has completed the following tests to demonstrate compliance with the relevant provisions of the **Connection Conditions** to **The Company's** satisfaction:

- (i) those tests required to establish the open and short circuit saturation characteristics of the **Synchronous Power Generating Module** (as detailed in Appendix ECP.A.4.3) to enable assessment of the short circuit ratio in accordance with ECC.6.3.2. Such tests may be carried out at a location other than the **Power Station** site and supplied in the form of an **Equipment Certificate** or as otherwise agreed by **The Company**; and

- (ii) open circuit step response tests (as detailed in Appendix ECP.A.5.2) to demonstrate compliance with ECC.A.6.2.4.1.

ECP.6.2.5 **The Company** shall assess the schedule of tests submitted by the **Generator** with the **Notification of User's Intention to Synchronise** under ECP.6.2.3 and shall determine whether such schedule has been completed to **The Company's** satisfaction.

ECP.6.2.6 When the requirements of ECP.6.2.2 to ECP.6.2.5 have been met, **The Company** will notify the **Generator** that the:
Synchronous Power Generating Module,
CCGT Module,
Power Park Module or
Dynamically controlled **OTSUA**

as applicable may (subject to the **Generator** having fulfilled the requirements of ECP.6.2.3 where that applies) be **Synchronised** to the **Total System** through the issue of an **Interim Operational Notification**. Where the **Generator** is undertaking **OTSDUW** then the **Interim Operational Notification** will be in two parts, with the "**Interim Operational Notification Part A**" applicable to **OTSUA** and the "**Interim Operational Notification Part B**" applicable to the **EU Code Users Plant and Apparatus**. For the avoidance of doubt, the "**Interim Operational Notification Part A**" and the "**Interim Operational Notification Part B**" can be issued together or at different times. In respect of an **Embedded Power Station** or **Embedded HVDC Equipment**

Station (other than an **Embedded Medium Power Stations** not subject to a **Bilateral Agreement** and **Embedded HVDC Equipment Stations** not subject to a **Bilateral Agreement**), **The Company** will notify the **Network Operator** that an **Interim Operational Notification** has been issued.

- ECP.6.2.6.1 The **Interim Operational Notification** will be time limited, the expiration date being specified at the time of issue. The **Interim Operational Notification** may be renewed by **The Company**.
- ECP.6.2.6.2 The **Generator** must operate the **Power Generating Module** or **OTSUA** in accordance with the terms, arising from the **Unresolved Issues**, of the **Interim Operational Notification**. Where practicable, **The Company** will discuss such terms with the **Generator** prior to including them in the **Interim Operational Notification**.
- ECP.6.2.6.3 The **Interim Operational Notification** will include the following limitations:
- (a) In the case of **OTSUA**, the **Interim Operational Notification Part A** permits **Synchronisation** of the dynamically controlled **OTSUA** to the **Total System** only for the purposes of active control of voltage and reactive power and not for the purpose of exporting **Active Power**.
 - (b) In the case of a **Power Park Module** the **Interim Operational Notification** (and where **OTSDUW Arrangements** apply, this reference will be to the **Interim Operational Notification Part B**) will limit the proportion of the **Power Park Module** which can be simultaneously **Synchronised** to the **Total System** such that neither of the following figures is exceeded:
 - (i) 20% of the **Maximum Capacity** of the **Power Park Module** (or the output of a single **Power Park Unit** where this exceeds 20% of the **Power Station's Maximum Capacity**)until the **Generator** has completed the voltage control tests (detailed in ECP.A.6.2) (including in respect of any dynamically controlled **OTSUA**) to **The Company's** reasonable satisfaction. Following successful completion of this test each additional **Power Park Unit** should be included in the voltage control scheme as soon as is technically possible (unless **The Company** agrees otherwise).
 - (c) In the case of a **Synchronous Power Generating Module** employing a static **Excitation System** the **Interim Operational Notification** (and where **OTSDUW Arrangements** apply, this reference will be to the **Interim Operational Notification Part B**) may, if applicable, limit the maximum **Active Power** output and **Reactive Power** output of the **Synchronous Power Generating Module** or **CCGT module** prior to the successful commissioning of the **Power System Stabiliser** to **The Company's** satisfaction, if applicable.
- ECP.6.2.6.4 Operation in accordance with the **Interim Operational Notification** whilst it is in force will meet the requirements for compliance by the **Generator** and **The Company** of all the relevant provisions of the **European Connection Conditions**.
- ECP.6.2.7 Other than **Unresolved Issues** that are subject to tests required under ECP.7.2 to be witnessed by **The Company**, the **Generator** must resolve any **Unresolved Issues** prior to the commencement of the tests, unless **The Company** agrees to a later resolution. The **Generator** must liaise with **The**

Company in respect of such resolution. The tests that may be witnessed by **The Company** are specified in ECP.7.2.

ECP.6.2.8 Not less than 28 days, or such shorter period as may be acceptable in **The Company's** reasonable opinion, prior to the **Generator** wishing to commence tests required under ECP.7 to be witnessed by **The Company**, the **Generator** will notify **The Company** that the **Power Generating Module(s)** as applicable is ready to commence such tests.

ECP.6.2.9 The items referred to at ECP.7.3 shall be submitted by the **Generator** after successful completion of the tests required under ECP.7.2.

ECP.6.3 INTERIM OPERATIONAL NOTIFICATION (Type D and HVDC Equipment)

ECP.6.3.1 The following provisions apply in relation to the issue of an **Interim Operational Notification** in respect of a **Power Station** consisting of **Type D Power Generating Modules** or an **HVDC System**.

ECP.6.3.2 Not less than 28 days, or such shorter period as may be acceptable in **The Company's** reasonable opinion, prior to the **Generator** or **HVDC System Owner** wishing to **Synchronise** its **Plant** and **Apparatus** or dynamically controlled **OTSUA** for the first time the **Generator** or **HVDC System Owner** will:

- i. submit to **The Company** a **Notification of User's Intention to Synchronise**; and
- ii. submit to **The Company** the items referred to at ECP.6.3.3.

ECP.6.3.3 Items for submission prior to issue of the **Interim Operational Notification**.

ECP.6.3.3.1 Prior to the issue of an **Interim Operational Notification** in respect of the **EU Code User's Plant** and **Apparatus** or dynamically controlled **OTSUA** the **Generator** or **HVDC System Owner** must submit to **The Company** to **The Company's** satisfaction:

- (a) updated **Planning Code** data (both **Standard Planning Data** and **Detailed Planning Data**), with any estimated values assumed for planning purposes confirmed or, where practical, replaced by validated actual values and by updated estimates for the future and by updated forecasts for **Forecast Data** items such as **Demand**;
- (b) details of any special **Power Generating Module(s)** or **HVDC Equipment** protection as applicable. This may include Pole Slipping protection and islanding protection schemes;
- (c) any items required by ECP.5.2, updated by the **EU Code User** as necessary;
- (d) simulation study provisions of Appendix ECP.A.3 and the results demonstrating compliance with **Grid Code** requirements of:

PC.A.5.4.2
PC.A.5.4.3.2,
ECC.6.3.4,
ECC.6.3.7.3.1 to ECC.6.3.7.3.6,
ECC.6.3.15, ECC.6.3.16
ECC.A.6.2.5.6
ECC.A.7.2.3.1

as applicable to the **Power Station, Synchronous Power Generating Module(s), Power Park Module(s), HVDC Equipment** or dynamically controlled **OTSUA** unless agreed otherwise by **The Company**;

- (e) a detailed schedule of the tests and the procedures for the tests required to be carried out by the **Generator** or **HVDC System Owner** under ECP.7.2 to demonstrate compliance with relevant **Grid Code** requirements. Such schedule to be consistent with Appendix ECP.A.5 (in the case of **Synchronous Power Generating Modules**) or Appendix ECP.A.6 (in the case of **Power Park** Modules and **OTSUA** as applicable) or Appendix ECP.A.7 (in the case of **HVDC Equipment**); and
- (f) an interim **Compliance Statement** and a **User Self Certification of Compliance** completed by the **EU Code User** (including any **Unresolved Issues**) against the relevant **Grid Code** requirements including details of any requirements that the **Generator** or **HVDC System Owner** has identified that will not or may not be met or demonstrated.

ECP.6.3.3.2 The items referred to in ECP.6.3.3 shall be submitted by the **Generator** or **HVDC System Owner** using the **User Data File Structure**.

ECP.6.3.4 No **Power Generating Module** or **HVDC Equipment** shall be **Synchronised** to the **Total System** (and for the avoidance of doubt, dynamically controlled **OTSUA** will not be able to transmit) until the later of:

- (a) the date specified by **The Company** in the **Interim Operational Notification** issued in respect of the **Power Generating Module(s)** or **HVDC Equipment** or dynamically controlled **OTSUA**; and,
- (b) if **Embedded**, the date of receipt of a confirmation from the **Network Operator** in whose **System** the **Plant and Apparatus** is connected that it is acceptable to the **Network Operator** that the **Plant and Apparatus** be connected and **Synchronised**; and,
- (c) in the case of **Synchronous Power Generating Module(s)** only after the date of receipt by **Generator** of written confirmation from **The Company** that the **Synchronous Power Generating Module** has completed the following tests to demonstrate compliance with the relevant provisions of the **Connection Conditions** to **The Company's** satisfaction:
 - (i) those tests required to establish the open and short circuit saturation characteristics of the **Synchronous Power Generating Module** (as detailed in Appendix ECP.A.5.3) to enable assessment of the short circuit ratio in accordance with ECC.6.3.2. Such tests may be carried out at a location other than the **Power Station** site; and
 - (ii) open circuit step response tests (as detailed in Appendix ECP.A.5.2) to demonstrate compliance with ECC.A.6.2.4.1.

ECP.6.3.5 **The Company** shall assess the schedule of tests submitted by the **Generator** or **HVDC System Owner** with the **Notification of User's Intention to Synchronise** under ECP.6.3.1 and shall determine whether such schedule has been completed to **The Company's** satisfaction.

ECP.6.3.6 When the requirements of ECP.6.3.2 to ECP.6.3.5 have been met, **The Company** will notify the **Generator** or **HVDC System Owner** that the:
Synchronous Power Generating Module,
CCGT Module,
Power Park Module
Dynamically controlled **OTSUA** or
HVDC Equipment,

as applicable may (subject to the **Generator** or **HVDC System Owner** having fulfilled the requirements of ECP.6.3.3 where that applies) be **Synchronised** to the **Total System** through the issue of an **Interim Operational Notification**. Where the **Generator** is undertaking **OTSDUW** then the **Interim Operational Notification** will be in two parts, with the “**Interim Operational Notification Part A**” applicable to **OTSUA** and the “**Interim Operational Notification Part B**” applicable to the **EU Code Users Plant** and **Apparatus**. For the avoidance of doubt, the “**Interim Operational Notification Part A**” and the “**Interim Operational Notification Part B**” can be issued together or at different times. In respect of an **Embedded Power Station** or **Embedded HVDC Equipment Station** (other than **Embedded Medium Power Stations** not subject to a **Bilateral Agreement** and **Embedded HVDC Equipment** not subject to a **Bilateral Agreement**), **The Company** will notify the **Network Operator** that an **Interim Operational Notification** has been issued.

ECP.6.3.6.1 The **Interim Operational Notification** will be time limited, the expiration date being specified at the time of issue. The **Interim Operational Notification** may be renewed by **The Company** for up to a maximum of 24 months from the date of the first issue of the **Interim Operational Notification**. **The Company** may only issue an extension to an **Interim Operational Notification** beyond 24 months provided the **Generator** or **HVDC System Owner** has applied for a derogation for any remaining **Unresolved Issues** to the **Authority** as detailed in ECP.9.

ECP.6.3.6.2 The **Generator** or **HVDC System Owner** must operate the **Power Generating Module** or **HVDC Equipment** in accordance with the terms, arising from the **Unresolved Issues**, of the **Interim Operational Notification**. Where practicable, **The Company** will discuss such terms with the **Generator** or **HVDC System Owner** prior to including them in the **Interim Operational Notification**.

ECP.6.3.6.3 The **Interim Operational Notification** will include the following limitations:

- (a) In the case of **OTSUA**, the **Interim Operational Notification Part A** permits **Synchronisation** of the dynamically controlled **OTSUA** to the **Total System** only for the purposes of active control of voltage and **Reactive Power** and not for the purpose of exporting **Active Power**.
- (b) In the case of a **Power Park Module** the **Interim Operational Notification** (and where **OTSDUW** Arrangements apply, this reference will be to the **Interim Operational Notification Part B**) will limit the proportion of the **Power Park Module** which can be simultaneously **Synchronised** to the **Total System** such that neither of the following figures is exceeded:
 - (i) 20% of the **Maximum Capacity** of the **Power Park Module** (or the output of a single **Power Park Unit** where this exceeds 20% of the **Power Station’s Maximum Capacity**); nor
 - (ii) 50MW

until the **Generator** has completed the voltage control tests (detailed in ECP.A.6.3.2) to **The Company's** reasonable satisfaction. Following successful completion of this test, each additional **Power Park Unit** should be included in the voltage control scheme as soon as is technically possible (unless **The Company** agrees otherwise).

- (c) In the case of a **Power Park Module** with a **Maximum Capacity** greater or equal to 100MW, the **Interim Operational Notification** (and where **OTSDUW Arrangements** apply, this reference will be to the **Interim Operational Notification Part B**) will limit the proportion of the **Power Park Module** which can be simultaneously **Synchronised** to the **Total System** to 70% of **Maximum Capacity** until the **Generator** has completed the **Limited Frequency Sensitive Mode (LFSM-O)** control tests with at least 50% of the **Maximum Capacity** of the **Power Park Module** in service (detailed in ECP.A.6.3.1) to **The Company's** reasonable satisfaction.
- (d) In the case of a **Synchronous Power Generating Module** employing a static **Excitation System** or a **Power Park Module** employing a **Power System Stabiliser**, the **Interim Operational Notification** (and where **OTSDUW Arrangements** apply, this reference will be to the **Interim Operational Notification Part B**) may if applicable limit the maximum **Active Power** output and **Reactive Power** output of the **Synchronous Power Generating Module** or **CCGT module** prior to the successful commissioning of the **Power System Stabiliser** to **The Company's** satisfaction.

ECP.6.3.6.4 Operation in accordance with the **Interim Operational Notification** whilst it is in force will meet the requirements for compliance by the **Generator** or **HVDC System Owner** and **The Company** of all the relevant provisions of the **European Connection Conditions**.

ECP.6.3.7 Other than **Unresolved Issues** that are subject to tests required under ECP.7.2 to be witnessed by **The Company**, the **Generator** or **HVDC System Owner** must resolve any **Unresolved Issues** prior to the commencement of the tests, unless **The Company** agrees to a later resolution. The **Generator** or **HVDC System Owner** must liaise with **The Company** in respect of such resolution. The tests that may be witnessed by **The Company** are specified in ECP.7.2.

ECP.6.3.8 Not less than 28 days, or such shorter period as may be acceptable in **The Company's** reasonable opinion, prior to the **Generator** or **HVDC System Owner** wishing to commence tests required under ECP.7 to be witnessed by **The Company**, the **Generator** or **HVDC System Owner** will notify **The Company** that the **Power Generating Module(s)** or **HVDC Equipment(s)** as applicable is ready to commence such tests.

ECP.6.3.9 The items referred to at ECP.7.3 shall be submitted by the **Generator** or the **HVDC System Owner** after successful completion of the tests required under ECP.7.2.

ECP.6.4 INTERIM OPERATIONAL NOTIFICATION (Network Operator's or Non-Embedded Customer's Plant and Apparatus)

ECP.6.4.1 The following provisions apply in relation to the issue of an **Interim Operational Notification** in respect of **Network Operator's** or **Non-Embedded Customer's Plant and Apparatus**.

ECP.6.4.2 Not less than 28 days, or such shorter period as may be acceptable in **The Company's** reasonable opinion, prior to the **Network Operator** or **Non-**

Embedded Customer wishing to operate its **Plant** and **Apparatus** by using the **EU Grid Supply Point** for the first time, the **Network Operator** or **Non-Embedded Customer** will:

- i. submit to **The Company** a **Notification of User's Intention to Operate**; and
- ii. submit to **The Company** the items referred to at ECP.6.4.3.

ECP.6.4.3 Items for submission prior to issue of the **Interim Operational Notification**.

ECP.6.4.3.1 Prior to the issue of an **Interim Operational Notification** in respect of the **User's Plant** and **Apparatus** at an **EU Grid Supply Point**, the **Network Operator** or **Non-Embedded Customer** must submit to **The Company** to **The Company's** satisfaction:

- (a) updated **Planning Code** data (both **Standard Planning Data** and **Detailed Planning Data**), with any estimated values assumed for planning purposes confirmed or, where practical, replaced by validated actual values and by updated estimates for the future and by updated forecasts for **Forecast Data** items such as **Demand**;
- (b) details of any special protection as applicable;
- (c) any items required by ECP.5.2, updated as necessary;
- (d) data submission and results required by Appendix ECP.A.8 demonstrating compliance with **Grid Code** requirements of:

PC.A.2.2
PC.A.2.3
PC.A.2.4
PC.A.2.5.2
PC.A.2.5.3
PC.A.2.5.4
PC.A.2.5.6
PC.A.4
PC.A.6.1.3
PC.A.6.3
PC.A.6.7.1

as applicable to the **Network Operator's** or **Non-Embedded Customer's Plant** and **Apparatus** unless agreed otherwise by **The Company**;

- (e) a detailed schedule of the tests and the procedures for the tests required to be carried out by the **Network Operator** or **Non-Embedded Customer** under ECP.7.8 (or **Equipment Certificates** as relevant) to demonstrate compliance with relevant **Grid Code** requirements. Such schedule is to be consistent with Appendix ECP.A.8.
- (f) an interim **Compliance Statement** and a **User Self Certification of Compliance** completed by the **User** (including any **Unresolved Issues**) against the relevant **Grid Code** requirements including details of any requirements that the **Network Operator** or **Non-Embedded Customer** has identified that will not or may not be met or demonstrated.

- ECP.6.4.4 No **Network Operator's** or **Non-Embedded Customer's Plant and Apparatus** shall be operated by using the **EU Grid Supply Point** until the date specified by **The Company** in the **Interim Operational Notification**.
- ECP.6.4.5 **The Company** shall assess the schedule of tests submitted by the **Network Operator** or **Non-Embedded Customer** with the **Notification of User's Intention to Operate** under ECP.6.4.1 and shall determine whether such schedule has been completed to **The Company's** satisfaction.
- ECP.6.4.6 When the requirements of ECP.6.4.2 to ECP.6.4.5 have been met, **The Company** will notify the **Network Operator** or **Non-Embedded Customer** that the **Plant and Apparatus** may (subject to the **Network Operator** or **Non-Embedded Customer** having fulfilled the requirements of ECP.6.4.3 where that applies) be operated by using the **EU Grid Supply Point** through the issue of an **Interim Operational Notification**.
- ECP.6.4.6.1 The **Interim Operational Notification** will be time limited, the expiration date being specified at the time of issue. The **Interim Operational Notification** may be renewed by **The Company** for up to a maximum of 24 months from the date of the first issue of the **Interim Operational Notification**. **The Company** may only issue an extension to an **Interim Operational Notification** beyond 24 months provided the **Network Operator** or **Non-Embedded Customer** has applied for a derogation for any remaining **Unresolved Issues** to the **Authority** as detailed in ECP.9.
- ECP.6.4.6.2 The **Network Operator** or **Non-Embedded Customer** must operate the **Plant and Apparatus** in accordance with the terms, arising from the **Unresolved Issues**, of the **Interim Operational Notification**. Where practicable, **The Company** will discuss such terms with the **Network Operator** or **Non-Embedded Customer** prior to including them in the **Interim Operational Notification**.
- ECP.6.4.7 The **Network Operator** or **Non-Embedded Customer** must resolve any **Unresolved Issues** prior to the commencement of the tests, unless **The Company** agrees to a later resolution. The **Network Operator** or **Non-Embedded Customer** must liaise with **The Company** in respect of such resolution.
- ECP.6.4.8 Not less than 28 days, or such shorter period as may be acceptable in **The Company's** reasonable opinion, prior to the **Network Operator** or **Non-Embedded Customer** wishing to commence tests required under ECP.7.8(e) and ECP.A.8 to be witnessed by **The Company** the **Network Operator** or **Non-Embedded Customer** will notify **The Company** that the **Network Operator** or **Non-Embedded Customer** as applicable is ready to commence such tests.
- ECP.7. FINAL OPERATIONAL NOTIFICATION
Final Operational Notification in respect of Generators and HVDC System Owners
- ECP.7.1 The following provisions apply in relation to the issue of a **Final Operational Notification** in respect of a **Power Station** consisting of **Type B, Type C** and **Type D Power Generating Modules** or an **HVDC System**.
- ECP.7.2 Tests to be carried out prior to issue of the **Final Operational Notification**.
- ECP.7.2.1 Prior to the issue of a **Final Operational Notification** the **Generator** or **HVDC System Owner** must have completed the tests specified in this

ECP.7.2.2 to **The Company's** satisfaction to demonstrate compliance with the relevant **Grid Code** provisions.

ECP.7.2.2 In the case of any **Power Generating Module, OTSUA** (if applicable) or **HVDC Equipment** these tests will reflect the relevant technical requirements and will comprise one or more of the following:

- (a) Reactive capability tests to demonstrate that the **Power Generating Module, OTSUA** (if applicable) or **HVDC Equipment** can meet the requirements of ECC.6.3.2. These may be witnessed by **The Company** on site if there is no metering to **The Company** Control Centre.
- (b) voltage control system tests to demonstrate that the **Power Generating Module, OTSUA** (if applicable) or **HVDC Equipment** can meet the requirements of ECC.6.3.6.3, ECC.6.3.8 and, in the case of a **Power Park Module, OTSUA** (if applicable) and **HVDC Equipment**, the requirements of ECC.A.7 or ECC.A.8 and, in the case of **Synchronous Power Generating Module** and **CCGT Module**, the requirements of ECC.A.6, and any terms specified in the **Bilateral Agreement** as applicable. These tests may also be used to validate the **Excitation System** model (PC.A.5.3) or voltage control system model (PC.A.5.4) as applicable. These tests may be witnessed by **The Company**.
- (c) governor or frequency control system tests to demonstrate that the **Power Generating Module, OTSUA** (if applicable) or **HVDC Equipment** can meet the requirements of ECC.6.3.6.2, ECC.6.3.7, where applicable ECC.A.3, and BC.3.7. In the case of a **Type B Power Generating Module** only tests BC3 and BC4 in ECP.A.5.8 Figure 2 or ECP.A.6.6 Figure 2 must be completed. The results will also validate the **Mandatory Service Agreement** required by ECC.8.1. These tests may also be used to validate the governor model (PC.A.5.3) or frequency control system model (PC.A.5.4) as applicable. These tests may be witnessed by **The Company**.
- (d) fault ride through tests in respect of a **Power Station** with a **Maximum Capacity** of 100MW or greater, comprised of one or more **Power Park Modules**, to demonstrate compliance with ECC.6.3.15, ECC.6.3.16 and ECC.A.4. Where test results from a **Manufacturers Data & Performance Report** as defined in ECP.10 have been accepted this test will not be required.
- (e) any further tests reasonably required by **The Company** and agreed with the **EU Code User** to demonstrate any aspects of compliance with the **Grid Code** and the **CUSC Contracts**.

ECP.7.2.3 **The Company's** preferred range of tests to demonstrate compliance with the **ECCs** are specified in Appendix ECP.A.5 (in the case of **Synchronous Power Generating Modules**) or Appendix ECP.A.6 (in the case of a **Power Park Modules** or **OTSUA** (if applicable)) or Appendix ECP.A.7 (in the case of **HVDC Equipment** and are to be carried out by the **EU Code User** with the results of each test provided to **The Company**. The **EU Code User** may carry out an alternative range of tests if this is agreed with **The Company**. **The Company** may agree a reduced set of tests where there is a relevant **Manufacturers Data & Performance Report** as detailed in ECP.10 or an applicable **Equipment Certificate** has been accepted.

ECP.7.2.4 In the case of **Offshore Power Park Modules** which do not contribute to **Offshore Transmission Licensee Reactive Power** capability as described

in ECC.6.3.2.5 or ECC.6.3.2.6 or Voltage Control as described in ECC.6.3.8.5 the tests outlined in ECP.7.2.2 (a) and ECP.7.2.2 (b) are not required. However, the offshore **Reactive Power** transfer tests outlined in ECP.A.5.8 shall be completed in their place.

ECP.7.2.5 Following completion of each of the tests specified in this ECP.7.2, **The Company** will notify the **Generator** or **HVDC System Owner** whether, in the opinion of **The Company**, the results demonstrate compliance with the relevant **Grid Code** conditions.

ECP.7.2.6 The **Generator** or **HVDC System Owner** is responsible for carrying out the tests and retains the responsibility for safety and personnel during the test.

ECP.7.3 Items for submission prior to issue of the **Final Operational Notification**

ECP.7.3.1 Prior to the issue of a **Final Operational Notification** the **Generator** or **HVDC System Owner** must submit to **The Company** to **The Company's** satisfaction:

- (a) updated **Planning Code** data (both **Standard Planning Data** and **Detailed Planning Data**), with validated actual values and updated estimates for the future including **Forecast Data** items such as **Demand**;
- (b) any items required by ECP.5.2 and ECP.6.2.3 or ECP.6.3.3 as applicable, updated by the **EU Code User** as necessary;
- (c) evidence to **The Company's** satisfaction that demonstrates that the controller models and/or parameters (as required under PC.A.5.3.2(c) option 2, PC.A.5.3.2(d) option 2, PC.A.5.4.2, and/or PC.A.5.4.3.2) supplied to **The Company** provide a reasonable representation of the behaviour of the **EU Code User's Plant** and **Apparatus** and **OTSUA** if applicable;
- (d) copies of **Manufacturer's Test Certificates** or **Equipment Certificates** issued by an **Authorised Certifier** or equivalent where these are relied upon as part of the evidence of compliance;
- (e) results from the tests required in accordance with ECP.7.2 carried out by the **Generator** to demonstrate compliance with relevant **Grid Code** requirements including the tests witnessed by **The Company**; and
- (f) the final **Compliance Statement** and a **User Self Certification of Compliance** signed by the **EU Code User** and a statement of any requirements that the **Generator** or **HVDC System Owner** has identified that have not been met together with a copy of the derogation in respect of the same from the **Authority**.

ECP.7.3.2 The items in ECP.7.3 should be submitted by the **Generator** (including in respect of any **OTSUA** if applicable) or **HVDC System Owner** using the **User Data File Structure**.

ECP.7.4 If the requirements of ECP.7.2 and ECP.7.3 have been successfully met, **The Company** will notify the **Generator** or **HVDC System Owner** that compliance with the relevant **Grid Code** provisions has been demonstrated for the **Power Generating Module(s)**, **OTSUA** if applicable or **HVDC Equipment** as applicable through the issue of a **Final Operational Notification**. In respect of an **Embedded Power Station** or **Embedded HVDC Equipment** other than an **Embedded Medium Power Stations** not

subject to a **Bilateral Agreement** and **Embedded HVDC Equipment** not subject to a **Bilateral Agreement**, **The Company** will notify the **Network Operator** that a **Final Operational Notification** has been issued.

ECP.7.5 If a **Final Operational Notification** cannot be issued because the requirements of ECP.7.2 and ECP.7.3 have not been successfully met prior to the expiry of an **Interim Operational Notification** then the **Generator** or **HVDC System Owner** (where licensed in respect of its activities) and/or **The Company** shall apply to the **Authority** for a derogation. The provisions of ECP.9 shall then apply.

Final Operational Notification in respect of Network Operator's and Non-Embedded Customer's Plant and Apparatus

ECP.7.6 The following provisions apply in relation to the issue of a **Final Operational Notification** in respect of **Network Operators** and **Non-Embedded Customers Plant and Apparatus**.

ECP.7.7 Prior to the issue of a **Final Operational Notification** the **Network Operator** and **Non-Embedded Customer** must have addressed the **Unresolved Issues** to **The Company's** satisfaction to demonstrate compliance with the relevant **Grid Code** provisions.

ECP.7.8 Prior to the issue of a **Final Operational Notification** the **Network Operator** and **Non-Embedded Customer** must submit to **The Company** to **The Company's** satisfaction:

- (a) updated **Planning Code** data (both **Standard Planning Data** and **Detailed Planning Data**), with validated actual values and updated estimates for the future including **Forecast Data** items such as **Demand**;
- (b) any items required by ECP.5.2 and ECP.6.4 updated by the **User** as necessary;
- (c) evidence to **The Company's** reasonable satisfaction that demonstrates that the models and/or parameters as required under PC.A.2.2, PC.A.2.3, PC.A.2.4, PC.A.2.5, PC.A.4 and PC.A.6 (as applicable), supplied to **The Company** provide a reasonable representation of the behaviour of the **User's Plant and Apparatus**;
- (d) copies of **Manufacturer's Test Certificates** or **Equipment Certificates** issued by an **Authorised Certifier** or equivalent where these are relied upon as part of the evidence of compliance;
- (e) results from the tests and simulations required in accordance with ECP.A.8 carried out by the **Network Operator** or **Non-Embedded Customer** to demonstrate compliance with relevant **Grid Code** requirements including any tests witnessed by **The Company**; and
- (f) the final **Compliance Statement** and a **User Self Certification of Compliance** signed by the **User** and a statement of any requirements that the **Network Operator** or **Non-Embedded Customer** has identified that have not been met together with a copy of the derogation in respect of the same from the **Authority**.

ECP.7.9 The items referred to at ECP.7.8 shall be submitted by the **Network Operator** or **Non-Embedded Customer** after successful completion of the tests required under ECP.7.8.

ECP.7.10 If the requirements of ECP.7.8 have been successfully met, **The Company** will notify the **Network Operator** or **Non-Embedded Customer** that compliance with the relevant **Grid Code** provisions has been demonstrated for **Network Operators** or **Non-Embedded Customers Plant and Apparatus** as applicable through the issue of a **Final Operational Notification**.

ECP.7.11 If a **Final Operational Notification** cannot be issued because the requirements of ECP.7.8 have not been successfully met prior to the expiry of an **Interim Operational Notification**, then the **Network Operator** or **Non-Embedded Customer** and/or **The Company** shall apply to the **Authority** for a derogation. The provisions of ECP.9 shall then apply.

ECP.8 LIMITED OPERATIONAL NOTIFICATION

ECP.8.1 Following the issue of a **Final Operational Notification** for a **Power Station** consisting of **Type B, Type C or Type D Power Generating Module** or an **HVDC System** or **Network Operators** or **Non-Embedded Customers Plant and Apparatus** if:

- (i) the **Generator** or **HVDC System Owner** or **Network Operator** or **Non-Embedded Customer** becomes aware, that its **Plant** and/or **Apparatus**' (including **OTSUA** if applicable) capability to meet any provisions of the **Grid Code**, or where applicable the **Bilateral Agreement** is not fully available then the **Generator** or **HVDC System Owner** or **Network Operator** or **Non-Embedded Customer** shall follow the process in ECP.8.2 to ECP.8.11; or,
- (ii) a **Network Operator** becomes aware, that the capability of **Plant** and/or **Apparatus** belonging to an **Embedded Power Station** or **Embedded HVDC Equipment Station** (other than **Embedded Medium Power Stations** not subject to a **Bilateral Agreement** and **Embedded HVDC Equipment Stations** not subject to a **Bilateral Agreement**) is failing to meet any provisions of the **Grid Code**, or where applicable the **Bilateral Agreement**, then the **Network Operator** shall inform **The Company** and **The Company** shall inform the **Generator** or **HVDC System Owner** to then follow the process in ECP.8.2 to ECP.8.11; or,
- (iii) **The Company** becomes aware through monitoring as described in OC5.4, that a **Generator** or **HVDC System Owner Plant** and/or **Apparatus** (including **OTSUA** if applicable) capability to meet any provisions of the **Grid Code**, or where applicable the **Bilateral Agreement** is not fully available then **The Company** shall inform the other party. Where **The Company** and the **Generator** or **HVDC System Owner** cannot agree from the monitoring as described in OC5.4 whether the **Plant and/or Apparatus** (including **OTSUA** if applicable) is fully available and/or is compliant with the requirements of the **Grid Code** and where applicable the **Bilateral Agreement**, the parties shall first apply the process in OC5.5.1, before applying the process defined in ECP.8 (**LON**) if applicable. Where the testing instructed in accordance with OC.5.5.1 indicates that the **Plant** and/or **Apparatus** (including **OTSUA** if applicable) is not fully available and/or is not compliant with the requirements of the **Grid Code** and/or the **Bilateral Agreement**, or if the parties so agree, the process in ECP.8.2 to ECP.8.11 shall be followed.

- (iv) **The Company** becomes aware that a **Network Operator's** or **Non-Embedded Customer's Plant and Apparatus** capability to meet any provisions of the **Grid Code**, or where applicable the **Bilateral Agreement**, is not fully available then **The Company** shall inform the other party and the process in ECP.8.2 to ECP.8.11 shall be followed.

ECP.8.2 Immediately upon a **Generator, HVDC System Owner, Network Operator** or **Non-Embedded Customer** becoming aware that its **Power Generating Module, OTSUA** (if applicable), **HVDC Equipment or Plant and Apparatus**, as applicable may be unable to comply with certain provisions of the **Grid Code** or (where applicable) the **Bilateral Agreement**, the **Generator, HVDC System Owner Network Operator** or **Non-Embedded Customer** shall notify **The Company** in writing. Additional details of any operating restrictions or changes in applicable data arising from the potential non-compliance and an indication of the date from when the restrictions will be removed and full compliance demonstrated shall be provided as soon as reasonably practical.

ECP.8.3 If the nature of any unavailability and/or potential non-compliance described in ECP.8.1 causes or can reasonably be expected to cause a material adverse effect on the business or condition of **The Company** or other **Users** or the **National Electricity Transmission System** or any **User Systems**, then **The Company** may, notwithstanding the provisions of this ECP.8, follow the provisions of Paragraph 5.4 of the **CUSC**.

ECP.8.4 Except where the provisions of ECP.8.3 apply, where the restriction notified in ECP.8.2 is not resolved in 28 days, then

- (i) the **Generator** or **HVDC System Owner** with input from and discussion of conclusions with **The Company**, and the **Network Operator** where the **Synchronous Power Generating Module, CCGT Module, Power Park Module** or **Power Station** as applicable is **Embedded**, shall undertake an investigation to attempt to determine the causes of and determine a solution to the non-compliance. Such investigation shall continue for no longer than 56 days. During such investigation, the **Generator** or **HVDC System Owner** shall provide to **The Company** the relevant data which has changed due to the restriction in respect of ECP.7.3.1 as notified to the **Generator** or **HVDC System Owner** by **The Company** as being required to be provided; or
- (ii) the **Network Operator** or **Non-Embedded Customer** in discussion with **The Company**, shall undertake an investigation to attempt to determine the causes of and a solution to the non-compliance. Such investigation shall continue for no longer than 56 days. During such investigation the **Network Operator** or **Non-Embedded Customer** shall provide to **The Company** the relevant data which has changed due to the restriction in respect of ECP.7.8 as being required to be provided by **The Company**.

ECP.8.5 Issue and Effect of LON

ECP.8.5.1 Following the issue of a **Final Operational Notification**, **The Company** will issue to the **Generator, HVDC System Owner, Network Operator** or **Non-Embedded Customer** a **Limited Operational Notification** if:

- (a) by the end of the 56 day period referred to at ECP.8.4, the investigation has not resolved the non-compliance to **The Company's** satisfaction; or

- (b) **The Company** is notified by a **Generator, HVDC System Owner** (including **OTSUA** if applicable), **Network Operator** or **Non-Embedded Customer** of a **Modification** to its **Plant** and **Apparatus**; or
- (c) **The Company** receives a submission of data, or a statement from a **Generator, HVDC System Owner** (including **OTSUA** if applicable), **Network Operator** or **Non-Embedded Customer** indicating a change in **Plant** or **Apparatus** or settings (including but not limited to governor and excitation control systems) that may in **The Company's** reasonable opinion, acting in accordance with **Good Industry Practice** be expected to result in a material change of performance.

In the case of an **Embedded Generator** or **Embedded HVDC System Owner**, **The Company** will issue a copy of the **Limited Operational Notification** to the **Network Operator**.

ECP.8.5.2 The **Limited Operational Notification** will be time limited (in the case of **Type D Power Generating Modules, HVDC Systems, Network Operator's** or **Non-Embedded Customer's Plant** and **Apparatus** to expire no later than 12 months from the start of the non-compliance or restriction or from reconnection following a change). **The Company** may agree a longer duration in the case of a **Limited Operational Notification** following a **Modification** or whilst the **Authority** is considering the application for a derogation in accordance with ECP.9.1.

ECP.8.5.3 The **Limited Operational Notification** will notify the **Generator, HVDC System Owner, Network Operator** or **Non-Embedded Customer** of any restrictions on the operation of the **Synchronous Power Generating Module(s), CCGT Module(s), Power Park Module(s), OTSUA** if applicable, **HVDC Equipment** or **Plant** and **Apparatus** and will specify the **Unresolved Issues**. The **Generator, HVDC System Owner, Network Operator** or **Non-Embedded Customer** must operate in accordance with any notified restrictions and must resolve the **Unresolved Issues**.

ECP.8.5.4 The **User** and **The Company** will be deemed compliant with all the relevant provisions of the **Grid Code** provided operation is in accordance with the **Limited Operational Notification**, whilst it is in force, and that the provisions of and referred to in ECP.8 are complied with.

ECP.8.5.5 The **Unresolved Issues** included in a **Limited Operational Notification** will show the extent that the provisions of ECP.7.2 (testing) and ECP.7.3 (final data submission) or ECP.7.8 (d) - (e) (testing) and ECP.7.8 (a) - (c) (data submission, as applicable, shall apply. In respect of selecting the extent of any tests which may in **The Company's** view reasonably be needed to demonstrate the restored capability and in agreeing the time period in which the tests will be scheduled, **The Company** shall, where reasonably practicable, take account of the **Generator** or **HVDC System Owner's** input to contain its costs associated with the testing.

ECP.8.5.6 In the case of a change or **Modification**, the **Limited Operational Notification** may specify that the affected **Plant** and **Apparatus** (including **OTSUA** if applicable) or associated **Synchronous Power Generating Module(s)** or **Power Park Unit(s)** must not be **Synchronised** or, in the case of **Network Operator's** or **Non-Embedded Customer's Plant** and **Apparatus**, operated until all of the following items, that in **The Company's** reasonable opinion are relevant, have been submitted to **The Company** to **The Company's** satisfaction:

- (a) updated **Planning Code** data (both **Standard Planning Data** and **Detailed Planning Data**);

- (b) details of any relevant special **Power Station, Synchronous Power Generating Module(s), Power Park Module(s), OTSUA** (if applicable), **HVDC Equipment Station(s)** or **Network Operator's** or **Non-Embedded Customer's Plant** and **Apparatus** protection as applicable. This may include Pole Slipping protection and islanding protection schemes; and
- (c) simulation study provisions of Appendix ECP.A.3 or Appendix ECP.A.8 as appropriate and the results demonstrating compliance with **Grid Code** requirements relevant to the change or **Modification** as agreed by **The Company**; and
- (d) a detailed schedule of the tests and the procedures for the tests required to be carried out by the **Generator, HVDC Equipment Station, Network Operator** or **Non-Embedded Customer** to demonstrate compliance with relevant **Grid Code** requirements as agreed by **The Company**. The schedule of tests shall be consistent with Appendix ECP.A.5, Appendix ECP.A.6 or Appendix ECP.A.8 as appropriate; and
- (e) an interim **Compliance Statement** and a **User Self Certification of Compliance** completed by the **User** (including any **Unresolved Issues**) against the relevant **Grid Code** requirements including details of any requirements that the **Generator, HVDC System Owner, Network Operator** or **Non-Embedded Customer** has identified that will not or may not be met or demonstrated; and
- (f) any other items specified in the **LON**.

ECP.8.5.7 The items referred to in ECP.8.5.6 shall be submitted by the **Generator** (including in respect of any **OTSUA** if applicable) or **HVDC System Owner** using the **User Data File Structure** or **Power Generation Module Document** as applicable.

ECP.8.5.8 In the case of **Synchronous Power Generating Module(s)** only, the **Unresolved Issues** of the **LON** may require that the **Generator** must complete the following tests to **The Company's** satisfaction to demonstrate compliance with the relevant provisions of the **ECCs** prior to the **Synchronous Power Generating Module** being **Synchronised** to the **Total System**:

- (a) those tests required to establish the open and short circuit saturation characteristics of the **Synchronous Power Generating Module** (as detailed in Appendix ECP.A.5.3) to enable assessment of the short circuit ratio in accordance with ECC.6.3.2.3.4 or ECC.6.3.2.5. Such tests may be carried out at a location other than the **Power Station** site; and
- (b) open circuit step response tests (as detailed in Appendix ECP.A.5.2) to demonstrate compliance with ECC.A.6.2.4.1.

ECP.8.6 In the case of a change or **Modification**, not less than 28 days, or such shorter period as may be acceptable in **The Company's** reasonable opinion:

- (a) prior to the **Generator** or **HVDC System Owner** (including **OTSUA** if applicable) wishing to **Synchronise** its **Plant** and **Apparatus** for the first time following the change or **Modification**, the **Generator** or **HVDC System Owner** will:
 - (i) submit a **Notification of User's Intention to Synchronise**; and

- (ii) submit to **The Company** the items referred to at ECP.8.5.6.
- (b) prior to the **Network Operator** or **Non-Embedded Customer** wishing to operate its **Plant** and **Apparatus** for the first time following the change or **Modification**, the **Network Operator** or **Non-Embedded Customer** will;
 - (i) submit a **Notification of User's intention to operate**; and
 - (ii) submit to **The Company** the items referred to at ECP.8.5.6

ECP.8.7 Other than **Unresolved Issues** that are subject to tests to be witnessed by **The Company**, the **Generator**, **HVDC System Owner**, **Network Operator** or **Non-Embedded Customer** must resolve any **Unresolved Issues** prior to the commencement of the tests, unless **The Company** agrees to a later resolution. The **Generator**, **HVDC System Owner**, **Network Operator** or **Non-Embedded Customer** must liaise with **The Company** in respect of such resolution. The tests that may be witnessed by **The Company** are specified in ECP.7.2.2.

ECP.8.8 Not less than 28 days, or such shorter period as may be acceptable in **The Company's** reasonable opinion, prior to the **Generator** or **HVDC System Owner** wishing to commence tests listed as **Unresolved Issues** to be witnessed by **The Company**, the **Generator** or **HVDC System Owner** will notify **The Company** that the **Synchronous Power Generating Module(s)**, **CCGT Module(s)**, **Power Park Module(s)**, **OTSUA** if applicable or **HVDC Equipment** as applicable is ready to commence such tests.

ECP.8.9 The items referred to at ECP.7.3 or ECP.7.8 as applicable and listed as **Unresolved Issues** shall be submitted by the **Generator**, **HVDC System Owner**, **Network Operator** or **Embedded Customer** after successful completion of the tests.

ECP.8.10 Where the **Unresolved Issues** have been resolved a **Final Operational Notification** will be issued to the **User**.

ECP.8.11 If a **Final Operational Notification** has not been issued by **The Company** as referred to at ECP.8.5.2 (or where agreed following a **Modification** by the expiry time of the **LON**) then the **Generator**, **HVDC System Owner**, **Network Operator** or **Non-Embedded Customer** (where licensed in respect of its activities) and **The Company** shall apply to the **Authority** for a derogation.

ECP.9 PROCESSES RELATING TO DEROGATIONS

ECP.9.1 Whilst the **Authority** is considering the application for a derogation, the **Interim Operational Notification** or **Limited Operational Notification** will be extended to remain in force until the **Authority** has notified **The Company** and the **Generator**, **HVDC System Owner**, **Network Operator** or **Non-Embedded Customer** of its decision. Where the **Generator** or **HVDC System Owner** is not licensed, **The Company** may propose any necessary changes to the **Bilateral Agreement** with such unlicensed **Generator** or **HVDC System Owner**.

ECP.9.2 If the **Authority**:

- (a) grants a derogation in respect of the **Plant** and/or **Apparatus**, then **The Company** shall issue **Final Operational Notification** once all other **Unresolved Issues** are resolved; or

- (b) decides a derogation is not required in respect of the **Plant** and/or **Apparatus** then **The Company** will reconsider the relevant **Unresolved Issues** and may issue a **Final Operational Notification** once all other Unresolved Issues are resolved; or
- (c) decides not to grant any derogation in respect of the **Plant** and/or **Apparatus**, then there will be no **Operational Notification** in place and **The Company** and the **User** shall consider its rights pursuant to the **CUSC**.

ECP.9.3 Where an **Interim Operational Notification** or **Limited Operational Notification** is so conditional upon a derogation and such derogation includes any conditions (including any time limit to such derogation) the **Generator**, **HVDC System Owner**, **Network Operator** or **Non-Embedded Customer** will progress the resolution of any **Unresolved Issues** and / or progress and / or comply with any conditions upon such derogation and the provisions of ECP.6 to ECP.7.11 shall apply and shall be followed.

ECP.10 MANUFACTURER'S DATA & PERFORMANCE REPORT

ECP.10.1.1 Data and performance characteristics in respect of certain **Grid Code** requirements may be registered with **The Company** by **Power Park Unit** manufacturers in respect of specific models of **Power Park Units** by submitting information in the form of a **Manufacturer's Data and Performance Report** to **The Company**.

ECP.10.1.2 A **Generator** planning to construct a new **Power Station** containing the appropriate version of **Power Park Units** in respect of which a **Manufacturer's Data & Performance Report** has been submitted to **The Company** may reference the **Manufacturer's Data & Performance Report** in its submissions to **The Company**. Any **Generator** considering referring to a **Manufacturer's Data & Performance Report** for any aspect of its **Plant** and **Apparatus** may contact **The Company** to discuss the suitability of the relevant **Manufacturer's Data & Performance Report** to its project to determine if, and to what extent, the data included in the **Manufacturer's Data & Performance Report** contributes towards demonstrating compliance with those aspects of the **Grid Code** applicable to the **Generator**. **The Company** will inform the **Generator** if the reference to the **Manufacturer's Data & Performance Report** is not appropriate or not sufficient for its project.

ECP.10.1.3 The process to be followed by **Power Park Unit** manufacturers submitting a **Manufacturer's Data & Performance Report** is agreed by **The Company**. ECP.10.2 indicates the specific **Grid Code** requirement areas in respect of which a **Manufacturer's Data & Performance Report** may be submitted.

ECP.10.1.4 **The Company** will maintain and publish a register of those **Manufacturer's Data & Performance Reports** which **The Company** has received and accepted as being an accurate representation of the performance of the relevant **Plant** and / or **Apparatus**. Such register will identify the manufacturer, the model(s) of **Power Park Unit(s)** to which the report applies and the provisions of the **Grid Code** in respect of which the report contributes towards the demonstration of compliance. The inclusion of any report in the register does not in any way confirm that any **Power Park Modules** which utilise any **Power Park Unit(s)** covered by a report is or will be compliant with the **Grid Code**.

ECP.10.2 A **Manufacturer's Data & Performance Report** in respect of **Power Park Units** may cover one (or part of one) or more of the following provisions of the **Grid Code**:

- (a) Fault Ride Through capability ECC.6.3.15, ECC.6.3.16.
- (b) Power Park Module mathematical model PC.A.5.4.2.

ECP.10.3 Reference to a **Manufacturer's Data & Performance Report** in a **EU Code User's** submissions does not by itself constitute compliance with the **Grid Code**.

ECP.10.4 A **Generator** referencing a **Manufacturer's Data & Performance Report** should insert the relevant **Manufacturer's Data & Performance Report** reference in the appropriate place in the **DRC** data submission, **Power Generating Module Document** and / or in the **User Data File Structure**. **The Company** will consider the suitability of a **Manufacturer's Data & Performance Report**:

- (a) in place of **DRC** data submissions, a mathematical model suitable for representation of the entire **Power Park Module** as per ECP.A.3.4.4. For the avoidance of doubt only the relevant sections as specified in PC.A.2.5.5.7 apply. Site specific parameters will still need to be submitted by the **Generator**.

- (b) in place of Fault simulation studies as follows;

The Company will not require **Fault Ride Through** simulation studies to be conducted as per ECP.A.3.5.1 and qualified in ECP.A.3.5.2 provided that;

- (i) Adequate and relevant **Power Park Unit** data is included in respect of **Fault Ride Through** testing covered in ECP.A.6.7 in the relevant **Manufacturer's Data & Performance Report**, and

- (ii) For each type and duration of fault as detailed in ECP.A.3.5.1, the expected minimum retained voltage is greater than the corresponding minimum voltage achieved and successfully ridden through in the fault ride through tests covered by the **Manufacturer's Data & Performance Report**.

- (c) to reduce the scope of compliance site tests as follows;

- (i) Where there is a **Manufacturer's Data & Performance Report** in respect of a **Power Park Unit** which covers Fault Ride Through, **The Company** may agree that no Fault Ride Through testing is required.

ECP.10.5 It is the responsibility of the **EU Code User** to ensure that the correct reference for the **Manufacturer's Data & Performance Report** is used and the **EU Code User** by using that reference accepts responsibility for the accuracy of the information. The **EU Code User** shall ensure that the manufacturer has kept **The Company** informed of any relevant variations in plant specification since the submission of the relevant **Manufacturer's Data & Performance Report** which could impact on the validity of the information.

ECP.10.6 **The Company** may contact the **Power Park Unit** manufacturer directly to verify the relevance of the use of such **Manufacturer's Data & Performance Report**. If **The Company** believe the use some or all of such **Manufacturer's Data & Performance Report** information is incorrect or the referenced data is inappropriate, then the reference to the **Manufacturer's Data & Performance**

Report may be declared invalid by **The Company**. Where, and to the extent possible, the data included in the **Manufacturer's Data & Performance Report** is appropriate, the compliance assessment process will be continued using the data included in the **Manufacturer's Data & Performance Report**.

ECP.10.7

In the case of a co-located site, for example **Electricity Storage Modules** connected within a new or existing **Power Station**, **The Company** will accept demonstration of compliance at the **Grid Entry Point** or **User System Entry Point** (if **Embedded**) through a combination of the capabilities of the **Power Generating Modules** and **Electricity Storage Modules** or **Electricity Storage Modules** and **Generating Units** or **Power Park Modules**. **Generators** should however be aware that for the purposes of compliance, full Grid Code compliance should be demonstrated when, for example, the **Electricity Storage Module** is out of service and the remaining **Power Generating Module** is in service or the **Electricity Storage Module** is in service and the **Power Generating Module** is out of service. Equally, **The Company** will accept **Manufacturer's Data & Performance Reports** for the purposes of proving compliance at co-located sites.

APPENDIX 1
NOT USED

APPENDIX 2

USER SELF CERTIFICATION OF COMPLIANCE (Interim/Final)

Power Station/ HVDC Equipment Station	[Name of Connection Site/site of connection]	User:	[Full User name]	Maximum Capacity (MW) of Plant:	
--	--	--------------	------------------	--	--

This **User Self Certification of Compliance** records the compliance by the **EU Code User** in respect of [NAME] **Power Station/HVDC Equipment Station** with the **Grid Code** and the requirements of the **Bilateral Agreement** and **Construction Agreement** dated [] with reference number []. It is completed by the **Power Station/HVDC System Owner** in the case of **Plant** and/or **Apparatus** connected to the **National Electricity Transmission System** and for **Embedded Plant**.

We have recorded our compliance against each requirement of the **Grid Code** which applies to the **Power Station/HVDC Equipment Station**, together with references to supporting evidence and a commentary where this is appropriate, and have provided this to **The Company**. A copy of the **Compliance Statement** is attached.

Supporting evidence, in the form of simulation results, test results, manufacturer’s data and other documentation, is attached in the **User Data File Structure**.

The **EU Code User** hereby certifies that, to the best of its knowledge and acting in accordance with **Good Industry Practice**, the **Power Station** is compliant with the **Grid Code** and the **Bilateral Agreement** in all aspects [with the following **Unresolved Issues***] [with the following derogation(s)**]:

Connection Condition	Requirement	Ref:	Issue

Compliance certified by:	Name:	Title:
	[PERSON]	[PERSON DESIGNATION]
	Signature:	Of
	[PERSON]	[User details]
	Date:	

* Include for Interim **User Self Certification of Compliance** ahead of **Interim Operational Notification**.

** Include for final **User Self Certification of Compliance** ahead of **Final Operational Notification** where derogation(s) have been granted. If no derogation(s) required delete wording and Table.

APPENDIX 3

SIMULATION STUDIES

ECP.A.3.1 SCOPE

- ECP.A.3.1.1 This Appendix sets out the simulation studies required to be submitted to **The Company** to demonstrate compliance with the **European Connection Conditions** unless otherwise agreed with **The Company**. This Appendix should be read in conjunction with ECP.6 with regard to the submission of the reports to **The Company**. Where there is any inconsistency in the technical requirements in respect of which compliance is being demonstrated by simulation in this Appendix and ECC.6.3 and the **Bilateral Agreement**, the provisions of the **Bilateral Agreement** and ECC.6.3 prevail. The studies specified in this Appendix will normally be sufficient to demonstrate compliance. However, **The Company** may agree an alternative set of studies proposed by the **Generator** or **HVDC System Owner** provided **The Company** deem the alternative set of studies sufficient to demonstrate compliance with the **Grid Code** and the **Bilateral Agreement**.
- ECP.A.3.1.2 The **Generator** or **HVDC System Owner** shall submit simulation studies in the form of a report to demonstrate compliance. In all cases the simulation studies must utilise models applicable to the **Synchronous Power Generating Module**, **HVDC Equipment** or **Power Park Module** with proposed or actual parameter settings. Reports should be submitted in English with all diagrams and graphs plotted clearly with legible axes and scaling provided to ensure any variations in plotted values is clear. In all cases, the simulation studies must be presented over a sufficient time period to demonstrate compliance with all applicable requirements.
- ECP.A.3.1.3 In the case of an **Offshore Power Station** where **OTSDUW Arrangements** apply simulation studies, the **Generator** should include the action of any relevant **OTSUA** where applicable to demonstrate compliance with the **Grid Code** and the **Bilateral Agreement** at the **Interface Point**.
- ECP.A.3.1.4 **The Company** will permit relaxation from the requirement ECP.A.3.2 to ECP.A.3.8 where an **Equipment Certificate** for the **Power Generating Module** or **HVDC Equipment** has been provided which details the characteristics from appropriate simulations on a representative installation with the same equipment and settings and the performance of the **Power Generating Module** or **HVDC Equipment** can, in **The Company's** opinion, reasonably represent that of the installed **Power Generating Module** or **HVDC Equipment**.
- ECP.A.3.1.5 For **Type B**, **Type C** and **Type D Power Generating Modules** the relevant **Equipment Certificate** must be supplied in the **Power Generating Module Document** or **Users Data File structure** as applicable. For **HVDC Equipment** the relevant **Equipment Certificates** must be supplied in the **Users Data File structure**.
- ECP.A.3.1.6 In the case of a co-located site, for example **Electricity Storage Modules** connected within a new or existing **Power Station**, **The Company** will accept simulation studies to demonstrate compliance at the **Grid Entry Point** or **User System Entry Point** (if **Embedded**) through a combination of the capabilities of the **Power Generating Modules** and **Electricity Storage Modules** or **Electricity Storage Modules** and **Generating Units** or **Power Park Modules**. **Generators** should however be aware that for the purposes of simulations, full **Grid Code** compliance should be demonstrated when, for example, the **Electricity Storage Module** is out of service and the remaining **Power**

Generating Module is in service or the **Electricity Storage Module** is in service and the **Power Generating Module** is out of service.

ECP.A.3.2 Power System Stabiliser Tuning

ECP.A.3.2.1 In the case of a **Synchronous Power Generating Module** with an **Excitation System Power System Stabiliser** the **Power System Stabiliser** tuning simulation study report required by ECC.A.6.2.5.6 or required by the **Bilateral Agreement** shall contain:

- (i) the **Excitation System** model including the **Power System Stabiliser** with settings as required under the **Planning Code** (PC.A.5.3.2(c)).
- (ii) open circuit time series simulation study of the response of the **Excitation System** to a +10% step change from 90% to 100% terminal voltage.
- (iii) on load time series dynamic simulation studies of the response of the **Excitation System** with and without the **Power System Stabiliser** to 2% and 10% steps in the reference voltage and a three phase short circuit fault applied to the higher voltage side of the **Synchronous Power Generating Module** transformer for 100ms. The simulation studies should be carried out with the **Synchronous Power Generating Module** operating at full **Active Power** and maximum leading **Reactive Power** import with the fault level at the **Supergrid** HV connection point at minimum or as otherwise agreed with **The Company**. The results should show the **Synchronous Power Generating Module** field voltage, terminal voltage, **Power System Stabiliser** output, **Active Power** and **Reactive Power** output.
- (iv) gain and phase Bode diagrams for the open loop frequency domain response of the **Synchronous Power Generating Module Excitation System** with and without the **Power System Stabiliser**. These should be in a suitable format to allow assessment of the phase contribution of the **Power System Stabiliser** and the gain and phase margin of the **Excitation System** with and without the **Power System Stabiliser** in service.
- (v) an eigenvalue plot to demonstrate that all modes remain stable when the **Power System Stabiliser** gain is increased by at least a factor of 3 from the designed operating value.
- (vi) gain Bode diagram for the closed loop on load frequency domain response of the **Synchronous Power Generating Module Excitation System** with and without the **Power System Stabiliser**. The **Synchronous Power Generating Module** operating at full load and at unity power factor. These diagrams should be in a suitable format to allow comparison of the **Active Power** damping across the frequency range specified in ECC.A.6.2.6.3 with and without the **Power System Stabiliser** in service.

ECP.A.3.2.2 In the case of **Onshore Non-Synchronous Power Generating Module**, **Onshore HVDC Equipment** and **Onshore Power Park Modules** and **OTSDUW Plant** and **Apparatus** at the **Interface Point** the **Power System Stabiliser** tuning simulation study report required by ECC.A.7.2.4.1 or ECC.A.8.2.4 or required by the **Bilateral Agreement** shall contain:

- (i) the **Voltage Control System** model including the **Power System Stabiliser** with settings as required under the **Planning Code** (PC.A.5.4) and **Bilateral Agreement**.
- (ii) on load time series dynamic simulation studies of the response of the **Voltage Control System** with and without the **Power System Stabiliser** to 2% and 10% steps in the reference voltage and a three phase short circuit fault applied to the **Grid Entry Point** or the **Interface Point** in the case of **OTSDUW Plant** and **Apparatus** for 100ms. The simulation studies should be carried out operating at full **Active Power** and maximum leading **Reactive Power** import condition with the fault level at the **Supergrid** HV connection point at minimum or as otherwise agreed with **The Company**. The results should show appropriate signals to demonstrate the expected damping performance of the **Power System Stabiliser**.
- (iii) any other simulation as specified in the **Bilateral Agreement** or agreed between the **Generator** or **HVDC System Owner** or **Offshore Transmission Licensee** and **The Company**.

ECP.A.3.3 Reactive Capability across the Voltage Range

ECP.A.3.3.1 (a) The **Generator** shall supply simulation studies to demonstrate the capability to meet ECC.6.3.2 by submission of a report containing:

- (i) a load flow simulation study result to demonstrate the maximum lagging **Reactive Power** capability of the **Synchronous Power Generating Module, OTSUA** or **Power Park Module** at **Maximum Capacity** when the **Grid Entry Point** or **User System Entry Point** if **Embedded** or **Interface Point** (in the case of **OTSUA**) voltage is at 105% of nominal.
- (ii) a load flow simulation study result to demonstrate the maximum leading **Reactive Power** capability of the **Synchronous Power Generating Module, OTSUA** or **Power Park Module** at **Maximum Capacity** when the **Grid Entry Point** or **User System Entry Point** if **Embedded** or **Interface Point** (in the case of **OTSUA**) voltage is at 95% of nominal.
- (iii) a load flow simulation study result to demonstrate the maximum lagging **Reactive Power** capability of the **Synchronous Power Generating Module, OTSUA** or **Power Park Module** at the **Minimum Stable Operating Level** when the **Grid Entry Point** or **User System Entry Point** if **Embedded** or **Interface Point** (in the case of **OTSUA**) voltage is at 105% of nominal.
- (iv) a load flow simulation study result to demonstrate the maximum leading **Reactive Power** capability of the **Synchronous Power Generating Module, OTSUA** or **Power Park Module** at the **Minimum Stable Operating Level** when the **Grid Entry Point** or **User System Entry Point** if **Embedded** or **Interface Point** (in the case of **OTSUA**) voltage is at 95% of nominal.

ECP.A.3.3.1 (b) The **HVDC System Owner** shall supply simulation studies to demonstrate the capability to meet ECC.6.3.4.1 by submission of a report containing:

- (i) a load flow simulation study result to demonstrate the maximum lagging **Reactive Power** capability of the **Synchronous Power Generating Module, HVDC Equipment, OTSUA** or **Power**

Park Module at Maximum HVDC Active Power Transmission Capacity when the **Grid Entry Point** or **User System Entry Point** if **Embedded** or **Interface Point** (in case of **OTSUA**) voltage is at 105% of nominal.

- (ii) a load flow simulation study result to demonstrate the maximum leading **Reactive Power** capability of the **Synchronous Power Generating Module, HVDC Equipment, OTSUA** or **Power Park Module at Maximum HVDC Active Power Transmission Capacity** when the **Grid Entry Point** or **User System Entry Point** if **Embedded** or **Interface Point** (in case of **OTSUA**) voltage is at 95% of nominal.
- (iii) a load flow simulation study result to demonstrate the maximum lagging **Reactive Power** capability of the **Synchronous Power Generating Module, HVDC Equipment** or **Power Park Module** at the **Minimum HVDC Active Power Transmission Capacity** when the **Grid Entry Point** or **User System Entry Point** if **Embedded** or **Interface Point** (in case of **OTSUA**) voltage is at 105% of nominal.
- (iv) a load flow simulation study result to demonstrate the maximum leading **Reactive Power** capability of the **Synchronous Power Generating Module, HVDC Equipment** or **Power Park Module** at the **Minimum HVDC Active Power Transmission Capacity** when the **Grid Entry Point** or **User System Entry Point** voltage if **Embedded** or **Interface Point** (in case of **OTSUA**) is at 95% of nominal.

ECP.A.3.3.2 In the case of a **Synchronous Power Generating Module** the terminal voltage in the simulation should be the nominal voltage for the machine.

ECP.A.3.3.3 In the case of a **Power Park Module** where the load flow simulation studies show that the individual **Power Park Units** deviate from nominal voltage to meet the **Reactive Power** requirements then evidence must be provided from factory (e.g. in a **Manufacturer's Data & Performance Report**) or site testing that the **Power Park Unit** is capable of operating continuously at the operating points determined in the load flow simulation studies.

ECP.A.3.4 Voltage Control and Reactive Power Stability

ECP.A.3.4.1 This section applies to **HVDC Equipment**; and **Type C & Type D Power Park Modules** to demonstrate the voltage control capability and **Type B Power Park Modules** to demonstrate the voltage control capability if specified by **The Company**.

In the case of a **Power Station** containing **Power Park Modules** and/or **OTSUA**, the **Generator** shall provide a report to demonstrate the dynamic capability and control stability of the **Power Park Module**. The report shall contain:

- (i) a dynamic time series simulation study result of a sufficiently large negative step in **System** voltage to cause a change in **Reactive Power** from zero to the maximum lagging value at **Rated MW**.
- (ii) a dynamic time series simulation study result of a sufficiently large positive step in **System** voltage to cause a change in **Reactive Power** from zero to the maximum leading value at **Rated MW**.

- (iii) a dynamic time series simulation study result to demonstrate control stability at the lagging **Reactive Power** limit by application of a -2% voltage step while operating within 5% of the lagging **Reactive Power** limit.
- (iv) a dynamic time series simulation study result to demonstrate control stability at the leading **Reactive Power** limit by application of a +2% voltage step while operating within 5% of the leading **Reactive Power** limit.

ECP.A.3.4.2 All the above studies should be completed with a network operating at the voltage applicable for zero **Reactive Power** transfer at the **Grid Entry Point** or **User System Entry Point** if **Embedded** or, in the case of **OTSUA, Interface Point** unless stated otherwise. The fault level at the HV connection point should be set at the minimum level as agreed with **The Company**.

ECP.A.3.5 Fault Ride Through and Fast Fault Current Injection

ECP.A.3.5.1 This section applies to **Type B, Type C and Type D Power Generating Modules** and **HVDC Equipment** to demonstrate the modules **Fault Ride Through** and **Fast Fault Current** injection capability.

The **Generator** or **HVDC System Owner** shall supply time series simulation study results to demonstrate the capability of **Synchronous Power Generating Module, HVDC Equipment, and Power Park Modules** and **OTSUA** to meet ECC.6.3.15 and ECC.6.3.16 by submission of a report containing:

- (i) a time series simulation study of a 140ms three phase short circuit fault with a retained voltage as detailed in table A.3.5.1 below applied at the **Grid Entry Point** or (**User System Entry Point** if **Embedded**) of the **Power Generating Module** or **HVDC Equipment** or **OTSUA**.
- (ii) a time series simulation study of 140ms unbalanced short circuit faults with a retained voltage as detailed in table 1 on the faulted phase(s) applied at the **Grid Entry Point** or (**User System Entry Point** if **Embedded**) of the **Power Generating Module** or **HVDC Equipment** or **OTSUA**. The unbalanced faults to be simulated are:
 1. a phase to phase fault
 2. a two phase to earth fault
 3. a single phase to earth fault.

Power Generating Module	Retained Voltage
Synchronous Power Generating Module	
Type B	30%
Type C or Type D with Grid connection point voltage <110kV	10%
Type D with connection point voltage >110kV	0%
Power Park Module	
Type B or Type C or Type D with connection point voltage < 110kV	10%
Type D with connection point voltage >110kV	0%
HVDC Equipment	0%

Table A.3.5.1

For a **Power Generating Module** or **HVDC Equipment** or **OTSUA** the simulation study should be completed with the **Power Generating Module** or **HVDC Equipment** or **OTSUA** operating at full **Active**

Power and maximum leading **Reactive Power** and the fault level at the **Supergrid** HV connection point at minimum or as otherwise agreed with **The Company** as detailed in ECC.6.3.15.8.

- (iii) time series simulation studies of balanced **Supergrid** voltage dips applied on the nearest point of the **National Electricity Transmission System** operating at **Supergrid** voltage to the **Synchronous Power Generating Module** or **OTSUA**. The simulation studies should include:

1. 50% retained voltage lasting 0.45 seconds
2. 70% retained voltage lasting 0.81 seconds
3. 80% retained voltage lasting 1.00 seconds
4. 85% retained voltage lasting 180 seconds.

For a **Synchronous Power Generating Module** or **OTSUA**, the simulation study should be completed with the **Synchronous Power Generating Module** or **OTSUA** operating at full **Active Power** and zero **Reactive Power** output and the fault level at the **Supergrid** HV connection point at minimum or as otherwise agreed with **The Company**. Where the **Synchronous Power Generating Module** is **Embedded**, the minimum **Network Operator's System** impedance to the **Supergrid HV Connection Point** shall be used which may be calculated from the maximum fault level at the **User System Entry Point**.

- (iv) time series simulation studies of balanced **Supergrid** voltage dips applied on the nearest point of the **National Electricity Transmission System** operating at **Supergrid** voltage to the **HVDC Equipment** or **Power Park Module**. The simulation studies should include:

1. 30% retained voltage lasting 0.384 seconds
2. 50% retained voltage lasting 0.71 seconds
3. 80% retained voltage lasting 2.5 seconds
4. 85% retained voltage lasting 180 seconds.

For **HVDC Equipment** or **Power Park Modules** the simulation study should be completed with the **HVDC Equipment** or **Power Park Module** operating at full **Active Power** and zero **Reactive Power** output and the fault level at the **Supergrid HV Connection Point** at minimum or as otherwise agreed with **The Company**. Where the **HVDC Equipment** or **Power Park Module** is **Embedded** the minimum **Network Operator's System** impedance to the **Supergrid HV Connection Point** shall be used which may be calculated from the maximum fault level at the **User System Entry Point**.

For **HVDC Equipment** the simulations should include the duration of each voltage dip 1 to 4 above for which the **HVDC Equipment** will remain connected.

ECP.A.3.5.2 In the case of **Power Park Modules** comprised of **Power Park Units** in respect of which the **User's** reference to a **Manufacturer's Data & Performance Report** has been accepted by **The Company** for **Fault Ride Through**, ECP.A.3.5.1 will not apply provided:

- (i) the **Generator** or **HVDC System Owner** demonstrates by load flow simulation study result that the faults and voltage dips at either side of the **Power Park Unit** transformer corresponding to the required faults and voltage dips in ECP.A.3.5.1 applied at the nearest point of the

National Electricity Transmission System operating at **Supergrid** voltage are less than those included in the **Manufacturer's Data & Performance Report**,

or;

- (ii) the same or greater percentage faults and voltage dips in ECP.A.3.5.1 have been applied at either side of the **Power Park Unit** transformer in the **Manufacturer's Data & Performance Report**.

ECP.A.3.6 **Limited Frequency Sensitive Mode – Over Frequency (LFSM-O)**

ECP.A.3.6.1 This section applies to **Type B, Type C and Type D Power Generating Modules, HVDC Equipment** to demonstrate the capability to modulate **Active Power** at high frequency as required by ECC6.3.7.3.5(ii).

ECP.A.3.6.2 The simulation study should comprise of a **Power Generating Module** or **HVDC Equipment** connected to the total **System** with a local load shown as "X" in figure ECP.A.3.6.1. The load "X" is in addition to any auxiliary load of the **Power Station** connected directly to the **Power Generating Module** or **HVDC Equipment** and represents a small portion of the **System** to which the **Power Generating Module** or **HVDC Equipment** is attached. The value of "X" should be the minimum for which the **Power Generating Module** or **HVDC Equipment** can control the power island **Frequency** to less than 52Hz consistent with ECC.6.3.7.3.5(ii). Where transient excursions above 52Hz occur the **Generator** or **HVDC Equipment Owner** should ensure that the duration above 52Hz is less than any high **Frequency** protection system applied to the **Power Generating Module** or **HVDC Equipment**.

ECP.A.3.6.3 For **HVDC Equipment** and **Power Park Modules** consisting of units connected wholly by power electronic devices the simulation methodology may be modified by the addition of a **Synchronous Power Generating Module** (G2) connected as indicated in Figure ECP.A.3.6.2. This additional **Synchronous Power Generating Module** should have an inertia constant of 3.5MWs/MVA, be initially operating at rated power output and unity **Power Factor**. The mechanical power of the **Synchronous Power Generating Module** (G2) should remain constant throughout the simulation.

ECP.A.3.6.4 At the start of the simulation study the **Power Generating Module** or **HVDC Equipment** will be operating maximum **Active Power** output. The **Power Generating Module** or **HVDC Equipment** will then be islanded from the **Total System** but still supplying load "X" by the opening of a breaker, which is not the **Power Generating Module** or **HVDC Equipment** connection circuit breaker (the governor should therefore, not receive any signals that the breaker has opened other than the reduction in load and subsequent increase in speed). A schematic arrangement of the simulation study is illustrated by Figure ECP.A.3.6.1.

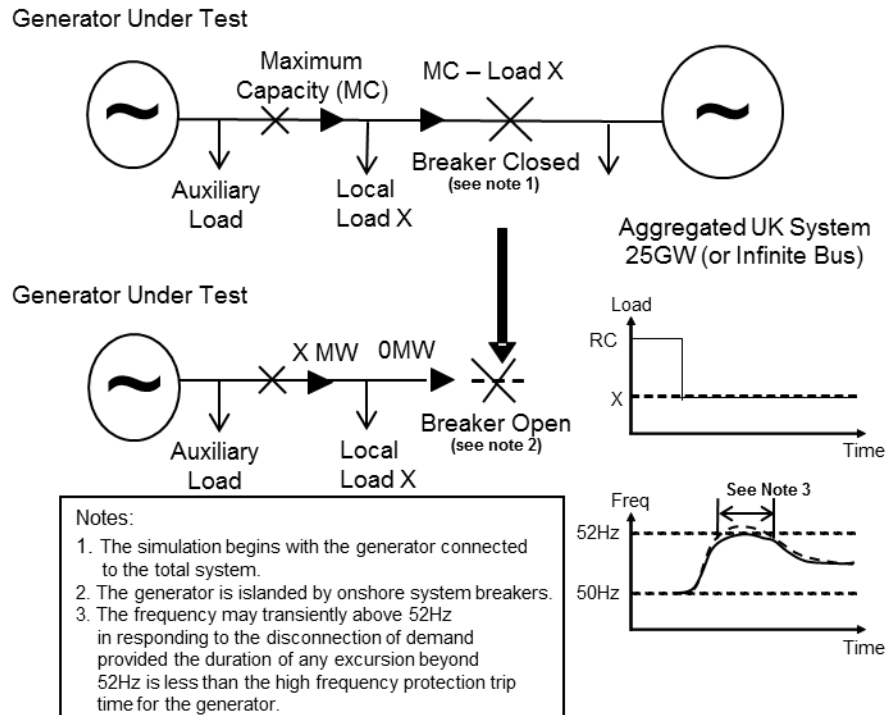

Figure ECP.A.3.6.1 – Diagram of Load Rejection Study

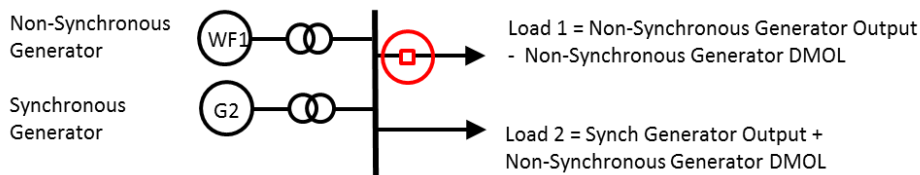

Figure ECP.A.3.6.2 – Addition of Generator G2 if applicable

ECP.A.3.6.5 A simulation study shall be performed for **Type B, C & D Power Generating Modules** in **Limited Frequency Sensitive Mode (LFSM)** and **Frequency Sensitive Mode (FSM)** for **Type C & D Power Generating Modules**. The simulation study results should indicate **Active Power** and **Frequency**.

ECP.A.3.6.6 To allow validation of the model used to simulate load rejection in accordance with ECC.6.3.7.3.5 as described, a further simulation study is required to represent the largest positive **Frequency** injection step or fast ramp (BC1 and BC3 of Figure 2) that will be applied as a test as described in ECP.A.5.8 and ECP.A.6.6.

Limited Frequency Sensitive Mode – Under Frequency (LFSM-U)

ECP.A.3.6.7 This section applies to:
Synchronous Power Generating Modules, Type C & D; or,
HVDC Equipment; or,
Power Park Modules, Type C & D to demonstrate the modules capability to modulate Active Power at low frequency.

ECP.A.3.6.8 To demonstrate the **LFSM-U** low **Frequency** control when operating in **Limited Frequency Sensitive Mode** the **Generator** or **HVDC System Owner** shall submit a simulation study representing the response of the **Power Generating Module** or **HVDC Equipment** operating at 80% of **Maximum Capacity**. The simulation study event shall be equivalent to:

- (i) a sufficiently large reduction in the measured **System Frequency** ramped over 10 seconds to cause an increase in **Active Power** output to the **Maximum Capacity** followed by
- (ii) 60 seconds of steady state with the measured **System Frequency** depressed to the same level as in ECP.A.3.6.8.1 (i) as illustrated in Figure ECP.A.3.6.1 below.
- (iii) then increase of the measured **System Frequency** ramped over 10 seconds to cause a reduction in **Active Power** output back to the original **Active Power** level followed by at least 60 seconds of steady output.

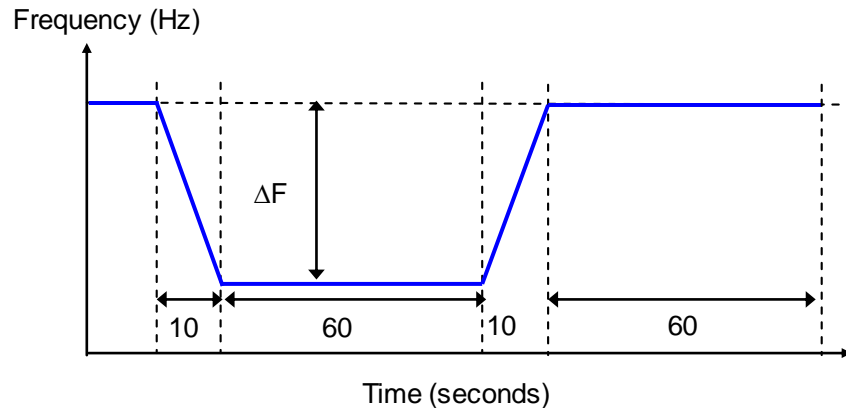

Figure ECP.A.3.6.1

ECP.A.3.7 Voltage and **Frequency** Controller Model Verification and Validation

ECP.A.3.7.1 For **Type C** and **Type D Synchronous Power Generating Modules, HVDC Equipment, OTSDUW Plant and Apparatus** or **Power Park Modules**, the **Generator** (including those undertaking **OTSDUW**) or **HVDC System Owner** shall provide simulation studies to verify that the proposed controller models supplied to **The Company** under the **Planning Code** are fit for purpose. These simulation study results shall be provided in the timescales stated in the **Planning Code**.

ECP.A.3.7.2 To demonstrate the **Frequency** control or governor/load controller/plant model the **Generator** or **HVDC System Owner** shall submit a simulation study representing the response of the **Synchronous Power Generating Module, HVDC Equipment** or **Power Park Module** operating at 80% of **Maximum Capacity**. The simulation study event shall be equivalent to:

- (i) a ramped reduction in the measured **System Frequency** of 0.5Hz in 10 seconds followed by
- (ii) 20 seconds of steady state with the measured **System Frequency** depressed by 0.5Hz followed by
- (iii) a ramped increase in measured **System Frequency** of 0.3Hz over 30 seconds followed by
- (iv) 60 seconds of steady state with the measured **System Frequency** depressed by 0.2Hz as illustrated in Figure ECP.A.3.7.2 below.

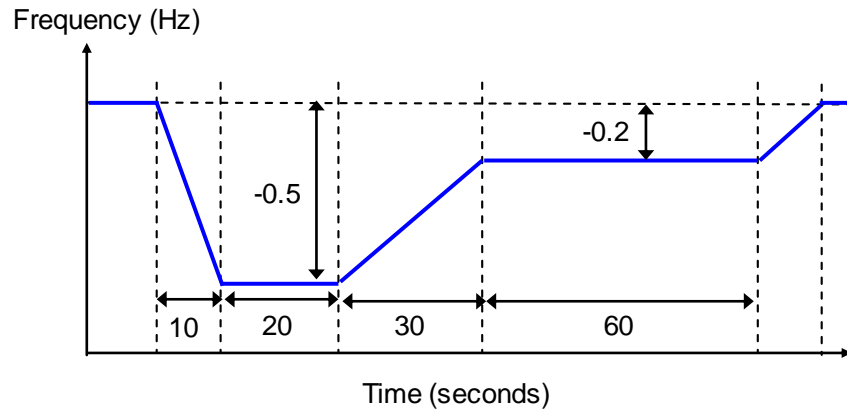

Figure ECP.A.3.7.2

The simulation study shall show **Active Power** output (MW) and the equivalent of **Frequency** injected.

ECP.A.3.7.3 To demonstrate the **Excitation System** model the **Generator** shall submit simulation studies representing the response of the **Synchronous Power Generating Module** as follows:

- (i) operating open circuit at rated terminal voltage and subjected to a 10% step increase in terminal voltage reference from 90% to 100%.
- (ii) operating at **Rated MW**, nominal terminal voltage and unity **Power Factor** subjected to a 2% step increase in the voltage reference. Where a **Power System Stabiliser** is included within the **Excitation System** this shall be in service.

The simulation study shall show the **Synchronous Power Generating Module** terminal voltage, field voltage, **Active Power**, **Reactive Power** and **Power System Stabiliser** output signal as appropriate.

ECP.A.3.7.4 To demonstrate the Voltage Controller model the **Generator** (including those undertaking **OTSDUW**) or **HVDC System Owner** shall submit a simulation study representing the response of the **HVDC Equipment**, **OTSDUW Plant and Apparatus** or **Power Park Module** operating at **Rated MW** and unity **Power Factor** at the connection point to a 2% step increase in the voltage reference. The simulation study shall show the terminal voltage, **Active Power**, **Reactive Power** and **Power System Stabiliser** output signal as appropriate.

ECP.A.3.7.5 To validate that the excitation and voltage control models submitted under the **Planning Code** are a reasonable representation of the dynamic behaviour of the **Synchronous Power Generating Module**, **OTSDUW Plant and Apparatus**, **HVDC Equipment** or **Power Park Module** as built, the **Generator** or **HVDC System Owner** shall repeat the simulation studies outlined above but using the operating conditions of the equivalent tests. The simulation study results shall be displayed overlaid on the actual test results.

ECP.A.3.7.6 For **Type C** and **Type D Synchronous Power Generating Modules** or **HVDC Equipment** to validate that the governor/load controller/plant or **Frequency** control models submitted under the **Planning Code** is a reasonable representation of the dynamic behaviour of the **Synchronous Power Generating Module** or **HVDC Equipment Station** as built, the **Generator** or **HVDC System Owner** shall repeat the simulation studies outlined above but using the operating conditions of the equivalent tests. The simulation study results shall be displayed overlaid on the actual test results.

- ECP.A.3.8 Sub-synchronous Resonance control and Power Oscillation Damping control for HVDC System.
- ECP.A.3.8.1 To demonstrate the compliance of the sub-synchronous control capability with ECC.6.3.17.1) and the terms of the **Bilateral Agreement**, the **HVDC System Owner** shall submit a simulation study report.
- ECP.A.3.8.2 Where power oscillation damping control function is specified on a **HVDC Equipment** the **HVDC System Owner** shall submit a simulation study report to demonstrate the compliance with ECC.6.3.17.2 and the terms of the **Bilateral Agreement**.
- ECP.A.3.8.3 The simulation studies should utilise the **HVDC Equipment** control system models including the settings as required under the **Planning Code** (PC.A.5.3.2). The network conditions for the above simulation studies should be discussed with **The Company** prior to commencing any simulation studies.

APPENDIX 4

ONSITE SIGNAL PROVISION FOR WITNESSING TESTS

ECP.A.4.1 During any tests witnessed on-site by **The Company**, the following signals shall be provided to **The Company** by the **Generator** undertaking **OTSDUW or HVDC System Owner** in accordance with ECC.6.6.3.

ECP.A.4.2 **Synchronous Power Generating Modules**

ECP.A.4.2(a) All Tests	<ul style="list-style-type: none"> • MW - Active Power at Synchronous Generating Unit terminals
ECP.A.4.2(b) Reactive & Excitation System	<ul style="list-style-type: none"> • MVar - Reactive Power at terminals • Vt - Synchronous Generating Unit terminal voltage • Efd- Synchronous Generating Unit field voltage and/or main exciter field voltage • Ifd – Synchronous Generating Unit Field current (where possible) • Power System Stabiliser output, where applicable. • Noise – Injected noise signal (where applicable and possible)
ECP.A.4.2(c) Governor System & Frequency Response	<ul style="list-style-type: none"> • Fsys - System Frequency • Finj - Injected Speed Setpoint • Logic - Stop / Start Logic Signal <p>For Gas Turbines:</p> <ul style="list-style-type: none"> • GT Fuel Demand • GT Fuel Valve Position • GT Inlet Guide Vane Position • GT Exhaust Gas Temperature <p>For Steam Turbines at >= 1Hz:</p> <ul style="list-style-type: none"> • Pressure before Turbine Governor Valves • Turbine Governor Valve Positions • Governor Oil Pressure* • Boiler Pressure Set Point * • Superheater Outlet Pressure * • Pressure after Turbine Governor Valves* • Boiler Firing Demand* <p>*Where applicable (typically not in CCGT module)</p> <p>For Hydro Plant:</p> <ul style="list-style-type: none"> • Speed Governor Demand Signal • Actuator Output Signal • Guide Vane / Needle Valve Position
ECP.A.4.2(d) Compliance with ECC.6.3.3	<ul style="list-style-type: none"> • Fsys - System Frequency • Finj - Injected Speed Setpoint • Appropriate control system parameters as agreed with The Company (See ECP.A.5.9)
ECP.A.4.2(e) Real Time on site or Down-loadable	<ul style="list-style-type: none"> • MW - Synchronous Power Generating Module Active Power at the Grid Entry Point or (User System Entry Point if Embedded). • MVar - Synchronous Power Generating Module Reactive Power at the Grid Entry Point or (User System Entry Point if Embedded).

	<ul style="list-style-type: none"> Line-line Voltage (kV) at the Grid Entry Point or (User System Entry Point if Embedded).
--	---

ECP.A.4.3 **Power Park Modules, OTSDUA and HVDC Equipment**

	Each Power Park Module and HVDC Equipment at Grid Entry Point or User System Entry Point
ECP.A.4.3.1(a) Real Time on site.	<ul style="list-style-type: none"> Total Active Power (MW) Total Reactive Power (MVar) Line-line Voltage (kV) System Frequency (Hz)
ECP.A.4.3.1(b) Real Time on site or Down-loadable	<ul style="list-style-type: none"> Injected frequency signal (Hz) or test logic signal (Boolean) when appropriate Injected voltage signal (per unit voltage) or test logic signal (Boolean) when appropriate In the case of an Onshore Power Park Module the Onshore Power Park Module site voltage (MV) (kV) Power System Stabiliser output, where appropriate In the case of a Power Park Module or HVDC Equipment where the Reactive Power is provided by more than one Reactive Power source, the individual Reactive Power contributions from each source, as agreed with The Company. In the case of HVDC Equipment appropriate control system parameters as agreed with The Company (See ECP.A.7) In the case of an Offshore Power Park Module the Total Active Power (MW) and the Total Reactive Power (MVar) at the offshore Grid Entry Point
ECP.A.4.3.1(c) Real Time on site or Down-loadable	<ul style="list-style-type: none"> Available power for Power Park Module (MW) Power source speed for Power Park Module (e.g. wind speed) (m/s) when appropriate Power source direction for Power Park Module (degrees) when appropriate <p>See ECP.A.4.3.2</p>

ECP.A.4.3.2 **The Company** accept that the signals specified in ECP.A.4.3.1(c) may have lower effective sample rates than those required in ECC.6.6.3 although any signals supplied for connection to **The Company's** recording equipment which do not meet at least the sample rates detailed in ECC.6.6.3 should have the actual sample rates indicated to **The Company** before testing commences.

ECP.A.4.3.3 For all **The Company** witnessed testing either;

- (i) the **Generator** or **HVDC System Owner** shall provide to **The Company** all signals outlined in ECP.A.4.3.1 direct from the **Power Park Module** control system without any attenuation, delay or filtering which would result in the inability to fully demonstrate the objectives of the test, or identify any potential safety or plant instability issues, and with a signal update rate corresponding to ECC.6.6.3.2; or
- (ii) in the case of **Onshore Power Park Modules**, the **Generator** or **HVDC System Owner** shall provide signals ECP.A.4.3.1(a) direct from one or more transducer(s) connected to current and voltage transformers for monitoring in real time on site; or,

- (iii) In the case of **Offshore Power Park Modules** and **OTSDUA** signals ECP.A.4.3.1(a) will be provided at the **Interface Point** by the **Offshore Transmission Licensee** pursuant to the **STC** or by the **Generator** when **OTSDUW Arrangements** apply.

ECP.A.4.3.4 Options ECP.A.4.3.3 (ii) and (iii) will only be available on condition that;

- (a) all signals outlined in ECP.A.4.3.1 are recorded and made available to **The Company** by the **Generator** or **HVDC System Owner** from the **Power Park Module** or **OTSDUA** or **HVDC Equipment** control systems as a download once the testing has been completed; and
- (b) the full test results are provided by the **Generator HVDC System Owner** within 2 working days of the test date to **The Company** unless **The Company** agrees otherwise; and
- (c) all data is provided with a sample rate in accordance with ECC.6.6.3.3 unless **The Company** agrees otherwise; and
- (d) in **The Company's** reasonable opinion, the solution does not unreasonably add a significant delay between tests or impede the volume of testing which can take place on the day.

ECP.A.4.3.5 In the case of where transducers connected to current and voltage transformers are installed (ECP.A.4. 3.3(ii) and (iii)), the transducers shall meet the following specification

- (a) The transducer(s) shall be permanently installed to easily allow safe testing at any point in the future, and to avoid a requirement for recalibration of the current transformers and voltage transformers.
- (b) The transducer(s) should be directly connected to the metering quality current transformers and voltage transformers or similar.
- (c) The transducers shall either have a response time no greater than 50ms to reach 90% of output, or no greater than 300ms to reach 99.5%.

APPENDIX 5

COMPLIANCE TESTING OF SYNCHRONOUS POWER GENERATING MODULES

ECP.A.5.1 SCOPE

ECP.A.5.1.1 This Appendix sets out the tests contained therein to demonstrate compliance with the relevant clauses of the **European Connection Conditions** of the **Grid Code**. This Appendix shall be read in conjunction with the ECP with regard to the submission of the reports to **The Company**.

ECP.A.5.1.2 The tests specified in this Appendix will normally be sufficient to demonstrate compliance however **The Company** may:

- (i) agree an alternative set of tests provided **The Company** deem the alternative set of tests sufficient to demonstrate compliance with the **Grid Code** and **Bilateral Agreement**; and/or
- (ii) require additional or alternative tests if information supplied to **The Company** during the compliance process suggests that the tests in this Appendix will not fully demonstrate compliance with the relevant section of the **Grid Code** or **Bilateral Agreement**.
- (iii) Agree a reduced set of tests for subsequent **Synchronous Power Generating Module** following successful completion of the first **Synchronous Power Generating Module** tests in the case of a **Power Station** comprised of two or more **Synchronous Power Generating Modules** which **The Company** reasonably considers to be identical.

If:

- (a) the tests performed pursuant to ECP.A.5.1.2(iii) in respect of subsequent **Synchronous Power Generating Modules** do not replicate the full tests for the first **Synchronous Power Generating Module**, or
- (b) any of the tests performed pursuant to ECP.A.5.1.2(iii) do not fully demonstrate compliance with the relevant aspects of the **Grid Code**, **Ancillary Services Agreement** and / or **Bilateral Agreement**,

then notwithstanding the provisions above, the full testing requirements set out in this Appendix will be applied.

ECP.A.5.1.3 The **Generator** is responsible for carrying out the tests set out in and in accordance with this Appendix and the **Generator** retains the responsibility for the safety of personnel and plant during the test. **The Company** will witness all of the tests outlined or agreed in relation to this Appendix unless **The Company** decides and notifies the **Generator** otherwise. Reactive Capability tests may be witnessed by **The Company** remotely from **The Company** control centre. For all on site, **The Company** witnessed tests the **Generator** should ensure suitable representatives from the **Generator** and manufacturer (if appropriate) are available on site for the entire testing period. In all cases the **Generator** shall provide suitable monitoring equipment to record all relevant test signals as outlined below in ECP.A.6.1.5.

ECP.A.5.1.4 The **Generator** shall submit a schedule of tests to **The Company** in accordance with CP.4.3.1.

ECP.A.5.1.5 Prior to the testing of a **Synchronous Power Generating Module** the

Generator shall complete the **Integral Equipment Test** procedure in accordance with OC.7.5.

ECP.A.5.1.6 Full **Synchronous Power Generating Module** testing as required by CP.7.2 is to be completed as defined in ECP.A.5.2 through to ECP.A.5.9.

ECP.A.5.1.7 **The Company** will permit relaxation from the requirement ECP.A.5.2 to ECP.A.5.9 where an **Equipment Certificate** for the **Synchronous Power Generating Module** has been provided which details the characteristics from tests on a representative machine with the same equipment and settings and the performance of the **Synchronous Power Generating Module** can, in **The Company's** opinion, reasonably represent that of the installed **Synchronous Power Generating Module** at that site. For **Type B, Type C** and **Type D Power Generating Modules** the relevant **Equipment Certificate** must be supplied in the **Power Generating Module Document** or **Users Data File structure** as applicable.

ECP.A.5.1.8 In the case of a co-located site, for example **Electricity Storage Modules** connected within a new or existing **Power Station**, **The Company** will accept test results to demonstrate compliance at the **Grid Entry Point** or **User System Entry Point (if Embedded)** through a combination of the capabilities of the **Power Generating Modules** and **Electricity Storage Modules** or **Electricity Storage Modules** and **Generating Units** or **Power Park Modules**. **Generators** should however be aware that for the purposes of testing, full Grid Code compliance should be demonstrated when, for example, the **Electricity Storage Module** is out of service and the remaining **Power Generating Module** is in service or the **Electricity Storage Module** is in service and the **Power Generating Module** is out of service. In the case of a **Synchronous Electricity Storage Module**, **The Company** would expect the full set of tests to be completed as detailed in ECP.A.5.2 to ECP.A.5.9.

ECP.A.5.2 Excitation System Open Circuit Step Response Tests

ECP.A.5.2.1 The open circuit step response of the **Excitation System** will be tested by applying a voltage step change from 90% to 100% of the nominal **Synchronous Power Generating Module** terminal voltage, with the **Synchronous Power Generating Module** on open circuit and at rated speed.

ECP.A.5.2.2 The test shall be carried out prior to synchronisation in accordance with CP.6.4. This is not witnessed by **The Company** unless specifically requested by **The Company**. Where **The Company** is not witnessing the tests, the **Generator** shall supply the recordings of the following signals to **The Company** in an electronic spreadsheet format:

Vt - **Synchronous Generating Unit** terminal voltage
Efd - **Synchronous Generating Unit** field voltage or main exciter field voltage
Ifd- **Synchronous Generating Unit** field current (where possible)
Step injection signal

ECP.A.5.2.3 Results shall be legible, identifiable by labelling, and shall have appropriate scaling.

ECP.A.5.3 Open & Short Circuit Saturation Characteristics

ECP.A.5.3.1 The test shall normally be carried out prior to synchronisation in accordance with ECP.6.2.4 or ECP.6.3.4 **Equipment Certificates** or **Manufacturer's Test Certificates** may be used where appropriate may be used if agreed by **The Company**.

- ECP.A.5.3.2 This is not witnessed by **The Company**. Graphical and tabular representations of the results in an electronic spreadsheet format showing per unit open circuit terminal voltage and short circuit current versus per unit field current shall be submitted to **The Company**.
- ECP.A.5.3.3 Results shall be legible, identifiable by labelling, and shall have appropriate scaling.
- ECP.A.5.4 **Excitation System On-Load Tests**
- ECP.A.5.4.1 The time domain performance of the **Excitation System** shall be tested by application of voltage step changes corresponding to 1% and 2% of the nominal terminal voltage.
- ECP.A.5.4.2 Where a **Power System Stabiliser** is present:
- (i) The **PSS** must only be commissioned in accordance with BC2.11.2. When a **PSS** is switched on for the first time as part of on-load commissioning or if parameters have been adjusted the **Generator** should consider reducing the **PSS** output gain by at least 50% and should consider reducing the limits on **PSS** output by at least a factor of 5 to prevent unexpected PSS action affecting the stability of the **Synchronous Generating Unit** or the **National Electricity Transmission System**.
 - (ii) The time domain performance of the **Excitation System** shall be tested by application of voltage step changes corresponding to 1% and 2% of the nominal terminal voltage, repeating with and without the **PSS** in service.
 - (iii) The frequency domain tuning of the **PSS** shall also be demonstrated by injecting a 0.2Hz-3Hz band limited random noise signal into the **Automatic Voltage Regulator** Setpoint with the **Synchronous Generating Unit** operating at points specified by **The Company** (up to rated MVA output).
 - (iv) The **PSS** gain margin shall be tested by increasing the **PSS** gain gradually to threefold and observing the **Synchronous Generating Unit** steady state **Active Power** output.
 - (v) The interaction of the **PSS** with changes in **Active Power** shall be tested by application of a +0.5Hz frequency injection to the governor while the **Synchronous Generating Unit** is selected to **Frequency Sensitive Mode**.
 - (vi) If the **Synchronous Power Generating Module** is of the **Pumped Storage** type then the step tests shall be carried out, with and without the **PSS**, in the pumping mode in addition to the generating mode. In the case of a **Synchronous Electricity Storage Module** the tests shall be carried out with and without the **PSS** in both importing and exporting modes of operation.
 - (vii) Where the **Bilateral Agreement** requires that the **PSS** is in service, at a specified loading level, additional testing witnessed by **The Company** will be required during the commissioning process before the **Synchronous Power Generating Module** may exceed this output level.
 - (viii) Where the **Excitation System** includes a **PSS**, the **Generator** shall provide a suitable noise source to facilitate noise injection testing.

ECP.A.5.4.3 The following typical procedure is provided to assist **Generators** in drawing up their own site specific procedures for **The Company** witnessed **PSS** Tests.

Test	Injection	Notes
	Synchronous Generating Unit running at Maximum Capacity , unity pf, PSS Switched Off	
1	<ul style="list-style-type: none"> Record steady state for 10 seconds Inject +1% step to AVR voltage setpoint and hold for at least 10 seconds until stabilised Remove step returning AVR voltage setpoint to nominal and hold for at least 10 seconds 	
2	<ul style="list-style-type: none"> Record steady state for 10 seconds Inject +2% step to AVR voltage setpoint and hold for at least 10 seconds until stabilised Remove step returning AVR voltage setpoint to nominal and hold for at least 10 seconds 	
3	<ul style="list-style-type: none"> Inject band limited (0.2-3Hz) random noise signal into voltage Setpoint and measure frequency spectrum of Real Power. Remove noise injection. 	
	Switch On Power System Stabiliser	
4	<ul style="list-style-type: none"> Record steady state for 10 seconds Inject +1% step to AVR voltage setpoint and hold for at least 10 seconds until stabilised Remove step returning AVR voltage setpoint to nominal and hold for at least 10 seconds 	
5	<ul style="list-style-type: none"> Record steady state for 10 seconds Inject +2% step to AVR Voltage Setpoint and hold for at least 10 seconds until stabilised Remove step returning AVR Voltage Setpoint to nominal and hold for at least 10 seconds 	
6	<ul style="list-style-type: none"> Increase PSS gain at 30second intervals. i.e. x1 – x1.5 – x2 – x2.5 – x3 Return PSS gain to initial setting 	
7	<ul style="list-style-type: none"> Inject band limited (0.2-3Hz) random noise signal into voltage Setpoint and measure frequency spectrum of Real Power. Remove noise injection. 	
8	<ul style="list-style-type: none"> Select the governor to FSM Inject +0.5 Hz step into governor. Hold until generator MW output is stabilised Remove step 	

ECP.A.5.5 Under-excitation Limiter Performance Test

ECP.A.5.5.1 Initially the performance of the **Under-excitation Limiter** should be checked by moving the limit line close to the operating point of the **Synchronous Generating Unit** when operating close to unity **Power Factor**. The operating point of the **Synchronous Generating Unit** is then stepped into the limit by applying a 2% decrease in **Automatic Voltage Regulator** Setpoint voltage.

ECP.A.5.5.2 The final performance of the **Under-excitation Limiter** shall be demonstrated by testing its response to a step change corresponding to a 2% decrease in **Automatic Voltage Regulator Setpoint** voltage when the **Synchronous Generating Unit** is operating just off the limit line, at the designed setting as indicated on the **Performance Chart** [P-Q Capability Diagram] submitted to **The Company** under OC2.

ECP.A.5.5.3 Where possible the **Under-excitation Limiter** should also be tested by operating the tap- changer when the **Synchronous Generating Unit** is operating just off the limit line, as set up.

ECP.A.5.5.4 The **Under-excitation Limiter** will normally be tested at low active power output and at maximum **Active Power** output.

ECP.A.5.5.5 The following typical procedure is provided to assist **Generators** in drawing up their own site specific procedures for **The Company** witnessed **Under-excitation Limiter Tests**.

Test	Injection	Notes
	Synchronous Generating Unit running at Maximum Capacity and unity Power Factor . Under-excitation limit temporarily moved close to the operating point of the Synchronous Generating Unit .	
1	<ul style="list-style-type: none"> • PSS on. • Inject -2% voltage step into AVR voltage setpoint and hold at least for 10 seconds until stabilised • Remove step returning AVR voltage setpoint to nominal and hold for at least 10 seconds 	
	Under-excitation limit moved to normal position. Synchronous Generating Unit running at Maximum Capacity and at leading Reactive Power close to Under-excitation limit.	
2	<ul style="list-style-type: none"> • PSS on. • Inject -2% voltage step into AVR voltage setpoint and hold at least for 10 seconds until stabilised • Remove step returning AVR voltage setpoint to nominal and hold for at least 10 seconds 	

ECP.A.5.6 Over-excitation Limiter Performance Test

ECP.A.5.6.1 The performance of the **Over-excitation Limiter**, where it exists, shall be demonstrated by testing its response to a step increase in the **Automatic Voltage Regulator Setpoint Voltage** that results in operation of the **Over-excitation Limiter**. Prior to application of the step the **Synchronous Generating Unit** shall be generating **Maximum Capacity** and operating within its continuous **Reactive Power** capability. The size of the step will be determined by the minimum value necessary to operate the **Over-excitation Limiter** and will be agreed by **The Company** and the **Generator**. The resulting operation beyond the **Over-excitation Limit** shall be controlled by the **Over-excitation Limiter** without the operation of any protection that could trip the **Synchronous Power Generating Module**. The step shall be removed immediately on completion of the test.

ECP.A.5.6.2 If the **Over-excitation Limiter** has multiple levels to account for heating effects, an explanation of this functionality will be necessary and if appropriate, a description of how this can be tested.

ECP.A.5.6.3 The following typical procedure is provided to assist **Generators** in drawing up their own site specific procedures for **The Company** witnessed **Under-excitation Limiter Tests**.

Test	Injection	Notes
	Synchronous Generating Unit running at Maximum Capacity and maximum lagging Reactive Power .	
	Over-excitation Limit temporarily set close to this operating point. PSS on.	
1	<ul style="list-style-type: none"> • Inject positive voltage step into AVR voltage setpoint and hold 	

	<ul style="list-style-type: none"> • Wait until Over-excitation Limiter operates after sufficient time delay to bring back the excitation back to the limit. • Remove step returning AVR voltage setpoint to nominal. 	
	Over-excitation Limit restored to its normal operating value. PSS on.	

ECP.A.5.7 Reactive Capability

ECP.A.5.7.1 The **Reactive Power** capability on each **Synchronous Power Generating Module** will normally be demonstrated by:

- (a) operation of the **Synchronous Power Generating Module** at maximum lagging **Reactive Power** and **Maximum Capacity** for 1 hour
- (b) operation of the **Synchronous Power Generating Module** at maximum leading **Reactive Power** and **Maximum Capacity** for 1 hour.
- (c) operation of the **Synchronous Power Generating Module** at maximum lagging **Reactive Power** and **Minimum Stable Operating Level** for 1 hour
- (d) operation of the **Synchronous Power Generating Module** at maximum leading **Reactive Power** and **Minimum Stable Operating Level** for 1 hour.
- (e) operation of the **Synchronous Power Generating Module** at maximum lagging **Reactive Power** and a power output between **Maximum Capacity** and **Minimum Stable Operating Level**.
- (f) operation of the **Synchronous Power Generating Module** at maximum leading **Reactive Power** and a power output between **Maximum Capacity** and **Minimum Stable Operating Level**.

In the case of a **Synchronous Electricity Storage Module**, **The Company** shall have discretion to reduce the durations of the tests set out in ECP.A.5.7.1 (a) – (f), depending upon the capacity of the energy store.

ECP.A.5.7.2 In the case of an **Embedded Synchronous Power Generating Module** where distribution network considerations restrict the **Synchronous Power Generating Module Reactive Power** output, **The Company** will only require demonstration within the acceptable limits of the **Network Operator's System**.

ECP.A.5.7.3 The test procedure, time and date will be agreed with **The Company** and will be to the instruction of **The Company** control centre and shall be monitored and recorded at both **The Company** control centre and by the **Generator**.

ECP.A.5.7.4 Where the **Generator** is recording the voltage, **Active Power** and **Reactive Power** at the HV connection point the voltage for these tests **Active Power** and **Reactive Power** at the **Synchronous Power Generating Module** terminals may also be included. The results shall be supplied in an electronic spreadsheet format. Where applicable the **Synchronous Power Generating Module** transformer tapchanger position should be noted throughout the test period.

ECP.A.5.8 Governor and Load Controller Response Performance

ECP.A.5.8.1 The governor and load controller response performance will be tested by

injecting simulated frequency deviations into the governor and load controller systems. Such simulated frequency deviation signals must be injected simultaneously at both speed governor and load controller setpoints. For **CCGT modules**, simultaneous injection into all gas turbines, steam turbine governors and module controllers is required.

ECP.A.5.8.2 Prior to witnessing the governor tests set out in ECP.A.5.8.6, **The Company** requires the **Generator** to conduct the preliminary tests detailed in ECP.A.5.8.4 and send the results to **The Company** for assessment unless agreed otherwise by **The Company**. The results should be supplied in an electronic spreadsheet format. These tests shall be completed at least two weeks prior to the witnessed governor response tests.

ECP.A.5.8.3 Where a **CCGT module** or **Synchronous Power Generating Module** is capable of operating on alternative fuels, tests will be required to demonstrate performance when operating on each fuel. **The Company** may agree a reduction from the tests listed in ECP.A.5.8.6 for demonstrating performance on the alternative fuel. This includes the case where a main fuel is supplemented by bio-fuel.

Preliminary Governor Frequency Response Testing

ECP.A.5.8.4 Prior to conducting the full set of tests as per ECP.A.5.8.6, **Generators** are required to conduct a preliminary set of tests below to confirm the frequency injection method is correct and the plant control performance is within expectation. The test numbers refer to Figure 1 below. With the plant running at 80% of full load, the following frequency injections shall be applied.

Test No (Figure1)	Frequency Injection	Notes
8	<ul style="list-style-type: none"> • Inject -0.5Hz frequency fall over 10 sec • Hold for a further 20 sec • At 30 sec from the start of the test, Inject a +0.3Hz frequency rise over 30 sec. • Hold until conditions stabilise • Remove the injected signal as a ramp over 10 seconds 	
13	<ul style="list-style-type: none"> • Inject - 0.5Hz frequency fall over 10 sec • Hold until conditions stabilise • Remove the injected signal as a ramp over 10 seconds 	
14	<ul style="list-style-type: none"> • Inject +0.5Hz frequency rise over 10 sec • Hold until conditions stabilise • Remove the injected signal as a ramp over 10 seconds 	
H	<ul style="list-style-type: none"> • Inject - 0.5Hz frequency fall as a stepchange • Hold until conditions stabilise • Remove the injected signal as a stepchange 	
I	<ul style="list-style-type: none"> • Inject +0.5Hz frequency rise as a stepchange • Hold until conditions stabilise • Remove the injected signal as a stepchange 	

ECP.A.5.8.5 The recorded results (e.g. Finj, MW and control signals) should be sampled at a minimum rate of 1 Hz to allow **The Company** to assess the plant performance from the initial transients (seconds) to the final steady state conditions (5-15 minutes depending on the plant design). This is not witnessed by **The Company**. The **Generator** shall supply the recordings including data to **The Company** in an electronic spreadsheet format. Results shall be legible, identifiable by labelling, and shall have appropriate scaling.

Full Frequency Response Testing Schedule Witnessed by **The Company**

ECP.A.5.8.6 The tests are to be conducted at a number of different Module Load Points (MLP). The load points are conducted as shown below unless agreed otherwise by **The Company**.

Module Load Point 6 (Maximum Export Limit)	100% MEL
Module Load Point 5	95% MEL
Module Load Point 4 (Mid-point of Operating Range)	80% MEL
Module Load Point 3	70% MEL
Module Load Point 2 (Lower of MRL+10% or Minimum Stable Operating Level)	MRL+10% or MSOL
Module Load Point 1 (Minimum Regulating Level)	MRL

ECP.A.5.8.7 The tests are divided into the following three types;

- (i) Frequency response compliance and volume tests as per ECP.A.5.8. Figure 1. These tests consist of frequency profile and ramp tests and adjustments to the target frequency setpoint as per ECP.5.8 Figure 3.
- (ii) System islanding and step response tests as shown by ECP.A.5.8. Figure 2.
- (iii) Frequency response tests in **Limited Frequency Sensitive Mode (LFSM)** to demonstrate **LFSM-O** and **LFSM-U** capability as shown by ECP.A.5.8 Figure 2.

ECP.A.5.8.8 There should be sufficient time allowed between tests for control systems to reach steady state. Where the diagram states 'HOLD' the current injection should be maintained until the **Active Power** (MW) output of the **Synchronous Power Generating Module** or **CCGT Module** has stabilised. The frequency response capability test (see Figure 1) injection signal shall be returned to zero at the same rate at which it was applied. **The Company** may require repeat tests should the tests give unexpected results.

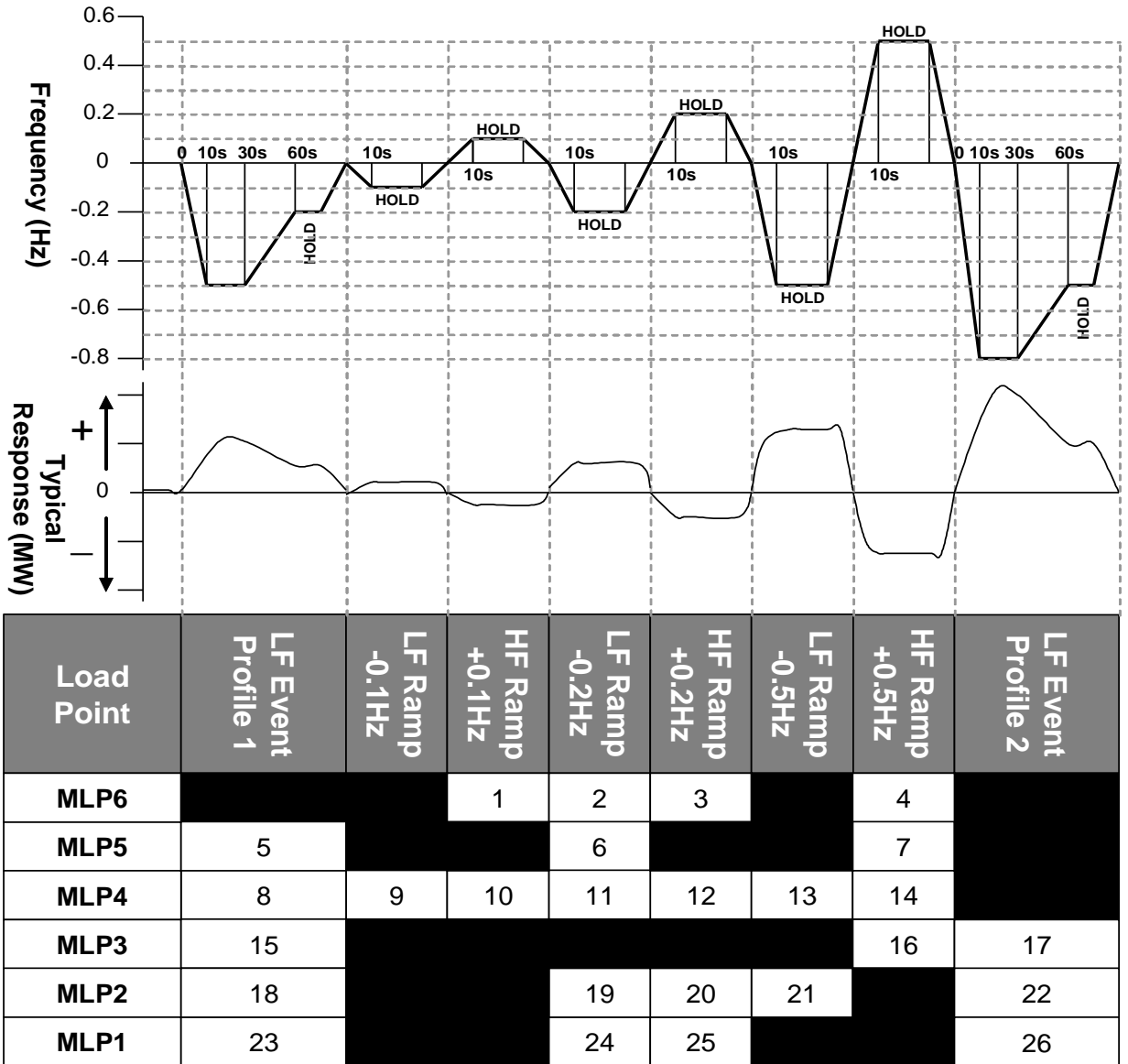

Figure 1: Frequency Response Capability FSM Ramp Response Tests

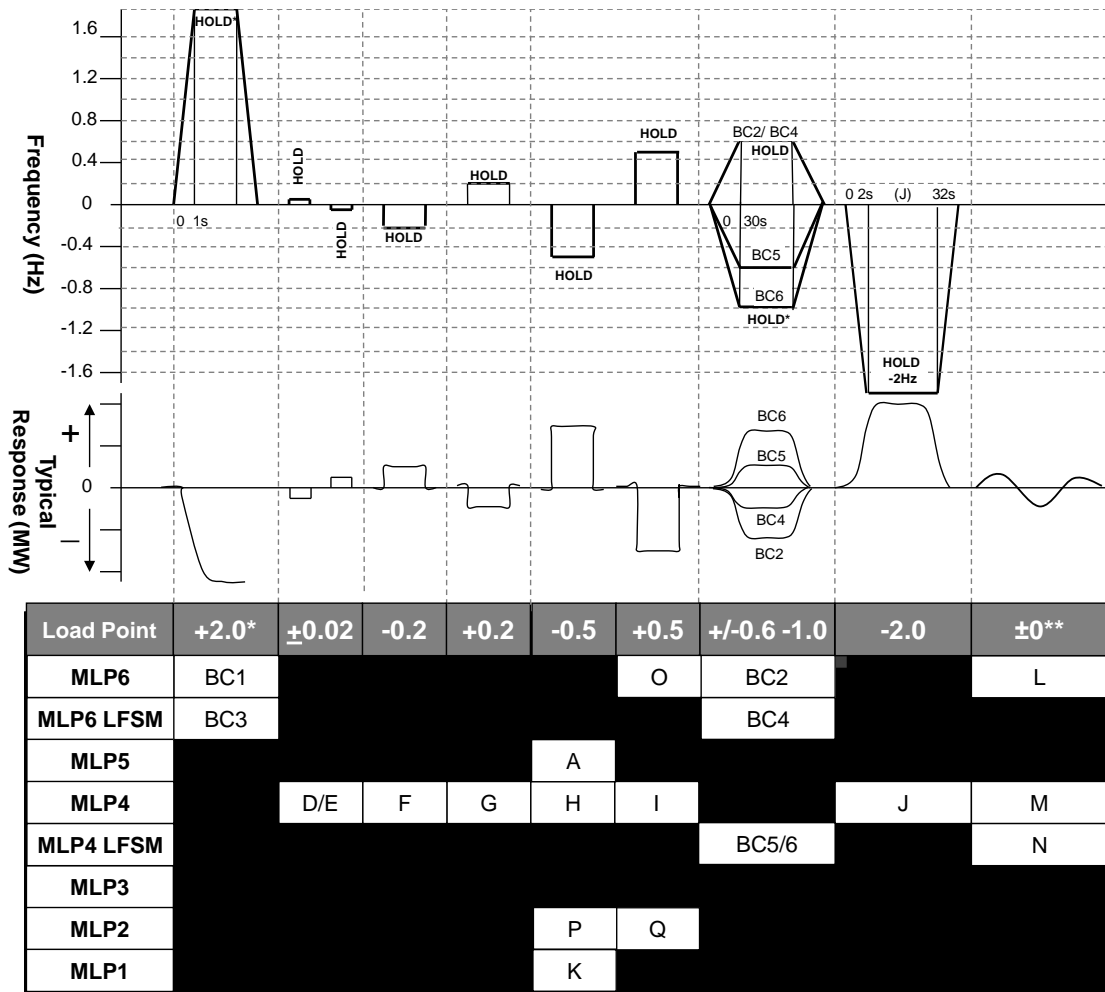

Figure 2: Frequency Response Capability LFSM-O, LFSM-U and FSM Step Response Tests

* This will generally be +2.0Hz unless an injection of this size causes a reduction in plant output that takes the operating point below the **Minimum Regulating Level** in which case an appropriate injection should be calculated in accordance with the following:

For example, 0.9Hz is needed to take an initial output 65% to a final output of 20%. If the initial output was not 65% and the **Minimum Regulating Level** is not 20% then the injected step should be adjusted accordingly as shown in the example given below

Initial Output	65%
Minimum Regulating Level	20%
Frequency Controller Droop	4%
Frequency to be injected = $(0.65-0.20) \times 0.04 \times 50 =$	0.9Hz

** Tests L and M in Figure 2 shall be conducted if in this range of tests the **System Frequency** feedback signal is replaced by the injection signal rather than the injection signal being added to the system frequency signal. The tests will consist of monitoring the **Synchronous Power Generating Module and CCGT Module** in **Frequency Sensitive Mode** during normal system frequency variations without applying any injection. Test N in figure 2 shall be

conducted in all cases. All three tests should be conducted for a period of at least 10 minutes.

ECP.A.5.8.9 The **Target Frequency** adjustment facility should be demonstrated from the normal control point within the range of 49.9Hz to 50.1Hz by step changes to the **Target Frequency** setpoint as indicated in ECP.A.5.8 Figure 3 while operating at MLP4.

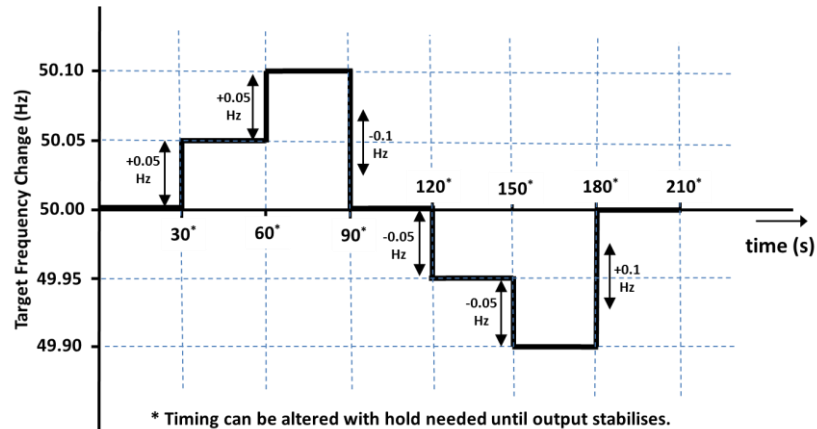

ECP.A.5.8 Figure 3 – **Target Frequency** setting changes

ECP.A.5.9 Compliance with ECC.6.3.3 Functionality Test

ECP.A.5.9.1 Where the plant design includes active control function or functions to deliver ECC.6.3.3 compliance, the **Generator** will propose and agree a test procedure with **The Company**, which will demonstrate how the **Synchronous Power Generating Module Active Power** output responds to changes in **System Frequency** and ambient conditions (e.g. by **Frequency** and temperature injection methods).

ECP.A.5.9.2 The **Generator** shall inform **The Company** if any load limiter control is additionally employed.

ECP.A.5.9.3 With the setpoint to the signals specified in ECP.A.4, **The Company** will agree with the **Generator** which additional control system parameters shall be monitored to demonstrate the functionality of ECC.6.3.3 compliance systems. Where **The Company** recording equipment is not used, results shall be supplied to **The Company** in an electronic spreadsheet format

APPENDIX 6

COMPLIANCE TESTING OF POWER PARK MODULES

ECP.A.6.1 SCOPE

ECP.A.6.1.1 This Appendix outlines the general testing requirements for **Power Park Modules** and **OTSDUA** to demonstrate compliance with the relevant aspects of the **Grid Code, Ancillary Services Agreement** and **Bilateral Agreement**. The tests specified in this Appendix will normally be sufficient to demonstrate compliance however **The Company** may:

- i) agree an alternative set of tests provided **The Company** deem the alternative set of tests sufficient to demonstrate compliance with the **Grid Code, Ancillary Services Agreement** and **Bilateral Agreement**; and/or
- ii) require additional or alternative tests if information supplied to **The Company** during the compliance process suggests that the tests in this Appendix will not fully demonstrate compliance with the relevant section of the **Grid Code, Ancillary Services Agreement** or **Bilateral Agreement**; and/or
- iii) require additional tests if a **Power System Stabiliser** is fitted; and/or
- iv) agree a reduced set of tests if a relevant **Manufacturer's Data & Performance Report** has been submitted to and deemed to be appropriate by **The Company**; and/or
- v) agree a reduced set of tests for subsequent **Power Park Modules** or **OTSDUA** following successful completion of the first **Power Park Module** or **OTSDUA** tests in the case of a **Power Station** comprised of two or more **Power Park Modules** or **OTSDUA** which **The Company** reasonably considers to be identical.

If:

- (a) the tests performed pursuant to ECP.A.6.1.1(iv) do not replicate the results contained in the **Manufacturer's Data & Performance Report**, or
- (b) the tests performed pursuant to ECP.A.6.1.1(v) in respect of subsequent **Power Park Modules** or **OTSDUA** do not replicate the full tests for the first **Power Park Module** or **OTSDUA**, or
- (c) any of the tests performed pursuant to ECP.A.6.1.1(iv) or ECP.A.6.1.1(v) do not fully demonstrate compliance with the relevant aspects of the **Grid Code, Ancillary Services Agreement** and / or **Bilateral Agreement**,

then notwithstanding the provisions above, the full testing requirements set out in this Appendix will be applied.

ECP.A.6.1.2 The **Generator** is responsible for carrying out the tests set out in and in accordance with this Appendix and the **Generator** retains the responsibility for the safety of personnel and plant during the test. **The Company** will witness all of the tests outlined or agreed in relation to this Appendix unless **The Company** decides and notifies the **Generator** otherwise. Reactive Capability tests may be witnessed by **The Company** remotely from **The Company** control centre. For all on site **The Company** witnessed tests the **Generator**

must ensure suitable representatives from the **Generator** and / or **Power Park Module** manufacturer (if appropriate) and/or **OTSDUA** manufacturer (if appropriate) are available on site for the entire testing period. In all cases and in addition to any recording of signals conducted by **The Company**, the **Generator** shall record all relevant test signals as outlined in ECP.A.4.

- ECP.A.6.1.3 In addition to the dynamic signals supplied in ECP.A.4 the **Generator** shall inform **The Company** of the following information prior to the commencement of the tests and any changes to the following, if any values change during the tests:
- (i) All relevant transformer tap numbers; and
 - (ii) Number of **Power Park Units** in operation
- ECP.A.6.1.4 The **Generator** shall submit a detailed schedule of tests to **The Company** in accordance with CP.6.3.1, and this Appendix.
- ECP.A.6.1.5 Prior to the testing of a **Power Park Module** or **OTSDUA**, the **Generator** shall complete the **Integral Equipment Tests** procedure in accordance with OC.7.5.
- ECP.A.6.1.6 Partial **Power Park Module** or **OTSDUA** testing as defined in ECP.A.6.2 and ECP.A.6.3 is to be completed at the appropriate stage in accordance with ECP.6, ECP6.4A, ECP6.4B.
- ECP.A.6.1.7 Full **Power Park Module** or **OTSDUA** testing as required by CP.7.2 is to be completed as defined in ECP.A.6.4 through to ECP.A.6.7.
- ECP.A.6.1.8 Where **OTSDUW Arrangements** apply and prior to the **OTSUA Transfer Time** any relevant **OTSDUW Plant and Apparatus** shall be considered within the scope of testing described in this Appendix. Performance shall be assessed against the relevant Grid Code requirements for **OTSDUW Plant and Apparatus** at the **Interface Point** and other **Generator Plant and Apparatus** at the **Offshore Grid Entry Point**. This Appendix should be read accordingly.
- ECP.A.6.1.9 **The Company** will permit relaxation from the requirement ECP.A.6.2 to ECP.A.6.8 where an **Equipment Certificate** for the **Power Park Module** has been provided which details the characteristics from tests on a representative installation with the same equipment and settings and the performance of the **Power Park Module** can, in **The Company's** opinion, reasonably represent that of the installed **Power Park Module** at that site. For **Type B, Type C** and **Type D Power Park Modules**, the relevant **Equipment Certificate** must be supplied in the **Power Generating Module Document** or **Users Data File structure** as applicable.
- ECP.A.6.1.10 In the case of a co-located site, for example **Electricity Storage Modules** connected within a new or existing **Power Station**, **The Company** will accept test results to demonstrate compliance at the **Grid Entry Point** or **User System Entry Point** (if **Embedded**) through a combination of the capabilities of the **Power Generating Modules** and **Electricity Storage Modules** or **Electricity Storage Modules** and **Generating Units** or **Power Park Modules**. **Generators** should however be aware that for the purposes of testing, full Grid Code compliance should be demonstrated when, for example, the **Electricity Storage Module** is out of service and the remaining **Power Generating Module** is in service or the **Electricity Storage Module** is in service and the **Power Generating Module** is out of service. In the case of a **Non-Synchronous Electricity Storage Module**, **The Company** would expect the full set of tests to be completed as detailed in ECP.A.6.2 to ECP.A.6.8.

ECP.A.6.2 Pre 20% (or <50MW) Synchronised Power Park Module Basic Voltage Control Tests

ECP.A.6.2.1 Before 20% of the **Power Park Module** (or 50MW if less) has commissioned, either voltage control test ECP.A.6.5.6(i) or (ii) must be completed in accordance with ECP.6, ECP.6A or ECP.6B. In the case of an **Offshore Power Park Module** the test must be completed by the **Generator** undertaking **OTSDUW** or the **Offshore Transmission Licensee** under STCP19-5.

ECP.A.6.2.2 In the case of an **Offshore Power Park Module** which provides all or a portion of the **Reactive Power** capability as described in ECC.6.3.2.5.2 or ECP.6.3.2.6.3 and / or voltage control requirements as described in ECC.6.3.8.5 to enable an **Offshore Transmission Licensee** to meet the requirements of **STC** Section K, the **Generator** is required to cooperate with the **Offshore Transmission Licensee** to conduct the 20% voltage control test. The results in relation to the **Offshore Power Park Module** will be assessed against the requirements in the **Bilateral Agreement**.

ECP.A.6.3 Power Park Modules with Maximum Capacity \geq 100MW Pre 70% Power Park Module Tests

ECP.A.6.3.1 Before 70% but with at least 50% of the **Power Park Module** commissioned the following **Limited Frequency Sensitive** tests as detailed in ECP.A.6.6.2 must be completed.

- (a) BC3
- (b) BC4

ECP.A.6.4 Reactive Capability Test

ECP.A.6.4.1 This section details the procedure for demonstrating the reactive capability of an **Onshore Power Park Module** or an **Offshore Power Park Module** or **OTSDUA** which provides all or a portion of the **Reactive Power** capability as described in ECC.6.3.2.5.2 or ECP.6.3.2.6.3 as applicable (for the avoidance of doubt, an **Offshore Power Park Module** which does not provide part of the **Offshore Transmission Licensee Reactive Power** capability as described in ECC.6.3.2.5.1 and ECP.6.3.2.6.1 should complete the **Reactive Power** transfer / voltage control tests as per section ECP.A.6.8). These tests should be scheduled at a time where there are at least 95% of the **Power Park Units** within the **Power Park Module** in service. There should be sufficient MW resource forecasted in order to generate at least 85% of **Maximum Capacity** of the **Power Park Module**.

ECP.A.6.4.2 The tests shall be performed by modifying the voltage set-point of the voltage control scheme of the **Power Park Module** or **OTSDUA** by the amount necessary to demonstrate the required reactive range. This is to be conducted for the operating points and durations specified in ECP.A.6.4.5.

ECP.A.6.4.3 An **Embedded Generator** or **Embedded Generator** undertaking **OTSDUW** should liaise with the relevant **Network Operator** to ensure the following tests will not have an adverse impact upon the **Network Operator's System** as per OC.7.5. In situations where the tests have an adverse impact upon the **Network Operator's System**, **The Company** will only require demonstration within the acceptable limits of the **Network Operator**. For the avoidance of doubt, these tests do not negate the requirement to produce a complete **Power Park Module** or **OTSDUA** performance chart as specified in OC2.4.2.1

ECP.A.6.4.4 In the case where the **Reactive Power** metering point is not at the same

location as the **Reactive Power** capability requirement, then an equivalent **Reactive Power** capability for the metering point shall be agreed between the **Generator** and **The Company**.

ECP.A.6.4.5 The following tests shall be completed:

- (i) Operation in excess of 60% **Maximum Capacity** and maximum continuous lagging **Reactive Power** for 30 minutes.
- (ii) Operation in excess of 60% **Maximum Capacity** and maximum continuous leading **Reactive Power** for 30 minutes.
- (iii) Operation at 50% **Maximum Capacity** and maximum continuous leading **Reactive Power** for 30 minutes.
- (iv) Operation at 50% **Maximum Capacity** and maximum continuous lagging **Reactive Power** for 30 minutes.
- (v) Operation at 20% **Maximum Capacity** and maximum continuous leading **Reactive Power** for 60 minutes.
- (vi) Operation at 20% **Maximum Capacity** and maximum continuous lagging **Reactive Power** for 60 minutes.
- (vii) Operation at less than 20% **Maximum Capacity** and unity **Power Factor** for 5 minutes. This test only applies to systems which do not offer voltage control below 20% of **Maximum Capacity**.
- (viii) Operation at the lower of the **Minimum Stable Operating Level** or 0% **Maximum Capacity** and maximum continuous leading **Reactive Power** for 5 minutes. This test only applies to systems which offer voltage control below 20% and hence establishes actual capability rather than required capability.
- (ix) Operation at the lower of the **Minimum Stable Operating Level** or 0% **Maximum Capacity** and maximum continuous lagging **Reactive Power** for 5 minutes. This test only applies to systems which offer voltage control below 20% and hence establishes actual capability rather than required capability.

In the case of a **Non-Synchronous Electricity Storage Module**, **The Company** shall have discretion to reduce the duration of the tests required in ECP.A.6.4.5 (i) – (viii) depending upon the capability of the energy store.

ECP.A.6 Within this ECP, lagging **Reactive Power** is the export of **Reactive Power** from the **Power Park Module** to the **Total System** and leading **Reactive Power** is the import of **Reactive Power** from the **Total System** to the **Power Park Module** or **OTSDUA**.

ECP.A.6.5 Voltage Control Tests

ECP.A.6.5.1 This section details the procedure for conducting voltage control tests on **Onshore Power Park Modules** or **OTSDUA** or an **Offshore Power Park Module** which provides all or a portion of the voltage control capability as described in ECC.6.3.8.5 (for the avoidance of doubt, **Offshore Power Park Modules** which do not provide part of the **Offshore Transmission Licensee** voltage control capability as described in CC6.3.8.5 should complete the **Reactive Power** transfer / voltage control tests as per section ECP.A.6.8). These tests should be scheduled at a time when there are at least 95% of the

Power Park Units within the **Power Park Module** in service. There should be sufficient MW resource forecasted in order to generate at least 65% of **Maximum Capacity** of the **Onshore Power Park Module**. An **Embedded Generator** or **Embedded Generators** undertaking **OTSDUW** should also liaise with the relevant **Network Operator** to ensure all requirements covered in this section will not have a detrimental effect on the **Network Operator's System**.

- ECP.A.6.5.2 The voltage control system shall be perturbed with a series of step injections to the **Power Park Module** voltage setpoint, and where possible, multiple up-stream transformer taps. In the case of an **Offshore Power Park Module** providing part of the **Offshore Transmission Licensee** voltage control capability this may require a series of step injections to the voltage setpoint of the **Offshore Transmission Licensee** control system.
- ECP.A.6.5.3 For steps initiated using network tap changers, the **Generator** will need to coordinate with **The Company** or the relevant **Network Operator** as appropriate. The time between transformer taps shall be at least 10 seconds as per ECP.A.6.5 Figure 1.
- ECP.A.6.5.4 For a step injection into the **Power Park Module** or **OTSDUA** voltage setpoint, steps of $\pm 1\%$ and $\pm 2\%$ (or larger if required by **The Company**) shall be applied to the voltage control system setpoint summing junction. The injection shall be maintained for 10 seconds as per ECP.A.6.5 Figure 2.
- ECP.A.6.5.5 Where the voltage control system comprises of discretely switched **Plant** and **Apparatus** additional tests will be required to demonstrate that its performance is in accordance with **Grid Code** and **Bilateral Agreement** requirements.
- ECP.A.6.5.6 Tests to be completed:

(i)

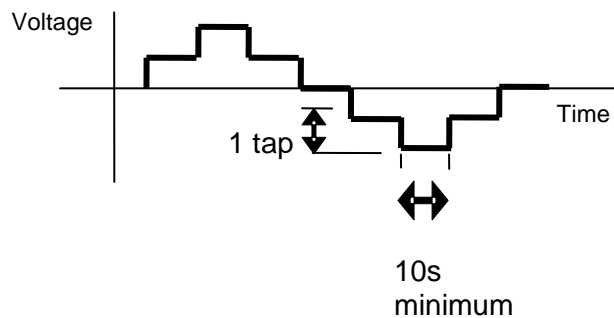

ECP.A.6.5 Figure 1 – Transformer tap sequence for voltage control tests

(ii)

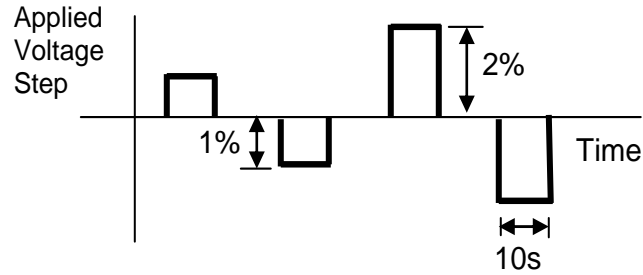

ECP.A.6.5 Figure 2 – Step injection sequence for voltage control tests

ECP.A.6.5.7 In the case of **OTSDUA**, where the **Bilateral Agreement** specifies additional damping facilities, additional testing to demonstrate these damping facilities may be required.

ECP.A.6.6 Frequency Response Tests

ECP.A.6.6.1 This section describes the procedure for performing frequency response testing on a **Power Park Module**. These tests should be scheduled at a time where there are at least 95% of the **Power Park Units** within the **Power Park Module** in service. There should be sufficient MW resource forecasted in order to generate at least 65% of **Maximum Capacity** of the **Power Park Module**.

ECP.A.6.6.2 The frequency controller shall be in **Frequency Sensitive Mode** or **Limited Frequency Sensitive Mode** as appropriate for each test. Simulated frequency deviation signals shall be injected into the frequency controller setpoint/feedback summing junction. If the injected frequency signal replaces rather than sums with the real **System Frequency** signal then the additional tests outlined in ECP.A.6.6.6 shall be performed with the **Power Park Module** or **Power Park Unit** in normal **Frequency Sensitive Mode** monitoring actual **System Frequency**, over a period of at least 10 minutes. The aim of this additional test is to verify that the control system correctly measures the real **System Frequency** for normal variations over a period of time.

ECP.A.6.6.3 In addition to the frequency response requirements it is necessary to demonstrate the **Power Park Module** ability to deliver a requested steady state power output which is not impacted by power source variation as per ECC.6.3.9. This test shall be conducted in **Limited Frequency Sensitive Mode** at a part-loaded output for a period of 10 minutes as per ECP.A.6.6.6.

Preliminary Frequency Response Testing

ECP.A.6.6.4 Prior to conducting the full set of tests as per ECP.A.6.6.6, **Generators** are required to conduct the preliminary set of tests below to confirm the frequency injection method is correct and the plant control performance is within expectation. The test numbers refer to Figure 1 below. The test should be conducted when sufficient MW resource is forecast in order to generate at least 65% of **Maximum Capacity** of the **Power Park Module**. The following frequency injections shall be applied when operating at module load point 4.

Test No (Figure1)	Frequency Injection	Notes
8	<ul style="list-style-type: none"> • Inject -0.5Hz frequency fall over 10 sec • Hold for a further 20 sec • At 30 sec from the start of the test, Inject a +0.3Hz frequency rise over 30 sec. • Hold until conditions stabilise • Remove the injected signal as a ramp over 10 seconds 	

13	<ul style="list-style-type: none"> • Inject - 0.5Hz frequency fall over 10 sec • Hold until conditions stabilise • Remove the injected signal as a ramp over 10 seconds 	
14	<ul style="list-style-type: none"> • Inject +0.5Hz frequency rise over 10 sec • Hold until conditions stabilise • Remove the injected signal as a ramp over 10 seconds 	
H	<ul style="list-style-type: none"> • Inject - 0.5Hz frequency fall as a stepchange • Hold until conditions stabilise • Remove the injected signal as a stepchange 	
I	<ul style="list-style-type: none"> • Inject +0.5Hz frequency rise as a stepchange • Hold until conditions stabilise • Remove the injected signal as a stepchange 	

ECP.A.6.6.5 The recorded results (e.g. Finj, MW and control signals) should be sampled at a minimum rate of 1 Hz to allow **The Company** to assess the plant performance from the initial transients (seconds) to the final steady state conditions (5-15 minutes depending on the plant design). This is not witnessed by **The Company**. The **Generator** shall supply the recordings including data to **The Company** in an electronic spreadsheet format. Results shall be legible, identifiable by labelling, and shall have appropriate scaling.

Full Frequency Response Testing Schedule Witnessed by **The Company**.

ECP.A.6.6.6 The tests are to be conducted at a number of different Module Load Points (MLP). In the case of a **Power Park Module** the module load points are conducted as shown below unless agreed otherwise by **The Company**.

Module Load Point 6 (Maximum Export Limit)	100% MEL
Module Load Point 5	90% MEL
Module Load Point 4 (Mid point of Operating Range)	80% MEL
Module Load Point 3	MRL+20%
Module Load Point 2 Lower of MRL +10% or Minimum Stable Operating Level	MRL+10% or MSOL
Module Load Point 1 (Minimum Regulating Level)	MRL

ECP.A.6.6.7 The tests are divided into the following two types;

- (i) Frequency response compliance and volume tests as per ECP.A.6.6. Figure 1. These tests consist of frequency profile and ramp tests and adjustments to target frequency setpoint as per ECP.A.6.6 Figure 3.
- (ii) System islanding and step response tests as shown by ECP.A.6.6. Figure 2.
- (iii) Frequency response tests in **Limited Frequency Sensitive Mode (LFSM)** to demonstrate **LFSM-O** and **LFSM-U** capability as shown by ECP.A.6.6 Figure 2.

ECP.A.6.6.8 There should be sufficient time allowed between tests for control systems to reach steady state (depending on available power resource). Where the diagram states 'HOLD' the current injection should be maintained until the **Active Power** (MW) output of the **Power Park Module** has stabilised. All frequency response tests should be removed over the same timescale for which they were applied. **The Company** may require repeat tests should the response volume be affected by the available power, or if tests give unexpected results.

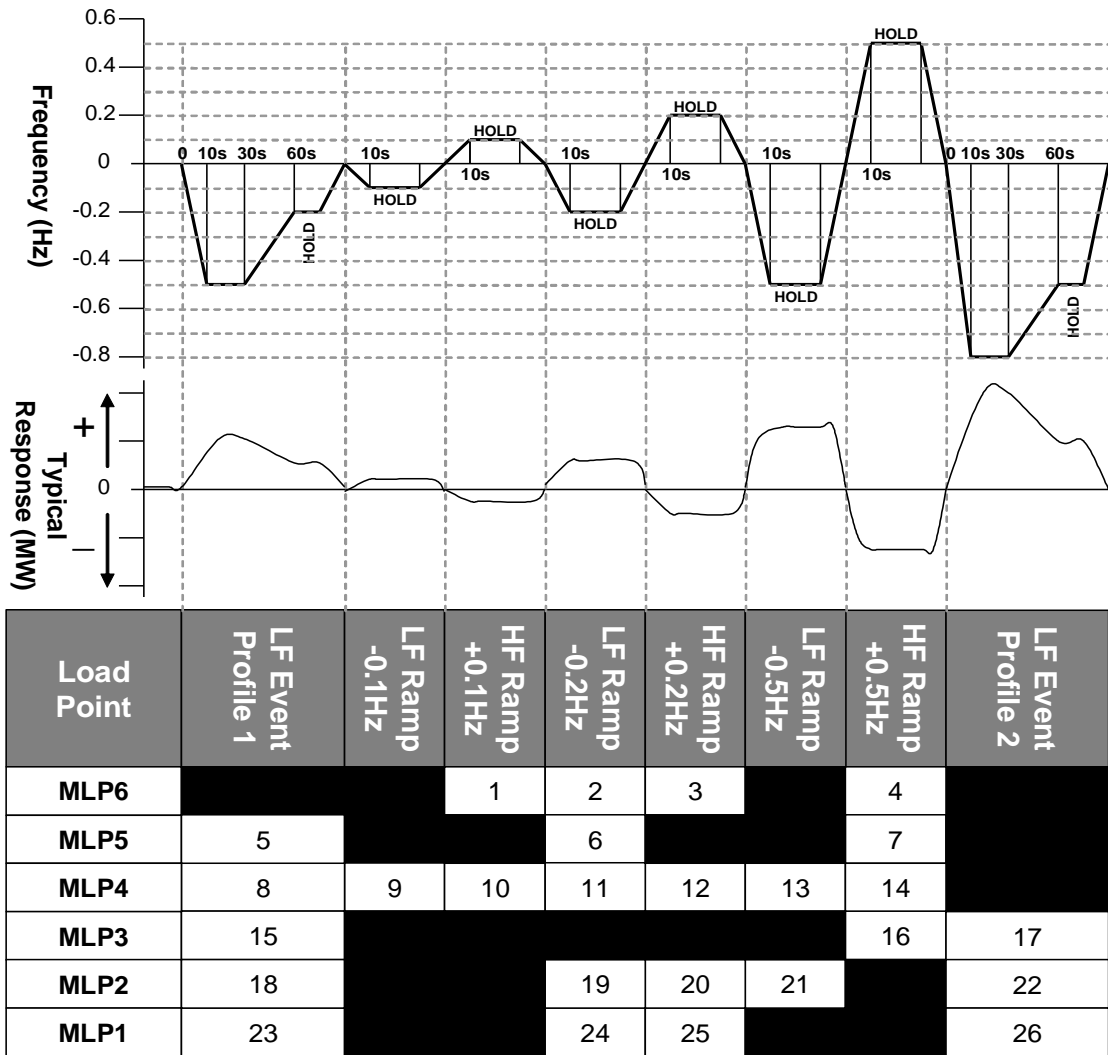

ECP.A.6.6. Figure 1 – Frequency Response Capability FSM Ramp Response tests

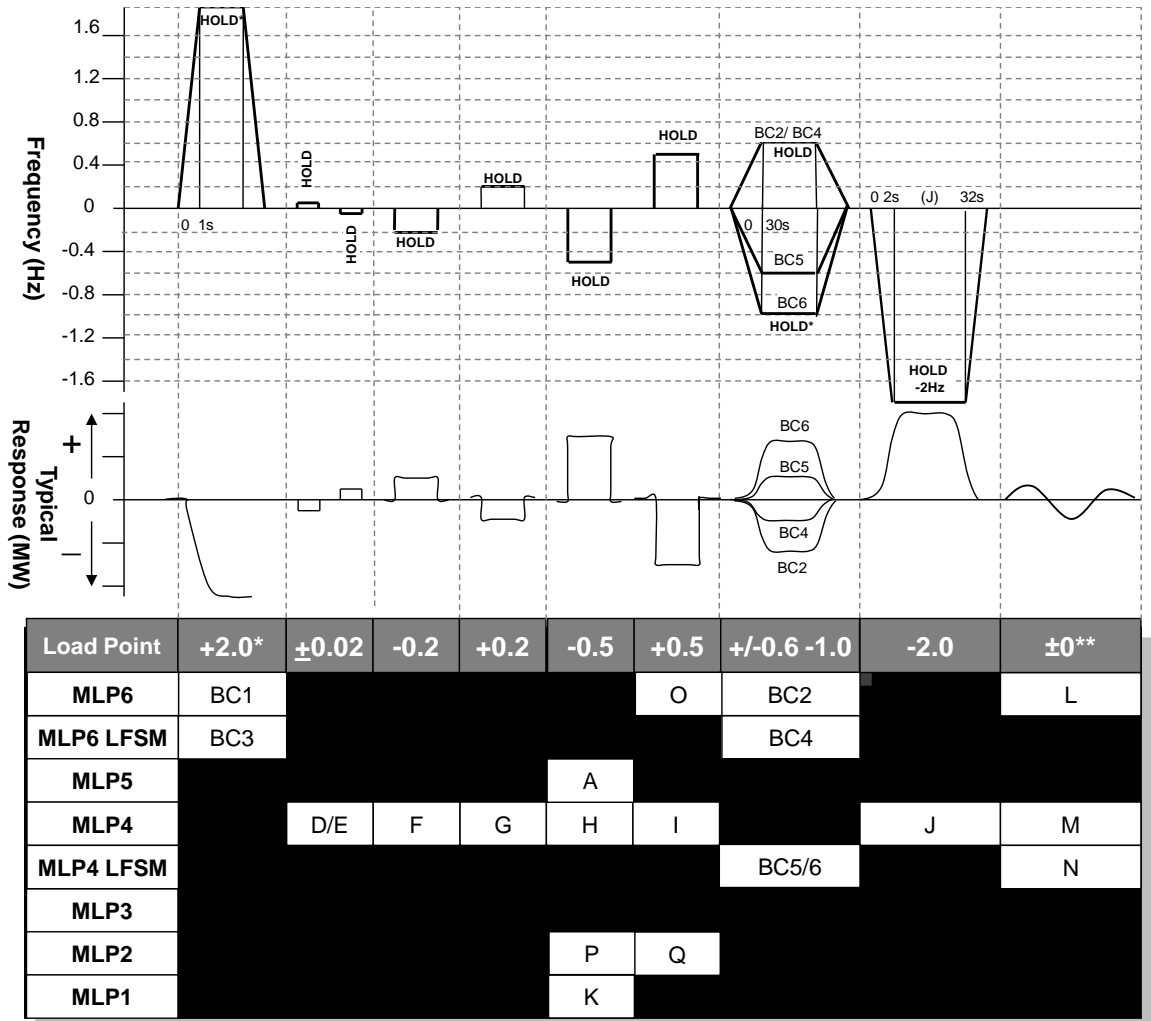

ECP.A.6.6. Figure 2 – Frequency Response Capability LFSM-O, LFSM-U, FSM Step Response tests

* This will generally be +2.0Hz unless an injection of this size causes a reduction in plant output that takes the operating point below the **Minimum Regulating Level** in which case an appropriate injection should be calculated in accordance with the following:

For example 0.9Hz is needed to take an initial output 65% to a final output of 20%. If the initial output was not 65% and the **Minimum Regulating Level** is not 20% then the injected step should be adjusted accordingly as shown in the example given below

Initial Output		65%
Minimum Regulating Level	20%	
Frequency Controller Droop		4%
Frequency to be injected = $(0.65-0.20) \times 0.04 \times 50 =$		0.9Hz

** Tests L and M in Figure 2 shall be conducted if in this range of tests the **System Frequency** feedback signal is replaced by the injection signal rather than the injection signal being added to the system frequency signal. The tests will consist of monitoring the **Power Park Module** in **Frequency Sensitive Mode** during normal **System Frequency** variations without applying any injection. Test N in Figure 2 shall be conducted in all cases. All three tests should be conducted for a period of at least 10 minutes.

ECP.A.6.6.9 The **Target Frequency** adjustment facility should be demonstrated from the

normal control point within the range of 49.9Hz to 50.1Hz by step changes to the **Target Frequency** setpoint as indicated in ECP.A.6.6 Figure 3 while operating at MLP4.

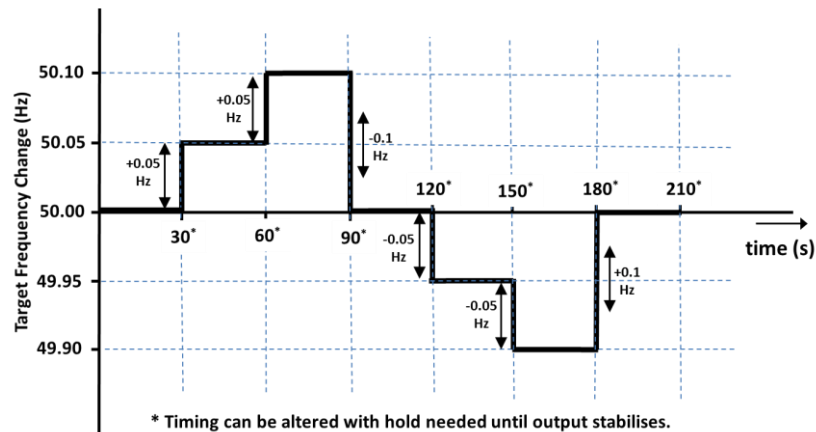

ECP.A.6.6. Figure 3 – **Target Frequency** setting changes

ECP.A.6.7 Fault Ride Through Testing

ECP.A.6.7.1 This section describes the procedure for conducting **Fault Ride Through** tests on a single **Power Park Unit** as required by ECP.7.2.2(d).

ECP.A.6.7.2 The test circuit will utilise the full **Power Park Unit** with no exclusions (e.g. in the case of a wind turbine it would include the full wind turbine structure) and shall be conducted with sufficient resource available to produce at least 95% of the **Maximum Capacity** of the **Power Park Unit**. The test will comprise of a number of controlled short circuits applied to a test network to which the **Power Park Unit** is connected, typically comprising of the **Power Park Unit** transformer and a test impedance to shield the connected network from voltage dips at the **Power Park Unit** terminals.

ECP.A.6.7.3 In each case, the tests should demonstrate the minimum voltage at the **Power Park Unit** terminals or **High Voltage** side of the **Power Park Unit** transformer which the **Power Park Unit** can withstand for the length of time specified in ECP.A.6.7.5. Any test results provided to **The Company** should contain sufficient data pre and post fault in order to determine steady state values of all signals, and the power recovery timescales.

ECP.A.6.7.4 In addition to the signals outlined in ECP.A.4.2. the following signals from either the **Power Park Unit** terminals or **High Voltage** side of the **Power Park Unit** transformer should be provided for this test only:

- (i) Phase voltages
- (ii) Positive phase sequence and negative phase sequence voltages
- (iii) Phase currents
- (iv) Positive phase sequence and negative phase sequence currents
- (v) Estimate of **Power Park Unit** negative phase sequence impedance
- (vi) MW – **Active Power** at the **Power Generating Module**.
- (vii) MVar – **Reactive Power** at the **Power Generating Module**.
- (viii) Mechanical Rotor Speed
- (ix) Real / reactive, current / power Setpoint as appropriate
- (x) **Fault Ride Through** protection operation (e.g. a crowbar in the case of a doubly fed induction generator)
- (xi) Any other signals relevant to the control action of the **Fault Ride Through** control deemed applicable for model validation.

At a suitable frequency rate for fault ride through tests as agreed with **The Company**.

- ECP.A.6.7.5 The tests should be conducted for the times and fault types indicated in ECC.6.3.15 as applicable.
- ECP.A.6.8 Reactive Power Transfer / Voltage Control Tests for **Offshore Power Park Modules**
- ECP.A.6.8.1 In the case of an **Offshore Power Park Module** which provides all or a portion of the **Reactive Power** capability as described in ECP.6.3.2.5.2 or ECP.6.3.6.3 and / or voltage control requirements as described in ECC.6.3.8.5 to enable an **Offshore Transmission Licensee** to meet the requirements of **STC** Section K, the testing, will comprise of the entire control system responding to changes at the onshore **Interface Point**. Therefore, the tests in this section ECP.A.6.8 will not apply. The **Generator** shall cooperate with the relevant **Offshore Transmission Licensee** to facilitate these tests as required by **The Company**. The testing may be combined with testing of the corresponding **Offshore Transmission Licensee** requirements under the **STC**. The results in relation to the **Offshore Power Park Module** will be assessed against the requirements in the **Bilateral Agreement**.
- ECP.A.6.8.2 In the case of an **Offshore Power Park Module** which does not provide part of the **Offshore Transmission Licensee Reactive Power** capability the following procedure for conducting **Reactive Power** transfer control tests on **Offshore Power Park Modules** and / or voltage control system as per ECC.6.3.2.5 and ECC.6.3.2.6 apply. These tests should be carried out prior to 20% of the **Power Park Units** within the **Offshore Power Park Module** being synchronised, and again when at least 95% of the **Power Park Units** within the **Offshore Power Park Module** in service. There should be sufficient power resource forecast to generate at least 85% of the **Maximum Capacity** of the **Offshore Power Park Module**.
- ECP.A.6.8.3 The **Reactive Power** control system shall be perturbed by a series of system voltage changes and changes to the **Active Power** output of the **Offshore Power Park Module**.
- ECP.A.6.8.4 **System** voltage changes should be created by a series of multiple upstream transformer taps. The **Generator** should coordinate with **The Company** or the relevant **Network Operator** in order to conduct the required tests. The time between transformer taps should be at least 10 seconds as per ECP.A.6.8 Figure 1.
- ECP.A.6.8.5 The **Active Power** output of the **Offshore Power Park Module** should be varied by applying a sufficiently large step to the frequency controller Setpoint/feedback summing junction to cause a 10% change in output of the **Maximum Capacity** of the **Offshore Power Park Module** in a time not exceeding 10 seconds. This test does not need to be conducted provided that the frequency response tests as outlined in ECP.A.6.6 are completed.
- ECP.A.6.8.6 The following diagrams illustrate the tests to be completed:

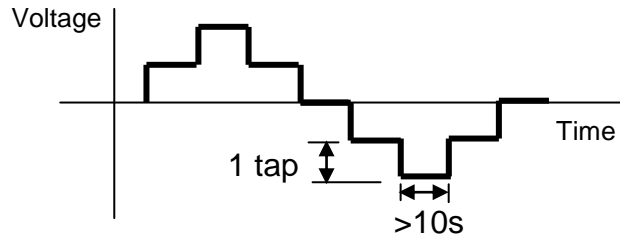

ECP.A.6.8 Figure 1 – Transformer tap sequence for reactive transfer tests

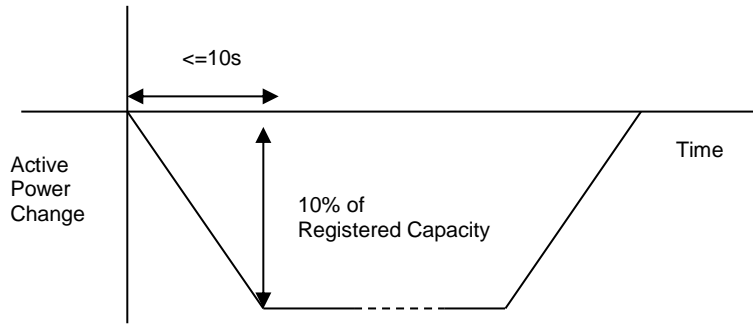

ECP.A.6.8 Figure 2 – **Active Power** ramp for reactive transfer tests

APPENDIX 7

COMPLIANCE TESTING FOR HVDC EQUIPMENT

ECP.A.7.1 SCOPE

ECP.A.7.1.1 This Appendix outlines the general testing requirements for **HVDC System Owners** to demonstrate compliance with the relevant aspects of the **Grid Code, Ancillary Services Agreement** and **Bilateral Agreement**. The tests specified in this Appendix will normally be sufficient to demonstrate compliance however **The Company** may:

- i) agree an alternative set of tests provided **The Company** deem the alternative set of tests sufficient to demonstrate compliance with the **Grid Code, Ancillary Services Agreement** and **Bilateral Agreement**; and/or
- ii) require additional or alternative tests if information supplied to **The Company** during the compliance process suggests that the tests in this Appendix will not fully demonstrate compliance with the relevant section of the **Grid Code, Ancillary Services Agreement** or **Bilateral Agreement**; and/or
- iii) require additional tests if control functions to improve damping of power system oscillations and/or subsynchronous resonance torsional oscillations required by the **Bilateral Agreement** or included in the control scheme and active; and/or
- iv) agree a reduced set of tests for subsequent **HVDC Equipment** following successful completion of the first **HVDC Equipment** tests in the case of an installation comprising of two or more **HVDC Systems** or **DC Connected Power Park Modules** which **The Company** reasonably considers to be identical.

If:

- (a) the tests performed pursuant to ECP.A.7.1.1(iv) in respect of subsequent **HVDC Systems** or **DC Connected Power Park Modules** do not replicate the full tests for the first **HVDC Equipment**, or
- (b) any of the tests performed pursuant to ECP.A.7.1.1(iv) do not fully demonstrate compliance with the relevant aspects of the **Grid Code, Ancillary Services Agreement** and / or **Bilateral**

ECP.A.7.1.2 The **HVDC System Owner** is responsible for carrying out the tests set out in and in accordance with this Appendix and the **HVDC System Owner** retains the responsibility for the safety of personnel and plant during the test. The **HVDC System Owner** is responsible for ensuring that suitable arrangements are in place with the **Externally Interconnected System Operator** to facilitate testing. **The Company** will witness all of the tests outlined or agreed in relation to this Appendix unless **The Company** decides and notifies the **HVDC System Owner** otherwise. Reactive Capability tests if required, may be witnessed by **The Company** remotely from **The Company** control centre. For all on site at **The Company** witnessed tests, the **HVDC System Owner** must ensure suitable representatives from the **HVDC System Owner** and / or **HVDC Equipment** manufacturer (if appropriate) are available on site for the entire testing period. In all cases and in addition to any recording of signals conducted by **The Company**, the **HVDC System Owner** shall record all relevant test signals as outlined in ECP.A.4.

- ECP.A.7.1.3 In addition to the dynamic signals supplied in ECP.A.4 the **HVDC System Owner** shall inform **The Company** of the following information prior to the commencement of the tests and any changes to the following, if any values change during the tests:
- (i) All relevant transformer tap numbers.
- ECP.A.7.1.4 The **HVDC System Owner** shall submit a detailed schedule of tests to **The Company** in accordance with CP.6.3.1, and this Appendix.
- ECP.A.7.1.5 Prior to the testing of **HVDC Equipment**, the **HVDC System Owner** shall complete the **Integral Equipment Tests** procedure in accordance with OC.7.5.
- ECP.A.7.1.6 Full **HVDC Equipment** testing as required by ECP.7.2 is to be completed as defined in ECP.A.7.2 through to ECP.A.7.5.
- ECP.A.7.1.7 **The Company** will permit relaxation from the requirement ECP.A.7.2 to ECP.A.7.5 where an **Equipment Certificate for HVDC Equipment** has been provided which details the characteristics from tests on a representative installation with the same equipment and settings and the performance of the **HVDC Equipment** can, in **The Company's** opinion, reasonably represent that of the installed **HVDC Equipment** at that site. The relevant **Equipment Certificate** must be supplied in the **Users Data File structure**.
- ECP.A.7.2 Reactive Capability Test
- ECP.A.7.2.1 This section details the procedure for demonstrating the reactive capability of **HVDC Equipment**. These tests should be scheduled at a time where there are sufficient MW resource forecasted in order to import and export full **Maximum Capacity** of the **HVDC Equipment**.
- ECP.A.7.2.2 The tests shall be performed by modifying the voltage set-point of the voltage control scheme of the **HVDC Equipment** by the amount necessary to demonstrate the required reactive range. This is to be conducted for the operating points and durations specified in ECP.A.7.2.5.
- ECP.A.7.2.3 **Embedded HVDC System Owners** should liaise with the relevant **Network Operator** to ensure the following tests will not have an adverse impact upon the **Network Operator's System** as per OC.7.5. In situations where the tests have an adverse impact upon the **Network Operator's System**, **The Company** will only require demonstration within the acceptable limits of the **Network Operator**. For the avoidance of doubt, these tests do not negate the requirement to produce a complete **HVDC Equipment** performance chart as specified in OC2.4.2.1
- ECP.A.7.2.4 In the case where the **Reactive Power** metering point is not at the same location as the **Reactive Power** capability requirement, then an equivalent **Reactive Power** capability for the metering point shall be agreed between the **HVDC System Owner** and **The Company**.
- ECP.A.7.2.5 The following tests shall be completed for both importing and exporting of **Active Power** for a **DC Converter**:
- (i) Operation at **Maximum Capacity** and maximum continuous lagging **Reactive Power** for 60 minutes.
 - (ii) Operation at **Maximum Capacity** and maximum continuous leading **Reactive Power** for 60 minutes.

- (iii) Operation at 50% **Maximum Capacity** and maximum continuous leading **Reactive Power** for 60 minutes.
- (iv) Operation at 50% **Maximum Capacity** and maximum continuous lagging **Reactive Power** for 60 minutes.
- (v) Operation at **Minimum Capacity** and maximum continuous leading Reactive Power for 60 minutes.
- (vi) Operation at **Minimum Capacity** and maximum continuous lagging **Reactive Power** for 60 minutes.

ECP.A.7.2.6 For the avoidance of doubt, lagging **Reactive Power** is the export of **Reactive Power** from the **HVDC Equipment** to the **Total System** and leading **Reactive Power** is the import of **Reactive Power** from the **Total System** to the **HVDC Equipment**.

ECP.A.7.3 Not used

ECP.A.7.4 Voltage Control Tests

ECP.A.7.4.1 This section details the procedure for conducting voltage control tests on **HVDC Equipment**. These tests should be scheduled at a time where there is sufficient MW resource in order to import and export **Maximum Capacity** of the **HVDC Equipment**. An **Embedded HVDC System Owner** should also liaise with the relevant **Network Operator** to ensure all requirements covered in this section will not have a detrimental effect on the **Network Operator's System**.

ECP.A.7.4.2 The voltage control system shall be perturbed with a series of step injections to the **HVDC Equipment** voltage Setpoint, and where possible, multiple up-stream transformer taps.

ECP.A.7.4.3 For steps initiated using network tap changers the **HVDC System Owner** will need to coordinate with **The Company** or the relevant **Network Operator** as appropriate. The time between transformer taps shall be at least 10 seconds as per ECP.A.7.4 Figure 1.

ECP.A.7.4.4 For step injection into the **HVDC Equipment** voltage setpoint, steps of $\pm 1\%$ and $\pm 2\%$ shall be applied to the voltage control system setpoint summing junction. The injection shall be maintained for 10 seconds as per ECP.A.7.4 Figure 2.

ECP.A.7.4.5 Where the voltage control system comprises of discretely switched plant and apparatus, additional tests will be required to demonstrate that its performance is in accordance with **Grid Code** and **Bilateral Agreement** requirements.

ECP.A.7.4.6 Tests to be completed:

(i)

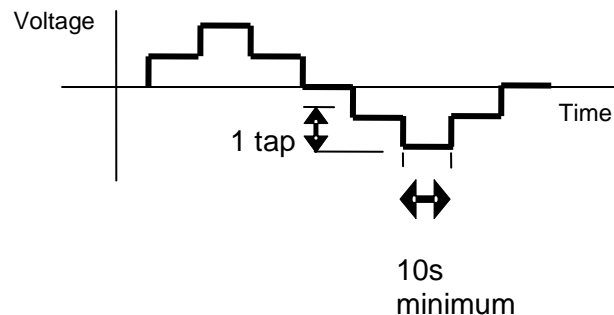

ECP.A.7.4 Figure 1 – Transformer tap sequence for voltage control tests

(ii)

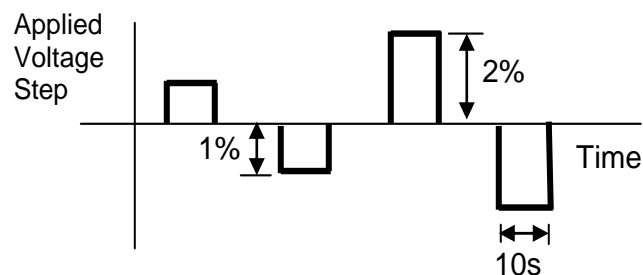

ECP.A.7.4 Figure 2 – Step injection sequence for voltage control tests

ECP.A.7.5 Frequency Response Tests

ECP.A.7.5.1 This section describes the procedure for performing frequency response testing on **HVDC Equipment**. These tests should be scheduled at a time where there is sufficient MW resource in order to import and export full **Maximum Capacity** of the **HVDC Equipment**. The **HVDC System Owner** is responsible for ensuring that suitable arrangements are in place with the **Externally Interconnected System Operator** to facilitate the **Active Power** changes required by these tests

ECP.A.7.5.2 The frequency controller shall be in **Frequency Sensitive Mode** or **Limited Frequency Sensitive Mode** as appropriate for each test. Simulated frequency deviation signals shall be injected into the frequency controller Setpoint/feedback summing junction. If the injected frequency signal replaces rather than sums with the real **System Frequency** signal, then the additional tests outlined in ECP.A.7.5.6 shall be performed with the **HVDC Equipment** in normal **Frequency Sensitive Mode** monitoring actual **System Frequency**, over a period of at least 10 minutes. The aim of this additional test is to verify that the control system correctly measures the real **System Frequency** for normal variations over a period of time.

ECP.A.7.5.3 In addition to the frequency response requirements, it is necessary to demonstrate the **HVDC Equipment** ability to deliver a requested steady state power output which is not impacted by power source variation as per ECC.6.3.9. This test shall be conducted in **Limited Frequency Sensitive Mode** at a part-loaded output for a period of 10 minutes as per ECP.A.7.5.6.

Preliminary Frequency Response Testing

ECP.A.7.5.4 Prior to conducting the full set of tests as per ECP.A.7.5.6, **HVDC System Owners** are required to conduct a preliminary set of tests below to confirm the frequency injection method is correct and the plant control performance is within expectation. The test numbers refer to Figure 1 below. These tests should be scheduled at a time where there is sufficient MW resource in order to export full **Maximum Capacity** from the **HVDC Equipment**. The following frequency injections shall be applied when operating at module load point 4.

Test No (Figure1)	Frequency Injection	Notes
8	<ul style="list-style-type: none"> Inject -0.5Hz frequency fall over 10 sec Hold for a further 20 sec At 30 sec from the start of the test, Inject a +0.3Hz frequency rise over 30 sec. Hold until conditions stabilise Remove the injected signal as a ramp over 10 seconds 	
13	<ul style="list-style-type: none"> Inject - 0.5Hz frequency fall over 10 sec Hold until conditions stabilise Remove the injected signal as a ramp over 10 seconds 	
14	<ul style="list-style-type: none"> Inject +0.5Hz frequency rise over 10 sec Hold until conditions stabilise Remove the injected signal as a ramp over 10 seconds 	
H	<ul style="list-style-type: none"> Inject - 0.5Hz frequency fall as a stepchange Hold until conditions stabilise Remove the injected signal as a stepchange 	
I	<ul style="list-style-type: none"> Inject +0.5Hz frequency rise as a stepchange Hold until conditions stabilise Remove the injected signal as a stepchange 	

ECP.A.7.5.5 The recorded results (e.g. Finj, MW and control signals) should be sampled at a minimum rate of 1Hz to allow **The Company** to assess the plant performance from the initial transients (seconds) to the final steady state conditions (5-15 minutes depending on the plant design). This is not witnessed by **The Company**. The **HVDC System Owner** shall supply the recordings including data to **The Company** in an electronic spreadsheet format. Results shall be legible, identifiable by labelling, and shall have appropriate scaling.

Full Frequency Response Testing Schedule Witnessed by **The Company**

ECP.A.7.5.6 The tests are to be conducted at a number of different Module Load Points (MLP). In the case of **HVDC Equipment** the load points are conducted as shown below unless agreed otherwise by **The Company**.

Module Load Point 6 (Maximum Export Limit)	100% MEL
Module Load Point 5	90% MEL
Module Load Point 4 (Mid point of Operating Range)	80% MEL
Module Load Point 3	MRL+20%
Module Load Point 2	MRL+10%
Module Load Point 1 (Minimum Regulating Level)	MRL

ECP.A.7.5.7 The tests are divided into the following two types;

- (i) Frequency response compliance and volume tests as per ECP.A.7.5. Figure 1. These tests consist of frequency profile and ramp tests and adjustments to **Target Frequency** setpoint as per ECP.A.7.5 Figure 3.
- (ii) System islanding and step response tests as shown by ECP.A.7.5 Figure 2

ECP.A.7.5. Fig 1 and 2 are shown for the Importing of **Active Power**, simulated frequency polarity should be reversed when exporting **Active Power**.

ECP.A.7.5.8 There should be sufficient time allowed between tests for control systems to reach steady state (depending on available power resource). Where the diagram states 'HOLD' the current injection should be maintained until the **Active Power** (MW) output of the **HVDC Equipment** has stabilised. All frequency response tests should be removed over the same timescale for which they were applied. **The Company** may require repeat tests should the response volume be affected by the available power, or if tests give unexpected results.

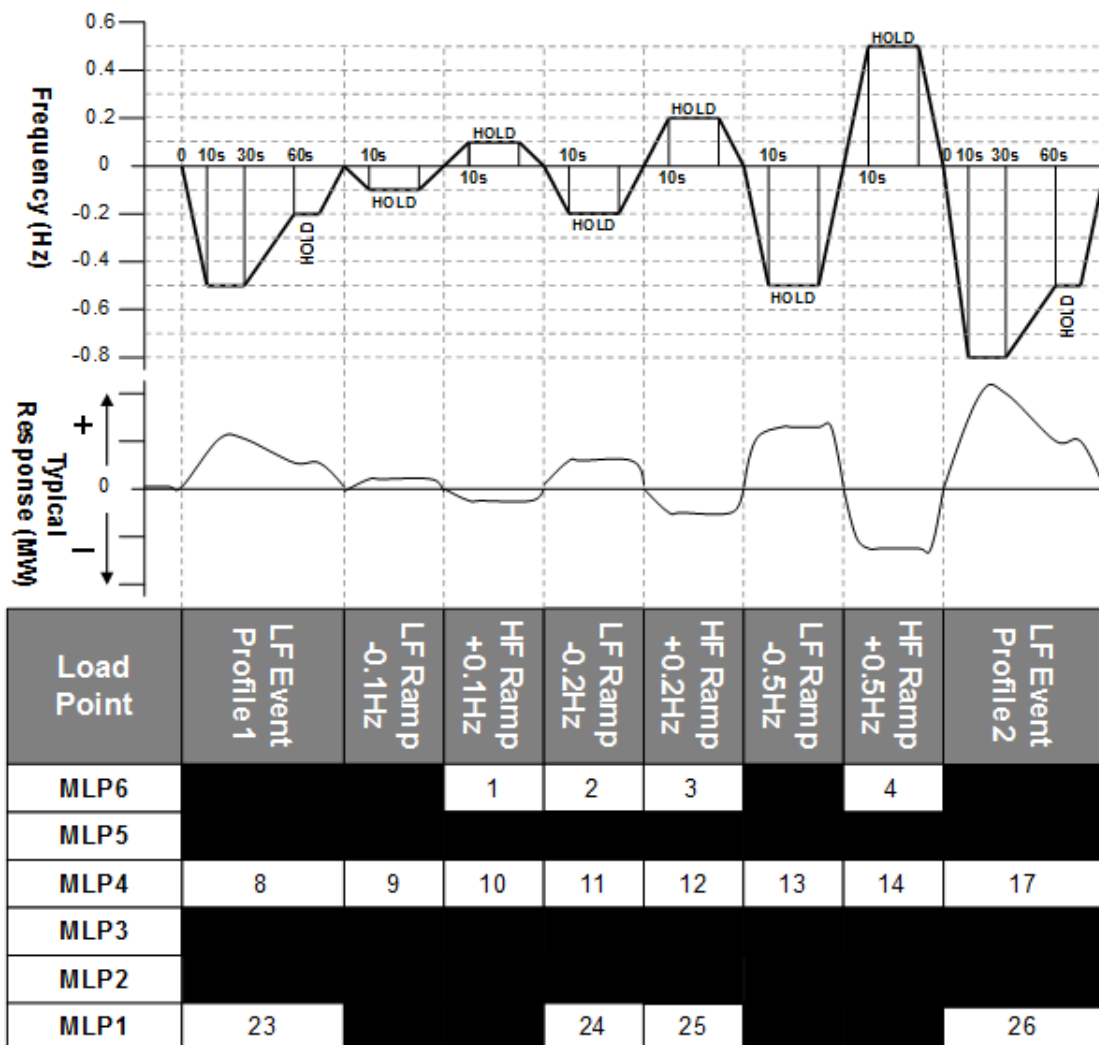

ECP.A.7.5. Figure 1 – Frequency Response Capability FSM Ramp Response tests

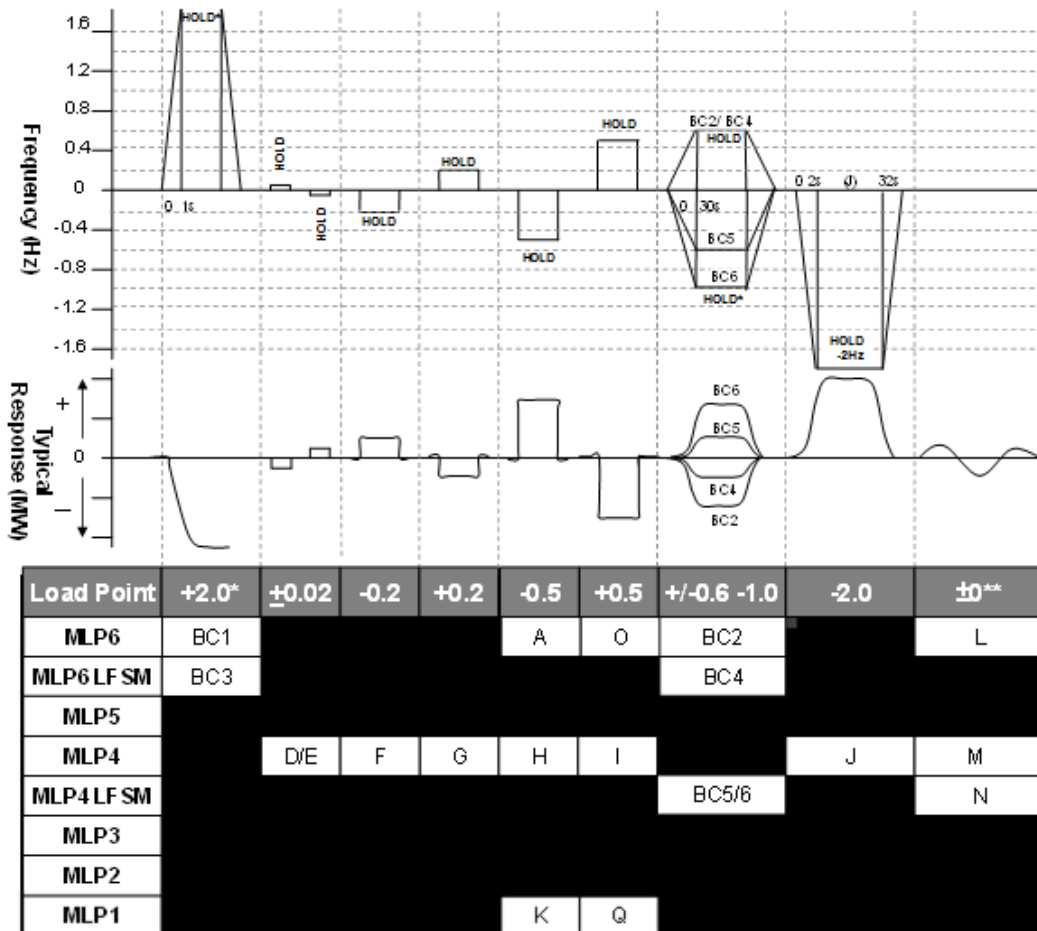

ECP.A.7.5. Figure 2 – Frequency Response Capability LFSM-O, LFSM-U, FSM Step Response tests

* This will generally be +2.0Hz unless an injection of this size causes a reduction in plant output that takes the operating point below the **Minimum Regulating Level** in which case an appropriate injection should be calculated in accordance with the following:

For example 0.9Hz is needed to take an initial output 65% to a final output of 20%. If the initial output was not 65% and the **Minimum Regulating Level** is not 20%, then the injected step should be adjusted accordingly as shown in the example given below

Initial Output		65%
Minimum Regulating Level	20%	
Frequency Controller Droop		4%
Frequency to be injected =		$(0.65-0.20) \times 0.04 \times 50 = 0.9\text{Hz}$

** Tests L and M in Figure 2 shall be conducted if in this range of tests the **System Frequency** feedback signal is replaced by the injection signal rather than the injection signal being added to the **System Frequency** signal. The tests will consist of monitoring the **HVDC Equipment in Frequency Sensitive Mode** during normal **System Frequency** variations without applying any injection. Test N in Figure 2 shall be conducted in all cases. All three tests should be conducted for a period of at least 10 minutes.

ECP.A.7.5.9 The target frequency adjustment facility should be demonstrated from the normal control point within the range of 49.9Hz to 50.1Hz by step changes to

the **Target Frequency** setpoint as indicated in ECP.A.7.5 Figure 3 while operating at MLP4.

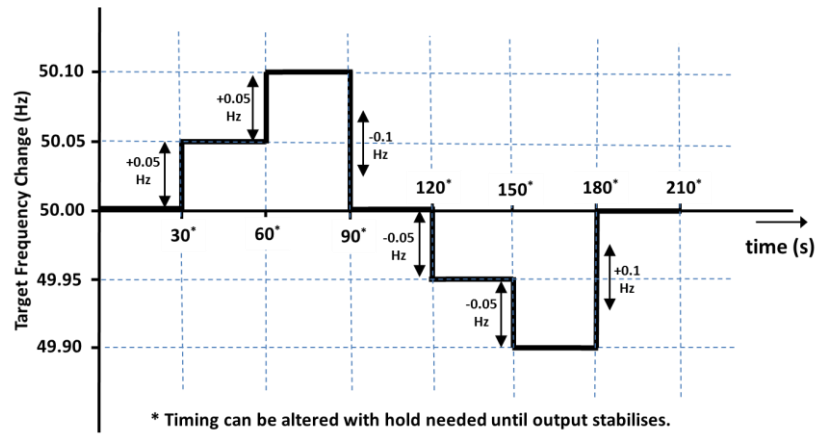

ECP.A.7.5. Figure 3 – Target Frequency setting changes

APPENDIX 8

SIMULATION STUDIES AND COMPLIANCE TESTING FOR NETWORK OPERATORS AND NON-EMBEDDED CUSTOMERS PLANT AND APPARATUS

- ECP.A.8.1 Compliance testing for disconnection and reconnection of Network Operator's Plant and Apparatus
- ECP.A.8.1.1 **Network Operators** shall comply with the following applicable requirements in respect of **EU Grid Supply Points**:
- (i) Demand disconnection schemes;
 - (ii) Synchronising; and/or
 - (iii) low frequency demand disconnection;
- ECP.A.8.1.2 The requirements for demand disconnection, other than low frequency demand disconnection, are pursuant to the requirements of the **Bilateral Agreement**. Any requirements for testing shall be agreed with the **User** where such requirements are applicable.
- ECP.A.8.1.3 The requirements for synchronising (where applicable) shall be pursuant to the requirements of the **Bilateral Agreement** and ECC.6.2.3.10. Any requirements for testing (as applicable) shall be agreed with the **User** and carried out during the commissioning process.
- ECP.A.8.1.4 **Network Operators** who are **EU Code Users** must demonstrate compliance with the low frequency demand disconnection requirements of ECC.6.4.3, ECC.A.5 and OC.6.6 for their entire distribution **System**.
- ECP.A.8.1.5 An equipment certificate may be submitted to **The Company** instead of part of the tests provided for in ECP.A.8.1.1.
- ECP.A.8.2 Compliance testing for operational metering at EU Grid Supply Points
- ECP.A.8.2.1 The requirements for operational metering (where required) shall be pursuant to the requirements of the **Bilateral Agreement** and ECC.6.5.6. Any applicable requirements for testing shall be agreed with the **User** and carried out during the commissioning process. An **Equipment Certificate** may be used for this purpose where agreed with **The Company**.
- ECP.A.8.3 Compliance testing for disconnection and reconnection of Non-Embedded Customers Plant and Apparatus
- ECP.A.8.3.1 **Non-Embedded Customers** shall comply with the following requirements where applicable:
- (i) Demand disconnection schemes;
 - (ii) Synchronising; and/or
 - (iii) low frequency demand disconnection;
- ECP.A.8.3.2 The requirements for demand disconnection, other than low frequency demand disconnection, are pursuant to the requirements of the **Bilateral Agreement**. Any requirements for testing shall be agreed with the **User**.
- ECP.A.8.3.3 The requirements for synchronising (where applicable) shall be pursuant to the requirements of the **Bilateral Agreement** and ECC.6.2.3.10. Any requirements for testing (as applicable) shall be agreed with the **User** and carried out during the commissioning process.

ECP.A.8.3.4 **Non-Embedded Customers** who are **EU Code Users** must demonstrate compliance with the low frequency demand disconnection requirements of ECC.6.4.3, ECC.A.5 and OC.6.6 of their **System**.

ECP.A.8.3.5 An equipment certificate may be submitted to **The Company** instead of part of the tests provided for in ECP.A.8.3.1.

ECP.A.8.4 Compliance testing for operational metering on Non-Embedded Customers Plant and Apparatus

ECP.A.8.4.1 The requirements for operational metering (where required)) shall be pursuant to the requirements of the **Bilateral Agreement** and ECC.6.5.6. Any applicable requirements for testing shall be agreed with the **User** and carried out during the commissioning process. An **Equipment Certificate** may be used for this purpose where agreed with **The Company**. ECP.A.8.5 Common Provisions on Compliance Simulations

ECP.A.8.5.1 **Users** are required to provide simulation studies or equivalent information to the satisfaction of **The Company** in the following circumstances.

- (i) a new connection to the **Transmission System** is required forming part of an **EU Grid Supply Point**;
- (ii) a **Substantial Modification** takes place at an **EU Grid Supply Point**
- (iii) **The Company** becomes aware of a potential non-compliance by the **Network Operator** or **Non-Embedded Customer** at an **EU Grid Supply Point**.

ECP.A.8.5.2 Notwithstanding the requirements of ECP.A.8.5.1, **The Company** shall be entitled to:-

- (a) Allow the **Network Operator** or **Non-Embedded Customer** to carry out an alternative set of simulations (or equivalent information) provided that they demonstrate that the **Network Operators** or **Non-Embedded Customers Plant and Apparatus** is capable of satisfying the applicable requirements of the **Data Registration Code**.
- (b) Require the **Network Operator** or **Non-Embedded Customer** to carry out additional or alternative simulations (or equivalent information) to those specified in ECP.A.8.5.1 where they would otherwise be insufficient to demonstrate compliance.
- (c) **The Company** may check that the **Network Operator** or **Non-Embedded Customer** complies with the requirements of the **Grid Code** by carrying out its own compliance simulations based on the simulation reports, models and test measurements submitted under the **Data Registration Code**.

ECP.A.8.5.3 **The Company** will supply (under PC.A.8) upon request to the **Network Operator** or **Non-Embedded Customer**, data to enable the **Network Operator** or **Non-Embedded Customer** to carry out the required simulations or supply the equivalent information required under the **Data Registration Code**.

ECP.A.8.6 Compliance simulations for EU Grid Supply Points

ECP.A.8.6.1 **Networks Operators** who are also **EU Code Users**, are required to provide simulation studies (or make available equivalent information) at each **EU Grid Supply Point** to demonstrate compliance with the **Reactive Power** capability requirements set out in ECC.6.4.5. The study or equivalent information provided shall include a steady state simulation model under both maximum

and minimum demand conditions. In addition, the model or equivalent information provided shall include the conditions when the **Reactive Power** export is at an **Active Power** flow of less than 25% of the **Maximum Import Capability** as detailed under ECC.6.4.5.2. In all cases the models or equivalent information submitted shall be agreed and approved with **The Company**.

ECP.A.8.7 Compliance simulations for Non-Embedded Customers Plant and Apparatus

ECP.A.8.7.1 **None Embedded Customers** who are also **EU Code Users** are required at each **EU Grid Supply Point** to provide simulation studies (or equivalent information) to demonstrate compliance with the **Reactive Power** capability requirements set out in ECC.6.4.5. The study or equivalent information provided shall include a steady state simulation model under both maximum and minimum demand conditions and with and without on-site generation. In all cases the models or equivalent information submitted shall be agreed and approved with **The Company**.

ECP.A.8.8 Compliance monitoring at EU Grid Supply Points

ECP.A.8.8.1 To satisfy the requirements of ECC.6.4.5, **EU Code Users** who are either **Network Operators** or **Non-Embedded Customers** shall ensure their **Plant and Apparatus** is equipped (where applicable), with the necessary equipment to measure the **Active Power** and **Reactive Power**, at each **EU Grid Supply Point**. The requirement for and time frame for compliance monitoring shall be agreed between **The Company** and the **EU Code User** for each **EU Grid Supply Point**.

< End of ECP >

OPERATING CODE NO. 2

(OC2)

OPERATIONAL PLANNING AND DATA PROVISION

CONTENTS

(This contents page does not form part of the Grid Code)

<u>Paragraph No/Title</u>	<u>Page Number</u>
OC2.1 INTRODUCTION.....	2
OC2.2 OBJECTIVE	3
OC2.3 SCOPE.....	3
OC2.4 PROCEDURE	3
OC2.4.1 Co-ordination of outages	3
OC2.4.2 Data Requirements	13
OC2.4.3 Negative Reserve Active Power Margins	16
OC2.4.4 Frequency Sensitive Operation	17
OC2.4.6 Operating Margin Data Requirements	18
APPENDIX 1 - PERFORMANCE CHART EXAMPLES	20
APPENDIX 2 - GENERATION PLANNING PARAMETERS.....	23
APPENDIX 3 - CCGT MODULE PLANNING MATRIX	25
APPENDIX 4 - POWER PARK MODULE PLANNING MATRIX.....	26
APPENDIX 3 - CCGT MODULE PLANNING MATRIX	27

OC2.1 INTRODUCTION

OC2.1.1 **Operating Code No. 2 ("OC2")** is concerned with:

- (a) the co-ordination of the release of **Power Generating Modules** (including **DC Connected Power Park Modules**), **Synchronous Generating Units** and **Power Park Modules**, **External Interconnections**, the **National Electricity Transmission System** and **Network Operators' Systems** for construction, repair and maintenance;
- (b) provision by **The Company** of the **Surplus** for the **National Electricity Transmission System**;
- (c) the provision by **Generators** of **Generation Planning Parameters** for **Gensets**, including **Synchronous Power Generating Module Planning Matrices**, **CCGT Module Planning Matrices** and **Power Park Module Planning Matrices**, to **The Company** for planning purposes only; and
- (d) the agreement for release of **Existing Gas Cooled Reactor Plant** for outages in certain circumstances.

OC2.1.2 (a) **Operational Planning** involves planning, through various timescales, the matching of generation output with forecast **National Electricity Transmission System Demand** together with a reserve of generation to provide a margin, taking into account outages of certain **Power Generating Modules** (including **DC Connected Power Park Modules**), **Generating Units**, **Power Park Modules**, **External Interconnections**, **HVDC Systems** and **DC Converters**, and of parts of the **National Electricity Transmission System** and of parts of **Network Operators' Systems** which is carried out to achieve, so far as possible, the standards of security set out in **The Company's Transmission Licence**, each **Relevant Transmission Licensee's Transmission Licence** or **Electricity Distribution Licence** as the case may be.

- (b) In general terms, there is an "envelope of opportunity" for the release of **Power Generating Modules** (including **DC Connected Power Park Modules**), **Synchronous Generating Units**, **Power Park Modules** and **External Interconnections**, and for the release of parts of the **National Electricity Transmission System** and parts of the **Network Operator's User Systems** for outages. The envelope is defined by the difference between the total generation output expected from **Large Power Stations**, **Medium Power Stations** and **Demand**, the operational planning margin and taking into account **External Interconnections**.

OC2.1.3 In this **OC2**, for the purpose of **Generator** and **Interconnector Owner** outage co-ordination, Year 0 means the current calendar year at any time, Year 1 means the next calendar year at any time, Year 2 means the calendar year after Year 1, etc. For the purpose of **Transmission** outage planning, Year 0 means the current **Financial Year** at any time, Year 1 means the next **Financial Year** at any time, Year 2 means the **Financial Year** after Year 1, etc. References to 'weeks' in **OC2** are to calendar weeks as defined in ISO 8601.

OC2.1.4 References in **OC2** to a **Generator's** and **Interconnector Owner's** "best estimate" shall be that **Generator's** or **Interconnector Owner's** best estimate acting as a reasonable and prudent **Generator** or **Interconnector Owner** in all the circumstances.

OC2.1.5 References to **The Company** planning the **National Electricity Transmission System** outage programme on the basis of the **Final Generation Outage Programme**, are to **The Company** planning against the **Final Generation Outage Programme** current at the time it so plans.

OC2.1.6 Where in **OC2**, data is required to be submitted or information is to be given on a particular weekday, that data does not need to be submitted and that information does not need to be given on that day if it is not a **Business Day** or it falls within a holiday period (the occurrence and length of which shall be determined by **The Company**, in its reasonable discretion, and notified to **Users**). Instead, that data shall be submitted and/or that information shall be given on such other **Business Day** as **The Company** shall, in its reasonable discretion, determine. However, **The Company** may determine that that data and/or information need not be submitted or given at all, in which case it shall notify each **User** as appropriate.

- OC2.1.7 In Scotland, it may be possible with the agreement of **The Company** to reduce the administrative burden for **Users** in producing planning information where either the output or demand is small.
- OC2.2 OBJECTIVE
- OC2.2.1 (a) The objective of **OC2** is to seek to enable **The Company** to harmonise outages of **Power Generating Modules** (including **DC Connected Power Park Modules**), **Generating Units**, **Power Park Modules** and **External Interconnections** in order that such outages are co-ordinated (taking account of **Embedded Medium Power Stations**) between **Generators** and **Network Operators**, and that such outages are co-ordinated taking into account **National Electricity Transmission System** outages and other **System** outages, so far as possible to minimise the number and effect of constraints on the **National Electricity Transmission System** or any other **System**.
- (b) In the case of **Network Operator' User Systems** directly connected to the **National Electricity Transmission System**, this means in particular that there will also need to be harmonisation of outages of **Embedded Power Generating Modules**, **Embedded Synchronous Generating Units** and **Embedded Power Park Modules**, and **National Electricity Transmission System** outages, with **Network Operators** in respect of their outages on those **Systems**.
- OC2.2.2 The objective of **OC2** is also to enable the provision by **The Company** of the **Surplus** for the **National Electricity Transmission System**.
- OC2.2.3 A further objective of **OC2** is to provide for the agreement for outages for **Existing Gas Cooled Reactor Plant** in certain circumstances and to enable a process to be followed in order to provide for that.
- OC2.3 SCOPE
- OC2.3.1 **OC2** applies to **The Company** and to **Users** which in **OC2** means:
- (a) **Generators**, only in respect of their **Large Power Stations** or their **Power Stations** which are directly connected to **National Electricity Transmission System** (and the term **Generator** in this **OC2** shall be construed accordingly);
- (b) **Network Operators**; and
- (c) **Non-Embedded Customers**; and
- (d) **HVDC System Owners** and **DC Converter Station** owners; and
- (e) **Interconnector Owners** in respect of their **External Interconnections**.
- OC2.3.2 **The Company** may provide to the **Relevant Transmission Licensees** any data which has been submitted to **The Company** by any **Users** in respect of **Relevant Units** pursuant to the following paragraphs of the **OC2**.
- OC2.4.1.2.1
- OC2.4.1.3.2 (a)
- OC2.4.1.3.2 (b)
- OC2.4.1.3.3
- OC2.4.2.1 (a)
- OC2.3.3 For the purpose of **OC2** only, the term **Output Usable** shall include the terms **Interconnector Export Capacity** and **Interconnector Import Capacity** where the term **Output Usable** is being applied to an **External Interconnection**.
- OC2.4 PROCEDURE
- OC2.4.1 Co-ordination of Outages
- OC2.4.1.1 Under **OC2** the interaction between **The Company** and **Users** will be as follows:

- | | | |
|-----|---|--|
| (a) | Each Generator , and each Interconnector Owner and The Company | In respect of outages of Power Generating Modules (including DC Connected Power Park Modules), Synchronous Generating Units , Power Park Modules and External Interconnection Circuits and in respect of outages of other Plant and/or Apparatus directly connected to the National Electricity Transmission System ; |
| (b) | The Company and each Generator and each Interconnector Owner | in respect of National Electricity Transmission System outages relevant to each Generator (other than in respect of Embedded Small Power Stations or Embedded Medium Power Stations) and Interconnector Owner ; |
| (c) | The Company and each Network Operator | in respect of outages of all Embedded Large Power Stations and in respect of outages of other Plant and/or Apparatus relating to such Embedded Large Power Stations ; |
| (d) | The Company and each Network Operator and each Non-Embedded Customer | in respect of National Electricity Transmission System outages relevant to the particular Network Operator or Non-Embedded Customers ; |
| (e) | Each Network Operator and each Non-Embedded Customer and The Company | in respect of User System outages relevant to The Company ; and
in respect of Network Operators only, outages of the Network Operator's User System that may impact upon an Offshore Transmission System connected to that Network Operator's User System . |

OC2.4.1.2 Data Provision of **Output Usable** of **Power Generating Modules**, **Generating Units**, **External Interconnection Circuits** and **Power Park Modules** and the Publication of **National Surplus**.

OC2.4.1.2.1 In the event that:

- a) a **Generator** referred to in OC2.3.1(a) experiences any unplanned change to the availability of a **Generating Unit** and/or **Power-Generating Module** and/or **Power Park Module** or makes a future plan which would impact the availability of a **Generating Unit** and/or **Power-Generating Module** and/or **Power Park Module** resulting in a change of level in the **Output Usable** of that **Generating Unit** and/or **Power-Generating Module** and/or **Power Park Module** below or above its previously notified availability, which is expected to last one **Settlement Period** or longer and up to three years ahead; or
- b) an **Interconnector Owner** referred to in OC2.3.1(e) experiences any unplanned change to the availability of an **External Interconnection Circuit** or makes a future plan which would impact the availability of an **External Interconnection Circuit** resulting in any change in the **Output Usable** of that **External Interconnection Circuit** below or above its previously notified availability, which is expected to last one **Settlement Period** or longer and up to three years ahead;

The **Generator** or **Interconnector Owner** shall provide **The Company** with the best estimate of the revised available **Output Usable** profile using one of **The Company's** recommended platforms.

For **Generators** subject to EU Transparency Regulations the **Generator** shall provide the data within 1 hour of the unplanned change in availability occurring, and for a planned change to the availability, the **Generator** shall provide the data within 1 hour of planning the availability change in line with EU Transparency Regulations. For **Generators** not subject to EU Transparency Regulations the **Generator** shall provide the data within 24 hours of the unplanned change in availability occurring, and for a planned change to the availability, the **Generator** shall provide the data within 24 hours of planning the availability change.

For an unplanned change in availability, the **Interconnector Owner** shall provide the data within 1 hour of the unplanned change in availability occurring, and for a planned change to the availability, the **Interconnector Owner** shall provide the data within 1 hour of planning the availability change in line with EU Transparency Regulations.

If the **Generator** referred to in OC2.3.1(a) provides information relating to multi-shaft **Generating Units** then the detail of the individual shaft availability levels, that have been summed to produce the **Output Usable** should also be defined within 24 hours.

In the case of an **External Interconnection Circuit**, the details of the individual pole-capacity levels that have been summed to produce the **Output Usable** should also be defined within 24 hours.

The Company may, as appropriate, contact each **Generator** and each **Interconnector Owner** who has supplied information to seek clarification on their **Output Usable** submissions.

OC2.4.1.2.2 At a regular time interval, at least once per day (by 1600 hours) and up to every hour:

The Company will:

(i) having taken into account the information notified to it by **Generators** and **Interconnector Owners** via the process defined in OC2.4.1.2.1 and taking into account:

- (1) **Demand** forecasts and details of proposed use of **Demand Control** received under **OC1**, and an **Operational Planning Margin** requirement set by **The Company** (the "OPMR"),
- (2) **National Electricity Transmission System** constraints and outages,
- (3) **Network Operator System** constraints and outages, known to **The Company**, and
- (4) the **Output Usable** required, in its view, to meet daily total MW requirements,

Provide each **Generator** and each **Interconnector Owner** (where required by **The Company**) in writing with any suggested amendments to the provisional **Output Usable** supplied by the **Generator** and **Interconnector Owner** which **The Company** believes necessary, and will advise **Generators** with **Large Power Stations** of the **Surpluses** for the **National Electricity Transmission System** and potential export limitations, which would occur without such amendments;

(ii) calculate and submit to **BMRA**:

1. total generating **Output Usable** from **Generating Units** assumed to be available to the **Total System** (**National Output Useable**);
2. generating **Output Usable** by fuel type from **Generating Units** assumed to be available to the **Total System** (**Output Useable** by fuel type);
3. generating **Output Usable** by individual **Generating Units** assumed to be available to the **Total System** (**Output Useable** by **Generating Unit**);
4. total **Generating Plant Demand Margin** assumed to be available to the **Total System** (**National Margin**);
5. total **Generating Surplus** assumed to be available to the **Total System** (**National Surplus**);

with daily resolution, for at least the peak **Demand** of each day for 2 day-ahead to 14 day-ahead time scope, and

with weekly resolution, for at least peak **Demand** of each week for 2 week-ahead up to 3 year-ahead time scope.

The calculation under (ii) will effectively define the envelope of opportunity for outages of **Power Generating Modules** (including **DC Connected Power Park Modules**), **Synchronous Generating Units** and **Power Park Modules** covering both **Embedded** and directly connected **Large Power Stations**.

The Company may, as appropriate, contact each **Generator** and each **Interconnector Owner** who has supplied information to seek clarification on outages and suggest amendments.

- (iii) Where a **Generator** or **Interconnector Owner** or a **Network Operator** is unhappy with the suggested amendments to its provisional outage programme (in the case of a **Generator** or **Interconnector Owner**) or such potential outages (in the case of a **Network Operator**) it may contact **The Company** to explain its concerns and **The Company** and that **Generator**, **Interconnector Owner** or **Network Operator** will then discuss the problem and seek to resolve it.
- (iv) The possible resolution of the problem may require **The Company** or a **User** to contact other **Generators**, **Interconnector Owner** or **Network Operators**, and joint meetings of all parties may, if any **User** feels it would be helpful, be convened by **The Company**. The need for further discussions, be they on the telephone or at meetings, can only be determined at the time.

Each **Generator** will provide **The Company** with updated **Output Usable** as per OC2.4.1 resulting from the above for **Generating Unit**, **Power Generating Module** and **Power Part Module** outage programme covering both **Embedded** and non-Embedded **Large Power Stations**.

The Company will then consider the updated **Output Usable** and takes this into account in the next calculation and submission to **BMRA**.

OC2.4.1.2.3 **The Company** retains the right to contact **Generators** with **Large Power Stations**, **Interconnector Owners** and **Network Operators** in reference to planned outages of their assets in timescales beyond the European Requirements (3 years) up to the 5 year ahead period to assist in the operational planning of **National Electricity Transmission System** outages.

OC2.4.1.3 Planning of National Electricity Transmission System Outages

OC2.4.1.3.1 Operational Planning Phase - Planning for Financial Years 2 to 5 inclusive ahead

The Company shall plan **National Electricity Transmission System** outages required in Years 2 to 5 inclusive required as a result of construction or refurbishment works. This contrasts with the planning of **National Electricity Transmission System** outages required in Years 0 and 1 ahead, when **The Company** also takes into account **National Electricity Transmission System** outages required as a result of maintenance.

Users should bear in mind that **The Company** will be planning the **National Electricity Transmission System** outage programme on the basis of the previous year's **Final Generation Outage Programme** and if in the event a **Generator's**, an **Interconnector Owner's** or **Network Operator's** outages differ from those contained in the **Final Generation Outage Programme**, or in the case of **Network Operators**, those known to **The Company**, in any way conflict with the **National Electricity Transmission System** outage programme, **The Company** need not alter the **National Electricity Transmission System** outage programme.

OC2.4.1.3.2 In each calendar year:

(a) By the end of week 8

Each **Network Operator** will notify **The Company** in writing of details of proposed outages in Years 2-5 ahead in its **User System** which may affect the performance of the **Total System** (which includes but is not limited to outages of **User System Apparatus** at **Grid Supply Points** and outages which constrain the output of **Power Generating Modules** (including **DC Connected Power Park Modules**) and/or **Synchronous Generating Units** and/or **Power Park Modules Embedded** within that **User System**).

Each **Network Operator** will notify **The Company** in writing of details of proposed outages in Years 2-5 ahead in its **User System** which may affect the declared values of **Maximum Export Capacity** and/or **Maximum Import Capacity** for each **Interface Point** within its **User System** together with the **Network Operator's** revised best estimate of the **Maximum Export Capacity** and/or **Maximum Import Capacity** during such outages. **Network Operators** will also notify **The Company** of any automatic and/or manual post fault actions that it intends to utilise or plans to utilise during such outages.

(b) By the end of week 13

Each **Generator** will inform **The Company** in writing of proposed outages in Years 2 - 5 ahead of **Generator** owned **Apparatus** (eg. busbar selectors) other than **Power Generating Modules** (including **DC Connected Power Park Modules**) and/or **Synchronous Generating Units**, and/or **Power Park Modules**, at each **Grid Entry Point**.

The Company will provide to each **Network Operator** and to each **Generator** and each **Interconnector Owner**, a copy of the information given to **The Company** under paragraph (a) above (other than the information given by that **Network Operator**). In relation to a **Network Operator**, the data must only be used by that **User** in planning and operating that **Network Operator's User System** and must not be used for any other purpose or passed on to, or used by, any other business of that **User** or to, or by, any person within any other such business or elsewhere.

(c) By the end of week 28

The Company will provide each **Network Operator** in writing with details of proposed outages in Years 2-5 ahead which may, in **The Company's** reasonable judgement, affect the performance of that **Network Operator's User System**.

(d) By the end of week 30

Where **The Company** or a **Network Operator** is unhappy with the proposed outages notified to it under (a), (b) or (c) above, as the case may be, equivalent provisions to those set out in OC2.4.1.2.1 (d) will apply.

(e) By the end of week 34

The Company will draw up a draft **National Electricity Transmission System** outage plan covering the period Years 2 to 5 ahead and **The Company** will notify each **Generator**, **Interconnector Owner** and **Network Operator** in writing of those aspects of the plan which may operationally affect such **Generator** (other than those aspects which may operationally affect **Embedded Small Power Stations** or **Embedded Medium Power Stations**), **Interconnector Owner** or **Network Operator**. **The Company** will also indicate where a need may exist to issue other operational instructions or notifications (including but not limited to the requirement for the arming of an **Operational Intertripping** scheme) or **Emergency Instructions** to **Users** in accordance with **BC2** to allow the security of the **National Electricity Transmission System** to be maintained within the **Licence Standards**.

OC2.4.1.3.3 Operational Planning Phase - Planning for Financial Year 1 ahead

Each calendar year, **The Company** shall update the draft **National Electricity Transmission System** outage plan prepared under OC2.4.1.3.2 above and shall in addition take into account outages required as a result of maintenance work.

In each calendar year:

(a) By the end of week 13

Generators and **Non-Embedded Customers** will inform **The Company** in writing of proposed outages for Year 1 of **Generator** owned **Apparatus** at each **Grid Entry Point** (e.g. busbar selectors) other than **Power Generating Modules** (including **DC Connected Power Park Modules**), **Synchronous Generating Units** and/or **Power Park Modules** or **Non-Embedded Customer** owned **Apparatus**, as the case may be, at each **Grid Supply Point**.

(b) By the end of week 28

The Company will provide each **Network Operator** and each **Non-Embedded Customer** in writing with details of proposed outages in Year 1 ahead which may, in **The Company's** reasonable judgement, affect the performance of its **User System** or the **Non-Embedded Customer Apparatus** at the **Grid Supply Point**.

(c) By the end of week 32

Each **Network Operator** will notify **The Company** in writing with details of proposed outages in Year 1 in its **User System** which may affect the performance of the **Total System** (which includes but is not limited to outages of **User System Apparatus** at **Grid Supply Points** and outages which constrain the output of **Power Generating Modules** (including **DC Connected Power Park Modules**), **Synchronous Generating Units** and/or **Power Park Modules Embedded** within that **User System**).

Each **Network Operator** will notify **The Company** in writing of details of proposed outages in Year 1 in its **User System** which may affect the declared values of **Maximum Export Capacity** and/or **Maximum Import Capacity** for each **Interface Point** within its **User System** together with the **Network Operator's** revised best estimate of the **Maximum Export Capacity** and/or **Maximum Import Capacity** during such outages. **Network Operators** will also notify **The Company** of any automatic and/or manual post fault actions that it intends to utilise or plans to utilise during such outages.

Each **Network Operator** will also notify **The Company** in writing of any revisions to **Interface Point Target Voltage/Power Factor** data submitted pursuant to PC.A.2.5.4.2.

(d) Between the end of week 32 and the end of week 34

The Company will draw up a revised **National Electricity Transmission System** outage plan (which for the avoidance of doubt includes **Transmission Apparatus** at the **Connection Points**).

(e) By the end of week 34

The Company will notify each **Generator**, **Interconnector Owner**, and **Network Operator**, in writing, of those aspects of the **National Electricity Transmission System** outage programme which may, in **The Company's** reasonable opinion, operationally affect that **Generator** (other than those aspects which may operationally affect **Embedded Small Power Stations** or **Embedded Medium Power Stations**), **Interconnector Owner**, or **Network Operator** including in particular proposed start dates and end dates of relevant **National Electricity Transmission System** outages.

The Company will provide to each **Network Operator** and to each **Generator** and each **Interconnector Owner** a copy of the information given to **The Company** under paragraph (c) above (other than the information given by that **Network Operator**). In relation to a **Network Operator**, the data must only be used by that **User** in planning and operating that **Network Operator's User System** and must not be used for any other purpose or passed on to, or used by, any other business of that **User** or to, or by, any person within any other such business or elsewhere.

(f) By the end of week 36

Where a **Generator**, **Interconnector Owner** or **Network Operator** is unhappy with the proposed aspects notified to it under (e) above, equivalent provisions to those set out in OC2.4.1.2.1 (d) will apply.

(g) Between the end of week 34 and 49

The Company will draw up a final **National Electricity Transmission System** outage plan covering Year 1.

(h) By the end of week 49

(i) **The Company** will complete the final **National Electricity Transmission System** outage plan for Year 1. The plan for Year 1 becomes the final plan for Year 0 when by expiry of time Year 1 becomes Year 0.

(ii) **The Company** will notify each **Generator**, each **Interconnector Owner** and each **Network Operator** in writing of those aspects of the plan which may operationally affect such **Generator** (other than those aspects which may operationally affect **Embedded Small Power Stations** or **Embedded Medium Power Stations**), **Interconnector Owner** or **Network Operator** including in particular proposed start dates and end dates of relevant **National Electricity Transmission System** outages. **The Company** will also indicate where a need may exist to issue other operational instructions or notifications (including but not limited to the requirement for the arming of an **Operational Intertripping** scheme) or **Emergency Instructions to Users** in accordance with **BC2** to allow the security of the **National Electricity Transmission System** to be maintained within the **Licence Standards**. **The Company** will also inform each relevant **Non-Embedded Customer** of the aspects of the plan which may affect it.

(iii) In addition, in relation to the final **National Electricity Transmission System** outage plan for Year 1, **The Company** will provide to each **Generator** and each **Interconnector Owner** a copy of the final **National Electricity Transmission System** outage plan for that year. OC2.4.1.3.4 contains provisions whereby updates of the final **National Electricity Transmission System** outage plan are provided. The plan and the updates will be provided in writing. It should be noted that the final **National Electricity Transmission System** outage plan for Year 1 and the updates will not give a complete understanding of how the **National Electricity Transmission System** will operate in real time, where the **National Electricity Transmission System** operation may be affected by other factors which may not be known at the time of the plan and the updates. Therefore, **Users** should place no reliance on the plan or the updates showing a set of conditions which will actually arise in real time.

(i) Information Release Or Exchange

This paragraph (i) contains alternative requirements on **The Company**, paragraph (z) being an alternative to a combination of paragraphs (x) and (y). Paragraph (z) will only apply in relation to a particular **User** if **The Company** and that **User** agree that it should apply, in which case paragraphs (x) and (y) will not apply. In the absence of any relevant agreement between **The Company** and the **User**, **The Company** will only be required to comply with paragraphs (x) and (y).

Information Release To Each Network Operator And Non-Embedded Customer

Between the end of Week 34 and 49 **The Company** will upon written request:

(x) for radial systems, provide each **Network Operator** and **Non Embedded Customer** with data to allow the calculation by the **Network Operator**, and each **Non Embedded Customer**, of symmetrical and asymmetrical fault levels; and

(y) for interconnected **Systems**, provide to each **Network Operator** an equivalent network, sufficient to allow the identification of symmetrical and asymmetrical fault levels, and power flows across interconnecting **User Systems** directly connected to the **National Electricity Transmission System**; or

System Data Exchange

(z) as part of a process to facilitate understanding of the operation of the **Total System**,

- (1) **The Company** will make available to each **Network Operator**, the **National Electricity Transmission System Study Network Data Files** covering Year 1 which are of relevance to that **User's System**;
- (2) where **The Company** and a **User** have agreed to the use of data links between them, the making available will be by way of allowing the **User** access to take a copy of the **National Electricity Transmission System Study Network Data Files** once during that period. The **User** may, having taken that copy, refer to the copy as often as it wishes. Such access will be in a manner agreed by **The Company** and may be subject to separate agreements governing the manner of access. In the absence of agreement, the copy of the **National Electricity Transmission System Study Network Data Files** will be given to the **User** on a disc, or in hard copy, as determined by **The Company**;
- (3) the data contained in the **National Electricity Transmission System Study Network Data Files** represents **The Company's** view of operating conditions although the actual conditions may be different;
- (4) **The Company** will notify each **Network Operator**, as soon as reasonably practicable after it has updated the **National Electricity Transmission System Study Network Data Files** covering Year 1 that it has done so, when this update falls before the next annual update under this OC2.4.1.3.3(i). **The Company** will then make available to each **Network Operator** who has received an earlier version (and in respect of whom the agreement still exists), the updated **National Electricity Transmission System Study Network Files** covering the balance of Years 1 and 2 which remain given the passage of time, and which are of relevance to that **User's System**. The provisions of paragraphs (2) and (3) above shall apply to the making available of these updates;
- (5) the data from the **National Electricity Transmission System Study Network Data Files** received by each **Network Operator** must only be used by that **User** in planning and operating that **Network Operator's User System** and must not be used for any other purpose or passed on to, or used by, any other business of that **User** or to, or by, any person within any other such business or elsewhere.

OC2.4.1.3.4 Operational Planning Phase - Planning In Financial Year 0 Down To The Programming Phase (And In The Case Of Load Transfer Capability, Also During The Programming Phase)

- (a) The **National Electricity Transmission System** outage plan for Year 1 issued under OC2.4.1.3.3 shall become the plan for Year 0 when by expiry of time Year 1 becomes Year 0.
- (b) Each **Generator** or **Interconnector Owner** or **Network Operator** or **Non-Embedded Customer** may at any time during Year 0, request **The Company** in writing for changes to the outages requested by them under OC2.4.1.3.3. In relation to that part of Year 0, excluding the period 1-7 weeks from the date of request, **The Company** shall determine whether the changes are possible and shall notify the **Generator**, **Interconnector Owner**, **Network Operator** or **Non-Embedded Customer** in question whether this is the case as soon as possible, and in any event within 14 days of the date of receipt by **The Company** of the written request in question.

Where **The Company** determines that any change so requested is possible and notifies the relevant **User** accordingly, **The Company** will provide to each **Network Operator**, each **Interconnector Owner**, and each **Generator** a copy of the request to which **The Company** has agreed which relates to outages on **Systems** of **Network Operators** (other than any request made by that **Network Operator**). The information must only be used by that **Network Operator** in planning and operating that **Network Operator's User System** and must not be used for any other purpose or passed on to, or used by, any other business of that **User** or to, or by, any person within any other such business or elsewhere.

- (c) During Year 0 (including the **Programming Phase**) each **Network Operator** shall at **The Company's** request, make available to **The Company**, such details of automatic and manual load transfer capability of:
- (i) 12MW or more (averaged over any half hour) for England and Wales
 - (ii) 10MW or more (averaged over any half hour) for Scotland

between Grid Supply Points.

During Year 0 (including the **Programming Phase**) each **Network Operator** shall notify **The Company** of any revisions to the information provided pursuant to OC2.4.1.3.3 (c) for **Interface Points** as soon as reasonably practicable after the **Network Operator** becomes aware of the need to make such revisions.

- (d) When necessary during Year 0, **The Company** will notify each **Generator**, each **Interconnector Owner** and **Network Operator** and each **Non-Embedded Customer**, in writing of those aspects of the **National Electricity Transmission System** outage programme in the period from the 8th week ahead to the 52nd week ahead, which may, in **The Company's** reasonable opinion, operationally affect that **Generator** (other than those aspects which may operationally affect **Embedded Small Power Stations** or **Embedded Medium Power Stations**) **Interconnector Owner** or **Network Operator** or **Non-Embedded Customer** including in particular proposed start dates and end dates of relevant **National Electricity Transmission System** outages.

The Company will also notify changes to information supplied by **The Company** pursuant to OC2.4.1.3.3(i)(x) and (y) except where in relation to a **User** information was supplied pursuant to OC2.4.1.3.3(i)(z). In that case:-

- (i) **The Company** will, by way of update of the information supplied by it pursuant to OC2.4.1.3.3(i)(z), make available at the first time in Year 0 that it updates the **National Electricity Transmission System Study Network Data Files** in respect of Year 0 (such update being an update on what was shown in respect of Year 1 which has then become Year 0) to each **Network Operator** who has received an earlier version under OC2.4.1.3.3(i)(z) (and in respect of whom the agreement still exists), the **National Electricity Transmission System Study Network Data Files** covering Year 0 which are of relevance to that **User's System**.
- (ii) **The Company** will notify each relevant **Network Operator**, as soon as reasonably practicable after it has updated the **National Electricity Transmission System Study Network Data Files** covering Year 0, that it has done so. **The Company** will then make available to each such **Network Operator**, the updated **National Electricity Transmission System Study Network Data Files** covering the balance of Year 0 which remains given the passage of time, and which are of relevance to that **User's System**.
- (iii) The provisions of OC2.4.1.3.3(i)(z)(2), (3) and (5) shall apply to the provision of data under this part of OC2.4.1.3.4(d) as if set out in full.

The Company will also indicate where a need may exist to issue other operational instructions or notifications (including but not limited to the requirement for the arming of an **Operational Intertipping** scheme) or **Emergency Instructions** to **Users** in accordance with **BC2** to allow the security of the **National Electricity Transmission System** to be maintained within the **Licence Standards**.

- (e) In addition, by the end of each month during Year 0, **The Company** will provide to each **Generator** and each **Interconnector Owner** a notice containing any revisions to the final **National Electricity Transmission System** outage plan for Year 1, provided to the **Generator** or the **Interconnector Owner** under OC2.4.1.3.3 or previously under this provision, whichever is the more recent.

OC2.4.1.3.5 Programming Phase

(a) By 1600 hours each Thursday

- (i) **The Company** shall continue to update a preliminary **National Electricity Transmission System** outage programme for the eighth week ahead, a provisional **National Electricity Transmission System** outage programme for the next week ahead and a final day ahead **National Electricity Transmission System** outage programme for the following day.
- (ii) **The Company** will notify each **Generator, Interconnector Owner** and **Network Operator** and each **Non-Embedded Customer**, in writing of those aspects of the preliminary **National Electricity Transmission System** outage programme which may operationally affect each **Generator** (other than those aspects which may operationally affect **Embedded Small Power Stations** or **Embedded Medium Power Stations**) or **Interconnector Owner** or **Network Operator** and each **Non-Embedded Customer** including in particular proposed start dates and end dates of relevant **National Electricity Transmission System** outages.

The Company will also notify changes to information supplied by **The Company** pursuant to OC2.4.1.3.3(i)(x) and (y) except where in relation to a **User** information was supplied pursuant to OC2.4.1.3.3(i)(z). In that case:

- (1) **The Company** will, by way of update of the information supplied by it pursuant to OC2.4.1.3.3(i)(z), make available the **National Electricity Transmission System Study Network Data Files** for the next week ahead and
- (2) **The Company** will notify each relevant **Network Operator**, as soon as reasonably practicable after it has updated the **National Electricity Transmission System Study Network Data Files** covering the next week ahead that it has done so, and
- (3) The provisions of OC2.4.1.3.3(i)(z)(2), (3) and (5) shall apply to the provision of data under this part of OC2.4.1.3.5(a)(ii) as if set out in full.

The Company may make available, the **National Electricity Transmission System Study Network Data Files** for the next week ahead where **The Company** and a particular **User** agree, and in such case the provisions of OC2.4.1.1.3.3(i)(x) and (y) and the provisions of OC2.4.1.3.4(d) and OC2.4.1.3.5(a) which relate to OC2.4.1.1.3.3(i)(x) and (y) shall not apply. In such case, the provisions of this OC2.4.1.3.5(a)(ii)2 and 3 shall apply to the provision of the data under this part of OC2.4.1.3.5(a)(ii) as if set out in full.

The Company will also indicate where a need may exist to arm an **Operational Intertripping** scheme, emergency switching, emergency **Demand** management or other measures including the issuing of other operational instructions or notifications or **Emergency Instructions** to **Users** in accordance with **BC2** to allow the security of the **National Electricity Transmission System** to be maintained within the **Licence Standards**.

(b) By 1000 hours each Friday

Generators, Interconnector Owners and **Network Operators** will discuss with **The Company** and confirm in writing to **The Company**, acceptance or otherwise of the requirements detailed under OC2.4.1.3.5.

Network Operators shall confirm for the following week:

- (i) the details of any outages of its **User System** that will restrict the **Maximum Export Capacity** and/or **Maximum Import Capacity** at any **Interface Points** within its **User System** for the following week; and
- (ii) any changes to the previously declared values of the **Interface Point Target Voltage/Power Factor**.

- (c) By 1600 hours each Friday
- (i) **The Company** shall finalise the preliminary **National Electricity Transmission System** outage programme up to the seventh week ahead. **The Company** will endeavour to give as much notice as possible to a **Generator** with nuclear **Large Power Stations** which may be operationally affected by an outage which is to be included in such programme.
 - (ii) **The Company** shall finalise the provisional **National Electricity Transmission System** outage programme for the next week ahead.
 - (iii) **The Company** shall finalise the **National Electricity Transmission System** outage programme for the weekend through to the next normal working day.
 - (iv) In each case, **The Company** will indicate the factors set out in (a)(ii) above (other than those aspects which may operationally affect **Embedded Small Power Stations** or **Embedded Medium Power Stations**) to the relevant **Generators** and **Network Operators** and **Non-Embedded Customers**.
 - (v) Where a **Generator** with nuclear **Large Power Stations** which may be operationally affected by the preliminary **National Electricity Transmission System** outage programme referred to in (i) above (acting as a reasonable operator) is concerned on grounds relating to safety about the effect which an outage within such outage programme might have on one or more of its nuclear **Large Power Stations**, it may contact **The Company** to explain its concerns and discuss whether there is an alternative way of taking that outage (having regard to technical feasibility). If there is such an alternative way, but **The Company** refuses to adopt that alternative way in taking that outage, that **Generator** may involve the **Disputes Resolution Procedure** to decide on the way the outage should be taken. If there is no such alternative way, then **The Company** may take the outage despite that **Generator's** concerns.
- (d) By 1600 hours each Monday, Tuesday, Wednesday and Thursday
- (i) **The Company** shall prepare a final **National Electricity Transmission System** outage programme for the following day.
 - (ii) **The Company** shall notify each **Generator** and **Network Operator** and **Non-Embedded Customer** in writing of the factors set out in (a)(ii) above (other than those aspects which may operationally affect **Embedded Small Power Stations** or **Embedded Medium Power Stations**).

OC2.4.2 DATA REQUIREMENTS

OC2.4.2.1 When a **Statement of Readiness** under the **Bilateral Agreement** and/or **Construction Agreement** is submitted, and thereafter in calendar week 24 in each calendar year,

- (a) each **Generator** shall (subject to OC2.4.2.1(k)) in respect of each of its:-
- (i) **Gensets** (in the case of the **Generation Planning Parameters**); and
 - (ii) **CCGT Units** within each of its **CCGT Modules** at a **Large Power Station** (in the case of the **Generator Performance Chart**)
 - (iii) **Generating Units** within each of its **Synchronous Power Generating Modules** at a **Large Power Station** (in the case of the **Power-Generating Module Performance Chart** and **Synchronous Generating Unit Performance Chart**)
- submit to **The Company** in writing the **Generation Planning Parameters** and the **Generator Performance Charts** as required.
- (b) Each shall meet the requirements of CC.6.3.2 or ECC.6.3.2 (as applicable) and shall reasonably reflect the true operating characteristics of the **Genset**.

- (c) They shall be applied (unless revised under this **OC2** or (in the case of the **Generator Performance Chart** only) **BC1** in relation to **Other Relevant Data**) from the **Completion Date**, in the case of the ones submitted with the **Statement of Readiness**, and in the case of the ones submitted in calendar week 24, from the beginning of week 25 onwards.
- (d) They shall be in the format indicated in Appendix 1 for these charts and as set out in Appendix 2 for the **Generation Planning Parameters**.
- (e) Any changes to the **Generator Performance Chart** or **Generation Planning Parameters** should be notified to **The Company** promptly.
- (f) **Generators** should note that amendments to the composition of the **Power Generating Module**, **CCGT Module** or **Power Park Module** at **Large Power Stations** may only be made in accordance with the principles set out in PC.A.3.2.3 or PC.A.3.2.4 respectively. If in accordance with PC.A.3.2.3 or PC.A.3.2.4 an amendment is made, any consequential changes to the **Generation Planning Parameters** should be notified to **The Company** promptly.
- (g) **The Generator Performance Chart** must be as described below and demonstrate the limitation on reactive capability of the **System** voltage at 3% above nominal. It must also include any limitations on output due to the prime mover (both maximum and minimum), **Generating Unit** step up transformer or **User System**.
 - (i) For a **Synchronous Generating Unit** on a **Generating Unit** specific basis at the **Generating Unit** stator terminals. It must include details of the **Generating Unit** transformer parameters.
 - (ii) For a **Non-Synchronous Generating Unit** (excluding a **Power Park Unit**) on a **Generating Unit** specific basis at the **Grid Entry Point** (or **User System Entry Point** if **Embedded**).
 - (iii) For a **Power Park Module**, on a **Power Park Module** specific basis at the **Grid Entry Point** (or **User System Entry Point** if **Embedded**).
 - (iv) For a **DC Converter** on a **DC Converter** specific basis at the **Grid Entry Point** (or **User System Entry Point** if **Embedded**).
 - (v) For a **Synchronous Generating Unit** within a **Synchronous Power Generating Module**, both the **Power-Generating Module Performance Chart** and **Synchronous Generating Unit Performance Chart** should be provided.
- (h) For each **CCGT Unit**, and any other **Generating Unit** or **Power Park Module** or **Power Generating Module** whose performance varies significantly with ambient temperature, the **Generator Performance Chart** (including the **Power-Generating Module Performance Chart** and **Synchronous Generating Unit Performance Chart** in the case of **Synchronous Power Generating Modules**) shall show curves for at least two values of ambient temperature so that **The Company** can assess the variation in performance over all likely ambient temperatures by a process of linear interpolation or extrapolation. One of these curves shall be for the ambient temperature at which the **Generating Unit's** output, or **CCGT Module** or **Power-Generating Module** at a **Large Power Station** output or **Power Park Module's** output, as appropriate, equals its **Registered Capacity**.
- (i) The **Generation Planning Parameters** supplied under OC2.4.2.1 shall be used by **The Company** for operational planning purposes only and not in connection with the operation of the **Balancing Mechanism** (subject as otherwise permitted in the **BC**).

- (j) Each **Generator** shall in respect of each of its **Synchronous Power Generating Modules** or **CCGT Modules** (including those which are part of a **Synchronous Power Generating Module**) at **Large Power Stations** submit to **The Company** in writing a **CCGT Module Planning Matrix** and/or a **Synchronous Power-Generating Module Planning Matrix**. It shall be prepared on a best estimate basis relating to how it is anticipated the **Synchronous Power-Generating Module** or **CCGT Module** will be running and which shall reasonably reflect the true operating characteristics of the **Power-Generating Module** or **CCGT Module**. It will be applied (unless revised under this OC2) from the **Completion Date**, in the case of the one submitted with the **Statement of Readiness**, and in the case of the one submitted in calendar week 24, from the beginning of week 31 onwards. It must show the combination of **CCGT Units** or **Synchronous Power Generating Units** which would be running in relation to any given MW output, in the format indicated in Appendix 3.

Any changes must be notified to **The Company** promptly. **Generators** should note that amendments to the composition of the **CCGT Module** or **Synchronous Power-Generating Module** at **Large Power Stations** may only be made in accordance with the principles set out in PC.A.3.2.3. If in accordance with PC.A.3.2.3 an amendment is made, an updated **CCGT Module Planning Matrix** or **Synchronous Power-Generating Module Planning Matrix** must be immediately submitted to **The Company** in accordance with this OC2.4.2.1(b).

The **CCGT Module Planning Matrix** or **Synchronous Power-Generating Module Planning Matrix** will be used by **The Company** for operational planning purposes only and not in connection with the operation of the **Balancing Mechanism**.

- (k) Each **Generator** shall in respect of each of its **Cascade Hydro Schemes** also submit the **Generation Planning Parameters** detailed at OC2.A.2.6 to OC2.A.2.10 for each **Cascade Hydro Scheme**. Such parameters need not also be submitted for the individual **Gensets** within such **Cascade Hydro Scheme**.
- (l) Each **Generator** shall in respect of each of its **Power Park Modules** at **Large Power Stations** submit to **The Company** in writing a **Power Park Module Planning Matrix**. It shall be prepared on a best estimate basis relating to how it is anticipated the **Power Park Module** will be running and which shall reasonably reflect the operating characteristics of the **Power Park Module** and the **BM Unit** of which it forms part. It will be applied (unless revised under this OC2) from the **Completion Date**, in the case of the one submitted with the **Statement of Readiness**, and in the case of the one submitted in calendar week 24, from the beginning of week 31 onwards. It must show the number of each type of **Power Park Unit** in the **Power Park Module** typically expected to be available to generate and the **BM Unit** of which it forms part, in the format indicated in Appendix 4. The **Power Park Module Planning Matrix** shall be accompanied by a graph showing the variation in MW output with **Intermittent Power Source** (e.g. MW vs wind speed) for the **Power Park Module**. The graph shall indicate the typical value of the **Intermittent Power Source** for the **Power Park Module**.

Any changes must be notified to **The Company** promptly. **Generators** should note that amendments to the composition of the **Power Park Module** at **Large Power Stations** may only be made in accordance with the principles set out in PC.A.3.2.4. If in accordance with PC.A.3.2.4 an amendment is made, an updated **Power Park Module Planning Matrix** must be immediately submitted to **The Company** in accordance with this OC2.4.2.1(a).

The **Power Park Module Planning Matrix** will be used by **The Company** for operational planning purposes only and not in connection with the operation of the **Balancing Mechanism**.

- (m) For each **Synchronous Generating Unit** (including **Synchronous Generating Units** within a **Power Generating Module**) where the **Generator** intends to adjust the **Generating Unit** terminal voltage in response to a MVar output Instruction or a Target Voltage Level instruction in accordance with BC2.A.2.6 the **Generator Performance Chart** including the **Synchronous Generating Unit Performance Chart** shall show curves corresponding to the **Generating Unit** terminal voltage being controlled to its rated value and to its maximum value.

OC2.4.2.2 Each **Network Operator** shall by 1000 hrs on the day falling seven days before each **Operational Day** inform **The Company** in writing of any changes to the circuit details called for in PC.A.2.2.1 which it is anticipated will apply on that **Operational Day** (under **BC1** revisions can be made to this data).

OC2.4.2.3 Under **Retained EU Law** (Commission Regulation (EU) 543/2013), **Users** are required to submit certain data to the **Data Publisher** for publication. **The Company** is required to facilitate the collection, verification and processing of data from **Users** for onward transmission to the **Data Publisher**.

Each **Generator** and each **Non-Embedded Customer** connected to or using the **National Electricity Transmission System** shall provide **The Company** with such information as required by and set out in **DRC** Schedule 6 (**Users' Outage Data EU Transparency Availability Data**) in the timescales detailed therein.

OC2.4.3 NEGATIVE RESERVE ACTIVE POWER MARGINS

OC2.4.3.1 At a regular time interval, at least once each day (by 1600 hours) and up to every hour **The Company** will, taking into account the **Generation Outage Programme** and forecast of **Output Usable** supplied by each **Generator** and by each **Interconnector Owner** defined in OC2.4.1.2.1 and forecast **Demand** for the minimum **Demand** period, calculate and publish:-

- (1) the level of the **System NRAPM** each day within the period 2 to 14 days ahead (inclusive) and for each week the level of risk of **System NRAPM** within the 2-52 week ahead period; and
- (2) the level of the **Localised NRAPM** (currently for the main constraint between England and Scotland only) for each day within the period 2 to 14 days ahead (inclusive) having taken into account the appropriate limit on transfers to and from the **System Constraint Group** and for each week the level of risk of **Localised NRAPM** within the 2-52 week ahead period.

Outages Adjustments

- (a) Under the necessary circumstances **The Company** will then contact **Generators** in respect of their **Large Power Stations** and **Interconnector Owners** to discuss outages as set out in the following paragraphs of this OC2.4.3.1.
- (b) **The Company** will contact all **Generators** and **Interconnector Owners** in the case of low **System NRAPM** and will contact **Generators** in relation to relevant **Large Power Stations** and **Interconnector Owners** in the case of low **Localised NRAPM**. **The Company** will raise with each **Generator** and **Interconnector Owner** the problems it is anticipating due to the low **System NRAPM** or **Localised NRAPM** and will discuss:
 - (1) whether any change is possible to the estimate of **Genset** inflexibility; and
 - (2) whether **Genset** or **External Interconnection** outages can be taken to coincide with the periods of low **System NRAPM** or **Localised NRAPM** (as the case may be).

In relation to **Generators** with nuclear **Large Power Stations** the discussions on outages can include the issue of whether outages can be taken for re-fuelling purposes to coincide with the relevant low **System NRAPM** and/or **Localised NRAPM** periods.

- (c) If agreement is reached with a **Generator** or an **Interconnector Owner**, then such **Generator** or **Interconnector Owner** will take such outage, as agreed with **The Company**, and the **Generator** or an **Interconnector Owner** will issue updates to its **Output Usable** via the data provision process defined in OC2.4.1.2.1 and **The Company** will process the updated data which will then be included in the next published update of the **System NRAPM** and/or **Localised NRAPM**.
- (d) If on the day prior to an **Operational Day**, it is apparent from the **BM Unit Data** submitted by **Users** under **BC1** that **System NRAPM** and/or **Localised NRAPM** (as the case may be) is, in **The Company's** reasonable opinion, too low, then in accordance with the procedures and requirements set out in BC1.5.5 **The Company** may contact **Users** to discuss whether changes to **Physical Notifications** are possible, and if they are, will reflect those in the operational plans for the next following **Operational Day** or will, in accordance with BC2.9.4 instruct **Generators** to **De-Synchronise** a specified **Genset** for such period. In determining which **Genset** to so instruct, **BC2** provides that **The Company** will not (other than as referred to below) consider in such determination (and accordingly shall not instruct to **De-Synchronise**) any **Genset** within an **Existing Gas Cooled Reactor Plant**. **BC2** further provides that:-
- (i) **The Company** is permitted to instruct to **De-Synchronise** any **Gensets** within an **Existing AGR Plant** if those **Gensets** within an **Existing AGR Plant** have failed to offer to be flexible for the relevant instance at the request of **The Company** provided the request is within the **Existing AGR Plant Flexibility Limit**.
- (ii) **The Company** will only instruct to **De-Synchronise** any **Gensets** within an **Existing Magnox Reactor Plant** or within an **Existing AGR Plant** (other than under (i) above) if the level of **System NRAPM** (taken together with **System** constraints) and/or **Localised NRAPM** is such that it is not possible to avoid **De-Synchronising** such **Generating Unit** or **Power Generating Module**, and provided the power flow across each **External Interconnection** is either at zero or results in an export of power from the **Total System**. This proviso applies in all cases in the case of **System NRAPM** and in the case of **Localised NRAPM**, only when the power flow would have a relevant effect.

OC2.4.4 FREQUENCY SENSITIVE OPERATION

By 1600 hours each Wednesday

- OC2.4.4.1 Using such information as **The Company** shall consider relevant including, if appropriate, forecast **Demand**, any estimates provided by **Generators** of **Genset** inflexibility and anticipated plant mix relating to operation in **Frequency Sensitive Mode**, **The Company** shall determine for the period 2 to 7 weeks ahead (inclusive) whether it is possible that there will be insufficient **Gensets** (other than those **Gensets** within **Existing Gas Cooled Reactor Plant** which are permitted to operate in **Limited Frequency Sensitive Mode** at all times under BC3.5.3) to operate in **Frequency Sensitive Mode** for all or any part of that period.
- OC2.4.4.2 BC3.5.3 explains that **The Company** permits **Existing Gas Cooled Reactor Plant** other than **Frequency Sensitive AGR Units** to operate in a **Limited Frequency Sensitive Mode** at all times.
- OC2.4.4.3 If **The Company** foresees that there will be an insufficiency in **Gensets** operating in a **Frequency Sensitive Mode**, it will contact **Generators** in order to seek to agree (as soon as reasonably practicable) that all or some of the **Gensets** (the MW amount being determined by **The Company** but the **Gensets** involved being determined by the **Generator**) will take outages to coincide with such period as **The Company** shall specify to enable replacement by other **Gensets** which can operate in a **Frequency Sensitive Mode**. If agreement is reached (which unlike the remainder of **OC2** will constitute a binding agreement) then such **Generator** will take such outage as agreed with **The Company**. If agreement is not reached, then the provisions of BC2.9.5 may apply.

OC2.4.5 If in **The Company 's** reasonable opinion it is necessary for both the procedure set out in OC2.4.3 (relating to **System NRAPM** and **Localised NRAPM**) and in OC2.4.4 (relating to operation in **Frequency Sensitive Mode**) to be followed in any given situation, the procedure set out in OC2.4.3 will be followed first, and then the procedure set out in OC2.4.4. For the avoidance of doubt, nothing in this paragraph shall prevent either procedure from being followed separately and independently of the other.

OC2.4.6 OPERATING MARGIN DATA REQUIREMENTS

OC2.4.6.1 Modifications to relay settings

'Relay settings' in this OC2.4.6.1 refers to the settings of **Low Frequency Relays** in respect of **Gensets** that are available for start from standby by **Low Frequency Relay** initiation with **Fast Start Capability** agreed pursuant to the **Bilateral Agreement**.

By 1600 hours each Wednesday

A change in relay settings will be sent by **The Company** no later than 1600 hours on a Wednesday to apply from 1000 hours on the Monday following. The settings allocated to particular **Large Power Stations** may be interchanged between 49.70Hz and 49.60Hz (or such other **System Frequencies** as **The Company** may have specified) provided the overall capacity at each setting and **System** requirements can, in **The Company 's** view, be met.

Between 1600 hours each Wednesday and 1200 hours each Friday

If a **Generator** wishes to discuss or interchange settings it should contact **The Company** by 1200 hours on the Friday prior to the Monday on which it would like to institute the changes to seek **The Company 's** agreement. If **The Company** agrees, **The Company** will then send confirmation of the agreed new settings.

By 1500 hours each Friday

If any alterations to relay settings have been agreed, then the updated version of the current relay settings will be sent to affected **Users** by 1500 hours on the Friday prior to the Monday on which the changes will take effect. Once accepted, each **Generator** (if that **Large Power Station** is not subject to forced outage or **Planned Outage**) will abide by the terms of its latest relay settings.

In addition, **The Company** will take account of any **Large Power Station** unavailability (as notified under OC2.4.1.2 submissions) in its total **Operating Reserve** policy.

The Company may from time to time, for confirmation purposes only, issue the latest version of the current relay settings to each affected **Generator**

OC2.4.6.2 Operational Planning Margin Requirements (OPMR)

At a regular time interval, at least once each day (by 1600 hours) and up to every hour

The Company will provide an indication of the level of **Operating Reserve** to be utilised by **The Company** in connection with the operation of the **Balancing Mechanism** covering a 2-14 day ahead period (with a daily peak demand resolution) and the 2-52 week resolution (with a weekly resolution focusing on the peak demand of the week). This level shall be purely indicative.

This **Operational Planning Margin** requirements indication will also note the possible level of **High Frequency Response** to be utilised by **The Company** in connection with the operation of the **Balancing Mechanism** in the week beginning with the **Operational Day** commencing during the subsequent Monday, which level shall be purely indicative.

OC2.4.7 In the event that:

- a) a **Non-Embedded Customer** experiences the planned unavailability of its **Apparatus** resulting in the reduction of Demand of 100MW or more, or a change to the planned unavailability of its **Apparatus** resulting in a change in Demand of 100MW or more, for one Settlement Period or longer; or
- b) a **Non-Embedded Customer** experiences a change in the actual availability of its **Apparatus** resulting in a change in Demand of 100MW or greater; or
- c) a **Generator** experiences a planned unavailability of a **Generating Unit** and/or **Power-Generating Module** resulting in a change of 100MW or more in the **Output Usable** of that **Generating Unit** and/or **Power-Generating Module** below its previously notified availability, which is expected to last one **Settlement Period** or longer and up to three years ahead; or
- d) a **Generator** experiences a change of 100MW or more in the Maximum Export Limit of a **Generating Unit** which is expected to last one **Settlement Period** or longer; or
- e) a **Generator** experiences a planned unavailability resulting in a change of 100MW or more in its aggregated **Output Usable** below its previously notified availability for a **Power Station** with a **Registered Capacity** of 200MW or more and which is expected to last one **Settlement Period** or longer and up to three years ahead, save where data has been provided pursuant to OC.2.4.7(c) above; or
- f) a **Generator** experiences a change of 100MW or more in the aggregated Maximum Export Limit of a **Power Station** with a **Registered Capacity** of 200MW or more, which is expected to last one **Settlement Period** or longer, save where data has been provided pursuant to OC.2.4.7(d) above;

such **Non-Embedded Customer** or **Generator** shall provide **The Company** with the **EU Transparency Availability Data** in accordance with **DRC** Schedule 6 (Users' Outage Data) using **MODIS** and, with reference to points OC2.4.7(a) to (f), **Retained EU Law** (Commission Regulation (EU) 543/2013) articles 7.1(a), 7.1(b), 15.1(a), 15.1(b), 15.1(c) and 15.1(d).

APPENDIX 1 - PERFORMANCE CHART EXAMPLES

GENERATOR PERFORMANCE CHART

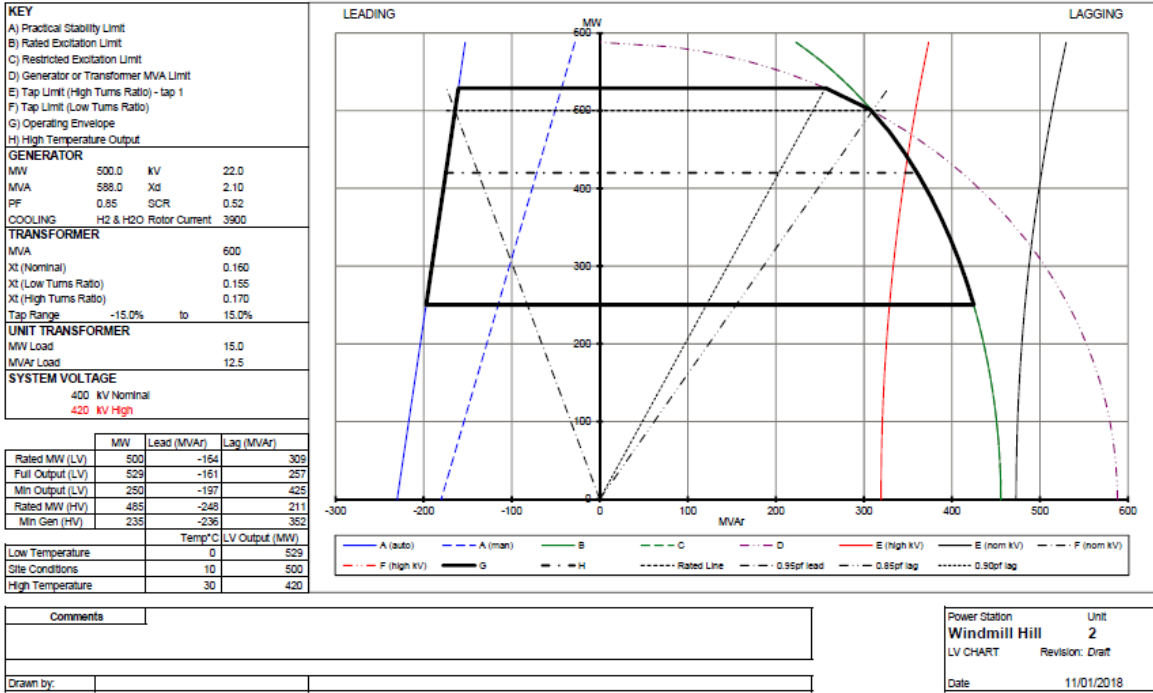

Synchronous Generating Unit Performance Chart within a Synchronous Power Generating Module

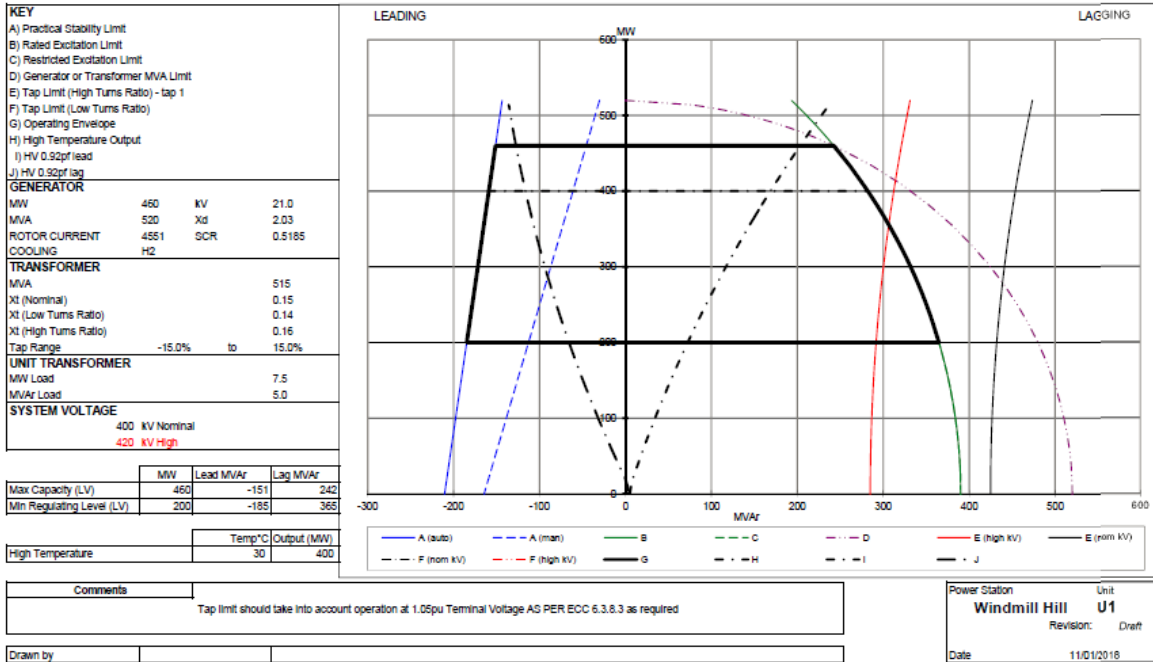

GENERATOR PERFORMANCE CHART

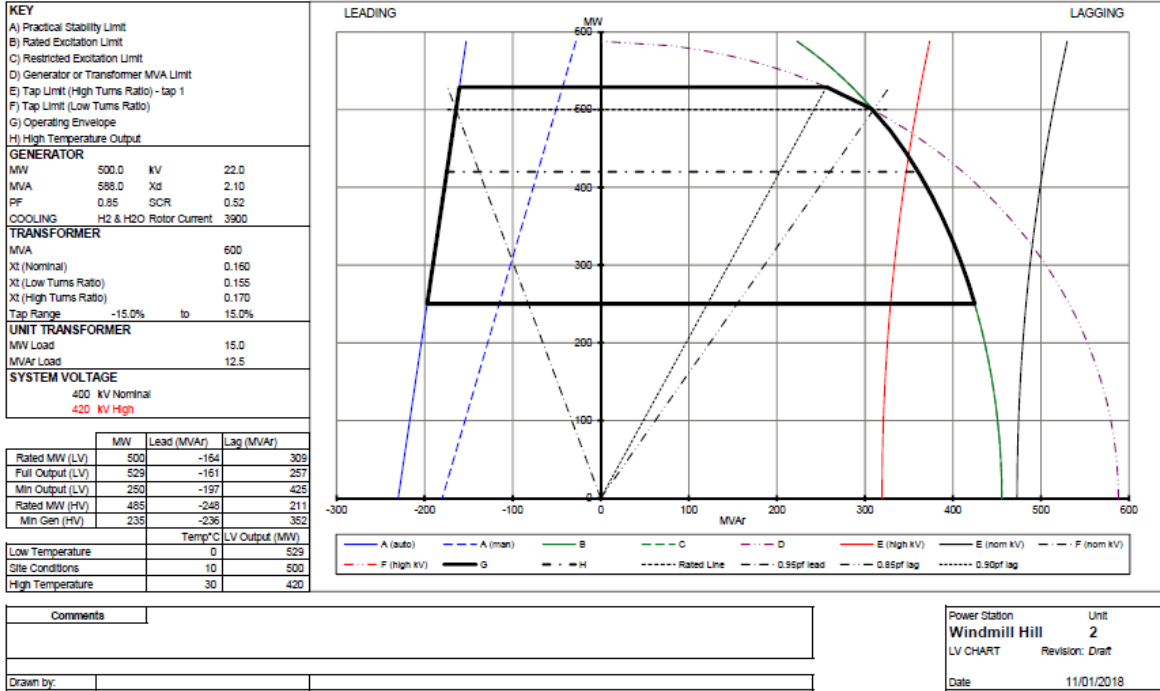

Synchronous Generating Unit Performance Chart within a Synchronous Power Generating Module

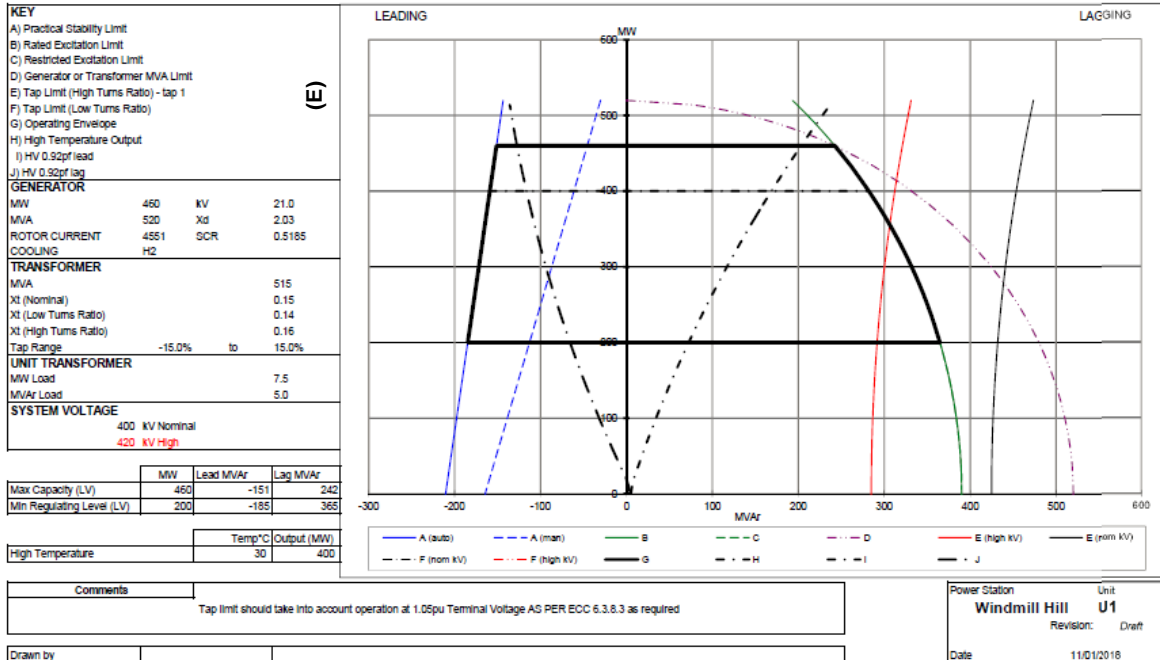

POWER PARK MODULE PERFORMANCE CHART AT THE CONNECTION POINT OR USER'S SYSTEM ENTRY POINT

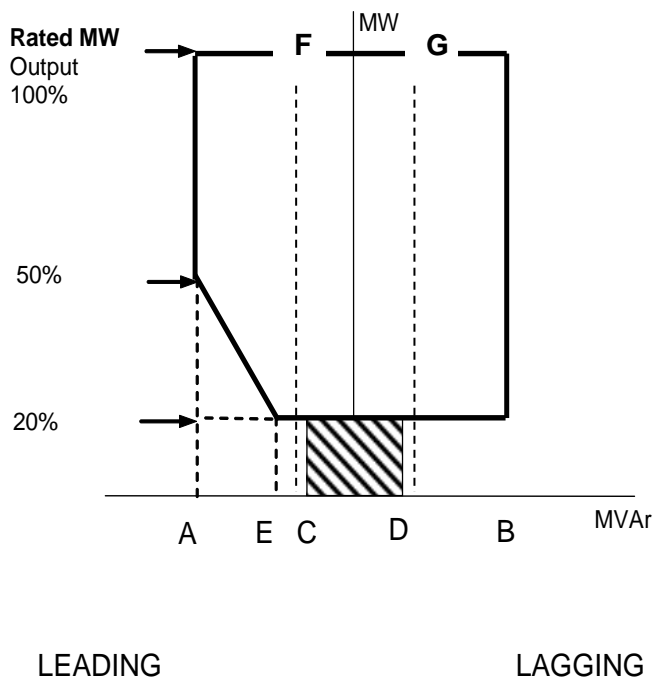

- Point A is equivalent (in MVAr) to: 0.95 leading **Power Factor** at **Rated MW** output
- Point B is equivalent (in MVAr) to: 0.95 lagging **Power Factor** at **Rated MW** output
- Point C is equivalent (in MVAr) to: -5% of **Rated MW** output
- Point D is equivalent (in MVAr) to: +5% of **Rated MW** output
- Point E is equivalent (in MVAr) to: -12% of **Rated MW** output
- Line F is equivalent (in MVAr) to: Leading **Power Factor Reactive Dispatch Network Restriction**
- Line G is equivalent (in MVAr) to: Lagging **Power Factor Reactive Dispatch Network Restriction**

Where a **Reactive Dispatch Network Restriction** is in place which requires following of local voltage conditions, alternatively to Line F and G, please check this box.

APPENDIX 2 - GENERATION PLANNING PARAMETERS

OC2.A.2 Generation Planning Parameters

The following parameters are required in respect of each **Genset**.

OC2.A.2.1 Regime Unavailability

Where applicable the following information must be recorded for each **Genset**.

- Earliest synchronising time:
 - Monday
 - Tuesday to Friday
 - Saturday to Sunday
- Latest de-synchronising time:
 - Monday to Thursday
 - Friday
 - Saturday to Sunday

OC2.A.2.2 Synchronising Intervals

- (a) The synchronising interval between **Gensets** in a **Synchronising Group** assuming all **Gensets** have been **Shutdown** for 48 hours;
- (b) The **Synchronising Group** within the **Power Station** to which each **Genset** should be allocated.

OC2.A.2.3 De-Synchronising Interval

A fixed value **De-Synchronising** interval between **Gensets** within a **Synchronising Group**.

OC2.A.2.4 Synchronising Generation

The amount of MW produced at the moment of **Synchronising** assuming the **Genset** has been **Shutdown** for 48 hours.

OC2.A.2.5 Minimum Non-zero time (MNZT)

The minimum period on-load between **Synchronising** and **De-Synchronising** assuming the **Genset** has been **Shutdown** for 48 hours.

OC2.A.2.6 Run-Up rates

A run-up characteristic consisting of up to three stages from **Synchronising Generation** to **Output Usable** with up to two intervening break points assuming the **Genset** has been **Shutdown** for 48 hours.

OC2.A.2.7 Run-down rates

A run down characteristic consisting of up to three stages from **Output Usable** to **De-Synchronising** with breakpoints at up to two intermediate load levels.

OC2.A.2.8 Notice to Deviate from Zero (NDZ)

The period of time normally required to **Synchronise** a **Genset** following instruction from **The Company** assuming the **Genset** has been **Shutdown** for 48 hours.

OC2.A.2.9 Minimum Zero time (MZT)

The minimum interval between **De-Synchronising** and **Synchronising** a **Genset**.

OC2.A.2.10 Not used.

OC2.A.2.11 Gas Turbine Units loading parameters

- Loading rate for fast starting
- Loading rate for slow starting

APPENDIX 3 - CCGT MODULE PLANNING MATRIX

CCGT Module Planning Matrix Example Form

CCGT MODULE	CCGT GENERATING UNITS AVAILABLE								
	1st GT	2nd GT	3rd GT	4th GT	5th GT	6th GT	1st ST	2nd ST	3rd ST
	OUTPUT USABLE								
	150	150	150				100		
OUTPUT USABLE									
MW									
0MW to 150MW	/								
151MW to 250MW	/						/		
251MW to 300MW	/	/							
301MW to 400MW	/	/					/		
401MW to 450MW	/	/	/						
451MW to 550MW	/	/	/				/		

APPENDIX 4 - POWER PARK MODULE PLANNING MATRIX

Power Park Module Planning Matrix Example Form

BM Unit Name				
Power Park Module [unique identifier]				
POWER PARK UNIT AVAILABILITY	POWER PARK UNITS			
	Type A	Type B	Type C	Type D
Description (Make/Model)				
Number of units				
Power Park Module [unique identifier]				
POWER PARK UNIT AVAILABILITY	POWER PARK UNITS			
	Type A	Type B	Type C	Type D
Description (Make/Model)				
Number of units				

The **Power Park Module Planning Matrix** may have as many columns as are required to provide information on the different make and model for each type of **Power Park Unit** in a **Power Park Module** and as many rows as are required to provide information on the **Power Park Modules** within each **BM Unit**. The description is required to assist identification of the **Power Park Units** within the **Power Park Module** and correlation with data provided under the **Planning Code**.

APPENDIX 5 – SYNCHRONOUS POWER GENERATING MODULE PLANNING MATRIX

Synchronous Power Generating Module Planning Matrix Example Form

SYNCHRONOUS POWER GENERATING MODULE	SYNCHRONOUS POWER GENERATING UNITS AVAILABLE								
	1st GT	2nd GT	3rd GT	4th GT	5th GT	6th GT	1st ST	2nd ST	3rd ST
	OUTPUT USABLE								
	150	150	150				100		
OUTPUT USABLE									
MW									
0MW to 150MW	/								
151MW to 250MW	/						/		
251MW to 300MW	/	/							
301MW to 400MW	/	/					/		
401MW to 450MW	/	/	/						
451MW to 550MW	/	/	/				/		

< END OF OPERATING CODE NO. 2 >

BALANCING CODE NO. 4

(BC4)

TERRE PROCESSES

CONTENTS

(This contents page does not form part of the Grid Code)

<u>Paragraph No/Title</u>	<u>Page Number</u>
BC4.1 <u>INTRODUCTION</u>	2
BC4.2 <u>OBJECTIVE</u>	2
BC4.3 <u>SCOPE</u>	2
BC4.4 <u>REQUIREMENTS FOR BM PARTICIPANTS WHO WISH TO PARTICIPATE IN TERRE</u>	2
BC4.4.1 <u>RR Provider Prequalification Prequalification Timelines</u>	2
BC4.4.2 <u>Minimum Technical Requirements</u>	2
BC4.4.3 <u>Prequalification Timelines</u>	3
BC4.4.4 <u>Requalification Criteria</u>	3
BC4.5 <u>SUBMISSION OF TERRE RELATED DATA BY BM PARTICIPANTS</u>	3
BC4.5.1 <u>Communication from BM Participants to The Company</u>	3
BC4.5.2 <u>RR Provider Data submissions before TERRE Gate Closure</u>	4
BC4.5.3 <u>Re-submission of parameters by BM Participants before TERRE Gate Closure</u>	5
BC4.5.4 <u>Defaulting Rules for TERRE Bids</u>	5
BC4.6 <u>Processing of TERRE Bids before passing to the TERRE Central Platform</u>	5
BC4.6.1 <u>Cases where a TERRE Bid will be Restricted</u>	5
BC4.7 <u>Instructing BM Participants</u>	5
BC4.7.1 <u>Communication from The Company to BM Participants</u>	5
BC4.7.2 <u>Creating RR Instructions from RR Acceptances</u>	5
BC4.7.3 <u>Cases where RR Instructions may not be issued</u>	6
BC4.7.4 <u>Infeasibility of RR Acceptances</u>	6
BC4.8 <u>Publication of TERRE Data</u>	6
BC4.8.2 <u>Publication of Data at the National Level</u>	6
BC4.9 <u>Outages of computer systems leading to the suspension of the TERRE market</u>	6
BC4.10 <u>TERRE Market Suspension</u>	7

BC4.1 INTRODUCTION

Balancing Code No 4 (BC4) sets out the procedures for:

- (a) prequalification requirements for participation in **TERRE** by **BM Participants**;
- (b) submission of data by **BM Participants** wishing to take part in **TERRE**;
- (c) validation of data from **BM Participants** wishing to take part in **TERRE**;
- (d) issuing of **RR Instructions**; and
- (e) publication of **TERRE** related data.

BC4.2 OBJECTIVE

This procedure facilitates the participation of **BM Participants** in the **TERRE** market. Participation in **TERRE** is voluntary for **BM Participants**.

BC4.3 SCOPE

BC4 applies to :-

- (a) **The Company**;
- (b) **BM Participants**;
- (b) **Externally Interconnected System Operators**; and
- (c) **Network Operators**.

BC4.4 REQUIREMENTS FOR BM PARTICIPANTS WHO WISH TO PARTICIPATE IN TERRE

The Company shall ensure that each relevant Balancing Service prequalification process shall, as a minimum, require the **RR** provider to submit a self-certification of the **RR** Minimum Technical Requirements as defined in BC4.4.1 and BC4.4.2.

BC4.4.1 RR Provider Prequalification Prequalification Timelines

All **BM Participants** who wish to participate in **TERRE** must have successfully completed the prequalification process to be a **RR** provider as detailed in **BC5**.

BC4.4.2 Minimum Technical Requirements

All **BM Participants** who wish to participate in **TERRE** must have the following capabilities:

- (a) **BM Participants** must have the ability to submit data and receive instructions by the use of electronic data communication facilities as provided for in CC.6.5.8 or ECC.6.5.8.
- (b) **BM Participants** must be capable of following an **RR Instruction** issued by **The Company**.
- (c) **BM Participants** must be able to provide **Physical Notifications**.
- (d) **BM Participants** must be able to provide a subset of **Dynamic Parameters** (as detailed in BC4.5.2).
- (e) **BM Participants** must provide operational metering for their total output and for any individual component that may have an output greater than 1MW. This metering must have the following accuracy;
 - a. For a **BM Unit** with either a **Generation Capacity** greater than 100MW or **Demand Capacity** greater than 100MW, a metering accuracy better than 0.5%.

- b. For a **BM Unit** with a **Generation Capacity** greater than 10MW but less than or equal to 100MW or **Demand Capacity** greater than 10MW but less than or equal to 100MW, a metering accuracy better than 1%.
- c. For all other **BM Units**, an accuracy better than 2.5% is required.
- (f) **BM Participants** must have the ability to inform **The Company** if their availability changes using **Export and Import Limits**.
- (g) For **BM Participants** connected within a **User System**, **BM Participants** must be capable of informing **Network Operators** of their availability and activation in realtime if required.

BC4.4.3 Prequalification Timelines

The following minimum timescales for the prequalification process apply:-

- (a) Within 8 weeks of a formal application from the **BM Participant**, **The Company** shall confirm the application is complete (from the perspective of information provision).
- (b) If the application is incomplete, the **BM Participant** shall provide the missing evidence within 4 weeks of the a request from **The Company** or it will be presumed that the application has been withdrawn.
- (c) Within 3 months of confirming that all information has been provided, **The Company** shall confirm if the potential **BM Participant** meets the requirements in BC4.4.2. For the avoidance of doubt, **The Company** will not carry out independent tests but will review the evidence provided.

BC4.4.4 Requalification criteria

Under certain conditions, an **BM Participant** must requalify.

- (a) Every five years, a **BM Participant** must requalify to the technical requirements in BC4.4.2 and according to the timescales in BC4.4.3.
- (b) If at any time, a **BM Participant** becomes aware of changes to the configuration forming the **BM Unit**, that means the minimum technical requirements in BC4.4.2 can no longer be met, then that **BM Participant** must withdraw from **TERRE** and must requalify.

BC4.5 SUBMISSION OF TERRE RELATED DATA BY BM PARTICIPANTS

BC4.5.1 Communication from BM Participants to The Company

- (a) Submission of data specified in BC4.5.2 will be by use of electronic data communications facilities, as provided for in CC.6.5.8 or ECC.6.5.8.
- (b) In the event of a failure of the electronic data communication facilities, the data used in the **TERRE** auction will be based on the most recent data received and acknowledged by **The Company**. In the event of missing data, it will be assumed the **BM Participant** did not wish to submit data for the relevant **TERRE Auction Period**.
- (c) **Planned Maintenance Outages** will normally be arranged to take place during periods of low data transfer activity.
- (d) Upon any **Planned Maintenance Outage**, or following an unplanned outage described in BC4.5.1(b) (where it is termed a "failure") in relation to a pre-**TERRE Gate Closure**:
 - (i) If a **BM Participant** has submitted **Physical Notifications** and a **TERRE Bid** for a **TERRE Auction Period** the **BM Participant** should continue to act in relation to any period of time in accordance with the **Physical Notifications** current at the time of

the start of the **Planned Maintenance Outage** or the computer system failure in relation to each such period of time subject to the provisions of BC2.5.1. Depending on when in relation to **TERRE Gate Closure** the planned or unplanned maintenance outage arises, such operation will either be operation in preparation for the relevant output in real time, or will be operation in real time. No further submissions of **BM Participants** data should be attempted. **Plant** failure or similar problems causing significant deviation from the **Physical Notification** should be notified to **The Company** by the submission of a revision to **Export and Import Limits** in relation to the **RR Provider** so affected;

- (ii) No data will be transferred from **The Company** to the **Balancing Mechanism Reporting Agent (BMRA)** until the communication facilities are re-established.

BC4.5.2 RR Provider Data submissions before TERRE Gate Closure

To participate in a **TERRE** auction, a **BM Participant** must have prequalified and must submit a **TERRE Bid** covering at least one of the **TERRE Activation Periods** within the **TERRE Auction Period**.

In addition to a valid **TERRE Bid**, a sub-set of **Balancing Mechanism** parameters are also required covering the **TERRE Auction Period** and the **Settlement Periods** immediately before and after the **TERRE Auction Period** (to allow ramping before and after).

If a **BM Participant** is active in the **Balancing Mechanism** the only additional data needed to participate in a **TERRE** auction is a valid **TERRE Bid** covering the relevant times.

For a **BM Participant** that is not active in the **Balancing Mechanism**, the following subset of parameters are required with exceptions as noted below:

(a) Physical Notifications

Physical Notifications follow the same format and rules as covered in **BC1** and **BC2** with the following exceptions;

- (1) A **BM Participant** that is not active in the **Balancing Mechanism** but wishes to participate in **TERRE** is only required to have submitted **Physical Notifications** covering the **TERRE Auction Period** and the **Settlement Periods** immediately before and after the **TERRE Auction Period** for which they have submitted a **TERRE Bid**.
- (2) Defaulting rules as described in the **Data Validation, Consistency and Defaulting Rules** will only apply to **Settlement Periods** for which the **BM Participant** previously submitted **Physical Notifications** for the previous **Operational Day**.

(b) Export and Import Limits

For a **BM Participant** that is not active in the **Balancing Mechanism** but wishes to participate in **TERRE**, these are the same as described in **BC1** and **BC2**.

(c) Run Up Rate and Run Down Rates

For a **BM Participant** that is not active in the **Balancing Mechanism** but wishes to participate in **TERRE** these are the same as described in **BC1** and **BC2**.

- (d) For a **BM Participant** that is not active in the **Balancing Mechanism** but wishes to participate in **TERRE**, the other **Dynamic Parameters** listed in BC1.A.1.5 are not required.

TERRE Bids must follow the formats and rules in the **TERRE Data Validation and Consistency Rules**.

BC4.5.3 Re-submission of parameters by BM Participants before TERRE Gate Closure

The rules outlined in **BC1** and **BC2** for the revision of **Physical Notifications, Export and Import Limits, Run Up Rates** and **Run Down Rates** also apply for **TERRE**.

TERRE Bids can be revised up to **TERRE Gate Closure** in order to be used in the **TERRE** auction (as described in the **TERRE Data Validation and Consistency Rules**).

BC4.5.4 Defaulting rules for TERRE Bids

TERRE Bids will not be defaulted using previously submitted values. This is due to the ability to link **TERRE Bids** and the re-use of sequence numbers. Hence a **BM Participant** wishing to participate in a particular **TERRE** auction must submit **RR Bids** specifically covering the relevant **TERRE Activation Periods**.

BC4.6 Processing of TERRE Bids before passing to the TERRE Central Platform

BC4.6.1 Cases where a TERRE Bid will be Restricted

TERRE Bids will be passed to the **TERRE Central Platform** but will be flagged as **Restricted** under the following cases:-

- (a) Data within the submission does not conform to formats required as detailed in the **TERRE Data Validation and Consistency Rules** (e.g. missing or incorrect keywords, data in the wrong order, corrupted files etc).
- (b) If a **TERRE Bid** does not have a corresponding **Physical Notification**, the **TERRE Bid** will be flagged as **Restricted**.
- (c) If a **TERRE Bid** will result in violating a **System Constraint**, it will be flagged as **Restricted**.
- (d) If a **BM Participant** has already been instructed for an **Ancillary Service** or for **Reserve**, a **TERRE Bid** may need to be flagged as **Restricted**. For the avoidance of doubt – participation in **TERRE** does not exclude an **BM Participant** from offering other services to **The Company** but on occasions if there are conflicts between services, **The Company** may have to flag these **TERRE Bids** as **Restricted**.

BC4.7 Instructing BM Participants

BC4.7.1 Communication from The Company to BM Participants

For the purposes of communication, an **RR Instruction** will follow the same format as a **Bid-Offer Acceptance** and so the rules of BC2.7 also apply for **RR Instructions**.

BC4.7.2 Creating RR Instructions from RR Acceptances

Results from the **TERRE Central Platform** are returned to **The Company** in the form of **RR Acceptances**.

RR Acceptances do not include physical ramps and so **Run Up Rates** and **Run Down Rates** will be used to create **RR Instructions**.

In order to comply with all of the **RR Acceptances** for a **BM Participant**, several **RR Instructions** may be required.

RR instructions will ramp **BM Participants** from their **Committed Level**, hold them at the required output level, and then return the **BM Participant** back to the **Committed Level**.

The **TERRE** market wishes to incentivise **RR Instructions** which ramp within +/-5 minutes of the start and end of the **TERRE Activation Periods**. Hence, where possible, **Run Up Rates** and **Run Down Rates** will be applied so that ramping is symmetric around the start and end of the **TERRE Activation Periods**.

However the **TERRE Product** allows for up to 30 minute ramping to and from full activation and so for the first and final ramps up to 30 minutes of ramping can be used for creating an **RR Instruction**.

Details of how **RR Instructions** will be created can be found in the **TERRE Instruction Guide**.

BC4.7.3 Cases where RR Instructions may not be issued

In the time between receiving **TERRE Bids** and the **RR Acceptances** being returned to **The Company**, system conditions may require the issuing of a **Bid Offer Acceptance** to the **BM Participant** for which the **RR Acceptance** applies.

In these cases, it may be necessary to not issue an **RR Instruction** to the **BM Participant** or to modify the **RR Instruction** so that it is compatible with the **Bid Offer Acceptance** that has been previously been issued to the **BM Participant**.

This situation can only arise for a **BM Participant** which is also active in the **Balancing Mechanism**.

The following may apply:

- (a) If the **Bid Offer Acceptance** is in the same direction as the **RR Instruction** but the MW levels of the **RR Instruction** are less than the **Committed Level** after the **Bid Offer Acceptance** is applied, the **RR Instruction** will not be issued.
- (b) If the **Bid Offer Acceptance** is in the same direction as the **RR Instruction** but the MW levels of the **RR Instruction** are greater than the **Committed Level** after the **Bid Offer Acceptance** is applied the **RR Instruction** will be issued relative to the **Committed Level**.
- (c) If the **Bid Offer Acceptance** is in the opposite direction to the **RR Instruction** the **RR instruction** will not be issued.

BC4.7.4 Infeasibility of RR Acceptances

If the **RR Acceptances** for an **BM Participant** are not consistent with the **Physical Notifications** and the **Run Up Rates** and **Run Down Rates**, then **The Company** will adjust the MW levels so that **RR Instructions** can be created using the declared parameters.

Details of how these infeasibility rules will be applied are contained in the **TERRE Instruction Guide**.

BC4.8 Publication of TERRE Data

BC4.8.1 Publication of Data at the National level

The Company shall provide data in accordance with the requirements of the **BSC**. The following data items will be provided:

- (a) **TERRE Bids** and details of those restricted
- (b) **Final Physical Notifications**
- (c) **RR activations**
- (d) **RR Instructions**
- (e) Interconnector Volumes per 15 minute period of the **TERRE Activation Period**
- (f) The **TERRE** clearing price
- (g) Volume of **GB** need met

BC4.9 Outages of computer systems leading to the suspension of the TERRE market

The **TERRE** market operates in short processing times meaning that **Planned Maintenance Outages** or unplanned computer system failures can result in the suspension of the **TERRE** market.

Suspension of the **TERRE** market in **GB** will occur in the following circumstances:

- (a) Loss of communication from **The Company** to the **TERRE Central Platform**
- (b) Failure of the **TERRE Central Platform** to produce **RR Acceptances**
- (c) Loss of communication from the **TERRE Central Platform** to **The Company**
- (d) Loss of electronic logging devices to a large number of **BM Participants**

BC4.10

TERRE Market Suspension

The **TERRE** market shall be suspended in **GB** when one of the following circumstances arises:

- (a) Suspension of the **Balancing Mechanism** in accordance with OC9.4.6; or
- (b) Outages of computer systems leading to the suspension of the **TERRE** market as provided for in BC4.9; or
- (c) Operators of the **TERRE Central Platform** notify **The Company** that the **TERRE** market has been or is to be suspended.

Where the **TERRE** market has been suspended as a result of item (a) above, or is to be or has been suspended as a result of items (b) or (c) above, **The Company** will as soon as reasonably practical, inform **Users** and the **BSCCo** that the **TERRE** market is to be or has been suspended. **The Company** will notify **Users** and the **BSCCo** if the **TERRE** market suspension arose as a result of a **Black Start** event or another condition in accordance with the requirements of the **BSC**.

In the case of **TERRE** market suspension under BC4.10 (b) or (c), **The Company** shall (as soon as is practicable) determine, in its reasonable opinion, the time and date from when the **TERRE** market is to be suspended. **The Company** shall also notify **Users** and the **BSCCo** of the time of **TERRE** market suspension and the reason for the suspension.

Where the **TERRE** market has been suspended, it will not be resumed until the start of a defined **Settlement Period** which shall be determined:-

- i) by the **BSC Panel** in accordance with section G3.1.8 of the **BSC** (in the case of a **Black Start** event); or
- ii) by section Q.5.A of the **BSC** (in the case of **TERRE** market suspension for any other reason other than **Black Start**).

In the case of **TERRE** market suspension as a result of a **Black Start** event, as provided for under BC4.10(a), **Users** shall use reasonable endeavours to submit **TERRE Bids** ten hours prior to the start of the **Settlement Period** determined by the **BSC Panel** in accordance with paragraph G3.1.8 of the **BSC** and as notified by **The Company** to **Users** in preparation for the resumption of the **TERRE** market.

In the case of **TERRE** market suspension as a result of another event as provided for under BC4.10(b) or BC4.10(c), **Users** shall use reasonable endeavours to submit **TERRE Bids** as soon as possible after notification from **The Company** of the **Settlement Period** from when the **TERRE** market is to be resumed.

< End of BC4 >

DATA REGISTRATION CODE (DRC)

CONTENTS

(This contents page does not form part of the Grid Code)

<u>Paragraph No/Title</u>	<u>Page Number</u>
DRC.1 INTRODUCTION	3
DRC.2 OBJECTIVE	3
DRC.3 SCOPE	3
DRC.4 DATA CATEGORIES AND STAGES IN REGISTRATION	3
DRC.4.2 Standard Planning Data	4
DRC.4.3 Detailed Planning Data	4
DRC.4.4 Operational Data	4
DRC.5 PROCEDURES AND RESPONSIBILITIES	4
DRC.5.1 Responsibility For Submission And Updating Of Data	4
DRC.5.2 Methods Of Submitting Data	4
DRC.5.3 Changes To Users Data	5
DRC.5.4 Data Not Supplied	5
DRC.5.5 Substituted Data	5
DRC.6 DATA TO BE REGISTERED	5
SCHEDULE 1 - GENERATING UNIT (OR CCGT MODULE), POWER PARK MODULE AND DC CONVERTER TECHNICAL DATA	9
SCHEDULE 2 - GENERATION PLANNING PARAMETERS	35
SCHEDULE 3 - LARGE POWER STATION OUTAGE PROGRAMMES, OUTPUT USABLE AND INFLEXIBILITY INFORMATION	39
SCHEDULE 4 - LARGE POWER STATION DROOP AND RESPONSE DATA	42
SCHEDULE 5 - USERS SYSTEM DATA	43
SCHEDULE 6 - USERS OUTAGE INFORMATION	54
SCHEDULE 7 - LOAD CHARACTERISTICS AT GRID SUPPLY POINTS	58
SCHEDULE 8 - DATA SUPPLIED BY BM PARTICIPANTS	59
SCHEDULE 9 - DATA SUPPLIED BY THE COMPANY TO USERS	60
SCHEDULE 10 - DEMAND PROFILES AND ACTIVE ENERGY DATA	61
SCHEDULE 11 - CONNECTION POINT DATA	63
SCHEDULE 12 - DEMAND CONTROL	68
SCHEDULE 13 - FAULT INFEEED DATA	72
SCHEDULE 14 - FAULT INFEEED DATA (GENERATORS INCLUDING UNIT TRANSFORMERS AND STATION TRANSFORMERS)	76
SCHEDULE 15 - MOTHBALLED GENERATING UNIT, MOTHBALLED POWER PARK MODULE, MOTHBALLED DC CONVERTERS AT A DC CONVERTER STATION AND ALTERNATIVE FUEL DATA)	79
SCHEDULE 16 - BLACK START INFORMATION	84

SCHEDULE 17 - ACCESS PERIOD DATA.....	84
SCHEDULE 18 - OFFSHORE TRANSMISSION SYSTEM DATA.....	85
SCHEDULE 19 - USER DATA FILE STRUCTURE	109

- DRC.1 INTRODUCTION
- DRC.1.1 The **Data Registration Code ("DRC")** presents a unified listing of all data required by **The Company** from **Users** and by **Users** from **The Company**, from time to time under the **Grid Code**. The data which is specified in each section of the **Grid Code** is collated here in the **DRC**. Where there is any inconsistency in the data requirements under any particular section of the **Grid Code** and the **Data Registration Code** the provisions of the particular section of the **Grid Code** shall prevail.
- DRC.1.2 The **DRC** identifies the section of the **Grid Code** under which each item of data is required.
- DRC.1.3 The Code under which any item of data is required specifies procedures and timings for the supply of that data, for routine updating and for recording temporary or permanent changes to that data. All timetables for the provision of data are repeated in the **DRC**.
- DRC.1.4 Various sections of the **Grid Code** also specify information which **Users** will receive from **The Company**. This information is summarised in a single schedule in the **DRC** (Schedule 9).
- DRC.1.5 The categorisation of data into **DPD I** and **DPD II** is indicated in the **DRC** below.
- DRC.2 OBJECTIVE
- The objective of the **DRC** is to:
- DRC.2.1 List and collate all the data to be provided by each category of **User** to **The Company** under the **Grid Code**.
- DRC.2.2 List all the data to be provided by **The Company** to each category of **User** under the **Grid Code**.
- DRC.3 SCOPE
- DRC.3.1 The **DRC** applies to **The Company** and to **Users**, which in this **DRC** means:-
- (a) **Generators** (including those undertaking **OTSDUW** and/or those who own and/or operate **DC Connected Power Park Modules**);
 - (b) **Network Operators**;
 - (c) **DC Converter Station** owners and **HVDC System Owners**;
 - (d) **Suppliers**;
 - (e) **Non-Embedded Customers**;
 - (f) **Externally Interconnected System Operators**;
 - (g) **Interconnector Users**;
 - (h) **BM Participants**; and
 - (i) **Pumped Storage Generators** and **Generators** in respect of Electricity **Storage Modules**.
- DRC.3.2 For the avoidance of doubt, the **DRC** applies to both **GB Code Users** and **EU Code Users**.
- DRC.4 DATA CATEGORIES AND STAGES IN REGISTRATION
- DRC.4.1.1 Within the **DRC** each data item is allocated to one of the following three categories:
- (a) **Standard Planning Data (SPD)**
 - (b) **Detailed Planning Data (DPD)**
 - (c) **Operational Data**

- DRC.4.2 Standard Planning Data (SPD)
- DRC.4.2.1 The **Standard Planning Data** listed and collated in this **DRC** is that data listed in Part 1 of the Appendix to the **PC**.
- DRC.4.2.2 **Standard Planning Data** will be provided to **The Company** in accordance with PC.4.4 and PC.A.1.2.
- DRC.4.3 Detailed Planning Data (DPD)
- DRC.4.3.1 The **Detailed Planning Data** listed and collated in this **DRC** is categorised as **DPD I** and **DPD II** and is that data listed in Part 2 of the Appendix to the **PC**.
- DRC.4.3.2 **Detailed Planning Data** will be provided to **The Company** in accordance with PC.4.4, PC.4.5 and PC.A.1.2.
- DRC.4.4 Operational Data
- DRC.4.4.1 **Operational Data** is data which is required by the **Operating Codes** and the **Balancing Codes**. Within the **DRC**, **Operational Data** is sub-categorised according to the Code under which it is required, namely **OC1**, **OC2**, **BC1** or **BC2**.
- DRC.4.4.2 **Operational Data** is to be supplied in accordance with timetables set down in the relevant **Operating Codes** and **Balancing Codes** and repeated in tabular form in the schedules to the **DRC**.
- DRC.5 PROCEDURES AND RESPONSIBILITIES
- DRC.5.1 Responsibility For Submission And Updating Of Data
- In accordance with the provisions of the various sections of the **Grid Code**, each **User** must submit data as summarised in DRC.6 and listed and collated in the attached schedules.
- DRC.5.2 Methods Of Submitting Data
- DRC.5.2.1 Wherever possible, the data schedules to the **DRC** are structured to serve as standard formats for data submission and such format must be used for the written submission of data to **The Company**.
- DRC.5.2.2 Data must be submitted to the **Transmission Control Centre** notified by **The Company**, or to such other department or address as **The Company** may from time to time advise. The name of the person at the **User Site** who is submitting each schedule of data must be included.
- DRC.5.2.3 Where a computer data link exists between a **User** and **The Company**, data may be submitted via this link. **The Company** will, in this situation, provide computer files for completion by the **User** containing all the data in the corresponding **DRC** schedule.
- Data submitted can be in an electronic format using a proforma to be supplied by **The Company** or other format to be agreed annually in advance with **The Company**. In all cases the data must be complete and relate to, and relate only to, what is required by the relevant section of the **Grid Code**.
- DRC.5.2.4 Other modes of data transfer, such as magnetic tape, may be utilised if **The Company** gives its prior written consent.
- DRC.5.2.5 **Generators, HVDC System Owners** and **DC Converter Station** owners submitting data for a **Power Generating Module, Generating Unit, DC Converter, HVDC System, Power Park Module** (including **DC Connected Power Park Modules**) or **CCGT Module** before the issue of a **Final Operational Notification** should submit the **DRC** data schedules and compliance information required under the **CP** electronically using the **User Data File Structure** unless otherwise agreed with **The Company**.

- DRC.5.3 Changes To User's Data
- DRC.5.3.1 Whenever a **User** becomes aware of a change to an item of data which is registered with **The Company**, the **User** must notify **The Company** in accordance with each section of the Grid Code. The method and timing of the notification to **The Company** is set out in each section of the Grid Code.
- DRC.5.4 Data Not Supplied
- DRC.5.4.1 **Users** and **The Company** are obliged to supply data as set out in the individual sections of the **Grid Code** and repeated in the **DRC**. If a **User** fails to supply data when required by any section of the **Grid Code**, **The Company** will estimate such data if and when, in **The Company's** view, it is necessary to do so. If **The Company** fails to supply data when required by any section of the **Grid Code**, the **User** to whom that data ought to have been supplied, will estimate such data if and when, in that **User's** view, it is necessary to do so. Such estimates will, in each case, be based upon data supplied previously for the same **Plant** or **Apparatus** or upon corresponding data for similar **Plant** or **Apparatus** or upon such other information as **The Company** or that **User**, as the case may be, deems appropriate.
- DRC.5.4.2 **The Company** will advise a **User** in writing of any estimated data it intends to use pursuant to DRC.5.4.1 relating directly to that **User's Plant** or **Apparatus** in the event of data not being supplied.
- DRC.5.4.3 A **User** will advise **The Company** in writing of any estimated data it intends to use pursuant to DRC.5.4.1 in the event of data not being supplied.
- DRC.5.5 Substituted Data
- DRC.5.5.1 In the case of PC.A.4 only, if the data supplied by a **User** does not in **The Company's** reasonable opinion reflect the equivalent data recorded by **The Company**, **The Company** may estimate such data if and when, in the view of **The Company**, it is necessary to do so. Such estimates will, in each case, be based upon data supplied previously for the same **Plant** or **Apparatus** or upon corresponding data for similar **Plant** or **Apparatus** or upon such other information as **The Company** deems appropriate.
- DRC.5.5.2 **The Company** will advise a **User** in writing of any estimated data it intends to use pursuant to DRC.5.5.1 relating directly to that **User's Plant** or **Apparatus** where it does not in **The Company's** reasonable opinion reflect the equivalent data recorded by **The Company**. Such estimated data will be used by **The Company** in place of the appropriate data submitted by the **User** pursuant to PC.A.4 and as such shall be deemed to accurately represent the **User's** submission until such time as the **User** provides data to **The Company's** reasonable satisfaction.
- DRC.6 DATA TO BE REGISTERED
- DRC.6.1 Schedules 1 to 19 attached cover the following data areas.
- DRC.6.1.1 Schedule 1 – Power Generating Module, Generating Unit (or CCGT Module), Power Park Module (including DC Connected Power Park Module and Power Park Unit), HVDC System and DC Converter Technical Data.
- Comprising **Power Generating Module, Generating Unit** (and **CCGT Module**), **Power Park Module** (including **DC Connected Power Park Module** and **Power Park Unit**) and **DC Converter** fixed electrical parameters.
- DRC.6.1.2 Schedule 2 - Generation Planning Parameters
- Comprising the **Genset** parameters required for **Operational Planning** studies.
- DRC.6.1.3 Schedule 3 - Large Power Station Outage Programmes, Output Usable and Inflexibility Information.
- Comprising generation and storage outage planning, **Output Usable** and inflexibility information at timescales down to the daily **BM Unit Data** submission.

- DRC.6.1.4 Schedule 4 - Large Power Station Droop and Response Data.
Comprising data on governor **Droop** settings and **Primary, Secondary and High Frequency Response** data for **Large Power Stations**.
- DRC.6.1.5 Schedule 5 – User's System Data.
Comprising electrical parameters relating to **Plant** and **Apparatus** connected to the **National Electricity Transmission System**.
- DRC.6.1.6 Schedule 6 – Users Outage Information.
Comprising the information required by **The Company** for outages on the **User System**, including outages at **Power Stations** other than outages of **Gensets**
- DRC.6.1.7 Schedule 7 - Load Characteristics.
Comprising the estimated parameters of load groups in respect of, for example, harmonic content and response to frequency.
- DRC.6.1.8 Schedule 8 - BM Unit Data.
- DRC.6.1.9 Schedule 9 - Data Supplied by The Company to Users.
- DRC.6.1.10 Schedule 10 - Demand Profiles and Active Energy Data
Comprising information relating to the **Network Operators'** and **Non-Embedded Customers'** total **Demand** and **Active Energy** taken from the **National Electricity Transmission System**
- DRC.6.1.11 Schedule 11 - Connection Point Data
Comprising information relating to **Demand**, demand transfer capability and the **Small Power Station, Medium Power Station** and **Customer** generation connected to the **Connection Point**
- DRC.6.1.12 Schedule 12 - Demand Control Data
Comprising information related to **Demand Control**
- DRC.6.1.13 Schedule 13 - Fault Infeed Data
Comprising information relating to the short circuit contribution to the **National Electricity Transmission System** from **Users** other than **Generators, HVDC System Owners** and **DC Converter Station** owners.
- DRC.6.1.14 Schedule 14 - Fault Infeed Data (Generators Including Unit and Station Transformers)
Comprising information relating to the Short Circuit contribution to the **National Electricity Transmission System** from **Generators, HVDC System Owners** and **DC Converter Station** owners.
- DRC.6.1.15 Schedule 15 – Mothballed Power Generating Module, Mothballed Generating Unit, Mothballed Power Park Module (including Mothballed DC Connected Power Park Modules), Mothballed HVDC Systems, Mothballed HVDC Converters, Mothballed DC Converters at a DC Converter Station and Alternative Fuel Data
Comprising information relating to estimated return to service times for **Mothballed Power Generating Modules, Mothballed Generating Units, Mothballed Power Park Modules** (including **Mothballed DC Connected Power Park Modules**), **Mothballed HVDC Systems, Mothballed HVDC Converters** and **Mothballed DC Converters at a DC Converter Station** and the capability of gas-fired **Generating Units** to operate using alternative fuels.
- DRC.6.1.16 Schedule 16 – Black Start Information
Comprising information relating to **Black Start**.
- DRC.6.1.17 Schedule 17 – Access Period Schedule
Comprising **Access Period** information for **Transmission Interface Circuits** within an **Access Group**.

DRC.6.1.18 Schedule 18 – Generators Undertaking OTSDUW Arrangements

Comprising electrical parameters relating to **OTSDUW Plant and Apparatus** between the **Offshore Grid Entry Point** and **Transmission Interface Point**.

DRC.6.1.19 Schedule 19 – User Data File Structure

Comprising information relating to the **User Data File Structure**.

DRC.6.2 The **Schedules** applicable to each class of **User** are as follows:

<u>User</u>	<u>Schedule</u>
Generators with Large Power Stations	1, 2, 3, 4, 9, 14, 15, 16, 19
Generators with Medium Power Stations (see notes 2, 3, 4)	1, 2 (part), 9, 14, 15, 19
Generators with Small Power Stations directly connected to the National Electricity Transmission System	1, 6, 14, 15, 19
Generators undertaking OTSDUW (see note 5)	18, 19
All Users connected directly to the National Electricity Transmission System	5, 6, 9
All Users connected directly to the National Electricity Transmission System other than Generators	10,11,13,17
All Users connected directly to the National Electricity Transmission System with Demand	7, 9
A Pumped Storage Generator , a Generator in respect of one or more Electricity Storage Modules and an Externally Interconnected System Operator and Interconnector Users	12 (as marked)
All Suppliers	12
All Network Operators	12
All BM Participants	8
All DC Converter Station owners	1, 4, 9, 14, 15, 19

Notes:

- (1) **Network Operators** must provide data relating to **Small Power Stations** and/or **Customer Generating Plant Embedded** in their **Systems** when such data is requested by **The Company** pursuant to PC.A.3.1.4 or PC.A.5.1.4.
- (2) The data in schedules 1, 14 and 15 need not be supplied in relation to **Medium Power Stations** connected at a voltage level below the voltage level of the **Subtransmission System** except in connection with a **CUSC Contract** or unless specifically requested by **The Company**.
- (3) Each **Network Operator** within whose **System** an **Embedded Medium Power Station** not subject to a **Bilateral Agreement** or **Embedded DC Converter Station** not subject to a **Bilateral Agreement** is situated shall provide the data to **The Company** in respect of each such **Embedded Medium Power Station** or **Embedded DC Converter Station** or **HVDC System**.
- (4) In the case of Schedule 2, **Generators**, **HVDC System Owners**, **DC Converter Station** owners or **Network Operators** in the case of **Embedded Medium Power Stations** not subject to a **Bilateral Agreement** or **Embedded DC Converter Stations** not subject to a **Bilateral Agreement**, would only be expected to submit data in relation to **Standard Planning Data** as required by the **Planning Code**.

- (5) In the case of **Generators** undertaking **OTSDUW**, the **Generator** will need to supply **User** data in accordance with the requirements of **Large** or **Small Power Stations** (as defined in DRC.6.2) up to the **Offshore Grid Entry Point**. In addition, the **User** will also need to submit **Offshore Transmission System** data in between the **Interface Point** and its **Connection Points** in accordance with the requirements of Schedule 18.

SCHEDULE 1 – POWER GENERATING MODULE, GENERATING UNIT (OR CCGT MODULE), POWER PARK MODULE, DC CONNECTED POWER PARK MODULE, HVDC SYSTEM AND DC CONVERTER TECHNICAL DATA
PAGE 1 OF 19

ABBREVIATIONS:

SPD = Standard Planning Data

% on MVA = % on Rated MVA

% on 100 = % on 100 MVA

DPD = Detailed Planning Data

RC = Registered Capacity

MC = Maximum Capacity

OC1, BC1, etc = Grid Code
for which data is required

CUSC Contract = User data which may be submitted to the **Relevant Transmission Licensees** by **The Company**, following the acceptance by a **User** of a **CUSC Contract**.

CUSC App. Form = User data which may be submitted to the **Relevant Transmission Licensees** by **The Company**, following an application by a **User** for a **CUSC Contract**.

Note:

All parameters, where applicable, are to be measured at nominal **System Frequency**

- + these **SPD** items should only be given in the data supplied with the application for a **CUSC Contract**.
- * Asterisk items are not required for **Small Power Stations** and **Medium Power Stations**
Information is to be given on a **Unit** basis, unless otherwise stated. Where references to **CCGT Modules** are made, the columns "G1" etc should be amended to read "M1" etc, as appropriate
- These data items may be submitted to the **Relevant Transmission Licensees** from **The Company** in respect of the **National Electricity Transmission System**. The data may be submitted to the **Relevant Transmission Licensees** in a summarised form e.g. network model; the data transferred will have been originally derived from data submitted by **Users** to **The Company**.
- these data items may be submitted to the **Relevant Transmission Licensee** from **The Company** in respect to **Relevant Units** only. The data may be submitted to the **Relevant Transmission Licensee** in a summarised form e.g. network model; the data transferred will have been originally derived from data submitted by **Users** to **The Company**.

SCHEDULE 1 – POWER GENERATING MODULE, GENERATING UNIT (OR CCGT MODULE), POWER PARK MODULE, DC CONNECTED POWER PARK MODULE, HVDC SYSTEM AND DC CONVERTER TECHNICAL DATA

POWER STATION NAME: _____

DATE: _____

DATA DESCRIPTION	UNITS	DATA to		DATA CAT.	GENERATING UNIT OR STATION DATA							
		RTL CUSC Cont ract	CUSC App. Form		F.Yr. 0	F.Yr. 1	F.Yr. 2	F.Yr. 3	F.Yr. 4	F.Yr. 5	F.Yr. 6	
<p><u>GENERATING STATION DEMANDS:</u> Demand associated with the Power Station supplied through the National Electricity Transmission System or the Generator's User System (PC.A.5.2)</p> <ul style="list-style-type: none"> - The maximum Demand that could occur. - Demand at specified time of annual peak half hour of National Electricity Transmission System Demand at Annual ACS Conditions. - Demand at specified time of annual minimum half-hour of National Electricity Transmission System Demand. <p>(Additional Demand supplied through the unit transformers to be provided below)</p> <p><u>INDIVIDUAL GENERATING UNIT (OR AS THE CASE MAY BE, SYNCHRONOUS POWER GENERATING MODULE OR CCGT MODULE) DATA</u></p> <p>Point of connection to the National Electricity Transmission System (or the Total System if embedded) of the Generating Unit or Synchronous Power Generating Module (other than a CCGT Unit) or the CCGT Module, as the case may be in terms of geographical and electrical location and system voltage (PC.A.3.4.1)</p> <p>If the busbars at the Connection Point are normally run in separate sections identify the section to which the Generating Unit (other than a CCGT Unit) or Synchronous Power Generating Module or CCGT Module, as the case may be is connected (PC.A.3.1.5)</p>	<p>MW MVA MW MVA</p> <p>MW MVA</p>	<p><input type="checkbox"/></p> <p><input type="checkbox"/></p> <p><input type="checkbox"/></p> <p><input type="checkbox"/></p> <p><input type="checkbox"/></p> <p><input type="checkbox"/></p>	<p><input type="checkbox"/></p> <p><input type="checkbox"/></p> <p><input type="checkbox"/></p> <p><input type="checkbox"/></p> <p><input type="checkbox"/></p> <p><input type="checkbox"/></p>	<p>DPD I DPD I DPD II DPD II</p> <p>DPD II DPD II</p>								
					G1	G2	G3	G4	G5	G6	STN	
	Text	<input type="checkbox"/>	<input checked="" type="checkbox"/>	SPD								
	Section Number	<input type="checkbox"/>	<input checked="" type="checkbox"/>	SPD								

Type of Unit (steam, **Gas Turbine Combined Cycle Gas Turbine Unit**, tidal, wind, storage type etc.)
(PC.A.3.2.2 (h), PC.A.3.4.4)

□

SCHEDULE 1 – POWER GENERATING MODULE, GENERATING UNIT (OR CCGT MODULE), POWER PARK MODULE, DC CONNECTED POWER PARK MODULE, HVDC SYSTEM AND DC CONVERTER TECHNICAL DATA

<u>INDIVIDUAL SYNCHRONOUS POWER GENERATING MODULE GENERATING UNIT (OR AS THE CASE MAY BE, CCGT MODULE) DATA</u>				G1	G2	G3	G4	G5	G6	STN
<p>A list of the Generating Units and CCGT Units within a Synchronous Power Generating Module or CCGT Module, identifying each CCGT Unit, and the Power Generating Module or CCGT Module of which it forms part, unambiguously. In the case of a Range CCGT Module, details of the possible configurations should also be submitted. <i>(P.C.A.3.2.2 (g))</i></p>	□	■	SPD							

SCHEDULE 1 – POWER GENERATING MODULE, GENERATING UNIT (OR CCGT MODULE), POWER PARK MODULE, DC CONNECTED POWER PARK MODULE, HVDC SYSTEM AND DC CONVERTER TECHNICAL DATA

DATA DESCRIPTION	UNITS	DATA to RTL		DATA CAT.	GENERATING UNIT (OR CCGT MODULE, AS THE CASE MAY BE)							
		CUSC Cont ract	CUSC App. Form		G1	G2	G3	G4	G5	G6	STN	
Rated MVA (PC.A.3.3.1)	MVA	<input type="checkbox"/>	<input checked="" type="checkbox"/>	SPD+ SPD+ DPD I								
Rated MW (PC.A.3.3.1)	MW	<input type="checkbox"/>	<input checked="" type="checkbox"/>									
Rated terminal voltage (PC.A.5.3.2.(a) & PC.A.5.4.2 (b))	kV	<input type="checkbox"/>	<input type="checkbox"/>									
*Performance Chart at Onshore Synchronous Generating Unit stator terminals (PC.A.3.2.2(f)(i))				SPD	(see OC2 for specification)							
* Performance Chart of the Offshore Synchronous Generating Unit at the Offshore Grid Entry Point (PC.A.3.2.2(f)(ii))												
* Synchronous Generating Unit Performance Chart (PC.A.3.2.2(f))												
* Power Generating Module Performance Chart of the Synchronous Power Generating Module (PC.A.3.2.2(f))												
* Maximum terminal voltage set point (PC.A.5.3.2.(a) & PC.A.5.4.2 (b))	kV	<input type="checkbox"/>		DPD I								
* Terminal voltage set point step resolution – if not continuous (PC.A.5.3.2.(a) & PC.A.5.4.2 (b))	kV	<input type="checkbox"/>		DPD I								
* Output Usable (on a monthly basis) (PC.A.3.2.2(b))	MW			SPD	(except in relation to CCGT Modules when required on a unit basis under the Grid Code , this data item may be supplied under Schedule 3)							
Turbo-Generator inertia constant (for synchronous machines) (PC.A.5.3.2(a))	MW secs /MVA	<input type="checkbox"/>	<input checked="" type="checkbox"/>	SPD+								
Short circuit ratio (synchronous machines) (PC.A.5.3.2(a))		<input type="checkbox"/>	<input checked="" type="checkbox"/>	SPD+								
Normal auxiliary load supplied by the Generating Unit at rated MW output (PC.A.5.2.1)	MW MVAr	<input type="checkbox"/>		DPD II DPD II								
Rated field current at rated MW and MVAr output and at rated terminal voltage (PC.A.5.3.2 (a))	A	<input type="checkbox"/>		DPD II								
Field current open circuit saturation curve (as derived from appropriate manufacturers' test certificates): (PC.A.5.3.2 (a))												
120% rated terminal volts	A	<input type="checkbox"/>		DPD II								
110% rated terminal volts	A	<input type="checkbox"/>		DPD II								
100% rated terminal volts	A	<input type="checkbox"/>		DPD II								
90% rated terminal volts	A	<input type="checkbox"/>		DPD II								
80% rated terminal volts	A	<input type="checkbox"/>		DPD II								
70% rated terminal volts	A	<input type="checkbox"/>		DPD II								
60% rated terminal volts	A	<input type="checkbox"/>		DPD II								
50% rated terminal volts	A	<input type="checkbox"/>		DPD II								
IMPEDANCES: (Unsaturated)												
Direct axis synchronous reactance (PC.A.5.3.2(a))	% on MVA	<input type="checkbox"/>		DPD I								
Direct axis transient reactance (PC.A.3.3.1(a)& PC.A.5.3.2(a))	% on MVA	<input type="checkbox"/>	<input checked="" type="checkbox"/>	SPD+								
Direct axis sub-transient reactance (PC.A.5.3.2(a))	% on MVA	<input type="checkbox"/>		DPD I								
Quad axis synch reactance (PC.A.5.3.2(a))	% on MVA	<input type="checkbox"/>		DPD I								
Quad axis sub-transient reactance (PC.A.5.3.2(a))	% on MVA	<input type="checkbox"/>		DPD I								
Stator leakage reactance (PC.A.5.3.2(a))	% on MVA	<input type="checkbox"/>		DPD I								
Armature winding direct current resistance. (PC.A.5.3.2(a))	% on MVA	<input type="checkbox"/>		DPD I								

In Scotland, negative sequence resistance (PC.A.2.5.6 (a) (iv))	% on MVA	□	DPD I														
Note:- the above data item relating to armature winding direct-current resistance need only be provided by Generators in relation to Generating Units or Synchronous Generating Units within Power Generating Modules commissioned after 1st March 1996 and in cases where, for whatever reason, the Generator is aware of the value of the data item.																	

SCHEDULE 1 – POWER GENERATING MODULE, GENERATING UNIT (OR CCGT MODULE), POWER PARK MODULE DC CONNECTED POWER PARK MODULE, HVDC SYSTEM AND DC CONVERTER TECHNICAL DATA

DATA DESCRIPTION	UNITS	DATA to RTL		DATA CAT.	GENERATING UNIT OR STATION DATA						
		CUSC Contract	CUSC App. Form		G1	G2	G3	G4	G5	G6	STN
TIME CONSTANTS (Short-circuit and Unsaturated)											
Direct axis transient time constant (PC.A.5.3.2(a))	S	<input type="checkbox"/>		DPD I							
Direct axis sub-transient time constant (PC.A.5.3.2(a))	S	<input type="checkbox"/>		DPD I							
Quadrature axis sub-transient time constant (PC.A.5.3.2(a))	S	<input type="checkbox"/>		DPD I							
Stator time constant (PC.A.5.3.2(a))	S	<input type="checkbox"/>		DPD I							
MECHANICAL PARAMETERS (PC.A.5.3.2(a))											
The number of turbine generator masses		<input type="checkbox"/>		DPD II							
Diagram showing the Inertia and parameters for each turbine generator mass for the complete drive train	Kgm ²	<input type="checkbox"/>		DPD II							
Diagram showing Stiffness constants and parameters between each turbine generator mass for the complete drive train	Nm/rad	<input type="checkbox"/>		DPD II							
Number of poles		<input type="checkbox"/>		DPD II							
Relative power applied to different parts of the turbine	%	<input type="checkbox"/>		DPD II							
Torsional mode frequencies	Hz	<input type="checkbox"/>		DPD II							
Modal damping decrement factors for the different mechanical modes		<input type="checkbox"/>		DPD II							
GENERATING UNIT STEP-UP TRANSFORMER											
Rated MVA (PC.A.3.3.1 & PC.A.5.3.2)	MVA	<input type="checkbox"/>	■	SPD+							
Voltage Ratio (PC.A.5.3.2)	-	<input type="checkbox"/>		DPD I							
Positive sequence reactance: (PC.A.5.3.2)											
Max tap	% on MVA	<input type="checkbox"/>	■	SPD+							
Min tap	% on MVA	<input type="checkbox"/>	■	SPD+							
Nominal tap	% on MVA	<input type="checkbox"/>	■	SPD+							
Positive sequence resistance: (PC.A.5.3.2)											
Max tap	% on MVA	<input type="checkbox"/>		DPD II							
Min tap	% on MVA	<input type="checkbox"/>		DPD II							
Nominal tap	% on MVA	<input type="checkbox"/>		DPD II							
Zero phase sequence reactance (PC.A.5.3.2)	% on MVA	<input type="checkbox"/>		DPD II							
Tap change range (PC.A.5.3.2)	+% / -%	<input type="checkbox"/>		DPD II							
Tap change step size (PC.A.5.3.2)	%	<input type="checkbox"/>		DPD II							
Tap changer type: on-load or off-circuit (PC.A.5.3.2)	On/Off	<input type="checkbox"/>		DPD II							

SCHEDULE 1 – POWER GENERATING MODULE, GENERATING UNIT (OR CCGT MODULE), POWER PARK MODULE, DC CONNECTED POWER PARK MODULE, HVDC SYSTEM AND DC CONVERTER TECHNICAL DATA

DATA DESCRIPTION	UNITS	DATA to		DATA CAT.	GENERATING UNIT OR STATION DATA						
		CUSC Contract	CUSC App. Form		G1	G2	G3	G4	G5	G6	STN
<u>EXCITATION:</u>											
<p><u>Note:</u> The data items requested under Option 1 below may continue to be provided by Generators in relation to Generating Units on the System at 9 January 1995 (in this paragraph, the "relevant date") or they may provide the new data items set out under Option 2. Generators must supply the data as set out under Option 2 (and not those under Option 1) for Generating Unit and Synchronous Power Generating Unit excitation control systems commissioned after the relevant date, those Generating Unit or Synchronous Power Generating Unit excitation control systems recommissioned for any reason such as refurbishment after the relevant date and Generating Unit or Synchronous Power Generating Unit excitation control systems where, as a result of testing or other process, the Generator is aware of the data items listed under Option 2 in relation to that Generating Unit or Synchronous Power Generating Unit.</p>											
Option 1											
DC gain of Excitation Loop (PC.A.5.3.2(c))		<input type="checkbox"/>		DPD II							
Max field voltage (PC.A.5.3.2(c))	V	<input type="checkbox"/>		DPD II							
Min field voltage (PC.A.5.3.2(c))	V	<input type="checkbox"/>		DPD II							
Rated field voltage (PC.A.5.3.2(c))	V	<input type="checkbox"/>		DPD II							
Max rate of change of field volts: (PC.A.5.3.2(c))											
Rising	V/Sec	<input type="checkbox"/>		DPD II							
Falling	V/Sec	<input type="checkbox"/>		DPD II							
Details of Excitation Loop (PC.A.5.3.2(c)) Described in block diagram form showing transfer functions of individual elements	Diagram	<input type="checkbox"/>		DPD II	(please attach)						
Dynamic characteristics of over- excitation limiter (PC.A.5.3.2(c))		<input type="checkbox"/>		DPD II							
Dynamic characteristics of under-excitation limiter (PC.A.5.3.2(c))		<input type="checkbox"/>		DPD II							
Option 2											
Exciter category, e.g. Rotating Exciter , or Static Exciter etc (PC.A.5.3.2(c))	Text	<input type="checkbox"/>	<input checked="" type="checkbox"/>	SPD							
Excitation System Nominal Response (PC.A.5.3.2(c))	Sec ⁻¹	<input type="checkbox"/>		DPD II							
Rated Field Voltage (PC.A.5.3.2(c)) U_{fN}	V	<input type="checkbox"/>		DPD II							
No-load Field Voltage (PC.A.5.3.2(c)) U_{f0}	V	<input type="checkbox"/>		DPD II							
Excitation System On-Load Positive Ceiling Voltage (PC.A.5.3.2(c)) U_{pL+}	V	<input type="checkbox"/>		DPD II							
Excitation System No-Load Positive Ceiling Voltage (PC.A.5.3.2(c)) U_{p0+}	V	<input type="checkbox"/>		DPD II							
Excitation System No-Load Negative Ceiling Voltage (PC.A.5.3.2(c)) U_{p0-}	V	<input type="checkbox"/>		DPD II							
Power System Stabiliser (PSS) <u>fitted</u> (PC.A.3.4.2)	Yes/No	<input type="checkbox"/>	<input checked="" type="checkbox"/>	SPD							
Stator Current Limit (PC.A.5.3.2(c))	A	<input type="checkbox"/>		DPD II							
Details of Excitation System (PC.A.5.3.2(c)) (including PSS if fitted) described in block diagram form showing transfer functions of individual elements.	Diagram	<input type="checkbox"/>		DPD II							
Details of Over-excitation Limiter (PC.A.5.3.2(c)) described in block diagram form showing transfer functions of individual elements.	Diagram	<input type="checkbox"/>		DPD II							
Details of Under-excitation Limiter (PC.A.5.3.2(c)) described in block diagram form showing	Diagram	<input type="checkbox"/>		DPD II							

transfer functions of individual elements.

SCHEDULE 1 – POWER GENERATING MODULE, GENERATING UNIT (OR CCGT MODULE), POWER PARK MODULE, DC CONNECTED POWER PARK MODULE, HVDC SYSTEM AND DC CONVERTER TECHNICAL DATA

DATA DESCRIPTION	UNITS	DATA to		DATA CAT.	GENERATING UNIT OR STATION DATA								
		RTL	RTL		G1	G2	G3	G4	G5	G6	STN		
		CUSC Contract	CUSC App. Form										
<u>GOVERNOR AND ASSOCIATED PRIME MOVER PARAMETERS</u>													
<p><u>Note:</u> The data items requested under Option 1 below may continue to be provided by Generators in relation to Generating Units on the System at 9 January 1995 (in this paragraph, the "relevant date") or they may provide the new data items set out under Option 2. Generators must supply the data as set out under Option 2 (and not those under Option 1) for Generating Unit and Synchronous Power Generating Unit governor control systems commissioned after the relevant date, those Generating Unit and Synchronous Power Generating Unit governor control systems recommissioned for any reason such as refurbishment after the relevant date and Generating Unit and Synchronous Power Generating Unit governor control systems where, as a result of testing or other process, the Generator is aware of the data items listed under Option 2 in relation to that Generating Unit and Synchronous Power Generating Unit.</p>													
Option 1													
<u>GOVERNOR PARAMETERS (REHEAT UNITS) (PC.A.5.3.2(d) – Option 1(i))</u>													
HP Governor average gain	MW/Hz	<input type="checkbox"/>		DPD II									
Speeder motor setting range	Hz	<input type="checkbox"/>		DPD II									
HP governor valve time constant	S	<input type="checkbox"/>		DPD II									
HP governor valve opening limits		<input type="checkbox"/>		DPD II									
HP governor valve rate limits		<input type="checkbox"/>		DPD II									
Re-heat time constant (stored Active Energy in reheater)	S	<input type="checkbox"/>		DPD II									
IP governor average gain	MW/Hz	<input type="checkbox"/>		DPD II									
IP governor setting range	Hz	<input type="checkbox"/>		DPD II									
IP governor time constant	S	<input type="checkbox"/>		DPD II									
IP governor valve opening limits		<input type="checkbox"/>		DPD II									
IP governor valve rate limits		<input type="checkbox"/>		DPD II									
Details of acceleration sensitive elements HP & IP in governor loop		<input type="checkbox"/>		DPD II	(please attach)								
Governor block diagram showing transfer functions of individual elements		<input type="checkbox"/>		DPD II	(please attach)								
<u>GOVERNOR (Non-reheat steam and Gas Turbines) (PC.A.5.3.2(d) – Option 1(ii))</u>													
Governor average gain	MW/Hz	<input type="checkbox"/>		DPD II									
Speeder motor setting range		<input type="checkbox"/>		DPD II									
Time constant of steam or fuel governor valve	S	<input type="checkbox"/>		DPD II									
Governor valve opening limits		<input type="checkbox"/>		DPD II									
Governor valve rate limits		<input type="checkbox"/>		DPD II									
Time constant of turbine	S	<input type="checkbox"/>		DPD II									
Governor block diagram		<input type="checkbox"/>		DPD II	(please attach)								

SCHEDULE 1 – POWER GENERATING MODULE, GENERATING UNIT (OR CCGT MODULE), POWER PARK MODULE DC CONNECTED POWER PARK MODULE, HVDC SYSTEM AND DC CONVERTER TECHNICAL DATA

DATA DESCRIPTION	UNITS	DATA to RTL		DATA CAT.	GENERATING UNIT OR STATION DATA						
		CUSC Contract	CUSC App. Form		G1	G2	G3	G4	G5	G6	STN
<i>(PC.A.5.3.2(d) – Option 1(iii))</i>											
<u>BOILER & STEAM TURBINE DATA*</u>											
Boiler time constant (Stored Active Energy)	S			DPD II							
HP turbine response ratio: (Proportion of Primary Response arising from HP turbine)	%			DPD II							
HP turbine response ratio: (Proportion of High Frequency Response arising from HP turbine)	%			DPD II							
End of Option 1											
Option 2											
<u>All Generating Units and Synchronous Power Generating Units</u>											
Governor Block Diagram showing transfer function of individual elements including acceleration sensitive elements		<input type="checkbox"/>		DPD II							
Governor Time Constant <i>(PC.A.5.3.2(d) – Option 2(i))</i>	Sec	<input type="checkbox"/>		DPD II							
#Governor Deadband <i>(PC.A.5.3.2(d) – Option 2(i))</i>											
- Maximum Setting	±Hz			DPD II							
- Normal Setting	±Hz			DPD II							
- Minimum Setting	±Hz			DPD II							
Speeder Motor Setting Range <i>(PC.A.5.3.2(d) – Option 2(i))</i>	%	<input type="checkbox"/>		DPD II							
Average Gain <i>(PC.A.5.3.2(d) – Option 2(i))</i>	MW/Hz	<input type="checkbox"/>		DPD II							
<u>Steam Units</u>											
<i>(PC.A.5.3.2(d) – Option 2(ii))</i>											
HP Valve Time Constant	sec	<input type="checkbox"/>		DPD II							
HP Valve Opening Limits	%	<input type="checkbox"/>		DPD II							
HP Valve Opening Rate Limits	%/sec	<input type="checkbox"/>		DPD II							
HP Valve Closing Rate Limits	%/sec	<input type="checkbox"/>		DPD II							
HP Turbine Time Constant <i>(PC.A.5.3.2(d) – Option 2(ii))</i>	sec	<input type="checkbox"/>		DPD II							
IP Valve Time Constant	sec	<input type="checkbox"/>		DPD II							
IP Valve Opening Limits	%	<input type="checkbox"/>		DPD II							
IP Valve Opening Rate Limits	%/sec	<input type="checkbox"/>		DPD II							
IP Valve Closing Rate Limits	%/sec	<input type="checkbox"/>		DPD II							
IP Turbine Time Constant <i>(PC.A.5.3.2(d) – Option 2(ii))</i>	sec	<input type="checkbox"/>		DPD II							
LP Valve Time Constant	sec	<input type="checkbox"/>		DPD II							
LP Valve Opening Limits	%	<input type="checkbox"/>		DPD II							
LP Valve Opening Rate Limits	%/sec	<input type="checkbox"/>		DPD II							
LP Valve Closing Rate Limits	%/sec	<input type="checkbox"/>		DPD II							
LP Turbine Time Constant <i>(PC.A.5.3.2(d) – Option 2(ii))</i>	sec	<input type="checkbox"/>		DPD II							
Reheater Time Constant	sec			DPD II							
Boiler Time Constant	sec			DPD II							
HP Power Fraction	%			DPD II							
IP Power Fraction	%			DPD II							

Where the generating unit or synchronous power generating unit governor does not have a selectable deadband facility, then the actual value of the deadband need only be provided.

SCHEDULE 1 – POWER GENERATING MODULE, GENERATING UNIT (OR CCGT MODULE), POWER PARK MODULE, DC CONNECTED POWER PARK MODULE, HVDC SYSTEM AND DC CONVERTER TECHNICAL DATA

DATA DESCRIPTION	UNITS	DATA to		DATA CAT.	GENERATING UNIT OR STATION DATA						
		CUSC Contract	CUSC App. Form		G1	G2	G3	G4	G5	G6	STN
Gas Turbine Units											
<i>(PC.A.5.3.2(d) – Option 2(iii))</i>											
Inlet Guide Vane Time Constant	sec		<input type="checkbox"/>	DPD II							
Inlet Guide Vane Opening Limits	%		<input type="checkbox"/>	DPD II							
Inlet Guide Vane Opening Rate Limits	%/sec		<input type="checkbox"/>	DPD II							
Inlet Guide Vane Closing Rate Limits	%/sec		<input type="checkbox"/>	DPD II							
<i>(PC.A.5.3.2(d) – Option 2(iii))</i>											
Fuel Valve Time Constant	sec		<input type="checkbox"/>	DPD II							
Fuel Valve Opening Limits	%		<input type="checkbox"/>	DPD II							
Fuel Valve Opening Rate Limits	%/sec		<input type="checkbox"/>	DPD II							
Fuel Valve Closing Rate Limits	%/sec		<input type="checkbox"/>	DPD II							
<i>(PC.A.5.3.2(d) – Option 2(iii))</i>											
Waste Heat Recovery Boiler Time Constant											
Hydro Generating Units											
<i>(PC.A.5.3.2(d) – Option 2(iv))</i>											
Guide Vane Actuator Time Constant	sec		<input type="checkbox"/>	DPD II							
Guide Vane Opening Limits	%		<input type="checkbox"/>	DPD II							
Guide Vane Opening Rate Limits	%/sec		<input type="checkbox"/>	DPD II							
Guide Vane Closing Rate Limits	%/sec		<input type="checkbox"/>	DPD II							
Water Time Constant	sec		<input type="checkbox"/>	DPD II							
Synchronous Electricity Storage Units and Modules											
<i>(PC.A.5.3.2(d) – Option 2(v))</i>											
Valve Actuator Time Constant	sec		<input type="checkbox"/>	DPD II							
Valve Opening Limits	%		<input type="checkbox"/>	DPD II							
Valve Opening Rate Limits	%/sec		<input type="checkbox"/>	DPD II							
Valve Closing Rate Limits	%/sec		<input type="checkbox"/>	DPD II							
For Synchronous Electricity Storage Modules which are derived from compressed air energy storage systems the above data should be provided. For other Synchronous Electricity Storage Modules data should be supplied as required by The Company in accordance with PC.A.7.											
End of Option 2											
UNIT CONTROL OPTIONS*											
<i>(PC.A.5.3.2(e))</i>											
Maximum droop	%		<input type="checkbox"/>	DPD II							
Normal droop	%		<input type="checkbox"/>	DPD II							
Minimum droop	%		<input type="checkbox"/>	DPD II							
Maximum Governor Deadband				DPD II							
Normal Governor Deadband				DPD II							
Minimum Governor Deadband				DPD II							
Maximum Frequency Response Deadband ¹	±Hz			DPD II							
Normal Frequency Response Deadband ¹	±Hz			DPD II							
Minimum Frequency Response Deadband ¹	±Hz			DPD II							
Maximum Frequency Response Insensitivity ¹	±Hz			DPDII							
Normal Frequency Response Insensitivity ¹	±Hz			DPDII							
Minimum Frequency Response Insensitivity ¹	±Hz			DPDII							

	±Hz									
	±Hz									
	±Hz									
Frequency settings between which Unit Load Controller droop applies:										
Maximum	Hz			DPD II						
Normal	Hz			DPD II						
Minimum	Hz			DPD II						
Sustained response normally selected	Yes/No			DPD II						
¹ Data required only in respect of Large Power Stations comprising Type C and Type D Power Generating Modules owned and operated by EU Code Generators .										

SCHEDULE 1 – POWER GENERATING MODULE, GENERATING UNIT (OR CCGT MODULE), POWER PARK MODULE, DC CONNECTED POWER PARK MODULE, HVDC SYSTEM AND DC CONVERTER TECHNICAL DATA

DATA DESCRIPTION	UNITS	DATA to RTL		DATA CAT.	POWER PARK UNIT (OR POWER PARK MODULE, AS THE CASE MAY BE)							
		CUSC Contract	CUSC App. Form		G1	G2	G3	G4	G5	G6	STN	
Power Park Module Rated MVA <i>(PC.A.3.3.1(a))</i>	MVA	<input type="checkbox"/>	<input checked="" type="checkbox"/>	SPD+								
Power Park Module Rated MW <i>(PC.A.3.3.1(a))</i>	MW	<input type="checkbox"/>	<input checked="" type="checkbox"/>	SPD+								
*Performance Chart of a Power Park Module at the connection point <i>(PC.A.3.2.2(f)(ii))</i>				SPD	(see OC2 for specification)							
* Output Usable (on a monthly basis) <i>(PC.A.3.2.2(b))</i>	MW			SPD	(except in relation to CCGT Modules when required on a unit basis under the Grid Code , this data item may be supplied under Schedule 3)							
Number & Type of Power Park Units within each Power Park Module <i>(PC.A.3.2.2(k))</i>		<input type="checkbox"/>		SPD								
Number & Type of Offshore Power Park Units within each Offshore Power Park String and the number of Offshore Power Park Strings and connection point within each Offshore Power Park Module <i>(PC.A.3.2.2.(k))</i>				SPD								
In the case where an appropriate Manufacturer's Data & Performance Report is registered with The Company then subject to The Company's agreement, the report reference may be given as an alternative to completion of the following sections of this Schedule 1 to the end of page 11 with the exception of the sections marked thus # below.	Reference the Manufacturer's Data & Performance Report			SPD								
Power Park Unit Model (including Non Synchronous Electricity Storage Units) - A validated mathematical model in accordance with PC.5.4.2 (a)	Transfer function block diagram and algebraic equations, simulation and measured test results	<input type="checkbox"/>		DPD II								

SCHEDULE 1 – POWER GENERATING MODULE, GENERATING UNIT (OR CCGT MODULE), POWER PARK MODULE DC CONNECTED POWER PARK MODULE, HVDC SYSTEM AND DC CONVERTER TECHNICAL DATA

DATA DESCRIPTION	UNITS	DATA to RTL		DATA CAT.	POWER PARK UNIT (OR POWER PARK MODULE, AS THE CASE MAY BE)							
		CUSC Contract	CUSC App. Form		G1	G2	G3	G4	G5	G6	STN	
Power Park Unit Data (where applicable)												
Rated MVA (PC.A.3.3.1(e))	MVA	<input type="checkbox"/>	<input checked="" type="checkbox"/>	SPD+								
Rated MW (PC.A.3.3.1(e))	MW	<input type="checkbox"/>	<input checked="" type="checkbox"/>	SPD+								
Rated terminal voltage (PC.A.3.3.1(e))	V	<input type="checkbox"/>	<input checked="" type="checkbox"/>	SPD+								
Site minimum air density (PC.A.5.4.2(b))	kg/m ³	<input type="checkbox"/>	<input checked="" type="checkbox"/>	DPD II								
Site maximum air density	kg/m ³	<input type="checkbox"/>	<input checked="" type="checkbox"/>	DPD II								
Site average air density	kg/m ³	<input type="checkbox"/>	<input checked="" type="checkbox"/>	DPD II								
Year for which air density data is submitted		<input type="checkbox"/>	<input checked="" type="checkbox"/>	DPD II								
Number of pole pairs		<input type="checkbox"/>	<input checked="" type="checkbox"/>	DPD II								
Blade swept area	m ²	<input type="checkbox"/>	<input checked="" type="checkbox"/>	DPD II								
Gear Box Ratio		<input type="checkbox"/>	<input checked="" type="checkbox"/>	DPD II								
Stator Resistance (PC.A.5.4.2(b))	% on MVA	<input type="checkbox"/>	<input checked="" type="checkbox"/>	SPD+								
Stator Reactance (PC.A.3.3.1(e))	% on MVA	<input type="checkbox"/>	<input checked="" type="checkbox"/>	SPD+								
Magnetising Reactance (PC.A.3.3.1(e))	% on MVA	<input type="checkbox"/>	<input checked="" type="checkbox"/>	SPD+								
Rotor Resistance (at starting). (PC.A.5.4.2(b))	% on MVA	<input type="checkbox"/>	<input checked="" type="checkbox"/>	DPD II								
Rotor Resistance (at rated running) (PC.A.3.3.1(e))	% on MVA	<input type="checkbox"/>	<input checked="" type="checkbox"/>	SPD+								
Rotor Reactance (at starting). (PC.A.5.4.2(b))	% on MVA	<input type="checkbox"/>	<input checked="" type="checkbox"/>	DPD II								
Rotor Reactance (at rated running) (PC.A.3.3.1(e))	% on MVA	<input type="checkbox"/>	<input checked="" type="checkbox"/>	SPD								
Equivalent inertia constant of the first mass (e.g. wind turbine rotor and blades) at minimum speed (PC.A.5.4.2(b))	MW secs /MVA	<input type="checkbox"/>	<input checked="" type="checkbox"/>	SPD+								
Equivalent inertia constant of the first mass (e.g. wind turbine rotor and blades) at synchronous speed (PC.A.5.4.2(b))	MW secs /MVA	<input type="checkbox"/>	<input checked="" type="checkbox"/>	SPD+								
Equivalent inertia constant of the first mass (e.g. wind turbine rotor and blades) at rated speed (PC.A.5.4.2(b))	MW secs /MVA	<input type="checkbox"/>	<input checked="" type="checkbox"/>	SPD+								
Equivalent inertia constant of the second mass (e.g. generator rotor) at minimum speed (PC.A.5.4.2(b))	MW secs /MVA	<input type="checkbox"/>	<input checked="" type="checkbox"/>	SPD+								
Equivalent inertia constant of the second mass (e.g. generator rotor) at synchronous speed (PC.A.5.4.2(b))	MW secs /MVA	<input type="checkbox"/>	<input checked="" type="checkbox"/>	SPD+								
Equivalent inertia constant of the second mass (e.g. generator rotor) at rated speed (PC.A.5.4.2(b))	MW secs /MVA	<input type="checkbox"/>	<input checked="" type="checkbox"/>	SPD+								
Equivalent shaft stiffness between the two masses (PC.A.5.4.2(b))	Nm / electrical radian	<input type="checkbox"/>	<input checked="" type="checkbox"/>	SPD+								

SCHEDULE 1 – POWER GENERATING MODULE, GENERATING UNIT (OR CCGT MODULE), POWER PARK MODULE, DC CONNECTED POWER PARK MODULE, HVDC SYSTEM AND DC CONVERTER TECHNICAL DATA

DATA DESCRIPTION	UNITS	DATA to RTL		DATA CAT.	POWER PARK UNIT (OR POWER PARK MODULE, AS THE CASE MAY BE)						
		CUSC Contract	CUSC App. Form		G1	G2	G3	G4	G5	G6	STN
Minimum generator rotor speed (Doubly Fed Induction Generators) (PC.A.3.3.1(e))	RPM	<input type="checkbox"/>	<input checked="" type="checkbox"/>	SPD+							
Maximum generator rotor speed (Doubly Fed Induction Generators) (PC.A.3.3.1(e))	RPM	<input type="checkbox"/>	<input checked="" type="checkbox"/>	SPD+							
The optimum generator rotor speed versus wind speed (PC.A.5.4.2(b))	tabular format	<input type="checkbox"/>		DPD II							
Power Converter Rating (Doubly Fed Induction Generators) (PC.A.5.4.2(b))	MVA	<input type="checkbox"/>	<input checked="" type="checkbox"/>	DPD II							
The rotor power coefficient (C_p) versus tip speed ratio (λ) curves for a range of blade angles (where applicable) (PC.A.5.4.2(b))	Diagram + tabular format	<input type="checkbox"/>		DPD II							
# The electrical power output versus generator rotor speed for a range of wind speeds over the entire operating range of the Power Park Unit . (PC.A.5.4.2(b))	Diagram + tabular format	<input type="checkbox"/>		DPD II							
The blade angle versus wind speed curve (PC.A.5.4.2(b))	Diagram + tabular format	<input type="checkbox"/>		DPD II							
The electrical power output versus wind speed over the entire operating range of the Power Park Unit . (PC.A.5.4.2(b))	Diagram + tabular format	<input type="checkbox"/>		DPD II							
Transfer function block diagram, parameters and description of the operation of the power electronic converter including fault ride through capability (where applicable). (PC.A.5.4.2(b))	Diagram	<input type="checkbox"/>		DPD II							
For a Power Park Unit consisting of a synchronous machine in combination with a back to back DC Converter or HVDC Converter , or for a Power Park Unit not driven by a wind turbine, the data to be supplied shall be agreed with The Company in accordance with PC.A.7. (PC.A.5.4.2(b))		<input type="checkbox"/>									

SCHEDULE 1 – POWER GENERATING MODULE, GENERATING UNIT (OR CCGT MODULE), POWER PARK MODULE, DC CONNECTED POWER PARK MODULE, HVDC SYSTEM AND DC CONVERTER TECHNICAL DATA

DATA DESCRIPTION	UNITS	DATA to RTL		DATA CAT.	POWER PARK UNIT (OR POWER PARK MODULE, AS THE CASE MAY BE)							
		CUSC Contract	CUSC App. Form		G1	G2	G3	G4	G5	G6	STN	
<p>Torque / Speed and blade angle control systems and parameters (PC.A.5.4.2(c))</p> <p>For the Power Park Unit, details of the torque / speed controller and blade angle controller in the case of a wind turbine and power limitation functions (where applicable) described in block diagram form showing transfer functions and parameters of individual elements</p>	Diagram	<input type="checkbox"/>		DPD II								
<p># Voltage/Reactive Power/Power Factor control system parameters (PC.A.5.4.2(d))</p> <p># For the Power Park Unit and Power Park Module details of Voltage/Reactive Power/Power Factor controller (and PSS if fitted) described in block diagram form including parameters showing transfer functions of individual elements.</p>	Diagram	<input type="checkbox"/>		DPD II								
<p># Frequency control system parameters (PC.A.5.4.2(e))</p> <p># For the Power Park Unit and Power Park Module details of the Frequency controller described in block diagram form showing transfer functions and parameters of individual elements.</p>	Diagram	<input type="checkbox"/>		DPD II								
<p>As an alternative to PC.A.5.4.2 (a), (b), (c), (d), (e) and (f), is the submission of a single complete model that consists of the full information required under PC.A.5.4.2 (a), (b), (c), (d) (e) and (f) provided that all the information required under PC.A.5.4.2 (a), (b), (c), (d), (e) and (f) individually is clearly identifiable. (PC.A.5.4.2(g))</p>	Diagram	<input type="checkbox"/>		DPD II								
<p># Harmonic Assessment Information (PC.A.5.4.2(h)) (as defined in IEC 61400-21 (2001)) for each Power Park Unit:-</p>												
# Flicker coefficient for continuous operation		<input type="checkbox"/>		DPD I								
# Flicker step factor		<input type="checkbox"/>		DPD I								
# Number of switching operations in a 10 minute window		<input type="checkbox"/>		DPD I								
# Number of switching operations in a 2 hour window		<input type="checkbox"/>		DPD I								
# Voltage change factor		<input type="checkbox"/>		DPD I								
# Current Injection at each harmonic for each Power Park Unit and for each Power Park Module	Tabular format	<input type="checkbox"/>		DPD I								
<p>Note:- Generators who own or operate DC Connected Power Park Modules shall supply all data for their DC Connected Power Park Modules as applicable to Power Park Modules.</p>												

SCHEDULE 1 – POWER GENERATING MODULE, GENERATING UNIT (OR CCGT MODULE), POWER PARK MODULE, DC CONNECTED POWER PARK MODULE, HVDC SYSTEM AND DC CONVERTER TECHNICAL DATA

HVDC SYSTEM AND DC CONVERTER STATION TECHNICAL DATA

HVDC SYSTEM OR DC CONVERTER STATION NAME _____

DATE: _____

Data Description	Units	DATA to		Data Category	DC Converter Station Data
		RTL			
(PC.A.4)		CUSC Contract	CUSC App. Form		
HVDC SYSTEM AND DC CONVERTER STATION DEMANDS:					
Demand supplied through Station Transformers associated with the DC Converter Station and HVDC System [PC.A.4.1]	MW MVA _r	<input type="checkbox"/>		DPD II DPD II	
- Demand with all DC Converters and HVDC Converters within and HVDC System operating at Rated MW import.	MW MVA _r	<input type="checkbox"/>		DPD II DPD II	
- Demand with all DC Converters and HVDC Converters within an HVDC System operating at Rated MW export.					
Additional Demand associated with the DC Converter Station or HVDC System supplied through the National Electricity Transmission System . [PC.A.4.1]	MW MVA _r	<input type="checkbox"/>		DPD II DPD II	
- The maximum Demand that could occur.	MW MVA _r	<input type="checkbox"/>		DPD II DPD II	
- Demand at specified time of annual peak half hour of The Company Demand at Annual ACS Conditions .	MW MVA _r	<input type="checkbox"/>		DPD II DPD II	
- Demand at specified time of annual minimum half-hour of The Company Demand .	Text	<input type="checkbox"/>	■	SPD+	
DC CONVERTER STATION AND HVDC SYSTEM DATA	Text	<input type="checkbox"/>	■	SPD+	
Number of poles, i.e. number of DC Converters or HVDC Converters within the HVDC System		<input type="checkbox"/>	■	SPD+	
Pole arrangement (e.g. monopole or bipole)		<input type="checkbox"/>	■		
Details of each viable operating configuration	Diagram	<input type="checkbox"/>	■	SPD	
Configuration 1	Diagram	<input type="checkbox"/>			
Configuration 2	Diagram	<input type="checkbox"/>			
Configuration 3	Diagram	<input type="checkbox"/>			

Configuration 4	Diagram	<input type="checkbox"/>			
Configuration 5		<input type="checkbox"/>			
Configuration 6	Diagram	<input type="checkbox"/>			
Remote ac connection arrangement		<input type="checkbox"/>			

**SCHEDULE 1 – POWER PARK MODULE, GENERATING UNIT (OR CCGT MODULE),
POWER PARK MODULE, DC CONNECTED POWER PARK MODULE, HVDC SYSTEM
AND DC CONVERTER TECHNICAL DATA**

Data Description	Units	DATA to RTL		Data Category	Operating Configuration					
		CUSC Contract	CUSC App. Form		1	2	3	4	5	6
DC CONVERTER STATION AND HVDC SYSTEM DATA (PC.A.3.3.1d)										
DC Converter or HVDC Converter Type (e.g. current or Voltage source)	Text	<input type="checkbox"/>	<input checked="" type="checkbox"/>	SPD						
Point of connection to the National Electricity Transmission System (or the Total System if Embedded) of the DC Converter Station or HVDC System configuration in terms of geographical and electrical location and system voltage	Text	<input type="checkbox"/>	<input checked="" type="checkbox"/>	SPD						
If the busbars at the Connection Point are normally run in separate sections identify the section to which the DC Converter Station or HVDC System configuration is connected	Section Number	<input type="checkbox"/>	<input checked="" type="checkbox"/>	SPD						
	MW			SPD +						
Rated MW import per pole [PC.A.3.3.1]	MW	<input type="checkbox"/>	<input checked="" type="checkbox"/>	SPD +						
Rated MW export per pole [PC.A.3.3.1]		<input type="checkbox"/>	<input checked="" type="checkbox"/>							

Data Description	Units	DATA to RTL		Data Category	Operating Configuration						
		CUSC Contract	CUSC App. Form		1	2	3	4	5	6	
ACTIVE POWER TRANSFER CAPABILITY (PC.A.3.2.2)											
Registered Capacity	MW	<input type="checkbox"/>	<input checked="" type="checkbox"/>	SPD							
Registered Import Capacity	MW	<input type="checkbox"/>	<input checked="" type="checkbox"/>								
Minimum Generation	MW	<input type="checkbox"/>	<input checked="" type="checkbox"/>	SPD							
Minimum Import Capacity	MW	<input type="checkbox"/>	<input checked="" type="checkbox"/>								
Maximum HVDC Active Power	MW										
Transmission Capacity	MW	<input type="checkbox"/>		SPD							
Minimum Active Power Transmission Capacity	MW	<input type="checkbox"/>		SPD							
Import MW available in excess of Registered Import Capacity and Maximum Active Power Transmission Capacity	MW	<input type="checkbox"/>		SPD							
Time duration for which MW in excess of Registered Import Capacity is available	Min	<input type="checkbox"/>		SPD							
Export MW available in excess of Registered Capacity and Maximum Active Power Transmission Capacity .	MW	<input type="checkbox"/>		SPD							
Time duration for which MW in excess of Registered Capacity is available	Min	<input type="checkbox"/>		SPD							

SCHEDULE 1 –POWER GENERATING MODULE, GENERATING UNIT (OR CCGT MODULE), POWER PARK MODULE, DC CONNECTED POWER PARK MODULE, HVDC SYSTEM AND DC CONVERTER TECHNICAL DATA

Data Description	Units	DATA to		Data Category	Operating Configuration						
		RTL			1	2	3	4	5	6	
		CUSC Contract	CUSC App. Form								
DC CONVERTER AND HVDC CONVERTER TRANSFORMER [PC.A.5.4.3.1]											
Rated MVA	MVA	<input type="checkbox"/>		DPD II							
Winding arrangement		<input type="checkbox"/>		DPD II							
Nominal primary voltage	kV	<input type="checkbox"/>		DPD II							
Nominal secondary (converter-side) voltage(s)	kV	<input type="checkbox"/>		DPD II							
Positive sequence reactance											
Maximum tap	% on MVA	<input type="checkbox"/>		DPD II							
Nominal tap	% on MVA	<input type="checkbox"/>		DPD II							
Minimum tap	% on MVA	<input type="checkbox"/>		DPD II							
Positive sequence resistance											
Maximum tap	% on MVA	<input type="checkbox"/>		DPD II							
Nominal tap	% on MVA	<input type="checkbox"/>		DPD II							
Minimum tap	% on MVA	<input type="checkbox"/>		DPD II							
Zero phase sequence reactance	% on MVA	<input type="checkbox"/>		DPD II							
Tap change range	+% / -%	<input type="checkbox"/>		DPD II							
Number of steps				DPD II							

SCHEDULE 1 – POWER GENERATING MODULE, GENERATING UNIT (OR CCGT MODULE), DC CONNECTED POWER PARK MODULE, HVDC SYSTEM, POWER PARK MODULE AND DC CONVERTER TECHNICAL DATA
PAGE 17 OF 19

Data Description	Units	DATA to RTL		Data Category	Operating configuration					
		CUSC Contract	CUSC App. Form		1	2	3	4	5	6
<p>DC NETWORK [PC.A.5.4.3.1 (c)]</p> <p>Rated DC voltage per pole Rated DC current per pole</p> <p>Details of the DC Network described in diagram form including resistance, inductance and capacitance of all DC cables and/or DC lines. Details of any line reactors (including line reactor resistance), line capacitors, DC filters, earthing electrodes and other conductors that form part of the DC Network should be shown.</p>	<p>kV A</p> <p>Diagram</p>	<p><input type="checkbox"/> <input type="checkbox"/> <input type="checkbox"/></p>		<p>DPD II DPD II</p> <p>DPD II</p>						
<p>DC CONVERTER STATION AND HVDC SYSTEM AC HARMONIC FILTER AND REACTIVE COMPENSATION EQUIPMENT [PC.A.5.4.3.1 (d)]</p> <p>For all switched reactive compensation equipment</p> <p>Total number of AC filter banks Diagram of filter connections Type of equipment (e.g. fixed or variable) Capacitive rating; or Inductive rating; or Operating range</p> <p>Reactive Power capability as a function of various MW transfer levels</p>	<p>Diagram</p> <p>Text Diagram Text MVar MVar MVar MVar Table</p>	<p><input type="checkbox"/> <input type="checkbox"/> <input type="checkbox"/> <input type="checkbox"/> <input type="checkbox"/> <input type="checkbox"/> <input type="checkbox"/></p>	<p>■ ■ ■</p>	<p>DPD II</p> <p>DPD II DPD II DPD II DPD II DPD II DPD II</p> <p>DPD II</p>						

**SCHEDULE 1 – POWER GENERATING MODULE, GENERATING UNIT (OR CCGT
MODULE), POWER PARK MODULE, DC CONNECTED POWER PARK MODULE,
HVDC SYSTEM AND DC CONVERTER TECHNICAL DATA**

PAGE 18 OF 19

Data Description	Units	DATA to		Data Category	Operating configuration						
		RTL			1	2	3	4	5	6	
		CUSC Contract	CUSC App. Form								

CONTROL SYSTEMS [PC.A.5.4.3.2]										
Static $V_{DC} - P_{DC}$ (DC voltage – DC power) or Static $V_{DC} - I_{DC}$ (DC voltage – DC current) characteristic (as appropriate) when operating as –Rectifier –Inverter										
Details of rectifier mode control system, in block diagram form together with parameters showing transfer functions of individual elements.	Diagram	<input type="checkbox"/>								
	Diagram	<input type="checkbox"/>								
Details of inverter mode control system, in block diagram form showing transfer functions of individual elements including parameters.	Diagram	<input type="checkbox"/>								
Details of converter transformer tap changer control system in block diagram form showing transfer functions of individual elements including parameters. (Only required for DC Converters and HVDC Systems connected to the National Electricity Transmission System .)	Diagram	<input type="checkbox"/>								
Details of AC filter and reactive compensation equipment control systems in block diagram form showing transfer functions of individual elements including parameters. (Only required for DC Converters and HVDC Systems connected to the National Electricity Transmission System .)	Diagram	<input type="checkbox"/>								
Details of any frequency and/or load control systems in block diagram form showing transfer functions of individual elements including parameters.	Diagram	<input type="checkbox"/>								
Details of any large or small signal modulating controls, such as power oscillation damping controls or sub-synchronous oscillation damping controls, that have not been submitted as part of the above control system data.	Diagram	<input type="checkbox"/>								
Details of HVDC Converter unit models and/or control systems in block diagram form showing transfer functions of individual elements including parameters.	Diagram	<input type="checkbox"/>								
Details of AC component models and/or control systems in block diagram form showing transfer functions of individual elements including parameters.	Diagram	<input type="checkbox"/>								
Details of DC Grid models and/or control systems in block diagram form showing transfer functions of individual elements including parameters.	Diagram	<input type="checkbox"/>								
Details of Voltage and power controller and/or control systems in block diagram form showing transfer functions of individual elements including parameters.	Diagram	<input type="checkbox"/>								
Details of Special control features if applicable (e.g., power oscillation damping (POD) function, subsynchronous torsional interaction (SSTI) control and/or control systems in block diagram form showing transfer functions of individual elements including parameters.	Diagram	<input type="checkbox"/>								
Details of Multi terminal control, if applicable and/or control systems in block diagram form showing transfer functions of individual elements including parameters.	Diagram	<input type="checkbox"/>								
Details of HVDC System protection models as agreed between The Company the HVDC System Owner and/or control systems in block diagram form showing transfer functions of individual elements including parameters.	Diagram	<input type="checkbox"/>								
Transfer block diagram representation of the reactive power control at converter ends for a voltage source converter	Diagram	<input type="checkbox"/>								
Transfer block diagram representation of the reactive power control at converter ends for a voltage source converter.		<input type="checkbox"/>								

Data Description	Units	DATA to RTL		Data Category	Operating configuration						
		CUSC Contract	CUSC App. Form		1	2	3	4	5	6	
		<input type="checkbox"/>									
		<input type="checkbox"/>									
		<input type="checkbox"/>									
		<input type="checkbox"/>									
		<input type="checkbox"/>									
		<input type="checkbox"/>									

SCHEDULE 1 – POWER GENERATING MODULE, GENERATING UNIT (OR CCGT MODULE), POWER PARK MODULE, DC CONNECTED POWER PARK MODULE, HVDC SYSTEM AND DC CONVERTER TECHNICAL DATA

PAGE 19 OF 19

Data Description	Units	DATA to RTL		Data Category	Operating configuration						
		CUSC Contract	CUSC App. Form		1	2	3	4	5	6	
LOADING PARAMETERS [PC.A.5.4.3.3]											
MW Export											
Nominal loading rate	MW/s			DPD I							
Maximum (emergency) loading rate	MW/s			DPD I							
MW Import											
Nominal loading rate	MW/s			DPD I							
Maximum (emergency) loading rate	MW/s			DPD I							
Maximum recovery time, to 90% of pre-fault loading, following an AC system fault or severe voltage depression.	s	<input type="checkbox"/>		DPD II							
Maximum recovery time, to 90% of pre-fault loading, following a transient DC Network fault.	s	<input type="checkbox"/>		DPD II							

NOTE: **Users** are referred to Schedules 5 & 14 which set down data required for all **Users** directly connected to the **National Electricity Transmission System**, including **Power Stations**. **Generators** undertaking **OTSDUW Arrangements** and are utilising an **OTSDUW DC Converter** are referred to Schedule 18.

SCHEDULE 2 - GENERATION PLANNING PARAMETERS

PAGE 1 OF 3

This schedule contains the **Genset Generation Planning Parameters** required by **The Company** to facilitate studies in **Operational Planning** timescales.

For a **Generating Unit** including those within a **Power Generating Module** (other than a **Power Park Unit**) at a **Large Power Station**, the information is to be submitted on a unit basis and for a **CCGT Module** or **Power Park Module** at a **Large Power Station** the information is to be submitted on a module basis, unless otherwise stated.

Where references to **CCGT Modules** or **Power Park Modules** at a **Large Power Station** are made, the columns "G1" etc should be amended to read "M1" etc, as appropriate.

Power Station: _____

Generation Planning Parameters

DATA DESCRIPTION	UNITS	DATA to		DATA CAT.	GENSET OR STATION DATA						
		CUSC Contract	CUSC App. Form		G1	G2	G3	G4	G5	G6	STN
OUTPUT CAPABILITY (PC.A.3.2.2)											
Registered Capacity on a station and unit basis (on a station and module basis in the case of a CCGT Module or Power Park Module at a Large Power Station)	MW	<input type="checkbox"/>	<input checked="" type="checkbox"/>	SPD							
Maximum Capacity on a Power Generating Module basis and Synchronous Generating Unit basis and Registered Capacity on a Power Station basis)	MW	<input type="checkbox"/>	<input checked="" type="checkbox"/>	SPD							
Minimum Generation (on a module basis in the case of a CCGT Module or Power Park Module at a Large Power Station)	MW	<input type="checkbox"/>	<input checked="" type="checkbox"/>	SPD							
Minimum Stable Operating Level (on a module basis in the case of a Power Generating Module at a Large Power Station)	MW	<input type="checkbox"/>	<input checked="" type="checkbox"/>	SPD							
MW available from Power Generating Modules and Generating Units or Power Park Modules in excess of Registered Capacity or Maximum Capacity	MW	<input type="checkbox"/>	<input checked="" type="checkbox"/>	SPD							
REGIME UNAVAILABILITY											
These data blocks are provided to allow fixed periods of unavailability to be registered.											
Expected Running Regime. Is Power Station normally available for full output 24 hours per day, 7 days per week? If No please provide details of unavailability below. (PC.A.3.2.2.)		<input type="checkbox"/>	<input checked="" type="checkbox"/>	SPD							
Earliest Synchronising time: OC2.4.2.1(a)											
Monday	hr/min	<input checked="" type="checkbox"/>		OC2							-
Tuesday – Friday	hr/min	<input checked="" type="checkbox"/>		OC2							-
Saturday – Sunday	hr/min	<input checked="" type="checkbox"/>		OC2							-
Latest De-Synchronising time: OC2.4.2.1(a)											
Monday – Thursday	hr/min	<input checked="" type="checkbox"/>		OC2							-
Friday	hr/min	<input checked="" type="checkbox"/>		OC2							-
Saturday – Sunday	hr/min	<input checked="" type="checkbox"/>		OC2							-
SYNCHRONISING PARAMETERS											
OC2.4.2.1(a) Notice to Deviate from Zero (NDZ) after 48 hour Shutdown	Mins	<input checked="" type="checkbox"/>		OC2							

Station Synchronising Intervals (SI) after 48 hour Shutdown	Mins	■			-	-	-	-	-	-	
Synchronising Group (if applicable)	1 to 4	■		OC2							-

SCHEDULE 2 - GENERATION PLANNING PARAMETERS

PAGE 2 OF 3

DATA DESCRIPTION	UNITS	DATA to RTL		DATA CAT.	GENSET OR STATION DATA							
		CUSC Contract	CUSC App. Form		G1	G2	G3	G4	G5	G6	STN	
Synchronising Generation (SYG) after 48 hour Shutdown <i>PC.A.5.3.2(f) & OC2.4.2.1(a)</i>	MW	■		DPD II & OC2								-
De-Synchronising Intervals (Single value) <i>OC2.4.2.1(a)</i>	Mins	■		OC2	-	-	-	-	-	-	-	
<u>RUNNING AND SHUTDOWN PERIOD LIMITATIONS:</u>												
Minimum Non Zero time (MNZT) after 48 hour Shutdown <i>OC2.4.2.1(a)</i>	Mins	■		OC2								
Minimum Zero time (MZT) <i>OC2.4.2.1(a)</i>	Mins			OC2								
Existing AGR Plant Flexibility Limit (Existing AGR Plant only)	No.			OC2								
80% Reactor Thermal Power (expressed as Gross-Net MW) (Existing AGR Plant only)	MW			OC2								
Frequency Sensitive AGR Unit Limit (Frequency Sensitive AGR Units only)	No.			OC2								
<u>RUN-UP PARAMETERS</u> <i>PC.A.5.3.2(f) & OC2.4.2.1(a)</i>												
<u>Run-up rates</u> (RUR) after 48 hour Shutdown: (See note 2 page 3)					(Note that for DPD only a single value of run-up rate from Synch Gen to Registered Capacity is required)							
MW Level 1 (MWL1)	MW	■		DPD II OC2								-
MW Level 2 (MWL2)	MW	■		DPD II OC2								-
RUR from Synch. Gen to MWL1	MW/Mins	■		DPD II OC2								
RUR from MWL1 to MWL2	MW/Mins	■		OC2								
RUR from MWL2 to RC	MW/Mins	■		OC2								
<u>Run-Down Rates (RDR):</u> (Note that for DPD only a single value of run-down rate from Registered Capacity to de-synch is required)												
MWL2	MW	■		DPD II OC2								
RDR from RC to MWL2	MW/Min	■		DPD II OC2								
MWL1	MW	■		DPD II OC2								
RDR from MWL2 to MWL1	MW/Min	■		DPD II OC2								
RDR from MWL1 to de-synch	MW/Min	■		DPD II OC2								

SCHEDULE 2 - GENERATION PLANNING PARAMETERS

PAGE 3 OF 3

DATA DESCRIPTION	UNITS	DATA to		DATA CAT.	GENSET OR STATION DATA							
		RTL CUSC Contract	CUSC App. Form		G1	G2	G3	G4	G5	G6	STN	
REGULATION PARAMETERS <i>OC2.4.2.1(a)</i> Regulating Range Load rejection capability while still Synchronised and able to supply Load .	MW MW	■		DPD II DPD II								
GAS TURBINE LOADING PARAMETERS: <i>OC2.4.2.1(a)</i> Fast loading Slow loading	MW/Min MW/Min	■		OC2 OC2								
CCGT MODULE PLANNING MATRIX				OC2	(please attach)							
POWER PARK MODULE PLANNING MATRIX				OC2	(please attach)							
Power Park Module Active Power Output/ Intermittent Power Source Curve (e.g., MW output / Wind speed)				OC2	(please attach)							

NOTES:

- (1) To allow for different groups of **Gensets** within a **Power Station** (e.g., **Gensets** with the same operator) each **Genset** may be allocated to one of up to four **Synchronising Groups**. Within each such **Synchronising Group** the single synchronising interval will apply but between **Synchronising Groups** a zero synchronising interval will be assumed.
- (2) The run-up of a **Genset** from synchronising block load to **Registered Capacity** or **Maximum Capacity** is represented as a three stage characteristic in which the run-up rate changes at two intermediate loads, MWL1 and MWL2. The values MWL1 & MWL2 can be different for each **Genset**.

SCHEDULE 3 - LARGE POWER STATION OUTAGE PROGRAMMES, OUTPUT USABLE AND INFLEXIBILITY INFORMATION

PAGE 1 OF 3

(Also outline information on contracts involving **External Interconnections**)

For a **Generating Unit** at a **Large Power Station** the information is to be submitted on a unit basis and for a **CCGT Module** or **Power Park Module** at a **Large Power Station** the information is to be submitted on a module basis, unless otherwise stated.

DATA DESCRIPTION	UNITS	TIME COVERED	UPDATE TIME	DATA CAT.	DATA to RTL		
Power Station name: Generating Unit (or CCGT Module or Power Park Module at a Large Power Station) number:.... Registered Capacity:							
<table style="width: 100%; border: none;"> <tr> <td style="border: none; width: 30%;">Large Power Station OUTAGE PROGRAMME</td> <td style="border: none; width: 70%;">Large Power Station OUTPUT USABLE</td> </tr> </table>	Large Power Station OUTAGE PROGRAMME	Large Power Station OUTPUT USABLE					
Large Power Station OUTAGE PROGRAMME	Large Power Station OUTPUT USABLE						
<u>PLANNING FOR YEARS 3 - 7 AHEAD (OC2.4.1.2.1(a)(i), (e) & (j))</u>							
	Monthly average OU	MW	F. yrs 5 - 7	Week 24	SPD	CUSC Contract CUSC App. Form	
Provisional outage programme comprising:			C. yrs 3 - 5	Week 2	OC2		
duration		weeks	"	"	"	■	
preferred start date		date	"	"	"	■	
earliest start date		date	"	"	"	■	
latest finish date		date	"	"	"	■	
	Weekly OU	MW	"	"	"	■	
(The Company response as detailed in OC2			C. yrs 3 - 5	Week12)		■	
(Users' response to The Company suggested changes or potential outages)			C. yrs 3 - 5	Week14)		■	
Updated provisional outage programme comprising:			C. yrs 3 - 5	Week 25	OC2		
duration		weeks	"	"	"	■	
preferred start date		date	"	"	"	■	
earliest start date		date	"	"	"	■	
latest finish date		date	"	"	"	■	
	Updated weekly OU	MW	"	"	"	■	
(The Company response as detailed in OC2 for			C. yrs 3 - 5	Week28)		■	
(Users' response to The Company suggested changes or update of potential outages)			C. yrs 3 - 5	Week31)		■	
(The Company further suggested revisions etc. (as detailed in OC2 for			C. yrs 3 - 5	Week42)		■	
Agreement of final Generation Outage Programme			C. yrs 3 - 5	Week 45	OC2	■	

SCHEDULE 3 - LARGE POWER STATION OUTAGE PROGRAMMES, OUTPUT USABLE AND INFLEXIBILITY INFORMATION

PAGE 2 OF 3

DATA DESCRIPTION	UNITS	TIME COVERED	UPDATE TIME	DATA CAT	DATA to RTL
<u>PLANNING FOR YEAR 0</u>					
Updated Final Generation Outage Programme		C. yr 0 Week 2 ahead to year end	1600 Weds.	OC2	
OU at weekly peak	MW	"	"	"	
(The Company response as detailed in OC2 for		C. yrs 0	1600)		
(Weeks 2 to 52 ahead	Friday)		
(The Company response as detailed in OC2 for		Weeks 2 - 7 ahead	1600)		
(days 2 to 14 ahead	Thurs)		
Forecast return to services (Planned Outage or breakdown)	date	days 2 to 14 ahead	0900 daily	OC2	
OU (all hours)	MW	"	"	OC2	
(The Company response as detailed in OC2 for		days 2 to 14 ahead	1600)		
(daily)		
<u>INFLEXIBILITY</u>					
Genset inflexibility	Min MW (Weekly)	Weeks 2 - 8 ahead	1600 Tues	OC2	
(The Company response on Negative Reserve Active (Power Margin)		"	1200)		
(days 2 -14 ahead	Friday)		
Genset inflexibility	Min MW (daily)	days 2 -14 ahead	0900 daily	OC2	
(The Company response on Negative Reserve Active (Power Margin)		"	1600)		
(daily)		

**SCHEDULE 3 - LARGE POWER STATION OUTAGE PROGRAMMES, OUTPUT
USABLE AND INFLEXIBILITY INFORMATION
PAGE 3 OF 3**

DATA DESCRIPTION	UNITS	TIME COVERED	UPDATE TIME	DATA CAT	DATA to RTL	
<u>OUTPUT PROFILES</u>						
					CUSC Contract	CUSC App. Form
In the case of Large Power Stations whose output may be expected to vary in a random manner (e.g., wind power) or to some other pattern (e.g., Tidal) sufficient information is required to enable an understanding of the possible profile	MW	F. yrs 1 - 7	Week 24	SPD		

Notes: 1. The week numbers quoted in the Update Time column refer to standard weeks in the current year.

SCHEDULE 4 - LARGE POWER STATION DROOP AND RESPONSE DATA

PAGE 1 OF 1

GOVERNOR DROOP AND RESPONSE (PC.A.5.5 ■ CUSC Contract)

The Data in this Schedule 4 is to be supplied by **Generators** with respect to all **Large Power Stations, HVDC System Owners** and by **DC Converter Station** owners (where agreed), whether directly connected or **Embedded**

DATA DESCRIPTION	NORMAL VALUE	MW	DATA CAT	DROOP%			RESPONSE CAPABILITY			
				Unit 1	Unit 2	Unit 3	Primary	Secondary	High Frequency	
MLP1	Designed Minimum Operating Level or Minimum Regulating Level (for a CCGT Module or Power Park Module, on a modular basis assuming all units are Synchronised)									
MLP2	Minimum Generation or Minimum Stable Operating Level (for a CCGT Module or Power Park Module, or Power Generating Module on a modular basis assuming all units are Synchronised)									
MLP3	70% of Registered Capacity or Maximum Capacity									
MLP4	80% of Registered Capacity or Maximum Capacity									
MLP5	95% of Registered Capacity or Maximum Capacity									
MLP6	Registered Capacity or Maximum Capacity									

Notes:

1. The data provided in this Schedule 4 is not intended to constrain any **Ancillary Services Agreement**.
2. **Registered Capacity or Maximum Capacity** should be identical to that provided in Schedule 2.
3. The Governor **Droop** should be provided for each **Generating Unit**(excluding **Power Park Units**), **Power Park Module**, **HVDC Converter** or **DC Converter**. The Response Capability should be provided for each **Genset** or **DC Converter**.
4. **Primary**, **Secondary** and **High Frequency Response** are defined in CC.A.3.2 or ECC.A.3.2 and are based on a frequency ramp of 0.5Hz over 10 seconds. **Primary Response** is the minimum value of response between 10s and 30s after the frequency ramp starts, **Secondary Response** between 30s and 30 minutes, and **High Frequency Response** is the minimum value after 10s on an indefinite basis.
5. For plants which have not yet **Synchronised**, the data values of MLP1 to MLP6 should be as described above. For plants which have already **Synchronised**, the values of MLP1 to MLP6 can take any value between **Designed Operating Minimum Level** or **Minimum Regulating Level** and **Registered Capacity** or **Maximum Capacity**. If MLP1 is not provided at the **Designed Minimum Operating Level**, the value of the **Designed Minimum Operating Level** should be separately stated.
6. For the avoidance of doubt **Transmission DC Converters** and **OTSDUW DC Converters** must be capable of providing a continuous signal indicating the real time frequency measured at the **Transmission Interface Point** to the **Offshore Grid Entry Point** (as detailed in CC.6.3.7(e)(vii) and CC.6.3.7(e)(viii) or ECC.6.3.3.1.(f) to enable **Offshore Power Generating Modules Offshore Generating Units, Offshore Power Park Modules** and/or **Offshore DC Converters** to satisfy the frequency response requirements of CC.6.3.7 or ECC.6.3.7.

SCHEDULE 5 - USERS SYSTEM DATA

PAGE 1 OF 11

The data in this Schedule 5 is required from **Users** who are connected to the **National Electricity Transmission System** via a **Connection Point** (or who are seeking such a connection). **Generators** undertaking **OTSDUW** should use **DRC** Schedule 18 although they should still supply data under Schedule 5 in relation to their **User's System** up to the **Offshore Grid Entry Point**.

Table 5 (a)

DATA DESCRIPTION	UNITS	DATA to RTL		DATA CATEGORY
		CUSC Contract	CUSC App. Form	
<p><u>USERS SYSTEM LAYOUT</u> (PC.A.2.2)</p> <p>A Single Line Diagram showing all or part of the User's System is required. This diagram shall include:-</p> <p>(a) all parts of the User's System, whether existing or proposed, operating at Supergrid Voltage, and in Scotland and Offshore, also all parts of the User System operating at 110kV and greater,</p> <p>(b) all parts of the User's System operating at a voltage of 50kV and greater, and in Scotland and Offshore greater than 30kV, or higher which can interconnect Connection Points, or split bus-bars at a single Connection Point,</p> <p>(c) all parts of the User's System between Embedded Medium Power Stations or Large Power Stations or Offshore Transmission Systems connected to the User's Subtransmission System and the relevant Connection Point or Interface Point,</p> <p>(d) all parts of the User's System at a Transmission Site.</p> <p>The Single Line Diagram may also include additional details of the User's Subtransmission System, and the transformers connecting the User's Subtransmission System to a lower voltage. With The Company's agreement, it may also include details of the User's System at a voltage below the voltage of the Subtransmission System.</p> <p>This Single Line Diagram shall depict the arrangement(s) of all of the existing and proposed load current carrying Apparatus relating to both existing and proposed Connection Points, showing electrical circuitry (i.e., overhead lines, underground cables, power transformers and similar equipment), operating voltages. In addition, for equipment operating at a Supergrid Voltage, and in Scotland and Offshore also at 110kV and greater, circuit breakers and phasing arrangements shall be shown.</p>		■	■	SPD
		■	■	
		■	■	
		■	■	
		■	■	

SCHEDULE 5 - USERS SYSTEM DATA

PAGE 2 OF 11

Table 5(b)

DATA DESCRIPTION	UNITS	DATA EXCH		DATA CATEGORY
		CUSC Contract	CUSC App. Form	
REACTIVE COMPENSATION (PC.A.2.4)				
For independently switched reactive compensation equipment not owned by a Relevant Transmission Licensee connected to the User's System at 132kV and above, and also in Scotland and Offshore , connected at 33kV and above, other than power factor correction equipment associated with a customer's Plant or Apparatus :				
Type of equipment (e.g., fixed or variable)	Text	■	■	SPD
Capacitive rating; or	MVar	■	■	SPD
Inductive rating; or	MVar	■	■	SPD
Operating range	MVar	■	■	SPD
Details of automatic control logic to enable operating characteristics to be determined	text and/or diagrams	■	■	SPD
Point of connection to User's System (electrical location and system voltage)	Text	■	■	SPD
SUBSTATION INFRASTRUCTURE (PC.A.2.2.6(b))				
For the infrastructure associated with any User's equipment at a Substation owned by a Relevant Transmission Licensee or operated or managed by The Company :-				
Rated 3-phase rms short-circuit withstand current	kA	■	■	SPD
Rated 1-phase rms short-circuit withstand current	kA	■	■	SPD
Rated Duration of short-circuit withstand	s	■	■	SPD
Rated rms continuous current	A	■	■	SPD

SCHEDULE 5 – USERS SYSTEM DATA

PAGE 3 OF 11

Table 5 (c)

DATA DESCRIPTION		UNITS	DATA EXCH		DATA CATEGORY
LUMPED SUSCEPTANCES (PC.A.2.3)			CUSC Contract	CUSC App. Form	
Equivalent Lumped Susceptance required for all parts of the User's Subtransmission System which are not included in the Single Line Diagram .			■	■	
This should not include:			■	■	
(a)	independently switched reactive compensation equipment identified above.		■	■	
(b)	any susceptance of the User's System inherent in the Demand (Reactive Power) data provided in Schedule 1 (Generator Data) or Schedule 11 (Connection Point data).		■	■	
Equivalent lumped shunt susceptance at nominal Frequency .		% on 100 MVA	■	■	SPD

SCHEDULE 5 – USERS SYSTEM DATA

USER'S SYSTEM DATA

Circuit Parameters (PC.A.2.2.4) (■ CUSC Contract & ■ CUSC Application Form)

The data below is all **Standard Planning Data**. Details are to be given for all circuits shown on the **Single Line Diagram Table 5 (d)**

Years Valid	Node 1	Node 2	Rated Voltage kV	Operating Voltage kV	Positive Phase Sequence % on 100 MVA			Zero Phase Sequence (self) % on 100 MVA			Zero Phase Sequence (mutual) % on 100 MVA												
					R	X	B	R	X	B	R	X	B										

Notes

1. Data should be supplied for the current, and each of the seven succeeding Financial Years. This should be done by showing for which years the data is valid in the first column of the Table.

USERS SYSTEM DATA

Transformer Data (PC.A.2.2.5) (■ CUSC Contract & ■ CUSC Application Form)

The data below is all **Standard Planning Data**, and details should be shown below of all transformers shown on the **Single Line Diagram**. Details of Winding Arrangement, Tap Changer and earthing details are only required for transformers connecting the **User's** higher voltage system with its **Primary Voltage System**.

Table 5 (e)

Years valid	Name of Node or Connection	Transformer	Rating MVA	Voltage Ratio		Positive Phase Sequence Reactance % on Rating			Positive Phase Sequence Resistance % on Rating			Zero Sequence Reactance % on Rating	Winding Arr.	Tap Changer			Earthing Details (delete as app.)*
				HV	LV	Max. Tap	Min. Tap	Nom. Tap	Max. Tap	Min. Tap	Nom. Tap			range +% to -%	step size %	type (delete)	
																	Direct/ Res/ Rea
																	Direct/ Res/ Rea
																	Direct/ Res/ Rea
																	Direct/ Res/ Rea
																	Direct/ Res/ Rea
																	Direct/ Res/ Rea

*If Resistance or Reactance please give impedance value

Notes

1. Data should be supplied for the current, and each of the seven succeeding Financial Years. This should be done by showing for which years the data is valid in the first column of the Table
2. For a transformer with two secondary windings, the positive and zero phase sequence leakage impedances between the HV and LV1, HV and LV2, and LV1 and LV2 windings are required.

SCHEDULE 5 –USERS SYSTEM DATA

USER'S SYSTEM DATA

Switchgear Data (PC.A.2.2.6(a)) (■ CUSC Contract & CUSC Application Form ■)

The data below is all **Standard Planning Data**, and should be provided for all switchgear (i.e., circuit breakers, load disconnectors and disconnectors) operating at a **Supergrid Voltage**, and also in Scotland and **Offshore**, operating at 132kV. In addition, data should be provided for all circuit breakers irrespective of voltage located at a **Connection Site** which is owned by a **Relevant Transmission Licensee** or operated or managed by **The Company**.

Table 5(f)

Years Valid	Connect-ion Point	Switch No.	Rated Voltage kV rms	Operating Voltage kV rms	Rated short-circuit breaking current		Rated short-circuit peak making current		Rated rms continuous current (A)	DC time constant at testing of asymmetrical breaking ability(s)
					3 Phase kA rms	1 Phase kA rms	3 Phase kA peak	1 Phase kA peak		

Notes

1. Rated Voltage should be as defined by IEC 694.
2. Data should be supplied for the current, and each of the seven succeeding Financial Years. This should be done by showing for which years the data is valid in the first column of the Table

SCHEDULE 5 –USERS SYSTEM DATA

PAGE 7 OF 11

Table 5(g)

DATA DESCRIPTION	UNITS	DATA to RTL		DATA CATEGORY
		CUSC Contract	CUSC App. Form	
<p>PROTECTION SYSTEMS (PC.A.6.3)</p> <p>The following information relates only to Protection equipment which can trip or inter-trip or close any Connection Point circuit breaker or any Transmission circuit breaker. The information need only be supplied once, in accordance with the timing requirements set out in PC.A.1.4 (b) and need not be supplied on a routine annual basis thereafter, although The Company should be notified if any of the information changes.</p> <p>(a) A full description, including estimated settings, for all relays and Protection systems installed or to be installed on the User's System;</p> <p>(b) A full description of any auto-reclose facilities installed or to be installed on the User's System, including type and time delays;</p> <p>(c) A full description, including estimated settings, for all relays and Protection systems installed or to be installed on the Power Generating Module, Power Park Module or Generating Unit's generator transformer, unit transformer, station transformer and their associated connections;</p> <p>(d) For Generating Units (other than Power Park Units) having a circuit breaker at the generator terminal voltage clearance times for electrical faults within the Generating Unit zone must be declared.</p> <p>(e) Fault Clearance Times: Most probable fault clearance time for electrical faults on any part of the Users System directly connected to the National Electricity Transmission System.</p>				
		▪		DPD II
		▪		DPD II
		▪		DPD II
		▪		DPD II
	mSec	▪		DPD II

DATA DESCRIPTION	UNITS	DATA to RTL		DATA CATEGORY
		CUSC Contract	CUSC App. Form	
<p>POWER PARK MODULE/UNIT PROTECTION SYSTEMS</p> <p>Details of settings for the Power Park Module/Unit protection relays (to include): (PC.A.5.4.2(f))</p> <p>(a) Under frequency,</p> <p>(b) Over Frequency,</p> <p>(c) Under Voltage, Over Voltage,</p> <p>(d) Rotor Over current,</p> <p>(e) Stator Over current,</p> <p>(f) High Wind Speed Shut Down Level,</p> <p>(g) Rotor Underspeed,</p> <p>(h) Rotor Overspeed.</p>				
		▪		DPD II
		▪		DPD II
		▪		DPD II
		▪		DPD II
		▪		DPD II
		▪		DPD II
		▪		DPD II
		▪		DPD II

SCHEDULE 5 - USERS SYSTEM DATA

PAGE 8 OF 11

Information for Transient Overvoltage Assessment (DPD I) (PC.A.6.2 ■ CUSC Contract)

The information listed below may be requested by **The Company** from each **User** with respect to any **Connection Site** between that **User** and the **National Electricity Transmission System**. The impact of any third party **Embedded** within the **Users System** should be reflected.

- (a) Busbar layout plan(s), including dimensions and geometry showing positioning of any current and voltage transformers, through bushings, support insulators, disconnectors, circuit breakers, surge arresters, etc. Electrical parameters of any associated current and voltage transformers, stray capacitances of wall bushings and support insulators, and grading capacitances of circuit breakers;
- (b) Electrical parameters and physical construction details of lines and cables connected at that busbar. Electrical parameters of all plant e.g., transformers (including neutral earthing impedance or zig-zag transformers if any), series reactors and shunt compensation equipment connected at that busbar (or to the tertiary of a transformer) or by lines or cables to that busbar;
- (c) Basic insulation levels (BIL) of all **Apparatus** connected directly, by lines or by cables to the busbar;
- (d) Characteristics of overvoltage **Protection** devices at the busbar and at the termination points of all lines, and all cables connected to the busbar;
- (e) Fault levels at the lower voltage terminals of each transformer connected directly or indirectly to the **National Electricity Transmission System** without intermediate transformation;
- (f) The following data is required on all transformers operating at **Supergrid Voltage** throughout **Great Britain** and, in Scotland and **Offshore**, also at greater than 110kV: three or five limb cores or single phase units to be specified, and operating peak flux density at nominal voltage.
- (g) An indication of which items of equipment may be out of service simultaneously during **Planned Outage** conditions.

Harmonic Studies (DPD I) (PC.A.6.4 ■ CUSC Contract)

The information given below, both current and forecast, where not already supplied in this Schedule 5 may be requested by **The Company** from each **User** if it is necessary for **The Company** to evaluate the production/magnification of harmonic distortion on the **National Electricity Transmission System** and **User's** systems. The impact of any third party **Embedded** within the **User's System** should be reflected:

- (a) Overhead lines and underground cable circuits of the **User's Subtransmission System** must be differentiated and the following data provided separately for each type:
 - Positive phase sequence resistance
 - Positive phase sequence reactance
 - Positive phase sequence susceptance
- (b) for all transformers connecting the **User's Subtransmission System** to a lower voltage:
 - Rated MVA
 - Voltage Ratio
 - Positive phase sequence resistance
 - Positive phase sequence reactance

SCHEDULE 5 – USERS SYSTEM DATA

PAGE 9 OF 11

- (c) at the lower voltage points of those connecting transformers:

Equivalent positive phase sequence susceptance

Connection voltage and MVA_r rating of any capacitor bank and component design parameters if configured as a filter

Equivalent positive phase sequence interconnection impedance with other lower voltage points

The minimum and maximum **Demand** (both MW and MVA_r) that could occur

Harmonic current injection sources in Amps at the Connection voltage points

Details of traction loads, e.g., connection phase pairs, continuous variation with time, etc.

- (d) an indication of which items of equipment may be out of service simultaneously during **Planned Outage** conditions

Voltage Assessment Studies (DPD I) (PC.A.6.5 ■ CUSC Contract)

The information listed below, where not already supplied in this Schedule 5, may be requested by **The Company** from each **User** with respect to any **Connection Site** if it is necessary for **The Company** to undertake detailed voltage assessment studies (e.g., to examine potential voltage instability, voltage control co-ordination or to calculate voltage step changes). The impact of any third party **Embedded** within the **Users System** should be reflected:

- (a) For all circuits of the **User's Subtransmission System**:

Positive Phase Sequence Reactance

Positive Phase Sequence Resistance

Positive Phase Sequence Susceptance

MVA_r rating of any reactive compensation equipment

- (b) for all transformers connecting the **User's Subtransmission System** to a lower voltage:

Rated MVA

Voltage Ratio

Positive phase sequence resistance

Positive Phase sequence reactance

Tap-changer range

Number of tap steps

Tap-changer type: on-load or off-circuit

AVC/tap-changer time delay to first tap movement

AVC/tap-changer inter-tap time delay

SCHEDULE 5 – USERS SYSTEM DATA

PAGE 10 OF 11

- (c) at the lower voltage points of those connecting transformers:-

Equivalent positive phase sequence susceptance

MVA_r rating of any reactive compensation equipment

Equivalent positive phase sequence interconnection impedance with other lower voltage points

The maximum **Demand** (both MW and MVA_r) that could occur

Estimate of voltage insensitive (constant power) load content in % of total load at both winter peak and 75% off-peak load conditions

Short Circuit Analyses:(DPD I) (PC.A.6.6 ■ CUSC Contract)

The information listed below, both current and forecast, and where not already supplied under this Schedule 5, may be requested by **The Company** from each **User** with respect to any **Connection Site** where prospective short-circuit currents on equipment owned by a **Relevant Transmission Licensee** or operated or managed by **The Company** are close to the equipment rating. The impact of any third party **Embedded** within the **User's System** should be reflected:-

- (a) For all circuits of the **User's Subtransmission System**:

Positive phase sequence resistance

Positive phase sequence reactance

Positive phase sequence susceptance

Zero phase sequence resistance (both self and mutuals)

Zero phase sequence reactance (both self and mutuals)

Zero phase sequence susceptance (both self and mutuals)

- (b) for all transformers connecting the **User's Subtransmission System** to a lower voltage:

Rated MVA

Voltage Ratio

Positive phase sequence resistance (at max, min and nominal tap)

Positive phase sequence reactance (at max, min and nominal tap)

Zero phase sequence reactance (at nominal tap)

Tap changer range

Earthing method: direct, resistance or reactance

Impedance if not directly earthed

- (c) at the lower voltage points of those connecting transformers:-

The maximum **Demand** (in MW and MVA_r) that could occur

Short-circuit infeed data in accordance with PC.A.2.5.6(a) unless the **User's** lower voltage network runs in parallel with the **Subtransmission System**, when to prevent double counting in each node infeed data, a π equivalent comprising the data items of PC.A.2.5.6(a) for each node together with the positive phase sequence interconnection impedance between the nodes shall be submitted.

SCHEDULE 5 – USERS SYSTEM DATA

PAGE 11 OF 11

Dynamic Models:(DPD II) (PC.A.6.7 ■ CUSC Contract)

The information listed below, both current and forecast, and where not already supplied under this Schedule 5, may be requested by **The Company** from each **EU Code User** or in respect of each **EU Grid Supply Point** with respect to any **Connection Site**

- (a) Dynamic model structure and block diagrams including parameters, transfer functions and individual elements (as applicable)
- (b) Power control functions and block diagrams including parameters, transfer functions and individual elements (as applicable)
- (c) Voltage control functions and block diagrams including parameters, transfer functions and individual elements (as applicable)
- (d) Converter control models and block diagrams including parameters, transfer functions and individual elements (as applicable)

SCHEDULE 6 – USERS OUTAGE INFORMATION

PAGE 1 OF 2

DATA DESCRIPTION	UNITS	DATA to RTL		TIMESCALE COVERED	UPDATE TIME	DATA CAT.	
<p>Details are required from Network Operators of proposed outages in their User Systems and from Generators with respect to their outages, which may affect the performance of the Total System (e.g., at a Connection Point or constraining Embedded Large Power Stations or constraints to the Maximum Import Capacity or Maximum Export Capacity at an Interface Point) (OC2.4.1.3.2(a) & (b))</p> <p>(The Company advises Network Operators of National Electricity Transmission System outages affecting their Systems)</p> <p>Network Operator informs The Company if unhappy with proposed outages)</p> <p>(The Company draws up revised National Electricity Transmission System (outage plan advises Users of operational effects)</p> <p>Generators and Non-Embedded Customers provide Details of Apparatus owned by them (other than Gensets) at each Grid Supply Point (OC2.4.1.3.3)</p> <p>(The Company advises Network Operators of outages affecting their Systems) (OC2.4.1.3.3)</p> <p>Network Operator details of relevant outages affecting the Total System (OC2.4.1.3.3)</p> <p>Details of:- Maximum Import Capacity for each Interface Point Maximum Export Capacity for each Interface Point Changes to previously declared values of the Interface Point Target Voltage/Power Factor (OC2.4.1.3.3(c)).</p> <p>(The Company informs Users of aspects that may affect their Systems) (OC2.4.1.3.3)</p> <p>Users inform The Company if unhappy with aspects as notified (OC2.4.1.3.3)</p> <p>(The Company issues final National Electricity Transmission System (outage plan with advice of operational) (OC2.4.1.3.3) (effects on Users System)</p> <p>Generator, Network Operator and Non-Embedded Customers to inform The Company of changes to outages previously requested</p> <p>Details of load transfer capability of 12MW or more between Grid Supply Points in England and Wales and 10MW or more between Grid Supply Points in Scotland.</p> <p>Details of:- Maximum Import Capacity for each Interface Point Maximum Export Capacity for each Interface Point Changes to previously declared values of the Interface Point Target Voltage/Power Factor</p>		CUSC Contract	CUSC App. Form	Years 2-5	Week 8 (Network Operator etc) Week 13 (Generators)	OC2 OC2	
	Years 2-5	Week 28)					
	"	Week 30					OC2
	"	Week 34)					
	Year 1	Week 13					OC2
	Year 1	Week 28)					
	Year 1	Week 32					OC2
	Year 1	Week 32					OC2
	Year 1	Week 34)					
	Year 1	Week 36					OC2
	Year 1	Week 49					OC2
	Week 8 ahead to year end	As occurring					OC2
	Within Yr 0	As The Company request					OC2
	Within Yr 0	As occurring					OC2

Note: **Users** should refer to **OC2** for full details of the procedure summarised above and for the information which **The Company** will provide on the **Programming Phase**.

SCHEDULE 6 – USERS OUTAGE INFORMATION
PAGE 2 OF 2

The data below is to be provided to **The Company** as required for compliance with the applicable **Retained EU Law** (Commission Regulation (EU) No 543/2013 (OC2.4.2.3)). Data provided under Article Numbers 7.1(a), 7.1(b), 15.1(a), 15.1(b), and 15.1(c) and 15.1(d) is to be provided using **MODIS**.

ECR ARTICLE No.	DATA DESCRIPTION	USERS PROVIDING DATA	FREQUENCY OF SUBMISSION
7.1(a)	<p>Planned unavailability of the Apparatus belonging to a Non-Embedded Customer where OC2.4.7 (a) applies</p> <ul style="list-style-type: none"> - Unavailable demand capacity during the event (MW) - Estimated start date and time (dd.mm.yy hh:mm) - Estimated end date and time (dd.mm.yy hh:mm) - Reason for unavailability from the list below: <ul style="list-style-type: none"> . Maintenance . Failure . Shutdown . Other 	Non-Embedded Customer	To be received by The Company as soon as reasonably possible but in any case, to facilitate publication of data no later than 1 hour after a decision has been made by the Non-Embedded Customer regarding the planned unavailability
7.1(b)	<p>Changes in actual availability of the Apparatus belonging to a Non-Embedded Customer where OC2.4.7 (b) applies</p> <ul style="list-style-type: none"> - Unavailable demand capacity during the event (MW) - Start date and time (dd.mm.yy hh:mm) - Estimated end date and time (dd.mm.yy hh:mm) - Reason for unavailability from the list below : <ul style="list-style-type: none"> . Maintenance . Failure . Shutdown . Other 	Non-Embedded Customer	To be received by The Company as soon as reasonably possible but in any case, to facilitate publication of data no later than 1 hour after the change in actual availability
8.1	<p>Year Ahead Forecast Margin information as provided in accordance with OC2.4.1.2.2</p> <ul style="list-style-type: none"> - Output Usable 	Generator	In accordance with OC2.4.1.2.2
14.1(a)	<p>Registered Capacity or Maximum Capacity for Generating Units or Power Generating Modules with greater than 1 MW Registered Capacity or Maximum Capacity provided in accordance with PC.4.3.1 and PC.A.3.4.3 or PC.A.3.1.4</p> <ul style="list-style-type: none"> - Registered Capacity or Maximum Capacity (MW) - Production type (from that listed under PC.A.3.4.3) 	Generator	Week 24
14.1(b)	<p>Power Station Registered Capacity for units with equal or greater than 100 MW Registered Capacity provided in accordance with PC.4.3.1 and PC.A.3.4.3</p> <ul style="list-style-type: none"> - Power Station name - Location of Generating Unit - Production type (from that listed under PC.A.3.4.3) - Voltage connection levels - Registered Capacity or Maximum Capacity (MW) 	Generator	Week 24
14.1(c)	<p>Estimated output of Active Power of a BM Unit or Generating Unit for each per Settlement Period of the next Operational Day provided in accordance with BC1.4.2</p> <ul style="list-style-type: none"> - Physical Notification 	Generator	In accordance with BC1.4.2

15.1(a)	<p>Planned unavailability of a Generating Unit where OC2.4.7(c) applies</p> <ul style="list-style-type: none"> - Power Station name - Generating Unit and/or Power Generating Module name - Location of Generating Unit and/or Power Generating Module - Generating Unit Registered Capacity (MW) - Production type (from that listed under PC.A.3.4.3) - Output Usable (MW) during the event - Start date and time (dd.mm.yy hh:mm) - Estimated end date and time (dd.mm.yy hh:mm) - Reason for unavailability from the list below: <ul style="list-style-type: none"> . Maintenance . Shutdown . Other 	Generator	To be received by The Company as soon as reasonably possible but in any case, to facilitate publication of data no later than 1 hour after a decision has been made by the Generator regarding the planned unavailability
15.1(b)	<p>Changes in availability of a Generating Unit and/or Power Generating Module where OC2.4.7 (d) applies</p> <ul style="list-style-type: none"> - Power Station name - Generating Unit and/or Power Generating Module name - Location of Generating Unit and/or Power Generating Module - Generating Unit Registered Capacity and Power Generating Module Maximum Capacity (MW) - Production type (from that listed under PC.A.3.4.3) - Maximum Export Limit (MW) during the event - Start date and time (dd.mm.yy hh:mm) - Estimated end date and time (dd.mm.yy hh:mm) - Reason for unavailability from the list below: <ul style="list-style-type: none"> . Maintenance . Shutdown . Other 	Generator	To be received by The Company as soon as reasonably possible but in any case, to facilitate publication of data no later than 1 hour after the change in actual availability
15.1(c)	<p>Planned unavailability of a Power Station where OC2.4.7(e) applies</p> <ul style="list-style-type: none"> - Power Station name - Location of Power Station - Power Station Registered Capacity (MW) - Production type (from that listed under PC.A.3.4.3) - Power Station aggregated Output Usable (MW) during the event - Start date and time (dd.mm.yy hh:mm) - Estimated end date and time (dd.mm.yy hh:mm) - Reason for unavailability from the list below: <ul style="list-style-type: none"> . Maintenance . Shutdown . Other 	Generator	To be received by The Company as soon as reasonably possible but in any case, to facilitate publication of data no later than 1 hour after a decision has been made by the Generator regarding the planned unavailability
15.1(d)	<p>Changes in actual availability of a Power Station where OC2.4.7 (f) applies</p> <ul style="list-style-type: none"> - Power Station name - Location of Power Station - Power Station Registered Capacity (MW) - Production type (from that listed under PC.A.3.4.3) - Power Station aggregated Maximum Export Limit (MW) during the event - Start date and time (dd.mm.yy hh:mm) - Estimated end date and time (dd.mm.yy hh:mm) - Reason for unavailability from the list below: <ul style="list-style-type: none"> . Maintenance . Shutdown . Other 	Generator	To be received by The Company as soon as reasonably possible but in any case, to facilitate publication of data no later than 1 hour after the change in actual availability

SCHEDULE 7 - LOAD CHARACTERISTICS AT GRID SUPPLY POINTS

PAGE 1 OF 1

All data in this schedule 7 is categorised as **Standard Planning Data (SPD)** and is required for existing and agreed future connections. This data is only required to be updated when requested by **The Company**.

DATA DESCRIPTION	UNITS	DATA to		DATA FOR FUTURE YEARS						
		RTL		Yr 1	Yr 2	Yr 3	Yr 4	Yr 5	Yr 6	Yr 7
<p>FOR ALL TYPES OF DEMAND FOR EACH GRID SUPPLY POINT</p> <p>The following information is required infrequently and should only be supplied, wherever possible, when requested by The Company (PC.A.4.7)</p> <p>Details of individual loads which have Characteristics significantly different from the typical range of domestic or commercial and industrial load supplied: (PC.A.4.7(a))</p> <p>Sensitivity of demand to fluctuations in voltage And frequency on National Electricity Transmission System at time of peak Connection Point Demand (Active Power) (PC.A.4.7(b))</p> <p>Voltage Sensitivity (PC.A.4.7(b))</p> <p>Frequency Sensitivity (PC.A.4.7(b))</p> <p>Reactive Power sensitivity should relate to the Power Factor information given in Schedule 11 (or for Generators, Schedule 1) and note 6 on Schedule 11 relating to Reactive Power therefore applies: (PC.A.4.7(b))</p> <p>Phase unbalance imposed on the National Electricity Transmission System (PC.A.4.7(d))</p> <p style="padding-left: 20px;">- maximum</p> <p style="padding-left: 20px;">- average</p> <p>Maximum Harmonic Content imposed on National Electricity Transmission System (PC.A.4.7(e))</p> <p>Details of any loads which may cause Demand Fluctuations greater than those permitted under Engineering Recommendation P28, Stage 1 at the Point of Common Coupling including Flicker Severity (Short Term) and Flicker Severity (Long Term) (PC.A.4.7(f))</p>		<p>CUSC Contract</p> <p>CUSC App. Form</p>								
		<input type="checkbox"/>								
		<input type="checkbox"/>		(Please Attach)						
		<input type="checkbox"/>								
	MW/kV MVar/kV	<input type="checkbox"/>								
	MW/Hz MVar/Hz	<input type="checkbox"/>								
		<input type="checkbox"/>								
	%	<input type="checkbox"/>								
	%	<input type="checkbox"/>								
	%	<input type="checkbox"/>								
		<input type="checkbox"/>								

SCHEDULE 8 - DATA SUPPLIED BY BM PARTICIPANTS
PAGE 1 OF 1

CODE	DESCRIPTION
BC1	Physical Notifications
BC1 & BC2	Export and Import Limits
BC1	Bid-Offer Data
BC1	Dynamic Parameters (Day Ahead)
BC2	Dynamic Parameters (For use in Balancing Mechanism)
BC1 & BC2	Other Relevant Data

- No information collated under this Schedule will be transferred to the **Relevant Transmission Licensees**

SCHEDULE 9 - DATA SUPPLIED BY THE COMPANY TO USERS

PAGE 1 OF 1

(Example of data to be supplied)

CODE	DESCRIPTION
CC or ECC	Operation Diagram
CC or ECC	Site Responsibility Schedules
PC	Day of the peak National Electricity Transmission System Demand Day of the minimum National Electricity Transmission System Demand
OC2	Surpluses and Output Useable (OU) requirements for each Generator over varying timescales Equivalent networks to Users for Outage Planning Negative Reserve Active Power Margins (when necessary) Operating Reserve information
BC1	Demand Estimates, Indicated Margin and Indicated Imbalance , indicative Synchronising and Desynchronising times of Embedded Power Stations to Network Operators , special actions.
BC2	Bid-Offer Acceptances, Ancillary Services instructions to relevant Users , Emergency Instructions
BC3	Location, amount, and Low Frequency Relay settings of any Low Frequency Relay initiated Demand reduction for Demand which is Embedded .

- No information collated under this Schedule will be transferred to the **Relevant Transmission Licensees**

DATA TO BE SUPPLIED BY THE COMPANY TO USERS

PURSUANT TO THE TRANSMISSION LICENCE

1. The **Transmission Licence** requires **The Company** to publish annually the **Seven Year Statement** which is designed to provide **Users** and potential **Users** with information to enable them to identify opportunities for continued and further use of the **National Electricity Transmission System**.

When a **User** is considering a development at a specific site, certain additional information may be required in relation to that site which is of such a level of detail that it is inappropriate to include it in the **Seven Year Statement**. In these circumstances, the **User** may contact **The Company** who will be pleased to arrange a discussion and the provision of such additional information relevant to the site under consideration as the **User** may reasonably require.

2. The **Transmission Licence** also requires **The Company** to offer terms for an agreement for connection to and use of the **National Electricity Transmission System** and further information will be given by **The Company** to the potential **User** in the course of the discussions of the terms of such an agreement.

SCHEDULE 10 - DEMAND PROFILES AND ACTIVE ENERGY DATA

PAGE 1 OF 2

The following information is required from each **Network Operator** and from each **Non-Embedded Customer**. The data should be provided in calendar week 24 each year (although **Network Operators** may delay the submission until calendar week 28).

DATA DESCRIPTION	F. Yr. 0	F. Yr. 1	F. Yr. 2	F. Yr. 3	F. Yr. 4	F. Yr. 5	F. Yr. 6	F. Yr. 7	UPDATE TIME	DATA CAT
<u>Demand Profiles</u>	<i>(PC.A.4.2) (■ - CUSC Contract & ■ CUSC Application Form)</i>									
Total User's system profile (please delete as applicable)	Day of User's annual Maximum demand at Annual ACS Conditions (MW)									
	Day of annual peak of National Electricity Transmission System Demand at Annual ACS Conditions (MW)									
	Day of annual minimum National Electricity Transmission System Demand at average conditions (MW)									
0000 : 0030									Wk.24	SPD
0030 : 0100									:	:
0100 : 0130									:	:
0130 : 0200									:	:
0200 : 0230									:	:
0230 : 0300									:	:
0300 : 0330									:	:
0330 : 0400									:	:
0400 : 0430									:	:
0430 : 0500									:	:
0500 : 0530									:	:
0530 : 0600									:	:
0600 : 0630									:	:
0630 : 0700									:	:
0700 : 0730									:	:
0730 : 0800									:	:
0800 : 0830									:	:
0830 : 0900									:	:
0900 : 0930									:	:
0930 : 1000									:	:
1000 : 1030									:	:
1030 : 1100									:	:
1100 : 1130									:	:
1130 : 1200									:	:
1200 : 1230									:	:
1230 : 1300									:	:
1300 : 1330									:	:
1330 : 1400									:	:
1400 : 1430									:	:
1430 : 1500									:	:
1500 : 1530									:	:
1530 : 1600									:	:
1600 : 1630									:	:
1630 : 1700									:	:
1700 : 1730									:	:
1730 : 1800									:	:
1800 : 1830									:	:
1830 : 1900									:	:
1900 : 1930									:	:
1930 : 2000									:	:
2000 : 2030									:	:
2030 : 2100									:	:
2100 : 2130									:	:
2130 : 2200									:	:
2200 : 2230									:	:
2230 : 2300									:	:
2300 : 2330									:	:
2330 : 0000									:	:

SCHEDULE 10 - DEMAND PROFILES AND ACTIVE ENERGY DATA

PAGE 2 OF 2

DATA DESCRIPTION	Out-turn		F. Yr. 0	Update Time	Data Cat	DATA to RTL	
	Actual	Weather Corrected.				CUSC Contract	CUSC App. Form
<p>(PC.A.4.3)</p> <p>Active Energy Data</p> <p>Total annual Active Energy requirements under average conditions of each Network Operator and each Non-Embedded Customer in the following categories of Customer Tariff:-</p> <p style="padding-left: 40px;">LV1 LV2 LV3 EHV HV Traction Lighting User System Losses</p> <p>Active Energy from Embedded Small Power Stations and Embedded Medium Power Stations</p>				Week 24	SPD	<p>■</p> <p>■</p> <p>■</p> <p>■</p> <p>■</p> <p>■</p> <p>■</p> <p>■</p> <p>■</p> <p>■</p>	<p>■</p> <p>■</p> <p>■</p> <p>■</p> <p>■</p> <p>■</p> <p>■</p> <p>■</p> <p>■</p>

NOTES:

1. 'F. yr.' means '**Financial Year**'
2. **Demand and Active Energy Data (General)**

Demand and Active Energy data should relate to the point of connection to the **National Electricity Transmission System** and should be net of the output (as reasonably considered appropriate by the **User**) of all **Embedded Small Power Stations, Medium Power Stations and Customer Generating Plant**. Auxiliary demand of **Embedded Power Stations** should be included in the demand data submitted by the **User** at the **Connection Point**. **Users** should refer to the **PC** for a full definition of the **Demand** to be included.
3. **Demand** profiles and **Active Energy** data should be for the total **System** of the **Network Operator**, including all **Connection Points**, and for each **Non-Embedded Customer**. **Demand Profiles** should give the numerical maximum demand that in the **User's** opinion could reasonably be imposed on the **National Electricity Transmission System**.
4. In addition the demand profile is to be supplied for such days as **The Company** may specify, but such a request is not to be made more than once per calendar year.

SCHEDULE 11 - CONNECTION POINT DATA

PAGE 1 OF 5

The following information is required from each **Network Operator** and from each **Non-Embedded Customer**. The data should be provided in calendar week 24 each year (although **Network Operators** may delay the submission until calendar week 28).

Table 11(a)

Connection Point:

<p>Connection Point Demand at the time of - (select each one in turn) (Provide data for each Access Period associated with the Connection Point)</p>	<p>a) maximum Demand b) peak National Electricity Transmission System Demand (specified by The Company) c) minimum National Electricity Transmission System Demand (specified by The Company) d) maximum Demand during Access Period e) specified by either The Company or a User</p>
<p>Name of Transmission Interface Circuit out of service during Access Period (if reqd).</p>	<p style="text-align: right;">PC.A.4.1.4.2</p>

DATA DESCRIPTION (CUSC Contract □ & CUSC Application Form ■)	Outturn	Outturn Weather Corrected	F.Yr	F.Yr	F.Yr	F.Yr	F.Yr	F.Yr	F.Yr	F.Yr	F.Yr	DATA CAT
			1	2	3	4	5	6	7	8		
Date of a), b), c), d) or e) as denoted above.												PC.A.4.3.3
Time of a), b), c), d) or e) as denoted above.												PC.A.4.3.3
Connection Point Demand (MW)												PC.A.4.3.1
Connection Point Demand (MVA _r)												PC.A.4.3.1
Deduction made at Connection Point for Small Power Stations, Medium Power Stations and Customer Generating Plant (MW)												PC.A.4.3.2(a)
Reference to valid Single Line Diagram												PC.A.4.3.5
Reference to node and branch data.												PC.A.2.2

Note: The following data block can be repeated for each post fault network revision that may impact on the Transmission System.

Reference to post-fault revision of Single Line Diagram												PC.A.4.5
Reference to post-fault revision of the node and branch data associated with the Single Line Diagram												PC.A.4.5
Reference to the description of the actions and timescales involved in effecting the post-fault actions (e.g. auto-switching, manual, teleswitching, overload protection operation etc)												PC.A.4.5

Access Group:		
----------------------	--	--

Note: The following data block to be repeated for each **Connection Point** with the **Access Group**.

Name of associated Connection Point within the same Access Group:												PC.A.4.3.1
Demand at associated Connection Point (MW)												PC.A.4.3.1
Demand at associated Connection Point (MVA _r)												PC.A.4.3.1
Deduction made at associated Connection Point for Small Power Stations, Medium Power Stations and Customer Generating Plant (MW)												PC.A.4.3.2(a)

SCHEDULE 11 - CONNECTION POINT DATA

Table 11(b)

Embedded Generation Data											
Connection Point:											
DATA DESCRIPTION	Outturn	Outturn Weather Corrected	F.Yr 1	F.Yr 2	F.Yr. 3	F.Yr. 4	F.Yr. 5	F.Yr. 6	F.Yr 7	F.Yr 8	DATA CAT
Small Power Station, Medium Power Station and Customer Generation Summary	For each Connection Point where there are Embedded Small Power Stations, Medium Power Stations or Customer Generating Stations the following information is required:										
No. of Small Power Stations, Medium Power Stations or Customer Power Stations											PC.A.3.1 .4(a)
Number of Generating Units within these stations											PC.A.3.1 .4(a)
Summated Capacity of all these Generating Units											PC.A.3.1 .4(a)
Where the Network Operator's System places a constraint on the capacity of an Embedded Large Power Station											
Station Name											PC.A.3.2 .2(c)
Generating Unit											PC.A.3.2 .2(c)
System Constrained Capacity											PC.A.3.2 .2(c)(i)
Reactive Despatch Network Restriction											PC.A.3.2 .2(c)(ii)

Where the Network Operator's System places a constraint on the capacity of an Offshore Transmission System at an Interface Point											
Offshore Transmission System Name											PC.A.3.2.2(c)
Interface Point Name											PC.A.3.2.2(c)
Maximum Export Capacity											PC.A.3.2.2(c)
Maximum Import Capacity											PC.A.3.2.2(c)

SCHEDULE 11 - CONNECTION POINT DATA
PAGE 3 OF 5

Table 11(c)

For each **Embedded Small Power Station** of 1MW and above, the following information is required, effective 2015 in line with the Week 24 data submissions.

DATA DESCRIPTION	An Embedded Small Power Station reference unique to each Network Operator	Connection Date (Financial Year for generator connecting after week 24 2015)	Generator unit Reference	Technology Type / Production type	CHP (Y/N)	Registered capacity in MW (as defined in the Distribution Code)	Lowest voltage node on the most up-to-date Single Line Diagram to which it connects or where it will export most of its power	Where it exports electricity from wind PV or storage, the geographical location of the primary or higher voltage substation to which it connects	Control mode	Control mode voltage target and reactive range or target pf (as appropriate)	Loss of mains protection type	Loss of mains protection settings
DATA CAT	PC.A.3.1.4 (a)		PC.A.3.1.4 (a)	PC.A.3.1.4 (a)	PC.A.3.1.4	PC.A.3.1.4 (a)	PC.A.3.1.4 (a)	PC.A.3.1.4 (a)	PC.A.3.1.4 (a)	PC.A.3.1.4 (a)	PC.A.3.1.4 (a)	PC.A.3.1.4 (a)

SCHEDULE 11 - CONNECTION POINT DATA

PAGE 4 OF 5

NOTES:

1. 'F.Yr.' means '**Financial Year**'. F.Yr. 1 refers to the current financial year.
2. All **Demand** data should be net of the output (as reasonably considered appropriate by the **User**) of all **Embedded Small Power Stations, Embedded Medium Power Stations** and **Customer Generating Plant**. Generation and / or Auxiliary demand of **Embedded Large Power Stations** should not be included in the demand data submitted by the **User**. **Users** should refer to the **PC** for a full definition of the **Demand** to be included.
3. Peak **Demand** should relate to each **Connection Point** individually and should give the maximum demand that in the **User's** opinion could reasonably be imposed on the **National Electricity Transmission System**. **Users** may submit the **Demand** data at each node on the **Single Line Diagram** instead of at a **Connection Point** as long as the **User** reasonably believes such data relates to the peak (or minimum) at the **Connection Point**.

In deriving **Demand** any deduction made by the **User** (as detailed in note 2 above) to allow for **Embedded Small Power Stations, Embedded Medium Power Stations** and **Customer Generating Plant** is to be specifically stated as indicated on the Schedule.

4. **The Company** may at its discretion require details of any **Embedded Small Power Stations** or **Embedded Medium Power Stations** whose output can be expected to vary in a random manner (e.g. wind power) or according to some other pattern (e.g. tidal power)
5. Where more than 95% of the total **Demand** at a **Connection Point** is taken by synchronous motors, values of the **Power Factor** at maximum and minimum continuous excitation may be given instead. **Power Factor** data should allow for series reactive losses on the **User's System** but exclude reactive compensation network susceptance specified separately in Schedule 5.
6. Where a **Reactive Despatch Network Restriction** is in place which requires the generator to maintain a target voltage set point this should be stated as an alternative to the size of the **Reactive Despatch Network Restriction**.

SCHEDULE 11 - CONNECTION POINT DATA
PAGE 5 OF 5

Table 11 (d)

Embedded Small Power Stations <1MW

Network Operator	
-------------------------	--

Fuel Type	Aggregate Registered Capacity Total MW	Number of PGMs	Comments
Biomass			
Fossil brown coal/lignite			
Fossil coal-derived gas			
Fossil gas			
Fossil hard coal			
Fossil oil			
Fossil oil shale			
Fossil peat			
Geothermal			
Hydro pumped storage			
Hydro run-of-river and poundage			
Hydro water reservoir			
Marine			
Nuclear			
Other renewable			
Solar			
Waste			
Wind offshore			
Wind onshore			
Other			

SCHEDULE 12 - DEMAND CONTROL

PAGE 1 OF 2

The following information is required from each **Network Operator** and where indicated with an asterisk from **Externally Interconnected System Operators** and/or **Interconnector Users** and a **Pumped Storage Generator** and **Generators** in respect of **Electricity Storage Modules**. Where indicated with a double asterisk, the information is only required from **Suppliers**.

DATA DESCRIPTION	UNITS		UPDATE TIME	
<u>Demand Control</u>				
Demand met or to be relieved by Demand Control (averaging at the Demand Control Notification Level or more over a half hour) at each Connection Point .				
Demand Control at time of National Electricity Transmission System weekly peak demand				
Amount	MW)F.yrs 0 to 5	Week 24	OC1
Duration	Min)		
For each half hour	MW	Wks 2-8 ahead	1000 Mon	OC1
For each half hour	MW	Days 2-12 ahead	1200 Wed	OC1
For each half hour	MW	Previous calendar day	0600 daily	OC1
<u>**Customer Demand Management</u> <u>(at the Customer Demand Management Notification Level or more at the Connection Point)</u>				
For each half hour	MW	Any time in Control Phase		OC1
For each half hour	MW	Remainder of period	When changes occur to previous plan	OC1
For each half hour	MW	Previous calendar day	0600 daily	OC1
**In Scotland, Load Management Blocks For each block of 5MW or more, for each half hour	MW	For the next day	11:00	OC1

SCHEDULE 12 - DEMAND CONTROL

PAGE 2 OF 2

DATA DESCRIPTION	UNITS	TIME COVERED	UPDATE TIME	DATA CAT.
*Demand Control or Pump				
<u>Tripping Offered as Reserve</u>				
Magnitude of Demand or pumping load or Electricity Storage charging load which is tripped	MW	Year ahead from week 24	Week 24	DPD I
System Frequency at which tripping is initiated	Hz	"	"	"
Time duration of System Frequency below trip setting for tripping to be initiated	S	"	"	"
Time delay from trip initiation to Tripping	S	"	"	"
Electricity Storage Module data				
Maximum Capacity	MW	"	"	"
		"	"	"
Maximum Import Power	MW	"	"	"
Registered Import Capability	MW	"	"	"
Charge Time	Min	"	"	"
		"	"	"
Discharge time	Min	"	"	"
Operating periods	Min	"	"	"
<u>Emergency Manual Load</u>				
<u>Disconnection</u>				
Method of achieving load disconnection	Text	Year ahead from week 24	Annual in week 24	OC6
Annual ACS Peak Demand (Active Power) at Connection Point (requested under Schedule 11 - repeated here for reference)	MW	"	"	"
Cumulative percentage of Connection Point Demand (Active Power) which can be disconnected by the following times from an instruction from The Company				
5 mins	%	"	"	"
10 mins	%	"	"	"
15 mins	%	"	"	"
20 mins	%	"	"	"
25 mins	%	"	"	"
30 mins	%	"	"	"

--	--	--	--	--

Notes:

1. **Network Operators** may delay the submission until calendar week 28.
2. No information collated under this Schedule will be transferred to the **Relevant Transmission Licensees** (or **Generators** undertaking **OTSDUW**).

SCHEDULE 12A - AUTOMATIC LOW FREQUENCY DEMAND DISCONNECTION

PAGE 1 OF 1

Time Covered: Year ahead from week 24

Data Category: OC6

Update Time: Annual in week 24

Grid Supply Point	GSP Demand MW	Low Frequency Demand Disconnection Blocks MW									Residual demand MW	
		1 48.8Hz	2 48.75Hz	3 48.7Hz	4 48.6Hz	5 48.5Hz	6 48.4Hz	7 48.2Hz	8 48.0Hz	9 47.8Hz		
GSP1												
GSP2												
GSP3												
Total demand disconnected per block		MW										
		%										
Total demand disconnection		MW (% of aggregate demand of							MW)		

Note: All demand refers to that at the time of forecast **National Electricity Transmission System** peak demand.

Network Operators may delay the submission until calendar week 28

No information collated under this schedule will be transferred to the **Relevant Transmission Licensees** (or **Generators** undertaking **OTSDUW**).

SCHEDULE 13 - FAULT INFEED DATA

PAGE 1 OF 2

The data in this Schedule 13 is all **Standard Planning Data**, and is required from all **Users** other than **Generators** who are connected to the **National Electricity Transmission System** via a **Connection Point** (or who are seeking such a connection). A data submission is to be made each year in Week 24 (although **Network Operators** may delay the submission until Week 28). A separate submission is required for each node included in the **Single Line Diagram** provided in Schedule 5.

DATA DESCRIPTION	UNITS	F.Yr.	F.Yr.	F.Yr.	F.Yr.	F.Yr.	F.Yr.	F.Yr.	F.Yr.	DATA to		
		0	1	2	3	4	5	6	7	RTL		
SHORT CIRCUIT INFEED TO THE NATIONAL ELECTRICITY TRANSMISSION SYSTEM FROM USERS SYSTEM AT A CONNECTION POINT											CUSC Contract	CUSC App. Form
<i>(P.C.A.2.5)</i>												
Name of node or Connection Point											□	■
Symmetrical three phase short-circuit current infeed												
- at instant of fault	kA										□	■
- after subtransient fault current contribution has substantially decayed	Ka										□	■
Zero sequence source impedances as seen from the Point of Connection or node on the Single Line Diagram (as appropriate) consistent with the maximum infeed above:												
- Resistance	% on 100										□	■
- Reactance	% on 100										□	■
Positive sequence X/R ratio at instance of fault											□	■
Pre-Fault voltage magnitude at which the maximum fault currents were calculated	p.u.										□	■

SCHEDULE 13 - FAULT INFEED DATA

PAGE 2 OF 2

DATA DESCRIPTION	UNITS	F.Yr	F.Yr.	F.Yr.	F.Yr.	F.Yr.	F.Yr.	F.Yr.	F.Yr.	DATA to		
		0	1	2	3	4	5	6	7	RTL		
<u>SHORT CIRCUIT INFEED TO THE NATIONAL ELECTRICITY TRANSMISSION SYSTEM FROM USERS SYSTEM AT A CONNECTION POINT</u>											CUSC Contract	CUSC App. Form
Negative sequence impedances of User's System as seen from the Point of Connection or node on the Single Line Diagram (as appropriate). If no data is given, it will be assumed that they are equal to the positive sequence values.												
- Resistance	% on 100										<input type="checkbox"/>	<input checked="" type="checkbox"/>
- Reactance	% on 100										<input type="checkbox"/>	<input checked="" type="checkbox"/>

SCHEDULE 14 - FAULT INFEED DATA (GENERATORS INCLUDING UNIT TRANSFORMERS AND STATION TRANSFORMERS)

PAGE 1 OF 5

The data in this Schedule 14 is all **Standard Planning Data**, and is to be provided by **Generators**, with respect to all directly connected **Power Stations**, all **Embedded Large Power Stations** and all **Embedded Medium Power Stations** connected to the **Subtransmission System**. A data submission is to be made each year in Week 24.

Fault infeeds via Unit Transformers

A submission should be made for each **Generating Unit** (including those which are part of a **Synchronous Power Generating Module**) with an associated **Unit Transformer**. Where there is more than one **Unit Transformer** associated with a **Generating Unit**, a value for the total infeed through all **Unit Transformers** should be provided. The infeed through the **Unit Transformer(s)** should include contributions from all motors normally connected to the **Unit Board**, together with any generation (e.g. **Auxiliary Gas Turbines**) which would normally be connected to the **Unit Board**, and should be expressed as a fault current at the **Generating Unit** terminals for a fault at that location.

DATA DESCRIPTION	UNITS	F.Yr.	F.Yr.	F.Yr.	F.Yr.	F.Yr.	F.Yr.	F.Yr.	F.Yr.	DATA to	
		0	1	2	3	4	5	6	7	RTL	
<i>(P.C.A.2.5)</i>										CUSC Contract	CUSC App. Form
Name of Power Station										<input type="checkbox"/>	<input checked="" type="checkbox"/>
Number of Unit Transformers										<input type="checkbox"/>	<input checked="" type="checkbox"/>
Symmetrical three phase short-circuit current infeed through the Unit Transformers(s) for a fault at the Generating Unit terminals											
- at instant of fault	kA									<input type="checkbox"/>	<input checked="" type="checkbox"/>
- after subtransient fault current contribution has substantially decayed	kA									<input type="checkbox"/>	<input checked="" type="checkbox"/>
Positive sequence X/R ratio at instance of fault										<input type="checkbox"/>	<input checked="" type="checkbox"/>
Subtransient time constant (if significantly different from 40ms)	ms									<input type="checkbox"/>	<input checked="" type="checkbox"/>
Pre-fault voltage at fault point (if different from 1.0 p.u.)										<input type="checkbox"/>	<input checked="" type="checkbox"/>
The following data items need only be supplied if the Generating Unit Step-up Transformer can supply zero sequence current from the Generating Unit side to the National Electricity Transmission System											
Zero sequence source impedances as seen from the Generating Unit terminals consistent with the maximum infeed above:											
- Resistance	% on 100									<input type="checkbox"/>	<input checked="" type="checkbox"/>
- Reactance	% on 100									<input type="checkbox"/>	<input checked="" type="checkbox"/>

SCHEDULE 14 - FAULT INFEEED DATA (GENERATORS INCLUDING UNIT TRANSFORMERS AND STATION TRANSFORMERS)

PAGE 2 OF 5

Fault infeeds via Station Transformers

A submission is required for each **Station Transformer** directly connected to the **National Electricity Transmission System**. The submission should represent normal operating conditions when the maximum number of **Gensets** are **Synchronised** to the **System**, and should include the fault current from all motors normally connected to the **Station Board**, together with any Generation (e.g. **Auxiliary Gas Turbines**) which would normally be connected to the **Station Board**. The fault infeed should be expressed as a fault current at the hv terminals of the **Station Transformer** for a fault at that location.

If the submission for normal operating conditions does not represent the worst case, then a separate submission representing the maximum fault infeed that could occur in practice should be made.

DATA DESCRIPTION	UNITS	F.Yr.	F.Yr.	F.Yr.	F.Yr.	F.Yr.	F.Yr.	F.Yr.	F.Yr.	DATA to		
		0	1	2	3	4	5	6	7	RTL	CUSC Contract	CUSC App. Form
<i>(PC.A.2.5)</i>												
Name of Power Station											<input type="checkbox"/>	<input checked="" type="checkbox"/>
Number of Station Transformers											<input type="checkbox"/>	<input checked="" type="checkbox"/>
Symmetrical three phase short-circuit current infeed for a fault at the Connection Point												
- at instant of fault	kA										<input type="checkbox"/>	<input checked="" type="checkbox"/>
- after subtransient fault current contribution has substantially decayed	kA										<input type="checkbox"/>	<input checked="" type="checkbox"/>
Positive sequence X/R ratio At instance of fault											<input type="checkbox"/>	<input checked="" type="checkbox"/>
Subtransient time constant (if significantly different from 40ms)	ms										<input type="checkbox"/>	<input checked="" type="checkbox"/>
Pre-fault voltage (if different from 1.0 p.u.) at fault point (See note 1)											<input type="checkbox"/>	<input checked="" type="checkbox"/>
Zero sequence source Impedances as seen from the Point of Connection Consistent with the maximum Infeed above:												
- Resistance	% on 100										<input type="checkbox"/>	<input checked="" type="checkbox"/>
- Reactance	% on 100										<input type="checkbox"/>	<input checked="" type="checkbox"/>

Note 1. The pre-fault voltage provided above should represent the voltage within the range 0.95 to 1.05 that gives the highest fault current

Note 2. % on 100 is an abbreviation for % on 100 MVA

SCHEDULE 14 - FAULT INFEED DATA (GENERATORS INCLUDING UNIT TRANSFORMERS AND STATION TRANSFORMERS)

Fault infeeds from Power Park Modules

A submission is required for the whole **Power Park Module** and for each **Power Park Unit** type or equivalent. The submission shall represent operating conditions that result in the maximum fault infeed. The fault current from all motors normally connected to the **Power Park Unit's** electrical system shall be included. The fault infeed shall be expressed as a fault current at the terminals of the **Power Park Unit**, or the **Common Collection Busbar** if an equivalent **Single Line Diagram** and associated data as described in PC.A.2.2.2 is provided, and the **Grid Entry Point**, or **User System Entry Point** if **Embedded**, for a fault at the **Grid Entry Point**, or **User System Entry Point** if **Embedded**.

Should actual data in respect of fault infeeds be unavailable at the time of the application for a **CUSC Contract** or **Embedded Development Agreement**, a limited subset of the data, representing the maximum fault infeed that may result from all of the plant types being considered, shall be submitted. This data will, as a minimum, represent the root mean square of the positive, negative and zero sequence components of the fault current for both single phase and three phase solid faults at the **Grid Entry Point** (or **User System Entry Point** if **Embedded**) at the time of fault application and 50ms following fault application. Actual data in respect of fault infeeds shall be submitted to **The Company** as soon as it is available, in line with PC.A.1.2

DATA DESCRIPTION	UNITS	F.Yr.	F.Yr.	F.Yr.	F.Yr.	F.Yr.	F.Yr.	F.Yr.	F.Yr.	DATA to		
		<u>0</u>	<u>1</u>	<u>2</u>	<u>3</u>	<u>4</u>	<u>5</u>	<u>6</u>	<u>7</u>	RTL		
(PC.A.2.5)											CUSC Contract	CUSC App. Form
Name of Power Station											<input type="checkbox"/>	<input checked="" type="checkbox"/>
Name of Power Park Module											<input type="checkbox"/>	<input checked="" type="checkbox"/>
Power Park Unit type											<input type="checkbox"/>	<input checked="" type="checkbox"/>
A submission shall be provided for the contribution of the entire Power Park Module and each type of Power Park Unit or equivalent to the positive, negative and zero sequence components of the short circuit current at the Power Park Unit terminals, or Common Collection Busbar , and Grid Entry Point or User System Entry Point if Embedded for												
(i) a solid symmetrical three phase short circuit											<input type="checkbox"/>	<input checked="" type="checkbox"/>
(ii) a solid single phase to earth short circuit											<input type="checkbox"/>	<input checked="" type="checkbox"/>
(iii) a solid phase to phase short circuit											<input type="checkbox"/>	<input checked="" type="checkbox"/>
(iv) a solid two phase to earth short circuit											<input type="checkbox"/>	<input checked="" type="checkbox"/>
at the Grid Entry Point or User System Entry Point if Embedded .											<input type="checkbox"/>	<input checked="" type="checkbox"/>
If protective controls are used and active for the above conditions, a submission shall be provided in the limiting case where the protective control is not active. This case may require application of a non-solid fault, resulting in a retained voltage at the fault point.											<input type="checkbox"/>	<input checked="" type="checkbox"/>

SCHEDULE 14 - FAULT INFEEED DATA (GENERATORS INCLUDING UNIT TRANSFORMERS AND STATION TRANSFORMERS)

PAGE 4 OF 5

DATA DESCRIPTION	UNITS	F.Yr. 0	F.Yr. 1	F.Yr. 2	F.Yr. 3	F.Yr. 4	F.Yr. 5	F.Yr. 6	F.Yr. 7	DATA to RTL	DATA DESCRIPTION
										CUSC Contract	CUSC App. Form
- A continuous time trace and table showing the root mean square of the positive, negative and zero sequence components of the fault current from the time of fault inception to 140ms after fault inception at 10ms intervals	Graphical and tabular kA versus s									□	■
- A continuous time trace and table showing the positive, negative and zero sequence components of retained voltage at the terminals or Common Collection Busbar , if appropriate	pu versus s									□	■
- A continuous time trace and table showing the root mean square of the positive, negative and zero sequence components of retained voltage at the fault point, if appropriate	pu versus s									□	■

SCHEDULE 14 - FAULT INFEED DATA (GENERATORS INCLUDING UNIT TRANSFORMERS AND STATION TRANSFORMERS)

PAGE 5 OF 5

DATA DESCRIPTION	UNITS	F.Yr. 0	F.Yr. 1	F.Yr. 2	F.Yr. 3	F.Yr. 4	F.Yr. 5	F.Yr. 6	F.Yr. 7	DATA to RTL	DATA DESCRIPTION
										CUSC Contract	CUSC App. Form
<p>For Power Park Units that utilise a protective control, such as a crowbar circuit,</p> <ul style="list-style-type: none"> - additional rotor resistance applied to the Power Park Unit under a fault situation - additional rotor reactance applied to the Power Park Unit under a fault situation. <p>Positive sequence X/R ratio of the equivalent at time of fault at the Common Collection Busbar</p> <p>Minimum zero sequence impedance of the equivalent at a Common Collection Busbar</p> <p>Active Power generated pre-fault</p> <p>Number of Power Park Units in equivalent generator</p> <p>Power Factor (lead or lag)</p> <p>Pre-fault voltage (if different from 1.0 pu) at fault point (See note 1)</p> <p>Items of reactive compensation switched in pre-fault</p>	<p>% on MVA</p> <p>% on MVA</p> <p>MW</p> <p>pu</p>									<p style="text-align: center;"><input type="checkbox"/></p> <p style="text-align: center;"><input type="checkbox"/></p> <p style="text-align: center;"><input type="checkbox"/></p> <p style="text-align: center;"><input type="checkbox"/></p> <p style="text-align: center;"><input type="checkbox"/></p> <p style="text-align: center;"><input type="checkbox"/></p> <p style="text-align: center;"><input type="checkbox"/></p> <p style="text-align: center;"><input type="checkbox"/></p> <p style="text-align: center;"><input type="checkbox"/></p>	<p style="text-align: center;">■</p> <p style="text-align: center;">■</p> <p style="text-align: center;">■</p> <p style="text-align: center;">■</p> <p style="text-align: center;">■</p> <p style="text-align: center;">■</p> <p style="text-align: center;">■</p> <p style="text-align: center;">■</p>

Note 1. The pre-fault voltage provided above should represent the voltage within the range 0.95 pu to 1.05 pu that gives the highest fault current

SCHEDULE 15 – MOTHBALLED POWER GENERATING MODULE, MOTHBALLED GENERATING UNIT, MOTHBALLED POWER PARK MODULE (INCLUDING MOTHBALLED DC CONNECTED POWER PARK MODULES), MOTHBALLED HVDC SYSTEMS, MOTHBALLED HVDC CONVERTERS, MOTHBALLED DC CONVERTERS AT A DC CONVERTER STATION AND ALTERNATIVE FUEL DATA

MOTHBALLED POWER GENERATING MODULES, MOTHBALLED GENERATING UNIT, MOTHBALLED POWER PARK MODULE (INCLUDING MOTHBALLED DC CONNECTED POWER PARK MODULES), MOTHBALLED HVDC SYSTEMS, MOTHBALLED HVDC CONVERTERS OR MOTHBALLED DC CONVERTER AT A DC CONVERTER STATION AND ALTERNATIVE FUEL DATA
 The following data items must be supplied with respect to each **Mothballed Power Generating Module, Mothballed Generating Unit, Mothballed Power Park Module** (including **Mothballed DC Connected Power Park Modules**), **Mothballed HVDC Systems, Mothballed HVDC Converters** or **Mothballed DC Converters** at a DC Converter station

Power Station _____ **Generating Unit, Power Park Module or DC Converter Name** (e.g. Unit 1)

DATA DESCRIPTION	UNITS	DATA CAT	GENERATING UNIT DATA					Total MW being returned
			<1 month	1-2 months	2-3 months	3-6 months	6-12 months	
MW output that can be returned to service	MW	DPD II						

Notes

- The time periods identified in the above table represent the estimated time it would take to return the **Mothballed Power Generating Module, Mothballed Generating Unit, Mothballed Power Park Module (Mothballed DC Connected Power Park Modules), Mothballed HVDC Systems, Mothballed HVDC Converters** or **Mothballed DC Converter** at a **DC Converter Station** to service once a decision to return has been made.
- Where a **Mothballed Power Generating Module, Mothballed Generating Unit, Mothballed Power Park Module** (including a **Mothballed DC Connected Power Park Module**), **Mothballed HVDC System, Mothballed HVDC Converter** or **Mothballed DC Converter** at a **DC Converter Station** can be physically returned in stages covering more than one of the time periods identified in the above table then information should be provided for each applicable time period.
- The estimated notice to physically return MW output to service should be determined in accordance with **Good Industry Practice** assuming normal working arrangements and normal plant procurement lead times.
- The MW output values in each time period should be incremental MW values, e.g. if 150MW could be returned in 2 – 3 months and an additional 50MW in 3 – 6 months then the values in the columns should be Nil, Nil, 150, 50, Nil, Nil, 200 respectively.
- Significant factors which may prevent the **Mothballed Power Generating Module, Mothballed Generating Unit, Mothballed Power Park Module (Mothballed DC Connected Power Park Module)**, **Mothballed HVDC System, Mothballed HVDC Converter** or **Mothballed DC Converter** at a **DC Converter Station** achieving the estimated values provided in this table, excluding factors relating to **Transmission Entry Capacity**, should be appended separately.

SCHEDULE 15 – MOTHBALLED POWER GENERATING MODULES, MOTHBALLED GENERATING UNIT, MOTHBALLED POWER PARK MODULE (INCLUDING DC CONNECTED POWER PARK MODULES), MOTHBALLED HVDC SYSTEMS, MOTHBALLED HVDC CONVERTERS, MOTHBALLED DC CONVERTERS AT A DC CONVERTER STATION AND ALTERNATIVE FUEL DATA

ALTERNATIVE FUEL INFORMATION

The following data items for alternative fuels need only be supplied with respect to each **Generating Unit** whose primary fuel is gas including those which form part of a **Power Generating Module**.

Power Station	Generating Unit Name (e.g. Unit 1)			
	DATA DESCRIPTION	UNITS	DATA CAT	GENERATING UNIT DATA
Alternative Fuel Type (*please specify)	Text	DPD II	1	2 3 4 Other gas* Other* Other*
CHANGEOVER TO ALTERNATIVE FUEL				
For off-line changeover:				
Time to carry out off-line fuel changeover	Minutes	DPD II		
Maximum output following off-line changeover	MW	DPD II		
For on-line changeover:				
Time to carry out on-line fuel changeover	Minutes	DPD II		
Maximum output during on-line fuel changeover	MW	DPD II		
Maximum output following on-line changeover	MW	DPD II		
Maximum operating time at full load assuming:				
Typical stock levels	Hours	DPD II		
Maximum possible stock levels	Hours	DPD II		
Maximum rate of replacement of depleted stocks of alternative fuels on the basis of Good Industry Practice	MWh(electrical) /day	DPD II		
Is changeover to alternative fuel used in normal operating arrangements?	Text	DPD II		
Number of successful changeovers carried out in the last Financial Year (** delete as appropriate)	Text	DPD II	0 / 1-5 / 6-10 / 11-20 / >20 **	0 / 1-5 / 6-10 / 11-20 / >20 **

SCHEDULE 15 – MOTHBALLED POWER GENERATING MODULES, MOTHBALLED GENERATING UNIT, MOTHBALLED POWER PARK MODULE (INCLUDING MOTHBALLED DC CONNECTED POWER PARK MODULES), MOTHBALLED HVDC SYSTEMS, MOTHBALLED HVDC CONVERTERS MOTHBALLED DC CONVERTERS AT A DC CONVERTER STATION AND ALTERNATIVE FUEL DATA

DATA DESCRIPTION	UNITS	DATA CAT	GENERATING UNIT DATA			
			1	2	3	4
CHANGEOVER BACK TO MAIN FUEL						
For off-line changeover:						
Time to carry out off-line fuel changeover	Minutes					
For on-line changeover:						
Time to carry out on-line fuel changeover	Minutes					
Maximum output during on-line fuel changeover	MW					

Notes

1. Where a **Generating Unit** has the facilities installed to generate using more than one alternative fuel type details of each alternative fuel should be given.
2. Significant factors and their effects which may prevent the use of alternative fuels achieving the estimated values provided in this table (e.g. emissions limits, distilled water stocks etc.) should be appended separately.

SCHEDULE 16 - BLACK START INFORMATION

PAGE 1 OF 2

PART I

BLACK START INFORMATION The following data/text items are required from each Generator for each BM Unit at a Large Power Station as detailed in PC.A.5.7. Data is not required for Generating Units that are contracted to provide Black Start Capability , or Electricity Storage Modules which have short cycle times. The data should be provided in accordance with PC.A.1.2 and also, where possible, upon request from The Company during a Black Start .			Data Category
Data Description (PC.A.5.7) (■ CUSC Contract)	Units	Data Category	
Assuming all BM Units were running immediately prior to the Total Shutdown or Partial Shutdown and in the event of loss of all external power supplies, provide the following information:			
a) Expected time for the first and subsequent BM Units to be Synchronised , from the restoration of external power supplies, assuming external power supplies are not available for up to 24hrs	Tabular or Graphical	DPD II	
b) Describe any likely issues that would have a significant impact on a BM Unit's time to be Synchronised arising as a direct consequence of the inherent design or operational practice of the Power Station and/or BM Unit , e.g. limited barring facilities, time from a Total Shutdown or Partial Shutdown at which batteries would be discharged.	Text	DPD II	
Block Loading Capability:			
c) Provide estimated Block Loading Capability from 0MW to Registered Capacity of each BM Unit based on the unit being 'hot' (run prior to shutdown) and also 'cold' (not run for 48hrs or more prior to the shutdown). The Block Loading Capability should be valid for a frequency deviation of 49.5Hz – 50.5Hz. The data should identify any required 'hold' points.	Tabular or Graphical	DPD II	

SCHEDULE 16 - BLACK START INFORMATION

PAGE 1 OF 2

PART II

Data Description (PC.A.5.7) (■ CUSC Contract)	Units	Data Category
<p>BLACK START INFORMATION The following data/text items are required from each HVDC System Owner or DC Converter Station Owner for each HVDC System and DC Converter Station as detailed in PC.A.5.7. Data is not required for HVDC Systems and DC Converter Stations that are contracted to provide a Black Start Capability. The data should be provided in accordance with PC.A. 1.2 and also, where possible, upon request from The Company during a Black Start.</p> <p>Assuming all BM Units were running immediately prior to the Total Shutdown or Partial Shutdown and in the event of loss of all external power supplies, provide the following information:</p>		
a) Expected time for the first and subsequent BM Units to be Synchronised , from the restoration of external power supplies, assuming external power supplies are not available for up to 24hrs	Tabular or Graphical	DPD II
b) Describe any likely issues that would have a significant impact on a BM Units time to be Synchronised arising as a direct consequence of the inherent design or operational practice of the HVDC System or DC Converter Station and/or BM Unit , e.g. time from a Total Shutdown or Partial Shutdown at which batteries would be discharged.	Text	DPD II
Block Loading Capability:		
c) Provide estimated incremental Active Power steps, form no load to Rated MW which an HVDC System or DC Converter Station can instantaneously supply without causing it to trip or go outside the Frequency range of 47.5Hz – 52Hz (or an otherwise agreed Frequency range). The time between each incremental step shall also be provided. In addition data should be provided from 0MW to Registered Capacity of each BM Unit based on the HVDC System or DC Converter Station being (not run for 48hrs or more prior to the shutdown) or run immediately before the Partial Shutdown or Total Shutdown . The data supplied should be valid for a Frequency deviation of 49.5Hz – 50.5Hz and should identify any required 'hold' points.	Tabular or Graphical	DPD II

SCHEDULE 17 - ACCESS PERIOD DATA

PAGE 1 OF 1

(PC.A.4 - CUSC Contract ■)

Submissions by **Users** using this Schedule 17 shall commence in 2011 and shall then continue in each year thereafter

Access Group	
---------------------	--

Asset Identifier	Start Week	End Week	Maintenance Year (1, 2 or 3)	Duration	Potential Concurrent Outage (Y/N)

Comments

SCHEDULE 18 - OFFSHORE TRANSMISSION SYSTEM DATA

PAGE 1 OF 24

The data in this Schedule 18 is required from **Generators** who are undertaking **OTSDUW** and connecting to a **Transmission Interface Point**.

DATA DESCRIPTION	UNITS	DATA to RTL		DATA CAT.	GENERATING UNIT OR STATION DATA						
		CUSC Cont ract	CUSC App. Form		F.Yr0	F.Yr1	F.Yr2	F.Yr3	F.Yr4	F.Yr5	F.Yr 6
INDIVIDUAL OTSDUW DATA											
Interface Point Capacity (PC.A.3.2.2 (a)) Performance Chart at the Transmission Interface Point for OTSDUW Plant and Apparatus (PC.A.3.2.2(f)(iv))	MW MVA _r	<input type="checkbox"/>	<input checked="" type="checkbox"/>								
OTSDUW DEMANDS											
Demand associated with the OTSDUW Plant and Apparatus (excluding OTSDUW DC Converters – see Note 1)) supplied at each Interface Point. The User should also provide the Demand supplied to each Connection Point on the OTSDUW Plant and Apparatus. (PC.A.5.2.5)											
- The maximum Demand that could occur. - Demand at specified time of annual peak half hour of National Electricity Transmission System Demand at Annual ACS Conditions.	MW MVA _r MW MVA _r	<input type="checkbox"/> <input type="checkbox"/> <input type="checkbox"/> <input type="checkbox"/>		DPD I DPD I DPD II DPD II							
Demand at specified time of annual minimum half-hour of National Electricity Transmission System Demand.	MW MVA _r	<input type="checkbox"/> <input type="checkbox"/>		DPD II DPD II							
(Note 1 – Demand required from OTSDUW DC Converters should be supplied under page 2 of Schedule 18).											

SCHEDULE 18 - OFFSHORE TRANSMISSION SYSTEM DATA

PAGE 2 OF 24

OTSDUW USERS SYSTEM DATA

DATA DESCRIPTION	UNITS	DATA to RTL		DATA CATEGORY
		CUSC Contract	CUSC App. Form	
OFFSHORE TRANSMISSION SYSTEM LAYOUT (PC.A.2.2.1, PC.A.2.2.2 and P.C.A.2.2.3)				
A Single Line Diagram showing connectivity of all of the Offshore Transmission System including all Plant and Apparatus between the Interface Point and all Connection Points is required.		■	■	SPD
This Single Line Diagram shall depict the arrangement(s) of all of the existing and proposed load current carrying Apparatus relating to both existing and proposed Interface Points and Connection Points , showing electrical circuitry (i.e. overhead lines, underground cables (including subsea cables), power transformers and similar equipment), operating voltages, circuit breakers and phasing arrangements		■	■	SPD
Operational Diagrams of all substations within the OTSDUW Plant and Apparatus		■	■	SPD
SUBSTATION INFRASTRUCTURE (PC.A.2.2.6)				
For the infrastructure associated with any OTSDUW Plant and Apparatus				
Rated 3-phase rms short-circuit withstand current	kA	■	■	SPD
Rated 1-phase rms short-circuit withstand current	kA	■	■	SPD
Rated Duration of short-circuit withstand	s	■	■	SPD
Rated rms continuous current	A	■	■	SPD
LUMPED SUSCEPTANCES (PC.A.2.3)				
Equivalent Lumped Susceptance required for all parts of the User's Subtransmission System (including OTSDUW Plant and Apparatus) which are not included in the Single Line Diagram.				
This should not include:				
(a)	independently switched reactive compensation equipment identified above.	■	■	
(b)	any susceptance of the OTSDUW Plant and Apparatus inherent in the Demand (Reactive Power) data provided on Page 1 and 2 of this Schedule 14.	■	■	
Equivalent lumped shunt susceptance at nominal Frequency .	% on 100 MVA	■	■	

SCHEDULE 18 - OFFSHORE TRANSMISSION SYSTEM DATA
PAGE 3 OF 24

OFFSHORE TRANSMISSION SYSTEM DATA
 Branch Data (PC.A.2.2.4)

Node 1	Node 2	Rated Voltage (kV)	Operating Voltage (kV)	Circuit	PPS PARAMETERS			ZPS PARAMETERS			Maximum Continuous Ratings			Length (km)
					R1 %100 MVA	X1 %100 MVA	B 1 %100 MVA	R0 %100 MVA	X0 %100M VA	B0 %100M VA	Winter (MVA)	Spring Autumn (MVA)	Summer (MVA)	

Notes

1. For information equivalent STC Reference: STCP12-1m Part 3 – 2.1 Branch Data
2. In the case where an overhead line exists within the OTSDUW Plant and Apparatus the Mutual inductances should also be provided.

SCHEDULE 18 - OFFSHORE TRANSMISSION SYSTEM DATA
PAGE 4 OF 24

OFFSHORE TRANSMISSION SYSTEM DATA

2 Winding Transformer Data (PC.A.2.2.5)

The data below is **Standard Planning Data**, and details should be shown below of all transformers shown on the **Single Line Diagram**

HV Node	HV (kV)	LV Node	LV (kV)	Rating (MVA)	Trans-former	Positive Phase Sequence Reactance % on 100MVA			Positive Phase Sequence Resistance % on 100 MVA			Tap Changer			Winding Arr.	Earthing Method (Direct /Res /Reac)	Earthing Imped Ance method
						Max Tap	Min Tap	Nom Tap	Max Tap	Min Tap	Nom Tap	Range +% to -%	Step size %	type			

Notes

1 For information the corresponding STC Reference is STCP12-1: Part 3 – 2.4 Transformers

SCHEDULE 18 - OFFSHORE TRANSMISSION SYSTEM DATA

OFFSHORE TRANSMISSION SYSTEM DATA

Circuit Breaker Data (PC-A.2.2.6(a))

The data below is all **Standard Planning Data**, and should be provided for all **OTSUA** switchgear (i.e. circuit breakers, load disconnectors and disconnectors)

Location	Circuit Breaker Data							Assumed Operating Times			3 Phase				1 Phase				DC time constant at testing of asymmetrical breaking ability (s)		
	Name	Rated Voltage	Operating Voltage	Make	Model	Type	Year Commissioned	Circuit Breaker (mS)	Minimum Protection & Trip Relay (mS)	Total Time (mS)	Continuous Rating (A)	Fault Rating (RMS Symmetrical) (3 phase) (MVA)	Fault Break Rating (RMS Symmetrical) (3 phase) (kA)	Fault Break Rating (Peak Asymmetrical) (3 phase) (kA)	Fault Make Rating (Peak Asymmetrical) (3 phase) (kA)	Fault Rating (RMS Symmetrical) (1 phase) (MVA)	Fault Break Rating (RMS Symmetrical) (1 phase) (kA)	Fault Break Rating (Peak Asymmetrical) (1 phase) (kA)		Fault Make Rating (Peak Asymmetrical) (1 phase) (kA)	

SCHEDULE 18 - OFFSHORE TRANSMISSION SYSTEM DATA

PAGE 7 OF 24

OFFSHORE TRANSMISSION SYSTEM DATA

REACTIVE COMPENSATION EQUIPMENT (PC.A.2.4(e))

Item	Node	kV	Device No.	Rating (MVar)	P Loss (kW)	Tap range	Connection Arrangement

Notes:

1. For information STC Reference: STCP12-1: Part 3 - 2.5 Reactive Compensation Equipment
2. Data relating to continuously variable reactive compensation equipment (such as statcoms or SVCs) should be entered on the SVC Modelling table.
3. For the avoidance of doubt this includes any AC Reactive Compensation equipment included within the OTSDUW DC Converter other than harmonic filter data which is to be entered in the harmonic filter data table.

<i>PC.A.2.4.1(e)</i>	A mathematical representation in block diagram format to model the control of any dynamic compensation plant. The model should be suitable for RMS dynamic stability type studies in which the time constants used should not be less than 10ms.
----------------------	--

SCHEDULE 18 - OFFSHORE TRANSMISSION SYSTEM DATA

OFFSHORE TRANSMISSION SYSTEM DATA

REACTIVE COMPENSATION - SVC Modelling Data (PC.A.2.4.1(e)(iii))

HV Node	LV Node	Control Node	Nominal Voltage (kV)	Target Voltage (kV)	Max MVAR at HV	Min MVAR at HV	Slope %	Voltage Dependant Q Limit	Normal Running Mode	R1 PPS_R	X1 PPS_X	R0 ZPS_R	X0 ZPS_X	Transf. Winding Type	Connection (Direct/Tertiary)

Notes:

1. For information the equivalent STC Reference is: STCP12-1: Part 3 - 2.7 SVC Modelling Data

SCHEDULE 18 - OFFSHORE TRANSMISSION SYSTEM DATA

PAGE 9 OF 24

OFFSHORE TRANSMISSION SYSTEM DATA

Harmonic Filter Data (including OTSDUW DC Converter harmonic Filter Data)
(PC.A.5.4.3.1(d) and PC.A.6.4.2)

Site Name	SLD Reference	Point of Filter Connection		
Filter Description				
Manufacturer	Model	Filter Type	Filter connection type (Delta/Star, Grounded/ Ungrounded)	Notes
Bus Voltage	Rating	Q factor	Tuning Frequency	Notes
Component Parameters (as per SLD)				
Parameter as applicable				
Filter Component (R, C or L)	Capacitance (micro-Farads)	Inductance (milli-Henrys)	Resistance (Ohms)	Notes
Filter frequency characteristics (graphs) detailing for frequency range up to 10kHz and higher				
<ol style="list-style-type: none"> 1. Graph of impedance (ohm) against frequency (Hz) 2. Graph of angle (degree) against frequency (Hz) 3. Connection diagram of Filter & Elements 				

Notes:

1. For information STC Reference: STCP12-1: Part 3 - 2.8 Harmonic Filter Data

SCHEDULE 18 - OFFSHORE TRANSMISSION SYSTEM DATA

PAGE 10 OF 24

Information for Transient Overvoltage Assessment (DPD I) (PC.A.6.2 ■ CUSC Contract)

The information listed below may be requested by **The Company** from each **User** undertaking **OTSDUW** with respect to any **Interface Point** or **Connection Point** to enable **The Company** to assess transient overvoltage on the **National Electricity Transmission System**.

- (a) Busbar layout plan(s), including dimensions and geometry showing positioning of any current and voltage transformers, through bushings, support insulators, disconnectors, circuit breakers, surge arresters, etc. Electrical parameters of any associated current and voltage transformers, stray capacitances of wall bushings and support insulators, and grading capacitances of circuit breakers;
- (b) Electrical parameters and physical construction details of lines and cables connected at that busbar. Electrical parameters of all plant e.g., transformers (including neutral earthing impedance or zig-zag transformers if any), series reactors and shunt compensation equipment connected at that busbar (or to the tertiary of a transformer) or by lines or cables to that busbar;
- (c) Basic insulation levels (BIL) of all **Apparatus** connected directly, by lines or by cables to the busbar;
- (d) Characteristics of overvoltage **Protection** devices at the busbar and at the termination points of all lines, and all cables connected to the busbar;
- (e) Fault levels at the lower voltage terminals of each transformer connected to each **Interface Point** or **Connection Point** without intermediate transformation;
- (f) The following data is required on all transformers within the **OTSDUW Plant and Apparatus**.
- (g) An indication of which items of equipment may be out of service simultaneously during **Planned Outage** conditions.

Harmonic Studies (DPD I) (PC.A.6.4 ■ CUSC Contract)

The information given below, both current and forecast, where not already supplied in this Schedule 14 may be requested by **The Company** from each **User** if it is necessary for **The Company** to evaluate the production/magnification of harmonic distortion on **National Electricity Transmission System**. The impact of any third party **Embedded** within the **User's System** should be reflected:-

- (a) Overhead lines and underground cable circuits (including subsea cables) of the **User's OTSDUW Plant and Apparatus** must be differentiated and the following data provided separately for each type:-

- Positive phase sequence resistance
- Positive phase sequence reactance
- Positive phase sequence susceptance

- (b) for all transformers connecting the **OTSDUW Plant and Apparatus** to a lower voltage:-

- Rated MVA
- Voltage Ratio
- Positive phase sequence resistance
- Positive phase sequence reactance

SCHEDULE 18 - OFFSHORE TRANSMISSION SYSTEM DATA

PAGE 11 OF 24

- (c) at the lower voltage points of those connecting transformers:-

Equivalent positive phase sequence susceptance

Connection voltage and MVA_r rating of any capacitor bank and component design parameters if configured as a filter

Equivalent positive phase sequence interconnection impedance with other lower voltage points

The minimum and maximum **Demand** (both MW and MVA_r) that could occur

Harmonic current injection sources in Amps at the Connection Points and Interface Points

- (d) an indication of which items of equipment may be out of service simultaneously during **Planned Outage** conditions

Voltage Assessment Studies (DPD I) (PC.A.6.5 ■ CUSC Contract)

The information listed below, where not already supplied in this Schedule 14, may be requested by **The Company** from each **User** undertaking **OTSDUW** with respect to any **Connection Point** or **Interface Point** if it is necessary for **The Company** to undertake detailed voltage assessment studies (e.g. to examine potential voltage instability, voltage control co-ordination or to calculate voltage step changes on the **National Electricity Transmission System**).

- (a) For all circuits of the **User's OTSDUW Plant and Apparatus**:-

Positive Phase Sequence Reactance

Positive Phase Sequence Resistance

Positive Phase Sequence Susceptance

MVA_r rating of any reactive compensation equipment

- (b) for all transformers connecting the **User's OTSDUW Plant and Apparatus** to a lower voltage:-

Rated MVA

Voltage Ratio

Positive phase sequence resistance

Positive Phase sequence reactance

Tap-changer range

Number of tap steps

Tap-changer type: on-load or off-circuit

AVC/tap-changer time delay to first tap movement

AVC/tap-changer inter-tap time delay

- (c) at the lower voltage points of those connecting transformers

Equivalent positive phase sequence susceptance

MVA_r rating of any reactive compensation equipment

Equivalent positive phase sequence interconnection impedance with other lower voltage points

The maximum **Demand** (both MW and MVA_r) that could occur

Estimate of voltage insensitive (constant power) load content in % of total load at both winter peak and 75% off-peak load conditions

SCHEDULE 18 - OFFSHORE TRANSMISSION SYSTEM DATA

PAGE 12 OF 24

Short Circuit Analyses:(DPD I) (PC.A.6.6 ■ CUSC Contract)

The information listed below, both current and forecast, and where not already supplied under this Schedule 14, may be requested by **The Company** from each **User** undertaking **OTSDUW** with respect to any **Connection Point** or **Interface Point** where prospective short-circuit currents on **Transmission** equipment are close to the equipment rating.

(a) For all circuits of the **User's OTSDUW Plant and Apparatus:-**

- Positive phase sequence resistance
- Positive phase sequence reactance
- Positive phase sequence susceptance
- Zero phase sequence resistance (both self and mutuals)
- Zero phase sequence reactance (both self and mutuals)
- Zero phase sequence susceptance (both self and mutuals)

(b) For all transformers connecting the **User's OTSDUW Plant and Apparatus** to a lower voltage:-

- Rated MVA
- Voltage Ratio
- Positive phase sequence resistance (at max, min and nominal tap)
- Positive Phase sequence reactance (at max, min and nominal tap)
- Zero phase sequence reactance (at nominal tap)
- Tap changer range
- Earthing method: direct, resistance or reactance
- Impedance if not directly earthed

(c) At the lower voltage points of those connecting transformers:-

The maximum **Demand** (in MW and MVA_r) that could occur Short-circuit infeed data in accordance with PC.A.2.5.6(a) unless the **User's OTSDUW Plant and Apparatus** runs in parallel with the **Subtransmission System**, when to prevent double counting in each node infeed data, a π equivalent comprising the data items of PC.A.2.5.6(a) for each node together with the positive phase sequence interconnection impedance between the nodes shall be submitted.

SCHEDULE 18 - OFFSHORE TRANSMISSION SYSTEM DATA

Fault infeed data to be submitted by OTSDUW Plant and Apparatus providing a fault infeed (including OTSDUW DC Converters) (PC.A.2.5.5)

A submission is required for **OTSDUW Plant and Apparatus** (including **OTSDUW DC Converters** at each **Transmission Interface Point** and **Connection Point**. The submission shall represent operating conditions that result in the maximum fault infeed. The fault current from all auxiliaries of the **OTSDUW Plant and Apparatus** at the **Transmission Interface Point** and **Connection Point** shall be included. The fault infeed shall be expressed as a fault current at the **Transmission Interface Point** and also at each **Connection Point**.

Should actual data in respect of fault infeeds be unavailable at the time of the application for a **CUSC Contract** or **Embedded Development Agreement**, a limited subset of the data, representing the maximum fault infeed that may result from the **OTSDUW Plant and Apparatus**, shall be submitted. This data will, as a minimum, represent the root mean square of the positive, negative and zero sequence components of the fault current for both single phase and three phase solid faults at each **Connection Point** and **Interface Point** at the time of fault application and 50ms following fault application. Actual data in respect of fault infeeds shall be submitted to **The Company** as soon as it is available, in line with PC.A.1.2.

DATA DESCRIPTION	UNITS	F.Yr.	F.Yr.	F.Yr.	F.Yr.	F.Yr.	F.Yr.	F.Yr.	F.Yr.	DATA to RTL	
		<u>0</u>	<u>1</u>	<u>2</u>	<u>3</u>	<u>4</u>	<u>5</u>	<u>6</u>	<u>7</u>	CUSC Contract	CUSC App. Form
(PC.A.2.5)											
Name of OTSDUW Plant and Apparatus											
OTSDUW DC Converter type (i.e. voltage or current source)											
<p>A submission shall be provided for the contribution of each OTSDUW Plant and Apparatus to the positive, negative and zero sequence components of the short circuit current at the Interface Point and each Connection Point for</p> <ul style="list-style-type: none"> (i) a solid symmetrical three phase short circuit (ii) a solid single phase to earth short circuit (iii) a solid phase to phase short circuit (iv) a solid two phase to earth short circuit <p>If protective controls are used and active for the above conditions, a submission shall be provided in the limiting case where the protective control is not active. This case may require application of a non-solid fault, resulting in a retained voltage at the fault point.</p>										<input type="checkbox"/> <input type="checkbox"/> <input type="checkbox"/> <input type="checkbox"/> <input type="checkbox"/> <input type="checkbox"/>	<input checked="" type="checkbox"/> <input checked="" type="checkbox"/> <input checked="" type="checkbox"/> <input checked="" type="checkbox"/> <input checked="" type="checkbox"/>

SCHEDULE 18 - OFFSHORE TRANSMISSION SYSTEM DATA

PAGE 14 OF 24

DATA DESCRIPTION	UNITS	F.	F.	F.	F.	F.	F.	F.	F.	F.	DATA to	
		Yr.	Yr.	Yr.	Yr.	Yr.	Yr.	Yr.	Yr.	Yr.	Yr.	RTL
		0	1	2	3	4	5	6	7		CUSC Contract	CUSC App. Form
- A continuous time trace and table showing the root mean square of the positive, negative and zero sequence components of the fault current from the time of fault inception to 140ms after fault inception at 10ms intervals	Graphical and tabular kA versus s										<input type="checkbox"/>	<input checked="" type="checkbox"/>
- A continuous time trace and table showing the positive, negative and zero sequence components of retained voltage at the Interface Point and each Connection Point , if appropriate	p.u. versus s										<input type="checkbox"/>	<input checked="" type="checkbox"/>
- A continuous time trace and table showing the root mean square of the positive, negative and zero sequence components of retained voltage at the fault point, if appropriate	p.u. versus s										<input type="checkbox"/>	<input checked="" type="checkbox"/>
Positive sequence X/R ratio of the equivalent at time of fault at the Interface Point and each Connection Point											<input type="checkbox"/>	<input checked="" type="checkbox"/>
Minimum zero sequence impedance of the equivalent at the Interface Point and each Connection Point											<input type="checkbox"/>	<input checked="" type="checkbox"/>
Active Power transfer at the Interface Point and each Connection Point pre-fault	MW										<input type="checkbox"/>	<input checked="" type="checkbox"/>
Power Factor (lead or lag)											<input type="checkbox"/>	<input checked="" type="checkbox"/>
Pre-fault voltage (if different from 1.0 p.u.) at fault point (See note 1)	p.u.										<input type="checkbox"/>	<input checked="" type="checkbox"/>
Items of reactive compensation switched in pre-fault											<input type="checkbox"/>	<input checked="" type="checkbox"/>

Note 1. The pre-fault voltage provided above should represent the voltage within the range 0.95 to 1.05 that gives the highest fault current

SCHEDULE 18 - OFFSHORE TRANSMISSION SYSTEM DATA

Thermal Ratings Data (PC.A.2.2.4)

Voltage
132kV

CIRCUIT RATING SCHEDULE

<i>Offshore TO Name</i>
Issue Date

CIRCUIT Name from Site A – Site B

OVERALL CCT RATINGS		Winter				Spring/Autumn				Summer			
		%Nom	Limit	Amps	MVA	%Nom	Limit	Amps	MVA	%Nom	Limit	Amps	MVA
Pre-Fault Continuous		84%	Line	485	111	84%	Line	450	103	84%	Line	390	89
Post-Fault Continuous		100%	Line	580	132	100%	Line	540	123	100%	Line	465	106
Prefault load exceeds line prefault continuous rating	6hr	95%	Line	580	132	95%	Line	540	123	95%	Line	465	106
	20m		Line	580	132		Line	540	123		Line	465	106
	10m	mva	Line	580	132	mva	Line	540	123	mva	Line	465	106
	5m	125	Line	580	132	116	Line	540	123	100	Line	465	106
	3m		Line	580	132		Line	540	123		Line	465	106
Short Term Overloads	6hr	90%	Line	580	132	90%	Line	540	123	90%	Line	465	106
	20m		Line	580	132		Line	540	123		Line	465	106
	10m	mva	Line	580	132	mva	Line	540	123	mva	Line	465	106
	5m	118	Line	580	132	110	Line	540	123	95	Line	465	106
	3m		Line	580	132		Line	540	123		Line	465	106
Limiting Item and permitted overload values for different times and pre-fault loads	6hr	84%	Line	580	132	84%	Line	540	123	84%	Line	465	106
	20m		Line	590	135		Line	545	125		Line	470	108
	10m	mva	Line	630	144	mva	Line	580	133	mva	Line	495	113
	5m	110	Line	710	163	103	Line	655	149	89	Line	555	126
	3m		Line	810	185		Line	740	170		Line	625	143
	6hr	75%	Line	580	132	75%	Line	540	123	75%	Line	465	106
	20m		Line	595	136		Line	555	126		Line	475	109
	10m	mva	Line	650	149	mva	Line	600	137	mva	Line	510	116
	5m	99	Line	760	173	92	Line	695	159	79	Line	585	134
	3m		Line	885	203		Line	810	185		Line	685	156
	6hr	60%	Line	580	132	60%	Line	540	123	60%	Line	465	106
	20m		Line	605	138		Line	560	128		Line	480	110
	10m	mva	Line	675	155	mva	Line	620	142	mva	Line	530	121
	5m	79	Line	820	187	73	Line	750	172	63	Line	635	145
	3m		Line	985	226		Line	900	206		Line	755	173
	6hr	30%	Line	580	132	30%	Line	540	123	30%	Line	465	106
	20m		Line	615	141		Line	570	130		Line	490	112
	10m	mva	Line	710	163	mva	Line	655	150	mva	Line	555	127
	5m	39	Line	895	205	36	Line	820	187	31	Line	690	158
	3m		Line	1110	255		Line	1010	230		Line	845	193

SCHEDULE 18 - OFFSHORE TRANSMISSION SYSTEM DATA
PAGE 16 OF 24

6hr												
20m												
10m												
5m												
3m												
6hr												
20m												
10m												
5m												
3m												
Notes or Restrictions Detailed												

- Notes: 1. For information the equivalent STC Reference: STCP12-1: Part 3 - 2.6 Thermal Ratings
 2. The values shown in the above table is example data.

SCHEDULE 18 - OFFSHORE TRANSMISSION SYSTEM DATA

PAGE 17 OF 24

Protection Policy (PC.A.6.3)

To include details of the protection policy

Protection Schedules(PC.A.6.3)

Data schedules for the protection systems associated with each primary plant item including:

Protection, Intertrip Signalling & operating times

Intertripping and protection unstabilisation initiation

Synchronising facilities

Delayed Auto Reclose sequence schedules

Automatic Switching Scheme Schedules (PC.A.2.2.7)

A diagram of the scheme and an explanation of how the system will operate and what plant will be affected by the scheme's operation.

SCHEDULE 18 - OFFSHORE TRANSMISSION SYSTEM DATA
PAGE 18 OF 24

GENERATOR INTERTRIP SCHEMES (PC.A.2.2.7(b))

Substation: _____

Details of Generator Intertrip Schemes:

A diagram of the scheme and an explanation of how the system will operate and what plant will be effected by the schemes operation.

DEMAND INTERTRIP SCHEMES (PC.A.2.2.7(b))

Substation: _____

Details of Demand Intertrip Schemes:

A diagram of the scheme and an explanation of how the system will operate and what plant will be effected by the schemes operation

SCHEDULE 18 - OFFSHORE TRANSMISSION SYSTEM DATA

PAGE 19 OF 24

Specific Operating Requirements (CC.5.2.1 or ECC.5.2.1)

SUBSTATION OPERATIONAL GUIDE

Substation: _____

Location Details:

Postal Address:	Telephone Nos.	Map Ref.
Transmission Interface		
Generator Interface		

- 1. Substation Type:**
- 2. Voltage Control:** *(short description of voltage control system. To include mention of modes i.e. Voltage, manual etc. Plus control step increments i.e. 0.5% or 0.33kV)*
- 3. Energisation Switching Information:** *(The standard energisation switching process from dead.)*
- 4. Intertrip Systems:**
- 5. Reactive Plant Outage:** *(A short explanation of any system re-configurations required to facilitate the outage of any reactive plant which form part of the OTSDUW Plant and Apparatus equipment. Also any generation restrictions required).*
- 6. Harmonic Filter Outage:** *(An explanation as to any OTSDUW Plant and Apparatus reconfigurations required to facilitate the outage and maintain the system within specified Harmonic limits, also any generation restrictions required).*

SCHEDULE 18 - OFFSHORE TRANSMISSION SYSTEM DATA

PAGE 20 OF 24

OTSDUW DC CONVERTER TECHNICAL DATA

OTSDUW DC CONVERTER NAME _____

DATE: _____

Data Description	Units	DATA to RTL		Data Category	DC Converter Station Data
		CUSC Contract	CUSC App. Form		
(PC.A.4 and PC.A.5.2.5)					
<p>OTSDUW DC CONVERTER (CONVERTER DEMANDS):</p> <p>Demand supplied through Station Transformers associated with the OTSDUW DC Converter at each Interface Point and each Offshore Connection Point Grid Entry Point [PC.A.4.1]</p> <p>- Demand with all OTSDUW DC Converters operating at Interface Point Capacity .</p> <p>- Demand with all OTSDUW DC Converters operating at maximum Interface Point flow from the Interface Point to each Offshore Grid Entry Point .</p> <p>- The maximum Demand that could occur.</p> <p>- Demand at specified time of annual peak half hour of The Company Demand at Annual ACS Conditions.</p> <p>- Demand at specified time of annual minimum half-hour of The Company Demand.</p>	<p>MW MVA_r</p> <p>MW MVA_r</p> <p>MW MVA_r</p> <p>MW MVA_r</p> <p>MW MVA_r</p>	<p><input type="checkbox"/> <input type="checkbox"/></p> <p><input type="checkbox"/> <input type="checkbox"/></p> <p><input type="checkbox"/> <input type="checkbox"/></p> <p><input type="checkbox"/> <input type="checkbox"/></p> <p><input type="checkbox"/> <input type="checkbox"/></p>	<p><input type="checkbox"/> <input type="checkbox"/></p> <p><input type="checkbox"/> <input type="checkbox"/></p> <p><input type="checkbox"/> <input type="checkbox"/></p> <p><input type="checkbox"/> <input type="checkbox"/></p>	<p>DPD II DPD II</p> <p>DPD II DPD II</p> <p>DPD II DPD II</p> <p>DPD II DPD II</p> <p>DPD II</p>	
OTSDUW DC CONVERTER DATA	Text	<input type="checkbox"/>	<input checked="" type="checkbox"/>	SPD+	
Number of poles, i.e. number of OTSDUW DC Converters	Text	<input type="checkbox"/>	<input checked="" type="checkbox"/>	SPD+	
Pole arrangement (e.g. monopole or bipole)	Diagram	<input type="checkbox"/>			
Return path arrangement					
Details of each viable operating configuration					
Configuration 1	Diagram	<input type="checkbox"/>	<input checked="" type="checkbox"/>	SPD+	
Configuration 2	Diagram	<input type="checkbox"/>	<input checked="" type="checkbox"/>		
Configuration 3	Diagram	<input type="checkbox"/>	<input checked="" type="checkbox"/>		
Configuration 4	Diagram	<input type="checkbox"/>	<input checked="" type="checkbox"/>		
Configuration 5	Diagram	<input type="checkbox"/>	<input checked="" type="checkbox"/>		
Configuration 6	Diagram	<input type="checkbox"/>	<input checked="" type="checkbox"/>		

SCHEDULE 18 - OFFSHORE TRANSMISSION SYSTEM DATA

Data Description	Units	DATA to RTL		Data Category	Operating Configuration					
		CUSC Contract	CUSC App. Form		1	2	3	4	5	6
OTSDUW DC CONVERTER DATA <i>(PC.A.3.3.1(d))</i>										
OTSDUW DC Converter Type (e.g. current or Voltage source)	Text	<input type="checkbox"/>	<input checked="" type="checkbox"/>	SPD						
If the busbars at the Interface Point or Connection Point are normally run in separate sections identify the section to which the OTSDUW DC Converter configuration is connected	Section Number	<input type="checkbox"/>	<input checked="" type="checkbox"/>	SPD						
Rated MW import per pole (PC.A.3.3.1)	MW	<input type="checkbox"/>	<input checked="" type="checkbox"/>	SPD+						
Rated MW export per pole (PC.A.3.3.1)	MW	<input type="checkbox"/>	<input checked="" type="checkbox"/>	SPD+						
ACTIVE POWER TRANSFER CAPABILITY <i>(PC.A.3.2.2)</i>										
Interface Point Capacity	MW MVA _r	<input type="checkbox"/> <input type="checkbox"/>	<input checked="" type="checkbox"/> <input checked="" type="checkbox"/>	SPD SPD						
OTSDUW DC CONVERTER TRANSFORMER <i>(PC.A.5.4.3.1)</i>										
Rated MVA	MVA	<input type="checkbox"/>		DPD II						
Winding arrangement	kV	<input type="checkbox"/>		DPD II						
Nominal primary voltage	kV	<input type="checkbox"/>		DPD II						
Nominal secondary (converter-side) voltage(s)		<input type="checkbox"/>								
Positive sequence reactance	% on	<input type="checkbox"/>		DPD II						
Maximum tap	MVA	<input type="checkbox"/>		DPD II						
Nominal tap	% on			DPD II						
Minimum tap	MVA									
Positive sequence resistance	% on	<input type="checkbox"/>		DPD II						
Maximum tap	MVA	<input type="checkbox"/>		DPD II						
Nominal tap	% on	<input type="checkbox"/>		DPD II						
Minimum tap	MVA	<input type="checkbox"/>		DPD II						
Zero phase sequence reactance	MVA	<input type="checkbox"/>		DPD II						
Tap change range	% on			DPD II						
Number of steps	MVA									
	% on									
	MVA									
	% on									
	MVA									
	+% / -%									

SCHEDULE 18 - OFFSHORE TRANSMISSION SYSTEM DATA
PAGE 22 OF 24

Data Description	Units	DATA to RTL		Data Category	Operating configuration						
		CUSC Contract	CUSC App. Form		1	2	3	4	5	6	
OTSDUW DC CONVERTER NETWORK DATA (PC.A.5.4.3.1 (c)) Rated DC voltage per pole Rated DC current per pole Details of the OTSDUW DC Network described in diagram form including resistance, inductance and capacitance of all DC cables and/or DC lines. Details of any line reactors (including line reactor resistance), line capacitors, DC filters, earthing electrodes and other conductors that form part of the OTSDUW DC Network should be shown.	kV A Diagram	<input type="checkbox"/> <input type="checkbox"/> <input type="checkbox"/>		DPD II DPD II DPD II							

SCHEDULE 18 - OFFSHORE TRANSMISSION SYSTEM DATA
PAGE 23 OF 24

Data Description	Units	DATA to RTL		Data Category	Operating configuration					
		CUSC Contract	CUSC App. Form		1	2	3	4	5	6

OTSDUW DC CONVERTER CONTROL SYSTEMS

(PC.A.5.4.3.2)

Static $V_{DC} - P_{DC}$ (DC voltage – DC power) or Static $V_{DC} - I_{DC}$ (DC voltage – DC current) characteristic (as appropriate) when operating as
 –Rectifier
 –Inverter

Details of rectifier mode control system, in block diagram form together with parameters showing transfer functions of individual elements.

Details of inverter mode control system, in block diagram form showing transfer functions of individual elements including parameters (as applicable).

Details of **OTSDUW DC Converter** transformer tap changer control system in block diagram form showing transfer functions of individual elements including parameters.

Details of AC filter control systems in block diagram form showing transfer functions of individual elements including parameters

Details of any frequency and/or load control systems in block diagram form showing transfer functions of individual elements including parameters.

Details of any large or small signal modulating controls, such as power oscillation damping controls or sub-synchronous oscillation damping controls, that have not been submitted as part of the above control system data.

Transfer block diagram representation of the reactive power control at converter ends for a voltage source converter.

For **Generators** in respect of **OTSDUW** who are also **EU Code Users** details of **OTSDUW DC Converter** unit models and/or control systems in block diagram form showing transfer functions of individual elements including parameters.

For **Generators** in respect of **OTSDUW** who are also **EU Code Users** details of AC component models and/or control systems in block diagram form showing transfer functions of individual elements including parameters.

For **Generators** in respect of **OTSDUW** who are also **EU Code Users** details of DC Grid models and/or control systems in block diagram form showing transfer functions of individual elements including parameters.

For **Generators** in respect of **OTSDUW** who are also **EU Code Users** details of Voltage and power controller and/or control systems in block diagram form showing transfer functions of individual elements including parameters.

For **Generators** in respect of **OTSDUW** who are also **EU Code Users** details of Special control features if applicable (e.g. power oscillation

Diagram
 Diagram
 Diagram
 Diagram
 Diagram
 Diagram
 Diagram
 Diagram
 Diagram
 Diagram
 Diagram
 Diagram
 Diagram
 Diagram
 Diagram
 Diagram
 Diagram
 Diagram
 Diagram
 Diagram

DPD II
DPD II
DPD II
DPD II
DPD II
DPD II
DPD II
DPD II
DPD II
DPD II
DPD II
DPD II
DPD II
DPD II
DPD II
DPD II
DPD II
DPD II
DPD II
DPD II

Data Description	Units	DATA to RTL		Data Category	Operating configuration					
		CUSC Contract	CUSC App. Form		1	2	3	4	5	6
<p>damping (POD) function, subsynchronous torsional interaction (SSTI) control and/or control systems in block diagram form showing transfer functions of individual elements including parameters.</p> <p>For Generators in respect of OTSDUW who are also EU Code Users details of Multi terminal control, if applicable and/or control systems in block diagram form showing transfer functions of individual elements including parameters.</p> <p>For Generators in respect of OTSDUW who are also EU Code Users details of OTSDUW DC Converter protection models as agreed between The Company and the Generator (in respect of OTSDW) and/or control systems in block diagram form showing transfer functions of individual elements including parameters.</p>	Diagram	<input type="checkbox"/>		DPD II						
	Diagram	<input type="checkbox"/>		DPD II						

SCHEDULE 18 - OFFSHORE TRANSMISSION SYSTEM DATA

PAGE 24 OF 24

Data Description	Units	DATA to RTL		Data Category	Operating configuration					
		CUSC Contract	CUSC App. Form		1	2	3	4	5	6
LOADING PARAMETERS (PC.A.5.4.3.3)										
MW Export from the Offshore Grid Entry Point to the Transmission Interface Point	MW/s	<input type="checkbox"/>		DPD I DPD I						
Nominal loading rate	MW/s	<input type="checkbox"/>								
Maximum (emergency) loading rate				DPD II						
Maximum recovery time, to 90% of pre-fault loading, following an AC system fault or severe voltage depression.	s	<input type="checkbox"/>								
Maximum recovery time, to 90% of pre-fault loading, following a transient DC Network fault.	s	<input type="checkbox"/>		DPD II						

SCHEDULE 19 – USER DATA FILE STRUCTURE

PAGE 1 OF 2

The structure of the **User Data File Structure** is given below.

i.d.	Folder name	Description of contents
Part A: Commercial & Legal		
A2	Commissioning	Commissioning & Test Programmes
A3	Statements	Statements of Readiness
A9	AS Monitoring	Ancillary Services Monitoring
A10	Self-Certification	User Self Certification of Compliance
A11	Compliance statements	Compliance Statement
Part 1: Safety & System Operation		
1.1	Interface Agreements	Interface Agreements
1.2	Safety Rules	Safety Rules
1.3	Switching Procedures	Local Switching Procedures
1.4	Earthing	Earthing
1.5	SRS	Site Responsibility Schedules
1.6	Diagrams	Operational and Gas Zone Diagrams
1.7	Drawings	Site Common Drawings
1.8	Telephony	Control Telephony
1.9	Safety Procedures	Local Safety Procedures
1.10	Co-ordinators	Safety Co-ordinators
1.11	RISSP	Record of Inter System Safety Precautions
1.12	Tel Numbers	Telephone Numbers for Joint System Incidents
1.13	Contact Details	Contact Details (fax, tel, email)
1.14	Restoration Plan	Local Joint Restoration Plan (incl. black start if applicable)
1.15	Maintenance	Maintenance Standards
Part 2: Connection Technical Data		
2.1	DRC Schedule 5	DRC Schedule 5 – Users System Data
2.2	Protection Report	Protection Settings Reports
2.3	Special Automatic Facilities	Special Automatic Facilities e.g. intertrip
2.4	Operational Metering	Operational Metering
2.5	Tariff Metering	Tariff Metering
2.6	Operational Comms	Operational Communications
2.7	Monitoring	Performance Monitoring
2.8	Power Quality	Power Quality Test Results (if required)

SCHEDULE 19 – USER DATA FILE STRUCTURE

PAGE 2 OF 2

Part 3: Generator Technical Data		
3.1	DRC Schedule 1	DRC Schedule 1 - Generating Unit, Power Generating Module, HVDC System and DC Converter Technical Data
3.2	DRC Schedule 2	DRC Schedule 2 - Generation Planning Data
3.3	DRC Schedule 4	DRC Schedule 4 – Frequency Droop & Response
3.4	DRC Schedule 14	DRC Schedule 14 – Fault Infeed Data – Generators
3.5	Special Generator Protection	Special Generator Protection e.g. Pole slipping; islanding
3.6	Compliance Tests	Compliance Tests & Evidence
3.7	Compliance Studies	Compliance Simulation Studies
3.8	Site Specific	Bilateral Connections Agreement Technical Data & Compliance
Part 4: General DRC Schedules		
4.1	DRC Schedule 3	DRC Schedule 3 – Large Power Station Outage Information
4.2	DRC Schedule 6	DRC Schedule 6 – Users Outage Information
4.3	DRC Schedule 7	DRC Schedule 7 – Load Characteristics
4.4	DRC Schedule 8	DRC Schedule 8 – BM Unit Data (if applicable)
4.5	DRC Schedule 10	DRC Schedule 10 –Demand Profiles
4.6	DRC Schedule 11	DRC Schedule 11 – Connection Point Data
Part 5: OTSDUW Data And Information (if applicable and prior to OTSUA Transfer Time)		
		Diagrams Circuits Plant and Apparatus Circuit Parameters Protection Operation and Autoswitching Automatic Control Systems
		Mathematical model of dynamic compensation plant

< END OF DATA REGISTRATION CODE

GOVERNANCE RULES

(GR)

CONTENTS

(This contents page does not form part of the Grid Code)

<u>Paragraph No/Title</u>	<u>Page Number</u>
PART A	
GR.1 INTRODUCTION.....	2
PART B	
GR.2 CODE ADMINISTRATOR.....	2
GR.3 GRID CODE REVIEW PANEL.....	2
GR.4 APPOINTMENT OF PANEL MEMBERS.....	4
GR.5 TERM OF OFFICE.....	5
GR.6 REMOVAL FROM OFFICE.....	5
GR.7 ALTERNATES.....	6
GR.8 MEETINGS.....	7
GR.9 PROCEEDINGS AT MEETINGS.....	9
GR.10 QUORUM.....	9
GR.11 VOTING.....	10
GR.12 PROTECTIONS FOR PANEL MEMBERS.....	10
PART C	
GR.13 GRID CODE MODIFICATION REGISTER.....	11
GR.14 CHANGE CO-ORDINATION.....	11
GR.15 GRID CODE MODIFICATION PROPOSALS.....	12
GR.16 SIGNIFICANT CODE REVIEW.....	15
GR.17 AUTHORITY LET MODIFICATIONS.....	17
GR.18 GRID CODE MODIFICATION PROPOSAL EVALUATION.....	19
GR.19 PANEL PROCEEDINGS.....	19
GR.20 WORKGROUPS.....	21
GR.21 THE CODE ADMINISTRATOR CONSULTATION.....	25
GR.22 GRID CODE MODIFICATION REPORTS.....	27
GR.23 URGENT MODIFICATIONS.....	28
GR.24 SELF-GOVERNANCE.....	33
GR.25 IMPLEMENTATION.....	36
GR.26 FAST TRACK.....	37
ANNEX GR.A ELECTION OF USERS' PANEL MEMBERS.....	39
ANNEX GR.B REGULATED SECTIONS MAPPING OF EGBL ARTICLE 18 TERMS AND CONDITIONS FOR BALANCING SERVICE PROVIDERS AND BALANCING RESPONSIBLE PARTIES TO THE GRID CODE.....	40

PART A

GR.1 INTRODUCTION

- GR.1.1 This section of the Grid Code sets out how the Grid Code is to be amended and the procedures set out in this section, to the extent that they are dealt with in the Code Administration Code of Practice, are consistent with the principles contained in the Code Administration Code of Practice. Where inconsistencies or conflicts exist between the Grid Code and the Code Administration **Code of Practice**, the Grid Code shall take precedence.
- GR.1.2 There is a need to bring proposed amendments to the attention of **Users** and others, to discuss such proposals and to report on them to the **Authority** and in furtherance of this, the **Governance Rules** set out the functions of a **Grid Code Review Panel** and **Workgroups** and for consultation by the **Code Administrator**.
- GR.1.3 For the purpose of these **Governance Rules** the term “**User**” shall mean any person who is under any obligation or granted any rights under the Grid Code.

PART B

GR.2 CODE ADMINISTRATOR

- GR.2.1 **The Company** shall establish and maintain a **Code Administrator** function, which shall carry out the roles referred to in GR.2.2 and GR.3.2. **The Company** shall ensure the functions are consistent with the **Code Administration Code of Practice**.
- GR.2.2 The **Code Administrator** shall in conjunction with other code administrators, maintain, publish, review and (where appropriate) amend from time to time the **Code Administration Code of Practice** approved by the **Authority** provided that any amendments to the **Code Administration Code of Practice** proposed by the **Code Administrator** are approved by the **Grid Code Review Panel** prior to being raised by the **Code Administrator**, and any amendments to be made to the **Code Administration Code of Practice** are approved by the **Authority**.

GR.3 THE GRID CODE REVIEW PANEL

- GR.3.1 Establishment and Composition
- GR.3.1.1 The **Grid Code Review Panel** shall be the standing body to carry out the functions referred to in GR.3.2
- GR.3.1.2 The **Grid Code Review Panel** shall comprise the following members:
- (a) the person appointed as the chairman of the **Grid Code Review Panel** (the “**Panel Chairman**”) in accordance with GR.4.1, who shall (subject to GR.11.4) be a voting member unless they are an employee of **The Company** in which case they will be a non-voting member;
 - (b) the following members, appointed in accordance with GR.4.2 (a), who shall be non-voting members:
 - (i) a representative of the **Code Administrator**;
 - (ii) a representative of the **Authority** appointed in accordance with GR.4.3;
 - (iii) a person representing the **BSC Panel** appointed in accordance with GR.4.2(d);
 - and
 - (iv) the chair of the **GCDF**;
 - (c) the following members who shall be voting **Panel Members**:

- (i) a representative of **The Company** appointed in accordance with GR.4.2(c);
 - (ii) two representatives of the **Network Operators**;
 - (iii) a representative of **Suppliers**;
 - (iv) a representative of the **Onshore Transmission Licensees**;
 - (v) a representative of the **Offshore Transmission Licensees**;
 - (vi) four representatives of the **Generators**;
 - (vii) the **Consumer Representative**, appointed in accordance with GR.4.2(b);
 - (viii) the person appointed (if the **Authority** so decides) by the Authority in accordance with GR.4.4;
- (d) a secretary (the “**Panel Secretary**”), who shall be a person appointed and provided by the **Code Administrator** to assist the **Grid Code Review Panel** and who shall be responsible for the administration of the **Grid Code Review Panel** and **Grid Code Modification Proposals**. The **Panel Secretary** will be a non-voting member of the **Grid Code Review Panel**.

GR.3.2

Functions of the **Grid Code Review Panel** and the **Code Administrator’s** Role

- (a) The **Grid Code Review Panel** shall have the functions assigned to it in these **Governance Rules**.
- (b) Without prejudice to GR.3.2(a) and to the further provisions of these **Governance Rules**, the **Grid Code Review Panel** shall endeavour at all times to operate:
- (i) in an efficient, economical and expeditious manner, taking account of the complexity, importance and urgency of particular **Grid Code Modification Proposals**; and
 - (ii) with a view to ensuring that the **Grid Code** facilitates achievement of the **Grid Code Objectives**.
- (c) **The Company** shall be responsible for implementing or supervising the implementation of **Approved Modifications** and **Approved Grid Code Self Governance Proposals** and **Approved Grid Code Fast Track Proposals** in accordance with the provisions of the Grid Code which shall reflect the production of the revised Grid Code. The **Code Administrator** and **The Company** shall be responsible for implementing and supervising the implementation of any amendments to their respective systems and processes necessary for the implementation of the **Approved Modification** and the **Approved Grid Code Self-Governance Proposals** provided there is no successful appeal and the **Approved Grid Code Fast Track Proposals** provided no objections are received in accordance with GR.26. However, it will not include the implementation of **Users’** systems and processes. The **Code Administrator** will carry out its role in an efficient, economical and expeditious manner and (subject to any extension granted by the **Authority** where the **Code Administrator** has applied for one in accordance with GR.3.2(d) or (e) in accordance with the **Implementation Date**.
- (d) Subject to notifying **Users**, the **Code Administrator** will, with the **Authority’s** approval, apply to the **Authority** for a revision or revisions to the **Implementation Date** where the **Code Administrator** becomes aware of any circumstances which is likely to mean that the **Implementation Date** is unachievable, which shall include as a result of a **Legal Challenge**, at any point following the approval of the **Grid Code Modification Proposal**.
- (e) In the event that the **Authority’s** decision to approve or not to approve a **Grid Code Modification Proposal** is subject of **Legal Challenge** (and the party raising such **Legal Challenge** has received from the relevant authority the necessary permission to proceed) then the **Code Administrator** will, with the **Authority’s** approval, apply to the **Authority** for a revision or revisions to the **Proposed Implementation Date** in the **Grid Code Modification Report** in respect of such **Grid Code Modification Proposal** as necessary such that if such **Grid Code Modification Proposal** were to be approved following such **Legal Challenge** the **Proposed Implementation Date** would be achievable.

- (f) Prior to making any request to the **Authority** for any revision pursuant to GR.3.2(d) (including where it is necessary as a result of a **Legal Challenge**) or GR.3.2(e) the **Code Administrator** shall consult on the revision with **Users** and such other person who may properly be considered to have an appropriate interest in it in accordance with GR.21.2 and GR.21.8. The request to the **Authority** shall contain copies of (and a summary of) all written representations or objections made by consultees during the consultation period.

GR.3.3 Duties of Panel Members

- (a) A person appointed as a **Panel Member**, or an **Alternate Member**, by **Users** under GR.3.1 or GR.7.2, by the **Authority** under GR.4.3 and the person appointed as **Panel Chairman** under GR.4.1, and each of their alternates when acting in that capacity:
 - (i) shall act impartially and in accordance with the requirements of the **Grid Code**; and
 - (ii) shall not be representative of, and shall act without undue regard to the particular interests of the persons or body of persons by whom he was appointed as **Panel Member** and any **Related Person** from time to time.
- (b) Such a person shall not be appointed as a **Panel Member** or an **Alternate Member** (as the case may be) unless he shall have first:
 - (i) confirmed in writing to the **Code Administrator** for the benefit of all **Users** that he agrees to act as a **Panel Member** or **Alternate Member** in accordance with the **Grid Code** and acknowledges the requirements of GR.3.3 (a) and GR.3.3(c);
 - (ii) where that person is employed, provided to the **Panel Secretary** a letter from his employer agreeing that he may act as **Panel Member** or **Alternate Member**, and that the requirement in GR.3.3(a)(ii) shall prevail over his duties as an employee.
- (c) A **Panel Member** or **Alternate Member** shall, at the time of appointment and upon any change in such interests, disclose (in writing) to the **Panel Secretary** any such interests (in relation to the **Grid Code**) as are referred to in GR.3.3(a)(ii).
- (d) Upon a change in employment of a **Panel Member** or **Alternate Member**, he shall so notify the **Panel Secretary** and shall endeavour to obtain from his new employer and provide to the **Panel Secretary** a letter in the terms required in GR.3.3(b)(ii); and he shall be removed from office if he does not do so within a period of sixty (60) days after such change in employment.

GR.4 APPOINTMENT OF PANEL MEMBERS

GR.4.1 Panel Chairman

- (a) The **Panel Chairman** shall be a person appointed (or re-appointed) by **The Company**, having particular regard to the views of the **Grid Code Review Panel**, and shall act independently of **The Company**.
- (b) A person shall be appointed or re-appointed as the **Panel Chairman** where the **Authority** has approved such appointment or reappointment and **The Company** has given notice to the **Panel Secretary** of such appointment, with effect from the date of such notice or (if later) with effect from the date specified in such notice.

GR.4.2 Other Panel Members:

- (a) the **Network Operators, Suppliers, Onshore Transmission Licensees, Offshore Transmission Licensees** and **Generators** may appoint **Panel Members** by election in accordance with Annex GR.A.

- (b) The **Citizens Advice** or the **Citizens Advice Scotland** may appoint one person as a **Panel Member** representing customers by giving notice of such appointment to the **Panel Secretary**, and may remove and re-appoint by notice.
- (c) **The Company** shall appoint the **The Company** representative referred to at GR.3.1.2(c)(i) and shall give notice of the identity of such person to the **Panel Secretary**, and may remove and re-appoint by notice to the **Panel Secretary**.
- (d) The **BSC Panel** shall appoint a representative to be the member of the **Grid Code Review Panel** referred to at GR.3.1.2(c) (iii) and shall give notice of the identity of such person to the **Panel Secretary**, and may remove and re-appoint by notice to the **Panel Secretary**.

GR.4.3. The **Authority** shall from time to time notify the **Panel Secretary** of the identity of the **Authority** representative referred to at GR.3.1.2(b)(ii).

GR.4.4 Appointment of Further Member:

- (a) If in the opinion of the **Authority** there is a class or category of person (whether or not a **User**) who have interests in respect of the **Grid Code** but whose interests:
 - (i) are not reflected in the composition of **Panel Members** for the time being appointed; but
 - (ii) would be so reflected if a particular person was appointed as an additional **Panel Member**, then the **Authority** may at any time appoint (or re-appoint) that person as a **Panel Member** by giving notice of such appointment to the **Panel Secretary** but in no event shall the **Authority** be able to appoint more than one person so that there could be more than one such **Panel Member**.
- (b) A person appointed as a **Panel Member** pursuant to this GR.4.4 shall remain appointed, subject to GR.5 and GR.6, notwithstanding that the conditions by virtue of which he was appointed (for example that the interests he reflects are otherwise reflected) may cease to be satisfied.

GR.4.5 Natural Person

No person other than an individual shall be appointed a **Panel Member** or his alternate.

GR.5 TERM OF OFFICE

The term of office of a **Panel Member**, the **Panel Chairman** and **Alternate Members** shall be a period expiring on 31 December every second year. A **Panel Member**, the **Panel Chairman** and **Alternate Member** shall be eligible for reappointment on expiry of his term of office.

GR.6 REMOVAL FROM OFFICE

GR.6.1 A person shall cease to hold office as the **Panel Chairman**, a **Panel Member** or an **Alternate Member**:

- (a) upon expiry of his term of office unless re-appointed;
- (b) if he:
 - (i) resigns from office by notice delivered to the **Panel Secretary**;
 - (ii) becomes bankrupt or makes any arrangement or composition with his creditors generally;
 - (iii) is or may be suffering from mental disorder and either is admitted to hospital in pursuance of an application under the Mental Health Act 1983 or the Mental Health (Scotland) Act 1960 or an order is made by a court having jurisdiction in matters concerning mental disorder for his detention or for the appointment of a receiver, *curator bonis* or other person with respect to his property or affairs;
 - (iv) becomes prohibited by law from being a director of a company under the Companies Act 1985;

- (v) dies; or
- (vi) is convicted on an indictable offence; or

(c) as provided for in GR.3.3(d);

(d) if the **Grid Code Review Panel** resolves (and the **Authority** does not veto such resolution by notice in writing to the **Panel Secretary** within fifteen (15) **Business Days**) that he should cease to hold office on grounds of his serious misconduct;

(e) if the **Grid Code Review Panel** resolves (and the **Authority** does not veto such resolution by notice in writing to the **Panel Secretary** within fifteen (15) **Business Days**) that he should cease to hold office due to a change in employer notwithstanding compliance with GR.3.3(d).

GR.6.2 A **Grid Code Review Panel** resolution under GR.6.1(d) or (e) shall, notwithstanding any other paragraph, require the vote in favour of at least all **Panel Members** less one (other than the **Panel Member** or **Alternate Member** who is the subject of such resolution) and for these purposes an abstention shall count as a vote cast in favour of the resolution. A copy of any such resolution shall forthwith be sent to the **Authority** by the **Panel Secretary**.

GR.6.3 A person shall not qualify for appointment as a **Panel Member** or **Alternate Member** if at the time of the proposed appointment he would be required by the above to cease to hold that office.

GR.6.4 The **Panel Secretary** shall give prompt notice to **The Company**, all **Panel Members**, all **Users** and the **Authority** of the appointment or re-appointment of any **Panel Member** or **Alternate Member** or of any **Panel Member** or **Alternate Member** ceasing to hold office and publication on the **Website** and (where relevant details are supplied to the **Panel Secretary**) despatch by electronic mail shall fulfil this obligation.

GR.7 ALTERNATES

GR.7.1 Alternate: Panel Chairman

The **Panel Chairman** shall preside at every meeting of the **Grid Code Review Panel** at which he is present. If he is unable to be present at a meeting, he may appoint an alternate (who shall be a senior employee of **The Company**) to act as the **Panel Chairman**, who may or may not be a **Panel Member**. If neither the **Panel Chairman** nor his alternate is present at the meeting within half an hour of the time appointed for holding the meeting, the **Panel Members** present may appoint one of their number to be the chairman of the meeting.

GR.7.2 Alternate(s): other Panel Members

- (a) At the same time that the parties entitled to vote in the relevant election appoint **Elected Panel Members** under GR.4.2(a), they shall appoint the following **Alternate Members**:
- (i) one alternate representative of the **Suppliers**;
 - (ii) one alternate representative of the **Onshore Transmission Licensees**;
 - (iii) one alternate representative of the **Offshore Transmission Licensees**; and
 - (iv) two alternate representatives of the **Generators**.

In the event that the election process fails to appoint an **Alternate Member** for any of the **Elected Panel Members**, each **Elected Panel Member** shall be entitled (but not obligated) to each at their own discretion nominate their own **Alternate Member**.

- (b) Any **Panel Member** that is not an **Elected Panel Member** shall be entitled (but not obligated) to each at their own discretion nominate their own **Alternate Member**.
- (c) A **Panel Member** shall give notice to the **Panel Secretary** in the event it will be represented by an **Alternate Member** for any one **Grid Code Review Panel** meeting.
- (d) Where a **Panel Member** has nominated an **Alternate Member** in accordance with GR.7.2(a) or (b), they may remove such **Alternate Member**, by giving notice of such removal, and any nomination of a different **Alternate Member**, to the **Panel Secretary**. A **Panel Member** may not choose as his **Alternate Member**: any party who is already acting

as an **Alternate Member** for another **Panel Member**; or another **Panel Member**.

- (e) All information to be sent by the **Panel Secretary** to **Panel Members** pursuant to these **Governance Rules** shall also be sent by the **Panel Secretary** to each **Alternate Member** by electronic mail (where relevant details shall have been provided by each **Alternate Member**).

GR.7.3 Alternates: General Provisions

- (a) The appointment or removal by a **Panel Member** of an **Alternate Member** shall be effective from the time when such notice is given to the **Panel Secretary** or (if later) the time specified in such notice.
- (b) The **Panel Secretary** shall promptly notify all **Panel Members** and **Users** of appointment or removal by any **Panel Member** of any alternate and publication on the **Website** and (where relevant details have been provided to the **Panel Secretary**) despatch by electronic mail shall fulfil this obligation.

GR.7.4 Alternates: Rights, Cessation and References

- (a) Where the **Panel Chairman** or a **Panel Member** has appointed an alternate:
- (i) the alternate shall be entitled:
 - i. unless the appointing **Panel Member** shall otherwise notify the **Panel Secretary**, to receive notices of meetings of the **Grid Code Review Panel**;
 - ii. to attend, speak and vote at any meeting of the **Grid Code Review Panel** at which the **Panel Member** by whom he was appointed is not present, and at such meeting to exercise and discharge all of the functions, duties and powers of such **Panel Member**;
 - (ii) the **Alternate Member** shall have the same voting rights the **Panel Member** in whose place he is attending;
 - (iii) GR.8, GR.9, GR.10, GR.11 and GR.12 shall apply to the **Alternate Member** as if he were the appointing **Panel Member** and a reference to a **Panel Member** elsewhere in the **Grid Code** shall, unless the context otherwise requires, include his duly appointed **Alternate Member**.
 - (iv) for the avoidance of doubt, the appointing **Panel Member** shall not enjoy any of the rights transferred to the **Alternate Member** at any meeting at which, or in relation to any matter on which, the **Alternate Member** acts on his behalf.
- (b) A person appointed as an **Alternate Member** shall automatically cease to be such **Alternate Member**:
- (i) if the appointing **Panel Member** ceases to be a **Panel Member**;
 - (ii) if any of the circumstances in GR.6.1(b) applies in relation to such person, but, in the case of a person elected as an **Alternate Member**, they shall continue to be an **Alternate Member** available for appointment under GR.7.2.

GR.8 MEETINGS

GR.8.1 Meetings of the **Grid Code Review Panel** shall be held at regular intervals and at least every 2 months at such time and such place as the **Grid Code Review Panel** shall decide.

GR.8.2 A regular meeting of the **Grid Code Review Panel** may be cancelled if:

- (a) the **Panel Chairman** considers, having due regard to the lack of business in the agenda, that there is insufficient business for the **Grid Code Review Panel** to conduct and requests the **Panel Secretary** to cancel the meeting;
- (b) the **Panel Secretary** notifies all **Panel Members**, not less than five (5) **Business Days** before the date for which the meeting is to be convened, of the proposal to cancel the

meeting; and

(c) by the time three (3) **Business Days** before the date for which the meeting is or is to be convened, no **Panel Member** has notified the **Panel Secretary** that they object to such cancellation.

GR.8.3 If any **Panel Member** wishes, acting reasonably, to hold a special meeting (in addition to regular meetings under GR.8.1) of the **Grid Code Review Panel**:

- (a) they shall request the **Panel Secretary** to convene such a meeting and inform the **Panel Secretary** of the matters to be discussed at the meeting;
- (b) the **Panel Secretary** shall promptly convene the special meeting for a day as soon as practicable but not less than five (5) **Business Days** after such request.

GR.8.4 Any meeting of the **Grid Code Review Panel** shall be convened by the **Panel Secretary** by notice (which will be given by electronic mail if the relevant details are supplied to the **Panel Secretary**) to each **Panel Member** (and to the **Authority**):

- (a) setting out the date, time and place of the meeting and (unless the **Grid Code Review Panel** has otherwise decided) given at least five (5) **Business Days** before the date of the meeting;
- (b) accompanied by an agenda of the matters for consideration at the meeting and any supporting papers available to the **Panel Secretary** at the time the notice is given (and the **Panel Secretary** shall circulate to **Panel Members** any late papers as and when they are received by him).

GR.8.5 The **Panel Secretary** shall send a copy of the notice convening a meeting of the **Grid Code Review Panel**, and the agenda and papers accompanying the notice, to the **Panel Members and Alternate Members**, and publication on the **Website** and despatch by electronic mail (if the relevant details are supplied to the **Panel Secretary**) shall fulfil this obligation.

GR.8.6 Any **Panel Member** (or, at the **Panel Member's** request, the **Panel Secretary**) may notify matters for consideration at a meeting of the **Grid Code Review Panel** in addition to those notified by the **Panel Secretary** under GR.8.4 by notice to all **Panel Members** and persons entitled to receive notice under GR.8.5, not less than three (3) **Business Days** before the date of the meeting.

GR.8.7 The proceedings of a meeting of the **Grid Code Review Panel** shall not be invalidated by the accidental omission to give or send notice of the meeting or a copy thereof or any of the accompanying agenda or papers to, or failure to receive the same by, any person entitled to receive such notice, copy, agenda or paper.

GR.8.8 A meeting of the **Grid Code Review Panel** may consist of a conference between **Panel Members** who are not all in one place but who are able (by telephone or otherwise) to speak to each of the others and to be heard by each of the others simultaneously.

GR.8.9 With the consent of all **Panel Members** (whether obtained before, at or after any such meeting) the requirements of this GR.8 as to the manner in and notice on which a meeting of the **Grid Code Review Panel** is convened may be waived or modified provided that no meeting of the **Grid Code Review Panel** shall be held unless notice of the meeting and its agenda has been sent to the persons entitled to receive the same under GR.8.5 at least 24 hours before the time of the meeting.

GR.8.10 Subject to GR.8.11, no matter shall be resolved at a meeting of the **Grid Code Review Panel** unless such matter was contained in the agenda accompanying the **Panel Secretary's** notice under GR.8.4 or was notified in accordance with GR.8.6.

GR.8.11 Where:

- (a) any matter (not contained in the agenda and not notified pursuant to GR.8.4 and

GR.8.6) is put before a meeting of the **Grid Code Review Panel**, and

- (b) in the opinion of the **Grid Code Review Panel** it is necessary (in view of the urgency of the matter) that the **Grid Code Review Panel** resolve upon such matter at the meeting, the **Grid Code Review Panel** may so resolve upon such matter, and the **Grid Code Review Panel** shall also determine at such meeting whether the decision of the **Grid Code Review Panel** in relation to such matter should stand until the following meeting of the **Grid Code Review Panel**, in which case (at such following meeting) the decision shall be reviewed and confirmed or (but not with effect earlier than that meeting, and only so far as the consequences of such revocation do not make implementation of the **Grid Code** or compliance by **Users** with it impracticable) revoked.

GR.9 PROCEEDINGS AT MEETINGS

GR.9.1 Subject as provided in the **Grid Code**, the **Grid Code Review Panel** may regulate the conduct of and adjourn and reconvene its meetings as it sees fit.

GR.9.2 Meetings of the **Grid Code Review Panel** shall be open to attendance by a representative of any **User** (including any **Authorised Electricity Operator**; **The Company** or a **Materially Affected Party**), the **Citizens Advice** or the **Citizens Advice Scotland** and any person invited by the **Panel Chairman** and/or any other **Panel Member**.

GR.9.3 The **Panel Chairman** and any other **Panel Member** may invite any person invited by them under GR.9.2, and/or any attending representative of a **User**, to speak at the meeting (but such person shall have no vote).

GR.9.4 As soon as practicable after each meeting of the **Grid Code Review Panel**, the **Panel Secretary** shall prepare and send (by electronic mail or otherwise) to **Panel Members** the minutes of such meeting, which shall be (subject to GR.9.5) approved (or amended and approved) at the next meeting of the **Grid Code Review Panel** after they were so sent, and when approved (excluding any matter which the **Grid Code Review Panel** decided was not appropriate for such publication) shall be placed on the **Website**.

GR.9.5 If, following the circulation of minutes (as referred to in GR.9.4), the meeting of the **Grid Code Review Panel** at which they were to be approved is cancelled pursuant to GR.8.2, such minutes (including any proposed changes thereto which have already been received) shall be recirculated with the notification of the cancellation of the meeting of the **Grid Code Review Panel**. **Panel Members** shall confirm their approval of such minutes to the **Panel Secretary** (by electronic mail) no later than five (5) **Business Days** following such minutes being re-circulated. If no suggested amendments are received within such five (5) **Business Days** period, the minutes will be deemed to have been approved. If the minutes are approved, or deemed to have been approved, (excluding any matter which the **Grid Code Review Panel** decided was not appropriate for such publication) they shall be placed on the **Website**. If suggested amendments are received within such five (5) **Business Days** period, the minutes shall remain unapproved and the process for approval (or amendment and approval) of such minutes at the next meeting of the **Grid Code Review Panel**, as described in GR.9.4, shall be followed.

GR.10 QUORUM

GR.10.1 No business shall be transacted at any meeting of the **Grid Code Review Panel** unless a quorum is present throughout the meeting.

GR.10.2 Subject to GR.10.4, a quorum shall be 6 **Panel Members** who have a vote present (subject to GR.8.8) in person or by their alternates, of whom at least one shall be appointed by **The Company**. Where a **Panel Member** is represented by an **Alternate Member**, that **Alternate Member** cannot represent any other **Panel Member** at the same meeting.

GR.10.3 If within half an hour after the time for which the meeting of the **Grid Code Review Panel** has been convened a quorum is not present (and provided the **Panel Secretary** has not been notified by **Panel Members** that they have been delayed and are expected to arrive within a reasonable time):

- (a) the meeting shall be adjourned to the same day in the following week (or, if that day is not a **Business Day** the next **Business Day** following such day) at the same time;
- (b) the **Panel Secretary** shall give notice of the adjourned meeting as far as practicable in accordance with GR.8.

GR.10.4 If at the adjourned meeting there is not a quorum present within half an hour after the time for which the meeting was convened, those present shall be a quorum.

GR.11 VOTING

GR.11.1 At any meeting of the **Grid Code Review Panel** any matter to be decided which shall include the **Grid Code Review Panel Recommendation Vote** shall be put to a vote of those **Panel Members** entitled to vote in accordance with these **Governance Rules** upon the request of the **Panel Chairman** or any **Panel Member**.

GR.11.2 Subject to GR.11.4, in deciding any matter at any meeting of the **Grid Code Review Panel** each **Panel Member** other than the **Panel Chairman** shall cast one vote.

GR.11.3 Except as otherwise expressly provided in the Grid Code, and in particular GR.6.2, any matter to be decided at any meeting of the **Grid Code Review Panel** shall be decided by simple majority of the votes cast at the meeting (an abstention shall not be counted as a cast vote).

GR.11.4 The **Panel Chairman** shall not cast a vote as a **Panel Member** but shall have a casting vote on any matter where votes are otherwise cast equally in favour of and against the relevant motion. Where the vote is in respect of a **Grid Code Modification Proposal** the **Panel Chairman** may only use such casting vote to vote against such **Grid Code Modification Proposal**. The **Panel Chairman** will have a free vote in respect of any other vote. Where any person other than the actual **Panel Chairman** is acting as chairman he shall not have a casting vote.

GR.11.5 Any resolution in writing signed by or on behalf of all **Panel Members** shall be valid and effectual as if it had been passed at a duly convened and quorate meeting of the **Grid Code Review Panel**. Such a resolution may consist of several instruments in like form signed by or on behalf of one or more **Panel Members**.

GR.12 PROTECTIONS FOR PANEL MEMBERS

GR.12.1 Subject to GR.12.2 all **CUSC Parties** shall jointly and severally indemnify and keep indemnified each **Panel Member**, the **Panel Secretary** and each member of a **Workgroup** ("Indemnified Persons") in respect of all costs (including legal costs), expenses, damages and other liabilities properly incurred or suffered by such Indemnified Persons when acting in or in connection with his office under the **Grid Code**, or in what he in good faith believes to be the proper exercise and discharge of the powers, duties, functions and discretions of that office in accordance with the **Grid Code**, and all claims, demands and proceedings in connection therewith other than any such costs, expenses, damages or other liabilities incurred or suffered as a result of the wilful default or bad faith of such Indemnified Person.

GR.12.2 The indemnity provided in GR.12.1 shall not extend to costs and expenses incurred in the ordinary conduct of being a **Panel Member** or **Panel Secretary**, or member of a **Workgroup** including, without limitation, accommodation costs and travel costs or any remuneration for their services to the **Grid Code Review Panel** or **Workgroup**.

GR.12.3 The **Users** agree that no Indemnified Person shall be liable for anything done when acting properly in or in connection with his office under the **Grid Code**, or anything done in what he in good faith believes to be the proper exercise and discharge of the powers, duties, functions and discretions of that office in accordance with the **Grid Code**. Each **CUSC Party** hereby irrevocably and unconditionally waives any such liability of any Indemnified Person and any rights, remedies and claims against any Indemnified Person in respect thereof.

GR.12.4 Without prejudice to GR.12.2, nothing in GR.12.3 shall exclude or limit the liability of an

Indemnified Person for death or personal injury resulting from the negligence of such Indemnified Person.

PART C

GR.13 GRID CODE MODIFICATION REGISTER

GR.13.1 The **Code Administrator** shall establish and maintain a register ("**Grid Code Modification Register**") in a form as may be agreed with the **Authority** from time to time, which shall record the matters set out in GR.13.3.

GR.13.2 The purpose of the **Grid Code Modification Register** shall be to assist the **Grid Code Review Panel** and to enable the **Grid Code Review Panel, Users** and any other persons who may be interested to be reasonably informed of the progress of **Grid Code Modification Proposals** and **Approved Modifications** from time to time.

GR.13.3 The **Grid Code Modification Register** shall record in respect of current outstanding **Grid Code Review Panel** business:

- (a) details of each **Grid Code Modification Proposal** (including the name of the **Proposer**, the date of the **Grid Code Modification Proposal** and a brief description of the **Grid Code Modification Proposal**);
- (b) whether such **Grid Code Modification Proposal** is an **Urgent Modification**;
- (c) the current status and progress of each **Grid Code Modification Proposal**, if appropriate the anticipated date for reporting to the **Authority** in respect thereof, and whether it has been withdrawn, rejected or implemented for a period of three (3) months after such withdrawal, rejection or implementation or such longer period as the **Authority** may determine;
- (d) the current status and progress of each **Approved Modification**, each **Approved Grid Code Self-Governance Proposal**, and each **Approved Fast Track Proposal**; and
- (e) such other matters as the **Grid Code Review Panel** may consider appropriate from time to time to achieve the purpose of GR.13.2.

GR.13.4 The **Grid Code Modification Register** (as updated from time to time and indicating the revisions since the previous issue) shall be published on the **Website** or (in the absence, for whatever reason, of the **Website**) in such other manner and with such frequency (being not less than once per month) as the **Code Administrator** may decide in order to bring it to the attention of the **Grid Code Review Panel, Users** and other persons who may be interested.

GR.14 CHANGE CO-ORDINATION

GR.14.1 The **Code Administrator** shall establish (and, where appropriate, revise from time to time) joint working arrangements for change co-ordination with each **Core Industry Document Owner** and with the **STC Modification Panel** to facilitate the identification, co-ordination, making and implementation of change to **Core Industry Documents** and the **STC** consequent on a **Grid Code Modification Proposal**, including, but not limited to, changes that are appropriate in order to avoid conflict or inconsistency as between the **Grid Code** and any **Core Industry Document** and the **STC**, in a full and timely manner.

GR.14.2 The working arrangements referred to in GR.14.1 shall be such as to enable the consideration, development and evaluation of **Grid Code Modification Proposals**, and the implementation of **Approved Modifications**, to proceed in a full and timely manner and enable changes to **Core Industry Documents** and the **STC** consequent on an amendment to be made and given effect wherever possible (subject to any necessary consent of the **Authority**) at the same time as such **Grid Code Modification Proposal** is made and given effect.

GR.15 GRID CODE MODIFICATION PROPOSALS

- GR.15.1 A proposal to modify the Grid Code may be made:
- (a) by any **User**; any **Authorised Electricity Operator** liable to be materially affected by such a proposal; the **Citizens Advice** or the **Citizens Advice Scotland**;
 - (b) under GR.25.5, by the **Grid Code Review Panel**; or
 - (c) by the **Authority**:
 - (i) following publication of its **Significant Code Review** conclusions; or
 - (ii) under GR.17; or
 - (iii) in order to comply with or implement the **Electricity Regulation** and/or any relevant **Legally Binding Decisions of the European Commission and/or the Agency**.

GR.15.2 A **Standard Modification** shall follow the procedure set out in GR.18 to GR.22.

GR.15.3 A **Grid Code Modification Proposal** shall be submitted in writing to the **Panel Secretary** and, subject to the provisions of GR.15.4 below, shall contain the following information in relation to such proposal:

- (a) the name of the **Proposer**;
- (b) the name of the representative of the **Proposer** who shall represent the **Proposer** in person for the purposes of this GR.15;
- (c) a description (in reasonable but not excessive detail) of the issue or defect which the proposed modification seeks to address;
- (d) a description (in reasonable but not excessive detail) of the proposed modification and of its nature and purpose;
- (e) where possible, an indication of those parts of the Grid Code which would require amendment in order to give effect to (and/or would otherwise be affected by) the proposed modification and an indication of the nature of those amendments or effects;
- (f) the reasons why the **Proposer** believes that the proposed modification would better facilitate achievement of the **Grid Code Objectives** as compared with the current version of the Grid Code together with background information in support thereof;
- (g) the reasoned opinion of the **Proposer** as to why the proposed modification should not fall within a current **Significant Code Review**, whether the proposed modification should be treated as a **Self-Governance Modification** or whether the proposed modification fails to meet the **Self-Governance Criteria** and as a result should proceed along the **Standard Modification** route;
- (h) the reasoned opinion of the **Proposer** as to whether that impact is likely to be material and if so an assessment of the quantifiable impact of the proposed modification on greenhouse gas emissions, to be conducted in accordance with such current guidance on the treatment of carbon costs and evaluation of the greenhouse gas emissions as may be issued by the **Authority** from time to time;
- (i) where possible, an indication of the impact of the proposed modification on **Core Industry Documents** and the **STC**;
- (j) where possible, an indication of the impact of the proposed modification on relevant computer systems and processes used by **Users**.
- (k) whether or not (and to the extent) that in the proposer's view the **Grid Code Modification Proposal** constitutes an amendment to the **Regulated Sections** of the Grid Code.

- GR.15.4 The **Proposer** of a **Grid Code Fast Track Proposal** is not required to provide the items referenced at GR.15.3 (f) – (j) inclusive, unless either:
- (a) the **Grid Code Review Panel** has, pursuant to GR.26.5 or GR.26.6, not agreed unanimously that the **Grid Code Fast Track Proposal** meets the **Fast Track Criteria**, or has not unanimously approved the **Grid Code Fast Track Proposal**; or
 - (b) there has been an objection to the **Approved Fast Track Proposal** pursuant to GR.26.12, whereupon the **Proposer** shall be entitled to provide the additional information required pursuant to GR.15.3 for a **Grid Code Modification Proposal** within 28 days of the **Panel Secretary's** request. Where the **Proposer** fails to provide the additional information in accordance with such timescales, the **Panel Secretary** may reject such proposal in accordance with GR.15.5.
- GR.15.5 If a proposal fails in any material respect to provide the information in GR.15.3 (excluding (e), (i) and (j) thereof), the **Panel Secretary** may reject such proposal provided that:
- (a) the **Panel Secretary** shall furnish the **Proposer** with the reasons for such rejection;
 - (b) the **Panel Secretary** shall report such rejection to the **Grid Code Review Panel** at the next **Grid Code Review Panel** meeting, with details of the reasons;
 - (c) if the **Grid Code Review Panel** decides or the **Authority** directs to reverse the **Panel Secretary's** decision to refuse the submission, the **Panel Secretary** shall notify the **Proposer** accordingly and the proposal shall be dealt with in accordance with these **Governance Rules**;
 - (d) nothing in these **Governance Rules** shall prevent a **Proposer** from submitting a revised proposal in compliance with the requirements of GR.15.3 in respect of the same subject-matter.
- GR.15.6 Without prejudice to the development of a **Workgroup Alternative Grid Code Modification(s)** pursuant to GR.20.13 and GR.20.18, the **Grid Code Review Panel** shall direct in the case of (a), and may direct in the case of (b), the **Panel Secretary** to reject a proposal pursuant to GR.15, other than a proposal submitted by **The Company** pursuant to a direction issued by the **Authority** following a **Significant Code Review** in accordance with GR.16.4, or an Authority Led modification, if and to the extent that such proposal has, in the opinion of the **Grid Code Review Panel**, substantially the same effect as:
- (a) a **Pending Grid Code Modification Proposal**; or
 - (b) a **Rejected Grid Code Modification Proposal**, where such proposal is made at any time within two (2) months after the decision of the **Authority** not to direct **The Company** to modify the Grid Code pursuant to the **Transmission Licence** in the manner set out in such **Grid Code Modification Proposal**, and the **Panel Secretary** shall notify the **Proposer** accordingly.
- GR.15.7 Promptly upon receipt of a **Grid Code Modification Proposal**, the **Panel Secretary** shall:
- (a) allocate a unique reference number to the **Grid Code Modification Proposal**;
 - (b) enter details of the **Grid Code Modification Proposal** on the **Grid Code Modification Register**;
 - (c) reserve the right to modify the title or summary of the **Grid Code Modification Proposal** to better reflect the content or intent of the proposal. If such changes are made these shall be agreed by the **Proposer**, or where this cannot be achieved by the **Grid Code Review Panel** at their next meeting; and
 - (d) note whether in the proposer's view the **Grid Code Modification Proposal**

constitutes an amendment to the **Regulated Sections** of the Grid Code.

- GR.15.8 Subject to GR.8.6 and GR.26, where the **Grid Code Modification Proposal** is received more than ten (10) **Business Days** prior to the next **Grid Code Review Panel** meeting, the **Panel Secretary** shall place the **Grid Code Modification Proposal** on the agenda of the next **Grid Code Review Panel** meeting and otherwise shall place it on the agenda of the next succeeding **Grid Code Review Panel** meeting.
- GR.15.9 It shall be a condition to the right to make a proposal to modify the **Grid Code** under this GR.15 that the **Proposer**:
- (a) grants a non-exclusive royalty free licence to all **Users** who request the same covering all present and future rights, **IPRs** and moral rights it may have in such proposal (as regards use or application in Great Britain); and
 - (b) warrants that, to the best of its knowledge, information and belief, no other person has asserted to the **Proposer** that such person has any **IPRs** or normal rights or rights of confidence in such proposal, and, in making a proposal, a **Proposer** which is a **Grid Code Party** shall be deemed to have granted the licence and given the warranty in (a) and (b) above.
 - (c) The provisions of this GR.15.9 shall apply to any **WG Consultation Alternative Request**, and also to a **Relevant Party** supporting a **Grid Code Modification Proposal** in place of the original **Proposer** in accordance with GR.15.10 (a) for these purposes the term **Proposer** shall include any such **Relevant Party** or a person making such a **WG Consultation Alternative Request**.
- GR.15.10 Subject to GR.16.1, which deals with the withdrawal of a **Grid Code Modification Proposal** made pursuant to a direction following a **Significant Code Review**, a **Proposer** may withdraw his support for a **Standard Modification** by notice to the **Panel Secretary** at any time prior to the **Grid Code Review Panel Recommendation Vote** undertaken in relation to that **Standard Modification** pursuant to GR.22.4, and a **Proposer** may withdraw his support for a **Grid Code Modification Proposal** that meets the **Self-Governance Criteria** by notice to the **Panel Secretary** at any time prior to the **Grid Code Review Panel Self-Governance Vote** undertaken in relation to that **Grid Code Modification Proposal** pursuant to GR.24.9, and a **Proposer** may withdraw his support for a **Grid Code Fast Track Proposal** by notice to the **Panel Secretary** at any time prior to the **Panel's** vote on whether to approve the **Grid Code Fast Track Proposal** pursuant to GR.26 in which case the **Panel Secretary** shall forthwith:
- (a) notify those parties specified in GR.15.1 as relevant in relation to the **Grid Code Modification Proposal** in question (a "**Relevant Party**") that he has been notified of the withdrawal of support by the **Proposer** by publication on the **Website** and (where relevant details are supplied) by electronic mail. A **Relevant Party** may within five (5) **Business Days** notify the **Panel Secretary** that it is prepared to support the **Grid Code Modification Proposal** in place of the original **Proposer**. If such notice is received, the name of such **Relevant Party** shall replace that of the original **Proposer** as the **Proposer**, and the **Grid Code Modification Proposal** shall continue. If more than one notice is received, the first received shall be utilised;
 - (b) if no notice of support is received under (a), the matter shall be discussed at the next **Grid Code Review Panel** meeting. If the **Grid Code Review Panel** so agrees, it may notify **Relevant Parties** that the **Grid Code Modification Proposal** is to be withdrawn, and a further period of five (5) **Business Days** shall be given for support to be indicated by way of notice;
 - (c) if no notice of support is received under (a) or (b), the **Grid Code Modification Proposal** shall be marked as withdrawn on the **Grid Code Modification Register**; **Code Administrator** as Critical Friend.
- GR.15.11 The **Code Administrator** shall provide assistance insofar as is reasonably practicable and on reasonable request to parties with an interest in the **Grid Code Modification Proposal**

process that request it in relation to the **Grid Code**, as provided for in the **Code Administration Code of Practice**, including, but not limited to, assistance with:

- (a) Drafting a **Grid Code Modification Proposal**;
- (b) Understanding the operation of the **Grid Code**;
- (c) Their involvement in, and representation during, the **Grid Code Modification Proposal** process (including but not limited to **Grid Code Review Panel**, and/or **Workgroup** meetings) as required or as described in the **Code Administration Code of Practice**;
- (d) Helping the **Proposer** and **Workgroup** by producing draft legal text once a clear solution has been developed to support the discussion and understanding of a **Grid Code Modification Proposal**; and
- (e) accessing information relating to **Grid Code Modification Proposals** and/or **Approved Modifications**.

GR.16 SIGNIFICANT CODE REVIEW

GR.16.1 If any party specified under GR.15.1 (other than the **Authority**) makes a **Grid Code Modification Proposal** during a **Significant Code Review Phase**, unless exempted by the **Authority** or unless GR.16.4(b) applies, the **Grid Code Review Panel** shall assess whether the **Grid Code Modification Proposal** falls within the scope of a **Significant Code Review** and the applicability of the exceptions set out in GR.16.4 and shall notify the **Authority** of its assessment, its reasons for that assessment and any representations received in relation to it as soon as practicable.

GR.16.2 The **Grid Code Review Panel** shall proceed with the **Grid Code Modification Proposal** made during a **Significant Code Review Phase** in accordance with GR.18 (notwithstanding any consultation undertaken pursuant to GR.16.5 and its outcome), unless directed otherwise by the **Authority** pursuant to GR.16.3.

GR.16.3 Subject to GR.16.4, the **Authority** may at any time direct that a **Grid Code Modification Proposal** made during a **Significant Code Review Phase** falls within the scope of a **Significant Code Review** and must not be made during the **Significant Code Review Phase**. If so directed, the **Grid Code Review Panel** will not proceed with that **Grid Code Modification Proposal**, and the **Proposer** shall decide whether the **Grid Code Modification Proposal** shall be withdrawn or suspended until the end of the **Significant Code Review Phase**. If the **Proposer** fails to indicate its decision whether to withdraw or suspend the **Grid Code Modification Proposal** within twenty-eight (28) days of the **Authority's** direction, it shall be deemed to be suspended. If the **Grid Code Modification Proposal** is suspended, it shall be open to the **Proposer** at the end of the **Significant Code Review Phase** to indicate to the **Grid Code Review Panel** that it wishes that **Grid Code Modification Proposal** to proceed, and it shall be considered and taken forward in the manner decided upon by the **Grid Code Review Panel** at the next meeting, and it is open to the **Grid Code Review Panel** to take into account any work previously undertaken in respect of that **Grid Code Modification Proposal**. If the **Proposer** makes no indication to the **Grid Code Review Panel** within twenty-eight (28) days of the end of the **Significant Code Review Phase** as to whether or not it wishes the **Grid Code Modification Proposal** to proceed, it shall be deemed to be withdrawn.

GR.16.4 A **Grid Code Modification Proposal** that falls within the scope of a **Significant Code Review** may be made where:

- (a) the **Authority** so determines, having taken into account (among other things) the urgency of the subject matter of the **Grid Code Modification Proposal**; or
- (b) the **Grid Code Modification Proposal** is made by **The Company** pursuant to a direction from the **Authority**; or

- (c) it is raised by the **Authority** pursuant to GR15.1(c)(i) who reasonably considers the **Grid Code Modification Proposal** to be necessary to comply with or implement the **Electricity Regulation** and/or any relevant **Legally Binding Decisions of the European Commission and/or the Agency**;
- (d) it is raised by the **Authority** and is in respect of a **Significant Code Review**.

GR.16.5

Where a direction under GR.16.3 has not been issued, GR.16.4 does not apply and the **Grid Code Review Panel** considers that a **Grid Code Modification Proposal** made during a **Significant Code Review Phase** falls within the scope of a **Significant Code Review**, the **Grid Code Review Panel** may consult on its suitability as part of the **Standard Modification** route set out in GR.19, GR.20, GR.21 and GR.22.

GR.16.6

If, within twenty eight (28) days after the **Authority** has published its **Significant Code Review** conclusions:

- (a) the **Authority** issues directions to **The Company**, including directions to **The Company** to make a **Grid Code Modification Proposal**, **The Company** shall comply with those directions and **The Company** and all **Users** shall treat the **Significant Code Review Phase** as ended on the date on which **The Company** makes a **Grid Code Modification Proposal** in accordance with the **Authority's** directions;
- (b) the **Authority** issues to the **The Company** a statement that no directions under sub-paragraph (a) will be issued in relation to a **Grid Code Modification Proposal**, **The Company** and all **Users** shall treat the **Significant Code Review Phase** as ended on the date of such statement;
- (c) the **Authority** raises a **Grid Code Modification Proposal** in accordance with GR.15.1(c) or GR.17 **The Company** and all **Users** shall treat the **Significant Code Review Phase** as ended;
- (d) the **Authority** issues a statement that it will continue work on the **Significant Code Review**, **The Company** and all **Users** shall treat the **Significant Code Review Phase** as continuing until it is brought to an end in accordance with GR.16.7;
- (e) neither directions under sub-paragraph (a) nor a statement under sub-paragraphs (b) or (d) have been issued, nor a **Grid Code Modification Proposal** under sub-paragraph (c) has been made, the **Significant Code Review Phase** will be deemed to have ended. The **Authority's** published conclusions and directions to **The Company** will not fetter any voting rights of the **Panel Members** or the procedures informing the **Grid Code Modification Report**.

GR.16.7

If the **Authority** issues a statement under GR.16.6(d) and/or a direction in accordance with GR.16.10, the **Significant Code Review Phase** will be deemed to have ended when:

- (a) the **Authority** issues a statement that the **Significant Code Review Phase** has ended;
- (b) one of the circumstances in sub-paragraphs GR.16.6(a) or (c) occurs (irrespective of whether such circumstance occurs within twenty-eight (28) days after the **Authority** has published its **Significant Code Review** conclusions); or
- (c) the **Authority** makes a decision consenting, or otherwise, to an **Authority-Led Modification** following the **Grid Code Review Panel's** submission of its **Grid Code Modification Report**.

GR.16.8

Any **Grid Code Modification Proposal** in respect of a **Significant Code Review**

that is not an **Authority-Led Modification** raised pursuant to GR.17 shall be treated as a **Standard Modification** and shall proceed through the process for **Standard Modifications** set out in GR.18, GR.19, GR.20, GR.21 and GR.22.

GR.16.9 **The Company** may not, without the prior consent of the **Authority**, withdraw a **Grid Code Modification Proposal** made pursuant to a direction issued by the **Authority** pursuant to GR.16.4(b)).

GR.16.10 Where a **Grid Code Modification Proposal** has been raised in accordance with GR.16.4(b) or GR.15.1(a), or by the **Authority** under GR.15.1(c) and it is in respect of a **Significant Code Review**, the **Authority** may issue a direction (a "backstop direction"), which requires such proposal(s) and any alternatives to be withdrawn and which causes the **Significant Code Review Phase** to recommence.

GR.17 AUTHORITY LED MODIFICATIONS

Power to develop a proposed modification

GR.17.1 The **Authority** may develop an **Authority-Led Modification** in respect of a **Significant Code Review**, in accordance with the procedures set out in this GR.17.

GR.17.2 An **Authority-led Modification** may be submitted where the **Significant Code Review Phase** is extended by a statement issued by the **Authority** as described in GR.16.6(d), or where a direction is issued under GR.16.10.

Authority-Led Modification Report

GR.17.3 The **Authority** may submit its proposed **Authority-Led Modification** to the **Code Administrator**, together with such supplemental information as the **Authority** considers appropriate.

GR.17.4 Upon receipt of the **Authority's** proposal under GR.17.3, the **Code Administrator** shall prepare a written report on the proposal (the "**Authority-Led Modification Report**"). Where the **Code Administrator** does not reasonably believe the information provided by the **Authority** under 17.3 to be sufficient for it to prepare an **Authority-Led Modification Report** the **Code Administrator** will notify the **Authority** as soon as reasonably practical. The **Authority-Led Modification Report** must be consistent with the information provided by the **Authority** under GR.17.3, and shall:

- (a) be addressed and delivered to the **Grid Code Review Panel**;
- (b) set out the legal text of the proposed **Authority-Led Modification**;
- (c) include a description of the proposed **Authority-Led Modification**;
- (d) include a summary of the views (including any recommendations) from parties consulted in respect of the proposed **Authority-Led Modification**;
- (e) include an analysis of whether (and, if so, to what extent) the proposed **Authority-Led Modification** would better facilitate achievement of the **Grid Code Objective(s)** with a detailed explanation of the **Authority's** reasons for its assessment, including, where the impact is likely to be material, an assessment of the quantifiable impact of the proposed **Authority-Led Modification** on greenhouse gas emissions, to be conducted in accordance with such current guidance on the treatment of carbon costs and evaluation of the greenhouse gas emissions as may be issued by the **Authority** from time to time, and providing a detailed explanation of the **Authority's** reasons for that assessment;
- (f) specify the proposed implementation timetable (including the **Proposed Implementation Date**);

- (g) provide an assessment of:
- (i) the impact of the proposed **Authority-Led Modification** on the **Core Industry Documents** and the **STC**;
 - (ii) the changes which would be required to the **Core Industry Documents** and the **STC** in order to give effect to the proposed **Authority-Led Modification**;
 - (iii) the mechanism and likely timescale for the making of the changes referred to in (ii);
 - (iv) the changes and/or developments which would be required to central computer systems and, if practicable, processes used in connection with the operation of arrangements established under the **Core Industry Documents** and the **STC**;
 - (v) the mechanism and likely timescale for the making of the changes referred to in (iv);
 - (vi) an estimate of the costs associated with making and delivering the changes referred to in (ii) and (iv), such costs are expected to relate to: for (ii) the costs of amending the **Core Industry Document(s)** and **STC** and for (iv) the costs of changes to computer systems and possibly processes which are established for the operation of the **Core Industry Documents** and the **STC**, together with an analysis and a summary of representations in relation to such matters, including any made by **Small Participants**, the **Citizens Advice** and the **Citizens Advice Scotland**;
- (h) contain, to the extent such information is available to the **Code Administrator**, an assessment of the impact of the proposed **Authority-Led Modification** on **Users** in general (or classes of **Users**), including the changes which are likely to be required to their internal systems and processes and an estimate of the development, capital and operating costs associated with implementing the changes to the **Grid Code** and to **Core Industry Documents** and the **STC**;
- (i) include copies of (and a summary of) all written representations or objections made by parties consulted by the **Authority** in respect of the proposed **Authority-Led Modification** and subsequently maintained; and
- (j) have appended a copy of any impact assessment prepared by **Core Industry Document Owners** and the **STC** committee and the views and comments of the **Code Administrator** in respect thereof.

GR.17.5 Where the **Authority-Led Modification Report** is received more than ten (10) **Business Days** prior to the next **Grid Code Review Panel** meeting, the **Panel Secretary** shall place the proposed **Authority-Led Modification** on the agenda of the next **Grid Code Review Panel** meeting and otherwise shall place it on the agenda of the next succeeding **Grid Code Review Panel** meeting.

Grid Code Review Panel Decision

GR.17.6 In the case of **Authority-Led Modifications** GR.22 shall apply, save for GR.22.1 and GR.22.2 and the **Authority-Led Modification Report** shall be used as the draft **Grid Code Modification Report**.

GR.17.7 Where an **Authority-Led Modification** has been approved in accordance with Section GR.22, GR.25 (Implementation) shall apply.

GR.18 GRID CODE MODIFICATION PROPOSAL EVALUATION

GR.18.1 This GR.18 is subject to the **Urgent Modification** procedures set out in GR.23 and the **Significant Code Review** procedures set out in GR.16.

GR.18.2 A **Grid Code Modification Proposal** shall, subject to GR.15.8, be discussed by the **Grid Code Review Panel** at the next following **Grid Code Review Panel** meeting convened.

GR.18.3 The **Proposer's** representative shall attend such **Grid Code Review Panel** meeting and the **Grid Code Review Panel** may invite the **Proposer's** representative to present his **Grid Code Modification Proposal** to the **Grid Code Review Panel**.

- GR.18.4 The **Grid Code Review Panel** shall evaluate each **Grid Code Modification Proposal** against the **Self-Governance Criteria**.
- GR.18.5 The **Grid Code Review Panel** shall follow the procedure set out in GR.24 in respect of any **Modification** that the **Grid Code Review Panel** considers meets the **Self-Governance Criteria** unless the **Authority** makes a direction in accordance with GR.24.2 and in such a case that **Modification** shall be a **Standard Modification** and shall follow the procedure set out in GR.19, GR.20, GR.21 and GR.22.
- GR.18.6 Unless the **Authority** makes a direction in accordance with GR.24.4, a **Modification** that the **Grid Code Review Panel** considers does not meet the **Self-Governance Criteria** shall be a **Standard Modification** and shall follow the procedure set out in GR.19, GR.20, GR.21 and GR.22.
- GR.18.7 The **Grid Code Review Panel** shall evaluate each **Grid Code Fast Track Proposal** against the **Fast Track Criteria**.
- GR.18.8 The **Grid Code Review Panel** shall follow the procedure set out in GR.26 in respect of any **Grid Code Fast Track Proposal**. The provisions of GR.19 to GR.24 shall not apply to a **Grid Code Fast Track Proposal**.
- GR.18.9 The **Grid Code Review Panel** shall evaluate each **Grid Code Modification Proposal** and determine whether the **Grid Code Modification Proposal** constitutes an amendment to the **Regulated Sections** of the Grid Code and its expected impact on the objectives of **Retained EU Law** (Commission Regulation (EU) 2017/2195) (and in the event of disagreement **The Company's** view shall prevail).

GR.19 PANEL PROCEEDINGS

GR.19.1

- (a) The **Code Administrator** and the **Grid Code Review Panel** shall together establish a timetable to apply for the **Grid Code Modification Proposal** process. That timetable must comply with any direction(s) issued by the **Authority** setting and/or amending a timetable in relation to a **Grid Code Modification Proposal** that is in the respect of a **Significant Code Review**.
- (b) The **Grid Code Review Panel** shall establish the part of the timetable for the consideration by the **Grid Code Review Panel** and by a **Workgroup** (if any) which shall be no longer than six months unless in any case the particular circumstances of the **Grid Code Modification Proposal** (taking due account of its complexity, importance and urgency) justify an extension of such timetable, and provided the **Authority**, after receiving notice, does not object, taking into account all those issues.
- (c) The **Code Administrator** shall establish the part of the timetable for the consultation to be undertaken by the **Code Administrator** under these **Governance Rules** and separately the preparation of a **Grid Code Modification Report** to the **Authority**. Where the particular circumstances of the **Grid Code Modification Proposal** (taking due account of its complexity, importance and urgency) justify an extension of such timescales and provided the **Authority**, after receiving notice, does not object, taking into account all those issues, the **Code Administrator** may revise such part of the timetable.
- (d) In setting such a timetable, the **Grid Code Review Panel** and the **Code Administrator** shall exercise their respective discretions such that, in respect of each **Grid Code Modification Proposal**, a **Grid Code Modification Report** may be submitted to the **Authority** as soon after the **Grid Code Modification Proposal** is made as is consistent with the proper evaluation of such **Grid Code Modification Proposal**, taking due account of its complexity, importance and urgency.
- (e) Having regard to the complexity, importance and urgency of particular **Grid Code Modification Proposals**, the **Grid Code Review Panel** may determine the priority of

Grid Code Modification Proposals and may (subject to any objection from the **Authority** taking into account all those issues) adjust the priority of the relevant **Grid Code Modification Proposal** accordingly.

GR.19.2 In relation to each **Grid Code Modification Proposal**, the **Grid Code Review Panel** shall determine at any meeting of the **Grid Code Review Panel** whether to:

- (a) amalgamate the **Grid Code Modification Proposal** with any other **Grid Code Modification Proposal**;
- (b) invite the **Proposer** to further develop their **Grid Code Modification Proposal** before presenting it to a subsequent meeting of the **Grid Code Review Panel** or to withdraw their modification proposal;
- (c) establish a **Workgroup** of the **Grid Code Review Panel**, to consider the **Grid Code Modification Proposal**;
- (d) review the evaluation made pursuant to GR.18.4, taking into account any new information received; or
- (e) proceed directly to wider consultation (in which case the **Proposer's** right to vary his **Grid Code Modification Proposal** shall lapse).

GR.19.3 The **Grid Code Review Panel** may decide to amalgamate a **Grid Code Modification Proposal** with one or more other **Grid Code Modification Proposals** where the subject-matter of such **Grid Code Modification Proposals** is sufficiently proximate to justify amalgamation on the grounds of efficiency and/or where such **Grid Code Modification Proposals** are logically dependent on each other. Such amalgamation may only occur with the consent of the **Proposers** of the respective **Grid Code Modification Proposals**. The **Authority** shall be entitled to direct that a **Grid Code Modification Proposal** is not amalgamated with one or more other **Grid Code Modification Proposals**.

GR.19.4 Without prejudice to each **Proposer's** right to withdraw his **Grid Code Modification Proposal** prior to the amalgamation of his **Grid Code Modification Proposal** where **Grid Code Modification Proposals** are amalgamated pursuant to GR.19.3:

- (a) such **Grid Code Modification Proposals** shall be treated as a single **Grid Code Modification Proposal**;
- (b) references in these **Governance Rules** to a **Grid Code Modification Proposal** shall include and apply to a group of two or more **Grid Code Modification Proposals** so amalgamated; and
- (c) the **Proposers** of each such **Grid Code Modification Proposal** shall cooperate in deciding which of them is to provide a representative for any **Workgroup** in respect of the amalgamated **Grid Code Modification Proposal** and, in default of agreement, the **Panel Chairman** shall nominate one of the **Proposers** for that purpose.

GR.19.5 In respect of any **Grid Code Modification Proposal** that the **Grid Code Review Panel** determines to proceed directly to wider consultation in accordance with GR.19.2, the **Grid Code Review Panel**, may at any time prior to the **Grid Code Review Panel Recommendation Vote** having taken place decide to establish a **Workgroup** of the **Grid Code Review Panel** and the provisions of GR.20 shall apply. In such case the **Grid Code Review Panel** shall be entitled to adjust the timetable referred to at GR.19.1(b) and the **Code Administrator** shall be entitled to adjust the timetable referred to at GR.19.1(c), provided that the **Authority**, after receiving notice, does not object.

GR.19.6 Where the **Grid Code Review Panel** according to GR.19.2(b) invites the **Proposer** to further develop their **Grid Code Modification Proposal**, on presenting this to a subsequent meeting of the **Grid Code Review Panel**, the **Panel** will determine a way forward from the options in GR.19.2 (a), (c), (d) and (e) or invite the **Proposer** to withdraw their modification proposal.

GR.19.7 Where the **Grid Code Review Panel** according to GR.19.2(b) or GR.19.6 invites the **Proposer** to further develop or withdraw their modification and this is declined, the **Panel** will determine a way forward from the options in GR.19.2 (a), (c), (d) or (e).

GR.20 WORKGROUPS

GR.20.1 If the **Grid Code Review Panel** has decided not to proceed directly to wider consultation (or where the provisions of GR.19.5, GR.23.10 or GR.25.5 apply), a **Workgroup** will be established by the **Grid Code Review Panel** to assist the **Grid Code Review Panel** in evaluating whether a **Grid Code Modification Proposal** better facilitates achieving the **Grid Code Objectives** and whether a **Workgroup Alternative Grid Code Modification(s)** would, as compared with the **Grid Code Modification Proposal**, better facilitate achieving the **Grid Code Objectives** in relation to the issue or defect identified in the **Grid Code Modification Proposal**.

GR.20.2 A single **Workgroup** may be responsible for the evaluation of more than one **Grid Code Modification Proposal** at the same time, but need not be so responsible.

GR.20.3 A **Workgroup** shall comprise at least five (5) persons (who may be **Panel Members**) selected by the **Grid Code Review Panel** from those nominated by **Users**, the **Citizens Advice** or the **Citizens Advice Scotland** for their relevant experience and/or expertise in the areas forming the subject-matter of the **Grid Code Modification Proposal(s)** to be considered by such **Workgroup** (and the **Grid Code Review Panel** shall ensure, as far as possible, that an appropriate cross-section of representation, experience and expertise is represented on such **Workgroup**) provided that there shall always be at least one member representing **The Company** and if, and only if, the **Grid Code Review Panel** is of the view that a **Grid Code Modification Proposal** is likely to have an impact on the **STC**, the **Grid Code Review Panel** may invite the **STC** committee to appoint a representative to become a member of the **Workgroup**. A representative of the **Authority** may attend any meeting of a **Workgroup** as an observer and may speak at such meeting.

GR.20.4 The **Code Administrator** shall in consultation with the **Grid Code Review Panel** appoint the chairman of the **Workgroup** who shall act impartially and as an independent chairman.

GR.20.5 No **Workgroup** or meeting of a **Workgroup** will be considered quorate with less than five (5) persons, not including the **Code Administrator** representative or the chair of the **Workgroup**. Where insufficient persons are nominated to a **Workgroup** for it to be quorate, the **Code Administrator** will report this to the next meeting of the **Grid Code Review Panel**. The **Panel** may:

- (a) Request the **Code Administrator** to seek further nominations;
- (b) Reconsider their decision on how to progress the **Grid Code Modification Proposal** as allowed under GR.19.2; or
- (c) Request that those parties that have nominated themselves to a **Workgroup** which is less than quorate should proceed as a **Limited Membership Workgroup**, subject to the following additional checks and balances:
 - (i) A **Limited Membership Workgroup** shall always hold a **Workgroup Consultation** in addition to the mandatory **Code Administrator Consultation**.
 - (ii) Prior to the **Workgroup Consultation**, a draft of this shall be circulated to the **Grid Code Review Panel** for five (5) days or another timescale as agreed by the **Panel** for approval.
 - (iii) At the same time as the **Workgroup Consultation** is initiated, the **Code Administrator** shall again formally seek nominations and if quoracy is not established then again seek advice from the **Panel** on how to proceed from the options set out in GR.20.5.

Where a **Workgroup** remains non-quorate, and with the permission of the **Panel**, a **Limited Membership Workgroup** may continue following a **Workgroup**

Consultation as if it were a standard **Workgroup**.

GR.20.6 A **Limited Membership Workgroup** may at any point be instructed by the **Authority** to either:

- (a) Stop work; or
- (b) To provide a report on progress to the next meeting of the **Grid Code Review Panel**.

The **Authority** may also at any point instruct the **Code Administrator** to seek further nominations for membership.

GR.20.7 Where a specific meeting of an otherwise quorate **Workgroup** is not quorate, or where member(s) of a **Limited Membership Workgroup** are unable to attend a meeting:

- (a) A member of the **Workgroup** unable to attend will be invited by the **Code Administrator** to send an alternate;
- (b) All members will be invited to participate by telephone, webinar or other equivalent if not able to attend in person;
- (c) A meeting may proceed as a **Workgroup** meeting as long as none of the members either present or absent raise an objection to this, however no voting can take place unless the **Code Administrator** has obtained enough votes to be quorate from members not in attendance or from all members of a **Limited Membership Workgroup**. This shall include where there has not been an opportunity to check with all **Workgroup** members to see if they have an objection (typically where a change of plans or circumstances has occurred too late to achieve this);
- (d) If any **Workgroup** member objects to the progressing of a **Workgroup** without them, they must communicate this to the **Code Administrator** at least 24 hours before the meeting indicating that they will not be present and do not wish the meeting to take place. The **Code Administrator** will then endeavour to rearrange the meeting to accommodate such a member's availability;
- (e) Where a **Workgroup** member is repeatedly unavailable, as guidance on 3 consecutive occasions, and does not give permission for the **Workgroup** to proceed without them as in (d), under GR.20.7 the **Grid Code Review Panel** may choose to replace or remove them.

GR.20.8 The **Grid Code Review Panel** may add further members or the **Workgroup** chairman may add or vary members to a **Workgroup**.

GR.20.9 The **Grid Code Review Panel** may (but shall not be obliged to) replace or remove any member or observer of a **Workgroup** appointed pursuant to GR.20.3 at any time if such member is unwilling or unable for whatever reason to fulfil that function and/or is deliberately and persistently disrupting or frustrating the work of the **Workgroup**.

GR.20.10 The **Grid Code Review Panel** shall determine the terms of reference of each **Workgroup** and may change those terms of reference from time to time as it sees fit.

GR.20.11 The terms of reference of a **Workgroup** must include provision in respect of the following matters:

- (a) those areas of a **Workgroup's** powers or activities which require the prior approval of the **Grid Code Review Panel**;
- (b) the seeking of instructions, clarification or guidance from the **Grid Code Review Panel**, including on the suspension of a **Workgroup Alternative Grid Code Modification(s)** during a **Significant Code Review Phase**;
- (c) the timetable for the work to be done by the **Workgroup**, in accordance with the timetable established pursuant to GR.19.1 (save where GR.19.5 applies); and

(d) the length of any **Workgroup Consultation**.

In addition, prior to the taking of any steps which would result in the undertaking of a significant amount of work (including the production of draft legal text to modify the **Grid Code** in order to give effect to a **Grid Code Modification Proposal** and/or **Workgroup Alternative Grid Code Modification(s)**, with the relevant terms of reference setting out what a significant amount of work would be in any given case), the **Workgroup** shall seek the views of the **Grid Code Review Panel** as to whether to proceed with such steps and, in giving its views, the **Grid Code Review Panel** may consult the **Authority** in respect thereof.

GR.20.12 Subject to the provisions of this GR.20.12 and unless otherwise determined by the **Grid Code Review Panel**, the **Workgroup** shall develop and adopt its own internal working procedures for the conduct of its business and shall provide a copy of such procedures to the **Panel Secretary** in respect of each **Grid Code Modification Proposal** for which it is responsible. Unless the **Grid Code Review Panel** otherwise determines, meetings of each **Workgroup** shall be open to attendance by a representative of any **User**, (including any **Authorised Electricity Operator**; **The Company** or a **Materially Affected Party**), the **Citizens Advice**, the **Citizens Advice Scotland**, the **Authority** and any person invited by the chairman, and the chairman of a **Workgroup** may invite any such person to speak at such meetings, other than the **Authority** who may speak at any time as per GR.20.3.

GR.20.13 After development by the **Workgroup** of the **Grid Code Modification Proposal**, and (if applicable) after development of any draft **Workgroup Alternative Grid Code Modification(s)**, the **Workgroup** may (subject to the provisions of GR.20.19) consult ("**Workgroup Consultation**") on the **Grid Code Modification Proposal** and, if applicable, on any draft **Workgroup Alternative Grid Code Modification(s)** with:

- (a) **Users**; and
- (b) such other persons who may properly be considered to have an appropriate interest in it.

GR.20.14 The **Workgroup Consultation** will be undertaken by issuing a **Workgroup Consultation** paper (and its provision in electronic form on the **Website** and in electronic mails to **Users** and such other persons, who have supplied relevant details, shall meet this requirement).

Such **Workgroup Consultation** paper will include:

- (a) Issues which arose in the **Workgroup** discussions;
- (b) Details of any draft **Workgroup Alternative Grid Code Modification(s)**;
- (c) The date proposed by the **Code Administrator** as the **Proposed Implementation Date**.

GR.20.15 **Workgroup Consultation** papers will be copied to **Core Industry Document Owners** and the secretary of the **STC** committee.

GR.20.16 Any **Authorised Electricity Operator**; the **Citizens Advice** or the **Citizens Advice Scotland**, **The Company** or a **Materially Affected Party** may (subject to GR.20.20) raise a **Workgroup Consultation Alternative Request** in response to the **Workgroup Consultation**. Such **Workgroup Consultation Alternative Request** must include:

- (a) the information required by GR.15.3 (which shall be read and construed so that any references therein to "amendment proposal" or "proposal" shall be read as "request" and any reference to "Proposer" shall be read as "requester"); and
- (b) sufficient detail to enable consideration of the request including details as to how the request better facilitates the **Grid Code Objectives** than the current version of the **Grid Code**, than the **Grid Code Modification Proposal** and than any draft **Workgroup Alternative Grid Code Modification(s)**.

- GR.20.17 The **Workgroup** shall consider and analyse any comments made or any **Workgroup Consultation Alternative Request** made by any **User** (including any **Authorised Electricity Operator; The Company** or a **Materially Affected Party**), the **Citizens Advice** and the **Citizens Advice Scotland** in response to the **Workgroup Consultation**.
- GR.20.18 If a majority of the members of the **Workgroup** or the chairman of the **Workgroup** believe that the **Workgroup Consultation Alternative Request** may better facilitate the **Grid Code Objectives** than the **Grid Code Modification Proposal**, the **Workgroup** shall develop it as a **Workgroup Alternative Grid Code Modification(s)** or, where the chairman of the **Workgroup** agrees, amalgamate it with one or more other draft **Workgroup Alternative Grid Code Modification(s)** or **Workgroup Consultation Alternative Request(s)**;
- GR.20.19 Unless the **Grid Code Review Panel** directs the **Workgroup** otherwise pursuant to GR.20.20, and provided that a **Workgroup Consultation** has been undertaken in respect of the **Grid Code Modification Proposal**, no further **Workgroup Consultation** will be required in respect of any **Workgroup Alternative Grid Code Modification(s)** developed in respect of such **Grid Code Modification Proposal**.
- GR.20.20 The **Grid Code Review Panel** may, at the request of the chairman of the **Workgroup**, direct the **Workgroup** to undertake further **Workgroup Consultation(s)**. At the same time as such direction the **Grid Code Review Panel** shall adjust the timetable referred to at GR.19.1(b) and the **Code Administrator** shall be entitled to adjust the timetable referred to at GR.19.1 (c), provided that the **Authority**, after receiving notice, does not object. No **Workgroup Consultation Alternative Request** may be raised by any **User** (including any **Authorised Electricity Operator; The Company** or a **Materially Affected Party**), the **Citizens Advice** and the **Citizens Advice Scotland** during any second or subsequent **Workgroup Consultation**.
- GR.20. 21 The **Workgroup** shall finalise the **Workgroup Alternative Grid Code Modification(s)** for inclusion in the report to the **Grid Code Review Panel**.
- (a) Each **Workgroup** chairman shall prepare a report to the **Grid Code Review Panel** responding to the matters detailed in the terms of reference in accordance with the timetable set out in the terms of reference.
 - (b) If a **Workgroup** is unable to reach agreement on any such matter, the report must reflect the views of the members of the **Workgroup**.
 - (c) The report will be circulated in draft form to **Workgroup** members and a period of not less than five (5) **Business Days** or if all **Workgroup** members agree three (3) **Business Days** given for comments thereon. Any unresolved comments made shall be reflected in the final report.
- GR.20.23 The chairman or another member (nominated by the chairman) of the **Workgroup** shall attend the next **Grid Code Review Panel** meeting following delivery of the report and may be invited to present the findings and/or answer the questions of **Panel Members** in respect thereof. Other members of the **Workgroup** may also attend such **Grid Code Review Panel** meeting.
- GR.20.24 At the meeting referred to in GR.20.23 the **Grid Code Review Panel** shall consider the **Workgroup's** report and shall determine whether to:-
- (a) refer the proposed **Grid Code Modification Proposal** back to the **Workgroup** for further analysis (in which case the **Grid Code Review Panel** shall determine the timetable and terms of reference to apply in relation to such further analysis); or
 - (b) proceed then to wider consultation as set out in GR.21; or
 - (c) decide on another suitable course of action.
- GR.20.25 Subject to GR.16.4 if, at any time during the assessment process carried out by the **Workgroup** pursuant to this GR.20, the **Workgroup** considers that a **Grid Code**

Modification Proposal or any **Workgroup Alternative Grid Code Modification(s)** falls within the scope of a **Significant Code Review**, it shall consult on this as part of the **Workgroup Consultation** and include its reasoned assessment in the report to the **Grid Code Review Panel** prepared pursuant to GR.20.22. If the **Grid Code Review Panel** considers that the **Grid Code Modification Proposal** or the **Workgroup Alternative Grid Code Modification(s)** falls within the scope of a **Significant Code Review**, it shall consult with the **Authority**. If the **Authority** directs that the **Grid Code Modification Proposal** or **Workgroup Alternative Grid Code Modification(s)** falls within the scope of the **Significant Code Review**, the **Grid Code Modification Proposal** and any **Workgroup Alternative Grid Code Modification(s)** shall be suspended or withdrawn during the **Significant Code Review Phase**, in accordance with GR.16.3.

GR.20.26 The **Proposer** may, at any time prior to the final evaluation by the **Workgroup** (in accordance with its terms of reference and working practices) of that **Grid Code Modification Proposal** against the **Grid Code Objectives**, vary his **Grid Code Modification Proposal** on notice (which may be given verbally) to the chairman of the **Workgroup** provided that such varied **Grid Code Modification Proposal** shall address the same issue or defect originally identified by the **Proposer** in his **Grid Code Modification Proposal**.

GR.20.27 The **Grid Code Review Panel** may (but shall not be obliged to) require a **Grid Code Modification Proposal** to be withdrawn if, in the **Panel's** opinion, the **Proposer** of that **Grid Code Modification Proposal** is deliberately and persistently disrupting or frustrating the work of the **Workgroup** and that **Grid Code Modification Proposal** shall be deemed to have been so withdrawn. In the event that a **Grid Code Modification Proposal** is so withdrawn, the provisions of GR.15.10 shall apply in respect of that **Grid Code Modification Proposal**.

GR.21 THE CODE ADMINISTRATOR CONSULTATION

GR.21.1 In respect of any **Grid Code Modification Proposal** where a **Workgroup** has been established GR.21.2 to GR.21.6 shall apply.

GR.21.2 After consideration of any **Workgroup** report on the **Grid Code Modification Proposal** and if applicable any **Workgroup Alternative Grid Code Modification(s)** by the **Grid Code Review Panel** and a determination by the **Grid Code Review Panel** to proceed to wider consultation, the **Code Administrator** shall bring to the attention of and consult on the **Grid Code Modification Proposal** and if applicable any **Workgroup Alternative Grid Code Modification(s)** with:

- (i) **Users**; and
- (ii) such other persons who may properly be considered to have an appropriate interest in it, including **Small Participants**, the **Citizens Advice** and the **Citizens Advice Scotland**.

GR.21.3 The consultation will be undertaken by issuing a Consultation Paper (and its provision in electronic form on the **Website** and in electronic mails to **Users** and such other persons, who have supplied relevant details, shall meet this requirement). The consultation shall last for a minimum of one month unless it is deemed to be an **Urgent Modification**. For **Urgent Modifications** the **Grid Code Review Panel** shall confirm the proposed drafting for the **Grid Code Modification Proposal** and any **Workgroup Alternative Grid Code Modification(s)** do not include changes to **Regulated Sections**; provided there are no proposed changes to a **Regulated Section** then a shorter consultation duration can be applied if approved by the **Authority**, otherwise the standard one month consultation will apply.

GR.21.4 The Consultation Paper will contain:

- (a) the proposed drafting for the **Grid Code Modification Proposal** and any **Workgroup Alternative Grid Code Modification(s)** (unless the **Authority** decides none is needed in the **Grid Code Modification Report** under GR.21.5) and will indicate the issues which arose in the **Workgroup** discussions, where there has been a **Workgroup** and will incorporate

The Company's and the **Grid Code Review Panel's** initial views on the way forward; and

- (b) the date proposed by the **Code Administrator** as the **Proposed Implementation Date** and, where the **Workgroup** terms of reference require and the dates proposed by the **Workgroup** are different from those proposed by the **Code Administrator**, those proposed by the **Workgroup**. In relation to a **Grid Code Modification Proposal** that meets the **Self-Governance Criteria**, the **Code Administrator** may not propose an implementation date earlier than the sixteenth (16) **Business Day** following the publication of the **Grid Code Review Panel's** decision to approve or reject the **Grid Code Modification Proposal**. Views will be invited on these dates.

- GR.21.5 Where the **Grid Code Review Panel** is of the view that the proposed text to amend the Grid Code for a **Grid Code Modification Proposal** or **Workgroup Alternative Grid Code Modification(s)** is not needed in the **Grid Code Modification Report**, the **Grid Code Review Panel** shall consult (giving its reasons as to why it is of this view) with the **Authority** as to whether the **Authority** would like the **Grid Code Modification Report** to include the proposed text to amend the **Grid Code**. If it does not, no text needs to be included. If it does, and no detailed text has yet been prepared, the **Code Administrator** shall prepare such text to modify the **Grid Code** in order to give effect to such **Grid Code Modification Proposal** or **Workgroup Alternative Grid Code Modification(s)** and shall seek the conclusions of the relevant **Workgroup** before consulting those identified in GR.21.2.
- GR.21.6 Consultation Papers will be copied to **Core Industry Document Owners** and the secretary of the **STC** committee.
- GR.21.7 In respect of any **Grid Code Modification Proposal** where a **Workgroup** has not been established GR.21.8 to GR.21.11 shall apply.
- GR.21.8 After determination by the **Grid Code Review Panel** to proceed to wider consultation, such consultation shall be conducted by the **Code Administrator** on the **Grid Code Modification Proposal** with:
- (i) **Users**; and
 - (ii) such other persons who may properly be considered to have an appropriate interest in it, including **Small Participants**, the **Citizens Advice** and the **Citizens Advice Scotland**.
- GR.21.9 The consultation will be undertaken by issuing a Consultation Paper (and its provision in electronic form on the **Website** and in electronic mails to **Users** and such other persons, who have supplied relevant details, shall meet this requirement). The consultation shall last for a minimum of one month unless it is deemed to be an **Urgent Modification**. For **Urgent Modifications** the **Grid Code Review Panel** shall confirm the proposed drafting for the **Grid Code Modification Proposal** and any **Workgroup Alternative Grid Code Modification(s)** do not include changes to **Regulated Sections**; provided there are no proposed changes to a **Regulated Section** then a shorter consultation duration can be applied if approved by the **Authority**, otherwise the standard one month consultation will apply.
- GR.21.10 The Consultation Paper will contain:
- (a) the proposed drafting for the **Grid Code Modification Proposal** (unless the **Authority** decides none is needed in the **Grid Code Modification Report** under GR.21.11) and will incorporate **The Company's** and the **Grid Code Review Panel's** initial views on the way forward; and
 - (b) the date proposed by the **Code Administrator** as the **Proposed Implementation Date**. Views will be invited on this date.
- GR.21.11 Where the **Grid Code Review Panel** is of the view that the proposed text to amend the **Grid Code** for a **Grid Code Modification Proposal** is not needed, the **Grid Code Review Panel** shall consult (giving its reasons to why it is of this view) with the **Authority** as to whether the **Authority** would like the **Grid Code Modification Report** to include the

proposed text to amend the **Grid Code**. If it does not, no text needs to be included. If it does, and no detailed text has yet been prepared, the **Code Administrator** shall prepare such text to modify the **Grid Code** in order to give effect to such **Grid Code Modification Proposal** and consult those identified in GR.21.2.

GR.22 GRID CODE MODIFICATION REPORTS

GR.22.1 Subject to the **Code Administrator's** consultation having been completed, the **Grid Code Review Panel** shall prepare and submit to the **Authority** a report (the "**Grid Code Modification Report**") in accordance with this GR.22 for each **Grid Code Modification Proposal** which is not withdrawn.

GR.22.1A Where a **Grid Code Modification Proposal** or any **Workgroup Alternative Grid Code Modification** constitutes an amendment to the **Regulated Sections**, the **Panel** will consider any consultation responses received and any further work required to assess these as required under GR.18.9.

GR.22.2 The matters to be included in a **Grid Code Modification Report** shall be the following (in respect of the **Grid Code Modification Proposal**):

- (a) A description of the **Grid Code Modification Proposal** and any **Workgroup Alternative Grid Code Modification(s)**, including the details of, and the rationale for, any variations made (or, as the case may be, omitted) by the **Proposer** together with the views of the **Workgroup**;
- (b) the **Panel Members' Recommendation**;
- (c) a summary (agreed by the **Grid Code Review Panel**) of the views (including any recommendations) from **Panel Members** in the **Grid Code Review Panel Recommendation Vote** and the conclusions of the **Workgroup** (if there is one) in respect of the **Grid Code Modification Proposal** and of any **Workgroup Alternative Grid Code Modification(s)**;
- (d) an analysis of whether (and, if so, to what extent) the **Grid Code Modification Proposal** and any **Workgroup Alternative Grid Code Modification(s)** would better facilitate achievement of the **Grid Code Objective(s)** with a detailed explanation of the **Grid Code Review Panel's** reasons for its assessment, including, where the impact is likely to be material, an assessment of the quantifiable impact of the **Grid Code Modification Proposal** and any **Workgroup Alternative Grid Code Modification(s)** on greenhouse gas emissions, to be conducted in accordance with such current guidance on the treatment of carbon costs and evaluation of the greenhouse gas emissions as may be issued by the **Authority** from time to time, and providing a detailed explanation of the **Grid Code Review Panel's** reasons for that assessment;
- (e) an analysis of whether (and, if so, to what extent) any **Workgroup Alternative Grid Code Modification(s)** would better facilitate achievement of the **Grid Code Objective(s)** as compared with the **Grid Code Modification Proposal** and any other **Workgroup Alternative Grid Code Modification(s)** and the current version of the **Grid Code**, with a detailed explanation of the **Grid Code Review Panel's** reasons for its assessment, including, where the impact is likely to be material, an assessment of the quantifiable impact of the **Workgroup Alternative Grid Code Modification(s)** on greenhouse gas emissions, to be conducted in accordance with such current guidance on the treatment of carbon costs and evaluation of the greenhouse gas emissions as may be issued by the **Authority** from time to time, and providing a detailed explanation of the **Grid Code Review Panel's** reasons for that assessment;
- (f) the **Proposed Implementation Date** taking into account the views put forward during the process described at GR.21.4 (b) such date to be determined by the **Grid Code Review Panel** in the event of any disparity between such views and those of the **Code Administrator**;
- (g) an assessment of:

- (i) the impact of the **Grid Code Modification Proposal** and any **Workgroup Alternative Grid Code Modification(s)** on the **Core Industry Documents** and the **STC**;
 - (ii) the changes which would be required to the **Core Industry Documents** and the **STC** in order to give effect to the **Grid Code Modification Proposal** and any **Workgroup Alternative Grid Code Modification(s)**;
 - (iii) the mechanism and likely timescale for the making of the changes referred to in (ii);
 - (iv) the changes and/or developments which would be required to central computer systems and, if practicable, processes used in connection with the operation of arrangements established under the **Core Industry Documents** and the **STC**;
 - (v) the mechanism and likely timescale for the making of the changes referred to in (iv);
 - (vi) an estimate of the costs associated with making and delivering the changes referred to in (ii) and (iv), such costs are expected to relate to: for (ii) the costs of amending the **Core Industry Document(s)** and **STC** and for (iv) the costs of changes to computer systems and possibly processes which are established for the operation of the **Core Industry Documents** and the **STC**, together with an analysis and a summary of representations in relation to such matters, including any made by **Small Participants**, the **Citizens Advice** and the **Citizens Advice Scotland**;
- (h) to the extent such information is available to the **Code Administrator**, an assessment of the impact of the **Grid Code Modification Proposal** and any **Workgroup Alternative Grid Code Modification(s)** on **Users** in general (or classes of **Users** in general), including the changes which are likely to be required to their internal systems and processes and an estimate of the development, capital and operating costs associated with implementing the changes to the **Grid Code** and to **Core Industry Documents** and the **STC**;
- (i) copies of (and a summary of) all written representations or objections made by consultees during the consultation in respect of the **Grid Code Modification Proposal** and any **Workgroup Alternative Grid Code Modification(s)** and subsequently maintained;
- (j) a copy of any impact assessment prepared by **Core Industry Document Owners** and the **STC** committee and the views and comments of the **Code Administrator** in respect thereof;
- (k) whether or not, in the opinion of **The Company**, the **Grid Code Modification Proposal** (or any **Workgroup Alternative Grid Code Modification(s)**) should be made.
- (l) **The Company's** justification for including or not including the views resulting from the relevant consultation in the **Grid Code Modification Report**.
- (m) where a **Grid Code Modification Proposal** or any **Workgroup Alternative Grid Code Modification(s)** constitutes an amendment to the **Regulated Sections**, the expected impact on the objectives of **Retained EU Law** (Commission Regulation (EU) 2017/2195).

GR.22.3 A draft of the **Grid Code Modification Report** will be circulated by the **Code Administrator** to **Users**, **Panel Members** and such other persons who may properly be considered to have an appropriate interest in it (and its provision in electronic form on the **Website** and in electronic mails to **Users** and **Panel Members**, who must supply relevant details, shall meet this requirement) and a period of no less than five (5) **Business Days** given for comments to be made thereon. Any unresolved comments made shall be reflected in the final **Grid Code Modification Report**.

GR.22.4 A draft of the **Grid Code Modification Report** shall be tabled at a meeting of the **Grid Code Review Panel** prior to submission of that **Grid Code Modification Report** to the **Authority** as set in accordance with the timetable established pursuant to GR.19.1, and at which the **Panel** may consider any minor changes to the legal drafting, which may include

any issues identified through the **Code Administrator** consultation, and:

- (i) if the change required is a typographical error the **Grid Code Review Panel** may instruct the **Code Administrator** to make the appropriate change and the **Panel Chairman** will undertake the **Grid Code Review Panel Recommendation Vote**;
or
- (ii) if the change required is not considered to be a typographical error then the **Grid Code Review Panel** may direct the **Workgroup** to review the change. If the **Workgroup** unanimously agree that the change is minor the **Grid Code Review Panel** may instruct the **Code Administrator** to make the appropriate change and the **Panel Chairman** will undertake the **Grid Code Review Panel Recommendation Vote**, otherwise for changes that are not considered to be minor the **Code Administrator** shall issue the **Grid Code Modification Proposal** for further **Code Administrator** consultation, after which the **Panel Chairman** will undertake the **Grid Code Review Panel Recommendation Vote**;
or
- (iii) In the case of a modification that had been directed pursuant to GR.19.2(e) to proceed directly to wider consultation without the formation of a **Workgroup**, and if the change required is not considered to be a typographical error, then the **Grid Code Review Panel** may direct the **Code Administrator** in conjunction with the **Proposer** to review the change. If the **Grid Code Review Panel**, the **Code Administrator** and the **Proposer** agree that the change is minor the **Grid Code Review Panel** may instruct the **Code Administrator** to make the appropriate change and the **Panel Chairman** will undertake the **Grid Code Review Panel Recommendation Vote**, otherwise for changes that are not considered to be minor the **Code Administrator** shall issue the **Grid Code Modification Proposal** for further **Code Administrator** consultation after which the **Panel Chairman** will undertake the **Grid Code Review Panel Recommendation Vote**. In the case of a change that is not considered to be minor, the **Grid Code Review Panel** may also consider whether to establish a **Workgroup** of the **Grid Code Review Panel**, to further consider the **Grid Code Modification Proposal**, in which case the procedures set out within GR.20 will be followed as required; or
- (iv) if a change is not required after consideration, the **Panel Chairman** will undertake the **Grid Code Review Panel Recommendation Vote**.

GR.22.5 A draft of the **Grid Code Modification Report** following the **Grid Code Review Panel Recommendation Vote** will be circulated by the **Code Administrator** to **Panel Members** (and in electronic mails to **Panel Members**, who must supply relevant details, shall meet this requirement) and a period of no less than five (5) **Business Days** given for comments to be made on whether the **Grid Code Modification Report** accurately reflects the views of the **Panel Members** as expressed at the **Grid Code Review Panel Recommendation Vote**. Any unresolved comments made shall be reflected in the final **Grid Code Modification Report**.

GR.22.6 Each **Grid Code Modification Report** shall be addressed and furnished to the **Authority** and none of the facts, opinions or statements contained in such may be relied upon by any other person.

GR.22.7 Subject to GR.22.9 to GR.22.12, in accordance with the **Transmission Licence**, the **Authority** may approve the **Grid Code Modification Proposal** or a **Workgroup Alternative Grid Code Modification(s)** contained in the **Grid Code Modification Report** (which shall then be an "**Approved Modification**" until implemented).

GR.22.8 The **Code Administrator** shall copy (by electronic mail to those persons who have supplied relevant details to the **Code Administrator**) the **Grid Code Modification Report** to:

- (i) each **Panel Member**; and
- (ii) any person who may request a copy, and shall place a copy on the **Website**.

GR.22.9 Revised Fixed Proposed Implementation Date

- GR.22.9.1 Where the **Proposed Implementation Date** included in a **Grid Code Modification Report** is a **Fixed Proposed Implementation Date** and the **Authority** considers that the **Fixed Proposed Implementation Date** is or may no longer be appropriate or might otherwise prevent the **Authority** from making such decision by reason of the effluxion of time the **Authority** may direct the **Grid Code Review Panel** to recommend a revised **Proposed Implementation Date**.
- GR.22.9.2 Such direction may:
- (a) specify that the revised **Proposed Implementation Date** shall not be prior to a specified date;
 - (b) specify a reasonable period (taking into account a reasonable period for consultation) within which the **Grid Code Review Panel** shall be requested to submit its recommendation; and
 - (c) provide such reasons as the **Authority** deems appropriate for such request (and in respect of those matters referred to in GR.22.9.2 (a) and (b) above).
- GR.22.9.3 Before making a recommendation to the **Authority**, the **Grid Code Review Panel** will consult on the revised **Proposed Implementation Date**, and may in addition consult on any matters relating to the **Grid Code Modification Report** which in the **Grid Code Review Panel's** opinion have materially changed since the **Grid Code Modification Report** was submitted to the **Authority** and where it does so the **Grid Code Review Panel** shall report on such matters as part of its recommendation under **Grid Code GR.22.9.4**, with:
- (a) **Users**; and
 - (b) such other persons who may properly be considered to have an appropriate interest in it. Such consultation will be undertaken in accordance with GR.21.3 and GR.21.6.
- GR.22.9.4 Following the completion of the consultation held pursuant to GR.22.9.3 the **Grid Code Review Panel** shall report to the **Authority** with copies of all the consultation responses and recommending a **Revised Proposed Implementation Date**.
- GR.22.9.5 The **Authority** shall notify the **Grid Code Review Panel** as to whether or not it intends to accept the **Revised Proposed Implementation Date** and where the **Authority** notifies the **Grid Code Review Panel** that it intends to accept the **Revised Proposed Implementation Date**, the **Revised Proposed Implementation Date** shall be deemed to be the **Proposed Implementation Date** as specified in the **Grid Code Modification Report**.
- GR.22.10 Authority Approval
- If:
- (a) the **Authority** has not given notice of its decision in respect of a **Grid Code Modification Report** within two (2) calendar months (in the case of an **Urgent Modification**), or four (4) calendar months (in the case of all other **Grid Code Modification Proposals**) from the date upon which the **Grid Code Modification Report** was submitted to it; or
 - (b) the **Grid Code Review Panel** is of the reasonable opinion that the circumstances relating to the **Grid Code Modification Proposal** and/or **Workgroup Alternative Grid Code Modification** which is the subject of a **Grid Code Modification Report** have materially changed, the **Grid Code Review Panel** may request the **Panel Secretary** to write to the **Authority** requesting the **Authority** to give an indication of the likely date by which the **Authority's** decision on the **Grid Code Modification Proposal** will be made.

GR.22.11 If the **Authority** determines that the **Grid Code Modification Report** is such that the **Authority** cannot properly form an opinion on the **Grid Code Modification Proposal** and any **Workgroup Alternative Grid Code Modification(s)**, or where the **Grid Code Modification Proposal** and/or any **Workgroup Alternative Grid Code Modification(s)** constitutes an amendment to the **Regulated Sections** of the code, where the **Authority** requires an amendment to the **Grid Code Modification Proposal** and/or any **Workgroup Alternative Grid Code Modification(s)** in order to approve it, it may issue a direction to the **Grid Code Review Panel**:

(a) specifying the additional steps (including drafting or amending existing drafting associated with the **Grid Code Modification Proposal** and any **Workgroup Alternative Grid Code Modification(s)**, revision (including revision to the timetable), analysis or information that it requires in order to form such an opinion; and

(b) requiring the **Grid Code Modification Report** to be revised and to be resubmitted.

GR.22.12 If a **Grid Code Modification Report** is to be revised and re-submitted in accordance with a direction issued pursuant to GR.22.11, it shall be re-submitted as soon after the **Authority's** direction as is appropriate (and in the case of an amendment to the **Regulated Sections** of the code within 2 months), taking into account the complexity, importance and urgency of the **Grid Code Modification Proposal** and any **Workgroup Alternative Grid Code Modification(s)**. The **Grid Code Review Panel** shall decide on the level of analysis and consultation required in order to comply with the **Authority's** direction and shall agree an appropriate timetable for meeting its obligations. Once the **Grid Code Modification Report** is revised, the **Grid Code Review Panel** shall carry out its **Grid Code Review Panel Recommendation Vote** again in respect of the revised **Grid Code Modification Report** and re-submit it to the **Authority** in compliance with GR.22.4 to GR.22.6.

GR.23 URGENT MODIFICATIONS

GR.23.1 If a **Relevant Party** recommends to the **Panel Secretary** that a proposal should be treated as an **Urgent Modification** in accordance with this GR.23, the **Panel Secretary** shall notify the **Panel Chairman** who shall then, in accordance with GR.23.2 (a) to (e) inclusive, and notwithstanding anything in the contrary in these **Governance Rules**, endeavour to obtain the views of the **Grid Code Review Panel** as to the matters set out in GR.23.3. If for any reason the **Panel Chairman** is unable to do that, the **Panel Secretary** shall attempt to do so (and the measures to be undertaken by the **Panel Chairman** in the following paragraphs shall in such case be undertaken by the **Panel Secretary**).

GR.23.2 (a) The **Panel Chairman** shall determine the time by which, in his opinion, a decision of the **Grid Review Panel** is required in relation to such matters, having regard to the degree of urgency in all circumstances, and references in this GR.23.1 to the "time available" shall mean the time available, based on any such determination by the **Panel Chairman**;

(b) The **Panel Secretary** shall, at the request of the **Panel Chairman**, convene a meeting or meetings (including meetings by telephone conference call, where appropriate) of the **Grid Code Review Panel** in such manner and upon such notice as the **Panel Chairman** considers appropriate, and such that, where practicable within the time available, as many **Panel Members** as possible may attend;

(c) Each **Panel Member** shall be deemed to have consented, for the purposes of GR.8.9. to the convening of such meeting or meetings in the manner and on the notice determined by the **Panel Chairman**. GR.8.10 shall not apply to any such business.

(d) Where:

- (i) it becomes apparent, in seeking to convene a meeting of the **Grid Code Review Panel** within the time available, that quorum will not be present; or
- (ii) it transpires that the meeting of the **Grid Code Review Panel** is not quorate and it is not possible to rearrange such meeting within the time available, the **Panel Chairman** shall endeavour to contact each **Panel Member** individually in order to ascertain such Panel Member's vote, and (subject to GR.23.2 (e))

any matter to be decided shall be decided by a majority of those **Panel Members** who so cast a vote. Where, for whatever reason no decision is reached, the **Panel Chairman** shall proceed to consult with the **Authority** in accordance with GR.23.5;

- (e) Where the **Panel Chairman** is unable to contact at least four **Panel Members** within the time available and where:
- (i) It is only **The Company**, who has recommended that the proposal should be treated as an **Urgent Modification**, then those **Panel Members** contacted shall decide such matters, such decision may be a majority decision. Where in such cases no decision is made for whatever reason, the **Panel Chairman** shall proceed to consult with the **Authority** in accordance with GR.23.5; or
 - (ii) any **User** (including any **Authorised Electricity Operator**; **The Company** or a **Materially Affected Party**), the **Citizens Advice** or the **Citizens Advice Scotland** has recommended that the proposal should be treated as an **Urgent Modification**, then the **Panel Chairman** may decide the matter (in consultation with those **Panel Members** (if any) which he managed to contact) provided that the **Panel Chairman** shall include details in the relevant **Grid Code Modification Report** of the steps which he took to contact other **Panel Members** first.

GR.23.3 The matters referred to in GR.23.1 are:

- (a) whether such proposal should be treated as an **Urgent Modification** in accordance with this GR.23 and
- (b) the procedure and timetable to be followed in respect of such **Urgent Modification**.

GR.23.4 The **Panel Chairman** or, in his absence, the **Panel Secretary** shall forthwith provide the **Authority** with the recommendation (if any) ascertained in accordance with GR.23.2 (a) to (e) inclusive, of the **Grid Code Review Panel** as to the matters referred to in GR.23.2, and shall consult the **Authority** as to whether such **Grid Code Modification Proposal** is an **Urgent Modification** and, if so, as to the procedure and timetable which should apply in respect thereof.

GR.23.5 If the **Grid Code Review Panel** has been unable to make a recommendation in accordance with GR.23.2.(d) or GR.23.2(e) as to the matters referred to in GR.23.3 then the **Panel Chairman** or, in his absence, the **Panel Secretary** may recommend whether he considers that such proposal should be treated as an **Urgent Modification** and shall forthwith consult the **Authority** as to whether such **Grid Code Modification Proposal** is an **Urgent Modification** and, if so, as to the procedure and timetable that should apply in respect thereof.

GR.23.6 The **Grid Code Review Panel** shall:

- (a) not treat any **Grid Code Modification Proposal** as an **Urgent Modification** except with the prior consent of the **Authority**;
- (b) comply with the procedure and timetable in respect of any **Urgent Modification** approved by the **Authority**; and
- (c) comply with any direction of the **Authority** issued in respect of any of the matters on which the **Authority** is consulted pursuant to GR.23.4 or GR.23.5.

GR.23.7 For the purposes of this GR.23.7, the procedure and timetable in respect of an **Urgent Modification** may (with the approval of the **Authority** pursuant to GR.23.4 or GR.23.5) deviate from all or part of the **Grid Code Modification Procedures** or follow any other procedure or timetable approved by the **Authority** except for the duration of the **Code Administrator** consultation for modifications relating to **Regulated Sections** which shall be for one month. Where the procedure and timetable approved by the **Authority** in respect

of an **Urgent Modification** do not provide for the establishment (or designation) of a **Workgroup** the **Proposer's** right to vary the **Grid Code Modification Proposal** pursuant to GR.15.10 and GR.20.26 shall lapse from the time and date of such approval.

- GR.23.8 The **Grid Code Modification Report** in respect of an **Urgent Modification** shall include:
- (a) a statement as to why the **Proposer** believes that such **Grid Code Modification Proposal** should be treated as an **Urgent Modification**;
 - (b) any statement provided by the **Authority** as to why the **Authority** believes that such **Grid Code Modification Proposal** should be treated as an **Urgent Modification**;
 - (c) any recommendation of the **Grid Code Review Panel** (or any recommendation of the **Panel Chairman**) provided in accordance with GR.23 in respect of whether any **Grid Code Modification Proposal** should be treated as an **Urgent Modification**; and
 - (d) the extent to which the procedure followed deviated from the process for **Standard Modifications** (other than the procedures in this GR.23).
- GR.23.9 Each **Panel Member** shall take all reasonable steps to ensure that an **Urgent Modification** is considered, evaluated and (subject to the approval of the **Authority**) implemented as soon as reasonably practicable, having regard to the urgency of the matter and, for the avoidance of doubt, an **Urgent Modification** may (subject to the approval of the **Authority**) result in the **Grid Code** being amended on the day on which such proposal is submitted.
- GR.23.10 Where an **Urgent Modification** results in an amendment being made in accordance with GR.25, the **Grid Code Review Panel** may or (where it appears to the **Grid Code Review Panel** that there is a reasonable level of support for a review amongst **Users**) shall following such amendment, establish a **Workgroup** on terms specified by the **Grid Code Review Panel** to consider and report as to whether any alternative amendment could, as compared with such amendment better facilitate achieving the **Grid Code Objectives** in respect of the subject matter of that **Urgent Modification**.
- GR.24 SELF-GOVERNANCE
- GR.24.1 If the **Grid Code Review Panel**, having evaluated a **Grid Code Modification Proposal** against the **Self-Governance Criteria**, pursuant to GR.18.4, considers that the **Grid Code Modification Proposal** meets the **Self-Governance Criteria**, the **Grid Code Review Panel** shall submit to the **Authority** a **Self-Governance Statement** setting out its reasoning in reasonable detail.
- GR.24.2 The **Authority** may, at any time prior to the **Grid Code Review Panel's** determination made pursuant to GR.24.9, give written notice that it disagrees with the **Self-Governance Statement** and may direct that the **Grid Code Modification Proposal** proceeds through the process for **Standard Modifications** set out in GR.19, GR.20, GR.21 and GR.22.
- GR.24.3 Subject to GR.24.2, after submitting a **Self-Governance Statement**, the **Grid Code Review Panel** shall follow the procedure set out in GR.19, GR.20, GR.21 and GR.22.
- GR.24.4 The **Authority** may issue a direction to the **Grid Code Review Panel** in relation to a **Modification** to follow the procedure set out for **Modifications** that meet the **Self-Governance Criteria**, notwithstanding that no **Self-Governance Statement** has been submitted or a **Self-Governance Statement** has been retracted.
- GR.24.5 Subject to the **Code Administrator's** consultation having been completed pursuant to GR.21, the **Grid Code Review Panel** shall prepare a report (the "**Grid Code Modification Self-Governance Report**").
- GR.24.6 The matters to be included in a **Grid Code Modification Self-Governance Report** shall be the following (in respect of the **Grid Code Modification Proposal**):

- (a) details of its analysis of the **Grid Code Modification Proposal** against the **Self-Governance Criteria**;
- (b) copies of all consultation responses received;
- (c) the date on which the **Grid Code Review Panel Self-Governance Vote** shall take place, which shall not be earlier than seven (7) days from the date on which the **Grid Code Modification Self-Governance Report** is furnished to the **Authority** in accordance with GR.24.8; and
- (d) such other information that is considered relevant by the **Grid Code Review Panel**.

GR.24.7 A draft of the **Grid Code Modification Self-Governance Report** will be circulated by the **Code Administrator** to **Users** and **Panel Members** (and its provision in electronic form on the **Website** and in electronic mails to **Users** and **Panel Members**, who must supply relevant details, shall meet this requirement) and a period of no less than five (5) **Business Days** given for comments to be made thereon. Any unresolved comments made shall be reflected in the final **Grid Code Modification Self-Governance Report**.

GR.24.8 Each **Grid Code Modification Self-Governance Report** shall be addressed and furnished to the **Authority** and none of the facts, opinions or statements contained in such **Grid Code Modification Self-Governance Report** may be relied upon by any other person.

GR.24.9 Subject to GR.24.11, if the **Authority** does not give written notice that its decision is required pursuant to GR.24.2, or if the **Authority** determines that the **Self-Governance Criteria** are satisfied in accordance with GR.24.4, then the **Grid Code Modification Self-Governance Report** shall be tabled at the **Panel Meeting** following submission of that **Grid Code Modification Self-Governance Report** to the **Authority** at which the **Panel Chairman** will undertake the **Grid Code Review Panel Self-Governance Vote** and the **Code Administrator** shall give notice of the outcome of such vote to the **Authority** as soon as possible thereafter.

GR.24.10 If the **Grid Code Review Panel** vote to approve the **Grid Code Modification Proposal** pursuant to GR.24.9 (which shall then be an “**Approved Grid Code Self-Governance Proposal**”) until implemented).

GR.24.11 The **Grid Code Review Panel** may at any time prior to the **Grid Code Review Panel’s** determination retract a **Self-Governance Statement** subject to GR.24.4, or if the **Authority** notifies the **Grid Code Review Panel** that it has determined that a **Grid Code Modification Proposal** does not meet the **Self-Governance Criteria** the **Grid Code Review Panel** shall treat the **Grid Code Modification Proposal** as a **Standard Modification** and shall comply with GR.22, using the **Grid Code Modification Self-Governance Report** as a basis for its **Grid Code Modification Report**.

GR.24.12 The **Code Administrator** shall make available on the **Website** and copy (by electronic mail to those persons who have supplied relevant details to the **Code Administrator**) the **Grid Code Modification Self-Governance Report** prepared in accordance with GR.24 to:

- (i) each **Panel Member**; and
- (ii) any person who may request a copy, and shall place a copy on the **Website**.

GR.24.13 A **User** (including any **Authorised Electricity Operator**; **The Company** or a **Materially Affected Party**), the **Citizens Advice** or the **Citizens Advice Scotland** may appeal to the **Authority** the approval or rejection by the **Grid Code Review Panel** of a **Grid Code Modification Proposal** and any **Workgroup Alternative Grid Code Modification(s)** in accordance with GR.24.9, provided that the **Panel Secretary** is also notified, and the appeal has been made up to and including fifteen (15) **Business Days** after the **Grid Code Review Panel Self-Governance Vote** has been undertaken pursuant to GR.24.9. If such an appeal is made, implementation of the **Grid Code Modification Proposal** shall be suspended pending the outcome. The appealing **User** (including any **Authorised Electricity Operator**; **The Company** or a **Materially Affected Party**), the **Citizens Advice**

or the **Citizens Advice Scotland** must notify the **Panel Secretary** of the appeal when the appeal is made.

- GR.24.14 The **Authority** shall consider whether the appeal satisfies the following criteria:
- (a) The appealing party is, or is likely to be, unfairly prejudiced by the implementation or non-implementation of that **Grid Code Modification Proposal** or **Workgroup Alternative Grid Code Modification(s)**; or
 - (b) The appeal is on the grounds that, in the case of implementation, the **Grid Code Modification Proposal** or **Workgroup Alternative**; or
 - (c) **Grid Code Modification(s)** may not better facilitate the achievement of at least one of the **Grid Code Objectives**; or
 - (d) The appeal is on the grounds that, in the case of non-implementation, the **Grid Code Modification Proposal** or **Workgroup Alternative Grid Code Modification(s)** may better facilitate the achievement of at least one of the **Grid Code Objectives**; and
 - (e) It is not brought for reasons that are trivial, vexatious or have no reasonable prospect of success and if the **Authority** considers that the criteria are not satisfied, it shall dismiss the appeal.
- GR.24.15 Following any appeal to the **Authority**, a **Grid Code Modification Proposal** or **Workgroup Alternative Grid Code Modification(s)** shall be treated in accordance with any decision and/or direction of the **Authority** following that appeal.
- GR.24.16 If the **Authority** quashes the **Grid Code Review Panel's** determination in respect of a **Grid Code Modification Proposal** or **Workgroup Alternative Grid Code Modification(s)** made in accordance with GR.24.9 and takes the decision on the relevant **Grid Code Modification Proposal** and any **Workgroup Alternative Grid Code Modification(s)** itself, following an appeal to the **Authority**, the **Grid Code Review Panel's** determination of that **Grid Code Modification Proposal** and any **Workgroup Alternative Grid Code Modification(s)** contained in the relevant **Grid Code Modification Self Governance Report** shall be treated as a **Grid Code Modification Report** submitted to the **Authority** pursuant to GR.22.6 (for the avoidance of doubt, subject to GR.22.8 to GR.22.12) and the **Grid Code Review Panel's** determination shall be treated as its recommendation pursuant to GR.22.4.
- GR.24.17 If the **Authority** quashes the **Grid Code Review Panel's** determination in respect of a **Grid Code Modification Proposal** or **Workgroup Alternative Grid Code Modification(s)** made in accordance with GR.24.9, the **Authority** may, following an appeal to the **Authority**, refer the **Grid Code Modification Proposal** back to the **Grid Code Review Panel** for further re-consideration and a further **Grid Code Review Panel Self-Governance Vote**.
- GR.24.18 Following an appeal to the **Authority**, the **Authority** may confirm the **Grid Code Review Panel's** determination in respect of a **Grid Code Modification Proposal** or **Workgroup Alternative Grid Code Modification(s)** made in accordance with GR.24.9.
- GR.25 IMPLEMENTATION
- GR.25.1 The **Grid Code** shall be modified either in accordance with the terms of the direction by the **Authority** relating to, or other approval by the **Authority** of, the **Grid Code Modification Proposal** or any **Workgroup Alternative Grid Code Modification(s)** contained in the relevant **Grid Code Modification Report**, or in respect of **Grid Code Modification Proposals** or any **Workgroup Alternative Grid Code Modification(s)** that are subject to the determination of the **Grid Code Review Panel** pursuant to GR.24.9, in accordance with the relevant **Grid Code Modification Self-Governance Report** subject to the appeal procedures set out in GR.24.13 to GR.24.18.

GR.25.2 The **Code Administrator** shall forthwith notify (by publication on the **Website** and, where relevant details are supplied by electronic mail):

- (a) each **User**;
- (b) each **Panel Member**;
- (c) the **Authority**;
- (d) each **Core Industry Document Owner**;
- (e) the secretary of the **STC** committee;
- (f) each **Materially Affected Party**; and
- (g) the **Citizens Advice** and the **Citizens Advice Scotland** of the change so made and the effective date of the change.

GR.25.3 A modification of the **Grid Code** shall take effect from the time and date specified in the direction, or other approval, from the **Authority** referred to in GR.25.1 or, in the absence of any such time and date in the direction or approval, from 00:00 hours on the day falling ten (10) **Business Days** after the date of such direction, or other approval, from the **Authority**. A modification of the **Grid Code** pursuant to GR.24.9 shall take effect, subject to the appeal procedures set out in GR.24.13 to GR.24.18, from the time and date specified by the **Code Administrator** in its notice given pursuant to GR.25.2, which shall be given after the expiry of the fifteen (15) **Business Day** period set out in GR.24.13 to allow for appeals, or where an appeal is raised in accordance with GR.24.13, on conclusion of the appeal in accordance with GR.24.15 or GR.24.18 but where conclusion of the appeal is earlier than the fifteen (15) **Business Day** period set out in GR.24.13, notice shall be given after the expiry of this period. A modification of the **Grid Code** pursuant to GR.26 shall take effect from the date specified in the **Grid Code Modification Fast Track Report**.

GR.25.4 A modification made pursuant to and in accordance with GR.25.1 shall not be impaired or invalidated in any way by any inadvertent failure to comply with or give effect to this Section.

GR.25.5 If a modification is made to the Grid Code in accordance with the **Transmission Licence** but other than pursuant to the other **Grid Code Modification Procedures** in these **Governance Rules**, the **Grid Code Review Panel** shall determine whether or not to submit the modification for review by a **Workgroup** established on terms specified by the **Grid Code Review Panel** to consider and report as to whether any alternative modification could, as compared with such modification better facilitate achieving the **Grid Code Objectives** in respect of the subject matter of the original modification. Where such a **Workgroup** is established the provisions of GR.20 shall apply as if such a modification were a **Grid Code Modification Proposal**.

Transitional Issues

GR.25.6 Notwithstanding the provisions of GR.25.3, Modification GC0132 changes the **Grid Code** process for **Grid Code Modification Proposals** and therefore may affect other **Grid Code Modification Proposals** which have not yet become **Approved Modifications**. Consequently, this GR.25.6 deals with issues arising out of the implementation of **Modification** GC0132. In particular this deals with which version of the **Grid Code** process for **Grid Code Modification Proposals** will apply to **Grid Code Modification Proposal(s)** which were already instigated prior to the implementation of **Modification** GC0132.

Any **Grid Code Modification Proposal** in respect of which a **Grid Code Modification Report** has been sent to the **Authority** prior to the date and time of implementation of **Modification** GC0132 is known as an “**Old Modification**”. Any **Grid Code Modification Proposal** in respect of which a **Grid Code Modification Report** has not been sent to the **Authority** as at the date and time of implementation of **Modification** GC0132 is known as a “**New Modification**”. The **Grid Code** provisions which will apply to any **Old Modification(s)** are the provisions of the **Grid Code** in force immediately prior to the implementation of GC0132. The provisions of the **Grid Code** which will apply to any **New Modifications** are the provisions of the **Grid Code** in force and as amended from time to time.

GR.25.7 Notwithstanding the provisions of GR.25.3, **Modification GC0131** changes the **Grid Code** process for **Grid Code Modification Proposals** and therefore may affect other **Grid Code Modification Proposals** which have not yet become **Approved Modifications**.

Consequently, this GR.25.7 deals with issues arising out of the implementation of **Modification GC0131**. In particular this deals with which version of the **Grid Code** process for **Grid Code Modification Proposals** will apply to **Grid Code Modification Proposal(s)** which were already instigated prior to the implementation of **Modification GC0131**.

Any **Grid Code Modification Proposal** in respect of which a **Grid Code Modification Report** has been sent to the **Authority** prior to the date and time of implementation of **Modification GC0131** is known as an “**Old GC0131 Modification**”. Any **Grid Code Modification Proposal** in respect of which a **Grid Code Modification Report** has not been sent to the **Authority** as at the date and time of implementation of **Modification GC0131** is known as a “**New GC0131 Modification**”. The **Grid Code** provisions which will apply to any **Old GC0131 Modification(s)** are the provisions of the **Grid Code** in force immediately prior to the implementation of **GC0131**. The provisions of the **Grid Code** which will apply to any **New GC0131 Modifications** are the provisions of the **Grid Code** in force from time to time.

GR.26 FAST TRACK

GR.26.1 Where a **Proposer** believes that a modification to the **Grid Code** which meets the **Fast Track Criteria** is required, a **Grid Code Fast Track Proposal** may be raised. In such case the **Proposer** is only required to provide the details listed in GR.15.3 (a), (b), (c), (d), (e) and (k).

GR.26.2 Provided that the **Panel Secretary** receives any modification to the **Grid Code** which the **Proposer** considers to be a **Grid Code Fast Track Proposal**, not less than ten (10) **Business Days** (or such shorter period as the **Panel Secretary** may agree, provided that the **Panel Secretary** shall not agree any period shorter than five (5) **Business Days**) prior to the next **Grid Code Review Panel** meeting, the **Panel Secretary** shall place the **Grid Code Fast Track Proposal** on the agenda of the next **Grid Code Review Panel** meeting, and otherwise, shall place it on the agenda of the next succeeding **Grid Code Review Panel** meeting.

GR.26.3 To facilitate the discussion at the **Grid Code Review Panel** meeting, the **Code Administrator** will circulate a draft of the **Grid Code Modification Fast Track Report** to **Users**, the **Authority** and **Panel Members** (and its provision in electronic form on the **Website** and in electronic mails to **Users**, the **Authority** and **Panel Members**, who must supply relevant details, shall meet this requirement) for comment not less than five (5) **Business Days** ahead of the **Grid Code Review Panel** meeting which will consider whether or not the **Fast Track Criteria** are met and whether or not to approve the **Grid Code Fast Track Proposal**.

GR.26.4 It is for the **Grid Code Review Panel** to decide whether or not a **Grid Code Fast Track Proposal** meets the **Fast Track Criteria** and if it does, to determine whether or not to approve the **Grid Code Fast Track Proposal**.

GR.26.5 The **Grid Code Review Panel’s** decision that a **Grid Code Fast Track Proposal** meets the **Fast Track Criteria** pursuant to GR.26.4 must be unanimous.

GR.26.6 The **Grid Code Review Panel’s** decision to approve the **Grid Code Fast Track Proposal** pursuant to GR.26.4 must be unanimous.

GR.26.7 If the **Grid Code Review Panel** vote unanimously that the **Grid Code Fast Track Proposal** meets the **Fast Track Criteria** and to approve the **Grid Code Fast Track Proposal** (which shall then be an “**Approved Fast Track Proposal**”) until implemented, or until an objection is received pursuant to GR.26.12), then subject to the objection procedures set out in GR.26.12 the **Grid Code Fast Track Proposal** will be implemented by **The Company** without the **Authority’s** approval. If the **Grid Code Review Panel** do not unanimously agree that the **Grid Code Modification Proposal** meets the **Fast Track Criteria** and/or do not unanimously agree that the **Grid Code Fast Track Proposal** should be made, then the **Panel Secretary** shall, in accordance with GR.15.4(a) notify the **Proposer** that additional information is required if the **Proposer** wishes the **Grid Code Modification Proposal** to continue.

- GR.26.8 Provided that the **Grid Code Review Panel** have unanimously agreed to treat a **Grid Code Modification Proposal** as a **Grid Code Fast Track Proposal** and unanimously approved that **Grid Code Fast Track Proposal**, the **Grid Code Review Panel** shall prepare and approve the **Grid Code Modification Fast Track Report** for issue in accordance with GR.26.11.
- GR.26.9 The matters to be included in a **Grid Code Modification Fast Track Report** shall be the following (in respect of the **Grid Code Fast Track Proposal**):
- (a) a description of the proposed modification and of its nature and purpose;
 - (b) details of the changes required to the Grid Code, including the proposed legal text to modify the Grid Code to implement the **Grid Code Fast Track Proposal**;
 - (c) details of the votes required pursuant to GR.26.5 and GR.26.6;
 - (d) the intended implementation date, from which the **Approved Fast Track Proposal** will take effect, which shall be no sooner than fifteen (15) **Business Days** after the date of notification of the **Grid Code Review Panel's** decision to approve; and
 - (e) details of how to object to the **Approved Fast Track Proposal** being made
- GR.26.10 Upon approval by the **Grid Code Review Panel** of the **Grid Code Modification Fast Track Report**, the **Code Administrator** will issue the report in accordance with GR.26.11.
- GR.26.11 The **Code Administrator** shall copy (by electronic mail to those persons who have supplied relevant details to the **Code Administrator**) the **Grid Code Modification Fast Track Report** prepared in accordance with GR.26 to:
- (i) each **Panel Member**;
 - (ii) the **Authority**; and
 - (iii) any person who may request a copy, and shall place a copy on the **Website**.
- GR.26.12 A **User**, any **Authorised Electricity Operator**; **The Company** or a **Materially Affected Party**, the **Citizens Advice**, the **Citizens Advice Scotland** or the **Authority** may object to the **Approved Fast Track Proposal** being implemented, and shall include with such objection the reasons for the objection. Any such objection must be made in writing (including by email) and be clearly stated to be an objection to the **Approved Fast Track Proposal** in accordance with this GR.26 of the Grid Code and be notified to the **Panel Secretary** by the date up to and including fifteen (15) **Business Days** after notification of the **Grid Code Review Panel's** decision to approve the **Grid Code Fast Track Proposal**. If such an objection is made the **Approved Fast Track Proposal** shall not be implemented. The **Panel Secretary** will notify each **Panel Member** and the **Authority** of the objection. The **Panel Secretary** shall notify the **Proposer**, in accordance with GR.15.4A that additional information is required if the **Proposer** wishes the **Grid Code Modification Proposal** to continue.

ANNEX GR.A - ELECTION OF USERS' PANEL MEMBERS

Grid Code Review Panel Election Process

1. The election process has two main elements: nomination and selection.
2. The process will be used to appoint **Panel Members** in the category of **Supplier, Generator, Offshore Transmission Owner** and **Onshore Transmission Owner**.
3. The **Code Administrator** will publish the Election timetable by [September] in the year preceding the start of each term of office of **Panel Members**.
4. Each step of the process set out below will be carried out in line with the published timetable.
5. The **Code Administrator** will establish an Electoral Roll from representatives of parties listed on CUSC Schedule 1 or designated by the **Authority** as a **Materially Affected Party** as at 31st August in the year preceding the start of each term of office of **Panel Members**.
6. The **Code Administrator** will keep the Electoral Roll up to date.

Nomination Process

7. Each party on the Electoral Roll may nominate a candidate to stand for election for the **Grid Code Review Panel**.
8. Parties may only nominate a candidate for their own category; a **Supplier** may nominate a candidate for the **Supplier Panel Member** seat and a **Generator** may nominate a candidate for the **Generator Panel Member** seats. If a party able to nominate a candidate is both a **Supplier** and a **Generator**, they may nominate a candidate in each category.
9. The nominating party must complete the nomination form which will be made available by the **Code Administrator** and return it to the **Code Administrator** by the stated deadline.
10. The **Code Administrator** will draw up a list of candidates for each category of election.
11. Where there are fewer candidates than seats available or the same number of candidates as seats available, no election will be required and the nominated candidate(s) will be elected. The **Code Administrator** will publish a list of the successful candidates on the Grid Code website and circulate the results by email to the Grid Code circulation list.

Selection Process

12. The **Code Administrator** will send a numbered voting paper to each party on the electoral roll for each of the elections in which they are eligible to vote. The voting paper will contain a list of candidates for each election and will be sent by email.
13. Each eligible party may vote for one [1] candidate for each of the **Supplier, Offshore Transmission Owner** and **Onshore Transmission Owner** seats and four [4] candidates for the **Generator** seats.
14. **Panel Members** will be elected using the First Past the Post method.
15. In the event of two or more candidates receiving the same number of votes, the **Code Administrator** will draw lots to decide who is elected.
16. The **Code Administrator** will publish the results of the election on the Grid Code website and circulate the results by email to the Grid Code circulation list.
17. The **Code Administrator** will send an Election Report to Ofgem after the election is complete.

ANNEX GR.B Regulated Sections
Mapping of Electricity Balancing Regulation Article 18 Terms and Conditions for Balancing Service
Providers and Balancing
Responsible Parties to the Grid Code

The Grid Code sections identified in this table are considered to be **Regulated Sections**.

Commission Regulation (EU) 2017/2195 Reference (Retained EU Law)	Description	Grid Code Reference
18.2	The terms and conditions pursuant to paragraph 1 shall also include the rules for suspension and restoration of market activities pursuant to Article 36 of Regulation (EU) 2017/2196 and rules for settlement in case of market suspension pursuant to Article 39 of Regulation (EU) 2017/2196 once approved in accordance with Article 4 of Regulation (EU) 2017/2196.	OC9.4
18.4.a	define reasonable and justified requirements for the provisions of balancing services;	BC1, BC2, BC3 & BC4
18.4.b	allow the aggregation of demand facilities, energy storage facilities and power generating facilities in a scheduling area to offer balancing services subject to conditions referred to in paragraph 5 (c);	DRSC 4.2, BC1.4
18.5.a	the rules for the qualification process to become a balancing service provider pursuant to Article 16;	<i>BC5, BC4.4.2</i>
18.5.c	the rules and conditions for the aggregation of demand facilities, energy storage facilities and power generating facilities in a scheduling area to become a balancing service provider;	BC1.4 and BC1.A.10
18.5.d	the requirements on data and information to be delivered to the connecting TSO and, where relevant, to the reserve connecting DSO during the prequalification process and operation of the balancing market;	DRC, <i>BC5 BC1.4,</i>
18.5. f	the requirements on data and information to be delivered to the connecting TSO and, where relevant, to the reserve connecting DSO to evaluate the provisions of balancing services pursuant to Article 154(1), Article 154(8), Article 158(1)(e), Article 158(4)(b), Article 161(1)(f) and Article 161(4)(b) of Regulation (EU) 2017/1485;	BC1.4, BC1.A.10,
18.5. g	the definition of a location for each standard product and each specific product taking into account paragraph 5 (c);	BC1.4

18.6. d	the requirements on data and information to be delivered to the connecting TSO to calculate the imbalances;	BC1.4.2,3,4, BC1 Appendix 1 BC2.5.1,
18.6. e	the rules for balance responsible parties to change their schedules prior to and after the intraday energy gate closure time pursuant to paragraphs 3 and 4 of Article 17;	BC1.4.3,4,

< END OF GOVERNANCE RULES >

REVISIONS

(R)

(This section does not form part of the Grid Code)

- R.1 **The Company's Transmission Licence** sets out the way in which changes to the Grid Code are to be made and reference is also made to **The Company's** obligations under the General Conditions.
- R.2 All pages re-issued have the revision number on the lower left hand corner of the page and date of the revision on the lower right hand corner of the page.
- R.3 The Grid Code was introduced in March 1990 and the first issue was revised 31 times. In March 2001 the New Electricity Trading Arrangements were introduced and Issue 2 of the Grid Code was introduced which was revised 16 times. At British Electricity Trading and Transmission Arrangements (BETTA) Go-Active Issue 3 of the Grid Code was introduced and subsequently revised 35 times. At Offshore Go-active Issue 4 of the Grid Code was introduced and has been revised 13 times since its original publication. Issue 5 of the Grid Code was published to accommodate the changes made by Grid Code Modification A/10 which has incorporated the **Generator** compliance process into the Grid Code, which was revised 47 times. Issue 6 was published to incorporate all the non-material amendments as a result of modification GC0136.
- R.4 This Revisions section provides a summary of the sections of the Grid Code changed by each revision to Issue 6.
- R.5 All enquiries in relation to revisions to the Grid Code, including revisions to Issues 1, 2, 3, 4 and 5 should be addressed to the Grid Code development team at the following email address:
Grid.Code@nationalgrideso.com

Revision	Section	Related Modification	Effective Date
0	Glossary Definitions	GC0136	05 March 2021
0	Planning Code	GC0136	05 March 2021
0	Connection Conditions	GC0136	05 March 2021
0	European Connection Conditions	GC0136	05 March 2021
0	Demand Response Services	GC0136	05 March 2021
0	Compliance Processes	GC0136	05 March 2021
0	Europeans Compliance Processes	GC0136	05 March 2021
0	Operating Code 1	GC0136	05 March 2021
0	Operating Code 2	GC0136	05 March 2021
0	Operating Code 5	GC0136	05 March 2021
0	Operating Code 6	GC0136	05 March 2021
0	Operating Code 7	GC0136	05 March 2021
0	Operating Code 8	GC0136	05 March 2021
0	Operating Code 8A	GC0136	05 March 2021
0	Operating Code 8B	GC0136	05 March 2021
0	Operating Code 9	GC0136	05 March 2021
0	Operating Code 11	GC0136	05 March 2021
0	Operating Code 12	GC0136	05 March 2021
0	Balancing Code 2	GC0136	05 March 2021

Revision	Section	Related Modification	Effective Date
0	Balancing Code 3	GC0136	05 March 2021
0	Balancing Code 4	GC0136	05 March 2021
0	Balancing Code 5	GC0136	05 March 2021
0	Data Registration Code	GC0136	05 March 2021
0	General Conditions	GC0136	05 March 2021
0	Governance Rules	GC0136	05 March 2021
1	Glossary Definitions	GC0130	18 March 2021
1	Operating Code 2	GC0130	18 March 2021
1	Data Registration Code	GC0130	18 March 2021
1	General Conditions	GC0130	18 March 2021
2	Glossary Definitions	GC0147	17 May 2021
2	Operating Code 6B	GC0147	17 May 2021
2	Operating Code 7	GC0147	17 May 2021
2	Balancing Code 1	GC0147	17 May 2021
2	Balancing Code 2	GC0147	17 May 2021
3	Balancing Code 2	GC0144	26 May 2021
3	Balancing Code 4	GC0144	26 May 2021
4	Preface	GC0149	03 August 2021
4	Glossary Definitions	GC0149	03 August 2021
4	Planning Code	GC0149	03 August 2021

Revision	Section	Related Modification	Effective Date
4	European Connection Conditions	GC0149	03 August 2021
4	European Compliance Processes	GC0149	03 August 2021
4	Demand Response Services Code	GC0149	03 August 2021
4	Operating Code 2	GC0149	03 August 2021
4	Balancing Code 4	GC0149	03 August 2021
4	Data Registration Code	GC0149	03 August 2021
4	Governance Rules	GC0149	03 August 2021

< END OF REVISIONS >