



Guidance Notes for HVDC Systems

EU Code User Issue 2
November 2020

Foreword

These Guidance Notes have been prepared by the National Grid Electricity System Operator (NGESO) to describe to HVDC system owners how the European Connection Conditions Compliance Processes is intended to work. Throughout this document National Grid refers to National Grid ESO unless explicitly stated otherwise.

These Guidance Notes are prepared, solely, for the assistance of prospective HVDC System owners connecting directly to the National Electricity Transmission or (if the installation has a rating of 50MW or more) to a User's System.

In the event of dispute, the Grid Code European Connection Conditions and Bilateral Agreement documents will take precedence over these notes.

Owners of HVDC installations rated 50MW or less should contact the relevant Distribution Network Operator (DNO) for guidance.

These Guidance Notes are based on the Grid Code, Issue 5, Revision 25, effective from the 07 September 2018. They have been developed from Issue 1 of the Guidance Notes of February 2013 and reflect the major changes brought about by Grid Code workgroup modifications GC0100, GC0101 and GC0102 as approved by the regulator on 16 May 2018. These modifications introduced the European Compliance Process (ECP) and European Connection Conditions (ECC).

Definitions for the terminology used within this document can be found in the Grid Code Glossary and Definitions.

The Electricity Customer Manager (see contact details) will be happy to provide clarification and assistance required in relation to these notes and European Connection Conditions compliance issues.

NGESO welcomes comments including ideas to reduce the compliance effort while maintaining the level of confidence. Feedback should be directed to the NGESO Electrical Connection & Compliance Team at:

Telephone: +44 (0) 777 502 7428

Email: Biniam.Haddish@nationalgrideso.com



Biniam Haddish
Connections Compliance Manager
Faraday House, Warwick

Disclaimer: This document has been prepared for guidance only and does not contain all the information needed to comply with the specific requirements of a Bilateral Agreement with NGESO. Please note that whilst these guidance notes have been prepared with due care, NGESO does not make any representation, warranty or undertaking, express or implied, in or in relation to the completeness and or accuracy of information contained in these guidance notes, and accordingly the contents should not be relied on as such.

Contents

- Foreword..... 2
- Contents..... 3
- Abbreviations 5
- Guidance Notes 7
- Introduction 9
- New Requirements..... 9
- Compliance Processes within the Grid Code 10
- Model 10
- Simulation Studies 11
- Fast Fault Current Injection requirement..... 11
- Factory Acceptance Tests (FAT) 12
- Compliance Testing 12
 - NGESO Data Recording Equipment 13
 - Compliance Test Signals..... 14
 - Compliance Test Logsheet..... 15
 - Test Notification to Control Room 15
- Model Validation 15
- Protection Requirements..... 16
- Power Quality Requirements 16
- Appendices 19
 - Appendix A Reactive Capability 21
 - Summary of Grid Code Requirements 21
 - Contractual Opportunities Relating to Reactive Services 21
 - Reactive Capability Compliance Tests..... 21
 - Appendix B Voltage Control Testing 24
 - Summary of Grid Code Requirements 24
 - Setpoint Voltage and Slope 24
 - Delivery of Reactive Capability Beyond +/-5% Voltage 24
 - Transient Response 25

- Compliance Test Description 25
- Suggested HVDC Converter Station Voltage Control Test Procedure 26
- Demonstration of Slope Characteristic..... 27
- Additional Power System Stabiliser Testing..... 27
- PSS testing is additional to the Module Voltage Control Tests..... 28

- Appendix C Frequency Control 30**
- Summary of Grid Code Requirements 30
- Modes of Frequency Control Operation 31
- Target Frequency 32
- De-load Instructions..... 32
- Summary of Steady State Load Accuracy Requirements 32
- Compliance Testing Requirements 33
- Typical Frequency Control Test Injection 33
- Preliminary Frequency Response Testing 33
- Witnessed Frequency Response Testing Sequence in European Compliance Processes..... 34
- Generic Frequency Response Test Procedure 35
- Control Requirements that may be witnessed 38

- Appendix D Other Technical Information 41**
- Technical Information on the Connection Bus Bar 41
- Equivalent Circuit between Supergrid Busbar and HVDC Converter Station Point of Connection 41
- Equivalent Sequence Impedances for Calculating Unbalanced Short-Circuit Current Contribution 42

- Appendix E Test Signal Schedules and Test Logsheet..... 45**
- Compliance Test Logsheet..... 45

- Appendix F Compliance Process 49**

- Appendix G Contacting National Grid 56**
- Contact Address: 56

Abbreviations

This section includes a list of the abbreviations that appear in this document.

Abbreviation	Description
AVC	Automatic Voltage Control (on transformers)
BA / BCA	Bilateral Agreement / Bilateral Connection Agreement
BC	Balancing Code
BM / BMU	Balancing Mechanism / Balancing Mechanism Unit
CC / CC.A	Connection Conditions / Connection Conditions Appendix
CCGT	Combined Cycle Gas Turbine
CP	Compliance Processes
CUSC	Connection and Use of System Code
DC	Direct Current
DNO	Distribution Network Operator
DMOL	Design Minimum Operating Level
DPD	Detailed Planning Data
DRC	Data Registration Code
EDL/EDT	Electronic Data Logging / Electronic Data Transfer
ELEXON	Balancing and Settlement Code Company
ENC	European Network Codes
FON	Final Operational Notification
FRT	Fault Ride Through
FSM	Frequency Sensitive Mode
GB	Great Britain
GCRP	Grid Code Review Panel
HVDC	High Voltage Direct Current
ION	Interim Operational Notification
LSFM	Limited Frequency Sensitive Mode
LON	Limited Operational Notification
MEL	Maximum Export Limit
MLP	Machine Load Point
NGESO	National Grid Electricity System Operator
NGET	National Grid Electricity Transmission

OC	Operating Code
OFGEM	Office of Gas and Electricity Markets
PC	Planning Code
PSS	Power System Stabiliser
PSSE	Power System Simulation for Engineering software
RISSP	Record of Inter System Safety Precautions
SEL	Stable Export limit
SO	System Operator (National Grid)
SPT	Scottish Power Transmission
SHET	Scottish Hydro Electric Transmission
ST	Steam Turbine
STC	System Operator Transmission Owner Code
TO	Transmission Owner
TOGA	Transmission Outages, Generation Availability
UDFS	User Data File Structure



1

Guidance Notes

Introduction

This document complements the European Compliance Processes (ECPs) included in the Grid Code providing additional description of the technical studies and testing set out within the Grid Code.

To achieve Operational Notification the HVDC System Owner must demonstrate compliance with Grid Code including the European Connection Conditions and Bilateral Agreement. The Grid Code is a generic document which specifies requirements regardless of local conditions. The Bilateral Agreement is a site specific document agreed between NGENSO and the Interconnector Owner, which for technical reasons, may specify additional/alternative requirements or specific parameters within a range indicated in the Grid Code. The Third Energy Package of European legislation created a requirement for European network codes (ENC), covering grid connections, markets, and system operation. The codes are designed to provide a sustainable, secure and competitive electricity market across Europe. Therefore, the European Connection Conditions have been added to the Grid Code to ensure consistency with the EU Connection Codes and apply to new connections after 29 September 2019. The total requirements placed on HVDC System Owners are therefore the aggregation of those specified in the Grid Code, European Connection Conditions and Bilateral Agreement which will inherently lead to compliance with the EU HVDC Connection Code.

This particular edition of the guidance notes has been written for HVDC System Owners. Separate guidance documents exist for Synchronous Generating Units, Power Park Modules and DC Converter Station owner as GB Users with existing connections.

HVDC System Owners may, if they wish, suggest alternative tests or studies, which they believe will demonstrate compliance in accordance with the requirements placed on themselves and NGENSO.

The introduction of the ECC sections in the Grid Code introduced two new technical requirements for Power Park Modules. These new areas are:

- Limited Frequency Sensitive Mode for low frequency (LFSM-U) ECC.6.3.7.2
- Specification for Fast Fault Current Injection (FFCI) ECC.6.3.15.
- In addition, a number of existing requirements such as fault ride through were changed as a result of the new RfG and HVDC requirements.

The compliance with these areas is discussed within this guidance note.

New Requirements

The new EU requirements have been applied within the existing GB regulatory frameworks. Customer will be affected by these Codes if customer

- 1). Connect to the electricity network (on Transmission or Distribution system) after Date of Contracted Connection Date and;

2) Have not concluded a signed final and binding contract by Date of National Implementation for main plant items and submitted evidence of this to the relevant system operator before Date of National Implementation + 6 months.

Network Code	Applies to which Users?	Entry Into Force Date	Date of National Implementation	Date of contracted connection date
HVDC	High Voltage Transmission Connection, e.g. interconnector or DC connected Power Park Module	29 September 2016	29 September 2018	29 September 2019

The new requirements for Synchronous Generating Units and Power park Modules are described in other guidance documents.

Compliance Processes within the Grid Code

The process for HVDC System Owners should demonstrate compliance with the European Connection Conditions and Bilateral Agreement is included in the Grid Code European Compliance Process . In addition to the process and details of the documentation that is exchanged to control the process an appendix to the Compliance Processes includes the technical details of the simulation studies that a HVDC System Owner should carry out. The Compliance Processes cross reference heavily with the European Compliance Processes (ECP).

The European Compliance Processes (ECP) set out a clear and consistent process for demonstration of compliance by EU Code Users with the European Connection Conditions and Bilateral Agreement which are similar for all EU Code Users of an equivalent category and will enable NGET to comply with its statutory and Transmission Licence obligations.

The Grid Code Planning Code (PC) sets out the data and information that an HVDC System Owner is required to submit prior to connection and then maintain during the lifetime of the HVDC Converter station. The format for submission of the majority of this information is set out in the Data Registration Code (DRC).

Model

The HVDC System Owners is required to provide NGESO and the Transmission Owner (NGET, SPT and SHET) with a model of their DC Converter as detailed in PC.A.5.4.3 of the Grid Code. The model data is to be provided in transfer functions block diagram format. Control systems with a number of discrete states or logic elements may be provided in flow chart format if a transfer function block diagram format does not provide a suitable representation.

The model structure and complexity must be suitable for NGESO to integrate into their power system analysis software (currently Digsilent and PSCAD), for power system dynamic simulation studies. In

cases where the model's functionality cannot be correctly or satisfactorily represented within NGESO's power system analysis software, the HVDC System Owner may be required to liaise with NGESO to determine appropriate simplifications or changes in representation to produce an appropriate model.

All model parameters must be identified along with units and site-specific values. A brief description of the model should ideally be provided as ultimately this will save time and money for both parties.

The model representation provided should ideally be implemented on a power system analysis software package of the HVDC System Owner's choosing, as it is otherwise highly unlikely to produce valid results when compared with the test results from the real equipment. In the event the model does not produce the correct output, the data submission will be considered incorrect and not contractually compliant. NGESO will confirm the model accuracy.

Simulation Studies

Simulation studies and site tests are required to provide evidence that the HVDC Converter Station's plant and apparatus comply with the provisions of the European Connection Conditions. Section of the ECP.A.3 describe the simulations studies which need to be carried out before any HVDC Converter Station will be issued an Interim Operational Notification (ION) as indicated in the ECP.6.3.

In general simulation studies are required where:

- i) It is necessary to predict the HVDC Converter behaviour before tests are carried out.
- ii) It is impractical to demonstrate capability through testing as the effects on other system users would be unacceptable.
- iii) it is necessary to demonstrate the model supplied is a true and accurate reflection of the plant as built.

ECP.A.3.1 outlines simulation studies that are required to verify compliance with European Connection Conditions requirements. The simulations must be based on the models supplied to NGESO in accordance with Grid Code Planning Code except for the load rejection simulations in ECP.A.3.6.4 where a more complex model may be utilised.

Simulations should be submitted in the form of a report (ECP.A.3.1.2) to demonstrate compliance in sufficient time to allow NGESO to review the content and validity of the report and models utilised prior to the planned synchronisation date (typically 3 -6 months).

Fast Fault Current Injection requirement

The requirement applies for type B, type C and type D Power Park Modules and HVDC equipment. The principles and details of the requirement are set out in ECC.6.3.16 and ECC.A.4EC1 of the Grid Code.

The Power Park Module or HVDC System Owner shall supply time series simulation study results to demonstrate the capability of HVDC Equipment and Power Park Modules and OTSUA to meet ECC.6.3.16 by submission of a report described in ECP.A.3.5.

An example of fast fault current injection during a 140ms three phase to ground fault is shown in Figure 1 below. Please note, this shows the fast fault current injection was blocked in 60ms to withstand the system transient over voltage but after this the full current recovers with a few milliseconds.

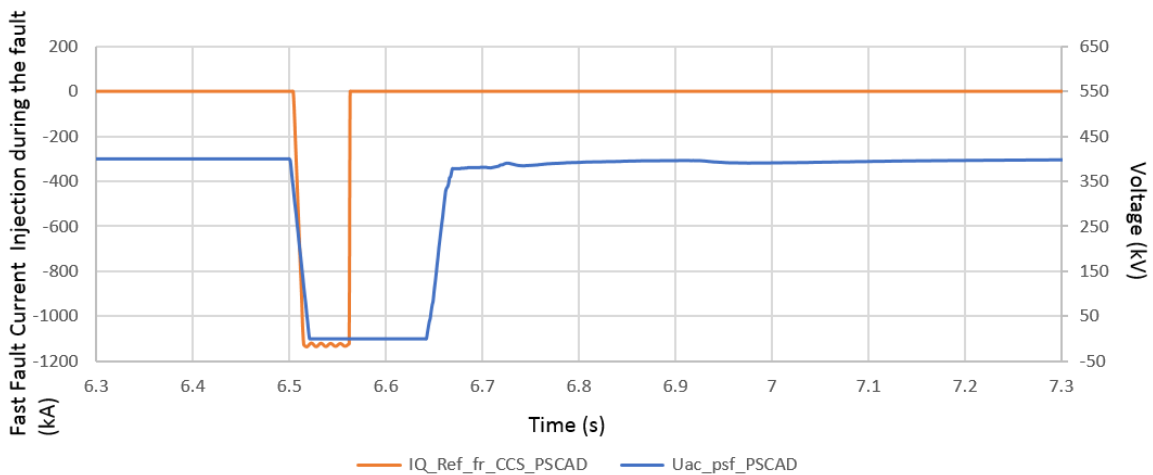

Figure 1: An example of fast fault current injection

Factory Acceptance Tests (FAT)

Factory Acceptance Tests, or FATs, are conducted at the manufacturer’s site prior to delivery and installation and these tests help to identify any issues and correct them prior to shipment. FAT is not required in the Grid Code however, FATs are beneficial not just for the NGENSO and Customers but for the manufacturer as well to simplify the process of on-site witness tests, the Compliance Engineers in ESO will happy to discuss the FAT process, accept the FATs invitation and witness the part of test.

Voltage Control, Frequency Control and Fault Ride Through tests can be witnessed in FAT. Following successful FATs of the voltage Control, Frequency Control and Fault Ride Through, the onsite test process can be simplified and discussed in the compliance process.

Reactive Power Capability, Reactive Power Capability, Voltage Control, and Frequency Control tests are identified in Grid Code ECP.A.7.1. and the fault ride through tests will be agreed with NGENSO to demonstrate compliance with ECC.6.3.15, ECC.6.3.16 and ECP.A.3.5.

Compliance Testing

Tests identified in Appendix 7 of ECP are designed to demonstrate where possible that the relevant provisions of the European Connection Conditions and Bilateral Agreement have been met. However if the test requirements described in Appendix 7 of ECP are at variance with the Bilateral Agreement or the test requirements are not relevant to the plant type the HVDC System Owner should contact NGENSO to discuss and agree an alternative test program and success criteria.

For each test to be carried out the description and purpose of the test to be carried out, results required, the relevant European Connection Conditions clause(s) and criteria of assessment are given in ECP. The HVDC System Owner is responsible for drafting test procedures for the HVDC Converter station as part of the compliance process prior to the issue of the ION. ECP Appendix 7 and the appendices of these Guidance Notes provide outline test schedules which may assist the HVDC System Owner with this activity.

NGESO may require further compliance tests or evidence to confirm site-specific technical requirements (in line with the Bilateral Agreement) or to address compliance issues that are of particular concern. Additional compliance tests, if required, will be identified following NGESO's review of submissions of User Data File Structure.

The tests are carried out by the HVDC System Owner, or by their agent, and not by NGESO. However, NGESO will witness some of the tests as indicated in ECP. Tests should be completed following the test procedures supplied in the UDFS prior to the issue of the ION unless otherwise agreed by NGESO.

The HVDC System Owner should also provide suitable digital monitoring equipment to record all relevant test signals needed to verify the HVDC Converter Station performance in parallel with NGESO's recording equipment.

NGESO Data Recording Equipment

NGESO will provide a digital recording instrument on site during the tests witnessed by NGESO. A generic list of signals to be monitored during NGESO witnessed tests is tabulated in ECP Appendix 4. This will be used to monitor all plant

signals at the sampling rates indicated in ECC.6.6.3. The station should provide its own digital recording equipment to record the same plant variables. This will provide a back up to the test results should one of the recording instruments fail at the time of testing.

The station is responsible for providing the listed signals to the User's and NGESO's recording equipment. For NGESO purposes the signals provided are required to be in the form of dc voltages within the range -10V to +10V (see ECC.6.6.3). The input impedance of the NGESO equipment is in the region of 1M Ω and its loading effect on the signal sources should be negligible.

The station should advise NGESO of the signals and scaling factors prior to the test day. The form of a typical test signal schedule is shown below

Signal	Unit	Voltage Range	Signal Representation
Active Power Output	MW	0 to 8V	0 to at least Maximum Capacity
Reactive Power Output	Mvar	-8V to +8V	- Reg Capacity to +Reg Capacity

Terminal Voltage	kV	0 to 8V	Nominal Voltage –10% to Nominal Voltage +10%
System Frequency	Hz	-8V to 8V	48.0Hz – 52Hz

List of other signals

.....

Table 1 : A typical test signal schedule

It may be appropriate for NGENSO to set up the recording equipment on the day prior to the test date. The station representatives are asked to ensure that a 230V single phase AC power supply is available and that the signals are brought to robust terminals at a single sampling point. Examples of ideal connection points with BNC or 4mm banana plug connections are shown below.



The station must inform NGENSO if the signal ground (0V) is not solidly tied to earth or of any other potential problems.

Compliance Test Signals

The Grid Code requires that a number of signals are provided from compliance tests to NGENSO to allow assessment of the compliance. The list of these signals are set out in OC5.A.1 for GB Users.

Where these signals are provided to NGENSO following witness tests or instead of witnessing there is a need to provide them in a consistent electronic format with a time stamp in a numerical format which can be interpreted in Excel. To facilitate efficient analysis the test results should include signals requested by NGENSO set out in the columns order as indicated in the tables in Appendix E.

- Signals for non-witness tests should be provided in excel format and in the order and format presented in Appendix E unless otherwise agreed, in advance, with NGENSO.
- Where any additional test signals to those indicated in the tables are presented these should only be added with the agreement of NGENSO and be entered within the files as additional columns to the right of the required signals.
- Where a signal cannot be provided, and this has been agreed with NGENSO in advance of the tests, a blank column should be retained within the data.

- Where additional signals are included or the signals are presented but not in the arrangement detailed above the data may be rejected and the customer will be asked to resubmit the data in the agreed format.

Compliance Test Logsheet

Where test results are completed without any NGENSO presence but are relied upon as evidence of the compliance they should be accompanied by a logsheet. This sheet should be legible, in English and detail the items in Appendix E.

Test Notification to Control Room

The station is responsible for notifying the 'NGESO Control Centre' of any tests to be carried out on their plant, which could have a material effect on the National Electricity Transmission System. The procedures for planning and co-ordinating all plant testing with the 'NGESO Control Centre' is detailed in OC7.5 of the Grid Code (i.e. Procedure in Relation to Integral Equipment Tests). For further details relating to this procedure, refer to "Integral Equipment Tests - Guidance Notes" which can be found on NGENSO's Internet site in Grid Code, Associated Documents.

The station should be aware that this interface with NGENSO transmission planning will normally be available in week-day working hours only. As best practice, the station should advise the 'NGESO Control Centre' and in Scotland the relevant Transmission Owner, or Distribution Network Operator (if embedded) of the times and nature of the proposed tests at the earliest stage possible. If there is insufficient notice or information provided by the station, then the proposed testing may not be allowed to proceed.

Model Validation

The results recorded during the compliance tests may be used to validate the HVDC Converter Station model as provided under the Grid Code Planning Code.

The compliance testing may have proved that the HVDC Converter Station and its control systems are compliant but the recorded behaviour tests may be different from the behaviour predicted by the simulation studies using the provided models. The differences may be due to the following reasons.

- The simulation conditions are different from the test conditions.
- The model supplied may be not accurate.

Following successful compliance tests the HVDC System Owner should validate the performance of the submitted model by providing overlays of recorded tests with simulations replicating as far as reasonably practical the same conditions.

Simulation should be carried out under test conditions and the simulation results should be then compared with the test results. If the simulation results are identical or matched very well with the test results then the submitted model has been validated and accepted as the accurate model of the plant. If the results are different, then the HVDC System Owner, should resubmit a modified model.

This process will be repeated until there is close agreement with the test results and simulation results.

Protection Requirements

Under the section ECC.6.2.2.2 of European Connection Conditions, the HVDC System Owner must meet a set of minimum protection requirements. As part of the User Data File Structure (UDFS) section 2 the HVDC System Owner should submit a Protection Settings report together with an overall trip logic diagram.

The HVDC System Owner should provide details of all the protection devices fitted to the HVDC Converter Station together with settings and time delays, including:

Protection Fitted	Typical Information Required
Under / Over Frequency Protection	Number of stages, trip characteristics, settings and time delays
Under / Over Voltage protection	Number of stages, trip characteristics, settings and time delays
Over Current Protection	Element types, characteristics, settings and time delays
Control Trip Functions	Functional Description, Control Characteristic and trip settings

Table 2: Typical Information Requirement of Protection Fitted

Power Quality Requirements

For HVDC Converter Stations that are to be connected to the National Electricity Transmission System, the harmonic distortion and voltage fluctuation (flicker) limits are set out in accordance with the European Connection Conditions. The Transmission Owner is required to meet the relevant terms of the European Connection Conditions.

With respect to harmonics, the European Connection Conditions ECC.6.1.5(a) requires that the electromagnetic Compatibility Levels for harmonic distortion on the Transmission System from all nonlinear sources under both planned outage and fault outage conditions, (unless abnormal conditions prevail) shall comply with the compatibility levels given in Appendix A of Engineering Recommendation G5/4. The European Connection Conditions further requires that the planning criteria contained within Engineering Recommendation G5/4 be applied for the connection of non-linear sources to the Transmission System, which result in harmonic limits being specified for these sources in the relevant Bilateral Agreement.

With respect to voltage fluctuations, it is also a requirement of the European Connection Conditions that voltage fluctuations are kept within the levels given in European Connection Conditions ECC.6.1.7 and/or Table 1 of Engineering Recommendation P28 and therefore limits on voltage fluctuations are also specified in the relevant Bilateral Agreement. The HVDC System Owner will be required to comply with the harmonic and voltage fluctuation limits specified in the Bilateral

Agreement. The Transmission System or Distribution Network Operator will monitor compliance with these limits.

Development schemes with non-linear element(s) are assessed by the Transmission Owner for their expected impact on the harmonic distortion and voltage fluctuation levels. For harmonic voltage distortion, the process detailed in Stage 3 of Engineering Recommendation G5/4 is applied. For the voltage fluctuation, the principles outlined in Engineering Recommendation P28 are used. Both assessments may lead to a requirement within the Bilateral Agreement specifying maximum permissible limits not to be exceeded.

Specific information required for the assessment of harmonic voltage distortion and voltage fluctuation is detailed in Grid Code DRC.6.1.1. Any component design parameters for planned reactive compensation for the HVDC Converter as detailed in Grid Code PC.A.6.4.2 should also be included giving due attention to tuned components.

For HVDC Converters that are to be connected to Distribution Systems, Distribution Network Operators may undertake similar assessments to comply with the requirements of the Distribution Code in terms of harmonic distortion and voltage fluctuation.

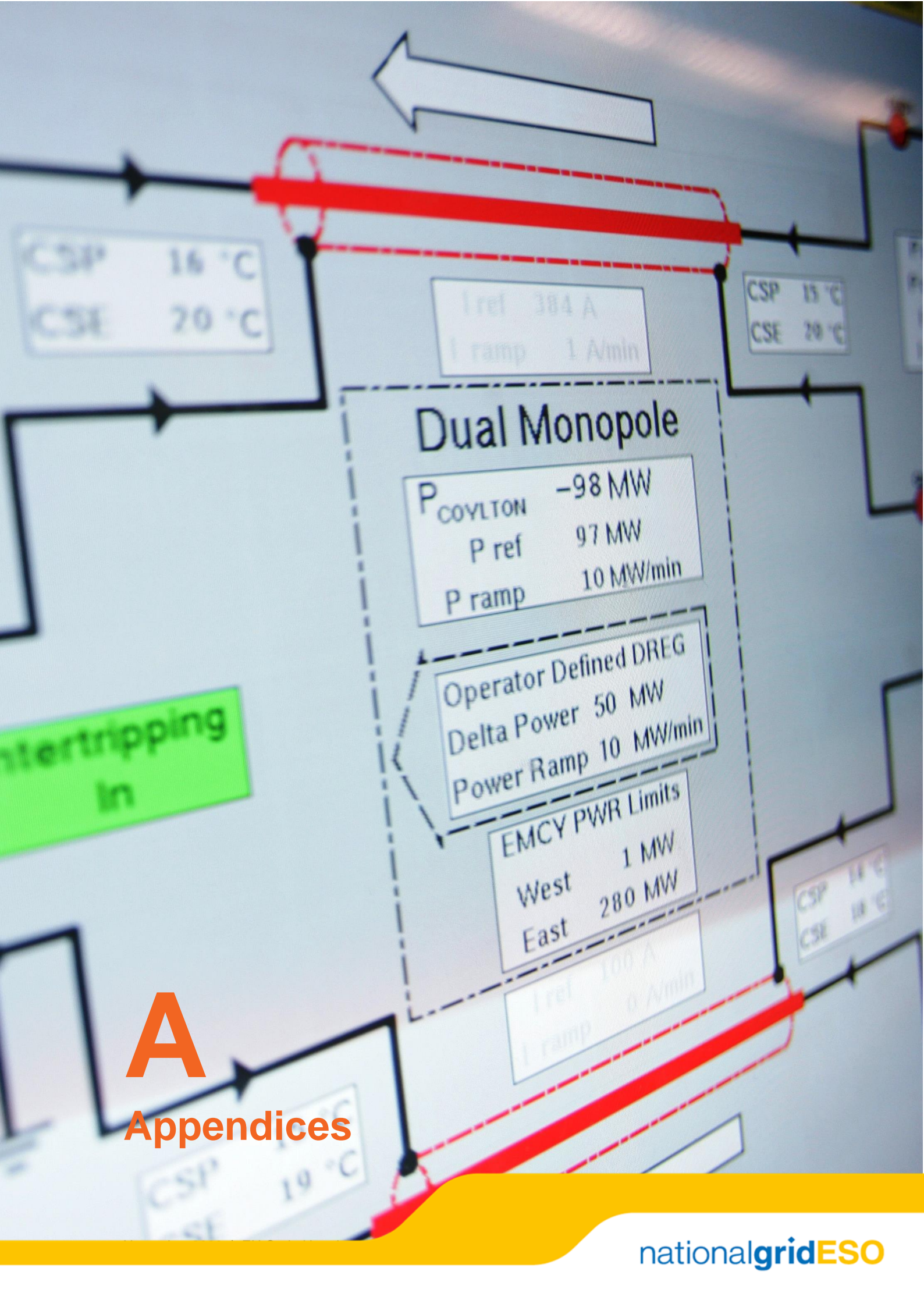

A

Appendices

Appendix A Reactive Capability

Summary of Grid Code Requirements

The reactive capability requirements for HVDC Converter Stations are specified in European Connection Conditions ECC.6.3.2.4.

In summary the requirements of EU Generators or HVDC System Owners which connect an Onshore Type C or Onshore Type D Power Park Module or HVDC Equipment to a Non Embedded Customers System are shown as follows:-

- 1) The ECC.6.3.2.4.2 applies to all Onshore Type C Power Park Modules and Onshore Type D Power Park Modules or HVDC Converters with a Grid Entry Point or User System Entry Point voltage above 33kV. The Reactive Power capability requirements at the Grid Entry Point was defined in Figure ECC.6.3.2.4(a) when operating at Maximum Capacity.
- 2) The ECC.6.3.2.4.3 applies to all Onshore Type C Power Park Modules and Onshore Type D Power Park Modules or HVDC Converters with a Grid Entry Point or User System Entry Point voltage below 33kV. The Reactive Power capability requirements at the Grid Entry Point was defined in Figure ECC.6.3.2.4(b) when operating at the Maximum Capacity.
- 3) The ECC.6.3.2.4.4 applies to all Type C and Type D Power Park Modules, HVDC Converters at a HVDC Converter Stations. The Reactive Power capability requirements at the Grid Entry Point was defined in Figure ECC.6.3.2.4(c) when operating below the Maximum Capacity.

Contractual Opportunities Relating to Reactive Services

For some technologies, there is an opportunity to provide an optional reactive service (beyond the basic mandatory reactive service). Developers interested in providing such a service should take the opportunity of reactive capability testing to demonstrate any additional reactive capability. The delivery of additional reactive power would be expected to be dynamic, i.e. responding to changes to system voltage in the same manner as the mandatory reactive service provided.

Reactive Capability Compliance Tests

ECP.A.7.2 Reactive Capability Test described Reactive Capability testing for HVDC converter. The required tests should demonstrate the maximum capability of the HVDC Converter beyond the corners of the envelope shown in Europe Connection Conditions Figure ECC.6.3.2.4(c) Given the steady state nature of the Reactive Capability requirements implying that reactive output can be maintained indefinitely, the tests are carried out over a longer period than other compliance tests.

The Reactive Capability test is not usually witnessed by a NGENSO compliance engineer.

In order to demonstrate that a DC Converter can satisfy the reactive capability requirements it is necessary to perform reactive capability tests as set out in ECP.A.7.2.5. The following should be completed for both importing and exporting of Active Power An example of a corresponding test schedule is shown below. For the avoidance of doubt, lagging Reactive Power is the export of Reactive Power from the HVDC Equipment to the Total System and leading Reactive Power is the import of Reactive Power from the Total System to the HVDC Equipment.

Test	Step	Description	Notes
1		<ul style="list-style-type: none"> Operation at Maximum Capacity and maximum continuous lagging Reactive Power for 60 minutes. 	
2		<ul style="list-style-type: none"> Operation at Maximum Capacity and maximum continuous leading Reactive Power for 60 minutes. 	
3		<ul style="list-style-type: none"> Operation at 50% Maximum Capacity and maximum continuous leading Reactive Power for 60 minutes. 	
4		<ul style="list-style-type: none"> Operation at 50% Maximum Capacity and maximum continuous lagging Reactive Power for 60 minutes. 	
5		<ul style="list-style-type: none"> Operation at Minimum Capacity and maximum continuous leading Reactive Power for 60 minutes. 	
6		<ul style="list-style-type: none"> Operation at Minimum Capacity and maximum continuous leading Reactive Power for 60 minutes. 	

Table A-1 Reactive Power Compliance Tests

For the avoidance of doubt, lagging Reactive Power is the export of Reactive Power from the HVDC Converter to the Total System and leading Reactive Power is the import of Reactive Power from the Total System to the HVDC Converter.

Appendix B Voltage Control Testing

Summary of Grid Code Requirements

The generic requirements for voltage control are set out in the European Connection Conditions ECC.6.3.8.5 with any site specific variations included in the Bilateral Agreement. This section summarises the key requirements using the generic values included in the European Connection Conditions.

European Connection Conditions ECC.6.3.8.5.1 requires provision of a continuously acting automatic voltage control which is stable at all operating points. The point of voltage control is the Grid Entry Point or User System Entry Point if Embedded.

Grid Code European Connection Conditions (ECC) Appendix 7 requires:

- ECC.A.7.2.2.1 describes the requirements of continuous steady state control of the voltage as illustrated in Figure ECC.A.7.2.2a.
- ECC.A.7.2.2.2 describes that the voltage set point should be adjustable over a range of +/-5% of nominal with a resolution of better than 0.25%.
- ECC.A.7.2.2.3 describes that The voltage control system should have a reactive slope characteristic which must be adjustable over a range of 2 to 7% with a resolution of 0.5%. The initial setting should be 4%.
- ECC.A.7.2.2.4 describes that the required envelope of operation as illustrated in Figure ECC.A.7.2.2b and Figure ECC.A.7.2.2c.
- ECC.A.7.2.2.5 describes that the control system should deliver any reactive power output correction due from the voltage operating point deviating from the slope characteristic within 5 seconds.
- ECC.A.7.2.2.6 The HVDC Converter Station must continue to provide voltage control through reactive power modulation within the designed capability limits over the full connection point voltage range $\pm 10\%$ (ECC.6.1.4) however the full reactive capability (ECC.6.3.2) is only required to be delivered for voltages within $\pm 5\%$ of nominal in line with figures ECC.A.7.2.2b and ECC.A.7.2.2c if applicable.

The HVDC System Owner must provide NGESO with a transfer block diagram illustrating the HVDC Converter voltage control scheme and include all associated parameters. This forms part of Schedule 1 of the Data Registration Code and should be included in part 3 of the User Data File Structure (UDFS). The information will enable NGESO to review the suitability of the proposed test programme to demonstrate compliance with the Grid Code.

Setpoint Voltage and Slope

The NGESO Control Centre issues voltage control instructions to all Balancing Market participants. For HVDC Converter Stations the usual instruction is to alter Setpoint Voltage and should be carried out in the usual 2 minutes required for Ancillary Service instructions. The slope may also be varied by control instruction but the HVDC System Owner has up to a week to complete the change. Slope is usually expected to be set at 4%. The procedures for Voltage Control instructions are included in Grid Code Balancing Code (BC) 2.

Delivery of Reactive Capability Beyond +/-5% Voltage

European Connection Conditions ECC.6.1.4 requires that the full Reactive Capability is capable of being delivered for voltages at the Grid Entry Point within +5% of nominal.

Outside this range the HVDC Converter must be capable of continuing to contribute to voltage control by delivering Reactive Power. However, the level of reactive power delivered may be limited by the design of the plant and apparatus. There is no low or high limit on this obligation, plant must continue to provide maximum reactive power within its design limits.

Transient Response

The European Connection Condition ECC.A.7.2.3 sets out a number of criteria for acceptable transient voltage response that shown in the Figure ECC.A.7.2.3.

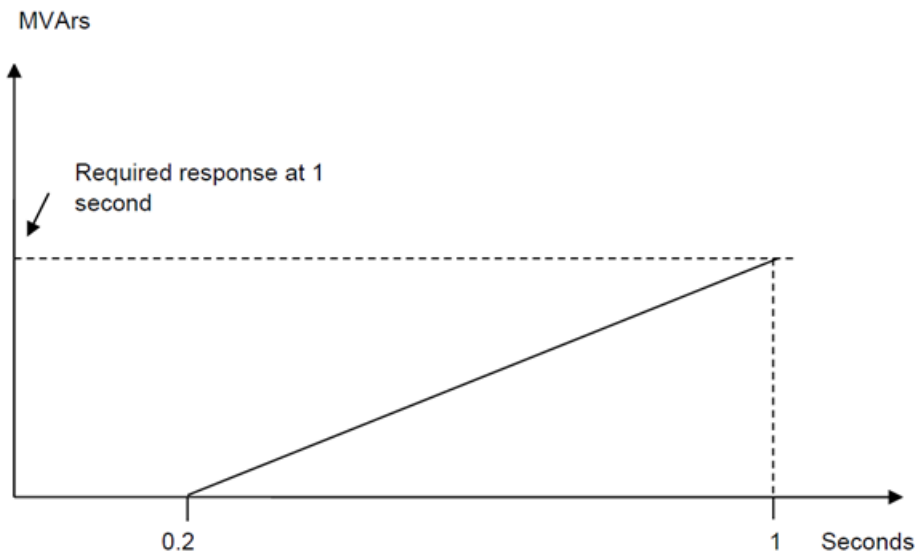

Figure ECC.A.7.2.3.1a

European Connection Conditions ECC.A.7.2.3 requires:

- The dead time is less than 200ms
- The response shall be such that 90% of the change in the Reactive Power output will be achieved within
 - 2 seconds, where the step is sufficiently large to require a change in the steady state Reactive Power output from its maximum leading value to its maximum lagging value or vice versa and
 - 1 second where the step is sufficiently large to require a change in the steady state Reactive Power output from zero to its maximum leading value or maximum lagging value as required by ECC.6.3.2 (or, if appropriate ECC.A.7.2.2.6 or ECC.A.7.2.2.7);
- Within 5 seconds from achieving 90% of the response as defined in ECC.A.7.2.3.1 (ii), the peak to peak magnitude of any oscillations shall be less than 5% of the change in steady state maximum Reactive Power.

Compliance Test Description

The voltage control tests for a HVDC Converter are set out in the ECP.A.7.4. As described testing should be by tapping of an upstream grid transformer and by injection to the control system reference.

Where steps can be initiated using network tap changers, the HVDC Converter will need to coordinate with the host Transmission or Distribution Network Operator. Consideration should also be given to switching the associated tap changer Automatic Voltage Control (AVC) from auto to manual for the duration of the test.

Suggested HVDC Converter Station Voltage Control Test Procedure

The following generic procedure is provided to assist HVDC Converter Stations in drawing up their own site specific procedures for the NGENO witnessed -HVDC Converter Voltage Control Tests.

Test	Describes	Notes
	HVDC Converter in Voltage Control at Maximum Export/Import Power Output and near Unity Power Factor	
1	<ul style="list-style-type: none"> Record steady state for 10 seconds Inject +1% step to Voltage Reference Hold for at least 10 seconds Remove injection as a step Hold for at least 10 seconds 	
2	<ul style="list-style-type: none"> Record steady state for 10 seconds Inject -1% step to Voltage Reference Hold for at least 10 seconds Remove injection as a step Hold for at least 10 seconds 	
3	<ul style="list-style-type: none"> Record steady state for 10 seconds Inject +2% step to Voltage Reference Hold for at least 10 seconds Remove injection as a step Hold for at least 10 seconds 	
4	<ul style="list-style-type: none"> Record steady state for 10 seconds Inject -2% step to Voltage Reference Hold for at least 10 seconds Remove injection as a step Hold for at least 10 seconds 	

Tests	Describes	Notes
	DC Converter Station in Voltage Control at Maximum Export/Import Power Output and near Unity Power Factor	
1	<ul style="list-style-type: none"> Record steady state for 10 seconds Tap up 1 position on external upstream tap changer Hold for at least 10 seconds 	
2	<ul style="list-style-type: none"> Tap up 1 position on external upstream tap changer i.e. up 2 positions from starting position. Hold for at least 10 seconds 	
3	<ul style="list-style-type: none"> Tap down 1 position on external upstream tap changer i.e. up 1 positions from starting position. Hold for at least 10 seconds 	
4	<ul style="list-style-type: none"> Tap down 1 position on external upstream tap changer i.e. at starting position. Hold for at least 10 seconds 	
5	<ul style="list-style-type: none"> Tap down 1 position on external upstream tap changer i.e. down 1 positions from starting position. Hold for at least 10 seconds 	
6	<ul style="list-style-type: none"> Tap down 1 position on external upstream tap changer i.e. down 2 positions from starting position. Hold for at least 10 seconds 	
7	<ul style="list-style-type: none"> Tap up 1 position on external upstream tap changer i.e. down 1 positions from starting position. Hold for at least 10 seconds 	
8	<ul style="list-style-type: none"> Tap up 1 position on external upstream tap changer i.e. return to starting position. Hold for at least 10 seconds 	

Where the voltage control system includes discretely switched shunt capacitors/reactors to provide part of the reactive capability the test program should demonstrate the performance when these are switched.

Tests	Describes	Notes
	Adjust voltage setpoint to a suitable operating point below switching threshold for shunt device.	
1	<ul style="list-style-type: none"> Record steady state for 10 seconds Inject a step to the HVDC Converter Station Voltage Reference of sufficient size and polarity to switch in shunt device. Hold for at least 10 seconds Remove injection with a step of sufficient size to switch out the switched device Repeat step 9 immediately (with minimum delay) Repeat step 9 immediately (with minimum delay) 	

Demonstration of Slope Characteristic

The HVDC Converter Station voltage control system is required to follow a steady state slope characteristic. This should be demonstrated by recording voltage at the controlled bus bar (usually the Grid Entry Point or User System Entry Point if Embedded) and the reactive power output at the same point over several hours. Plotting the values of Voltage against Reactive Power output should demonstrate the slope characteristic.

Additional Power System Stabiliser Testing

Additional tests are required if a Power System Stabiliser is fitted. Although the fitting of Power System Stabilisers on non-synchronous plant is a rarity, one may be provided within the control system by a manufacturer or NGENSO may specify the requirement in the Bilateral Agreement. The testing process outlined in this section is based largely on that employed on synchronous plant, which is believed to be comparable. However, HVDC System Owners should anticipate the possibility that an alternative testing regime may be developed in discussion with NGENSO.

NGESO will not permit PSS commissioning until the tuning methodologies and study results used in any PSS settings proposal have been provided to NGENSO. A report on the PSS tuning should be provided along with the proposed test procedure in the User Data File Structure (Part 3). Based on the information submitted, NGENSO will meet with the HVDC System Owner to discuss and agree the initial PSS settings for commissioning.

The suitability of the tuning of any PSS is checked in both the time and frequency domains. In the time domain, testing is achieved by applying a small voltage step change on a module basis. Comparisons are made between performance with and without the power system stabiliser in service.

For analysis in the frequency domain, a bandwidth-limited (200mHz-3Hz) random noise injection should be made to the HVDC Converter Station voltage reference. The HVDC System Owner should provide a suitable band limited (200mHz-3Hz) noise source to facilitate noise injection testing. The random noise injection will be carried out with and without the PSS in service to demonstrate damping. The PSS gain should be continuously controllable (i.e. not discrete components) during testing.

The suitability of the PSS gain will also be assessed by increasing the gain in stages to 3x the proposed setting.

The tests will be regarded as supporting compliance if:

- The PSS gives improved damping following a step change in voltage.

- Any oscillations are damped out within 2 cycles
- The PSS gives improved damping of frequencies in the band 300mHz – 2Hz.
- The gain margin is adequate if there is no appreciable instability at 3x proposed gain

PSS testing is additional to the Module Voltage Control Tests.

Suggested HVDC Converter PSS Test Procedure. The following generic procedure is provided to assist HVDC System Owners in drawing up their own site specific procedures for the NGEN PSS Tests.

Test	Describes	Notes
	HVDC Converter in Voltage Control at Maximum Power Output (>65% Rated MW) and near Unity Power Factor PSS Not in Service	
1	<ul style="list-style-type: none"> • Record steady state for 10 seconds • Inject +1% step to Voltage Reference and hold for at least 10 seconds • Remove step returning Voltage Reference to nominal and hold for at least 10 seconds 	
2	<ul style="list-style-type: none"> • Record steady state for 10 seconds • Inject +2% step to Voltage Reference and hold for at least 10 seconds • Remove step returning Voltage Reference to nominal and hold for at least 10 seconds 	
3	<ul style="list-style-type: none"> • Inject band limited (0.2-3Hz) random noise signal into voltage reference and measure frequency spectrum of Real Power. • Remove noise injection. 	
4	Switch On Power System Stabiliser	
5	<ul style="list-style-type: none"> • Record steady state for 10 seconds • Inject +1% step to HVDC Converter Voltage Reference and hold for at least 10 seconds • Remove step returning Voltage Reference to nominal and hold for at least 10 seconds 	
6	<ul style="list-style-type: none"> • Record steady state for 10 seconds • Inject +2% step to Voltage Reference and hold for at least 10 seconds • Remove step returning Voltage Reference to nominal and hold for at least 10 seconds 	
6	<ul style="list-style-type: none"> • Inject band limited (0.2-3Hz) random noise signal into voltage reference and measure frequency spectrum of Real Power. • Remove noise injection. 	
8	<ul style="list-style-type: none"> • Increase PSS gain at 30second intervals. i.e. x1 – x1.5 – x2 – x2.5 – x3 • Return PSS gain to initial setting 	
9	Repeat Voltage Control Tests with PSS in service.	

Appendix C Frequency Control

Summary of Grid Code Requirements

The National Electricity Transmission System is an island network with no AC connections to mainland Europe. In order to manage the system frequency within the normal operating range 49.5 to 50.5Hz (ECC.6.1.2.1.1) NGENSO requires generating units and power park modules to be able to continuously modulate their output in relation to frequency across this range. In order to maintain a stable system frequency it is important that response from plant is achieved without undue delay.

The Grid Code sets out Frequency Control requirements in a number of separate places, notably the Glossary & Definitions (GD), the Connection Conditions (CC) European Connection Conditions (ECC) and Balancing Code (BC) 3. This section summarises the key requirements

GD of the Grid Code defines Primary, Secondary and High frequency response including the requirement that the response is progressively delivered with increasing time.

It also states in ECC.6.3.3.1.1(d) that when in Rectifier mode (acting as a demand) that active power exported from the system should reduce as system frequency falls below 49.5 Hz in line with Figure ECC.6.3.3(b), for ease replicated here as the Limited frequency Sensitive Mode Rectifier Mode operation.

European Connection Conditions ECC.6.3.3.1 requires:

- Continuously maintaining constant Active Power output for System Frequency changes within the range 50.5 to 49.5 Hz.
- HVDC Converter must be capable of maintaining a minimum level of active power output (see Figure ECC.6.3.3(a) of ECC.6.3.3.1.1) in the frequency range 47Hz to 50.5Hz.
- In Rectifier mode (acting as a demand) that active power exported from the system should reduce as system frequency falls below 49.5 Hz in line with Figure ECC.6.3.3(b), for ease replicated here as the Limited frequency Sensitive Mode Rectifier Mode operation

ECC.6.3.7.1 of European connection conditions specifies the minimum frequency control capability for Limited Frequency Sensitive Mode – Overfrequency (LFSM-O), in particular the frequency control must be:

- Reducing active power output in response to frequency on the total system when this rises above 50.4Hz. However, if HVDC Systems operates in Frequency Sensitive Mode, the requirements of LFSM-O shall apply when the frequency exceeds 50.5Hz.
- The rate of change of Active Power output must be at a minimum a rate of 2 percent of output per 0.1 Hz deviation of System Frequency above 50.4Hz within 10 seconds (ie a Droop of 10%) as shown in Figure ECC.6.3.7.
- Frequency Control must reduce Active Power output when the Frequency increase above 50.4 Hz and reduction of active power output must be achieved within 10 seconds. If the delay exceeds 2 seconds the EU Generator or HVDC System Owner shall justify the delay, providing technical evidence to NGET.
- HVDC should not be tripped off if system frequency is below 52Hz in accordance with the requirements of ECC.6.1.2. If the System Frequency is at or above 52Hz, HVDC System Owner is required to take action to protect DC Connected Power Park Modules.

ECC.6.3.7.2 of European Connection Conditions specifies the minimum frequency control capability for Limited Frequency Sensitive Mode – Underfrequency (LFSM-U)

- Increase Active Power output in response to System Frequency when this falls below 49.5Hz. If the delay exceeds 2 seconds the EU Generator or HVDC System Owner shall justify the delay, providing technical evidence to NGET.
- The rate of change of Active Power output must be at a minimum a rate of 2 percent of output per 0.1 Hz deviation of System Frequency below 49.5Hz (ie a Droop of 10%) as shown in Figure ECC.6.3.7.2.2.
- For the avoidance of doubt, the provision of this increase in Active Power output is not a mandatory Ancillary Service.

ECC.6.3.7.3.4 of European connection conditions specifies the minimum frequency control capability for Frequency Sensitive Mode – (FSM)

- Capable of a frequency droop of between 3 and 5%.
- DC Connected Power Park Module shall be capable of activating full and stable Active Power Frequency response (without undue power oscillations), in accordance with the performance characteristic shown in Figure 6.3.7.3.4(a) with the corresponding parameters in Table 6.3.7.3.4(a).
- Have a frequency control dead band of less than $\pm 0.015\text{Hz}$.
- Initiating the delivery of Primary Response in no less than 0.5 seconds unless otherwise agreed with NGET, where the initial delay time t_1 – as shown in Figure 6.3.7.3.4(b)
- Able to contribute to controlling the frequency on an islanded network to below 52Hz.

The frequency response capability is defined in European Connection Conditions Appendix E3, in terms of Primary Response, Secondary Response and High Frequency Response.

ECC.A.3.2 specifies the Plant Operating Range. The upper limit of the operating range is the Maximum Capacity of HVDC and The Minimum Stable Operating Level may be less than, but must not be more than, 65% of the Maximum Capacity.

Figure ECC.A.3.1 shows the minimum Frequency response capability requirement profile diagrammatically for a 0.5 Hz change in Frequency. It also specifies a minimum requirement for frequency response of 10% of Registered Capacity achievable for Primary Secondary and High Frequency response. This minimum value is designed to ensure that plant provides a suitable contribution to maintain frequency correction when connected to the system and selected to Frequency Sensitive Mode (FSM) and response capability in excess of 10% is encouraged.

Modes of Frequency Control Operation

Balancing Code (BC) 3 of the Grid Code defines operation in Limited Frequency Sensitive Mode and Frequency Sensitive Mode. Limited Frequency Sensitive Mode is the default mode used when not instructed by NGESO to provide Frequency Response Services. The requirements for these two modes differ depending on the direction of active power flow through the HVDC Converter.

For HVDC Systems which act as interconnectors between different AC systems there must be agreement in place with the external Grid to accept the impact of the changes in output caused by the action of Limited Frequency Sensitive and Frequency Sensitive Modes of response.

- a) Inverter mode (acting as the generator) with Limited Frequency Sensitive Mode

The HVDC Converter shall meet the requirement of Limited Frequency Sensitive Mode – Overfrequency (LFSM-O) and Limited Frequency Sensitive Mode – Underfrequency (LFSM-U), that illustrated in ECC.6.3.7.1 and ECC.6.3.7.

- b) In Rectifier mode (acting as a demand) with Limited Frequency Sensitive Mode

The active power exported from the system should reduce as system frequency falls below 49.5 Hz in line with Figure ECC.6.3.3(b).

- c) In Inverter mode (acting as the generator) and in Rectifier mode (acting as a demand) with Frequency Sensitive Mode

When selected for Frequency Sensitive Mode by NGESO the HVDC Converter Station must adjust the active power input or output in response to any frequency change (within the range 49.5 Hz to 50.5 Hz) according to the agreed droop characteristic (between 3-5%) in line with Figure 6.3.7.3.4(a).

When system frequency moves outside of the range 49.5 Hz to 50.5 Hz the requirements of Limited Frequency Sensitive Mode apply.

Target Frequency

All Balancing Market Units (BMUs), irrespective of the plant type (wind, thermal, CCGT or HVDC Converter, whether directly Grid Connected or Embedded), are required to have the facility to set the levels of output power and frequency. These are generally known as Target MW and Target Frequency settings.

The NGESO Control Centre instructs all Active Balancing Market Units to operate with the same Target Frequency, normally 50.00 Hz. In order to adjust electric clock time the System Operator may instruct Target Frequency settings of 49.95Hz or 50.05Hz. However, under exceptional circumstances, the instructed settings could be outside this range. The European connection condition requires a minimum setting range from 49.90Hz to 50.10Hz.

De-load Instructions

System balancing is a separate issue to that of frequency response. A de-load instruction is to a fixed MW value rather than a delta MW value from available power. Typically Deloads may be instructed say from full output to enable both high and low frequency response to be available.

Summary of Steady State Load Accuracy Requirements

European connection conditions ECC.6.3.9 requires a HVDC Converter Station to be able to control output to a target with an accuracy specified as a standard deviation.

To demonstrate compliance, the HVDC Converter should self-dispatch for 30 minutes whilst in Limited Frequency Sensitive mode. The active power output and power available should be recorded with a sampling rate not less than once per minute.

Compliance Testing Requirements

The main objectives of the frequency controller response tests are to establish the plant performance characteristics for compliance with the European connection conditions technical requirements (including the validation of plant data/models). They are also required as a measured set of plant response values that will verify the response matrices for the Mandatory Services Agreement.

In order to verify the plant behaviour, it is essential that the HVDC Converter is tested in normal operating modes. A frequency disturbance can be simulated by injecting the required frequency variation signals to the frequency reference/feedback summing junction. The results obtained from reducing frequency ramps will be used to verify primary and secondary frequency response. Similarly the results obtained from increasing ramps will be used to verify the high frequency response. Robust and stable response to islanding events can be demonstrated by injecting large and rapid frequency disturbances and observing the response. The recommended tests are shown in ECP.A.6.6. Figure 1 and Figure 2.

Typical Frequency Control Test Injection

A frequency injection signal is needed to undertake all frequency related capability tests. Ideally the injected signal will be directly added into the raw frequency feedback as shown in the diagram below.

Ideally the signal will be software programmable with start/stop initiation via local or remote software interfaces or local digital inputs. Alternatively the signals should be a $\pm 10V$ analogue input where 1 volt represents 0.2 Hz frequency change.

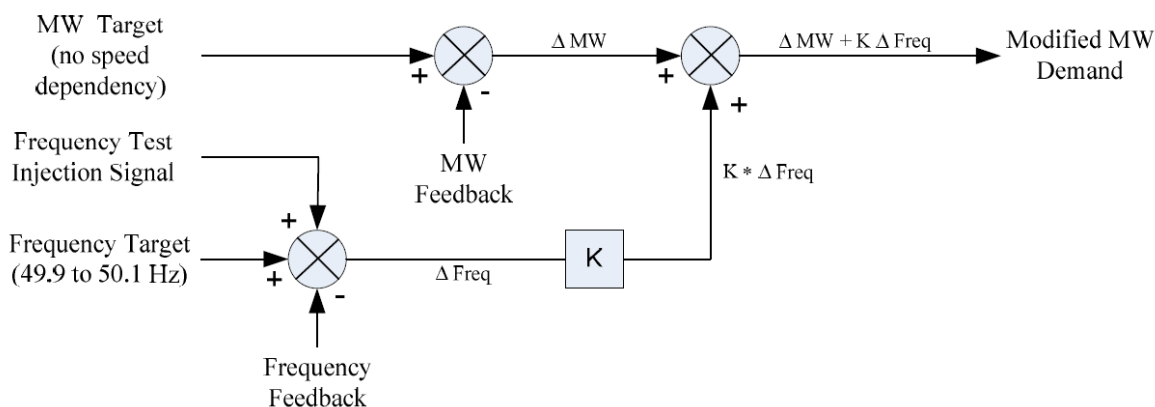

Figure C1: Typical Frequency Test Injection Scheme

Preliminary Frequency Response Testing

Past experience has demonstrated that significant delays can occur during testing because of problems associated with the frequency controller setup or frequency injection method. Frequently this results in considerable lost time and additional expense for both parties. Consequently this test has been drawn up and has been shown to help in preventing such situations arising.

Typical injection locations at the frequency controller are shown in Figure C1. In order to avoid the risk of re-testing, it is important that the injection method and the plant control are proved well in advance of the main tests by the HVDC System Owner. A preliminary test is therefore required with details given in ECP.A.7.5.4 and illustrated below. For all tests, the target frequency selected on the generating plant is that instructed by the NGESO Control Centre. This should normally be 50.00 Hz.

For both Import and Export modes of operation, with the plant running at a level approximately half way between full maximum output and Designed Minimum Operating Level, the following frequency injections should be applied.

The recorded results (e.g. Freq. injected, MW, Freq.sys) should be sampled at a minimum rate of 0.1 Hz to allow NGENSO to assess the plant performance from the initial transients (seconds) to the final steady state conditions (which may typically take 2-3 minutes depending on the plant design).

The preliminary frequency response test results should be sent to NGENSO for assessment at least two weeks prior to the final witnessed tests.

Test No (Figure1)	Frequency Injection	Notes
8	<ul style="list-style-type: none"> Inject -0.5Hz frequency fall over 10 sec Hold for a further 20 sec At 30 sec from the start of the test, Inject a +0.3Hz frequency rise over 30 sec. Hold until conditions stabilise Remove the injected signal as a ramp over 10 seconds 	
13	<ul style="list-style-type: none"> Inject - 0.5Hz frequency fall over 10 sec Hold until conditions stabilise Remove the injected signal as a ramp over 10 seconds 	
14	<ul style="list-style-type: none"> Inject +0.5Hz frequency rise over 10 sec Hold until conditions stabilise Remove the injected signal as a ramp over 10 seconds 	
H	<ul style="list-style-type: none"> Inject - 0.5Hz frequency fall as a stepchange Hold until conditions stabilise Remove the injected signal as a stepchange 	
I	<ul style="list-style-type: none"> Inject +0.5Hz frequency rise as a stepchange Hold until conditions stabilise Remove the injected signal as a stepchange 	

Table C1: Preliminary Frequency Response Testing

Witnessed Frequency Response Testing Sequence in European Compliance Processes

ECP.A.7.5 Figure 1. Figure 2 give the ramps and step frequency injection tests required at different loading levels (i.e. MLP 6 to MLP 1). The corresponding test sequence is outlined below with the initial test establishing the maximum steady state output condition of the plant (i.e. MLP 6). A full generic procedure is provided as an example.

1. Establish Maximum Plant Capacity as Loading Point MLP6

- Switch HVDC Converter controller to manual and raise load demand to confirm the maximum output level at the base settings.
- Record plant and ambient conditions.

2. Response Tests at Loading Point MLP6 (100% MEL)

- Operate the plant at MLP 6

- Inject ramp/profiled frequency changes simultaneously into the HVDC Converter controller (i.e. Tests 1-4 in ECP.A.7.5. Figure 1) and record plant responses.
- Conduct test BC1 – BC4, O, A and L as shown in ECP.A. 7.5. Figure 2 to establish the deloading capability as could occur under system islanding or system split conditions.

3. Response Tests at Loading Point MLP4 (80% MEL)

- Operate the plant at loading point 4 (MLP 4).
- Conduct tests 8-14 and 17 as shown in ECP.A. 7.5 Figure 1 and record plant responses.
- Conduct tests D – N, BC5/6 as shown in ECP.A. 7.5 Figure 2 to establish the HVDC Converter controller, and step response characteristics for HVDC Converter controller modelling purposes.
- Conduct test J as shown in ECP.A. 7.5 Figure 2 to establish the robustness of the control system under simulated extreme disturbances (e.g., system islanding or system split).

4. Response Tests at Designed Minimum Operating Level MLP1 (MRL)

- Operate the plant at MRL.
- Conduct tests 23 - 26 as shown in ECP.A. 7.5 Figure 1 and record plant responses.
- Conduct test K and Q as shown in ECP.A. 7.5 Figure 2 to establish the step response characteristics for HVDC Converter controller modelling purposes.

Note:

1. BC1 and BC3 in Figure 2 will generally be +2.0Hz unless an injection of this size causes a reduction in plant output that takes the operating point below Minimum Stable Operating Level in which case an appropriate injection should be calculated in accordance with the following:

For example 0.9Hz is needed to take an initial output 65% to a final output of 20%. If the initial output was not 65% and the Minimum Stable Operating Level is not 20% then the injected step should be adjusted accordingly as shown in the example given below

Initial Output 65%

Minimum Stable Operating Level 20%

Frequency Controller Droop 4%

Frequency to be injected = $(0.65-0.20) \times 0.04 \times 50 = 0.9\text{Hz}$

2. Tests L and M in Figure 2 shall be conducted if in this range of tests the system frequency feedback signal is replaced by the injection signal rather than the injection signal being added to the system frequency signal. The tests will consist of monitoring the Power Park Module in Frequency Sensitive Mode during normal system frequency variations without applying any injection.
3. Test N in Figure 2 shall be conducted in all cases. All three tests should be conducted for a period of at least 10 minutes.

Generic Frequency Response Test Procedure

Since the governor response tests described above are to be arranged and conducted by the HVDC System Owner, it is their responsibility to propose a test programme to suit their site specific requirements. A typical example of the test procedure based on ECP.A.7.5 Figures 1 and 2 is given below. This procedure is required to be submitted to NGEN for approval before an ION is issued. The tests should be carried out in both export and import active power directions.

Injection Tests at MLP6,		
Test No (Figure 1)	Action	Notes

1	<ul style="list-style-type: none"> Inject 0.10Hz frequency rise over 10 sec Hold until conditions stabilise Remove the injection signal over 10 sec Hold until conditions stabilise at MLP 6 	
2	<ul style="list-style-type: none"> Inject -0.20Hz frequency fall over 10 sec Hold until conditions stabilise Remove the injection signal over 10 sec Hold until conditions stabilise at MLP 6 	
3	<ul style="list-style-type: none"> Inject 0.20Hz frequency rise over 10 sec Hold until conditions stabilise Remove the injection signal over 10 sec Hold until conditions stabilise at MLP 6 	
4	<ul style="list-style-type: none"> Inject 0.50Hz frequency rise over 10 sec Hold until conditions stabilise Remove the injection signal over 10 sec Hold until conditions stabilise at MLP 6 	
BC1	<p>Plant in FSM</p> <ul style="list-style-type: none"> Inject +2.0 Hz frequency rise over 1 sec Hold until conditions stabilise Remove the injection signal Hold until conditions stabilise at MLP 6 	
O	<ul style="list-style-type: none"> Inject +0.5Hz frequency rise as a step change Hold until conditions stabilise Remove the injection signal Hold until conditions stabilise at MLP 6 	
A	<ul style="list-style-type: none"> Inject -0.5Hz frequency rise as a step change Hold until conditions stabilise Remove the injection signal Hold until conditions stabilise at MLP 6 	
BC2	<ul style="list-style-type: none"> Inject +0.6 Hz frequency rise over 30 sec Hold until conditions stabilise Remove the injection signal Hold until conditions stabilise at MLP 6 	
L	<ul style="list-style-type: none"> Record normal system variation in frequency and active power of the HVDC Converter over at least 10 minutes. Load setpoint at maximum. 	
BC3	<p>Plant in LFSM</p> <ul style="list-style-type: none"> Inject +2.0 Hz frequency rise over 1 sec Hold until conditions stabilise Remove the injection signal Hold until conditions stabilise at MLP 6 	
BC4	<p>Plant in LFSM</p> <ul style="list-style-type: none"> Inject +0.6 Hz frequency rise over 30 sec Hold until conditions stabilise Remove the injection signal Hold until conditions stabilise at MLP 6 	

Injection Tests at MLP4,		
Test No (Figure 1)	Frequency Injection	Notes
8	<ul style="list-style-type: none"> Inject -0.50Hz frequency fall over 10 sec Hold for 20 sec Inject +0.30Hz frequency rise over 30 sec Hold until conditions stabilise Remove the injection signal over 10 sec Hold until conditions stabilise at MLP 4 	
9	<ul style="list-style-type: none"> Inject -0.10Hz frequency fall over 10 sec Hold until conditions stabilise Remove the injection signal over 10 sec 	

	<ul style="list-style-type: none"> • Hold until conditions stabilise at MLP 4 	
10	<ul style="list-style-type: none"> • Inject 0.10Hz frequency rise over 10 sec • Hold until conditions stabilise • Remove the injection signal over 10 sec • Hold until conditions stabilise at MLP 4 	
11	<ul style="list-style-type: none"> • Inject -0.20Hz frequency fall over 10 sec • Hold until conditions stabilise • Remove the injection signal over 10 sec • Hold until conditions stabilise at MLP 4 	
12	<ul style="list-style-type: none"> • Inject 0.20Hz frequency rise over 10 sec • Hold until conditions stabilise • Remove the injection signal over 10 sec • Hold until conditions stabilise at MLP 4 	
13	<ul style="list-style-type: none"> • Inject -0.50Hz frequency fall over 10 sec • Hold until conditions stabilise • Remove the injection signal over 10 sec • Hold until conditions stabilise at MLP 4 	
14	<ul style="list-style-type: none"> • Inject +0.50Hz frequency rise over 10 sec • Hold until conditions stabilise • Remove the injection signal over 10 sec • Hold until conditions stabilise at MLP 4 	
17	<ul style="list-style-type: none"> • Inject -0.80Hz frequency fall over 10 sec • Hold for 20 sec. • Inject 0.30Hz frequency rise over 30 sec • Hold until conditions stabilise • Remove the injection signal over 10 sec • Hold until conditions stabilise at MLP 4 	
D	<ul style="list-style-type: none"> • Inject +0.02Hz frequency fall as a step change • Hold until conditions stabilise • Remove the injection signal • Hold until conditions stabilise at MLP 4 	
E	<ul style="list-style-type: none"> • Inject -0.02Hz frequency rise as a step change • Hold until conditions stabilise • Remove the injection signal • Hold until conditions stabilise at MLP 4 	
F	<ul style="list-style-type: none"> • Inject -0.20Hz frequency fall as a step change • Hold until conditions stabilise • Remove the injection signal • Hold until conditions stabilise at MLP 4 	
G	<ul style="list-style-type: none"> • Inject 0.20Hz frequency rise as a step change • Hold until conditions stabilise • Remove the injection signal • Hold until conditions stabilise at MLP 4 	
H	<ul style="list-style-type: none"> • Inject -0.50Hz frequency fall as a step change • Hold until conditions stabilise • Remove the injection signal • Hold until conditions stabilise at MLP 4 	
I	<ul style="list-style-type: none"> • Inject 0.50Hz frequency rise as a step change • Hold until conditions stabilise at MLP 4 • Remove the injection signal • Hold until conditions stabilise at MLP 4 	
J	<ul style="list-style-type: none"> • Inject 1.0Hz/sec frequency fall over 2 sec • Hold for 30 sec • Remove the injection signal • Hold until conditions stabilise at MLP4 	
M	<ul style="list-style-type: none"> • Record normal system variation in frequency • and active power of the HVDC Converter over at least 10 minutes 	
BC5	<p>Plant in LFSM</p> <ul style="list-style-type: none"> • Inject -0.6 Hz frequency rise over 30 sec 	

	<ul style="list-style-type: none"> • Hold until conditions stabilise • Remove the injection signal • Hold until conditions stabilise at MLP 4 	
BC6	Plant in LFSM <ul style="list-style-type: none"> • Inject -1.0 Hz frequency rise over 30 sec • Hold until conditions stabilise • Remove the injection signal • Hold until conditions stabilise at MLP 4 	
N	Plant in LFSM <ul style="list-style-type: none"> • Record normal system variation in frequency and active power of the HVDC Converter over at least 10 minutes • Switch plant to Frequency Sensitive Mode 	

Injection Tests at MLP1,		
Test No (Figure 1)	Frequency Injection	Notes
23	<ul style="list-style-type: none"> • Inject -0.50Hz frequency fall over 10 sec • Hold for 20 sec • Inject 0.30Hz frequency rise over 30 sec • Hold until conditions stabilise • Remove the injection signal over 10 sec • Hold until conditions stabilise at MLP 1 	
24	<ul style="list-style-type: none"> • Inject -0.20Hz frequency fall over 10 sec • Hold until conditions stabilise • Remove the injection signal over 10 sec • Hold until conditions stabilise at MLP 1 	
25	<ul style="list-style-type: none"> • Inject 0.20Hz frequency rise over 10 sec • Hold until conditions stabilise • Remove the injection signal over 10 sec • Hold until conditions stabilise at MLP 1 	
26	<ul style="list-style-type: none"> • Inject -0.80Hz frequency fall over 10 sec • Hold for 20 sec • Inject 0.30Hz frequency rise over 30 sec • Hold until conditions stabilise • Remove the injection signal over 10 sec • Hold until conditions stabilise at MLP 1 	
K	<ul style="list-style-type: none"> • Inject -0.5Hz frequency fall over 1 sec • Hold until conditions stabilise • Remove the injection signal • Hold until conditions stabilise at MLP 1 	
Q	<ul style="list-style-type: none"> • Inject +0.5Hz frequency fall over 1 sec • Hold until conditions stabilise • Remove the injection signal • Hold until conditions stabilise at MLP 1 	

Control Requirements that may be witnessed

During attendance on site for witness testing of frequency response, NGENSO may request that the HVDC System Owner alters the Target Frequency setpoint from the HVDC System Owners Control Room as an indication of controllability. This may be combined with tests M in ECP.A. 7.5.

Appendix D Other Technical Information

Technical Information on the Connection Bus Bar

This section illustrates the technical information relating to the connection bus bar that is provided by National Grid

Busbar on GB Transmission System operating at Supergrid Voltage:	Example 1 (Scottish Power Area 275kV)	275kV	
Item	Max	Min	Unit
Symmetrical Three-phase short circuit level at instant of fault from GB Transmission System (based on transient impedance)	19000	1300	MVA
Equivalent system reactance between the Supergrid Busbar and HVDC Converter Point of Connection	3.9	3.6	% on 100MVA
Total clearance time for fault on GB Transmission System operating at Supergrid Voltage, cleared by System Back-up Protection (C.C.6.3.15 (c))	800	N/A	msec

Equivalent Circuit between Supergrid Busbar and HVDC Converter Station Point of Connection

(showing transformer vector groups):

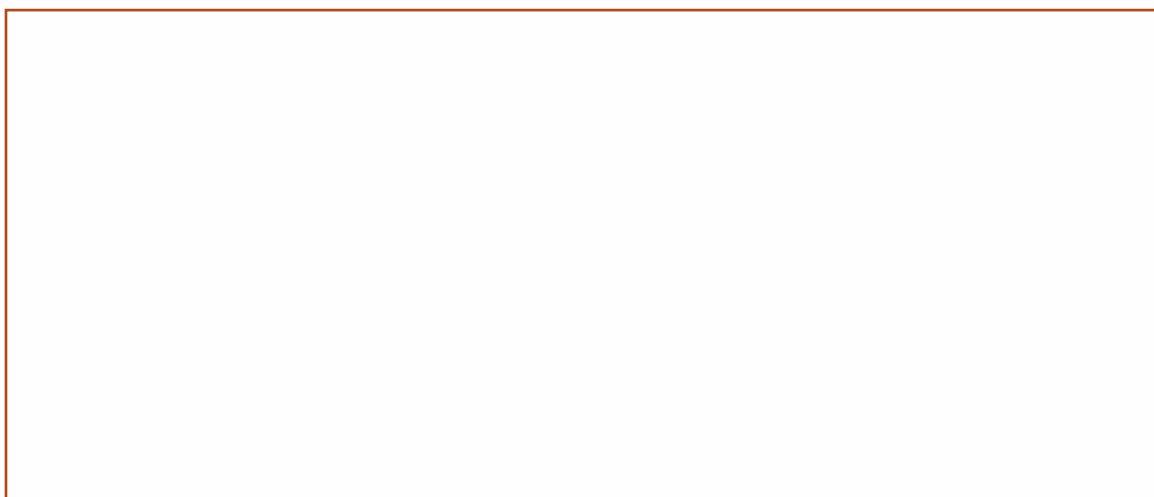

[For CC6.3.15 (c) assume system 'nps' impedance pre-and post-fault such that CC6.1.6 limits met]

Equivalent Sequence Impedances for Calculating Unbalanced Short-Circuit Current Contribution

The HVDC System Owner is required to provide the fault infeed from the HVDC Converter Station into the public transmission/distribution network. The data should be submitted in Grid Code DRC Schedule 14. The following transmission/distribution system equivalent sequence impedances may be used by the HVDC System Owner in calculating unbalanced short-circuit current contribution from the HVDC Converter Station at the entry point unless site specific values have been given. The HVDC System Owner should confirm the system equivalent sequence impedances that have been used in the submission.

33kV: $Z_1 = Z_2 = 14.580 \angle 88.091^\circ$ % on a 100 MVA base
 $Z_0 = 159.1 \angle 26.565^\circ$ % on a 100 MVA base

These impedances are based on the following assumptions:

- The PPS and NPS X/R ratio of the 33kV system is equal to 30
- The ZPS X/R ratio of the 33kV system is equal to 0.5
- The short-circuit current contribution from the 33kV distribution system for a 3-phase fault at the entry point is approximately 12kA
- The short-circuit current contribution from the 33kV distribution system for a 1-phase fault at the entry point is approximately 3kA

132kV: $Z_1 = Z_2 = 3.650 \angle 84.289^\circ$ % on a 100 MVA base
 $Z_0 = 1.460 \angle 84.289^\circ$ % on a 100 MVA base

These impedances are based on the following assumptions:

- The PPS, NPS and ZPS X/R ratio of the transmission/distribution system is 10.
- The short-circuit current contribution from the transmission/distribution system for a 3-phase fault at the entry point is approximately 12kA
- The short-circuit current contribution from the transmission/distribution system for a 1-phase fault at the entry point is approximately 15kA

275kV: $Z_1 = Z_2 = 0.700 \angle 85.236^\circ$ % on a 100 MVA base
 $Z_0 = 1.120 \angle 85.236^\circ$ % on a 100 MVA base

These impedances are based on the following assumptions:

- The PPS, NPS and ZPS X/R ratio of the 275kV system is equal to 12
- The short-circuit current contribution from the 275kV transmission system for a 3-phase fault at the entry point is approximately 30kA
- The short-circuit current contribution from the 275kV transmission system for a 1-phase fault at the entry point is approximately 25kA

400kV: $Z_1 = Z_2 = 0.361 \angle 85.914^\circ$ % on a 100 MVA base
 $Z_0 = 0.516 \angle 85.914^\circ$ % on a 100 MVA base

These impedances are based on the following assumptions:

- The PPS, NPS and ZPS X/R ratio of the 400kV system is equal to 14
- The short-circuit current contribution from the 400kV transmission system for a 3-phase fault at the entry point is approximately 40kA
- The short-circuit current contribution from the 400kV transmission system for a 1-phase fault at the entry point is approximately 35kA

Appendix E Test Signal Schedules and Test Logsheet

Compliance Test Signal Schedules Table 1 - Power Park Modules & DC Converters Voltage Control & Reactive Capability								
	Col 1	Col 2	Col 3	Col 4	Col 5	Col 6	Col 7	Col 8
1	Time (10ms)	Active Power	Reactive Power	Connection Voltage	Speed /Frequency #	Freq Injection #	Logic / Test Start#	Statcom or Windfarm Output #
	Col 9	Col 10	Col 11	Col 12	Col 13	Col 14	Col 15	Col 16
1	Power Available #	Wind Speed #	Wind Direction #	Voltage Setpoint				
2	State of Charge #							
# Columns may be left blank but the column must still be included in the files								

Table 2 - Power Park Modules & DC Converters Frequency Control								
	Col 1	Col 2	Col 3	Col 4	Col 5	Col 6	Col 7	Col 8
1	Time (100ms)	Active Power	Reactive Power #	Connection Voltage #	Speed /Frequency	Freq Injection	Logic / Test Start	Statcom or Windfarm Output #
	Col 9	Col 10	Col 11	Col 12	Col 13	Col 14	Col 15	Col 16
1	Power Available #	Wind Speed #	Wind Direction #					
2	State of Charge #							
# Columns may be left blank but must still be included in the files								

Compliance Test Logsheet

Where test results are completed without any NGENSO presence but are relied upon as evidence of the compliance they should be accompanied by a logsheet. This sheet should be legible, in English and detail the items set out below. Some of the items listed may not be relevant to all technology type addressed by guidance notes.

- Time and Date of test
- Name of Power Station and module if applicable.
- Name of Test engineer(s) and company name.

- Name of Customer(s) representative and company name.
- Type of testing being undertake eg Voltage Control.
- Ambient Conditions eg. Temperature, pressure, wind speed, wind direction.
- Controller settings, eg Voltage slope, Frequency droop, Voltage setpoint.

For each test the following items should be recorded as relevant to the type of test being undertaken. Where there is uncertainty on the information to be recorded, this should be discussed with NGENSO in advance of the test.

Voltage Control Tests

- Start time of each test step.
- Active Power.
- Reactive Power.
- Connection Voltage.
- Voltage Control Setpoint, if applicable or changed.
- Voltage Control Slope, if applicable or changed.
- Terminal Voltage if applicable.
- Generator tap position or Grid Transformer tap position, as applicable.
- Number of Power Park Units in service in each Module, if applicable.

For Offshore Connections

- Offshore Grid Entry Voltage.

Reactive Power Capability Tests

- Start time of test.
- Active Power.
- Reactive Power.
- Connection Voltage.
- Terminal Voltage if applicable.
- Generator tap position or Grid Transformer tap position as applicable.
- Number of Power Park Units in service in each Module, if applicable.

For Offshore Connections

- Offshore Grid Entry Voltage.

Frequency Response Capability Tests

- Start time of test.
- Module Active Power.
- System Frequency.
- For CCGT modules, Active Power for the individual units (GT &ST).

- For Boiler plant, HP steam pressure.
- Droop setting of controller if applicable
- Number of Power Park Units in service in each Module, if applicable.

For Offshore Connections

- Offshore Grid Entry Point Active Power for each Power Park Module.

Material changes during the test period should be recorded eg Units tripping / starting, changes to tapchange positions. Thought should be given as to whether such changes invalidate the test and a repeat test would be appropriate.

Appendix F Compliance Process

The flow charts that are shown below provide a graphical view of the following:

- The compliance process users seeking to connect any of the four types of generation modules or an HVDC equipment to the network are required to follow to obtain a final operational notification.
- The compliance process new users carrying out on-site commissioning activities must follow to obtain an Energisation Operational Notification.
- The compliance process existing users operating under a final operational notification carrying out works on their plant to reinstate grid code compliance are expected to follow to obtain a Limited Operational Notification.

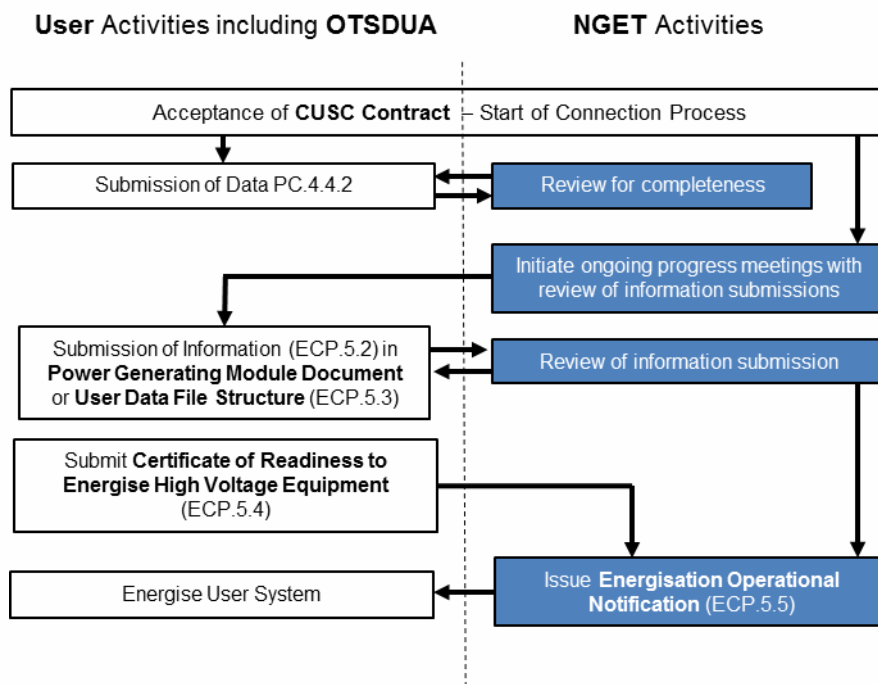

Figure F.1 – ECP.A.1.1 Energisation Process

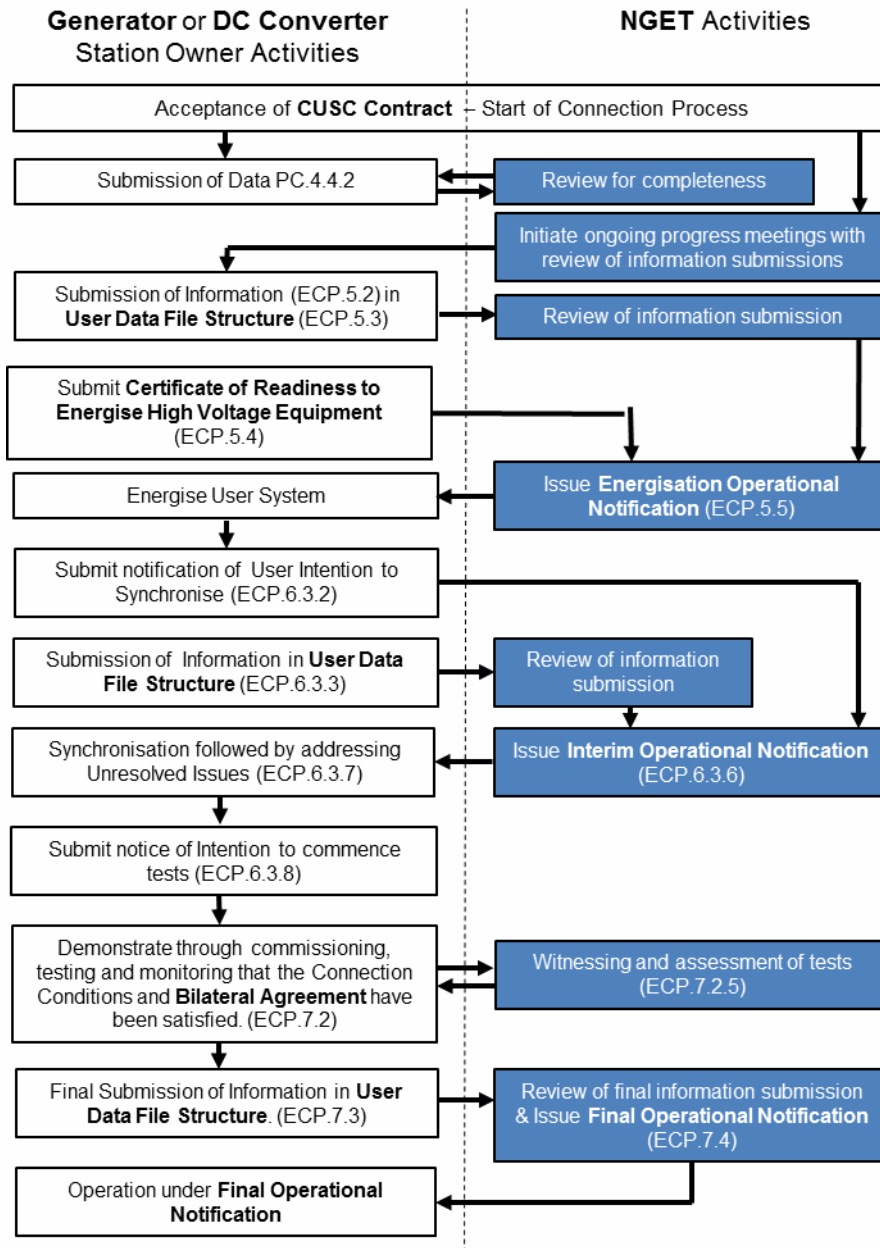

Figure F.2 – ECP.A.1.2 Type D Power Generating Module and HVDC Equipment Process

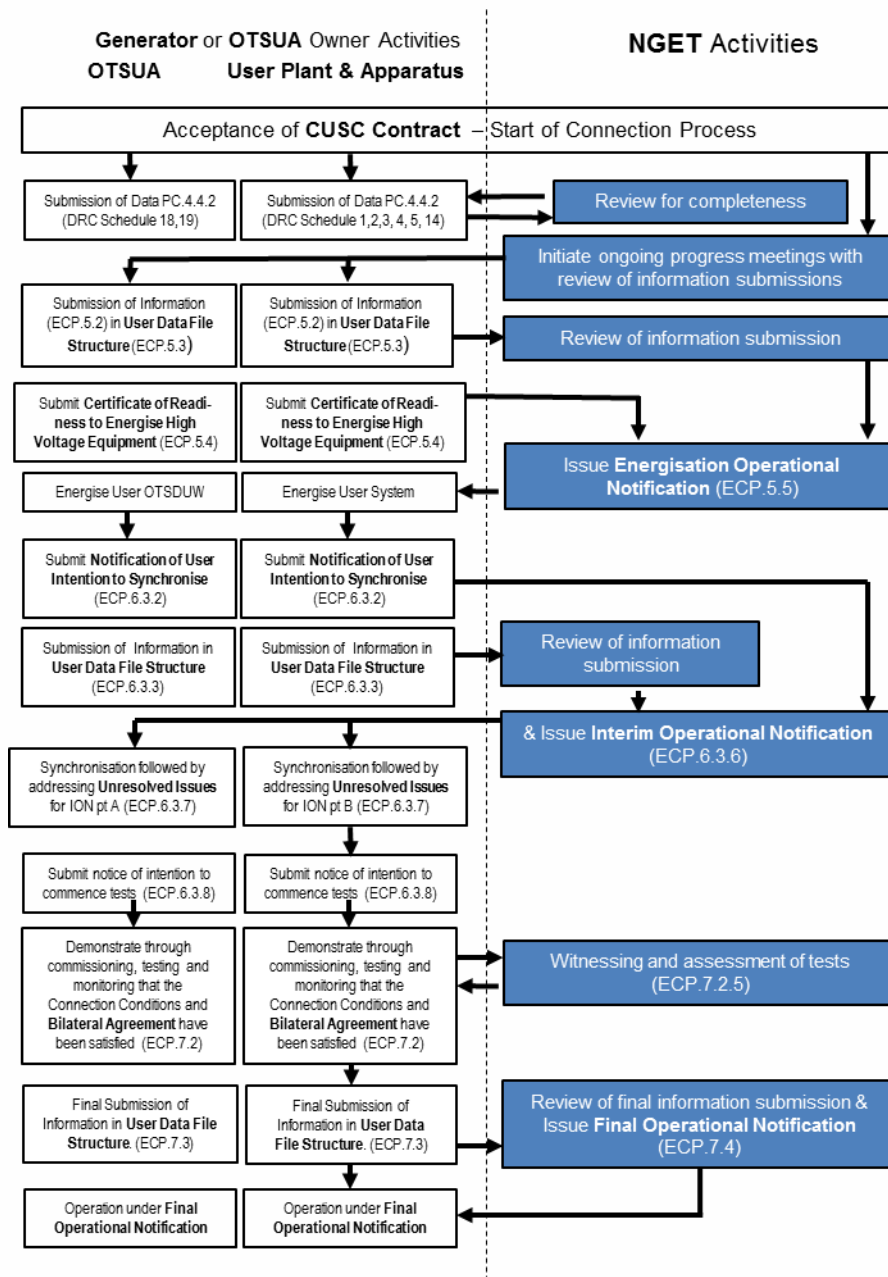

Figure F.3 – ECP.A.1.3 Offshore Type D Power Generating Module and OTSUA Equipment Process

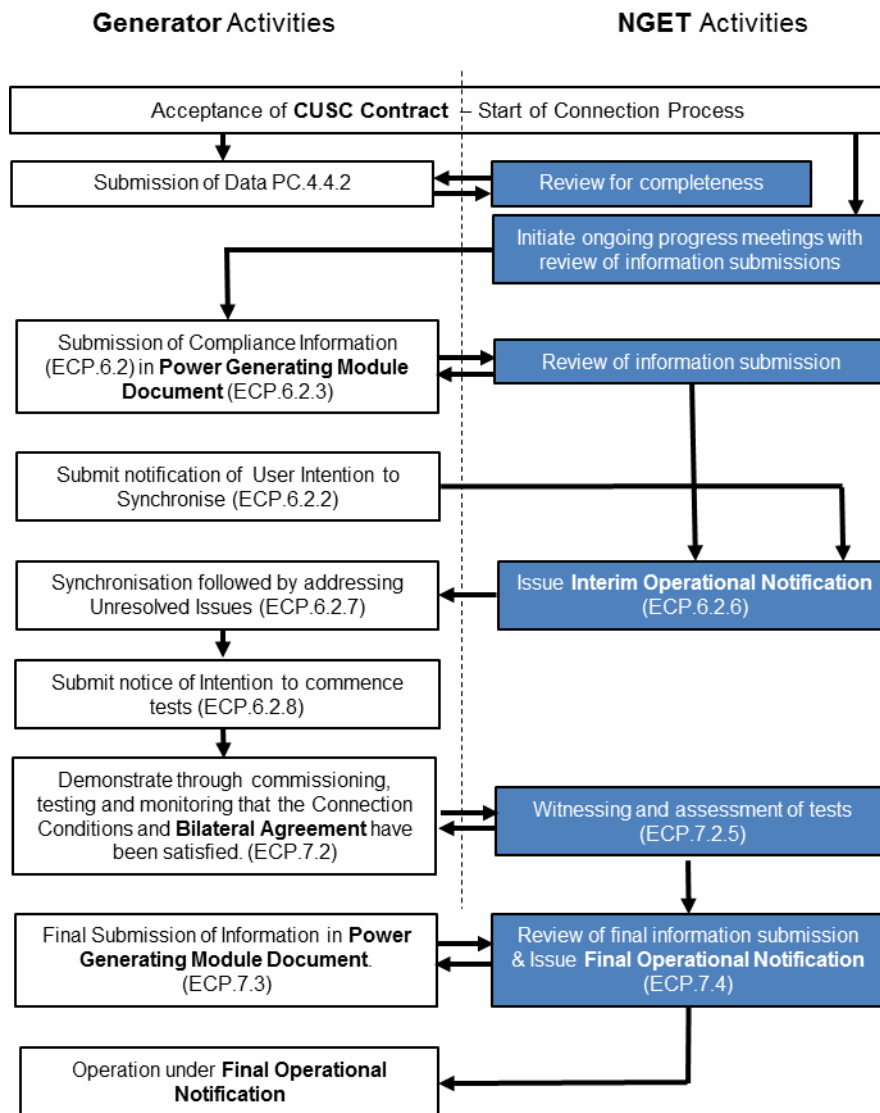

Figure F.4 – ECP.A.1.4 Type B and Type C Power Generating Module Process

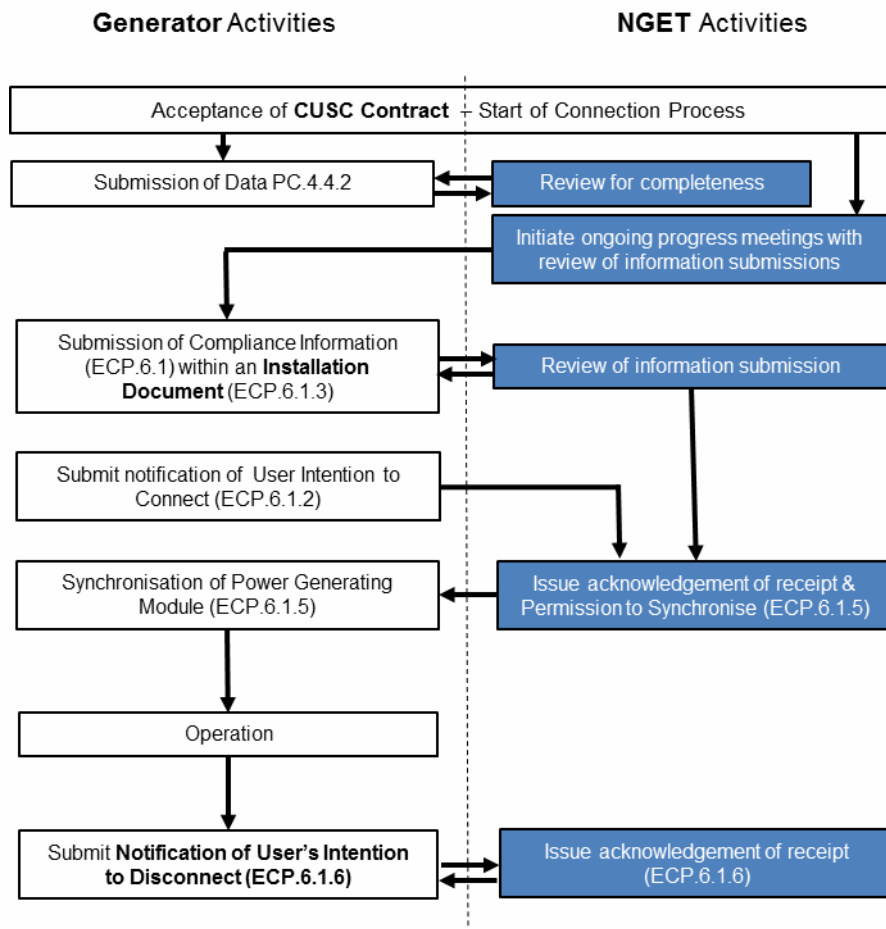

Figure F.5 – ECP.A.1.5 Type A Power Generating Module Process

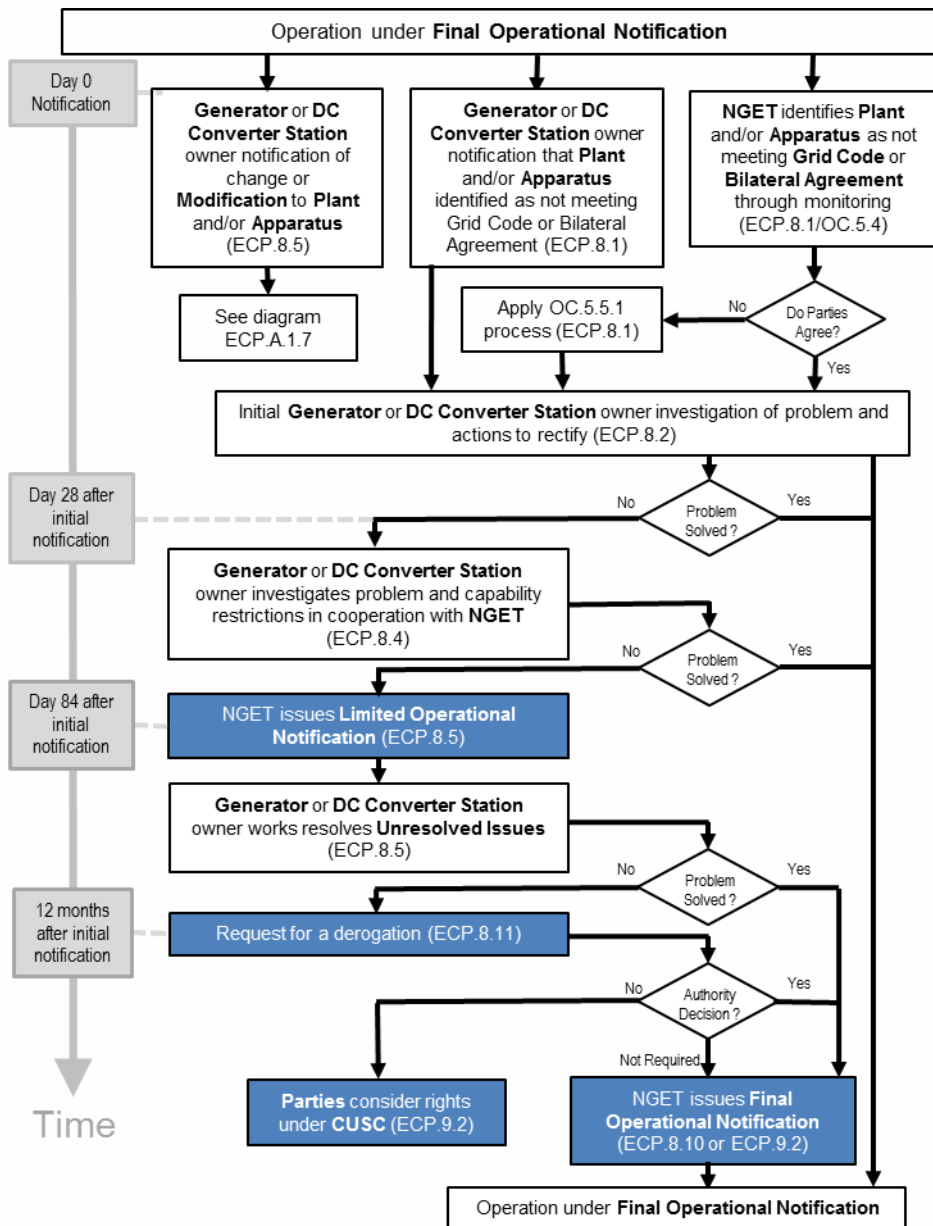

Figure F.6 – ECP.A.1.6 Ongoing Compliance Process

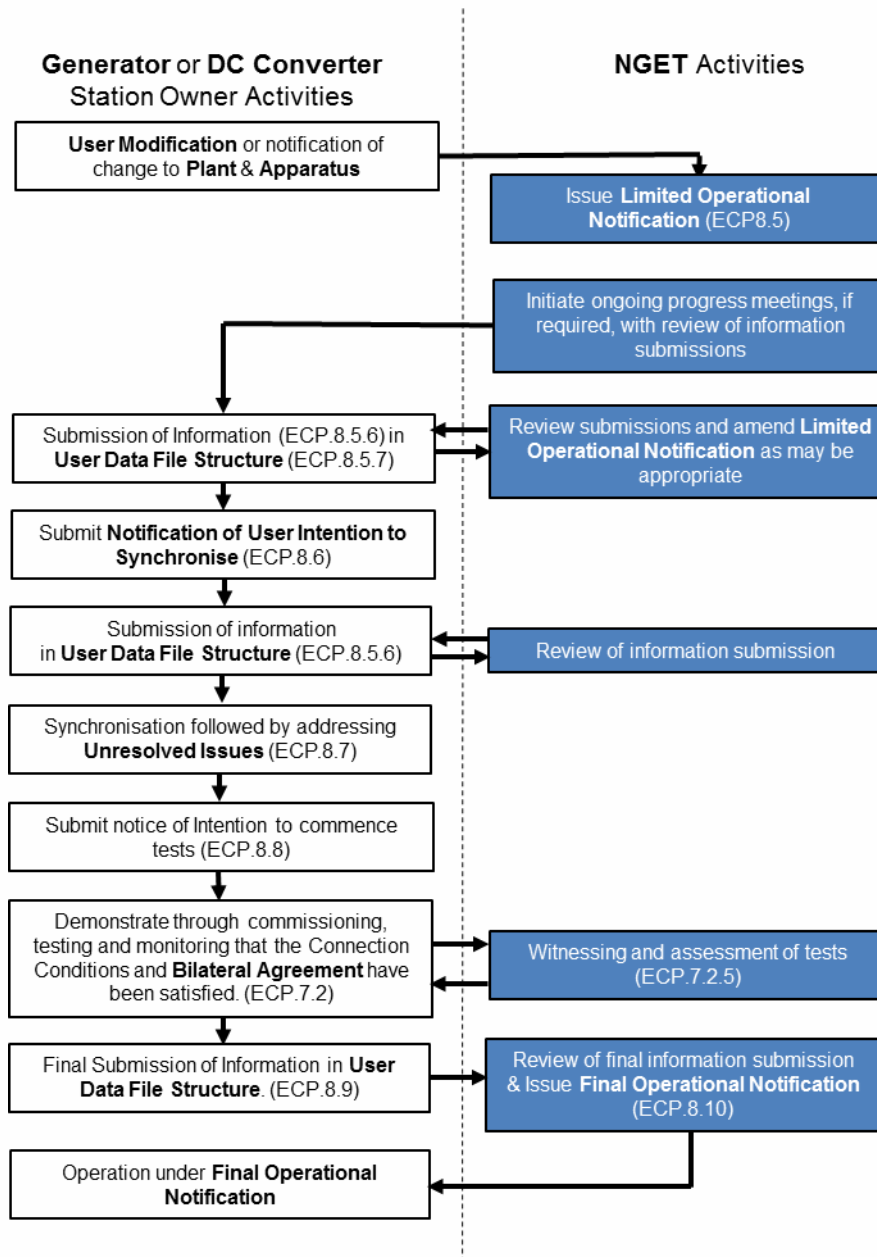

Figure F.7 – ECP.A.1.7 Modification or Change Process

Appendix G Contacting National Grid

There are a number of different departments within National Grid that will be involved with this connection. The initial point of contact for National Grid will be your allocated Customer Connection Contract Manager for your Bilateral Agreement. If you are unsure of who your allocated Customer Connection Contract Manager is then the team can be contacted on transmissionconnections@nationalgrid.com.

For any correspondence relating to testing on the system following the Grid Code the IET process should be followed with notifications made to the '.Box.Tranreq' email address for England and Wales connections and '.Box.TR.Scotland' for all connections in Scotland.

Contact Address:

National Grid ESO, Faraday House, Warwick Technology Park, Gallows Hill,
Warwick CV34 6DA



nationalgridESO

Faraday House, Warwick Technology Park,
Gallows Hill, Warwick, CV346DA

nationalgrideso.com