

# National Electricity Transmission System Security and Quality of Supply Standard

Version 2.54  
~~1 April 2019~~ 23 November 2020

## Contents

		Page
1	Introduction	4
2	Generation Connection Criteria Applicable to the <i>Onshore Transmission System</i>	<del>11</del> <u>12</u>
3	Demand Connection Criteria Applicable to the <i>Onshore Transmission System</i>	<del>18</del> <u>6</u>
4	Design of the <i>Main Interconnected Transmission System</i>	<del>22</del> <u>4</u>
5	Operation of the <i>Onshore Transmission System</i>	<del>27</del> <u>6</u>
6	Voltage Limits in Planning and Operating the <i>Onshore Transmission System</i>	<del>32</del> <u>0</u>
7	Generation Connection Criteria Applicable to an <i>Offshore Transmission System</i>	<del>34</del> <u>40</u>
8	Demand Connection Criteria Applicable to an <i>Offshore Transmission System</i>	<del>49</del> <u>4</u>
9	Operation of an <i>Offshore Transmission System</i>	<del>48</del> <u>53</u>
10	Voltage Limits in Planning and Operating an <i>Offshore Transmission System</i>	<del>50</del> <u>55</u>
11	Terms and Definitions	<del>56</del> <u>1</u>
Appendix A	Recommended Substation Configuration and Switching Arrangements	<del>77</del> <u>2</u>
Appendix B	Circuit Complexity on the <i>Onshore Transmission System</i>	<del>77</del> <u>82</u>
Appendix C	Modelling of <i>Security Planned Transfer</i>	<del>80</del> <u>5</u>

	<b>Appendix D</b>	<b>Application of the <i>Interconnection Allowance</i></b>	<b><a href="#">872</a></b>
	<b>Appendix E</b>	<b>Modelling of <i>Economy Planned Transfer</i></b>	<b><a href="#">8590</a></b>
	<b>Appendix F</b>	<b>Application of the <i>Boundary Allowance</i></b>	<b><a href="#">8792</a></b>
	<b>Appendix G</b>	<b>Guidance on Economic Justification</b>	<b><a href="#">8994</a></b>

# 1. Introduction

## Role and Scope

- 1.1 Pursuant to conditions C17, D3 and E16 of the Transmission Licences, this document sets out a coordinated set of criteria and methodologies (for example cost-benefit techniques and weather related operation) that *transmission licensees* shall use in the planning and operation of the *national electricity transmission system* of *Great Britain*. For the avoidance of doubt the *national electricity transmission system* is made up of both the *onshore transmission system* and the *offshore transmission systems*.
- 1.2 Both planning and operational criteria are set out in this Standard and these will determine the need for services provided to the relevant *transmission licensees*, e.g. reactive power as well as transmission equipment. The planning criteria set out the requirements for the *transmission capacity* (either investment or purchase of services) for the *national electricity transmission system*. The planning criteria also require consideration to be given to the operation and maintenance of the *national electricity transmission system* and so refer to the associated operational criteria where appropriate. The operational criteria are used in real time and in the development of plans for using the *national electricity transmission system* to permit satisfactory operation.
- 1.3 Additional criteria, for example covering more detailed and other aspects of quality of supply, are contained in the Grid Code and the SO-TO Code, which should be read in conjunction with this document.
- 1.4 *External interconnections* between the *onshore transmission system* and *external systems* (e.g. in Ireland & France) are covered by separate agreements, which will normally be consistent with this Standard. This Standard may be specifically referenced in the relevant agreements and shall apply to the extent of that reference.
- 1.5 The consideration of *secured events* as defined in this Standard may lead to the identification of inadequate capability of equipment or systems not owned or operated by the *transmission licensees* (for example, the overloading of lower voltage connections between *grid supply points*). In such cases the *transmission licensees* will notify the *network operators* affected. Reinforcement or alternative operation of the *national electricity transmission system* to alleviate inadequacies of equipment or systems not owned or operated by the *transmission licensees* would be undertaken where it is agreed by the *network operators* affected and the relevant *transmission licensees*.
- 1.6 The criteria presented in this Standard represent the minimum requirements for the planning and operation of the *national electricity transmission system*. While it is a requirement for *transmission capacity* to meet the planning criteria, it does not follow that the *transmission capacity* should be reduced so that it only meets the minimum requirement of those criteria. For example, it may not be beneficial to reduce the ratings of lines to reflect lower loading levels which have arisen due to changes in the generation or demand patterns.

## Document Structure

- 1.7 This Standard contains technical terms and phrases specific to *transmission systems* and the Electricity Supply Industry. The meanings of some terms or phrases in this Standard may also differ from those commonly used. For this reason a 'Terms and Definitions' has been included as Section 11 to this document. All defined terms have been identified in the text by the use of *italics*.
- 1.8 The criteria and methodologies applicable to the *onshore transmission system* differ in certain respects from those applicable to the *offshore transmission systems*. In view of this, the two sets of criteria and methodologies are presented separately for clarity. The criteria and methodologies applicable to the *onshore transmission system* are presented in Sections 2 to 6 and the criteria and methodologies applicable to *offshore transmission systems* are presented in Sections 7 to 10.

## Onshore Criteria and Methodologies

- 1.9 For ease of use, the criteria and methodologies relating to the planning of the *onshore transmission system* have been presented according to the functional parts of the *onshore transmission system* to which they primarily apply. These parts are the *generation points of connection* at which *power stations* feed into the *Main Interconnected Transmission System (MITS)* through the remainder of the *MITS* to the *Grid Supply Points (GSP)* where demand is connected. These parts are illustrated schematically in Figure 1.1.

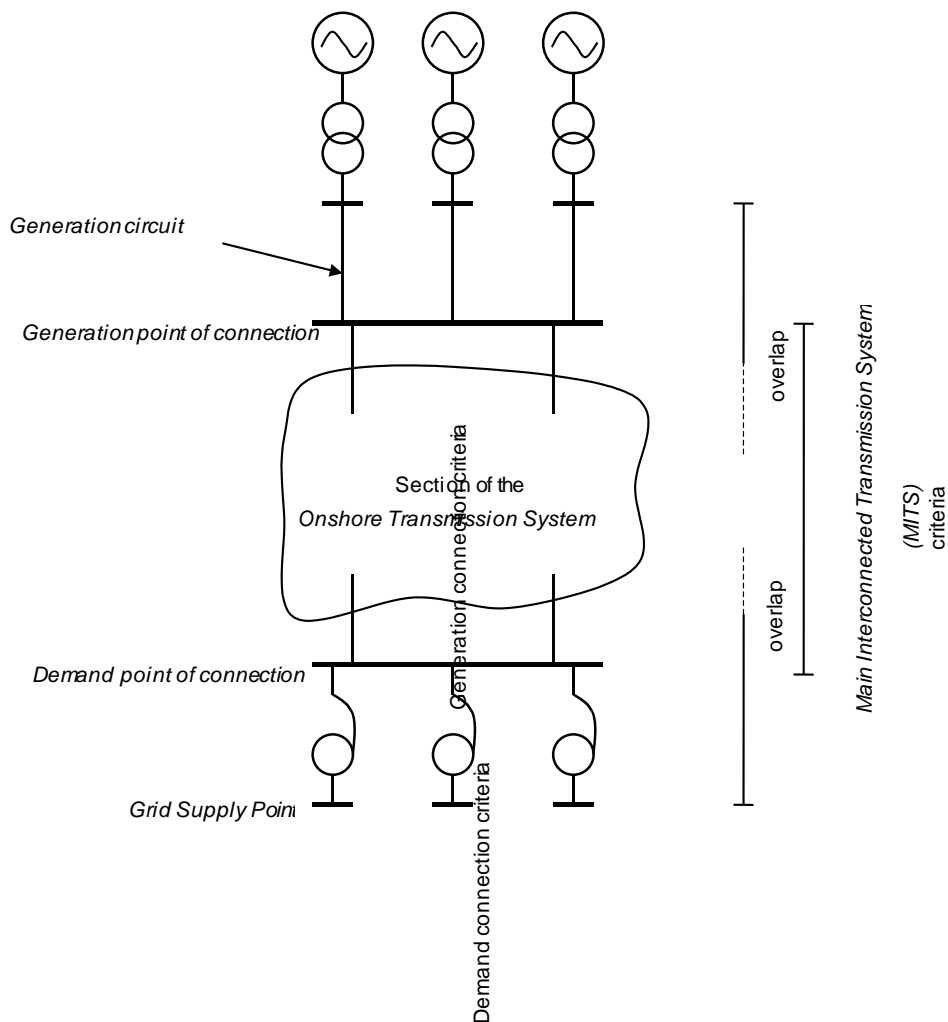

Figure 1.1 The *onshore transmission system with a directly connected power station*

- 1.10 The generation connection criteria applicable to the *onshore transmission system* are set out in Section 2 and cover the connections which extend from the *grid entry points (GEPS)* and reach into the *MITS*. The criteria also cover the risks affecting the *national electricity transmission system* arising from the *generation circuits*.
- 1.11 The demand connection criteria applicable to the *onshore transmission system* are given in Section 3 and cover the connections which extend from the lower voltage side of the *GSP* transformers and again reach into the *MITS*.
- 1.12 Section 4 sets out the criteria for minimum *transmission capacity* on the *MITS*, which extends from the *generation points of connection* through to the *demand points of connection* on the high voltage side of the *GSP* transformers.
- 1.13 The criteria relating to the operation of the *onshore transmission system* are presented in Section 5.

## Offshore Criteria and Methodologies

- 1.14 For ease of use, the criteria and methodologies relating to the planning of the *offshore transmission systems* have also been presented according to the functional parts of an *offshore transmission system* to which they primarily apply. An *offshore transmission system* extends from the *offshore grid entry point/s (GEP)* at which *offshore power stations* feed into the *offshore transmission system* through the remainder of the *offshore transmission system* to the point of connection of the *offshore transmission system* at the *first onshore substation*. This point of connection at the *first onshore substation* is the *interface point (IP)* in the case of a direct connection to the *onshore transmission system* or the *user system interface point (USIP)* in the case of a connection to an onshore *user system*.
- 1.15 The *first onshore substation* may be owned by the *offshore transmission licensee*, the *onshore transmission licensee* or onshore *user system* owner. Ownership boundaries are determined by the relevant *transmission licensees* and/or *distribution licensees* (as the case may be). Normally, and unless otherwise agreed, in the case of there being AC transformation or DC conversion facilities at the *first onshore substation* if the *offshore transmission* owner owns the *first onshore substation*, the *interface point* or *user system interface point* (as the case may be) would be on the HV *busbars*. If the *first onshore substation* is owned by the onshore transmission owner or onshore *user system* owner, the *interface point* or *user system interface point* (as the case may be) would be on the LV *busbars*. In the case of the former, the *first onshore substation* must meet the criteria relating to *offshore transmission systems* and, in the case of the latter the *first onshore substation* must meet the appropriate onshore criteria.
- 1.16 The functional parts of an *offshore transmission system* include:
- the *offshore* connection facilities on the *offshore platform/s*, which may include:
- 1.16.1 the *offshore grid entry point/s (GEP)* at which *offshore power stations* feed into an *offshore transmission system*,
- 1.16.2 any *offshore supply point/s (OSP)* where *offshore power station* demand is supplied from an *offshore transmission system*
- 1.16.3 AC or DC *offshore transmission circuits*
- the cable circuit/s, which may include:
- 1.16.4 AC or DC cable *offshore transmission circuits* connecting an *offshore platform* either directly to an onshore overhead line forming part of the *offshore transmission system* or to onshore connection facilities forming part of the *offshore transmission system*.
- an overhead line section, which may include:
- 1.16.5 AC or DC overhead line *offshore transmission circuits* connecting the cable *offshore transmission circuits* either directly to the *first onshore*

*substation* or to onshore AC transformation or AC/DC conversion facilities not forming part of the *first onshore substation*.

onshore connection facilities, which may include:

1.16.6 AC/DC conversion facilities connecting DC overhead line or DC cable *offshore transmission circuits* to the *interface point* or *user system interface point* (as the case may be). Such facilities may constitute the *first onshore substation*

1.16.7 AC transformation facilities connecting AC overhead line or AC cable *offshore transmission circuits* to the *interface point* or *user system interface point* (as the case may be). Such facilities may constitute the *first onshore substation*.

1.17 The above functional parts of an *offshore transmission system* are illustrated schematically in Figure 1.2. There are many variations to the form of an *offshore transmission system*. Figure 1.2, and Figure 1.3, illustrate just two such examples. The *offshore generator* has the option to connect to an *offshore transmission system* at a voltage level (in that system) of his choosing. Accordingly, the *offshore GEP* can be at a voltage level of the *generator's* choosing and the extent of the *offshore* generation connection criteria would vary accordingly. However, under the default arrangements, the *offshore generator's* circuits cannot be wholly or mainly at a voltage level of 132kV or above since such a combination of circuits would then constitute part of an *offshore transmission system*. Please note that, while Figure 1.2, and subsequent Figure 1.3, have been drawn such that they represent the functional parts of an AC *offshore transmission system*, they are equally representative of the functional parts of a DC *offshore transmission system*.



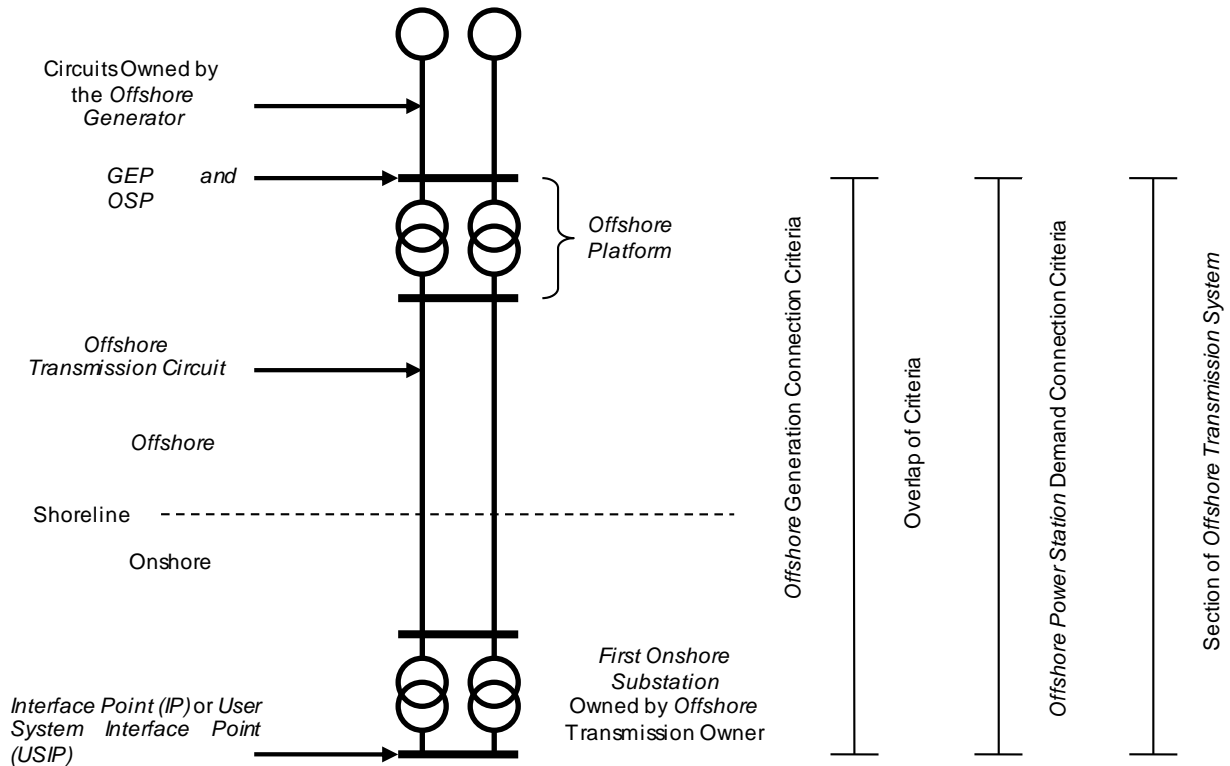

Figure 1.2 An offshore transmission system with a directly connected power station and first onshore substation owned by the offshore transmission owner

1.18 The boundaries between functional parts of an offshore transmission system will vary according to circumstances. In the example illustrated in Figure 1.3, the first onshore substation is owned by the onshore transmission system owner or user system owner. Accordingly, the interface point or user system interface point, as the case may be, would be at the lower voltage side rather than the higher voltage side of the transformers at the first onshore substation. Similarly, the extent of the offshore generation and demand connection criteria also move with the interface point or user system interface point. The first onshore substation forms part of the onshore transmission system or onshore user system as the case may be.

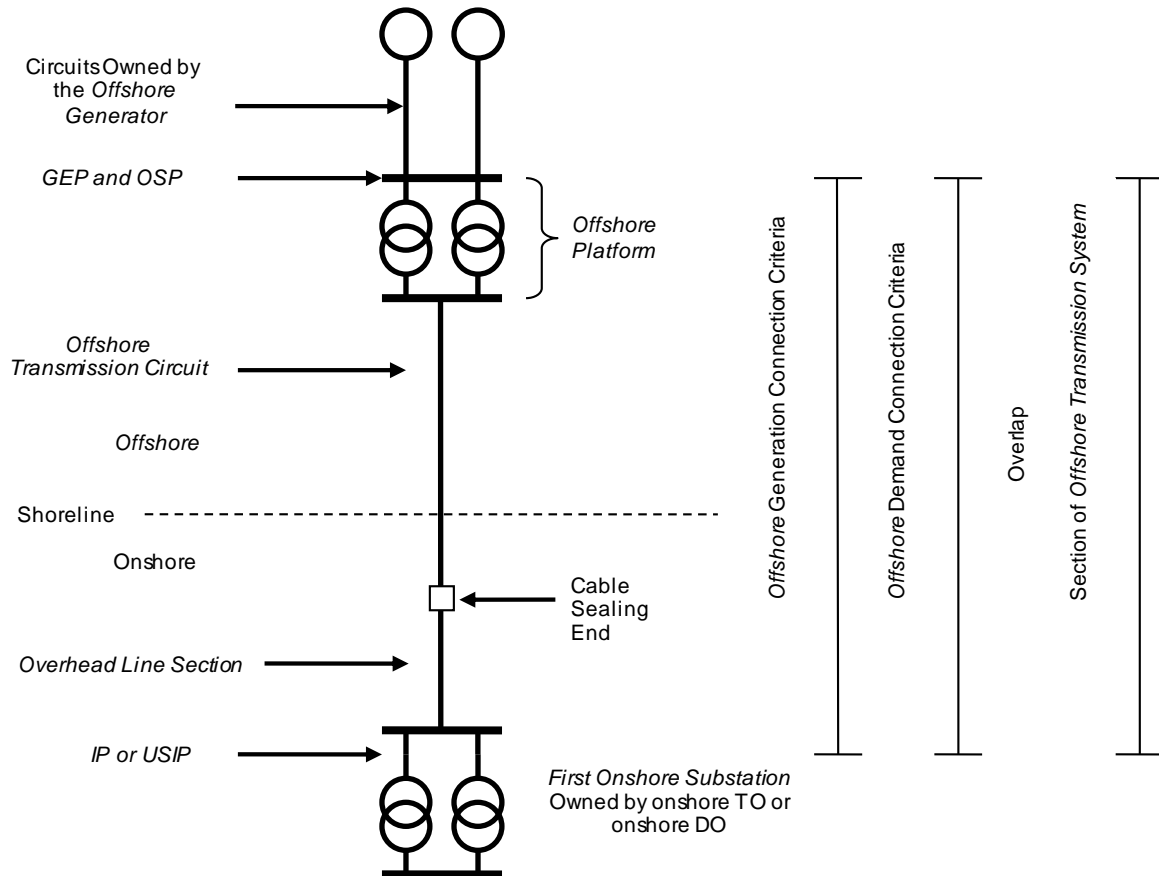

Figure 1.3 The *offshore transmission system* with a directly connected *power station* and *first onshore substation* owned by the onshore TO or onshore DO

- 1.19 The generation connection criteria applicable to an *offshore transmission system* are set out in Section 7 and cover the connections which extend from the *offshore grid entry points (GEP)*, through the *offshore transmission system*, to the *interface point (IP)* or *onshore user system interface point (USIP)*, as the case may be.
- 1.20 The demand connection criteria applicable to an *offshore transmission system* are given in Section 8 and cover the connection of station demand at the *offshore platform*. These criteria extend from the *offshore supply point (OSP)* on the *offshore platform* through the *offshore transmission system* to the onshore *interface point (IP)* or *onshore user system interface point (USIP)*, as the case may be.
- 1.21 The criteria relating to the operation of an *offshore transmission system* are presented in Section 9.
- 1.22 Voltage limits for use in planning and operating an *offshore transmission system* are presented in Section 10.

### **Overlap of Criteria**

1.23 As described above, and illustrated in Figures 1.1, 1.2 and 1.3, there will be parts of the *national electricity transmission system* where more than one set of criteria apply. In such places the requirements of all relevant criteria must be met. Particular examples are:

1.23.1 should an *offshore transmission system* be connected to the onshore *MITS* by two or more *AC offshore transmission circuits* routed to different onshore substations or to separate *busbar* sections at the same onshore substation, those *AC offshore transmission circuits* would parallel the *MITS*. In such cases the onshore criteria would also apply to the relevant sections of the *offshore transmission system*;

1.23.2 where sites are composite and have a mixture of demand connections and generation connections, the security afforded to the block of demand customers shall be not less than that provided for a standard demand connection of an identical size. The applicable security standard should therefore be the more secure of the corresponding criteria of Section 2 or Section 3. Specifically excluded from this category is a generation site with on-site station demand. Such sites shall be treated as a generation site connected to the *onshore transmission system* with appropriate security levels.

## 2. Generation Connection Criteria Applicable to the *Onshore Transmission System*

- 2.1 This section presents the planning criteria applicable to the connection of one or more *power stations* to the *onshore transmission system*. The criteria in this section will also apply to the connections from a GSP to the *onshore transmission system* by which *power stations* embedded within a customer's network (e.g. distribution network) are connected to the *onshore transmission system*.
- 2.2 In those parts of the *onshore transmission system* where the criteria of Section 3 and/or Section 4 also apply, those criteria must also be met.
- 2.3 In planning generation connections, this Standard is met if the connection design either:
- 2.3.1 satisfies the deterministic criteria detailed in paragraphs 2.5 to 2.13; or
  - 2.3.2 varies from the design necessary to meet paragraph 2.3.1 above in a manner which satisfies the conditions detailed in paragraphs 2.15 to 2.18.
- 2.4 It is permissible to design to standards higher than those set out in paragraphs 2.5 to 2.13 provided the higher standards can be economically justified. Guidance on economic justification is given in Appendix G.

### Limits to *Loss of Power Infeed Risks*

- 2.5 For the purpose of applying the criteria of paragraph 2.6, the *loss of power infeed* resulting from a *secured event* on the *onshore transmission system* shall be calculated as follows:
- 2.5.1 the sum of the *registered capacities* of the *generating units* disconnected from the system by a *secured event*, plus
  - 2.5.2 the planned import from any *external systems* disconnected from the system by the same event, less
  - 2.5.3 the *forecast minimum demand* disconnected from the system by the same event but excluding (from the deduction) any demand forming part of the *forecast minimum demand* which may be automatically tripped for system frequency control purposes and excluding (from the deduction) the demand of the largest single end customer.
- 2.6 Generation connections shall be planned such that, starting with an *intact system*, the consequences of *secured events* on the *onshore transmission system* shall be as follows:

- 2.6.1 following a *fault outage* of any single *transmission circuit*, no *loss of power infeed* shall occur;
  - 2.6.2 following the *planned outage* of any single section of *busbar* or mesh corner, no *loss of power infeed* shall occur;
  - 2.6.3 following a *fault outage* of any single *generation circuit* or single section of *busbar* or mesh corner, the *loss of power infeed* shall not exceed the *infrequent infeed loss risk*;
  - 2.6.4 following the concurrent *fault outage* of any two *transmission circuits*, or any two *generation circuits* on the same *double circuit overhead line*, or the *fault outage* of any single *busbar* coupler circuit breaker or *busbar* section circuit breaker or mesh circuit breaker, the *loss of power infeed* shall not exceed the *infrequent infeed loss risk*;
  - 2.6.5 following the *fault outage* of any single *transmission circuit*, single section of *busbar* or mesh corner, during the *planned outage* of any other single *transmission circuit* or single section of *busbar* or mesh corner, the *loss of power infeed* shall not exceed the *infrequent infeed loss risk*;
  - 2.6.6 following the *fault outage* of any single *busbar* coupler circuit breaker or *busbar* section circuit breaker or mesh circuit breaker, during the *planned outage* of any single section of *busbar* or mesh corner, the *loss of power infeed* shall not exceed the *infrequent infeed loss risk*.
- 2.7 The maximum length of overhead line connections in a *generation circuit* for *generating units* which are directly connected to the *onshore transmission system* shall not exceed:
- 2.7.1 5km for *generating units* of expected annual energy output greater than or equal to 2000GWh; otherwise
  - 2.7.2 20km

## Generation Connection Capacity Requirements

### Background conditions

- 2.8 The connection of a particular *power station* shall meet the criteria set out in paragraphs 2.9 to 2.13 under the following background conditions:
- 2.8.1 the active power output of the *power station* shall be set equal to its *registered capacity* or, for the purpose of *Sub-Synchronous Oscillations* studies, that which provides the lowest level of damping for the sub-synchronous mode under consideration;

- 2.8.2 the reactive power output of the *power station* shall be set to the full leading or lagging output that corresponds to an active power output equal to *registered capacity*, or for the purpose of assessment of system stability and voltage control issues, that which may reasonably be expected under the conditions described in paragraph 2.8.4;
- 2.8.3 for connections to an *offshore transmission system*, the reactive power output of the *offshore power station/s* shall normally, and unless otherwise agreed, be set to deliver zero reactive power at the *offshore grid entry point* with active power output equal to *registered capacity*; and the reactive power delivered at the *interface point* shall be set in accordance with the reactive requirements placed on the *offshore transmission licensee* set out in Section K of the STC (System Operator – Transmission Owner Code); and
- 2.8.4 conditions on the *onshore transmission system* shall be set to those which ought reasonably to be expected to arise in the course of a year of operation. Such conditions shall include forecast demand cycles, typical *power station* operating regimes and typical *planned outage* patterns modified where appropriate by the provisions of paragraph 2.11.

#### Pre-fault criteria

- 2.9 The *transmission capacity* for the connection of a *power station* shall be planned such that, for the background conditions described in paragraph 2.8, prior to any fault there shall not be any of the following:
- 2.9.1 equipment loadings exceeding the *pre-fault rating*;
- 2.9.2 voltages outside the *pre-fault planning voltage limits* or *insufficient voltage performance margins*;
- 2.9.3 *system instability*; or
- 2.9.4 *Unacceptable Sub-Synchronous Oscillations*.

#### Post-fault criteria – background condition of no local system outage

- 2.10 The *transmission capacity* for the connection of a *power station* shall also be planned such that for the background conditions described in paragraph 2.8 with no *local system outage* and for the *secured event* of a *fault outage* on the *onshore transmission system* of any of the following:
- 2.10.1 a single *transmission circuit*, a single *generation circuit*, a single *generating unit* (or several *generating units* sharing a common circuit breaker), a single *Power Park Module*, or a single *DC converter*, a reactive compensator or other reactive power provider;

- 2.10.2 a *double circuit overhead line* on the *supergrid*;
- 2.10.3 a *double circuit overhead line* where any part of either circuit is in *NGET's transmission system* or *SHET's transmission system*;
- 2.10.4 a single *transmission circuit* with the prior outage of another *transmission circuit*;
- 2.10.5 a section of *busbar* or mesh corner; or
- 2.10.6 a single *transmission circuit* with the prior outage of a *generation circuit*, *generating unit* (or several *generating units*, sharing a common circuit breaker, that cannot be separately isolated), a *Power Park Module*, a *DC converter*, a reactive compensator or other reactive power provider , or;
- 2.10.7 a single *generation circuit*, a single *generating unit* (or several *generating units*, sharing a common circuit breaker), a single *Power Park Module*, a single *DC converter*, a reactive compensator or other reactive power provider with the prior outage of a single *transmission circuit*

there shall not be any of the following:

- 2.10.8 a *loss of supply capacity* except as permitted by the demand connection criteria detailed in Section 3;
  - 2.10.9 unacceptable overloading of any primary transmission equipment;
  - 2.10.10 unacceptable voltage conditions or insufficient voltage performance margins;
  - 2.10.11 system instability; or
  - 2.10.12 *Unacceptable Sub-Synchronous Oscillations*.
- 2.11 Under *planned outage* conditions it shall be assumed that the prior circuit outage specified in paragraphs 2.10.3, 2.10.5 and 2.10.6 reasonably forms part of the typical outage pattern referred to in paragraph 2.8.4 rather than in addition to that typical outage pattern.

Post-fault criteria – background condition with a *local system outage*

- 2.12 The *transmission capacity* for the connection of a *power station* shall also be planned such that for the background conditions described in paragraph 2.8 with a *local system outage* on the *onshore transmission system*, the operational security criteria set out in Section 5 and Section 9 can be met.

- 2.13 Where necessary to satisfy the criteria set out in paragraph 2.12, investment should be made in *transmission capacity* except where operational measures suffice to meet the criteria in paragraph 2.12 provided that maintenance access for each *transmission circuit* can be achieved and provided that such measures are economically justified. The operational measures to be considered include rearrangement of transmission outages and appropriate reselection of *generating units* from those expected to be available, for example through *balancing services*. Guidance on economic justification is given in Appendix G.

### Switching Arrangements

- 2.14 Guidance on substation configurations and switching arrangements are described in Appendix A. These guidelines provide an acceptable way towards meeting the criteria of paragraph 2.6. However, other configurations and switching arrangements which meet those criteria are also acceptable.

### Variations to Connection Designs

- 2.15 Variations, arising from a generation customer's request, to the generation connection design necessary to meet the requirements of paragraphs 2.5 to 2.14 shall also satisfy the requirements of this Standard provided that the varied design satisfies the conditions set out in paragraphs 2.16.1 to 2.16.3. For example, such a generation connection design variation may be used to take account of the particular characteristics of a *power station*.
- 2.16 Any generation connection design variation must not, other than in respect of the generation customer requesting the variation, either immediately or in the foreseeable future:
- 2.16.1 reduce the security of the *MTS* to below the minimum planning criteria specified in Section 4; or
  - 2.16.2 result in additional investment or operational costs to any particular customer or overall, or a reduction in the security and quality of supply of the affected customers' connections to below the planning criteria in this section or Section 3, unless specific agreements are reached with affected customers; or
  - 2.16.3 compromise any *transmission licensee's* ability to meet other statutory obligations or licence obligations.
- 2.17 Should system conditions subsequently change, for example due to the proposed connection of a new customer, such that either immediately or in the foreseeable future, the conditions set out in paragraphs 2.16.1 to 2.16.3 are no longer satisfied, then alternative arrangements and/or agreements must be put in place such that this Standard continues to be satisfied.
- 2.18 The additional operational costs referred to in paragraph 2.16.2 and/or any potential reliability implications shall be calculated by simulating the expected operation of the *national electricity transmission system* in accordance with the



operational criteria set out in Section 5 and Section 9. Guidance on economic justification is given in Appendix G.

### **3. Demand Connection Criteria Applicable to the *Onshore Transmission System***

- 3.1 This section presents the planning criteria for the connection of *demand groups* to the remainder of the *onshore transmission system*.
- 3.2 In those parts of the *onshore transmission system* where the criteria of Section 2 and/or Section 4 also apply, those criteria must also be met.
- 3.3 In planning demand connections, this standard is met if the connection design either:
  - 3.3.1 satisfies the deterministic criteria detailed in paragraphs 3.5 to 3.12; or
  - 3.3.2 varies from the design necessary to meet paragraph 3.3.1 above in a manner which satisfies the conditions detailed in paragraphs 3.17 to 3.20.
- 3.4 It is permissible to design to standards higher than those set out in paragraphs 3.5 to 3.12 provided the higher standards can be economically justified. Guidance on economic justification is given in Appendix G.

#### **Demand Connection Capacity Requirements**

- 3.5 The *group demand* which is applicable for the assessment of connection capacity requirements is dependent on the nature of the associated connections, i.e.:
  - 3.5.1 where the network associated with a transmission connection comprises demand connections and connections to *small or medium power stations* (including those in composite-user sites), *group demand* for future years is equal to the *Network Operator's* estimated maximum demand for the group which they believe could reasonably be imposed on the *onshore transmission system*, after taking due cognisance of demand diversity and the expected operation of any embedded *small or medium power stations*.
  - 3.5.2 where the network associated with a transmission connection hosts the connection of one or more *large power stations*, irrespective of whether the *large power station* is connected at the transmission interface point or embedded within the *Network Operator's* system, the *group demand* at the date and time of the system/site maximum demand or other relevant assessment period is equal to:
    - 3.5.2.1 the *Network Operator's group demand* in accordance with paragraph 3.5.1, plus:
    - 3.5.2.2 the output of *large power station(s)*
- 3.6 Where considered appropriate, diversity may be applied to the summation of the power flows arising from consideration of paragraphs 3.5.2.1 and 3.5.2.2

- 3.7 The *transmission capacity* for the connection of a particular *demand group* shall meet the criteria set out in paragraphs 3.7 to 3.11 under the following background conditions:
- 3.7.1 when there are no *planned outages*, the demand of the *demand group* shall be set equal to *group demand*;
  - 3.7.2 when there is a *planned outage* local to the *demand group*, the demand of the *demand group* shall be set equal to *maintenance period demand*;
  - 3.7.3 the security contribution of *small and medium power stations* embedded is implicitly accounted for in the group demand established by the Network Operator as in paragraph 3.5.1 and need not be considered separately;
  - 3.7.4 the security contribution of a *large power station* embedded within a customer's network (e.g. distribution network) or connected at the transmission interface point shall be as specified in paragraphs 3.13 to 3.15 and Table 3.2;
  - 3.7.5 any *transfer capacity* (i.e. the ability to transfer demand from one demand group to another) declared by *Network Operators* shall be represented taking account of any restrictions on the timescales in which the *transfer capacity* applies. Any *transfer capacity* declared by the *Network Operators* for use in planning timescales must be reflective of that which could practically be used in operational timescales; and
  - 3.7.6 demand and generation outside the *demand group* shall be set in accordance with the *planned transfer conditions* using the appropriate method described in Appendix C.
- 3.8 The *transmission capacity* for the connection of a *demand group* shall be planned such that, for the background conditions described in paragraph 3.7, under intact system conditions there shall not be any of the following:
- 3.8.1 equipment loadings exceeding the *pre-fault rating*;
  - 3.8.2 voltages outside the *pre-fault planning voltage limits* or *insufficient voltage performance margins*; or
  - 3.8.3 *system instability*
- 3.9 The *transmission capacity* for the connection of a *demand group* shall also be planned such that for the background conditions described in paragraph 3.7 and for the *planned outage* of a single *transmission circuit* or a single section of *busbar* or mesh corner, there shall not be any of the following:
- 3.9.1 a *loss of supply capacity* for a *group demand* of greater than 1MW;
  - 3.9.2 unacceptable overloading of any primary transmission equipment;
  - 3.9.3 voltages outside the pre-fault planning voltage limits or insufficient voltage performance margins; or

- 3.9.4 *system instability*
- 3.10 The *transmission capacity* for the connection of a *demand group* shall also be planned such that for the background conditions described in paragraph 3.7 and the initial conditions of:
- 3.10.1 an *intact system condition*; or
- 3.10.2 the single *planned outage* of another *transmission circuit*, a *generation circuit*, a *generating unit* (or several *generating units*, sharing a common circuit breaker, that cannot be separately isolated), a *power park module*, a *DC converter*, a reactive compensator or other reactive power provider,
- for the *secured event* of a *fault outage* of:
- 3.10.3 a single *transmission circuit*,
- 3.10.4 a single *generation circuit*, a single *generating unit* (or several *generating units* sharing a common circuit breaker), *power park module* or a *DC converter*,
- there shall not be any of the following:
- 3.10.5 a *loss of supply capacity* such that the provisions set out in Table 3.1 are not met;
- 3.10.6 *unacceptable overloading* of any *primary transmission equipment*;
- 3.10.7 *unacceptable voltage conditions* or *insufficient voltage performance margins*; or
- 3.10.8 *system instability*
- 3.11 In addition to the requirements of paragraphs 3.7 to 3.9 for the background conditions described in paragraph 3.7, the system shall also be planned such that:
- 3.11.1 *operational switching* or *infrequent operational switching* shall not cause *unacceptable voltage conditions*
- 3.12 For a *secured event* on connections to more than one *demand group*, the permitted *loss of supply capacity* for that *secured event* is the maximum of the permitted *loss of supply capacities* set out in Table 3.1 for each of these *demand groups*.

Table 3.1 Minimum Planning Supply Capacity Following *Secured Events*

Class	Group Demand	Initial System Conditions
-------	--------------	---------------------------

	Minimum	Maximum	Intact System	With Single <i>Planned Outage</i> <sup>Note 1</sup>
A	0	≤1 MW	<b>In repair time</b> <i>Group Demand</i>	Nil
B	>1 MW	≤12 MW	<b>Within 3 hours</b> <i>Group Demand</i> minus 1MW  <b>In repair time</b> <i>Group Demand</i>	Nil
C	>12 MW	≤60 MW	<b>Within 15 minutes</b> Smaller of ( <i>Group Demand</i> minus 12MW) and two-thirds of <i>Group Demand</i>  <b>Within 3 hours</b> <i>Group Demand</i>	Nil
D	>60 MW	≤300 MW	<b>Immediately</b> <i>Group Demand</i> minus 20MW <sup>Note 2</sup>  <b>Within 3 hours</b> <i>Group Demand</i>	<b>Within 3 hours</b> Smaller of ( <i>Group Demand</i> minus 100MW) and one-third of <i>Group Demand</i>  <b>Within time to restore planned outage</b> <i>Group Demand</i>
E	>300 MW	≤1500 MW	<b>Immediately</b> <i>Group Demand</i> <sup>Note 3</sup>	<b>Immediately</b> <i>Maintenance Period Demand</i>  <b>Within time to restore planned outage</b> <i>Group Demand</i>
F	>1500 MW	∞	<b>Immediately</b> <i>Group Demand</i>	<b>Immediately</b> <i>Group Demand</i>

## Assessment of Contribution to Security from Generation

Note 1 The planned outage may be of a transmission circuit, generation circuit, generating unit, reactive compensator or other reactive power provider

Note 2 The group demand may be lost for up to 60 seconds if this leads to significant economies

Note 3 Up to 60MW may be lost for up to 60 seconds if this leads to significant economies

- 3.13 Where network assets are insufficient to meet the security requirements, it is necessary to assess the contribution to security from *large power stations* connected at either the transmission connection interface or embedded within the *Networks Operator's* system. This will identify whether the aggregate generation capacity of the *large power station* connected to the network has the potential to meet any deficit in system security from network assets.
- 3.14 The combined contribution by *large power stations* shall never have a greater impact on system security than the loss of the largest circuit infeed to the group. The contributions from embedded *small* and *medium power stations* provide additional capacity to enable the supply of demand which may not otherwise be met following a *secured event*, but shall not replace the requirement for system connection. The assessment of contribution of generation to group security will therefore consider;
- 3.14.1 the generation *annual load factor*;
  - 3.14.2 the availability of generation under outage conditions;
  - 3.14.3 the fuel source availability, i.e. whether energy is continuous, stored, storable or predictable;
  - 3.14.4 common-mode failure mechanisms such as common fuel source, connections or plant stability / ride-through capability;
  - 3.14.5 capping of generation contribution in the event that the generation contribution is dominant with respect to circuit infeed capability
- 3.15 The effective contribution of *large power stations* to *demand group* importing capacity, shall not exceed the levels indicated in Table 3.2 while taking due account of the considerations detailed in paragraph 3.13.

Table 3.2 Effective contribution of embedded *large power stations* to *demand group* importing capacity in *NGET's transmission system*

Expected <i>annual load factor</i> of generation	Initial system conditions	
	<i>Intact system</i>	with single <i>Planned Outage</i>
Over 30%	67% of <i>Registered Capacity</i>	<b>For demand groups greater than 60MW only</b> 67% of <i>Registered Capacity</i>
Over 10% to 30%	Smaller of 67% of <i>Registered Capacity</i> and 20% of <i>Group Demand</i>	<b>For demand groups greater than 300MW only</b> Smaller of 67% of <i>Registered Capacity</i> and 13% of <i>Group Demand</i>
up to 10%	Smaller of 67% of <i>Registered Capacity</i> and 10% of <i>Group Demand</i>	<b>For demand groups greater than 300MW only</b> Smaller of 67% of <i>Registered Capacity</i> and 7% of <i>Group Demand</i>

## Switching Arrangements

- 3.16 Guidance on substation configurations and switching arrangements are described in Appendix A. These guidelines provide an acceptable way towards

meeting the criteria of this chapter. However, other configurations and switching arrangements which meet the criteria are also acceptable.

### Variations to Connection Designs

- 3.17 Variations, arising from a demand customers request, to the demand connection design necessary to meet the requirements of paragraphs 3.5 to 3.12 shall also satisfy the requirements of this standard provided that the varied design satisfies the conditions set out in paragraphs 3.18.1 to 3.18.3. For example, such a demand connection design variation may be used to reflect the nature of connection of embedded generation or particular load cycles.
- 3.18 Any demand connections design variation must not, other than in respect of the demand customer requesting the variation, either immediately or in the foreseeable future:
- 3.18.1 reduce the security of the *MITS* to below the minimum planning criteria specified in Section 4; or
  - 3.18.2 result in additional investment or operational costs to any particular customer or overall, or a reduction in the security and quality of supply of the affected customers' connections to below the planning criteria in the section or Section 2, unless specific agreements are reached with affected customers; or
  - 3.18.3 compromise any *transmission licensee's* ability to meet other statutory obligations or license obligations.
- 3.19 Should system conditions change, for example due to the proposed connection of a new customer, such that either immediately or in the foreseeable future, the conditions set out in paragraphs 3.18.1 to 3.18.3 are no longer satisfied, then alternative arrangements and/or agreements must be put in place such that this standard continues to be satisfied.
- 3.20 The additional operational costs referred to in paragraph 3.18.2 and/or any potential reliability implications shall be calculated by simulating the expected operation of the *onshore transmission system* in accordance with the operational criteria set out in Section 5 and Section 9. Guidance on economic justification is given in Appendix G.

## 4. Design of the *Main Interconnected Transmission System*

- 4.1 This section presents the planning criteria for the *Main Interconnected Transmission System (MITS)*.
- 4.2 In those parts of the *onshore transmission system* where the criteria of Section 2 and/or Section 3 also apply, those criteria must also be met. In those parts of the *offshore transmission system* where the criteria of Section 7 and/or Section 8 also apply, those criteria must also be met.
- 4.3 In planning the *MITS*, this Standard is met if the design satisfies the minimum deterministic criteria detailed in paragraphs 4.4 to 4.12. It is permissible to design to standards higher than those set out in paragraphs 4.4 to 4.12 provided the higher standards can be economically justified. Guidance on economic justification is given in Appendix G.

### Minimum *Transmission Capacity Requirements*

#### At ACS peak demand with an intact system

- 4.4 The *MITS* shall meet the criteria set out in paragraphs 4.5 to 4.6 under both the Security and Economy background conditions below:

#### Security Background

- 4.4.1 *generating units'* outputs shall be set to those arising from the *security planned transfer condition* described in Appendix C;
- 4.4.2 power flows shall be set to those arising from the *security planned transfer condition* (using the appropriate method described in Appendix C) prior to any fault, and such power flows modified by an appropriate application of the *interconnection allowance* (using the methods described in Appendix D) under *secured events*;

#### Economy Background

- 4.4.3 *generating units'* outputs shall be set to those arising from the *economy planned transfer condition* described in Appendix E;
- 4.4.4 power flows shall be set to those arising from the *economy planned transfer condition* (using the appropriate method described in Appendix E) prior to any fault, and such power flows modified by an appropriate application of the *boundary allowance* (using the methods described in Appendix F) under *secured events*;

#### Security and Economy Backgrounds

- 4.4.5 sensitivity cases on the conditions described in 4.4.2 and 4.4.4 shall comprise *generating units* with output equal to their *registered capacities* such that the required power transfers described in 4.4.2 and 4.4.4 above are approximated by selection of individual units; and



- 4.4.6 the expected availability of generation reactive capability shall be set to that which ought reasonably to be expected to arise. This shall take into account the variation of reactive capability with the active power output (for example, as defined in the machine performance chart). In the absence of better data the expected available capability shall not exceed 90% of the Grid Code specified capability, (unless modified by a direction of the *Authority*) or 90% of the contracted capability for the active power output level, whichever is relevant.
- 4.5 The minimum *transmission capacity* of the *MITS* shall be planned such that, for the background conditions described in paragraph 4.4, prior to any fault there shall not be:
- 4.5.1 equipment loadings exceeding the *pre-fault rating*;
  - 4.5.2 voltages outside the *pre-fault planning voltage limits* or *insufficient voltage performance margins*;
  - 4.5.3 *system instability*; or
  - 4.5.4 *Unacceptable Sub-Synchronous Oscillations*.
- 4.6 The minimum *transmission capacity* of the *MITS* shall also be planned such that for the conditions described in paragraph 4.4 and for the *secured event* of a *fault outage* of any of the following:
- 4.6.1 a single *transmission circuit*, a reactive compensator or other reactive power provider;
  - 4.6.2 a single *generation circuit*, a single *generating unit* (or several *generating units* sharing a common circuit breaker), a single *power park module*, or a single *DC converter*;
  - 4.6.3 a double circuit overhead line on the supergrid;
  - 4.6.4 a double circuit overhead line where any part of either circuit is in *NGET's* transmission system or *SHET'S* transmission system;
  - 4.6.5 a section of *busbar* or mesh corner; or
  - 4.6.6 provided both the *fault outage* and prior outage involve plant that is wholly in *NGET's* transmission area, any single *transmission circuit* with the prior outage of another *transmission circuit* containing either a transformer in series or a cable section located wholly or mainly outside a substation, or a *generating unit* (or several *generating units*, sharing a common circuit breaker, that cannot be separately isolated), reactive compensator or other reactive power provider,
- there shall not be any of the following:
- 4.6.7 *loss of supply capacity* (except as permitted by the demand connection criteria detailed in Section 3 and Section 8);
  - 4.6.8 *unacceptable overloading* of any *primary transmission equipment*;

- 4.6.9 *unacceptable voltage conditions or insufficient voltage performance margins;*
- 4.6.10 *system instability; or*
- 4.6.11 *Unacceptable Sub-Synchronous Oscillations*

Under conditions in the course of a year of operation

- 4.7 The *MITS* shall meet the criteria set out in paragraphs 4.8 to 4.10 under the following background conditions:
  - 4.7.1 conditions on the *national electricity transmission system* shall be set to those which ought reasonably to be foreseen to arise in the course of a year of operation. Such conditions shall include forecast demand cycles, typical *power station* operating regimes and typical *planned outage* patterns; and
  - 4.7.2 the expected availability of generation reactive capability shall be set to that which ought reasonably to be expected to arise. This shall take into account the variation of reactive capability with the active power output (for example, as defined in the machine performance chart). In the absence of better data the expected available capability shall not exceed 90% of the Grid Code specified capability, (unless modified by a direction of the *Authority*) or 90% of the contracted capability for the active power output level, whichever is relevant.
- 4.8 The minimum *transmission capacity* of the *MITS* shall be planned such that, for the background conditions described in paragraph 4.7, prior to any fault there shall not be:
  - 4.8.1 equipment loadings exceeding the *pre-fault rating*;
  - 4.8.2 voltages outside the *pre-fault planning voltage limits* or *insufficient voltage performance margins*;
  - 4.8.3 *system instability; or*
  - 4.8.4 *Unacceptable Sub-Synchronous Oscillations.*
- 4.9 The minimum *transmission capacity* of the *MITS* shall also be planned such that, for the background conditions described in paragraph 4.7, the operational security criteria set out in Section 5 can be met.
- 4.10 Where necessary to satisfy the criteria set out in paragraphs 4.8 and 4.9, investment should be made in *transmission capacity* except where operational measures suffice to meet the criteria in paragraphs 4.8 and 4.9 provided that maintenance access for each *transmission circuit* can be achieved and provided that such measures are economically justified. The operational measures to be considered include rearrangement of transmission outages and appropriate reselection of *generating units* from those expected to be available, for example through *balancing services*. Guidance on economic justification is given in Appendix G.

## General Criteria

- 4.11 In addition to the requirements set out in paragraphs 4.4 to 4.10, the system shall also be planned such that:
- 4.11.1 *operational switching or infrequent operational switching shall not cause unacceptable voltage conditions,*
- 4.12 *Transmission circuits* comprising the *supergrid* part of the *MITS* shall not exceed the circuit complexity limit defined in paragraphs B.3 to B.7 of Appendix B.
- 4.13 Guidance on complexity of *transmission circuits* on the *MITS* operated at a nominal voltage of 132kV is given in paragraphs B.8 to B.13 of Appendix B. Relaxation of the restrictions cited in paragraphs B.8 to B.13 may be justified in certain circumstances following appropriate liaison between the relevant *transmission licensees* responsible for the design of the circuits and their operation.

## Switching Arrangements

- 4.14 Guidance on substation configurations and switching arrangements are described in Appendix A. These guidelines provide an acceptable way towards meeting the criteria of this section. However, other configurations and switching arrangements which meet the criteria are also acceptable.

## 5. Operation of the Onshore Transmission System

### Normal Operational Criteria

5.1 The *onshore transmission system* shall be operated under *prevailing system conditions* so that for the *secured event* of a *fault outage* on the *onshore transmission system* of any of the following:

5.1.1 a single *transmission circuit*, a reactive compensator or other reactive power provider; or

5.1.2 a single *generation circuit*, a single *generating unit* (or several *generating units* sharing a common circuit breaker), a single *power park module*, or a single *DC converter*; or

5.1.3 the most onerous *loss of power infeed*; or

5.1.4 5.1.4 the most onerous *loss of power outfeed*; or

5.1.5 5.1.5 where the system is designed to be secure against a *fault outage* of a section of *busbar* or mesh corner under *planned outage* conditions, a section of *busbar* or mesh corner,

there shall not be any of the following:

5.1.6 5.1.6 a *loss of supply capacity* except as specified in Table 5.1

5.1.7 5.1.7 unacceptable frequency conditions;

5.1.8 5.1.8 unacceptable overloading of any primary transmission equipment;

5.1.9 5.1.9 unacceptable voltage conditions;

5.1.10 5.1.10 *system instability*; or

5.1.11 5.1.11 *Unacceptable Sub-Synchronous Oscillations*.

5.2 For a *secured event* on the *onshore transmission system* on connections to more than one *demand group* the permitted *loss of supply capacity* for that *secured event* is the maximum of the permitted loss of supply capacities set out in Table 5.1 for each of these *demand groups*.

5.3 The *onshore transmission system* shall be operated under *prevailing system conditions* so that for the *secured event* on the *onshore transmission system* of a *fault outage* of:

5.3.1 a *double circuit overhead line*; or

5.3.2 a section of *busbar* or mesh corner,

there shall not be any of the following:

5.3.3 a *loss of supply capacity* greater than 1500 MW;

- 5.3.4 *unacceptable frequency conditions;*
  - 5.3.5 *unacceptable voltage conditions affecting one or more Grid Supply Points for which the total group demand is greater than 1500 MW;*
  - 5.3.6 *system instability of one or more generating units connected to the supergrid; or*
  - 5.3.7 *Unacceptable Sub-Synchronous Oscillations.*
- 5.4 The *onshore transmission system* shall be operated under *prevailing system conditions* so that for the *secured event* on the *supergrid* of a *fault outage* of:
- 5.4.1 *a double circuit overhead line where any part of either circuit is in NGET's transmission system; or*
  - 5.4.2 *a section of busbar or mesh corner in NGET's transmission system,*  
  
*there shall not be:*
  - 5.4.3 *unacceptable overloading of primary transmission equipment in NGET's transmission system;*
  - 5.4.4 *unacceptable voltage conditions in NGET's transmission system.*

Table 5.1 Maximum permitted *loss of supply capacity* following *secured events*

<i>Group Demand</i>	<i>Initial system conditions</i>	
	<i>Prevailing system conditions with no local system outage</i> <b>Note 1,2</b>	<i>Prevailing system conditions with a local system outage</i> <b>Note 1</b>
over 1500 MW	None	None <b>Note 3</b>
over 300 MW to 1500 MW	None <b>Note 4</b>	None <b>Note 3</b>
over 60 MW to 300 MW	None except that where such facilities and suitable measures for restoration are available, up to 20 MW by automatic disconnection <b>Note 5</b>	Whole group up to <i>Group Demand</i> for up to the operational specified time to restore supply capacity
over 12 MW to 60 MW	None except that where such facilities and suitable measures for restoration are available, up to 12 MW by automatic disconnection for up to 15 minutes.	Whole group up to <i>Group Demand</i>
over 1 MW to 12 MW	Whole group up to <i>Group Demand</i> for up to the operational specified time to restore supply capacity	Whole group up to <i>Group Demand</i>
up to 1 MW	Whole group up to <i>Group Demand</i> for up to the operational specified time to restore supply capacity	Whole group up to <i>Group Demand</i>

--	--	--

## Notes

1. The time to restore any lost supply capacity shall be as short as practicable. If any part of any lost supply capacity can be restored in less than the specified maximum time to restore all of it, it shall be restored.
2. Where the supply capacity was designed in such a way, there should be no *loss of supply capacity*.
3. Where the supply capacity to the *Grid Supply Point* was designed in accordance with the demand connection criteria in Section 3 in such a way as to permit it, a *loss of supply capacity* equal to any amount by which the prevailing demand exceeds the *maintenance period demand* may be permitted up to a maximum of 1500 MW for no longer than the operational specified time to restore supply capacity.
4. Where the supply capacity to the *Grid Supply Point* was designed in accordance with the demand connection criteria in Section 3 in such a way as to permit it, up to 60 MW may be lost for up to 60 seconds.
5. Where the supply capacity to the *Grid Supply Point* was designed in accordance with the demand connection criteria in Section 3 in such a way as to permit it, up to the *group demand* may be lost for up to 60 seconds.

## Conditional Further Operational Criteria

### 5.5 If:

5.5.1 there are *adverse conditions* such that the likelihood of a *double circuit overhead line* fault is significantly higher than normal; or

5.5.2 there is no significant economic justification for failing to secure the *onshore transmission system* to this criterion and the probability of *loss of supply capacity* is not increased by following this criterion,

the *onshore transmission system* shall be operated under *prevailing system conditions* so that for the *secured event of*

5.5.3 a *fault outage* on the *supergrid* of a *double circuit overhead line*

there shall not be:

5.5.4 where possible and there is no significant economic penalty, any *loss of supply capacity* greater than 300 MW;

5.5.5 *unacceptable overloading* of any *primary transmission equipment*;

5.5.6 *unacceptable voltage conditions*;

5.5.7 *system instability*; or

5.5.8 *Unacceptable Sub-Synchronous Oscillations*.

5.6 During periods of *major system risk*, NGE SO may implement measures to mitigate the consequences of this risk. Such measures may include: providing additional reserve; reducing system-to-*generator* intertrip risks, securing as far as possible appropriate two-circuit combinations, or reducing system transfers, for example through *balancing services*.

**5.7** In the case that neither of the conditions in paragraphs 5.5.1 and 5.5.2 is met, it is acceptable to utilise short term post fault actions to avoid *unacceptable overloading* of *primary transmission equipment* which may include a

requirement for demand reduction; however, this will not be used as a method of increasing reserve to cover abnormal post fault generation reduction. Where possible these post fault actions shall be notified to the appropriate *Network Operator* or *Generator*. Normally the provisions of the Grid Code, in respect of Emergency Manual Demand Disconnection and/or, for example through *balancing services*, will be applied. Additional post fault actions beyond the Grid Code provisions may be applied, but only where they have been agreed in advance with the appropriate *Network Operator* or *Generator*.

5.75.8 NGESO shall use the latest version of the *Frequency Risk and Control Report* as consulted on and approved by the Authority to determine the events for which unacceptable frequency conditions shall not occur. The *Frequency Risk and Control Report* assessment includes consideration of any consequential loss of distributed energy resources associated with any such event.

### **Post-fault Restoration of System Security**

5.85.9 Following the occurrence of a *secured event* on the *onshore transmission system*, measures shall be taken to re-secure the system to the above operational criteria as soon as reasonably practicable. To this end, it is permissible to put operational measures in place pre-fault to facilitate the speedy restoration of system security.

### **Authorised Variations from the Operational Criteria**

5.95.10 \_\_\_\_\_ Provided it is in accordance with the appropriate requirements of the demand connection criteria in Section 3, there may be associated *loss of supply capacity* due to a *secured event*, for example by virtue of the design of the generation connections and/or the designed switching arrangements at the substations concerned.

5.11 \_\_\_\_\_ Exceptions to the criteria in paragraphs 5.1 to 5.87 and 5.9 may be required:

5.11.1 -where variations to the connection designs as per paragraphs 3.12 to 3.15 have been agreed; or-

5.9.15.11.2 \_\_\_\_\_ in relation to 5.1.7 and 5.3.4 only, based on the outcome of an assessment conducted in accordance with the *Frequency Risk and Control Report*.

5.405.12 \_\_\_\_\_ The principles of these operational criteria shall be applied at all times except in special circumstances where NGESO, following consultation with the appropriate *Network Operator*, *Generator* or *Non-Embedded Customer*, may need to give instructions to the contrary to preserve overall system integrity.

## 6. Voltage Limits in Planning and Operating the *Onshore Transmission System*

### Voltage and Voltage Performance Margins in Planning Timescales

6.1. A voltage condition is unacceptable in planning timescales if:

6.1.1. There is any inability to achieve pre-fault steady-state voltages as specified in Table 6.1 at *onshore transmission system* substations or *GSPs*,

or

6.1.2. if, after either:

6.1.2.1. a *secured event*,

or

6.1.2.2. *operational switching*,

and the affected site remains directly connected to the *onshore transmission system* in the *steady state* after the relevant event above, any of the following conditions applies:

6.1.2.3. the *voltage step change* at an interface between the *onshore transmission system* and a *User System* exceeds that specified in Table 6.5

or

6.1.2.4. there is any inability following such an event to achieve a *steady state* voltage as specified in Table 6.2 at *onshore transmission system* substations or *GSPs* using manual and/or automatic facilities available, including the switching in or out of relevant equipment,

or

6.1.3. if, pre-fault, or after either:

6.1.3.1. a *secured event*,

or

6.1.3.2. *operational switching*

there are *insufficient voltage performance margins*, as evidenced by:

- i) *voltage collapse*;
- ii) over-sensitivity of system voltage; or
- iii) unavoidably exceeding the continuous reactive capability expected to be available from *generating units* or other reactive sources, so that accessible reactive reserves are exhausted;

under any of the following conditions:

- i) credible demand sensitivities;



- ii) the unavailability of any single reactive compensator or other reactive power provider; or
- iii) the loss of any one automatic switching system or any automatic voltage control system for on-load tap changing.

6.2. The *steady state* voltages are to be achieved without widespread post-fault re-dispatch of *generating unit* reactive output or changes to set-points of SVCs or automatic reactive switching schemes and without exceeding the available reactive capability of generation or SVCs. In particular, following a *secured event*, the target voltages at Grid Supply Points should be achieved after the operation of local reactive switching and auto-switching schemes, and after the operation of Grid Supply Transformer tap-changers.

6.3. The *pre-fault planning voltage limits* and targets on the *onshore transmission system* are as shown in Table 6.1.

Table 6.1: Pre-Fault Steady State Voltage Limits and Requirements in Planning Timescales

<b>(a) Voltage Limits on Transmission Networks</b>			
Nominal Voltage	<u>PU Value (1pu relates to the Nominal Voltage)</u>	<u>Minimum (percentage of Nominal Voltage)</u> <b>(Note 1)</b>	<u>Maximum (percentage of Nominal Voltage)</u>
<u>Greater than 300kV/400kV</u>	<u>0.975pu-1.025pu</u>	<del>-2.5% 390kV (97.5%)</del>	<del>+2.5% 410kV (102.5%)</del> <b>Note 2</b>
<u>200kV up to and including 300kV/275kV</u>	<u>0.95pu-1.05pu</u>	<del>-5% 261kV (95%)</del>	<del>+5% 289kV (105%)</del>
<del>132kV up to and including 200kV</del>	<u>0.95pu-1.05pu</u>	<del>-5% 125kV (95%)</del>	<del>+5% 139kV (105%)</del>
<b>(b) Voltages to be Achievable at -Interfaces to Distribution Networks <u>and Non-Embedded Customers</u></b>			
Any <u>Nominal Voltage</u>	<u>1.05pu 105%</u> at forecast <i>Group Demand</i> ; <u>1.00pu 100%</u> at forecast <i>Minimum Demand</i> , or as otherwise agreed with the relevant Network Operator <u>or Non-Embedded Customer</u>		

**Notes**

1. It is permissible to relax these to the limits specified in Table 6.2 if:
  - (i) following a *secured event*, the voltage limits specified in Table 6.2 can be achieved, and
  - (ii) there is judged to be sufficient certainty of meeting Security and Quality of Supply Standards in operational timescales.
2. It is permissible to relax this to ~~420kV (105%) of the nominal voltage~~ if there is judged to be sufficient certainty that the limit of ~~420kV (105%) of the nominal voltage~~ can be met in operational timescales.

6.4. The voltage limits in Table 6.2 are to be observed following any *secured event*.

Table 6.2 Steady State Voltage Limits and Requirements in Planning Timescales

<b>(a) Voltage Limits on Transmission Networks</b>			
Nominal Voltage	<u>PU Value (1pu relates to the Nominal Voltage)</u>	Minimum <u>(percentage of Nominal Voltage)</u>	Maximum <u>(percentage of Nominal Voltage)</u>
<u>Greater than 300kV/400kV</u>	<u>0.95pu-1.025pu</u>	<del>-5%</del> <u>380kV (95%)</u> <b>Note 3</b>	<u>+2.5%</u> <u>410kV (102.5%)</u> <b>Note 4</b>
<u>200kV up to and including 300kV/275kV</u>	<u>0.90pu-1.05pu</u>	<del>-10%</del> <u>248kV (90%)</u>	<del>+5%</del> <u>289kV (105%)</u>
<u>132kV up to and including 200kV</u>	<u>0.90pu-1.05pu</u>	<del>-10%</del> <u>119kV (90%)</u>	<del>+5%</del> <u>139kV (105%)</u>
<b>(b) Voltage Limits at Interfaces to Distribution Networks <u>and Non-Embedded Customers</u></b>			
Any <u>Nominal Voltage</u>	See below for the minimum voltage that must be achievable. Must always exceed lower limits of Table 6.4(b)		<del>+5%</del> <u>105%</u>
<b>(c) Voltages to be Achievable at <u>-Interfaces to Distribution Networks and Non-Embedded Customers</u></b>			
Any <u>Nominal Voltage</u>	<u>1.00pu</u> <del>100%</del> at any demand level <b>Note 5</b> or as otherwise agreed with the relevant Network Operator <u>or Non-Embedded Customer</u> .		

**Notes**

3. It is permissible to relax this to 90% of the nominal voltage 360kV (-10%) if the affected substations are on the same radially fed spur post-fault, and:
  - (i) there is no lower voltage interconnection from these substations to other *supergrid* substations; and
  - (ii) no auxiliaries of *large power stations* are derived from them.
4. It is permissible to relax this to 105% of the nominal voltage 420kV (+5%) if there is judged to be sufficient certainty of meeting Security and Quality of Supply Standards in operational timescales, and operational measures to achieve these are identified at the planning stage.
5. May be relaxed downwards following a secured event involving the outage of a Grid Supply Transformer, provided that there is judged to be sufficient certainty that the limits of Table 6.4(b) can be met in operational timescales.

6.5. For a site or a group of sites with a combined *group demand* of less than 1500MW, operational measures shall be identified at the planning stage to ensure that the requirements of Table 6.3 and 6.4 can be met in operational timescales for all sites remaining connected following any *secured event* for which it is not required to secure the full *group demand*.

**Voltage Limits in Operational Timescales**

6.6. A voltage condition is unacceptable in operational timescales if:

- 6.6.1. there is any inability to achieve pre-fault *steady-state* voltages as specified in Table 6.3 at *onshore transmission system* substations or *GSPs*

or

6.6.2. if, after either

6.6.2.1. a *secured event*,

or

6.6.2.2. *operational switching*

and the affected site remains directly connected to the *onshore transmission system* in the *steady state* after the relevant event above, either of the following conditions applies:

6.6.2.3. the *voltage step change* at an interface between the *onshore transmission system* and a *User System* exceeds that specified in Table 6.5,

or

6.6.2.4. there is any inability following such an event to achieve a *steady state* voltage as specified in Table 6.4 at *onshore transmission system* substations or *GSPs* using manual and/or automatic facilities available, including the switching in or out of relevant equipment.

Table 6.3 Pre-Fault Steady State Voltage Limits and Targets in Operational Timescales

<b>(a) Voltage Limits on Transmission Networks</b>			
Nominal Voltage	<u>PU Value (1pu relates to the Nominal Voltage)</u>	<u>Minimum (percentage of Nominal Voltage)</u>	<u>Maximum (percentage of Nominal Voltage)</u>
<u>Greater than 4300kV</u>	<u>0.95pu-1.05pu</u>	<u>-5%380kV (95%)</u> <b>Note 6</b>	<u>+5%420kV (105%)</u>
<u>200kV up to 300kV</u> <del>275kV</del>	<u>0.95pu-1.09pu</u>	<u>-5%261kV (95%)</u> <b>Note 6</b>	<u>+9%300kV (109%)</u>
<u>132kV up to and including 200kV</u>	<u>0.95pu-1.10pu</u>	<u>-5% 125kV (95%)</u> <b>Note 6</b>	<u>+10%145kV (110%)</u>
<b>(b) Voltages to be Achievable at Interfaces to Distribution Networks <u>and Non-Embedded Customers</u></b>			
<u>Any Nominal Voltage</u>	Target voltages and voltage ranges as agreed with the relevant Distribution Network Operators <u>or Non-Embedded Customers</u> , within the limits of Table 6.4		

**Notes**

6. It is permissible to relax this to 90% at substations if no auxiliaries of *large power stations* are derived from them.

Table 6.4 Steady State Voltage Limits and Targets in Operational Timescales

<b>(a) Voltage Limits on Transmission Networks</b>			
Nominal Voltage	PU Value (1pu relates to the Nominal Voltage)	Minimum (percentage of Nominal Voltage)	Maximum (percentage of Nominal Voltage)
<u>Greater than 3400kV</u>	<u>0.90pu-1.05pu</u>	<u>-10%360kV (90%)</u>	<u>+5%420kV (105%)</u> <b>Note 7</b>
<u>200kV up to and including 300kV</u> <del>275kV</del>	<u>0.90pu-1.0pu</u>	<u>-10%248kV (90%)</u>	<u>+9%300kV (109%)</u>
<u>132kV up to and including 200kV</u>	<u>0.90pu-1.10pu</u>	<u>-10%119kV (90%)</u>	<u>+10%145kV (110%)</u>
<b>(b) Voltage Limits at Interfaces to Distribution Networks and Non-Embedded Customers</b>			
Nominal Voltage			
132kV	<u>0.90pu-1.10pu</u>	<u>-10%119kV (90%)</u>	<u>+10%145kV (110%)</u>
At less than 132kV	<u>0.94pu-1.06pu</u>	<u>-6%94%</u>	<u>+6%106%</u>

**Notes**

7. May be relaxed to ~~440kV (110%)~~ for no longer than 15 minutes following a *secured event*.

**Voltage Step Change Limits in All Timescales**

- 6.7. *Voltage step change* limits must be observed at every interface point between the *national electricity transmission system* and Users' plant. The *voltage step change* limits do not apply where no User is connected.
- 6.8. The *voltage step change* limits must be applied with load response taken into account.

Table 6.5 Voltage Step Change Limits in Planning and Operational Timescales

Type of Event	Voltage Fall	Voltage Rise
<b>(a) At substations supplying User Systems at any voltage</b>		
1. Following <i>operational switching</i> at intervals of less than <del>408</del> minutes	In accordance with Figure 6.1	
2. Following <i>operational switching</i> at intervals of more than <del>408</del> minutes, 3. except for <i>infrequent operational switching</i> events as described below	-3%	+3%
4. Following <i>infrequent operational switching</i> ( <b>Notes 8, 9</b> )	-6%	+6%

5. In planning timescales, following a <i>fault outage</i> of a <i>double circuit supergrid</i> overhead line <b>(Note 10)</b>	-6%	+6%
6. Following any other <i>secured event</i> , <b>(Note 11)</b> <u>except as detailed below:</u>	-6%	+6%
<b>(b) At substations supplying User Systems at voltages above 132kV</b>		
7. Following a <i>secured event</i> involving a <i>fault outage</i> of a section of <i>busbar</i> or a mesh corner	-12%	+6%
8. In operational timescales, following a <i>secured event</i> involving a <i>fault outage</i> of a <i>double circuit</i> overhead line	-12%	+6%
<b>(c) At substations supplying User Systems at 132kV</b> <b>As (a) and (b) plus:</b>		
9. Following a <i>secured event</i> involving loss of a double circuit transmission overhead line, and one or more <i>supergrid</i> transformers stepping down to 132 kV	-12%	+6%
10. Following a <i>secured event</i> involving loss of a single <i>transmission circuit</i> and one or more <i>supergrid</i> transformers stepping down to 132kV, with a prior outage of another circuit connected to the substation or of another mesh corner at the substation	-12%	+6%
11. Following a <i>secured event</i> involving loss of a <i>double circuit</i> transmission overhead line operating at 132kV <b>(Note 12)</b>	-12%	+6%
<b>(d) At substations supplying User Systems at voltages below 132kV</b> <b>As (a), (b) and (c) plus:</b>		
12. Following a <i>secured event</i> involving the loss of one or more Grid Supply Transformers	-12%	+6%

#### Notes

8. An individual User must not experience voltage steps exceeding  $\pm 3\%$  due to infrequent operational switching:
- (i) on a regular basis, and / or
  - (ii) at intervals of less than two hours,
  - (iii) unless abnormal conditions prevail
- Infrequent operational switching* would typically include disconnection of circuits for routine maintenance. It would not include switching out of circuits for voltage control, or switching out of circuits to allow safe access to other plant, where it is foreseen that such switching may be a regular practice; such events would be classed as *operational switching*.
9. Voltage steps exceeding  $\pm 3\%$  due to *infrequent operational switching* may be accepted only on busbars or circuits fed directly by the *transmission circuits* involved in the *infrequent operational switching*.

10. It is permissible to relax this to -12%, +6% in Scotland if the aggregate demand of sites experiencing voltage falls between 6% and 12% and does not exceed 1500MW.
11. Operationally, the -6% requirement may be relaxed to -12% at a site or sites with a combined group demand of less than 1500MW, provided all other NETS SQSS requirements are met, if the -6% requirement may only be met by shedding load.
12. In planning timescales, for demand groups with aggregate demand less than 1500MW, this criterion applies to any demand left connected post-fault. Operationally, this criterion only applies for demand groups with aggregate demand greater than 1500MW.

### Maximum Voltage Changes Permitted for Frequent Voltage Steps\*

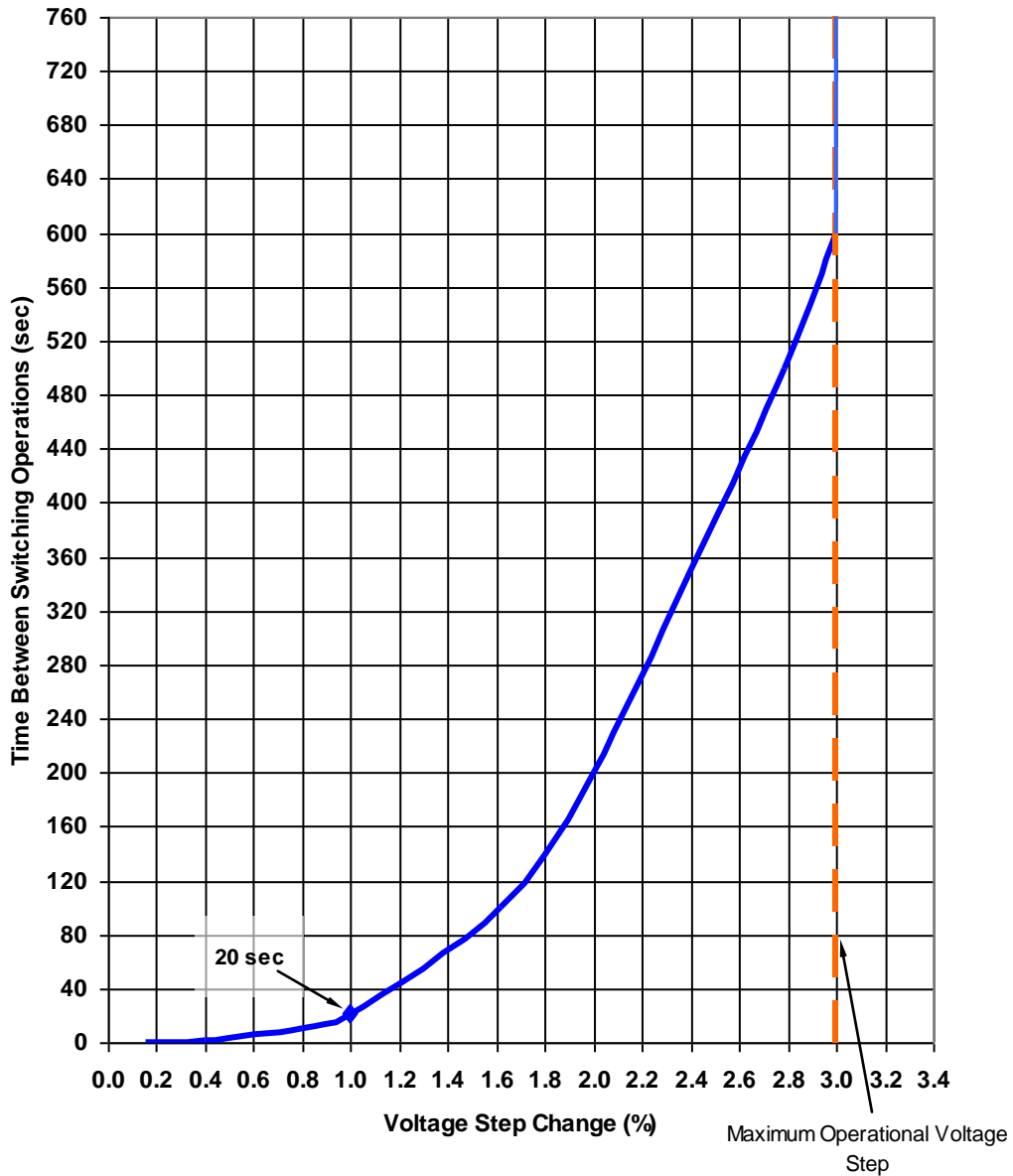

\*Derived from ER P28 Fig. 4

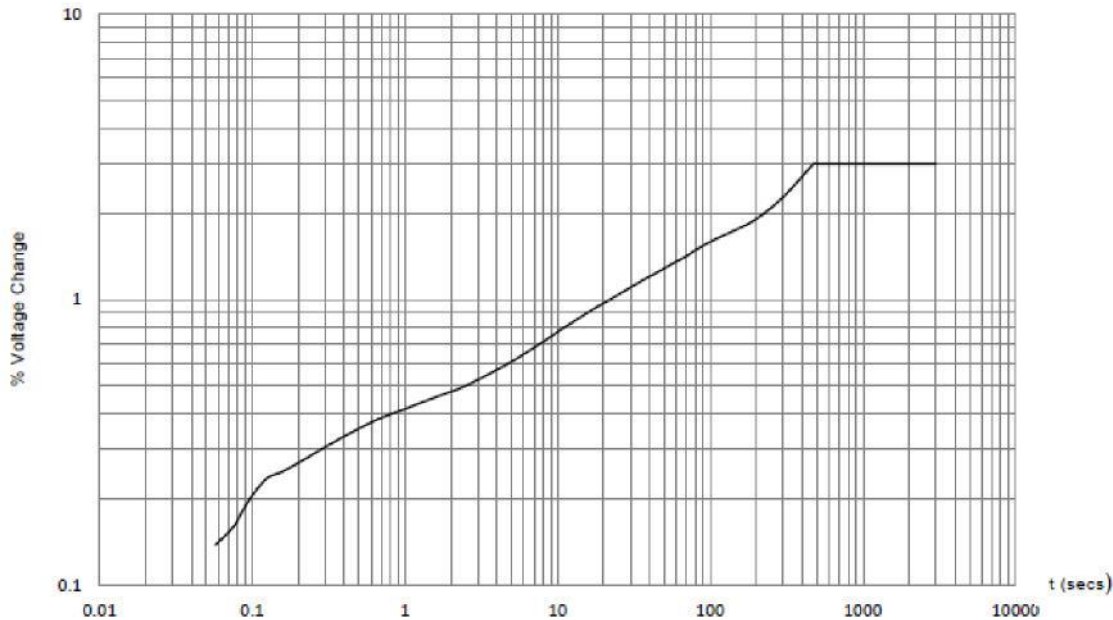

**6.1 Maximum Voltage Step Changes Permitted for Operational Switching**

Figure 6.1 Maximum Voltage Step Changes Permitted for Operational Switching derived from ER P28 B.1.2

## 7. Generation Connection Criteria Applicable to an Offshore Transmission System

- 7.1 This section presents the planning criteria applicable to the connection of one or more *offshore power stations* to an *offshore transmission system*. The criteria in this section apply from the *offshore grid entry point/s (GEP)* at which each *offshore power station* connects to an *offshore transmission system*, through the remainder of the *offshore transmission system* to the point of connection at the *first onshore substation*, which is the *interface point (IP)* in the case of a direct connection to the *onshore transmission system* or the *user system interface point (USIP)* in the case of a connection to an onshore user system.
- 7.2 Planning criteria are defined for all elements of an *offshore transmission system* including: the *offshore transmission circuits* and equipment on the *offshore platform* (whether AC or DC); the *offshore transmission circuits* from the *offshore platform* to the *interface point* or *user system interface point* (as the case may be) including undersea cables and any overhead lines (whether AC or DC); and any onshore AC voltage transformation facilities or *DC converter* facilities.
- 7.3 In those parts of the *national electricity transmission system* where the criteria of Section 8 and/or Section 4 also apply, those criteria must also be met.
- 7.4 In planning *offshore* generation connections, this Standard is met if the connection design either:
- 7.4.1 satisfies the deterministic criteria detailed in paragraphs 7.6 to 7.18; or



- 7.4.2 varies from the design necessary to meet paragraph 7.4.1 above in a manner which satisfies the conditions detailed in paragraphs 7.20 to 7.23.
- 7.5 It is permissible to design to standards higher than those set out in paragraphs 7.6 to 7.18 provided the higher standards can be economically justified. Guidance on economic justification is given in Appendix G.

### **Limits to Loss of Power Infeed Risks**

- 7.6 For the purpose of applying the criteria of paragraphs 7.7 to 7.12, the *loss of power infeed* resulting from a *secured event* shall be calculated as follows:
- 7.6.1 the sum of the *registered capacities* of the *offshore power park modules* or *offshore* gas turbines disconnected from the system by a *secured event*, less
- 7.6.2 the *forecast minimum demand* disconnected from the system by the same event but excluding (from the deduction) any demand forming part of the *forecast minimum demand* which may be automatically tripped for system frequency control purposes and excluding (from the deduction) the demand of the largest single end customer.

### Offshore Platforms (AC and DC)

- 7.7 *Offshore* generation connections on *offshore platforms* shall be planned such that, starting with an *intact system*, the consequences of *secured events* on the *offshore transmission system* shall be as follows;

#### 7.7.1 AC Circuits on an offshore platform

- 7.7.1.1 in the case of *offshore power park module* only connections, and where the *offshore grid entry point capacity* is 90MW or more, following a *planned outage* or a *fault outage* of a single AC *offshore* transformer circuit on the *offshore platform*, the *loss of power infeed* shall not exceed the smaller of either:

50% of the *offshore grid entry point capacity*; or  
the full *normal infeed loss risk*.

- 7.7.1.2 in the case of gas turbine only connections, and where the *offshore grid entry point capacity* is 90MW or more, following a *planned outage* or a *fault outage* of a single AC *offshore transmission circuit* on the *offshore platform*, there shall be no *loss of power infeed*;

- 7.7.1.3 following a *fault outage* of a single AC *offshore transmission circuit* on the *offshore platform*, during a *planned outage* of another AC *offshore transmission circuit* on the *offshore platform*, the further *loss of power infeed* shall not exceed the *infrequent infeed loss risk*.

#### 7.7.2 DC Circuits on an offshore platform

7.7.2.1 following a *planned outage* or a *fault outage* of a single *DC converter* on the *offshore platform*, the *loss of power infeed* shall not exceed the *normal infeed loss risk*;

7.7.2.2 following a *fault outage* of a single *DC converter* on the *offshore platform*, during a *planned outage* of another *DC converter* on the *offshore platform*, the further *loss of power infeed* shall not exceed the *infrequent infeed loss risk*.

### 7.7.3 Busbars and Switchgear on an offshore platform

7.7.3.1 following a *planned outage* of any single section of *busbar* or mesh corner, the *loss of power infeed* shall not exceed the *normal infeed loss risk*;

7.7.3.2 following a *fault outage* of any single section of *busbar* or mesh corner, the *loss of power infeed* shall not exceed the *infrequent infeed loss risk*;

7.7.3.3 following a *fault outage* of any single *busbar* coupler circuit breaker or *busbar* section circuit breaker or mesh circuit breaker, the *loss of power infeed* shall not exceed the *infrequent infeed loss risk*;

7.7.3.4 following a *fault outage* of any single section of *busbar* or mesh corner, during a *planned outage* of any other single section of *busbar* or mesh corner, the *loss of power infeed* shall not exceed the *infrequent infeed loss risk*;

7.7.3.5 following a *fault outage* of any single *busbar* coupler circuit breaker or *busbar* section circuit breaker or mesh circuit breaker, during a *planned outage* of any single section of *busbar* or mesh corner, the *loss of power infeed* shall not exceed the *infrequent infeed loss risk*.

### Cable Circuits (AC and DC)

7.8 The transmission connections between one *offshore platform* and another *offshore platform* or from an *offshore platform* to the *interface point* or *user system interface point* at the *first onshore substation* shall be planned such that, starting with an *intact system* and for the full *offshore grid entry point capacity* at the *offshore grid entry point*, the consequences of *secured events* shall be as follows:

7.8.1 following a *planned outage* or a *fault outage* of a single cable *offshore transmission circuit*, the *loss of power infeed* shall not exceed the *infrequent infeed loss risk*; and

7.8.2 following a *fault outage* of a single cable *offshore transmission circuit* during a *planned outage* of another cable *offshore transmission circuit* the further *loss of power infeed* shall not exceed the *infrequent infeed loss risk*.

## Overhead Line Sections (AC and DC)

- 7.9 In the case AC overhead line connections of 132kV, between the incoming AC cable *offshore transmission circuits* and the *first onshore substation* or the onshore AC transformation facilities (as the case may be), the justification for a minimum of one circuit or two circuits is illustrated in Figure 7.1. In Figure 7.1 the justification is presented as a function of route length and *offshore grid entry point capacity*. The area above the line represents justification for a minimum of two circuits and the area below the line represents justification for a minimum of one circuit.

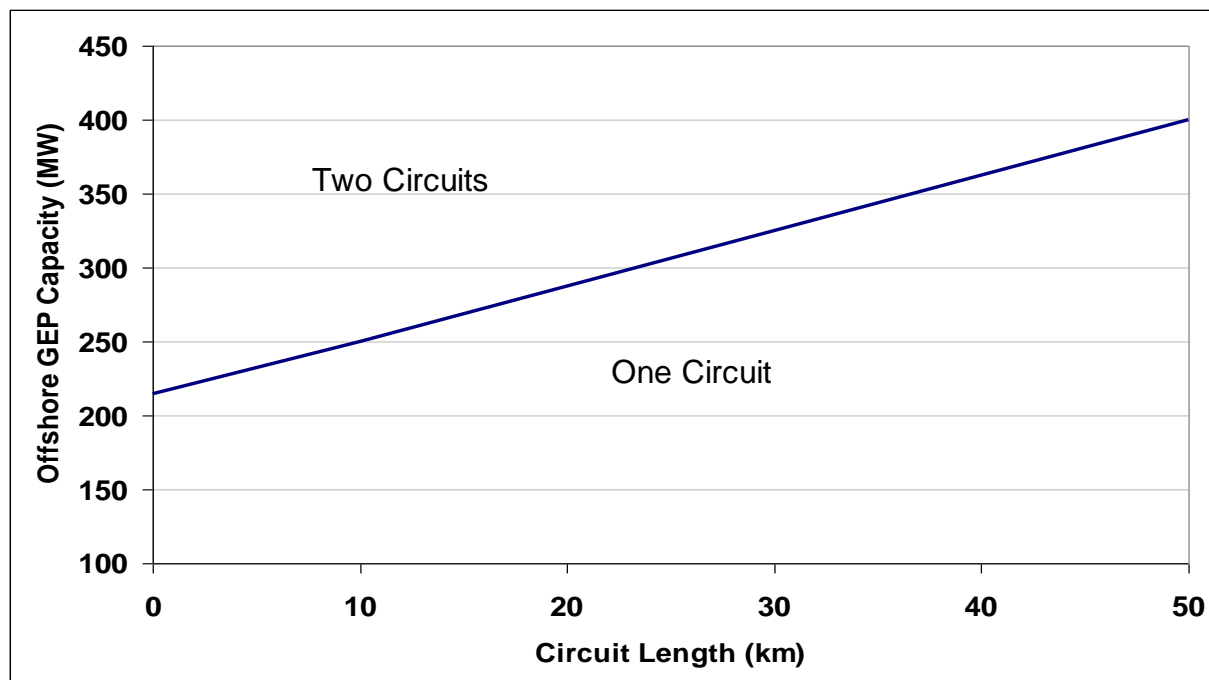

Figure 7.1 Justification for a Minimum of One Circuit or a Minimum of Two Circuits for 132kV AC Overhead Lines

- 7.10 In the case of AC overhead line connections of 220kV or above, between the incoming AC cable *offshore transmission circuits* and the *first onshore substation* or the onshore AC transformation facilities (as the case may be), a single circuit is justified as a minimum for *offshore grid entry point capacities* of 1250MW or less and two circuits are justified as a minimum for *offshore grid entry point capacities* greater than 1250MW.
- 7.11 Overhead line (AC or DC) connections between the cable (AC or DC) *offshore transmission circuits* and the *first onshore substation* or the onshore AC transformation facilities or DC conversion facilities, as the case may be, shall be planned such that, starting with an *intact system* and for the full *offshore grid entry point capacity* at the *offshore grid entry point*, the consequences of a *secured event* on the *offshore transmission system* shall be as follows:
- 7.11.1 following a *planned outage* or a *fault outage* of a single overhead line circuit, the *loss of power infeed* shall not exceed the *infrequent infeed loss risk*;

7.11.2 following a *fault outage* of a single overhead line circuit during a *planned outage* of another overhead line circuit, the further *loss of power infeed* shall not exceed the *infrequent infeed loss risk*.

### Onshore Connection Facilities (AC and DC)

7.12 The transmission connections at the onshore AC transformation or DC conversion facilities shall be planned such that, starting with an *intact system*, the consequences of *secured events* on the *offshore transmission system* shall be as follows;

#### 7.12.1 AC Circuits

7.12.1.1 in the case of *offshore power park module* only connections, and where the *offshore grid entry point capacity* is 120MW or more, following a *planned outage* or a *fault outage* of a single AC *offshore* transformer circuit at the onshore AC transformation facilities, the *loss of power infeed* shall not exceed the smaller of either:

50% of the *offshore grid entry point capacity*; or  
the full *normal infeed loss risk*.

7.12.1.2 in the case of gas turbine only connections, following a *planned outage* or a *fault outage* of a single AC *offshore transmission circuit* at the onshore AC transformation facilities, the *loss of power infeed* shall not exceed the *normal infeed loss risk*;

7.12.1.3 following a *fault outage* of a single AC *offshore transmission circuit* at the onshore AC transformation facilities, during a *planned outage* of another AC *offshore transmission circuit* at the onshore AC transformation facilities, the further *loss of power infeed* shall not exceed the *infrequent infeed loss risk*.

#### 7.12.2 DC Circuits

7.12.2.1 following a *planned outage* or a *fault outage* of a single DC *converter* at the onshore DC conversion facilities, the *loss of power infeed* shall not exceed the *normal infeed loss risk*;

7.12.2.2 following a *fault outage* of a single DC *converter* at the onshore DC conversion facilities, during a *planned outage* of another DC *converter* at the onshore DC conversion facilities, the further *loss of power infeed* shall not exceed the *infrequent infeed loss risk*.

#### 7.12.3 Busbars and Switchgear

- 7.12.3.1 in the case of *offshore power park module* connections or multiple gas turbine connections, following a *planned outage* of any single section of *busbar* or mesh corner, *no loss of power infeed* shall occur;
- 7.12.3.2 in the case of a single gas turbine connection, following a *planned outage* of any single section of *busbar* or mesh corner, the *loss of power infeed* shall not exceed the *infrequent infeed loss risk*;
- 7.12.3.3 following a *fault outage* of any single section of *busbar* or mesh corner, the *loss of power infeed* shall not exceed the *infrequent infeed loss risk*;
- 7.12.3.4 following a *fault outage* of any single *busbar* coupler circuit breaker or *busbar* section circuit breaker or mesh circuit breaker, the *loss of power infeed* shall not exceed the *infrequent infeed loss risk*;
- 7.12.3.5 following a *fault outage* of any single section of *busbar* or mesh corner, during a *planned outage* of any other single section of *busbar* or mesh corner, the *loss of power infeed* shall not exceed the *infrequent infeed loss risk*;
- 7.12.3.6 following a *fault outage* of any single *busbar* coupler circuit breaker or *busbar* section circuit breaker or mesh circuit breaker, during a *planned outage* of any single section of *busbar* or mesh corner, the *loss of power infeed* shall not exceed the *infrequent infeed loss risk*.

## Generation Connection Capacity Requirements

### Background conditions

- 7.13 The connection of a particular *offshore power station* shall meet the criteria set out in paragraphs 7.14 to 7.23 under the following background conditions:
  - 7.13.1 the active power output of the *offshore power station* shall be set to deliver active power at the *offshore grid entry point* equal to its *registered capacity* or, for the purpose of *Sub-Synchronous Oscillations* studies, that which provides the lowest level of damping for the sub-synchronous mode under consideration;
  - 7.13.2 the reactive power output of the *offshore power station* shall normally, and unless otherwise agreed, be set to deliver zero reactive power at the *offshore grid entry point* with active power output equal to *registered capacity*; and the reactive power delivered at the *interface point* shall be set in accordance with the reactive requirements placed on the *offshore transmission licensee* set out in Section K of the STC (System Operator – Transmission Owner Code); and
  - 7.13.3 conditions on the *national electricity transmission system* shall be set to those which ought reasonably to be expected to arise in the course

of a year of operation. Such conditions shall include forecast demand cycles, typical *power station* operating regimes and typical *planned outage* patterns modified where appropriate by the provisions of paragraph 7.16.

#### Pre-Fault Criteria – background conditions of no *local system outage*

7.14 The *transmission capacity* of the *offshore transmission circuits* for the connection of one or more *offshore power stations* shall be planned such that, for the background conditions described in paragraph 7.13, with *no local system outage* and prior to any fault, there shall not be any of the following:

- 7.14.1 equipment loadings exceeding the *pre-fault rating*;
- 7.14.2 voltages outside the *pre-fault planning voltage limits* or *insufficient voltage performance margins*;
- 7.14.3 *system instability*; or
- 7.14.4 *Unacceptable Sub-Synchronous Oscillations*.

#### Post-Fault Criteria – background conditions of no *local system outage*

7.15 The *transmission capacity* of the *offshore transmission circuits* for the connection of one or more *offshore power stations* shall also be planned such that for the background conditions described in paragraph 7.13 with *no local system outage* and for the *secured event* on the *offshore transmission system* of any of the following:

- 7.15.1 in the case of an *offshore power park module* connection with an *OffGEP capacity* of 90MW or more, with the *OffGEP capacity* reduced by 50%, a *fault outage* or *planned outage* of a single AC *offshore transmission circuit* on the *offshore platform*;
- 7.15.2 in the case of an *offshore power park module* connection with an *OffGEP capacity* of 120MW or more, with the *OffGEP capacity* reduced to 50%, a *fault outage* or a *planned outage* of a single AC *offshore transmission circuit* at the onshore transformation facilities

And in all cases other than specified in 7.15.1 and 7.15.2 above:

- 7.15.3 a *fault outage* or a *planned outage* of a single *offshore transmission circuit*;

And in all cases:

- 7.15.4 a *fault outage* or a *planned outage* of a *generation circuit*, a *generating unit* (or *several generating units sharing* a common circuit breaker), a *power park*

*module, a DC converter, single reactive compensator or other reactive provider;*

7.15.5 a *fault outage* of a single *offshore transmission circuit* during a *planned outage* of another *offshore transmission circuit, generation circuit, a generating unit (or several generating units sharing a common circuit breaker), a power park module, a DC converter, a reactive compensator or other reactive power provider;*

7.15.6 a *fault outage* or a *planned outage* of a single section of *busbar* or mesh corner;

There shall not be any of the following:

7.15.7 a *loss of supply capacity* except as permitted by the demand connection criteria detailed in Section 8;

7.15.8 *unacceptable overloading* of any *primary transmission equipment;*

7.15.9 *unacceptable voltage conditions* or *insufficient voltage performance margins;*

7.15.10 *system instability; or*

7.15.11 *Unacceptable Sub-Synchronous Oscillations.*

7.16 Under planned outage conditions it shall be assumed that the planned outage specified in paragraphs 7.15.5 reasonably forms part of the typical outage pattern referred to in paragraph 7.13.3 rather than in addition to the typical outage pattern.

#### Post-fault criteria – background conditions with a *local system outage*

7.17 The *transmission capacity* of the *offshore transmission circuits* for the connection of one or more *offshore power stations* to an *offshore transmission system* shall also be planned such that, for the background conditions described in paragraph 7.13 with a *local system outage*, the operational security criteria set out in Section 9 can be met.

7.18 Where necessary to satisfy the criteria set out in paragraph 7.17, investment should be made in *transmission capacity* except where operational measures suffice to meet the criteria in paragraph 7.17 provided that maintenance access for each *offshore transmission circuit* can be achieved and provided that such measures are economically justified. The operational measures to be considered include rearrangement of transmission outages and appropriate reselection of *generating units* from those expected to be available, for example through *balancing services*. Guidance on economic justification is given in Appendix G.

## Switching Arrangements

7.19 Guidance on *offshore* substation configurations and switching arrangements are described in Appendix A. These guidelines provide an acceptable way towards meeting the criteria of paragraphs 7.7 to 7.12. However, other configurations and switching arrangements which meet those criteria are also acceptable.

## Variations to Connection Designs

7.20 Variations, arising from a generation customer's request, to the generation connection design necessary to meet the requirements of paragraphs 7.6 to 7.18 shall also satisfy the requirements of this Standard provided that the varied design satisfies the conditions set out in paragraphs 7.21.1 to 7.21.3. For example, such a generation connection design variation may be used to take account of the particular characteristics of an *offshore power station*.

7.21 Any generation connection design variation must not, other than in respect of the generation customer requesting the variation, either immediately or in the foreseeable future:

7.21.1 reduce the security of the *MITS* to below the minimum planning criteria specified in Section 4; or

7.21.2 result in additional investment or operational costs to any particular customer or overall, or a reduction in the security and quality of supply of the affected customers' connections to below the planning criteria in this section or Section 8, unless specific agreements are reached with affected customers; or

7.21.3 compromise any *transmission licensee's* ability to meet other statutory obligations or licence obligations.

7.22 system conditions subsequently change, for example due to the proposed connection of a new customer, such that either immediately or in the foreseeable future, the conditions set out in paragraphs 7.21.1 to 7.21.3 are no longer satisfied, then alternative arrangements and/or agreements must be put in place such that this Standard continues to be satisfied.

7.23 The additional operational costs referred to in paragraph 7.21.2 and/or any potential reliability implications shall be calculated by simulating the expected operation of the *national electricity transmission system* in accordance with the operational criteria set out in Section 5 and Section 9. Guidance on economic justification is given in Appendix G.



## 8. Demand Connection Criteria Applicable to an *Offshore Transmission System*

- 8.1 This section presents the planning criteria applicable to the connection of *offshore power station demand groups* to the remainder of the *national electricity transmission system*.
- 8.2 In those parts of an *offshore transmission system* where the criteria of Section 7 also apply, those criteria must also be met.
- 8.3 In planning demand connections, this Standard is met if the connection design either:
- 8.3.1 satisfies the deterministic criteria detailed in paragraphs 8.5 to 8.10; or
  - 8.3.2 varies from the design necessary to meet paragraph 8.3.1 above in a manner which satisfies the conditions detailed in paragraphs 8.12 to 8.15.
- 8.4 It is permissible to design to standards higher than those set out in paragraphs 8.5 to 8.10 provided the higher standards can be economically justified. Guidance on economic justification is given in Appendix G.

### ***Offshore Power Station Demand Connection Capacity Requirements***

- 8.5 The connection of a particular *offshore power station demand group* shall meet the criteria set out in paragraphs 8.6 to 8.10 under the following background conditions:
- 8.5.1 when the power output of the *offshore power station* is set to zero and there are no *planned outages*, the demand of the *offshore power station demand group* shall be set equal to *group demand*; and
  - 8.5.2 demand and generation outside the *offshore power station demand group* shall be set in accordance with the *planned transfer conditions* using the appropriate method described in Appendix C.
- 8.6 The *transmission capacity* for the connection of an *offshore power station demand group* shall be planned such that, for the background conditions described in paragraph 8.5, under *intact system* conditions there shall not be any of the following:
- 8.6.1 equipment loadings exceeding the *pre-fault rating*;
  - 8.6.2 voltages outside the *pre-fault planning voltage limits* or *insufficient voltage performance margins*; or
  - 8.6.3 *system instability*.
- 8.7 The *transmission capacity* for the connection of an *offshore power station demand group* shall also be planned such that for the background conditions described in paragraph 8.5 and for the *planned outage* of a single *transmission*

*circuit* or a single section of *busbar* or mesh corner, there shall not be any of the following:

- 8.7.1 a *loss of supply capacity* for a *group demand* of greater than 1 MW;
- 8.7.2 *unacceptable overloading* of any *primary transmission equipment*;
- 8.7.3 voltages outside the *pre-fault planning voltage limits* or *insufficient voltage performance margins*; or
- 8.7.4 *system instability*.

8.8 The *transmission capacity* for the connection of an *offshore power station demand group* shall also be planned such that for the background conditions described in paragraph 8.5 and the initial conditions of

- 8.8.1 an *intact system* condition; or
- 8.8.2 the single *planned outage* of another *transmission circuit* or a *generating unit* (or several *generating units*, sharing a common circuit breaker, that cannot be separately isolated), a *power park module*, or a *DC converter*, a reactive compensator or other reactive power provider,

for the *secured event* of a *fault outage* of

- 8.8.3 a single *transmission circuit*, or
- 8.8.4 a single generating unit (or several *generating units* sharing a common circuit breaker), a single *power park module*, or a single *DC converter*

there shall not be any of the following:

- 8.8.5 a *loss of supply capacity* such that the provisions set out in Table 8.1 are not met;
- 8.8.6 *unacceptable overloading* of any *primary transmission equipment*;
- 8.8.7 *unacceptable voltage conditions* or *insufficient voltage performance margins*; or
- 8.8.8 *system instability*.

8.9 In addition to the requirements of paragraphs 8.6 to 8.8, for the background conditions described in paragraph 8.5, the system shall also be planned such that operational switching does not cause *unacceptable voltage conditions*.

8.10 For a *secured event* on connections to more than one *offshore power station demand group*, the permitted *loss of supply capacity* for that *secured event* is the maximum of the permitted *loss of supply capacities* set out in Table 8.1 for each of these *offshore power station demand groups*.

Table 8.1 Minimum planning supply capacity following *secured events*

<i>Group Demand</i>	Initial system conditions	
	<i>Intact system</i>	With single <i>planned outage</i> <b>Note 1</b>
over 1 MW to 12 MW	<b>Within 3 hours</b> <i>Group Demand</i> minus 1 MW  <b>In repair time</b> <i>Group Demand</i>	Nil
up to 1 MW	<b>In repair time</b> <i>Group Demand</i>	Nil

**Notes**

1. The planned outage may be of a transmission circuit, generating unit, reactive compensator or other reactive power provider.

**Switching Arrangements**

8.11 Guidance on substation configurations and switching arrangements are described in Appendix A. These guidelines provide an acceptable way towards meeting the criteria of this chapter. However, other configurations and switching arrangements which meet the criteria are also acceptable.

**Variations to Connection Designs**

8.12 Variations, arising from a *generator's* request, to the demand connection design necessary to meet the requirements of paragraphs 8.5 to 8.10 shall also satisfy the requirements of this Standard provided that the varied design satisfies the conditions set out in paragraphs 8.13.1 to 8.13.3. For example, such a demand connection design variation may be used to limit overall costs.

8.13 Any demand connection design variation must not, other than in respect of the *generator* requesting the variation, either immediately or in the foreseeable future:

8.13.1 reduce the security of the *MITS* to below the minimum planning criteria specified in Section 4; or

8.13.2 result in additional investment or operational costs to any particular customer or overall, or a reduction in the security and quality of supply of the affected customers' connections to below the planning criteria in this section or Section 7, unless specific agreements are reached with affected customers; or

8.13.3 compromise any *transmission licensee's* ability to meet other statutory obligations or licence obligations.

8.14 Should system conditions change, for example due to the proposed connection of a new customer, such that either immediately or in the foreseeable future, the conditions set out in paragraphs 8.13.1 to 8.13.3 are no longer satisfied, then alternative arrangements and/or agreements must be put in place such that this Standard continues to be satisfied.

- 8.15 The additional operational costs referred to in paragraph 8.13.2 and/or any potential reliability implications shall be calculated by simulating the expected operation of the *national electricity transmission system* in accordance with the operational criteria set out in Section 5 and Section 9. Guidance on economic justification is given in Appendix G.

## 9. Operation of an Offshore Transmission System

### Normal Operational Criteria

9.1 An offshore transmission system shall be operated under prevailing system conditions so that for the secured event on the offshore transmission system of a fault outage of any of the following:

9.1.1 a single transmission circuit, a reactive compensator or other reactive power provider; or

9.1.2 a single generation circuit, a single generating unit (or several generating units sharing a common circuit breaker), a single power park module, or a single DC converter, or

~~9.1.3~~ the most onerous loss of power infeed; or

~~9.1.3~~~~9.1.4~~ the most onerous loss of power outfeed; or

~~9.1.4~~~~9.1.5~~ a section of busbar or mesh corner, or

~~9.1.5~~~~9.1.6~~ a double circuit overhead line

there shall not be any of the following:

~~9.1.6~~~~9.1.7~~ a loss of supply capacity except as specified in Table 9.1;

~~9.1.7~~~~9.1.8~~ unacceptable frequency conditions;

~~9.1.8~~~~9.1.9~~ unacceptable overloading of any primary transmission equipment;

~~9.1.9~~~~9.1.10~~ unacceptable voltage conditions;

~~9.1.10~~~~9.1.11~~ system instability; or

~~9.1.11~~~~9.1.12~~ Unacceptable Sub-Synchronous Oscillations.

Table 9.1 Maximum permitted loss of supply capacity following secured events

Group Demand	Initial system conditions	
	Prevailing system conditions with no local system outage	Prevailing system conditions with a local system outage
over 1 MW to 12 MW	Whole group up to Group Demand for up to the operational specified time to restore supply capacity	Whole group up to Group Demand
up to 1 MW	Whole group up to Group Demand for up to the operational specified time to restore supply capacity	Whole group up to Group Demand

#### Notes

1. The time to restore any lost supply capacity shall be as short as practicable. If any part of any lost supply capacity can be restored in less than the specified maximum time to restore all of it, it shall be restored.

## **Conditional Further Operational Criteria**

9.2 NGESO shall use the latest version of the *Frequency Risk and Control Report* as consulted on and approved by the Authority to determine the events for which *unacceptable frequency conditions* shall not occur. The *Frequency Risk and Control Report* assessment includes consideration of any consequential loss of distributed energy resources associated with any such event.

## **Post-fault Restoration of System Security**

9.29.3 Following the occurrence of a *secured event*, measures shall be taken to re-secure an *offshore transmission system* to the above operational criteria as soon as reasonably practicable. To this end, it is permissible to put operational measures in place pre-fault to facilitate the speedy restoration of system security.

## **Authorised Variations from the Operational Criteria**

9.4 Exceptions to the criteria in paragraphs 9.1 and ~~9.32~~ may be required:

9.4.1 -where variations to the connection designs as per paragraphs 7.21 to 7.24 and paragraphs 8.12 to 8.15 have been agreed; or-

~~9.2.1~~9.4.2 in relation to 9.1.8 only, based on the outcome of an assessment conducted in accordance with the *Frequency Risk and Control Report*.

~~9.39~~5 The principles of these operational criteria shall be applied at all times except in special circumstances where NGESO, following consultation with the appropriate *Generator*, may need to give instructions to the contrary to preserve overall system integrity.

## 10. Voltage Limits in Planning and Operating an *Offshore Transmission System*

### Voltage Limits

10.1 The *pre-fault planning voltage limits* and *steady state* voltage limits on an *offshore transmission system* are as shown in Table 10.1.

Table 10.1 *Pre-fault planning voltage limits* and *steady state* voltage limits in both planning and operational timescales

Nominal voltage	Minimum	Maximum
400kV <b>Note 1</b>	- 10%	+ 5%
Less than 400kV down to 132kV inclusive	- 10%	+ 10%
Less than 132kV	- 6%	+ 6%

#### Notes

1. For 400kV, the maximum limit is aligned with the equivalent onshore limit pending review in the light of technological developments.
- 10.2 A voltage condition on an *offshore transmission system* is unacceptable in both planning and operational timescales if, after either
- 10.2.1 a *secured event*, or
  - 10.2.2 operational switching,
- and the affected site remains directly connected to the *national electricity transmission system* in the *steady state* after the relevant event above, the following condition applies:
- 10.2.3 there is any inability following such an event to achieve a *steady state* voltage as specified in Table 10.1 at *offshore transmission system* substations or *OSPs* using manual and/or automatic facilities available, including the switching in or out of relevant equipment.
- 10.3 In planning timescales, the *steady state* voltages are to be achieved without widespread post-fault generation transformer re-tapping or post-fault adjustment of SVC set points to increase the reactive power output or to avoid exceeding the available reactive capability of generation or SVCs.

## 11. Terms and Definitions

ACS Peak Demand	The estimated unrestricted winter peak demand (MW and MVar) on the total system for the <i>average cold spell</i> (ACS) condition. This represents the demand to be met by <i>large power stations</i> (directly connected or embedded), <i>medium power stations</i> (directly connected or embedded) and <i>small power stations</i> (directly connected or embedded) and by electricity imported into the <i>onshore transmission system</i> from <i>external systems</i> across <i>external interconnections</i> (and which is not adjusted to take into account demand management or other techniques that could modify demand).
Adverse Conditions	For the purpose of this Standard, those conditions that significantly increase the likelihood of an overhead line fault, e.g. high winds, lightning, very high or very low ambient temperatures, high precipitation levels, high insulator or atmospheric pollution, flooding.
Ancillary Services	This means: (a) such services as any authorised electricity operator may be required to have available as <i>Ancillary Services</i> pursuant to the Grid Code; and (b) such services as any authorised electricity operator or person making transfers on <i>external interconnections</i> may have agreed to have available as being <i>ancillary services</i> pursuant to agreement made with NGENSO and which may be offered for purchase by NGENSO.
Annual Load Factor	The ratio of the actual energy output of a <i>generating unit</i> , CCGT module or <i>power station</i> (as the case may be) to the maximum possible energy output of that <i>generating unit</i> , CCGT module or <i>power station</i> (as the case may be) over a year. It is often expressed in percentage terms.
Authority	This means the Gas and Electricity Markets Authority established by section 1(1) of the Utilities Act 2000.
Average Cold Spell (ACS)	A particular combination of weather elements which give rise to a level of peak demand within a financial year (1 April to 31 March) which has a 50% chance of being exceeded as a result of weather variation alone.
Balancing Mechanism	This is the mechanism for the making and acceptance of offers and bids pursuant to the arrangements contained in the Balancing and Settlement Code (BSC)



Balancing Services	This means: (a) <i>Ancillary Services</i> ; (b) Offers and bids in the <i>Balancing Mechanism</i> ; and (c) Other services available to NGESO, which serve to assist NGESO in operating the <i>national electricity transmission system</i> in accordance with the Electricity Act 1989 (Act) or the Conditions of the Transmission Licence granted under Section 6(1) (b) of the Act and/or in doing so efficiently and economically.
Boundary Allowance	An allowance in MW to be added in whole or in part to transfers arising out of the <i>Economy planned transfer condition</i> to take some account of year round variations in levels of generation and demand. This allowance is calculated by an empirical method described in Appendix F of this Standard.
Busbar	The common connection point of two or more <i>transmission circuits</i> .
Corrective Action	Manual and automatic action taken after an outage or switching action to assist recovery of satisfactory system conditions; for example, tap changing or switching of plant.
Credible Demand Sensitivities	Such variations in demands above those forecast as are appropriate to the locations and the forecast error for the number of years ahead for which the forecast has been produced, e.g. that which corresponds to an 80% demand forecast confidence level.
DC Converter	Any apparatus used as part of the <i>national electricity transmission system</i> to convert alternating current electricity to direct current electricity, or vice-versa. A <i>DC Converter</i> is a standalone operative configuration at a single site comprising one or more converter bridges, together with one or more converter transformers, converter control equipment, essential protective and switching devices and auxiliaries, if any, used for conversion. In a bipolar arrangement, a <i>DC Converter</i> represents the bipolar configuration.
Demand Group	A site or group of sites which collectively take power from the remainder of the <i>onshore transmission system</i> .

Demand Point of Connection	For the purpose of defining the boundaries between the MITS and <i>Grid Supply Point</i> transformer circuits, the <i>Demand Point of Connection</i> is taken to be the <i>Busbar</i> clamp in the case of an air insulated substation, gas zone separator in the case of a gas insulated substation, or other equivalent point as may be determined by the relevant <i>transmission licensees</i> for new types of substation.
Distribution Licensee	Means the holder of a Distribution Licence in respect of an onshore distribution system granted under Section 6 (1) (c) of the Electricity Act 1989 (as amended under the Utilities Act 2000 and the Energy Act 2004).
Double Circuit Overhead Line	<p>In the case of the <i>onshore transmission system</i>, this is a transmission line which consists of two circuits sharing the same towers for at least one span in SHET's transmission system or <i>NGET's transmission system</i> or for at least 2 miles in <i>SPT's transmission system</i>.</p> <p>In the case of an <i>offshore transmission system</i>, this is a transmission line which consists of two circuits sharing the same towers for at least one span.</p>
Economy Planned Transfer Conditions	The condition arising from scaling the <i>registered capacity</i> of each <i>power station</i> according to the type of generation such that the total of the scaled capacities is equal to the <i>ACS peak demand</i> . This scaling shall follow the techniques described in Appendix E.
External Interconnection	Apparatus for the transmission of electricity to or from the <i>onshore transmission system</i> into or out of an <i>external system</i> .
External System	A transmission or distribution system located outside the <i>national electricity transmission system operator area</i> , which is electrically connected to the <i>onshore transmission system</i> by an <i>external interconnection</i>
Fault Outage	An outage of one or more items of <i>primary transmission equipment</i> and/or <del>generation plant</del> <u>user equipment</u> , <u>which may or may not result in a loss of power infeed or loss of power outfeed</u> , initiated by automatic action unplanned at that time, <u>and</u> which may or may not involve the passage of fault current.

## First Onshore Substation

The *first onshore substation* defines the onshore limit of an *offshore transmission system*. An *offshore transmission system* cannot extend beyond the *first onshore substation*.

Accordingly, the security criteria relating to an *offshore transmission system* extend from the *offshore GEP* up to the *interface point* or *user system interface point* (as the case may be), which is located at the *first onshore substation*.

The security criteria relating to the *onshore transmission system* extend from the *interface point* located at the *first onshore substation* and extend across the remainder of the *onshore transmission system*.

The security criteria relating to an onshore *user system* extend from the *user system interface point* located at the *first onshore substation* and extend across the remainder of the relevant *user system*.

The *first onshore substation* will comprise, inter alia, facilities for the connection between, or isolation of, *transmission circuits* and/or distribution circuits. These facilities will include at least one *busbar* to which the *offshore transmission system* connects and one or more circuit breakers and disconnectors. For the avoidance of doubt, if the substation does not include these elements, then it does not constitute the *first onshore substation*.

The *first onshore substation* may be owned by the *offshore transmission owner*, the onshore transmission owner or onshore *user system owner* as determined by the relevant *transmission licensee* and/or *distribution licensee* as the case may be.

Normally, in the case of there being transformation facilities at the *first onshore substation* and unless otherwise agreed, if the *offshore transmission owner* owns the *first onshore substation*, the *interface point* would be on the HV *busbars* and, if the *first onshore substation* is owned by the onshore transmission owner or onshore *user system owner*, the *interface point* or *user system interface point* (as the case may be) would be on the LV *busbars*.

## Forecast Minimum Demand

This is the minimum demand level expected at a *GSP* or *OSP* or a group of *GSPs* or group of *OSPs*. Unless more specific data are available, this is the expected demand at the time of the annual minimum demand on the *national electricity transmission system* as provided under the Grid Code. In the case of a group of *GSPs* or group of *OSPs*, the demand diversity within the group should be taken into account.

Frequency Risk and Control Report

The periodic report setting out the results of an assessment of the operational frequency risks on the system produced by NGENSO and approved by the Authority and as set out in the SQSS Appendix H, and prepared in accordance with the *Frequency Risk and Control Report Methodology* as also prepared and approved as set out in the SQSS Appendix H. The report shall include an assessment of the magnitude, duration and likelihood of transient frequency deviations, forecast impact and the cost of securing the system and confirm which risks will or will not be secured operationally by NGENSO in accordance with paragraphs 5.8, 5.11.2, 9.2 and 9.4.2.

Frequency Risk and Control Report Methodology

The methodology by which a *Frequency Risk Control Report* will be developed, consulted on and approved by the Authority, and as set out in the SQSS Appendix H.

Generating Plant Type

A type of *generating unit* classified by the type of prime move, e.g. thermal hydro.

Generating Units

An *onshore generating unit* or an *offshore generating unit*.

Generation Circuit

The sole electrical connection between one or more *generating units* and the *Main Interconnected Transmission System* i.e. a radial circuit which if removed would disconnect the *generating units*.

Generation Point of Connection

For the purpose of defining the boundaries between the *MITS* and *generation circuits*, the *generation point of connection* is taken to be the *busbar clamp* in the case of an air insulated substation, gas zone separator in the case of a gas insulated substation, or other equivalent point as may be determined by the relevant *transmission licensees* for new types of substation

Generator

A person who generates electricity under licence or exemption under the Electricity Act 1989 as amended by the Utilities Act 2000 and the Energy Act 2004 as a *generator* in *Great Britain* or *Offshore*.

Great Britain (GB)

The landmass of England and Wales and Scotland, including internal waters.

Grid Entry Point (GEP)	A point at which a <i>generating unit</i> or a CCGT module or an <i>offshore power park module</i> , as the case may be, which is directly connected to the <i>national electricity transmission system</i> , connects to the <i>national electricity transmission system</i> . The default point of connection is taken to be the <i>busbar</i> clamp in the case of an air insulated substation, gas zone separator in the case of a gas insulated substation, or equivalent point as may be determined by the relevant <i>transmission licensees</i> for new types of substation.
Grid Supply Point (GSP)	A point of supply from the <i>onshore transmission system</i> to <i>network operators</i> or <i>non-embedded customers</i> .
Group Demand	For a single <i>GSP</i> or <i>OSP</i> : The forecast maximum demand for the <i>GSP</i> or <i>OSP</i> provided in accordance with the requirements of the Grid Code by the <i>network operators</i> or <i>non-embedded customers</i> taking demand from the <i>national electricity transmission system</i> . For multiple <i>GSPs</i> or <i>OSPs</i> : The sum of the forecast maximum demands for the <i>GSPs</i> or <i>OSPs</i> as provided by the <i>network operators</i> or <i>non-embedded customers</i> taking demand from the <i>national electricity transmission system</i> .
Infrequent Infeed Loss Risk	Until 31st March 2014, this is a <i>loss of power infeed</i> risk of 1320MW. From April 1st 2014, this is a <i>loss of power infeed</i> risk of 1800MW.
Infrequent Operational Switching	<i>Operational switching</i> associated with rare or infrequent events rather than routine management of the system. <i>Infrequent operational switching</i> includes, for example, isolation of circuits for maintenance and subsequent re-energisation, and operation of intertrip schemes consequent upon <i>secured events</i> . It would not include switching out of circuits for voltage control, or switching out of circuits to allow safe access to other plant, where it is foreseen that such switching may be a regular practice; such events would be classed as <i>operational switching</i> .

Insufficient Voltage Performance Margins In all timescales and in particular the post-fault periods (i.e. before, during and after the automatic controls take place), there are *insufficient voltage performance margins* when the following occurs:

- i) *voltage collapse*;
- ii) over-sensitivity of system voltage; or
- iii) unavoidably exceeds the reactive capability of *generating units* such that accessible reactive reserves are exhausted;

A.1 under any of the following conditions:

- i) *credible demand sensitivities*;
- ii) the unavailability of any single reactive compensator or other reactive power provider; or
- iii) the loss of any one automatic switching system or any automatic voltage control system for on-load tap changing.

Intact System This is the *national electricity transmission system* with no system outages i.e. with no *planned outages* (e.g. for maintenance) and no *unplanned outages* (e.g. subsequent to a fault).

Interconnection Allowance An allowance in MW to be added in whole or in part to transfers arising out of the *Security planned transfer condition* to take some account of non-average conditions (e.g. *power station* availability, weather and demand). This allowance is calculated by an empirical method described in Appendix D of this Standard.

Interface Point (IP) A point at which an *offshore transmission system*, which is directly connected to an *onshore transmission system*, connects to the *onshore transmission system*. The *Interface Point* is located at the *first onshore substation* which the *offshore transmission circuits* reach onshore. The default point of connection, within the *first onshore substation*, is taken to be the *busbar clamp* in the case of an air insulated substation, *gas zone separator* in the case of a gas insulated substation, on either the lower voltage (LV) *busbars* or the higher voltage (HV) *busbars* as may be determined by the relevant *transmission licensees*. Normally, and unless otherwise agreed, if the *offshore transmission owner* owns the *first onshore substation*, the *interface point* would be on the HV *busbars* and, if the *first onshore substation* is owned by the onshore transmission owner, the *interface point* would be on the LV *busbars*.

## Large Power Station

A *power station* which is:

1. directly connected to
  - a. *NGET's transmission system* where such *power station* has a *registered capacity* of 100MW or more;
  - b. *SPT's transmission system* where such *power station* has a *registered capacity* of 30MW or more; or
  - c. *SHET's transmission system* where such *power station* has a *registered capacity* of 10MW or more;

Or

2. Embedded within a *user system* (or part thereof) where such *user system* (or part thereof) is connected under normal operating conditions to:
  - a. *NGET's transmission system* where such *power station* has a *registered capacity* of 100MW or more; or
  - b. *SPT's transmission system* where such *power station* has a *registered capacity* of 30MW or more; or
  - c. *SHET's transmission system* where such *power station* has a *registered capacity* of 10MW or more.

Or

3. In *offshore waters*, a *power station* connected to an *offshore transmission system* with a *registered capacity* of 10MW or more.

## Local System Outage

In the context of a *demand group* or *offshore power station demand group*, a *planned outage* or *unplanned outage* local to a *demand group* or *offshore power station demand group*, as the case may be, such that it has a direct effect on the supply capacity to that *demand group* or *offshore power station demand group*. In the context of planning generation connections, a *planned outage* local to a *power station* such that it has a direct effect on the generation connection capacity requirements for that *power station*

## Loss of Power Infeed

The output of a *generating unit* or a group of *generating units* or the import from *external systems* disconnected from the *national electricity transmission system* by a *secured event*, less the demand disconnected from the *national electricity transmission system* by the same *secured event*.

-For the avoidance of doubt if, following such a *secured event*, demand associated with the normal operation of the affected *generating unit* or *generating units* is automatically transferred to a supply point which is not disconnected from the system, e.g. the station board, then this shall not be deducted from the total *loss of power infeed* to the system.

For the purpose of the operational criteria:

i) ~~the *loss of power infeed* includes the output of a single *generating unit*, CCGT Module, boiler, nuclear reactor or *import from an external system via a HV/DC Link, bi-pole lost as a result of an event.*~~

ii) In the case of an *offshore generating unit* or group of *offshore generating units*, the *loss of power infeed* is measured at the *interface point*, or *user system interface point*, as appropriate.

iii) In the case of an *offshore generating unit* or group of *offshore generating units* for which infeed will be automatically re-distributed to one or more *interface points* or *user system interface points* through one or more interlinks, the re-distribution should be taken into account in determining the total generation capacity that is disconnected. However, in assessing this re-distribution, consequential losses of infeed that might occur in the re-distribution timescales due to wider generation instability or tripping, including losses at distribution voltage levels, should be taken into account.



### Loss of Power Outfeed

The load taken by storage units, non-embedded customers, grid supply points, or the export to external systems disconnected from the national electricity transmission system by a secured event, less the generation disconnected from the national electricity transmission system by the same secured event.

For the avoidance of doubt if, following such a secured event, demand associated with the normal operation of the affected outfeed is automatically transferred to a grid supply point which is not disconnected from the national electricity transmission system, then this shall not be added to the total loss of power outfeed to the system.

For the purpose of the operational criteria:

- i) the loss of power outfeed includes demand from pump storage, battery storage and other storage, non-embedded customers, and export to external systems via a HVDC Link.
- ii) In the case of an offshore transmission system, the loss of power outfeed is measured at the interface point, or user system interface point, as appropriate.

### Loss of Supply Capacity

This is the reduction in the supply capacity at a *Grid Supply Point* or *offshore supply point* as a result of the *transmission licensees' failure* to maintain the potential to provide the supply capacity in full. For the avoidance of doubt, where the *transmission licensees* do maintain the potential to provide a supply but, following an outage, demand is lost because of circuit configurations not under the control of the *transmission licensees*, that lost supply does not constitute *loss of supply capacity*.

### Main Interconnected Transmission System (MITS)

This comprises all the 400kV and 275kV elements of the *onshore transmission system* and, in Scotland, the 132kV elements of the *onshore transmission system* operated in parallel with the *supergrid*, and any elements of an *offshore transmission system* operated in parallel with the *supergrid*, but excludes *generation circuits*, transformer connections to lower voltage systems, *external interconnections* between the *onshore transmission system* and *external systems*, and any *offshore transmission systems* radially connected to the *onshore transmission system* via single *interface points*.

### Maintenance Period Demand

This is the demand level experienced at a *GSP* and is the maximum demand level expected during the normal maintenance period. This level is such that the period in which maintenance could be undertaken is not unduly limited. Unless better data are available this should be 67% of the *group demand*.

Major System Fault	An event or sequence of events so fast that it is not practically possible to re-secure the system between each one, more onerous than those included in the normal set of <i>secured events</i> .
Major System Risk	A period of <i>major system risk</i> is one in which <i>secured events</i> are judged to be significantly more likely than under the circumstances addressed by the normal criteria of this Standard, or they are judged to have a significantly greater impact than normal, or events not normally secured against are judged to be significantly more likely than normal such that measures should be taken to mitigate their impact.
Marshalling Substation	A substation which connects circuits from more than two line routes.
Medium Power Station	<p>A <i>power station</i> which is:</p> <ol style="list-style-type: none"> <li>1. directly connected to <i>NGET's transmission system</i> where such <i>power station</i> has a <i>registered capacity</i> of 50MW or more, but less than 100MW; or</li> <li>2. embedded within an <i>user system</i> (or part thereof) where such <i>user system</i> (or part thereof) is connected under normal operating conditions to <i>NGET's transmission system</i> where such <i>power station</i> has a <i>registered capacity</i> of 50MW or more but less than 100MW;</li> </ol> <p>The <i>medium power station</i> category does not exist in <i>SPT's transmission system</i> and <i>SHET's transmission system</i>.</p>
National Electricity Transmission System	The <i>national electricity transmission system</i> comprises the <i>onshore transmission system</i> and the <i>offshore transmission systems</i> .
National Electricity Transmission System Operator Area	Has the meaning set out in Schedule 1 of NGENO's Transmission Licence

Network Operator	A person with a system directly connected to the <i>onshore transmission system</i> to which customers and/or <i>power stations</i> (not forming part of that system) are connected, acting in its capacity as an operator of that system, but shall not include a person who operates an <i>external system</i> .
NGESO	National Grid Electricity System Operator Limited (No. 11014226) whose registered office is 1-3 Strand, London WC2N 5EH as the holder of the transmission licence granted, or treated as granted, pursuant to Section 6(1)(b) of the Act and in which section C of the standard transmission licence conditions applies.
NGET	National Grid Electricity Transmission plc (No. 2366977) whose registered office is 1-3 Strand, London WC2N 5EH
Non-Embedded Customer	A customer, except for a <i>Network Operator</i> acting in its capacity as such receiving electricity direct from the <i>national electricity transmission system</i> irrespective of from whom it is supplied.
Normal Infeed Loss Risk	Until 31st March 2014, this is a <i>loss of power infeed</i> risk of 1000MW. From April 1st 2014, this is a <i>loss of power infeed</i> risk of 1320MW.
Offshore	Means wholly or partly in <i>offshore waters</i> , and when used in conjunction with another term and not defined means that the associated term is to be read accordingly.
Offshore Generating Unit	Any apparatus, which produces electricity including, a synchronous <i>offshore generating unit</i> and non-synchronous <i>offshore generating unit</i> and which is located in <i>offshore waters</i> .
Offshore Grid Entry Point Capacity (OffGEP Capacity)	The cumulative <i>registered capacity</i> of all <i>offshore power stations</i> connected at a single <i>offshore grid entry point</i> and/or the cumulative <i>registered capacity</i> of all <i>offshore power stations</i> connected to all the <i>offshore grid entry points</i> of an <i>offshore transmission system</i>
Offshore Platform	A platform, located in <i>offshore waters</i> , which contains plant and apparatus associated with the generation and/or transmission of electricity including high voltage electrical circuits which form part of an <i>offshore transmission system</i> and which may include one or more <i>offshore grid entry points</i> .

Offshore Power Park Module	<p>A collection of one or more <i>offshore power park strings</i>, located in <i>offshore waters</i>, registered as an <i>offshore power park module</i> under the provisions of the Grid Code. There is no limit to the number of <i>offshore power park strings</i> within the <i>offshore power park module</i>, so long as they either:</p> <ul style="list-style-type: none"> <li>a) connect to the same <i>busbar</i> which cannot be electrically split; or</li> <li>b) connect to a collection of directly electrically connected <i>busbars</i> of the same nominal voltage and are configured in accordance with the operating arrangements set out in the relevant Bilateral Agreement.</li> </ul>
Offshore Power Park String	<p>A collection of non-synchronous <i>offshore generating units</i>, located in <i>offshore waters</i> that are powered by an intermittent power source joined together by cables with a single point of connection to an <i>offshore transmission system</i>.</p>
Offshore Power Station	<p>An installation, located in <i>offshore waters</i>, comprising one or more <i>offshore generating units</i> or <i>offshore power park modules</i> or <i>offshore gas turbines</i> (even where sited separately) owned and/or controlled by the same <i>generator</i>, which may reasonably be considered as being managed as one <i>offshore power station</i>.</p>
Offshore Power Station Demand Group	<p>An <i>offshore</i> site or group of <i>offshore</i> sites located on an <i>offshore platform/s</i> which collectively take power from the remainder of an <i>offshore transmission system</i> for the purpose of supplying <i>offshore power station</i> demand.</p>
Offshore Supply Point (OSP)	<p>A point of supply from an <i>offshore transmission system</i> to an <i>offshore power station</i>.</p>
Offshore Transmission Circuit	<p>Part of an <i>offshore transmission system</i> between two or more circuit-breakers which includes, for example, transformers, reactors, cables, overhead lines and <i>DC converters</i> but excludes <i>busbars</i> and <i>onshore transmission circuits</i>.</p>
Offshore Transmission Licensee	<p>Means the holder of a Transmission Licence in respect of an <i>offshore transmission system</i> granted under Section 6 (1) (b) of the Electricity Act 1989 (as amended by the Utilities Act 2000 and the Energy Act 2004)</p>

Offshore Transmission System	A system consisting (wholly or mainly) of high voltage lines of 132kV or greater owned and/or operated by an <i>offshore transmission licensee</i> and used for the transmission of electricity to or from an <i>offshore power station</i> to or from an <i>interface point</i> , or <i>user system interface point</i> if embedded, or to or from another <i>offshore power station</i> and includes equipment, plant and apparatus and meters owned or operated by an <i>offshore transmission licensee</i> in connection with the transmission of electricity. An <i>offshore transmission system</i> extends from the <i>interface point</i> or <i>user system interface point</i> , as the case may be, to the <i>offshore grid entry point/s</i> and may include plant and apparatus located onshore and <i>offshore</i> . For the avoidance of doubt, the <i>offshore transmission systems</i> , together with the <i>onshore transmission system</i> , form the <i>national electricity transmission system</i> .
Offshore Waters	Has the meaning given to “ <i>offshore waters</i> ” in Section 90(9) of the Energy Act 2004.
Onshore Generating Unit	Any apparatus which produces electricity including a synchronous <i>generating unit</i> and non-synchronous <i>generating unit</i> but excluding an <i>offshore generating unit</i> .
Onshore Power Park Module	A collection of non-synchronous <i>generating units</i> (registered as a <i>power park module</i> under the Planning Code in the Grid Code) that are powered by an intermittent power source, joined together by a system with a single point of electrical connection to the <i>onshore transmission system</i> (or <i>user system</i> if embedded). The connection to the <i>onshore transmission system</i> (or <i>user system</i> if embedded) may include a <i>DC converter</i> .
Onshore Power Station	An installation comprising one or more <i>onshore generating units</i> or <i>onshore power park module</i> (even where sited separately) owned and/or controlled by the same <i>generator</i> , which may reasonably be considered as being managed as one <i>onshore power station</i> .
Onshore Transmission Circuit	Part of the <i>onshore transmission system</i> between two or more circuit-breakers which include, for example, transformers, reactors, cables and overhead lines and <i>DC converters</i> , but excludes <i>busbars</i> , <i>generation circuits</i> and <i>offshore transmission circuits</i> .
Onshore Transmission Licensee	<i>NETG</i> , <i>SPT</i> , <i>SHET</i> 's and such other person who is the holder of a transmission licence in respect of an onshore transmission system granted under Section 6 (1) (b) of the Electricity Act 1989 (as amended by the Utilities Act 2000 and the Energy Act 2004).

Onshore Transmission System	The system consisting (wholly or mainly) of high voltage electric lines owned or operated by <i>onshore transmission licensees</i> and used for the transmission of electricity from one <i>power station</i> to a substation or to another <i>power station</i> or between substations or to or from <i>offshore transmission systems</i> or to or from any <i>external interconnections</i> and includes any plant and apparatus and meters owned or operated by <i>onshore transmission licensees</i> within <i>Great Britain</i> in connection with the transmission of electricity. The <i>onshore transmission system</i> does not include any <i>remote transmission assets</i> . For the avoidance of doubt, the <i>onshore transmission system</i> , together with the <i>offshore transmission systems</i> form the <i>national electricity transmission system</i> .
Operational Intertripping	The automatic tripping of circuit breakers to remove <i>generating units</i> and/or demand. It does not provide additional <i>transmission capacity</i> and must not lead to <i>unacceptable frequency conditions</i> for any <i>secured event</i> .
Operational Switching	Operation of plant and/or apparatus within the <i>onshore transmission system</i> or <i>offshore transmission system</i> to the instruction of the relevant control engineer. For the avoidance of doubt, <i>operational switching</i> includes manual actions and automatic actions including tap-changing, auto-switching schemes and automatic reactive switching schemes.
Planned Outage	An outage of one or more items of primary transmission apparatus and/or generation plant, initiated by manually instructed action which has been subject to the recognised <i>national electricity transmission system operator area</i> outage planning process.
Planned Transfer Conditions	The condition arising from scaling the <i>registered capacities</i> of each <i>power station</i> such that the total of the scaled capacities is equal to the <i>ACS peak demand</i> minus imports from <i>external systems</i> . This scaling shall follow the techniques described in Appendix C.

Plant Margin	The amount by which the total installed capacity of <i>power stations</i> exceeds the net amount of the <i>ACS peak demand</i> minus the total imports from <i>external systems</i> . This is often expressed as a percentage (e.g. 20%) or as a decimal fraction (e.g. 0.2) of the net amount of the <i>ACS peak demand</i> minus the total imports from <i>external systems</i> .
Power Park Module	An <i>onshore power park module</i> and/or an <i>offshore power park module</i>
Power Station	Means an <i>onshore power station</i> or an <i>offshore power station</i> .
Pre-Fault Planning Voltage Limits	The voltage limits for use in planning timescales for circumstances before a fault.
Pre-Fault Rating	The specified pre-fault capability of transmission equipment. Due allowance shall be made for specific conditions (e.g. ambient/seasonal temperature), agreed time-dependent loading cycles of equipment and any additional relevant procedures. In operational timeframes dynamic ratings may also be used where available.
Prevailing System Conditions	These are conditions on the <i>national electricity transmission system</i> prevailing at any given time and will therefore normally include <i>planned outages</i> and <i>unplanned outages</i> .
Primary Transmission Equipment	Any equipment installed on the <i>national electricity transmission system</i> to enable bulk transfer of power. This will include <i>transmission circuits</i> , <i>busbars</i> , and switchgear.

## Registered Capacity

- a) In the case of a *generating unit* other than that forming part of a CCGT module or *power park module*, the normal full load capacity of a *generating unit* as declared by the *generator*, less the MW consumed by the *generating unit* through the *generating unit's* unit transformer when producing the same (the resultant figure being expressed in whole MW).
- b) In the case of a CCGT module or *offshore gas turbine* or *power park module*, the normal full load capacity of the CCGT module or *offshore gas turbine* or *power park module* (as the case may be) as declared by the *generator*, being the active power declared by the *generator* as being deliverable by the CCGT module or *offshore gas turbine* or *power park module* at the *GEP* (or in the case of a CCGT module or *offshore gas turbine* or *power park module* embedded in a *user system*, at the *user system* entry point), expressed in whole MW.
- c) In the case of a *power station*, the maximum amount of active power deliverable by the *power station* at the *GEP* (or in the case of a *power station* embedded in a *user system*, at the *user system* entry point), as declared by the *generator*, expressed in whole MW. The maximum active power deliverable is the maximum amount deliverable simultaneously by the *generating units* and/or CCGT modules and/or *offshore gas turbines* and/or *power park modules* less the MW consumed by the *generating units* and/or CCGT modules and/or *offshore gas turbines* and/or *power park modules* in producing that active power.
- d) In the case of a *DC converter* at a *DC converter* station, supplying active power to the *national electricity transmission system*, or a *user system*, from an *external system* or *generating unit(s)*, the normal full load amount of active power transferable from a *DC converter* at the *GEP* (or in the case of an embedded *DC converter* station at the *user system* entry point), as declared by the *DC converter* station owner, expressed in whole MW, or in MW to one decimal place.
- e) In the case of a *DC converter* station supplying active power to the *national electricity transmission system*, or a *user system*, from an *external system* or *generating unit(s)*, the maximum amount of active power transferable from a *DC converter* station at the *GEP* (or in the case of an embedded *DC converter* station at the *user system* entry point), as declared by the *DC converter* station owner, expressed in whole MW, or in MW to one decimal place.



Secured Event

A contingency which would be considered for the purposes of assessing system security and which must not result in the remaining *national electricity transmission system* being in breach of the security criteria. *Secured events* are individually specified throughout the text of this Standard. It is recognised that more onerous unsecured events may occur and additional operational measures within the requirements of the Grid Code may be utilised to maintain overall *national electricity transmission system* integrity.

Security Conditions    Planned Transfer

The condition arising from scaling the *registered capacity* of each *power station* that is considered able to reliably contribute to peak demand security such that the total of the scaled capacities is equal to the *ACS peak demand*. Generation powered by intermittent sources (e.g. wind, wave, solar) and imports from *external systems* are not included in this condition. This scaling shall follow the techniques described in Appendix C.

SHET

Scottish Hydro-Electric Transmission plc (No. SC213461) whose registered office is situated at Inveralmond HS, 200 Dunkeld Road, Perth, Perthshire PH1 3AQ.

## Small Power Station

A *power station* which is:

1. directly connected to:
  - a. *NGET's transmission system* where such *power station* has a *registered capacity* of less than 50MW; or
  - b. *SPT's transmission system* where such *power station* has a *registered capacity* of less than 30MW;
  - c. *SHET's transmission system* where such *power station* has a *registered capacity* of less than 10 MW;

Or

2. embedded within a *user system* (or part thereof) where such *user system* (or part thereof) is connected under normal operating conditions to:

- a. *NGET's transmission system* where such *power station* has a *registered capacity* of less than 50MW;
- b. *SPT's transmission system* where such *power station* has a *registered capacity* of less than 30MW;
- c. *SHET's transmission system* where such *power station* has a *registered capacity* of less than 10MW;

Or

3. In *offshore waters*, a *power station* connected to an *offshore transmission system* with a *registered capacity* of less than 10MW.

## SPT

SP Transmission Limited (No. SC189126) whose registered office is situated at 1 Atlantic Quay, Robertson Street, Glasgow G2 8SP.

## Steady State

A condition of a power system in which all automatic and manual *corrective actions* have taken place and all of the operating quantities that characterise it can be considered constant for the purpose of analysis.

## Sub-Synchronous Oscillations

Power system oscillations at frequencies that are less than the power frequency. They arise from modes of oscillation associated with interactions between certain elements on the system such as generator rotor circuits, generator shaft systems, series compensated lines, excitation system controllers, power system stabilisers, converter controllers of power park modules and converter controllers of DC interconnectors and links.

## Supergrid

That part of the *national electricity transmission system* operated at a nominal voltage of ~~275kV and~~ above 200kV.

## System Instability

A.1 i) poor damping - where electromechanical oscillations of *generating units* are such that the resultant peak deviations in machine rotor angle and/or speed at the end of a 20 second period remain in excess of 15% of the peak deviations at the outset (i.e. the time constant of the slowest mode of oscillation exceeds 12 seconds); or

A.1 ii) pole slipping - where one or more transmission connected synchronous *generating units* lose synchronism with the remainder of the system to which it is connected

For the purpose of assessing the existence of *system instability*, a *fault outage* is taken to include a solid three phase to earth fault (or faults) anywhere on the *national electricity transmission system* with an appropriate clearance time.

The appropriate clearance time is identified as follows:

i) In *NGET's transmission system* and on other circuits identified by agreement between the relevant *transmission licensees*, clearance times consistent with the fault location together with the worst single failure in the main protection system should be used;

ii) elsewhere, clearance times should be consistent with the fault location and appropriate to the actual protection, signalling equipment, trip and interposing relays, and circuit breakers involved in clearing the fault.

## Transfer Capacity

That circuit capacity from adjacent *demand groups* which can be made available within the times stated in Table 3.1

## Transient Time Phase

The time within which fault clearance or initial system switching, the transient decay and recovery, auto switching schemes, *generator* inter-tripping, and fast, automatic responses of controls such as *generator* AVR and SVC take place. Load response may be assumed to have taken place. Typically 0 to 5 seconds after an initiating event.

## Transmission Capacity

The ability of a network to transmit electricity. It does not include the use of *operational intertripping* except in respect of paragraph 2.13 in Section 2, paragraph 4.10 in Section 4 and paragraphs 7.7 to 7.13 & 7.16 in Section 7.

## Transmission Circuit

This is either an *onshore transmission circuit* or an *offshore transmission circuit*.

Transmission Licensee Means an *onshore transmission licensee* or an *offshore transmission licensee* or *NGESO* and shall be construed accordingly.

Transmission System Has the same meaning as the term “*licensee’s transmission system*” in the Transmission licence of a *Transmission licensee*.

Unacceptable Frequency Conditions These are conditions where:  
i) the *steady state* frequency falls outside the statutory limits of 49.5Hz to 50.5Hz; or  
ii) a transient frequency deviation on the *MITS* ~~does not meet the criteria below, persists outside the above statutory limits and does not recover to within 49.5Hz to 50.5Hz within 60 seconds.~~

Transient frequency deviations outside the limits of 49.5Hz and 50.5Hz shall:

- ~~only~~ occur at intervals which ought to reasonably be considered as infrequent.
- ~~only persist for a duration which ought to reasonably be considered as tolerable; and~~
- ~~only deviate by a magnitude which ought to reasonably be considered as tolerable.~~

~~The *Frequency Risk and Control Report* will define what is considered reasonable, infrequent and tolerable for each of these criteria for transient frequency deviations.~~

~~In order to avoid the occurrence of *Unacceptable Frequency Conditions*:~~

- a) ~~The minimum level of *loss of power infeed risk* which is covered over long periods operationally by frequency response to avoid frequency deviations below 49.5Hz or above 50.5Hz will be the actual *loss of power infeed risk* present at connections planned in accordance with the *normal infeed loss risk criteria*;~~
- b) ~~The minimum level of *loss of power infeed risk* which is covered over long periods operationally by frequency response to avoid frequency deviations below 49.5Hz or above 50.5Hz for more than 60 seconds will be the actual *loss of power infeed risk* present at connections planned in accordance with the *infrequent infeed loss risk criteria*.~~

It is not possible to be prescriptive with regard to the type of *secured event* which could lead to transient *frequency* deviations since this will depend on the extant frequency response characteristics of the system which NGESO adjust from time to time to meet the security and quality requirements of this Standard.

Unacceptable Overloading	The overloading of any <i>primary transmission equipment</i> beyond its specified time-related capability. Due allowance shall be made for specific conditions (e.g. ambient/seasonal temperature), pre-fault loading, agreed time-dependent loading cycles of equipment and any additional relevant procedures. In operational timeframes dynamic ratings may also be used where available.
Unacceptable Sub-Synchronous Oscillations	Unacceptable Sub-Synchronous Oscillations are Sub-Synchronous Oscillations with the relevant modes of oscillation having negative or insufficient net damping. Unacceptable Sub-Synchronous Oscillations may have a significant effect on generating units including a significant reduction in the lifetime of the machine shaft system due to fatigue or the failure of some of its electrical components due to high voltages and / or currents.
Unacceptable Voltage Conditions	Voltages out with those specified in Section 6, Voltage Limits in Planning and Operating the <i>Onshore Transmission System</i> and/or outside the limits specified in Section 10, Voltage Limits in Planning and Operating an <i>Offshore Transmission System</i> , as applicable.
Unacceptably High Voltage	Steady state voltages above the maximum values specified in Section 6, Voltage Limits In Planning and Operating the <i>Onshore Transmission System</i> and/or above the maximum values specified in Section 10, Voltage Limits In Planning and Operating an <i>Offshore Transmission System</i> , as applicable.
Unplanned Outage	An outage of one or more items of <i>primary transmission apparatus</i> and/or generation plant, initiated by manually instructed action which has not been subject to the recognised <i>national electricity transmission system operator area</i> outage planning process.

## User System

Any system owned or operated by a user of the *national electricity transmission system* other than a *transmission licensee* comprising:

- a) *generating units*; and/or
- b) systems consisting wholly or mainly of electric circuits used for the distribution of electricity from *grid supply points* or *offshore supply points* or *generating units* or other entry points to the point of delivery to customers or other users.

and plant and/or apparatus connecting:

- c) the system described above; or
- d) *non-embedded customers'* equipment;

to the *national electricity transmission system* or to the relevant other *user system*, as the case may be.

The *user system* includes any *remote transmission assets* operated by such user or other person and any plant and/or apparatus and meters owned or operated by the user or other person in connection with the distribution of electricity but do not include any part of the *national electricity transmission system*.

## User System Interface Point (USIP)

A point at which an *offshore transmission system*, which is directly connected to a *user system*, connects to the *user system*. The *user system interface point* is located at the *first onshore substation* which the *offshore transmission circuits* reach onshore. The default point of connection, within the *first onshore substation*, is taken to be the *busbar clamp* in the case of an air insulated substation, gas zone separator in the case of a gas insulated substation, or equivalent point on either the lower voltage (LV) busbars or the higher voltage (HV) *busbars* as may be determined by the relevant *transmission licensee* and *distribution licensee*. Normally, and unless otherwise agreed, if the *offshore transmission owner* owns the *first onshore substation*, the *user system interface point* would be on the HV *busbars* and if the *first onshore substation* is owned by the onshore distribution owner, the *user system interface point* would be on the LV *busbars*.

## Voltage Collapse

Where progressive, fast or slow voltage decrease or increase develops such that it can lead to either tripping of *generating units* and/or loss of demand.

## Voltage Step Change

The difference in voltage between that immediately before a *secured event* or operational switching and that at the end of the *transient time phase* after the event.

# Appendix A Recommended Substation Configuration and Switching Arrangements

## Part 1 – Onshore Transmission System

A.1 The recommendations set out in paragraphs A.2 to A.6 apply to the *onshore transmission system*

A.2 The key factors which must be considered when planning the *onshore transmission system* substation include:

- A.2.1 Security and Quality of Supply - Relevant criteria are presented in Sections 2, 3 and 4.
- A.2.2 Extendibility - The design should allow for the forecast need for future extensions.
- A.2.3 Maintainability - The design must take account of the practicalities of maintaining the substation and associated circuits.
- A.2.4 Operational Flexibility - The physical layout of individual circuits and groups of circuits must permit the required power flow control.
- A.2.5 Protection Arrangements - The design must allow for adequate protection of each system element.
- A.2.6 Short Circuit Limitations - In order to contain short circuit currents to acceptable levels, *busbar* arrangements with sectioning facilities may be required to allow the system to be split or re-connected through a fault current limiting reactor.
- A.2.7 Land Area - The low availability and/or high cost of land particularly in densely populated areas may place a restriction on the size and consequent layout of the substation.
- A.2.8 Cost

A.3 Accordingly the design of a substation is a function of prevailing circumstances and future requirements as perceived in the planning time phase. This appendix is intended as a functional guidance for substation layout design and switchgear arrangements. Variations away from this guidance are permissible provided that such variations comply with the requirements of the criteria set out in the main text of this Standard.

### **Generation Point of Connection Substations**

A.4 In accordance with the planning criteria for generation connection set out in Section 2, *generation point of connection* substations should:

- A.4.1 have a double *busbar* design (i.e. with main and reserve *busbars* such that *generation circuits* and *onshore transmission circuits* may be selected to either);

- A.4.2 have sufficient *busbar* sections to permit the requirements of paragraph 2.6 to be met without splitting the substation during maintenance of *busbar* sections;
- A.4.3 have sufficient *busbar* coupler and/or *busbar* section circuit breakers so that each section of the main and reserve *busbar* may be energised using either a *busbar* coupler or *busbar* section circuit breaker;
- A.4.4 have *generation circuits* and *onshore transmission circuits* disposed between *busbar* sections such that the main *busbar* may be operated split for fault level control purposes; and
- A.4.5 have sufficient facilities to permit the transfer of *generation circuits* and *onshore transmission circuits* from one section of the main *busbar* to another.

### **Marshalling Substations**

- A.5 Marshalling substations should:
  - A.5.1 have a double *busbar* design (i.e. with main and reserve *busbars* such that *onshore transmission circuits* may be selected to either);
  - A.5.2 have sufficient *busbar* sections to permit the requirements of paragraphs 2.6, 4.6 and 4.9 to be met;
  - A.5.3 have *onshore transmission circuits* disposed between *busbar* sections such that the main *busbar* may be operated split for fault level control purposes; and
  - A.5.4 have sufficient facilities to permit the transfer of *onshore transmission circuits* from one section of *busbar* to another.

### **Grid Supply Point Substations**

A.6 In accordance with the planning criteria for demand connection set out in Section 3, *GSP* substations configurations range from a single transformer teed into an *onshore transmission circuit* to a four switched mesh substation or a double *busbar* substation. The choice and need for the extendibility will depend on the circumstances as perceived in the planning time phase.



## **Part 2 – Offshore Transmission Systems**

A.7 The recommendations set out in paragraphs A.7 to A.15 apply to *offshore transmission systems*

A.8 The key factors which must be considered when planning an *offshore transmission system* substation include:

- A.8.1 Security and Quality of Supply - Relevant criteria are presented in Sections 7 and 8.
- A.8.2 Maintainability - The design must take account of the practicalities of maintaining the substation and associated circuits.
- A.8.3 Operational Flexibility - The physical layout of individual circuits and groups of circuits must permit the required power flow control.
- A.8.4 Protection Arrangements - The design must allow for adequate protection of each system element.
- A.8.5 Short Circuit Limitations - In order to contain short circuit currents to acceptable levels, *busbar* arrangements with sectioning facilities may be required to allow the system to be split or re-connected through a fault current limiting reactor.
- A.8.6 Available Area –The high cost of the *offshore platform* may place a restriction on the size and consequent layout of the substation.
- A.8.7 Cost.

A.9 Accordingly the design of a substation is a function of prevailing circumstances and future requirements as perceived in the planning time phase. This appendix is intended as a functional guidance for substation layout design and switchgear arrangements. Variations away from this guidance are permissible provided that such variations comply with the requirements of the criteria set out in the main text of this Standard.

### **Offshore Transmission System Substations**

*Offshore* GEP Substations (on an *Offshore Platform*)

A.10 In accordance with the planning criteria for *offshore* generation connection set out in Section 7, the substation should:

- A.10.1 have sufficient *busbar* sections to permit the requirements of paragraph 7.8 to be met without splitting the substation during maintenance of *busbar* sections; and
- A.10.2 have sufficient *busbar* coupler and/or *busbar* section circuit breakers so that each *busbar* section may be energised using either a *busbar* coupler or *busbar* section circuit breaker.

### **IP and USIP Substations**

A.11 The following recommendations apply equally to substations at the:

- A.11.1 Onshore *Interface Point* (at the *First Onshore Substation*); and
- A.11.2 Onshore *User System Interface Point* (at the *First Onshore Substation*)
- A.12 In accordance with the planning criteria for *offshore* generation connection set out in Section 7, the substation should in the case of an *offshore power park module* and multiple gas turbine connections:
  - A.12.1 have a double *busbar* design (i.e. with main and reserve *busbars* such that *offshore generation circuits* owned by the *generator* and *offshore transmission circuits* may be selected to either);
  - A.12.2 have sufficient *busbar* sections to permit the requirements of paragraph 7.13 to be met without splitting the substation during maintenance of *busbar* sections;
  - A.12.3 have sufficient *busbar* coupler and/or *busbar* section circuit breakers so that each section of the main and reserve *busbar* may be energised using either a *busbar* coupler or *busbar* section circuit breaker; and
  - A.12.4 have sufficient facilities to permit the transfer of *offshore generation circuits* owned by the *generator* and *offshore transmission circuits* from one section of the main *busbar* to another.
- A.13 In the case of a single gas turbine connection and in accordance with the planning criteria for *offshore* generation connection set out in Section 7, the substation should have a single *busbar* design;

### ***Marshalling Substations***

- A.14 The following recommendations apply to *offshore marshalling substations*, which interconnect *offshore transmission circuits* from two or more *offshore platforms*, where *offshore grid entry points* are located, and the *first onshore substation*, where the *interface point* or *user system interface point* is located.
- A.15 *Marshalling Substations* should:
  - A.15.1 have a double *busbar* design (i.e. with main and reserve *busbars* such that *offshore transmission circuits* may be selected to either);
  - A.15.2 have sufficient *busbar* sections to permit the requirements of Section 7 to be met;
  - A.15.3 have *transmission circuits* disposed between *busbar* sections such that the main *busbar* may be operated split for fault level control purposes; and
  - A.15.4 have sufficient facilities to permit the transfer of *offshore transmission circuits* from one section of *busbar* to another.

## Offshore Supply Point Substations

A.16 *Offshore supply point substations* should be designed to meet the requirements of Section 8. The actual design will depend on the circumstances as perceived in the planning time phase.

## Appendix B      **Circuit Complexity on the *Onshore Transmission System***

B.1 This appendix defines restrictions to be applied by the relevant *onshore transmission licensee* when *onshore transmission circuits* are designed, constructed or extended. These restrictions are intended to ensure that the time required to isolate and earth circuits in preparation for maintenance work is kept to a minimum and is not disproportionate to the time required to carry out maintenance work. The restrictions also limit the potential for human error.

B.2 This appendix is divided into two parts. The first defines those restrictions that apply to *transmission circuits* on the *supergrid* part of the *MITS*. The second gives guidance on those restrictions that may be applied to *transmission circuits* on that part of the *MITS* operated at a nominal voltage of 132kV.

### **Restrictions for *Transmission Circuits* on the *Supergrid***

B.3 The three restrictions to be applied to *transmission circuits* on the *supergrid* part of the *MITS* are as follows.

B.3.1 The facilities, for the isolation and earthing of *transmission circuits* and Transmission Equipment, shall not be located at more than three individual sites;

B.3.2 The normal operational procedure, for the isolation and earthing of *transmission circuits* and Transmission Equipment, shall not require the operation of more than five circuit-breakers; and

B.3.3 No more than three transformers shall be connected together and controlled by the same circuit breaker.

B.4 A site, in this context, is defined as being where the points of isolation at one end of a *transmission circuit* are within the same substation such that only one authorised person is required, at the site, to enable the efficient and effective release and restoration of the circuit.

B.5 If the design of a substation is such that two circuit-breakers of the same voltage are used to control a circuit (e.g. in a mesh type of substation), for the purposes of the above restrictions the two circuit-breakers are to be considered as a single circuit breaker. This also applies where duplicate circuit-breakers control a circuit including those used for *busbar* selection.

B.6 Switch disconnectors that are not rated for fault breaking duty should not be included in the design of new *transmission circuits* and substations for the purpose of reducing complexity. Where the extension of an existing *transmission circuit* includes an existing switch disconnector and that switch disconnector is not rated for fault

breaking duty, that switch disconnecter can be considered for use in planned switching procedures only.

B.7 For the purposes of restriction in B.3.3 a transformer which includes two low voltage windings in its construction shall be considered as single transformer.

### **Guidance for *Transmission Circuits* Operated at a Nominal Voltage of 132kV**

B.8 The restrictions recommended below should be regarded as being in general the limits of good planning. The majority of 132 kV circuits do not reach this limit nor will they be expected to do so.

B.9 Any proposals which would result in these limits being exceeded should be fully explained and agreed with operational engineers.

B.10 Care must be observed in the application of these recommendations to “Active Circuits” to ensure that protective gear clearance times and discrimination are satisfactory and that the security of lower voltage connected generation is not unduly prejudiced.

#### Restriction A

B.11 The normal operating procedure or protective gear operation for making dead any 132 kV circuit shall not require the opening of more than seven circuit-breakers. These circuit-breakers shall not be located on more than four different sites.

B.11.1 The circuit-breakers to be counted include all those which connect the circuit to other parts of the system.

B.11.2 In a mesh or similar type substation, two circuit-breakers of the same voltage in the mesh controlling a circuit count as one circuit-breaker.

B.11.3 Where a circuit is controlled by two circuit-breakers which select between main and reserve *busbars*, these count as one circuit-breaker.

B.11.4 Switching isolators are not regarded as circuit-breakers for the purpose of this restriction.

#### Restriction B

B.12 Not more than three transformers shall be banked together on any one circuit at any one site.

B.12.1 A transformer with two lower voltage windings counts as one transformer.

#### Restriction C

B.13 No item of equipment shall have isolating facilities on more than four different sites.

B.13.1 Isolating facilities will normally be provided by means of circuit-breakers and their associated isolators.

B.13.2 Points of isolation on a circuit within an agreed reasonable walking distance to permit the efficient and effective use of one authorised

person only at those points during the release and restoration of the circuit shall be regarded as being on one site.

- B.13.3 Switching isolators having a “fault make, load break” capability shall be regarded as circuit-breakers for the purpose of this restriction.
- B.13.4 In special circumstances a plain-break normally-open isolator may be counted as an isolating facility for the equipment on either side of it. An example of this is an isolator in the route of a circuit bridging two *supergrid* zones which would be closed only for emergencies of greater severity than those covered by the security standards for 132 kV planning.

## Appendix C Modelling of Security Planned Transfer

C.1 There are two techniques relevant to the determination of *Security planned transfer conditions*. For circumstances in which apparent future *plant margins* exceed 20%, the 'Ranking Order technique' should be applied. Where the apparent future *plant margin* is 20% or less, the 'Straight Scaling Technique' should be applied. These techniques are described below.

C.2 Imports from *external systems* (e.g. in France or Ireland) shall not be scaled under either of these two scaling techniques because they result from tranches of generation rather than single *power stations*.

### Availability Factors

C.3 In derivation of *Security planned transfer conditions*, the registered capacities of *power stations* are scaled by availability factors, known as  $A_T$ , for classes T of *power station*. For the *Security planned transfer condition*, these factors are set as follows:

C.3.1 For stations powered by wind, wave, or tides,  $A_T = 0$ . This zero factor is set for the *Security planned transfer condition* so that there is confidence that there is sufficient *transmission capacity* to meet demand securely in the absence of this class of generation.

C.3.2 For imports or exports from / to *external systems*,  $A_T = 0$ .

A.1 C.3.3 For all other *power stations*,  $A_T = 1.0$

### Ranking Order Technique

C.4 In some circumstances apparent future *plant margins* may exceed 20%. This may arise where NGENSO has been notified of increases in future generation capacity but has not yet been formally notified of future reductions in generation capacity due to plant closures. The ranking order technique maintains the output of *power stations* considered more likely to operate at times of *ACS peak demand* at more realistic levels and treats those less likely to operate as non-contributory.

C.5 This is achieved by ranking all directly connected *power stations*, embedded *large power stations*, and groups of embedded *medium power stations* and embedded *small power stations* aggregated based on their generation technology and their location in order of likelihood of operation at times of *ACS peak demand*. Those *power stations* considered least likely to operate at peak are progressively removed and treated as non-contributory until a *plant margin* of 20% or just below is achieved. The output of the remainder is then calculated using the same scaling method as used in the straight scaling technique described in paragraphs C.5 and C.6 below.

### Straight Scaling Technique

C.6 In this technique, all *power stations* at the time of the *ACS peak demand* are considered contributory and their output is calculated by applying a scaling factor to their *registered capacity* proportional to an availability representative of the *generating*

*plant type* at the time of *ACS peak demand* such that their aggregate output is equal to the forecast *ACS peak demand* minus total imports from *external systems*.

C.7 Thus,

$$P_{T_i} = S \cdot A_T \cdot R_{T_i}$$

Where

$$S = \frac{P_{\text{loss}} + \sum_j L_j}{\sum_T \left( A_T \cdot \sum_i R_{T_i} \right)}$$

and

- $P_{T_i}$  = the output of the *i*th power station of generating plant type *T*
- $A_T$  = an availability representative of generating plant type *T* at the time of *ACS peak demand*
- $R_{T_i}$  = the registered capacity of the *i*th power station of generating plant type *T*
- $P_{\text{loss}}$  = total national electricity transmission system active power losses at time of *ACS peak demand*
- $L_j$  = the active power demand at the *j*th national electricity transmission system demand site at the time of *ACS peak demand*



## Appendix D Application of the *Interconnection Allowance*

D.1 This appendix outlines the techniques underlying the use of the *interconnection allowance* under paragraphs 4.4.2 and 4.4.5.

D.2 The modification of the *MITS Security planned transfer condition* power flow pattern to reflect an *interconnection allowance* shall apply to the *national electricity transmission system* divided into any two contiguous parts provided that

D.2.1 the smaller part contains more than 1500MW of demand at the time of the *ACS peak demand*; and

D.2.2 the boundary between the two parts lies on the boundary between *SHE's transmission system* and *SPT's transmission system*, or between *SPT's transmission system* and *NGET's transmission system*, or entirely within *NGET's transmission system*.

D.3 The *interconnection allowance* is then applied by:-

D.3.1 summing the demand and the total active power generation output (including imports from *external systems*) under the *Security planned transfer condition* within the smaller of the two parts and expressing this sum as a percentage of twice the *ACS peak demand*;

D.3.2 using Figure D.1, traditionally known as the 'Circle Diagram', to determine the *interconnection allowance* (in MW) by taking the appropriate percentage of the *ACS peak demand*;

D.3.3 finding the total active power generation output and total demand in each part of the system when applying the *interconnection allowance* or half *interconnection allowance* (as appropriate) as described in paragraphs D.4 and D.5;

D.3.4 for the conditions described under paragraph 4.4.2, proportionally scaling all the generation and demand in both parts of the system, as described in paragraphs D.4 and D.5 below, such that the transfer between the two parts increases by: first, the full *interconnection allowance* when considering the single *fault outages* in 4.6.1; and second, half the *interconnection allowance* for all other *secured events* in paragraph 4.6;

D.3.5 for the conditions described under paragraph 4.4.5, proportionally scaling demand in both parts of the system and setting *generating units* with their outputs such that their totals are as described in paragraphs D.4 and D.5 below such that the transfer between the two parts increases by: first, the full *interconnection allowance* when considering the single *fault outages* in item 4.6.1; and second, half the *interconnection allowance* for all other *secured events* in paragraph 4.6.

D.4 Suppose that the two contiguous parts of the system in question are areas 1 and 2 and that area 1 exports to area 2. Let  $G_1$  and  $G_2$  be the total generation in areas 1 and 2 respectively and  $D_1$  and  $D_2$  be the total demand in areas 1 and 2 under the *Security planned transfer condition*. Let  $I$  be the transfer required in addition to that under the *Security planned transfer condition* (i.e. the value of  $I$  is equal to the *interconnection allowance* or half the *interconnection allowance* as specified in paragraphs D.3.4 and D.3.5).

D.5 The additional transfer is proportionally divided between the generation and demand in the two areas as follows:

the total demands after application of the *interconnection allowance* or half *interconnection allowance* in areas 1 and 2 are

$$D'_1 = k_{d1} D_1$$
$$D'_2 = k_{d2} D_2$$

and the total amounts of generation in areas 1 and 2 are

$$G'_1 = k_{g1} G_1$$
$$G'_2 = k_{g2} G_2$$

where

$$k_{d1} = 1 - \frac{I}{D_1 + G_1}$$

$$k_{g1} = 1 + \frac{I}{D_1 + G_1}$$

and

$$k_{d2} = 1 + \frac{I}{D_2 + G_2}$$

$$k_{g2} = 1 - \frac{I}{D_2 + G_2}$$

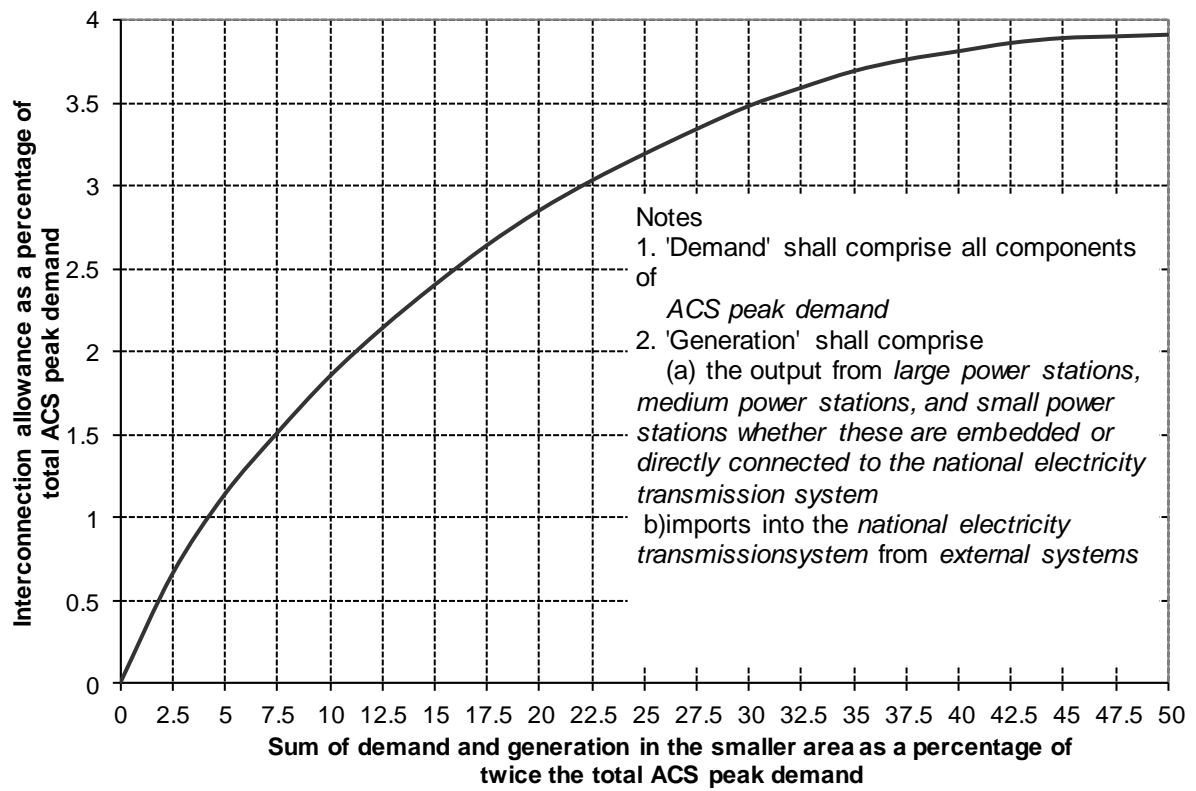

Figure D.1 *Interconnection allowance* as a function of area size (the 'circle diagram')

## Appendix E Modelling of *Economy Planned Transfer*

E.1 For the determination of *Economy planned transfer conditions* plant is categorised in three groups:

E.1.1 non-contributory generation. This plant, such as OCGTs, does not form part of the generation background

E.1.2 directly scaled plant. The output of plant in this category is determined by a fixed scaling factor, described in E.3

E.1.3 variably scaled plant. The output of plant in this category is uniformly scaled by a variable factor that is calculated to ensure that generation and demand balance. This is described in E.5.

E.2 The NGESO will from time-to-time review, consult on, and publish the categorisation of plant.

### Directly Scaled Plant

E.3 In the *Economy planned transfer condition* the *registered capacities* of certain classes of *power station* are scaled by fixed factors, known as  $D_T$ , for classes T of *power station*. These factors are set as follows:

E.3.1 For nuclear stations, and for coal-fired and gas-fired stations fitted with Carbon Capture and Storage,  $D_T = 0.85$

E.3.2 For stations powered by wind, wave, or tides,  $D_T = 0.70$ .

E.3.3 For pumped storage based stations,  $D_T = 0.5$

E.3.4 For interconnectors to *external systems* regarded as importing into GB at the time of peak demand,  $D_T = 1.0$

E.4 The NGESO will review the appropriateness of these factors and revise them where necessary, based on alignment with cost benefit analysis. The period between reviews shall be no more than five years, but may be less if required.

### Variably Scaled Plant

E.5 All remaining *power stations* and on the system at the time of the *ACS peak demand* are considered contributory and their output is calculated by applying a scaling factor to their *registered capacity* such that their aggregate output is equal to the forecast *ACS peak demand* minus the total output of directly scaled plant.

E.6 Thus,

$$P_{T_i} = \begin{cases} 0 & \text{for non - contributory plant} \\ D_T \times R_{DT_i} & \text{for directly scaled plant} \\ S \times R_{VT_i} & \text{for variably scaled plant} \end{cases}$$

where

$$S = \frac{P_{\text{loss}} + \sum_j L_j - \sum_{DT} \left( \sum_k (D_T \times R_{DT_k}) \right)}{\sum_{VT} \left( \sum_n R_{VTn} \right)}$$

and

- $P_{T_i}$  = the output of the  $i^{\text{th}}$  power station of generation plant type  $T$
- $D_T$  = the direct scaling factor for directly scaled generation of plant type  $T$
- $R_{DT_k}$  = the *registered capacity* of the  $k^{\text{th}}$  power station of generation plant type  $DT$  in the directly scaled category
- $R_{VTn}$  = the *registered capacity* of the  $n^{\text{th}}$  power station of generation plant type  $VT$  in the variably scaled category
- $P_{\text{loss}}$  = total *national electricity transmission system* active power losses at time of *ACS peak demand*
- $L_j$  = the active power demand at the  $j^{\text{th}}$  *national electricity transmission system* demand site at the time of *ACS peak demand*

## Appendix F Application of the *Boundary Allowance*

F.1 This appendix outlines the techniques underlying the use of the *boundary allowance* under paragraphs 4.4.4 and 4.4.5.

F.2 The modification of the *MITS Economy planned transfer condition* power flow pattern to reflect a *boundary allowance* shall apply to the *national electricity transmission system* divided into any two contiguous parts, irrespective of the size or location of the parts.

F.3 The *boundary allowance* is applied by:-

F.3.1 summing the demand and the total active power generation output (including imports from *external systems*) under the *Economy planned transfer condition* within the smaller of the two parts;

F.3.2 using Figure F.1 to determine the *boundary allowance* (in MW)

F.3.3 finding the total active power generation output and total demand in each part of the system when applying the *boundary allowance* or half *boundary allowance* (as appropriate) as described in paragraphs F.4 and F.5;

F.3.4 for the conditions described under paragraph 4.4.4, proportionally scaling all the generation and demand in both parts of the system, as described in paragraphs F.4 and F.5 below, such that the transfer between the two parts increases by: first, the full *boundary allowance* when considering the single *fault outages* in 4.6.1; and second, half the *boundary allowance* for all other *secured events* in paragraph 4.6;

F.3.5 for the conditions described under paragraph 4.4.5, proportionally scaling demand in both parts of the system and setting *generating units* with their outputs such that their totals are as described in paragraphs F.4 and F.5 below such that the transfer between the two parts increases by: first, the full *boundary allowance* when considering the single *fault outages* in item 4.6.1; and second, half the *boundary allowance* for all other *secured events* in paragraph 4.6.

F.4 Suppose that the two contiguous parts of the system in question are areas 1 and 2 and that area 1 exports to area 2. Let  $G_1$  and  $G_2$  be the total generation in areas 1 and 2 respectively and  $D_1$  and  $D_2$  be the total demand in areas 1 and 2 under the *planned transfer condition*. Let  $B$  be the transfer required in addition to that under the *planned transfer condition* (i.e. the value of  $B$  is equal to the *boundary allowance* or half the *boundary allowance* as specified in paragraphs F.3.4 and F.3.5).

F.5 The additional transfer is proportionally divided between the generation and demand in the two areas as follows:

the total demands after application of the *boundary allowance* or half *boundary allowance* in areas 1 and 2 are

$$D'_1 = k_{d1}D_1$$

$$D'_2 = k_{d2}D_2$$

and the total amounts of generation in areas 1 and 2 are

$$G'_1 = k_{g1}G_1$$

$$G'_2 = k_{g2}G_2$$

where

$$k_{d1} = 1 - \frac{B}{D_1 + G_1}$$

$$k_{g1} = 1 + \frac{B}{D_1 + G_1}$$

and

$$k_{d2} = 1 + \frac{B}{D_2 + G_2}$$

$$k_{g2} = 1 - \frac{B}{D_2 + G_2}$$

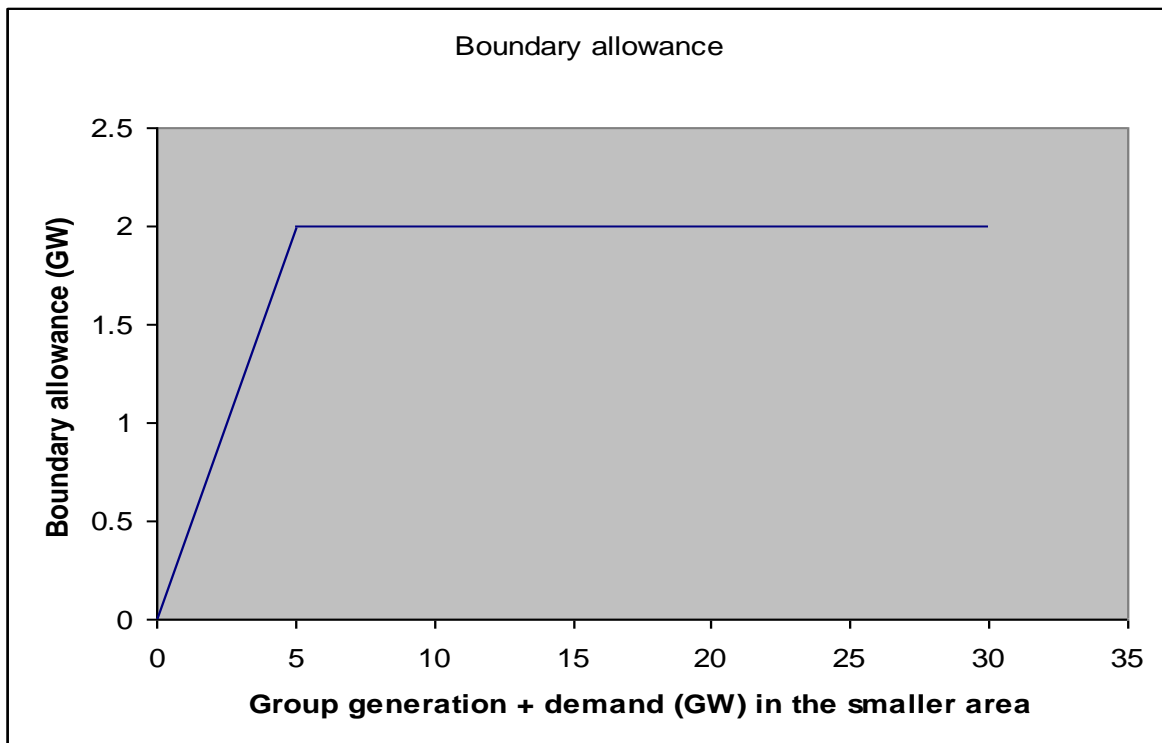

Figure F.1 *Boundary allowance*

## Appendix G      Guidance on Economic Justification

- G.1      These guidelines may be used to assist in the:
- G.1.1    economic justification of investment in transmission equipment and/or purchase of services such as reactive power in addition to that required to meet the planning criteria of Sections 2, 3, 4, 7 or 8.
  - G.1.2    economic justification of the rearrangement of typical *planned outage* patterns and appropriate re-selection of *generating units*, for example through *balancing services*, from those expected to be available under the provisions of paragraph 2.13 in Section 2, paragraph 4.10 in Section 4 and 7.19 in Section 7; and
  - G.1.3    evaluation of any expected additional operational costs or investments resulting from a proposed variation in connection design under the provisions of paragraphs 2.15 to 2.18 and/or paragraphs 3.12 to 3.15 and/or paragraphs 7.21 to 7.24.
- G.2      Guidelines:
- G.2.1    additional investment in transmission equipment and/or the purchase of services would normally be justified if the net present value of the additional investment and/or service cost is less than the net present value of the expected operational or unreliability cost that would otherwise arise.
  - G.2.2    the assessment of expected operational costs and the potential reliability implications shall normally require simulation of the expected operation of the *national electricity transmission system* in accordance with the operational criteria set out in Section 5 and Section 9 of the Standard.
  - G.2.3    due regard should be given to the expected duration of an appropriate range of prevailing conditions and the relevant *secured events* under those conditions as defined in section 5 and Section 9.
  - G.2.4    the operational costs to be considered shall normally include those arising from:
    - transmission power losses;
    - frequency response;
    - reserve;
    - reactive power requirements; and
    - system constraints,and may also include costs arising from:
    - rearrangement of transmission maintenance times; or
    - modified or additional contracts for other services.
  - G.2.5    all costs should take account of future uncertainties
  - G.2.6    the evaluation of unreliability costs expected from operation of the *national electricity transmission system* shall normally take account of the number and type of customers affected by supply interruptions and



use appropriate information available to facilitate a reasonable assessment of the economic consequences of such interruptions.

## **Appendix H Frequency Risk and Control Report Methodology and Application**

### **Introduction**

- H.1 This appendix sets out the process for production of a periodic Frequency Risk and Control Report (FRCR), in accordance with an agreed process and which is regularly reviewed and updated in consultation with interested parties and is subject to approval by the Authority.
- H.2 The FRCR is required to provide a transparent and consulted assessment of the risk of unacceptable frequency conditions occurring, and their impact on Security of Supply inherent in the operation of the National Electricity Transmission System. It will set out which of these frequency risks the system should be secured against by National Grid ESO in their operation of the system to allow a balance to be struck between the consideration of risks, the benefit of avoiding these risks materialising, and the economic and efficient costs that will be incurred in ensuring the safe and secure operation of the system to do so.
- H.3 The methodology underpinning the FRCR process, along with how this will be approved, is set out in Part A of this appendix. The requirements for the publication of the periodic FRCR are outlined in Part B. Obligations on parties regarding the provision of information underpinning the FRCR process are described in Part C. Together these activities make up the FRCR process.

### **Part A: The Frequency Risk and Control Report (FRCR) methodology**

- H.4 National Grid ESO shall initially and thereafter as required or as the Authority may direct, develop proposals for the FRCR methodology which will include the form and general expected content and structure of the FRCR. This will be carried out in consultation with interested parties. The consultation shall be of such a form and duration as to reasonably allow all interested parties to contribute.
- H.5 Following any consultation pursuant to paragraph H4, National Grid ESO must:
- (a) by 1 April 2021, or such other date as directed by the Authority, submit to the SQSS Panel an initial FRCR methodology and proposed form of the initial FRCR; and
  - (b) by such other date as directed by the Authority or as National Grid ESO may see fit, further submit to the SQSS Panel an updated FRCR methodology.

H.6 National Grid ESO must make reasonable endeavours to ensure the FRCR methodology includes the information set out in paragraph H9. Where this has not been possible, the National Grid ESO must explain the reasons and how it proposes to progress outstanding issues.

H.7 Submissions made under paragraph H5 must include:

(a) detailed explanation of the consultation process undertaken in the development of the FRCR methodology;

(b) a summary of the views received from interested parties as part of the consultation process and an explanation of how these were taken into account in the development of the FRCR methodology; and

(c) copies of any formal responses submitted as part of the consultation process.

H.8 The SQSS Panel will on receipt of a submission under paragraph H5:

(a) recommend that the proposed FRCR methodology be used in the subsequent production of a FRCR; or

(b) give direction to National Grid ESO that the FRCR methodology requires further development.

In making its recommendation the SQSS Panel will give due regard to its expertise in the matters covered by the proposed FRCR methodology and will seek appropriate advice and guidance where required.

H.9 The FRCR methodology must be designed to facilitate the economic assessment of the risk of unacceptable frequency conditions occurring on the National Electricity Transmission System and which of these risks will be secured. The FRCR methodology must include (but need not be limited to):

(a) the approach to be used to determine the circumstances for which unacceptable frequency conditions should not occur;

(b) the approach to be used in clearly setting out each of the risks or categories of risk that are present in the operation of the system which will be used in the assessment of unacceptable frequency conditions, including specific events and the direct and indirect consequences of these, and as will be set out in the FRCR in accordance with the methodology and the specific requirements of paragraph H17;

(c) how each of the risks identified in (b) will be assessed, including but not limited to:

(i) the approach used to assess the technical and economic impacts;

(ii) the approach used to assess the likelihood and consequence of each such risk occurring; and

- (iii) the approach used to quantify the cost of mitigating each such risk.
- (iv) the sources of information as used to perform the assessment.
- (d) the benefits to the consumer in mitigating risks to the secure operation of the system;
- (e) how National Grid ESO will engage with interested parties to share relevant information and how that information will be used to review and revise the FRCR methodology; and
- (f) details of National Grid ESO's proposed timetable for updating and consulting on the FRCR methodology.

### **Part B: The Frequency Risk and Control Report (FRCR)**

- H.10 National Grid ESO shall initially and at such other times as National Grid ESO may see fit or the Authority may direct, develop proposals for the FRCR in consultation with interested parties. The consultation shall be of such a form and duration as to reasonably allow all interested parties to contribute.
- H.11 Following any consultation pursuant to paragraph H10, National Grid ESO must:
- (a) produce an initial FRCR by 1 April 2021 or such other date as directed by the Authority and submit this to the SQSS Panel for their recommendation that this be onwards submitted to the Authority for approval. This must be based on and prepared in accordance with the draft initial methodology set out in part A; and
  - (b) by such other date as directed by the Authority or as National Grid ESO may see fit, and as set out in paragraph H12, publish a revised FRCR.
- H.12 Following publication of the initial FRCR, National Grid ESO must:
- (a) review at least once in each financial year the FRCR prepared and published in the previous financial year and consider any improvements to better facilitate the economic and efficient operation of the National Electricity Transmission System; and
  - (b) at least annually, or at such date as directed by the Authority, publish an updated FRCR and submit this to the SQSS Panel for their recommendation that this be onwards submitted to the Authority for approval. This must be based on and prepared in accordance with the latest approved methodology set out in part A.
- H.13 National Grid ESO must make reasonable endeavours to ensure any FRCR submitted under paragraph H11 or H12 includes the information set out in paragraph H14. Where this has not been possible, National

Grid ESO must explain the reasons and how it proposes to progress outstanding issues.

H.14 Submissions made under paragraphs H11 or H12 must include:

(a) a detailed explanation of the consultation process undertaken in the development of the FRCR;

(b) a summary of the views received from interested parties as part of the consultation process and an explanation of how these were taken into account in the development of the FRCR; and

(c) copies of any formal responses submitted to the National Grid ESO as part of its consultation process.

H.15 Following the approval of the FRCR under H19, National Grid ESO must publish the FRCR on its website in such readily accessible form and manner that it considers will best facilitate engagement with stakeholders, and provide a copy of the FRCR on request, and free of charge, to any person who asks for one.

H.16 In complying with the requirements of paragraph H15, National Grid ESO must have due regard to the need for excluding from the published FRCR any information that could cause security concerns or that would or might seriously and prejudicially affect the commercial interests of the owner of that information if published or might be expected to be incompatible with any legislation, rule of law or licence condition and will take due regard of any representations made by owners of such data. National Grid ESO must provide to the SQSS Panel and the Authority its reasons for any omission of information from the FRCR as published and where it is intended that this be different from the report as submitted for approval under H11 or H12.

H.17 Each FRCR (including the initial FRCR) prepared in accordance with the methodology set out in Part A must:

(a) set out:

(i) those risks to the secure operation of the system considered under the FRCR;

(ii) the likelihood and consequence of each such risk occurring;

(iii) the likely cost of securing the system against such risks;

(iv) the benefits to the consumer in mitigating such risks;

(b) include National Grid ESO's assessment of continued effective operation of the system and their considered view of which risks should be secured representing the best value for money for consumers and balancing the likelihood of risks occurring and their consequence with the cost of mitigation.

H.18 The SQSS Panel will on receipt of a submission made by National Grid ESO under paragraph H11 or H12:

(a) recommend that the proposed FRCR be onwards submitted to the Authority for approval; or

(b) give direction to National Grid ESO that the FRCR requires further development.

In making its recommendation the SQSS Panel will give due regard to its expertise in the matters covered by the proposed FRCR and will seek appropriate advice and guidance where required.

H.19 The Authority will on receipt of a submission made by the National Grid ESO under paragraph H11:

(a) approve the proposed FRCR and in particular the recommendations as detailed in H17 (b) of which operational risks the National Grid ESO will incur costs in securing the system against to avoid unacceptable frequency conditions; or

(b) give direction to National Grid ESO that the FRCR requires further development, and the date by which National Grid ESO is required to submit a revised FRCR to the Authority for approval.

H.20 On approval by the Authority of the FRCR, National Grid ESO shall ensure that the risks set out in the FRCR to be mitigated in its operation of the system shall reasonably be secured until the subsequent approval by the Authority of any update of the FRCR.

### **Part C: Provision of information**

H.21 Based on the FRCR methodology set out in Part A, National Grid ESO must provide licenced electricity operators if reasonably requested to do so:

(a) with information and analysis to support them in their decision-making on, for example, operation of their plant and equipment;

(b) with updated information and analysis to support submissions made to the Authority by National Grid ESO and in such form and within such timescales as reasonably requested; and

(c) In complying with the requirements of this paragraph, National Grid ESO must have due regard to the need to exclude from disclosure any information which would or might seriously and prejudicially affect the commercial interests of the owner of that information if disclosed or might be expected to be incompatible with any relevant legislation, code or licence condition. National Grid ESO must provide to the Authority its reasons for any non-disclosure of information.

H.22 The Authority may direct National Grid ESO to submit additional information on any submissions made under this appendix within such timeframe as the Authority may require in order to carry out any of its functions in relation to the assessment of submissions.