











Stage 5: Final Self Governance Modification Report		At what stage is this document in the process?										
<h1 style="color: #00a651;">GC0111:</h1> <h2 style="color: #00a651;">Mod Title: Fast Fault Current Injection specification text</h2>	<table border="1" style="width: 100%; text-align: center;"> <tr> <td style="border: 1px solid black; border-radius: 5px;">01</td> <td style="border: 1px solid black; border-radius: 5px;">Proposal Form</td> </tr> <tr> <td style="border: 1px solid black; border-radius: 5px;">02</td> <td style="border: 1px solid black; border-radius: 5px;">Workgroup Report</td> </tr> <tr> <td style="border: 1px solid black; border-radius: 5px;">03</td> <td style="border: 1px solid black; border-radius: 5px;">Consultation</td> </tr> <tr> <td style="border: 1px solid black; border-radius: 5px;">04</td> <td style="border: 1px solid black; border-radius: 5px;">Draft Self Governance Modification Report</td> </tr> <tr> <td style="background-color: #00a651; color: white; border: 1px solid black; border-radius: 5px;">05</td> <td style="background-color: #00a651; color: white; border: 1px solid black; border-radius: 5px;">Approved Self Governance Modification Report</td> </tr> </table>		01	Proposal Form	02	Workgroup Report	03	Consultation	04	Draft Self Governance Modification Report	05	Approved Self Governance Modification Report
01	Proposal Form											
02	Workgroup Report											
03	Consultation											
04	Draft Self Governance Modification Report											
05	Approved Self Governance Modification Report											
<p>Purpose of Modification: To update the Grid Code with revised text for fast fault current injection to dispel any confusion in interpretation of the existing text.</p>												
	<p>This Final Self Governance Modification Report has been prepared in accordance with the terms of the Grid Code. An electronic version of this document and all other GC0111 related documentation can be found on the National Grid ESO website via the following link:</p> <p>https://www.nationalgrideso.com/codes/grid-code/modifications/gc0111-fast-fault-current-injection-specification-text</p>											
	<p>High Impact: None</p>											
	<p>Medium Impact: Manufacturers, installers and owners of Type B to Type D power park modules connected to both distribution and transmission systems</p>											
	<p>Low Impact None</p>											
	<p>The Workgroup concludes:</p> <p>All Workgroup Members concluded that the Original proposal facilitates the Applicable Grid Code Objectives better than the baseline.</p>											

Contents		 Any questions?
1	About this document	3
2	Original Proposal	5
3	Proposer's solution	5
4	Workgroup Discussions	24
5	Workgroup Vote	30
6	GC0111: Relevant Objectives	33
7	Implementation and costs	34
8	Code Administrator Consultation Responses	34
9	Grid Code Review Panel Views	34
10	Legal Text	38
	Annex 1 – Terms of Reference	39
	Annex 2A – Workgroup Presentation July 2018	45
	Annex 2B – Workgroup Presentation September 2018	72
	Annex 2C – Workgroup Presentation November 2018	87
	Annex 2D – Workgroup Presentation December 2018	104
	Annex 2E – Workgroup Presentation February 2019	143
	Annex 3A – Grid Code Legal Text	175
	Annex 4 – Code Administrator Consultation Responses	193
Timetable		
The Code Administrator recommends the following timetable:		
Initial consideration by Workgroup		4 July 2018
Modification concluded by Workgroup		February 2019
Workgroup Report presented to Panel		28 March 2019
Code Administrator Consultation Report issued to the Industry (20 working days)		5 April 2019
Code Administrator Consultation closes		8 May 2019
Draft Self Governance Report presented to Panel		30 May 2019
Grid Code Review Panel decision		30 May 2019
Appeal Window Open		7 June 2019
Appeal Window Close		28 June 2019
Decision implemented in Grid Code		15 July 2019
		 077854 28175
		Proposer: Mike Kay, P2 Analysis Limited (nominated by Steve Cox, Electricity North West)
		 matthew.bent@nationalgrideso.com
		 07768038913
		National Grid Representative: Tony Johnson
		 Antony.Johnson@nationalgrideso.com
		 01926 655466

1 About this document

This document is the Final Self Governance Modification Report that contains the discussion of the Workgroup which formed in July 2018 to develop and assess the proposal and the voting of the Workgroup held on 13 March 2019. The Panel reviewed the Workgroup Report at their Grid Code Review Panel meeting on 28 March 2019 and agreed that the Workgroup had met its Terms of Reference and that the Workgroup could be discharged. This document contains the responses received from the Code Administrator Consultation which closed on 8 May 2019.

GC0111 was proposed by Mike Kay on behalf of Electricity North West and was submitted to the Grid Code Review Panel in April 2018. The Panel decided to send the Proposal to a joint Workgroup (with the Distribution Code) to be developed and assessed against the Grid Code Applicable Objectives.

GC0111 aims to update the Grid Code with revised text for fast fault current injection to dispel any confusion in interpretation of the existing text.

Code Administrator Consultation Responses

Two responses were received to the Code Administrator Consultation. A copy of the responses can be found in Annex 4 of this document.

The Final Self Governance Grid Code Modification Report has been prepared in accordance with the terms of the Grid Code. An electronic copy can be found on the National Grid Electricity System Operator Website: -

<https://www.nationalgrideso.com/codes/grid-code/modifications/gc0111-fast-fault-current-injection-specification-text>

Workgroup Conclusions

At the final Workgroup meeting, Workgroup members voted on the Original proposal. They unanimously voted that the Original Proposal better facilitated the applicable Grid Code objectives.

Section 2 (Original Proposal) and Section 3 (Proposer's solution) are sourced directly from the Proposer and any statements or assertions have not been altered or substantiated/supported or refuted by the Workgroup. Section 4 of the Workgroup contains the discussion by the Workgroup on the Proposal and the potential solution.

The Grid Code Review Panel detailed in the Terms of Reference the scope of work for the GC0111 Workgroup and the specific areas that the Workgroup should consider.

The table below details these specific areas and where the Workgroup have addressed the Terms of Reference within the report.

The full Terms of Reference can be found in Annex 1.

Grid Code Review Panel View

At the Grid Code Review Panel meeting on 30 May 2019, the Panel voted on GC0111 against the Applicable Grid Code Objectives.

The Panel members unanimously agreed that the Original was better than the baseline and determined that it should be implemented.

This Final Modification Report has been prepared in accordance with the terms of the Grid Code. An electronic copy can be found on the National Grid ESO website (<https://www.nationalgrideso.com/codes/grid-code/modifications/gc0111-fast-fault-current-injection-specification-text>), along with the Grid Code Modification Proposal Form.

Table 1: GC0111 Terms of Reference

Specific Area	Location in the report
a) Implementation and costs	Section 3 and 4
b) Review draft legal text should it have been provided. If legal text is not submitted within the Modification Proposal the Workgroup should be instructed to assist in the developing of the legal text.	Section 4 and 9
c) Consider whether any further Industry experts or stakeholders should be invited to participate within the Workgroup to ensure that all potentially affected stakeholders have the opportunity to be represented in the Workgroup. Demonstrate what has been done to cover this clearly in the report	Section 4
d) Consider materiality of change	Section 4
e) Workgroup consultation and whether required	Section 4
f) Review the trigger voltage and FRT requirements and whether compatible.	Section 4

Acronym Table

Acronym	Meaning
EREC	Engineering Recommendation
RFG	Requirement for Generators
FFCI	Fast Fault Current Injection
HVDC	High Voltage Direct Current
DFIG	Doubly-fed Induction Generator
ECC	European Connection Conditions

2 Original Proposal

Defect

The Grid Code and Distribution Code modification that has been implemented in [GC0100 EU Connection Codes GB Implementation Mod 1](#) has recast the long-standing Grid Code Fast Fault Current Injection (FFCI) requirements in a way that is phrased so as to be compatible with the Requirements for Generators (RfG). However, the wording chosen is open to misinterpretation and has induced some confusion amongst a small number of stakeholders.

What

The specification and testing requirements for FFCI need to be clarified in the Grid Code.

Why

Manufacturers of Power Park Modules need clarity on the FFCI requirements so that they can ensure compliance at the point of manufacture. It is not possible to test for compliance with the FFCI requirements on site, so it is crucially important that the requirements are specified with complete clarity and freedom from ambiguity.

How

The Grid Code will need to be modified post clarification of the compliance requirements.

3 Proposer's solution

Existing Requirements and Issues

The requirements for FFCI as specified in ECC 6.3.16.1 will need to be updated following agreement in the Workgroup as to the precise requirements that need to be complied with.

In [GC0100 EU Connection Codes GB Implementation Mod 1](#) new requirements were introduced into the Grid Code in respect of fast fault current injection. These requirements

apply only to Power Park Modules. Prior to the introduction of RfG (implemented on 16 May 2018), there was a loose requirement for fast fault current injection although this simply stated that each Power Park Module shall generate maximum reactive current without exceeding the transient rating of the Power Park Module and/or any constituent Power Park Unit. There was no requirement until G0100 for distribution connected Power Park Modules to provide FFCI.

RfG (Article 21(3)) specifies a much more detailed requirement with respect to the reactive current injection requirements. These issues and the approach to implementation were covered in [GC0100 EU Connection Codes GB Implementation Mod 1](#).

Shortly after the GC0100 Code Administrator Consultation, and after the proposals had been submitted to the Authority, a number of comments were received in relation to the clarity over the interpretation of fast fault current injection. These mainly related to the plant rating, how the injected current may vary in phase and magnitude with respect to both voltage deviation and time.

Plant Rating and Upper Limitations on Reactive Current Injection

The first meeting was held in July 2018 to articulate the scope of the problem and defined that there would be no requirement for the rating of the Power Park Module to be exceeded. The slides for this first meeting are attached in Annex 2A. Of importance during this meeting was the introduction of a concept to specify that the rating of the Power Park Module was not expected to be exceeded.

Figure 1.0 below shows a typical wind farm comprising one Power Park Module. Under a faulted condition where the voltage at the connection point falls to zero the intention would be for the Power Park Module to supply full reactive current without exceeding the rating of the Power Park Module or HVDC System.

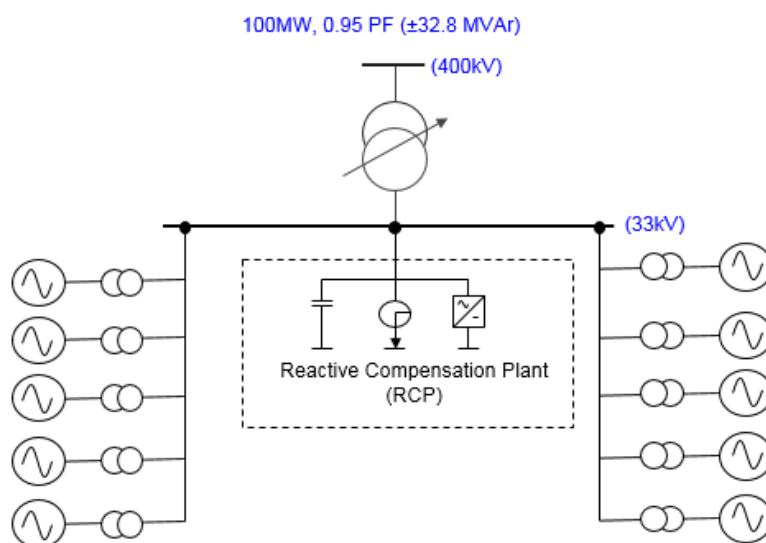

Figure 1.0

The rating of the Power Park Module or HVDC System is calculated on the basis of the rated MW output at maximum Reactive Power Output. Taking the example of the wind

farm shown in Figure 1.0, if the Rated MW output was 100MW to meet the ECC.6.3.2.4 reactive capability requirement of 0.95 Power Factor lead to 0.95 Power Factor lag, this requires a reactive capability of $\pm 32.9\text{MVar}$ and hence the rating of the Power Park Module becomes 105.3 MVA (ie $\sqrt{100^2 + 32.9^2}$) or 1.0pu on Rated MVA (ie 105.3/105.3).

Under a faulted condition, the reduction in system voltage will result in a consequential increase in reactive current to the point where at zero voltage at the connection point the full reactive current injection. As noted above, the reactive current injection would not be required to exceed the rating of the Power Park Module or HVDC System.

Figure 2.0 below shows how the real and reactive current varies. The locus (ie the circle) being the rating of the Power Park Module or HVDC Converter which in this example is 1.0pu on the MVA base of the Power Park Module or 105MVA.

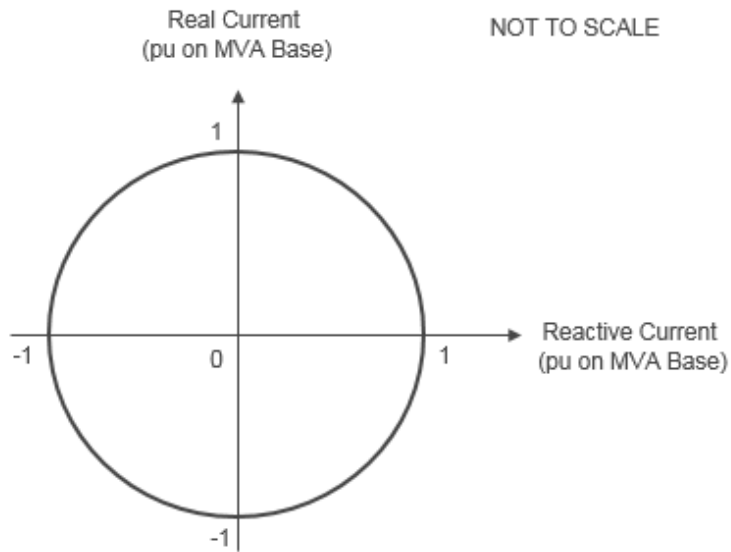

Figure 2.0

In the event of a fault, Figure 3.0 shows the blue vector and blue dashed vector moving towards the x axis (ie an increase in reactive current supply as compared to the red and green vector which forms the boundary between when the Power Park Module is operating in a steady state condition (ie operation between 0.95 lead and 0.95 lag).

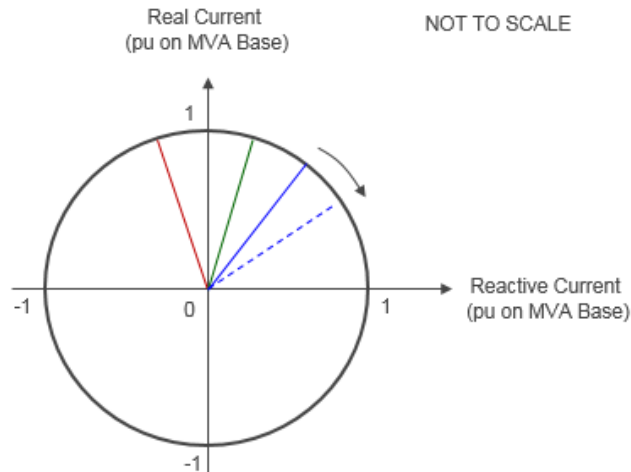

Figure 3.0

Whilst the current version of ECC.6.3.16 does not make the upper limitations on requirements clear, this has now been covered in more detail in the proposed new sections ECC.6.3.16.1.7 based on the explanation above.

Required Reactive Current Injection in Response to Voltage Variation and Time

The second deficiency is that in the current version of ECC it is not clear how the reactive current should vary with depressed voltage.

At its highest level, National Grid has a number of fundamental requirements when it comes to ensuring the robustness of the system under fault conditions. These are summarised as follows:-

Criteria	Requirement
Fault Ride Through	Power Generating Modules to remain connected and stable for up to 140ms in duration for both balanced and unbalanced faults which would include a close up solid three phase short circuit adjacent to the Connection Point
	Power Generating Modules to remain connected and stable for any balanced fault in excess of 140ms so long as the retained voltage is above the heavy black line specified in ECC.6.3.15.9.
Fast Fault Current Injection	<p>Reactive current injection required each time the voltage falls below the nominal voltage levels in ECC.6.1.4. The reactive current injected should progressive increase as the voltage drop increases with any residual current being supplied as active current.</p> <p>There should be a smooth control between steady state operation and faulted conditions</p>

These criteria are important. The requirements for fault ride through are well documented in numerous texts and the reader is encouraged not only to refer to the material included in the appendices within this report but also Grid Code Consultation GC0100 which is available from the link below.

https://www.nationalgrideso.com/sites/eso/files/documents/Final%20Workgroup%20consultation_0.pdf

In summary when a generator is exposed to a close up solid three phase short circuit fault there is a requirement to inject maximum reactive current so as to maintain System voltage and for longer duration voltage dips there is a requirement for a contribution of reactive current with the residual to be supplied as Active Current so as to contribute to

Active Power, this being important criteria for the support of system frequency in the event of a voltage dip.

Initial Consideration of the German Model for Reactive Current Injection

As an initial starting point, the German model was first considered as shown in Figure 4.0 where the injected reactive current is a function of the voltage.

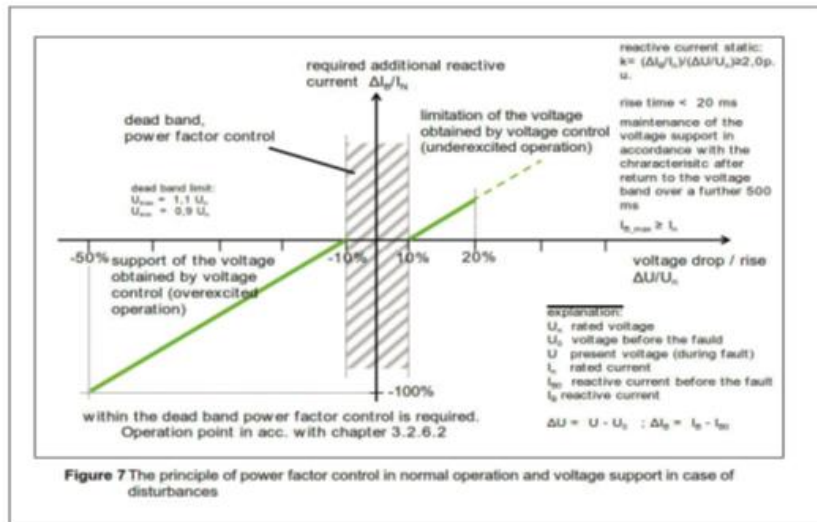

Figure 4.0

This interpretation uses the following formula's

$$I_R = \Delta V.k + I_{Prefault}$$

I_R – The Reactive Current injected in pu during the fault in pu. This cannot exceed 1.0pu on the MVA Rating

$$V = V_{prefault} - V_{deadband} - V_{retained}$$

$V_{prefault}$ – Is the Prefault Positive Phase Sequence voltage in pu

$V_{deadband}$ - Is the deadband either side of nominal voltage set at 0.1pu

$V_{retained}$ – Is the positive sequence voltage at the Grid Entry Point or User System Entry Point under faulted conditions

K – Is the voltage gain factor set to 1

$I_{prefault}$ – Is the prefault reactive current in pu.

These concepts were further explored and presented to the workgroup in September 2018, which resulted in the following revised voltage / reactive current diagram shown in Figure 5.0.

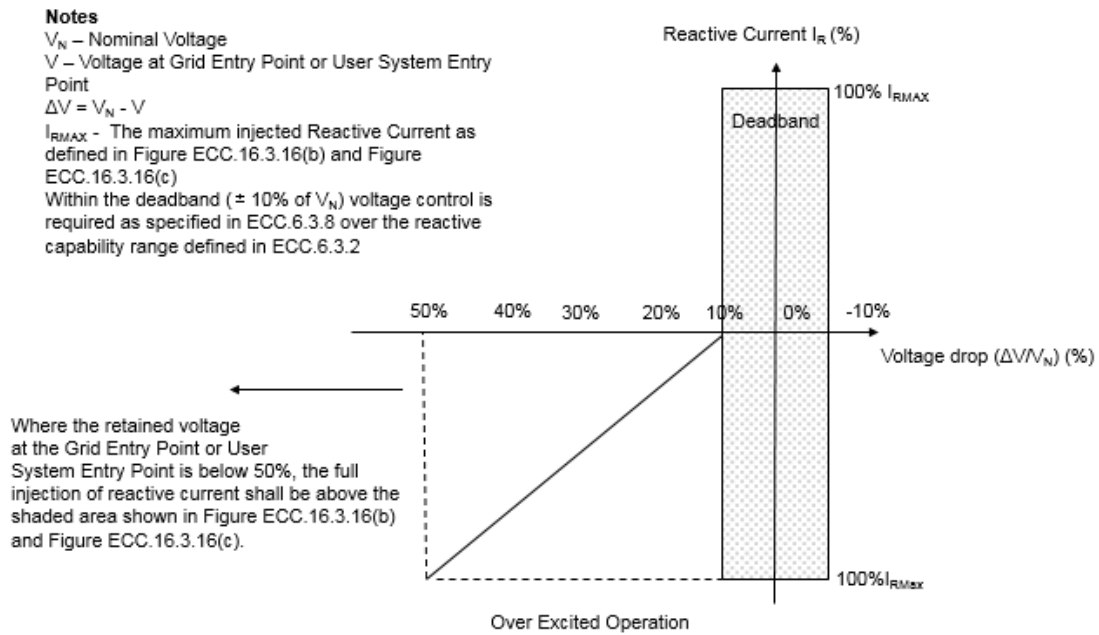

Figure 5.0

In addition, corresponding legal text was also developed. At this stage, a number of Workgroup members expressed concern over the behaviour of Power Park Modules and HVDC Systems during unbalanced faults and that the performance of plant can vary quite significantly between full converter based plant or DFIG derived equipment. A number of concerns were also expressed with regard to operation between steady state and under faulted conditions.

At this stage two options were suggested by the workgroup. One was to consider the approach adopted as discussed in September, another was to adopt an approach similar to that proposed in EN 50549. EN50549 is much more specific in its treatment of unbalanced injection and the use of positive and negative components. These issues start to become complex very quickly and whilst two versions of the legal text were drawn up (ie one drawn up based on the discussion held in September and one drawn up based on EN 50549) the general view was that the initial approach suggested in September should be the one taken forward as the EN50549 is complex with the conclusion that any form of individual phase behaviour would be outside the scope of the workgroup.

However some very useful findings came out of these discussions in which it was agreed that in adopting the September option, the deadband should be changed to insensitivity and a number of detailed examples should also be prepared outlining how a plant would be expected to respond when operating in full lead or full lag and then subsequently exposed to range of voltage dips of various degrees ranging from 85% retained voltage to 10% retained voltage.

In addition, to reflect the difference between different technologies (ie full converter or DFIG etc), a relaxation was introduced into the drafting which effectively permitted a temporary drop below the shaded area provided this was agreed with National Grid. There is some concern how this could be interpreted as such solution would be to ensure the volume of reactive current supplied exceeds the minimum requirement specified in Figures ECC.6.3.16(b) and ECC.6.3.16(c).

In light of these discussions, a further presentation (with examples) and revised legal text was presented to the workgroup in December 2018. A copy of this presentation is shown in Annex 2D which includes the examples.

The revised voltage / reactive current characteristic is shown in Figure 6.0 below.

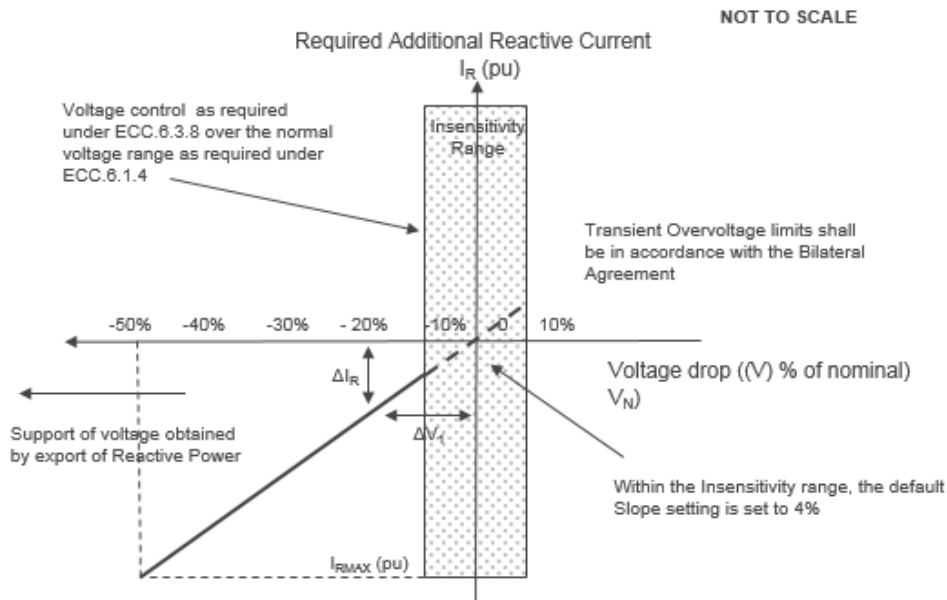

Figure 6.0

Where the corresponding formula's are:-

Where:-

- V_N – Rated Voltage
- V - Actual voltage at the Grid Entry Point or User System Entry Point during the fault
- I_R - Additional reactive current where: _

$$I_R = \Delta V_{1.k} + I_{Prefault} \quad (\text{when } V \text{ is between } 50\% \text{ and less than } 90\%)$$

$$I_R = I_{RMAX} \quad (\text{when } V \text{ is less than } 50\%)$$

as defined by Figure ECC.16.3.16(b) or Figure ECC.16.3.16(c)

(I_R - Is the additional Reactive Current injected during the fault in per unit. This cannot exceed 1.0pu on the MVA Rating of the Power Park Module or HVDC Equipment as detailed in ECC.6.3.16.1.5)

In this approach where the voltage exceeds 50% the formula $I_R = \Delta V_{1.k} + I_{Prefault}$ and below 50% retained voltage, full reactive current would be required to be supplied.

At this point a number of stakeholders expressed concern over the mode change at retained voltages of 50% and at this meeting it was suggested that a formula based

approach should be used over the entire voltage operating range. As a result, the following approach formula was proposed which would apply over the full voltage range.

V Actual voltage at the Grid Entry Point or User System Entry Point during the fault

I_R The reactive current supplied under fault conditions where:-

$$I_R = \Delta V_{1.k} + I_{Prefault} \quad (1)$$

I_R The Reactive Current supplied under fault conditions shall be above the shape shown in Figure ECC.16.3.16(b) and Figure ECC.16.3.16(c) with the peak steady state reactive current defined by Equation (1) above. This value is capped at a maximum of 1.0pu.

There is no requirement for I_R to exceed 1.0pu (I_{RMAX}) but this would not preclude a Power Park Module (or any constituent Power Park Unit) or HVDC Equipment from supplying more should it wish to do so.

$$\Delta V_1 = V_{prefault} - V_{insensitivity} - V_{retained}$$

V_{prefault} Is the Prefault Positive Phase Sequence RMS voltage in per unit

V_{insensitivity} Is the voltage either side of nominal voltage and set at any value between 0 and 0.1 as agreed between The Company and the Generator - Default setting 0.1 unless otherwise agreed.

V_{retained} Is the retained positive sequence voltage at the Grid Entry Point or User System Entry Point (under fault conditions)

k Is the gain factor (range proposed 2 – 7) – Default setting 2.5

I_{prefault} is the prefault reactive current in per unit
The prefault reactive current (I_{prefault}) for a future fault ride through event, shall be determined when the voltage has returned above the minimum levels specified in ECC.6.1.4,

I_{RMAX} The maximum current which shall, as a minimum, be above the shaded areas defined by Figures ECC.16.3.16(b) or ECC.16.3.16(c). There is no requirement for the maximum supplied current to exceed 1.0pu.

Numerous examples of this approach at the extreme operating range (ie low and high pre-fault voltages) were prepared and these are shown in Appendix 2E and forwarded to the workgroup in January 2019.

For completeness two examples are shown below. In both cases the retained voltage is set at 50% with one case operating at a low pre-fault voltage and in another a high pre-fault voltage.

First Example –

Power Park Module operating at full MW output and full MVar output – volt drop to 50% and $V_{insensitivity}$ set to 0.1 and $K = 2.5$

- Wind farm is operating at 100MW output and 0.95 PF lagging (ie 32.8MVar or export to the System)
- $I_R = \Delta V_1 \cdot k + I_{Prefault}$
- And $\Delta V_1 = V_{prefault} - V_{insensitivity} - V_{retained}$
- If $V_{Prefault} = 0.96 \text{ p.u}$ and $Q_{max} = 0.95 \text{ PF lag}$ on a 4% droop
- $V_{insensitivity} = 0.1 \text{ p.u}$
- In this case the retained voltage ($V_{retained}$) is 0.5 pu
- $\Delta V_1 = V_{prefault} - V_{insensitivity} - V_{retained} = 0.96 - 0.1 - 0.5 = 0.36$
- $I_{prefault} = \sin(\arccos 0.95) = 0.312 \text{ pu}$
- $I_R = \Delta V_1 \cdot k + I_{Prefault} = 0.36 \times 2.5 + 0.312 = 1.212 \text{ pu} - \text{capped at } 1.0 \text{ pu reactive current}$
- $IR \text{ at } 60\text{ms} = (0.65 \times \Delta V_1 \cdot k) + I_{prefault} = 0.65 \times 2.5 \times 0.36 + 0.312 = 0.897 \text{ pu}$

Which when superimposed on Figure ECC.6.3.16(b) and ECC.6.3.16(c) results in Figure 7.0 and Figure 8.0

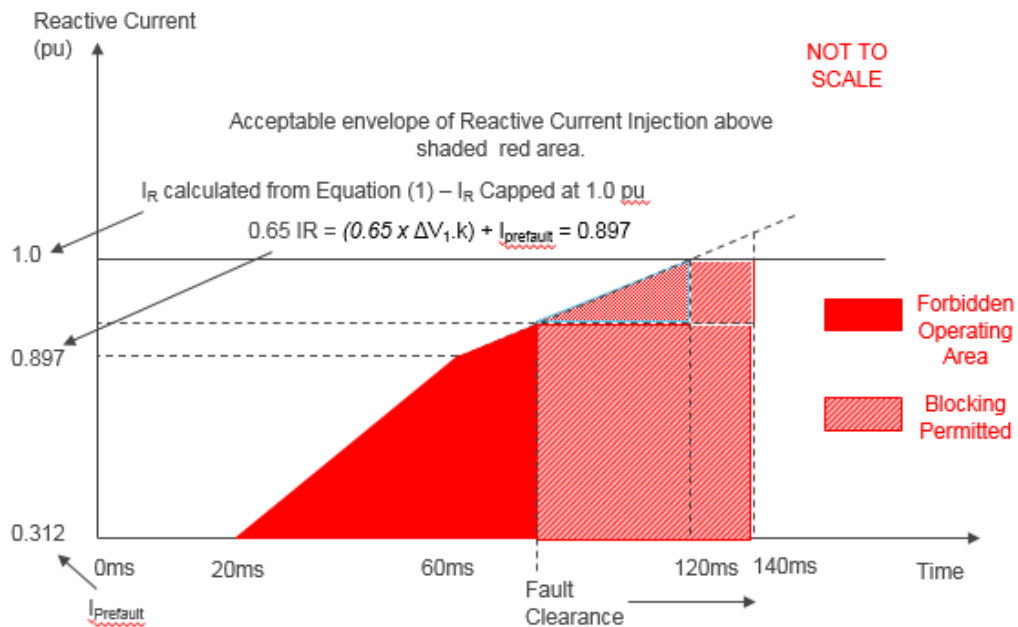

Figure 7.0

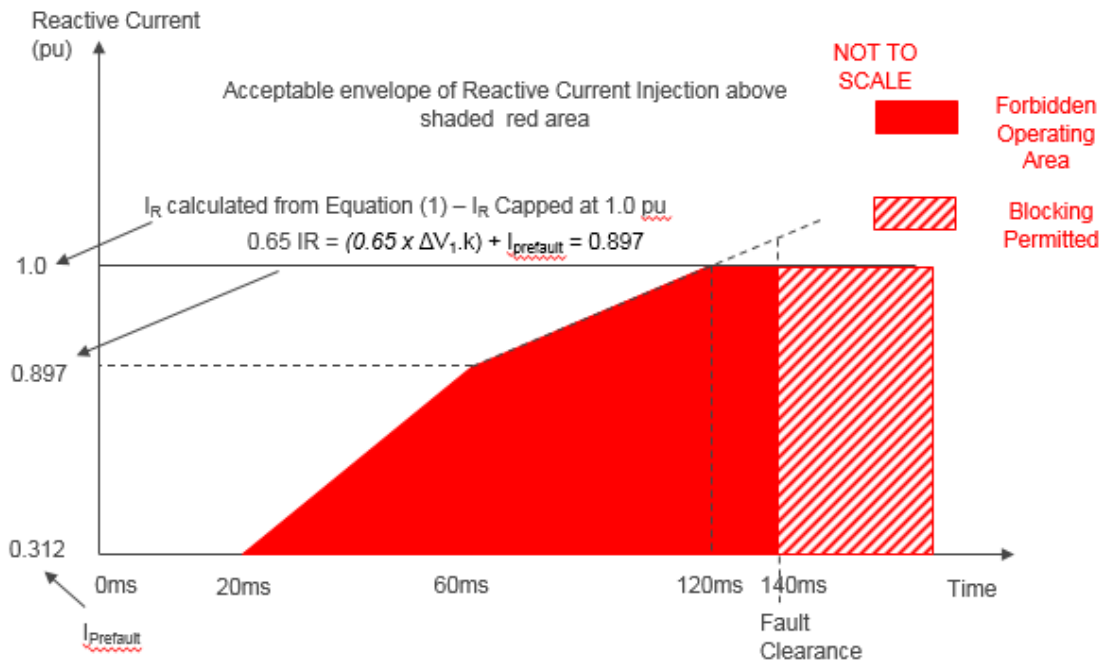

Figure 8.0

Second Example

Power Park Module operating at full MW output and full MVar output – volt drop to 50% and $V_{insensitivity}$ set to 0.1 and $K = 2.5$

- Wind farm is operating at 100MW output and 0.95 PF leading (ie 32.8MVar or import to the System)
- $I_R = \Delta V_1 \cdot k + I_{Prefault}$
- And $\Delta V_1 = V_{prefault} - V_{insensitivity} - V_{retained}$
- If $V_{Prefault} = 1.04p.u$ and $Q_{max} = 0.95$ PF lead on a 4% droop
- $V_{insensitivity} = 0.1 p.u$
- In this case the retained voltage ($V_{retained}$) is 0.5 pu
- $\Delta V_1 = V_{prefault} - V_{insensitivity} - V_{retained} = 1.04 - 0.1 - 0.5 = 0.44$
- $I_{prefault} = \sin(\arccos 0.95) = -0.312pu$
- $I_R = \Delta V_1 \cdot k + I_{Prefault} = 0.44 \times 2.5 - 0.312 = 0.788pu$
- $IR \text{ at } 60ms = (0.65 \times \Delta V_1 \cdot k) + I_{prefault} = (0.65 \times 2.5 \times 0.44) - 0.312 = 0.403 pu$

Which when superimposed on Figure ECC.6.3.16(b) and ECC.6.3.16(c) results in Figure 9.0 and Figure 10.0

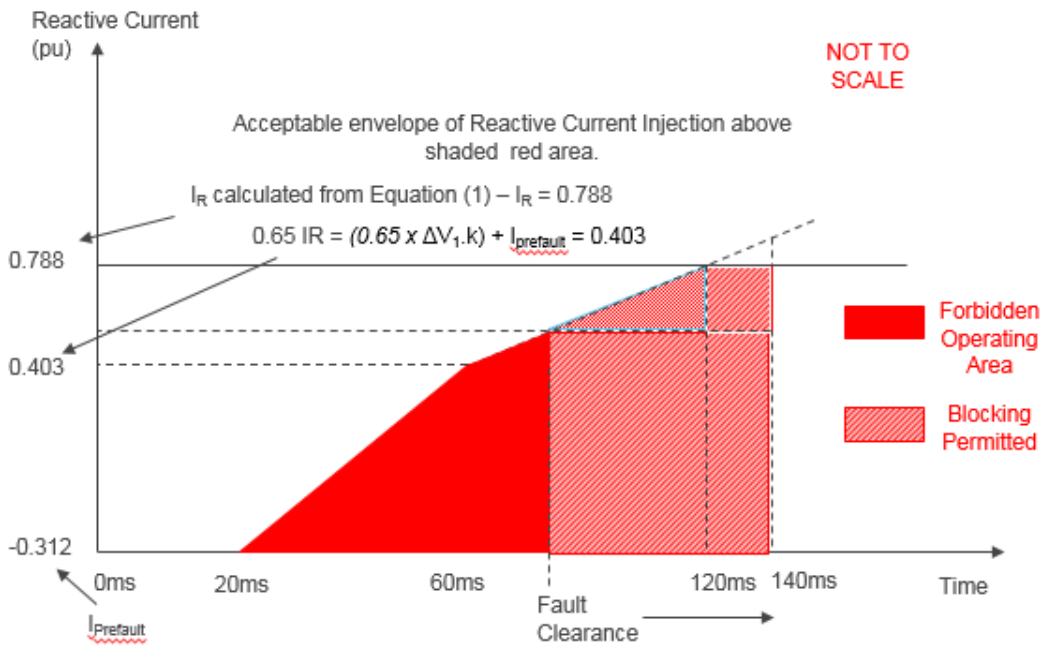

Figure 9.0

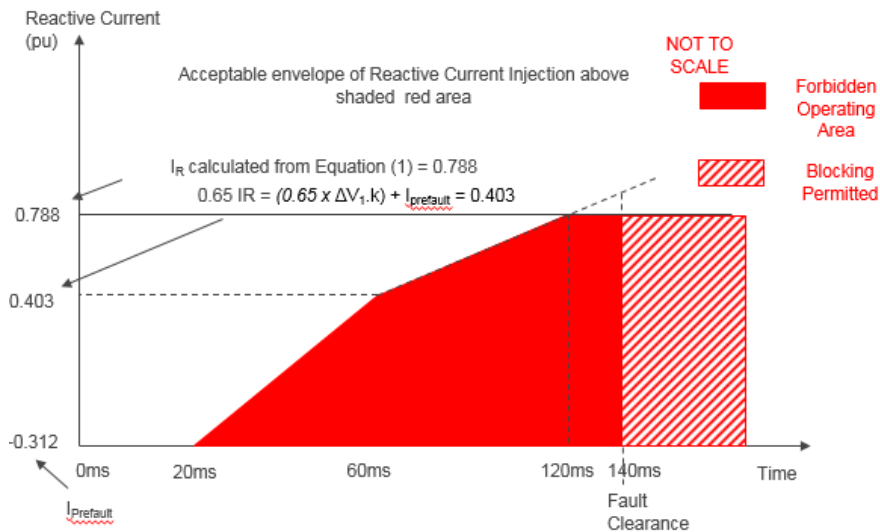

Figure 10.0

As can be seen in the leading example the injection of reactive current is lower than that in the lagging case which means that the gain factor (k) would need to be increased if full reactive current was to be achieved for a voltage drop of 50%. Whilst it is accepted that the delta (ie the reactive current swing) between the two is broadly similar, full reactive injection would be required under a faulted condition.

To address this concern, the effect can be limited by changing the formula so that the additional reactive current becomes $I_R = \Delta V_1.k + |I_{prefault}|$ where $I_{prefault}$ becomes the modulus of $I_{prefault}$ and ΔV_1 simply becomes $V_{prefault} - V_{retained}$. Whilst there will be a slight difference between the reactive current injected between unity power factor and full lead or full lag, full reactive current would be obtained for a retained voltage of 0.5pu. This also means the k factor can be retained at 2.5 although in simplifying the formula this would require the need to make sure developers and manufacturers are comfortable with the transition from the steady state mode between the normal operational voltage of 0.9pu to

1.05pu and a faulted condition. The revised voltage drop / reactive current characteristic is shown in Figure 11.0.

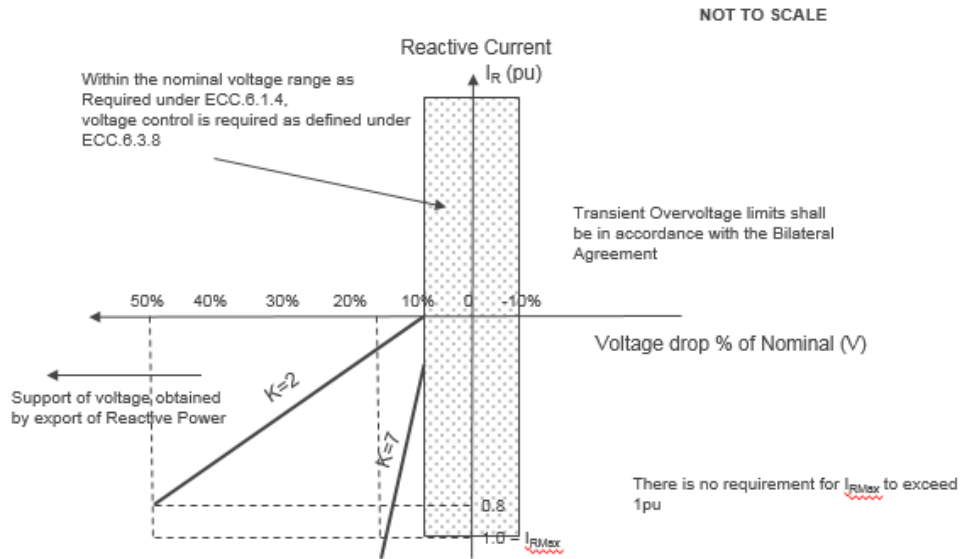

Figure 11.0

Where:-

V - Actual voltage at the Grid Entry Point or User System Entry Point during the fault

I_R - The reactive current supplied under fault conditions where:-

$$I_R = \Delta V_{1.k} + |I_{\text{Prefault}}| \quad \text{Equation (1)}$$

I_R The Reactive Current supplied under fault conditions shall be above the shape shown in Figure ECC.16.3.16(b) and Figure ECC.16.3.16(c) with the peak steady state reactive current defined by Equation (1) above. This value is capped at a maximum of 1.0pu.

There is no requirement for I_R to exceed 1.0pu (I_{RMAX}) but this would not preclude a Power Park Module (or any constituent Power Park Unit) or HVDC Equipment from supplying more should it wish to do so.

|I_{prefault}| is the modulus of the pre-fault reactive current in per unit the pre-fault reactive current (I_{prefault}) for a future fault ride through event, shall be determined when the voltage has returned above the minimum levels specified in ECC.6.1.4,

$$\Delta V_1 = 0.9 - V_{\text{retained}}$$

V_{prefault} Is the Prefault Positive Phase Sequence RMS voltage in per unit

V_{retained} Is the retained positive sequence voltage at the Grid Entry Point or User System Entry Point (under fault conditions)

k Is the gain factor (range proposed 2 – 7) – Default setting 2.5

I_{RMAX}

There is no requirement for the maximum supplied reactive current to exceed 1.0pu.

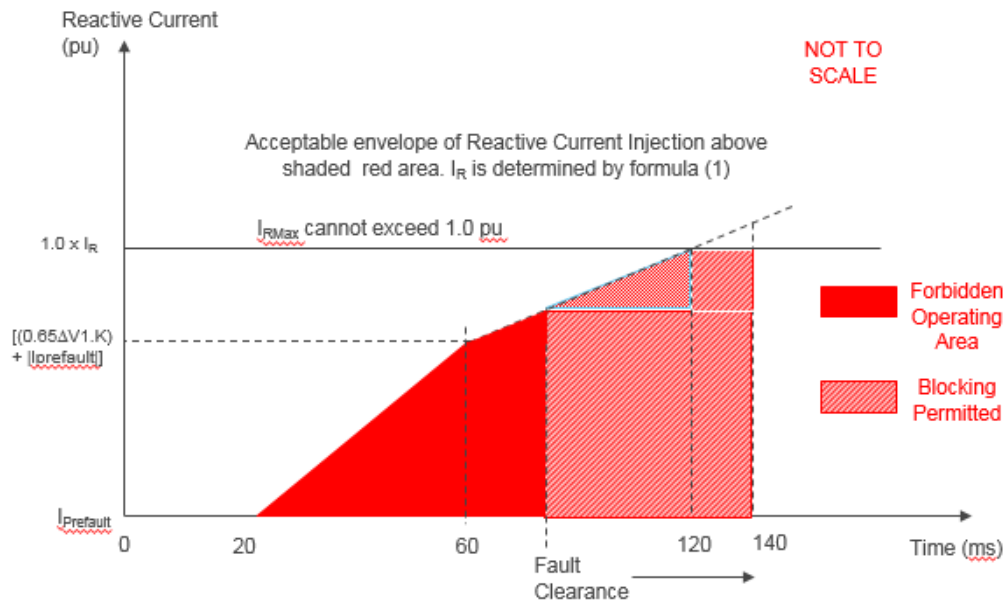

Figure 12.0

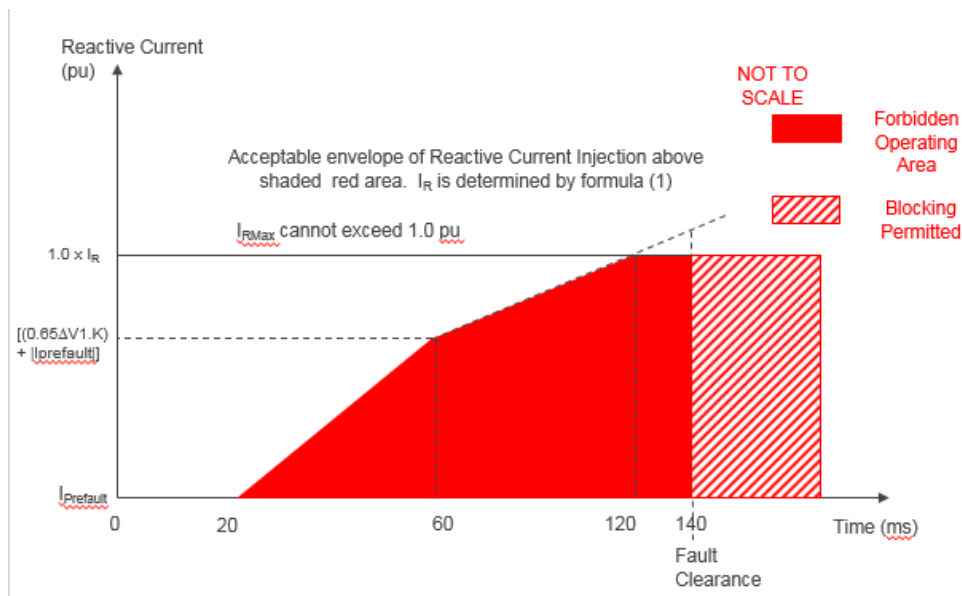

Figure 13.0

The problem with the above approach however is that there is still a difference between the reactive current injected and the pre-fault operating condition. There is also the risk of hunting between the normal voltage operating range and a fault ride through condition.

Final Proposed Reactive Current Injection Requirements

To investigate potential hunting issues figure 14.0 below shows a more detailed representation of the requirement between steady state operation and a fault ride through condition.

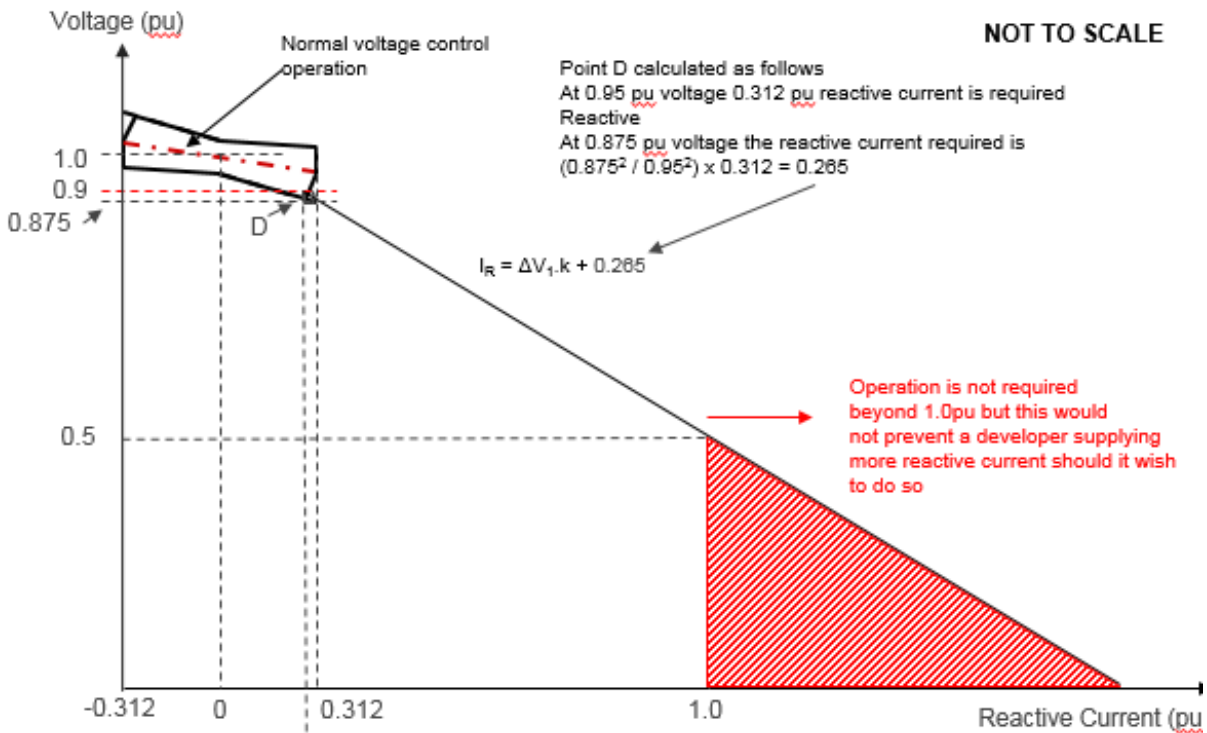

Figure 14.0

As part of this approach the proposal was for the reactive current injection to be defined by the following formula.

$$I_R = \Delta V_{1.k} + 0.265$$

and

$$\Delta V_1 = 0.9 - V_{\text{retained}}$$

In this case the gain factor K was set at 2.5 but can be varied between 2 and 7.

The advantage of this approach is that the reactive current injection will be the same irrespective of the pre fault operating point. In addition, as soon as the voltage drops to 0.5pu with a gain factor of 2.5, a reactive current injection of 1.0pu will be delivered.

The problem with this approach is that some developers and manufacturers could struggle with the requirement especially in the common case for distribution connected modules if the plant was operating in power factor control mode or reactive power control mode and the Connection Point Voltage remained at 0.9pu and the generator was operating under full import – although such an operating point itself is not likely. To address this issue, it was suggested at the February 2019 Workgroup meeting that the normal voltage operating envelope should be retained and an envelope of operation defined between the two black lines (ie starting at the extreme ends of the voltage

operating range at 0.9pu and 1.1pu voltage and ending at the intersection of the 0.5 pu voltage and 1pu reactive current point). This characteristic is shown in Figure 15.0 below but would at least ensure a progressive injection of reactive current between 0.9pu and 0.5 pu voltage whilst ensuring below 0.5pu voltage the full 1.0pu reactive current would be delivered.

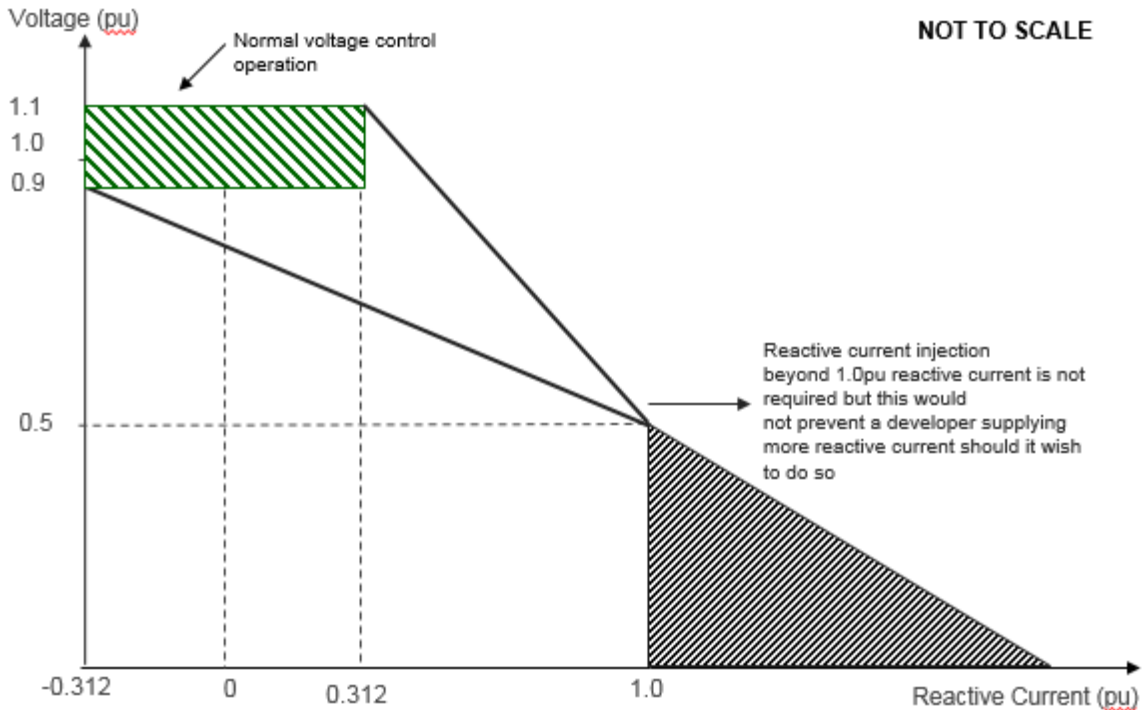

Figure 15.0

In this case, the point was raised that a plant could be operating at 0.9 power factor in a leading mode of operation at 0.9 pu voltage which could only apply in a power factor or reactive power mode of operation and even then in the unlikely event this were to occur, the voltage would have to drop for a small amount even to get zero injection of reactive current although there would be a delta change (i.e. the difference between the final reactive current injection and the pre-fault reactive current injection) in transiting from a fully leading power factor to unity.

To address this concern, two points were raised. The first, that irrespective of the operating point within the normal voltage operating range, the locus of I_R should converge to the 0.5pu voltage / 1.0pu reactive current coordinate so as not solely to give a minimum performance requirement. Secondly, some concern was expressed as to how this requirement would interface with Figures ECC.6.3.16(b) and ECC.6.3.16(c). A comment was also noted that the upper boundary would not be required.

To illustrate the concept of this approach, two examples are shown below. It should be noted that the diagrams associated with these examples are for illustration purposes only and not to scale.

Figure 16 shows an illustrative requirement of the behaviour expected from a plant operating in the leading mode of operation and the I_R value required when subject to a voltage dip of 0.7pu at the connection point.

In this case, the pre-fault operating condition is assumed to be arbitrarily operating at 1.07pu voltage and the reactive current is -0.3pu. This is shown by the blue circle in the

green shaded area. The reactive current injection can take any shape being linear or non-linear but would need to be on or above the blue dashed line shown in Figure 16 constructed between points A and B.

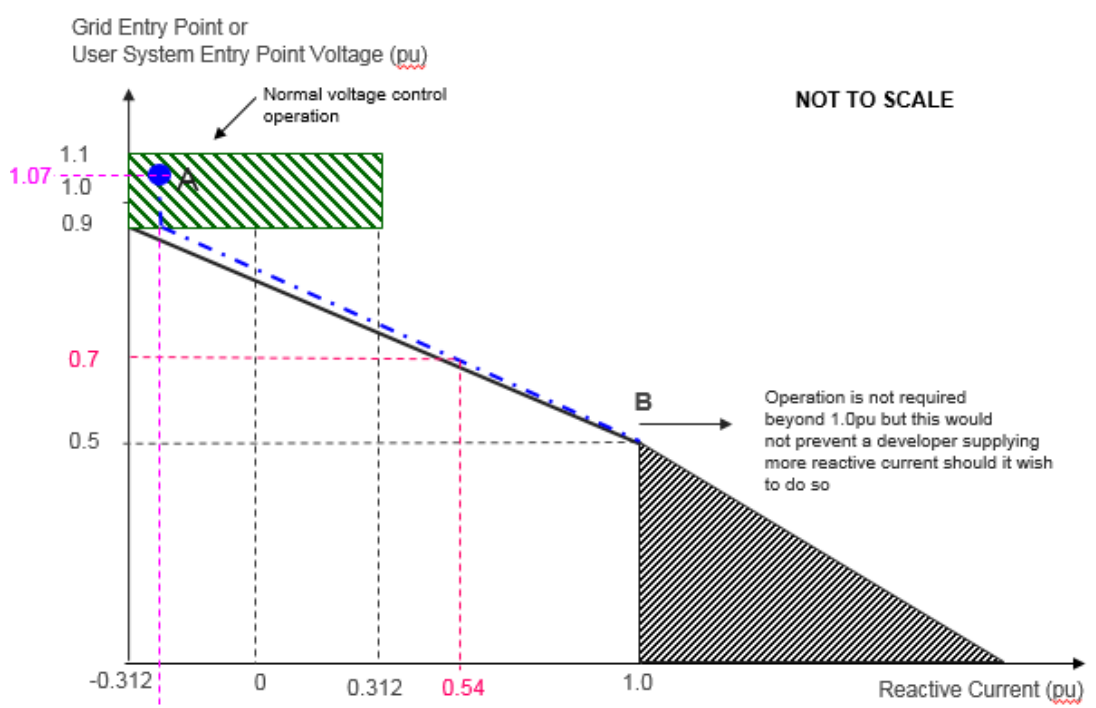

Figure 16.0

For the purposes of this example we are assuming the Power Park Module is exposed to a voltage dip of 0.7 pu. At 0.7pu voltage this corresponds to I_R of 0.54 pu reactive current as shown by the purple dashed line and where it intersects with the blue dashed line. I_R would need to be greater than or equal to 0.54.

In terms of time frames and reactive current injection and the minimum performance requirement that would be expected is shown in Figures 17 and 18. In summary the reactive current injection would need to be 0.54pu or above by 120ms after fault inception, with any residual current (ie taking into account the converter rating) being supplied as active current. There is no real difference between these two figures other than in respect of the fault clearance time.

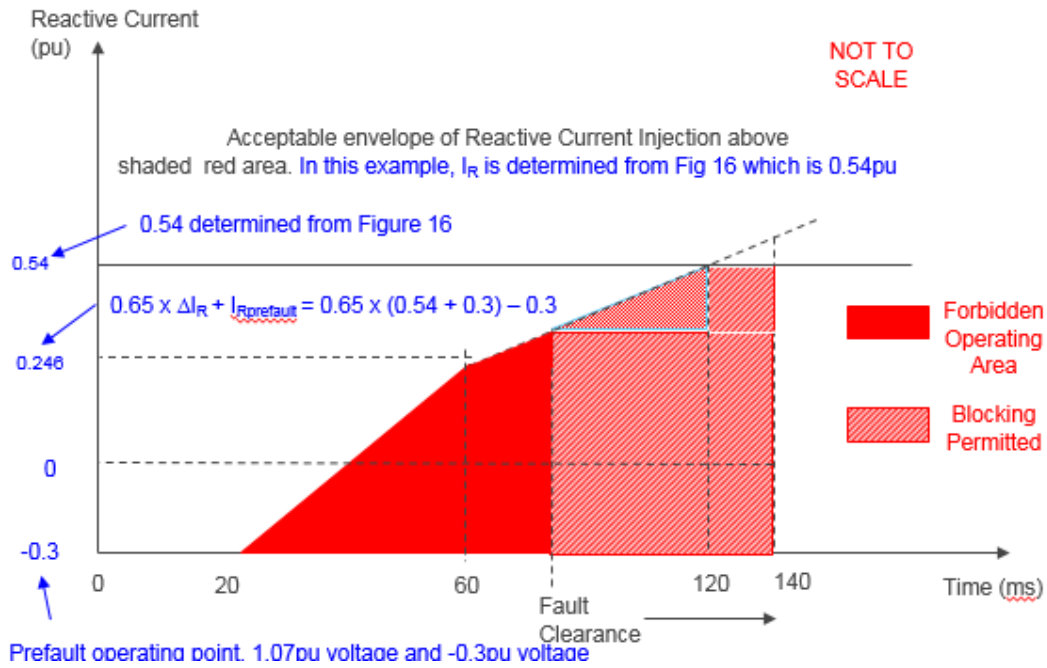

Figure 17

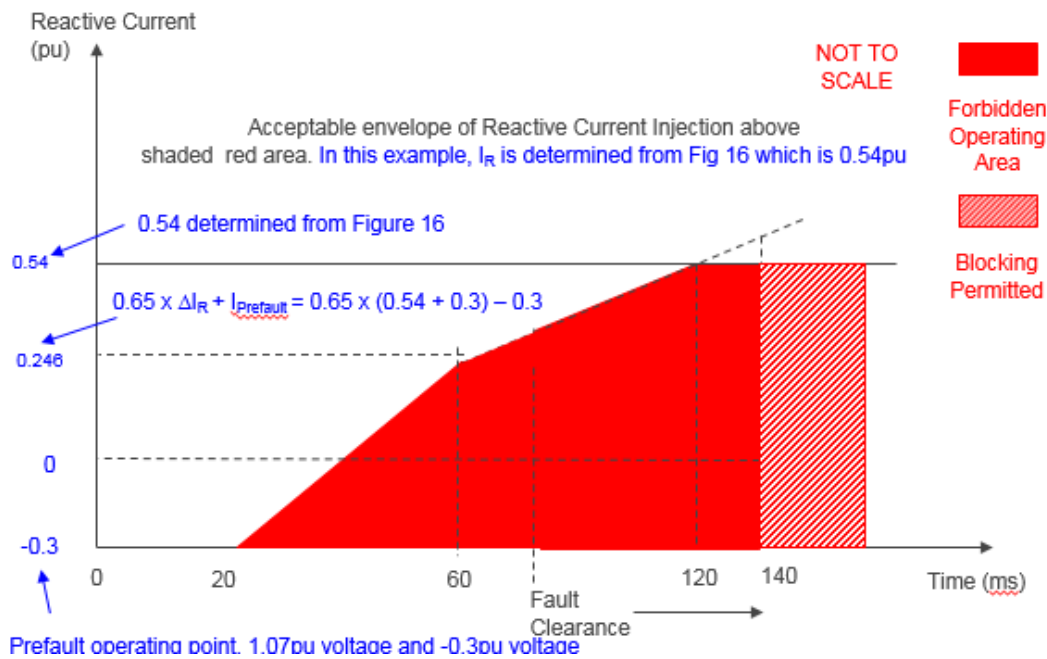

Figure 18

Example 2 is shown in Figure 19 which shows an illustrative requirement of the behaviour expected from a plant operating in the lagging mode of operation and the resultant I_R required when subject to a voltage dip of 0.7pu at the connection point.

In this case, the pre-fault operating condition is assumed to be arbitrarily operating at 0.96pu voltage and the reactive current is 0.312pu. This is shown by the brown circle in the green shaded area. Applying the same approach as in example 1, the brown dotted line constructed between points A and B of Figure 19 indicates the I_R required as a function of the retained voltage. However we need to ensure that the rating of the plant is not exceeded and therefore an additional pink line at point C is drawn. This reduction is permitted as the Grid Code requires full reactive capability to be provided over a voltage range of 1.05pu to 0.95pu. Below 0.95pu voltage, a drop in the reactive power export is

permitted as it is possible a number of developers may choose to use fixed capacitors to contribute to voltage control in which case the reactive power falls off with the square of the voltage. This characteristic showing the allowed fall in reactive power is shown in Figures ECC.A.7.2.2b and ECC.A.7.2.2c of Appendix 7 of the Grid Code European Connection Conditions.

For the purposes of this example, we are assuming the Power Park Module is exposed to a voltage dip of 0.7 pu. At 0.7 pu voltage this corresponds to a I_R of 0.64 pu reactive current as shown by the purple dashed line and where it intersects with the pink dashed line at 0.7pu voltage.

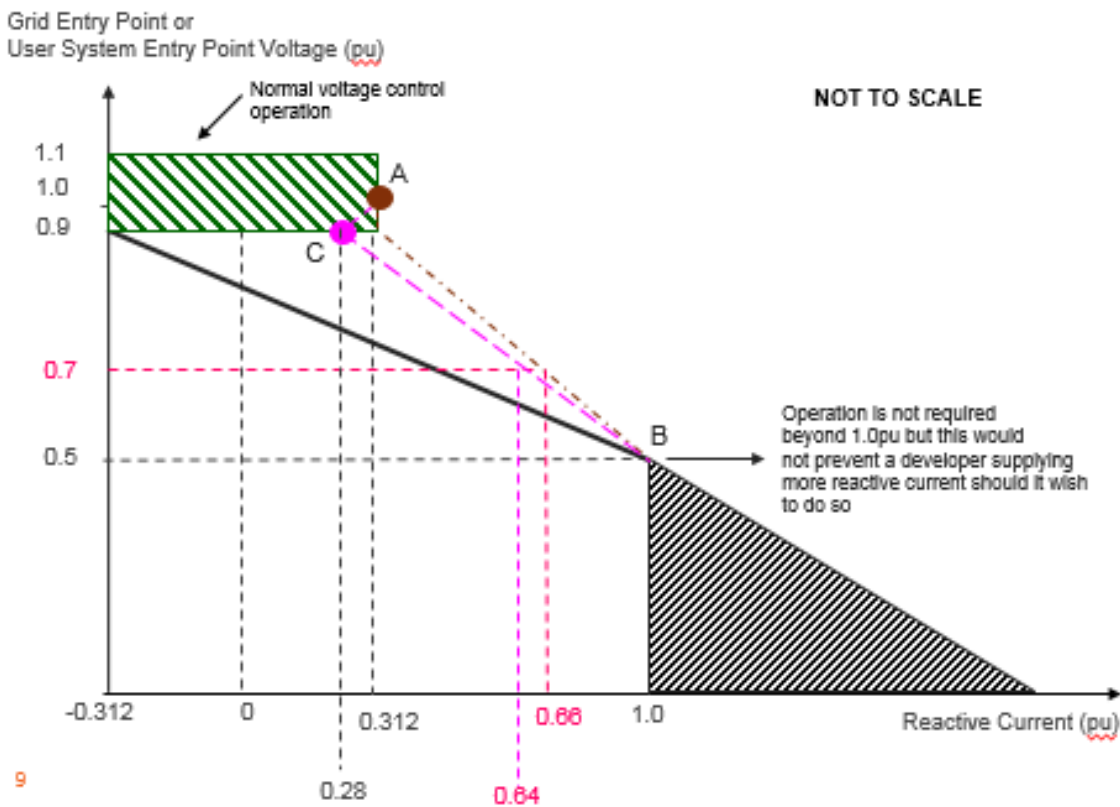

Figure 19.0

In terms of time frames and reactive current injection the minimum performance requirement that would be expected is shown in Figures 20 and 21. There is no real difference between these two figures other than in respect of the fault clearance time. In this example the green hashed area is showing the effect of the pre-fault operating condition of the Power Park Module.

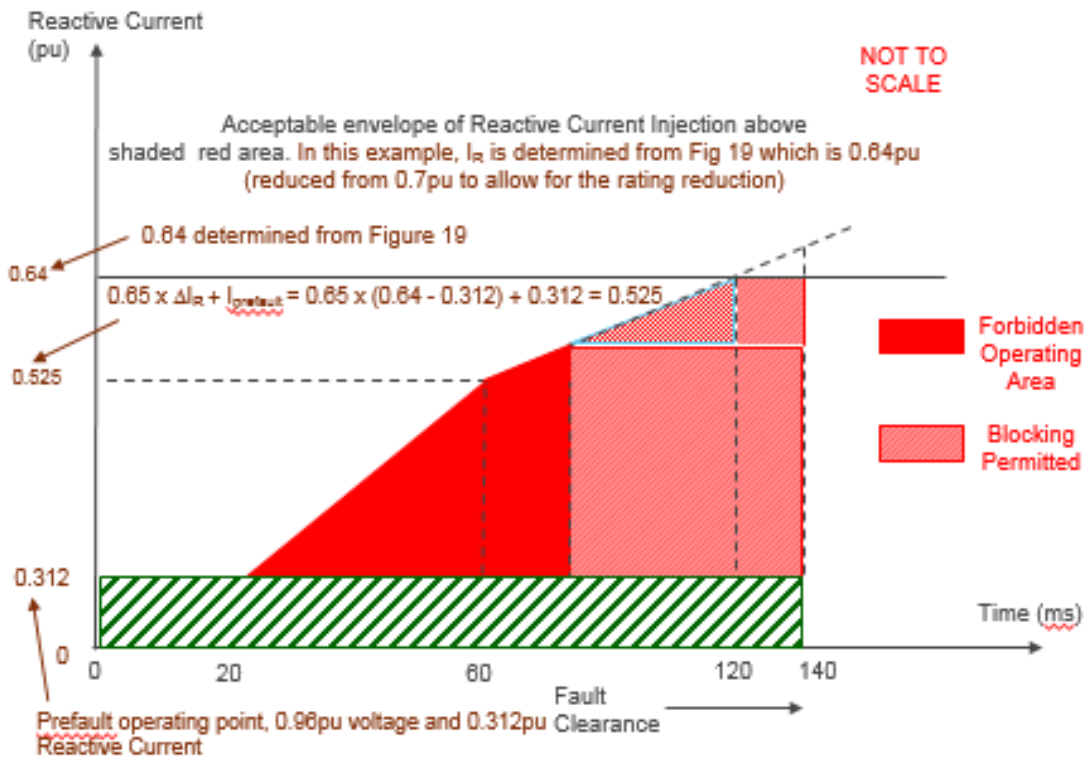

Figure 20.0

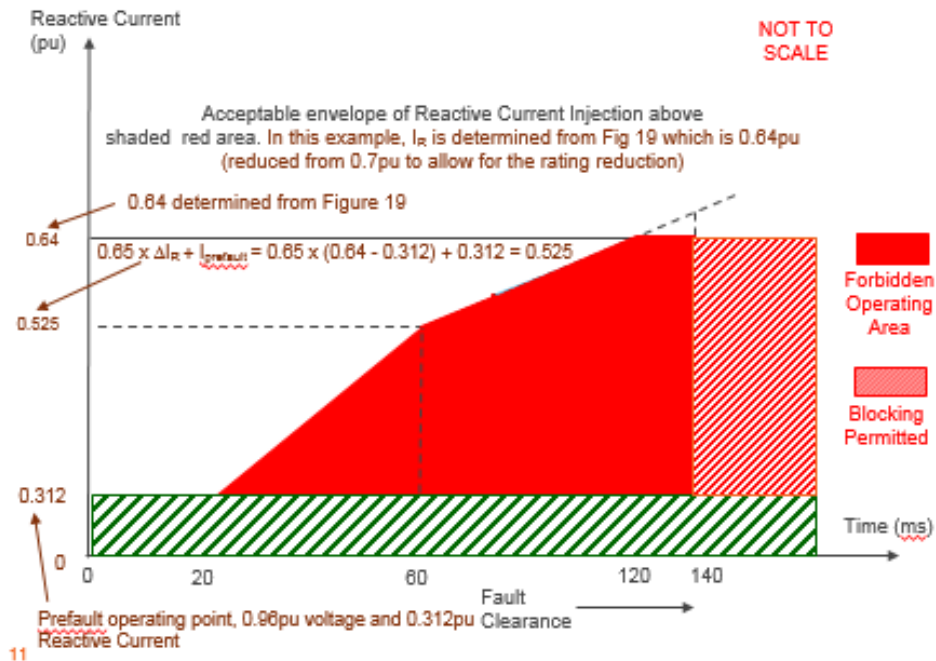

Figure 21

The above approach was discussed amongst the workgroup at the meeting on 7 February 2019 and re-discussed at a later meeting on 13 February 2019. To fix the second deficiency that the current Grid Code text is not clear how the reactive current should vary with depressed voltage, changes to Grid Code sections ECC.6.3.16.1.1 to ECC.6.3.16.1.5 has been modified based on the above discussion text.

Also as part of the proposal following workgroup discussion it was agreed to separate out the requirements for balanced and unbalanced faults, as RfG leaves the behaviour of unbalanced faults and fast fault current injection performance to the TSO, by removing the word “unbalanced” from ECC.6.3.16.1.2.

Does this modification impact a Significant Code Review (SCR) or other significant industry change projects, if so, how?

No

Consumer impacts

There are no consumer impacts

4 Workgroup Discussions

The Workgroup convened six times to discuss the issue, detail the scope of the proposed defect, devise potential solutions, assess the proposal in terms of the Grid Code Applicable Objectives. The Proposer presented the defect that they had identified in the GC0111 proposal and highlighted that the defect related to update the Grid Code with revised text for fast fault current injection to dispel any confusion in interpretation of the existing text.

The Workgroup explored a number of aspects in its meetings to understand the implications of the proposed defect and solutions. The discussions and views of the Workgroup are outlined below.

Workgroup 1 – 4 July 2018

The slides presented by National Grid as Electricity System Operator are attached in Annex 2A. In summary, this concentrated on the background to the issue, the defect and the key clarification that during a fault there is no requirement for the Power Park Module to exceed its rating. In addition, the point was also raised with regard to the defect in ECC.6.3.16.1.4 which states “the reactive current injected from each Power Park Module or HVDC Equipment shall be injected in proportion and remain in phase to the change in System voltage at the Connection Point or User System Entry Point during the period of the fault.

At the workgroup meeting it was advised that some form of specification would be required to detail how the reactive current should vary with depressed voltage and address the linkage between the fault ride through requirements in ECC.6.3.15 and the fast fault current requirements in ECC.6.3.16.

Workgroup 2 – 10 September 2018

A presentation was provided by the National Grid Electricity System Operator (NGESO) representative to the Workgroup which is attached in Annex 2B. The NGESO representative advised that the aim of the legal text would be to keep the requirements

as generic but robust as possible. The following is the discussion on the proposed draft legal text as of 10 September 2018.

A Workgroup member stated that he found it difficult to follow all of the proposed graphs and therefore suggesting to only keep the graphs for Transmission connections but it may be useful to specify a description which would be equally effective.

A Workgroup member stated that in Figure ECC.16.3.16(a), a statement on what the maximum voltage and proportionality criteria needed to be clarified. It was agreed that this is what the graph was trying to achieve.

A Workgroup member queried whether the figures in ECC.16.3.16(a) are absolute figures. The NGESO representative tried to address this issue but further thought and clarity was needed for the legal text.

The NGESO representative referred to Figure ECC.3.16(b) and stated that the Workgroup needs to consider whether this would be a rise time or a settlement time. He explained that the reactive current has to be above the red section on the figure. The control performance should be adequately damped.

Another Workgroup member stated that their comments had already been addressed and they will forward some comments by E Mail to aid the drafting of the legal text.

A Workgroup member queried how the changes on RfG were going to be taken forward. The NGESO representative confirmed that the RfG requirements were captured in [GC0100 EU Connection Codes GB Implementation Mod 1](#) and these have now been implemented into the Grid Code. However, it did not capture faults greater than 140 ms which have been retained as part of the existing GB Code drafting.

A Workgroup member stated that it is common for type tests to be completed for fault ride through. There may not be clear testing requirements, so this will need some clarity.

The NGESO representative informed the Workgroup that it was discussed that it is not possible to demonstrate on a module basis but you can do so on individual turbines basis. There is a challenge in articulating this in the Grid Code legal text as the Grid Code is based around a performance requirement for the module rather than the turbine. Although the text is written with respect to Power Park Module performance, the proposed text does provide a clause for assessment at a unit level.

A Workgroup member queried what would happen if the voltage drops below 1 per unit ie what would be the consequences as the Power Park Module could include various combinations as there is a phase between operation within the normal voltage operating range (ie $\pm 10\%$) and under fault ride through conditions. The NGESO representative stated that they would review this when looking at the legal text.

The NGESO representative clarified that in relation to slide 11 that below 50% is a priority for reactive current injection and above 50% there should be a minimum requirement to supply reactive current with any residual being supplied as active current. It was agreed that it needs to be clarified which of these are the priority and this needs to be clearly articulated. A Workgroup member queried whether there needed to be an example around where the voltage drops below 50%. The NGESO representative stated that where the voltage drops below 50% the reactive current should be prioritised.

A Workgroup member queried whether the proposal was asking for absolute levels of current. The NGESO representative stated that he would review whether these are absolute values or delta values.

A Workgroup member raised in relation to ECC.6.3.16.1.4 that if this is a requirement, then this should be in the compliance section of the Grid Code as opposed to the European Connection Code. The NGESO representative agreed to discuss this with the National Grid Compliance Team before updating the legal text.

A Workgroup member queried where the items specified in Article 20 are reflected in the draft legal text? The NGESO representative stated that as part of the mapping exercise that was completed as part of the GC0100 consultation.

The NGESO representative confirmed that he would take the Workgroup feedback on board, amend the legal text and recirculate it around the Workgroup for comment. Part of this analysis would be to ensure there is consistency between the proposed legal text and the European Connection Codes.

Workgroup 3 – 7 November 2018

A presentation was presented by the National Grid Electricity System Operator (NGESO) representative to the Workgroup which is attached in Annex 2C.

Following discussions and emails in between the Workgroups, the NGESO representative drafted and presented to the Workgroup two draft versions of legal text – 1A and 1B. As noted above version 1A was based on the draft text discussed at the September meeting and version 1B incorporates elements from the fast fault current injection requirements of EN50549.

A Workgroup member stated that they would suggest not using pre-fault in the formula on slide 7 of the slide pack. In addition, some practical examples would be helpful to understand the requirements better.

A Workgroup member observed that the changes to voltage would have a minimal impact on Distribution Network Operators.

In relation to the legal text – version 1A, the NGESO representative stated that the diagram on slide 10 is in relation to the sum of all the turbines.

In relation to legal text – version 1B, the NGESO representative stated that incorporating EN50549 means that it becomes very complex very quickly but does more easily address the issue of unbalanced faults. Based on discussions prior to the Workgroup, the NGESO representative stated that it seemed that the majority of the Workgroup were in favour of legal text -version 1A although it was recognised that it needed further work including agreeing a recommendation for implementation. Legal text 1A will result in minimal impact on the industry when devising the solution.

A Workgroup member queried whether the EN50549 requirements link to HVDC equipment and queried whether any Workgroup members manufacture that kind of equipment to ensure their view is reflected. The NGESO representative confirmed that this did relate to HDVC Equipment and that there are Workgroup members from Siemens who manufacture HVDC equipment.

The Workgroup unanimously agreed that the Workgroup should proceed with version 1A of the legal text for the solution.

The Workgroup reviewed the legal text by exception to allow the legal text to be further developed.

A Workgroup discussed the timeline, and agreed that they wanted to talk through some worked examples before deciding whether to proceed to a Workgroup consultation.

The Workgroup discussed the terms of reference set by the Grid Code Review Panel:

a. Implementation and costs

In terms of costs, the NGESO representative stated that the implementation will be linked to contracts and that the aim is to minimise any costs as the changes to the legal text are for clarification purposes only and should not result in additional cost.

b. Develop draft the legal text

This is currently in progress and will be completed to be submitted with the Workgroup Report to the Grid Code Review Panel.

c. Consider whether any further industry experts or stakeholders should be invited to participate in the Workgroup

This has been done on an ongoing basis. The Workgroup is comprised of industry experts. The NGESO representative expressed his gratitude for the participation and help given so far in developing the solution.

d. Consider the materiality of the change

The materiality of the change is low as the purpose of the modification is to provide clarity to industry.

e. Requirement for a Workgroup Consultation

This is unknown until the Workgroup has seen some worked examples. At that point the Workgroup can decide whether to proceed to a Workgroup consultation.

f. Review the trigger voltage and Fault Ride Through requirements and whether the changes are compatible

The NGESO representative stated that this is a National Grid issue and he believes this is minimal. He will continue to consider this as the solution is developed.

One Workgroup member provided a spreadsheet showing plant performance, which was circulated to the Workgroup.

Workgroup 4 – 6 December 2018

A presentation was presented by the National Grid Electricity System Operator (NGESO) representative to the Workgroup which is attached in Annex 2D.

The NGESO representative presented to the Workgroup a presentation which included a number of worked examples to demonstrate how the proposed solution would work in practice.

The Workgroup discussed compliance and agreed there needed to be section on compliance legal text included in the solution to complete the modification.

A Workgroup member queried whether there was a need for a further compliance modification as there are a number of issues that needed to be addressed.

The Workgroup agreed to continue to use the term “insensitivity” as opposed to dead band to provide greater clarity to Grid Code users.

A Workgroup member queried when the 20 milliseconds in example 5 starts. It was agreed that NGESO would look at this.

The Workgroup discussed the formula in example 2 of the slide pack (see Appendix 1D) and it was agreed that the NGESO representative would review the formula and re-circulate this around the Workgroup.

On slide 36, The NGESO representative stated that based on the approach set out in slide 36, it is possible to calculate the FFCI Power Park Module performance requirement at the connection point and work back to each turbine.

In terms of the implementation, it was agreed by the Workgroup that the approach should be that it runs from the signing of the contract rather than the completion date of plant installation though care needed to be exercised as the current Grid Code drafting is not that clear.

A Workgroup member asked for the implementation to be clearly set out including how long it will take manufacturers to implement this modification.

Based on the worked examples, the Workgroup agreed that a Workgroup consultation was not necessary or required to develop the solution.

Workgroup 5 – 7 February 2019

A presentation was presented by the National Grid Electricity System Operator (NGESO) representative to the Workgroup which is attached in Annex 2E.

At this meeting, the NGESO representative outlined the revised thinking based on the stakeholder comments received in January. At this meeting, the NGESO representative highlighted that the current drafting as prepared in December 2018 and circulated to the Workgroup in January 2019 still presented a few issues, but these mainly related to the variation in injected reactive current depending upon whether the plant was operating in a pre fault leading or lagging mode of operation. To this extent the NGESO representative suggested changing the formula as follows:-

$$I_R = \Delta V_{1.k} + 0.265$$

and

$$\Delta V_1 = 0.9 - V_{\text{retained}}$$

The details of this approach are summarised in section 3 however a number of Workgroup members stated that this would cause a number of problems.

The Proposer did note at this stage that they were clear what was required which in principle required injection of reactive current in a progressive manner as the retained voltage starts to fall with the full reactive current injection of 1.0pu required at retained voltages of 0.5pu or less.

As a consequence of this, a number of options were discussed which revolved around a solution defining a criterion around a minimum requirement injection requirement between the normal steady state operating range and the need to inject 1.0pu reactive current at connection point voltages of 0.5pu or less.

A number of slides around this discussion were developed at the meeting and these are shown in Annex 2F. This approach and detailed examples are shown in Section 3 which the Proposer is comfortable with and which is believed to provide the best approach for this solution.

As part of the discussion the issue of compliance was also mentioned and it was advised that developers would be able to have the option of demonstrating compliance at the Generating Unit terminals should they so wish. This will be included in the revised legal drafting.

One Workgroup member expressed concern over the requirement for unbalanced faults. It was suggested that they may wish to raise a Workgroup Alternative to address this issue.

As a post meeting note, NGENSO considers that a simple way in which this issue could be addressed is based on the fact that RfG for Fast Fault Current Injection does not apply to Unbalanced Faults and it down to the TSO to define this requirement. Put simply, and with this flexibility, it would enable the text to revert back to the GB Grid Code requirement pre RfG which simply states that in the case of unbalanced faults, the Power Park Module should inject maximum reactive current without exceeding the transient rating of the Power Park Module or HVDC Equipment whilst any such performance requirement would need to be agreed with NGENSO against the control philosophy of the design. This issue was addressed and included in the updated legal text which was discussed with Stakeholders at the Webex held on 13 February. For distribution connected plant there is no pre-existing FFCI requirement and the same approach will be adopted for distribution connected Power Park Modules.

Workgroup 6 Webex – 13 February 2019

Following the meeting held on 7 February 2019, it was proposed to hold the workgroup vote based on an updated workgroup report and legal text which was circulated on 8 February and 11 February respectively. Following the re-issue of this text a number of comments were received and these issues were discussed at the meeting with the

decision taken to delay the vote until Workgroup members had been given adequate time to re-assess the workgroup report and legal text.

The final proposal as drafted and the approach proposed is summarised in section 3 of this report. It was also agreed to treat unbalanced faults separately from balanced faults and the legal text has been updated to address this.

During the discussion, one workgroup member suggested ECC.6.3.15.9.2.1(b)(ii) be changed to refer to 0.9pu voltage rather than the minimum voltage levels specified in ECC.6.1.4. The Proposer considered this change but felt it would not be entirely correct as the voltage range varies depending on connection voltage. For example, at voltages of 275, 132 or 100kV the voltage range is $\pm 10\%$ whereas for connection voltages below 110kV the voltage range is $\pm 6\%$. As such the proposer declined to make this change.

5 Workgroup Vote

The Workgroup believe that the Terms of Reference have been fulfilled and GC0111 has been fully considered.

The Workgroup met on 13 March 2019 and voted on whether the Original would better facilitate the Applicable Grid Code Objectives than the baseline and what option was best overall.

The Workgroup agreed unanimously that the Original was better than the baseline. The voting record is detailed below.

The Workgroup voted against the Grid Code objectives for the Original Proposal. The Workgroup voted, and eight Workgroup members concluded that the Original Proposal is the best option and the baseline received zero votes.

In conclusion, the Workgroup supported the Original as the best option.

The voting record is detailed below:

Vote 1 – does the original facilitate the objectives better than the Baseline?

Vote recording guidelines:

“Y” = Yes

“N” = No

“-” = Neutral

Workgroup Member	Better facilitates AGCO (i)	Better facilitates AGCO (ii)?	Better facilitates AGCO (iii)?	Better facilitates AGCO (vi)?	Better facilitates AGCO (v)?	Overall (Y/N)
Mike Kay (Proposer)						
Original	Yes	Yes	Yes	Yes	Neutral	Yes

<p>Voting Statement:</p> <p>The proposed drafting makes clearer the detailed requirements of FFCI for all stakeholders.</p>						
<p>Antony Johnson</p>						
Original	Yes	Yes	Yes	Yes	Yes	Yes
<p>Voting Statement:</p> <p>Provides clarity to users for the obligations they have to meet.</p>						
<p>Isaac Gutierrez</p>						
Original	Yes	Yes	Yes	Yes	Yes	Yes
<p>Voting Statement:</p> <p>This modification provides clarity in relation to the FFCI technical requirements for both developers and frequency converter based generation manufacturers</p>						
<p>Alastair Frew</p>						
Original	Yes	Yes	Yes	Yes	Neutral	Yes
<p>Voting Statement:</p> <p>This modification clarifies the requirements for fast fault current injection by removing the transitional change of response after 140ms and simplifying this into a continuous response requirement.</p>						
<p>Sridhar Sahukari</p>						
Original	Yes	Yes	Yes	Yes	Neutral	Yes
<p>Voting Statement:</p> <p>The new drafting provides clarity for developers and manufacturers for fast fault current injection</p>						
<p>Sigrid Bolik</p>						
Original	Neutral	Yes	Yes	Yes	Neutral	Yes
<p>Voting Statement:</p> <p>The new drafting providing clarity to fulfil the grid code obligations</p>						
<p>Christos Taratoris</p>						
Original	Yes	Yes	Yes	Yes	Yes	Yes
<p>Voting Statement:</p>						

Provides clarity to users and manufactures						
Ireneusz Grzegorz Szczesny						
Original	Yes	Yes	Yes	Yes	Neutral	Yes
Voting Statement: The new drafting provides better clarity						

Vote 2 – Which option is the best? (Baseline, Original solution or WACM(s))

Workgroup Member	BEST Option?
Mike Kay	Original
Tony Johnson	Original
Isaac Gutierrez	Original
Alastair Frew	Original
Sridhar Sahukari	Original
Sigrid Bolik	Original
Christos Taratoris	Original
Ireneusz Grzegorz Szczesny	Original

6 GC0111: Relevant Objectives

Below sets out how the Proposal meets the Applicable Grid Code Objectives as stated by the Proposer:

Impact of the modification on the Applicable Grid Code Objectives:

Relevant Objective	Identified impact
(a) To permit the development, maintenance and operation of an efficient, coordinated and economical system for the transmission of electricity	Positive
(b) Facilitating effective competition in the generation and supply of electricity (and without limiting the foregoing, to facilitate the national electricity transmission system being made available to persons authorised to supply or generate electricity on terms which neither prevent nor restrict competition in the supply or generation of electricity);	Positive
(c) Subject to sub-paragraphs (i) and (ii), to promote the security and efficiency of the electricity generation, transmission and distribution systems in the national electricity transmission system operator area taken as a whole;	Neutral
(d) To efficiently discharge the obligations imposed upon the licensee by this license and to comply with the Electricity Regulation and any relevant legally binding decisions of the European Commission and/or the Agency; and	Positive
(e) To promote efficiency in the implementation and administration of the Grid Code arrangements	Neutral

Proposer's initial view:

The view of the Proposer is that GC0111 should be implemented without delay so that manufacturers are in no doubt about the necessary performance requirements for compliance with the RfG as implemented in GB.

7 Implementation and costs

The current Grid Code is considered to be unclear in their treatment of fast fault current injection. As this change is deemed as clarification the Proposer seeks to implement this proposed modification ten working days following a decision made by the Panel.

Industry Costs	
Resource costs	<p>£59,895 - 6 Workgroup meetings</p> <p>£1,815 – 1 Consultations</p> <ul style="list-style-type: none"> • 6 Workgroup meetings • 11 Workgroup members • 1.5 man days effort per meeting • 1.5 man days effort per consultation response • 2 consultation respondents
Total Code Administrator costs	£10,890
Total Industry Costs	£72,974

8 Code Administrator Consultation Responses

The Code Administrator Consultation was issued on 5 April 2019 for 20 Working Days, with a closing date of 8 May 2019.

Two responses were received to the Code Administrator Consultation and are detailed in Annex 4.

9 Grid Code Review Panel Views

At the Grid Code Review Panel meeting on 30 May 2019, the Panel voted on GC0111 against the Applicable Grid Code Objectives.

The Panel members unanimously agreed that the Original was better than the baseline and determined that it should be implemented.

For reference the Applicable Grid Code Objectives are;

- i. to permit the development, maintenance and operation of an efficient, coordinated and economical system for the transmission of electricity;
- ii. to facilitate competition in the generation and supply of electricity (and without limiting the foregoing, to facilitate the national electricity transmission system being made available to persons authorised to supply or generate electricity on terms which neither prevent nor restrict competition in the supply or generation of electricity);
- iii. subject to sub-paragraphs (i) and (ii), to promote the security and efficiency of the electricity generation, transmission and distribution systems in the national electricity transmission system operator area taken as a whole;

- iv. to efficiently discharge the obligations imposed upon the licensee by this license and to comply with the Electricity Regulation and any relevant legally binding decisions of the European Commission and/or the Agency; and
- v. to promote efficiency in the implementation and administration of the Grid Code arrangements.

Vote 1: Does the original facilitate the objectives better than the Baseline?

Panel Member	Better facilitates GCO (i)	Better facilitates GCO (ii)?	Better facilitates GCO (iii)?	Better facilitates GCO (iv)?	Better facilitates GCO (v)?	Overall (Y/N)
Tony Johnson (alternate to Colm Murphy)						
Original	Yes	Yes	Yes	No	Neutral	Yes
<p>Voting Statement: As part of the GB implementation of the RfG European Network Code, fast fault current requirements from generators were defined as part of mod GC0100.</p> <p>Following this implementation, stakeholders expressed concern that the drafting of Grid Code clause ECC.6.3.16 was unclear, particularly relating to the rated current. The key word that caused the issue and which GC0111 sought to resolve was ‘reactive’ in the clause below referring to the fault current and which was drawn from the European legislation. If this were interpreted as purely reactive then wind turbines could have to produce full rated reactive current plus some active component putting them over their ratings. If what the clause specified was actually the magnitude of the injected current (which was the intention) then this is not an issue – as ‘reactive’ refers to an overwhelmingly reactive fault current but was not intended to be definitive.</p> <p>ECC.6.3.16.1.2 For any balanced or unbalanced fault which results in the phase voltage on one or more phases falling outside the limits specified in ECC.6.1.42 at the Grid Entry Point or User System Entry Point, each Type B, Type C and Type D Power Park Module or HVDC Equipment shall, unless otherwise agreed with NGESO, be required to inject a reactive current above the shaded area shown in Figure ECC.16.3.16(a) and Figure 16.3.16(b). For the purposes of this requirement, the maximum rated current is taken to be the maximum current each Power Park Module (or constituent Power Park Unit) or HVDC Converter is capable of supplying when operating at rated Active Power and rated Reactive Power (as required under ECC.6.3.2) at a nominal voltage of 1.0pu.</p> <p>NGESO set out that the intention of the drafting of the European Code from which this requirement was drawn was not to push turbines into producing greater than rated current, that NGESO had no intention of applying the alternative and more onerous interpretation, and that the clause ‘unless otherwise agreed with NGESO’ also gave scope both for flexibility and agreement. Stakeholders still felt that this required clarification and Grid Code modification proposal GC0111 was therefore proposed to develop a more detailed specification.</p> <p>NGESO supports the proposal which satisfies stakeholders and against which the procurement and operation of equipment can be derisked. NGESO also supports the proposal as it provides greater clarity for unbalanced faults. However, NGESO feels that there is a debate to be had about the purpose of the Grid Code and whether it is a detailed</p>						

technical specification or a broader setting out of technical and operational requirements which could perhaps be progressed as part of the Energy Codes Review, noting as well that the legal text has increased from a single paragraph to several pages.

Damian Jackman						
Original	Yes	Yes	Yes	Yes	Yes	Yes
Voting Statement: The proposal better defines the FFCI characteristics to provide clarity for developers and manufacturers.						

Alastair Frew						
Original	Yes	Yes	Yes	Yes	Neutral	Yes
Voting Statement: This modification clarifies the requirements for fast fault current injection by removing the transitional change of response after 140ms and simplifying this into a continuous response requirement.						

Joe Underwood						
Original	Yes	Yes	Yes	Yes	Neutral	Yes
Voting Statement: Better provides clarity of the regulation/Grid Code and will provide increased investor confidence.						

Guy Nicholson						
Original	Yes	Yes	Yes	Yes	Neutral	Yes
Voting Statement: Agree with workgroup.						

Robert Longden						
Original	Yes	Yes	Yes	Yes	Neutral	Yes
Voting Statement: The modification provides clarity on the requirements for FFCI for all stakeholders.						

Richard Woodward (alternate to Ross McGhin)						
Original	Yes	Yes	Yes	Yes	Neutral	Yes
Voting Statement: We are satisfied with the approach taken by the proposer and the workgroup, and are happy to endorse the outcome they advocate.						

Christopher Smith						
Original	Yes	Yes	Yes	Yes	Neutral	Yes
Voting Statement: Provides clarification on the technical requirements.						

Graeme Vincent (alternate to Alan Creighton)						
Original	Yes	Yes	Yes	Yes	Neutral	Yes
Voting Statement: Modification provides additional clarity in relation to the Fast Fault Current Injection (FFCI) requirements expected from new Users.						

Vote 2 – Which option is the best?

Panel Member	BEST Option?
Tony Johnson (alternate to Colm Murphy)	Original
Damian Jackman	Original
Alastair Frew	Original
Joe Underwood	Original
Guy Nicholson	Original
Robert Longden	Original
Richard Woodward (alternate to Ross McGhin)	Original
Christopher Smith	Original
Graeme Vincent (alternate to Alan Creighton)	Original

Breakdown of voting:

Option	Overall Support of the option achieving the Grid Code Objectives than the baseline
Original	9 Yes

The Grid Code Review Panel therefore determined unanimously that this could be implemented.

10 Legal Text

Annex 3A details the proposed changes to the European Connection Code and European Compliance Processes should GC0111 be approved and implemented.

Annex 1 – Terms of Reference

Workgroup Terms of Reference and Membership

TERMS OF REFERENCE FOR GC0111 WORKGROUP

To update the Grid Code and G99 with revised text for fast fault current injection to dispel any confusion in interpretation of the existing text.

Responsibilities

1. The Workgroup is responsible for assisting the Grid Code Review Panel in the evaluation of Grid Code Modification Proposal **GC0111 Fast Fault Current Injection specification text** proposed by Mike Kay of Energy Networks Association in April 2018 and presented to the Grid Code Review Panel on 26 April 2018.
2. The proposal must be evaluated to consider whether it better facilitates achievement of the Grid Code Objectives. These can be summarised as follows:
 - (i) *To permit the development, maintenance and operation of an efficient, coordinated and economical system for the transmission of electricity;*
 - (ii) *To facilitate competition in the generation and supply of electricity (and without limiting the foregoing, to facilitate the national electricity transmission system being made available to persons authorised to supply or generate electricity on terms which neither prevent nor restrict competition in the supply or generation of electricity);*
 - (iii) *Subject to sub-paragraphs (i) and (ii), to promote the security and efficiency of the electricity generation, transmission and distribution systems in the national; and*
 - (iv) *To efficiently discharge the obligations imposed upon the licensee by this license and to comply with the Electricity Regulation and any relevant legally binding decisions of the European Commission and/or the Agency. In conducting its business, the Workgroup will at all times endeavour to operate in a manner that is consistent with the Code Administration Code of Practice principles.*
 - (v) *To promote efficiency in the implementation and administration of the Grid Code arrangements.*

Scope

3. The Workgroup must consider the issues raised by the Modification Proposal and consider if the proposal identified better facilitates achievement of the Grid Code Objectives.
4. In addition to the overriding requirement of point 3 above, the Workgroup shall consider and report on the following specific issues:
 - a) *Implementation and costs;*
 - b) *Review draft legal text should it have been provided. If legal text is not submitted within the Grid Code Modification Proposal the Workgroup should be instructed to assist in the developing of the legal text; and*
 - c) *Consider whether any further Industry experts or stakeholders should be invited to participate within the Workgroup to ensure that all potentially affected stakeholders*

have the opportunity to be represented in the Workgroup. Demonstrate what has been done to cover this clearly in the report

- d) *Consider materiality of change*
 - e) *Workgroup consultation and whether required*
 - f) *Review the trigger voltage and FRT requirements and whether compatible*
5. As per Grid Code GR20.8 (a) and (b) the Workgroup should seek clarification and guidance from the Grid Code Review Panel when appropriate and required.
 6. The Workgroup is responsible for the formulation and evaluation of any Workgroup Alternative Grid Code Modifications arising from Group discussions which would, as compared with the Modification Proposal or the current version of the Grid Code, better facilitate achieving the Grid Code Objectives in relation to the issue or defect identified.
 7. The Workgroup should become conversant with the definition of Workgroup Alternative Grid Code Modification which appears in the Governance Rules of the Grid Code. The definition entitles the Group and/or an individual member of the Workgroup to put forward a Workgroup Alternative Code Modification proposal if the member(s) genuinely believes the alternative proposal compared with the Modification Proposal or the current version of the Grid Code better facilitates the Grid Code objectives. The extent of the support for the Modification Proposal or any Workgroup Alternative Modification (WACM) proposal arising from the Workgroup's discussions should be clearly described in the final Workgroup Report to the Grid Code Review Panel.
 8. Workgroup members should be mindful of efficiency and propose the fewest number of WACM proposals as possible. All new alternative proposals need to be proposed using the Alternative request Proposal form ensuring a reliable source of information for the Workgroup, Panel, Industry participants and the Authority.
 9. All WACM proposals should include the Proposer(s)'s details within the final Workgroup report, for the avoidance of doubt this includes WACM proposals which are proposed by the entire Workgroup or subset of members.
 10. There is an option for the Workgroup to undertake a period of Consultation in accordance with Grid Code GR. 20.11, if defined within the timetable agreed by the Grid Code Panel. Should the Workgroup determine that they see the benefit in a Workgroup Consultation being issued they can recommend this to the Grid Code Review Panel to consider.
 11. Following the Consultation period the Workgroup is required to consider all responses including any Workgroup Consultation Alternative Requests. In undertaking an assessment of any Workgroup Consultation Alternative Request, the Workgroup should consider whether it better facilitates the Grid Code Objectives than the current version of the Grid Code.
 12. As appropriate, the Workgroup will be required to undertake any further analysis and update the appropriate sections of the original Modification Proposal and/or WACM proposals (Workgroup members cannot amend the original text submitted by the Proposer of the modification) All responses including any Workgroup Consultation Alternative Requests shall be included within the final report including a summary of the Workgroup's deliberations and conclusions. The report should make it clear where and why the Workgroup chairman has exercised their right under the Grid Code to progress a Workgroup Consultation Alternative Request or a WACM proposal against the majority views of Workgroup members. It should also be explicitly stated where, under these circumstances, the Workgroup chairman is employed by the same organisation who submitted the Workgroup Consultation Alternative Request.

13. The Workgroup is to submit its final report to the Modifications Panel Secretary on 20 March 2019 for circulation to Panel Members. The final report conclusions will be presented to the Grid Code Review Panel meeting on 27 March 2019.

Membership

It is recommended that the Workgroup has the following members:

Role	Name	Representing (User nominated)
Chair	Matthew Bent	Code Administrator
Technical Secretary	Emma Hart	Code Administrator
National Grid Representative*	Antony Johnson	National Grid Electricity System Operator
Workgroup Member*	Isaac Gutierrez	Scottish Power Renewables
Workgroup Member*	Mike Kay (Proposer)	ENA
Workgroup Member*	Alastair Frew	Drax Generation
Workgroup Member*	Sridhar Sahukari	Orsted
Workgroup Member*	Garth Graham	SSE
Workgroup Member*	Sigrid Bolik	Senvion
Alternate Workgroup Member*	Nial Duncan	Senvion
Workgroup Member*	Federico Rueda Londono	Vestas Wind Systems A/S
Workgroup Member*	Marko Grizelj	Siemens
Alternate Workgroup Member*	Christos Taratoris	Siemens
Alternate Workgroup Member*	Chandu Bapatu	Siemens
Alternate Workgroup Member*	Umair Sheikh	Siemens
Alternate Workgroup Member*	Alvaro Jose Hernandez Manchola	Siemens
Workgroup Member*	Ireneusz Grzegorz Szczesny	Siemens Gamesa Renewable Energy
Workgroup Member*	Vicenc Casadevall	GE Renewable Energy

14. A (*) Workgroup must comprise at least 5 members (who may be Panel Members). The roles identified with an asterisk (*) in the table above contribute toward the required quorum, determined in accordance with paragraph 15 below.
15. The Grid Code Review Panel must agree a number that will be quorum for each Workgroup meeting. The agreed figure for GC0110 is that at least 5 Workgroup members must participate in a meeting for quorum to be met.
16. A vote is to take place by all eligible Workgroup members on the Modification Proposal and each WACM proposal and Workgroup Consultation Alternative Request based on their assessment of the Proposal(s) against the Grid Code objectives when compared against the current Grid Code baseline.

- Do you support the Original or any of the alternative Proposals?
- Which of the Proposals best facilitates the Grid Code Objectives?

The Workgroup chairman shall not have a vote, casting or otherwise.

The results from the vote and the reasons for such voting shall be recorded in the Workgroup report in as much detail as practicable.

17. It is expected that Workgroup members would only abstain from voting under limited circumstances, for example where a member feels that a proposal has been insufficiently developed. Where a member has such concerns, they should raise these with the

Workgroup chairman at the earliest possible opportunity and certainly before the Workgroup vote takes place. Where abstention occurs, the reason should be recorded in the Workgroup report.

18. Workgroup members or their appointed alternate are required to attend a minimum of 50% of the Workgroup meetings to be eligible to participate in the Workgroup vote.
19. The Technical Secretary shall keep an Attendance Record for the Workgroup meetings and circulate the Attendance Record with the Action Notes after each meeting. This will be attached to the final Workgroup report.
20. The Workgroup membership can be amended from time to time by the Grid Code Review Panel and the Chairman of the Workgroup.

Timeline

Initial consideration by Workgroup	4 July 2018
Modification concluded by Workgroup	February 2019
Workgroup Report presented to Panel	28 March 2019
Code Administration Consultation Report issued to the Industry	w/c 1 April 2019
Draft Self Governance Report presented to Panel	30 May 2019
Grid Code Review Panel decision	30 May 2019
Appeal Window Open	31 May 2019
Appeal Window Close	21 June 2019
Decision implemented in Grid Code	5 July 2019

Annex 2A – Workgroup Presentation July 2018

GC0111

RfG Clarifications to Fast Fault Current Injection

nationalgrid



Antony Johnson
National Grid – Network Capability
July 2018

-
- Background to the RfG Fast Fault Current Requirements
 - Summary of the RfG Fast Fault Current Requirements
 - Areas of concern raised by Stakeholders
 - Proposed clarifications
 - Examples
 - Summary
 - Next Steps

Background to RfG Fast Fault Current Injection Requirements nationalgrid

- Addressed through Consultation G0100
 - https://www.nationalgrid.com/sites/default/files/documents/Final%20Workgroup%20consultation_0.pdf
- Three options Proposed
 - Option 1 - Enhanced Converter Control (Virtual Synchronous Machine capability) – Rejected – Covered under a new Expert Working Group
 - Option 2 – Classical Phase Locked Loop (PLL) type control with a 1.25 pu ceiling reactive current – rejected
 - Option 3 – Classical Phase Locked Loop (PLL) type control with a 1.0 pu ceiling reactive current – Accepted
- Applies only to Power Park Modules and HVDC Systems – Synchronous Generation is excluded from these requirements as it already has a natural capability to provide high levels of fault current

High level Summary of the FFCI Requirements (Option 3)

Requirement (RfG)	Specification (GB Requirement)
Point of Fast Fault current injection	Connection Point of Power Park Module
How and when voltage is to be determined as well as the end of the voltage deviation	Each time the voltage at the Connection Point drops below 0.9 pu Blocking permitted on fault clearance
The characteristics of the fast fault current, including the time domain for measuring the voltage deviation and fast fault current from which current and voltage may be measured differently from the method specified in (RfG) Article 2 – definition of Fast Fault Current	Each Power Park Module shall be capable of generating maximum Reactive current during the period of the fault without exceeding the transient rating of the Power Park Module. The PLL needs to be disabled in order to maintain the same phase reference
The timing and accuracy of the fast fault current, which may include several stages during a fault and after its clearance	Generator to provide a continuous time trace of reactive current injection before during and after the fault, which demonstrates an acceptable degree of injection within the time period 20-60ms
When post fault active power recovery begins based on a voltage criterion	Active Power Recovery to commence on fault clearance (ie voltage above 0.9 pu, but less than 1.05 pu)
Maximum allowed time for active power recovery	Active Power to be restored within 0.5 seconds of fault clearance (ie voltage above 0.9 pu)
Magnitude and accuracy for active power recovery	Active Power to be restored to 90% of its pre-fault value. Active Power oscillations shall be acceptable provided that the total active energy delivered during the period of the oscillations is at least that which would have been delivered if the Active Energy was constant and the oscillations are adequately damped.

RfG Definition of Fast Fault Current (Article 2)

-
- “Means a current injected by a Power Park Module or HVDC System during and after a voltage deviation caused by an electrical fault with the aim of identifying a fault by network protection systems at the initial stage of the fault, supporting system voltage retention at a later stage of the fault and system voltage restoration after fault clearance”

FFCI Figure ECC.16.3.16(a)

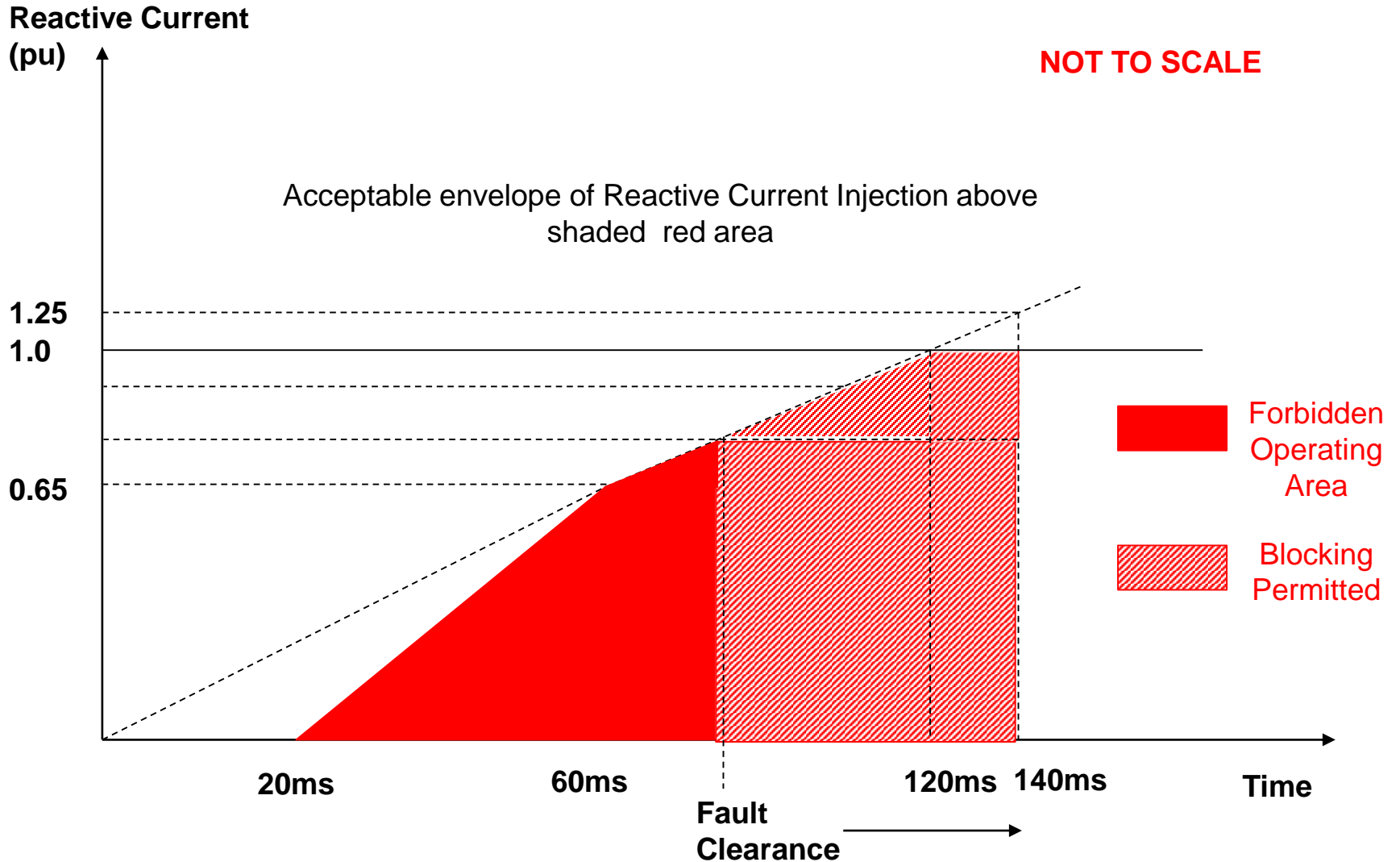

FFCI Figure ECC.16.3.16(b)

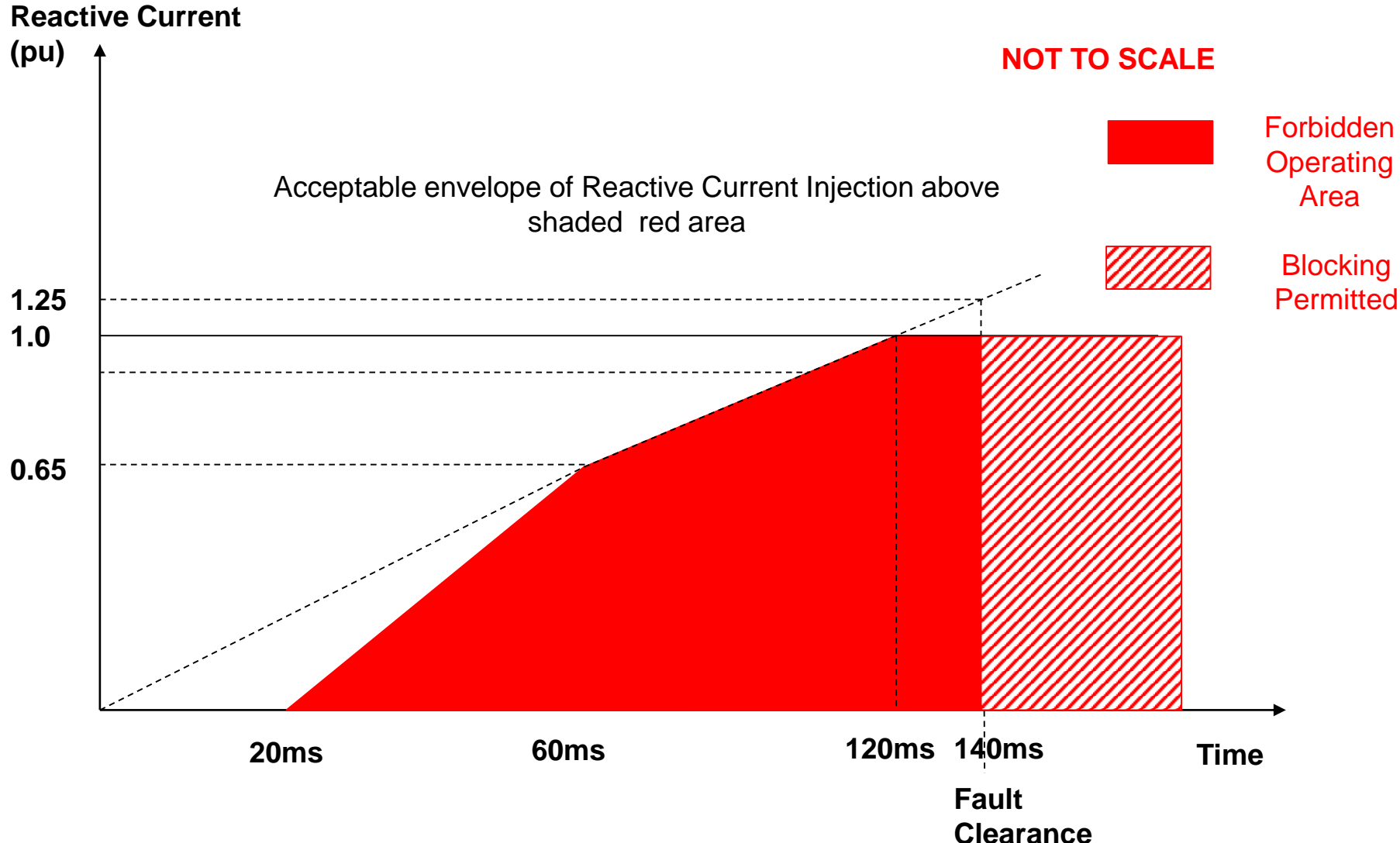

Key Features of the FFCI Requirements

-
- Requirement for Reactive Current Injection to remain above the shaded area (see slides 5 and 6)
 - Blocking permitted on fault clearance to prevent the risk of transient over voltages
 - Reactive current injected from each Power Park Module or HVDC Equipment shall be injected in proportion and remain in phase to the change in System Voltage at the Connection Point during the period of the fault
 - Generators to state their repeated ability to supply fast fault current to the system each time the voltage at the connection point falls below the nominal levels.
 - NGET will accept demonstration of compliance at the Power Park Unit Terminals rather than at the Connection Point where it is not practical to do so
 - A further example is contained in Appendix 4EC

-
- Following the final GC0100 consultation, no comments were received in respect of FFCI though a number of comments were received following the G99 and Distribution Code Consultation
 - ECC.6.3.16.1.2 refers to reactive current, implying the current is always in quadrature with the voltage. This also states the reactive current will be in proportion to the retained voltage
 - ECC.6.3.16.1.4 states that the reactive current injected shall be in proportion and in phase with the change in System Voltage at the Connection Point
 - A number of questions have been raised in relation to the base quantities and how this relates to rating
 - These issues are confusing and it is recognised that clarity is required
 - Figures ECC.6.3.16(a) and (b) show the reactive current against time but do not show retained voltage
 - Further clarification is required to the Example in Appendix 4EC

-
- Redraft the Grid Code to address the defect including:-
 - Clearly define the maximum current rating and confirm that the transient rating of the Power Park Module should not be exceeded under fault conditions.
 - Locus diagram included showing relationship between real and reactive current.
 - Define that priority should be given to reactive current as soon as the voltage dips below the minimum levels specified in ECC.6.1.4 (ie the reactive current injected should be above the minimum requirement shown in Figures ECC.16.3.16(a) and (b) (ie slides 6 and 7 above)
 - Remove references to “reactive current injected shall be in proportion and in phase with the change in System Voltage at the Connection Point
 - Appendix 4EC has been removed as the examples are considered to be misleading. A number of examples however will be included as part of this work which will be publicly available going forwards.
 - The requirements for Active Power recovery (restoration of 90% of the Active Power within 500ms of restoration of the voltage at the Connection Point to the minimum levels specified in ECC.6.3.15.8(vii)) remain unchanged.

Active / Reactive Current Circle Diagram – Faulted Condition

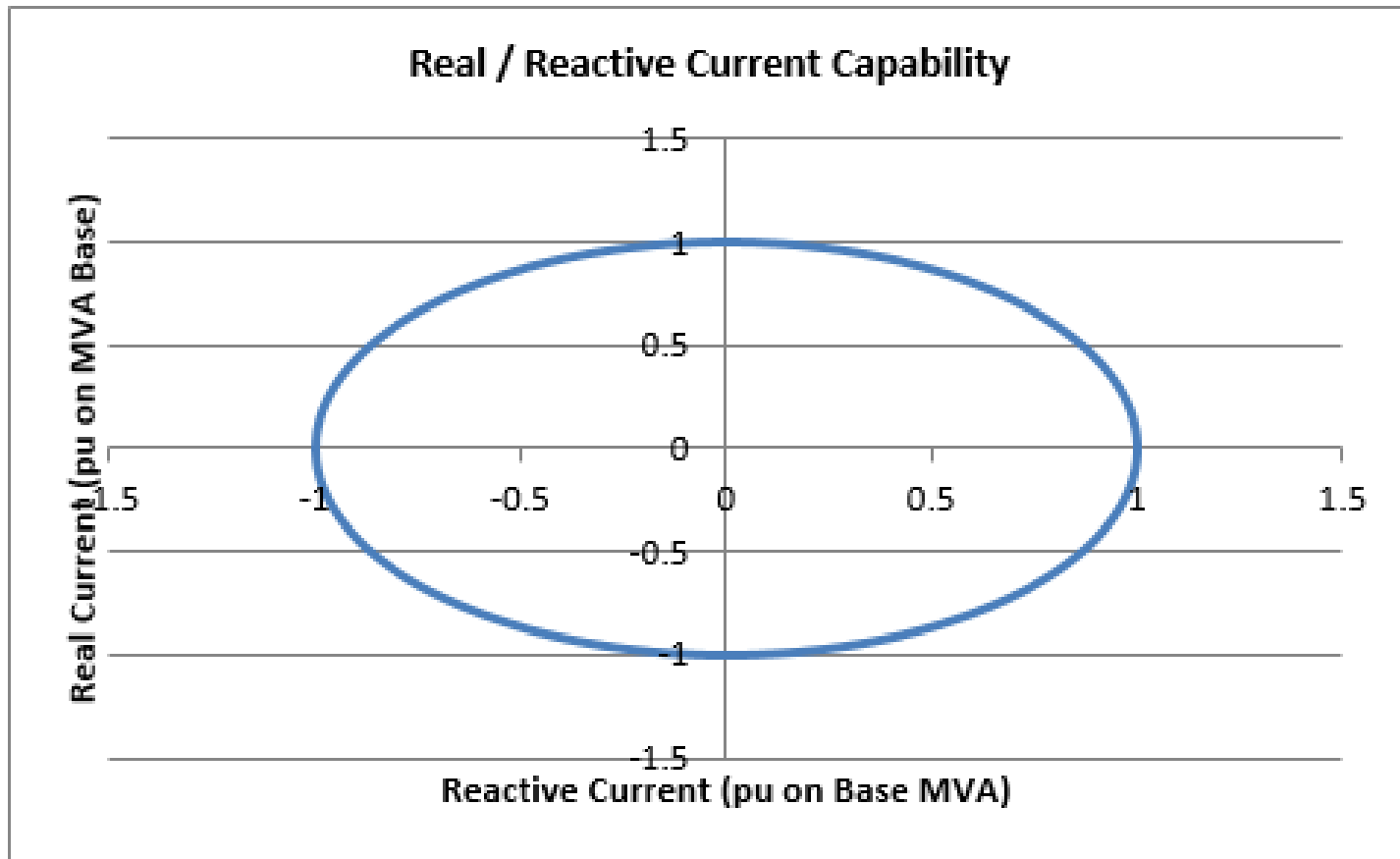

Example 1 – Pre Fault Condition

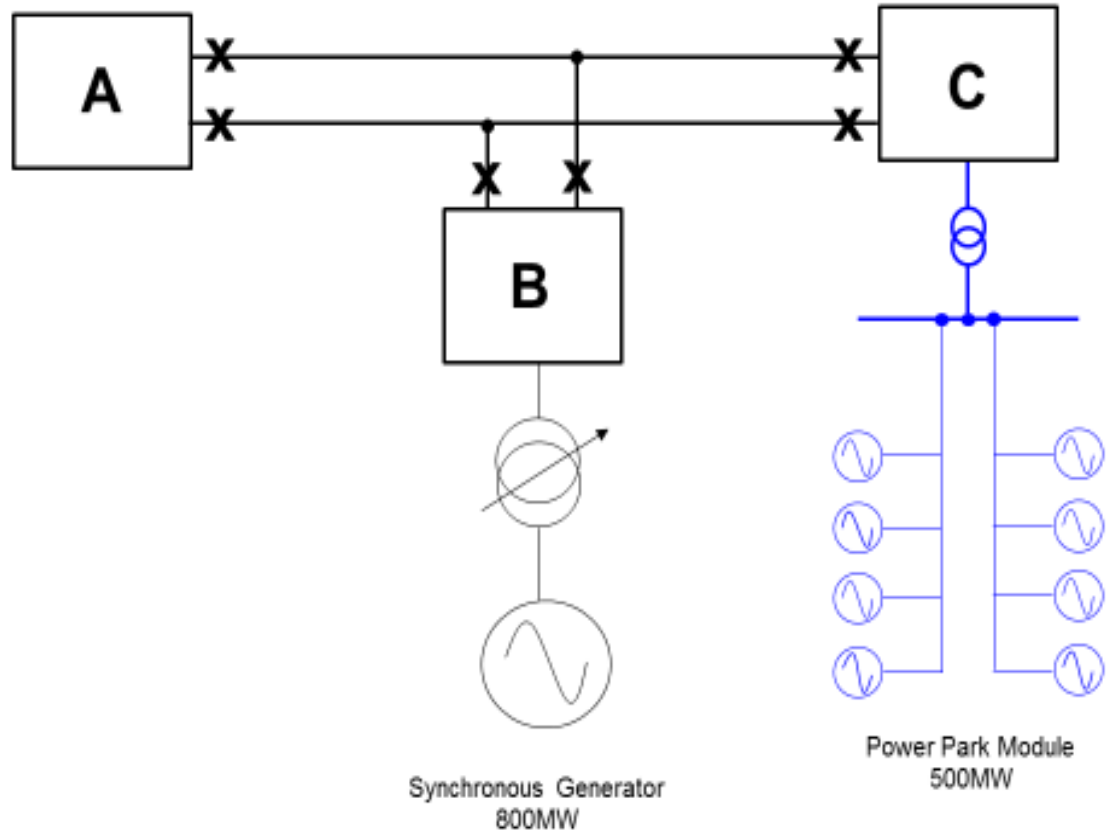

Example 1 – Pre Fault Vector Diagram

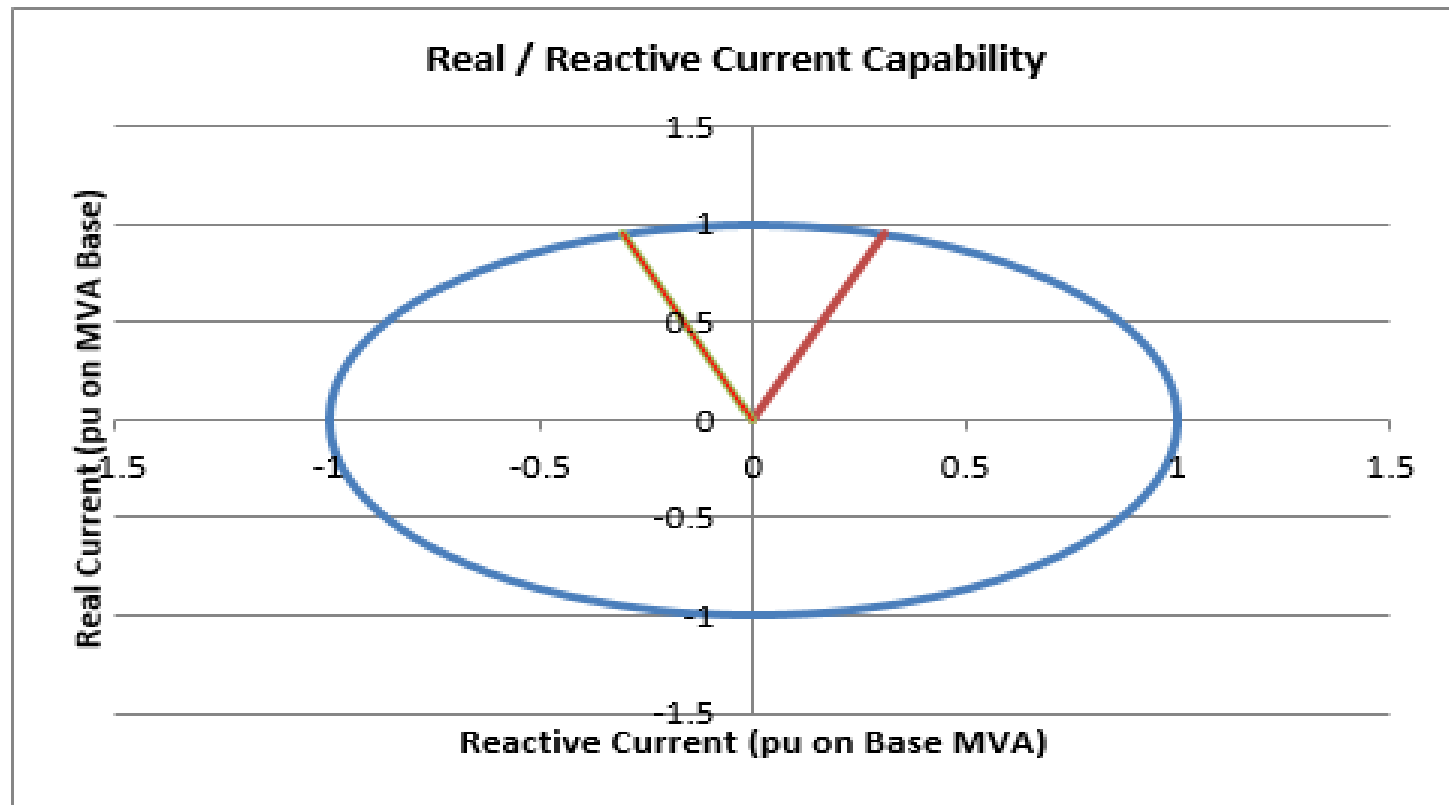

Example 1 – Close up fault adjacent to Substation C nationalgrid

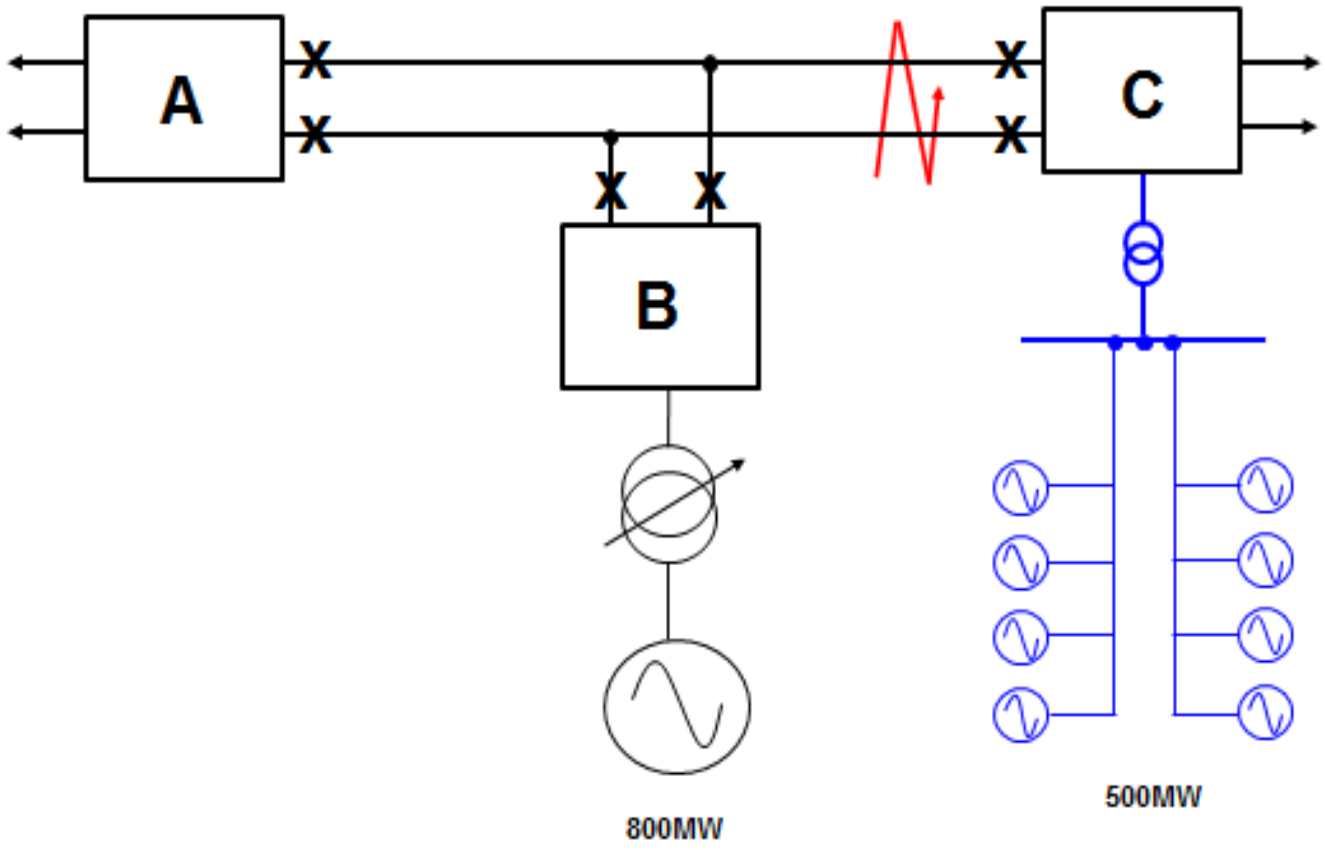

Example 1 – Close up fault adjacent to Substation C – Voltage / Current Traces

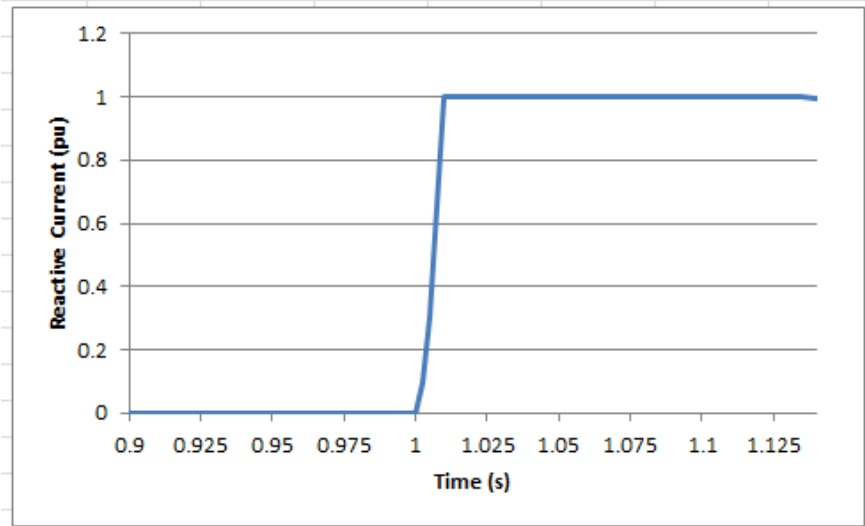
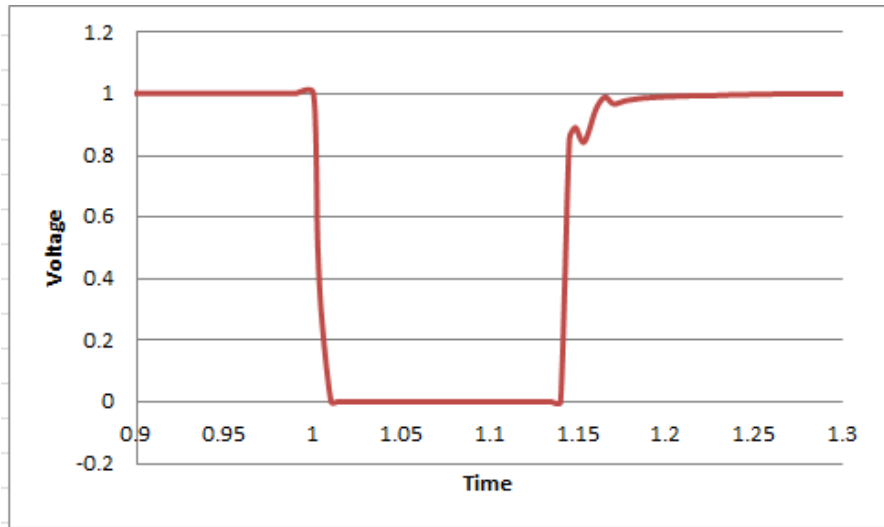

Example 1 – MVA Locus / Comparison against the ECC.6.3.16 requirement

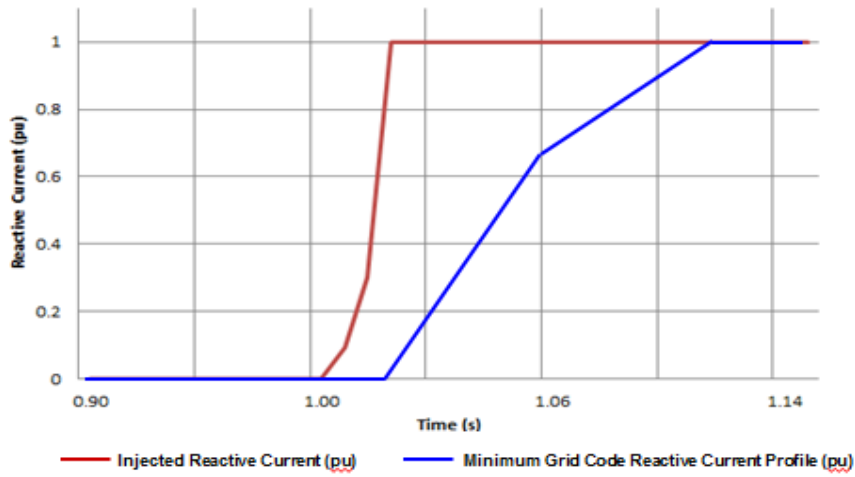
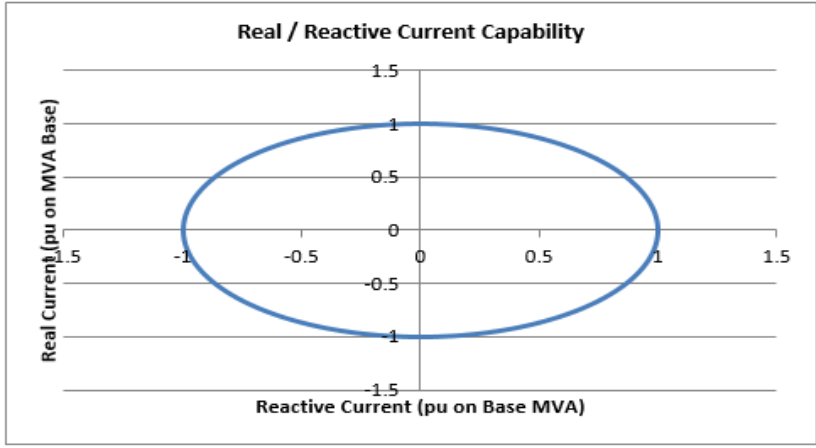

Example 2 – Faulted Condition

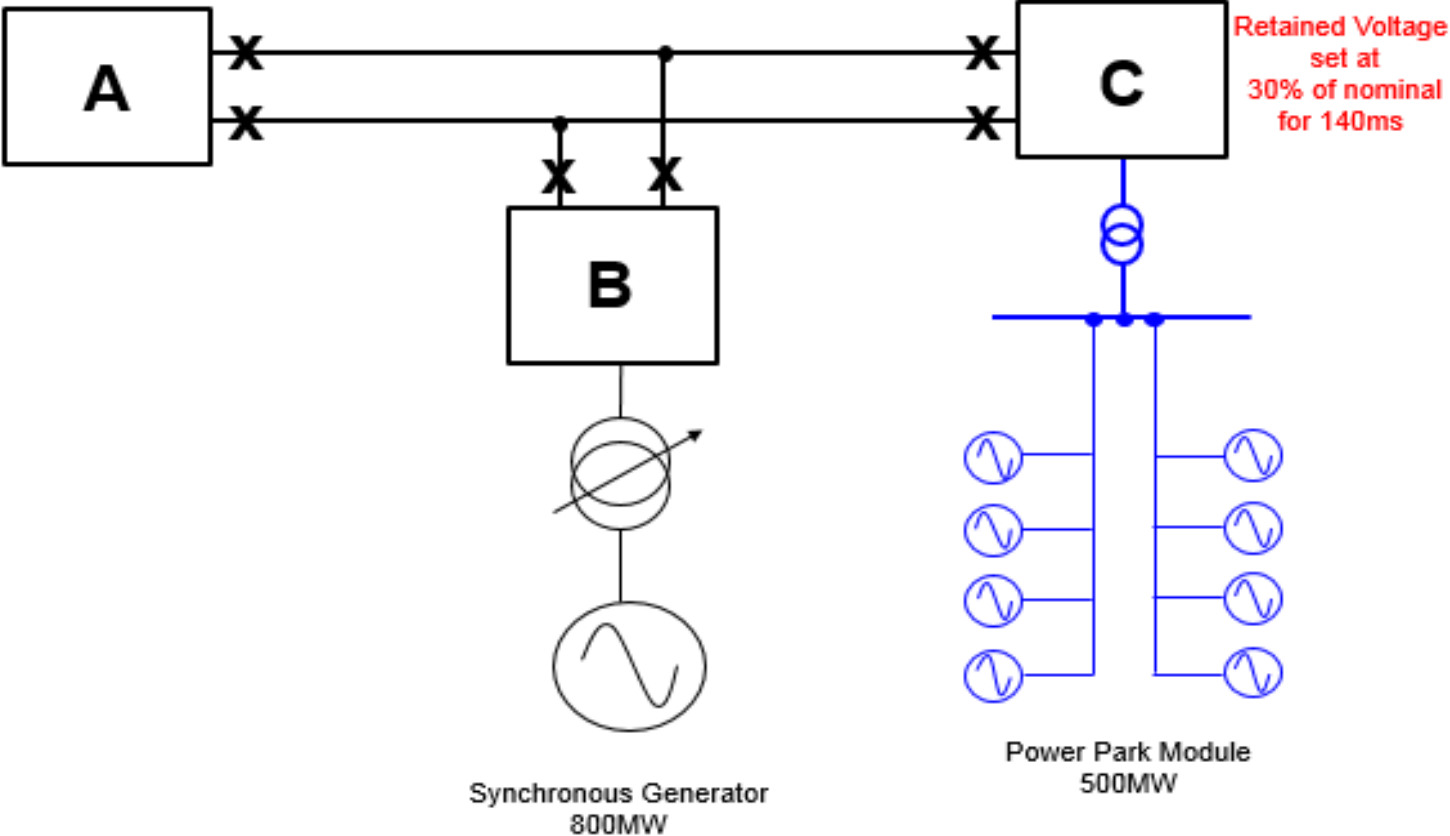

Example 2 – Voltage depression

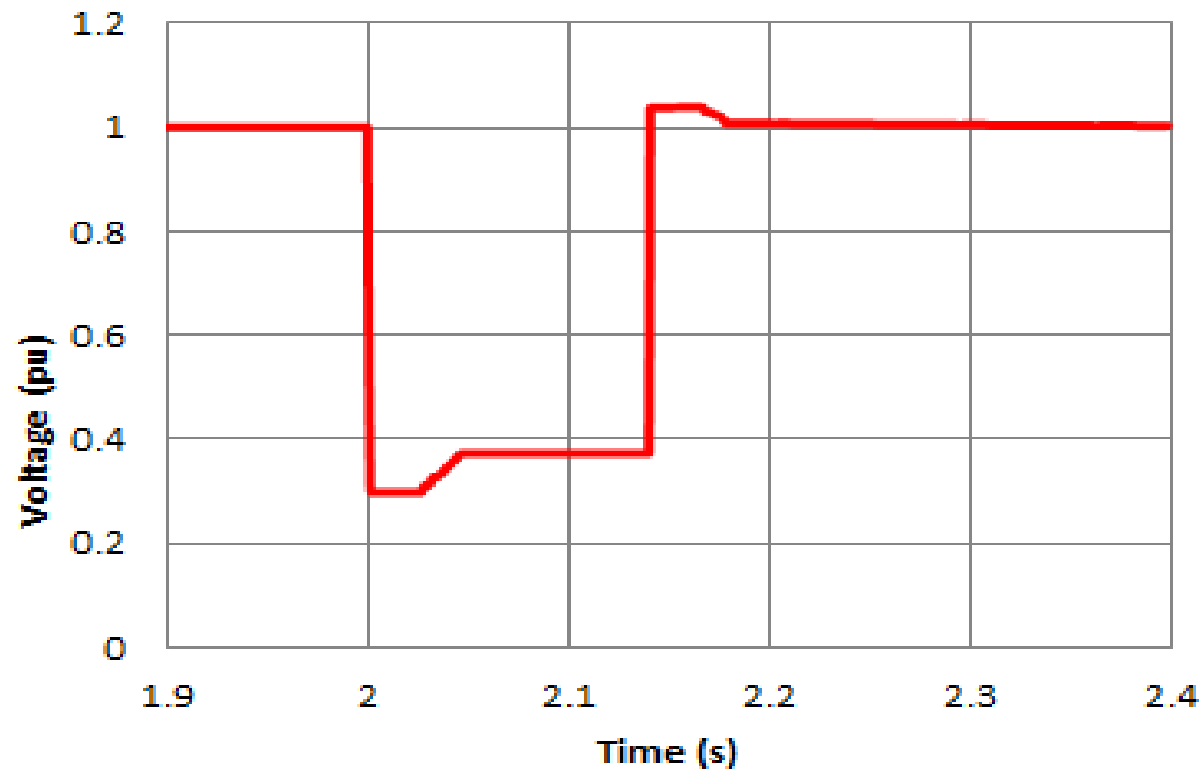

Example 2 – Traces of Active and Reactive Current

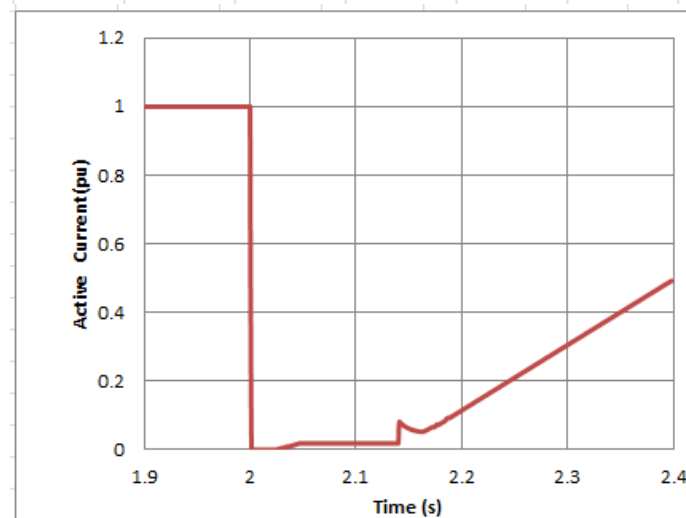
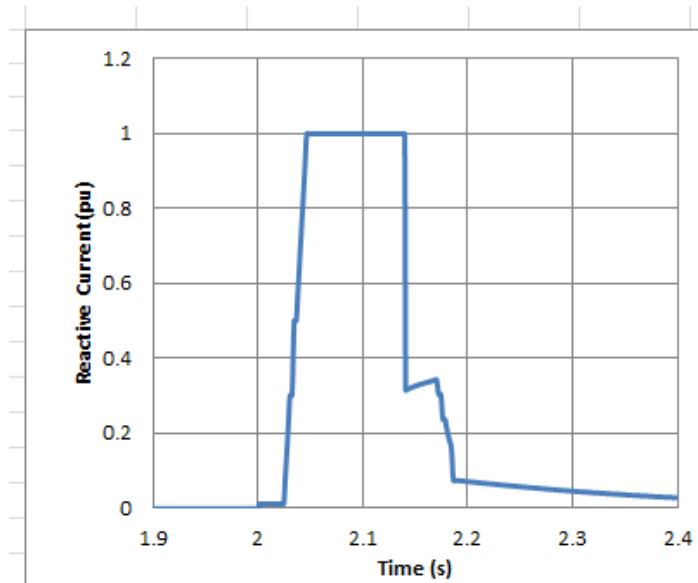

Example 2 – Comparison against ECC.6.3.16 requirement

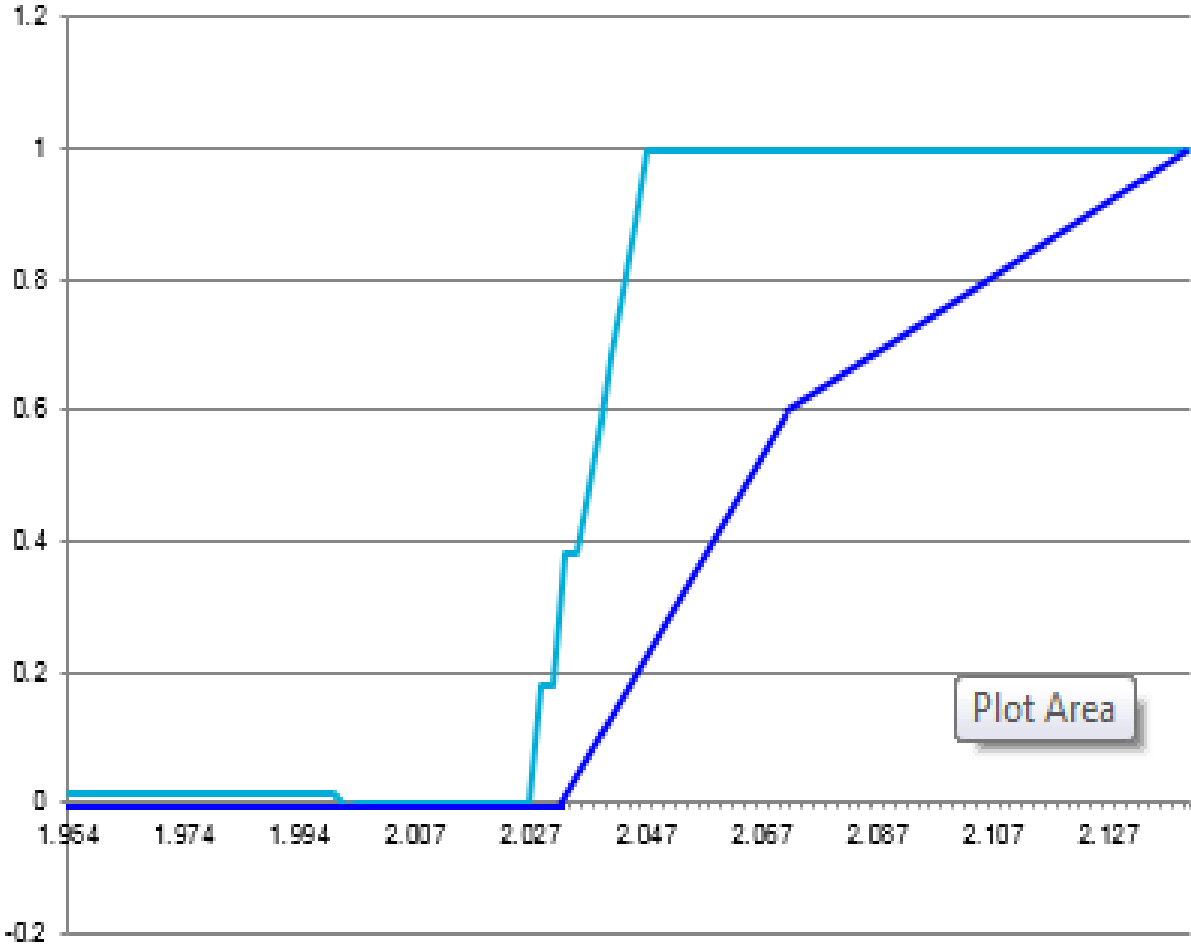

Example 3 – Retained Voltage set at 50% for 710ms

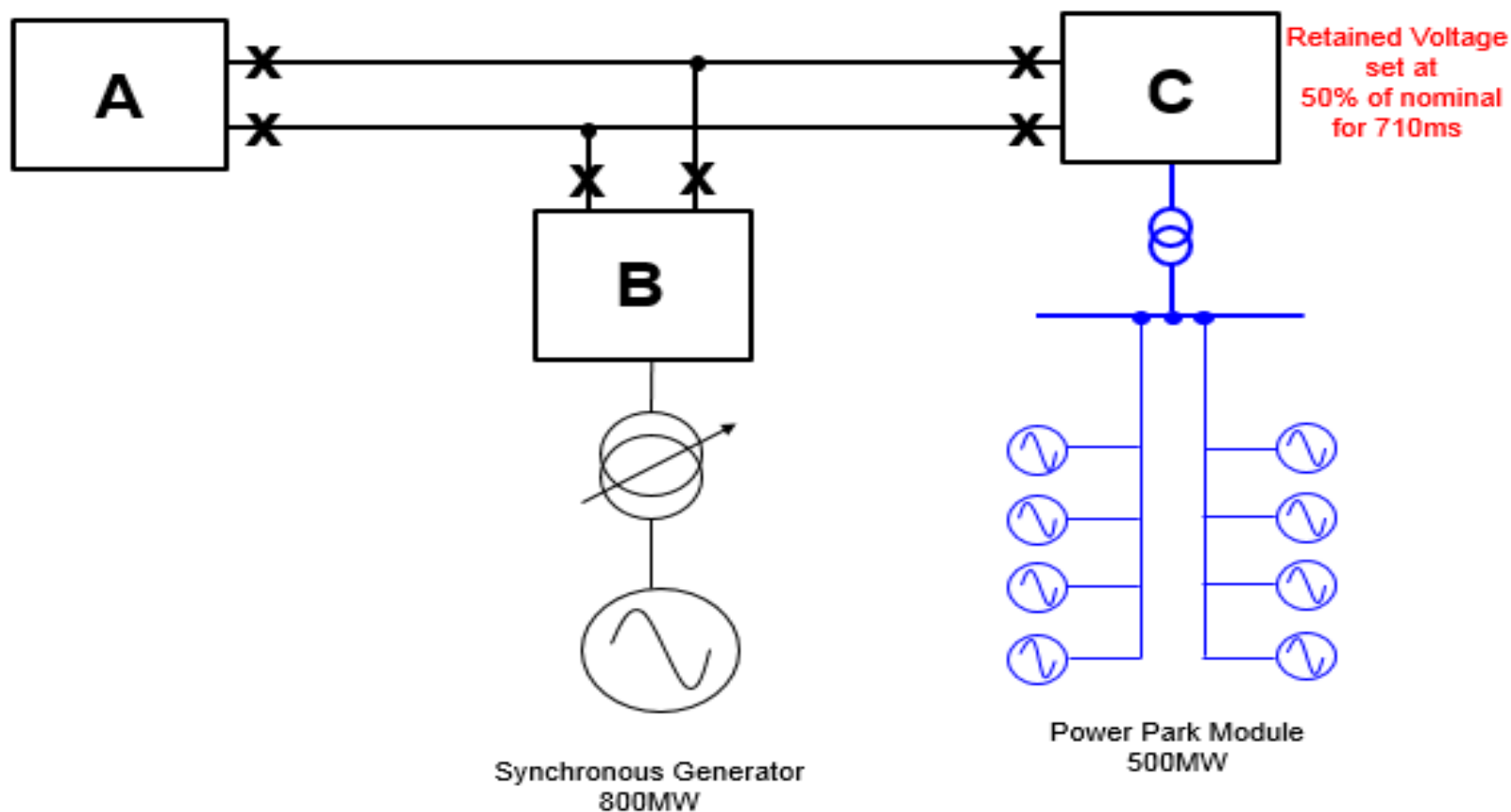

Example 3 – Retained Voltage set at 50% for 710ms

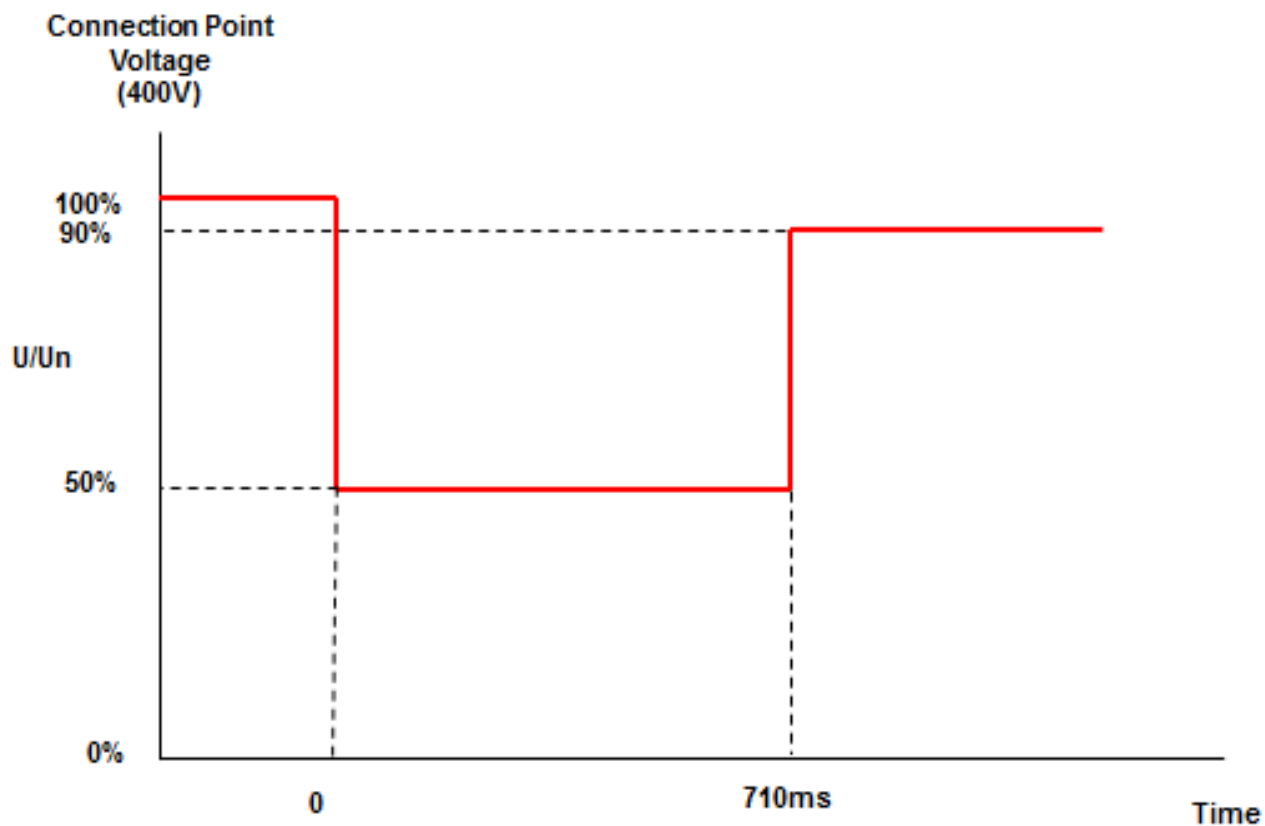

50% retained voltage, 710ms duration

Example 3 – Reactive Current

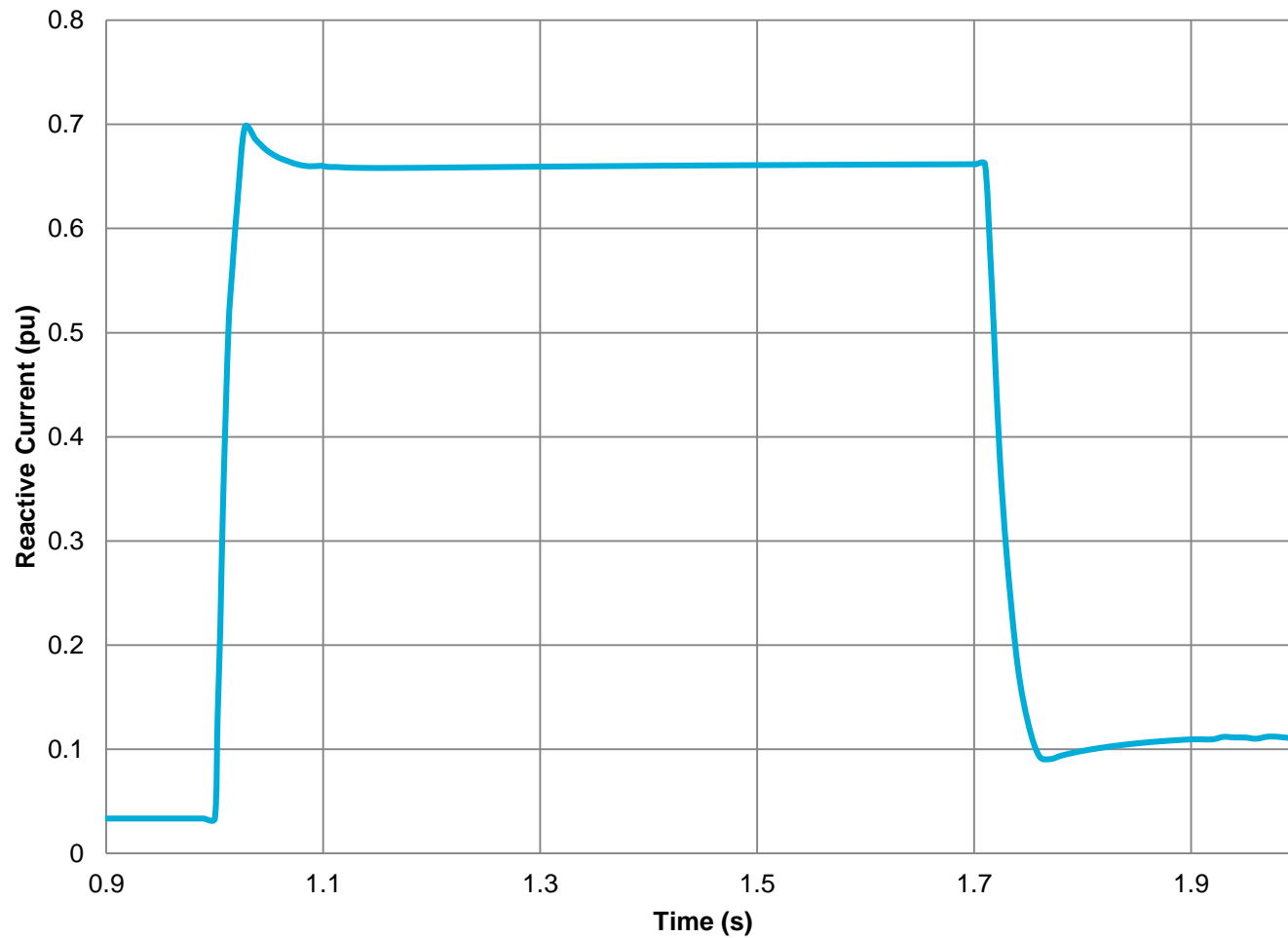

-
- The requirements of ECC.6.3.15.9 (faults in excess of 140ms) continue to apply to Type C and Type D Power Park Modules which are caught by the requirements of the Grid Code
 - During the period of the fault, reactive current injection is the primary driver as this is required to support system voltage – a fundamental prerequisite for fault ride through.
 - Following fault clearance, restoration of active power is the fundamental requirement to avoid system frequency collapse
 - In the event of voltage depressions in excess of 140ms – eg a widespread voltage depression caused by say a stuck breaker which would be cleared in backup operating times, the requirement (as currently codified in the Grid Code – both the CC's and ECC's) is to provide Active Power at least in proportion to the retained voltage at the Connection Point and generate maximum reactive current without exceeding the transient rating of the Power Park Module or OTSDUW Plant and Apparatus
 - These requirements are not included in G99 as they fall outside the requirement of RfG and are a continuation of the existing Grid Code

-
- For faults cleared in 140ms, priority to be given to reactive current injection without exceeding the transient rating of the Power Park Module or HVDC Equipment.
 - As a minimum, the reactive current injection should be above shaded boundary shown in Figures ECC.16.3.16(a) and ECC.16.3.16(b), as soon as the voltage falls below the minimum levels in ECC.6.3.16
 - For faults in excess of 140ms, Power Park Modules and OTSDUW Plant and Apparatus are required to provide Active Power at least in proportion to the retained voltage at the Connection Point and generate maximum reactive current without exceeding the transient rating of the Power Park Module or OTSDUW Plant and Apparatus

-
- National Grid welcome the comments received
 - ECC.6.3.16 updated in draft form to provide clarification and address the defect raised
 - Stakeholders requested to review draft text and establish if it provides the clarity sought
 - Further issues / areas for improved text?
 - Process for proceeding to the next phase

Annex 2B – Workgroup Presentation September 2018

GC0111

RfG Clarifications to Fast Fault Current Injection

nationalgrid



Antony Johnson
National Grid – Network Capability
September 2018

-
- Current Status
 - Key Features of the Revised requirements
 - Resume of the fast fault current capability when subject to a balanced or unbalanced fault
 - Example of a short circuit fault in excess of 140ms and the expected requirement
 - Summary of the requirements
 - Next Steps

-
- At the last GC0111 meeting held on 4th July the following key concerns were raised amongst stakeholders
 - Clarification regarding the proportionality criteria
 - (ie We would not want full reactive current to be injected for small drops in connection point voltage below 0.9pu – eg full reactive injection at say 0.85pu voltage)
 - Modifications required for longer duration faults (ie greater than 140ms), to ensure consistency with Fast Fault Current Injection proposals
 - Clarification required in relation to unbalanced faults
 - Stakeholders generally seemed comfortable with the rating and adoption of a locus plot indicating the maximum rating that would be expected from the plant under both steady state and faulted conditions
 - Reactive current against time curves to be retained
 - Appendix 4EC to be removed

Key Features of the Revised requirements

-
- A new voltage / Reactive Current requirement has now been introduced similar to that adopted in a number of other European countries
 - Defines the Fast Fault capability required for a specified voltage drop.
 - For voltage drops below 50% of nominal full reactive current injection is required
 - Amendments to ECC.6.3.15.9 (ie fault ride through - voltage dips in excess of 140 ms) to ensure consistency with fast fault current injection requirements.
 - The requirements for fast fault current applies to both balanced and unbalanced faults. Reference is now made to RMS positive phase sequence RMS values.
 - A new clause (ECC.6.3.16.1.4) has been added with regard to the transition from pre-fault operation to post operation. This is to address the pre-fault operating conditions of the Power Park Module or HVDC Equipment

Reactive Current / Voltage Curve

FFCI Figure ECC.16.3.16(a)

Notes

V_N – Nominal Voltage

V – Voltage at Grid Entry Point or User System Entry Point

$$\Delta V = V_N - V$$

I_{RMAX} - The maximum injected Reactive Current as defined in Figure ECC.16.3.16(b) and Figure ECC.16.3.16(c)

Within the deadband ($\pm 10\%$ of V_N) voltage control is required as specified in ECC.6.3.8 over the reactive capability range defined in ECC.6.3.2

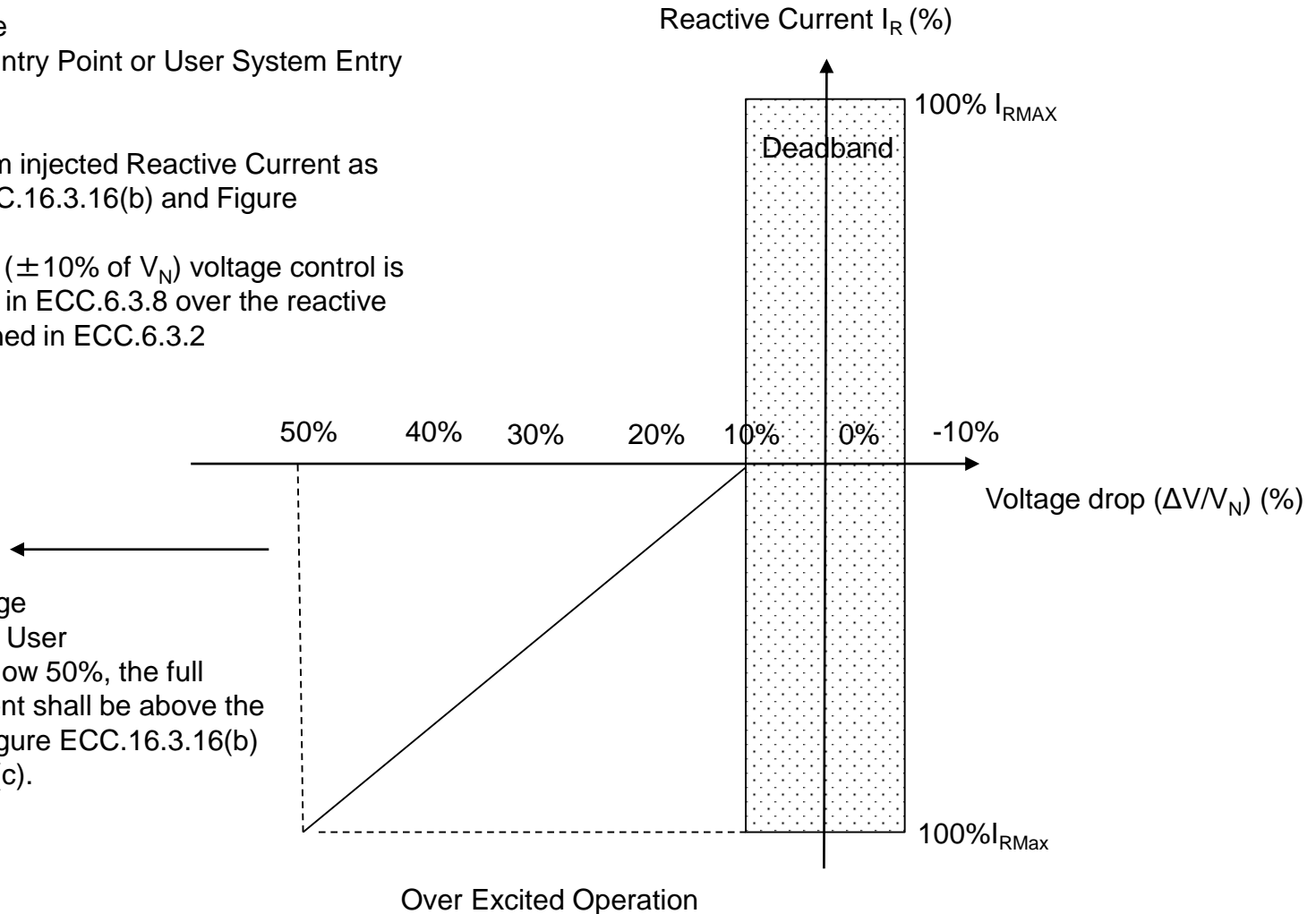

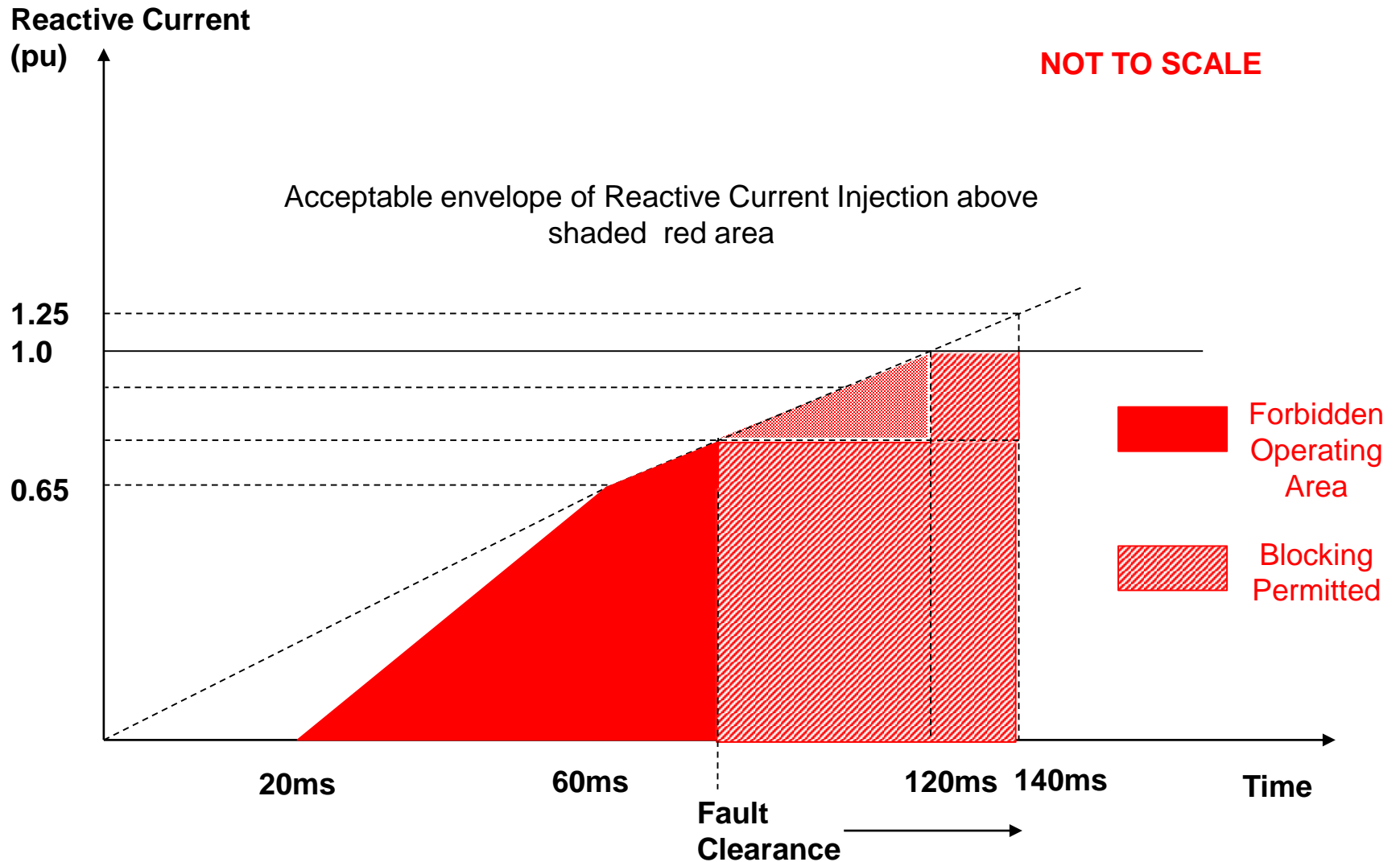

FFCI Figure ECC.16.3.16(c)

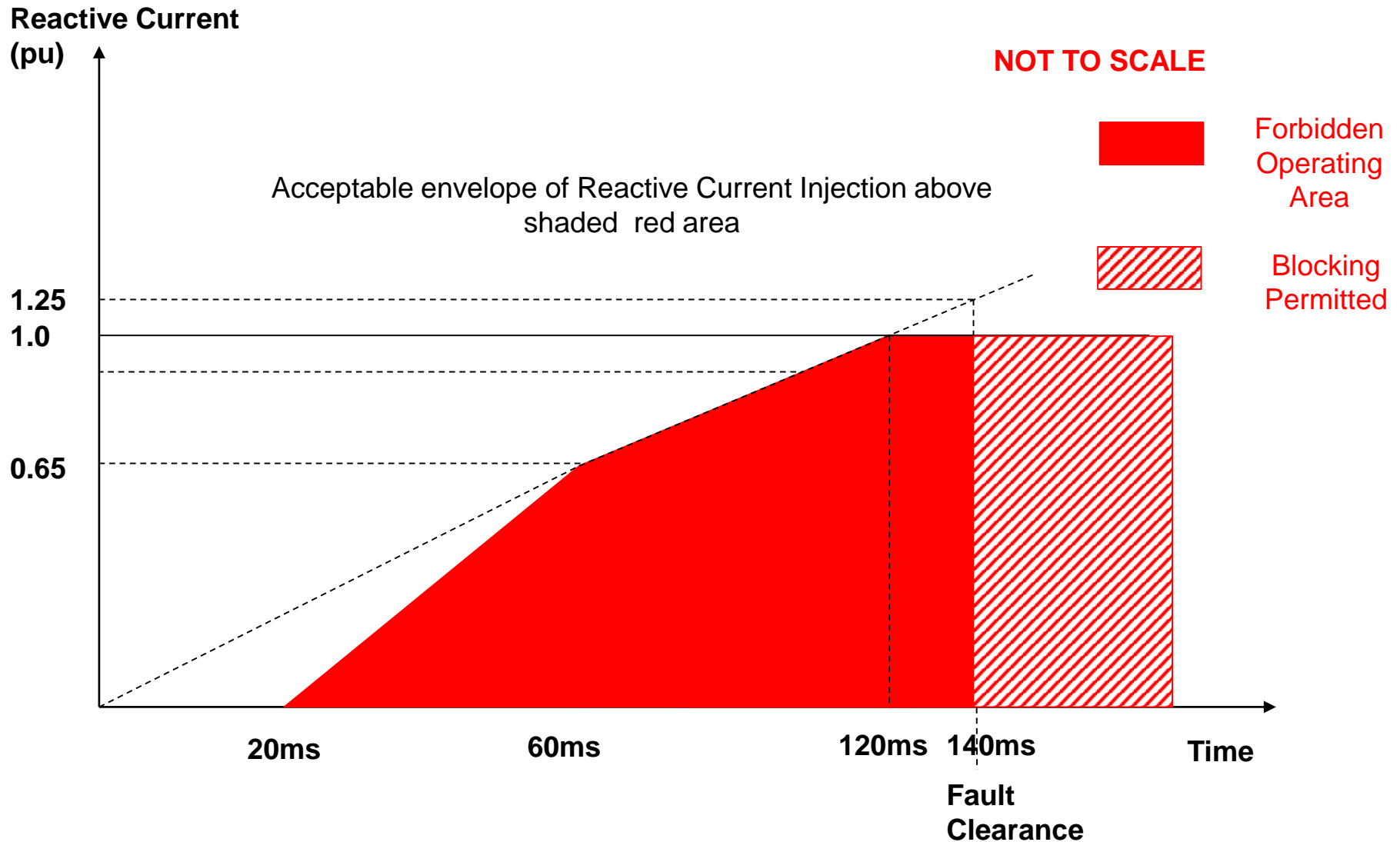

Active / Reactive Current Circle Diagram *(FFCI Figure ECC.16.3.16(d))*

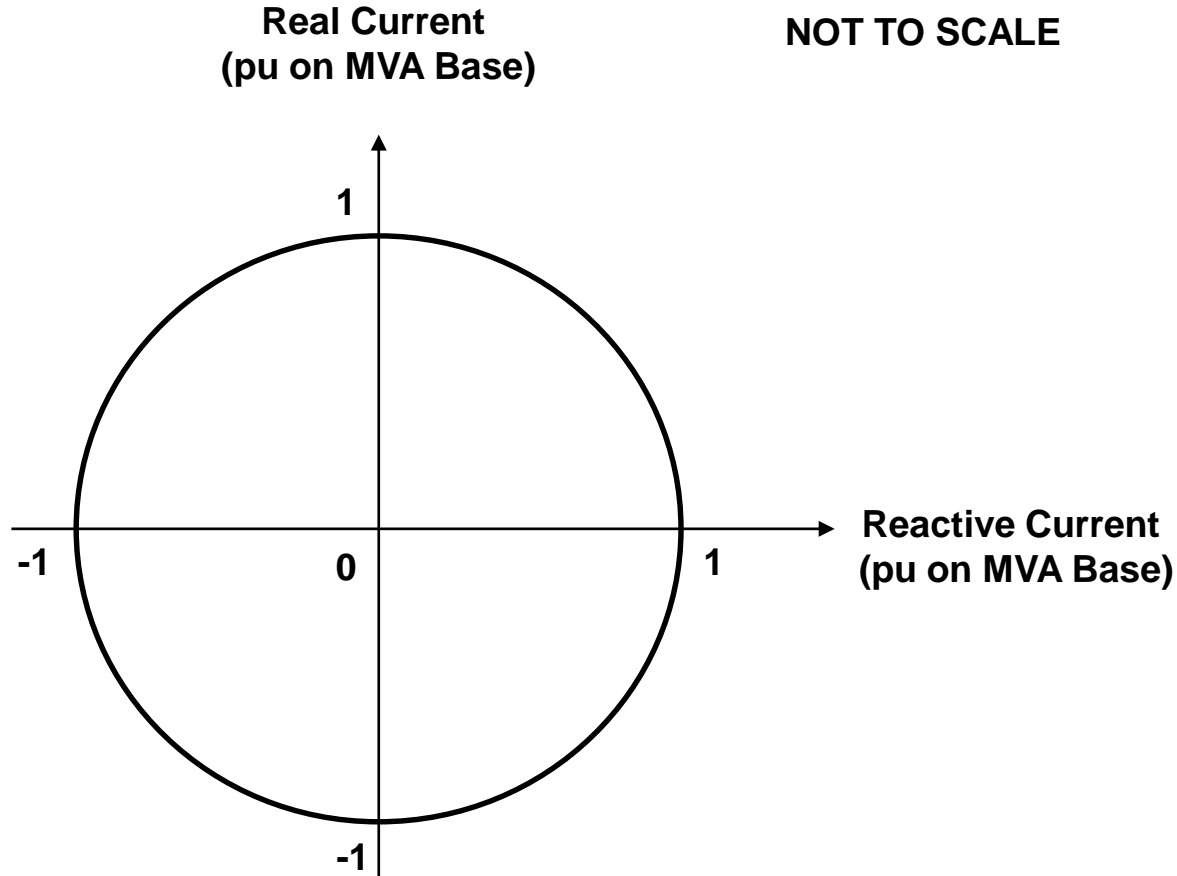

NOTE:- 1 pu current is the rated current of the Power Park Module or HVDC Equipment when operating at full MW output and full leading or Lagging MVA_r capability (eg for a 100MW Power Park Module Rated Current would be obtained when the Power Park Module is supplying 100MW and 0.95 Power Factor lead or 0.95 Power Factor lag at the Connection Point)

Example – Retained Voltage set at 80% for 1.2s

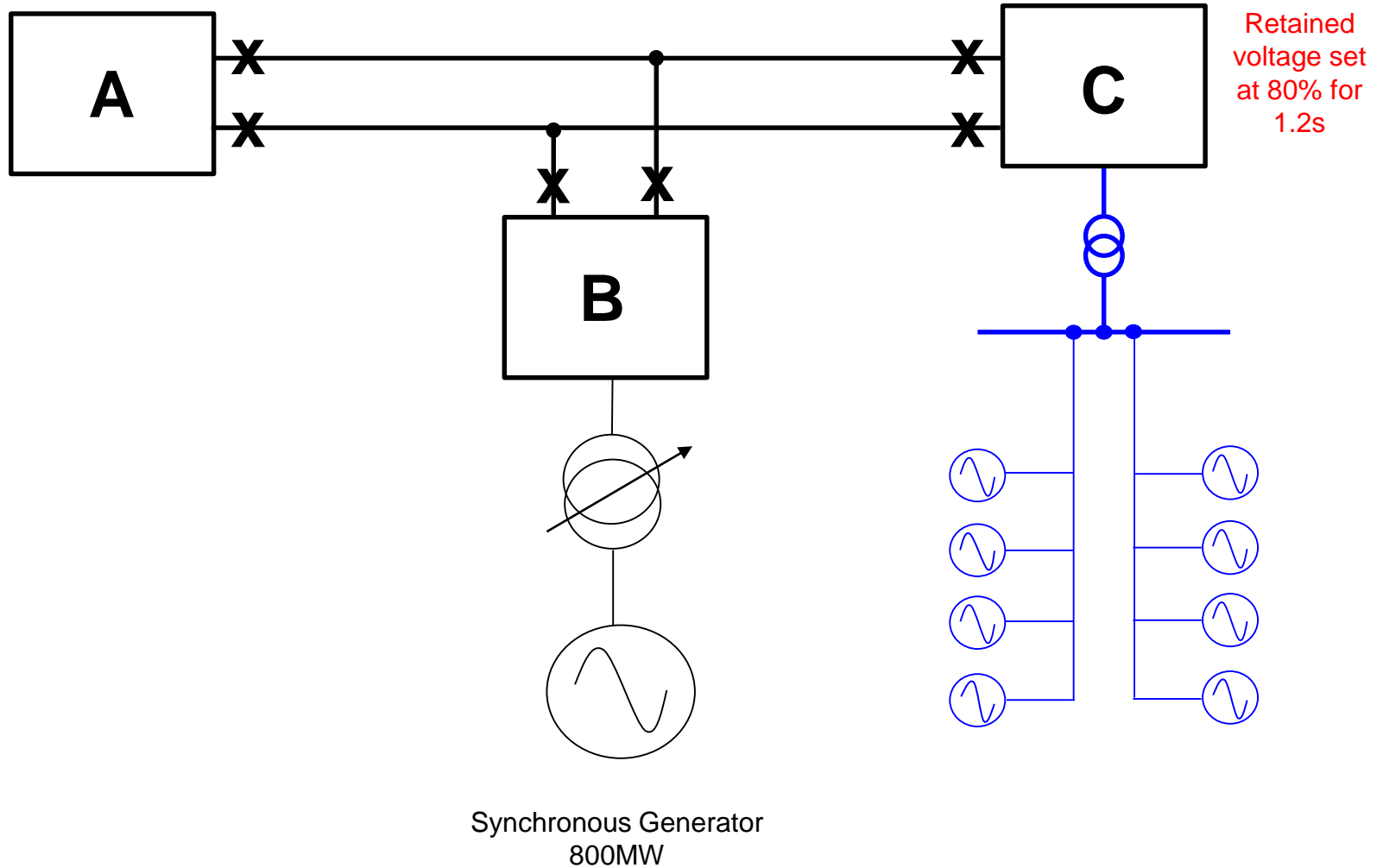

Example - Voltage dip in excess of 140ms - 80% Retained Voltage

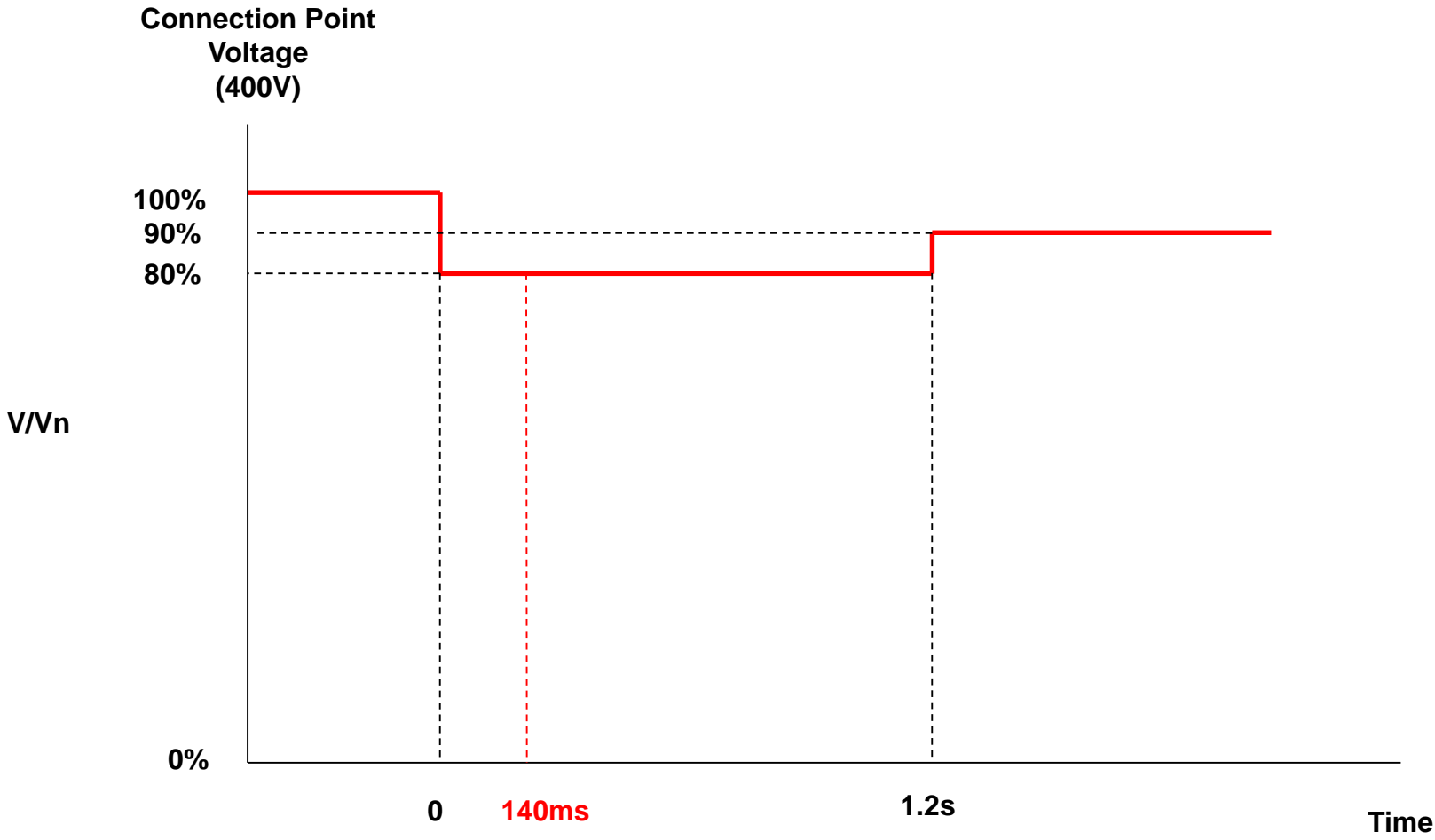

80% retained voltage, 1.2s duration

Example – Reactive Current injection for a 80% retained voltage for 1.2s

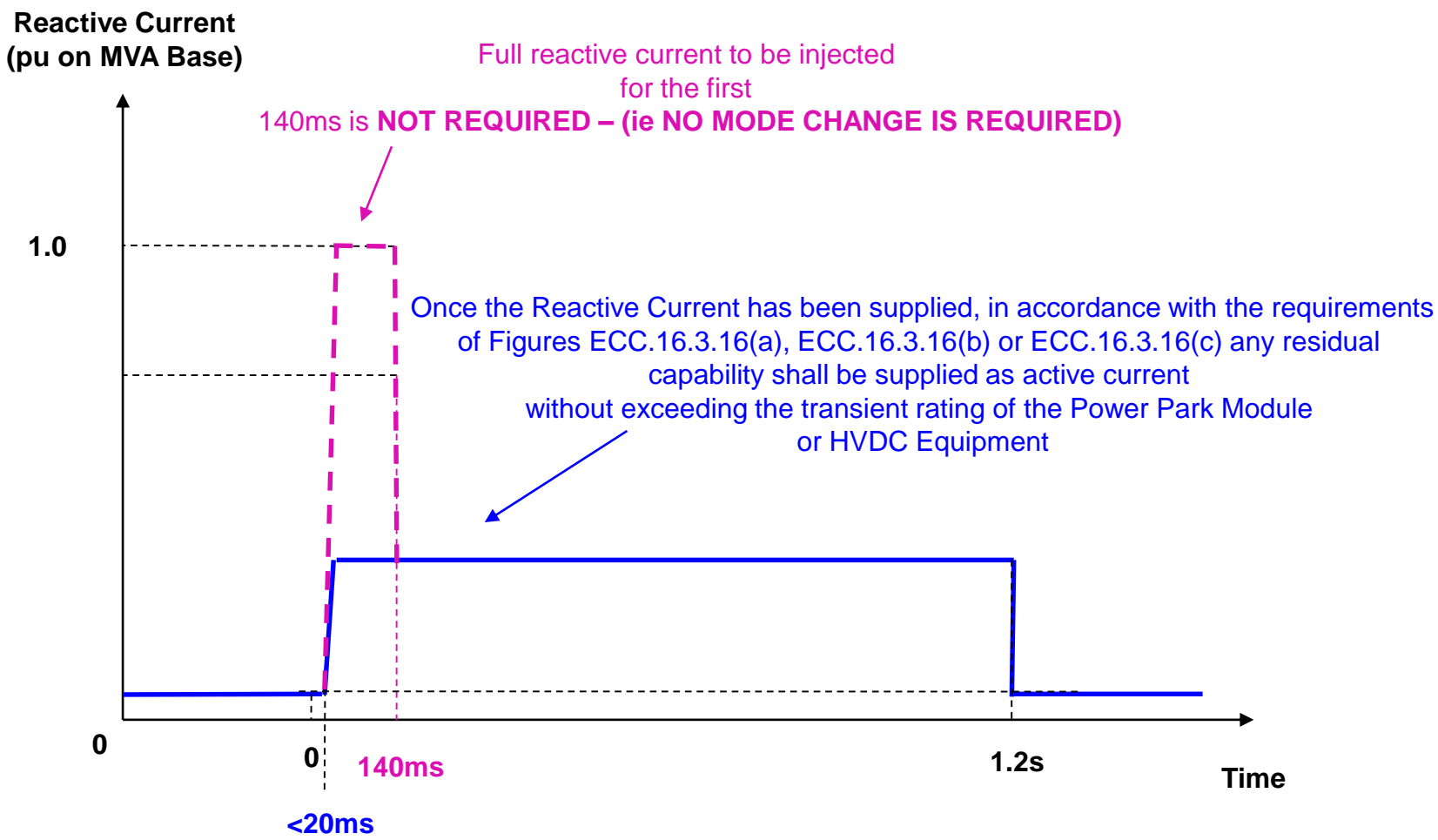

80% retained voltage, 1.2s duration

Example – Circle Diagram - 80% Retained Voltage

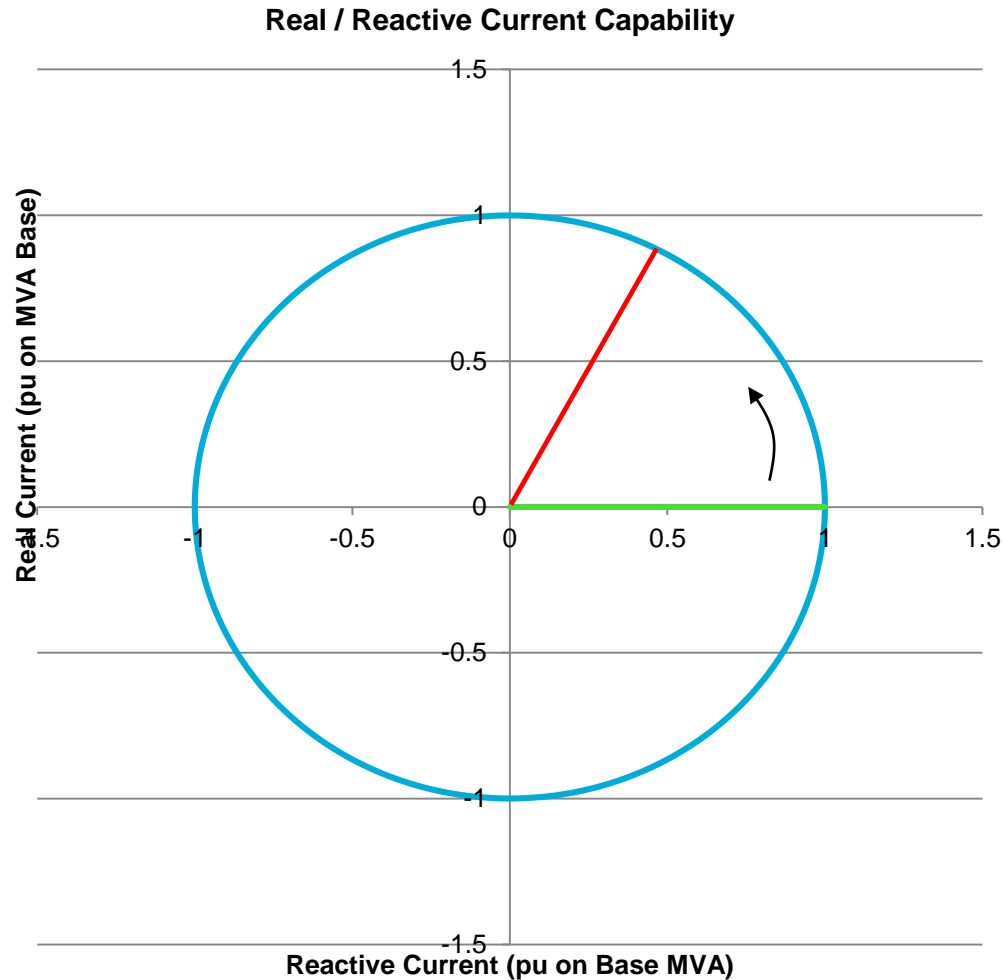

- The criteria for fast fault current injection is closely linked to the requirements for fault ride through
- Criteria defined with respect to a voltage / reactive current characteristic (Figure ECC.16.3.16(a) – Slide 5)
- Full reactive current injection is required as per Figures ECC.16.3.16(b) and ECC.16.3.16(c) (Slides 6 and 7)
- Under fault conditions the Power Park Module or HVDC Equipment would not be expected to exceed the locus shown in Figure ECC.16.3.16(d) (Slide 8)
- A new clause has been added (ECC.6.3.16.1.4) to cater for the pre-fault operating condition and the subsequent performance required under faulted conditions.
- Modifications have been made to ECC.6.3.15.9.2.1 (faults / voltage dips in excess of 140ms) to ensure consistency with the revised fault current injection requirements under ECC.6.3.16.
- The wording has been clarified with respect to both balanced and unbalanced faults and all quantities are assumed to be positive phase sequence RMS values.
- For the avoidance of doubt, the requirements of ECC.6.3.15 still apply including ECC.6.3.15.10(ii) – Power Park Modules and Non-Synchronous Generating Units will be required to withstand without tripping the negative phase sequence loading incurred by clearance of a close up phase to phase fault by System Backup Protection on the Onshore Transmission System operating at Supergrid Voltage

-
- National Grid welcome comments on the revised text
 - ECC.6.3.16 and EC.6.3.15.9.2.1(b) updated in draft form to provide clarification and address the defect raised
 - Stakeholders requested to review draft text and establish if it provides the clarity sought
 - Further issues / areas for improved text?
 - Process for proceeding to the next phase

Annex 2C – Workgroup Presentation November 2018

Fast Fault Current Injection GC0111

Antony Johnson
National Grid
November 2018



Summary

Current Status

Comments received following meeting on 10th September

Version 1A – Based on legal drafting presented at the meeting on 10th September

Version 1B – Based on extract of text taken from EN 50549

Initial response and suggested way forward

Other issues

Next Steps

Current Status

- At the last GC0111 meeting held on 10th September a number of additional comments were received.
 - Clarification of requirements and definitions
 - Update diagrams where necessary
 - Clarify the requirements applicable to Power Park Units (ie turbines) as well as Power Park Modules
 - Clearly define the requirements for additional reactive current
 - Include in the workgroup report why faults in excess of 140ms are excluded from G99.
 - One set of comments suggested adopting a similar set of principles as laid out in EN50549-2.
 - In view of the suggestion to include reference to EN50549-2 a two versions of the legal text have been prepared (version 1A (an updated version of the text as discussed on 10th September and Version 1B (based on the relevant extract from EN50549-2).
- The compliance section (ECP) also needs to be updated but it is suggested this is placed on hold until the correct version of the text is agreed.

Version 1A (based on wording discussed on 10th September) - Summary

- Clarifications to Power Park Units
- New diagram (Figure ECC.16.3.16(a)) and associated definitions based on the additional reactive current injection required
- Requirement to cover transient overvoltages through the Bilateral Agreement – new clause inserted at ECC.6.3.16.1.4 – At this stage we would recommend compliance with the requirements of TGN288
- An additional clause has been added with reference to Doubly Fed Induction Units only with respect to Negative phase sequence – new clause inserted at ECC.6.3.16.1.9
- Appendix 4EC has now been removed from the drafting. This was crossed out in previous iterations but has now been intentionally removed to reduce the file size.

Reactive Current / Voltage Curve

FFCI Figure ECC.16.3.16(a) - Version 1A

NOT TO SCALE

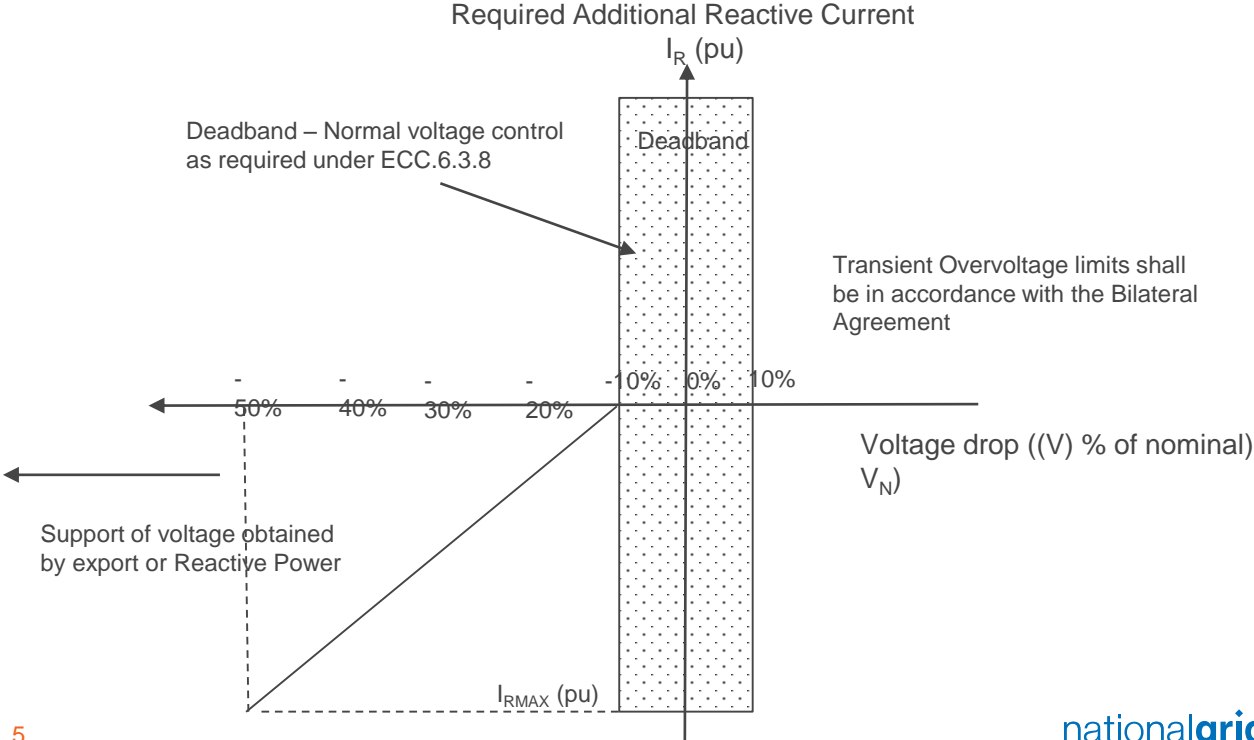

Reactive Current / Voltage curve – Parameters (1)

- Where:-
- V_N – Rated Voltage
- V - Actual voltage at the Grid Entry Point or User System Entry Point during the fault
- I_R - Additional reactive current where:_
- $$I_R = \Delta V_1 \cdot k + I_{P_{\text{prefault}}} \quad (\text{when } V \text{ is between } 50\% \text{ and less than } 90\%)$$
- $$I_R = I_{R_{\text{MAX}}} \quad (\text{when } V \text{ is less than } 50\% \text{ as defined by Figure ECC.16.3.16(b) or Figure ECC.16.3.16(c)})$$
- (I_R - Is the Reactive Current injected during the fault in per unit. This cannot exceed 1.0pu on the MVA Rating of the Power Park Module or HVDC Equipment as detailed in ECC.6.3.16.3)

Reactive Current / Voltage curve – Parameters (2)

$$\Delta V_1 = V_{\text{prefault}} - V_{\text{deadband}} - V_{\text{retained}}$$

V_{prefault} - Is the Prefault Positive Phase Sequence voltage in per unit

V_{deadband} – Is the deadband either side of nominal voltage and set at 0.1 per unit

V_{retained} – Is the retained positive sequence voltage at the Grid Entry Point or User System Entry Point (under fault conditions)

K – Is the voltage gain factor set to 2

I_{prefault} - is the prefault reactive current in per unit

The prefault reactive current (I_{prefault}) for a future fault ride through event, shall be determined when the voltage has returned above the minimum levels specified in ECC.6.1.4,

I_{RMAX} - The maximum current which shall, as a minimum, be above the shaded areas defined by Figures ECC.16.3.16(b) or ECC.16.3.16(b). There is no requirement for the maximum supplied current to exceed 1.0pu.

NOTE:- For TOV performance requirements these would be specified in the Bilateral Agreement but at this stage would be expected to be consistent with the requirements of TGN288

FFCI Figure ECC.16.3.16(b)

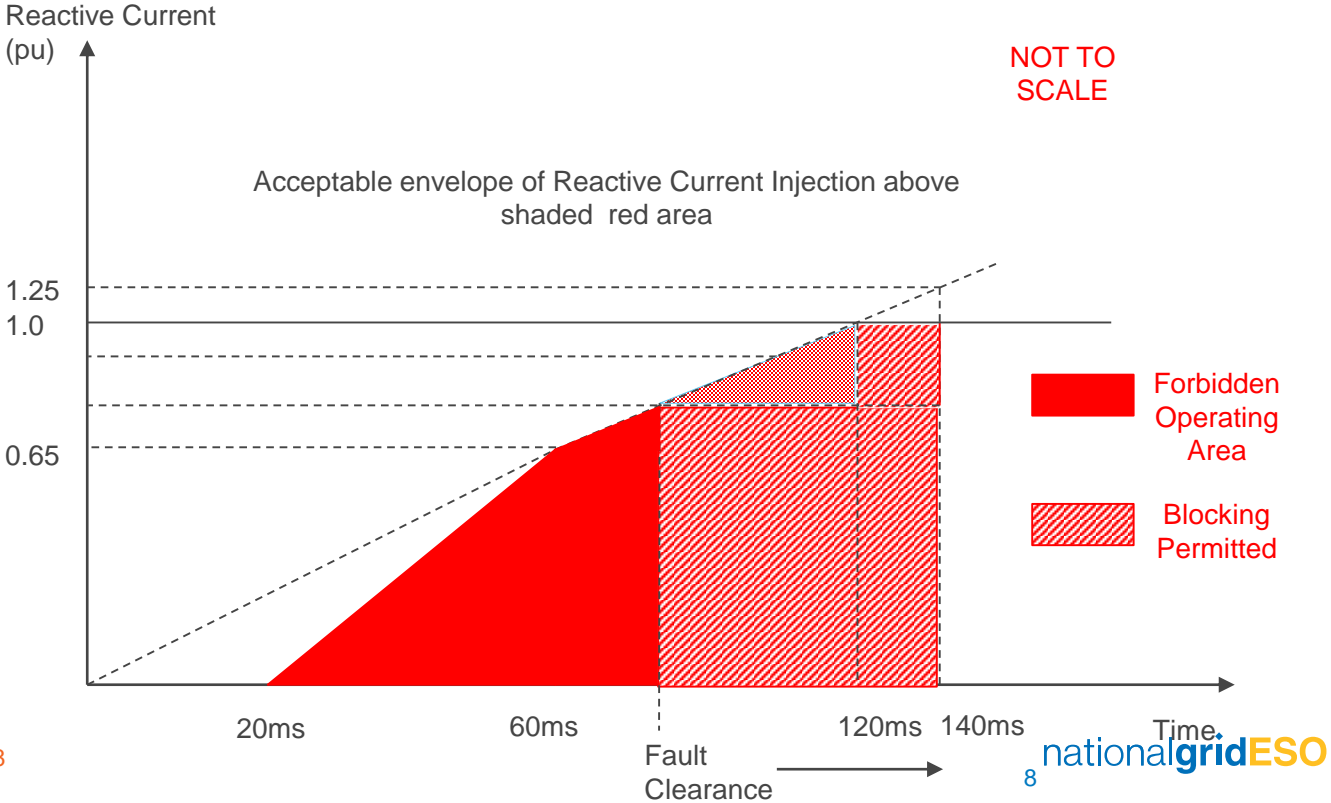

FFCI Figure ECC.16.3.16(c)

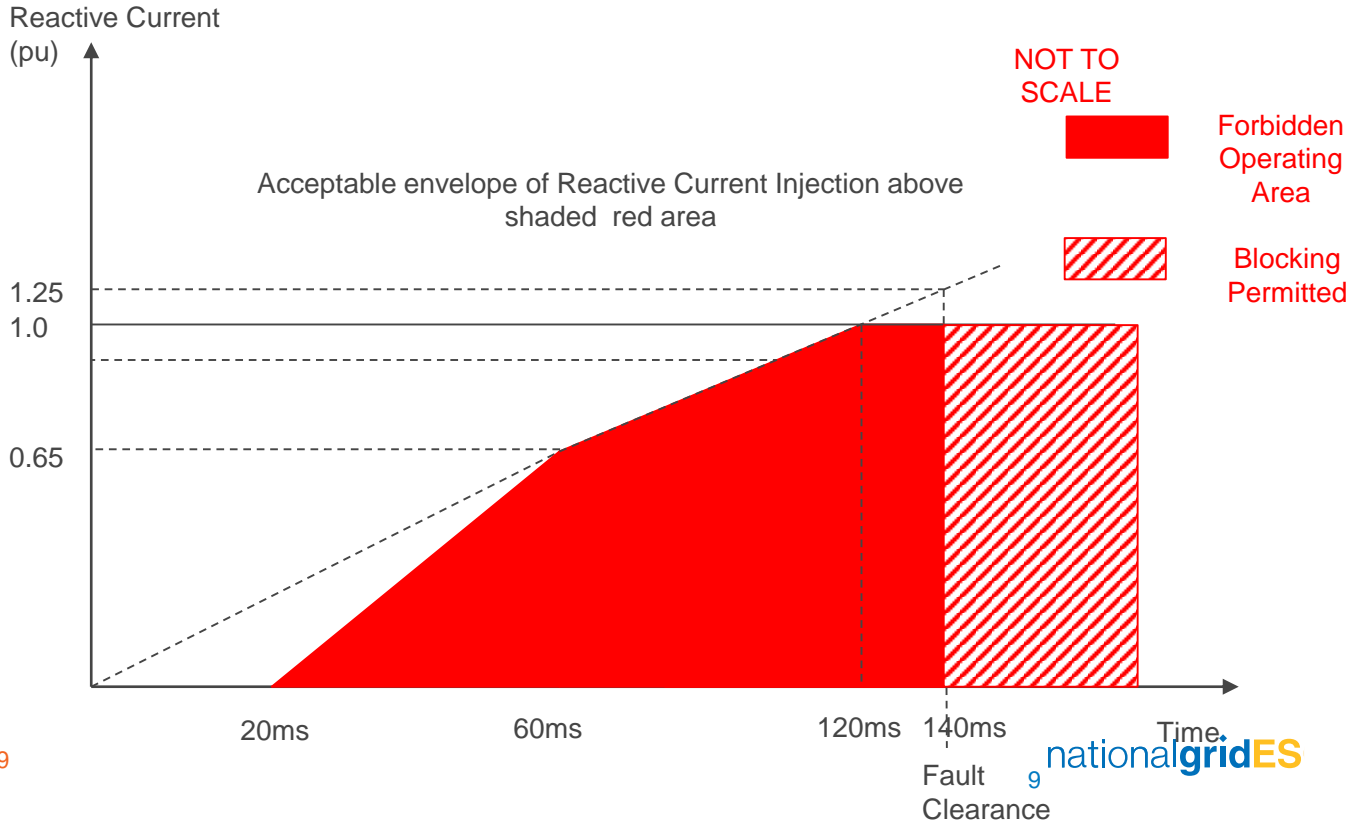

Active / Reactive Current Circle Diagram (FFCI Figure ECC.16.3.16(d))

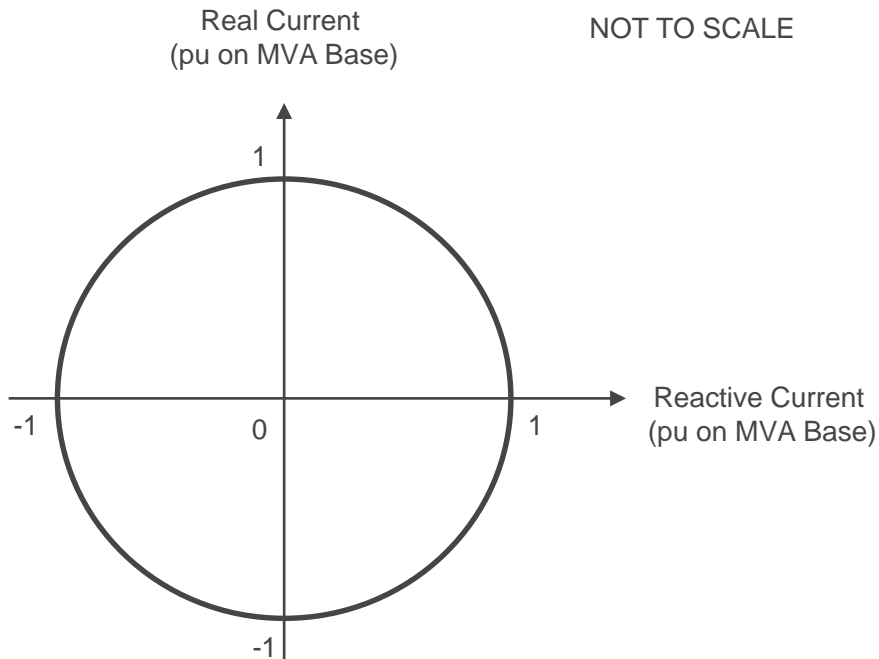

NOTE:- 1 pu current is the rated current of the Power Park Module or HVDC Equipment when operating at full MW output and full leading or Lagging MVA_r capability (eg for a 100MW Power Park Module Rated Current would be obtained when the Power Park Module is supplying 100MW and 0.95 Power Factor lead or 0.95 Power Factor lag at the Connection Point)

Version 1B (Based on EN50549) Summary

- Broadly based on Version 1 with amendments to include the voltage / additional reactive current figures included within section 4.7.4.2 of EN 50549-2.
- Additional amendments introduced from first draft based on EN50549-2
- Updated diagrams
- Corrections to formula references
- Updates to subsections of ECC.6.3.16.1.3 including a clause which relates to the negative phase sequence injection required from doubly fed induction generating units only

Reactive Current / Voltage Curve

FFCI Figure ECC.16.3.16(a) – Version 1B

NOT TO SCALE

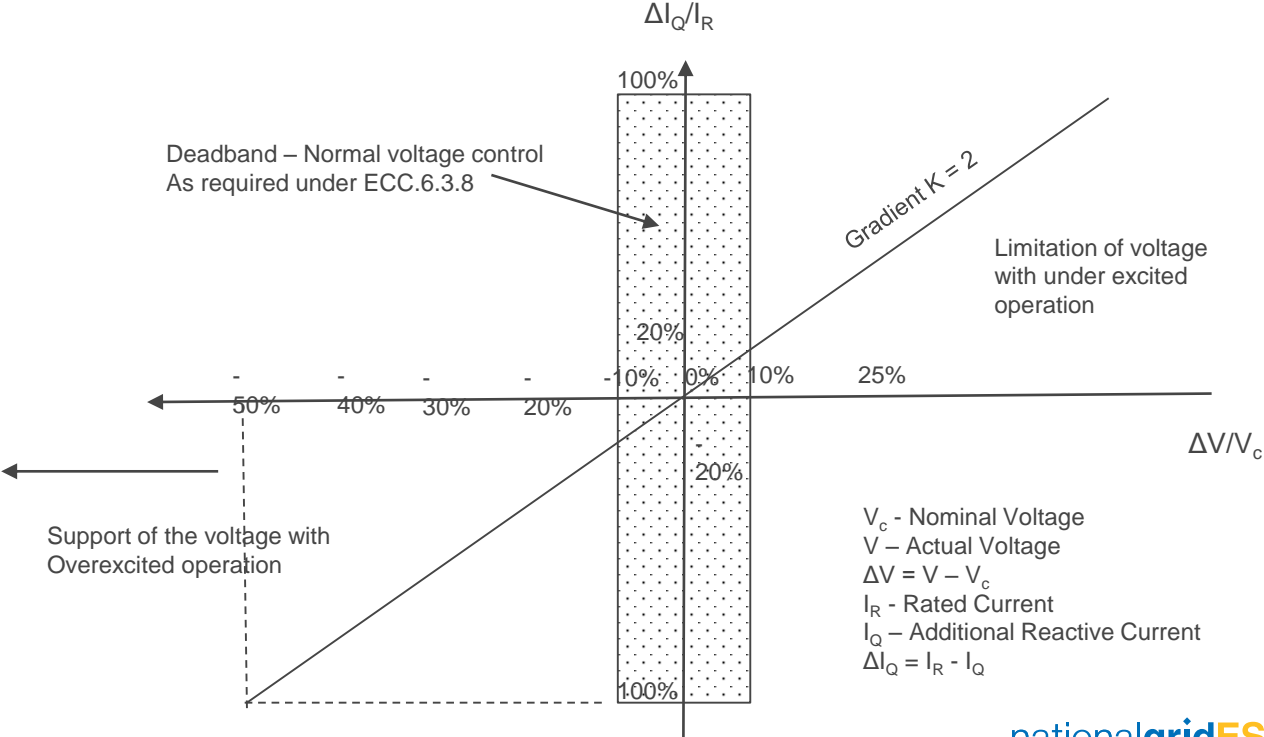

Reactive Current / Voltage curve – Parameters (1)

The additional reactive current in the positive sequence (ΔIQ_1) is set as follows:-

- (i) Where $\Delta V/V_c$ is within the range between 0.9 and 0.5 pu the following requirements shall apply:-

$$\Delta IQ_1 = K_1 \cdot \Delta V_1; \text{ and}$$

$$\Delta V_1 = (V_1 - V_{1_1min}) / V_c \text{ for the positive sequence}$$

where:

– V_1 : the actual voltage of the positive sequence; and

- V_{1_1min} : The 1 minute average of the pre-fault voltage of the positive sequence which would be expected to be the RMS value.

The gradient K_1 shall be set at 2

The additional reactive current in the negative sequence (ΔIQ_2) is set as:-

$$\Delta IQ_2 = k_2 \cdot V_2; \text{ and}$$

$$\Delta V_2 = (V_2 - V_{2_1min}) / V_c \text{ for the negative sequence}$$

where:

– V_2 : the actual voltage of the negative sequence

- V_{2_1min} : The 1 minute average of the pre-fault voltage of the negative sequence.

The gradient K_2 shall be set at 2

- (i) Where $\Delta V/V_c$ is below 0.5pu the total current injected is required to be above the shaded areas shown in Figure ECC.16.3.16(c) and Figure ECC.16.3.16(d).

Accuracy of requirement of additional reactive current in positive and negative sequence

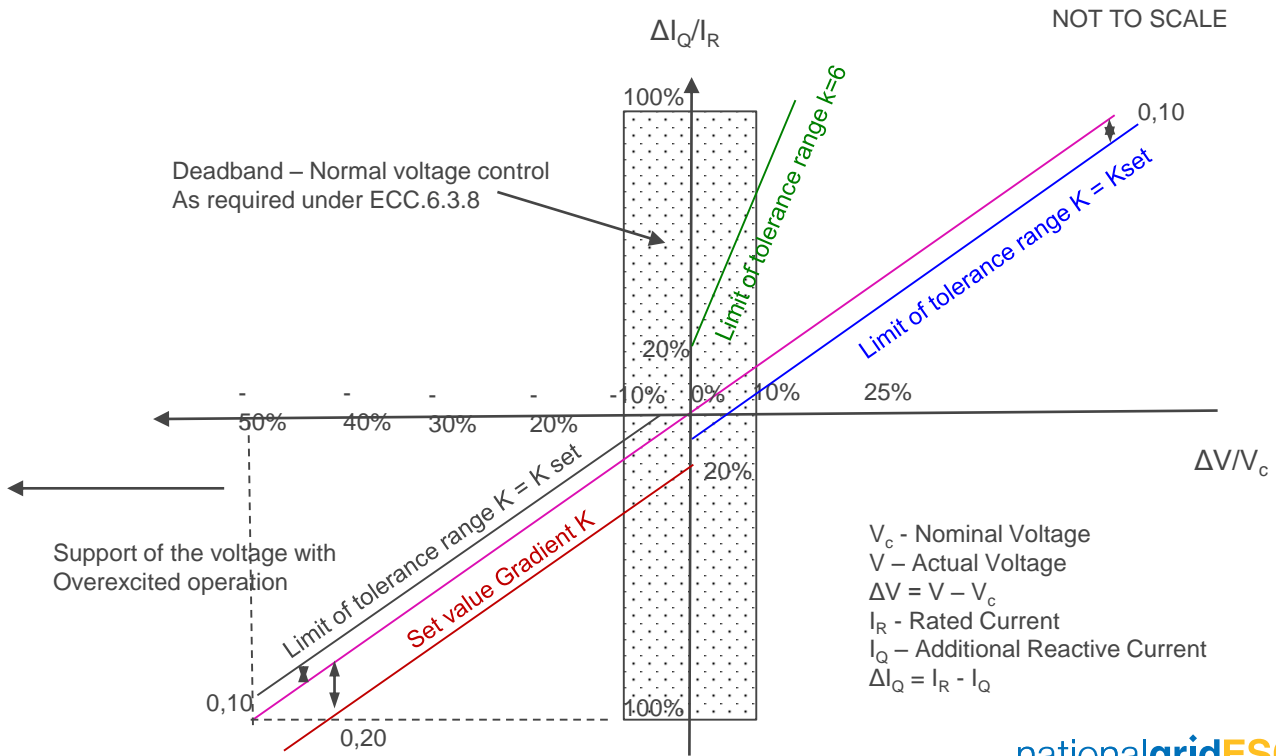

Initial Response – Way forward

- National Grid is grateful for the comments received
- National Grid's preferred option at this stage is Option 1A and would like to progress this option with Stakeholders as a possible solution. In doing so National Grid is open to further suggestions if some elements are identified to be particularly challenging.
- As part of this approach Option 1A has been favoured over Option 1B (EN 50549) on the following basis:_
 - Of the stakeholder comments received, more are in favour of option 1A than 1B.
 - EN50549 is not that easy to interpret
 - Option 1B is unclear in its treatment of transient overvoltage issues – The upper half of Figure ECC.6.3.16 (see slide 12) is unclear and it would be easier to specify the requirement in the Bilateral Agreement which would be expected to be consistent (at the time of writing with TGN288).
 - EN50549 appears to be written towards rotating machines rather than full converter based plant or HVDC Systems.
 - Additional reactive current in the negative sequence although feasible for HVDC introduces control challenges in terms of energy balance and overall network voltage support performance. Although the negative phase sequence current can help mitigate voltage impedances during unbalanced faults this will be dependent upon the network configuration, transformer arrangements and array layout
 - EN50549 defines requirements in respect of positive and negative phase sequence current injection which we see as challenging, requiring further guidance but also if this specific area requires further analysis it is likely to require a further workgroup.
 - Option 1A is believed to be reasonably flexible

Other Issues

- National Grid welcomes views from stakeholders on these revised proposals with a view to seeking if Option 1A is the best way forward acknowledging that there could be some challenges.
- Once the workgroup has agreed on an appropriate way forward, then some consequential modifications will need to be made to the European Compliance Processes to ensure consistency with the revised proposals
- Implementation timescales also require discussion as there are a number of projects which are in the design and development stage.
- We need to make sure that any implementation date when this modification is approved has no unintended consequences.
- In terms of timescales, the draft text needs to be developed a little further before the implementation dates can be agreed but National Grid would welcome a Stakeholders comments before a date is agreed.

Next Steps

- National Grid welcome comments on the revised text
- Stakeholders requested to confirm if Option 1A is an appropriate way forward.
- Stakeholders requested to review draft text and establish if it provides the clarity sought
- Further issues / areas for improved text?
- Views on implementation timescales
- Process for proceeding to the next phase

Annex 2D – Workgroup Presentation December 2018

Fast Fault Current Injection GC0111

Antony Johnson
National Grid
December 2018



Summary

Current Status

Comments received following meeting on 7th November

Revised text based on Version 1A

Additional flexibility / updates to recongise plant types

Examples

Other issues

Next Steps

Current Status (1)

- At the last GC0111 meeting held on 7th November a number of additional comments were received.
 - Version 1B (based on EN 50549) should be dropped and attention should be given to Version 1A.
 - Provide examples of pre fault operation both at full lead and full lag and when operating at unity Power Factor.
 - Clarify the relationship between voltage control operation (ie between 0.9 pu and 1.1pu voltage) and subsequent fault ride through performance – see later slides.
 - Ensure a smooth transition between voltage control mode and fault ride through / FFCI mode
 - ECC.6.3.16.1.2 – Amended so this now includes a clause which states “unless an alternative Type Registered solution is otherwise agreed”.
 - ECC.6.3.15.9.2.1(b)(ii) – Text amended to state that “an allowance shall be made for the fall in input power”
 - Remove references to negative sequence injection in respect of DFIG machines – Ref ECC.6.3.16.9
 - Updates to Figure ECC.6.3.16(a)
 - V_{Deadbad} replaced by $V_{\text{insensitivity}}$ with range adjustable set between 0 and 0.1. The default setting is 0.1 unless otherwise agreed.

Current Status (2)

- At the last GC0111 meeting held on 7th November a number of additional comments were received - Continued
 - **Gain factor (k)** adjustable between 2 and 7 with a default setting of 2
 - Add additional flexibility for technology specific plant (eg remote end HVDC Converters / DFIG machines).
 - Amendments will need to be made to the compliance section of the Grid Code (eg allowance for measurement delays but this will not be updated until the requirements are clear.
 - General tidy up in text to ensure it is more explicit, especially for voltage dips between 50 and 90%
 - Clearly define what Rated MW are over the voltage operating range

Reactive Current / Voltage Curve

FFCI Figure ECC.16.3.16(a) - Version 1A

NOT TO SCALE

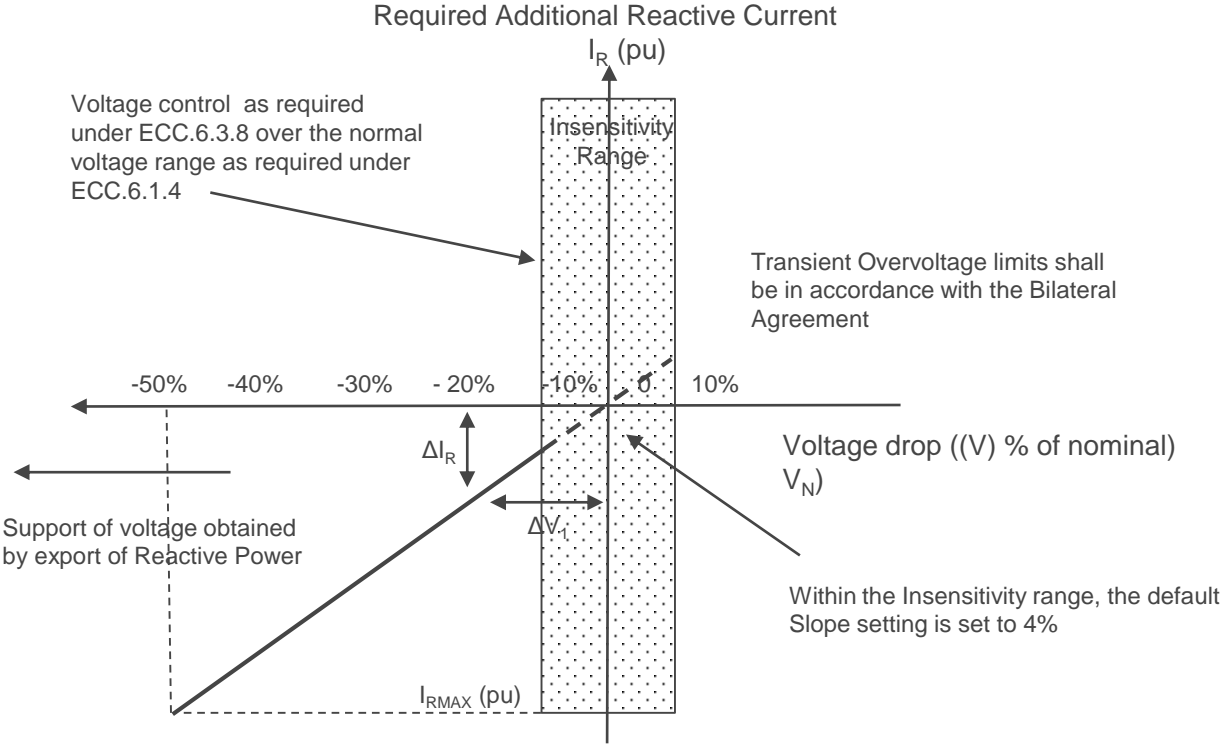

Reactive Current / Voltage curve – Parameters (1)

- Where:-
- V_N – Rated Voltage
- V - Actual voltage at the Grid Entry Point or User System Entry Point during the fault
- I_R - Additional reactive current where:_
- $$I_R = \Delta V_1 \cdot k + I_{P_{\text{prefault}}} \quad (\text{when } V \text{ is between } 50\% \text{ and less than } 90\%)$$
- $$I_R = I_{R_{\text{MAX}}} \quad (\text{when } V \text{ is less than } 50\% \text{ as defined by Figure ECC.16.3.16(b) or Figure ECC.16.3.16(c)})$$
- (I_R - Is the additional Reactive Current injected during the fault in per unit. This cannot exceed 1.0pu on the MVA Rating of the Power Park Module or HVDC Equipment as detailed in ECC.6.3.16.1.5)

Reactive Current / Voltage curve – Parameters (2)

$$\Delta V_1 = V_{\text{prefault}} - V_{\text{insensitivity}} - V_{\text{retained}}$$

V_{prefault} - Is the Prefault Positive Phase Sequence RMS voltage in per unit

$V_{\text{insensitivity}}$ Is the voltage either side of nominal voltage and set at any value between 0 and 0.1 as agreed between The Company and the Generator
- Default setting 0.1 unless otherwise agreed.

V_{retained} – Is the retained positive sequence voltage at the Grid Entry Point or User System Entry Point (under fault conditions)

k – Is the gain factor (range proposed 2 – 7) – Default setting 2

I_{prefault} - is the prefault reactive current in per unit

The prefault reactive current (I_{prefault}) for a future fault ride through event, shall be determined when the voltage has returned above the minimum levels specified in ECC.6.1.4,

I_{RMAX} - The maximum current which shall, as a minimum, be above the shaded areas defined by Figures ECC.16.3.16(b) or ECC.16.3.16(c). There is no requirement for the maximum supplied current to exceed 1.0pu.

FFCI Figure ECC.16.3.16(b)

(Performance required if the voltage falls below 50% of nominal – Short fault clearance time)

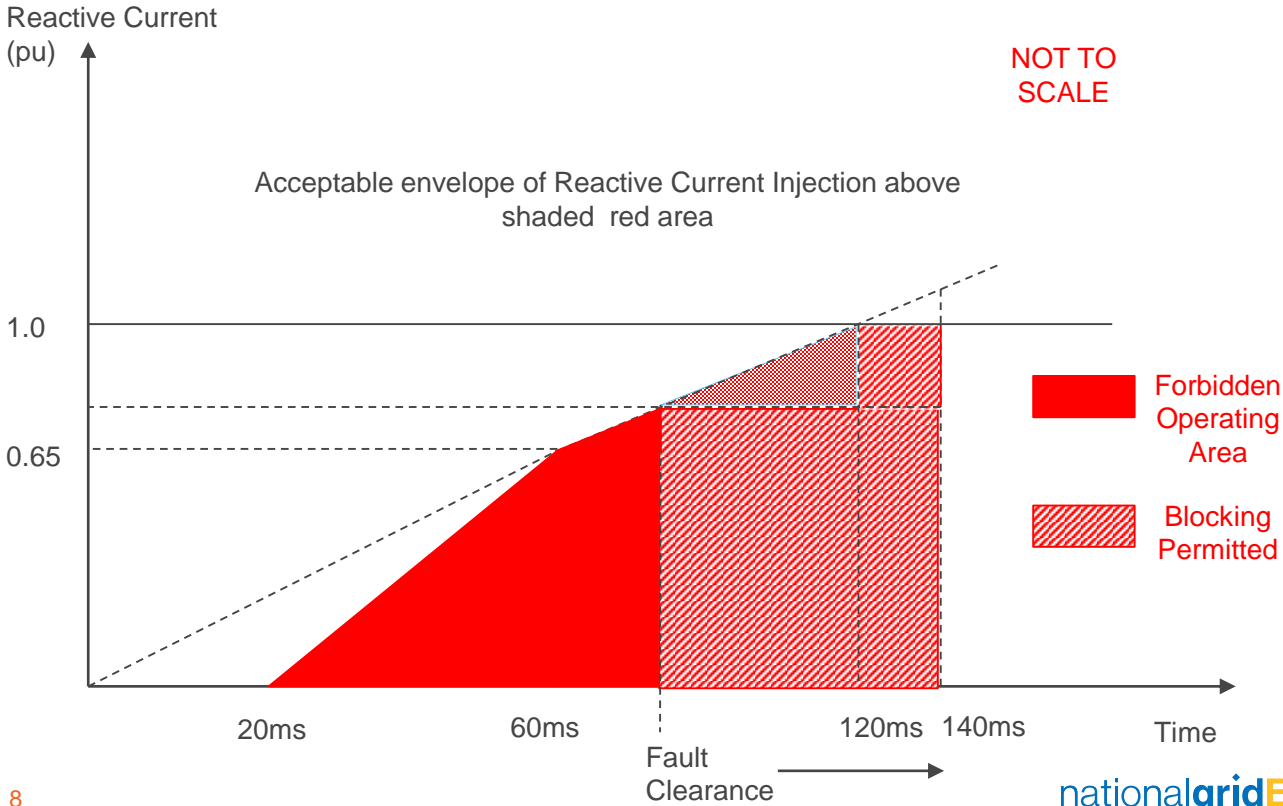

FFCI Figure ECC.16.3.16(c)

(Performance required if the voltage falls below 50% of nominal – long fault clearance time)

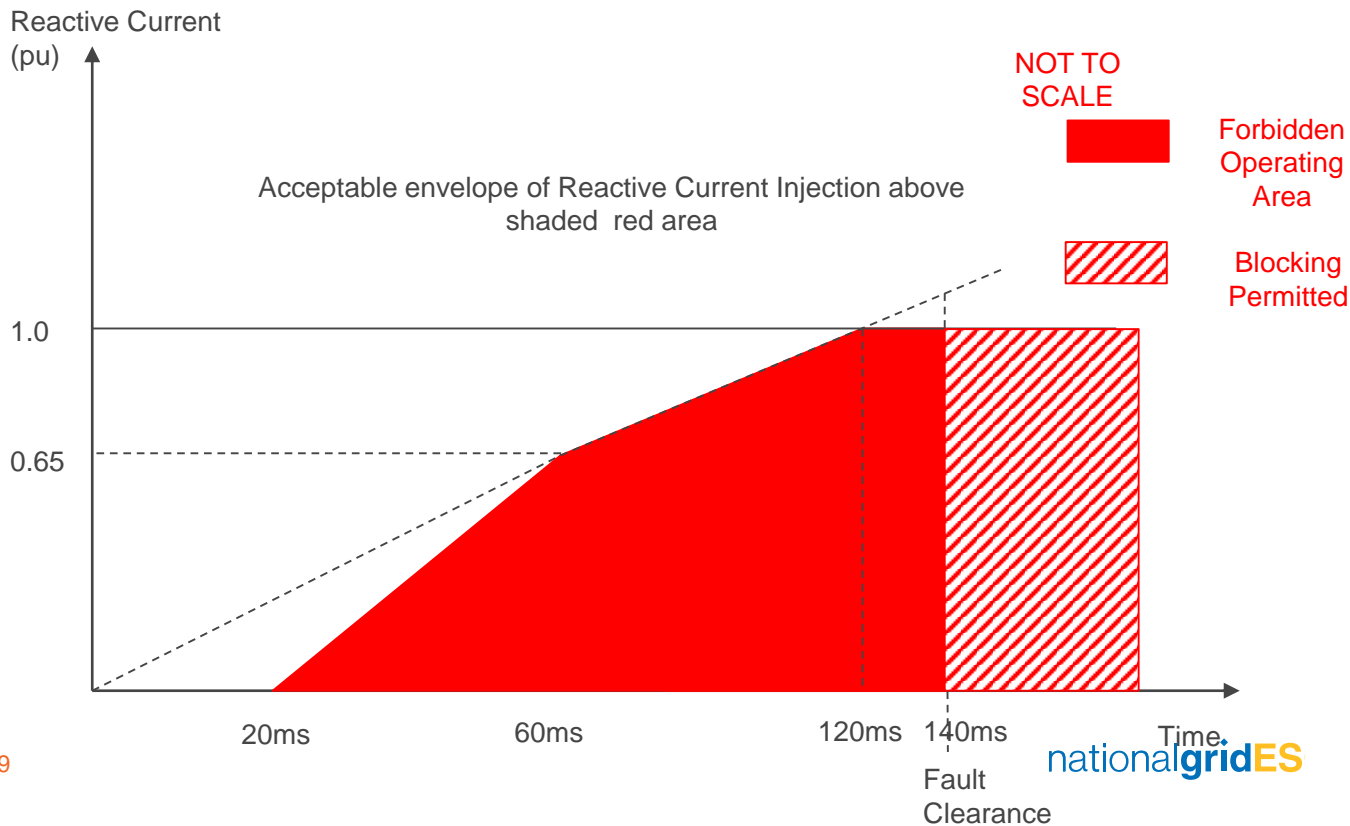

Active / Reactive Current Circle Diagram (FFCI Figure ECC.16.3.16(d))

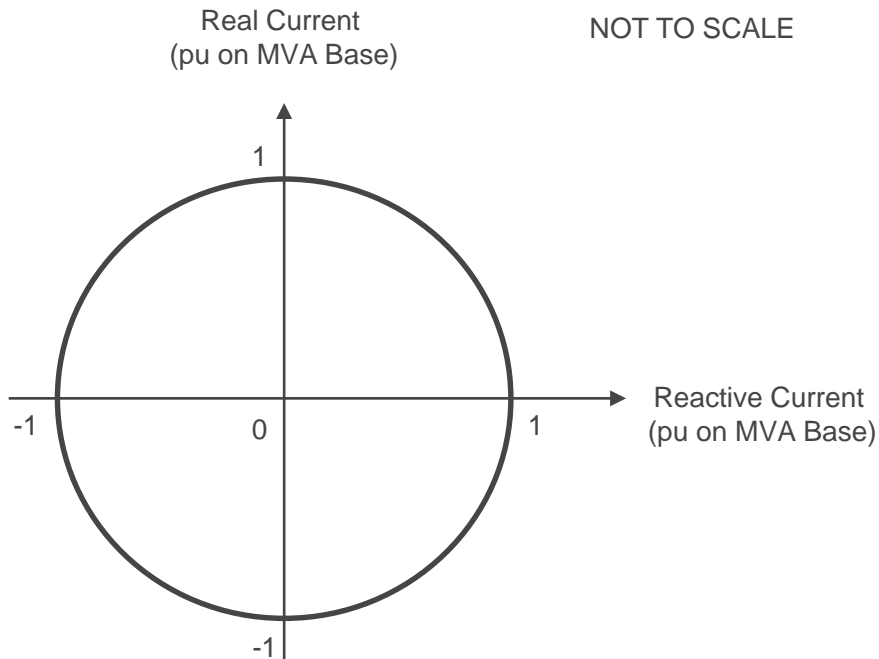

NOTE:- 1 pu current is the rated current of the Power Park Module or HVDC Equipment when operating at full MW output and full leading or Lagging MVA_r capability (eg for a 100MW Power Park Module Rated Current would be obtained when the Power Park Module is supplying 100MW and 0.95 Power Factor lead or 0.95 Power Factor lag at the Connection Point)

Example – Pre Fault

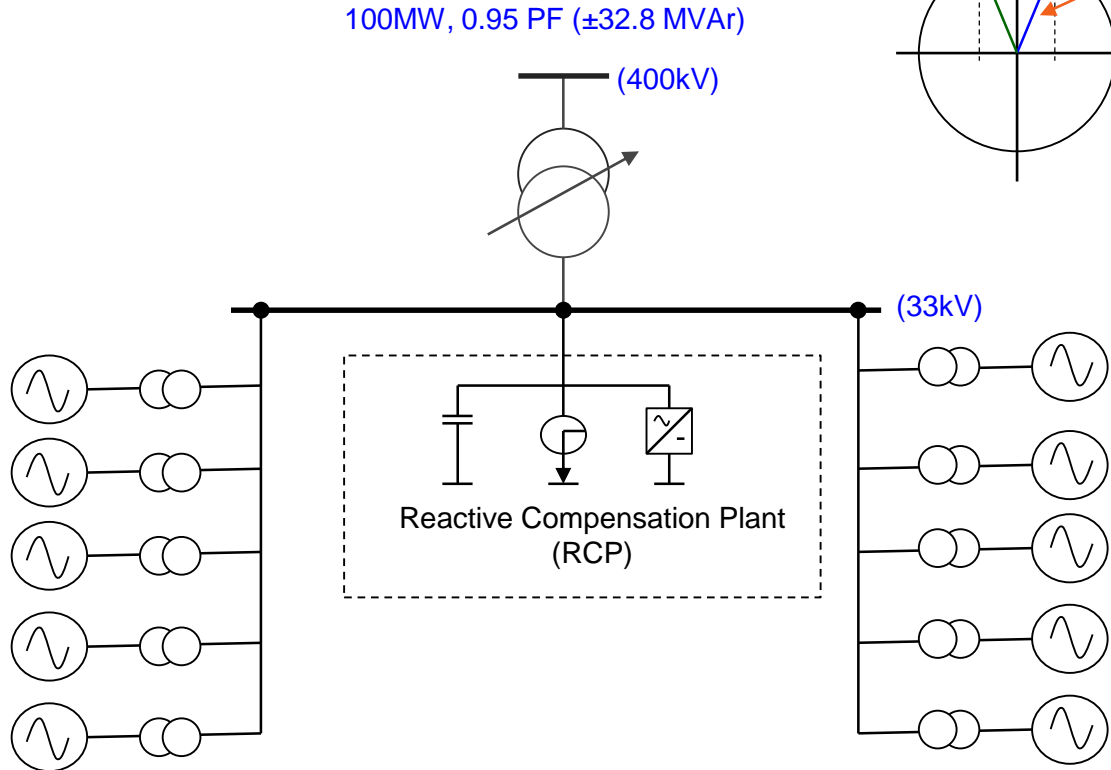

Steady State Voltage Control – Pre Fault

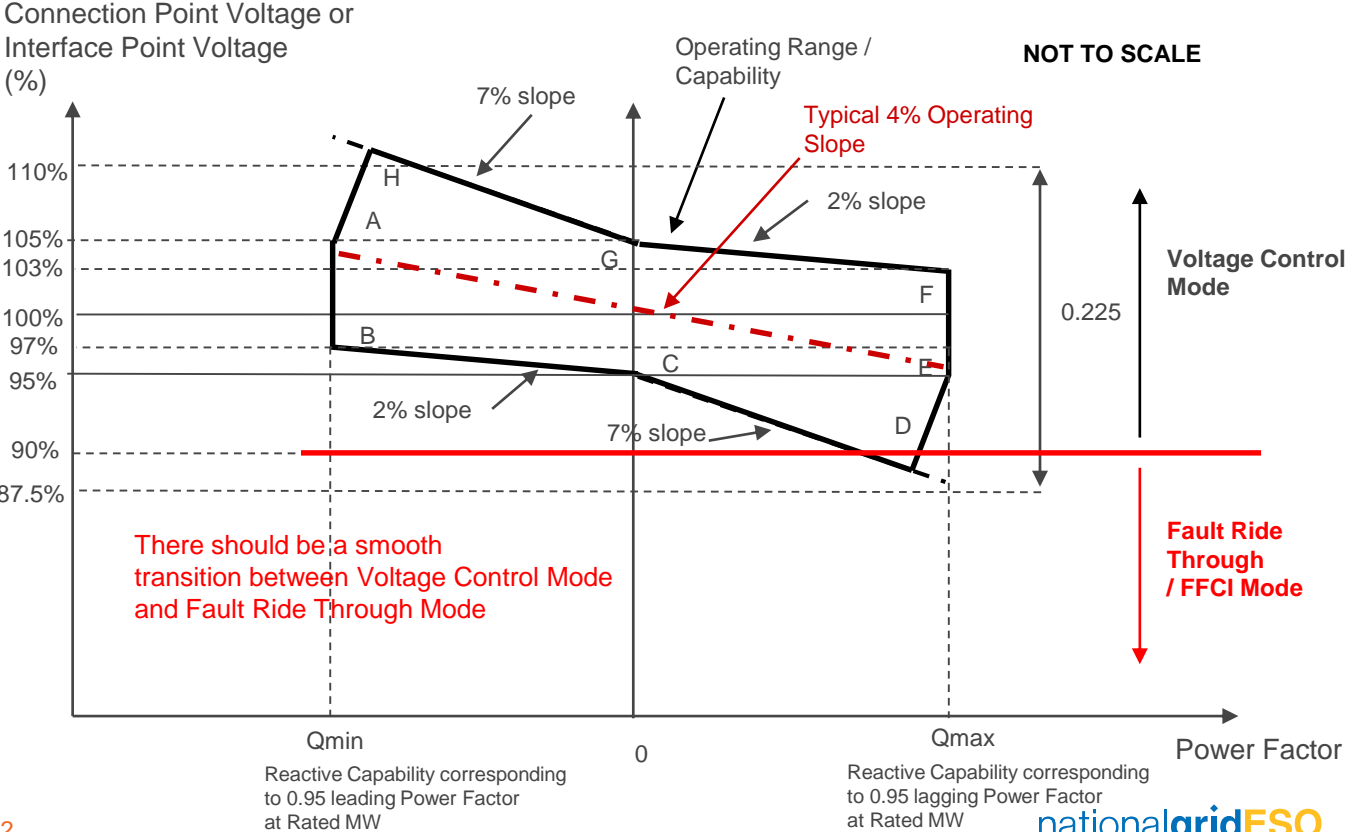

Voltage Control Testing – Slope (Pre Fault)

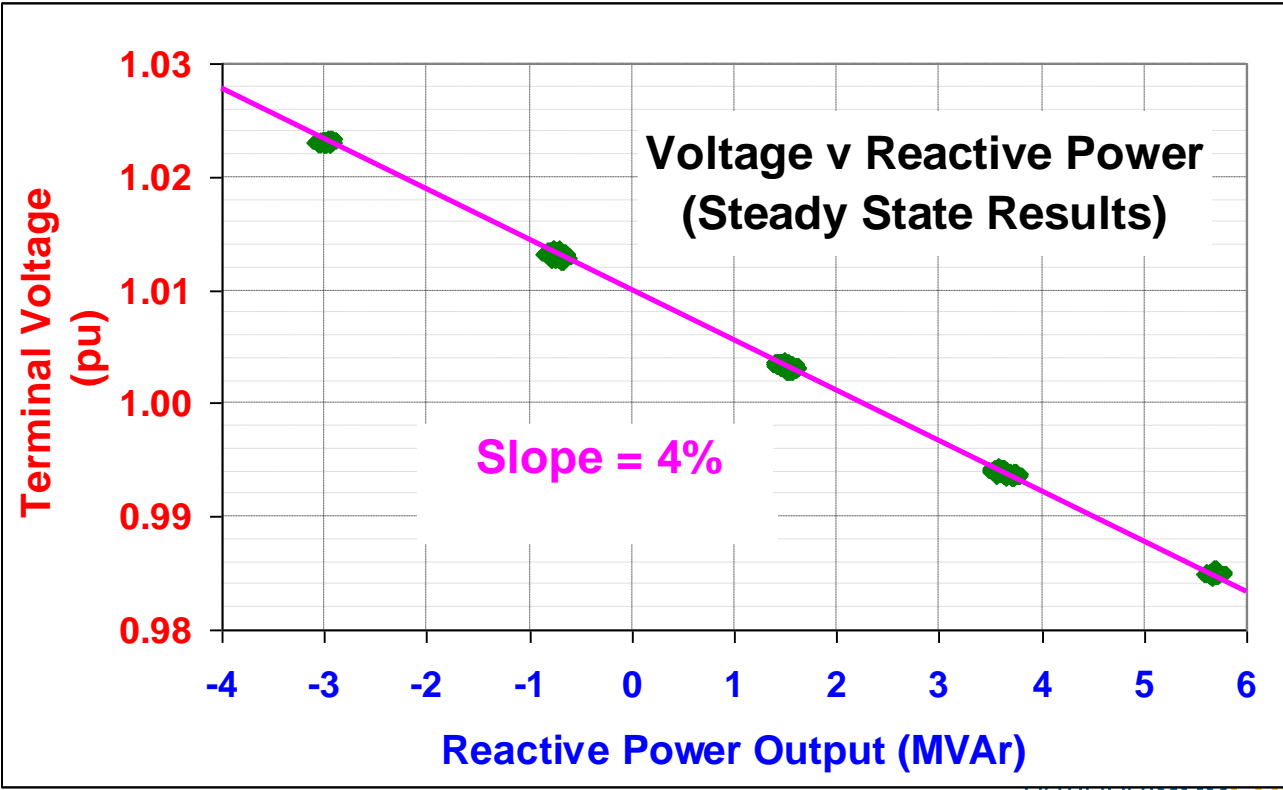

Voltage Control Testing – Pre fault

Step to voltage reference

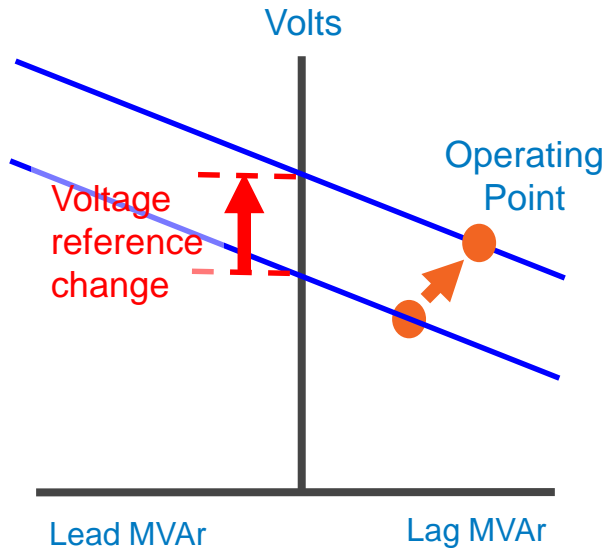

■ External Tap change

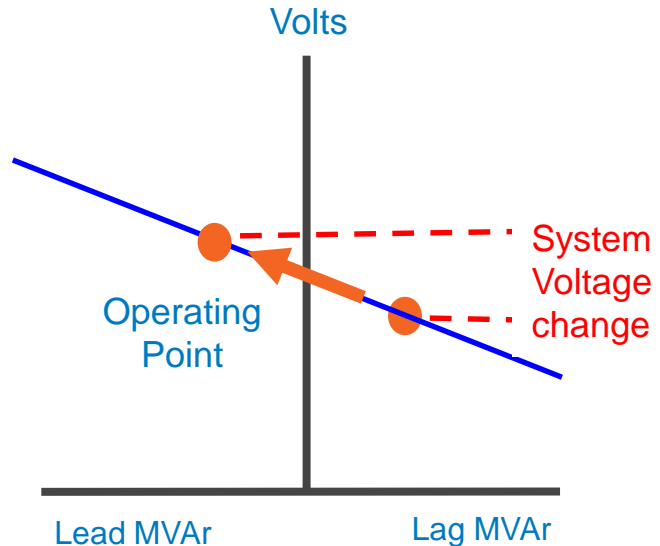

PPM Reactive Capability Requirements – Type C&D (ECC.6.3.2.4.4)

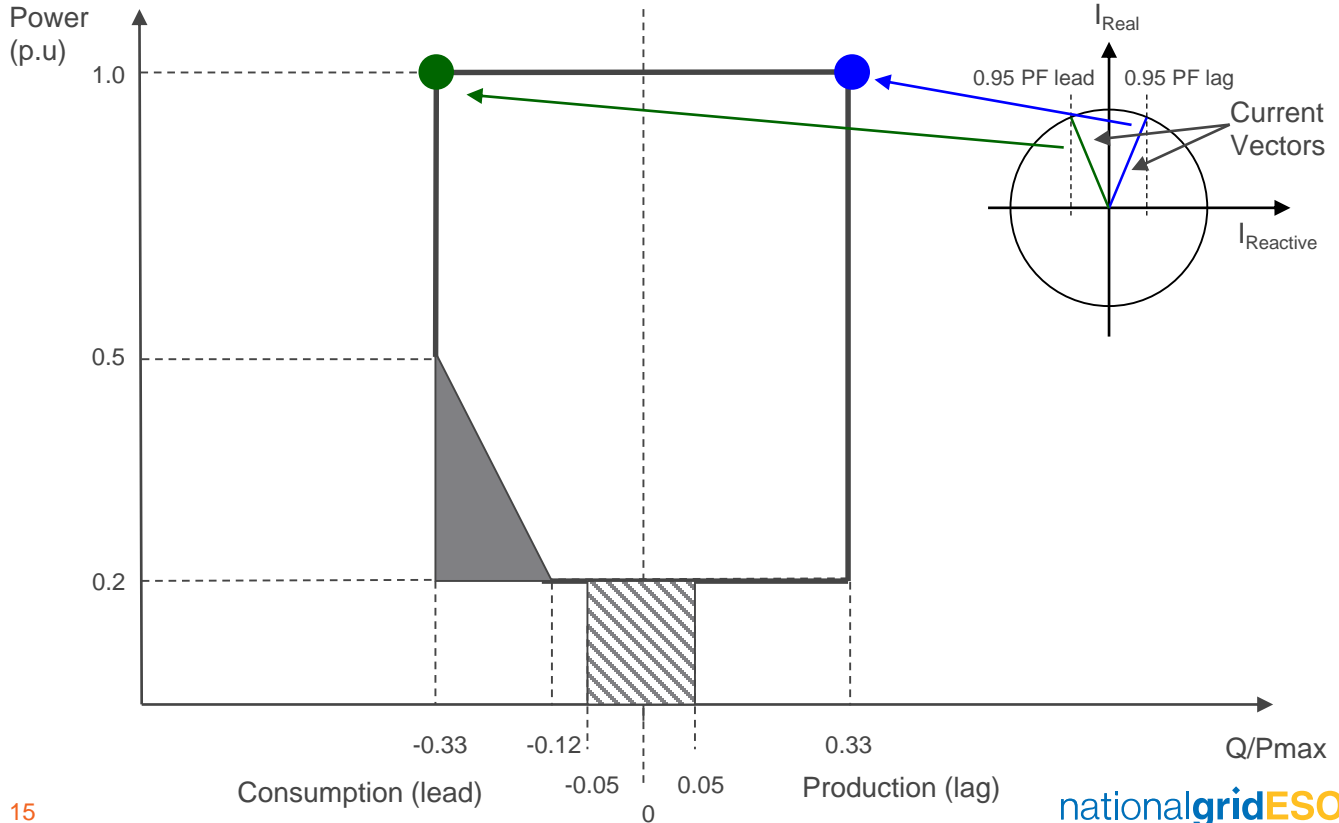

Why is Voltage Control Relevant for Fast Fault Current Injection (1)

- Fast fault current injection is dependent upon the pre fault voltage

- Recalling that

- I_R - Additional reactive current where: _

- $I_R = \Delta V_1 \cdot k + I_{Prefault}$ (when V is between 50% and less than 90%)

- $I_R = I_{RMAX}$ (when V is less than 50% as defined by Figure ECC.16.3.16(b) or Figure ECC.16.3.16(c))

- Where:-

$$\Delta V_1 = V_{prefault} - V_{insensitivity} - V_{retained}$$

Why is Voltage Control Relevant for Fast Fault Current Injection (2)

- In summary under pre-fault conditions with the Power Park Module operating at full leading conditions or full lagging conditions at Rated MW output it will be operating at rated current and therefore the additional current supplied will be limited under fault conditions.
- NOTE – With priority given to reactive current - under a voltage dip condition the vector will start to move along the locus resulting in an increase in the reactive current

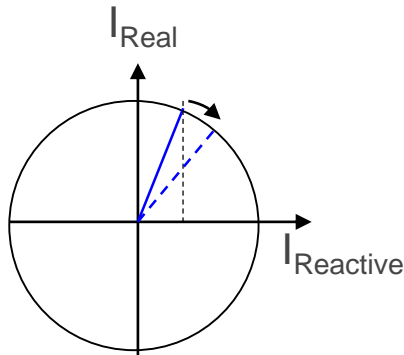

Example 1 – Power Park Module (Slide 11) operating at full MW output and full MVAR output – volt drop to 85% and $V_{\text{insensitivity}}$ set to 0

- Wind farm is operating at 100MW output and 0.95 PF lagging (ie 32.8MVAR or export to the System)

- $I_R = \Delta V_1 \cdot k + I_{\text{Prefault}}$

- And $\Delta V_1 = V_{\text{prefault}} - V_{\text{insensitivity}} - V_{\text{retained}}$

- If $V_{\text{Prefault}} = 0.96$ pu and $Q_{\text{max}} = 0.95$ PF lag on a 4% droop

- $V_{\text{insensitivity}} = 0$ pu

- In this case the retained voltage (V_{retained}) is 0.85 pu

- $\Delta V_1 = V_{\text{prefault}} - V_{\text{insensitivity}} - V_{\text{retained}} = 0.96 - 0 - 0.85 = 0.11$

- $I_{\text{prefault}} = \sin(\arccos 0.95) = 0.312$ pu

- $I_R = \Delta V_1 \cdot k + I_{\text{Prefault}} = 0.11 \times 2 + 0.312 = 0.532$ pu

Example 2 – Power Park Module (Slide 11) operating at full MW output and full MVar output – volt drop to 85% and $V_{\text{insensitivity}}$ set to 0.1 pu

- Wind farm is operating at 100MW output and 0.95 PF lagging (ie 32.8MVar or export to the System)

- $I_R = \Delta V_1 \cdot k + I_{\text{Prefault}}$

- And $\Delta V_1 = V_{\text{prefault}} - V_{\text{insensitivity}} - V_{\text{retained}}$

- If $V_{\text{Prefault}} = 0.96\text{p.u}$ and $Q_{\text{max}} = 0.95$ PF lag on a 4% droop

- $V_{\text{insensitivity}} = 0.1 \text{ pu}$

- In this case the retained voltage (V_{retained}) is 0.85 pu

- $\Delta V_1 = V_{\text{prefault}} - V_{\text{insensitivity}} - V_{\text{retained}} = 0.96 - 0.1 - 0.85 = 0.01$

- $I_{\text{prefault}} = \sin(\arccos 0.95) = 0.312\text{pu}$

- $I_R = \Delta V_1 \cdot k + I_{\text{Prefault}} = 0.01 \times 2 + 0.312 = 0.332\text{pu}$

Example 3 – Power Park Module (Slide 11) operating at full MW output and full MVAR output – volt drop to 50% and $V_{\text{insensitivity}}$ set to 0

- Wind farm is operating at 100MW output and 0.95 PF lagging (ie 32.8MVAR or export to the System)
- $I_R = \Delta V_1 \cdot k + I_{\text{Prefault}}$
- And $\Delta V_1 = V_{\text{prefault}} - V_{\text{insensitivity}} - V_{\text{retained}}$
- If $V_{\text{Prefault}} = 0.96 \text{ p.u}$ and $Q_{\text{max}} = 0.95 \text{ PF lag}$ on a 4% droop
- $V_{\text{insensitivity}} = 0 \text{ p.u}$
- In this case the retained voltage (V_{retained}) is 0.5 pu
- $\Delta V_1 = V_{\text{prefault}} - V_{\text{insensitivity}} - V_{\text{retained}} = 0.96 - 0 - 0.5 = 0.46$
- $I_{\text{prefault}} = \sin(\arccos 0.95) = 0.312 \text{ pu}$
- $I_R = \Delta V_1 \cdot k + I_{\text{Prefault}} = 0.46 \times 2 + 0.312 = 1.232 \text{ pu}$ – capped at 1.0pu reactive current

Example 4 – Power Park Module (Slide 11) operating at full MW output and full MVar output – volt drop to 50% and $V_{\text{insensitivity}}$ set to 0.1

- Wind farm is operating at 100MW output and 0.95 PF lagging (ie 32.8MVar or export to the System)
- $I_R = \Delta V_1 \cdot k + I_{\text{Prefault}}$
- And $\Delta V_1 = V_{\text{prefault}} - V_{\text{insensitivity}} - V_{\text{retained}}$
- If $V_{\text{Prefault}} = 0.96\text{p.u}$ and $Q_{\text{max}} = 0.95$ PF lag on a 4% droop
- $V_{\text{insensitivity}} = 0.1 \text{ p.u}$
- In this case the retained voltage (V_{retained}) is 0.5 pu
- $\Delta V_1 = V_{\text{prefault}} - V_{\text{insensitivity}} - V_{\text{retained}} = 0.96 - 0.1 - 0.5 = 0.36$
- $I_{\text{prefault}} = \sin(\arccos 0.95) = 0.312\text{pu}$
- $I_R = \Delta V_1 \cdot k + I_{\text{Prefault}} = 0.36 \times 2 + 0.312 = 1.032 \text{ pu} - \text{capped at } 1.0\text{pu reactive current}$

Example 5 – Power Park Module (Slide 11) operating at full MW output and full MVar output – volt drop to 30%

- Wind farm is operating at 100MW output and 0.95 PF lagging (ie 32.8MVar or export to the System)
- Below 50% retained voltage, the wind farm will be required to satisfy the requirements of Figure ECC.16.3.16(b) or ECC.16.3.16(c)

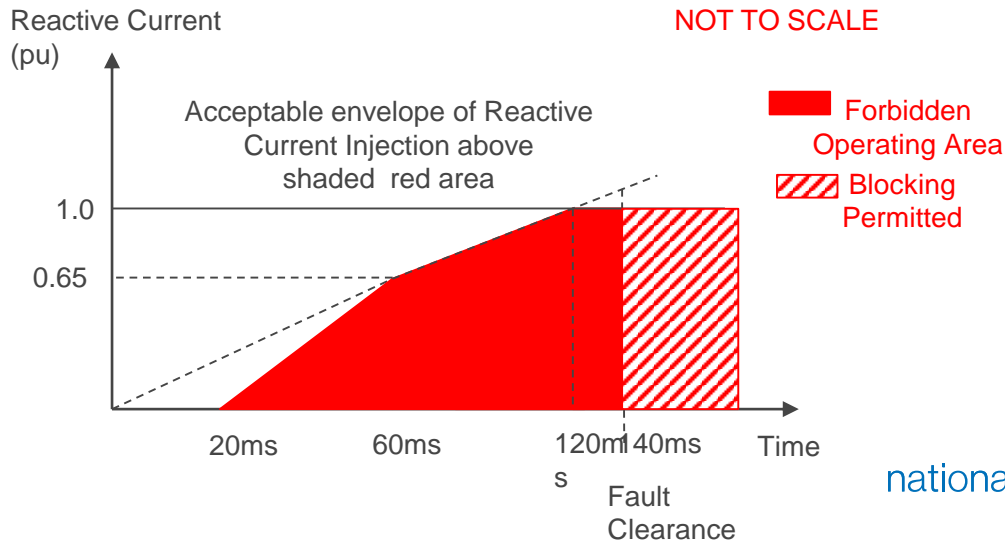

Example 6 – Power Park Module (Slide 11) operating at full MW output and Unity Power Factor – volt drop to 85% with $V_{\text{insensitivity}}$ set to 0

- Wind farm is operating at 100MW output and operating at unity power factor (ie 0 MVar export to the System)
- $I_R = \Delta V_1 \cdot k + I_{\text{Prefault}}$
- And $\Delta V_1 = V_{\text{prefault}} - V_{\text{insensitivity}} - V_{\text{retained}}$
- If $V_{\text{Prefault}} = 1.0$ p.u and $Q = 0$ on a 4% droop with a target voltage setpoint of 1.0pu.
- $V_{\text{insensitivity}} = 0$ p.u
- In this case the retained voltage (V_{retained}) is 0.85 pu
- $\Delta V_1 = V_{\text{prefault}} - V_{\text{insensitivity}} - V_{\text{retained}} = 1.0 - 0 - 0.85 = 0.15$
- $I_{\text{prefault}} = \sin(\arccos 1) = 0$ pu
- $I_R = \Delta V_1 \cdot k + I_{\text{Prefault}} = 0.15 \times 2 + 0 = 0.3$ pu

Example 7 – Power Park Module (Slide 11) operating at full MW output and Unity Power Factor – volt drop to 85% with $V_{\text{insensitivity}}$ set to 0.1

- Wind farm is operating at 100MW output and operating at unity power factor (ie 0 MVar export to the System)
- $I_R = \Delta V_1 \cdot k + I_{\text{Prefault}}$
- And $\Delta V_1 = V_{\text{prefault}} - V_{\text{insensitivity}} - V_{\text{retained}}$
- If $V_{\text{Prefault}} = 1.0$ p.u and $Q = 0$ on a 4% droop with a target voltage setpoint of 1.0pu.
- $V_{\text{insensitivity}} = 0.1$ p.u
- In this case the retained voltage (V_{retained}) is 0.85 pu
- $\Delta V_1 = V_{\text{prefault}} - V_{\text{insensitivity}} - V_{\text{retained}} = 1.0 - 0.1 - 0.85 = 0.05$
- $I_{\text{prefault}} = \sin(\arccos 1) = 0$ pu
- $I_R = \Delta V_1 \cdot k + I_{\text{Prefault}} = 0.05 \times 2 + 0 = 0.1$ pu

Example 8 – Power Park Module (Slide 11) operating at full MW output and Unity Power Factor – volt drop to 50% with $V_{\text{insensitivity}}$ set to 0

- Wind farm is operating at 100MW output and operating at unity power factor (ie 0 MVAR export to the System)
- $I_R = \Delta V_1 \cdot k + I_{\text{Prefault}}$
- And $\Delta V_1 = V_{\text{prefault}} - V_{\text{insensitivity}} - V_{\text{retained}}$
- If $V_{\text{Prefault}} = 1.0$ p.u and $Q = 0$ on a 4% droop with a target voltage setpoint of 1.0pu.
- $V_{\text{insensitivity}} = 0$ p.u
- In this case the retained voltage (V_{retained}) is 0.5 pu
- $\Delta V_1 = V_{\text{prefault}} - V_{\text{insensitivity}} - V_{\text{retained}} = 1.0 - 0 - 0.5 = 0.5$
- $I_{\text{prefault}} = \sin(\arccos 1) = 0$ pu
- $I_R = \Delta V_1 \cdot k + I_{\text{Prefault}} = 0.5 \times 2 + 0 = 1.0$ pu

Example 9 – Power Park Module (Slide 11) operating at full MW output and Unity Power Factor – volt drop to 50% with $V_{\text{insensitivity}}$ set to 0.1

- Wind farm is operating at 100MW output and operating at unity power factor (ie 0 MVar export to the System)
- $I_R = \Delta V_1 \cdot k + I_{\text{Prefault}}$
- And $\Delta V_1 = V_{\text{prefault}} - V_{\text{insensitivity}} - V_{\text{retained}}$
- If $V_{\text{Prefault}} = 1.0$ p.u and $Q = 0$ on a 4% droop with a target voltage setpoint of 1.0pu.
- $V_{\text{insensitivity}} = 0.1$ p.u
- In this case the retained voltage (V_{retained}) is 0.5 pu
- $\Delta V_1 = V_{\text{prefault}} - V_{\text{insensitivity}} - V_{\text{retained}} = 1.0 - 0.1 - 0.5 = 0.4$
- $I_{\text{prefault}} = \sin(\arccos 1) = 0$ pu
- $I_R = \Delta V_1 \cdot k + I_{\text{Prefault}} = 0.4 \times 2 + 0 = 0.8$ pu

Example 10 – Power Park Module (Slide 11) operating at full MW output and unity power factor – volt drop to 30%

- Wind farm is operating at 100MW output and unity power factor
- Below 50% retained voltage, the wind farm will be required to satisfy the requirements of Figure ECC.16.3.16(b) or ECC.16.3.16(c)

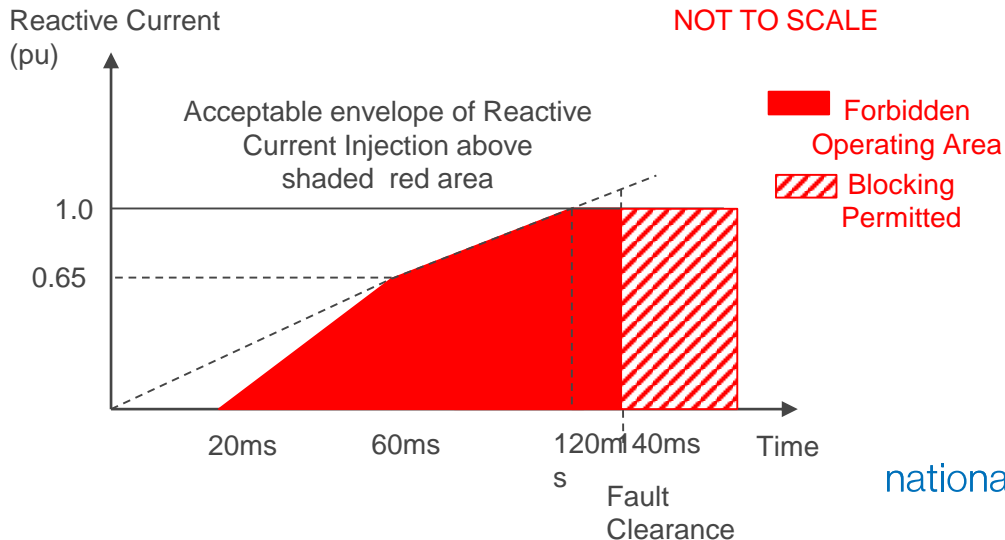

Example 11 – Power Park Module (Slide 11) operating at full MW output and full MVar output – volt drop to 85% with $V_{\text{insensitivity}}$ set to 0

- Wind farm is operating at 100MW output and 0.95 PF leading (ie -32.8MVar import to the System)
- $I_R = \Delta V_1 \cdot k + I_{\text{Prefault}}$
- And $\Delta V_1 = V_{\text{prefault}} - V_{\text{insensitivity}} - V_{\text{retained}}$
- If $V_{\text{Prefault}} = 1.04\text{p.u}$ and $Q_{\text{max}} = 0.95$ PF lead on a 4% droop
- $V_{\text{deadband}} = 0\text{p.u}$
- In this case the retained voltage (V_{retained}) is 0.85 pu
- $\Delta V_1 = V_{\text{prefault}} - V_{\text{insensitivity}} - V_{\text{retained}} = 1.04 - 0 - 0.85 = 0.19$
- $I_{\text{prefault}} = \sin(\arccos-0.95) = -0.312\text{pu}$ (lead)
- $I_R = \Delta V_1 \cdot k + I_{\text{Prefault}} = 0.19 \times 2 - 0.312 = 0.068\text{pu}$

Example 12 – Power Park Module (Slide 11) operating at full MW output and full MVar output – volt drop to 85% with $V_{\text{insensitivity}}$ set to 0.1

- Wind farm is operating at 100MW output and 0.95 PF leading (ie -32.8MVar import to the System)
- $I_R = \Delta V_1 \cdot k + I_{\text{Prefault}}$
- And $\Delta V_1 = V_{\text{prefault}} - V_{\text{insensitivity}} - V_{\text{retained}}$
- If $V_{\text{Prefault}} = 1.04\text{p.u}$ and $Q_{\text{max}} = 0.95$ PF lead on a 4% droop
- $V_{\text{deadband}} = 0.1\text{p.u}$
- In this case the retained voltage (V_{retained}) is 0.85 pu
- $\Delta V_1 = V_{\text{prefault}} - V_{\text{insensitivity}} - V_{\text{retained}} = 1.04 - 0.1 - 0.85 = 0.09$
- $I_{\text{prefault}} = \sin(\arccos-0.95) = -0.312\text{pu}$ (lead)
- $I_R = \Delta V_1 \cdot k + I_{\text{Prefault}} = 0.09 \times 2 - 0.312 = -0.132\text{pu}$ (lead)

Example 13 – Power Park Module (Slide 11) operating at full MW output and full MVAR output – volt drop to 50% with $V_{\text{insensitivity}}$ set to 0

- Wind farm is operating at 100MW output and 0.95 PF leading (ie -32.8MVAR import to the System)
- $I_R = \Delta V_1 \cdot k + I_{\text{Prefault}}$
- And $\Delta V_1 = V_{\text{prefault}} - V_{\text{insensitivity}} - V_{\text{retained}}$
- If $V_{\text{Prefault}} = 1.04 \text{ p.u}$ and $Q_{\text{max}} = 0.95 \text{ PF lead}$ on a 4% droop
- $V_{\text{insensitivity}} = 0 \text{ p.u}$
- In this case the retained voltage (V_{retained}) is 0.5 pu
- $\Delta V_1 = V_{\text{prefault}} - V_{\text{insensitivity}} - V_{\text{retained}} = 1.04 - 0 - 0.5 = 0.54$
- $I_{\text{prefault}} = \sin(\arccos-0.95) = -0.312 \text{ pu (lead)}$
- $I_R = \Delta V_1 \cdot k + I_{\text{Prefault}} = 0.54 \times 2 - 0.312 = 0.768 \text{ pu}$

Example 14 – Power Park Module (Slide 11) operating at full MW output and full MVar output – volt drop to 50% with $V_{\text{insensitivity}}$ set to 0.1

- Wind farm is operating at 100MW output and 0.95 PF leading (ie -32.8MVar import to the System)
- $I_R = \Delta V_1 \cdot k + I_{\text{Prefault}}$
- And $\Delta V_1 = V_{\text{prefault}} - V_{\text{insensitivity}} - V_{\text{retained}}$
- If $V_{\text{Prefault}} = 1.04\text{p.u}$ and $Q_{\text{max}} = 0.95$ PF lead on a 4% droop
- $V_{\text{deadband}} = 0.1\text{p.u}$
- In this case the retained voltage (V_{retained}) is 0.5 pu
- $\Delta V_1 = V_{\text{prefault}} - V_{\text{insensitivity}} - V_{\text{retained}} = 1.04 - 0.1 - 0.5 = 0.44$
- $I_{\text{prefault}} = \sin(\arccos-0.95) = -0.312\text{pu}$ (lead)
- $I_R = \Delta V_1 \cdot k + I_{\text{Prefault}} = 0.44 \times 2 - 0.312 = 0.568\text{pu}$

Example 15 – Power Park Module (Slide 11) operating at full MW output and full MVar output – volt drop to 30%

- Wind farm is operating at 100MW output and unity power factor
- Below 50% retained voltage, the wind farm will be required to satisfy the requirements of Figure ECC.16.3.16(b) or ECC.16.3.16(c)

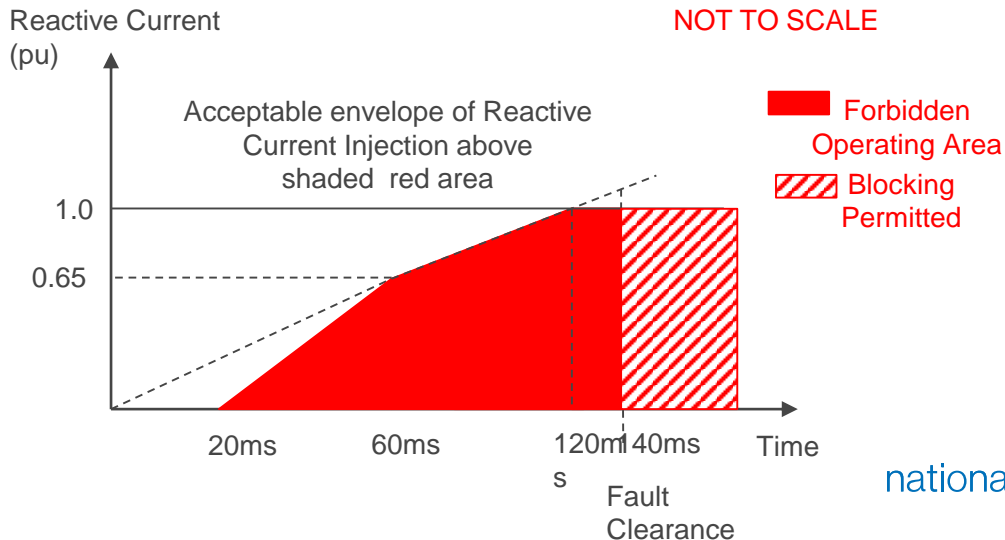

Interpretation of requirements for voltage dips between 90% and 50%

- Where the voltage dip falls between 90% to 50% the injected reactive current is required to be above the shaded area shown below with the value of I_R defined by the results of the above formulas. The Generator is free to inject as much reactive current as possible without exceeding the transient rating of the Power Park Module or constituent element thereof.

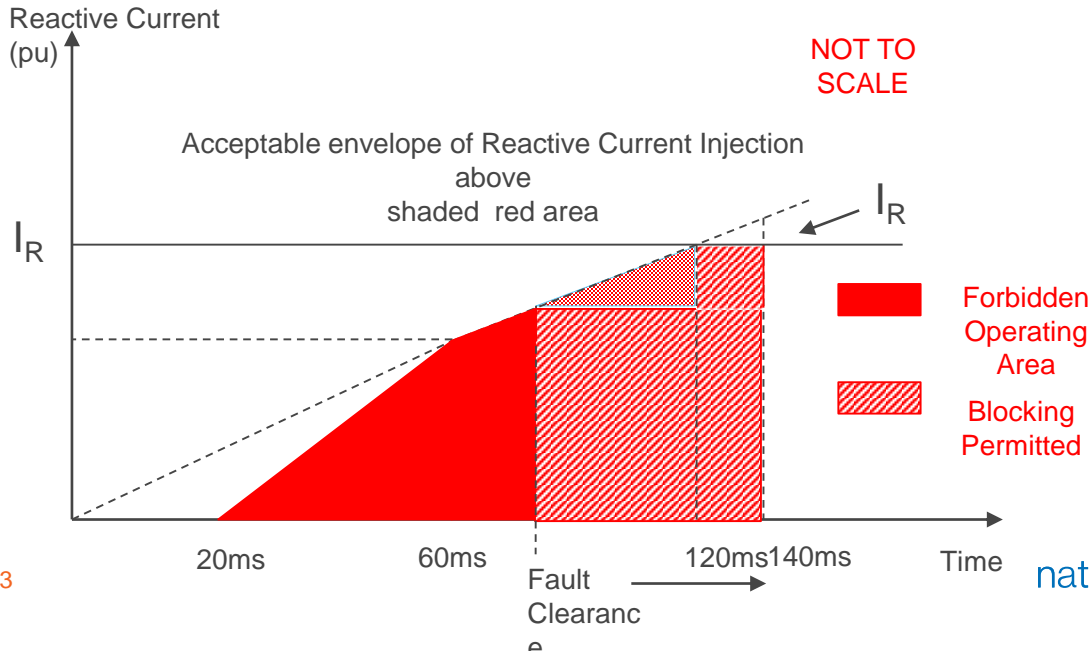

Interpretation of requirements for voltage dips between 90% and 50%

- Where the voltage dip falls between 90% to 50% the injected reactive current is required to be above the shaded area shown below with the value of I_R defined by the results of the above formula's. The Generator is free to inject as much reactive current as possible without exceeding the transient rating of the Power Park Module or constituent element thereof.

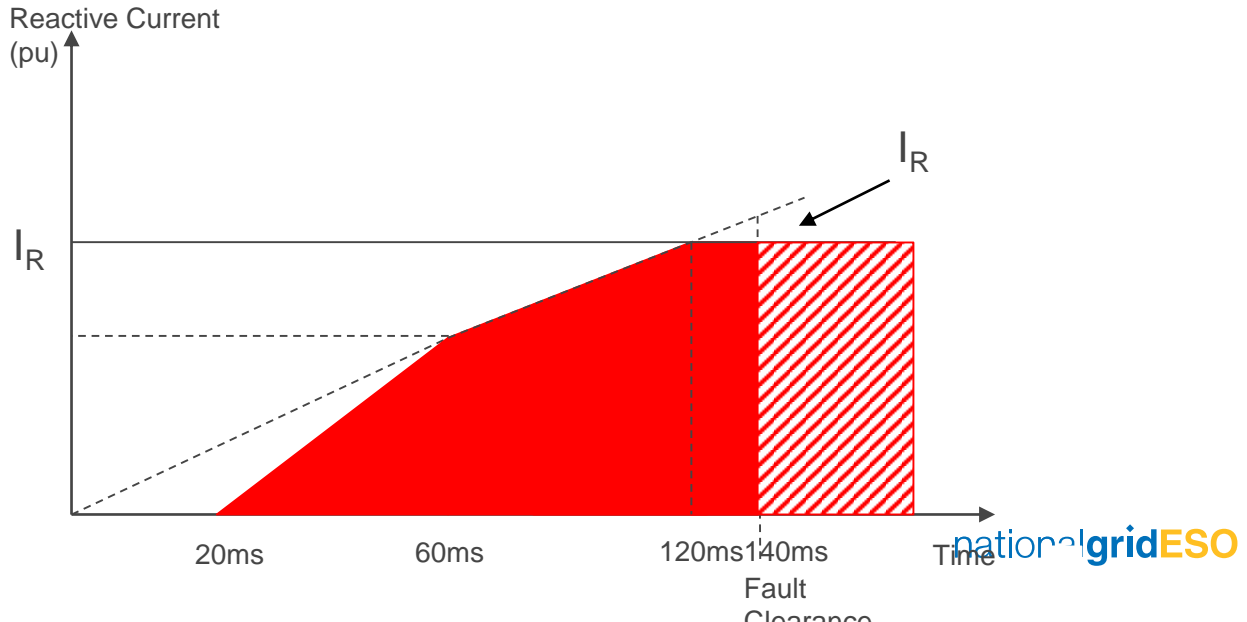

Requirements from a Power Park Unit Perspective

- The requirements for FFCI are generally defined at the Connection Point of the Power Park Module although the legal text also specifies the requirement can be demonstrated at the Power Park Unit terminals if required.
- This can be achieved by starting with the Rating of the PPM at the Connection Point
- Subtract any external reactive power compensation equipment contribution (MVAR) on the MVA base and calculate the wind turbine contribution. This could be achieved by dividing the total contribution by the number of turbines assuming they are all the same type and rating

Power Park Unit Contribution

100MW, 0.95 PF (± 32.8 MVar – 1 pu on PPM MVA base)
(ie S (MVA_{Base}) = 1.0pu = $\sqrt{P^2 + Q^2}$)

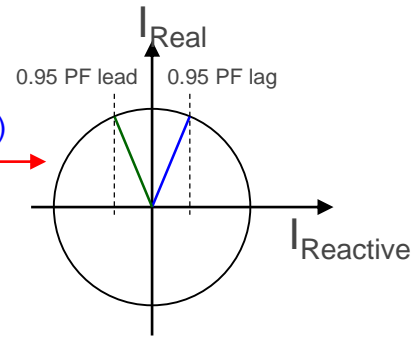

$$Q_{\text{WT}} = \sum Q_{\text{WTs}} - Q_{\text{RCP}}$$

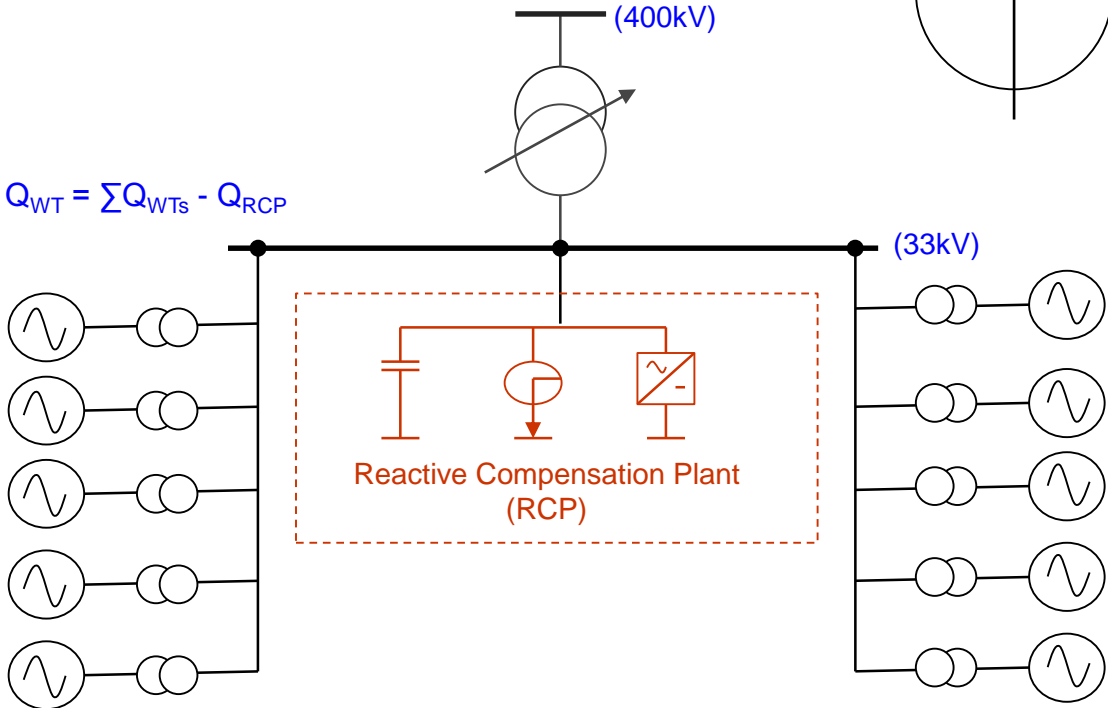

Other Issues

- As part of this work, it has been identified that there are differences between the characteristics of full converter based plant and DFIG Machines.
- The drafting has been amended to state “To permit additional flexibility for example from **Power Park Modules** made up of full converter machines, DFIG machines, induction generators or **HVDC Systems** or **Remote End HVDC Converters**, **The Company** will permit a relaxation to these requirements where there is a marginal or temporary fall in reactive current injection below the shaded area shown in Figures ECC.16.3.16(b) or ECC.16.3.16(c). Such agreement would be confirmed and agreed between **The Company** and **Generator**”.

Next Steps

- National Grid welcome comments on the revised text
- Stakeholders requested to review draft text and establish if it provides the clarity sought
- Does the mode change between 0.9pu – 0.5pu and below 0.5pu cause any issues?
- Examples will not be included in the Grid Code text but will be included in the Workgroup report and can be included in the Guidance Notes.
- Further issues / areas for improved text?
- Views on implementation timescales
- Process for proceeding to the next phase

Annex 2E – Workgroup Presentation February 2019

Fast Fault Current Injection GC0111

Antony Johnson
National Grid
January 2019



Summary

Current Status

Comments received following updated text in January 2019

Updated formulas and examples

Revised text additional flexibility / updates to recongise plant types

Examples – Power Park Modules

Other issues

Compliance

Next Steps

Current Status

- Following the last GC0111 meeting held on 6th December a number of additional comments were received which were added and the revised wording and legal drafting was issued early in the new year
- A number of comments have been received which include:-
 - Definition of $V_{\text{insensitivity}}$ / examples / compliance - Siemens
 - Clarification of $0.65 \times I_R$ and slope line – Drax Power
 - Active Current contribution - Senvion
 - Numerous comments from GE
 - To be discussed during the meeting
 - Additional comments from Senvion on GE's comments
 - Several comments received on the referencing to formula's and Iprefault – P2A Analysis

Additional Comments

- National Grid have number of additional comments which include:
- Concerns over the difference in reactive current injection between the pre-fault operation between full lead and full lag
- Concerns over the K factor
- Compliance issues
- Transition between the normal operating mode of operation and fault ride through

Reactive Current / Voltage Curve

FFCI Figure ECC.16.3.16(a)

NOT TO SCALE

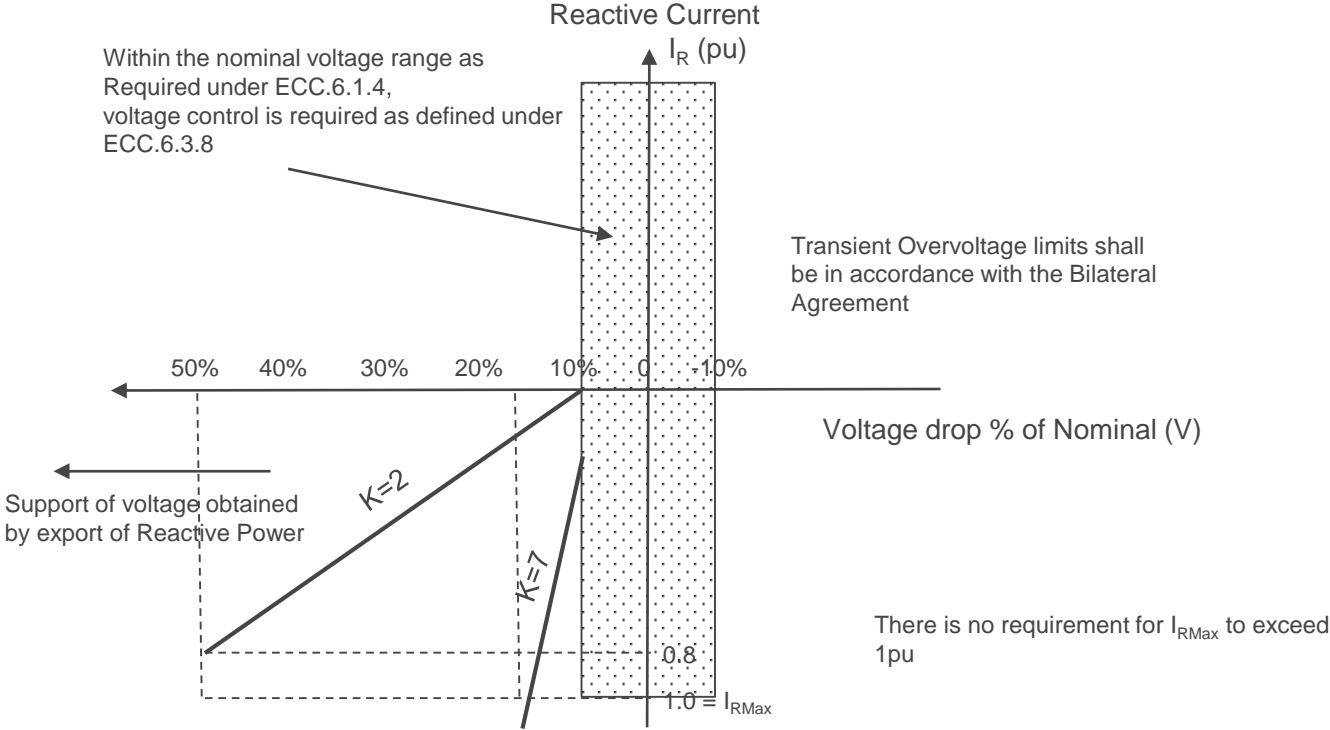

Reactive Current / Voltage curve – Parameters (1)

■ Where:-

■ V - Actual voltage at the Grid Entry Point or User System Entry Point during the fault

■ I_R - The reactive current supplied under fault conditions where:-

■
$$I_R = \Delta V_1 \cdot k + |I_{\text{Prefault}}| \quad \text{Equation (1)}$$

■ I_R The Reactive Current supplied under fault conditions shall be above the shape shown in Figure ECC.16.3.16(b) and Figure ECC.16.3.16(c) with the peak steady state reactive current defined by Equation (1) above. This value is capped at a maximum of 1.0pu.

■ There is no requirement for I_R to exceed 1.0pu ($I_{R\text{MAX}}$) but this would not preclude a Power Park Module (or any constituent Power Park Unit) or HVDC Equipment from supplying more should it wish to do so.

■ $|I_{\text{prefault}}|$ is the modulus of the pre-fault reactive current in per unit the pre-fault reactive current (I_{prefault}) for a future fault ride through event, shall be determined when the voltage has returned above the minimum levels specified in ECC.6.1.4,

■

Reactive Current / Voltage curve – Parameters (2)

$$\Delta V_1 = 0.9 - V_{\text{retained}}$$

~~V_{prefault} – Is the Prefault Positive Phase Sequence RMS voltage in per unit~~

~~$V_{\text{insensitivity}}$ – Is the difference in magnitude between the pre-fault voltage and the minimum continuous operating voltage as defined in ECC.6.1.4 (ie $V_{\text{prefault}} - 0.9$) – Default setting 0.1 unless otherwise agreed.~~

V_{retained} – Is the retained positive sequence voltage at the Grid Entry Point or User System Entry Point (under fault conditions)

k – Is the gain factor (range proposed 2 – 7) – Default setting 2.5

I_{RMAX} – The maximum current which shall, as a minimum, be above the shaded areas defined by Figures ECC.16.3.16(b) or ECC.16.3.16(c). There is no requirement for the maximum supplied current to exceed 1.0pu.

FFCI Figure ECC.16.3.16(b)

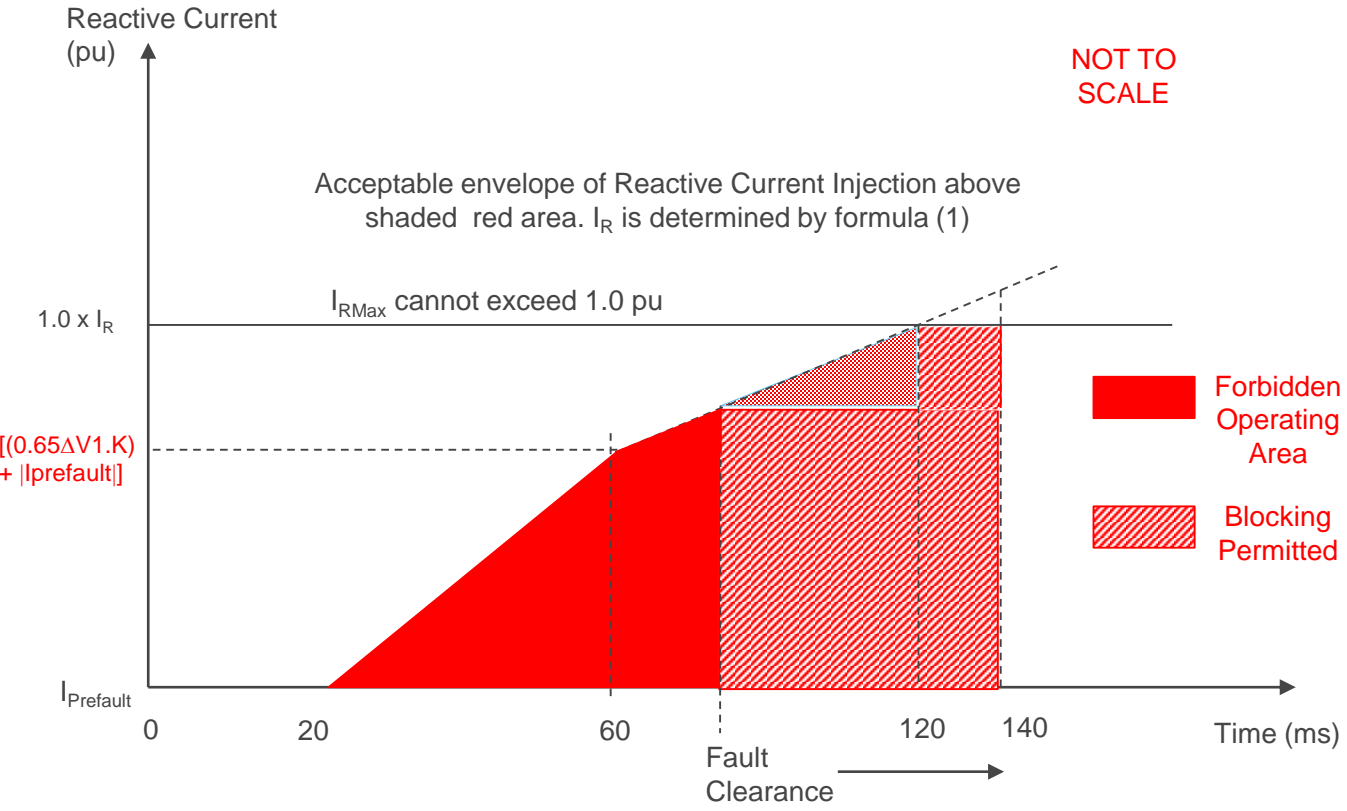

FFCI Figure ECC.16.3.16(c)

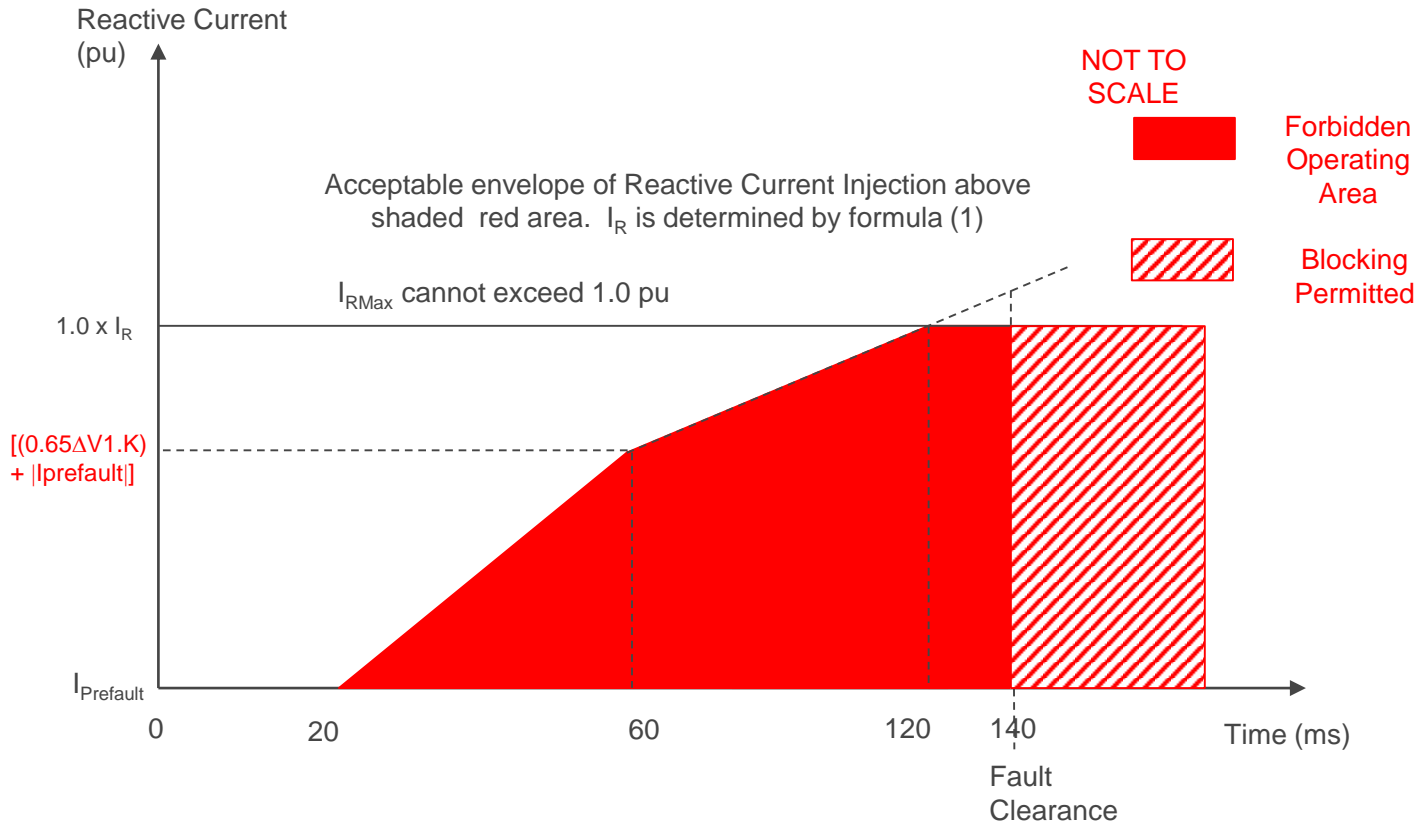

Active / Reactive Current Circle Diagram (FFCI Figure ECC.16.3.16(d))

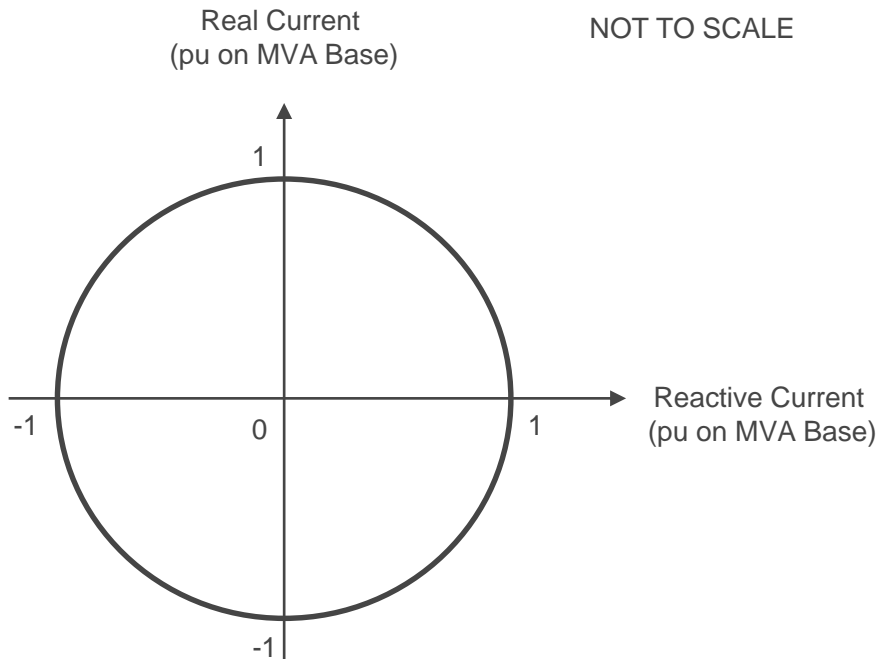

NOTE:- 1 pu current is the rated current of the Power Park Module or HVDC Equipment when operating at full MW output and full leading or Lagging MVA_r capability (eg for a 100MW Power Park Module Rated Current would be obtained when the Power Park Module is supplying 100MW and 0.95 Power Factor lead or 0.95 Power Factor lag at the Connection Point). **Note this is the rating of the converter. When I_R is less than 1.0 pu any residual reactive current should be supplied as Active Current**

Example – Pre Fault

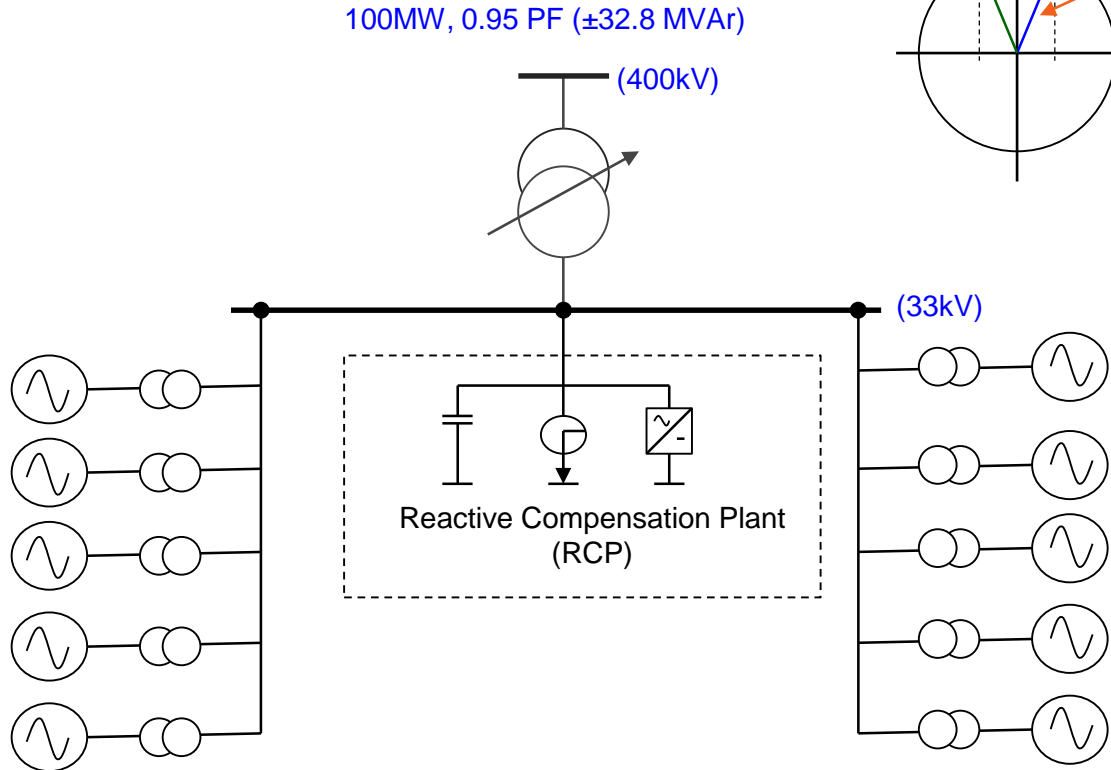

Steady State Voltage Control – Pre Fault

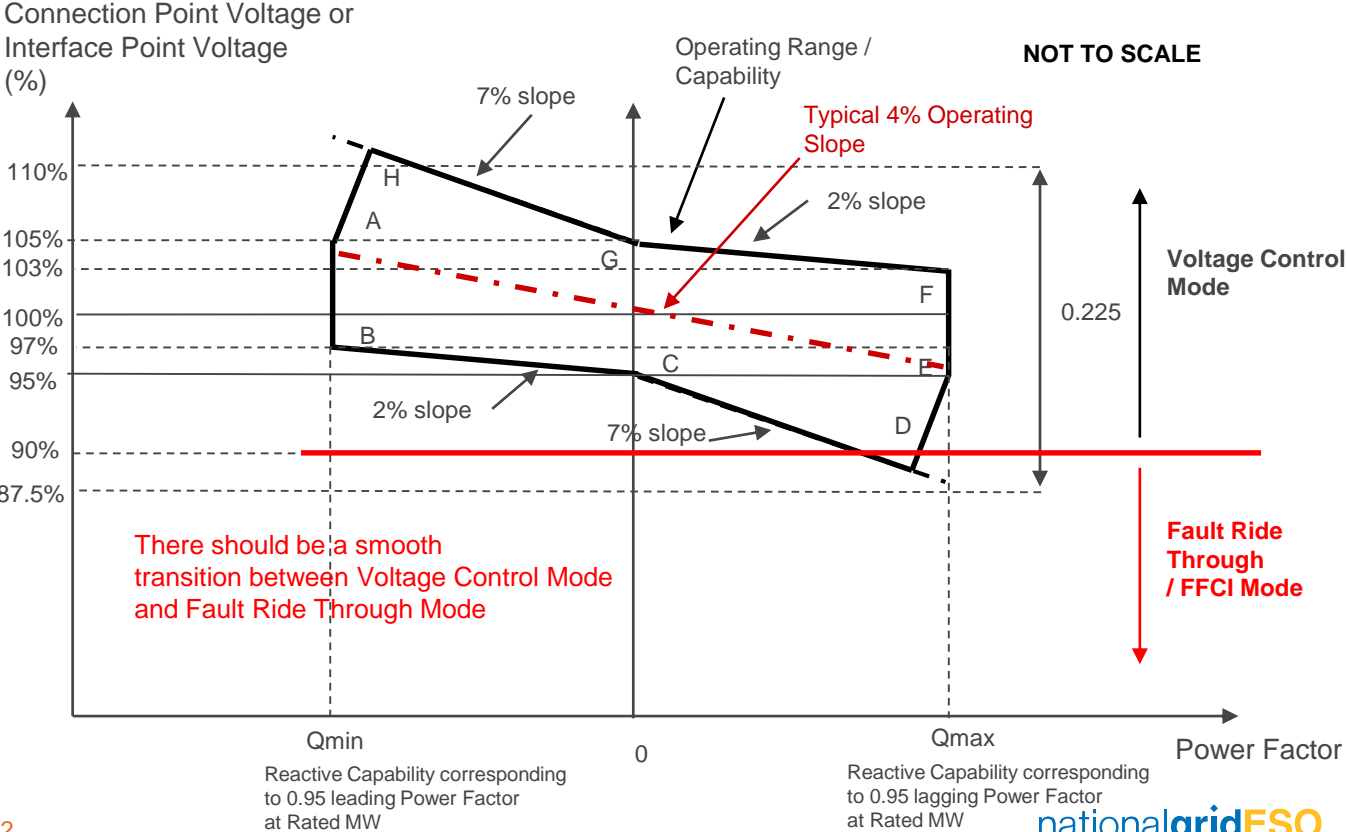

Voltage Control Testing – Slope (Pre Fault)

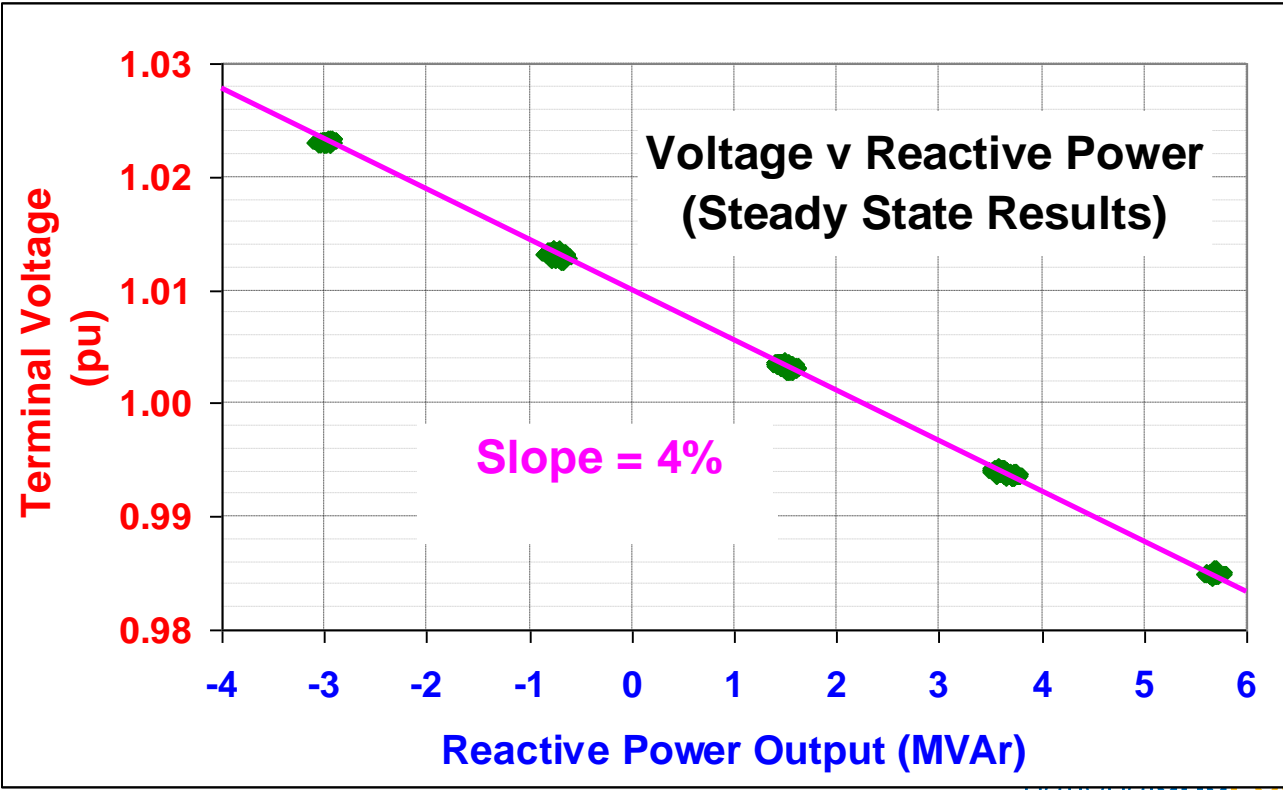

Voltage Control Testing – Pre fault

Step to voltage reference

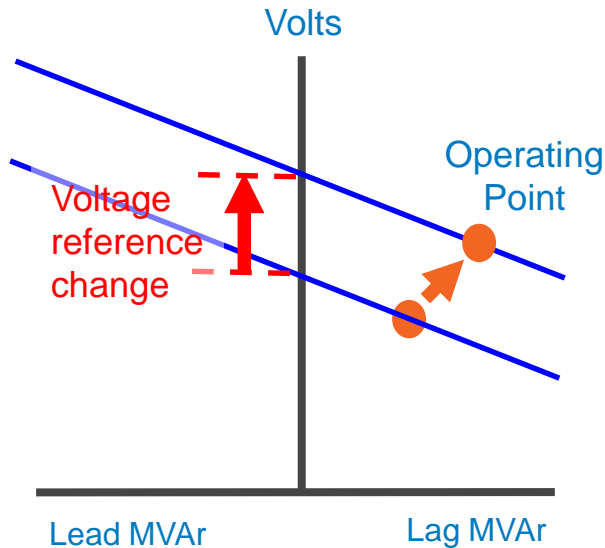

■ External Tap change

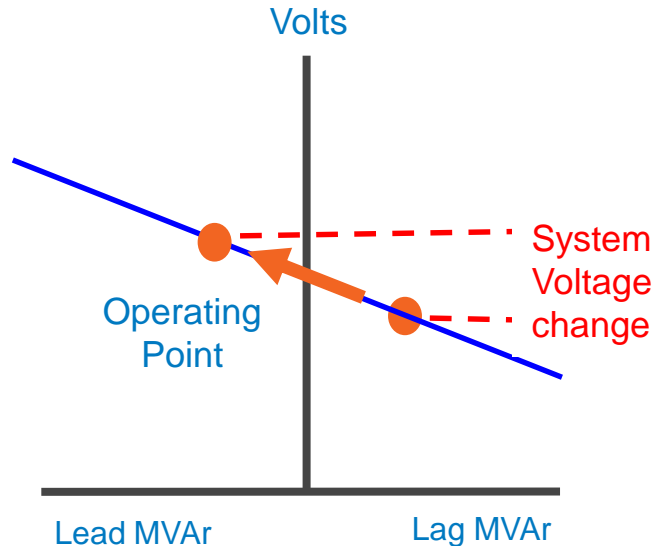

PPM Reactive Capability Requirements – Type C&D (ECC.6.3.2.4.4)

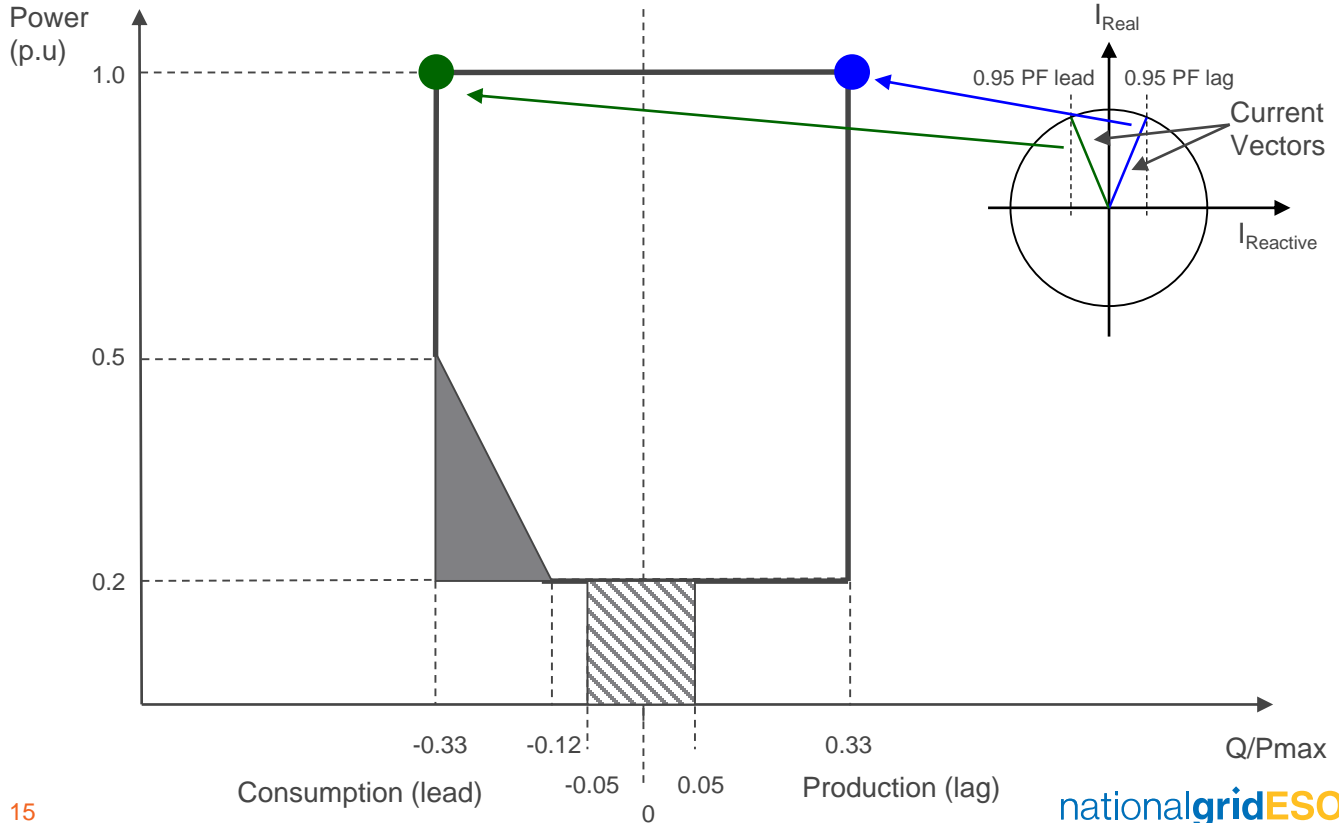

Why is Voltage Control Relevant for Fast Fault Current Injection (1)

- Fast fault current injection is dependent upon the pre fault voltage

- Recalling that

- I_R Reactive current supplied under fault conditions where:

- $$I_R = \Delta V_1 \cdot k + |I_{\text{prefault}}|$$

- and

$$\Delta V_1 = 0.9 - V_{\text{retained}}$$

Why is Voltage Control Relevant for Fast Fault Current Injection (2)

- In summary under pre-fault conditions with the Power Park Module operating at full leading conditions or full lagging conditions at Rated MW output it will be operating at rated current and therefore the additional current supplied will be limited under fault conditions.
- NOTE – With priority given to reactive current - under a voltage dip condition the vector will start to move along the locus resulting in an increase in the reactive current

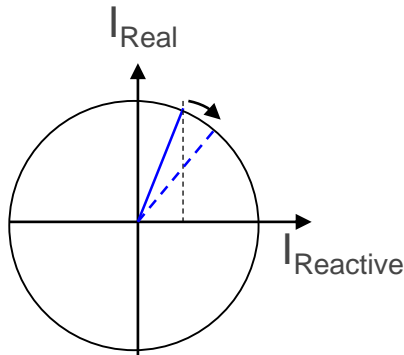

Example 1 – Power Park Module (Slide 10) operating at full MW output and full MVar lag – volt drop to 85% and K = 2.5

- Wind farm is operating at 100MW output and 0.95 PF lagging (ie 32.8MVar or export to the System)
- $I_R = \Delta V_1 \cdot k + |I_{\text{prefault}}|$
- And $\Delta V_1 = 0.9 - V_{\text{retained}}$
- If V Prefault = 0.96 pu and Q max = 0.95 PF lag on a 4% droop
- In this case the retained voltage (V_{retained}) is 0.85 pu
- $\Delta V_1 = 0.9 - V_{\text{retained}} = 0.9 - 0.85 = 0.05$
- $I_{\text{prefault}} = \sin(\arccos 0.95) = 0.312 \text{ pu}$
- $I_R = \Delta V_1 \cdot k + |I_{\text{prefault}}| = 0.05 \times 2.5 + 0.312 = 0.437 \text{ pu}$
- $I_R = (0.65 \Delta V_1 \cdot k) + |I_{\text{prefault}}| = (0.65 \times 0.05 \times 2.5) + 0.312 = 0.3933$

Example 1 - FFCI Figure ECC.16.3.16(b)

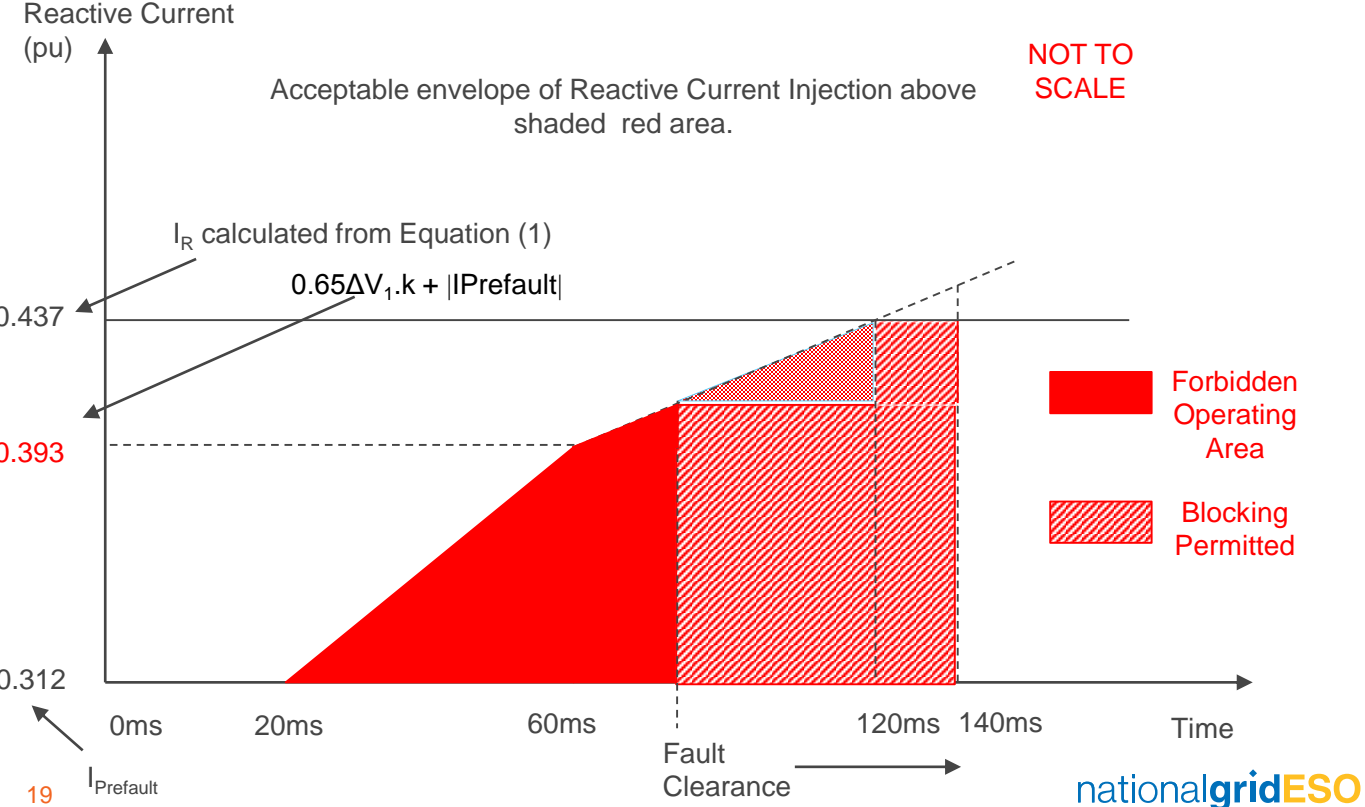

Example 1 - FFCI Figure ECC.16.3.16(c)

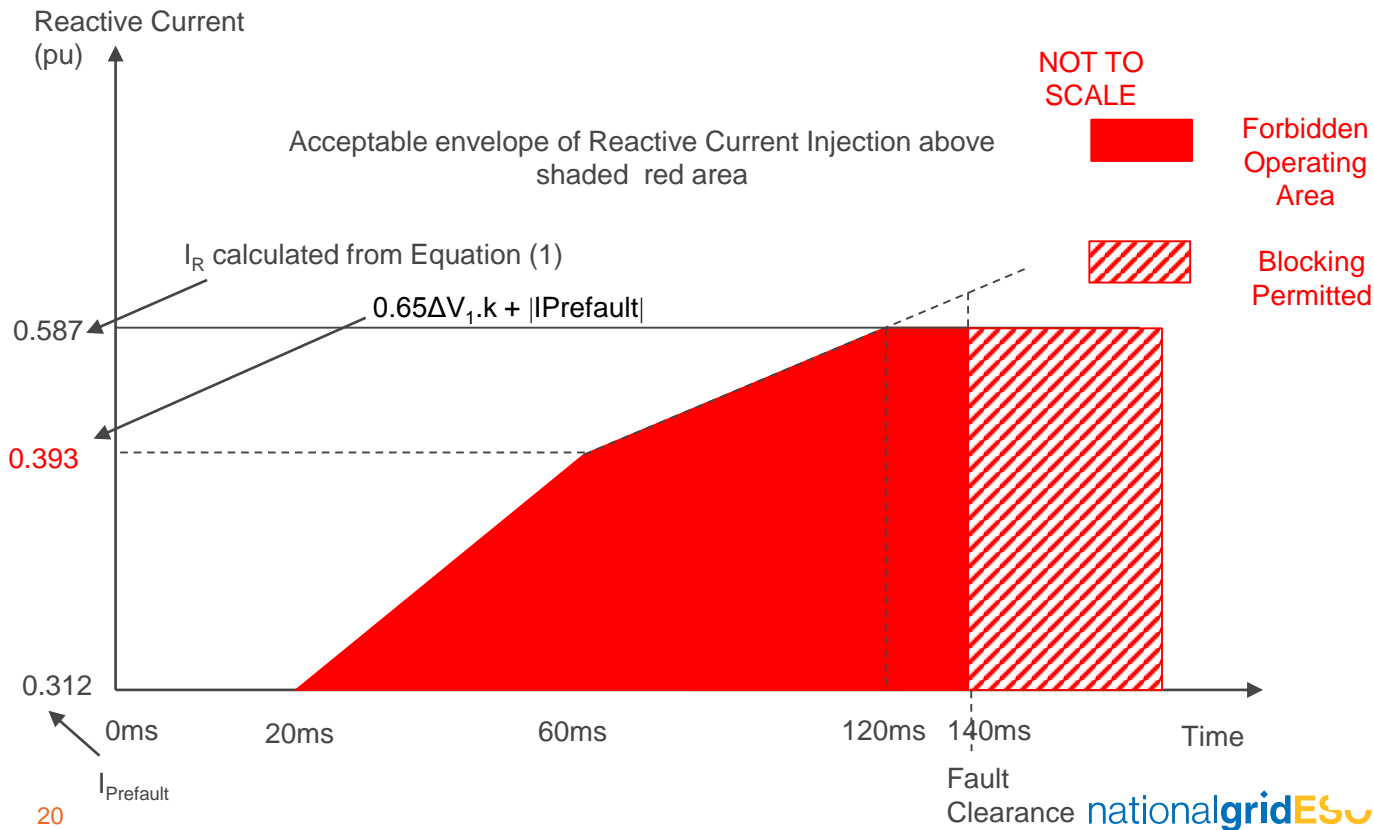

Example 3 – Power Park Module (Slide 11) operating at full MW output and full MVar output – volt drop to 50% and $K = 2.5$

- Wind farm is operating at 100MW output and 0.95 PF lagging (ie 32.8MVar or export to the System)
- $I_R = \Delta V_1 \cdot k + |I_{\text{Prefault}}|$
- And $\Delta V_1 = 0.9 - V_{\text{retained}}$
- If $V_{\text{Prefault}} = 0.96\text{p.u}$ and $Q_{\text{max}} = 0.95$ PF lag on a 4% droop
- In this case the retained voltage (V_{retained}) is 0.5 pu
- $\Delta V_1 = 0.9 - V_{\text{retained}} = 0.9 - 0.5 = 0.4$
- $I_{\text{prefault}} = \sin(\arccos 0.95) = 0.312\text{pu}$
- $I_R = \Delta V_1 \cdot k + |I_{\text{Prefault}}| = 0.4 \times 2.5 + 0.312 = 1.312\text{ pu}$ – capped at 1.0pu reactive current
- $I_R = (0.65\Delta V_1 \cdot k) + |I_{\text{prefault}}| = (0.65 \times 0.4 \times 2.5) + 0.312 = 0.962\text{ pu}$

Example 3 - FFCI Figure ECC.16.3.16(b)

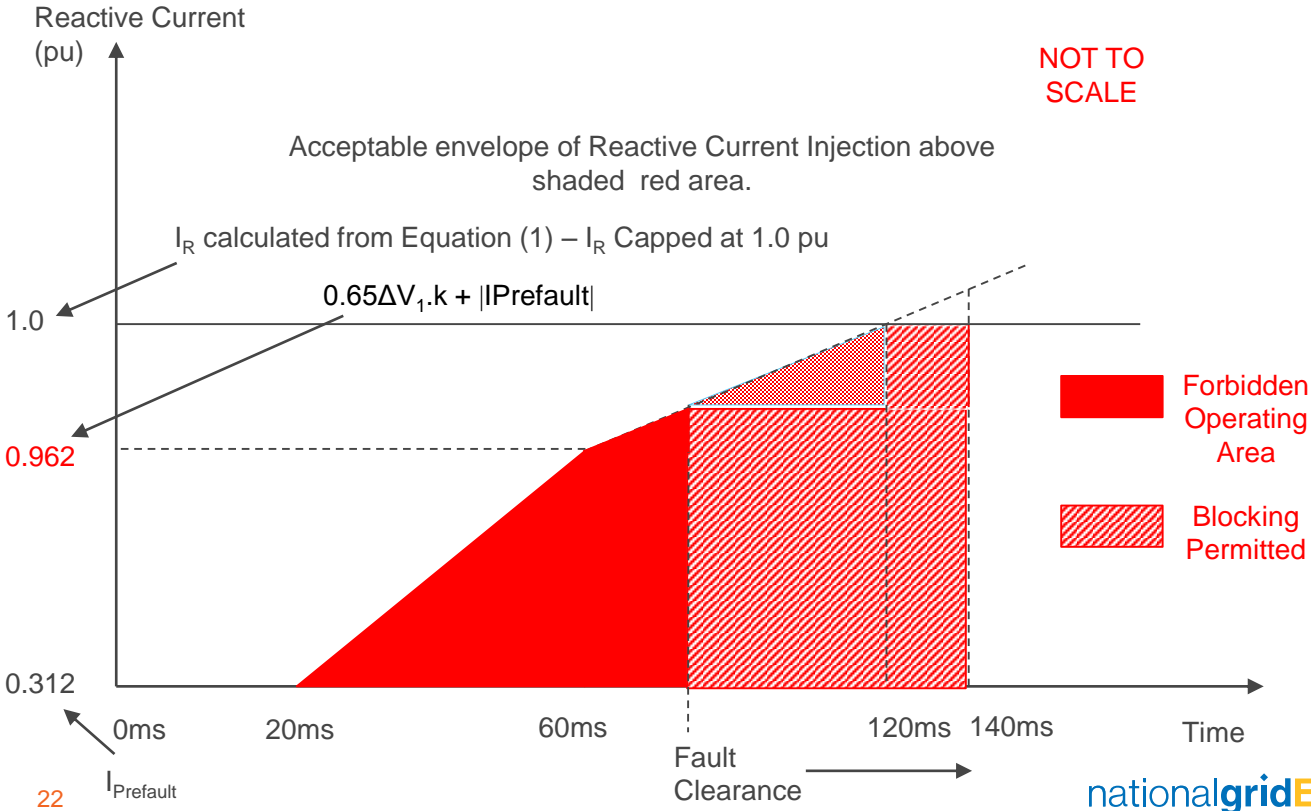

Example 3 - FFCI Figure ECC.16.3.16(c)

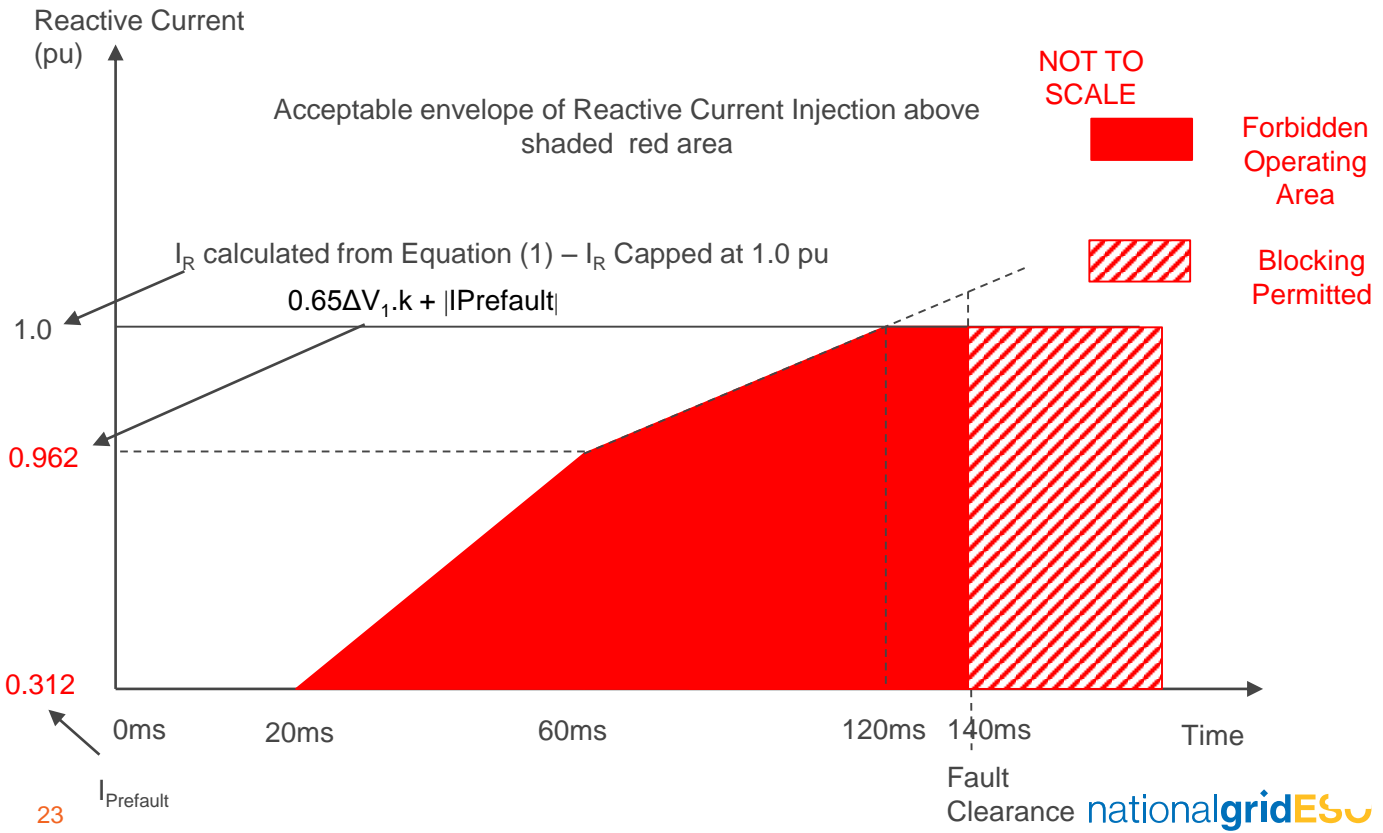

Example 6 – Power Park Module (Slide 11) operating at full MW output and Unity Power Factor – volt drop to 85% and $K = 2.5$

- Wind farm is operating at 100MW output and operating at unity power factor (ie 0 MVar export to the System)
- $I_R = \Delta V_1 \cdot k + |I_{\text{prefault}}|$
- And $\Delta V_1 = 0.9 - V_{\text{retained}}$
- If $V_{\text{Prefault}} = 1.0$ p.u and $Q = 0$ on a 4% droop with a target voltage setpoint of 1.0pu.
- In this case the retained voltage (V_{retained}) is 0.85 pu
- $\Delta V_1 = 0.9 - V_{\text{retained}} = 0.9 - 0.85 = 0.05$
- $I_{\text{prefault}} = \sin(\arccos 1) = 0$ pu
- $I_R = \Delta V_1 \cdot k + I_{\text{Prefault}} = 0.05 \times 2.5 + 0 = 0.125$ pu
- $I_R = (0.65 \Delta V_1 \cdot k) + |I_{\text{prefault}}| = (0.65 \times 0.05 \times 2.5) + 0 = 0.08125$

Example 7 – Power Park Module (Slide 11) operating at full MW output and Unity Power Factor – volt drop to 50% and $K = 2.5$

- Wind farm is operating at 100MW output and operating at unity power factor (ie 0 MVar export to the System)
- $I_R = \Delta V_1 \cdot k + |I_{\text{prefault}}|$
- And $\Delta V_1 = 0.9 - V_{\text{retained}}$
- If $V_{\text{Prefault}} = 1.0$ p.u and $Q = 0$ on a 4% droop with a target voltage setpoint of 1.0pu.
- In this case the retained voltage (V_{retained}) is 0.85 pu
- $\Delta V_1 = 0.9 - V_{\text{retained}} = 0.9 - 0.5 = 0.4$
- $I_{\text{prefault}} = \sin(\arccos 1) = 0$ pu
- $I_R = \Delta V_1 \cdot k + I_{\text{Prefault}} = 0.4 \times 2.5 + 0 = 1$ pu
- $I_R = (0.65 \Delta V_1 \cdot k) + |I_{\text{prefault}}| = (0.65 \times 0.4 \times 2.5) + 0 = 0.65$

Example 10 – Power Park Module (Slide 11) operating at full MW output and full MVAR output – volt drop to 85% and $K = 2.5$

- Wind farm is operating at 100MW output and 0.95 PF leading (ie - 32.8MVAR import to the System)
- $I_R = \Delta V_1 \cdot k + |I_{\text{Prefault}}|$
- And $\Delta V_1 = 0.9 - V_{\text{retained}}$
- If $V_{\text{Prefault}} = 1.04\text{p.u}$ and $Q_{\text{max}} = 0.95$ PF lead on a 4% droop
- In this case the retained voltage (V_{retained}) is 0.85 pu
- $\Delta V_1 = 0.9 - V_{\text{retained}} = 0.9 - 0.85 = 0.05$
- $I_{\text{prefault}} = \sin(\arccos-0.95) = -0.312\text{pu}$ (lead)
- $I_R = \Delta V_1 \cdot k + |I_{\text{Prefault}}| = 0.05 \times 2.5 + 0.312 = 0.437$
- $I_R = (0.65\Delta V_1 \cdot k) + |I_{\text{prefault}}| = (0.65 \times 0.05 \times 2.5) + 0.312 = 0.393$
- As per lagging case

Requirements from a Power Park Unit Perspective

- The requirements for FFCI are generally defined at the Connection Point of the Power Park Module although the legal text also specifies the requirement can be demonstrated at the Power Park Unit terminals if required.
- This can be achieved by starting with the Rating of the PPM at the Connection Point
- Subtract any external reactive power compensation equipment contribution (MVar) on the MVA base and calculate the wind turbine contribution. This could be achieved by dividing the total contribution by the number of turbines assuming they are all the same type and rating

Power Park Unit Contribution

100MW, 0.95 PF (± 32.8 MVar – 1 pu on PPM MVA base)
 (ie S (MVA_{Base}) = 1.0pu = $\sqrt{P^2 + Q^2}$)

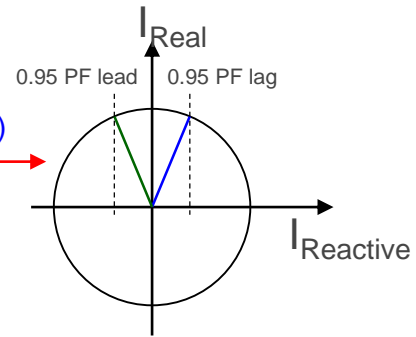

$$Q_{\text{WT}} = \sum Q_{\text{WTs}} - Q_{\text{RCP}}$$

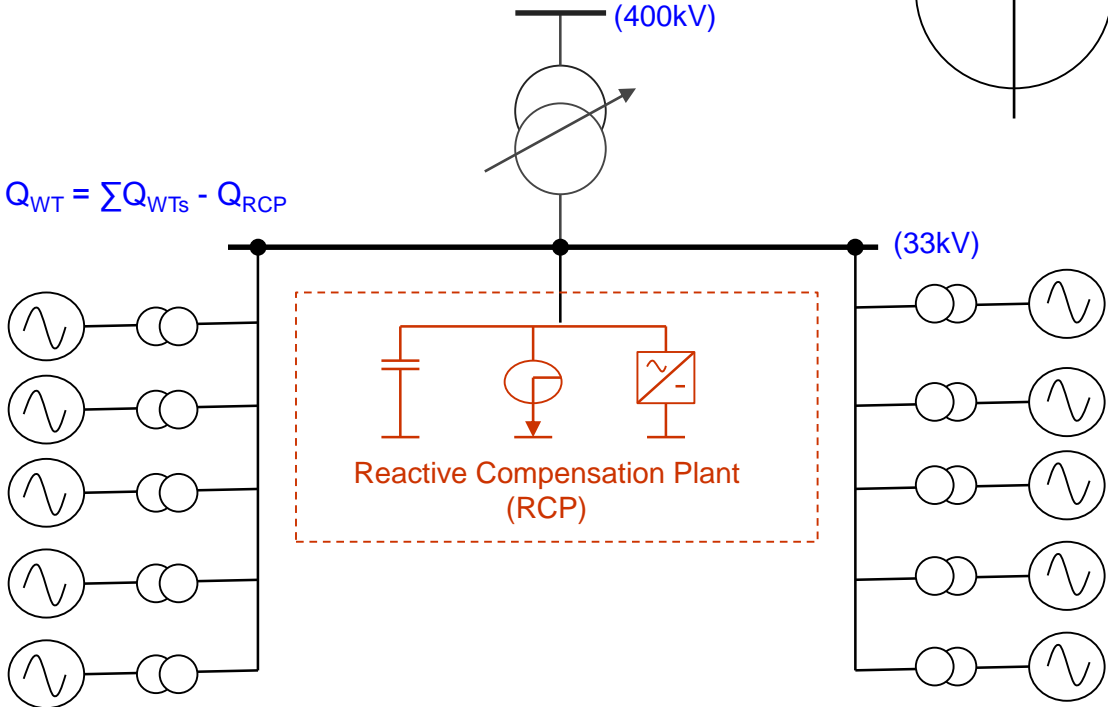

Other Issues

- As part of this work, it has been identified that there are differences between the characteristics of full converter based plant and DFIG Machines.
- The drafting has been amended to state “To permit additional flexibility for example from **Power Park Modules** made up of full converter machines, DFIG machines, induction generators or **HVDC Systems** or **Remote End HVDC Converters**, **The Company will permit transient deviations below the shaded area shown in Figure ECC.16.3.16(b) or ECC.16.3.16(c) but the total reactive current supplied during this period shall be at least that bound by the shaded area shown in Figure ECC.16.3.16(b) or ECC.16.3.16 (c).**”

Compliance

- Table A.3.5.1 – Typo from HVDC Implementation – should be 0% for HVDC Equipment
- Typo's – (i) / (ii) etc
- Type tested solutions – to be confirmed
- Queries on Fault Ride Through current injection testing

Next Steps

- National Grid welcome comments on the revised text but are very keen to finalise this solution.
- Stakeholders requested to identify if there are broadly comfortable or would wish to raise a workgroup alternative.
- Views on implementation
- Voting

Annex 3A – Grid Code Legal Text

GC0111 FAST FAULT CURRENT INJECTION DRAFT LEGAL TEXT
DATED 13 MARCH 2019
EXTRACTS FROM ECC'S

.....

ECC.6.3.15.9.2 Fault Ride Through requirements for Type C and Type D Synchronous Power Generating Modules and Type C and Type D Power Park Modules and OTSDUW Plant and Apparatus subject to faults and voltage disturbances on the Onshore Transmission System in excess of 140ms

ECC.6.3.15.9.2.1 The **Fault Ride Through** requirements for **Type C** and **Type D Synchronous Power Generating Modules** subject to faults and voltage disturbances on the Onshore Transmission System in excess of 140ms are defined in ECC.6.3.15.9.2.1(a) and the **Fault Ride Through Requirements** for **Power Park Modules** and **OTSDUW Plant and Apparatus** subject to faults and voltage disturbances on the Onshore Transmission System greater than 140ms in duration are defined in ECC.6.3.15.9.2.1(b).

- (a) Requirements applicable to **Synchronous Power Generating Modules** subject to **Supergrid Voltage** dips on the **Onshore Transmission System** greater than 140ms in duration.

In addition to the requirements of ECC.6.3.15.1 – ECC.6.3.15.8 each **Synchronous Power Generating Module** shall:

- (i) remain transiently stable and connected to the **System** without tripping of any **Synchronous Power Generating Module** for balanced **Supergrid Voltage** dips and associated durations on the **Onshore Transmission System** (which could be at the **Interface Point**) anywhere on or above the heavy black line shown in Figure ECC.6.3.15.9(a) Appendix 4 and Figures EA.4.3.2(a), (b) and (c) provide an explanation and illustrations of Figure ECC.6.3.15.9(a); and,

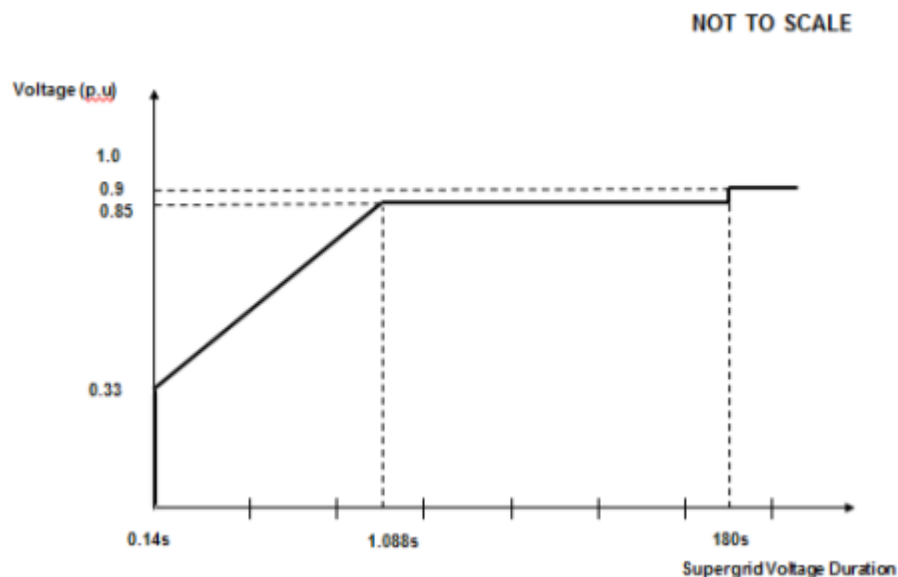

Figure ECC.6.3.15.9(a)

- (ii) provide **Active Power** output at the **Grid Entry Point**, during **Supergrid Voltage** dips on the **Onshore Transmission System** as described in Figure ECC.6.3.15.9(a), at least in proportion to the retained balanced voltage at the **Onshore Grid Entry Point** (for **Onshore Synchronous Power Generating Modules**) or **Interface Point** (for **Offshore Synchronous Power Generating Modules**) (or the retained balanced voltage at the **User System Entry Point** if **Embedded**) and shall generate maximum reactive current (where the voltage at the **Grid Entry Point** is outside the limits specified in ECC.6.1.4) without exceeding the transient rating limits of the **Synchronous Power Generating Module** and,
- (iii) restore **Active Power** output following **Supergrid Voltage** dips on the **Onshore Transmission System** as described in Figure ECC.6.3.15.9(a), within 1 second of

restoration of the voltage to 1.0pu of the nominal voltage at the:

Onshore Grid Entry Point for directly connected **Onshore Synchronous Power Generating Modules** or,

Interface Point for **Offshore Synchronous Power Generating Modules**
or,

User System Entry Point for **Embedded Onshore Synchronous Power Generating Modules**

or,

User System Entry Point for **Embedded Medium Power Stations** not subject to a **Bilateral Agreement** which comprise **Synchronous Generating Units** and with an **Onshore User System Entry Point** (irrespective of whether they are located **Onshore** or **Offshore**)

to at least 90% of the level available immediately before the occurrence of the dip. Once the **Active Power** output has been restored to the required level, **Active Power** oscillations shall be acceptable provided that:

- the total **Active Energy** delivered during the period of the oscillations is at least that which would have been delivered if the **Active Power** was constant
- the oscillations are adequately damped.

For the avoidance of doubt a balanced **Onshore Transmission System Supergrid Voltage** meets the requirements of ECC.6.1.5 (b) and ECC.6.1.6.

- (b) Requirements applicable to **Type C** and **Type D Power Park Modules** and **OTSDUW Plant and Apparatus** (excluding **OTSDUW DC Converters**) subject to **Supergrid Voltage** dips on the **Onshore Transmission System** greater than 140ms in duration.

In addition to the requirements of ECC.6.3.15.5, ECC.6.3.15.6 and ECC.6.3.15.8 (as applicable) each **OTSDUW Plant and Apparatus** or each **Power Park Module** and / or any constituent **Power Park Unit**, shall:

- (i) remain transiently stable and connected to the **System** without tripping of any **OTSDUW Plant and Apparatus**, or **Power Park Module** and / or any constituent **Power Park Unit**, for balanced **Supergrid Voltage** dips and associated durations on the **Onshore Transmission System** (which could be at the **Interface Point**) anywhere on or above the heavy black line shown in Figure ECC.6.3.15.9(b). Appendix 4 and Figures EA.4.3.4 (a), (b) and (c) provide an explanation and illustrations of Figure ECC.6.3.15.9(b) ; and,

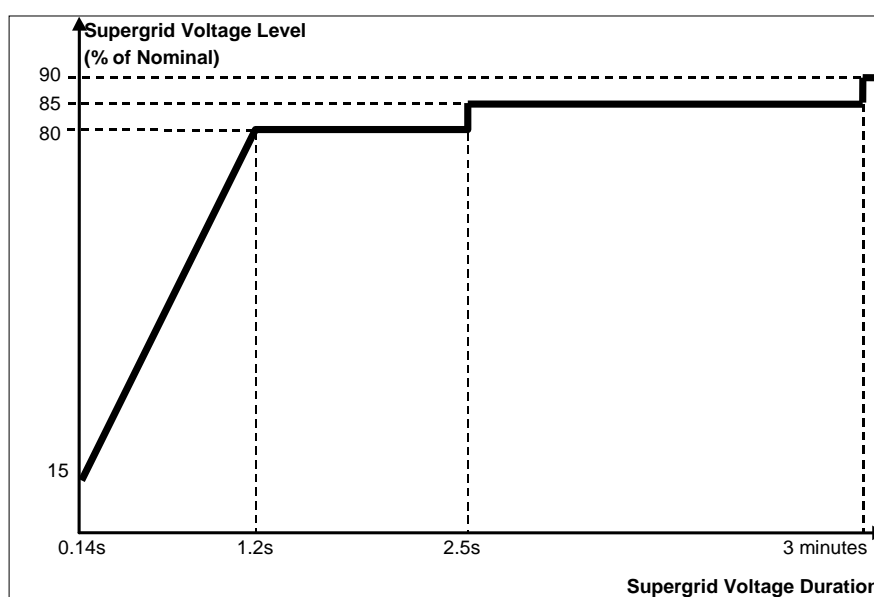

Figure ECC.6.3.15.9(b)

- (ii) ~~be required to satisfy the requirements of ECC.6.3.16. provide Active Power output at the Grid Entry Point or in the case of an OTSDUW, Active Power transfer~~

~~capability at the **Transmission Interface Point**, during **Supergrid Voltage** dips on the **Onshore Transmission System** as described in Figure ECC.6.3.15.9(b), at least in proportion to the retained balanced voltage at the **Onshore Grid Entry Point** (for **Onshore Power Park Modules**) or **Interface Point** (for **OTSDUW Plant and Apparatus** and **Offshore Power Park Modules**) (or the retained balanced voltage at the **User System Entry Point** if **Embedded**) except in the case of a **Non-Synchronous Generating Unit** or **OTSDUW Plant and Apparatus** or **Power Park Module** where there has been a reduction in the **Intermittent Power Source** or in the case of **OTSDUW Active Power** transfer capability in the time range in Figure ECC.6.3.15.9(b) an allowance shall be made for the fall in input power and the corresponding reduction of real and reactive current that restricts the **Active Power** output or in the case of an **OTSDUW Active Power** transfer capability below this level.~~

- (iii) restore **Active Power** output (or, in the case of **OTSDUW, Active Power** transfer capability), following **Supergrid Voltage** dips on the **Onshore Transmission System** as described in Figure ECC.6.3.15.9(b), within 1 second of restoration of the voltage to 0.9 pu of the nominal voltage at the:

Onshore Grid Entry Point for directly connected **Onshore Power Park Modules** or,

Interface Point for **OTSDUW Plant and Apparatus** and **Offshore Power Park Modules** or,

User System Entry Point for **Embedded Onshore Power Park Modules** or ,

User System Entry Point for **Embedded Medium Power Stations** which comprise **Power Park Modules** not subject to a **Bilateral Agreement** and with an **Onshore User System Entry Point** (irrespective of whether they are located **Onshore** or **Offshore**)

~~to the minimum levels specified in ECC.6.1.4~~ to at least 90% of the level available immediately before the occurrence of the dip except in the case of a **Non-Synchronous Generating Unit, OTSDUW Plant and Apparatus** or **Power Park Module** where there has been a reduction in the **Intermittent Power Source** in the time range in Figure ECC.6.3.15.9(b) that restricts the **Active Power** output or, in the case of **OTSDUW, Active Power** transfer capability below this level. Once the **Active Power** output or, in the case of **OTSDUW, Active Power** transfer capability has been restored to the required level, **Active Power** oscillations shall be acceptable provided that:

- the total **Active Energy** delivered during the period of the oscillations is at least that which would have been delivered if the **Active Power** was constant
- the oscillations are adequately damped.

For the avoidance of doubt a balanced **Onshore Transmission System Supergrid Voltage** meets the requirements of ECC.6.1.5 (b) and ECC.6.1.6.

.....

ECC.6.3.16 FAST FAULT CURRENT INJECTION

ECC.6.3.16.1 General Fast Fault Current injection, principles and concepts applicable to Type B, Type C and Type D Power Park Modules and HVDC Equipment

ECC.6.3.16.1.1 In addition to the requirements of ECC.6.1.4, ECC.6.3.2, ECC.6.3.8 and ECC.A.7, each **Type B, Type C** and **Type D Power Park Module** or each **Power Park Unit** within a **Type B, Type C** and **Type D Power Park Module** or **HVDC Equipment** shall be required to satisfy the following requirements. For the purposes of this requirement, current and voltage are assumed to be positive phase sequence values.

ECC.6.3.16.1.2

For any balanced ~~or unbalanced~~ fault which results in the positive phase sequence -voltage falling below the voltage levels specified in ECC.6.1.4 phase voltage on one or more phases falling outside the limits specified in ECC.6.1.2 at the **Grid Entry Point** or **User System Entry Point (if Embedded)**, each **Type B, Type C and Type D Power Park Module** or each Power Park Unit within a Type B, Type C and Type D Power Park Module or HVDC Equipment shall, as a minimum (unless an alternative type registered solution has unless otherwise been agreed with The Company), be required to inject a reactive current above the ~~heavy black line shaded area~~ shown in Figure ECC.16.3.16(a) and Figure 16.3.16(b). For the purposes of this requirement, the maximum rated current is taken to be the maximum current each Power Park Module (or constituent **Power Park Unit**) or **HVDC Converter** is capable of supplying when operating at rated **Active Power** and rated **Reactive Power** (as required under ECC.6.3.2) at a nominal voltage of 1.0pu. For example, in the case of a 100MW **Power Park Module** the **Rated Active Power** would be taken as 100MW and the rated **Reactive Power** would be taken as 32.8MVARs (ie **Rated MW** output operating at 0.95 **Power Factor** lead or 0.95 **Power Factor** lag as required under ECC.6.3.2.4). For the avoidance of doubt, where the phase voltage at the **Grid Entry Point** or **User System Entry Point** is not zero, the reactive current injected shall be in proportion to the retained voltage at the **Grid Entry Point** or **User System Entry Point** but shall still be required to remain above the shaded area in Figure 16.3.16(a) and Figure 16.3.16(b).

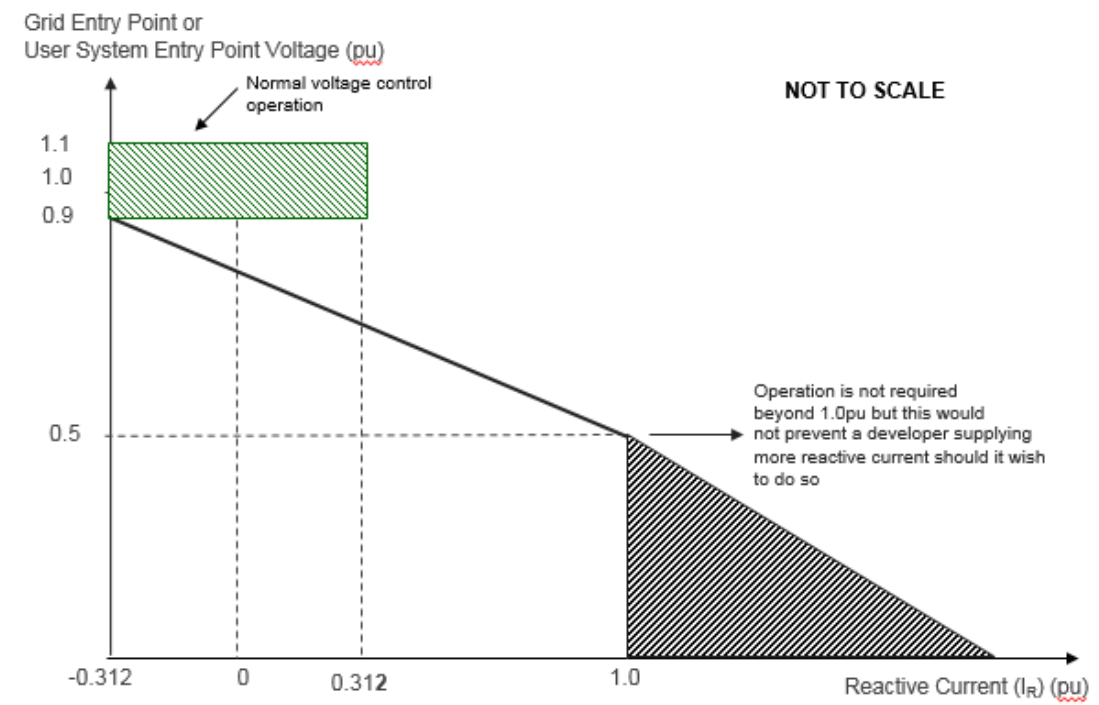

Figure ECC.6.3.16(a)

ECC.6.3.16.1.3 Figure ECC.6.3.16(a) defines the reactive current (I_R) to be supplied under a faulted condition which shall be dependent upon the pre-fault operating condition and the retained voltage at the **Grid Entry Point** or **User System Entry Point** voltage. For the avoidance of doubt, each **Power Park Module** (and any constituent element thereof) or **HVDC Equipment**, shall be required to inject a reactive current (I_R) which shall be not less than its pre-fault reactive current and which shall as a minimum increase with the fall in the retained voltage each time the retained-voltage at the **Grid Entry Point** or **User System Entry Point (if Embedded)** falls below 0.9pu whilst ensuring the overall rating of the **Power Park Module** (or constituent element thereof) or **HVDC Equipment** shall not be exceeded.

ECC.6.3.16.1.4 In addition to the requirements of ECC.6.3.16.1.2 and ECC.6.3.16.1.3, each **Type B, Type C and Type D Power Park Module** or each **Power Park Unit** within a **Type B, Type C and Type D Power Park Module** or **HVDC Equipment** shall be required to inject reactive current above the shaded area shown in Figure ECC.6.3.16(b) and Figure ECC.6.3.16(c) which illustrates how the reactive current shall be injected over time from fault inception in which the value of I_R is determined from Figure ECC.6.3.16(a). In figures ECC.6.3.16(b) and ECC.6.3.16(c) ΔI_R is the value of the reactive current (I_R) less the pre-fault current. In this context fault inception is taken to be when the voltage at the **Grid Entry Point** or **User System Entry Point** falls below 0.9pu.

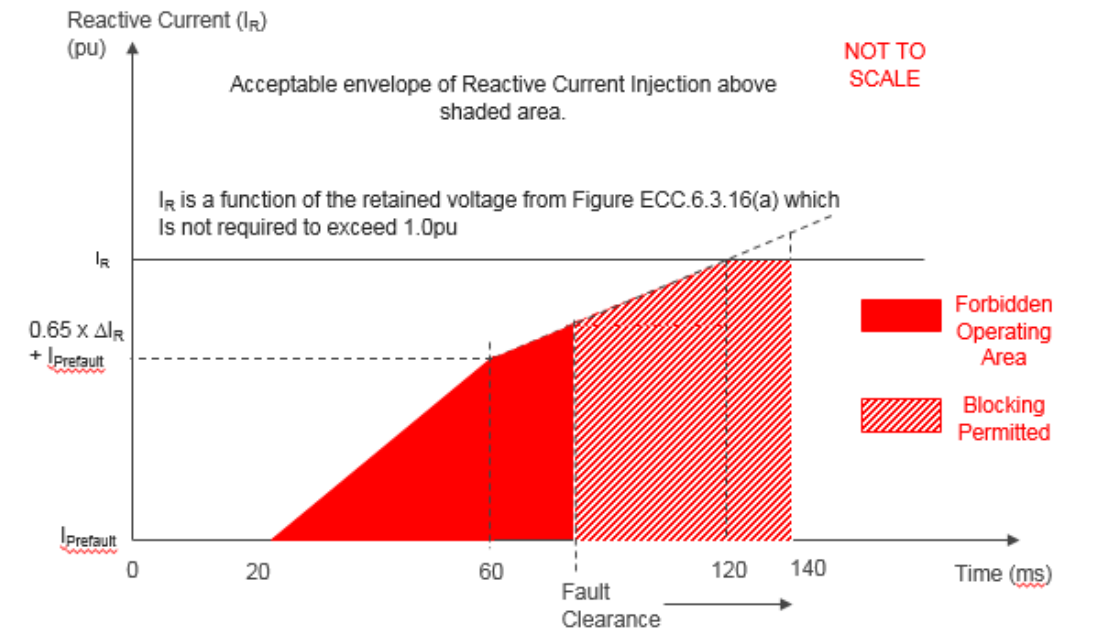

Figure ECC.6.3.16(b)

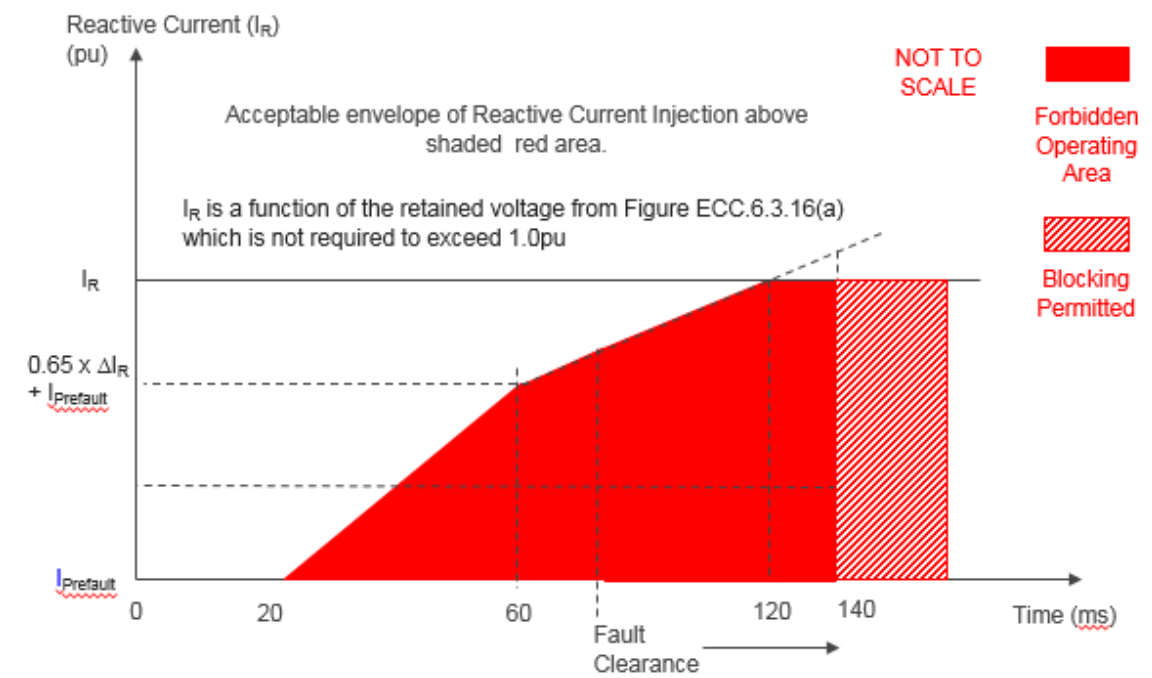

Figure ECC.6.3.16(c)

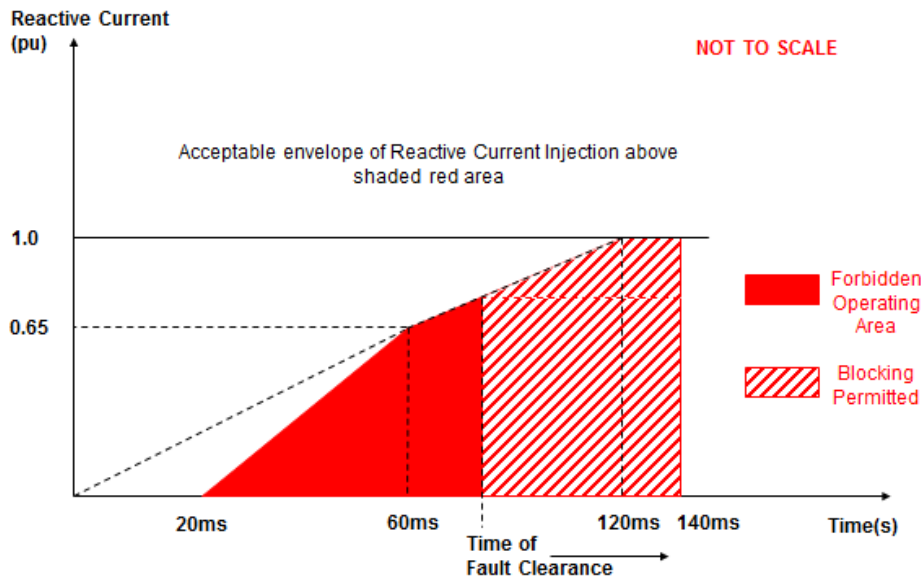

Figure ECC.16.3.16(a)

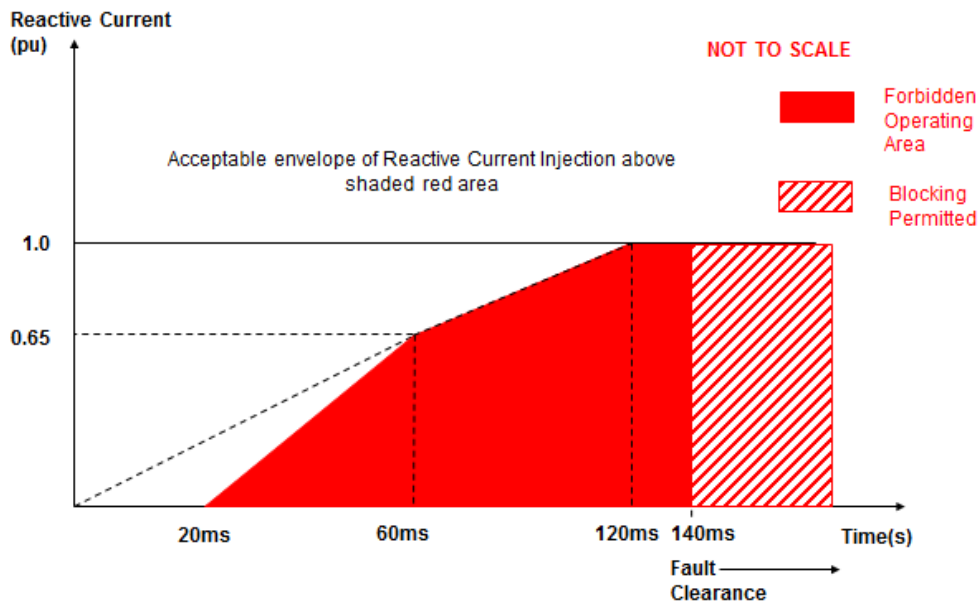

Figure ECC.16.3.16(b)

ECC.6.3.16.1.5 The injected reactive current (I_R) shall be above the shaded area shown in Figure ECC.6.3.16(b) and Figure ECC.6.3.16(c) with priority being given to reactive current injection with any residual capability being supplied as active current. Under any faulted condition, where the voltage falls outside the limits specified in ECC.6.1.4, there would be no requirement for each **Power Park Module** or constituent **Power Park Unit** or **HVDC Equipment** to exceed its transient or steady state rating of 1.0pu as defined in ECC.6.3.16.1.7.

ECC.6.3.16.1.6 For any planned or switching events (as outlined in ECC.6.1.7 of the Grid Code) or unplanned events which results in temporary power frequency overvoltages (TOV's), each **Type B, Type C and Type D Power Generating Module** or each **Power Park Unit** within a **Type B, Type C or Type D Power Park Module** or **HVDC Equipment** will be required to satisfy the transient overvoltage limits specified in the **Bilateral Agreement**.

ECC.6.3.16.1.7 For the purposes of this requirement, the maximum rated current is taken to be the maximum current each **Power Park Module** (or the sum of the constituent **Power Park Units** which are connected to the **System** at the **Grid Entry Point** or **User System Entry Point**) or **HVDC Converter** is capable of supplying. In the case of a **Power Park Module** this would be the maximum rated current at the **Grid Entry Point** (or **User System Entry Point** if **Embedded**) when the **Power Park Module** is operating at rated **Active Power** and rated **Reactive Power** (as required under ECC.6.3.2) whilst operating over the nominal voltage range as required under ECC.6.1.4 at the **Grid Entry Point** (or **User System Entry Point** if **Embedded**). In the case of a **Power Park Unit** forming part of a **Type B, Type C** and **Type D Power Park Module**, the maximum rated current expected would be the maximum current supplied from each constituent **Power Park Unit** when the **Power Park Module** is operating at rated **Active Power** and rated **Reactive Power** over the nominal voltage operating range as defined in ECC.6.1.4 less the contribution from the reactive compensation equipment.

For example, in the case of a 100MW **Power Park Module** (consisting of 50 x 2MW Power Park Units and +10MVar reactive compensation equipment) the **Rated Active Power** at the **Grid Entry Point** (or **User System Entry Point** if **Embedded**) would be taken as 100MW and the rated **Reactive Power** at the **Grid Entry Point** or (**User System Entry Point** if **Embedded**) would be taken as 32.8MVars (ie **Rated MW** output operating at 0.95 **Power Factor** lead or 0.95 **Power Factor** lag as required under ECC.6.3.2.4). In this example, the maximum rating of each constituent **Power Park Unit** is obtained when the **Power Park Module** is operating at 100MW, and +32.8MVar less 10MVar equal to 22.8MVar or – 32.8MVar (less the reactive compensation equipment component of 10MVar (ie -22.8MVar) when operating within the normal voltage operating range as defined under ECC.6.1.4 (allowing for any reactive compensation equipment or losses in the **Power Park Module** array network).

For the avoidance of doubt, the total current of 1.0pu would be assumed to be on the MVA rating of the **Power Park Module** or **HVDC Equipment** (less losses). Under all normal and abnormal conditions, the steady state or transient rating of the **Power Park Module** (or any constituent element including the **Power Park Units**) or **HVDC Equipment**, would not be required to exceed the locus shown in Figure 16.3.16(d).

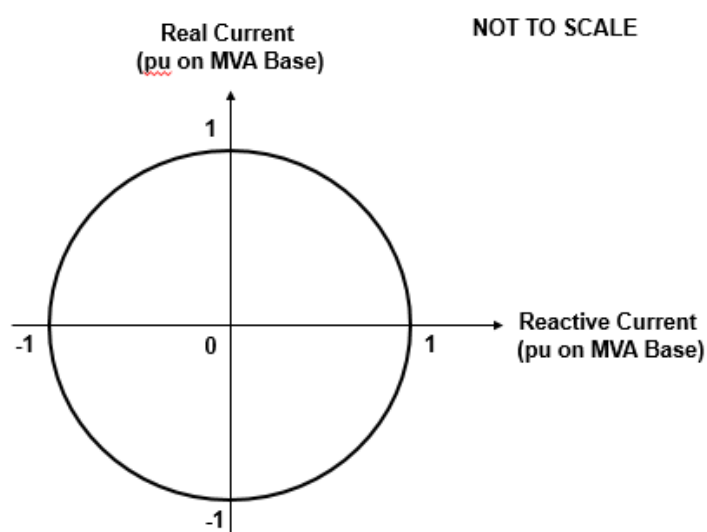

Figure ECC.16.3.16(d)

~~ECC.6.3.16.1.7~~ Each **Type B, Type C and Type D Power Park Module** or **HVDC Equipment** shall be designed to ensure a smooth transition between voltage control mode and fault ride through mode in order to prevent the risk of instability which could arise in the transition between the steady state voltage operating range as defined under ECC.6.1.4 and abnormal conditions where the retained voltage falls below 90% of nominal voltage. Such a requirement is necessary to ensure adequate performance between the pre-fault operating condition of the **Power Park Module** or **HVDC Equipment** and its subsequent behaviour under faulted conditions. **EU Generators** and **HVDC System Owners** are required to both advise and agree with **The Company** the control strategy employed to mitigate the risk of such instability.

~~ECC.6.3.16.1.8~~ —Each **Type B, Type C and Type D Power Park Module** or **HVDC Equipment** shall be designed to reduce the risk of transient over voltage levels arising following clearance of the fault and in order to mitigate the risk of any form of instability which could result. **EU Generators** or **HVDC System Owners** shall be permitted to block or employ other means where the anticipated transient overvoltage would otherwise exceed the maximum permitted values specified in ECC.6.1.7. Figure ECC.16.3.16(b) and Figure ECC.16.3.16(c) shows the impact of variations in fault clearance time. For main protection operating times this would not exceed 140ms. The requirements for the maximum transient overvoltage withstand capability and associated time duration, shall be agreed between the **EU Code User** and **The Company** as part of the **Bilateral Agreement**. Where the **EU Code User** is able to demonstrate to **The Company** that blocking or other control strategies are required in order to prevent the risk of transient over voltage excursions as specified in ECC.6.3.16.1.5, **EU Generators** and **HVDC System Owners** are required to both advise and agree with **The Company** the control strategy, which must also include the approach taken to de-blocking

~~ECC.6.3.16.1.3~~ —The converter(s) of each **Type B, Type C and Type D Power Park Module** or **HVDC Equipment** is permitted to block upon fault clearance in order to mitigate against the risk of instability that would otherwise occur due to transient overvoltage excursions. Figure ECC.16.3.16(a) and Figure ECC.16.3.16(b) shows the impact of variations in fault clearance time which shall be no greater than 140ms. The requirements for the maximum transient overvoltage withstand capability and associated time duration, shall be agreed between the **EU Code User** and **The Company** as part of the **Bilateral Agreement**. Where the **EU Code User** is able to demonstrate to **The Company** that blocking is required in order to prevent the risk of transient over voltage excursions as specified in ECC.6.3.16.1.5, **EU Generators** and **HVDC System Owners** are required to both advise and agree with **The Company** of the control strategy, which must also include the approach taken to de-blocking. Notwithstanding this requirement, **EU Generators** and **HVDC System Owners** should be aware of their requirement to fully satisfy the fault ride through requirements specified in ECC.6.3.15.

~~ECC.6.3.16.1.4~~ In addition, the reactive current injected from each **Power Park Module** or **HVDC Equipment** shall be injected in proportion and remain in phase to the change in **System** voltage at the **Connection Point** or **User System Entry Point** during the period of the fault. For the avoidance of doubt, a small delay time of no greater than 20ms from the point of fault inception is permitted before injection of the in phase reactive current.

~~ECC.6.3.16.1.5~~ Each **Type B, Type C and Type D Power Park Module** or **HVDC Equipment** shall be designed to reduce the risk of transient over voltage levels arising following clearance of the fault. **EU Generators** or **HVDC System Owners** shall be permitted to block where the anticipated transient overvoltage would otherwise exceed the maximum permitted values specified in ECC.6.1.7. Any additional requirements relating to transient overvoltage performance will be specified by **The Company**.

~~ECC.6.3.16.1.96~~ In addition to the requirements of ECC.6.3.15, **Generators** in respect of **Type B, Type C and Type D Power Park Modules** or each Power Park Unit within a Type B, Type C and Type D Power Park Module or DC Connected Power Park Modules and **HVDC System Owners** in respect of HVDC Systems are required to confirm to **The Company**, their repeated ability to supply **Fast Fault Current** to the **System** each time the voltage at the **Grid Entry Point** or **User System Entry Point** falls outside the limits specified in ECC.6.1.4. **EU Generators** and **HVDC Equipment Owners** should inform **The Company** of the maximum number of repeated operations that can be performed under such conditions and any limiting factors to repeated operation such as protection or thermal rating ~~;~~ ~~and~~

~~ECC.6.3.16.1.10~~ To permit additional flexibility for example from Power Park Modules made up of full converter machines, DFIG machines, induction generators or HVDC Systems or Remote End HVDC Converters, The Company will permit transient or marginal deviations below the shaded area shown in Figures ECC.16.3.16(b) or ECC.16.3.16(c) provided the injected reactive current supplied exceeds the area bound in Figure ECC.6.3.16(b) or ECC.6.3.16(c). Such agreement would be confirmed and agreed between The Company and Generator.

~~ECC.6.3.16.1.711~~ In the case of a **Power Park Module** or **DC Connected Power Park Module**, where it is not practical to demonstrate the compliance requirements of ECC.6.3.16.1.1 to ECC.6.3.16.1.6 at the **Grid Entry Point** or **User System Entry Point**, **The Company** will accept compliance of the above requirements at the **Power Park Unit** terminals.

~~ECC.6.3.16.1.12~~ For the avoidance of doubt, Generators in respect of Type C and Type D Power Park Modules and OTSDUW Plant and Apparatus are also required to satisfy the requirements of ECC.6.3.15.9.2.1(b) which specifies the requirements for fault ride through for voltage dips in excess of 140ms.

~~ECC.6.3.16.1.1328~~ Several examples of how the above requirements are to be interpreted are An illustration and examples of the performance requirements expected are illustrated in Appendix 4EC.

~~ECC.6.3.16.1.134~~ In the case of an unbalanced fault, each Type B, Type C and Type D Power Park Module or each Power Park Unit within a Type B, Type C and Type D Power Park Module or HVDC Equipment shall be required to inject reactive current (I_R) which shall as a minimum increase with the fall in the retained unbalanced voltage up to its maximum reactive current without exceeding the transient rating of the Power Park Module (or constituent element thereof) or HVDC Equipment.

~~ECC.6.3.16.1.145~~ In the case of an unbalanced fault, the Generator or HVDC System Owner shall confirm to The Company their ability to prevent transient overvoltages arising on the remaining healthy phases and the control strategy employed.

.....

APPENDIX 4EC – FAST FAULT CURRENT INJECTION REQUIREMENTS

~~FAST FAULT CURRENT INJECTION REQUIREMENTS FOR POWER PARK MODULES, HVDC SYSTEMS, DC CONNECTED POWER PARK MODULES AND REMOTE END HVDC CONVERTERS~~

~~ECC.A.4EC1~~ Fast Fault Current Injection requirements

~~ECC.A.4EC1.1~~ The requirements for fast fault current injection are detailed in ECC.6.3.16. This Appendix provides illustrations by way of examples only of how the requirements of ECC.6.3.16.1.1–ECC.6.3.16.12 are interpreted and not intended to show all permutations and combinations.

~~ECC.A.4EC1.2~~ Figure ECC.A.4.1 shows a typical 100MW wind farm which is connected to the Transmission System at 400kV which under ECC.6.3.2 is required to have a reactive capability of 0.95 Power Factor lead to 0.95 Power Factor lag at Rated MW output at the Grid Entry Point.

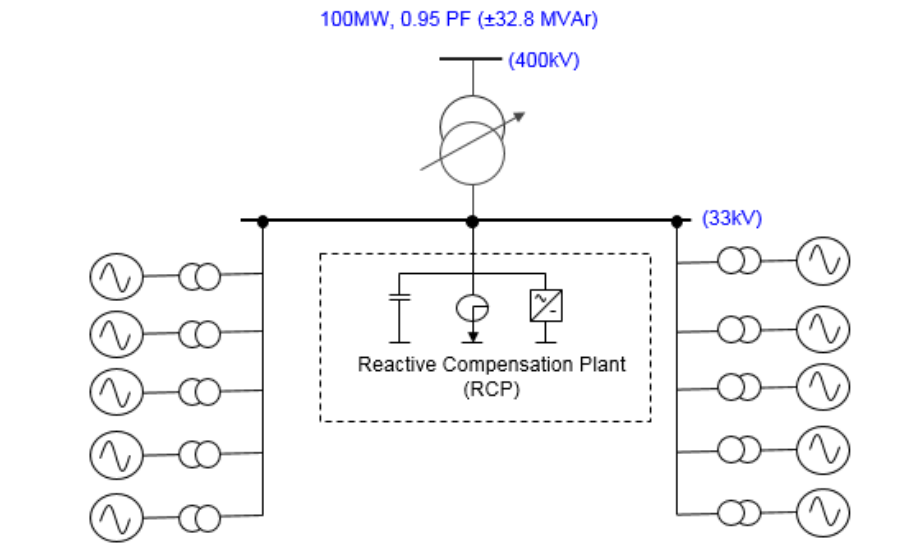

Figure ECC.A.4.1.

ECC.A.4EC1.3 For the purpose of this first example it is assumed that the wind farm in Figure ECC.A.4.1 is operating at an arbitrary pre fault voltage of 1.07pu voltage and a reactive current of -0.3 pu.

ECC.A.4EC1.4 Figure ECC.A.4.2 is an adaptation of Figure ECC.6.3.16(a) in which the pre-fault operating point is shown by point A in the rectangular shaded area. The trajectory from the initial operating point (point A) to the intersection at 0.5pu voltage and 1.0pu reactive current (point B) is shown by the dashed line. For the purposes of this example it is assumed that the wind farm is exposed to a voltage dip of 0.7 pu at the **Grid Entry Point**. At 0.7pu voltage this intersects line AB giving a reactive current injection of 0.54 pu reactive current which requires the **Power Park Module** to supply a reactive current (I_R) of 0.54pu or greater with any residual current being supplied as active current.

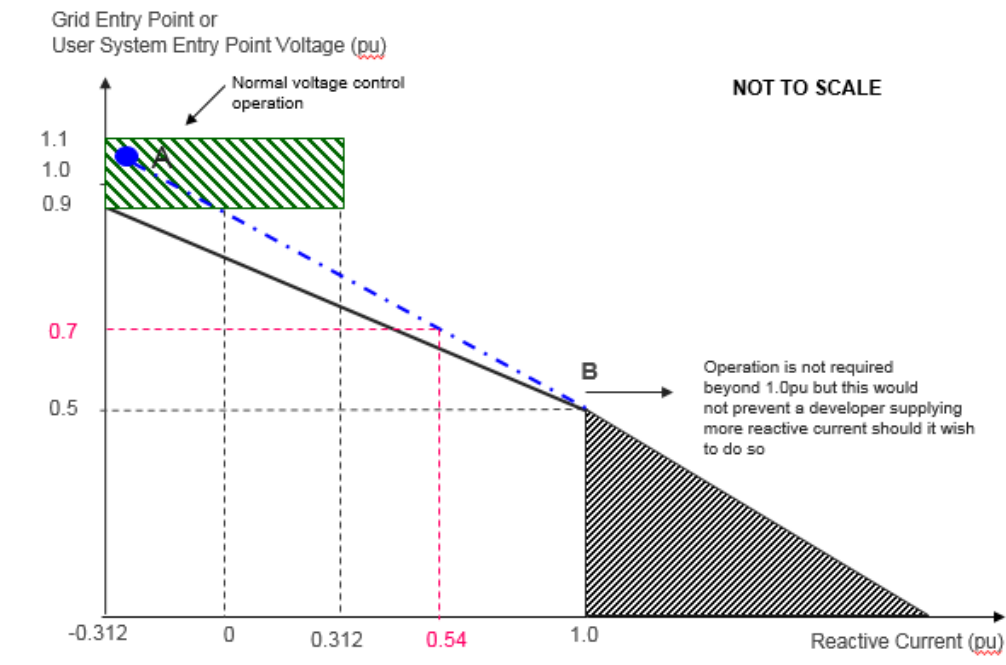

Figure ECC.A.4.2

ECC.A.4EC1.5 In terms of time frames and reactive current injection the minimum performance requirement that would be expected is shown in Figure ECC.A.4.3 and Figure ECC.A.4.4. There is no real difference between these two figures other than in respect of the fault clearance time.

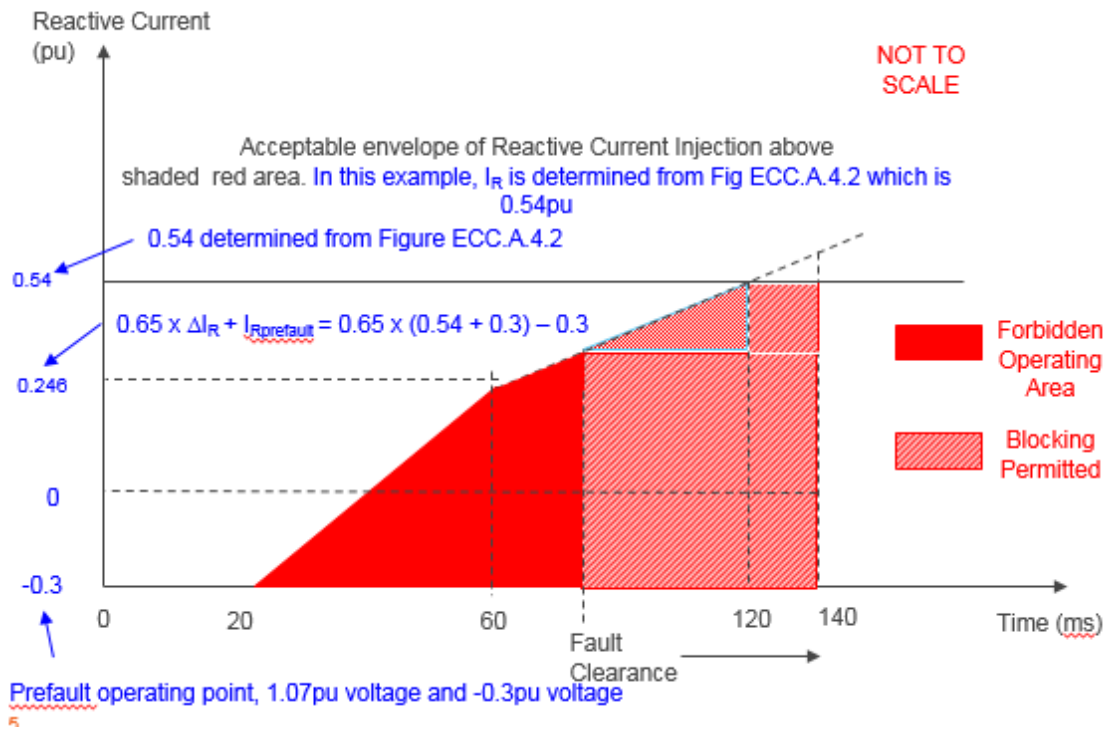

Figure ECC.A.4.3

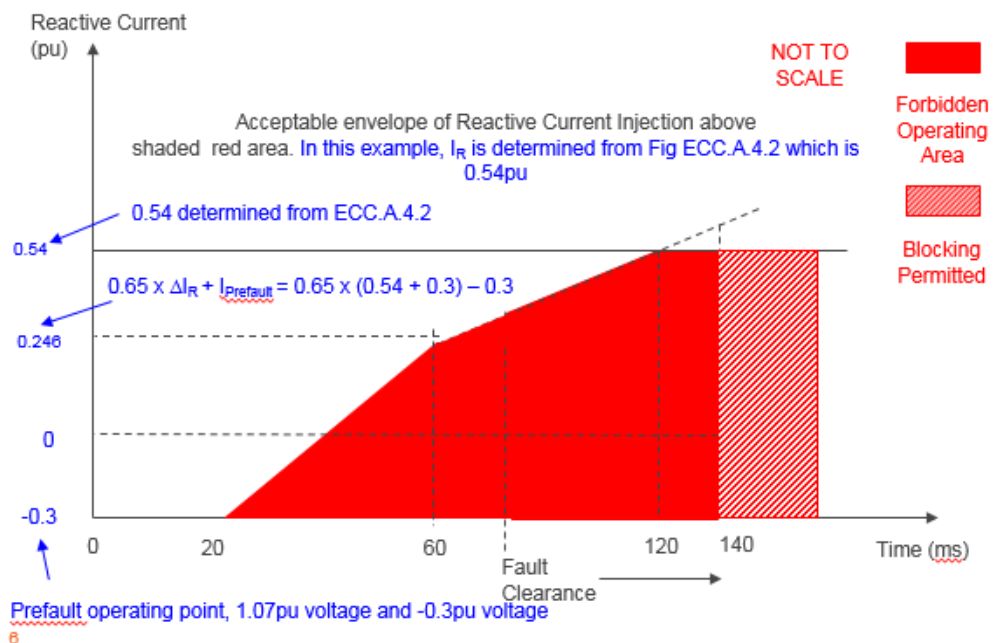

Figure ECC.A.4.4

ECC.A.4EC1.6 In the second example, Figure ECC.A.4.5 is an adaptation of Figure ECC.6.3.16(a) in which the wind farm is now operating in the lagging mode of operation. The wind farm is operating at a **Grid Entry Point** voltage of 0.96pu voltage and a reactive current (I_R) of 0.312 pu export. The prefault operating point is shown by point A in the rectangular shaded area. The trajectory from the initial operating point (point A) to the intersection at 0.5pu voltage and 1.0pu reactive current (point B) is shown by the dashed line. For the purposes of this example it is again assumed that the wind farm is exposed to a voltage dip of 0.7 pu at the **Grid Entry Point**. At 0.7pu voltage this intersects line AB giving a reactive current injection of 0.7 pu reactive current. However it is important to recall that the rating of the wind farm should not be exceeded which is shown by revised line CB shown in Figure ECC.A.4.5. The effect of this is important as it means that the reactive current (I_R) supplied should be reduced from 0.7pu to 0.64pu.

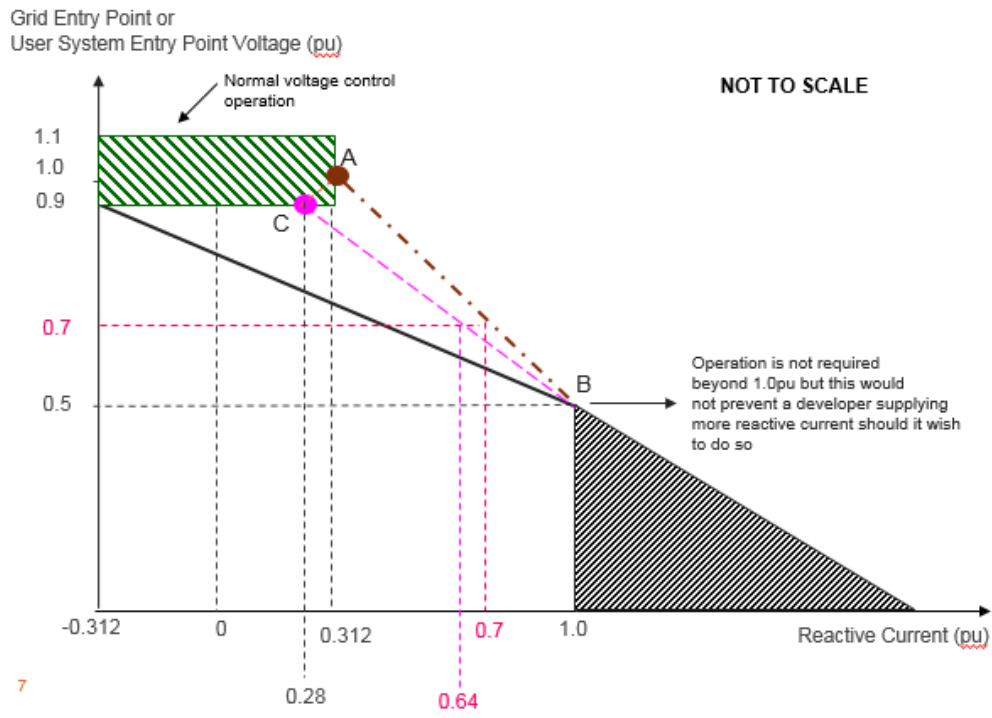

Figure ECC.A.4.5

ECC.A.4EC1.7 In terms of time frames and reactive current injection the minimum performance requirement that would be expected is shown in Figure ECC.A.4.6 and Figure ECC.A.4.7. There is no real difference between these two figures other than in respect of the fault clearance time.

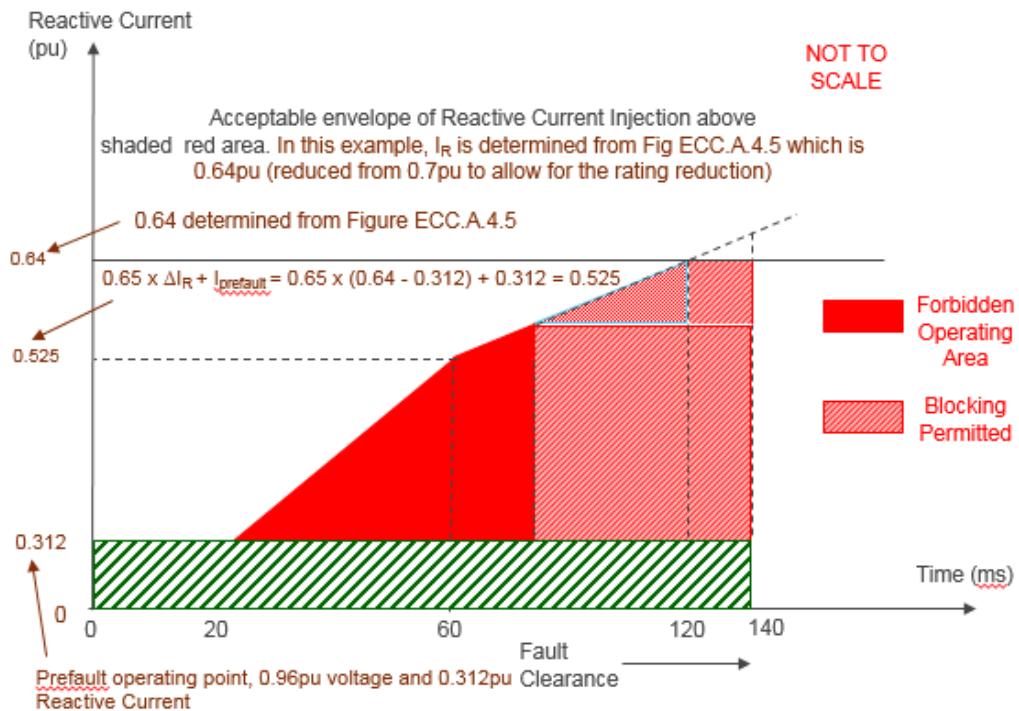

Figure ECC.A.4.6

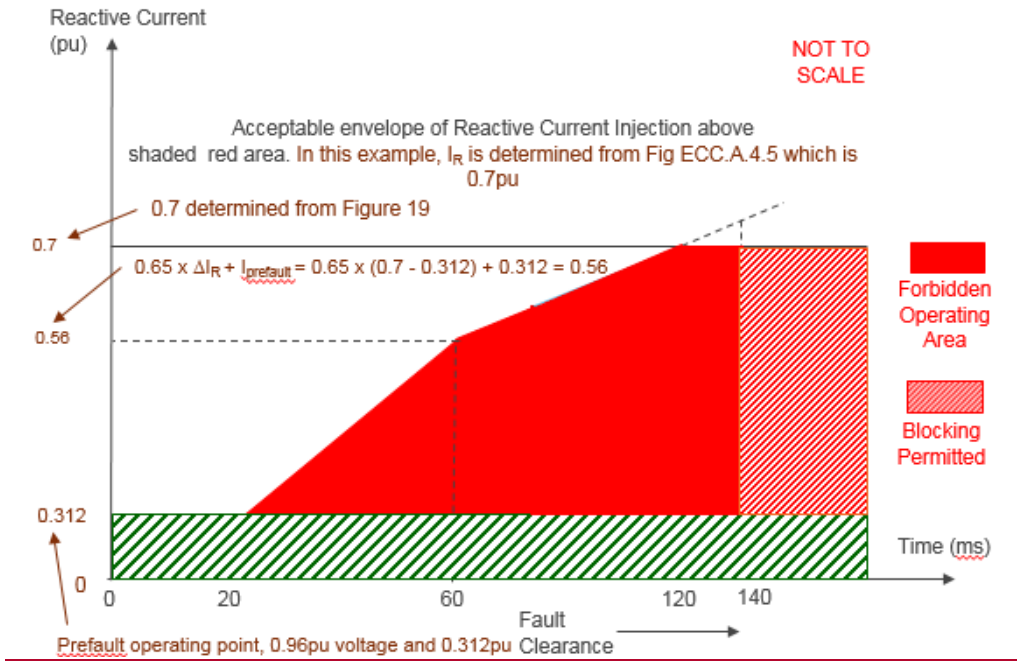

Figure ECC.A.4.7

ECC.A.4EC1.8 In the case of voltage dip or fault which results in the Grid Entry Point voltage falling below 50% the full reactive current of 1.0pu would be expected with 0.65pu reactive current expected to be delivered within 60ms. There is no requirement for the reactive current injection to exceed 1.0pu.

ECC.4EC1.1 Fast Fault Current Injection behaviour during a solid three phase close up short circuit fault lasting up to 140ms

ECC.4EC1.1.1 For a voltage depression at a **Grid Entry Point or User System Point**, the **Fast Fault Current** Injection requirements are detailed in ECC.6.3.16. Figure ECC4.1 shows an example of a 500MW **Power Park Module** subject to a close up solid three phase short circuit fault connected directly connected to the **Transmission System** operating at 400kV.

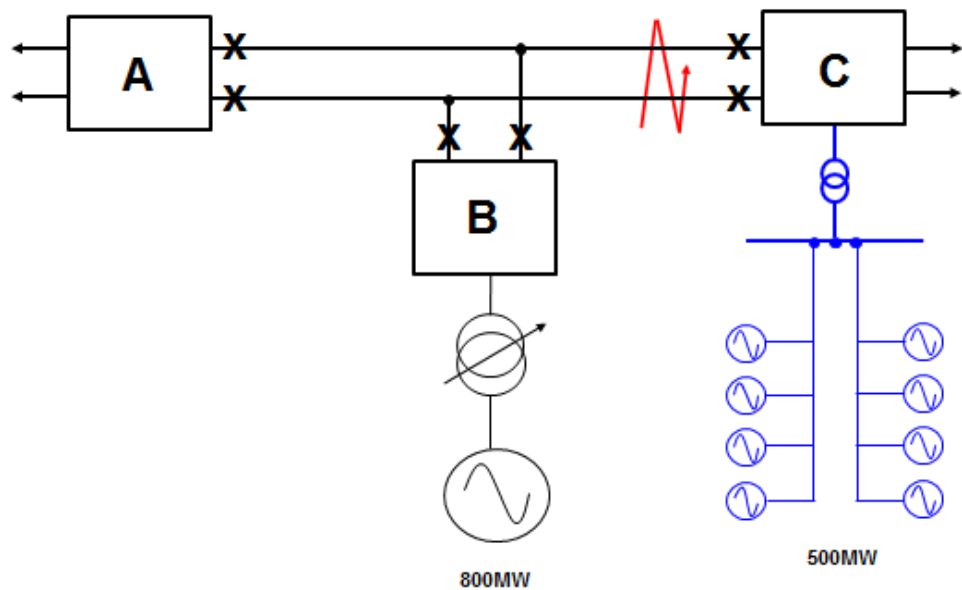

Figure ECC4.1

ECC.4EC1.1.2 Assuming negligible impedance between the fault and substation C, the voltage at Substation C will be close to zero until circuit breakers at Substation C open, typically within 80–100ms, subsequently followed by the opening of circuit breakers at substations A and B, typically 140ms after fault inception. The operation of circuit breakers at Substations A, B and C will also result in the tripping of the 800MW generator which is permitted under the SQSS. The **Power Park Module** is required to satisfy the requirements of ECC.6.3.16, and an example of the deviation in system voltage at the **Grid Entry Point** and expected reactive current injected by the **Power Park Module** before and during the fault is shown in Figure ECC4.2(a) and (b).

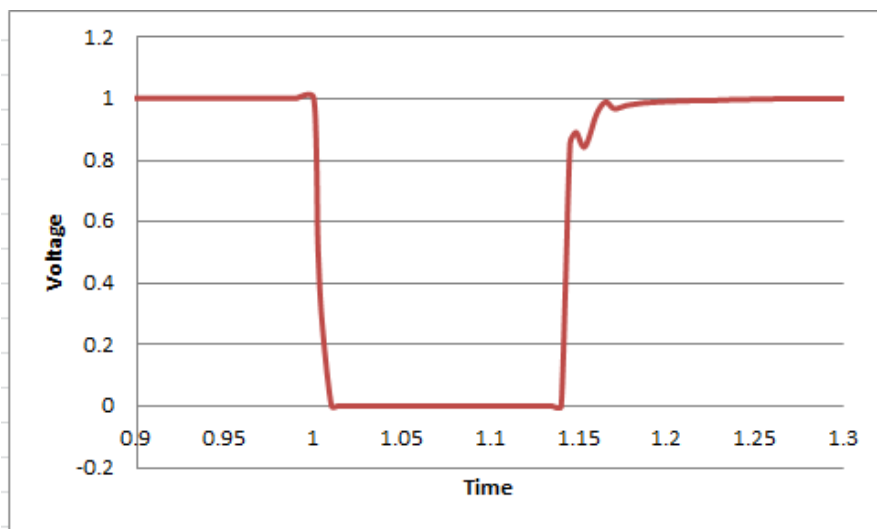

Figure ECC4.2(a) — Voltage deviation at Substation C

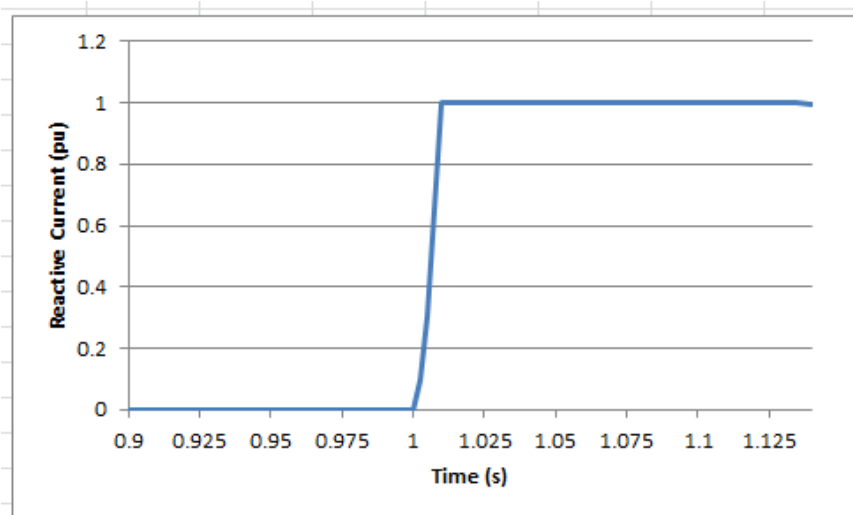

Figure ECC4.2(b) — Reactive Current Injected from the Power Park Module connected to Substation C

It is important to note that blocking is permitted upon fault clearance in order to limit the impact of transient overvoltages. This effect is shown in Figure ECC4.3(a) and Figure ECC4.3(b)

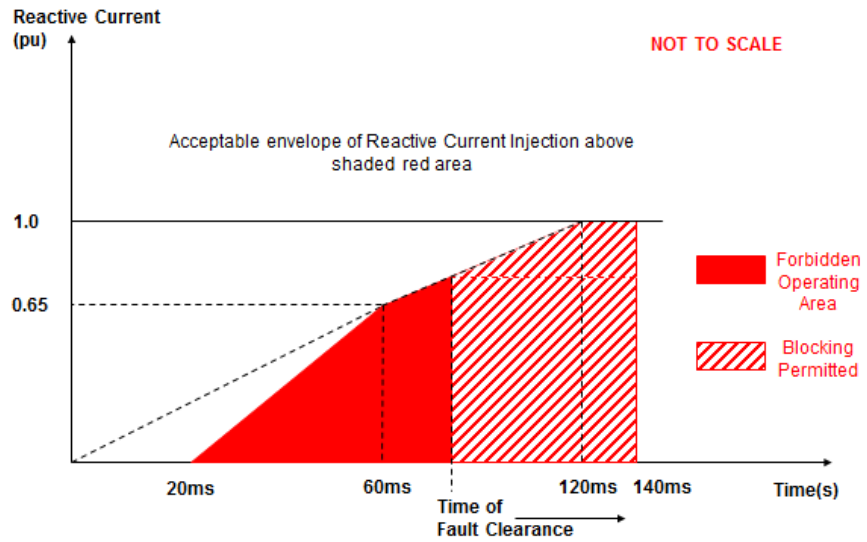

Figure ECC4.3(a)

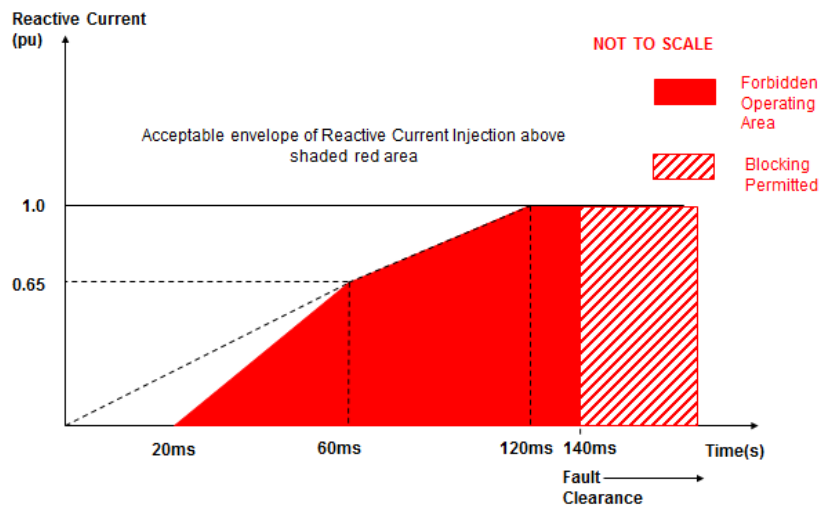

Figure ECC4.3(b)

~~ECC.4EC1.1.3 So long as the reactive current injected is above the shaded area as illustrated in Figure ECC4.3(a) or ECC4.3(b), the **Power Park Module** would be considered to be compliant with the requirements of ECC.6.3.16 Taking the example outlined in ECC.4EC1.1.1 where the fault is cleared in 140ms, the following diagram in Figure ECC4.4 results.~~

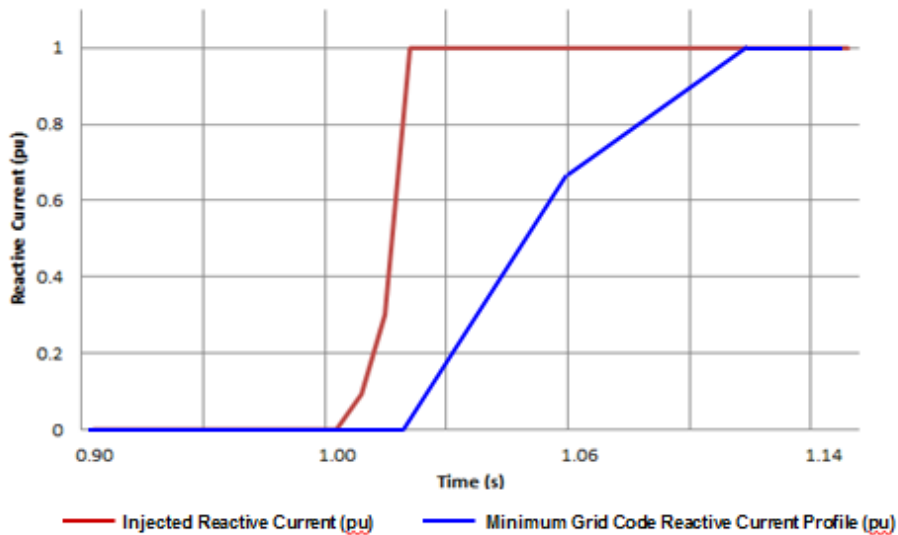

Figure ECC4.4— Injected Reactive Current from Power Park Module compared to the minimum required Grid Code profile

ECC.4EC1.2 Fast Fault Current Injection behaviour during a voltage dip at the Connection Point lasting in excess of 140ms

ECC.4EC1.2.1 Under the fault ride through requirements specified in ECC.6.3.15.9 (*Voltage dips cleared in excess of 140ms*), **Type B, Type C and Type D Power Park Modules** are also required to remain connected and stable for voltage dips on the **Transmission System** in excess of 140ms. Figure ECC4.4 (a) shows an example of a 500MW **Power Park Module** connected to the **Transmission System** and Figure ECC4.4 (b) shows the corresponding voltage dip seen at the **Grid Entry Point** or **User System Point** which has resulted from a remote fault on the **Transmission System** cleared in a backup operating time of 710ms.

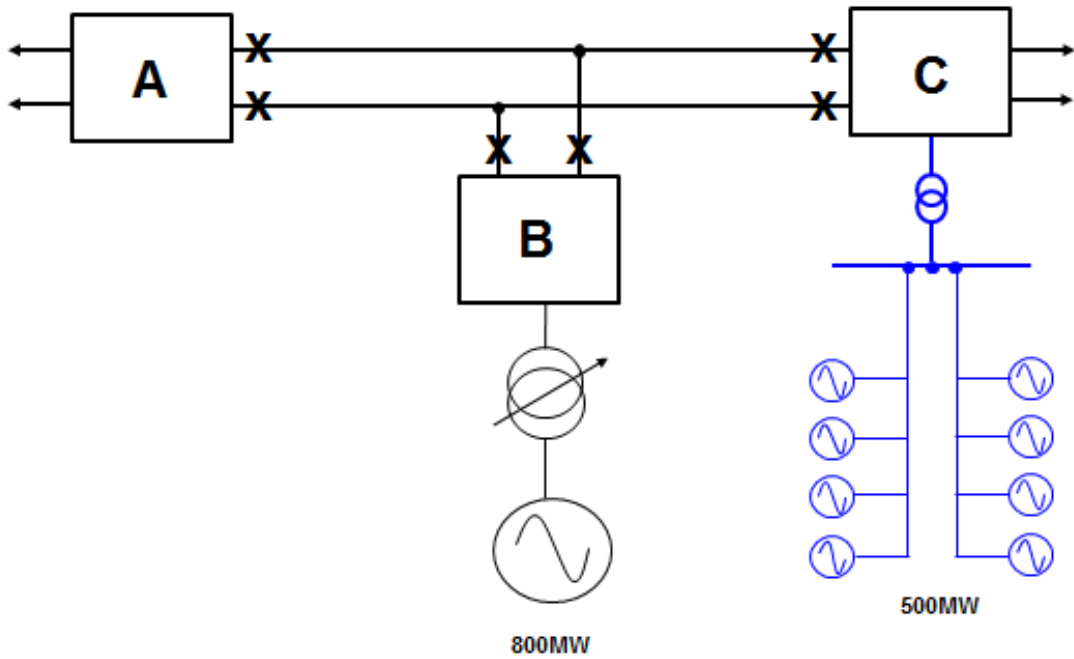

Figure ECC4.4(a)

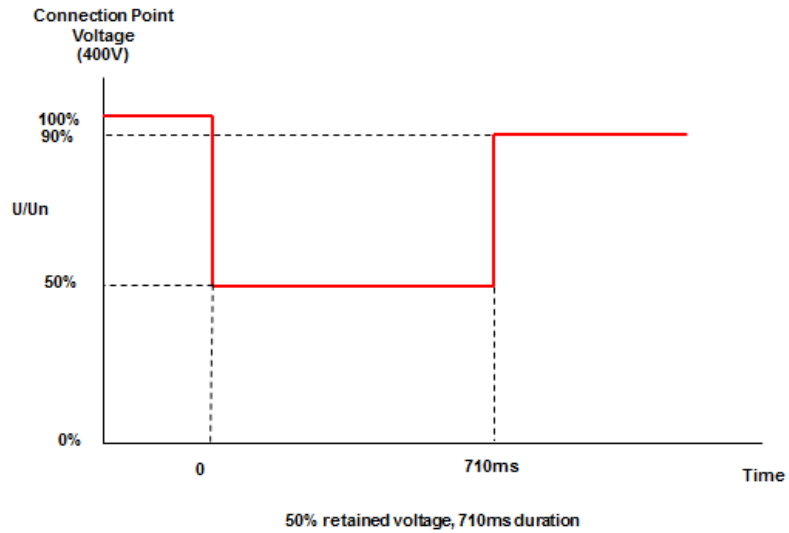

Figure ECC4.4 (b)

ECC.4EC1.2.1 In this example, the voltage dips to 0.5pu for 710ms. Under ECC.6.3.16 each **Type B, Type C and Type D Power Park Module** is required to inject reactive current into the **System** and shall respond in proportion to the change in **System** voltage at the **Grid Entry Point** or **User System Entry Point** up to a maximum value of 1.0pu of rated current. An example of the expected injected reactive current at the **Connection Point** is shown in Figure ECC4.5

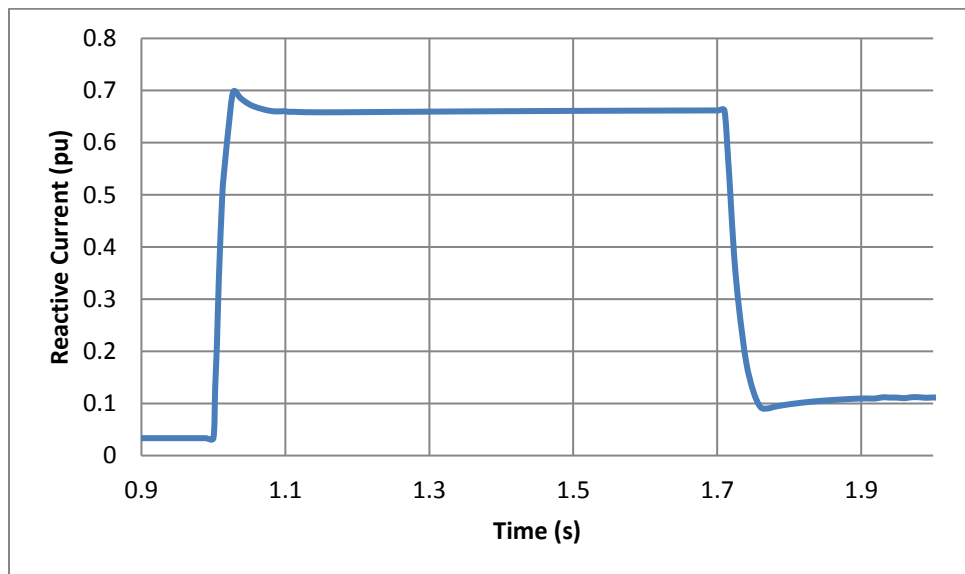

Figure ECC4.5 Reactive Current Injected for a 50% voltage dip for a period of 710ms

Annex 4 – Code Administrator Consultation Responses

Grid Code Administrator Consultation Response Proforma

GC0111 Fast Fault Current Injection specification text

Industry parties are invited to respond to this Code Administrator Consultation expressing their views and supplying the rationale for those views, particularly in respect of any specific questions detailed below.

Please send your responses by **5:00pm** on **8 May 2019** to grid.code@nationalgrideso.com. Please note that any responses received after the deadline or sent to a different email address may not be included within the Final Self Governance Grid Code Modification Report to the Grid Code Review Panel.

Any queries on the content of the consultation should be addressed to Matthew Bent at matthew.bent@nationalgrideso.com

These responses will be included within the Draft Self Governance Grid Code Modification Report to the Grid Code Review Panel and within the Final Self Governance Grid Code Modification Report to the Grid Code Review Panel.

Respondent:	<i>Antony Johnson</i> <i>E-Mail:- Antony.Johnson@nationalgrid.com</i> <i>Telephone:- 01926 655466</i>
Company Name:	<i>Electricity System Operator – National Grid</i>
Please express your views regarding the Code Administrator Consultation, including rationale. (Please include any issues, suggestions or queries)	<p><i>(a) To permit the development, maintenance and operation of an efficient, coordinated and economical system for the transmission of electricity. Supportive</i></p> <p><i>(b) Facilitating effective competition in the generation and supply of electricity (and without limiting the foregoing, to facilitate the national electricity transmission system being made available to persons authorised to supply or generate electricity on terms which neither prevent nor restrict competition in the supply or generation of electricity); Supportive</i></p> <p><i>(c) Subject to sub-paragraphs (i) and (ii), to promote the security and efficiency of the electricity generation, transmission and distribution systems in the national electricity transmission system operator area taken as a whole; Supportive</i></p>

	<p>(d) <i>To efficiently discharge the obligations imposed upon the licensee by this license and to comply with the Electricity Regulation and any relevant legally binding decisions of the European Commission and/or the Agency; - Supportive and</i></p> <p>(e) <i>To promote efficiency in the implementation and administration of the Grid Code arrangements - Supportive</i></p>
--	--

Code Administrator Consultation questions

Q	Question	Response
1	Do you believe that GC0111 better facilitates the Applicable Grid Code objectives? Please include your reasoning.	Yes we believe GC0111 better facilitates the applicable Grid Code objectives. The fast fault current injection requirements as currently drafted in ECC.6.3.16 of the Grid Code are ambiguous and we believe that these proposals address these issues and provide clarity to User's.
2	Do you support the proposed implementation approach?	Yes – We believe it is appropriate to introduce these changes into the Grid Code which will replace the current drafting which has been recognised as being ambiguous.
3	Do you have any other comments in relation to GC0111?	No

Grid Code Administrator Consultation Response Proforma

GC0111 Fast Fault Current Injection specification text

Industry parties are invited to respond to this Code Administrator Consultation expressing their views and supplying the rationale for those views, particularly in respect of any specific questions detailed below.

Please send your responses by **5:00pm** on **8 May 2019** to grid.code@nationalgrideso.com. Please note that any responses received after the deadline or sent to a different email address may not be included within the Final Self Governance Grid Code Modification Report to the Grid Code Review Panel.

Any queries on the content of the consultation should be addressed to Matthew Bent at matthew.bent@nationalgrideso.com

These responses will be included within the Draft Self Governance Grid Code Modification Report to the Grid Code Review Panel and within the Final Self Governance Grid Code Modification Report to the Grid Code Review Panel.

Respondent:	<i>Andy Vaudin</i>
Company Name:	<i>EDF Energy</i>
Please express your views regarding the Code Administrator Consultation, including rationale. (Please include any issues, suggestions or queries)	<p><i>(a) To permit the development, maintenance and operation of an efficient, coordinated and economical system for the transmission of electricity</i></p> <p><i>(b) Facilitating effective competition in the generation and supply of electricity (and without limiting the foregoing, to facilitate the national electricity transmission system being made available to persons authorised to supply or generate electricity on terms which neither prevent nor restrict competition in the supply or generation of electricity);</i></p> <p><i>(c) Subject to sub-paragraphs (i) and (ii), to promote the security and efficiency of the electricity generation, transmission and distribution systems in the national electricity transmission system operator area taken as a whole;</i></p> <p><i>(d) To efficiently discharge the obligations imposed upon the licensee by this license and to comply with the Electricity Regulation and any relevant legally binding decisions of the European</i></p>

	<p><i>Commission and/or the Agency; and</i></p> <p><i>(e) To promote efficiency in the implementation and administration of the Grid Code arrangements</i></p>
--	--

Code Administrator Consultation questions

Q	Question	Response
1	Do you believe that GC0111 better facilitates the Applicable Grid Code objectives? Please include your reasoning.	<p>We agree that GC0111 better facilitates the following Applicable Grid Code objectives:</p> <p>(b) - Revised text will add clarity to the existing FFCI requirements wording that has proven to be open to misinterpretation and confusing to stakeholders, such that developers and manufacturers can ensure compliance at the point of manufacture.</p> <p>(c) - FFCI contribution from PPMs provides important system operability support.</p> <p>(d) - The code amendments will enable developers and manufacturers to provide plant compliant with the requirements brought in to the Grid Code by the European Networks Codes</p>
2	Do you support the proposed implementation approach?	YES
3	Do you have any other comments in relation to GC0111?	NONE