

**EUROPEAN CONNECTION CONDITIONS**  
**(ECC)**  
**GC0096 LEGAL TEXT PROPOSALS**  
**5 NOVEMBER 2018**

**CONTENTS**

(This contents page does not form part of the Grid Code)

<u>Paragraph No/Title</u>	<u>Page Number</u>
ECC.1 INTRODUCTION .....	2
ECC.2 OBJECTIVE .....	2
ECC.3 SCOPE .....	3
ECC.4 PROCEDURE .....	4
ECC.5 CONNECTION.....	4
ECC.6 TECHNICAL, DESIGN AND OPERATIONAL CRITERIA .....	7
ECC.7 SITE RELATED CONDITIONS.....	74
ECC.8 ANCILLARY SERVICES.....	80
APPENDIX E1 - SITE RESPONSIBILITY SCHEDULES.....	82
PROFORMA FOR SITE RESPONSIBILITY SCHEDULE .....	85
APPENDIX E2 - OPERATION DIAGRAMS .....	91
PART 1A - PROCEDURES RELATING TO OPERATION DIAGRAMS .....	91
PART E1B - PROCEDURES RELATING TO GAS ZONE DIAGRAMS.....	94
PART E2 - NON-EXHAUSTIVE LIST OF APPARATUS TO BE INCLUDED ON OPERATION DIAGRAMS.....	95
APPENDIX E3 - MINIMUM FREQUENCY RESPONSE CAPABILITY REQUIREMENT PROFILE AND OPERATING RANGE FOR POWER GENERATING MODULES AND HVDC EQUIPMENT .....	97
APPENDIX 4 - FAULT RIDE THROUGH REQUIREMENTS.....	104
APPENDIX 4EC – FAST FAULT CURRENT INJECTION REQUIREMENTS.....	110
APPENDIX E5 - TECHNICAL REQUIREMENTS LOW FREQUENCY RELAYS FOR THE AUTOMATIC DISCONNECTION OF SUPPLIES AT LOW FREQUENCY .....	115
APPENDIX E6 - PERFORMANCE REQUIREMENTS FOR CONTINUOUSLY ACTING AUTOMATIC EXCITATION CONTROL SYSTEMS FOR ONSHORE SYNCHRONOUS GENERATING UNITS....	118
APPENDIX E7 - PERFORMANCE REQUIREMENTS FOR CONTINUOUSLY ACTING AUTOMATIC VOLTAGE CONTROL SYSTEMS FOR ONSHORE NON-SYNCHRONOUS GENERATING UNITS, ONSHORE DC CONVERTERS, ONSHORE POWER PARK MODULES AND OTSDUW PLANT AND APPARATUS AT THE INTERFACE POINT .....	122
APPENDIX E8 - PERFORMANCE REQUIREMENTS FOR CONTINUOUSLY ACTING AUTOMATIC VOLTAGE CONTROL SYSTEMS FOR CONFIGURATION 2 AC CONNECTED OFFSHORE POWER PARK MODULES AND CONFIGURATION 2 DC CONNECTED POWER PARK MODULES .....	129

ECC.1

## INTRODUCTION

ECC.1.1

The **European Connection Conditions** ("**ECC**") specify both:

- (a) the minimum technical, design and operational criteria which must be complied with by:
  - (i) any **EU Code User** connected to or seeking connection with the **National Electricity Transmission System**, or
  - (ii) **EU Generators** or **HVDC System Owners** connected to or seeking connection to a **User's System** which is located in **Great Britain** or **Offshore**, or
  - (iii) **Network Operators** who are **EU Code Users**
  - (iv) **Network Operators** who are **GB Code Users** but only in respect of:-
    - (a) Their obligations in respect of **Embedded Medium Power Stations** not subject to a **Bilateral Agreement** for whom the requirements of ECC.3.1(b)(iii) apply alone; and/or
    - (b) The requirements of this **ECC** only in relation to each **EU Grid Supply Point. Network Operators** in respect of all other **Grid Supply Points** should continue to satisfy the requirements as specified in the **CCs**.
  - (v) **Non-Embedded Customers** who are **EU Code Users**
- (b) the minimum technical, design and operational criteria with which **The Company** will comply in relation to the part of the **National Electricity Transmission System** at the **Connection Site** with **Users**. In the case of any **OTSDUW Plant and Apparatus**, the **ECC** also specify the minimum technical, design and operational criteria which must be complied with by the **User** when undertaking **OTSDUW**.
- (c) The requirements of **European Regulation (EU) 2016/631** shall not apply to
  - (i) **Power Generating Modules** that are installed to provide backup power and operate in parallel with the **Total System** for less than 5 minutes per calendar month while the **System** is in normal state. Parallel operation during maintenance or commissioning of tests of that **Power Generating Module** shall not count towards that five minute limit.
  - (ii) **Power Generating Modules** connected to the **Transmission System** or **Network Operators System** which are not operated in synchronism with a **Synchronous Area**.
  - (iii) **Power Generating Modules** that do not have a permanent **Connection Point** or **User System Entry Point** and used by **The Company** to temporarily provide power when normal **System** capacity is partly or completely unavailable.
  - (iv) **Electricity Storage Modules**.
- (d) For the avoidance of doubt, **Generators** in respect of **Electricity Storage Modules** are required to meet the requirements of this **ECC** but are not required to satisfy the requirements of **European Regulation (EU) 2016/631, European Regulation 2016/1388 and European Regulation 2016/1485. Any derogation in respect of **Electricity Storage Modules** would therefore be against the GB Grid Code as the requirements applicable to **Electricity Storage Modules** are not enforceable by EU Law.**

ECC.2

## OBJECTIVE

- ECC.2.1 The objective of the **ECC** is to ensure that by specifying minimum technical, design and operational criteria the basic rules for connection to the **National Electricity Transmission System** and (for certain **Users**) to a **User's System** are similar for all **Users** of an equivalent category and will enable **The Company** to comply with its statutory and **Transmission Licence** obligations and European Regulations.
- ECC.2.2 In the case of any **OTSDUW** the objective of the **ECC** is to ensure that by specifying the minimum technical, design and operational criteria the basic rules relating to an **Offshore Transmission System** designed and constructed by an **Offshore Transmission Licensee** and designed and/or constructed by a **User** under the **OTSDUW Arrangements** are equivalent.
- ECC.2.3 Provisions of the **ECC** which apply in relation to **OTSDUW** and **OTSUA**, and/or a **Transmission Interface Site**, shall (in any particular case) apply up to the **OTSUA Transfer Time**, whereupon such provisions shall (without prejudice to any prior non-compliance) cease to apply, without prejudice to the continuing application of provisions of the **ECC** applying in relation to the relevant **Offshore Transmission System** and/or **Connection Site**. It is the case therefore that in cases where the **OTSUA** becomes operational prior to the **OTSUA Transfer Time** that a **EU Generator** is required to comply with this **ECC** both as it applies to its **Plant** and **Apparatus** at a **Connection Site/Connection Point** and the **OTSUA** at the **Transmission Interface Site/Transmission Interface Point** until the **OTSUA Transfer Time** and this **ECC** shall be construed accordingly.
- ECC.2.4 In relation to **OTSDUW**, provisions otherwise to be contained in a **Bilateral Agreement** may be contained in the **Construction Agreement**, and accordingly a reference in the **ECC** to a relevant **Bilateral Agreement** includes the relevant **Construction Agreement**.
- ECC.3 SCOPE
- ECC.3.1 The **ECC** applies to **The Company** and to **Users**, which in the **ECC** means:
- (a) **EU Generators** (other than those which only have **Embedded Small Power Stations**), including those undertaking **OTSDUW** including **Power Generating Modules**, and **DC Connected Power Park Modules**. For the avoidance of doubt Electricity Storage Modules are included within the definition of Power Generating Modules for which the requirements of the ECC would be equally applicable.
  - (b) **Network Operators** but only in respect of:-
    - (i) **Network Operators** who are **EU Code Users**
    - (ii) **Network Operators** who only have **EU Grid Supply Points**
    - (iii) **Embedded Medium Power Stations** not subject to a **Bilateral Agreement** as provided for in ECC.3.2, ECC.3.3, EC3.4, EC3.5, ECC5.1, ECC.6.4.4 and ECA.3.4;  
~~(iv)~~(v) Notwithstanding the requirements of ECC3.1(b)(i)(ii) and (iii) , **Network Operators** who own and/or operate **EU Grid Supply Points**, are only required to satisfy the requirements of this **ECC** in relation to each **EU Grid Supply Point**. **Network Operators** in respect of all other **Grid Supply Points** should continue to satisfy the requirements as specified in the **CCs**.
  - (c) **Non-Embedded Customers** who are also **EU Code Users** ;
  - (d) **HVDC System Owners** who are also **EU Code Users**; and
  - (e) **BM Participants** and **Externally Interconnected System Operators** who are also **EU Code Users** in respect of ECC.6.5 only.

ECC.3.2 The above categories of **User** will become bound by the applicable sections of the **ECC** prior to them generating, distributing, storing, supplying or consuming, as the case may be, and references to the various categories should, therefore, be taken as referring to them in that prospective role.

ECC.3.3 **Embedded Medium Power Stations** not subject to a **Bilateral Agreement** and **Embedded HVDC Systems** not subject to a **Bilateral Agreement** Provisions.

The following provisions apply in respect of **Embedded Medium Power Stations** not subject to a **Bilateral Agreement** and **Embedded HVDC Systems** not subject to a **Bilateral Agreement**.

ECC.3.3.1 The obligations within the **ECC** that are expressed to be applicable to **EU Generators** in respect of **Embedded Medium Power Stations** not subject to a **Bilateral Agreement** and **HVDC System Owners** in respect of **Embedded HVDC Systems** not subject to a **Bilateral Agreement** (where the obligations are in each case listed in ECC.3.3.2) shall be read and construed as obligations that the **Network Operator** within whose **System** any such **Medium Power Station** or **HVDC System** is **Embedded** must ensure are performed and discharged by the **EU Generator** or the **HVDC Owner**. **Embedded Medium Power Stations** not subject to a **Bilateral Agreement** and **Embedded HVDC Systems** not subject to a **Bilateral Agreement** which are located **Offshore** and which are connected to an **Onshore User System** will be required to meet the applicable requirements of the Grid Code as though they are an **Onshore Generator** or **Onshore HVDC System Owner** connected to an **Onshore User System Entry Point**.

ECC.3.3.2 The **Network Operator** within whose **System** a **Medium Power Station** not subject to a **Bilateral Agreement** is **Embedded** or a **HVDC System** not subject to a **Bilateral Agreement** is **Embedded** must ensure that the following obligations in the **ECC** are performed and discharged by the **EU Generator** in respect of each such **Embedded Medium Power Station** or the **HVDC System Owner** in the case of an **Embedded HVDC System**:

ECC.5.1

ECC.5.2.2

ECC.5.3

ECC.6.1.3

ECC.6.1.5 (b)

ECC.6.3.2, ECC.6.3.3, ECC.6.3.4, ECC.6.3.6, ECC.6.3.7, ECC.6.3.8, ECC.6.3.9, ECC.6.3.10, ECC.6.3.12, ECC.6.3.13, ECC.6.3.15, ECC.6.3.16

ECC.6.4.4

ECC.6.5.6 (where required by ECC.6.4.4)

In respect of ECC.6.2.2.2, ECC.6.2.2.3, ECC.6.2.2.5, ECC.6.1.5(a), ECC.6.1.5(b) and ECC.6.3.11 equivalent provisions as co-ordinated and agreed with the **Network Operator** and **EU Generator** or **HVDC System Owner** may be required. Details of any such requirements will be notified to the **Network Operator** in accordance with ECC.3.5.

ECC.3.3.3 In the case of **Embedded Medium Power Stations** not subject to a **Bilateral Agreement** and **Embedded HVDC Systems** not subject to a **Bilateral Agreement** the requirements in:

ECC.6.1.6

ECC.6.3.8

ECC.6.3.12

ECC.6.3.15

ECC.6.3.16

ECC.6.3.17

that would otherwise have been specified in a **Bilateral Agreement** will be notified to the relevant **Network Operator** in writing in accordance with the provisions of the **CUSC** and the **Network Operator** must ensure such requirements are performed and discharged by the **Generator** or the **HVDC System** owner.

ECC.3.4 In the case of **Offshore Embedded Power Generating Modules** connected to an **Offshore User's System** which directly connects to an **Offshore Transmission System**, any additional requirements in respect of such **Offshore Embedded Power Generating Modules** may be specified in the relevant **Bilateral Agreement** with the **Network Operator** or in any **Bilateral Agreement** between **The Company** and such **Offshore Generator**.

ECC.3.5 In the case of a **Generator** undertaking **OTSDUW** connecting to an **Onshore Network Operator's System**, any additional requirements in respect of such **OTSDUW Plant and Apparatus** will be specified in the relevant **Bilateral Agreement** with the **EU Generator**. For the avoidance of doubt, requirements applicable to **EU Generators** undertaking **OTSDUW** and connecting to a **Network Operator's User System**, shall be consistent with those applicable requirements of **Generators** undertaking **OTSDUW** and connecting to a **Transmission Interface Point**.

ECC.3.6 The requirements of this **ECC** shall apply to **EU Code Users** in respect of **Power Generating Modules** (including **DC Connected Power Park Modules** and Electricity Storage Modules) and **HVDC Systems**.

#### ECC.4 PROCEDURE

ECC.4.1 The **CUSC** contains certain provisions relating to the procedure for connection to the **National Electricity Transmission System** or, in the case of **Embedded Power Stations** or **Embedded HVDC Systems**, becoming operational and includes provisions relating to certain conditions to be complied with by **EU Code Users** prior to and during the course of **The Company** notifying the **User** that it has the right to become operational. The procedure for an **EU Code User** to become connected is set out in the **Compliance Processes**.

#### ECC.5 CONNECTION

ECC.5.1 The provisions relating to connecting to the **National Electricity Transmission System** (or to a **User's System** in the case of a connection of an **Embedded Large Power Station** or **Embedded Medium Power Stations** or **Embedded HVDC System**) are contained in:

- (a) the **CUSC** and/or **CUSC Contract** (or in the relevant application form or offer for a **CUSC Contract**);
- (b) or, in the case of an **Embedded Development**, the relevant **Distribution Code** and/or the **Embedded Development Agreement** for the connection (or in the relevant application form or offer for an **Embedded Development Agreement**),

and include provisions relating to both the submission of information and reports relating to compliance with the relevant **European Connection Conditions** for that **EU Code User**, **Safety Rules**, commissioning programmes, **Operation Diagrams** and approval to connect (and their equivalents in the case of **Embedded Medium Power Stations** not subject to a **Bilateral Agreement** or **Embedded HVDC Systems** not subject to a **Bilateral Agreement**). References in the **ECC** to the "**Bilateral Agreement**" and/or "**Construction Agreement**" and/or "**Embedded Development Agreement**" shall be deemed to include references to the application form or offer therefor.

#### ECC.5.2 Items For Submission

ECC.5.2.1 Prior to the **Completion Date** (or, where the **EU Generator** is undertaking **OTSDUW**, any later date specified) under the **Bilateral Agreement** and/or **Construction Agreement**, the following is submitted pursuant to the terms of the **Bilateral Agreement** and/or **Construction Agreement**:

- (a) updated **Planning Code** data (both **Standard Planning Data** and **Detailed Planning Data**), with any estimated values assumed for planning purposes confirmed or, where practical, replaced by validated actual values and by updated estimates for the future and by updated forecasts for **Forecast Data** items such as **Demand**, pursuant to the requirements of the **Planning Code**;
- (b) details of the **Protection** arrangements and settings referred to in ECC.6;
- (c) copies of all **Safety Rules** and **Local Safety Instructions** applicable at **Users' Sites** which will be used at **The Company/User** interface (which, for the purpose of **OC8**, must be to **The Company's** satisfaction regarding the procedures for **Isolation** and **Earthing**. For **User Sites** in Scotland and **Offshore The Company** will consult the **Relevant Transmission Licensee** when determining whether the procedures for **Isolation** and **Earthing** are satisfactory);
- (d) information to enable **The Company** to prepare **Site Responsibility Schedules** on the basis of the provisions set out in Appendix 1;
- (e) an **Operation Diagram** for all **HV Apparatus** on the **User** side of the **Connection Point** as described in ECC.7;
- (f) the proposed name of the **User Site** (which shall not be the same as, or confusingly similar to, the name of any **Transmission Site** or of any other **User Site**);
- (g) written confirmation that **Safety Co-ordinators** acting on behalf of the **User** are authorised and competent pursuant to the requirements of **OC8**;
- (h) **RISSP** prefixes pursuant to the requirements of **OC8**. **The Company** is required to circulate prefixes utilising a proforma in accordance with **OC8**;
- (i) a list of the telephone numbers for **Joint System Incidents** at which senior management representatives nominated for the purpose can be contacted and confirmation that they are fully authorised to make binding decisions on behalf of the **User**, pursuant to **OC9**;
- (j) a list of managers who have been duly authorised to sign **Site Responsibility Schedules** on behalf of the **User**;
- (k) information to enable **The Company** to prepare **Site Common Drawings** as described in ECC.7;
- (l) a list of the telephone numbers for the **Users** facsimile machines referred to in ECC.6.5.9; and
- (m) for **Sites** in Scotland and **Offshore** a list of persons appointed by the **User** to undertake operational duties on the **User's System** (including any **OTSDUW** prior to the **OTSUA Transfer Time**) and to issue and receive operational messages and instructions in relation to the **User's System** (including any **OTSDUW** prior to the **OTSUA Transfer Time**); and an appointed person or persons responsible for the maintenance and testing of **User's Plant** and **Apparatus**.

ECC.5.2.2 Prior to the **Completion Date** the following must be submitted to **The Company** by the **Network Operator** in respect of an **Embedded Development**:

- (a) updated **Planning Code** data (both **Standard Planning Data** and **Detailed Planning Data**), with any estimated values assumed for planning purposes confirmed or, where practical, replaced by validated actual values and by updated estimates for the future and by updated forecasts for **Forecast Data** items such as **Demand**, pursuant to the requirements of the **Planning Code**;
- (b) details of the **Protection** arrangements and settings referred to in ECC.6;
- (c) the proposed name of the **Embedded Medium Power Station** or **Embedded HVDC System** (which shall be agreed with **The Company** unless it is the same as, or confusingly similar to, the name of other **Transmission Site** or **User Site**);

- ECC.5.2.3 Prior to the **Completion Date** contained within an **Offshore Transmission Distribution Connection Agreement** the following must be submitted to **The Company** by the **Network Operator** in respect of a proposed new **Interface Point** within its **User System**:
- (a) updated **Planning Code** data (both **Standard Planning Data** and **Detailed Planning Data**), with any estimated values assumed for planning purposes confirmed or, where practical, replaced by validated actual values and by updated estimates for the future and by updated forecasts for **Forecast Data** items such as **Demand**, pursuant to the requirements of the **Planning Code**;
  - (b) details of the **Protection** arrangements and settings referred to in ECC.6;
  - (c) the proposed name of the **Interface Point** (which shall not be the same as, or confusingly similar to, the name of any **Transmission Site** or of any other **User Site**);
- ECC.5.2.4 In the case of **OTSDUW Plant and Apparatus** (in addition to items under ECC.5.2.1 in respect of the **Connection Site**), prior to the **Completion Date** (or any later date specified) under the **Construction Agreement** the following must be submitted to **The Company** by the **User** in respect of the proposed new **Connection Point** and **Interface Point**:
- (a) updated **Planning Code** data (**Standard Planning Data**, **Detailed Planning Data** and **OTSDUW Data and Information**), with any estimated values assumed for planning purposes confirmed or, where practical, replaced by validated actual values and by updated estimates for the future and by updated forecasts for **Forecast Data** items such as **Demand**, pursuant to the requirements of the **Planning Code**;
  - (b) details of the **Protection** arrangements and settings referred to in ECC.6;
  - (c) information to enable preparation of the **Site Responsibility Schedules** at the **Transmission Interface Site** on the basis of the provisions set out in Appendix E1.
  - (d) the proposed name of the **Interface Point** (which shall not be the same as, or confusingly similar to, the name of any **Transmission Site** or of any other **User Site**);
- ECC.5.3
- (a) Of the items ECC.5.2.1 (c), (e), (g), (h), (k) and (m) need not be supplied in respect of **Embedded Power Stations** or **Embedded HVDC Systems**,
  - (b) item ECC.5.2.1(i) need not be supplied in respect of **Embedded Small Power Stations** and **Embedded Medium Power Stations** or **Embedded HVDC Systems** with a **Registered Capacity** of less than 100MW, and
  - (c) items ECC.5.2.1(d) and (j) are only needed in the case where the **Embedded Power Station** or the **Embedded HVDC System** is within a **Connection Site** with another **User**.
- ECC.5.4 In addition, at the time the information is given under ECC.5.2(g), **The Company** will provide written confirmation to the **User** that the **Safety Co-ordinators** acting on behalf of **The Company** are authorised and competent pursuant to the requirements of **OC8**.

## ECC.6 TECHNICAL, DESIGN AND OPERATIONAL CRITERIA

### ECC.6.1 National Electricity Transmission System Performance Characteristics

ECC.6.1.1 **The Company** shall ensure that, subject as provided in the **Grid Code**, the **National Electricity Transmission System** complies with the following technical, design and operational criteria in relation to the part of the **National Electricity Transmission System** at the **Connection Site** with a **User** and in the case of **OTSDUW Plant and Apparatus**, a **Transmission Interface Point** (unless otherwise specified in ECC.6) although in relation to operational criteria **The Company** may be unable (and will not be required) to comply with this obligation to the extent that there are insufficient **Power Stations** or **User Systems** are not available or **Users** do not comply with **The Company's** instructions or otherwise do not comply with the **Grid Code** and each **User** shall ensure that its **Plant** and **Apparatus** complies with the criteria set out in ECC.6.1.5.

### ECC.6.1.2 Grid Frequency Variations

ECC.6.1.2.1 Grid Frequency Variations

ECC.6.1.2.1.1 The **Frequency** of the **National Electricity Transmission System** shall be nominally 50Hz and shall be controlled within the limits of 49.5 - 50.5Hz unless exceptional circumstances prevail.

ECC.6.1.2.1.2 The **System Frequency** could rise to 52Hz or fall to 47Hz in exceptional circumstances. Design of **User's Plant and Apparatus** and **OTSDUW Plant and Apparatus** must enable operation of that **Plant and Apparatus** within that range in accordance with the following:

<u>Frequency Range</u>	<u>Requirement</u>
51.5Hz - 52Hz	Operation for a period of at least 15 minutes is required each time the Frequency is above 51.5Hz.
51Hz - 51.5Hz	Operation for a period of at least 90 minutes is required each time the Frequency is above 51Hz.
49.0Hz - 51Hz	Continuous operation is required
47.5Hz - 49.0Hz	Operation for a period of at least 90 minutes is required each time the Frequency is below 49.0Hz.
47Hz - 47.5Hz	Operation for a period of at least 20 seconds is required each time the Frequency is below 47.5Hz.

ECC.6.1.2.1.3 For the avoidance of doubt, disconnection, by frequency or speed based relays is not permitted within the frequency range 47.5Hz to 51.5Hz. **EU Generators** should however be aware of the combined voltage and frequency operating ranges as defined in ECC.6.3.12 and ECC.6.3.13.

ECC.6.1.2.1.4 **The Company** in co-ordination with the **Relevant Transmission Licensee** and/or **Network Operator** and a **User** may agree on wider variations in frequency or longer minimum operating times to those set out in ECC.6.1.2.1.2 or specific requirements for combined frequency and voltage deviations. Any such requirements in relation to **Power Generating Modules** shall be in accordance with ECC.6.3.12 and ECC.6.3.13. A **User** shall not unreasonably withhold consent to apply wider frequency ranges or longer minimum times for operation taking account of their economic and technical feasibility.

ECC.6.1.2.2 Grid Frequency variations for HVDC Systems and Remote End HVDC Converter Stations

ECC.6.1.2.2.1 **HVDC Systems** and **Remote End HVDC Converter Stations** shall be capable of staying connected to the **System** and remaining operable within the frequency ranges and time periods specified in Table ECC.6.1.2.2 below. This requirement shall continue to apply during the **Fault Ride Through** conditions defined in ECC.6.3.15

<b>Frequency Range (Hz)</b>	<b>Time Period for Operation (s)</b>
47.0 – 47.5Hz	60 seconds
47.5 – 49.0Hz	90 minutes and 30 seconds
49.0 – 51.0Hz	Unlimited
51.0 – 51.5Hz	90 minutes and 30 seconds
51.5Hz – 52 Hz	20 minutes

Table ECC.6.1.2.2 – Minimum time periods **HVDC Systems and Remote End HVDC Converter Stations** shall be able to operate for different frequencies deviating from a nominal value without disconnecting from the **National Electricity Transmission System**

ECC.6.1.2.2.2 **The Company** in coordination with the **Relevant Transmission Licensee** and a **HVDC System Owner** may agree wider frequency ranges or longer minimum operating times if required to preserve or restore system security. If wider frequency ranges or longer minimum times for operation are economically and technically feasible, the **HVDC System Owner** shall not unreasonably withhold consent.



ECC.6.1.2.2.3 Notwithstanding the requirements of ECC.6.1.2.2.1, an **HVDC System** or **Remote End HVDC Converter Station** shall be capable of automatic disconnection at frequencies specified by **The Company** and/or **Relevant Network Operator**.

ECC.6.1.2.2.4 In the case of **Remote End HVDC Converter Stations** where the **Remote End HVDC Converter Station** is operating at either nominal frequency other than 50Hz or a variable frequency, the requirements defined in ECC6.1.2.2.1 to ECC.6.1.2.2.3 shall apply to the **Remote End HVDC Converter Station** other than in respect of the frequency ranges and time periods.

ECC.6.1.2.3 Grid Frequency Variations for DC Connected Power Park Modules

ECC.6.1.2.3.1 **DC Connected Power Park Modules** shall be capable of staying connected to the **Remote End DC Converter** network at the HVDC Interface Point and operating within the **Frequency** ranges and time periods specified in Table ECC.6.1.2.3 below. Where a nominal frequency other than 50Hz, or a **Frequency** variable by design is used as agreed with **The Company** and the **Relevant Transmission Licensee** the applicable **Frequency** ranges and time periods shall be specified in the **Bilateral Agreement** which shall (where applicable) reflect the requirements in Table ECC.6.1.2.3 .

Frequency Range (Hz)	Time Period for Operation (s)
47.0 – 47.5Hz	20 seconds
47.5 – 49.0Hz	90 minutes
49.0 – 51.0Hz	Unlimited
51.0 – 51.5Hz	90 minutes
51.5Hz – 52 Hz	15 minutes

Table ECC.6.1.2.3 – Minimum time periods a **DC Connected Power Park Module** shall be able to operate for different frequencies deviating from a nominal value without disconnecting from the **System**

ECC.6.1.2.3.2 **The Company** in coordination with the **Relevant Transmission Licensee** and a **Generator** may agree wider frequency ranges or longer minimum operating times if required to preserve or restore system security and to ensure the optimum capability of the **DC Connected Power Park Module**. If wider frequency ranges or longer minimum times for operation are economically and technically feasible, the **EU Generator** shall not unreasonably withhold consent.

ECC.6.1.3 Not used

ECC.6.1.4 Grid Voltage Variations

ECC.6.1.4.1 Grid Voltage Variations for Users excluding DC Connected Power Park Modules and Remote End HVDC Converters

Subject as provided below, the voltage on the 400kV part of the **National Electricity Transmission System** at each **Connection Site** with a **User** (and in the case of **OTSDUW Plant and Apparatus**, a **Transmission Interface Point**, excluding **DC Connected Power Park Modules** and **Remote End HVDC Converters**) will normally remain within  $\pm 5\%$  of the nominal value unless abnormal conditions prevail. The minimum voltage is  $-10\%$  and the maximum voltage is  $+10\%$  unless abnormal conditions prevail, but voltages between  $+5\%$  and  $+10\%$  will not last longer than 15 minutes unless abnormal conditions prevail. Voltages on the 275kV and 132kV parts of the **National Electricity Transmission System** at each **Connection Point** (and in the case of **OTSDUW Plant and Apparatus**, a **Transmission Interface Point**) will normally remain within the limits  $\pm 10\%$  of the nominal value unless abnormal conditions prevail. At nominal **System** voltages below 110kV the voltage of the **National Electricity Transmission System** at each **Connection Site** with a **User** (and in the case of **OTSDUW Plant and Apparatus**, a **Transmission Interface Point**), excluding **Connection Sites** for **DC Connected Power Park Modules** and **Remote End HVDC Converters**) will normally remain within the limits  $\pm 6\%$  of the nominal value unless abnormal conditions prevail. Under fault conditions, the voltage may collapse transiently to zero at the point of fault until the fault is cleared. The normal operating ranges of the **National Electricity Transmission System** are summarised below:

National Electricity Transmission System Nominal Voltage	Normal Operating Range	Time period for Operation
400kV	400kV $-10\%$ to $+5\%$	Unlimited
	400kV $+5\%$ to $+10\%$	15 minutes
275kV	275kV $\pm 10\%$	Unlimited
132kV	132kV $\pm 10\%$	Unlimited
110kV	110kV $\pm 10\%$	Unlimited
Below 110kV	Below 110kV $\pm 6\%$	Unlimited

**The Company** and a **User** may agree greater variations or longer minimum time periods of operation in voltage to those set out above in relation to a particular **Connection Site**, and insofar as a greater variation is agreed, the relevant figure set out above shall, in relation to that **User** at the particular **Connection Site**, be replaced by the figure agreed.

ECC.6.1.4.2 **Grid Voltage Variations for all DC Connected Power Park Modules**

ECC.6.1.4.2.1 All **DC Connected Power Park Modules** shall be capable of staying connected to the **Remote End HVDC Converter Station** at the **HVDC Interface Point** and operating within the voltage ranges and time periods specified in Tables ECC.6.1.4.2(a) and ECC.6.1.4.2(b) below. The applicable voltage range and time periods specified are selected based on the reference 1pu voltage.

Voltage Range (pu)	Time Period for Operation (s)
0.85pu – 0.9pu	60 minutes
0.9pu – 1.1pu	Unlimited
1.1pu – 1.15pu	15 minutes

Table ECC.6.1.4.2(a) – Minimum time periods for which **DC Connected Power Park Modules** shall be capable of operating for different voltages deviating from reference 1pu without disconnecting from the network where the nominal voltage base is 110kV or above and less than 300kV.

Voltage Range (pu)	Time Period for Operation (s)
0.85pu – 0.9pu	60 minutes
0.9pu – 1.05pu	Unlimited
1.05pu – 1.15pu	15 minutes

Table ECC.6.1.4.2(b) – Minimum time periods for which **DC Connected Power Park Modules** shall be capable of operating for different voltages deviating from reference 1pu without disconnecting from the network where the nominal voltage base is from 300kV up to and including 400kV.

ECC.6.1.4.2.2 **The Company** and a **EU Generator** in respect of a **DC Connected Power Park Module** may agree greater voltage ranges or longer minimum operating times. If greater voltage ranges or longer minimum times for operation are economically and technically feasible, the **EU Generator** shall not unreasonably withhold any agreement .

ECC.6.1.4.2.3 For **DC Connected Power Park Modules** which have an **HVDC Interface Point** to the **Remote End HVDC Converter Station**, **The Company** in coordination with the **Relevant Transmission Licensee** may specify voltage limits at the **HVDC Interface Point** at which the **DC Connected Power Park Module** is capable of automatic disconnection.

ECC.6.1.4.2.4 For **HVDC Interface Points** which fall outside the scope of ECC.6.1.4.2.1, ECC.6.1.4.2.2 and ECC.6.1.4.2.3, **The Company** in coordination with the **Relevant Transmission Licensee** shall specify any applicable requirements at the **Grid Entry Point** or **User System Entry Point**.

ECC.6.1.4.2.5 Where the nominal frequency of the AC collector **System** which is connected to an **HVDC Interface Point** is at a value other than 50Hz, the voltage ranges and time periods specified by **The Company** in coordination with the **Relevant Transmission Licensee** shall be proportional to the values specified in Table ECC.6.1.4.2(a) and Table ECC.6.1.4.2(b)

ECC.6.1.4.3 Grid Voltage Variations for all Remote End HVDC Converters

ECC.6.1.4.3.1 All **Remote End HVDC Converter Stations** shall be capable of staying connected to the **HVDC Interface Point** and operating within the voltage ranges and time periods specified in Tables ECC.6.1.4.3(a) and ECC.6.1.4.3(b) below. The applicable voltage range and time periods specified are selected based on the reference 1pu voltage.

Voltage Range (pu)	Time Period for Operation (s)
0.85pu – 0.9pu	60 minutes
0.9pu – 1.1pu	Unlimited
1.1pu – 1.15pu	15 minutes

Table ECC.6.1.4.3(a) – Minimum time periods for which a **Remote End HVDC Converter** shall be capable of operating for different voltages deviating from reference 1pu without disconnecting from the network where the nominal voltage base is 110kV or above and less than 300kV.

Voltage Range (pu)	Time Period for Operation (s)
0.85pu – 0.9pu	60 minutes
0.9pu – 1.05pu	Unlimited
1.05pu – 1.15pu	15 minutes

Table ECC.6.1.4.3(b) – Minimum time periods for which a **Remote End HVDC Converter** shall be capable of operating for different voltages deviating from reference 1pu without disconnecting from the network where the nominal voltage base is from 300kV up to and including 400kV.

ECC.6.1.4.3.2 **The Company** and a **HVDC System Owner** may agree greater voltage ranges or longer minimum operating times which shall be in accordance with the requirements of ECC.6.1.4.2.

ECC.6.1.4.3.4 For **HVDC Interface Points** which fall outside the scope of ECC.6.1.4.3.1 **The Company** in coordination with the **Relevant Transmission Licensee** shall specify any applicable requirements at the **Grid Entry Point** or **User System Entry Point**.

ECC.6.1.4.3.5 Where the nominal frequency of the AC collector **System** which is connected to an **HVDC Interface Point** is at a value other than 50Hz, the voltage ranges and time periods specified by **The Company** in coordination with the **Relevant Transmission Licensee** shall be proportional to the values specified in Table ECC.6.1.4.3(a) and Table ECC.6.1.4.3(b)

#### Voltage Waveform Quality

ECC.6.1.5 All **Plant** and **Apparatus** connected to the **National Electricity Transmission System**, and that part of the **National Electricity Transmission System** at each **Connection Site** or, in the case of **OTSDUW Plant and Apparatus**, at each **Interface Point**, should be capable of withstanding the following distortions of the voltage waveform in respect of harmonic content and phase unbalance:

(a) Harmonic Content

The **Electromagnetic Compatibility Levels** for harmonic distortion on the **Onshore Transmission System** from all sources under both **Planned Outage** and fault outage conditions, (unless abnormal conditions prevail) shall comply with the levels shown in the tables of Appendix A of **Engineering Recommendation G5/4**. The **Electromagnetic Compatibility Levels** for harmonic distortion on an **Offshore Transmission System** will be defined in relevant **Bilateral Agreements**.

**Engineering Recommendation G5/4** contains planning criteria which **The Company** will apply to the connection of non-linear **Load** to the **National Electricity Transmission System**, which may result in harmonic emission limits being specified for these **Loads** in the relevant **Bilateral Agreement**. The application of the planning criteria will take into account the position of existing **User's** and **EU Code Users' Plant and Apparatus** (and **OTSDUW Plant and Apparatus**) in relation to harmonic emissions. **Users** must ensure that connection of distorting loads to their **User Systems** do not cause any harmonic emission limits specified in the **Bilateral Agreement**, or where no such limits are specified, the relevant planning levels specified in **Engineering Recommendation G5/4** to be exceeded.

(b) Phase Unbalance

Under **Planned Outage** conditions, the weekly 95 percentile of **Phase (Voltage) Unbalance**, calculated in accordance with IEC 61000-4-30 and IEC 61000-3-13, on the **National Electricity Transmission System** for voltages above 150kV should remain, in England and Wales, below 1.5%, and in Scotland, below 2%, and for voltages of 150kV and below, across GB below 2%, unless abnormal conditions prevail and **Offshore** (or in the case of **OTSDUW, OTSDUW Plant and Apparatus**) will be defined in relevant **Bilateral Agreements**.

The Phase Unbalance is calculated from the ratio of root mean square (rms) of negative phase sequence voltage to rms of positive phase sequence voltage, based on 10-minute average values, in accordance with IEC 61000-4-30.

ECC.6.1.6 Across GB, under the **Planned Outage** conditions stated in ECC.6.1.5(b) infrequent short duration peaks with a maximum value of 2% are permitted for **Phase (Voltage) Unbalance**, for voltages above 150kV, subject to the prior agreement of **The Company** under the **Bilateral Agreement** and in relation to **OTSDUW**, the **Construction Agreement**. **The Company** will only agree following a specific assessment of the impact of these levels on **Transmission Apparatus** and other **Users Apparatus** with which it is satisfied.

Voltage Fluctuations

ECC.6.1.7 Voltage changes at a **Point of Common Coupling** on the **Onshore Transmission System** shall not exceed:

(a) The limits specified in Table ECC.6.1.7 with the stated frequency of occurrence, where:

(i)

$$\% \Delta V_{\text{steadystate}} = \left| 100 \times \frac{\Delta V_{\text{steadystate}}}{V_0} \right|$$

and

$$\% \Delta V_{\text{max}} = 100 \times \frac{\Delta V_{\text{max}}}{V_0} ;$$

- (ii)  $V_0$  is the initial steady state system voltage;
- (iii)  $V_{\text{steadystate}}$  is the system voltage reached when the rate of change of system voltage over time is less than or equal to 0.5% over 1 second and  $\Delta V_{\text{steadystate}}$  is the absolute value of the difference between  $V_{\text{steadystate}}$  and  $V_0$ ;
- (iv)  $\Delta V_{\text{max}}$  is the absolute value of the maximum change in the system voltage relative to the initial steady state system voltage of  $V_0$ ;
- (v) All voltages are the root mean square of the voltage measured over one cycle refreshed every half a cycle as per IEC 61000-4-30;
- (vi) The voltage changes specified are the absolute maximum allowed, applied to phase to ground or phase to phase voltages whichever is the highest change;
- (vii) Voltage changes in category 3 do not exceed the limits depicted in the time dependent characteristic shown in Figure ECC.6.1.7;
- (viii) Voltage changes in category 3 only occur infrequently, typically not planned more than once per year on average over the lifetime of a connection, and in circumstances notified to **The Company**, such as for example commissioning in accordance with a commissioning programme, implementation of a planned outage notified in accordance with **OC2** or an **Operation** or **Event** notified in accordance with **OC7**; and
- (ix) For connections where voltage changes would constitute a risk to the **National Electricity Transmission System** or, in **The Company's** view, the **System** of any **User**, **Bilateral Agreements** may include provision for **The Company** to reasonably limit the number of voltage changes in category 2 or 3 to a lower number than specified in Table ECC.6.1.7 to ensure that the total number of voltage changes at the **Point of Common Coupling** across multiple **Users** remains within the limits of Table ECC.6.1.7.

Category	Maximum number of Occurrences	$\% \Delta V_{\text{max}}$ & $\% \Delta V_{\text{steadystate}}$
1	No Limit	$\left  \% \Delta V_{\text{max}} \right  \leq 1\% \text{ \& } \left  \% \Delta V_{\text{steadystate}} \right  \leq 1\%$
2	$\frac{3600}{\sqrt[0.304]{2.5 \times \% \Delta V_{\text{max}}}}$ occurrences per hour with events evenly distributed	$1\% < \left  \% \Delta V_{\text{max}} \right  \leq 3\% \text{ \& } \left  \% \Delta V_{\text{steadystate}} \right  \leq 3\%$
3	No more than 4 per day for Commissioning, Maintenance and Fault Restoration	For decreases in voltage: $\% \Delta V_{\text{max}} \leq 12\%^1 \text{ \& }$

		$\% \Delta V_{\text{steadystate}} \leq 3\%$ For increases in voltage: $\% \Delta V_{\text{max}} \leq 5\%^2$ & $\% \Delta V_{\text{steadystate}} \leq 3\%$ (see Figure ECC6.1.7)
--	--	---

Table ECC.6.1.7 - Limits for Rapid Voltage Changes

- <sup>1</sup> A decrease in voltage of up to 12% is permissible for up to 80ms, as highlighted in the shaded area in Figure ECC.6.1.7, reducing to up to 10% after 80ms and to up to 3% after 2 seconds.
- <sup>2</sup> An increase in voltage of up to 5% is permissible if it is reduced to up to 3% after 0.5 seconds.

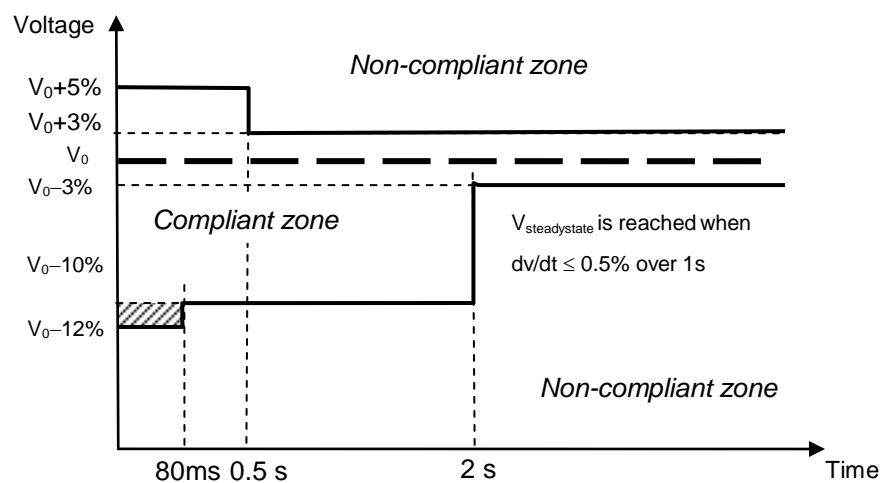

Figure ECC.6.1.7 - Time and magnitude limits for a category 3 Rapid Voltage Change

- (b) For voltages above 132kV, **Flicker Severity (Short Term)** of 0.8 Unit and a **Flicker Severity (Long Term)** of 0.6 Unit, for voltages 132kV and below, **Flicker Severity (Short Term)** of 1.0 Unit and a **Flicker Severity (Long Term)** of 0.8 Unit, as set out in **Engineering Recommendation P28** as current at the **Transfer Date**.

ECC.6.1.8 Voltage fluctuations at a **Point of Common Coupling** with a fluctuating **Load** directly connected to an **Offshore Transmission System** (or in the case of **OTSDUW, OTSDUW Plant and Apparatus**) shall not exceed the limits set out in the **Bilateral Agreement**.

Sub-Synchronous Resonance and Sub-Synchronous Torsional Interaction (SSTI)

ECC.6.1.9 **The Company** shall ensure that **Users' Plant and Apparatus** will not be subject to unacceptable Sub-Synchronous Oscillation conditions as specified in the relevant **License Standards**.

ECC.6.1.10 **The Company** shall ensure where necessary, and in consultation with **Transmission Licensees** where required, that any relevant site specific conditions applicable at a **User's Connection Site**, including a description of the Sub-Synchronous Oscillation conditions considered in the application of the relevant **License Standards**, are set out in the **User's Bilateral Agreement**.

-

ECC.6.2 Plant and Apparatus relating to Connection Sites and Interface Points and HVDC Interface Points

The following requirements apply to **Plant** and **Apparatus** relating to the **Connection Point** and **OTSDUW Plant and Apparatus** relating to the **Interface Point** (until the **OTSUA Transfer Time**), **HVDC Interface Points** relating to **Remote End HVDC Converters** and **Connection Points** which (except as otherwise provided in the relevant paragraph) each **EU Code User** must ensure are complied with in relation to its **Plant** and **Apparatus** and which in the case of ECC.6.2.2.2.2, ECC.6.2.3.1.1 and ECC.6.2.1.1(b) only, **The Company** must ensure are complied with in relation to **Transmission Plant** and **Apparatus**, as provided in those paragraphs.

ECC.6.2.1 General Requirements

- ECC.6.2.1.1 (a) The design of connections between the **National Electricity Transmission System** and:
- (i) any **Power Generating Module Generating Unit** (other than a **CCGT Unit** or **Power Park Unit**) **HVDC Equipment**, **Power Park Module** or **CCGT Module**, or
  - (ii) any **Network Operator's User System**, or
  - (iii) **Non-Embedded Customers** equipment;
- will be consistent with the **Licence Standards**.

In the case of **OTSDUW**, the design of the **OTSUA's** connections at the **Interface Point** and **Connection Point** will be consistent with **Licence Standards**.

- (b) The **National Electricity Transmission System** (and any **OTSDUW Plant and Apparatus**) at nominal **System** voltages of 132kV and above is/shall be designed to be earthed with an **Earth Fault Factor** of, in England and Wales or **Offshore**, below 1.4 and in Scotland, below 1.5. Under fault conditions the rated **Frequency** component of voltage could fall transiently to zero on one or more phases or, in England and Wales, rise to 140% phase-to-earth voltage, or in Scotland, rise to 150% phase-to-earth voltage. The voltage rise would last only for the time that the fault conditions exist. The fault conditions referred to here are those existing when the type of fault is single or two phase-to-earth.
- (c) For connections to the **National Electricity Transmission System** at nominal **System** voltages of below 132kV the earthing requirements and voltage rise conditions will be advised by **The Company** as soon as practicable prior to connection and in the case of **OTSDUW Plant and Apparatus** shall be advised to **The Company** by the **EU Code User**.

ECC.6.2.1.2 Substation Plant and Apparatus

- (a) The following provisions shall apply to all **Plant** and **Apparatus** which is connected at the voltage of the **Connection Point** (and **OTSDUW Plant and Apparatus** at the **Interface Point** ) and which is contained in equipment bays that are within the **Transmission busbar Protection** zone at the **Connection Point**. This includes circuit breakers, switch disconnectors, disconnectors, **Earthing Devices**, power transformers, voltage transformers, reactors, current transformers, surge arresters, bushings, neutral equipment, capacitors, line traps, coupling devices, external insulation and insulation co-ordination devices. Where necessary, this is as more precisely defined in the **Bilateral Agreement**.

- (ii) Plant and/or Apparatus in respect of EU Code Users connecting to a new Connection Point (including OTSDUW Plant and Apparatus at the Interface Point )

Each item of such **Plant** and/or **Apparatus** installed in relation to a new **Connection Point** (or **OTSDUW Plant and Apparatus** at the **Interface Point** or **Remote End HVDC Converter Station** at the **HVDC Interface Point**) shall comply with the relevant **Technical Specifications** and any further requirements identified by **The Company**, acting reasonably, to reflect the options to be followed within the **Technical Specifications** and/or to complement if necessary the **Technical**

**Specifications** so as to enable **The Company** to comply with its obligations in relation to the **National Electricity Transmission System** or, in Scotland or **Offshore**, the **Relevant Transmission Licensee** to comply with its obligations in relation to its **Transmission System**. This information, including the application dates of the relevant **Technical Specifications**, will be as specified in the **Bilateral Agreement**.

- (iii) EU Code User's Plant and/or Apparatus connecting to an existing Connection Point (including OTSDUW Plant and Apparatus at the Interface Point )

Each new additional and/or replacement item of such **Plant** and/or **Apparatus** installed in relation to a change to an existing **Connection Point** (or **OTSDUW Plant and Apparatus** at the **Interface Point** and **Connection Point** or **Remote End HVDC Converter Stations** at the **HVDC Interface Point**)—shall comply with the standards/specifications applicable when the change was designed, or such other standards/specifications as necessary to ensure that the item of **Plant** and/or **Apparatus** is reasonably fit for its intended purpose having due regard to the obligations of **NGET**, the relevant **User** and, in Scotland, or **Offshore**, also the **Relevant Transmission Licensee** under their respective **Licences**. Where appropriate this information, including the application dates of the relevant standards/specifications, will be as specified in the varied **Bilateral Agreement**.

- (iv) Used Plant and/or Apparatus being moved, re-used or modified

If, after its installation, any such item of **Plant** and/or **Apparatus** is subsequently:

- moved to a new location; or
- used for a different purpose; or
- otherwise modified;

then the standards/specifications as described in (i) or (ii) above as applicable will apply as appropriate to such **Plant** and/or **Apparatus**, which must be reasonably fit for its intended purpose having due regard to the obligations of **NGET**, the relevant **User** and, in Scotland or **Offshore**, also the **Relevant Transmission Licensee** under their respective **Licences**.

- (b) **NGET** shall at all times maintain a list of those **Technical Specifications** and additional requirements which might be applicable under this ECC.6.2.1.2 and which may be referenced by **NGET** in the **Bilateral Agreement**. **The Company** shall provide a copy of the list upon request to any **EU Code User**. **The Company** shall also provide a copy of the list to any **EU Code User** upon receipt of an application form for a **Bilateral Agreement** for a new **Connection Point**.
- (c) Where the **EU Code User** provides **The Company** with information and/or test reports in respect of **Plant** and/or **Apparatus** which the **EU Code User** reasonably believes demonstrate the compliance of such items with the provisions of a **Technical Specification** then **The Company** shall promptly and without unreasonable delay give due and proper consideration to such information.
- (d) **Plant** and **Apparatus** shall be designed, manufactured and tested in premises with an accredited certificate in accordance with the quality assurance requirements of the relevant standard in the BS EN ISO 9000 series (or equivalent as reasonably approved by **The Company**) or in respect of test premises which do not include a manufacturing facility premises with an accredited certificate in accordance with BS EN 45001.
- (e) Each connection between a **User** and the **National Electricity Transmission System** must be controlled by a circuit-breaker (or circuit breakers) capable of interrupting the maximum short circuit current at the point of connection. The **Seven Year Statement** gives values of short circuit current and the rating of **Transmission** circuit breakers at existing and committed **Connection Points** for future years.



- (f) Each connection between a **Generator** undertaking **OTSDUW** or an **Onshore Transmission Licensee**, must be controlled by a circuit breaker (or circuit breakers) capable of interrupting the maximum short circuit current at the **Transmission Interface Point**. The **Seven Year Statement** gives values of short circuit current and the rating of **Transmission** circuit breakers at existing and committed **Transmission Interface Points** for future years.

ECC.6.2.2 Requirements at **Connection Points** or, in the case of **OTSDUW** at **Interface Points** that relate to **Generators** or **OTSDUW Plant and Apparatus**

ECC.6.2.2.1 Not Used.

ECC.6.2.2.2 **Power Generating Module, OTSDUW Plant and Apparatus, HVDC Equipment and Power Station Protection Arrangements**

ECC.6.2.2.2.1 Minimum Requirements

**Protection of Power Generating Modules** (other than **Power Park Units**), **HVDC Equipment, OTSDUW Plant and Apparatus** and their connections to the **National Electricity Transmission System** shall meet the requirements given below. These are necessary to reduce the impact on the **National Electricity Transmission System** of faults on **OTSDUW Plant and Apparatus** circuits or circuits owned by **Generators** (including **DC Connected Power Park Modules**) or **HVDC System Owners**.

ECC.6.2.2.2.2 Fault Clearance Times

- (a) The required fault clearance time for faults on the **Generator's** (including **DC Connected Power Park Modules**) or **HVDC System Owner's** equipment directly connected to the **National Electricity Transmission System** or **OTSDUW Plant and Apparatus** and for faults on the **National Electricity Transmission System** directly connected to the **EU Generator** (including **DC Connected Power Park Modules**) or **HVDC System Owner's** equipment or **OTSDUW Plant and Apparatus**, from fault inception to the circuit breaker arc extinction, shall be set out in the **Bilateral Agreement**. The fault clearance time specified in the **Bilateral Agreement** shall not be shorter than the durations specified below:

- (i) 80ms at 400kV
- (ii) 100ms at 275kV
- (iii) 120ms at 132kV and below

but this shall not prevent the **User** or **The Company** or the **Relevant Transmission Licensee** or the **EU Generator** (including in respect of **OTSDUW Plant and Apparatus** and **DC Connected Power Park Modules**) from selecting a shorter fault clearance time on their own **Plant and Apparatus** provided **Discrimination** is achieved.

A longer fault clearance time may be specified in the **Bilateral Agreement** for faults on the **National Electricity Transmission System**. A longer fault clearance time for faults on the **EU Generator** or **HVDC System Owner's** equipment or **OTSDUW Plant and Apparatus** may be agreed with **The Company** in accordance with the terms of the **Bilateral Agreement** but only if **System** requirements, in **The Company's** view, permit. The probability that the fault clearance time stated in the **Bilateral Agreement** will be exceeded by any given fault, must be less than 2%.

- (b) In the event that the required fault clearance time is not met as a result of failure to operate on the **Main Protection System(s)** provided, the **Generators** or **HVDC System Owners** or **Generators** in the case of **OTSDUW Plant and Apparatus** shall, except as specified below provide **Independent Back-Up Protection**. **The Company** will also provide **Back-Up Protection** and **The Company's** and the **User's Back-Up Protections** will be co-ordinated so as to provide **Discrimination**.

On a **Power Generating Module** (other than a **Power Park Unit**), **HVDC Equipment** or **OTSDUW Plant and Apparatus** and connected to the **National Electricity Transmission System** at 400kV or 275kV and where two **Independent Main Protections** are provided to clear faults on the **HV Connections** within the required fault clearance time, the **Back-Up Protection** provided by **EU Generators** (including in respect of **OTSDUW Plant and Apparatus** and **DC Connected Power Park Modules**) and **HVDC System Owners** shall operate to give a fault clearance time of no longer than 300ms at the minimum infeed for normal operation for faults on the **HV Connections**. Where two **Independent Main Protections** are installed the **Back-Up Protection** may be integrated into one (or both) of the **Independent Main Protection** relays.

On a **Power Generating Module** (other than a **Power Park Unit**), **HVDC Equipment** or **OTSDUW Plant and Apparatus** and connected to the **National Electricity Transmission System** at 132 kV and where only one **Main Protection** is provided to clear faults on the **HV Connections** within the required fault clearance time, the **Independent Back-Up Protection** provided by the **Generator** (including in respect of **OTSDUW Plant and Apparatus** and **DC Connected Power Park Modules**) and the **HVDC System Owner** shall operate to give a fault clearance time of no longer than 300ms at the minimum infeed for normal operation for faults on the **HV Connections**.

A **Power Generating Module** (other than a **Power Park Unit**), **HVDC Equipment** or **OTSDUW Plant and Apparatus**) with **Back-Up Protection** or **Independent Back-Up Protection** will also be required to withstand, without tripping, the loading incurred during the clearance of a fault on the **National Electricity Transmission System** by breaker fail **Protection** at 400kV or 275kV or of a fault cleared by **Back-Up Protection** where the **EU Generator** (including in the case of **OTSDUW Plant and Apparatus** or **DC Connected Power Park Module**) or **HVDC System** is connected at 132kV and below. This will permit **Discrimination** between the **Generator** in respect of **OTSDUW Plant and Apparatus** or **DC Connected Power Park Modules** or **HVDC System Owners' Back-Up Protection** or **Independent Back-Up Protection** and the **Back-Up Protection** provided on the **National Electricity Transmission System** and other **Users' Systems**.

- (c) When the **Power Generating Module** (other than **Power Park Units**), or the **HVDC Equipment** or **OTSDUW Plant and Apparatus** is connected to the **National Electricity Transmission System** at 400kV or 275kV, and in Scotland and **Offshore** also at 132kV, and a circuit breaker is provided by the **Generator** (including in respect of **OTSDUW Plant and Apparatus** or **DC Connected Power Park Modules**) or the **HVDC System** owner, or **The Company**, as the case may be, to interrupt fault current interchange with the **National Electricity Transmission System**, or **Generator's System**, or **HVDC System Owner's System**, as the case may be, circuit breaker fail **Protection** shall be provided by the **Generator** (including in respect of **OTSDUW Plant and Apparatus** or **DC Connected Power Park Modules**) or **HVDC System-Owner**, or **The Company**, as the case may be, on this circuit breaker. In the event, following operation of a **Protection** system, of a failure to interrupt fault current by these circuit-breakers within the **Fault Current Interruption Time**, the circuit breaker fail **Protection** is required to initiate tripping of all the necessary electrically adjacent circuit-breakers so as to interrupt the fault current within the next 200ms.
- (d) The target performance for the **System Fault Dependability Index** shall be not less than 99%. This is a measure of the ability of **Protection** to initiate successful tripping of circuit breakers which are associated with the faulty item of **Apparatus**.

#### ECC.6.2.2.3 Equipment including **Protection** equipment to be provided

**The Company** shall specify the **Protection** schemes and settings necessary to protect the **National Electricity Transmission System**, taking into account the characteristics of the **Power Generating Module** or **HVDC Equipment**.

The protection schemes needed for the **Power Generating Module** or **HVDC Equipment** and the **National Electricity Transmission System** as well as the settings relevant to the **Power Generating Module** and/or **HVDC Equipment** shall be coordinated and agreed between **The Company** and the **EU Generator** or **HVDC System Owner**. The agreed **Protection** schemes and settings will be specified in the **Bilateral Agreement**.

The protection schemes and settings for internal electrical faults must not prevent the **Power Generating Module** or **HVDC Equipment** from satisfying the requirements of the Grid Code although **EU Generators** should be aware of the requirements of ECC.6.3.13.1. ;

**electrical Protection** of the **Power Generating Module** or **HVDC Equipment** shall take precedence over operational controls, taking into account the security of the **National Electricity Transmission System** and the health and safety of personnel, as well as mitigating any damage to the **Power Generating Module** or **HVDC Equipment**.

#### ECC.6.2.2.3.1 Protection of Interconnecting Connections

The requirements for the provision of **Protection** equipment for interconnecting connections will be specified in the **Bilateral Agreement**. In this ECC the term "interconnecting connections" means the primary conductors from the current transformer accommodation on the circuit side of the circuit breaker to the **Connection Point** or the primary conductors from the current transformer accommodation on the circuit side of the **OTSDUW Plant and Apparatus** of the circuit breaker to the **Transmission Interface Point**.

#### ECC.6.2.2.3.2 Circuit-breaker fail Protection

The **EU Generator** or **HVDC System Owner** will install circuit breaker fail **Protection** equipment in accordance with the requirements of the **Bilateral Agreement**. The **EU Generator** or **HVDC System Owner** will also provide a back-trip signal in the event of loss of air from its pressurised head circuit breakers, during the **Power Generating Module** (other than a **CCGT Unit** or **Power Park Unit**) or **HVDC Equipment** run-up sequence, where these circuit breakers are installed.

#### ECC.6.2.2.3.3 Loss of Excitation

The **EU Generator** must provide **Protection** to detect loss of excitation in respect of each of its **Generating Units** within a **Synchronous Power Generating Module** to initiate a **Generating Unit** trip.

#### ECC.6.2.2.3.4 Pole-Slipping Protection

Where, in **The Company's** reasonable opinion, **System** requirements dictate, **The Company** will specify in the **Bilateral Agreement** a requirement for **EU Generators** to fit pole-slipping **Protection** on their **Generating Units** within each **Synchronous Power Generating Module**.

#### ECC.6.2.2.3.5 Signals for Tariff Metering

**EU Generators** and **HVDC System Owners** will install current and voltage transformers supplying all tariff meters at a voltage to be specified in, and in accordance with, the **Bilateral Agreement**.

#### ECC.6.2.2.3.6 Commissioning of Protection Systems

No **EU Generator** or **HVDC System Owner** equipment shall be energised until the **Protection** settings have been finalised. The **EU Generator** or **HVDC System Owner** shall agree with **The Company** (in coordination with the **Relevant Transmission Licensee**) and carry out a combined commissioning programme for the **Protection** systems, and generally, to a minimum standard as specified in the **Bilateral Agreement**.

#### ECC.6.2.2.4 Work on Protection Equipment

No busbar **Protection**, mesh corner **Protection**, circuit-breaker fail **Protection** relays, AC or DC wiring (other than power supplies or DC tripping associated with the **Power Generating Module, HVDC Equipment** itself) may be worked upon or altered by the **EU Generator** or **HVDC System Owner** personnel in the absence of a representative of **The Company** or in Scotland or **Offshore**, a representative of **The Company**, or written authority from **The Company** to perform such work or alterations in the absence of a representative of **The Company**.

ECC.6.2.2.5 Relay Settings

**Protection** and relay settings will be co-ordinated (both on connection and subsequently) across the **Connection Point** in accordance with the **Bilateral Agreement** and in relation to **OTSDUW Plant and Apparatus**, across the **Interface Point** in accordance with the **Bilateral Agreement** to ensure effective disconnection of faulty **Apparatus**.

ECC.6.2.2.6 Changes to **Protection** Schemes and **HVDC System** Control Modes

ECC.6.2.2.6.1 Any subsequent alterations to the protection settings (whether by **The Company**, the **Relevant Transmission Licensee**, the **EU Generator** or the **HVDC System Owner**) shall be agreed between **The Company** (in co-ordination with the **Relevant Transmission Licensee**) and the **EU Generator** or **HVDC System Owner** in accordance with the Grid Code (ECC.6.2.2.5). No alterations are to be made to any protection schemes unless agreement has been reached between **The Company**, the **Relevant Transmission Licensee**, the **EU Generator** or **HVDC System Owner**.

ECC.6.2.2.6.2 The parameters of different control modes of the **HVDC System** shall be able to be changed in the **HVDC Converter Station**, if required by **The Company** in coordination with the **Relevant Transmission Licensee** and in accordance with ECC.6.2.2.6.4.

ECC.6.2.2.6.3 Any change to the schemes or settings of parameters of the different control modes and protection of the **HVDC System** including the procedure shall be agreed with **The Company** in coordination with the **Relevant Transmission Licensee** and the **HVDC System Owner**.

ECC.6.2.2.6.4 The control modes and associated set points shall be capable of being changed remotely, as specified by **The Company** in coordination with the **Relevant Transmission Licensee**.

ECC.6.2.2.7 Control Schemes and Settings

ECC.6.2.2.7.1 The schemes and settings of the different control devices on the **Power Generating Module** and **HVDC Equipment** that are necessary for **Transmission System** stability and for taking emergency action shall be agreed with **The Company** in coordination with the **Relevant Transmission Licensee** and the **EU Generator** or **HVDC System Owner**.

ECC.6.2.2.7.2 Subject to the requirements of ECC.6.2.2.7.1 any changes to the schemes and settings, defined in ECC.6.2.2.7.1, of the different control devices of the **Power Generating Module** or **HVDC Equipment** shall be coordinated and agreed between , the **Relevant Transmission Licensee**, the **EU Generator** and **HVDC System Owner**.

ECC.6.2.2.8 Ranking of **Protection** and **Control**

ECC.6.2.2.8.1 **The Company** in coordination with **Relevant Transmission Licensees**, shall agree and coordinate the protection and control devices of **EU Generators Plant and Apparatus** in accordance with the following general priority ranking (from highest to lowest):

- (i) The interface between the **National Electricity Transmission System** and the **Power Generating Module** or **HVDC Equipment Protection** equipment;
- (ii) frequency control (active power adjustment);
- (iii) power restriction; and
- (iv) power gradient constraint;

ECC.6.2.2.8.2 A control scheme, specified by the **HVDC System Owner** consisting of different control modes, including the settings of the specific parameters, shall be coordinated and agreed between **The Company** in coordination with the **Relevant Transmission Licensee** and the **HVDC System Owner**. These details would be specified in the **Bilateral Agreement**.

ECC.6.2.2.8.3 **The Company** in coordination with **Relevant Transmission Licensees**, shall agree and coordinate the protection and control devices of **HVDC System Owners Plant and Apparatus** in accordance with the following general priority ranking (from highest to lowest)

- (i) The interface between the **National Electricity Transmission System** and **HVDC System Protection** equipment;
- (ii) **Active Power** control for emergency assistance
- (iii) automatic remedial actions as specified in ECC.6.3.6.1.2.5
- (iv) **Limited Frequency Sensitive Mode (LFSM)** of operation;
- (v) **Frequency Sensitive Mode** of operation and **Frequency** control; and
- (vi) power gradient constraint.

ECC.6.2.2.9 Synchronising

ECC.6.2.2.9.1 For any **Power Generating Module** directly connected to the **National Electricity Transmission System** or **Type D Power Generating Module**, synchronisation shall be performed by the **EU Generator** only after instruction by **The Company** in accordance with the requirements of BC.2.5.2.

ECC.6.2.2.9.2 Each **Power Generating Module** directly connected to the **National Electricity Transmission System** or **Type D Power Generating Module** shall be equipped with the necessary synchronisation facilities. Synchronisation shall be possible within the range of frequencies specified in ECC.6.1.2.

ECC.6.2.2.9.3 The requirements for synchronising equipment shall be specified in accordance with the requirements in the **Electrical Standards** listed in the annex to the **General Conditions**. The synchronisation settings shall include the following elements below. Any variation to these requirements shall be pursuant to the terms of the **Bilateral Agreement**.

- (a) voltage
- (b) **Frequency**
- (c) phase angle range
- (d) phase sequence
- (e) deviation of voltage and **Frequency**

ECC.6.2.2.9.4 **HVDC Equipment** shall be required to satisfy the requirements of ECC.6.2.2.9.1 – ECC.6.2.2.9.3. In addition, unless otherwise specified by **The Company**, during the synchronisation of a **DC Connected Power Park Module** to the **National Electricity Transmission System**, any **HVDC Equipment** shall have the capability to limit any steady state voltage changes to the limits specified within ECC.6.1.7 or ECC.6.1.8 (as applicable) which shall not exceed 5% of the pre-synchronisation voltage. **The Company** in coordination with the **Relevant Transmission Licensee** shall specify any additional requirements for the maximum magnitude, duration and measurement of the voltage transients over and above those defined in ECC.6.1.7 and ECC.6.1.8 in the **Bilateral Agreement**.

ECC.6.2.2.9.5 **EU Generators** in respect of **DC Connected Power Park Modules** shall also provide output synchronisation signals specified by **The Company** in co-ordination with the **Relevant Transmission Licensee**.

ECC.6.2.2.9.6 In addition to the requirements of ECC.6.2.2.9.1 to ECC.6.2.2.9.5, **EU Generators** and **HVDC System Owners** should also be aware of the requirements of ECC.6.5.10 relating to busbar voltage

ECC.6.2.2.9.10 HVDC Parameters and Settings

ECC.6.2.2.9.10.1 The parameters and settings of the main control functions of an **HVDC System** shall be agreed between the **HVDC System** owner and **The Company**, in coordination with the **Relevant Transmission Licensee**. The parameters and settings shall be implemented within such a control hierarchy that makes their modification possible if necessary. Those main control functions are at least:

- (b) **Frequency Sensitive Modes** (FSM, LFSM-O, LFSM-U);
- (c) **Frequency** control, if applicable;
- (d) **Reactive Power** control mode, if applicable;
- (e) power oscillation damping capability;
- (f) subsynchronous torsional interaction damping capability,.

ECC.6.2.2.11 Automatic Reconnection

ECC.6.2.2.11.1 **EU Generators** in respect of **Type A**, **Type B**, **Type C** and **Type D Power Generating Modules** (including **DC Connected Power Park Modules**) which have signed a **CUSC Contract** with **The Company** are not permitted to automatically reconnect to the **Total System** without instruction from **The Company**. **The Company** will issue instructions for reconnection or re-synchronisation in accordance with the requirements of BC2.5.2. Where synchronising is permitted in accordance with BC2.5.2, the voltage and frequency at the **Grid Entry Point** or **User System Entry Point** shall be within the limits defined in ECC.6.1.2 and ECC.6.1.4 and the ramp rate limits pursuant to BC1.A.1.1. For the avoidance of doubt this requirement does not apply to **EU Generators** who are not required to satisfy the requirements of the Balancing Codes.

ECC.6.2.2.12 Automatic Disconnection

ECC.6.2.2.12.1 No **Power Generating Module** or **HVDC Equipment** shall disconnect within the frequency range or voltage range defined in ECC.6.1.2 and ECC.6.1.4.

ECC.6.2.2.13 Special Provisions relating to Power Generating Modules embedded within Industrial Sites which supply electricity as a bi-product of their industrial process

ECC.6.2.2.13.1 **Generators** in respect of **Power Generating Modules** which form part of an industrial network, where the **Power Generating Module** is used to supply critical loads within the industrial process shall be permitted to operate isolated from the **Total System** if agreed with **The Company** in the **Bilateral Agreement**.

ECC.6.2.2.13.2 Except for the requirements of ECC.6.3.3 and ECC.6.3.7.1, **Power Generating Modules** which are embedded within industrial sites are not required to satisfy the requirements of ECC.6.3.6.2.1 and ECC.6.3.9. In this case this exception would only apply to **Power Generating Modules** on industrial sites used for combined heat and power production which are embedded in the network of an industrial site where all the following criteria are met.

- (a) The primary purpose of these sites is to produce heat for production processes of the industrial site concerned,
- (b) Heat and power generation is inextricably interlinked, that is to say any change to heat generation results inadvertently in a change of active power generating and visa versa.
- (c) The **Power Generating Modules** are of **Type A**, **Type B** or **Type C**.
- (d) Combined heat and power generating facilities shall be assessed on the basis of their electrical **Maximum Capacity**.

ECC.6.2.3 Requirements at EU Grid Supply Points relating to Network Operators and Non-Embedded Customers

ECC.6.2.3.1 Protection Arrangements for EU Code Users in respect of Network Operators and Non-Embedded Customers

ECC.6.2.3.1.1 **Protection** arrangements for **EU Code Users** in respect of **Network Operators** and **Non-Embedded Customers User Systems** directly connected to the **National Electricity Transmission System**, shall meet the requirements given below:

Fault Clearance Times

(a) The required fault clearance time for faults on **Network Operator** and **Non-Embedded Customer** equipment directly connected to the **National Electricity Transmission System**, and for faults on the **National Electricity Transmission System** directly connected to the **Network Operator's** or **Non-Embedded Customer's** equipment, from fault inception to the circuit breaker arc extinction, shall be set out in each **Bilateral Agreement**. The fault clearance time specified in the **Bilateral Agreement** shall not be shorter than the durations specified below:

- (i) 80ms at 400kV
- (ii) 100ms at 275kV
- (iii) 120ms at 132kV and below

but this shall not prevent the **User** or **The Company** or **Relevant Transmission Licensee** from selecting a shorter fault clearance time on its own **Plant** and **Apparatus** provided **Discrimination** is achieved.

For the purpose of establishing the **Protection** requirements in accordance with ECC.6.2.3.1.1 only, the point of connection of the **Network Operator** or **Non-Embedded Customer** equipment to the **National Electricity Transmission System** shall be deemed to be the low voltage busbars at an **EU Grid Supply Point**, irrespective of the ownership of the equipment at the **EU Grid Supply Point**.

A longer fault clearance time may be specified in the **Bilateral Agreement** for faults on the **National Electricity Transmission System**. A longer fault clearance time for faults on the **Network Operator** and **Non-Embedded Customers** equipment may be agreed with **The Company** in accordance with the terms of the **Bilateral Agreement** but only if **System** requirements in **The Company's** view permit. The probability that the fault clearance time stated in the **Bilateral Agreement** will be exceeded by any given fault must be less than 2%.

- (b) (i) For the event of failure of the **Protection** systems provided to meet the above fault clearance time requirements, **Back-Up Protection** shall be provided by the **Network Operator** or **Non-Embedded Customer** as the case may be.
- (ii) **The Company** will also provide **Back-Up Protection**, which will result in a fault clearance time longer than that specified for the **Network Operator** or **Non-Embedded Customer Back-Up Protection** so as to provide **Discrimination**.
- (iii) For connections with the **National Electricity Transmission System** at 132kV and below, it is normally required that the **Back-Up Protection** on the **National Electricity Transmission System** shall discriminate with the **Network Operator** or **Non-Embedded Customer's Back-Up Protection**.
- (iv) For connections with the **National Electricity Transmission System** at 400kV or 275kV, the **Back-Up Protection** will be provided by the **Network Operator** or **Non-Embedded Customer**, as the case may be, with a fault clearance time not longer than 300ms for faults on the **Network Operator's** or **Non-Embedded Customer's Apparatus**.
- (v) Such **Protection** will also be required to withstand, without tripping, the loading incurred during the clearance of a fault on the **National Electricity Transmission**

**System** by breaker fail **Protection** at 400kV or 275kV. This will permit **Discrimination** between **Network Operator's Back-Up Protection** or **Non-Embedded Customer's Back-Up Protection**, as the case may be, and **Back-Up Protection** provided on the **National Electricity Transmission System** and other **User Systems**. The requirement for and level of **Discrimination** required will be specified in the **Bilateral Agreement**.

- (c) (i) Where the **Network Operator** or **Non-Embedded Customer** is connected to the **National Electricity Transmission System** at 400kV or 275kV, and in Scotland also at 132kV, and a circuit breaker is provided by the **Network Operator** or **Non-Embedded Customer**, or **The Company**, as the case may be, to interrupt the interchange of fault current with the **National Electricity Transmission System** or the **System** of the **Network Operator** or **Non-Embedded Customer**, as the case may be, circuit breaker fail **Protection** will be provided by the **Network Operator** or **Non-Embedded Customer**, or **The Company**, as the case may be, on this circuit breaker.
  - (ii) In the event, following operation of a **Protection** system, of a failure to interrupt fault current by these circuit-breakers within the **Fault Current Interruption Time**, the circuit breaker fail **Protection** is required to initiate tripping of all the necessary electrically adjacent circuit-breakers so as to interrupt the fault current within the next 200ms.
- (d) The target performance for the **System Fault Dependability Index** shall be not less than 99%. This is a measure of the ability of **Protection** to initiate successful tripping of circuit breakers which are associated with the faulty items of **Apparatus**.



#### ECC.6.2.3.2 Fault Disconnection Facilities

- (a) Where no **Transmission** circuit breaker is provided at the **User's** connection voltage, the **User** must provide **The Company** with the means of tripping all the **User's** circuit breakers necessary to isolate faults or **System** abnormalities on the **National Electricity Transmission System**. In these circumstances, for faults on the **User's System**, the **User's Protection** should also trip higher voltage **Transmission** circuit breakers. These tripping facilities shall be in accordance with the requirements specified in the **Bilateral Agreement**.
- (b) **The Company** may require the installation of a **System to Generator Operational Intertripping Scheme** in order to enable the timely restoration of circuits following power **System** fault(s). These requirements shall be set out in the relevant **Bilateral Agreement**.

#### ECC.6.2.3.3 Automatic Switching Equipment

Where automatic reclosure of **Transmission** circuit breakers is required following faults on the **User's System**, automatic switching equipment shall be provided in accordance with the requirements specified in the **Bilateral Agreement**.

#### ECC.6.2.3.4 Relay Settings

**Protection** and relay settings will be co-ordinated (both on connection and subsequently) across the **Connection Point** in accordance with the **Bilateral Agreement** to ensure effective disconnection of faulty **Apparatus**.

#### ECC.6.2.3.5 Work on Protection equipment

Where a **Transmission Licensee** owns the busbar at the **Connection Point**, no busbar **Protection**, mesh corner **Protection** relays, AC or DC wiring (other than power supplies or DC tripping associated with the **Network Operator** or **Non-Embedded Customer's Apparatus** itself) may be worked upon or altered by the **Network Operator** or **Non-Embedded Customer** personnel in the absence of a representative of **The Company** or in Scotland, a representative of **The Company**, or written authority from **The Company** to perform such work or alterations in the absence of a representative of **The Company**.

#### ECC.6.2.3.6 Equipment including Protection equipment to be provided

**NGET** in coordination with the **Relevant Transmission Licensee** shall specify and agree the **Protection** schemes and settings at each **EU Grid Supply Point** required to protect the **National Electricity Transmission System** in accordance with the characteristics of the **Network Operator's** or **Non Embedded Customer's System**. **NGET** in coordination with the **Relevant Transmission Licensee** and the **Network Operator** or **Non Embedded Customer** shall agree on the protection schemes and settings in respect of the busbar protection zone in respect of each **EU Grid Supply Point**.

**Protection** of the **Network Operator's** or **Non Embedded Customer's System** shall take precedence over operational controls whilst respecting the security of the **National Electricity Transmission System** and the health and safety of staff and the public.

#### ECC.6.2.3.6.1 Protection of Interconnecting Connections

The requirements for the provision of **Protection** equipment for interconnecting connections will be specified in the **Bilateral Agreement**.

#### ECC.6.2.3.7 Changes to Protection Schemes at EU Grid Supply Points

Any subsequent alterations to the busbar protection settings at the **EU Grid Supply Point** (whether by **NGET**, the **Relevant Transmission Licensee**, the **Network Operator** or the **Non Embedded Customer**) shall be agreed between **NGET** (in co-ordination with the **Relevant Transmission Licensee**) and the **Network Operator** or **Non Embedded Customer** in accordance with the Grid Code (ECC.6.2.3.4). No alterations are to be made to any busbar protection schemes unless agreement has been reached between **NGET**, the **Relevant Transmission Licensee**, the **Network Operator** or **Non Embedded Customer**.

No **Network Operator** or **Non Embedded Customer** equipment shall be energised until the **Protection** settings have been agreed prior to commissioning. The **Network Operator** or **Non Embedded Customer** shall agree with **NGET** (in coordination with the **Relevant Transmission Licensee**) and carry out a combined commissioning programme for the **Protection** systems, and generally, to a minimum standard as specified in the **Bilateral Agreement**.

#### ECC.6.2.3.8 Control Requirements

ECC.6.2.3.8.1 **NGET** in coordination with the **Relevant Transmission Licensee** and the **Network Operator** or **Non Embedded Customer** shall agree on the control schemes and settings at each **EU Grid Supply Point** of the different control devices of the **Network Operator's** or **Non Embedded Customer's System** relevant for security of the **National Electricity Transmission System**. Such requirements would be pursuant to the terms of the **Bilateral Agreement** which shall also cover at least the following elements:

- (a) Isolated (**National Electricity Transmission System**) operation;
- (b) Damping of oscillations;
- (c) Disturbances to the **National Electricity Transmission System**;
- (d) Automatic switching to emergency supply and restoration to normal topology;
- (e) Automatic circuit breaker re-closure (on 1-phase faults).

ECC.6.2.3.8.2 Subject to the requirements of ECC.6.2.3.8.1 any changes to the schemes and settings, defined in ECC.6.2.3.8.1 of the different control devices of the **Network Operator's** or **Non-Embedded Customer's System** at the **EU Grid Supply Point** shall be coordinated and agreed between **NGET**, the **Relevant Transmission Licensee**, the **Network Operator** or **Non Embedded Customer**.

#### ECC.6.2.3.9 Ranking of Protection and Control

ECC.6.2.3.9.1 The **Network Operator** or the **Non Embedded Customer** who owns or operates an **EU Grid Supply Point** shall set the **Protection** and control devices of its **System**, in compliance with the following priority ranking, organised in decreasing order of importance:

- (a) **National Electricity Transmission System Protection**;
- (b) **Protection** equipment at each **EU Grid Supply Point**;
- (c) **Frequency** control (**Active Power** adjustment);
- (d) **Power** restriction.

#### ECC.6.2.3.10 Synchronising

ECC.6.2.3.10.1 Each **Network Operator** or **Non Embedded Customer** at each **EU Grid Supply Point** shall be capable of synchronisation within the range of frequencies specified in ECC.6.1.2 unless otherwise agreed with **NGET**.

ECC.6.2.3.10.2 **NGET** and the **Network Operator** or **Non Embedded Customer** shall agree on the settings of the synchronisation equipment at each **EU Grid Supply Point** prior to the **Completion Date**. **NGET** and the relevant **Network Operator** or **Non-Embedded Customer** shall agree the synchronisation settings which shall include the following elements.

- (a) Voltage;
- (b) **Frequency**;
- (c) phase angle range;
- (d) deviation of voltage and **Frequency**.

ECC.6.3 GENERAL POWER GENERATING MODULE, OTSDUW AND HVDC EQUIPMENT REQUIREMENTS

ECC.6.3.1 This section sets out the technical and design criteria and performance requirements for **Power Generating Modules** (which includes Electricity Storage Modules) and **HVDC Equipment** (whether directly connected to the **National Electricity Transmission System** or **Embedded**) and (where provided in this section) **OTSDUW Plant and Apparatus** which each **Generator** or **HVDC System Owner** must ensure are complied with in relation to its **Power Generating Modules** (including Electricity Storage Modules), **HVDC Equipment** and **OTSDUW Plant and Apparatus**. References to **Power Generating Modules** (which includes Electricity Storage Modules), **HVDC Equipment** in this ECC.6.3 should be read accordingly. For the avoidance of doubt the requirements applicable to Synchronous Power Generating Modules also apply to Synchronous Electricity Storage Modules and the requirements applicable to Power Park Modules apply to Non-Synchronous Electricity Storage Modules unless otherwise specified.

Plant Performance Requirements

ECC.6.3.2 REACTIVE CAPABILITY

ECC.6.3.2.1 Reactive Capability for Type B Synchronous Power Generating Modules

ECC.6.3.2.1.1 When operating at **Maximum Capacity**, all **Type B Synchronous Power Generating Modules** must be capable of continuous operation at any points between the limits of 0.95 **Power Factor** lagging and 0.95 **Power Factor** leading at the **Grid Entry Point** or **User System Entry Point** unless otherwise agreed with **The Company** or relevant **Network Operator**. At **Active Power** output levels other than **Maximum Capacity**, all **Generating Units** within a **Type B Synchronous Power Generating Module** must be capable of continuous operation at any point between the **Reactive Power** capability limits identified on the **HV Generator Performance Chart** unless otherwise agreed with **The Company** or relevant **Network Operator**.

ECC.6.3.2.2 Reactive Capability for Type B Power Park Modules

ECC.6.3.2.2.1 When operating at **Maximum Capacity** all **Type B Power Park Modules** must be capable of continuous operation at any points between the limits of 0.95 **Power Factor** lagging and 0.95 **Power Factor** leading at the **Grid Entry Point** or **User System Entry Point** unless otherwise agreed with **The Company** or relevant **Network Operator**. At **Active Power** output levels other than **Maximum Capacity**, each **Power Park Module** must be capable of continuous operation at any point between the **Reactive Power** capability limits identified on the **HV Generator Performance Chart** unless otherwise agreed with **The Company** or **Network Operator**.

ECC.6.3.2.3 Reactive Capability for Type C and D Synchronous Power Generating Modules

ECC.6.3.2.3.1 In addition to meeting the requirements of ECC.6.3.2.3.2 – ECC.6.3.2.3.5, **EU Generators** which connect a **Type C** or **Type D Synchronous Power Generating Module(s)** to a **Non Embedded Customers System** or private network, may be required to meet additional reactive compensation requirements at the point of connection between the **System** and the **Non Embedded Customer** or private network where this is required for **System** reasons.

ECC.6.3.2.3.2 All **Type C** and **Type D Synchronous Power Generating Modules** shall be capable of satisfying the **Reactive Power** capability requirements at the **Grid Entry Point** or **User System Entry Point** as defined in Figure ECC.6.3.2.3 when operating at **Maximum Capacity**.

ECC.6.3.2.3.3

At **Active Power** output levels other than **Maximum Capacity**, all **Generating Units** within a **Synchronous Power Generating Module** must be capable of continuous operation at any point between the **Reactive Power** capability limit identified on the **HV Generator Performance Chart** at least down to the **Minimum Stable Operating Level**. At reduced **Active Power** output, **Reactive Power** supplied at the **Grid Entry Point** (or **User System Entry Point** if **Embedded**) shall correspond to the **HV Generator Performance Chart** of the **Synchronous Power Generating Module**, taking the auxiliary supplies and the **Active Power** and **Reactive Power** losses of the **Generating Unit** transformer or **Station Transformer** into account.

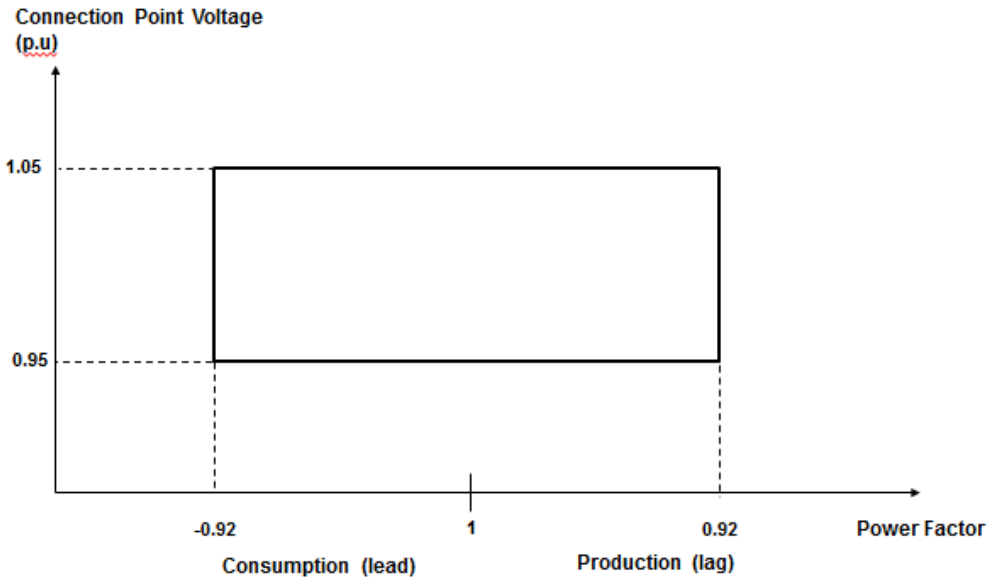

Figure ECC.6.3.2.3

ECC.6.3.2.3.4

In addition, to the requirements of ECC.6.3.2.3.1 – ECC.6.3.2.3.3 the short circuit ratio of all **Onshore Synchronous Generating Units** with an **Apparent Power** rating of less than 1600MVA shall not be less than 0.5. The short circuit ratio of **Onshore Synchronous Generating Units** with a rated **Apparent Power** of 1600MVA or above shall be not less than 0.4.

ECC.6.3.2.4

Reactive Capability for **Type C** and **D Power Park Modules, HVDC Equipment** and **OTSDUW Plant and Apparatus** at the **Interface Point**

ECC.6.3.2.4.1

**EU Generators** or **HVDC System Owners** which connect an **Onshore Type C** or **Onshore Type D Power Park Module** or **HVDC Equipment** to a **Non Embedded Customers System** or private network, may be required to meet additional reactive compensation requirements at the point of connection between the **System** and the **Non Embedded Customer** or private network where this is required for **System** reasons.

ECC.6.3.2.4.2

All **Onshore Type C Power Park Modules** and **Onshore Type D Power Park Modules** or **HVDC Converters** at an **HVDC Converter Station** with a **Grid Entry Point** or **User System Entry Point** voltage above 33kV, or **Remote End HVDC Converters** with an **HVDC Interface Point** voltage above 33kV, or **OTSDUW Plant and Apparatus** with an **Interface Point** voltage above 33kV shall be capable of satisfying the **Reactive Power** capability requirements at the **Grid Entry Point** or **User System Entry Point** (or **Interface Point** in the case of **OTSDUW Plant and Apparatus**, or **HVDC Interface Point** in the case of a **Remote End HVDC Converter Station**) as defined in Figure ECC.6.3.2.4(a) when operating at **Maximum Capacity** (or **Interface Point Capacity** in the case of **OTSUW Plant and Apparatus**). In the case of **Remote End HVDC Converters** and **DC Connected Power Park Modules**, **The Company** in co-ordination with the **Relevant Transmission Licensee** may agree to alternative reactive capability requirements to those specified in Figure ECC.6.3.2.4(a), where it is demonstrated that it is uneconomic and inefficient to do so, for example in the case of new technologies or advanced control strategies. For the avoidance of doubt, the requirements for **Offshore Power Park Modules** and **DC Connected Power Park Modules** are defined in ECC.6.3.2.5 and ECC.6.3.2.6.

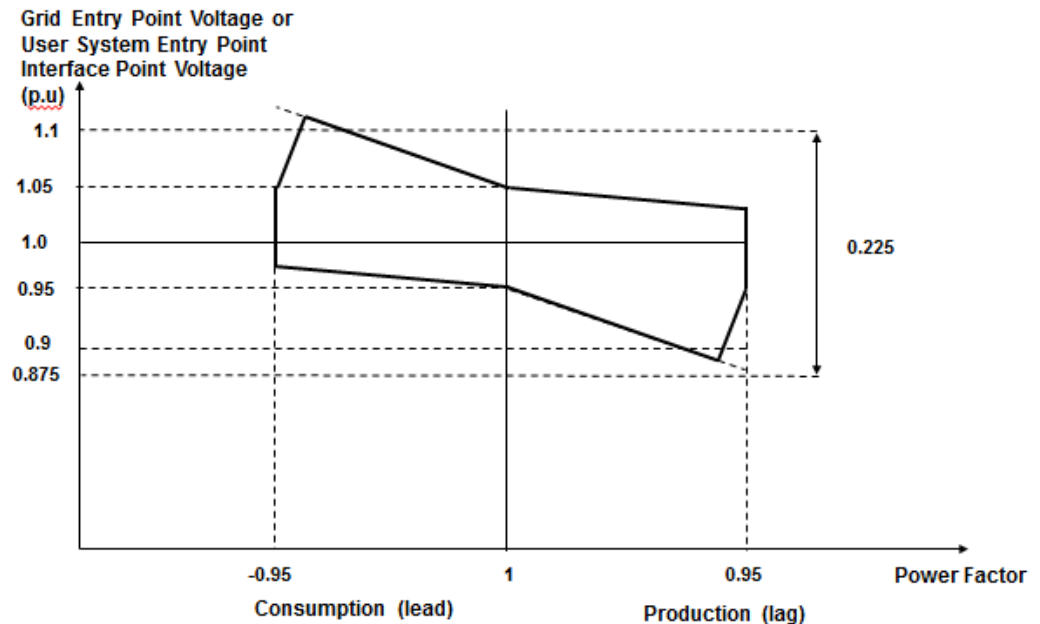

Figure ECC.6.3.2.4(a)

ECC.6.3.2.4.3

All **Onshore Type C** or **Type D Power Park Modules** or **HVDC Converters** at a **HVDC Converter Station** with a **Grid Entry Point** or **User System Entry Point** voltage at or below 33kV or **Remote End HVDC Converter Station** with an **HVDC Interface Point Voltage** at or below 33kV shall be capable of satisfying the **Reactive Power** capability requirements at the **Grid Entry Point** or **User System Entry Point** as defined in Figure ECC.6.3.2.4(b) when operating at **Maximum Capacity**. In the case of **Remote End HVDC Converters** **The Company** in co-ordination with the **Relevant Transmission Licensee** may agree to alternative reactive capability requirements to those specified in Figure ECC.6.3.2.4(b), where it is demonstrated that it is uneconomic and inefficient to do so, for example in the case of new technologies or advanced control strategies. For the avoidance of doubt, the requirements for **Offshore Power Park Modules** and **DC Connected Power Park Modules** are defined in ECC.6.3.2.5 and ECC.6.3.2.6.

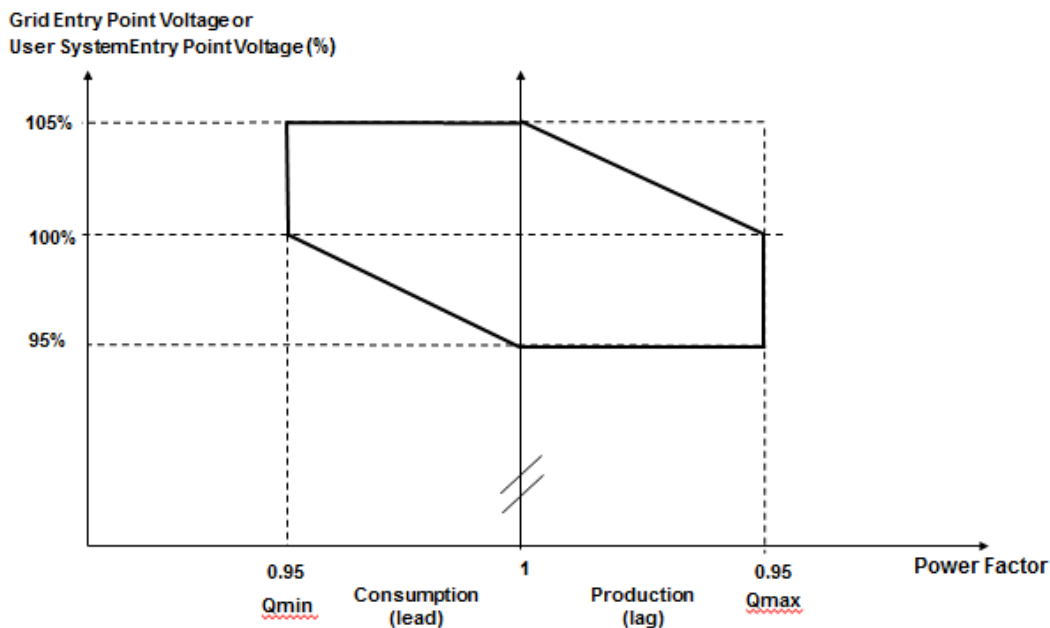

Figure ECC.6.3.2.4(a)

ECC.6.3.2.4.4 All **Type C** and **Type D Power Park Modules, HVDC Converters** at a **HVDC Converter Station** including **Remote End HVDC Converters** or **OTSDUW Plant and Apparatus**, shall be capable of satisfying the **Reactive Power** capability requirements at the **Grid Entry Point** or **User System Entry Point** (or **Interface Point Capacity** in the case of **OTSUW Plant and Apparatus** or **HVDC Interface Point** in the case of **Remote End HVDC Converter Stations**) as defined in Figure ECC.6.3.2.4(c) when operating below **Maximum Capacity**. With all **Plant** in service, the **Reactive Power** limits will reduce linearly below 50% **Active Power** output as shown in Figure ECC.6.3.2.4(c) unless the requirement to maintain the **Reactive Power** limits defined at **Maximum Capacity** (or **Interface Point Capacity** in the case of **OTSDUW Plant and Apparatus**) under absorbing **Reactive Power** conditions down to 20% **Active Power** output has been specified by **The Company**. These **Reactive Power** limits will be reduced pro rata to the amount of **Plant** in service. In the case of **Remote End HVDC Converters**, **The Company** in co-ordination with the **Relevant Transmission Licensee** may agree to alternative reactive capability requirements to those specified in Figure ECC.6.3.2.4(a), where it is demonstrated that it is uneconomic and inefficient to do so, for example in the case of new technologies or advanced control strategies. For the avoidance of doubt, the requirements for **Offshore Power Park Modules** and **DC Connected Power Park Modules** are defined in ECC.6.3.2.5 and ECC.6.3.2.6.

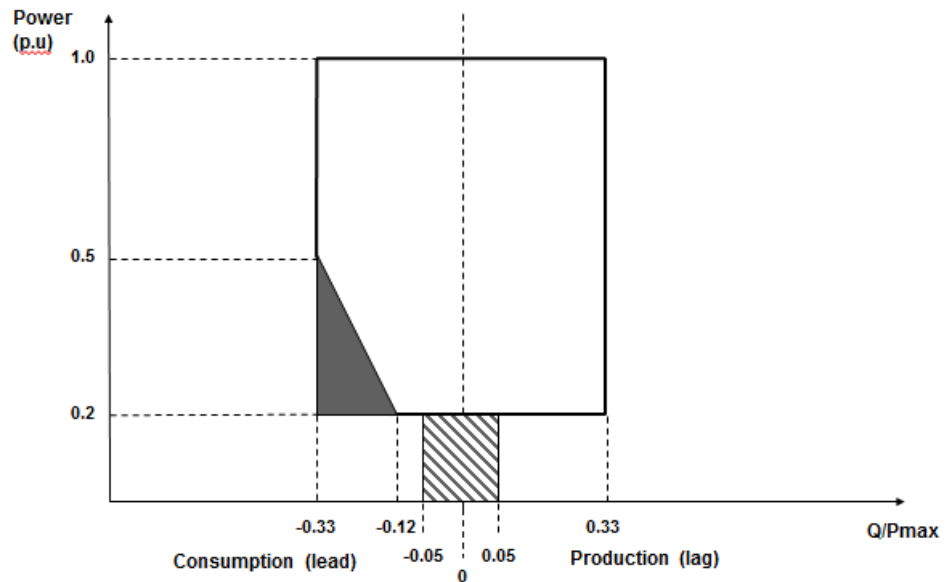

Figure ECC.6.3.2.4(c)

- ECC.6.3.2.5 Reactive Capability for Offshore Synchronous Power Generating Modules, Configuration 1 AC connected Offshore Power Park Modules and Configuration 1 DC Connected Power Park Modules.
- ECC.6.3.2.5.1 The short circuit ratio of any **Offshore Synchronous Generating Units** within a **Synchronous Power Generating Module** shall not be less than 0.5. All **Offshore Synchronous Generating Units, Configuration 1 AC connected Offshore Power Park Modules or Configuration 1 DC Connected Power Park Modules** must be capable of maintaining zero transfer of **Reactive Power** at the **Offshore Grid Entry Point**. The steady state tolerance on **Reactive Power** transfer to and from an **Offshore Transmission System** expressed in **MVar** shall be no greater than 5% of the **Maximum Capacity**.
- ECC.6.3.2.5.2 For the avoidance of doubt if an **EU Generator** (including those in respect of **DC Connected Power Park Modules**) wishes to provide a **Reactive Power** capability in excess of the minimum requirements defined in ECC.6.3.2.5.1 then such capability (including steady state tolerance) shall be agreed between the **Generator, Offshore Transmission Licensee and The Company** and/or the relevant **Network Operator**.
- ECC.6.3.2.6 Reactive Capability for Configuration 2 AC Connected Offshore Power Park Modules and Configuration 2 DC Connected Power Park Modules.
- ECC.6.3.2.6.1 All **Configuration 2 AC connected Offshore Power Park Modules and Configuration 2 DC Connected Power Park Modules** shall be capable of satisfying the minimum **Reactive Power** capability requirements at the **Offshore Grid Entry Point** as defined in Figure ECC.6.3.2.6(a) when operating at **Maximum Capacity**. **The Company** in co-ordination with the **Relevant Transmission Licensee** may agree to alternative reactive capability requirements to those specified in Figure ECC.6.3.2.6(a), where it is demonstrated that it is uneconomic and inefficient to do so, for example in the case of new technologies or advanced control strategies.

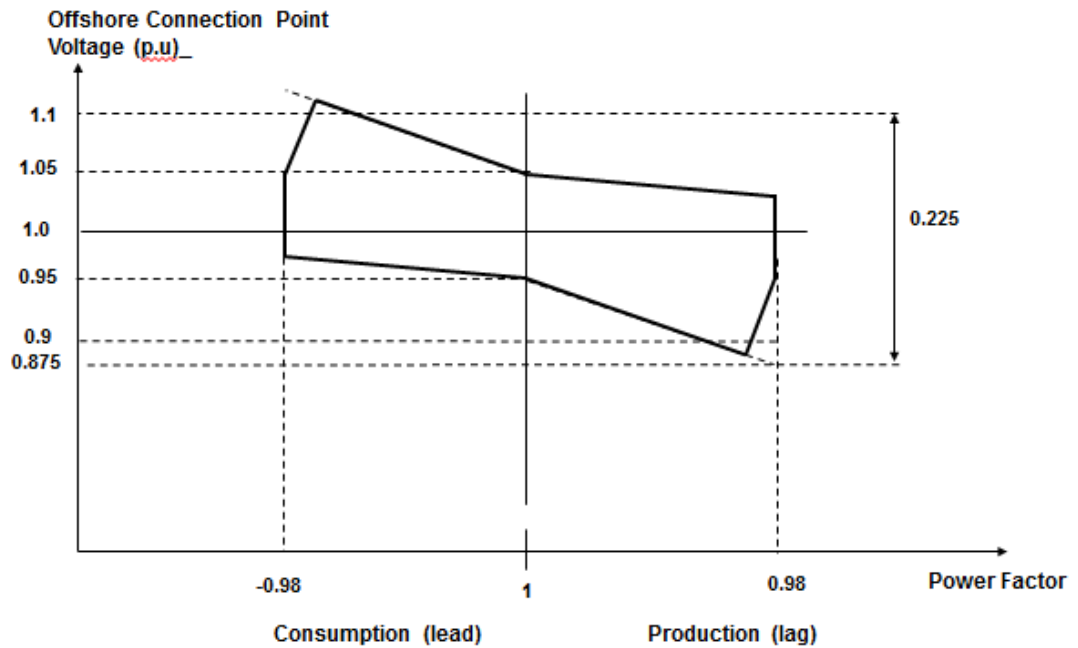

Figure ECC.6.3.2.6(a)

ECC.6.3.2.6.2

All **AC Connected Configuration 2 Offshore Power Park Modules** and **Configuration 2 DC Connected Power Park Modules** shall be capable of satisfying the **Reactive Power** capability requirements at the **Offshore Grid Entry Point** as defined in Figure ECC.6.3.2.6(b) when operating below **Maximum Capacity**. With all **Plant** in service, the **Reactive Power** limits will reduce linearly below 50% **Active Power** output as shown in Figure ECC.6.3.2.6(b) unless the requirement to maintain the **Reactive Power** limits defined at **Maximum Capacity** (or **Interface Point Capacity** in the case of **OTSDUW Plant and Apparatus**) under absorbing **Reactive Power** conditions down to 20% **Active Power** output has been specified with **The Company**. These **Reactive Power** limits will be reduced pro rata to the amount of **Plant** in service. **The Company** in co-ordination with the **Relevant Transmission Licensee** may agree to alternative reactive capability requirements to those specified in Figure ECC.6.3.2.6(b), where it is demonstrated that it is uneconomic and inefficient to do so, for example in the case of new technologies or advanced control strategies.



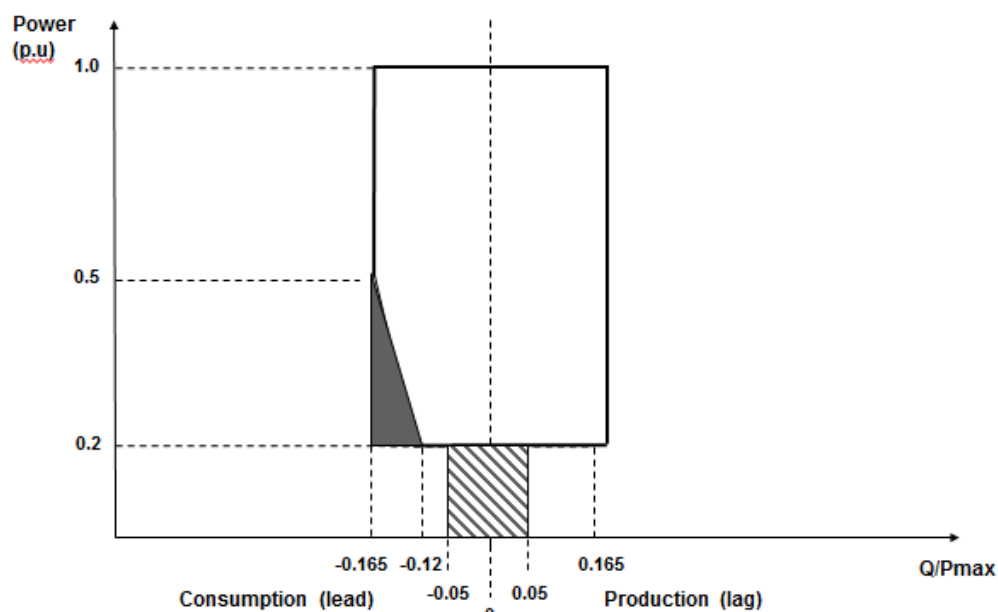

Figure ECC.6.3.2.6(b)

ECC.6.3.2.6.3 For the avoidance of doubt if an **EU Generator** (including **Generators** in respect of **DC Connected Power Park Modules** referred to in ECC.6.3.2.6.2) wishes to provide a **Reactive Power** capability in excess of the minimum requirements defined in ECC.6.3.2.6.1 then such capability (including any steady state tolerance) shall be between the **EU Generator**, **Offshore Transmission Licensee** and **The Company** and/or the relevant **Network Operator**.

### ECC.6.3.3 OUTPUT POWER WITH FALLING FREQUENCY

#### ECC.6.3.3.1 Output power with falling frequency for Power Generating Modules and HVDC Equipment

CC.6.3.3.1.1 Each **Power Generating Module** and **HVDC Equipment** must be capable of:

- (a) continuously maintaining constant **Active Power** output for **System Frequency** changes within the range 50.5 to 49.5 Hz; and
- (b) (subject to the provisions of ECC.6.1.2) maintaining its **Active Power** output at a level not lower than the figure determined by the linear relationship shown in Figure ECC.6.3.3(a) for **System Frequency** changes within the range 49.5 to 47 Hz for all ambient temperatures up to and including 25°C, such that if the **System Frequency** drops to 47 Hz the **Active Power** output does not decrease by more than 5%. In the case of a **CCGT Module**, the above requirement shall be retained down to the **Low Frequency Relay** trip setting of 48.8 Hz, which reflects the first stage of the **Automatic Low Frequency Demand Disconnection** scheme notified to **Network Operators** under OC6.6.2. For **System Frequency** below that setting, the existing requirement shall be retained for a minimum period of 5 minutes while **System Frequency** remains below that setting, and special measure(s) that may be required to meet this requirement shall be kept in service during this period. After that 5 minutes period, if **System Frequency** remains below that setting, the special measure(s) must be discontinued if there is a materially increased risk of the **Gas Turbine** tripping. The need for special measure(s) is linked to the inherent **Gas Turbine Active Power** output reduction caused by reduced shaft speed due to falling **System Frequency**. Where the need for special measures is identified in order to maintain output in line with the level identified in Figure ECC.6.3.3(a) these measures should be still continued at ambient temperatures above 25°C maintaining as much of the **Active Power** achievable within the capability of the plant.

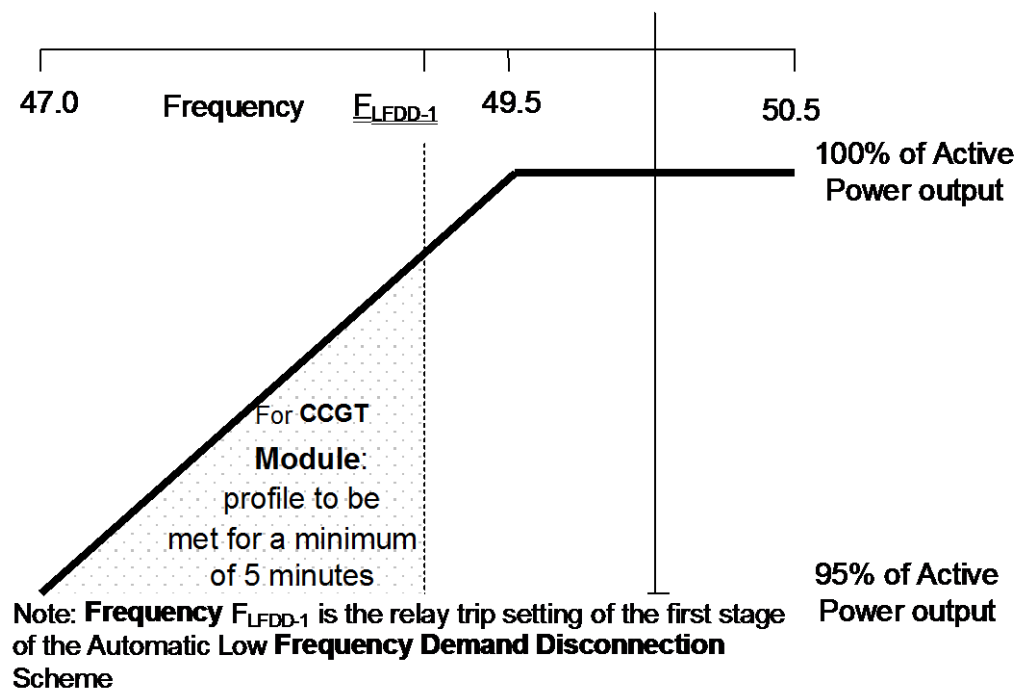

Figure ECC.6.3.3(a) Active Power Output with falling frequency for Power Generating Modules (including Electricity Storage Modules) and HVDC Systems when operating in an exporting mode of operation

- (c) For the avoidance of doubt, in the case of a **Power Generating Module** including a **DC Connected Power Park Module** using an **Intermittent Power Source** where the mechanical power input will not be constant over time, the requirement is that the **Active Power** output shall be independent of **System Frequency** under (a) above and should not drop with **System Frequency** by greater than the amount specified in (b) above. In the case of an Electricity Storage Module, which includes Electricity Storage an allowance will be made for the storage capability of the Power Generating Module Electricity Storage Module.
- (d) An HVDC Systems and Electricity Storage Modules must be capable of maintaining theirs **Active Power** input (i.e. when operating in a mode analogous to **Demand**) from the **National Electricity Transmission System** (or **User System** in the case of an **Embedded HVDC System** or **Embedded Power Station**) at a level not greater than the figure determined by the linear relationship shown in Figure ECC.6.3.3(b) for **System Frequency** changes within the range 49.5 to 47 Hz, such that if the **System Frequency** drops to 47.8 Hz the **Active Power** input decreases by more than 60%.

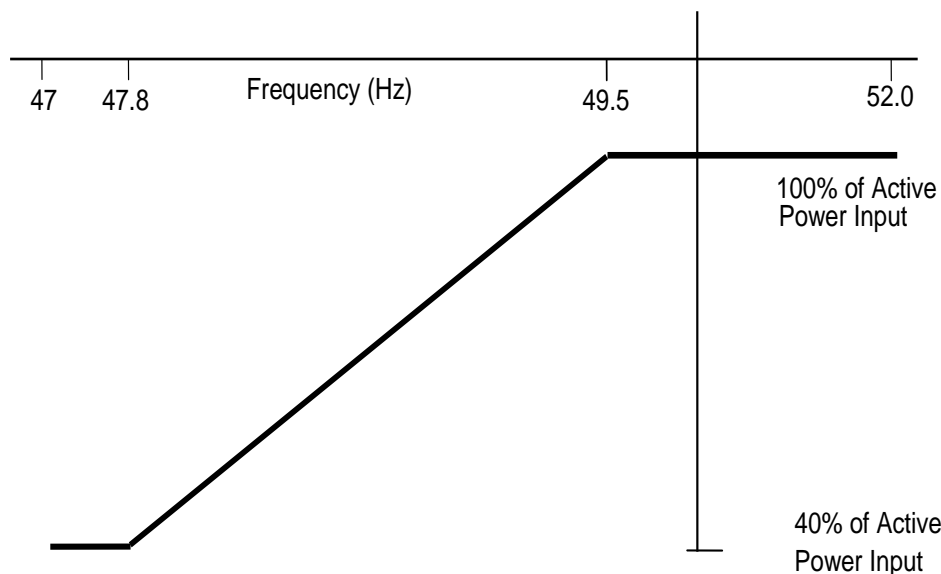

Figure ECC.6.3.3(b) Active Power input with falling frequency for HVDC Systems and Electricity Storage Modules when operating in an importing mode of operation

- (e) In the case of an **Offshore Generating Unit** or **Offshore Power Park Module** or **DC Connected Power Park Module** or **Remote End HVDC Converter** or **Transmission DC Converter**, the **EU Generator** shall comply with the requirements of ECC.6.3.3. **EU Generators** should be aware that Section K of the **STC** places requirements on **Offshore Transmission Licensees** which utilise a **Transmission DC Converter** as part of their **Offshore Transmission System** to make appropriate provisions to enable **EU Generators** to fulfil their obligations.
- (f) **Transmission DC Converters** and **Remote End HVDC Converters** shall provide a continuous signal indicating the real time frequency measured at the **Interface Point** to the **Offshore Grid Entry Point** or **HVDC Interface Point** for the purpose of **Offshore Generators** or **DC Connected Power Park Modules** to respond to changes in **System Frequency** on the Main Interconnected **Transmission System**. A **DC Connected Power Park Module** or **Offshore Power Generating Module** shall be capable of receiving and processing this signal within 100ms.

ECC.6.3.4 ACTIVE POWER OUTPUT UNDER SYSTEM VOLTAGE VARIATIONS

ECC.6.3.4.1 At the **Grid Entry Point** or **User System Entry Point**, the **Active Power** output under steady state conditions of any **Power Generating Module** or **HVDC Equipment** directly connected to the **National Electricity Transmission System** or in the case of **OTSDUW**, the **Active Power** transfer at the **Interface Point**, under steady state conditions of any **OTSDUW Plant and Apparatus** should not be affected by voltage changes in the normal operating range specified in paragraph ECC.6.1.4 by more than the change in **Active Power** losses at reduced or increased voltage.

ECC.6.3.5 BLACK START

ECC.6.3.5.1 **Black Start** is not a mandatory requirement, however **EU Code Users** may wish to notify **The Company** of their ability to provide a **Black Start** facility and the cost of the service. **The Company** will then consider whether it wishes to contract with the **EU Code User** for the provision of a **Black Start** service which would be specified via a **Black Start Contract**. Where an **EU Code User** does not offer to provide a cost for the provision of a **Black Start Capability**, **The Company** may make such a request if it considers **System** security to be at risk due to a lack of **Black Start** capability.

ECC.6.3.5.2 It is an essential requirement that the **National Electricity Transmission System** must incorporate a **Black Start Capability**. This will be achieved by agreeing a **Black Start Capability** at a number of strategically located **Power Stations** and **HVDC Systems**. For each **Power Station** or **HVDC System**, **The Company** will state in the **Bilateral Agreement** whether or not a **Black Start Capability** is required.

ECC.6.3.5.3 Where an **EU Code User** has entered into a **Black Start Contract** to provide a **Black Start Capability** in respect of a **Type C Power Generating Module** or **Type D Power Generating Module** (including **DC Connected Power Park Modules**) the following requirements shall apply.

- (i) The **Power-Generating Module** or **DC Connected Power Park Module** shall be capable of starting from shutdown without any external electrical energy supply within a time frame specified by **The Company** in the **Black Start Contract**.
- (ii) Each **Power Generating Module** or **DC Connected Power Park Module** shall be able to synchronise within the frequency limits defined in ECC.6.1. and, where applicable, voltage limits specified in ECC.6.1.4;
- (iii) The **Power Generating Module** or **DC Connected Power Park Module** shall be capable of connecting on to an unenergised **System**.
- (iv) The **Power-Generating Module** or **DC Connected Power Park Module** shall be capable of automatically regulating dips in voltage caused by connection of demand;
- (v) The **Power Generating Module** or **DC Connected Power Park Module** shall:
  - be capable of **Block Load Capability**,
  - be capable of operating in **LFSM-O** and **LFSM-U**, as specified in ECC.6.3.7.1 and ECC.6.3.7.2
  - control **Frequency** in case of overfrequency and underfrequency within the whole **Active Power** output range between the **Minimum Regulating Level** and **Maximum Capacity** as well as at houseload operation levels
  - be capable of parallel operation of a few **Power Generating Modules** including **DC Connected Power Park Modules** within an isolated part of the **Total System** that is still supplying **Customers**, and control voltage automatically during the system restoration phase;

ECC.6.3.5.4 Each **HVDC System** or **Remote End HVDC Converter Station** which has a **Black Start Capability** shall be capable of energising the busbar of an AC substation to which another **HVDC Converter Station** is connected. The timeframe after shutdown of the **HVDC System** prior to energisation of the AC substation shall be pursuant to the terms of the **Black Start Contract**. The **HVDC System** shall be able to synchronise within the **Frequency** limits defined in ECC.6.1.2.1.2 and voltage limits defined in ECC.6.1.4.1 unless otherwise specified in the **Black Start Contract**. Wider **Frequency** and voltage ranges can be specified in the **Black Start Contract** in order to restore **System** security.

ECC.6.3.5.5 With regard to the capability to take part in operation of an isolated part of the **Total System** that is still supplying **Customers**:

- (i) **Power Generating Modules** including **DC Connected Power Park Modules** shall be capable of taking part in island operation if specified in the **Black Start Contract** required by **The Company** and:
  - the **Frequency** limits for island operation shall be those specified in ECC.6.1.2,
  - the voltage limits for island operation shall be those defined in ECC.6.1.4;

- (ii) **Power Generating Modules** including **DC Connected Power Park Modules** shall be able to operate in **Frequency Sensitive Mode** during island operation, as specified in ECC.6.3.7.3. In the event of a power surplus, **Power Generating Modules** including **DC Connected Power Park Modules** shall be capable of reducing the **Active Power** output from a previous operating point to any new operating point within the **Power Generating Module Performance Chart**. **Power Generating Modules** including **DC Connected Power Park Modules** shall be capable of reducing **Active Power** output as much as inherently technically feasible, but to at least 55 % of **Maximum Capacity**;
- (iii) The method for detecting a change from interconnected system operation to island operation shall be agreed between the **EU Generator**, **The Company** and the **Relevant Transmission Licensee**. The agreed method of detection must not rely solely on **The Company**, **Relevant Transmission Licensee's** or **Network Operators** switchgear position signals;
- (iv) **Power Generating Modules** including **DC Connected Power Park Modules** shall be able to operate in **LFSM-O** and **LFSM-U** during island operation, as specified in ECC.6.3.7.1 and ECC.6.3.7.2;

ECC.6.3.5.6

With regard to quick re-synchronisation capability:

- (i) In case of disconnection of the **Power Generating Module** including **DC Connected Power Park Modules** from the **System**, the **Power Generating Module** shall be capable of quick re-synchronisation in line with the **Protection** strategy agreed between **The Company** and/or **Network Operator** in co-ordination with the **Relevant Transmission Licensee** and the **Generator**;
- (ii) A **Power Generating Module** including a **DC Connected Power Park Module** with a minimum re-synchronisation time greater than 15 minutes after its disconnection from any external power supply must be capable of **Houseload Operation** from any operating point on-its-**Power Generating Module Performance Chart**. In this case, the identification of **Houseload Operation** must not be based solely on the **Total System's** the-switchgear position signals;
- (iii) **Power Generating Modules** including **DC Connected Power Park Modules** shall be capable of **Houseload Operation**, irrespective of any auxiliary connection to the **Total System**. The minimum operation time shall be specified by **The Company**, taking into consideration the specific characteristics of prime mover technology.

ECC.6.3.6 CONTROL ARRANGEMENTS

ECC.6.3.6.1 ACTIVE POWER CONTROL

ECC.6.3.6.1.1 Active Power control in respect of **Power Generating Modules** including **DC Connected Power Park Modules**

ECC.6.3.6.1.1.1 **Type A Power Generating Modules** shall be equipped with a logic interface (input port) in order to cease **Active Power** output within five seconds following receipt of a signal from **The Company**. **The Company** shall specify the requirements for such facilities, including the need for remote operation, in the **Bilateral Agreement** where they are necessary for **System** reasons .

ECC.6.3.6.1.1.2 **Type B Power Generating Modules** shall be equipped with an interface (input port) in order to be able to reduce **Active Power** output following receipt of a signal from **The Company**. **The Company** shall specify the requirements for such facilities, including the need for remote operation, in the **Bilateral Agreement** where they are necessary for **System** reasons.

ECC.6.3.6.1.1.3 **Type C** and **Type D Power Generating Modules** and **DC Connected Power Park Modules** shall be capable of adjusting the **Active Power** setpoint in accordance with instructions issued by **The Company**.

ECC.6.3.6.1.2 Active Power control in respect of HVDC Systems and Remote End HVDC Converter Stations

ECC.6.3.6.1.2.1 HVDC Systems shall be capable of adjusting the transmitted Active Power upon receipt of an instruction from The Company which shall be in accordance with the requirements of BC2.6.1.

ECC.6.3.6.1.2.2 The requirements for fast Active Power reversal (if required) shall be specified by The Company. Where Active Power reversal is specified in the Bilateral Agreement, each HVDC System and Remote End HVDC Converter Station shall be capable of operating from maximum import to maximum export in a time which is as fast as technically feasible or in a time that is no greater than 2 seconds except where a HVDC Converter Station Owner has justified to The Company that a longer reversal time is required.

ECC.6.3.6.1.2.3 Where an HVDC System connects various Control Areas or Synchronous Areas, each HVDC System or Remote End HVDC Converter Station shall be capable of responding to instructions issued by The Company under the Balancing Code to modify the transmitted Active Power for the purposes of cross-border balancing.

ECC.6.3.6.1.2.4 An HVDC System shall be capable of adjusting the ramping rate of Active Power variations within its technical capabilities in accordance with instructions issued by The Company. In case of modification of Active Power according to ECC.6.3.15 and ECC.6.3.6.1.2.2, there shall be no adjustment of ramping rate.

ECC.6.3.6.1.2.5 If specified by The Company, in coordination with the Relevant Transmission Licensees, the control functions of an HVDC System shall be capable of taking automatic remedial actions including, but not limited to, stopping the ramping and blocking FSM, LFSM-O, LFSM-U and Frequency control. The triggering and blocking criteria shall be specified by The Company.

ECC.6.3.6.2 MODULATION OF ACTIVE POWER

ECC.6.3.6.2.1 Each Power Generating Module (including DC Connected Power Park Modules) and Onshore HVDC Converters at an Onshore HVDC Converter Station must be capable of contributing to Frequency control by continuous modulation of Active Power supplied to the National Electricity Transmission System. For the avoidance of doubt each Onshore HVDC Converter at an Onshore HVDC Converter Station and/or OTSDUW DC Converter shall provide each EU Code User in respect of its Offshore Power Stations connected to and/or using an Offshore Transmission System a continuous signal indicating the real time Frequency measured at the Transmission Interface Point. A DC Connected Power Park Module or Offshore Power Generating Module shall be capable of receiving and processing this signal within 100ms.

ECC.6.3.6.3 MODULATION OF REACTIVE POWER

ECC.6.3.6.3.1 Notwithstanding the requirements of ECC.6.3.2, each Power Generating Module or HVDC Equipment (and OTSDUW Plant and Apparatus at a Transmission Interface Point and Remote End HVDC Converter at an HVDC Interface Point) (as applicable) must be capable of contributing to voltage control by continuous changes to the Reactive Power supplied to the National Electricity Transmission System or the User System in which it is Embedded.

ECC.6.3.7 FREQUENCY RESPONSE

ECC.6.3.7.1 Limited Frequency Sensitive Mode – Overfrequency (LFSM-O)

- ECC.6.3.7.1.1 Each **Power Generating Module** (including **DC Connected Power Park Modules**) and **HVDC Systems** shall be capable of reducing **Active Power** output in response to **Frequency** on the **Total System** when this rises above 50.4Hz. For the avoidance of doubt, the provision of this reduction in **Active Power** output is not an **Ancillary Service**. Such provision is known as **Limited High Frequency Response**. The **Power Generating Module** (including **DC Connected Power Park Modules**) or **HVDC Systems** shall be capable of operating stably during **LFSM-O** operation. However for a **Power Generating Module** (including **DC Connected Power Park Modules**) or **HVDC Systems** operating in **Frequency Sensitive Mode** the requirements of **LFSM-O** shall apply when the frequency exceeds 50.5Hz.
- ECC.6.3.7.1.2 (i) The rate of change of **Active Power** output must be at a minimum a rate of 2 percent of output per 0.1 Hz deviation of **System Frequency** above 50.4Hz (ie a **Droop** of 10%) as shown in Figure ECC.6.3.7.1 below. This would not preclude a **EU Generator** or **HVDC System Owner** from designing their **Power Generating Module** with a **Droop** of less than 10% but in all cases the **Droop** should be 2% or greater.
- (ii) The reduction in **Active Power** output must be continuously and linearly proportional, as far as is practicable, to the excess of **Frequency** above 50.4 Hz and must be provided increasingly with time over the period specified in (iii) below.
- (iii) As much as possible of the proportional reduction in **Active Power** output must result from the frequency control device (or speed governor) action and must be achieved within 10 seconds of the time of the **Frequency** increase above 50.4 Hz. The **Power Generating Module** (including **DC Connected Power Park Modules**) or **HVDC Systems** shall be capable of initiating a power **Frequency** response with an initial delay that is as short as possible. If the delay exceeds 2 seconds the **EU Generator** or **HVDC System Owner** shall justify the variation, providing technical evidence to **The Company**.
- (iv) The residue of the proportional reduction in **Active Power** output which results from automatic action of the **Power Generating Module** (including **DC Connected Power Park Modules**) or **HVDC System** output control devices other than the frequency control devices (or speed governors) must be achieved within 3 minutes for the time of the **Frequency** increase above 50.4Hz.
- (v) For the avoidance of doubt, the **LFSM-O** response must be reduced when the **Frequency** falls again and, when to a value less than 50.4Hz, as much as possible of the increase in **Active Power** must be achieved within 10 seconds.
- (vi) For **Type A** and **Type B Power Generating Modules** which are not required to have **Frequency Sensitive Mode (FSM)** as described in ECC.6.3.7.3 for deviations in **Frequency** up to 50.9Hz at least half of the proportional reduction in **Active Power** output must be achieved in 10 seconds of the time of the **Frequency** increase above 50.4Hz. For deviations in **Frequency** beyond 50.9Hz the measured rate of change of **Active Power** reduction must exceed 0.5%/sec of the initial output. The **LFSM-O** response must be reduced when the **Frequency** subsequently falls again and when to a value less than 50.4Hz, at least half the increase in **Active Power** must be achieved in 10 seconds. For a **Frequency** excursion returning from beyond 50.9Hz the measured rate of change of **Active Power** increase must exceed 0.5%/second.

Active Power Frequency response capability of when operating in LFSM-O

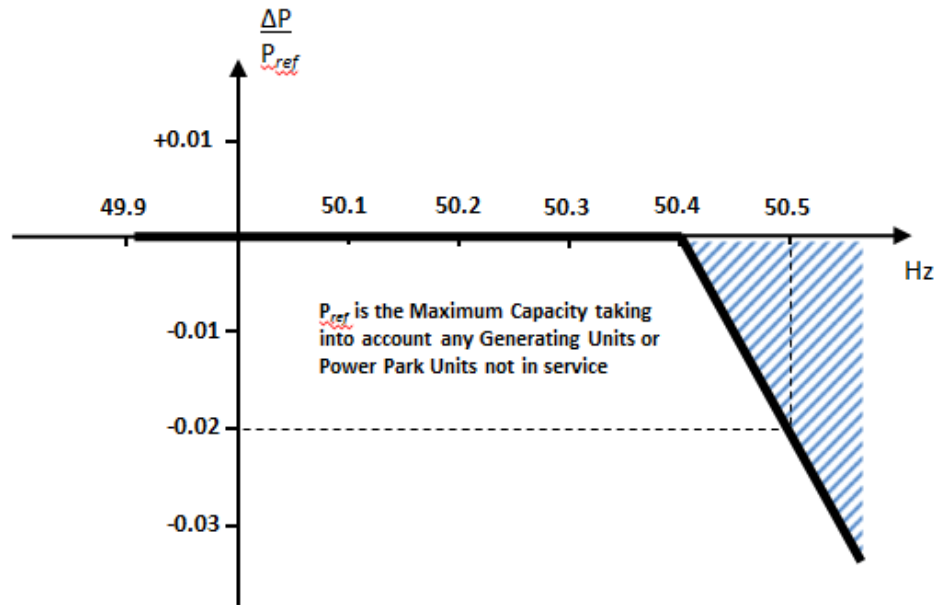

Figure ECC.6.3.7.1 –  $P_{ref}$  is the reference **Active Power** to which  $\Delta P$  is related and  $\Delta P$  is the change in **Active Power** output from the **Power Generating Module** (including **DC Connected Power Park Modules**) or **HVDC System**. The **Power Generating Module** (including **DC Connected Power Park Modules** or **HVDC Systems**) has to provide a negative **Active Power** output change with a droop of 10% or less based on  $P_{ref}$ .

ECC.6.3.7.1.3 Each **Power Generating Module** (including **DC Connected Power Park Modules**) or **HVDC Systems** which is providing **Limited High Frequency Response (LFSM-O)** must continue to provide it until the **Frequency** has returned to or below 50.4Hz or until otherwise instructed by **The Company**. **EU Generators** in respect of **Gensets** and **HVDC Converter Station Owners** in respect of an **HVDC System** should also be aware of the requirements in BC.3.7.2.2.

ECC.6.3.7.1.4 Steady state operation below the **Minimum Stable Operating Level** in the case of **Power Generating Modules** including **DC Connected Power Park Modules** or **Minimum Active Power Transmission Capacity** in the case of **HVDC Systems** is not expected but if **System** operating conditions cause operation below the **Minimum Stable Operating Level** or **Minimum Active Power Transmission Capacity** which could give rise to operational difficulties for the **Power Generating Module** including a **DC Connected Power Park Module** or **HVDC Systems** then the **EU Generator** or **HVDC System Owner** shall be able to return the output of the **Power Generating Module** including a **DC Connected Power Park Module** to an output of not less than the **Minimum Stable Operating Level** or **HVDC System** to an output of not less than the **Minimum Active Power Transmission Capacity**.

ECC.6.3.7.1.5 All reasonable efforts should in the event be made by the **EU Generator** or **HVDC System Owner** to avoid such tripping provided that the **System Frequency** is below 52Hz in accordance with the requirements of ECC.6.1.2. If the **System Frequency** is at or above 52Hz, the requirement to make all reasonable efforts to avoid tripping does not apply and the **EU Generator** or **HVDC System Owner** is required to take action to protect its **Power Generating Modules** including **DC Connected Power Park Modules** or **HVDC Converter Stations**.

ECC.6.3.7.1.6 In the case of an **HVDC System** or **Electricity Storage Module** in an importing mode of operation (ie **Demand**), the **HVDC System** or **Electricity Storage Module** shall be capable of increasing **Active Power** import pro-rata with **System Frequency** up to the **Electricity**



**Storage Module's Maximum Capacity or HVDC System's Maximum HVDC Active Power Transmission Capacity (PHmax).** These requirements would be consistent to the requirements specified in ECC.6.3.7.1.1 – ECC.6.3.7.1.5 whilst recognising the importing mode of operation of the **Electricity Storage Module or HVDC System.**

ECC.6.3.7.2 Limited Frequency Sensitive Mode – Underfrequency (LFSM-U)

ECC.6.3.7.2.1 Each **Type C Power Generating Module** and **Type D Power Generating Module** (including **DC Connected Power Park Modules**) or **HVDC Systems** operating in **Limited Frequency Sensitive Mode** shall be capable of increasing **Active Power** output in response to **System Frequency** when this falls below 49.5Hz. For the avoidance of doubt, the provision of this increase in **Active Power** output is not a mandatory **Ancillary Service** and it is not anticipated **Power Generating Modules** (including **DC Connected Power Park Modules**) or **HVDC Systems** are operated in an inefficient mode to facilitate delivery of **LFSM-U** response, but any inherent capability (where available) should be made without undue delay. The **Power Generating Module** (including **DC Connected Power Park Modules**) or **HVDC Systems** shall be capable of stable operation during **LFSM-U Mode**. For example, a **EU Generator** which is operating with no headroom (eg it is operating at maximum output or is de-loading as part of a run down sequence and has no headroom) would not be required to provide **LFSM-U**.

ECC.6.3.7.2.2 (i) The rate of change of **Active Power** output must be at a minimum a rate of 2 percent of output per 0.1 Hz deviation of **System Frequency** below 49.5Hz (ie a **Droop** of 10%) as shown in Figure ECC.6.3.7.2.2 below. This requirement only applies if the **Power Generating Module** has headroom and the ability to increase **Active Power** output. In the case of a **Power Park Module** or **DC Connected Power Park Module** the requirements of Figure ECC.6.3.7.2.2 shall be reduced pro-rata to the amount of **Power Park Units** in service and available to generate. For the avoidance of doubt, this would not preclude an **EU Generator** or **HVDC System Owner** from designing their **Power Generating Module** with a lower **Droop** setting, for example between 3 – 5%.

(ii) As much as possible of the proportional increase in **Active Power** output must result from the **Frequency** control device (or speed governor) action and must be achieved for **Frequencies** below 49.5 Hz. The **Power Generating Module** (including **DC Connected Power Park Modules**) or **HVDC Systems** shall be capable of initiating a power **Frequency** response with minimal delay. If the delay exceeds 2 seconds the **EU Generator** or **HVDC System Owner** shall justify the delay, providing technical evidence to **The Company**).

(iii) The actual delivery of **Active Power Frequency Response** in **LFSM-U** mode shall take into account

The ambient conditions when the response is to be triggered

The operating conditions of the **Power Generating Module** (including **DC Connected Power Park Modules**) or **HVDC Systems** in particular limitations on operation near **Maximum Capacity** or **Maximum HVDC Active Power Transmission Capacity** at low frequencies and the respective impact of ambient conditions as detailed in ECC.6.3.3.

The availability of primary energy sources.

(iv) In **LFSM\_U Mode**, the **Power Generating Module** (including **DC Connected Power Park Modules**) and **HVDC Systems**, shall be capable of providing a power increase up to its **Maximum Capacity** or **Maximum HVDC Active Power Transmission Capacity** (as applicable).

### Active Power Frequency response capability of when operating in LFSM-U

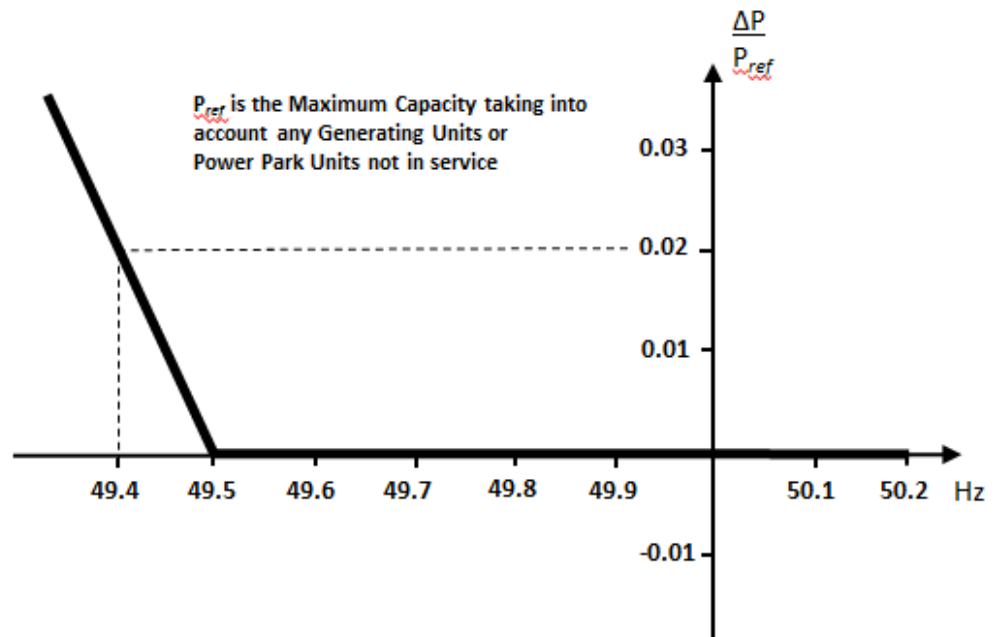

Figure ECC.6.3.7.2.2 –  $P_{ref}$  is the reference **Active Power** to which  $\Delta P$  is related and  $\Delta P$  is the change in **Active Power** output from the **Power Generating Module** (including **DC Connected Power Park Modules**) or **HVDC System**. The **Power Generating Module** (including **DC Connected Power Park Modules** or **HVDC Systems**) has to provide a positive **Active Power** output change with a droop of 10% or less based on  $P_{ref}$ .

#### ECC.6.3.7.3 Frequency Sensitive Mode – (FSM)

ECC.6.3.7.3.1 In addition to the requirements of ECC.6.3.7.1 and ECC.6.3.7.2 each **Type C Power Generating Module** and **Type D Power Generating Module** (including **DC Connected Power Park Modules**) or **HVDC Systems** must be fitted with a fast acting proportional **Frequency** control device (or turbine speed governor) and unit load controller or equivalent control device to provide **Frequency** response under normal operational conditions in accordance with **Balancing Code 3 (BC3)**. In the case of a **Power Park Module** including a **DC Connected Power Park Module**, the **Frequency** or speed control device(s) may be on the **Power Park Module** (including a **DC Connected Power Park Module**) or on each individual **Power Park Unit** (including a **Power Park Unit** within a **DC Connected Power Park Module**) or be a combination of both. The **Frequency** control device(s) (or speed governor(s)) must be designed and operated to the appropriate:

- (i) **European Specification:** or
- (ii) in the absence of a relevant **European Specification**, such other standard which is in common use within the European Community (which may include a manufacturer specification);

as at the time when the installation of which it forms part was designed or (in the case of modification or alteration to the **Frequency** control device (or turbine speed governor)) when the modification or alteration was designed.

The **European Specification** or other standard utilised in accordance with sub paragraph ECC.6.3.7.3.1 (a) (ii) will be notified to **The Company** by the **EU Generator** or **HVDC System Owner**:

- (i) as part of the application for a **Bilateral Agreement**; or
- (ii) as part of the application for a varied **Bilateral Agreement**; or

- (iii) in the case of an Embedded Development, within 28 days of entry into the Embedded Development Agreement (or such later time as agreed with **The Company**) or
- (iv) as soon as possible prior to any modification or alteration to the **Frequency** control device (or governor); and

ECC.6.3.7.3.2 The **Frequency** control device (or speed governor) in co-ordination with other control devices must control each **Type C Power Generating Module** and **Type D Power Generating Module** (including **DC Connected Power Park Modules**) or **HVDC Systems Active Power Output** or **Active Power** transfer capability with stability over the entire operating range of the **Power Generating Module** (including **DC Connected Power Park Modules**) or **HVDC Systems** ; and

ECC.6.3.7.3.3 **Type C** and **Type D Power Generating Modules** and **DC Connected Power Park Modules** shall also meet the following minimum requirements:

- (i) capable of providing **Active Power Frequency** response in accordance with the performance characteristic shown in Figure 6.3.7.3.3(a) and parameters in Table 6.3.7.3.3(a)

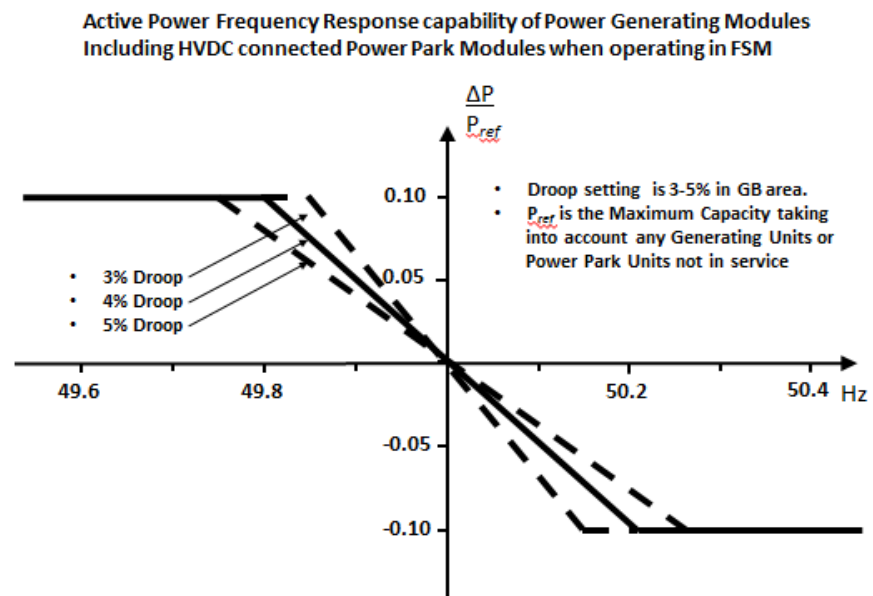

Figure 6.3.7.3.3(a) – **Frequency Sensitive Mode** capability of **Power Generating Modules** and **DC Connected Power Park Modules**

Parameter	Setting
Nominal <b>System Frequency</b>	50Hz
<b>Active Power</b> as a percentage of <b>Maximum Capacity</b> ( $\frac{ \Delta P_1 }{P_{max}}$ )	10%
<b>Frequency Response Insensitivity</b> in mHz ( $ \Delta f_i $ )	±15mHz
<b>Frequency Response Insensitivity</b> as a percentage of nominal frequency ( $\frac{ \Delta f_i }{f_n}$ )	±0.03%
<b>Frequency Response Deadband</b> in mHz	0 (mHz)
<b>Droop</b> (%)	3 – 5%

Table 6.3.7.3.3(a) – Parameters for **Active Power Frequency** response in **Frequency Sensitive Mode** including the mathematical expressions in Figure 6.3.7.3.3(a).

- (ii) In satisfying the performance requirements specified in ECC.6.3.7.3(i) **EU Generators** in respect of each **Type C** and **Type D Power Generating Modules and DC Connected Power Park Module** should be aware:-

in the case of overfrequency, the **Active Power Frequency** response is limited by the **Minimum Regulating Level**,

in the case of underfrequency, the **Active Power Frequency** response is limited by the **Maximum Capacity**,

the actual delivery of **Active Power** frequency response depends on the operating and ambient conditions of the **Power Generating Module** (including **DC Connected Power Park Modules**) when this response is triggered, in particular limitations on operation near **Maximum Capacity** at low **Frequencies** as specified in ECC.6.3.3 and available primary energy sources.

The frequency control device (or speed governor) must also be capable of being set so that it operates with an overall speed **Droop** of between 3 – 5%. The **Frequency Response Deadband** and **Droop** must be able to be reselected repeatedly. For the avoidance of doubt, in the case of a **Power Park Module** (including **DC Connected Power Park Modules**) the speed **Droop** should be equivalent of a fixed setting between 3% and 5% applied to each **Power Park Unit** in service.

- (iii) In the event of a **Frequency** step change, each **Type C** and **Type D Power Generating Module and DC Connected Power Park Module** shall be capable of activating full and stable **Active Power Frequency** response (without undue power oscillations), in accordance with the performance characteristic shown in Figure 6.3.7.3.3(b) and parameters in Table 6.3.7.3.3(b).

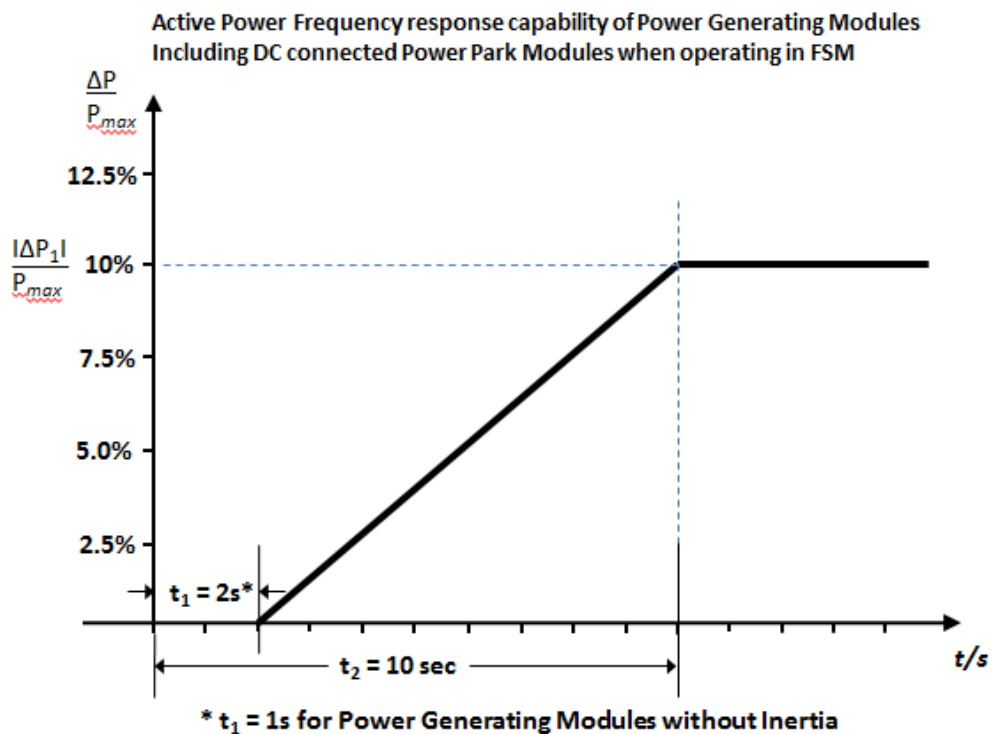

Figure 6.3.7.3.3(b) **Active Power Frequency Response** capability.

Parameter	Setting
<b>Active Power</b> as a percentage of <b>Maximum Capacity (frequency response range)</b> ( $\frac{ \Delta P_1 }{P_{max}}$ )	10%
Maximum admissible initial delay $t_1$ for <b>Power Generating Modules</b> (including <b>DC Connected Power Park Modules</b> ) with inertia unless justified as specified in ECC.6.3.7.3.3 (iv)	2 seconds
Maximum admissible initial delay $t_1$ for <b>Power Generating Modules</b> (including <b>DC Connected Power Park Modules</b> ) which do not contribute to <b>System</b> inertia unless justified as specified in ECC.6.3.7.3.3 (iv)	1 second
Activation time $t_2$	10 seconds

Table 6.3.7.3.3(b) – Parameters for full activation of **Active Power Frequency** response resulting from a **Frequency** step change. Table 6.3.7.3.3(b) also includes the mathematical expressions used in Figure 6.3.7.3.3(b).

- (iv) The initial activation of **Active Power Primary Frequency** response shall not be unduly delayed. For **Type C** and **Type D Power Generating Modules** (including **DC Connected Power Park Modules**) with inertia the delay in initial **Active Power Frequency** response shall not be greater than 2 seconds. For **Type C** and **Type D Power Generating Modules** (including **DC Connected Power Park Modules**) without inertia, the delay in initial **Active Power Frequency** response shall not be greater than 1 second. If the **Generator** cannot meet this requirement they shall provide technical evidence to **The Company** demonstrating why a longer time is needed for the initial activation of **Active Power Frequency** response.
- (v) in the case of **Type C** and **Type D Power Generating Modules** (including **DC Connected Power Park Modules**) other than the **Steam Unit** within a **CCGT Module** the combined effect of the **Frequency Response Insensitivity** and **Frequency Response Deadband** of the **Frequency** control device (or speed governor) should be no greater than 0.03Hz (for the avoidance of doubt,  $\pm 0.015\text{Hz}$ ). In the case of the **Steam Unit** within a **CCGT Module**, the **Frequency Response Deadband** should be set to an appropriate value consistent with the requirements of ECC.6.3.7.3.5(ii) and the requirements of BC3.7.2.2 for the provision of **LFSM-O** taking account of any **Frequency Response Insensitivity** of the **Frequency** control device (or speed governor);

ECC.6.3.7.3.4 **HVDC Systems** shall also meet the following minimum requirements:

- (i) **HVDC Systems** shall be capable of responding to **Frequency** deviations in each connected **AC System** by adjusting their **Active Power** import or export as shown in Figure 6.3.7.3.4(a) with the corresponding parameters in Table 6.3.7.3.4(a).

**Active Power Frequency response capability of HVDC systems when operating in FSI**

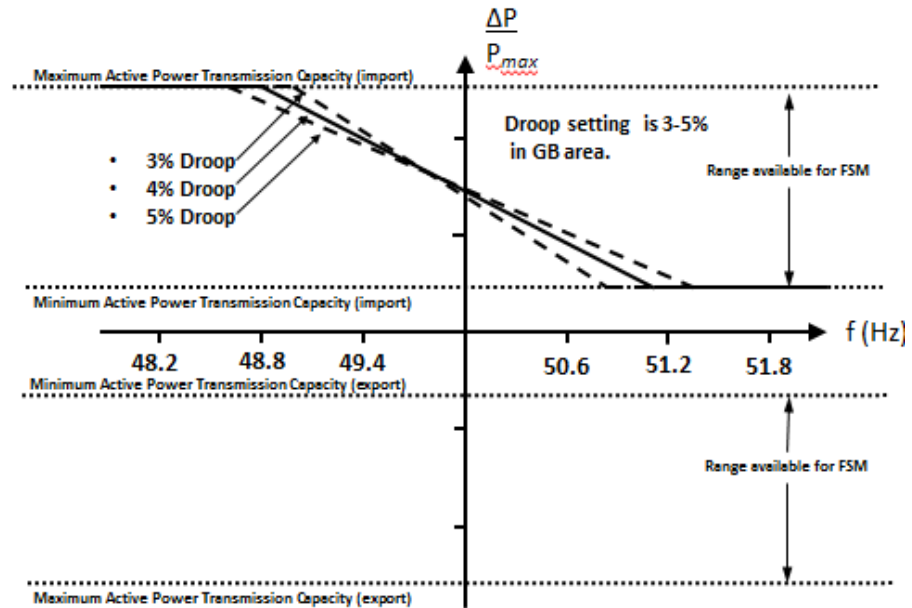

Figure 6.3.7.3.4(a) – **Active Power** frequency response capability of a **HVDC System** operating in **Frequency Sensitive Mode (FSM)**.  $\Delta P$  is the change in active power output from the **HVDC System**..

Parameter	Setting
<b>Frequency Response Deadband</b>	0
<b>Droop S1 and S2</b> (upward and downward regulation) where $S1=S2$ .	3 – 5%
<b>Frequency Response Insensitivity</b>	$\pm 15\text{mHz}$

Table 6.3.7.3.4(a) – Parameters for **Active Power Frequency** response in **FSM** including the mathematical expressions in Figure 6.3.7.3.4.

- (ii) Each **HVDC System** shall be capable of adjusting the **Droop** for both upward and downward regulation and the **Active Power** range over which **Frequency Sensitive Mode** of operation is available as defined in ECC.6.3.7.3.4.
- (iii) In addition to the requirements in ECC.6.3.7.4(i) and ECC.6.3.7.4(ii) each **HVDC System** shall be capable of:-

delivering the response as soon as technically feasible

delivering the response on or above the solid line in Figure 6.3.7.3.4(b) in accordance with the parameters shown in Table 6.3.7.3.4(b)

initiating the delivery of **Primary Response** in no less than 0.5 seconds unless otherwise agreed with **The Company**. Where the initial delay time ( $t_1$  – as shown in Figure 6.3.7.3.4(b)) is longer than 0.5 seconds the **HVDC Converter Station Owner** shall reasonably justify it to **The Company**.

Active Power Frequency response capability of HVDC Systems when operating in FSM

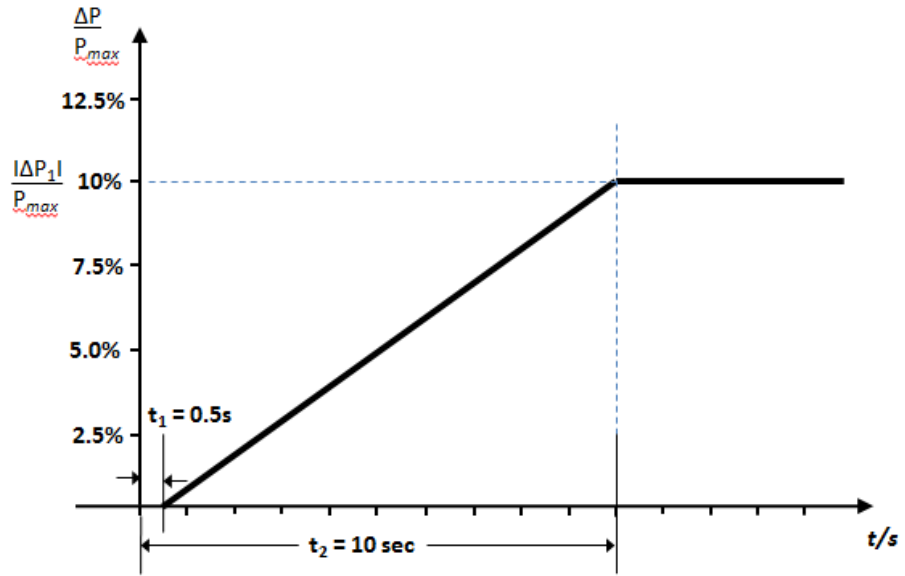

Figure 6.3.7.3.4(b) **Active Power Frequency Response** capability of a **HVDC System**.  $\Delta P$  is the change in **Active Power** triggered by the step change in frequency

Parameter	Setting
<b>Active Power as a percentage of Maximum Capacity (frequency response range) <math>(\frac{ \Delta P_1 }{P_{max}})</math></b>	10%
Maximum admissible delay $t_1$	0.5 seconds
Maximum admissible time for full activation $t_2$ , unless longer activation times are agreed with <b>The Company</b>	10 seconds

Table 6.3.7.3.4(b) – Parameters for full activation of **Active Power Frequency** response resulting from a **Frequency** step change.

- (iv) For **HVDC Systems** connecting various **Synchronous Areas**, each **HVDC System** shall be capable of adjusting the full **Active Power Frequency Response** when operating in **Frequency Sensitive Mode** at any time and for a continuous time period. In addition, the **Active Power** controller of each **HVDC System** shall not have any adverse impact on the delivery of frequency response.

ECC.6.3.7.3.5 For **HVDC Systems** and **Type C** and **Type D Power Generating Modules** (including **DC Connected Power Park Modules**), other than the **Steam Unit** within a **CCGT Module** the combined effect of the **Frequency Response Insensitivity** and **Frequency Response Deadband** of the **Frequency** control device (or speed governor) should be no greater than 0.03Hz (for the avoidance of doubt,  $\pm 0.015\text{Hz}$ ). In the case of the **Steam Unit** within a **CCGT Module**, the **Frequency Response Deadband** should be set to an appropriate value consistent with the requirements of ECC.6.3.7.3.5(ii) and the requirements of BC3.7.2.2 for the provision of **LFSM-O** taking account of any **Frequency Response Insensitivity** of the **Frequency** control device (or speed governor);

- (i) With regard to disconnection due to underfrequency, **EU Generators** responsible for **Type C** and **Type D Power Generating Modules** (including **DC Connected Power Park Modules**) capable of acting as a load, including but not limited to **Pumped Storage** and tidal **Power Generating Modules, HVDC Systems** and **Remote End HVDC Converter Stations**, shall be capable of disconnecting their load in case of underfrequency which will be agreed with **The Company**. For the avoidance of doubt this requirement does not apply to station auxiliary supplies; **EU Generators** in respect of **Type C** and **Type D Pumped Storage Power Generating Modules** should also be aware of the requirements in OC.6.6.6.
- (ii) Where a **Type C** or **Type D Power Generating Module, DC Connected Power Park Module** or **HVDC System** becomes isolated from the rest of the **Total System** but is still supplying **Customers**, the **Frequency** control device (or speed governor) must also be able to control **System Frequency** below 52Hz unless this causes the **Type C** or **Type D Power Generating Module** or **DC Connected Power Park Module** to operate below its **Minimum Regulating Level** or **Minimum Active Power Transmission Capacity** when it is possible that it may, as detailed in BC 3.7.3, trip after a time. For the avoidance of doubt **Power Generating Modules** (including **DC Connected Power Park Modules**) and **HVDC Systems** are only required to operate within the **System Frequency** range 47 - 52 Hz as defined in ECC.6.1.2 and for converter based technologies, the remaining island contains sufficient fault level for effective commutation;
- (iii) Each **Type C** and **Type D Power Generating Module** and **HVDC Systems** shall have the facility to modify the **Target Frequency** setting either continuously or in a maximum of 0.05Hz steps over at least the range 50 ±0.1Hz should be provided in the unit load controller or equivalent device.

ECC.6.3.7.3.6 In addition to the requirements of ECC.6.3.7.3 each **Type C** and **Type D Power Generating Module** and **HVDC System** shall be capable of meeting the minimum **Frequency** response requirement profile subject to and in accordance with the provisions of Appendix A3.

ECC.6.3.7.3.7 For the avoidance of doubt, the requirements of Appendix A3 do not apply to **Type A** and **Type B Power Generating Modules**.

## ECC.6.3.8 EXCITATION AND VOLTAGE CONTROL PERFORMANCE REQUIREMENTS

### ECC.6.3.8.1 Excitation Performance Requirements for Type B Synchronous Power Generating Modules

ECC.6.3.8.1.1 Each **Synchronous Generating Unit** within a **Type B Synchronous Power Generating Module** shall be equipped with a permanent automatic excitation control system that shall have the capability to provide constant terminal voltage control at a selectable setpoint without instability over the entire operating range of the **Type B Synchronous Power Generating Module**.

ECC.6.3.8.1.2 In addition to the requirements of ECC.6.3.8.1.1, **The Company** or the relevant **Network Operator** will specify if the control system of the **Type B Synchronous Power Generating Module** shall contribute to voltage control or **Reactive Power** control or **Power Factor** control at the **Grid Entry Point** or **User System Entry Point** (or other defined busbar). The performance requirements of the control system including slope (where applicable) shall be agreed between **The Company** and/or the relevant **Network Operator** and the **EU Generator**.

### ECC.6.3.8.2 Voltage Control Requirements for Type B Power Park Modules

ECC.6.3.8.2.1 **The Company** or the relevant **Network Operator** will specify if the control system of the **Type B Power Park Module** shall contribute to voltage control or **Reactive Power** control or **Power Factor** control at the **Grid Entry Point** or **User System Entry Point** (or other defined busbar). The performance requirements of the control system including slope (where applicable) shall be agreed between **The Company** and/or the relevant **Network Operator** and the **EU Generator**.



- ECC.6.3.8.3 Excitation Performance Requirements for Type C and Type D Onshore Synchronous Power Generating Modules
- ECC.6.3.8.3.1 Each **Synchronous Generating Unit** within a **Type C** and **Type D Onshore Synchronous Power Generating Modules** shall be equipped with a permanent automatic excitation control system that shall have the capability to provide constant terminal voltage control at a selectable setpoint without instability over the entire operating range of the **Synchronous Power Generating Module**.
- ECC.6.3.8.3.2 The requirements for excitation control facilities are specified in ECC.A.6. Any site specific requirements shall be specified by **The Company** or the relevant **Network Operator**.
- ECC.6.3.8.3.3 Unless otherwise required for testing in accordance with OC5.A.2, the automatic excitation control system of an **Onshore Synchronous Power Generating Module** shall always be operated such that it controls the **Onshore Synchronous Generating Unit** terminal voltage to a value that is
- equal to its rated value: or
  - only where provisions have been made in the **Bilateral Agreement**, greater than its rated value.
- ECC.6.3.8.3.4 In particular, other control facilities including constant **Reactive Power** output control modes and constant **Power Factor** control modes (but excluding VAR limiters) are not required. However if present in the excitation or voltage control system they will be disabled unless otherwise agreed with **The Company** or the relevant **Network Operator**. Operation of such control facilities will be in accordance with the provisions contained in **BC2**.
- ECC.6.3.8.3.5 The excitation performance requirements for **Offshore Synchronous Power Generating Modules** with an **Offshore Grid Entry Point** shall be specified by **The Company**.
- ECC.6.3.8.4 Voltage Control Performance Requirements for Type C and Type D Onshore Power Park Modules, Onshore HVDC Converters and OTSDUW Plant and Apparatus at the Interface Point
- ECC.6.3.8.4.1 Each **Type C** and **Type D Onshore Power Park Module**, **Onshore HVDC Converter** and **OTSDUW Plant and Apparatus** shall be fitted with a continuously acting automatic control system to provide control of the voltage at the **Grid Entry Point** or **User System Entry Point** (or **Interface Point** in the case of **OTSDUW Plant and Apparatus**) without instability over the entire operating range of the **Onshore Power Park Module**, or **Onshore HVDC Converter** or **OTSDUW Plant and Apparatus**. Any **Plant** or **Apparatus** used in the provisions of such voltage control within an **Onshore Power Park Module** may be located at the **Power Park Unit** terminals, an appropriate intermediate busbar or the **Grid Entry Point** or **User System Entry Point**. In the case of an **Onshore HVDC Converter** at a **HVDC Converter Station** any **Plant** or **Apparatus** used in the provisions of such voltage control may be located at any point within the **User's Plant and Apparatus** including the **Grid Entry Point** or **User System Entry Point**. **OTSDUW Plant and Apparatus** used in the provision of such voltage control may be located at the **Offshore Grid Entry Point** an appropriate intermediate busbar or at the **Interface Point**. When operating below 20% **Maximum Capacity** the automatic control system may continue to provide voltage control using any available reactive capability. If voltage control is not being provided, the automatic control system shall be designed to ensure a smooth transition between the shaded area below 20% of **Active Power** output and the non-shaded area above 20% of **Active Power** output in Figure ECC.6.3.2.5(c) and Figure ECC.6.3.2.7(b) The performance requirements for a continuously acting automatic voltage control system that shall be complied with by the **User** in respect of **Onshore Power Park Modules, Onshore HVDC Converters** at an **Onshore HVDC Converter Station, OTSDUW Plant and Apparatus** at the **Interface Point** are defined in ECC.A.7.

- ECC.6.3.8.4.3 In particular, other control facilities, including constant **Reactive Power** output control modes and constant **Power Factor** control modes (but excluding VAR limiters) are not required. However if present in the voltage control system they will be disabled unless otherwise agreed with **The Company** or the relevant **Network Operator**. Operation of such control facilities will be in accordance with the provisions contained in BC2. Where **Reactive Power** output control modes and constant **Power Factor** control modes have been fitted within the voltage control system they shall be required to satisfy the requirements of ECC.A.7.3 and ECC.A.7.4.
- ECC.6.3.8.5 Excitation Control Performance requirements applicable to AC Connected **Offshore Synchronous Power Generating Modules** and voltage control performance requirements applicable to AC connected **Offshore Power Park Modules, DC Connected Power Park Modules and Remote End HVDC Converters**
- ECC.6.3.8.5.1 A continuously acting automatic control system is required to provide control of **Reactive Power** (as specified in ECC.6.3.2.5 and ECC.6.3.2.6) at the **Offshore Grid Entry Point** (or **HVDC Interface Point** in the case of **Configuration 1 DC Connected Power Park Modules and Remote End HVDC Converters**) without instability over the entire operating range of the AC connected **Offshore Synchronous Power Generating Module** or **Configuration 1 AC connected Offshore Power Park Module** or **Configuration 1 DC Connected Power Park Modules** or **Remote End HVDC Converter**. The performance requirements for this automatic control system will be specified by **The Company** which would be consistent with the requirements of ECC.6.3.2.5 and ECC.6.3.2.6.
- ECC.6.3.8.5.2 A continuously acting automatic control system is required to provide control of **Reactive Power** (as specified in ECC.6.3.2.8) at the **Offshore Grid Entry Point** (or **HVDC Interface Point** in the case of **Configuration 2 DC Connected Power Park Modules**) without instability over the entire operating range of the **Configuration 2 AC connected Offshore Power Park Module** or **Configuration 2 DC Connected Power Park Modules**. otherwise the requirements of ECC.6.3.2.6 shall apply. The performance requirements for this automatic control system are specified in ECC.A.8
- ECC.6.3.8.5.3 In addition to ECC.6.3.8.5.1 and ECC.6.3.8.5.2 the requirements for excitation or voltage control facilities, including **Power System Stabilisers**, where these are necessary for system reasons, will be specified by **The Company**. Reference is made to on-load commissioning witnessed by **The Company** in BC2.11.2.
- ECC.6.3.9 STEADY STATE LOAD INACCURACIES
- ECC.6.3.9.1 The standard deviation of **Load** error at steady state **Load** over a 30 minute period must not exceed 2.5 per cent of a **Type C** or **Type D Power Generating Modules** (including a **DC Connected Power Park Module**) **Maximum Capacity**. Where a **Type C** or **Type D Power Generating Module** (including a **DC Connected Power Park Module**) is instructed to **Frequency** sensitive operation, allowance will be made in determining whether there has been an error according to the governor droop characteristic registered under the **PC**.
- For the avoidance of doubt in the case of a **Power Park Module** allowance will be made for the full variation of mechanical power output and in the case of an **Electricity Storage Module** allowance will be made for the storage capability of the **Electricity Storage Module**.
- ECC.6.3.10 NEGATIVE PHASE SEQUENCE LOADINGS
- ECC.6.3.10.1 In addition to meeting the conditions specified in ECC.6.1.5(b), each **Synchronous Power Generating Module** will be required to withstand, without tripping, the negative phase sequence loading incurred by clearance of a close-up phase-to-phase fault, by **System Back-Up Protection** on the **National Electricity Transmission System** or **User System** located **Onshore** in which it is **Embedded**.
- ECC.6.3.11 NEUTRAL EARTHING

- ECC.6.3.11 At nominal **System** voltages of 110kV and above the higher voltage windings of a transformer of a **Power Generating Module** or **HVDC Equipment** or transformer resulting from **OTSDUW** must be star connected with the star point suitable for connection to earth. The earthing and lower voltage winding arrangement shall be such as to ensure that the **Earth Fault Factor** requirement of paragraph ECC.6.2.1.1 (b) will be met on the **National Electricity Transmission System** at nominal **System** voltages of 110kV and above.
- ECC.6.3.12 FREQUENCY AND VOLTAGE DEVIATIONS
- ECC.6.3.12.1 As stated in ECC.6.1.2, the **System Frequency** could rise to 52Hz or fall to 47Hz. Each **Power Generating Module** (including **DC Connected Power Park Modules**) must continue to operate within this **Frequency** range for at least the periods of time given in ECC.6.1.2 unless **The Company** has specified any requirements for combined **Frequency** and voltage deviations which are required to ensure the best use of technical capabilities of **Power Generating Modules** (including **DC Connected Power Park Modules**) if required to preserve or restore system security.- Notwithstanding this requirement, **EU Generators** should also be aware of the requirements of ECC.6.3.13.
- ECC.6.3.13 FREQUENCY, RATE OF CHANGE OF FREQUENCY AND VOLATGE PROTECTION SETTING ARRANGEMENTS
- ECC.6.3.13.1 **EU Generators** (including in respect of **OTSDUW Plant and Apparatus**) and **HVDC System Owners** will be responsible for protecting all their **Power Generating Modules** (and **OTSDUW Plant and Apparatus**) or **HVDC Equipment** against damage should **Frequency** excursions outside the range 52Hz to 47Hz ever occur. Should such excursions occur, it is up to the **EU Generator** or **HVDC System Owner** to decide whether to disconnect his **Apparatus** for reasons of safety of **Apparatus, Plant** and/or personnel.
- ECC.6.3.13.2 Each **Power Generating Module** when connected and synchronised to the **System**, shall be capable of withstanding without tripping a rate of change of **Frequency** up to and including 1 Hz per second as measured over a rolling 500 milliseconds period. Voltage dips may cause localised rate of change of **Frequency** values in excess of 1 Hz per second for short periods, and in these cases, the requirements under ECC.6.3.15 (fault ride through) supersedes this clause. For the avoidance of doubt, this requirement relates to the capabilities of **Power Generating Modules** only and does not impose the need for rate of change of **Frequency** protection nor does it impose a specific setting for anti-islanding or loss-of-mains protection relays.
- ECC.6.3.13.3 Each **HVDC System** and **Remote End HVDC Converter Station** when connected and synchronised to the **System**, shall be capable of withstanding without tripping a rate of change of **Frequency** up to and including  $\pm 2.5$ Hz per second as measured over the previous 1 second period. Voltage dips may cause localised rate of change of **Frequency** values in excess of  $\pm 2.5$  Hz per second for short periods, and in these cases, the requirements under ECC.6.3.15 (fault ride through) supersedes this clause. For the avoidance of doubt, this requirement relates to the capabilities of **HVDC Systems** and **Remote End HVDC Converter Stations** only and does not impose the need for rate of change of **Frequency** protection nor does it impose a specific setting for anti-islanding or loss-of-mains protection relays.
- ECC.6.3.13.4 Each **DC Connected Power Park Module** when connected to the **System**, shall be capable of withstanding without tripping a rate of change of **Frequency** up to and including  $\pm 2.0$ Hz per second as measured over the previous 1 second period. **Voltage** dips may cause localised rate of change of **Frequency** values in excess of  $\pm 2.0$  Hz per second for short periods, and in these cases, the requirements under ECC.6.3.15 (fault ride through) supersedes this clause. For the avoidance of doubt, this requirement relates to the capabilities of **DC Connected Power Park Modules** only and does not impose the need for rate of change of **Frequency** protection nor does it impose a specific setting for anti-islanding or loss-of-mains protection relays.

- ECC.6.3.13.5 As stated in ECC.6.1.2, the **System Frequency** could rise to 52Hz or fall to 47Hz and the **System** voltage at the **Grid Entry Point** or **User System Entry Point** could rise or fall within the values outlined in ECC.6.1.4. Each **Type C** and **Type D Power Generating Module** (including **DC Connected Power Park Modules**) or any constituent element must continue to operate within this **Frequency** range for at least the periods of time given in ECC.6.1.2 and voltage range as defined in ECC.6.1.4 unless **The Company** has agreed to any simultaneous overvoltage and underfrequency relays and/or simultaneous undervoltage and over frequency relays which will trip such **Power Generating Module** (including **DC Connected Power Park Modules**), and any constituent element within this **Frequency** or voltage range.
- ECC.6.3.14 FAST START CAPABILITY
- ECC.6.3.14.1 It may be agreed in the **Bilateral Agreement** that a **Genset** shall have a **Fast-Start Capability**. Such **Gensets** may be used for **Operating Reserve** and their **Start-Up** may be initiated by **Frequency**-level relays with settings in the range 49Hz to 50Hz as specified pursuant to **OC2**.
- ECC.6.3.15 FAULT RIDE THROUGH
- ECC.6.3.15.1 General Fault Ride Through requirements, principles and concepts applicable to Type B, Type C and Type D Power Generating Modules and OTSDUW Plant and Apparatus subject to faults up to 140ms in duration
- ECC.6.3.15.1.1 ECC.6.3.15.1 – ECC.6.3.15.8 section sets out the **Fault Ride Through** requirements on **Type B, Type C and Type D Power Generating Modules, OTSDUW Plant and Apparatus** and **HVDC Equipment** that shall apply in the event of a fault lasting up to 140ms in duration.
- ECC.6.3.15.1.2 Each **Power Generating Module, Power Park Module, HVDC Equipment** and **OTSDUW Plant and Apparatus** is required to remain connected and stable for any balanced and unbalanced fault where the voltage at the **Grid Entry Point** or **User System Entry Point** or (**HVDC Interface Point** in the case of **Remote End DC Converter Stations** or **Interface Point** in the case of **OTSDUW Plant and Apparatus**) remains on or above the heavy black line defined in sections ECC.6.3.15.2 – ECC.6.3.15.7 below.
- ECC.6.3.15.1.3 The voltage against time curves defined in ECC.6.3.15.2 – ECC.6.3.15.7 expresses the lower limit (expressed as the ratio of its actual value and its reference 1pu) of the actual course of the phase to phase voltage (or phase to earth voltage in the case of asymmetrical/unbalanced faults) on the **System** voltage level at the **Grid Entry Point** or **User System Entry Point** (or **HVDC Interface Point** in the case of **Remote End HVDC Converter Stations** or **Interface Point** in the case of **OTSDUW Plant and Apparatus**) during a symmetrical or asymmetrical/unbalanced fault, as a function of time before, during and after the fault.
- ECC.6.3.15.2 Voltage against time curve and parameters applicable to Type B Synchronous Power Generating Modules

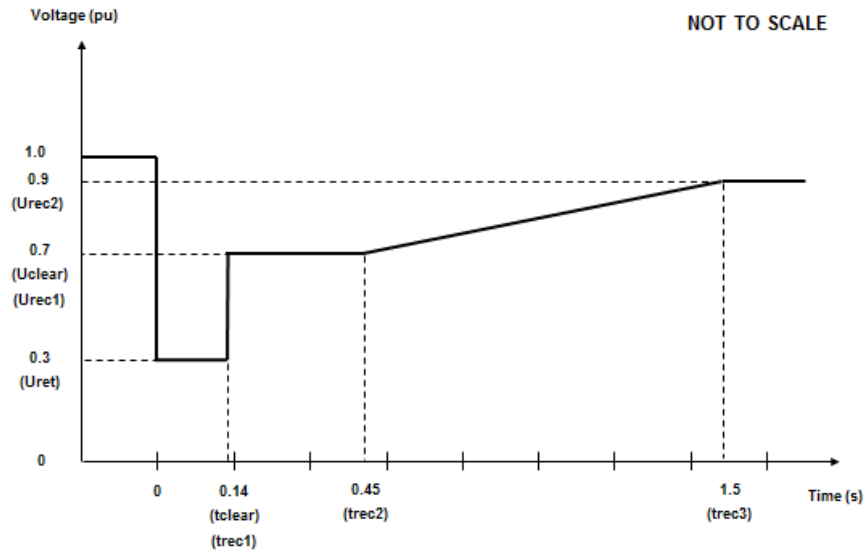

Figure ECC.6.3.15.2 - Voltage against time curve applicable to **Type B Synchronous Power Generating Modules**

Voltage parameters (pu)		Time parameters (seconds)	
Uret	0.3	tclear	0.14
Uclear	0.7	trec1	0.14
Urec1	0.7	trec2	0.45
Urec2	0.9	trec3	1.5

Table ECC.6.3.15.2 Voltage against time parameters applicable to **Type B Synchronous Power Generating Modules**

ECC.6.3.15.3 Voltage against time curve and parameters applicable to **Type C and D Synchronous Power Generating Modules** connected below 110kV

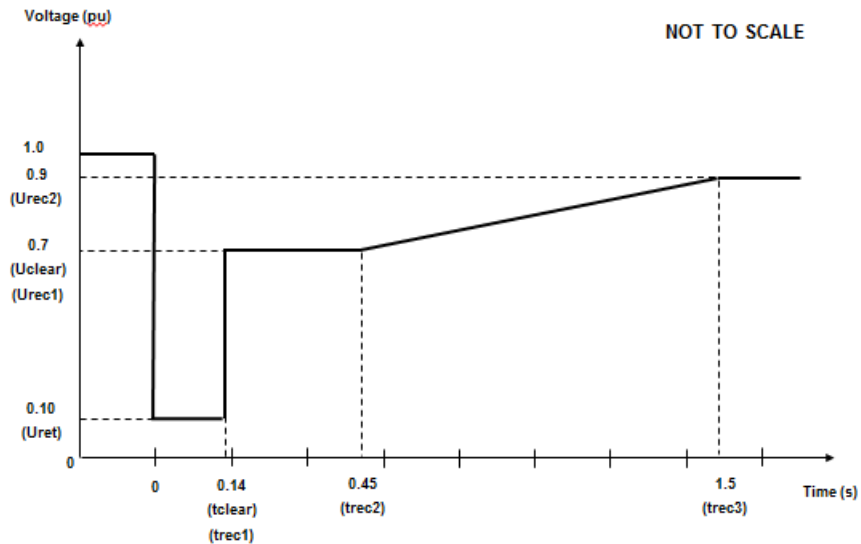

Figure ECC.6.3.15.3 - Voltage against time curve applicable to **Type C and D Synchronous Power Generating Modules** connected below 110kV

Voltage parameters (pu)		Time parameters (seconds)	
Uret	0.1	tclear	0.14
Uclear	0.7	trec1	0.14
Urec1	0.7	trec2	0.45
Urec2	0.9	trec3	1.5

Table ECC.6.3.15.3 Voltage against time parameters applicable to **Type C and D Synchronous Power Generating Modules** connected below 110kV

ECC.6.3.15.4 Voltage against time curve and parameters applicable to **Type D Synchronous Power Generating Modules** connected at or above 110kV

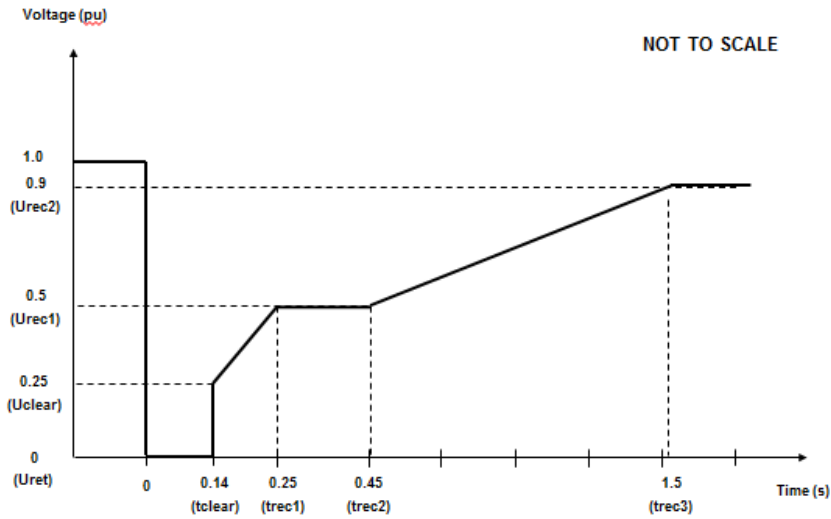

Figure ECC.6.3.15.4 - Voltage against time curve applicable to **Type D Synchronous Power Generating Modules** connected at or above 110kV

Voltage parameters (pu)		Time parameters (seconds)	
Uret	0	tclear	0.14
Uclear	0.25	trec1	0.25
Urec1	0.5	trec2	0.45
Urec2	0.9	trec3	1.5

Table ECC.6.3.15.4 Voltage against time parameters applicable to **Type D Synchronous Power Generating Modules** connected at or above 110kV

ECC.6.3.15.5 Voltage against time curve and parameters applicable to **Type B, C and D Power Park Modules** connected below 110kV

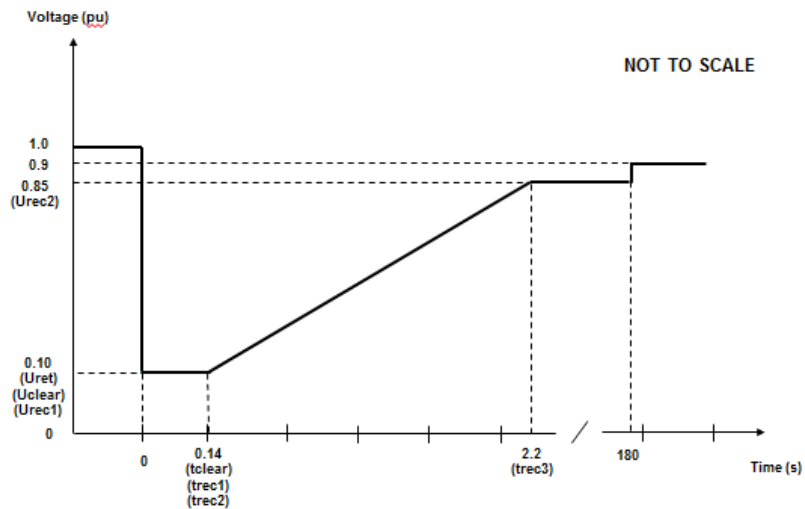

Figure ECC.6.3.15.5 - Voltage against time curve applicable to **Type B, C and D Power Park Modules** connected below 110kV

Voltage parameters (pu)		Time parameters (seconds)	
Uret	0.10	tclear	0.14
Uclear	0.10	trec1	0.14
Urec1	0.10	trec2	0.14
Urec2	0.85	trec3	2.2

Table ECC.6.3.15.5 Voltage against time parameters applicable to **Type B, C and D Power Park Modules** connected below 110kV

ECC.6.3.15.6 Voltage against time curve and parameters applicable to **Type D Power Park Modules** with a **Grid Entry Point** or **User System Entry Point** at or above 110kV, **DC Connected Power Park Modules** at the **HVDC Interface Point** or **OTSDUW Plant and Apparatus** at the **Interface Point**.

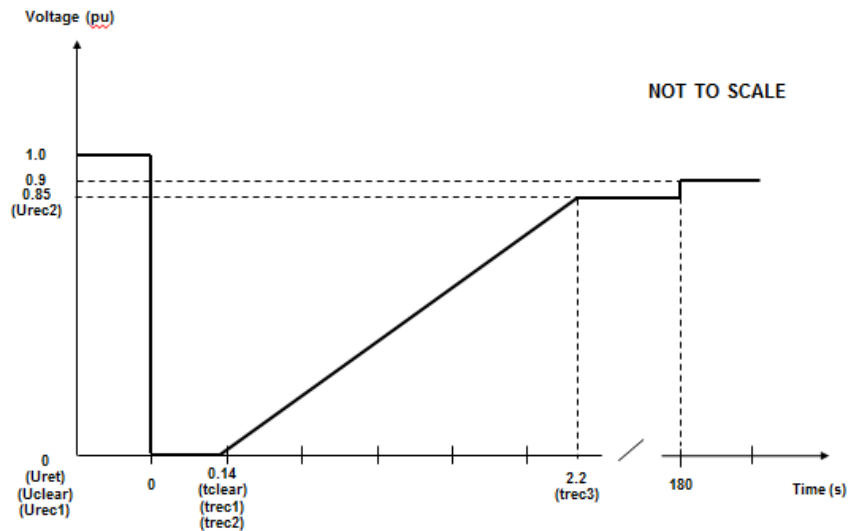

Figure ECC.6.3.15.6 - Voltage against time curve applicable to **Type D Power Park Modules** with a **Grid Entry Point** or **User System Entry Point** at or above 110kV, **DC Connected Power Park Modules** at the **HVDC Interface Point** or **OTSDUW Plant and Apparatus** at the **Interface Point**.

Voltage parameters (pu)		Time parameters (seconds)	
Uret	0	tclear	0.14
Uclear	0	trec1	0.14
Urec1	0	trec2	0.14
Urec2	0.85	trec3	2.2

Table ECC.6.3.15.6 Voltage against time parameters applicable to a **Type D Power Park Modules** with a **Grid Entry Point** or **User System Entry Point** at or above 110kV, **DC Connected Power Park Modules** at the **HVDC Interface Point** or **OTSDUW Plant and Apparatus** at the **Interface Point**.

ECC.6.3.15.7 Voltage against time curve and parameters applicable to **HVDC Systems** and **Remote End HVDC Converter Stations**

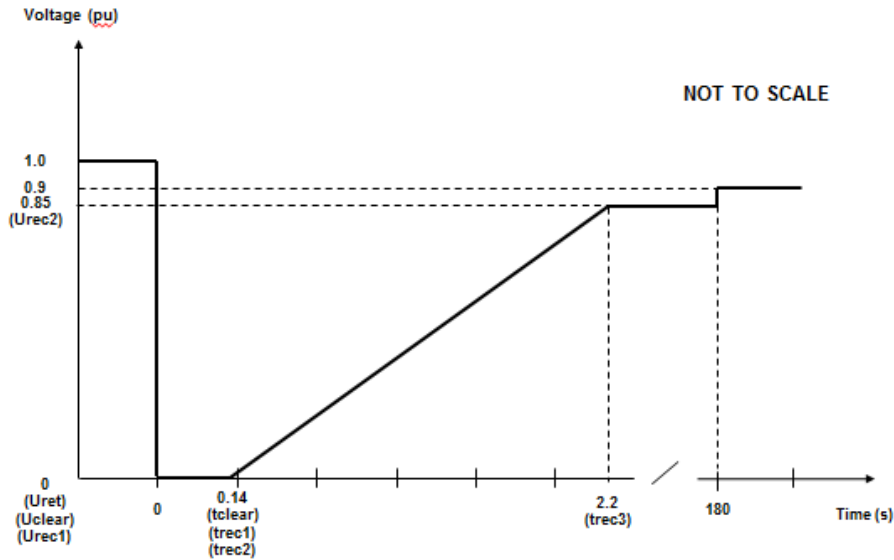

Figure ECC.6.3.15.7 - Voltage against time curve applicable to **HVDC Systems** and **Remote End HVDC Converter Stations**

Voltage parameters (pu)		Time parameters (seconds)	
Uret	0	tclear	0.14
Uclear	0	trec1	0.14
Urec1	0	trec2	0.14
Urec2	0.85	trec3	2.2

Table ECC.6.3.15.7 Voltage against time parameters applicable to **HVDC Systems** and **Remote End HVDC Converter Stations**

- ECC.6.3.15.8 In addition to the requirements in ECC.6.3.15.1 – ECC.6.3.15.7:
- (i) Each **Type B, Type C** and **Type D Power Generating Module** at the **Grid Entry Point** or **User System Entry Point**, **HVDC Equipment** (or **OTSDUW Plant and Apparatus** at the **Interface Point**) shall be capable of satisfying the above requirements when operating at **Rated MW** output and maximum leading **Power Factor**.
  - (ii) **The Company** will specify upon request by the **User** the pre-fault and post fault short circuit capacity (in MVA) at the **Grid Entry Point** or **User System Entry Point** (or **HVDC Interface Point** in the case of a remote end **HVDC Converter Stations** or **Interface Point** in the case of **OTSDUW Plant and Apparatus**).
  - (iii) The pre-fault voltage shall be taken to be 1.0pu and the post fault voltage shall not be less than 0.9pu.
  - (iv) To allow a **User** to model the **Fault Ride Through** performance of its **Type B, Type C** and/or **Type D Power Generating Modules** or **HVDC Equipment**, **The Company** will provide additional network data as may reasonably be required by the **EU Code User** to undertake such study work in accordance with PC.A.8. Alternatively, **The Company** may provide generic values derived from typical cases.
  - (v) **The Company** will publish fault level data under maximum and minimum demand conditions in the **Electricity Ten Year Statement**.



(vi) Each **EU Generator** (in respect of **Type B, Type C, Type D Power Generating Modules** and **DC Connected Power Park Modules**) and **HVDC System Owners** (in respect of **HVDC Systems**) shall satisfy the requirements in ECC.6.3.15.8(i) – (vii) unless the protection schemes and settings for internal electrical faults trips the **Type B, Type C** and **Type D Power Generating Module, HVDC Equipment** (or **OTSDUW Plant and Apparatus**) from the **System**. The protection schemes and settings should not jeopardise **Fault Ride Through** performance as specified in ECC.6.3.15.8(i) – (vii). The undervoltage protection at the **Grid Entry Point** or **User System Entry Point** (or **HVDC Interface Point** in the case of a **Remote End HVDC Converter Stations** or **Interface Point** in the case of **OTSDUW Plant and Apparatus**) shall be set by the **EU Generator** (or **HVDC System Owner** or **OTSDUA** in the case of **OTSDUW Plant and Apparatus**) according to the widest possible range unless **The Company** and the **EU Code User** have agreed to narrower settings. All protection settings associated with undervoltage protection shall be agreed between the **EU Generator** and/or **HVDC System Owner** with **The Company** and **Relevant Transmission Licensee’s** and relevant **Network Operator** (as applicable).

(vii) Each **Type B, Type C** and **Type D Power Generating Module, HVDC System** and **OTSDUW Plant and Apparatus** at the **Interface Point** shall be designed such that upon clearance of the fault on the **Onshore Transmission System** and within 0.5 seconds of restoration of the voltage at the **Grid Entry Point** or **User System Entry Point** or **HVDC Interface Point** in the case of a **Remote End HVDC Converter Stations** or **Interface Point** in the case of **OTSDUW Plant and Apparatus** to 90% of nominal voltage or greater, **Active Power** output (or **Active Power** transfer capability in the case of **OTSDUW Plant and Apparatus** or **Remote End HVDC Converter Stations**) shall be restored to at least 90% of the level immediately before the fault. Once **Active Power** output (or **Active Power** transfer capability in the case of **OTSDUW Plant and Apparatus** or **Remote End HVDC Converter Stations**) has been restored to the required level, **Active Power** oscillations shall be acceptable provided that:

- The total **Active Energy** delivered during the period of the oscillations is at least that which would have been delivered if the **Active Power** was constant
- The oscillations are adequately damped.
- In the event of power oscillations, **Power Generating Modules** shall retain steady state stability when operating at any point on the **Power Generating Module Performance Chart**.

For AC Connected **Onshore** and **Offshore Power Park Modules** comprising switched reactive compensation equipment (such as mechanically switched capacitors and reactors), such switched reactive compensation equipment shall be controlled such that it is not switched in or out of service during the fault but may act to assist in post fault voltage recovery.

ECC.6.3.15.9 General Fault Ride Through requirements for faults in excess of 140ms in duration.

ECC.6.3.15.9.1 General Fault Ride Through requirements applicable to HVDC Equipment and OTSDUW DC Converters subject to faults and voltage dips in excess of 140ms.

ECC.6.3.15.9.1.1 The requirements applicable to **HVDC Equipment** including **OTSDUW DC Converters** subject to faults and voltage disturbances at the **Grid Entry Point** or **User System Entry Point** or **Interface Point** or **HVDC Interface Point**, including **Active Power** transfer capability shall be specified in the **Bilateral Agreement**.

ECC.6.3.15.9.2 Fault Ride Through requirements for Type C and Type D Synchronous Power Generating Modules and Type C and Type D Power Park Modules and OTSDUW Plant and Apparatus subject to faults and voltage disturbances on the Onshore Transmission System in excess of 140ms

ECC.6.3.15.9.2.1 The **Fault Ride Through** requirements for **Type C** and **Type D Synchronous Power Generating Modules** subject to faults and voltage disturbances on the Onshore Transmission System in excess of 140ms are defined in ECC.6.3.15.9.2.1(a) and the **Fault Ride Through Requirements** for **Type C and Type D Power Park Modules** and **OTSDUW Plant and Apparatus** subject to faults and voltage disturbances on the Onshore Transmission System greater than 140ms in duration are defined in ECC.6.3.15.9.2.1(b).

- (a) Requirements applicable to **Synchronous Power Generating Modules** subject to **Supergrid Voltage** dips on the **Onshore Transmission System** greater than 140ms in duration.

In addition to the requirements of ECC.6.3.15.1 – ECC.6.3.15.8 each **Synchronous Power Generating Module** shall:

- (i) remain transiently stable and connected to the **System** without tripping of any **Synchronous Power Generating Module** for balanced **Supergrid Voltage** dips and associated durations on the **Onshore Transmission System** (which could be at the **Interface Point**) anywhere on or above the heavy black line shown in Figure ECC.6.3.15.9(a) Appendix 4 and Figures EA.4.3.2(a), (b) and (c) provide an explanation and illustrations of Figure ECC.6.3.15.9(a); and,

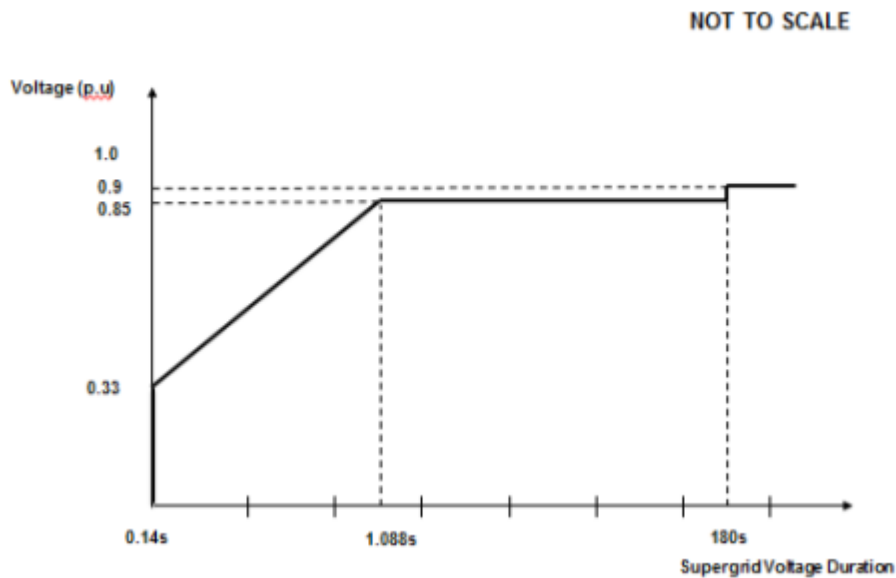

Figure ECC.6.3.15.9(a)

- (ii) provide **Active Power** output at the **Grid Entry Point**, during **Supergrid Voltage** dips on the **Onshore Transmission System** as described in Figure ECC.6.3.15.9(a), at least in proportion to the retained balanced voltage at the **Onshore Grid Entry Point** (for **Onshore Synchronous Power Generating Modules**) or **Interface Point** (for **Offshore Synchronous Power Generating Modules**) (or the retained balanced voltage at the **User System Entry Point** if **Embedded**) and shall generate maximum reactive current (where the voltage at the **Grid Entry Point** is outside the limits specified in ECC.6.1.4) without exceeding the transient rating limits of the **Synchronous Power Generating Module** and,
- (iii) restore **Active Power** output following **Supergrid Voltage** dips on the **Onshore Transmission System** as described in Figure ECC.6.3.15.9(a), within 1 second of restoration of the voltage to 1.0pu of the nominal voltage at the:

**Onshore Grid Entry Point** for directly connected **Onshore Synchronous Power Generating Modules** or,

**Interface Point** for **Offshore Synchronous Power Generating Modules**  
or,

**User System Entry Point** for **Embedded Onshore Synchronous Power**

### Generating Modules

or,

**User System Entry Point** for **Embedded Medium Power Stations** not subject to a **Bilateral Agreement** which comprise **Synchronous Generating Units** and with an **Onshore User System Entry Point** (irrespective of whether they are located **Onshore** or **Offshore**)

to at least 90% of the level available immediately before the occurrence of the dip. Once the **Active Power** output has been restored to the required level, **Active Power** oscillations shall be acceptable provided that:

- the total **Active Energy** delivered during the period of the oscillations is at least that which would have been delivered if the **Active Power** was constant
- the oscillations are adequately damped.

For the avoidance of doubt a balanced **Onshore Transmission System Supergrid Voltage** meets the requirements of ECC.6.1.5 (b) and ECC.6.1.6.

- (b) Requirements applicable to **Type C** and **Type D Power Park Modules** and **OTSDUW Plant and Apparatus** (excluding **OTSDUW DC Converters**) subject to **Supergrid Voltage** dips on the **Onshore Transmission System** greater than 140ms in duration.

In addition to the requirements of ECC.6.3.15.5, ECC.6.3.15.6 and ECC.6.3.15.8 (as applicable) each **OTSDUW Plant and Apparatus** or each **Power Park Module** and / or any constituent **Power Park Unit**, shall:

- (i) remain transiently stable and connected to the **System** without tripping of any **OTSDUW Plant and Apparatus**, or **Power Park Module** and / or any constituent **Power Park Unit**, for balanced **Supergrid Voltage** dips and associated durations on the **Onshore Transmission System** (which could be at the **Interface Point**) anywhere on or above the heavy black line shown in Figure ECC.6.3.15.9(b). Appendix 4 and Figures EA.4.3.4 (a), (b) and (c) provide an explanation and illustrations of Figure ECC.6.3.15.9(b) ; and,

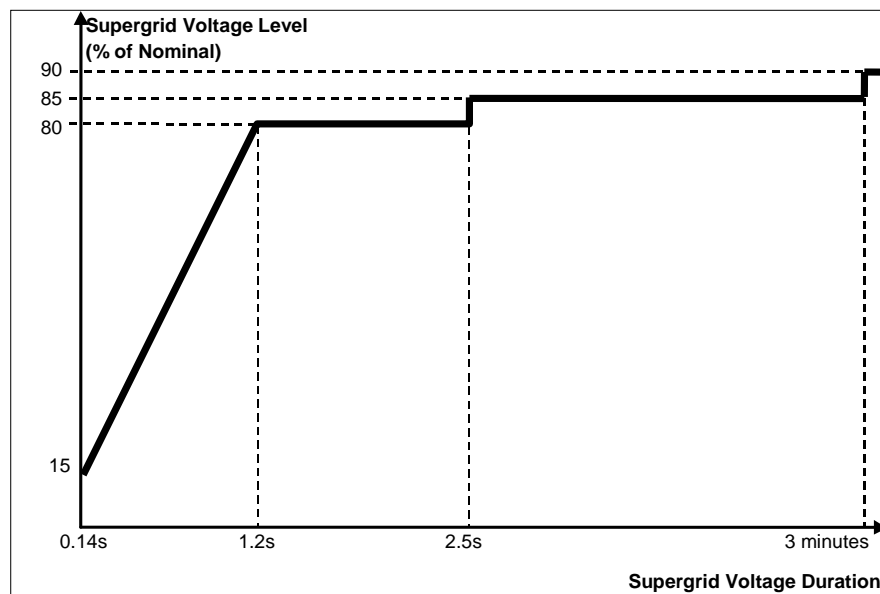

Figure ECC.6.3.15.9(b)

- (ii) provide **Active Power** output at the **Grid Entry Point** or in the case of an **OTSDUW**, **Active Power** transfer capability at the **Transmission Interface Point**, during **Supergrid Voltage** dips on the **Onshore Transmission System** as described in Figure ECC.6.3.15.9(b), at least in proportion to the retained balanced voltage at the **Onshore Grid Entry Point** (for **Onshore Power Park Modules**) or **Interface Point** (for **OTSDUW Plant and Apparatus** and **Offshore Power Park Modules**) (or the retained balanced voltage at the **User System Entry Point** if **Embedded**) except in the case of a **Non-Synchronous Generating Unit** or **OTSDUW Plant and**

**Apparatus or Power Park Module** where there has been a reduction in the **Intermittent Power Source** or in the case of **OTSDUW Active Power** transfer capability in the time range in Figure ECC.6.3.15.9(b) that restricts the **Active Power** output or in the case of an **OTSDUW Active Power** transfer capability below this level. In the case of a **Non-Synchronous Electricity Storage Module**, an allowance will be made for the storage capability of the **Non-Synchronous Electricity Storage Module**.

- (iii) restore **Active Power** output (or, in the case of **OTSDUW**, **Active Power** transfer capability), following **Supergrid Voltage** dips on the **Onshore Transmission System** as described in Figure ECC.6.3.15.9(b), within 1 second of restoration of the voltage at the:

**Onshore Grid Entry Point** for directly connected **Onshore Power Park Modules** or,

**Interface Point** for **OTSDUW Plant and Apparatus** and **Offshore Power Park Modules** or,

**User System Entry Point** for **Embedded Onshore Power Park Modules** or ,

**User System Entry Point** for **Embedded Medium Power Stations** which comprise **Power Park Modules** not subject to a **Bilateral Agreement** and with an **Onshore User System Entry Point** (irrespective of whether they are located **Onshore** or **Offshore**)

to the minimum levels specified in ECC.6.1.4 to at least 90% of the level available immediately before the occurrence of the dip except in the case of a **Non-Synchronous Generating Unit, OTSDUW Plant and Apparatus** or **Power Park Module** where there has been a reduction in the **Intermittent Power Source** in the time range in Figure ECC.6.3.15.9(b) that restricts the **Active Power** output or, in the case of **OTSDUW**, **Active Power** transfer capability below this level. Once the **Active Power** output or, in the case of **OTSDUW**, **Active Power** transfer capability has been restored to the required level, **Active Power** oscillations shall be acceptable provided that:

- the total **Active Energy** delivered during the period of the oscillations is at least that which would have been delivered if the **Active Power** was constant
- the oscillations are adequately damped.

In the case of a **Non-Synchronous Electricity Storage Module**, allowance will be made for the storage capability of the **Non-Synchronous Electricity Storage Module**.

For the avoidance of doubt a balanced **Onshore Transmission System Supergrid Voltage** meets the requirements of ECC.6.1.5 (b) and ECC.6.1.6.

#### ECC.6.3.15.10 Other **Fault Ride Through** Requirements

- (i) In the case of a **Power Park Module**, the requirements in ECC.6.3.15.9 do not apply when the **Power Park Module** is operating at less than 5% of its **Rated MW**. In the case of a **Power Park Module** such as a wind or wave farm (excluding any **Electricity Storage Modules**) the requirements of ECC.6.3.15.9 do not apply or during very high primary energy source conditions when more than 50% of the **Power Park Units** in a **Power Park Module** have been shut down or disconnected under an emergency shutdown sequence to protect **User's Plant** and **Apparatus**.
- (ii) In addition to meeting the conditions specified in ECC.6.1.5(b) and ECC.6.1.6, each **Non-Synchronous Generating Unit, OTSDUW Plant and Apparatus** or **Power Park Module** and any constituent **Power Park Unit** thereof will be required to withstand, without tripping, the negative phase sequence loading incurred by clearance of a close-up phase-to-phase fault, by **System Back-Up Protection** on the **Onshore Transmission System** operating at **Supergrid Voltage**.

- (iii) **Generators** in respect of **Type B, Type C and Type D Power Park Modules** and **HVDC System Owners** are required to confirm to **The Company**, their repeated ability to operate through balanced and unbalanced faults and **System** disturbances each time the voltage at the **Grid Entry Point** or **User System Entry Point** falls outside the limits specified in ECC.6.1.4. Demonstration of this capability would be satisfied by **EU Generators** and **HVDC System Owners** supplying the protection settings of their plant, informing **The Company** of the maximum number of repeated operations that can be performed under such conditions and any limiting factors to repeated operation such as protection or thermal rating; and
- (iv) Notwithstanding the requirements of ECC.6.3.15(v), **Power Generating Modules** shall be capable of remaining connected during single phase or three phase auto-reclosures to the **National Electricity Transmission System** and operating without power reduction as long as the voltage and frequency remain within the limits defined in ECC.6.1.4 and ECC.6.1.2; and
- (v) For the avoidance of doubt the requirements specified in ECC.6.3.15 do not apply to **Power Generating Modules** connected to either an unhealthy circuit and/or islanded from the **Transmission System** even for delayed auto reclosure times.
- (vi) To avoid unwanted island operation, **Non-Synchronous Generating Units** in Scotland (and those directly connected to a **Scottish Offshore Transmission System**), **Power Park Modules** in Scotland (and those directly connected to a **Scottish Offshore Transmission System**), or **OTSDUW Plant and Apparatus** with an **Interface Point** in Scotland shall be tripped for the following conditions:
  - (1) **Frequency** above 52Hz for more than 2 seconds
  - (2) **Frequency** below 47Hz for more than 2 seconds
  - (3) Voltage as measured at the **Onshore Connection Point** or **Onshore User System Entry Point** or **Offshore Grid Entry Point** or **Interface Point** in the case of **OTSDUW Plant and Apparatus** is below 80% for more than 2.5 seconds

Voltage as measured at the **Onshore Connection Point** or **Onshore User System Entry Point** or **Offshore Grid Entry Point** or **Interface Point** in the case of **OTSDUW Plant and Apparatus** is above 120% (115% for 275kV) for more than 1 second. The times in sections (1) and (2) are maximum trip times. Shorter times may be used to protect the **Non-Synchronous Generating Units**, or **OTSDUW Plant and Apparatus**.

ECC.6.3.15.11 HVDC System Robustness

ECC.6.3.15.11.1 The **HVDC System** shall be capable of finding stable operation points with a minimum change in **Active Power** flow and voltage level, during and after any planned or unplanned change in the **HVDC System** or **AC System** to which it is connected. **The Company** shall specify the changes in the System conditions for which the **HVDC Systems** shall remain in stable operation.

ECC.6.3.15.11.2 The **HVDC System** owner shall ensure that the tripping or disconnection of an **HVDC Converter Station**, as part of any multi-terminal or embedded **HVDC System**, does not result in transients at the **Grid Entry Point** or **User System Entry Point** beyond the limit specified by **The Company** in co-ordination with the **Relevant Transmission Licensee**.

ECC.6.3.15.11.3 The **HVDC System** shall withstand transient faults on HVAC lines in the network adjacent or close to the **HVDC System**, and shall not cause any of the equipment in the **HVDC System** to disconnect from the network due to autoreclosure of lines in the **System**.

ECC.6.3.15.11.4 The **HVDC System Owner** shall provide information to **The Company** on the resilience of the **HVDC System** to **AC System** disturbances.

ECC.6.3.16 FAST FAULT CURRENT INJECTION

ECC.6.3.16.1 General Fast Fault Current injection, principles and concepts applicable to Type B, Type C and Type D Power Park Modules and HVDC Equipment

ECC.6.3.16.1.1 Each **Type B, Type C and Type D Power Park Module** or **HVDC Equipment** shall be required to satisfy the following requirements.

ECC.6.3.16.1.2 For any balanced or unbalanced fault which results in the phase voltage on one or more phases falling outside the limits specified in ECC.6.1.2 at the **Grid Entry Point** or **User System Entry Point**, each **Type B, Type C and Type D Power Park Module** or **HVDC Equipment** shall, unless otherwise agreed with **The Company**, be required to inject a reactive current above the shaded area shown in Figure ECC.16.3.16(a) and Figure 16.3.16(b). For the purposes of this requirement, the maximum rated current is taken to be the maximum current each Power Park Module (or constituent **Power Park Unit**) or **HVDC Converter** is capable of supplying when operating at rated **Active Power** and rated **Reactive Power** (as required under ECC.6.3.2) at a nominal voltage of 1.0pu. For example, in the case of a 100MW **Power Park Module** the **Rated Active Power** would be taken as 100MW and the rated **Reactive Power** would be taken as 32.8MVAr (ie **Rated MW** output operating at 0.95 **Power Factor** lead or 0.95 **Power Factor** lag as required under ECC.6.3.2.4). For the avoidance of doubt, where the phase voltage at the **Grid Entry Point** or **User System Entry Point** is not zero, the reactive current injected shall be in proportion to the retained voltage at the **Grid Entry Point** or **User System Entry Point** but shall still be required to remain above the shaded area in Figure 16.3.16(a) and Figure 16.3.16(b).

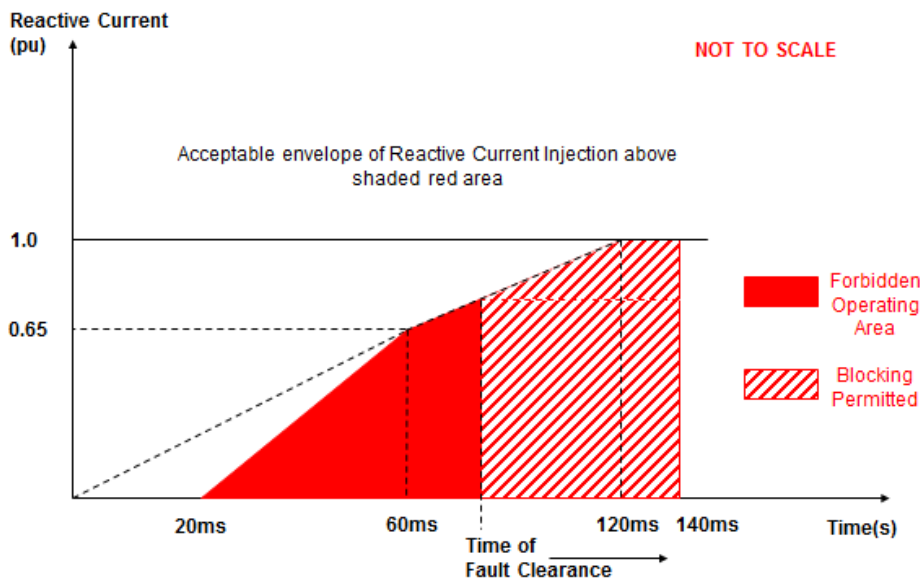

Figure ECC.16.3.16(a)

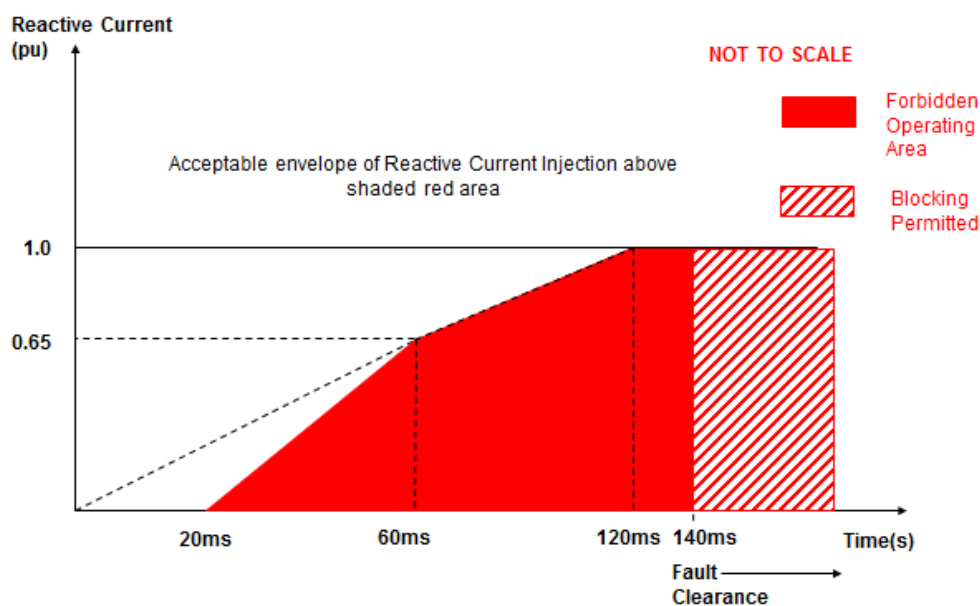

Figure ECC.16.3.16(b)

- ECC.6.3.16.1.3 The converter(s) of each **Type B, Type C and Type D Power Park Module or HVDC Equipment** is permitted to block upon fault clearance in order to mitigate against the risk of instability that would otherwise occur due to transient overvoltage excursions. Figure ECC.16.3.16(a) and Figure ECC.16.3.16(b) shows the impact of variations in fault clearance time which shall be no greater than 140ms. The requirements for the maximum transient overvoltage withstand capability and associated time duration, shall be agreed between the **EU Code User** and **The Company** as part of the **Bilateral Agreement**. Where the **EU Code User** is able to demonstrate to **The Company** that blocking is required in order to prevent the risk of transient over voltage excursions as specified in ECC.6.3.16.1.5. **EU Generators** and **HVDC System Owners** are required to both advise and agree with **The Company** of the control strategy, which must also include the approach taken to de-blocking. Notwithstanding this requirement, **EU Generators** and **HVDC System Owners** should be aware of their requirement to fully satisfy the fault ride through requirements specified in ECC.6.3.15.
- ECC.6.3.16.1.4 In addition, the reactive current injected from each **Power Park Module or HVDC Equipment** shall be injected in proportion and remain in phase to the change in **System** voltage at the **Connection Point or User System Entry Point** during the period of the fault. For the avoidance of doubt, a small delay time of no greater than 20ms from the point of fault inception is permitted before injection of the in phase reactive current.
- ECC.6.3.16.1.5 Each **Type B, Type C and Type D Power Park Module or HVDC Equipment** shall be designed to reduce the risk of transient over voltage levels arising following clearance of the fault. **EU Generators** or **HVDC System Owners** shall be permitted to block where the anticipated transient overvoltage would otherwise exceed the maximum permitted values specified in ECC.6.1.7. Any additional requirements relating to transient overvoltage performance will be specified by **The Company**.
- ECC.6.3.16.1.6 In addition to the requirements of ECC.6.3.15, **Generators** in respect of **Type B, Type C and Type D Power Park Modules** and **HVDC System Owners** are required to confirm to **The Company**, their repeated ability to supply **Fast Fault Current** to the **System** each time the voltage at the **Grid Entry Point or User System Entry Point** falls outside the limits specified in ECC.6.1.4. **EU Generators** and **HVDC Equipment Owners** should inform **The Company** of the maximum number of repeated operations that can be performed under such conditions and any limiting factors to repeated operation such as protection or thermal rating; and

ECC.6.3.16.1.7 In the case of a **Power Park Module** or **DC Connected Power Park Module**, where it is not practical to demonstrate the compliance requirements of ECC.6.3.16.1.1 to ECC.6.3.16.1.6 at the **Grid Entry Point** or **User System Entry Point**, **The Company** will accept compliance of the above requirements at the **Power Park Unit** terminals.

ECC.6.3.16.1.8 An illustration and examples of the performance requirements expected are illustrated in Appendix 4EC.

ECC.6.3.17 SUBSYNCHRONOUS TORSIONAL INTERACTION DAMPING CAPABILITY, POWER OSCILLATION DAMPING CAPABILITY AND CONTROL FACILITIES FOR HVDC SYSTEMS

ECC.6.3.17.1 Subsynchronous Torsional Interaction Damping Capability

ECC.6.3.17.1.1 **HVDC System Owners**, or **Generators** in respect of **OTSDUW DC Converters** or **Network Operators** in the case of an **Embedded HVDC Systems** not subject to a **Bilateral Agreement** must ensure that any of their **Onshore HVDC Systems** or **OTSDUW DC Converters** will not cause a sub-synchronous resonance problem on the **Total System**. Each **HVDC System** or **OTSDUW DC Converter** is required to be provided with sub-synchronous resonance damping control facilities. **HVDC System Owners** and **EU Generators** in respect of **OTSDUW DC Converters** should also be aware of the requirements in ECC.6.1.9 and ECC.6.1.10.

ECC.6.3.17.1.2 Where specified in the **Bilateral Agreement**, each **OTSDUW DC Converter** is required to be provided with power oscillation damping or any other identified additional control facilities.

ECC.6.3.17.1.3 Each **HVDC System** shall be capable of contributing to the damping of power oscillations on the **National Electricity Transmission System**. The control system of the **HVDC System** shall not reduce the damping of power oscillations. **The Company** in coordination with the **Relevant Transmission Licensee** (as applicable) shall specify a frequency range of oscillations that the control scheme shall positively damp and the **System** conditions when this occurs, at least accounting for any dynamic stability assessment studies undertaken by the **Relevant Transmission Licensee** or **The Company** (as applicable) to identify the stability limits and potential stability problems on the **National Electricity Transmission System**. The selection of the control parameter settings shall be agreed between **The Company** in coordination with the **Relevant Transmission Licensee** and the **HVDC System Owner**.

ECC.6.3.17.1.4 **The Company** shall specify the necessary extent of SSTI studies and provide input parameters, to the extent available, related to the equipment and relevant system conditions on the **National Electricity Transmission System**. The SSTI studies shall be provided by the **HVDC System Owner**. The studies shall identify the conditions, if any, where SSTI exists and propose any necessary mitigation procedure. The responsibility for undertaking the studies in accordance with these requirements lies with the **Relevant Transmission Licensee** in co-ordination with **The Company**. All parties shall be informed of the results of the studies.

ECC.6.3.17.1.5 All parties identified by **The Company** as relevant to each **Grid Entry Point** or **User System Entry Point** (if **Embedded**), including the **Relevant Transmission Licensee**, shall contribute to the studies and shall provide all relevant data and models as reasonably required to meet the purposes of the studies. **The Company** shall collect this data and, where applicable, pass it on to the party responsible for the studies in accordance with Article 10 of **European Regulation 2016/1447**. Specific information relating to the interface schedules, input/output requirements, timing and submission of any studies or data would be agreed between the **User** and **The Company** and specified (where applicable) in the **Bilateral Agreement**.

ECC.6.3.17.1.6 **The Company** in coordination with the **Relevant Transmission Licensee** shall assess the result of the SSTI studies. If necessary for the assessment, **The Company** in coordination with the **Relevant Transmission Licensee** may request that the **HVDC System Owner** perform further SSTI studies in line with this same scope and extent.



ECC.6.3.17.1.7 **The Company** in coordination with the **Relevant Transmission Licensee** may review or replicate the study. The **HVDC System Owner** shall provide **The Company** with all relevant data and models that allow such studies to be performed. Submission of this data to **Relevant Transmission Licensee's** shall be in accordance with the requirements of Article 10 of **European Regulation 2016/1447**.

ECC.6.3.17.1.8 Any necessary mitigating actions identified by the studies carried out in accordance with paragraphs ECC.6.3.17.1.4 or ECC.6.3.17.1.6, and reviewed by **The Company** in coordination with the **Relevant Transmission Licensees**, shall be undertaken by the **HVDC System Owner** as part of the connection of the new **HVDC Converter Station**.

ECC.6.3.17.1.9 As part of the studies and data flow in respect of ECC.6.3.17.1 – ECC.6.3.17.8 the following data exchange would take place with the time scales being pursuant to the terms of the Bilateral Agreement.

Information supplied by **The Company** and **Relevant Transmission Licensees**

**Studies** provided by the **User**

**User** review

**The Company** review

Changes to studies and agreed updates between **The Company**, the **Relevant Transmission Licensee** and **User**

Final review

ECC.6.3.17.2 Interaction between **HVDC Systems** or other **User's Plant** and **Apparatus**

ECC.6.3.17.2.1 Notwithstanding the requirements of ECC6.1.9 and ECC.6.1.10, when several **HVDC Converter Stations** or other **User's Plant** and **Apparatus** are within close electrical proximity, **The Company** may specify that a study is required, and the scope and extent of that study, to demonstrate that no adverse interaction will occur. If adverse interaction is identified, the studies shall identify possible mitigating actions to be implemented to ensure compliance with the requirements of ECC.6.1.9

ECC.6.3.17.2.2 The studies shall be carried out by the connecting **HVDC System Owner** with the participation of all other **User's** identified by **The Company** in coordination with **Relevant Transmission Licensees** as relevant to each **Connection Point**.

ECC.6.3.17.2.3 All **User's** identified by **The Company** as relevant to the connection, and where applicable **Relevant Transmission Licensee's**, shall contribute to the studies and shall provide all relevant data and models as reasonably required to meet the purposes of the studies. **The Company** shall collect this input and, where applicable, pass it on to the party responsible for the studies in accordance with Article 10 of **European Regulation 2016/1447**. Specific information relating to the interface schedules, input/output requirements, timing and submission of any studies or data would be agreed between the **User** and **The Company** and specified (where applicable) in the **Bilateral Agreement**.

ECC.6.3.17.2.4 **The Company** in coordination with **Relevant Transmission Licensees** shall assess the result of the studies based on their scope and extent as specified in accordance with ECC.6.3.17.2.1. If necessary for the assessment, **The Company** in coordination with the **Relevant Transmission Licensee** may request the **HVDC System Owner** to perform further studies in line with the scope and extent specified in accordance with ECC.6.3.17.2.1.

ECC.6.3.17.2.5 **The Company** in coordination with the **Relevant Transmission Licensee** may review or replicate some or all of the studies. The **HVDC System Owner** shall provide **The Company** all relevant data and models that allow such studies to be performed.

ECC.6.3.17.2.6 The **EU Code User** and **The Company**, in coordination with the **Relevant Transmission Licensee**, shall agree any mitigating actions identified by the studies carried out following the site specific requirements and works, including any transmission reinforcement works and / or **User** works required to ensure that all sub-synchronous oscillations are sufficiently damped.

ECC.6.1.17.3 Fast Recovery from DC faults

ECC.6.1.17.3.1 **HVDC Systems**, including DC overhead lines, shall be capable of fast recovery from transient faults within the **HVDC System**. Details of this capability shall be subject to the **Bilateral Agreement** and the protection requirements specified in ECC.6.2.2 .

ECC.6.1.17.4 Maximum loss of **Active Power**

ECC.6.1.14.4.1 An **HVDC System** shall be configured in such a way that its loss of **Active Power** injection in the **GB Synchronous Area** shall be in accordance with the requirements of the **SQSS**.

ECC.6.3.18 SYSTEM TO GENERATOR OPERATIONAL INTERTRIPPING SCHEMES

ECC.6.3.18.1 **The Company** may require that a **System to Generator Operational Intertripping Scheme** be installed as part of a condition of the connection of the **EU Generator**. Scheme specific details shall be included in the relevant **Bilateral Agreement** and shall, include the following information:

- (1) the relevant category(ies) of the scheme (referred to as **Category 1 Intertripping Scheme, Category 2 Intertripping Scheme, Category 3 Intertripping Scheme** and **Category 4 Intertripping Scheme**);
- (2) the **Power Generating Module** to be either permanently armed or that can be instructed to be armed in accordance with BC2.8;
- (3) the time within which the **Power Generating Module** circuit breaker(s) are to be automatically tripped;
- (4) the location to which the trip signal will be provided by **The Company**. Such location will be provided by **The Company** prior to the commissioning of the **Power Generating Module**.

Where applicable, the **Bilateral Agreement** shall include the conditions on the **National Electricity Transmission System** during which **The Company** may instruct the **System to Generator Operational Intertripping Scheme** to be armed and the conditions that would initiate a trip signal.

ECC.6.3.18.2 The time within which the **Power Generating Module(s)** circuit breaker(s) need to be automatically tripped is determined by the specific conditions local to the **EU Generator**. This 'time to trip' (defined as the time from provision of the trip signal by **The Company** to the specified location, to circuit breaker main contact opening) can typically range from 100ms to 10sec. A longer time to trip may allow the initiation of an automatic reduction in the **Power Generating Module(s)** output prior to the automatic tripping of the **Power Generating Module(s)** circuit breaker. Where applicable **The Company** may provide separate trip signals to allow for either a longer or shorter 'time to trip' to be initiated.

ECC.6.4 General Network Operator And Non-Embedded Customer Requirements

ECC.6.4.1 This part of the **Grid Code** describes the technical and design criteria and performance requirements for **Network Operators** and **Non-Embedded Customers**.

### Neutral Earthing

ECC.6.4.2 At nominal **System** voltages of 132kV and above the higher voltage windings of three phase transformers and transformer banks connected to the **National Electricity Transmission System** must be star connected with the star point suitable for connection to earth. The earthing and lower voltage winding arrangement shall be such as to ensure that the **Earth Fault Factor** requirement of paragraph ECC.6.2.1.1 (b) will be met on the **National Electricity Transmission System** at nominal **System** voltages of 132kV and above.

### Frequency Sensitive Relays

ECC.6.4.3 As explained under **OC6**, each **Network Operator** and **Non Embedded Customer**, will make arrangements that will facilitate automatic low **Frequency Disconnection of Demand** (based on **Annual ACS Conditions**). ECC.A.5.5. of Appendix E5 includes specifications of the local percentage **Demand** that shall be disconnected at specific frequencies. The manner in which **Demand** subject to low **Frequency** disconnection will be split into discrete MW blocks is specified in OC6.6. Technical requirements relating to **Low Frequency Relays** are also listed in Appendix E5.

### Operational Metering

ECC.6.4.4 Where **The Company** can reasonably demonstrate that an **Embedded Medium Power Station** or **Embedded HVDC System** has a significant effect on the **National Electricity Transmission System**, it may require the **Network Operator** within whose **System** the **Embedded Medium Power Station** or **Embedded HVDC System** is situated to ensure that the operational metering equipment described in ECC.6.5.6 is installed such that **The Company** can receive the data referred to in ECC.6.5.6. In the case of an **Embedded Medium Power Station** subject to, or proposed to be subject to a **Bilateral Agreement**, **The Company** shall notify such **Network Operator** of the details of such installation in writing within 3 months of being notified of the application to connect under **CUSC** and in the case of an **Embedded Medium Power Station** not subject to, or not proposed to be subject to a **Bilateral Agreement** in writing as a **Site Specific Requirement** in accordance with the timescales in CUSC 6.5.5. In either case the **Network Operator** shall ensure that the data referred to in ECC.6.5.6 is provided to **The Company**.

ECC.6.4.5 Reactive Power Requirements at each EU Grid Supply Point

ECC.6.4.5.1 At each **EU Grid Supply Point**, **Non-Embedded Customers** and **Network Operators** who are **EU Code Users** shall ensure their **Systems** are capable of steady state operation within the **Reactive Power** limits as specified in ECC.6.4.5.1(a) and ECC.6.4.5.1(b). Where **NGET** requires a **Reactive Power** range which is broader than the limits defined in ECC.6.4.5.1(a) and ECC.6.4.5.1(b), this will be agreed as a reasonable requirement through joint assessment between the relevant **EU Code User** and **NGET** and justified in accordance with the requirements of ECC.6.4.5.1(c), (d), (e) and (f). For **Non-Embedded Customers** who are **EU Code Users**, the **Reactive Power** range at each **EU Grid Supply Point**, under both importing and exporting conditions, shall not exceed 48% of the larger of the **Maximum Import Capability** or **Maximum Export Capability** (0.9 **Power Factor** import or export of **Active Power**), except in situations where either technical or financial system benefits are demonstrated for **Non-Embedded Customers** and accepted by **NGET** in coordination with the **Relevant Transmission Licensee**.

(a) For **Network Operators** who are **EU Code Users** at each **EU Grid Supply Point**, the **Reactive Power** range shall not exceed:

- (i) 48 percent (i.e. 0.9 **Power Factor**) of the larger of the **Maximum Import Capability** or **Maximum Export Capability** during **Reactive Power** import (consumption); and
- (ii) 48 percent (i.e. 0.9 **Power Factor**) of the larger of the **Maximum Import Capability** or **Maximum Export Capability** during **Reactive Power** export (production);

Except in situations where either technical or financial system benefits are proved by **NGET** in coordination with the **Relevant Transmission Licensee** and the relevant **Network Operator** through joint analysis.

- (b) **NGET** in co-ordination with the **Relevant Transmission Licensee** shall agree with the **Network Operator** on the scope of the analysis, which shall determine the optimal solution for **Reactive Power** exchange between their **Systems** at each **EU Grid Supply Point**, taking adequately into consideration the specific **System** characteristics, variable structure of power exchange, bidirectional flows and the **Reactive Power** capabilities of the **Network Operator's System**. Any proposed solutions shall take the above issues into account and shall be agreed as a reasonable requirement through joint assessment between the relevant **Network Operator** or **Non-Embedded Customer** and **NGET** in coordination with the **Relevant Transmission Licensee**. In the event of a shared site between a **GB Code User** and **EU Code User**, the requirements would generally be allocated to each **User** on the basis of their **Demand** in the case of a **Network Operator** who is a **GB Code User** and applied on the basis of the **Maximum Import Capability** or **Maximum Export Capability** as specified in ECC.6.4.5.1 in the case of a **Network Operator** who is an **EU Code User**.
- (c) **NGET** in coordination with the **Relevant Transmission Licensee** may specify the **Reactive Power** capability range at the **EU Grid Supply Point** in another form other than **Power Factor**.
- (d) Notwithstanding the ability of **Network Operators** or **Non Embedded Customers** to apply for a derogation from ECC.6.4.5.1 (e), where an **EU Grid Supply Point** is shared between a **Power Generating Module** and a **Non-Embedded Customers System**, the **Reactive Power** range would be apportioned to each **EU Code User** at their **Connection Point**.

ECC.6.4.5.2 Where agreed with the **Network Operator** who is an **EU Code User** and justified through appropriate **System** studies, **NGET** may reasonably require the **Network Operator** not to export **Reactive Power** at the **EU Grid Supply Point** (at nominal voltage) at an **Active Power** flow of less than 25 % of the **Maximum Import Capability**. Where applicable, the **Authority** may require **NGET** in coordination with the **Relevant Transmission Licensee** to justify its request through a joint analysis with the relevant **Network Operator** and demonstrate that any such requirement is reasonable. If this requirement is not justified based on the joint analysis, **NGET** in coordination with the **Relevant Transmission Licensee** and the **Network Operator** shall agree on necessary requirements according to the outcomes of a joint analysis.

ECC.6.4.5.3 Notwithstanding the requirements of ECC.6.4.5.1(b) and subject to agreement between **NGET** and the relevant **Network Operator** there may be a requirement to actively control the exchange of **Reactive Power** at the **EU Grid Supply Point** for the benefit of the **Total System**. **NGET** and the relevant **Network Operator** shall agree on a method to carry out this control, to ensure the justified level of security of supply for both parties. Any such solution including joint study work and timelines would be agreed between **NGET** and the relevant **Network Operator** as reasonable, efficient and proportionate.

ECC.6.4.5.4 In accordance with ECC.6.4.5.3, the relevant **Network Operator** may require **NGET** to consider its **Network Operator's System** for **Reactive Power** management. Any such requirement would need to be agreed between **NGET** and the relevant **Network Operator** and justified by **NGET**.

## ECC.6.5 Communications Plant

ECC.6.5.1 In order to ensure control of the **National Electricity Transmission System**, telecommunications between **Users** and **The Company** must (including in respect of any **OTSDUW Plant and Apparatus** at the **OTSUA Transfer Time**), if required by **The Company**, be established in accordance with the requirements set down below.

## ECC.6.5.2 Control Telephony and System Telephony

- ECC.6.5.2.1 **Control Telephony** is the principle method by which a **User's Responsible Engineer/Operator** and **The Company's Control Engineers** speak to one another for the purposes of control of the **Total System** in both normal and emergency operating conditions. **Control Telephony** provides secure point to point telephony for routine **Control Calls**, priority **Control Calls** and emergency **Control Calls**.
- ECC.6.5.2.2 **System Telephony** is an alternate method by which a **User's Responsible Engineer/Operator** and **The Company's Control Engineers** speak to one another for the purposes of control of the **Total System** in both normal operating conditions and where practicable, emergency operating conditions. **System Telephony** uses the Public Switched Telephony Network to provide telephony for **Control Calls**, inclusive of emergency **Control Calls**.
- ECC.6.5.2.3 Calls made and received over **Control Telephony** and **System Telephony** may be recorded and subsequently replayed for commercial and operational reasons.
- ECC.6.5.3 Supervisory Tones
- ECC.6.5.3.1 **Control Telephony** supervisory tones indicate to the calling and receiving parties dial, engaged, ringing, secondary engaged (signifying that priority may be exercised) and priority disconnect tones.
- ECC.6.5.3.2 **System Telephony** supervisory tones indicate to the calling and receiving parties dial, engaged and ringing tones.
- ECC.6.5.4 Obligations in respect of Control Telephony and System Telephony
- ECC.6.5.4.1 Where **The Company** requires **Control Telephony**, **Users** are required to use the **Control Telephony** with **The Company** in respect of all **Connection Points** with the **National Electricity Transmission System** and in respect of all **Embedded Large Power Stations** and **Embedded HVDC Systems**. **The Company** will install **Control Telephony** at the **User's Control Point** where the **User's** telephony equipment is not capable of providing the required facilities or is otherwise incompatible with the **Transmission Control Telephony**. Details of and relating to the **Control Telephony** required are contained in the **Bilateral Agreement**.
- ECC.6.5.4.2 Where in **The Company's** sole opinion the installation of **Control Telephony** is not practicable at a **User's Control Point(s)**, **The Company** shall specify in the **Bilateral Agreement** whether **System Telephony** is required. Where **System Telephony** is required by **The Company**, the **User** shall ensure that **System Telephony** is installed.
- ECC.6.5.4.3 Where **System Telephony** is installed, **Users** are required to use the **System Telephony** with **The Company** in respect of those **Control Point(s)** for which it has been installed. Details of and relating to the **System Telephony** required are contained in the **Bilateral Agreement**.
- ECC.6.5.4.4 Where **Control Telephony** or **System Telephony** is installed, routine testing of such facilities may be required by **The Company** (not normally more than once in any calendar month). The **User** and **The Company** shall use reasonable endeavours to agree a test programme and where **The Company** requests the assistance of the **User** in performing the agreed test programme the **User** shall provide such assistance.
- ECC.6.5.4.5 **Control Telephony** and **System Telephony** shall only be used for the purposes of operational voice communication between **The Company** and the relevant **User**.
- ECC.6.5.4.6 **Control Telephony** contains emergency calling functionality to be used for urgent operational communication only. Such functionality enables **The Company** and **Users** to utilise a priority call in the event of an emergency. **The Company** and **Users** shall only use such priority call functionality for urgent operational communications.
- ECC.6.5.5 Technical Requirements for Control Telephony and System Telephony
- ECC.6.5.5.1 Detailed information on the technical interfaces and support requirements for **Control Telephony** applicable in **The Company's Transmission Area** is provided in the **Control Telephony Electrical Standard** identified in the Annex to the **General Conditions**. Where additional information, or information in relation to **Control Telephony** applicable in Scotland, is requested by **Users**, this will be provided, where possible, by **The Company**.

- ECC.6.5.5.2 **System Telephony** shall consist of a dedicated Public Switched Telephone Network telephone line that shall be installed and configured by the relevant **User**. **The Company** shall provide a dedicated free phone number (UK only), for the purposes of receiving incoming calls to **The Company**, which **Users** shall utilise for **System Telephony**. **System Telephony** shall only be utilised by **The Company's Control Engineer** and the **User's Responsible Engineer/Operator** for the purposes of operational communications.
- ECC.6.5.6 Operational Metering
- ECC.6.5.6.1 It is an essential requirement for **The Company** and **Network Operators** to have visibility of the real time output and status of indications of **User's Plant and Apparatus** so they can control the operation of the **System**.
- ECC.6.5.6.2 **Type B, Type C and Type D Power Park Modules, HVDC Equipment, Network Operators and Non Embedded Customers** are required to be capable of exchanging operational metering data with **The Company** and **Relevant Transmission Licensees** (as applicable) with time stamping. Time stamping would generally be to a sampling rate of 1 second or better unless otherwise specified by **The Company** in the **Bilateral Agreement**.
- ECC.6.5.6.3 **The Company** in coordination with the **Relevant Transmission Licensee** shall specify in the **Bilateral Agreement** the operational metering signals to be provided by the **EU Generator, HVDC System Owner, Network Operator or Non-Embedded Customer**. In the case of **Network Operators and Non-Embedded Customers**, detailed specifications relating to the operational metering standards at **EU Grid Supply Points** and the data required are published as **Electrical Standards** in the Annex to the **General Conditions**.
- ECC.6.5.6.4 (a) **The Company** shall provide system control and data acquisition (SCADA) outstation interface equipment., each **EU Code User** shall provide such voltage, current, **Frequency, Active Power and Reactive Power** measurement outputs and plant status indications and alarms to the **Transmission SCADA** outstation interface equipment as required by **The Company** in accordance with the terms of the **Bilateral Agreement**. In the case of **OTSDUW**, the **User** shall provide such SCADA outstation interface equipment and voltage, current, **Frequency, Active Power and Reactive Power** measurement outputs and plant status indications and alarms to the SCADA outstation interface equipment as required by **The Company** in accordance with the terms of the **Bilateral Agreement**.
- (b) For the avoidance of doubt, for **Active Power and Reactive Power** measurements, circuit breaker and disconnect status indications from:
- (i) **CCGT Modules** from **Type B, Type C and Type D Power Generating Modules**, the outputs and status indications must each be provided to **The Company** on an individual **CCGT Unit** basis. In addition, where identified in the **Bilateral Agreement**, **Active Power and Reactive Power** measurements from **Unit Transformers** and/or **Station Transformers** must be provided.
  - (iii) For **Type B, Type C and Type D Power Park Modules** the outputs and status indications must each be provided to **The Company** on an individual **Power Park Module** basis. In addition, where identified in the **Bilateral Agreement**, **Active Power and Reactive Power** measurements from station transformers must be provided.
  - (iv) In respect of **OTSDUW Plant and Apparatus**, the outputs and status indications must be provided to **The Company** for each piece of electrical equipment. In addition, where identified in the **Bilateral Agreement**, **Active Power and Reactive Power** measurements at the **Interface Point** must be provided.

- (c) For the avoidance of doubt, the requirements of ECC.6.5.6.4(a) in the case of a **Cascade Hydro Scheme** will be provided for each **Generating Unit** forming part of that **Cascade Hydro Scheme**. In the case of **Embedded Generating Units** forming part of a **Cascade Hydro Scheme** the data may be provided by means other than **The Company** SCADA outstation located at the **Power Station**, such as, with the agreement of the **Network Operator** in whose system such **Embedded Generating Unit** is located, from the **Network Operator's** SCADA system to **The Company**. Details of such arrangements will be contained in the relevant **Bilateral Agreements** between **The Company** and the **Generator** and the **Network Operator**.
- (d) In the case of a **Power Park Module**, additional energy input signals (e.g. wind speed, and wind direction) may be specified in the **Bilateral Agreement**. A **Power Available** signal will also be specified in the **Bilateral Agreement**. The signals would be used to establish the potential level of energy input from the **Intermittent Power Source** for monitoring pursuant to ECC.6.6.1 and **Ancillary Services** and will, in the case of a wind farm, be used to provide **The Company** with advanced warning of excess wind speed shutdown and to determine the level of **Headroom** available from **Power Park Modules** for the purposes of calculating response and reserve. For the avoidance of doubt, the **Power Available** signal would be automatically provided to **The Company** and represent the sum of the potential output of all available and operational **Power Park Units** within the **Power Park Module**. The refresh rate of the **Power Available** signal shall be specified in the **Bilateral Agreement**.
- (e) In the case of an **Electricity Storage Module**, additional input signals (e.g. state of charge, and system availability) may be specified in the **Bilateral Agreement**. A **Power Available** signal will also be specified in the **Bilateral Agreement** in accordance with the requirements of ECC.6.5.6.4(d).

ECC.6.5.6.5 In addition to the requirements of the **Balancing Codes**, each **HVDC Converter** unit of an **HVDC system** shall be equipped with an automatic controller capable of receiving instructions from **The Company**. This automatic controller shall be capable of operating the **HVDC Converter** units of the **HVDC System** in a coordinated way. **The Company** shall specify the automatic controller hierarchy per **HVDC Converter** unit.

ECC.6.5.6.6 The automatic controller of the **HVDC System** referred to in paragraph ECC.6.5.6.5 shall be capable of sending the following signal types to **The Company** (where applicable) :

- (a) operational metering signals, providing at least the following:
  - (i) start-up signals;
  - (ii) AC and DC voltage measurements;
  - (iii) AC and DC current measurements;
  - (iv) **Active** and **Reactive Power** measurements on the AC side;
  - (v) DC power measurements;
  - (vi) **HVDC Converter** unit level operation in a multi-pole type **HVDC Converter**;
  - (vii) elements and topology status; and
  - (viii) **Frequency Sensitive Mode, Limited Frequency Sensitive Mode Overfrequency** and **Limited Frequency Sensitive Mode Underfrequency Active Power** ranges (where applicable).
- (b) alarm signals, providing at least the following:
  - (i) emergency blocking;
  - (ii) ramp blocking;
  - (iii) fast **Active Power** reversal (where applicable)

ECC.6.5.6.7 The automatic controller referred to in ECC.6.5.6.5 shall be capable of receiving the following signal types from **The Company** (where applicable) :

(a) operational metering signals, receiving at least the following:

- (i) start-up command;
- (ii) **Active Power** setpoints;
- (iii) **Frequency Sensitive Mode** settings;
- (iv) **Reactive Power**, voltage or similar setpoints;
- (v) **Reactive Power** control modes;
- (vi) power oscillation damping control; and

(b) alarm signals, receiving at least the following:

- (i) emergency blocking command;
- (ii) ramp blocking command;
- (iii) **Active Power** flow direction; and
- (iv) fast **Active Power** reversal command.

ECC.6.5.6.8 With regards to operational metering signals, the resolution and refresh rate required would be 1 second or better unless otherwise agreed with **The Company**

Instructor Facilities

ECC.6.5.7 The **User** shall accommodate **Instructor Facilities** provided by **The Company** for the receipt of operational messages relating to **System** conditions.

Electronic Data Communication Facilities

ECC.6.5.8 (a) All **BM Participants** must ensure that appropriate electronic data communication facilities are in place to permit the submission of data, as required by the **Grid Code**, to **The Company**.

(b) In addition,

(1) any **User** that wishes to participate in the **Balancing Mechanism**;

or

(2) any **BM Participant** in respect of its **BM Units** at a **Power Station** and the **BM Participant** is required to provide all **Part 1 System Ancillary Services** in accordance with ECC.8.1 (unless **The Company** has otherwise agreed)

must ensure that appropriate automatic logging devices are installed at the **Control Points** of its **BM Units** to submit data to and to receive instructions from **The Company**, as required by the **Grid Code**. For the avoidance of doubt, in the case of an **Interconnector User** the **Control Point** will be at the **Control Centre** of the appropriate **Externally Interconnected System Operator**.

(c) Detailed specifications of these required electronic facilities will be provided by **The Company** on request and they are listed as **Electrical Standards** in the Annex to the **General Conditions**.

Facsimile Machines

ECC.6.5.9 Each **User** and **The Company** shall provide a facsimile machine or machines:

(a) in the case of **Generators**, at the **Control Point** of each **Power Station** and at its **Trading Point**;

(b) in the case of **The Company** and **Network Operators**, at the **Control Centre(s)**; and



- (c) in the case of **Non-Embedded Customers** and **HVDC Equipment** owners at the **Control Point**.

Each **User** shall notify, prior to connection to the **System** of the **User's Plant and Apparatus**, **The Company** of its or their telephone number or numbers, and will notify **The Company** of any changes. Prior to connection to the **System** of the **User's Plant and Apparatus** **The Company** shall notify each **User** of the telephone number or numbers of its facsimile machine or machines and will notify any changes.

ECC.6.5.10 Busbar Voltage

**The Company** shall, subject as provided below, provide each **Generator** or **HVDC System Owner** at each **Grid Entry Point** where one of its **Power Stations** or **HVDC Systems** is connected with appropriate voltage signals to enable the **Generator** or **HVDC System** owner to obtain the necessary information to permit its **Power Generating Modules** (including **DC Connected Power Park Modules**) or **HVDC System** to be **Synchronised** to the **National Electricity Transmission System**. The term "voltage signal" shall mean in this context, a point of connection on (or wire or wires from) a relevant part of **Transmission Plant** and/or **Apparatus** at the **Grid Entry Point**, to which the **Generator** or **HVDC System Owner**, with **The Company's** agreement (not to be unreasonably withheld) in relation to the **Plant** and/or **Apparatus** to be attached, will be able to attach its **Plant** and/or **Apparatus** (normally a wire or wires) in order to obtain measurement outputs in relation to the busbar.

ECC.6.5.11 Bilingual Message Facilities

- (a) A Bilingual Message Facility is the method by which the **User's Responsible Engineer/Operator**, the **Externally Interconnected System Operator** and **The Company's Control Engineers** communicate clear and unambiguous information in two languages for the purposes of control of the **Total System** in both normal and emergency operating conditions.
- (b) A Bilingual Message Facility, where required, will provide up to two hundred pre-defined messages with up to five hundred and sixty characters each. A maximum of one minute is allowed for the transmission to, and display of, the selected message at any destination. The standard messages must be capable of being displayed at any combination of locations and can originate from any of these locations. Messages displayed in the UK will be displayed in the English language.
- (c) Detailed information on a Bilingual Message Facility and suitable equipment required for individual **User** applications will be provided by **The Company** upon request.

ECC.6.6 Monitoring

ECC.6.6.1 System Monitoring

ECC.6.6.1.1 Each **Type C** and **Type D Power Generating Module** including **DC Connected Power Park Modules** shall be equipped with a facility to provide fault recording and monitoring of dynamic system behaviour. These requirements are necessary to record conditions during **System** faults and detect poorly damped power oscillations. This facility shall record the following parameters:

- voltage,
- **Active Power**,
- **Reactive Power**, and
- **Frequency**.

ECC.6.6.1.2 Detailed specifications for fault recording and dynamic system monitoring equipment including triggering criteria and sample rates are listed as **Electrical Standards** in the **Annex** to the **General Conditions**. For Dynamic System Monitoring, the specification for the communication protocol and recorded data shall also be included in the **Electrical Standard**.

- ECC.6.6.1.3 **The Company** in coordination with the **Relevant Transmission Licensee** shall specify any requirements for **Power Quality Monitoring** in the **Bilateral Agreement**. The power quality parameters to be monitored, the communication protocols for the recorded data and the time frames for compliance shall be agreed between **The Company**, the **Relevant Transmission Licensee** and **EU Generator**.
- ECC.6.6.1.4 **HVDC Systems** shall be equipped with a facility to provide fault recording and dynamic system behaviour monitoring of the following parameters for each of its **HVDC Converter Stations**:
- (a) AC and DC voltage;
  - (b) AC and DC current;
  - (c) **Active Power**;
  - (d) **Reactive Power**; and
  - (e) **Frequency**.
- ECC.6.6.1.5 **The Company** in coordination with the **Relevant Transmission Licensee** may specify quality of supply parameters to be complied with by the **HVDC System**, provided a reasonable prior notice is given.
- ECC.6.6.1.6 The particulars of the fault recording equipment referred to in ECC.6.6.1.4, including analogue and digital channels, the settings, including triggering criteria and the sampling rates, shall be agreed between the **HVDC System Owner** and **The Company** in coordination with the **Relevant Transmission Licensee**.
- ECC.6.6.1.7 All dynamic system behaviour monitoring equipment shall include an oscillation trigger, specified by **The Company**, in coordination with the **Relevant Transmission Licensee**, with the purpose of detecting poorly damped power oscillations.
- ECC.6.6.1.8 The facilities for quality of supply and dynamic system behaviour monitoring shall include arrangements for the **HVDC System Owner** and **The Company** and/or **Relevant Transmission Licensee** to access the information electronically. The communications protocols for recorded data shall be agreed between the **HVDC System Owner**, **The Company** and the **Relevant Transmission Licensee**.
- ECC.6.6.2 Frequency Response Monitoring
- ECC.6.6.2.1 Each **Type C** and **Type D Power Generating Module** including **DC Connected Power Park Modules** shall be fitted with equipment capable of monitoring the real time **Active Power** output of a **Power Generating Module** when operating in **Frequency Sensitive Mode**.
- ECC.6.6.2.2 Detailed specifications of the **Active Power Frequency** response requirements including the communication requirements are listed as **Electrical Standards** in the **Annex** to the **General Conditions**.
- ECC.6.6.2.3 **The Company** in co-ordination with the **Relevant Transmission Licensee** shall specify additional signals to be provided by the **EU Generator** by monitoring and recording devices in order to verify the performance of the **Active Power Frequency** response provision of participating **Power Generating Modules**.
- ECC.6.6.3 Compliance Monitoring
- ECC.6.6.3.1 For all on site monitoring by **The Company** of witnessed tests pursuant to the **CP** or **OC5** or **ECP** the **User** shall provide suitable test signals as outlined in either **OC5.A.1** or **ECP.A.4** (as applicable).
- ECC.6.6.3.2 The signals which shall be provided by the **User** to **The Company** for onsite monitoring shall be of the following resolution, unless otherwise agreed by **The Company**:
- (i) 1 Hz for reactive range tests

- (ii) 10 Hz for frequency control tests
  - (iii) 100 Hz for voltage control tests
- ECC.6.6.3.3 The **User** will provide all relevant signals for this purpose in the form of d.c. voltages within the range -10V to +10V. In exceptional circumstances some signals may be accepted as d.c. voltages within the range -60V to +60V with prior agreement between the **User** and **The Company**. All signals shall:
- (i) in the case of an **Onshore Power Generating Module** or **Onshore HVDC Converter Station**, be suitably terminated in a single accessible location at the **Generator** or **HVDC Converter Station** owner's site.
  - (ii) in the case of an **Offshore Power Generating Module** and **OTSDUW Plant and Apparatus**, be transmitted onshore without attenuation, delay or filtering which would result in the inability to fully demonstrate the objectives of the test, or identify any potential safety or plant instability issues, and be suitably terminated in a single robust location normally located at or near the onshore **Interface Point** of the **Offshore Transmission System** to which it is connected.
- ECC.6.6.3.4 All signals shall be suitably scaled across the range. The following scaling would (unless **The Company** notify the **User** otherwise) be acceptable to **The Company**:
- (a) 0MW to **Maximum Capacity** or **Interface Point Capacity** 0-8V dc
  - (b) Maximum leading **Reactive Power** to maximum lagging **Reactive Power** -8 to 8V dc
  - (c) 48 – 52Hz as -8 to 8V dc
  - (d) Nominal terminal or connection point voltage -10% to +10% as -8 to 8V dc
- ECC.6.6.3.5 The **User** shall provide to **The Company** a 230V power supply adjacent to the signal terminal location.

## ECC.7 SITE RELATED CONDITIONS

ECC.7.1 Not used.

### ECC.7.2 Responsibilities For Safety

ECC.7.2.1 In England and Wales, any **User** entering and working on its **Plant** and/or **Apparatus** (including, until the **OTSUA Transfer Time**, any **OTSUA**) on a **Transmission Site** will work to the **Safety Rules** of **The Company**.

In Scotland or **Offshore**, any **User** entering and working on its **Plant** and/or **Apparatus** (including, until the **OTSUA Transfer Time**, any **OTSUA**) on a **Transmission Site** will work to the **Safety Rules** of the **Relevant Transmission Licensee**, as advised by **The Company**.

ECC.7.2.2 **The Company** entering and working on **Transmission Plant** and/or **Apparatus** on a **User Site** will work to the **User's Safety Rules**. For **User Sites** in Scotland or **Offshore**, **The Company** shall procure that the **Relevant Transmission Licensee** entering and working on **Transmission Plant** and/or **Apparatus** on a **User Site** will work to the **User's Safety Rules**.

ECC.7.2.3 A **User** may, with a minimum of six weeks notice, apply to **The Company** for permission to work according to that **Users** own **Safety Rules** when working on its **Plant** and/or **Apparatus** on a **Transmission Site** rather than those set out in ECC.7.2.1. If **The Company** is of the opinion that the **User's Safety Rules** provide for a level of safety commensurate with those set out in ECC.7.2.1, **The Company** will notify the **User**, in writing, that, with effect from the date requested by the **User**, the **User** may use its own **Safety Rules** when working on its **Plant** and/or **Apparatus** on the **Transmission Site**. For a **Transmission Site** in Scotland or **Offshore**, in forming its opinion, **The Company** will seek the opinion of the **Relevant Transmission Licensee**. Until receipt of such written approval from **The Company**, the **User** will continue to use the **Safety Rules** as set out in ECC.7.2.1.

ECC.7.2.4 In the case of a **User Site** in England and Wales, **The Company** may, with a minimum of six weeks notice, apply to a **User** for permission to work according to **The Company's Safety Rules** when working on **Transmission Plant** and/or **Apparatus** on that **User Site**, rather than the **User's Safety Rules**. If the **User** is of the opinion that **The Company's Safety Rules** provide for a level of safety commensurate with that of that **User's Safety Rules**, it will notify **The Company**, in writing, that, with the effect from the date requested by **The Company**, **The Company** may use its own **Safety Rules** when working on its **Transmission Plant** and/or **Apparatus** on that **User Site**. Until receipt of such written approval from the **User**, **The Company** shall continue to use the **User's Safety Rules**.

In the case of a **User Site** in Scotland or **Offshore**, **The Company** may, with a minimum of six weeks notice, apply to a **User** for permission for the **Relevant Transmission Licensee** to work according to the **Relevant Transmission Licensee's Safety Rules** when working on **Transmission Plant** and/or **Apparatus** on that **User Site**, rather than the **User's Safety Rules**. If the **User** is of the opinion that the **Relevant Transmission Licensee's Safety Rules**, provide for a level of safety commensurate with that of that **User's Safety Rules**, it will notify **The Company**, in writing, that, with effect from the date requested by **The Company**, that the **Relevant Transmission Licensee** may use its own **Safety Rules** when working on its **Transmission Plant** and/or **Apparatus** on that **User's Site**. Until receipt of such written approval from the **User**, **The Company** shall procure that the **Relevant Transmission Licensee** shall continue to use the **User's Safety Rules**.

ECC.7.2.5 For a **Transmission Site** in England and Wales, if **The Company** gives its approval for the **User's Safety Rules** to apply to the **User** when working on its **Plant** and/or **Apparatus**, that does not imply that the **User's Safety Rules** will apply to entering the **Transmission Site** and access to the **User's Plant** and/or **Apparatus** on that **Transmission Site**. Bearing in mind **The Company's** responsibility for the whole **Transmission Site**, entry and access will always be in accordance with **The Company's** site access procedures. For a **User Site** in England and Wales, if the **User** gives its approval for **The Company's Safety Rules** to apply to **The Company** when working on its **Plant** and **Apparatus**, that does not imply that **The Company's Safety Rules** will apply to entering the **User Site**, and access to the **Transmission Plant** and **Apparatus** on that **User Site**. Bearing in mind the **User's** responsibility for the whole **User Site**, entry and access will always be in accordance with the **User's** site access procedures.

For a **Transmission Site** in Scotland or **Offshore**, if **The Company** gives its approval for the **User's Safety Rules** to apply to the **User** when working on its **Plant** and/or **Apparatus**, that does not imply that the **User's Safety Rules** will apply to entering the **Transmission Site** and access to the **User's Plant** and/or **Apparatus** on that **Transmission Site**. Bearing in mind the **Relevant Transmission Licensee's** responsibility for the whole **Transmission Site**, entry and access will always be in accordance with the **Relevant Transmission Licensee's** site access procedures. For a **User Site** in Scotland or **Offshore**, if the **User** gives its approval for **Relevant Transmission Licensee Safety Rules** to apply to the **Relevant Transmission Licensee** when working on its **Plant** and **Apparatus**, that does not imply that the **Relevant Transmission Licensee's Safety Rules** will apply to entering the **User Site**, and access to the **Transmission Plant** and **Apparatus** on that **User Site**. Bearing in mind the **User's** responsibility for the whole **User Site**, entry and access will always be in accordance with the **User's** site access procedures.

ECC.7.2.6 For **User Sites** in England and Wales, **Users** shall notify **The Company** of any **Safety Rules** that apply to **The Company's** staff working on **User Sites**. For **Transmission Sites** in England and Wales, **The Company** shall notify **Users** of any **Safety Rules** that apply to the **User's** staff working on the **Transmission Site**.

For **User Sites** in Scotland or **Offshore**, **Users** shall notify **The Company** of any **Safety Rules** that apply to the **Relevant Transmission Licensee's** staff working on **User Sites**. For **Transmission Sites** in Scotland or **Offshore** **The Company** shall procure that the **Relevant Transmission Licensee** shall notify **Users** of any **Safety Rules** that apply to the **User's** staff working on the **Transmission Site**.

- ECC.7.2.7 Each **Site Responsibility Schedule** must have recorded on it the **Safety Rules** which apply to each item of **Plant** and/or **Apparatus**.
- ECC.7.2.8 In the case of **OTSUA** a **User Site** or **Transmission Site** shall, for the purposes of this ECC.7.2, include a site at which there is an **Interface Point** until the **OTSUA Transfer Time** when it becomes part of the **National Electricity Transmission System**.
- ECC.7.3 Site Responsibility Schedules
- ECC.7.3.1 In order to inform site operational staff and **The Company's Control Engineers** of agreed responsibilities for **Plant** and/or **Apparatus** at the operational interface, a **Site Responsibility Schedule** shall be produced for **Connection Sites** (and in the case of **OTSUA**, until the **OTSUA Transfer Time, Interface Sites**) in England and Wales for **The Company** and **Users** with whom they interface, and for **Connection Sites** (and in the case of **OTSUA**, until the **OTSUA Transfer Time, Interface Sites**) in Scotland or **Offshore** for **The Company**, the **Relevant Transmission Licensee** and **Users** with whom they interface.
- ECC.7.3.2 The format, principles and basic procedure to be used in the preparation of **Site Responsibility Schedules** are set down in Appendix 1.
- ECC.7.4 Operation And Gas Zone Diagrams
- Operation Diagrams
- ECC.7.4.1 An **Operation Diagram** shall be prepared for each **Connection Site** at which a **Connection Point** exists (and in the case of **OTSDUW Plant and Apparatus**, by **User's** for each **Interface Point**) using, where appropriate, the graphical symbols shown in Part 1A of Appendix 2. **Users** should also note that the provisions of **OC11** apply in certain circumstances.
- ECC.7.4.2 The **Operation Diagram** shall include all **HV Apparatus** and the connections to all external circuits and incorporate numbering, nomenclature and labelling, as set out in **OC11**. At those **Connection Sites** (or in the case of **OTSDUW Plant and Apparatus, Interface Points**) where gas-insulated metal enclosed switchgear and/or other gas-insulated **HV Apparatus** is installed, those items must be depicted within an area delineated by a chain dotted line which intersects gas-zone boundaries. The nomenclature used shall conform with that used on the relevant **Connection Site** and circuit (and in the case of **OTSDUW Plant and Apparatus, Interface Point** and circuit). The **Operation Diagram** (and the list of technical details) is intended to provide an accurate record of the layout and circuit interconnections, ratings and numbering and nomenclature of **HV Apparatus** and related **Plant**.
- ECC.7.4.3 A non-exhaustive guide to the types of **HV Apparatus** to be shown in the **Operation Diagram** is shown in Part 2 of Appendix 2, together with certain basic principles to be followed unless equivalent principles are approved by **The Company**.
- Gas Zone Diagrams
- ECC.7.4.4 A **Gas Zone Diagram** shall be prepared for each **Connection Site** at which a **Connection Point** (and in the case of **OTSDUW Plant and Apparatus**, by **User's** for an **Interface Point**) exists where gas-insulated switchgear and/or other gas-insulated **HV Apparatus** is utilised. They shall use, where appropriate, the graphical symbols shown in Part 1B of Appendix 2.
- ECC.7.4.5 The nomenclature used shall conform with that used in the relevant **Connection Site** and circuit (and in the case of **OTSDUW Plant and Apparatus**, relevant **Interface Point** and circuit).
- ECC.7.4.6 The basic principles set out in Part 2 of Appendix 2 shall be followed in the preparation of **Gas Zone Diagrams** unless equivalent principles are approved by **The Company**.
- Preparation of Operation and Gas Zone Diagrams for Users' Sites and Transmission Interface Sites

- ECC.7.4.7 In the case of a **User Site**, the **User** shall prepare and submit to **The Company**, an **Operation Diagram** for all **HV Apparatus** on the **User** side of the **Connection Point** (and in the case of **OTSDUW Plant and Apparatus**, on what will be the **Offshore Transmission** side of the **Connection Point** and the **Interface Point**) and **The Company** shall provide the **User** with an **Operation Diagram** for all **HV Apparatus** on the **Transmission** side of the **Connection Point** (and in the case of **OTSDUW Plant and Apparatus** on what will be the **Onshore Transmission** side of the **Interface Point**, in accordance with the timing requirements of the **Bilateral Agreement** and/or **Construction Agreement** prior to the **Completion Date** under the **Bilateral Agreement** and/or **Construction Agreement**.
- ECC.7.4.8 The **User** will then prepare, produce and distribute, using the information submitted on the **User's Operation Diagram** and **The Company's Operation Diagram**, a composite **Operation Diagram** for the complete **Connection Site** (and in the case of **OTSDUW Plant and Apparatus, Interface Point**), also in accordance with the timing requirements of the **Bilateral Agreement** and/or **Construction Agreement** .
- ECC.7.4.9 The provisions of ECC.7.4.7 and ECC.7.4.8 shall apply in relation to **Gas Zone Diagrams** where gas-insulated switchgear and/or other gas-insulated **HV Apparatus** is utilised.
- Preparation of Operation and Gas Zone Diagrams for Transmission Sites
- ECC.7.4.10 In the case of an **Transmission Site**, the **User** shall prepare and submit to **The Company** an **Operation Diagram** for all **HV Apparatus** on the **User** side of the **Connection Point**, in accordance with the timing requirements of the **Bilateral Agreement** and/or **Construction Agreement**.
- ECC.7.4.11 **The Company** will then prepare, produce and distribute, using the information submitted on the **User's Operation Diagram**, a composite **Operation Diagram** for the complete **Connection Site**, also in accordance with the timing requirements of the **Bilateral Agreement** and/or **Construction Agreement** .
- ECC.7.4.12 The provisions of ECC.7.4.10 and ECC.7.4.11 shall apply in relation to **Gas Zone Diagrams** where gas-insulated switchgear and/or other gas-insulated **HV Apparatus** is utilised.
- ECC.7.4.13 Changes to Operation and Gas Zone Diagrams
- ECC.7.4.13.1 When **The Company** has decided that it wishes to install new **HV Apparatus** or it wishes to change the existing numbering or nomenclature of **Transmission HV Apparatus** at a **Transmission Site**, **The Company** will (unless it gives rise to a **Modification** under the **CUSC**, in which case the provisions of the **CUSC** as to the timing apply) one month prior to the installation or change, send to each such **User** a revised **Operation Diagram** of that **Transmission Site**, incorporating the new **Transmission HV Apparatus** to be installed and its numbering and nomenclature or the changes, as the case may be. **OC11** is also relevant to certain **Apparatus**.
- ECC.7.4.13.2 When a **User** has decided that it wishes to install new **HV Apparatus**, or it wishes to change the existing numbering or nomenclature of its **HV Apparatus** at its **User Site**, the **User** will (unless it gives rise to a **Modification** under the **CUSC**, in which case the provisions of the **CUSC** as to the timing apply) one month prior to the installation or change, send to **The Company** a revised **Operation Diagram** of that **User Site** incorporating the **EU Code User HV Apparatus** to be installed and its numbering and nomenclature or the changes as the case may be. **OC11** is also relevant to certain **Apparatus**.
- ECC.7.4.13.3 The provisions of ECC.7.4.13.1 and ECC.7.4.13.2 shall apply in relation to **Gas Zone Diagrams** where gas-insulated switchgear and/or other gas-insulated **HV Apparatus** is installed.

Validity

- ECC.7.4.14 (a) The composite **Operation Diagram** prepared by **The Company** or the **User**, as the case may be, will be the definitive **Operation Diagram** for all operational and planning activities associated with the **Connection Site**. If a dispute arises as to the accuracy of the composite **Operation Diagram**, a meeting shall be held at the **Connection Site**, as soon as reasonably practicable, between **The Company** and the **User**, to endeavour to resolve the matters in dispute.
- (b) The composite **Operation Diagram** prepared by **The Company** or the **User**, as the case may be, will be the definitive **Operation Diagram** for all operational and planning activities associated with the **Interface Point** until the **OTSUA Transfer Time**. If a dispute arises as to the accuracy of the composite **Operation Diagram** prior to the **OTSUA Transfer Time**, a meeting shall be held at the **Interface Point**, as soon as reasonably practicable, between **The Company** and the **User**, to endeavour to resolve the matters in dispute.
- (c) An equivalent rule shall apply for **Gas Zone Diagrams** where they exist for a **Connection Site**.
- ECC.7.4.15 In the case of **OTSUA**, a **User Site** and **Transmission Site** shall, for the purposes of this ECC.7.4, include a site at which there is an **Interface Point** until the **OTSUA Transfer Time** when it becomes part of the **National Electricity Transmission System** and references to **HV Apparatus** in this ECC.7.4 shall include references to **HV OTSUA**.
- ECC.7.5 Site Common Drawings
- ECC.7.5.1 **Site Common Drawings** will be prepared for each **Connection Site** (and in the case of **OTSDUW**, each **Interface Point**) and will include **Connection Site** (and in the case of **OTSDUW**, **Interface Point**) layout drawings, electrical layout drawings, common **Protection/control** drawings and common services drawings.
- Preparation of Site Common Drawings for a User Site and Transmission Interface Site
- ECC.7.5.2 In the case of a **User Site**, **The Company** shall prepare and submit to the **User**, **Site Common Drawings** for the **Transmission** side of the **Connection Point** (and in the case of **OTSDUW Plant and Apparatus**, on what will be the **Onshore Transmission** side of the **Interface Point**.) and the **User** shall prepare and submit to **The Company**, **Site Common Drawings** for the **User** side of the **Connection Point** (and in the case of **OTSDUW**, on what will be the **Offshore Transmission** side of the **Interface Point**) in accordance with the timing requirements of the **Bilateral Agreement** and/or **Construction Agreement**.
- ECC.7.5.3 The **User** will then prepare, produce and distribute, using the information submitted on the **Transmission Site Common Drawings**, **Site Common Drawings** for the complete **Connection Site** (and in the case of **OTSDUW**, **Interface Point**) in accordance with the timing requirements of the **Bilateral Agreement** and/or **Construction Agreement** .
- Preparation of Site Common Drawings for a Transmission Site
- ECC.7.5.4 In the case of a **Transmission Site**, the **User** will prepare and submit to **The Company** **Site Common Drawings** for the **User** side of the **Connection Point** in accordance with the timing requirements of the **Bilateral Agreement** and/or **Construction Agreement**.
- ECC.7.5.5 **The Company** will then prepare, produce and distribute, using the information submitted in the **User's Site Common Drawings**, **Site Common Drawings** for the complete **Connection Site** in accordance with the timing requirements of the **Bilateral Agreement** and/or **Construction Agreement**.
- ECC.7.5.6 When a **User** becomes aware that it is necessary to change any aspect of the **Site Common Drawings** at a **Connection Site** (and in the case of **OTSDUW**, **Interface Point**) it will:
- (a) if it is a **User Site**, as soon as reasonably practicable, prepare, produce and distribute revised **Site Common Drawings** for the complete **Connection Site** (and in the case of **OTSDUW**, **Interface Point**); and

- (b) if it is a **Transmission Site**, as soon as reasonably practicable, prepare and submit to **The Company** revised **Site Common Drawings** for the **User** side of the **Connection Point** (and in the case of **OTSDUW, Interface Point**) and **The Company** will then, as soon as reasonably practicable, prepare, produce and distribute, using the information submitted in the **User's Site Common Drawings**, revised **Site Common Drawings** for the complete **Connection Site** (and in the case of **OTSDUW, Interface Point**).

In either case, if in the **User's** reasonable opinion the change can be dealt with by it notifying **The Company** in writing of the change and for each party to amend its copy of the **Site Common Drawings** (or where there is only one set, for the party holding that set to amend it), then it shall so notify and each party shall so amend. If the change gives rise to a **Modification** under the **CUSC**, the provisions of the **CUSC** as to timing will apply.

ECC.7.5.7 When **The Company** becomes aware that it is necessary to change any aspect of the **Site Common Drawings** at a **Connection Site**(and in the case of **OTSDUW, Interface Point**) it will:

- (a) if it is a **Transmission Site**, as soon as reasonably practicable, prepare, produce and distribute revised **Site Common Drawings** for the complete **Connection Site** (and in the case of **OTSDUW, Interface Point**); and
- (b) if it is a **User Site**, as soon as reasonably practicable, prepare and submit to the **User** revised **Site Common Drawings** for the **Transmission** side of the **Connection Point** (in the case of **OTSDUW, Interface Point**) and the **User** will then, as soon as reasonably practicable, prepare, produce and distribute, using the information submitted in the **Transmission Site Common Drawings**, revised **Site Common Drawings** for the complete **Connection Site** (and in the case of **OTSDUW, Interface Point**).

In either case, if in **The Company's** reasonable opinion the change can be dealt with by it notifying the **User** in writing of the change and for each party to amend its copy of the **Site Common Drawings** (or where there is only one set, for the party holding that set to amend it), then it shall so notify and each party shall so amend. If the change gives rise to a **Modification** under the **CUSC**, the provisions of the **CUSC** as to timing will apply.

#### Validity

- ECC.7.5.8 (a) The **Site Common Drawings** for the complete **Connection Site** prepared by the **User** or **The Company**, as the case may be, will be the definitive **Site Common Drawings** for all operational and planning activities associated with the **Connection Site**. If a dispute arises as to the accuracy of the **Site Common Drawings**, a meeting shall be held at the **Site**, as soon as reasonably practicable, between **The Company** and the **User**, to endeavour to resolve the matters in dispute.
- (b) The **Site Common Drawing** prepared by **The Company** or the **User**, as the case may be, will be the definitive **Site Common Drawing** for all operational and planning activities associated with the **Interface Point** until the **OTSUA Transfer Time**. If a dispute arises as to the accuracy of the composite **Operation Diagram** prior to the **OTSUA Transfer Time**, a meeting shall be held at the **Interface Point**, as soon as reasonably practicable, between **The Company** and the **User**, to endeavour to resolve the matters in dispute.

ECC.7.5.9 In the case of **OTSUA**, a **User Site** and **Transmission Site** shall, for the purposes of this ECC.7.5, include a site at which there is an **Interface Point** until the **OTSUA Transfer Time** when it becomes part of the **National Electricity Transmission System**.

#### ECC.7.6 Access

ECC.7.6.1 The provisions relating to access to **Transmission Sites** by **Users**, and to **Users' Sites** by **Transmission Licensees**, are set out in each **Interface Agreement** (or in the case of **Interfaces Sites** prior to the **OTSUA Transfer Time** agreements in similar form) with, for **Transmission Sites** in England and Wales, **The Company** and each **User**, and for **Transmission Sites** in Scotland and **Offshore**, the **Relevant Transmission Licensee** and each **User**.



- ECC.7.6.2 In addition to those provisions, where a **Transmission Site** in England and Wales contains exposed **HV** conductors, unaccompanied access will only be granted to individuals holding an **Authority for Access** issued by **The Company** and where a **Transmission Site** in Scotland or **Offshore** contains exposed **HV** conductors, unaccompanied access will only be granted to individuals holding an **Authority for Access** issued by the **Relevant Transmission Licensee**.
- ECC.7.6.3 The procedure for applying for an **Authority for Access** is contained in the **Interface Agreement**.
- ECC.7.7 Maintenance Standards
- ECC.7.7.1 It is the **User's** responsibility to ensure that all its **Plant** and **Apparatus** (including, until the **OTSUA Transfer Time**, any **OTSUA**) on a **Transmission Site** is tested and maintained adequately for the purpose for which it is intended, and to ensure that it does not pose a threat to the safety of any **Transmission Plant, Apparatus** or personnel on the **Transmission Site**. **The Company** will have the right to inspect the test results and maintenance records relating to such **Plant** and **Apparatus** at any time
- ECC.7.7.2 For **User Sites** in England and Wales, **The Company** has a responsibility to ensure that all **Transmission Plant** and **Apparatus** on a **User Site** is tested and maintained adequately for the purposes for which it is intended and to ensure that it does not pose a threat to the safety of any **User's Plant, Apparatus** or personnel on the **User Site**.
- For **User Sites** in Scotland and **Offshore**, **The Company** shall procure that the **Relevant Transmission Licensee** has a responsibility to ensure that all **Transmission Plant** and **Apparatus** on a **User Site** is tested and maintained adequately for the purposes for which it is intended and to ensure that it does not pose a threat to the safety of any **User's Plant, Apparatus** or personnel on the **User Site**.
- The **User** will have the right to inspect the test results and maintenance records relating to such **Plant** and **Apparatus** on its **User Site** at any time.
- ECC.7.8 Site Operational Procedures
- ECC.7.8.1 **The Company** and **Users** with an interface with **The Company**, must make available staff to take necessary **Safety Precautions** and carry out operational duties as may be required to enable work/testing to be carried out and for the operation of **Plant** and **Apparatus** (including, prior to the **OTSUA Transfer Time**, any **OTSUA**) connected to the **Total System**.
- ECC.7.9 **Generators** and **HVDC System** owners shall provide a **Control Point** in respect of each **Power Station** directly connected to the **National Electricity Transmission System** and **Embedded Large Power Station** or **HVDC System** to receive and act upon instructions pursuant to OC7 and BC2 at all times that **Power Generating Modules** at the **Power Station** are generating or available to generate or **HVDC Systems** are importing or exporting or available to do so. The **Control Point** shall be continuously manned except where the **Bilateral Agreement** in respect of such **Embedded Power Station** specifies that compliance with BC2 is not required, where the **Control Point** shall be manned between the hours of 0800 and 1800 each day.
- ECC.8 ANCILLARY SERVICES
- ECC.8.1 System Ancillary Services
- The **ECC** contain requirements for the capability for certain **Ancillary Services**, which are needed for **System** reasons ("**System Ancillary Services**"). There follows a list of these **System Ancillary Services**, together with the paragraph number of the **ECC** (or other part of the **Grid Code**) in which the minimum capability is required or referred to. The list is divided into two categories: Part 1 lists the **System Ancillary Services** which
- (a) **Generators** in respect of **Type C** and **Type D Power Generating Modules** (including **DC Connected Power Park Modules** and **Electricity Storage Modules**) are obliged to provide; and,

- (b) **HVDC System Owners** are obliged to have the capability to supply;
- (c) **Generators** in respect of **Medium Power Stations** (except **Embedded Medium Power Stations**) are obliged to provide in respect of **Reactive Power** only:

and Part 2 lists the **System Ancillary Services** which **Generators** will provide only if agreement to provide them is reached with **The Company**:

Part 1

- (a) **Reactive Power** supplied (in accordance with ECC.6.3.2)
- (b) **Frequency** Control by means of **Frequency** sensitive generation - ECC.6.3.7 and BC3.5.1

Part 2

- (c) **Frequency** Control by means of **Fast Start** - ECC.6.3.14
- (d) **Black Start Capability** - ECC.6.3.5
- (e) **System to Generator Operational Intertipping**

ECC.8.2

Commercial Ancillary Services

Other **Ancillary Services** are also utilised by **The Company** in operating the **Total System** if these have been agreed to be provided by a **User** (or other person) under an **Ancillary Services Agreement** or under a **Bilateral Agreement**, with payment being dealt with under an **Ancillary Services Agreement** or in the case of **Externally Interconnected System Operators** or **Interconnector Users**, under any other agreement (and in the case of **Externally Interconnected System Operators** and **Interconnector Users** includes ancillary services equivalent to or similar to **System Ancillary Services**) ("**Commercial Ancillary Services**"). The capability for these **Commercial Ancillary Services** is set out in the relevant **Ancillary Services Agreement** or **Bilateral Agreement** (as the case may be).

## APPENDIX E1 - SITE RESPONSIBILITY SCHEDULES

### FORMAT, PRINCIPLES AND BASIC PROCEDURE TO BE USED IN THE PREPARATION OF SITE RESPONSIBILITY SCHEDULES

#### ECC.A.1.1 Principles

##### Types of Schedules

ECC.A.1.1.1 At all **Complexes** (which in the context of this ECC shall include, **Interface Sites** until the **OTSUA Transfer Time**) the following **Site Responsibility Schedules** shall be drawn up using the relevant proforma attached or with such variations as may be agreed between **The Company** and **Users**, but in the absence of agreement the relevant proforma attached will be used. In addition, in the case of **OTSDUW Plant and Apparatus**, and in readiness for the **OTSUA Transfer Time**, the **User** shall provide **The Company** with the necessary information such that **Site Responsibility Schedules** in this form can be prepared by the **Relevant Transmission Licensees** for the **Transmission Interface Site**:

- (a) Schedule of **HV Apparatus**
- (b) Schedule of **Plant, LV/MV Apparatus**, services and supplies;
- (c) Schedule of telecommunications and measurements **Apparatus**.

Other than at **Power Generating Module** (including **DC Connected Power Park Modules**) and **Power Station** locations, the schedules referred to in (b) and (c) may be combined.

##### New Connection Sites

ECC.A.1.1.2 In the case of a new **Connection Site** each **Site Responsibility Schedule** for a **Connection Site** shall be prepared by **The Company** in consultation with relevant **Users** at least 2 weeks prior to the **Completion Date** (or, where the **OTSUA** is to become **Operational** prior to the **OTSUA Transfer Time**, an alternative date) under the **Bilateral Agreement** and/or **Construction Agreement** for that **Connection Site** (which may form part of a **Complex**). In the case of a new **Interface Site** where the **OTSUA** is to become **Operational** prior to the **OTSUA Transfer Time** each **Site Responsibility Schedule** for an **Interface Site** shall be prepared by **The Company** in consultation with relevant **Users** at least 2 weeks prior to the **Completion Date** under the **Bilateral Agreement** and/or **Construction Agreement** for that **Interface Site** (which may form part of a **Complex**) (and references to and requirements placed on "**Connection Site**" in this ECC shall also be read as "**Interface Site**" where the context requires and until the **OTSUA Transfer Time**). Each **User** shall, in accordance with the timing requirements of the **Bilateral Agreement** and/or **Construction Agreement**, provide information to **The Company** to enable it to prepare the **Site Responsibility Schedule**.

##### Sub-division

ECC.A.1.1.3 Each **Site Responsibility Schedule** will be subdivided to take account of any separate **Connection Sites** on that **Complex**.

##### Scope

ECC.A.1.1.4 Each **Site Responsibility Schedule** shall detail for each item of **Plant** and **Apparatus**:

- (a) **Plant/Apparatus** ownership;
- (b) Site Manager (Controller) (except in the case of **Plant/Apparatus** located in **SPT's Transmission Area**);
- (c) Safety issues comprising applicable **Safety Rules** and **Control Person** or other responsible person (**Safety Co-ordinator**), or such other person who is responsible for safety;
- (d) Operations issues comprising applicable **Operational Procedures** and control engineer;
- (e) Responsibility to undertake statutory inspections, fault investigation and maintenance.

Each **Connection Point** shall be precisely shown.

#### Detail

- ECC.A.1.1.5 (a) In the case of **Site Responsibility Schedules** referred to in ECC.A.1.1.1(b) and (c), with the exception of **Protection Apparatus** and **Intertrip Apparatus** operation, it will be sufficient to indicate the responsible **User** or **Transmission Licensee**, as the case may be.
- (b) In the case of the **Site Responsibility Schedule** referred to in ECC.A.1.1.1(a) and for **Protection Apparatus** and **Intertrip Apparatus**, the responsible management unit must be shown in addition to the **User** or **Transmission Licensee**, as the case may be.
- ECC.A.1.1.6 The **HV Apparatus Site Responsibility Schedule** for each **Connection Site** must include lines and cables emanating from or traversing<sup>1</sup> the **Connection Site**.

#### Issue Details

- ECC.A.1.1.7 Every page of each **Site Responsibility Schedule** shall bear the date of issue and the issue number.

#### Accuracy Confirmation

- ECC.A.1.1.8 When a **Site Responsibility Schedule** is prepared it shall be sent by **The Company** to the **Users** involved for confirmation of its accuracy.
- ECC.A.1.1.9 The **Site Responsibility Schedule** shall then be signed on behalf of **The Company** by its **Responsible Manager** (see ECC.A.1.1.16) and on behalf of each **User** involved by its **Responsible Manager** (see ECC.A.1.1.16), by way of written confirmation of its accuracy. For **Connection Sites** in Scotland or **Offshore**, the **Site Responsibility Schedule** will also be signed on behalf of the **Relevant Transmission Licensee** by its **Responsible Manager**.

#### Distribution and Availability

- ECC.A.1.1.10 Once signed, two copies will be distributed by **The Company**, not less than two weeks prior to its implementation date, to each **User** which is a party on the **Site Responsibility Schedule**, accompanied by a note indicating the issue number and the date of implementation.
- ECC.A.1.1.11 **The Company** and **Users** must make the **Site Responsibility Schedules** readily available to operational staff at the **Complex** and at the other relevant control points.

#### Alterations to Existing Site Responsibility Schedules

- ECC.A 1.1.12 Without prejudice to the provisions of ECC.A.1.1.15 which deals with urgent changes, when a **User** identified on a **Site Responsibility Schedule** becomes aware that an alteration is necessary, it must inform **The Company** immediately and in any event 8 weeks prior to any change taking effect (or as soon as possible after becoming aware of it, if less than 8 weeks remain when the **User** becomes aware of the change). This will cover the commissioning of new **Plant** and/or **Apparatus** at the **Connection Site**, whether requiring a revised **Bilateral Agreement** or not, de-commissioning of **Plant** and/or **Apparatus**, and other changes which affect the accuracy of the **Site Responsibility Schedule**.
- ECC.A 1.1.13 Where **The Company** has been informed of a change by a **User**, or itself proposes a change, it will prepare a revised **Site Responsibility Schedule** by not less than six weeks prior to the change taking effect (subject to it having been informed or knowing of the change eight weeks prior to that time) and the procedure set out in ECC.A.1.1.8 shall be followed with regard to the revised **Site Responsibility Schedule**.

---

<sup>1</sup> Details of circuits traversing the **Connection Site** are only needed from the date which is the earlier of the date when the **Site Responsibility Schedule** is first updated and 15<sup>th</sup> October 2004. In Scotland or **Offshore**, from a date to be agreed between **The Company** and the **Relevant Transmission Licensee**.

ECC.A.1.1.14 The revised **Site Responsibility Schedule** shall then be signed in accordance with the procedure set out in ECC.A.1.1.9 and distributed in accordance with the procedure set out in ECC.A.1.1.10, accompanied by a note indicating where the alteration(s) has/have been made, the new issue number and the date of implementation.

#### Urgent Changes

ECC.A.1.1.15 When a **User** identified on a **Site Responsibility Schedule**, or **The Company**, as the case may be, becomes aware that an alteration to the **Site Responsibility Schedule** is necessary urgently to reflect, for example, an emergency situation which has arisen outside its control, the **User** shall notify **The Company**, or **The Company** shall notify the **User**, as the case may be, immediately and will discuss:

- (a) what change is necessary to the **Site Responsibility Schedule**;
- (b) whether the **Site Responsibility Schedule** is to be modified temporarily or permanently;
- (c) the distribution of the revised **Site Responsibility Schedule**.

**The Company** will prepare a revised **Site Responsibility Schedule** as soon as possible, and in any event within seven days of it being informed of or knowing the necessary alteration. The **Site Responsibility Schedule** will be confirmed by **Users** and signed on behalf of **The Company** and **Users** (by the persons referred to in ECC.A.1.1.9) as soon as possible after it has been prepared and sent to **Users** for confirmation.

#### Responsible Managers

ECC.A.1.1.16 Each **User** shall, prior to the **Completion Date** under each **Bilateral Agreement** and/or **Construction Agreement**, supply to **The Company** a list of Managers who have been duly authorised to sign **Site Responsibility Schedules** on behalf of the **User** and **The Company** shall, prior to the **Completion Date** under each **Bilateral Agreement** and/or **Construction Agreement**, supply to that **User** the name of its **Responsible Manager** and for **Connection Sites** in Scotland or **Offshore**, the name of the **Relevant Transmission Licensee's Responsible Manager** and each shall supply to the other any changes to such list six weeks before the change takes effect where the change is anticipated, and as soon as possible after the change, where the change was not anticipated.

#### De-commissioning of Connection Sites

ECC.A.1.1.17 Where a **Connection Site** is to be de-commissioned, whichever of **The Company** or the **User** who is initiating the de-commissioning must contact the other to arrange for the **Site Responsibility Schedule** to be amended at the relevant time.

**PROFORMA FOR SITE RESPONSIBILITY SCHEDULE**

\_\_\_\_\_ AREA

COMPLEX: \_\_\_\_\_

SCHEDULE: \_\_\_\_\_

CONNECTION SITE: \_\_\_\_\_

ITEM OF PLANT/ APPARATUS	PLANT APPARATUS OWNER	SITE MANAGER	SAFETY		OPERATIONS		PARTY RESPONSIBLE FOR UNDERTAKING STATUTORY INSPECTIONS, FAULT INVESTIGATION & MAINTENANCE	REMARKS
			SAFETY RULES	CONTROL OR OTHER RESPONSIBLE PERSON (SAFETY CO-ORDINATOR)	OPERATIONAL PROCEDURES	CONTROL OR OTHER RESPONSIBLE ENGINEER		

--	--	--	--	--	--	--	--	--

PAGE: \_\_\_\_\_ ISSUE NO: \_\_\_\_\_ DATE: \_\_\_\_\_

**PROFORMA FOR SITE RESPONSIBILITY SCHEDULE**

AREA \_\_\_\_\_

COMPLEX: \_\_\_\_\_

SCHEDULE: \_\_\_\_\_

CONNECTION SITE: \_\_\_\_\_

ITEM OF PLANT/ APPARATUS	PLANT APPARATUS OWNER	SITE MANAGER	SAFETY		OPERATIONS		PARTY RESPONSIBLE FOR UNDERTAKING STATUTORY INSPECTIONS, FAULT INVESTIGATION & MAINTENANCE	REMARKS
			SAFETY RULES	CONTROL OR OTHER RESPONSIBLE PERSON (SAFETY CO-ORDINATOR)	OPERATIONAL PROCEDURES	CONTROL OR OTHER RESPONSIBLE ENGINEER		

NOTES:

SIGNATURE: \_\_\_\_\_ NAME: \_\_\_\_\_ COMPANY: \_\_\_\_\_ DATE: \_\_\_\_\_



SIGNE D: _____	NAM E: _____	COMPAN Y: _____	DAT E: _____
SIGNE D: _____	NAM E: _____	COMPAN Y: _____	DAT E: _____
SIGNE D: _____	NAM E: _____	COMPAN Y: _____	DAT E: _____

PAGE: \_\_\_\_\_ ISSUE NO: \_\_\_\_\_ DATE: \_\_\_\_\_

**SP TRANSMISSION Ltd  
SITE RESPONSIBILITY SCHEDULE  
OWNERSHIP, MAINTENANCE AND OPERATIONS OF EQUIPMENT  
IN JOINT USER SITUATIONS**

Sheet No. \_\_\_\_\_  
Revision: \_\_\_\_\_  
Date: \_\_\_\_\_

Network Area: \_\_\_\_\_

SECTION 'A' BUILDING AND SITE		SECTION 'B' CUSTOMER OR OTHER PARTY			
OWNER	ACCESS REQUIRED:-	NAME:-			
LESSEE	SPECIAL CONDITIONS:-	ADDRESS:-			
MAINTENANCE	LOCATION OF SUPPLY TERMINALS:-	TEL NO:-			
SAFETY		SUB STATION:-			
SECURITY		LOCATION:-			

**SECTION 'C' PLANT**

ITEM Nos.	EQUIPMENT	IDENTIFICATION	OWNER	SAFETY RULES APPLICABLE	OPERATION			MAINTENANCE		FAULT INVESTIGATION		TESTING		RELAY SETTINGS	REMARKS
					Tripping	Closing	Isolating	Earthing	Primary Equip.	Protection Equip.	Primary Equip.	Protection Equip.	Trip and Alarm		

**SECTION 'D' CONFIGURATION AND CONTROL**

ITEM No.	CONFIGURATION RESPONSIBILITY	TELEPHONE NUMBER	REMARKS

**ABBREVIATIONS:-**  
D - SP AUTHORISED PERSON - DISTRIBUTION SYSTEM  
NGC - NATIONAL GRID COMPANY  
SPD - SP DISTRIBUTION Ltd  
SPPS - POWERSYSTEMS  
SPT - SP TRANSMISSION Ltd  
ST - SCOTTISH POWER TELECOMMUNICATIONS  
T - SP AUTHORISED PERSON - TRANSMISSION SYSTEM  
U - USER

**SECTION 'E' ADDITIONAL INFORMATION**

--	--	--	--	--	--	--	--	--	--	--	--	--	--	--	--

SIGNED \_\_\_\_\_ FOR SP Transmission DATE \_\_\_\_\_

SIGNED \_\_\_\_\_ FOR SP Distribution DATE \_\_\_\_\_















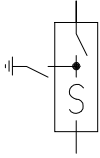





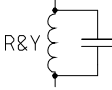

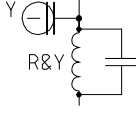

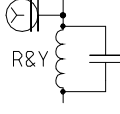

SIGNED \_\_\_\_\_ FOR PowerSystems/User DATE \_\_\_\_\_

**Scottish Hydro-Electric Transmission Limited**  
**Site Responsibility Schedule**

Substation Type		Number:				Revision:			
Equipment	Owner	Controller	Maintainer	Responsible System User	Responsible Management Unit	Control Authority	Safety Rules	Operational Procedures	Notes

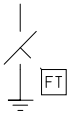
## APPENDIX E2 - OPERATION DIAGRAMS

### PART 1A - PROCEDURES RELATING TO OPERATION DIAGRAMS

FIXED CAPACITOR		SWITCH DISCONNECTOR	
EARTH			
EARTHING RESISTOR		SWITCH DISCONNECTOR WITH INCORPORATED EARTH SWITCH	
LIQUID EARTHING RESISTOR			
ARC SUPPRESSION COIL		DISCONNECTOR (CENTRE ROTATING POST)	
FIXED MAINTENANCE EARTHING DEVICE		DISCONNECTOR (SINGLE BREAK DOUBLE ROTATING)	
CARRIER COUPLING EQUIPMENT (WITHOUT VT)		DISCONNECTOR (SINGLE BREAK)	
CARRIER COUPLING EQUIPMENT (WITH VT ON ONE PHASE)		DISCONNECTOR (NON-INTERLOCKED)	
CARRIER COUPLING EQUIPMENT (WITH VT ON 3 PHASES)		DISCONNECTOR (POWER OPERATED) NA - NON-AUTOMATIC A - AUTOMATIC SO - SEQUENTIAL OPERATION FI - FAULT INTERFERING OPERATION	
AC GENERATOR		EARTH SWITCH	
SYNCHRONOUS COMPENSATOR			
CIRCUIT BREAKER		FAULT THROWING SWITCH (PHASE TO PHASE)	
CIRCUIT BREAKER WITH DELAYED AUTO RECLOSE		FAULT THROWING SWITCH (EARTH FAULT)	
WITHDRAWABLE METALCLAD SWITCHGEAR		SURGE ARRESTOR	
		THYRISTOR	

TRANSFORMERS  
(VECTORS TO INDICATE  
WINDING CONFIGURATION)

TWO WINDING



THREE WINDING

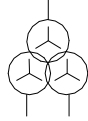

AUTO



AUTO WITH DELTA TERTIARY

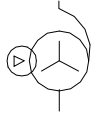

EARTHING OR AUX. TRANSFORMER

(-) INDICATE REMOTE SITE  
IF APPLICABLE

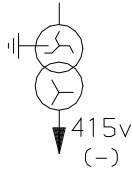

VOLTAGE TRANSFORMERS

SINGLE PHASE WOUND



THREE PHASE WOUND



SINGLE PHASE CAPACITOR



TWO SINGLE PHASE CAPACITOR

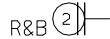

THREE PHASE CAPACITOR



\* CURRENT TRANSFORMER  
(WHERE SEPARATE PRIMARY  
APPARATUS)



\* COMBINED VT/CT UNIT  
FOR METERING

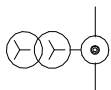

REACTOR



\* BUSBARS



\* OTHER PRIMARY CONNECTIONS



\* CABLE & CABLE SEALING END

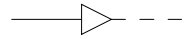

\* THROUGH WALL BUSHING

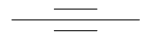

\* BYPASS FACILITY



\* CROSSING OF CONDUCTORS  
(LOWER CONDUCTOR  
TO BE BROKEN)

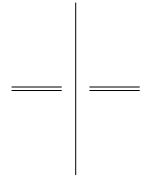

PREFERENTIAL ABBREVIATIONS

AUXILIARY TRANSFORMER	Aux T
EARTHING TRANSFORMER	ET
GAS TURBINE	Gas T
GENERATOR TRANSFORMER	Gen T
GRID TRANSFORMER	Gr T
SERIES REACTOR	Ser Reac
SHUNT REACTOR	Sh Reac
STATION TRANSFORMER	Stn T
SUPERGRID TRANSFORMER	SGT
UNIT TRANSFORMER	UT

\* NON-STANDARD SYMBOL

PORTABLE MAINTENANCE  
EARTH DEVICE



DISCONNECTOR  
(PANTOGRAPH TYPE)



QUADRATURE BOOSTER

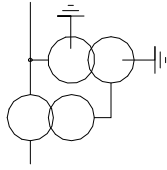

DISCONNECTOR  
(KNEE TYPE)



SHORTING/DISCHARGE SWITCH

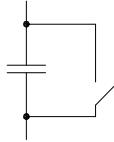

CAPACITOR  
(INCLUDING HARMONIC FILTER)



SINGLE PHASE TRANSFORMER (BR)  
NEUTRAL AND PHASE CONNECTIONS

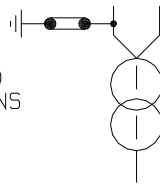

RESISTOR WITH INHERENT  
NON-LINEAR VARIABILITY,  
VOLTAGE DEPENDANT

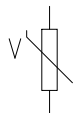

## PART E1B - PROCEDURES RELATING TO GAS ZONE DIAGRAMS

GAS INSULATED  
BUSBAR

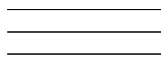

DOUBLE-BREAK  
DISCONNECTOR

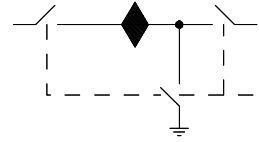

GAS BOUNDARY



EXTERNAL MOUNTED  
CURRENT TRANSFORMER  
(WHERE SEPARATE  
PRIMARY APPARATUS)

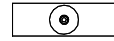

GAS/GAS BOUNDARY



STOP VALVE  
NORMALLY CLOSED



GAS/CABLE BOUNDARY



STOP VALVE  
NORMALLY OPEN



GAS/AIR BOUNDARY



GAS MONITOR



GAS/TRANSFORMER BOUNDARY



FILTER



MAINTENANCE VALVE

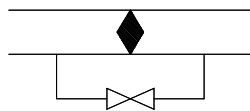

QUICK ACTING COUPLING



## PART E2 - NON-EXHAUSTIVE LIST OF APPARATUS TO BE INCLUDED ON OPERATION DIAGRAMS

### Basic Principles

- (1) Where practicable, all the **HV Apparatus** on any **Connection Site** shall be shown on one **Operation Diagram**. Provided the clarity of the diagram is not impaired, the layout shall represent as closely as possible the geographical arrangement on the **Connection Site**.
- (2) Where more than one **Operation Diagram** is unavoidable, duplication of identical information on more than one **Operation Diagram** must be avoided.
- (3) The **Operation Diagram** must show accurately the current status of the **Apparatus** e.g. whether commissioned or decommissioned. Where decommissioned, the associated switchbay will be labelled "spare bay".
- (4) Provision will be made on the **Operation Diagram** for signifying approvals, together with provision for details of revisions and dates.
- (5) **Operation Diagrams** will be prepared in A4 format or such other format as may be agreed with **The Company**.
- (6) The **Operation Diagram** should normally be drawn single line. However, where appropriate, detail which applies to individual phases shall be shown. For example, some **HV Apparatus** is numbered individually per phase.

### Apparatus To Be Shown On Operation Diagram

- (1) Busbars
- (2) Circuit Breakers
- (3) Disconnecter (Isolator) and Switch Disconnecters (Switching Isolators)
- (4) Disconnectors (Isolators) - Automatic Facilities
- (5) Bypass Facilities
- (6) Earthing Switches
- (7) Maintenance Earths
- (8) Overhead Line Entries
- (9) Overhead Line Traps
- (10) Cable and Cable Sealing Ends
- (11) Generating Unit
- (12) Generator Transformers
- (13) Generating Unit Transformers, Station Transformers, including the lower voltage circuit-breakers.
- (14) Synchronous Compensators
- (15) Static Variable Compensators
- (16) Capacitors (including Harmonic Filters)
- (17) Series or Shunt Reactors (Referred to as "Inductors" at nuclear power station sites)
- (18) Supergrid and Grid Transformers
- (19) Tertiary Windings
- (20) Earthing and Auxiliary Transformers
- (21) Three Phase VT's



- (22) Single Phase VT & Phase Identity
- (23) High Accuracy VT and Phase Identity
- (24) Surge Arrestors/Diverter
- (25) Neutral Earthing Arrangements on HV Plant
- (26) Fault Throwing Devices
- (27) Quadrature Boosters
- (28) Arc Suppression Coils
- (29) Single Phase Transformers (BR) Neutral and Phase Connections
- (30) Current Transformers (where separate plant items)
- (31) Wall Bushings
- (32) Combined VT/CT Units
- (33) Shorting and Discharge Switches
- (34) Thyristor
- (35) Resistor with Inherent Non-Linear Variability, Voltage Dependent
- (36) Gas Zone

## APPENDIX E3 - MINIMUM FREQUENCY RESPONSE CAPABILITY REQUIREMENT PROFILE AND OPERATING RANGE FOR POWER GENERATING MODULES AND HVDC EQUIPMENT

### ECC.A.3.1 Scope

The frequency response capability is defined in terms of **Primary Response**, **Secondary Response** and **High Frequency Response**. In addition to the requirements defined in ECC.6.3.7 this appendix defines the minimum frequency response requirements for:-

- (a) each **Type C** and **Type D Power Generating Module**
- (b) each **DC Connected Power Park Module**
- (c) each **HVDC System**

For the avoidance of doubt, this appendix does not apply to **Type A** and **Type B Power Generating Modules**.

**OTSDUW Plant and Apparatus** should facilitate the delivery of frequency response services provided by **Offshore Generating Units** and **Offshore Power Park Units**.

The functional definition provides appropriate performance criteria relating to the provision of **Frequency** control by means of **Frequency** sensitive generation in addition to the other requirements identified in ECC.6.3.7.

In this Appendix 3 to the ECC, for a **Power Generating Module** including a **CCGT Module** or a **Power Park Module** or **DC Connected Power Park Module**, the phrase **Minimum Regulating Level** applies to the entire **CCGT Module** or **Power Park Module** or **DC Connected Power Park Module** operating with all **Generating Units Synchronised** to the **System**.

The minimum **Frequency** response requirement profile is shown diagrammatically in Figure ECC.A.3.1. The capability profile specifies the minimum required level of **Frequency Response** Capability throughout the normal plant operating range.

### ECC.A.3.2 Plant Operating Range

The upper limit of the operating range is the **Maximum Capacity** of the **Power Generating Module** or **Generating Unit** or **CCGT Module** or **HVDC Equipment**.

The **Minimum Stable Operating Level** may be less than, but must not be more than, 65% of the **Maximum Capacity**. Each **Power Generating Module** and/or **Generating Unit** and/or **CCGT Module** and/or **Power Park Module** or **HVDC Equipment** must be capable of operating satisfactorily down to the **Minimum Regulating Level** as dictated by **System** operating conditions, although it will not be instructed to below its **Minimum Stable Operating Level**. If a **Power Generating Module** or **Generating Unit** or **CCGT Module** or **Power Park Module**, or **HVDC Equipment** is operating below **Minimum Stable Operating Level** because of high **System Frequency**, it should recover adequately to its **Minimum Stable Operating Level** as the **System Frequency** returns to **Target Frequency** so that it can provide **Primary** and **Secondary Response** from its **Minimum Stable Operating Level** if the **System Frequency** continues to fall. For the avoidance of doubt, under normal operating conditions steady state operation below the **Minimum Stable Operating Level** is not expected. The **Minimum Regulating Level** must not be more than 55% of **Maximum Capacity**.

In the event of a **Power Generating Module** or **Generating Unit** or **CCGT Module** or **Power Park Module** or **HVDC Equipment** load rejecting down to no less than its **Minimum Regulating Level** it should not trip as a result of automatic action as detailed in BC3.7. If the load rejection is to a level less than the **Minimum Regulating Level** then it is accepted that the condition might be so severe as to cause it to be disconnected from the **System**.

### ECC.A.3.3 Minimum Frequency Response Requirement Profile

Figure ECC.A.3.1 shows the minimum **Frequency** response capability requirement profile diagrammatically for a 0.5 Hz change in **Frequency**. The percentage response capabilities and loading levels are defined on the basis of the **Maximum Capacity** of the **Power Generating Module** or **CCGT Module** or **Power Park Module** or **HVDC Equipment**. Each **Power Generating Module** or and/or **CCGT Module** or **Power Park Module** (including a **DC Connected Power Park Module**) and/or **HVDC Equipment** must be capable of operating in a manner to provide **Frequency** response at least to the solid boundaries shown in the figure. If the **Frequency** response capability falls within the solid boundaries, the **Power Generating Module** or **CCGT Module** or **Power Park Module** or **HVDC Equipment** is providing response below the minimum requirement which is not acceptable. Nothing in this appendix is intended to prevent a **Power Generating Module** or **CCGT Module** or **Power Park Module** or **HVDC Equipment** from being designed to deliver a **Frequency** response in excess of the identified minimum requirement.

The **Frequency** response delivered for **Frequency** deviations of less than 0.5 Hz should be no less than a figure which is directly proportional to the minimum **Frequency** response requirement for a **Frequency** deviation of 0.5 Hz. For example, if the **Frequency** deviation is 0.2 Hz, the corresponding minimum **Frequency** response requirement is 40% of the level shown in Figure ECC.A.3.1. The **Frequency** response delivered for **Frequency** deviations of more than 0.5 Hz should be no less than the response delivered for a **Frequency** deviation of 0.5 Hz.

Each **Power Generating Module** and/or **CCGT Module** and/or **Power Park Module** or **HVDC Equipment** must be capable of providing some response, in keeping with its specific operational characteristics, when operating between 95% to 100% of **Maximum Capacity** as illustrated by the dotted lines in Figure ECC.A.3.1.

At the **Minimum Stable Operating** level, each **Power Generating Module** and/or **CCGT Module** and/or **Power Park Module** and/or **HVDC Equipment** is required to provide high and low frequency response depending on the **System Frequency** conditions. Where the **Frequency** is high, the **Active Power** output is therefore expected to fall below the **Minimum Stable Operating** level.

The **Minimum Regulating Level** is the output at which a **Power Generating Module** and/or **CCGT Module** and/or **Power Park Module** and/or **HVDC Equipment** has no **High Frequency Response** capability. It may be less than, but must not be more than, 55% of the **Maximum Capacity**. This implies that a **Power Generating Module** or **CCGT Module** or **Power Park Module** ) or **HVDC Equipment** is not obliged to reduce its output to below this level unless the **Frequency** is at or above 50.5 Hz (cf BC3.7).

#### ECC.A.3.4 Testing of Frequency Response Capability

The frequency response capabilities shown diagrammatically in Figure ECC.A.3.1 are measured by taking the responses as obtained from some of the dynamic step response tests specified by **The Company** and carried out by **Generators** and **HVDC System** owners for compliance purposes. The injected signal is a step of 0.5Hz from zero to 0.5 Hz **Frequency** change, and is sustained at 0.5 Hz **Frequency** change thereafter, the latter as illustrated diagrammatically in figures ECC.A.3.4 and ECC.A.3.5.

In addition to provide and/or to validate the content of **Ancillary Services Agreements** a progressive injection of a **Frequency** change to the plant control system (i.e. governor and load controller) is used. The injected signal is a ramp of 0.5Hz from zero to 0.5 Hz **Frequency** change over a ten second period, and is sustained at 0.5 Hz **Frequency** change thereafter, the latter as illustrated diagrammatically in figures ECC.A.3.2 and ECC.A.3.3. In the case of an **Embedded Medium Power Station** not subject to a **Bilateral Agreement** or **Embedded HVDC System** not subject to a **Bilateral Agreement**, **The Company** may require the **Network Operator** within whose System the **Embedded Medium Power Station** or **Embedded HVDC System** is situated, to ensure that the **Embedded Person** performs the dynamic response tests reasonably required by **The Company** in order to demonstrate compliance within the relevant requirements in the **ECC**.

The **Primary Response** capability (P) of a **Power Generating Module** or a **CCGT Module** or **Power Park Module** or **HVDC Equipment** is the minimum increase in **Active Power** output between 10 and 30 seconds after the start of the ramp injection as illustrated diagrammatically in Figure ECC.A.3.2. This increase in **Active Power** output should be released increasingly with time over the period 0 to 10 seconds from the time of the start of the **Frequency** fall as illustrated by the response from Figure ECC.A.3.2.

The **Secondary Response** capability (S) of a **Power Generating Module** or a **CCGT Module** or **Power Park Module** or **HVDC Equipment** is the minimum increase in **Active Power** output between 30 seconds and 30 minutes after the start of the ramp injection as illustrated diagrammatically in Figure ECC.A.3.2.

The **High Frequency Response** capability (H) of a **Power Generating Module** or a **CCGT Module** or **Power Park Module** or **HVDC Equipment** is the decrease in **Active Power** output provided 10 seconds after the start of the ramp injection and sustained thereafter as illustrated diagrammatically in Figure ECC.A.3.3. This reduction in **Active Power** output should be released increasingly with time over the period 0 to 10 seconds from the time of the start of the **Frequency** rise as illustrated by the response in Figure ECC.A.3.2.

#### ECC.A.3.5 Repeatability Of Response

When a **Power Generating Module** or **CCGT Module** or **Power Park Module** or **HVDC Equipment** has responded to a significant **Frequency** disturbance, its response capability must be fully restored as soon as technically possible. Full response capability should be restored no later than 20 minutes after the initial change of **System Frequency** arising from the **Frequency** disturbance.

Figure ECC.A.3.1 - Minimum **Frequency** Response requirement profile for a 0.5 Hz frequency change from Target Frequency

Figure ECC.A.3.1 – Minimum Frequency Response Capability Requirement Profile for a 0.5Hz change from Target Frequency

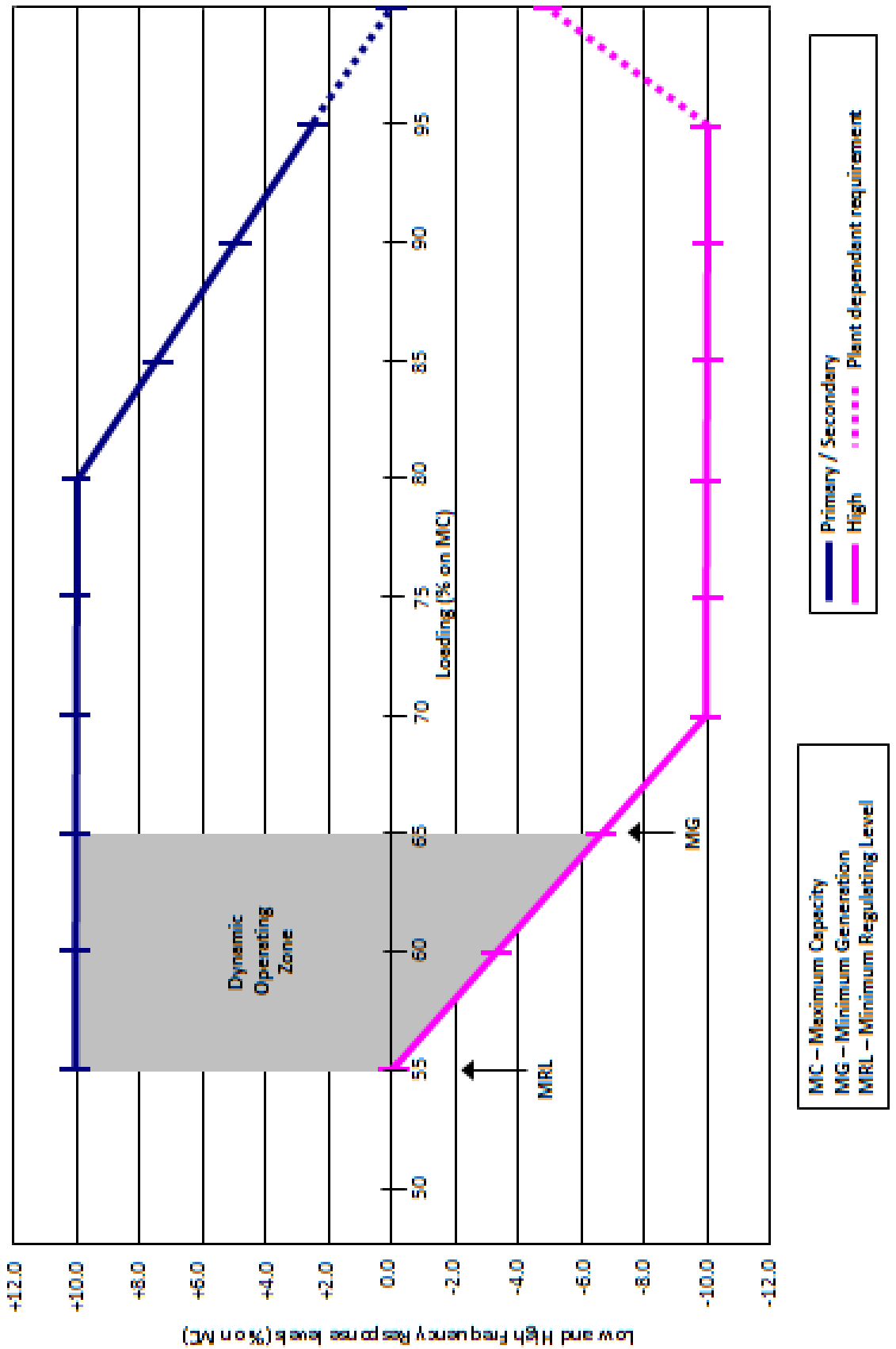

Figure ECC.A.3.2 – Interpretation of Primary and Secondary Response Service Values

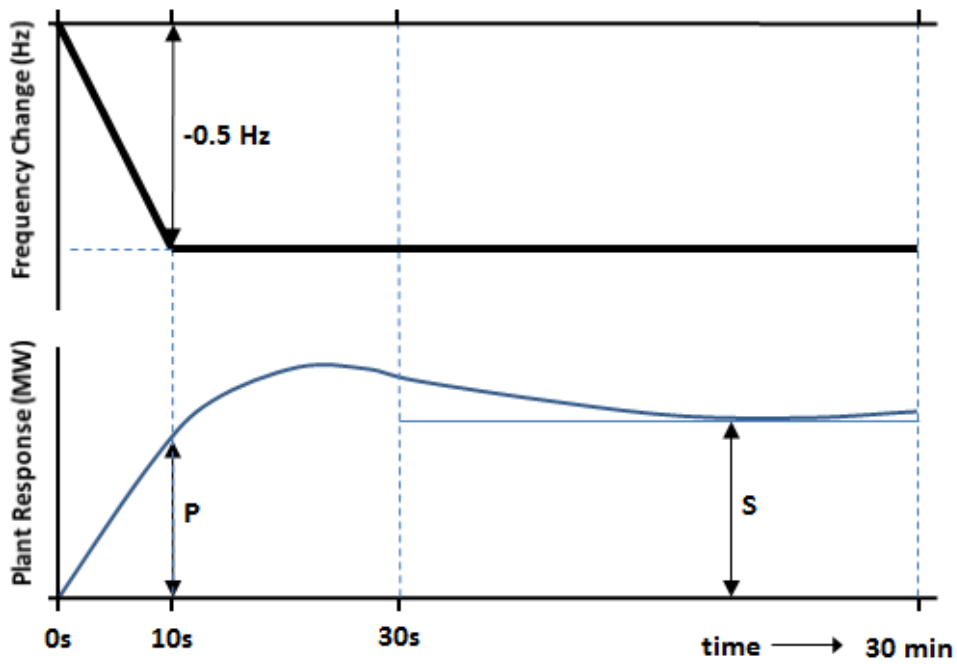

Figure ECC.A.3.3 – Interpretation of High Frequency Response Service Values

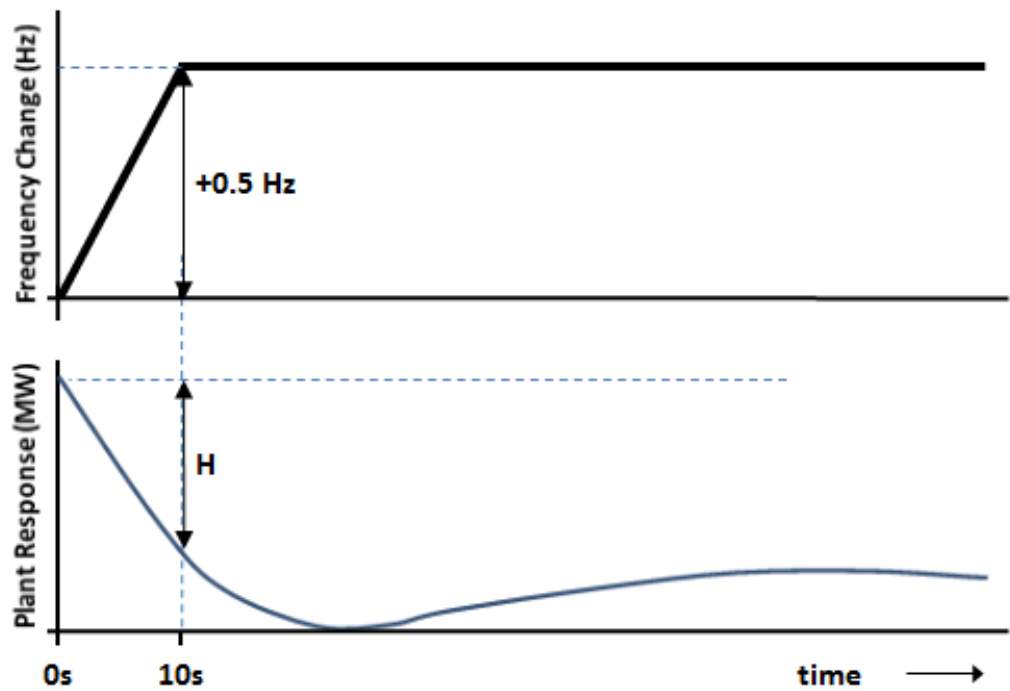

Figure ECC.A.3.4 – Interpretation of Low Frequency Response Capability Values

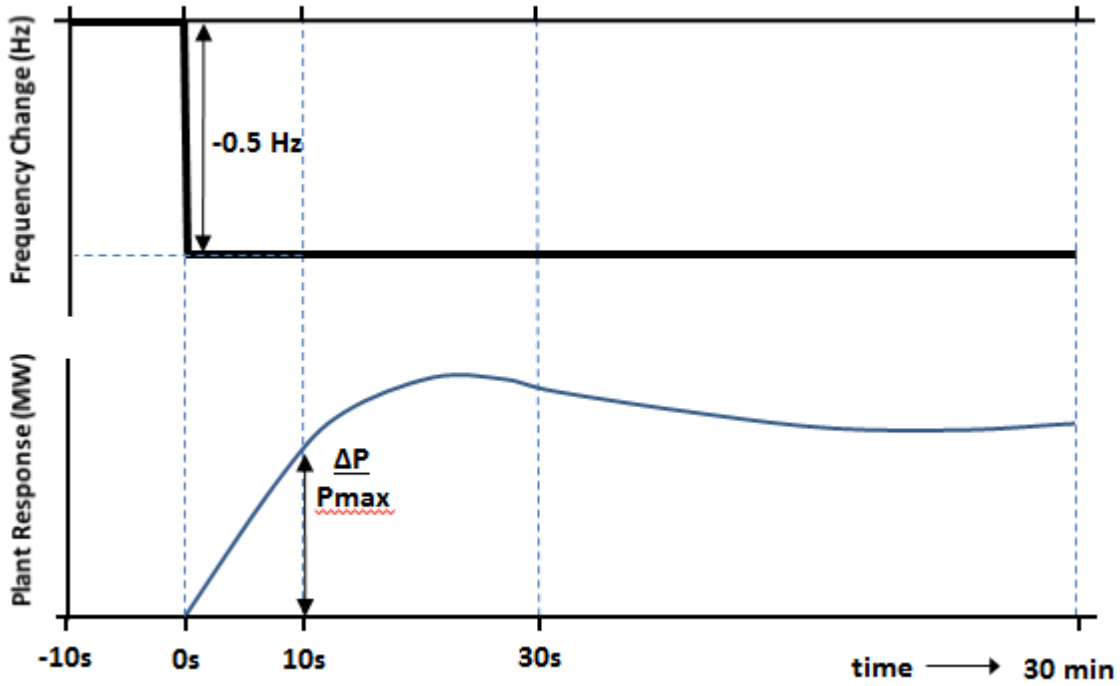
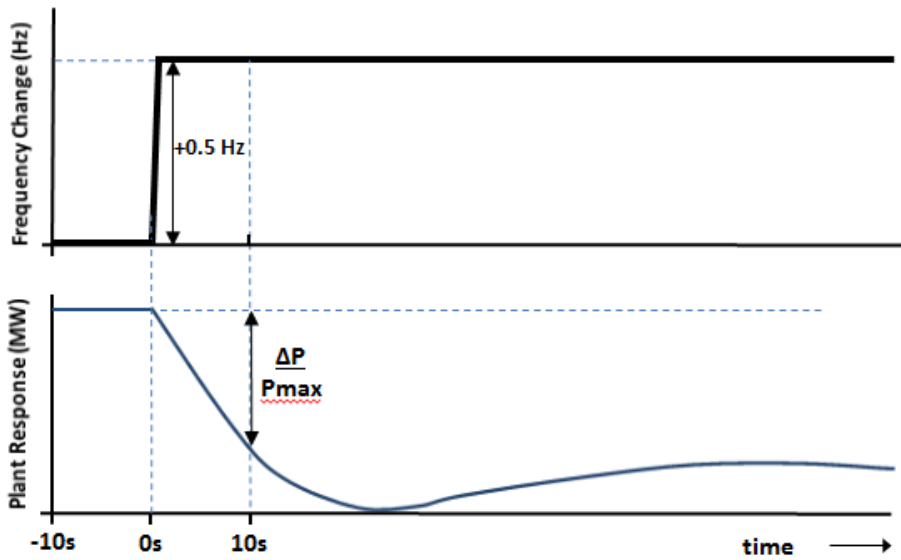

Figure ECC.A.3.5 – Interpretation of High Frequency Response Capability Values



## ECC.4 - APPENDIX 4 - FAULT RIDE THROUGH REQUIREMENTS

### FAULT RIDE THROUGH REQUIREMENTS FOR TYPE B, TYPE C AND TYPE D POWER GENERATING MODULES (INCLUDING OFFSHORE POWER PARK MODULES WHICH ARE EITHER AC CONNECTED POWER PARK MODULES OR DC CONNECTED POWER PARK MODULES), HVDC SYSTEMS AND OTSDUW PLANT AND APPARATUS

#### ECC.A.4A.1 Scope

The **Fault Ride Through** requirements are defined in ECC.6.3.15. This Appendix provides illustrations by way of examples only of ECC.6.3.15.1 to ECC.6.3.15.10 and further background and illustrations and is not intended to show all possible permutations.

#### ECC.A.4A.2 Short Circuit Faults At Supergrid Voltage On The Onshore Transmission System Up To 140ms In Duration

For short circuit faults at **Supergrid Voltage** on the **Onshore Transmission System** (which could be at an **Interface Point**) up to 140ms in duration, the **Fault Ride Through** requirement is defined in ECC.6.3.15. In summary any **Power Generating Module** (including a **DC Connected Power Park Module**) or **HVDC System** is required to remain connected and stable whilst connected to a healthy circuit. Figure ECC.A.4.A.2 illustrates this principle.

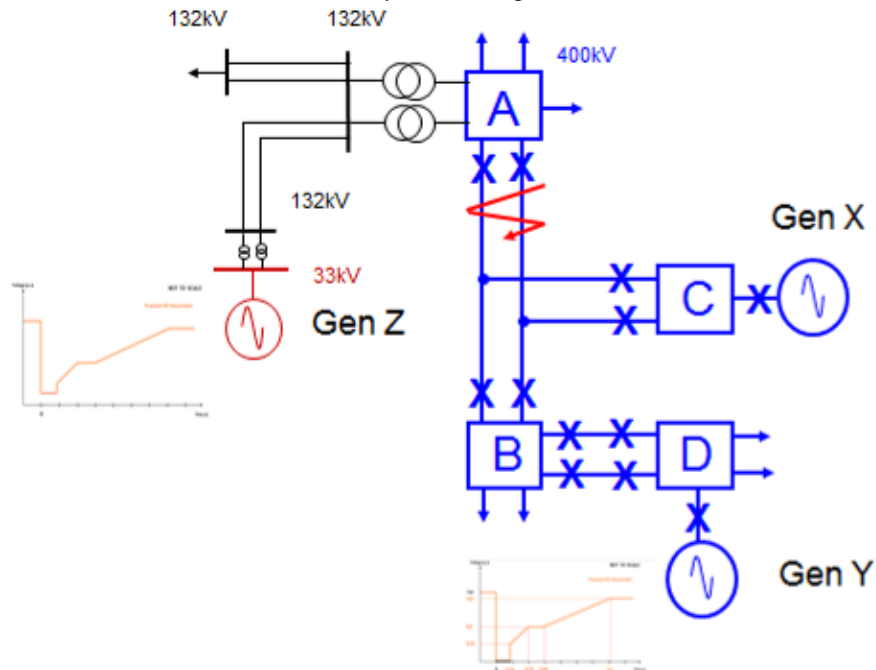

Figure ECC.A.4.A.2

In Figure ECC.A.4.A.2 a solid three phase short circuit fault is applied adjacent to substation A resulting in zero voltage at the point of fault. All circuit breakers on the faulty circuit (Lines ABC) will open within 140ms resulting in Gen X tripping. The effect of this fault, due to the low impedance of the network, will be the observation of a low voltage at each substation node across the **Total System** until the fault has been cleared. In this example, Gen Y and Gen Z (an Embedded Generator) would need to remain connected and stable as both are still connected to the **Total System** and remain connected to healthy circuits .

The criteria for assessment is based on a voltage against time curve at each **Grid Entry Point** or **User System Entry Point**. The voltage against time curve at the **Grid Entry Point** or **User System Entry Point** varies for each different type and size of **Power Generating Module** as detailed in ECC.6.3.15.2. – ECC.6.3.15.7.



The voltage against time curve represents the voltage profile at a **Grid Entry Point or User System Entry Point** that would be obtained by plotting the voltage at that **Grid Entry Point or User System Entry Point** before during and after the fault. This is not to be confused with a voltage duration curve (as defined under ECC.6.3.15.9) which represents a voltage level and associated time duration.

The post fault voltage at a **Grid Entry Point or User System Entry Point** is largely influenced by the topology of the network rather than the behaviour of the **Power Generating Module** itself. The **EU Generator** therefore needs to ensure each **Power Generating Module** remains connected and stable for a close up solid three phase short circuit fault for 140ms at the **Grid Entry Point or User System Entry Point**.

Two examples are shown in Figure EA.4.2(a) and Figure EA.4.2(b). In Figure EA.4.2(a) the post fault profile is above the heavy black line. In this case the **Power Generating Module** must remain connected and stable. In Figure EA.4.2(b) the post fault voltage dips below the heavy black line in which case the **Power Generating Module** is permitted to trip.

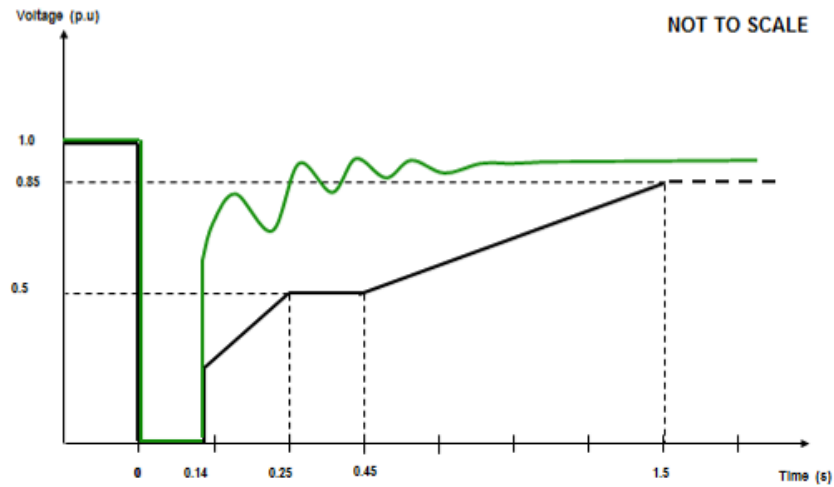

Figure EA.4.2(a)

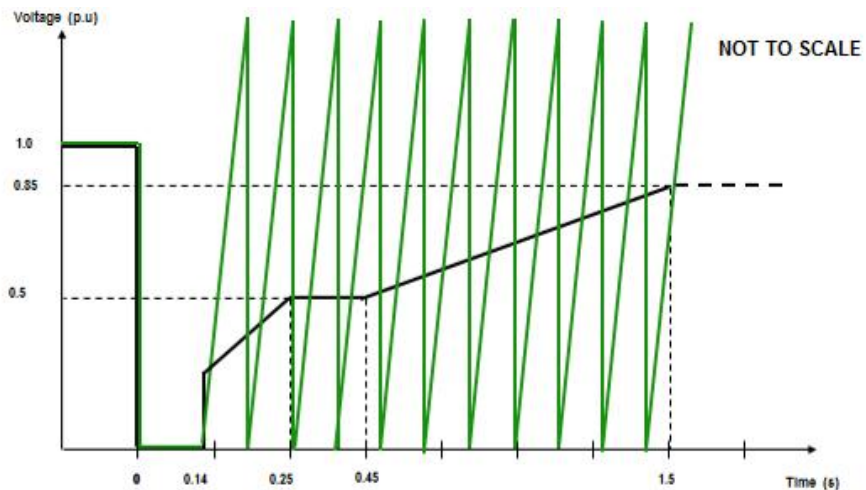

Figure EA.4.2(b)

The process for demonstrating **Fault Ride Through** compliance against the requirements of ECC.6.3.15 is detailed in ECP.A.3.5 and ECP.A.6.7 (as applicable).

ECC.A.4A.3 Supergrid Voltage Dips On The Onshore Transmission System Greater Than 140ms In Duration

ECC.A.4A3.1 Requirements applicable to **Synchronous Power Generating Modules** subject to **Supergrid Voltage** dips on the **Onshore Transmission System** greater than 140ms in duration.

For balanced **Supergrid Voltage** dips on the **Onshore Transmission System** having durations greater than 140ms and up to 3 minutes, the **Fault Ride Through** requirement is defined in ECC.6.3.15.9.2.1(a) and Figure ECC.6.3.15.9(a) which is reproduced in this Appendix as Figure EA.4.3.1 and termed the voltage–duration profile.

This profile is not a voltage-time response curve that would be obtained by plotting the transient voltage response at a point on the **Onshore Transmission System** (or **User System** if located **Onshore**) to a disturbance. Rather, each point on the profile (ie the heavy black line) represents a voltage level and an associated time duration which connected **Synchronous Power Generating Modules** must withstand or ride through.

Figures EA.4.3.2 (a), (b) and (c) illustrate the meaning of the voltage-duration profile for voltage dips having durations greater than 140ms.

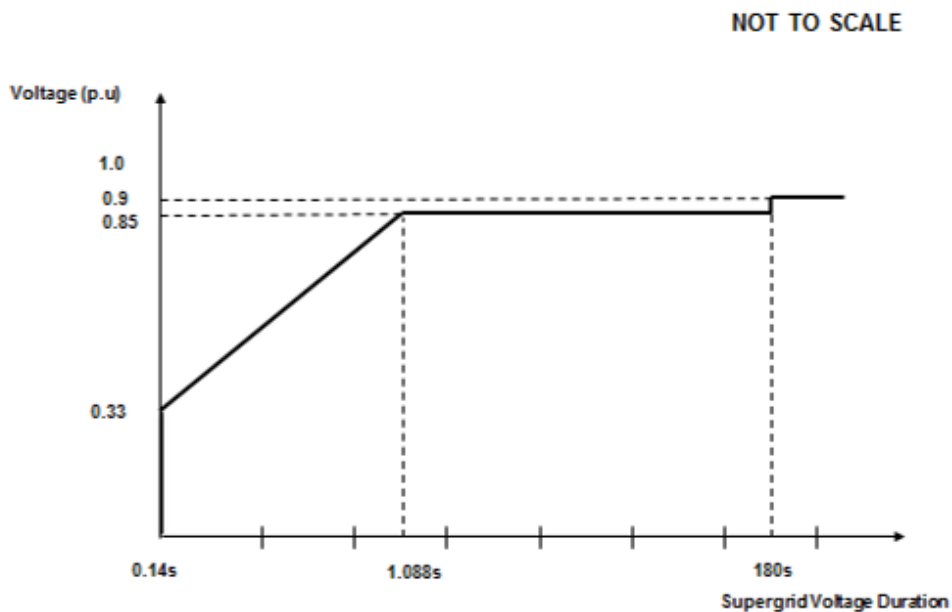

Figure EA.4.3.1

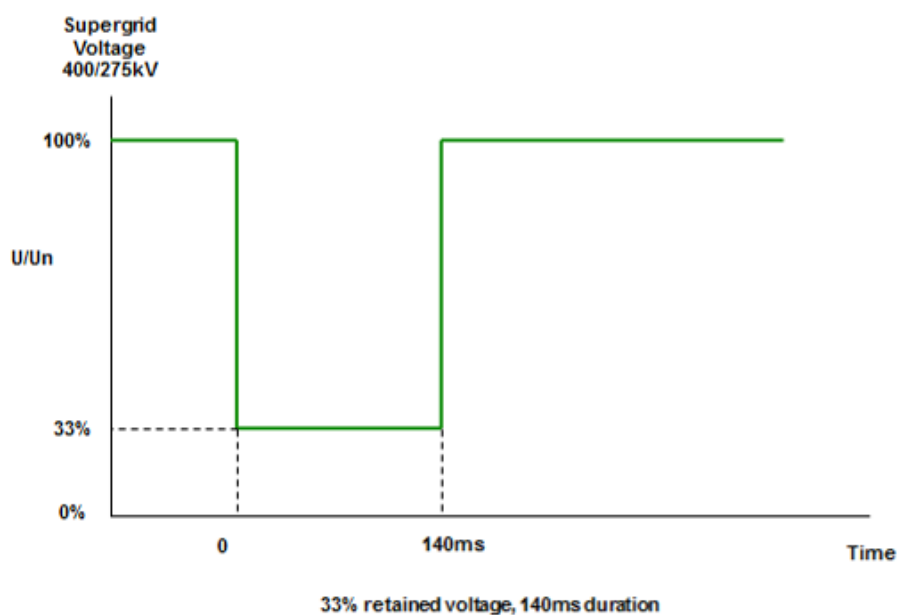

Figure EA.4.3.2 (a)

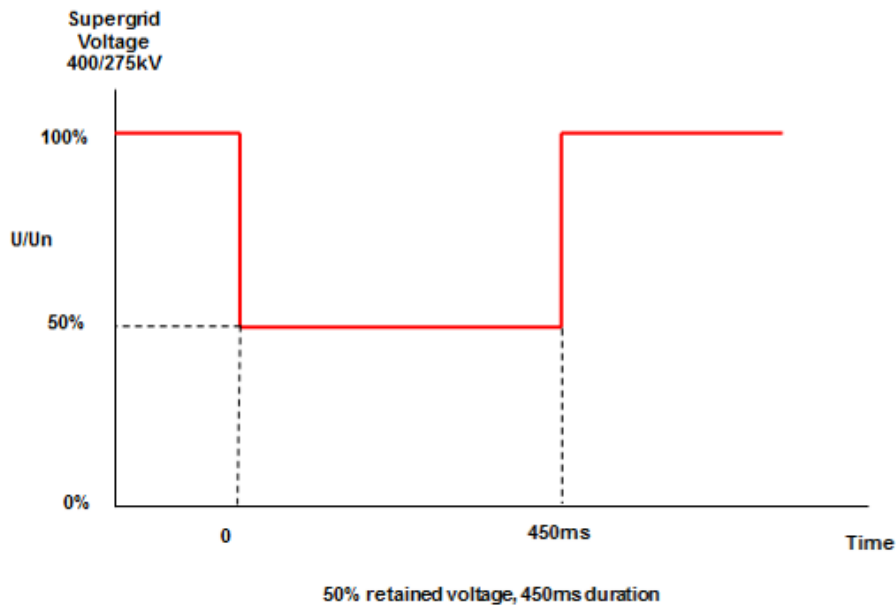

Figure EA.4.3.2 (b)

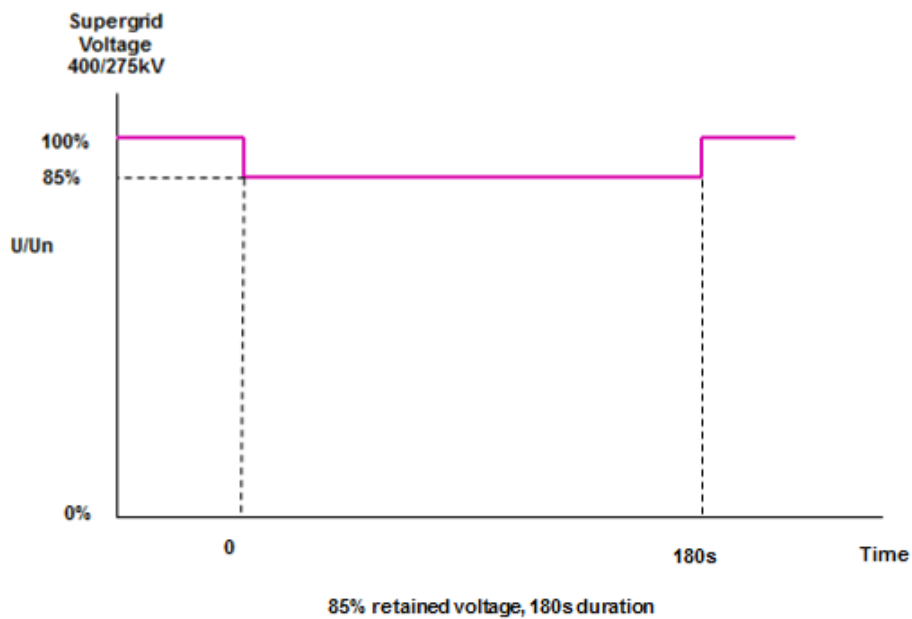

Figure EA.4.3.2 (c)

ECC.A.4A3.2 Requirements applicable to **Power Park Modules** or **OTSDUW Plant and Apparatus** subject to **Supergrid Voltage** dips on the **Onshore Transmission System** greater than 140ms in duration

For balanced **Supergrid Voltage** dips on the **Onshore Transmission System** (which could be at an **Interface Point**) having durations greater than 140ms and up to 3 minutes the **Fault Ride Through** requirement is defined in ECC.6.3.15.9.2.1(b) and Figure ECC.6.3.15.9(b) which is reproduced in this Appendix as Figure EA.4.3.3 and termed the voltage–duration profile.

This profile is not a voltage–time response curve that would be obtained by plotting the transient voltage response at a point on the **Onshore Transmission System** (or **User System** if located **Onshore**) to a disturbance. Rather, each point on the profile (ie the heavy black line) represents a voltage level and an associated time duration which connected **Power Park Modules** or **OTSDUW Plant and Apparatus** must withstand or ride through.

Figures EA.4.3.4 (a), (b) and (c) illustrate the meaning of the voltage-duration profile for voltage dips having durations greater than 140ms.

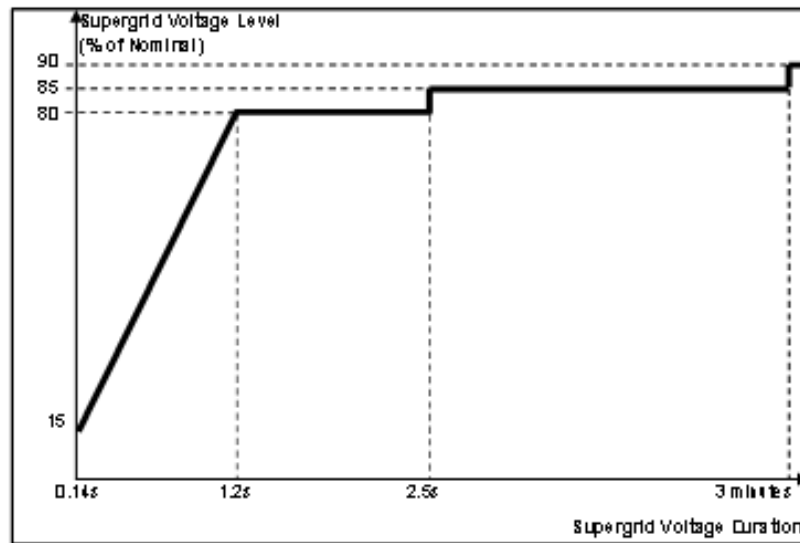

Figure EA.4.3.3

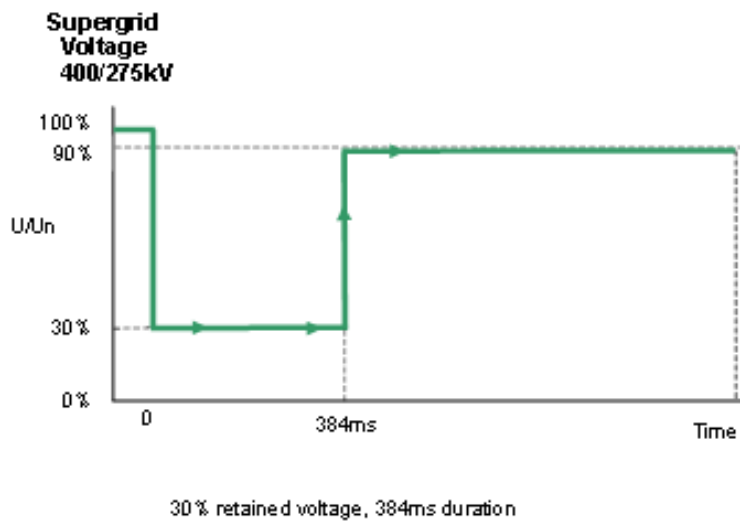
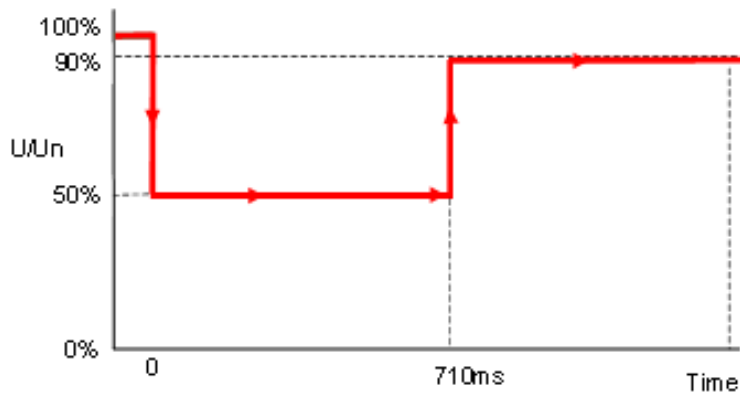

Figure EA.4.3.4(a)

**Supergrid  
Voltage  
400/275kV**



50% retained voltage, 710ms duration

Figure EA.4.3.4 (b)

**Supergrid  
Voltage  
400/275kV**

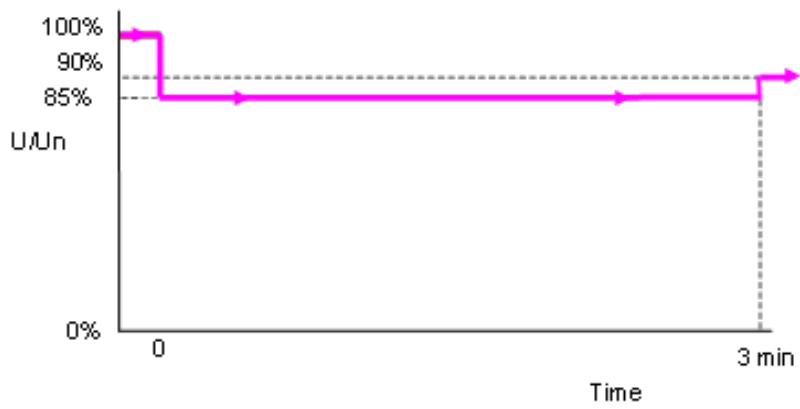

85% retained voltage, 3 minutes duration

Figure EA.4.3.4 (c)

**APPENDIX 4EC – FAST FAULT CURRENT INJECTION REQUIREMENTS**  
**FAST FAULT CURRENT INJECTION REQUIREMENTS FOR POWER PARK MODULES, HVDC**  
**SYSTEMS, DC CONNECTED POWER PARK MODULES AND REMOTE END HVDC**  
**CONVERTERS**

ECC.A.4EC1 Fast Fault Current Injection requirements

ECC.4EC1.1 Fast Fault Current Injection behaviour during a solid three phase close up short circuit fault lasting up to 140ms

ECC.4EC1.1.1 For a voltage depression at a **Grid Entry Point or User System Point**, the **Fast Fault Current** Injection requirements are detailed in ECC.6.3.16. Figure ECC4.1 shows an example of a 500MW **Power Park Module** subject to a close up solid three phase short circuit fault connected directly connected to the **Transmission System** operating at 400kV.

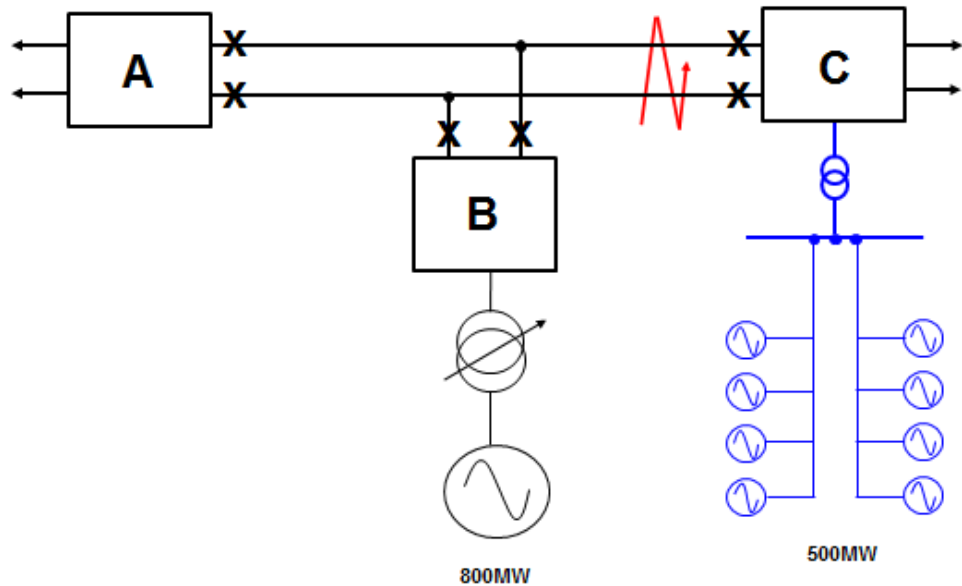

Figure ECC4.1

ECC.4EC1.1.2 Assuming negligible impedance between the fault and substation C, the voltage at Substation C will be close to zero until circuit breakers at Substation C open, typically within 80 – 100ms, subsequently followed by the opening of circuit breakers at substations A and B, typically 140ms after fault inception. The operation of circuit breakers at Substations A, B and C will also result in the tripping of the 800MW generator which is permitted under the SQSS. The **Power Park Module** is required to satisfy the requirements of ECC.6.3.16, and an example of the deviation in system voltage at the **Grid Entry Point** and expected reactive current injected by the **Power Park Module** before and during the fault is shown in Figure ECC4.2(a) and (b).

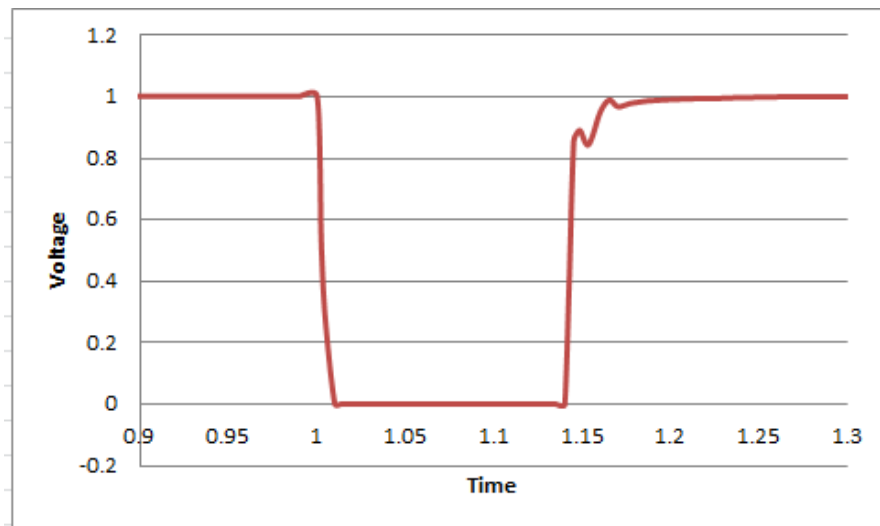

Figure ECC4.2(a) –Voltage deviation at Substation C

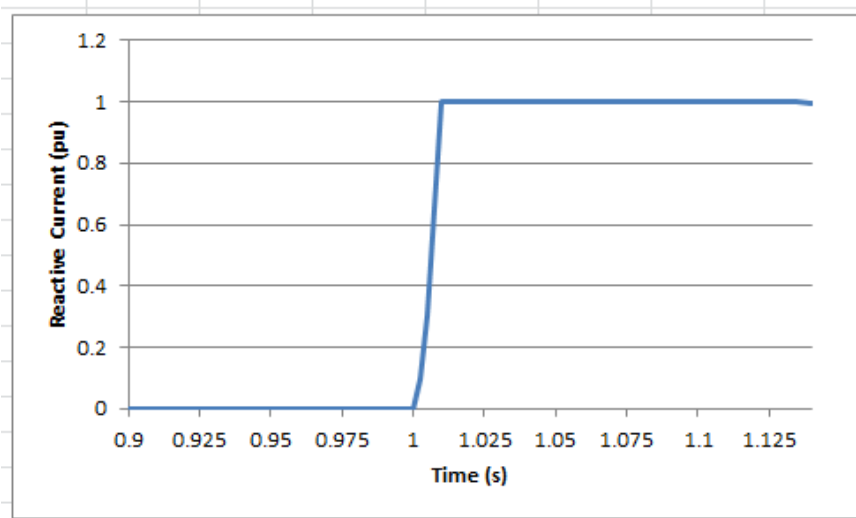

Figure ECC4.2(b) – Reactive Current Injected from the Power Park Module connected to Substation C

It is important to note that blocking is permitted upon fault clearance in order to limit the impact of transient overvoltages. This effect is shown in Figure ECC4.3(a) and Figure ECC4.3(b)

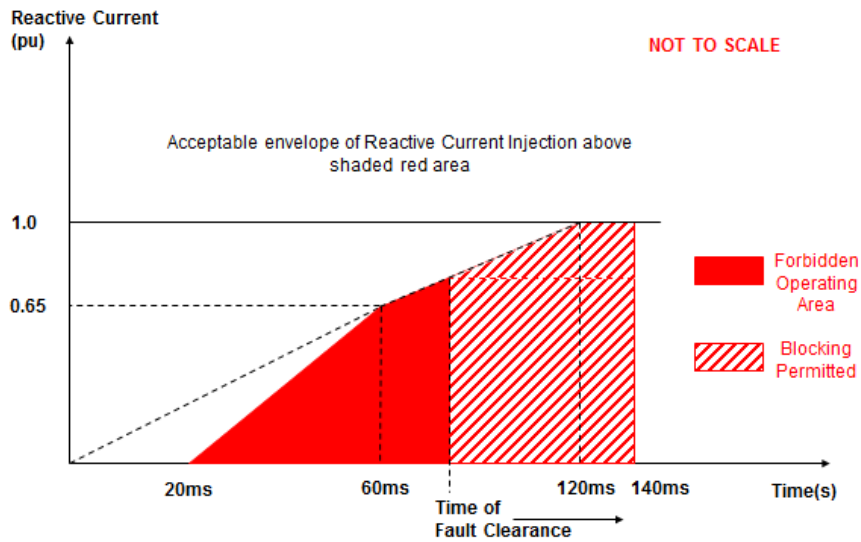

Figure ECC4.3(a)

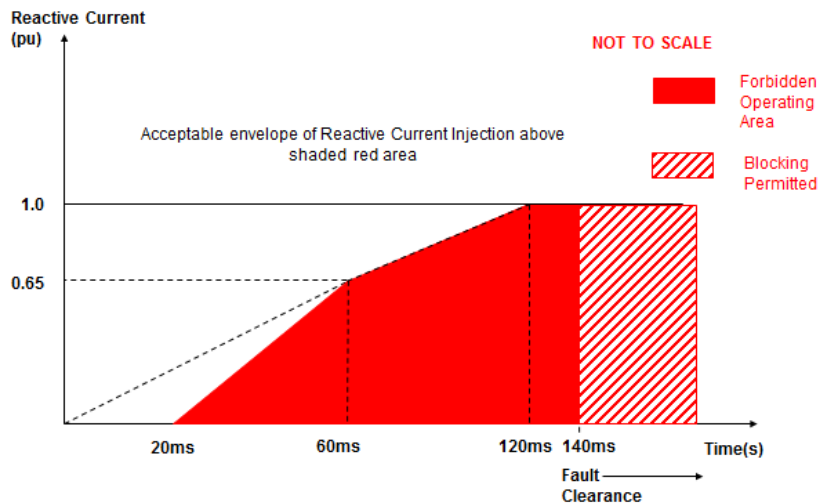



Figure ECC4.3(b)

ECC.4EC1.1.3 So long as the reactive current injected is above the shaded area as illustrated in Figure ECC4.3(a) or ECC4.3(b), the **Power Park Module** would be considered to be compliant with the requirements of ECC.6.3.16 Taking the example outlined in ECC.4EC1.1.1 where the fault is cleared in 140ms, the following diagram in Figure ECC4.4 results.

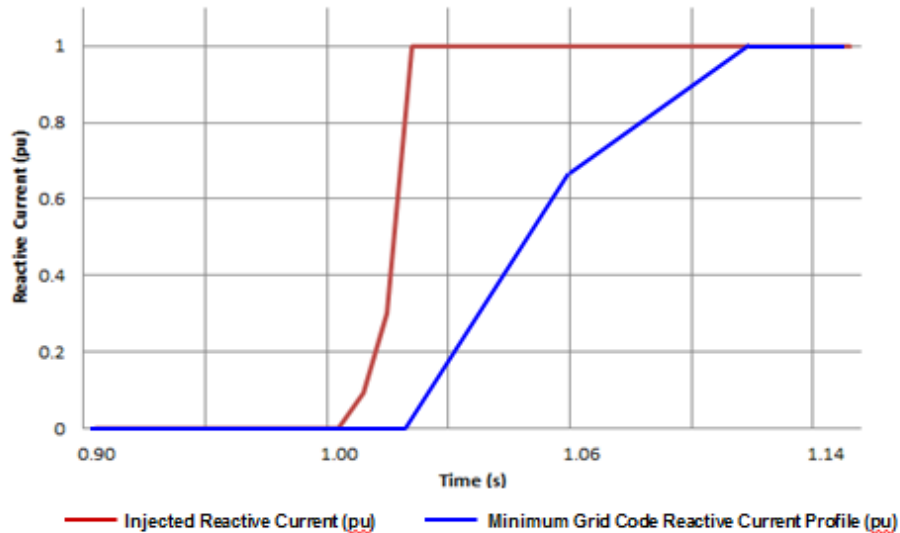

Figure ECC4.4 – Injected Reactive Current from Power Park Module compared to the minimum required Grid Code profile

ECC.4EC1.2 Fast Fault Current Injection behaviour during a voltage dip at the Connection Point lasting in excess of 140ms

ECC.4EC1.2.1 Under the fault ride through requirements specified in ECC.6.3.15.9 (*Voltage dips cleared in excess of 140ms*), **Type B**, **Type C** and **Type D Power Park Modules** are also required to remain connected and stable for voltage dips on the **Transmission System** in excess of 140ms. Figure ECC4.4 (a) shows an example of a 500MW **Power Park Module** connected to the **Transmission System** and Figure ECC4.4 (b) shows the corresponding voltage dip seen at the **Grid Entry Point** or **User System Point** which has resulted from a remote fault on the **Transmission System** cleared in a backup operating time of 710ms.

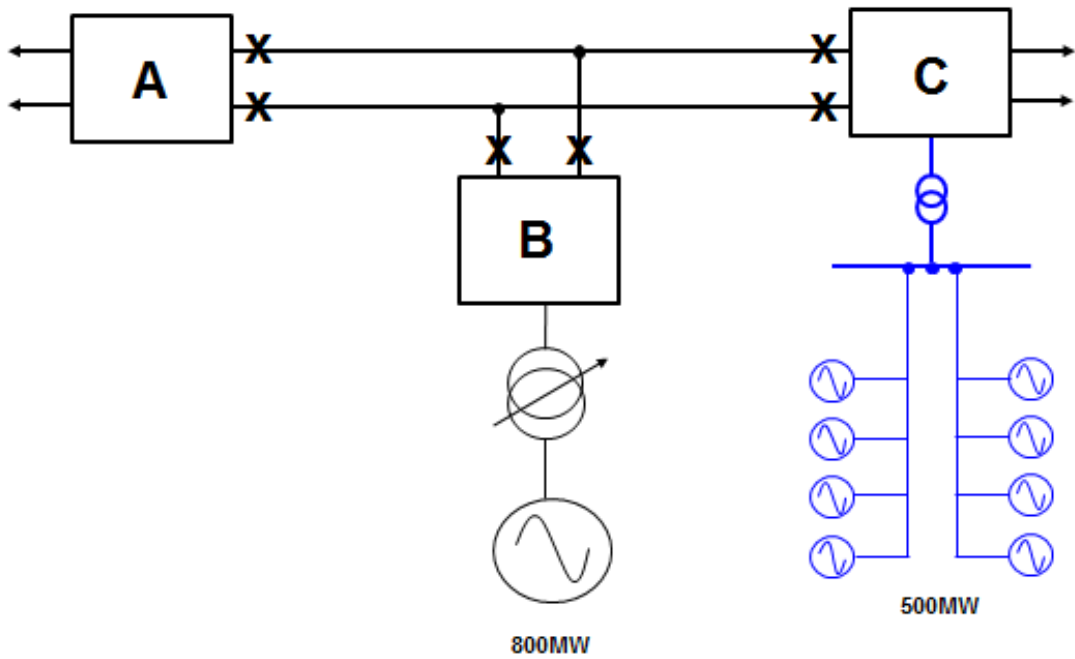

Figure ECC4.4(a)

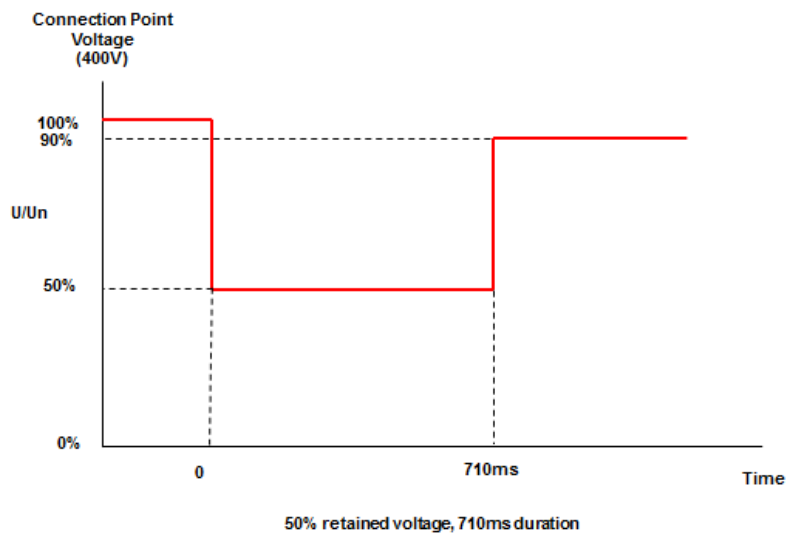

Figure ECC4.4 (b)

ECC.4EC1.2.1 In this example, the voltage dips to 0.5pu for 710ms. Under ECC.6.3.16 each **Type B**, **Type C** and **Type D Power Park Module** is required to inject reactive current into the **System** and shall respond in proportion to the change in **System** voltage at the **Grid Entry Point** or **User System Entry Point** up to a maximum value of 1.0pu of rated current. An example of the expected injected reactive current at the **Connection Point** is shown in Figure ECC4.5

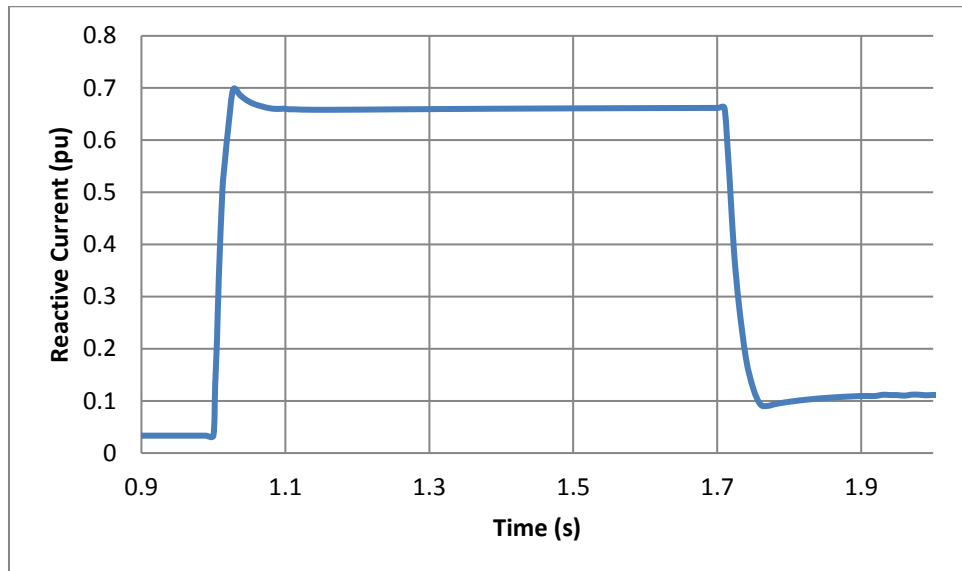

Figure ECC4.5 Reactive Current Injected for a 50% voltage dip for a period of 710ms

**APPENDIX E5 - TECHNICAL REQUIREMENTS  
LOW FREQUENCY RELAYS FOR THE AUTOMATIC  
DISCONNECTION OF SUPPLIES AT LOW FREQUENCY**

ECC.A.5.1 Low Frequency Relays

ECC.A.5.1.1 The **Low Frequency Relays** to be used shall have a setting range of 47.0 to 50Hz and be suitable for operation from a nominal AC input of 63.5, 110 or 240V. The following parameters specify the requirements of approved **Low Frequency Relays**:

- (a) **Frequency** settings: 47-50Hz in steps of 0.05Hz or better, preferably 0.01Hz;
- (b) Operating time: Relay operating time shall not be more than 150 ms;
- (c) Voltage lock-out: Selectable within a range of 55 to 90% of nominal voltage;
- (d) Direction: Tripping interlock for forward or reverse power flow capable of being set in either position or off
- (e) Facility stages: One or two stages of **Frequency** operation;
- (f) Output contacts: Two output contacts per stage to be capable of repetitively making and breaking for 1000 operations:
- (g) Accuracy: 0.01 Hz maximum error under reference environmental and system voltage conditions.  
0.05 Hz maximum error at 8% of total harmonic distortion  
**Electromagnetic Compatibility Level.**

In the case of **Network Operators** who are **GB Code Users**, the above requirements only apply to a relay (if any) installed at the **EU Grid Supply Point**. **Network Operators** who are also **GB Code Users** should continue to satisfy the requirements for low frequency relays as specified in the **CCs** as applicable to their **System**.

#### ECC.A.5.2 Low Frequency Relay Voltage Supplies

ECC.A.5.2.1 It is essential that the voltage supply to the **Low Frequency Relays** shall be derived from the primary **System** at the supply point concerned so that the **Frequency** of the **Low Frequency Relays** input voltage is the same as that of the primary **System**. This requires either:

- (a) the use of a secure supply obtained from voltage transformers directly associated with the grid transformer(s) concerned, the supply being obtained where necessary via a suitable automatic voltage selection scheme; or
- (b) the use of the substation 240V phase-to-neutral selected auxiliary supply, provided that this supply is always derived at the supply point concerned and is never derived from a standby supply **Power Generating Module** or from another part of the **User System**.

#### ECC.A.5.3 Scheme Requirements

ECC.A.5.3.1 The tripping facility should be engineered in accordance with the following reliability considerations:

##### (a) Dependability

Failure to trip at any one particular **Demand** shedding point would not harm the overall operation of the scheme. However, many failures would have the effect of reducing the amount of **Demand** under low **Frequency** control. An overall reasonable minimum requirement for the dependability of the **Demand** shedding scheme is 96%, i.e. the average probability of failure of each **Demand** shedding point should be less than 4%. Thus the **Demand** under low **Frequency** control will not be reduced by more than 4% due to relay failure.

##### (b) Outages

Low **Frequency Demand** shedding schemes will be engineered such that the amount of **Demand** under control is as specified in Table ECC.A.5.5.1a and is not reduced unacceptably during equipment outage or maintenance conditions.

ECC.A.5.3.2 The total operating time of the scheme, including circuit breakers operating time, shall where reasonably practicable, be less than 200 ms. For the avoidance of doubt, the replacement of plant installed prior to October 2009 will not be required in order to achieve lower total scheme operating times.

#### ECC.A.5.4 Low Frequency Relay Testing

ECC.A.5.4.1 **Low Frequency Relays** installed and commissioned after 1<sup>st</sup> January 2007 shall be type tested in accordance with and comply with the functional test requirements for **Frequency Protection** contained in Energy Networks Association Technical Specification 48-6-5 Issue 1 dated 2005 "ENA **Protection** Assessment Functional Test Requirements – Voltage and Frequency **Protection**".

For the avoidance of doubt, **Low Frequency Relays** installed and commissioned before 1<sup>st</sup> January 2007 shall comply with the version of ECC.A.5.1.1 applicable at the time such **Low Frequency Relays** were commissioned.

#### ECC.A.5.5 Scheme Settings

ECC.A.5.5.1 Table CC.A.5.5.1a shows, for each **Transmission Area**, the percentage of **Demand** (based on **Annual ACS Conditions**) at the time of forecast **National Electricity Transmission System** peak **Demand** that each **Network Operator** whose **System** is connected to the **Onshore Transmission System** within such **Transmission Area** shall disconnect by **Low Frequency Relays** at a range of frequencies. Where a **Network Operator's System** is connected to the **National Electricity Transmission System** in more than one **Transmission Area**, the settings for the **Transmission Area** in which the majority of the **Demand** is connected shall apply.

Frequency Hz	% <b>Demand</b> disconnection for each Network Operator in Transmission Area		
	<b>The Company</b>	SPT	SHETL
48.8	5		
48.75	5		
48.7	10		
48.6	7.5		10
48.5	7.5	10	
48.4	7.5	10	10
48.2	7.5	10	10
48.0	5	10	10
47.8	5		
<b>Total % Demand</b>	60	40	40

Table ECC.A.5.5.1a

Note – the percentages in table ECC.A.5.5.1a are cumulative such that, for example, should the frequency fall to 48.6 Hz in **The Company's Transmission Area**, 27.5% of the total **Demand** connected to the **National Electricity Transmission System** in **The Company's Transmission Area** shall be disconnected by the action of **Low Frequency Relays**.

The percentage **Demand** at each stage shall be allocated as far as reasonably practicable. The cumulative total percentage **Demand** is a minimum.

ECC.A.5.5.2 In the case of a **Non-Embedded Customer** (who is also an **EU Code User**) the percentage of **Demand** (based on **Annual ACS Conditions**) at the time of forecast **National Electricity Transmission System** peak **Demand** that each **Non-Embedded Customer** whose **System** is connected to the **Onshore Transmission System** which shall be disconnected by **Low Frequency Relays** shall be in accordance with OC6.6 and the **Bilateral Agreement**.

ECC.A.5.6 Connection and Reconnection

ECC.A.5.6.1 As defined under OC.6.6 once automatic low **Frequency Demand Disconnection** has taken place, the **Network Operator** on whose **User System** it has occurred, will not reconnect until **NGET** instructs that **Network Operator** to do so in accordance with OC6. The same requirement equally applies to **Non-Embedded Customers**.

ECC.A.5.6.1 Once **NGET** instructs the **Network Operator** or **Non Embedded Customer** to reconnect to the **National Electricity Transmission System** following operation of the **Low Frequency Demand Disconnection** scheme it shall do so in accordance with the requirements of ECC.6.2.3.10 and OC6.6.

ECC.A.5.6.2 **Network Operators** or **Non Embedded Customers** shall be capable of being remotely disconnected from the **National Electricity Transmission System** when instructed by **NGET**. Any requirement for the automated disconnection equipment for reconfiguration of the **National Electricity Transmission System** in preparation for block loading and the time required for remote disconnection shall be specified by **NGET** in accordance with the terms of the **Bilateral Agreement**.

**APPENDIX E6 - PERFORMANCE REQUIREMENTS FOR CONTINUOUSLY ACTING AUTOMATIC  
EXCITATION CONTROL SYSTEMS FOR ONSHORE SYNCHRONOUS POWER GENERATING  
MODULES,**

ECC.A.6.1 Scope

ECC.A.6.1.1 This Appendix sets out the performance requirements of continuously acting automatic excitation control systems for **Type C** and **Type D Onshore Synchronous Power Generating Modules** that must be complied with by the **User**. This Appendix does not limit any site specific requirements where in **The Company's** reasonable opinion these facilities are necessary for system reasons.

ECC.A.6.1.2 Where the requirements may vary the likely range of variation is given in this Appendix. It may be necessary to specify values outside this range where **The Company** identifies a system need, and notwithstanding anything to the contrary **The Company** may specify values outside of the ranges provided in this Appendix 6. The most common variations are in the on-load excitation ceiling voltage requirements and the response time required of the **Exciter**. Actual values will be included in the **Bilateral Agreement**.

ECC.A.6.1.3 Should an **EU Generator** anticipate making a change to the excitation control system it shall notify **The Company** under the **Planning Code** (PC.A.1.2(b) and (c)) as soon as the **EU Generator** anticipates making the change. The change may require a revision to the **Bilateral Agreement**.

ECC.A.6.2 Requirements

ECC.A.6.2.1 The **Excitation System** of a **Type C** or **Type D Onshore Synchronous Power Generating Module** shall include an excitation source (**Exciter**), and a continuously acting **Automatic Voltage Regulator (AVR)** and shall meet the following functional specification. **Type D Synchronous Power Generating Modules** are also required to be fitted with a **Power System Stabiliser** in accordance with the requirements of ECC.A.6.2.5.

ECC.A.6.2.3 Steady State Voltage Control

ECC.A.6.2.3.1 An accurate steady state control of the **Onshore Synchronous Power Generating Module** pre-set **Synchronous Generating Unit** terminal voltage is required. As a measure of the accuracy of the steady-state voltage control, the **Automatic Voltage Regulator** shall have static zero frequency gain, sufficient to limit the change in terminal voltage to a drop not exceeding 0.5% of rated terminal voltage, when the output of a **Synchronous Generating Unit** within an **Onshore Synchronous Power Generating Module** is gradually changed from zero to rated MVA output at rated voltage, **Active Power** and **Frequency**.

ECC.A.6.2.4 Transient Voltage Control

ECC.A.6.2.4.1 For a step change from 90% to 100% of the nominal **Onshore Synchronous Generating Unit** terminal voltage, with the **Onshore Synchronous Generating Unit** on open circuit, the **Excitation System** response shall have a damped oscillatory characteristic. For this characteristic, the time for the **Onshore Synchronous Generating Unit** terminal voltage to first reach 100% shall be less than 0.6 seconds. Also, the time to settle within 5% of the voltage change shall be less than 3 seconds.

ECC.A.6.2.4.2 To ensure that adequate synchronising power is maintained, when the **Onshore Power Generating Module** is subjected to a large voltage disturbance, the **Exciter** whose output is varied by the **Automatic Voltage Regulator** shall be capable of providing its achievable upper and lower limit ceiling voltages to the **Onshore Synchronous Generating Unit** field in a time not exceeding that specified in the **Bilateral Agreement**. This will normally be not less than 50 ms and not greater than 300 ms. The achievable upper and lower limit ceiling voltages may be dependent on the voltage disturbance.

ECC.A.6.2.4.3 The **Exciter** shall be capable of attaining an **Excitation System On Load Positive Ceiling Voltage** of not less than a value specified in the **Bilateral Agreement** that will be:

not less than 2 per unit (pu)  
normally not greater than 3 pu  
exceptionally up to 4 pu

of **Rated Field Voltage** when responding to a sudden drop in voltage of 10 percent or more at the **Onshore Synchronous Generating Unit** terminals. **The Company** may specify a value outside the above limits where **The Company** identifies a system need.

ECC.A.6.2.4.4 If a static type **Exciter** is employed:

- (i) the field voltage should be capable of attaining a negative ceiling level specified in the **Bilateral Agreement** after the removal of the step disturbance of ECC.A.6.2.4.3. The specified value will be 80% of the value specified in ECC.A.6.2.4.3. **The Company** may specify a value outside the above limits where **The Company** identifies a system need.
- (ii) the **Exciter** must be capable of maintaining free firing when the **Onshore Synchronous Generating Unit** terminal voltage is depressed to a level which may be between 20% to 30% of rated terminal voltage
- (iii) the **Exciter** shall be capable of attaining a positive ceiling voltage not less than 80% of the **Excitation System On Load Positive Ceiling Voltage** upon recovery of the **Onshore Synchronous Generating Unit** terminal voltage to 80% of rated terminal voltage following fault clearance. **The Company** may specify a value outside the above limits where **The Company** identifies a system need.
- (iv) the requirement to provide a separate power source for the **Exciter** will be specified if **The Company** identifies a **Transmission System** need.

ECC.A.6.2.5 Power Oscillations Damping Control

ECC.A.6.2.5.1 To allow **Type D Onshore Power Generating Modules** to maintain second and subsequent swing stability and also to ensure an adequate level of low frequency electrical damping power, the **Automatic Voltage Regulator** of each **Onshore Synchronous Generating Unit** within each **Type D Onshore Synchronous Power Generating Module** shall include a **Power System Stabiliser** as a means of supplementary control.

ECC.A.6.2.5.2 Whatever supplementary control signal is employed, it shall be of the type which operates into the **Automatic Voltage Regulator** to cause the field voltage to act in a manner which results in the damping power being improved while maintaining adequate synchronising power.

ECC.A.6.2.5.3 The arrangements for the supplementary control signal shall ensure that the **Power System Stabiliser** output signal relates only to changes in the supplementary control signal and not the steady state level of the signal. For example, if generator electrical power output is chosen as a supplementary control signal then the **Power System Stabiliser** output should relate only to changes in the **Synchronous Generating Unit** electrical power output and not the steady state level of power output. Additionally the **Power System Stabiliser** should not react to mechanical power changes in isolation for example during rapid changes in steady state load or when providing frequency response.

ECC.A.6.2.5.4 The output signal from the **Power System Stabiliser** shall be limited to not more than  $\pm 10\%$  of the **Onshore Synchronous Generating Unit** terminal voltage signal at the **Automatic Voltage Regulator** input. The gain of the **Power System Stabiliser** shall be such that an increase in the gain by a factor of 3 shall not cause instability.

ECC.A.6.2.5.5 The **Power System Stabiliser** shall include elements that limit the bandwidth of the output signal. The bandwidth limiting must ensure that the highest frequency of response cannot excite torsional oscillations on other plant connected to the network. A bandwidth of 0-5Hz would be judged to be acceptable for this application.



- ECC.A.6.2.5.6 The **EU Generator** in respect of its **Type D Synchronous Power Generating Modules** will agree **Power System Stabiliser** settings with **The Company** prior to the on-load commissioning detailed in BC2.11.2(d). To allow assessment of the performance before on-load commissioning the **EU Generator** will provide to **The Company** a report covering the areas specified in ECP.A.3.2.1.
- ECC.A.6.2.5.7 The **Power System Stabiliser** must be active within the **Excitation System** at all times when **Synchronised** including when the **Under Excitation Limiter** or **Over Excitation Limiter** are active. When operating at low load when **Synchronising** or **De-Synchronising** an **Onshore Synchronous Generating Unit**, within a **Type D Synchronous Power Generating Module**, the **Power System Stabiliser** may be out of service.
- ECC.A.6.2.5.8 Where a **Power System Stabiliser** is fitted to a **Pumped Storage Unit** within a **Type D Synchronous Power Generating Module** it must function when the **Pumped Storage Unit** is in both generating and pumping modes.
- ECC.A.6.2.6 Overall **Excitation System** Control Characteristics
- ECC.A.6.2.6.1 The overall **Excitation System** shall include elements that limit the bandwidth of the output signal. The bandwidth limiting must be consistent with the speed of response requirements and ensure that the highest frequency of response cannot excite torsional oscillations on other plant connected to the network. A bandwidth of 0-5 Hz will be judged to be acceptable for this application.
- ECC.A.6.2.6.2 The response of the **Automatic Voltage Regulator** combined with the **Power System Stabiliser** shall be demonstrated by injecting similar step signal disturbances into the **Automatic Voltage Regulator** reference as detailed in ECPA.5.2 and ECPA.5.4. The **Automatic Voltage Regulator** shall include a facility to allow step injections into the **Automatic Voltage Regulator** voltage reference, with the **Onshore Type D Power Generating Module** operating at points specified by **The Company** (up to rated MVA output). The damping shall be judged to be adequate if the corresponding **Active Power** response to the disturbances decays within two cycles of oscillation.
- ECC.A.6.2.6.3 A facility to inject a band limited random noise signal into the **Automatic Voltage Regulator** voltage reference shall be provided for demonstrating the frequency domain response of the **Power System Stabiliser**. The tuning of the **Power System Stabiliser** shall be judged to be adequate if the corresponding **Active Power** response shows improved damping with the **Power System Stabiliser** in combination with the **Automatic Voltage Regulator** compared with the **Automatic Voltage Regulator** alone over the frequency range 0.3Hz – 2Hz.
- ECC.A.6.2.7 Under-Excitation Limiters
- ECC.A.6.2.7.1 The security of the power system shall also be safeguarded by means of MVAr **Under Excitation Limiters** fitted to the **Synchronous Power Generating Module Excitation System**. The **Under Excitation Limiter** shall prevent the **Automatic Voltage Regulator** reducing the **Synchronous Generating Unit** excitation to a level which would endanger synchronous stability. The **Under Excitation Limiter** shall operate when the excitation system is providing automatic control. The **Under Excitation Limiter** shall respond to changes in the **Active Power** (MW) the **Reactive Power** (MVAr) and to the square of the **Synchronous Generating Unit** voltage in such a direction that an increase in voltage will permit an increase in leading MVAr. The characteristic of the **Under Excitation Limiter** shall be substantially linear from no-load to the maximum **Active Power** output of the **Onshore Power Generating Module** at any setting and shall be readily adjustable.

- ECC.A.6.2.7.2 The performance of the **Under Excitation Limiter** shall be independent of the rate of change of the **Onshore Synchronous Power Generating Module** load and shall be demonstrated by testing as detailed in ECP.A.5.5. The resulting maximum overshoot in response to a step injection which operates the **Under Excitation Limiter** shall not exceed 4% of the **Onshore Synchronous Generating Unit** rated MVA. The operating point of the **Onshore Synchronous Generating Unit** shall be returned to a steady state value at the limit line and the final settling time shall not be greater than 5 seconds. When the step change in **Automatic Voltage Regulator** reference voltage is reversed, the field voltage should begin to respond without any delay and should not be held down by the **Under Excitation Limiter**. Operation into or out of the preset limit levels shall ensure that any resultant oscillations are damped so that the disturbance is within 0.5% of the **Onshore Synchronous Generating Unit** MVA rating within a period of 5 seconds.
- ECC.A.6.2.7.3 The **EU Generator** shall also make provision to prevent the reduction of the **Onshore Synchronous Generating Unit** excitation to a level which would endanger synchronous stability when the **Excitation System** is under manual control.
- ECC.A.6.2.8 Over-Excitation and Stator Current Limiters
- ECC.A.6.2.8.1 The settings of the **Over-Excitation Limiter** and stator current limiter, shall ensure that the **Onshore Synchronous Generating Unit** excitation is not limited to less than the maximum value that can be achieved whilst ensuring the **Onshore Synchronous Generating Unit** is operating within its design limits. If the **Onshore Synchronous Generating Unit** excitation is reduced following a period of operation at a high level, the rate of reduction shall not exceed that required to remain within any time dependent operating characteristics of the **Onshore Synchronous Power Generating Module**.
- ECC.A.6.2.8.2 The performance of the **Over-Excitation Limiter**, shall be demonstrated by testing as described in ECP.A.5.6. Any operation beyond the **Over-Excitation Limit** shall be controlled by the **Over-Excitation Limiter** or stator current limiter without the operation of any **Protection** that could trip the **Onshore Synchronous Power Generating Module**.
- ECC.A.6.2.8.3 The **EU Generator** shall also make provision to prevent any over-excitation restriction of the **Onshore Synchronous Generating Unit** when the **Excitation System** is under manual control, other than that necessary to ensure the **Onshore Power Generating Module** is operating within its design limits.

**APPENDIX E7 - PERFORMANCE REQUIREMENTS FOR CONTINUOUSLY ACTING AUTOMATIC VOLTAGE CONTROL SYSTEMS FOR AC CONNECTED ONSHORE POWER PARK MODULES AND OTSDUW PLANT AND APPARATUS AT THE INTERFACE POINT HVDC SYSTEMS AND REMOTE END HVDC CONVERTER STATIONS**

ECC.A.7.1 Scope

ECC.A.7.1.1 This Appendix sets out the performance requirements of continuously acting automatic voltage control systems for **Onshore Power Park Modules, Onshore HVDC Converters Remote End HVDC Converter Stations** and **OTSDUW Plant and Apparatus** at the **Interface Point** that must be complied with by the **User**. This Appendix does not limit any site specific requirements where in **The Company's** reasonable opinion these facilities are necessary for system reasons. The control performance requirements applicable to **Configuration 2 AC Connected Offshore Power Park Modules** and **Configuration 2 DC Connected Power Park Modules** are defined in Appendix E8.

ECC.A.7.1.2 Proposals by **EU Generators** or **HVDC System Owners** to make a change to the voltage control systems are required to be notified to **The Company** under the **Planning Code** (PC.A.1.2(b) and (c)) as soon as the **Generator** or **HVDC System Owner** anticipates making the change. The change may require a revision to the **Bilateral Agreement**.

ECC.A.7.1.3 In the case of a **Remote End HVDC Converter** at a **HVDC Converter Station**, the control performance requirements shall be specified in the **Bilateral Agreement**. These requirements shall be consistent with those specified in ECC.6.3.2.4. In the case where the **Remote End HVDC Converter** is required to ensure the zero transfer of **Reactive Power** at the **HVDC Interface Point** then the requirements shall be specified in the **Bilateral Agreement** which shall be consistent with those requirements specified in ECC.A.8 . In the case where a wider reactive capability has been specified in ECC.6.3.2.4, then the requirements consistent with those specified in ECC.A.7.2 shall apply with any variations being agreed between the **User** and **The Company**.

ECC.A.7.2 Requirements

ECC.A.7.2.1 **The Company** requires that the continuously acting automatic voltage control system for the **Onshore Power Park Module, Onshore HVDC Converter or OTSDUW Plant and Apparatus** shall meet the following functional performance specification. If a **Network Operator** has confirmed to **The Company** that its network to which an **Embedded Onshore Power Park Module or Onshore HVDC Converter or OTSDUW Plant and Apparatus** is connected is restricted such that the full reactive range under the steady state voltage control requirements (ECC.A.7.2.2) cannot be utilised, **The Company** may specify alternative limits to the steady state voltage control range that reflect these restrictions. Where the **Network Operator** subsequently notifies **The Company** that such restriction has been removed, **The Company** may propose a **Modification** to the **Bilateral Agreement** (in accordance with the **CUSC** contract) to remove the alternative limits such that the continuously acting automatic voltage control system meets the following functional performance specification. All other requirements of the voltage control system will remain as in this Appendix.

ECC.A.7.2.2 Steady State Voltage Control

ECC.A.7.2.2.1 The **Onshore Power Park Module, Onshore HVDC Converter or OTSDUW Plant and Apparatus** shall provide continuous steady state control of the voltage at the **Onshore Grid Entry Point (or Onshore User System Entry Point if Embedded) (or the Interface Point in the case of OTSDUW Plant and Apparatus )** with a **Setpoint Voltage** and **Slope** characteristic as illustrated in Figure ECC.A.7.2.2a.

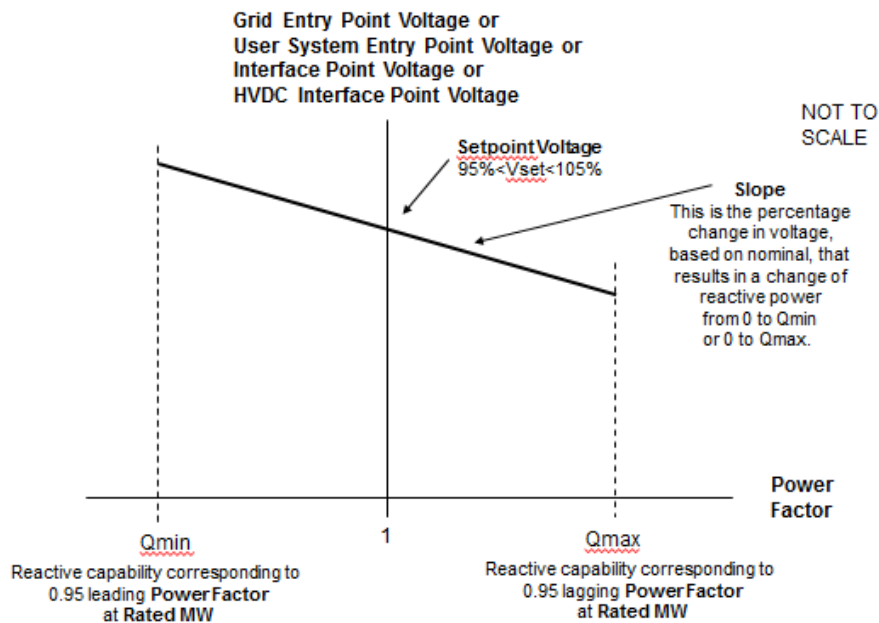

Figure ECC.A.7.2.2a

ECC.A.7.2.2.2 The continuously acting automatic control system shall be capable of operating to a **Setpoint Voltage** between 95% and 105% with a resolution of 0.25% of the nominal voltage. For the avoidance of doubt values of 95%, 95.25%, 95.5% ... may be specified, but not intermediate values. The initial **Setpoint Voltage** will be 100%. The tolerance within which this **Setpoint Voltage** shall be achieved is specified in BC2.A.2.6. For the avoidance of doubt, with a tolerance of 0.25% and a Setpoint Voltage of 100%, the achieved value shall be between 99.75% and 100.25%. **The Company** may request the **EU Generator or HVDC System Owner** to implement an alternative **Setpoint Voltage** within the range of 95% to 105%. For **Embedded Generators and Embedded HVDC System Owners** the **Setpoint Voltage** will be discussed between **The Company** and the relevant **Network Operator** and will be specified to ensure consistency with ECC.6.3.4.

ECC.A.7.2.2.3 The **Slope** characteristic of the continuously acting automatic control system shall be adjustable over the range 2% to 7% (with a resolution of 0.5%). For the avoidance of doubt values of 2%, 2.5%, 3% may be specified, but not intermediate values. The initial **Slope** setting will be 4%. The tolerance within which this **Slope** shall be achieved is specified in BC2.A.2.6. For the avoidance of doubt, with a tolerance of 0.5% and a **Slope** setting of 4%, the achieved value shall be between 3.5% and 4.5%. **The Company** may request the **EU Generator** or **HVDC System Owner** to implement an alternative slope setting within the range of 2% to 7%. For **Embedded Generators** and **Onshore Embedded HVDC Converter Station Owners** the **Slope** setting will be discussed between **The Company** and the relevant **Network Operator** and will be specified to ensure consistency with ECC.6.3.4.

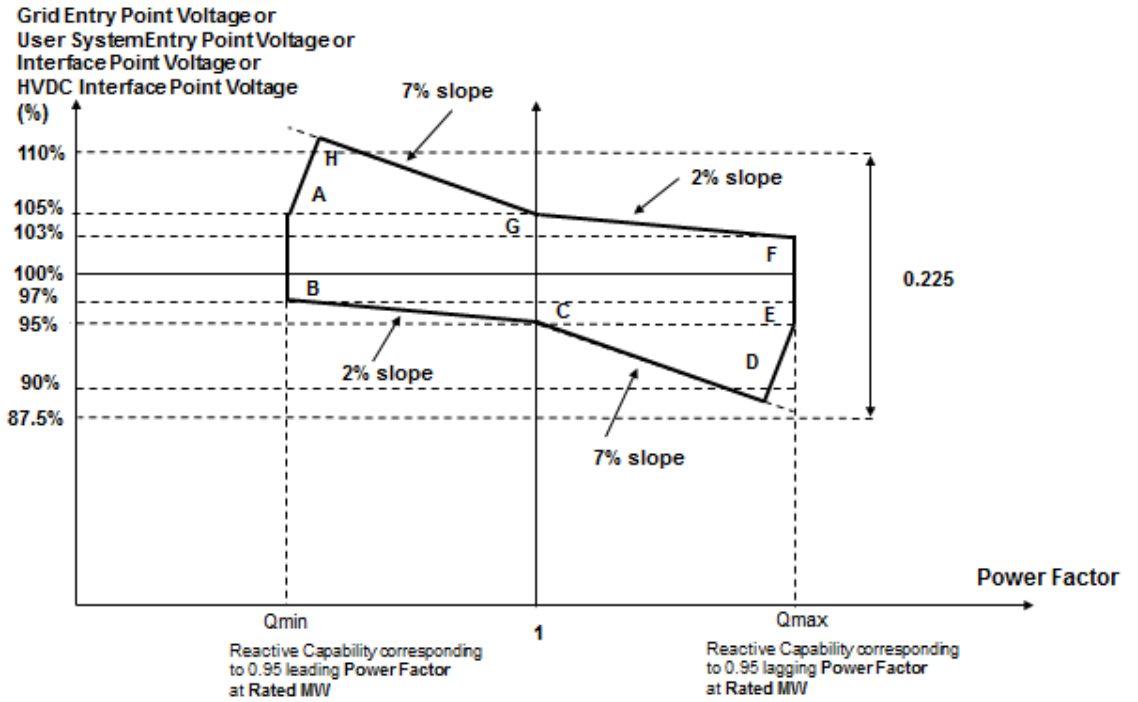

Figure ECC.A.7.2.2b

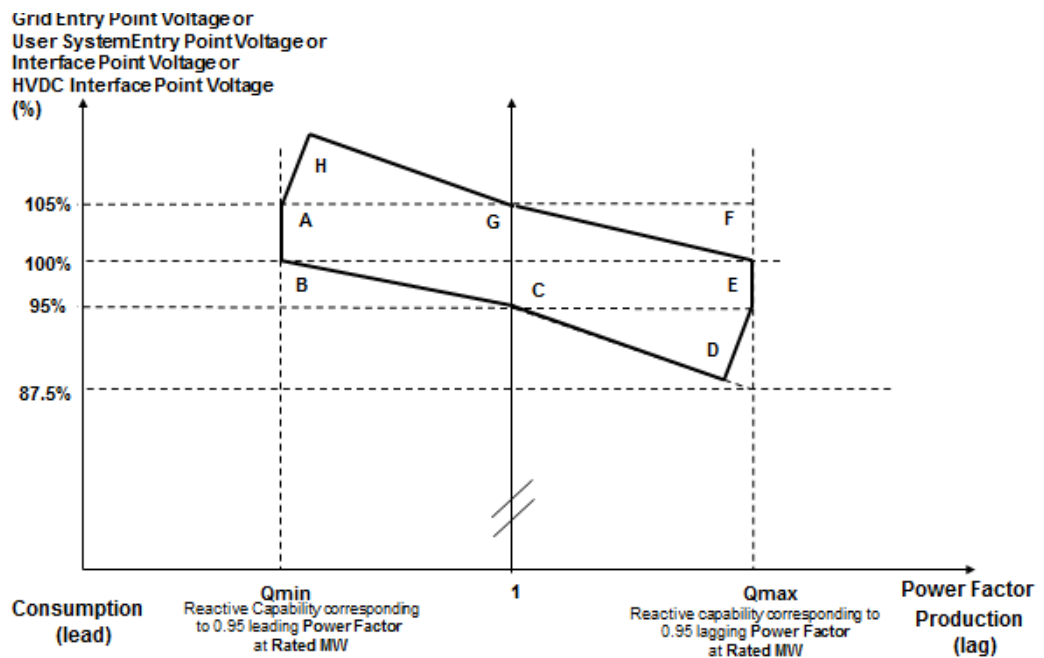

Figure ECC.A.7.2.2c

- ECC.A.7.2.2.4 Figure ECC.A.7.2.2b shows the required envelope of operation for **OTSDUW Plant and Apparatus, Onshore Power Park Modules and Onshore HVDC Converters** except for those **Embedded** at 33kV and below or directly connected to the **National Electricity Transmission System** at 33kV and below. Figure ECC.A.7.2.2c shows the required envelope of operation for **Onshore Power Park Modules Embedded** at 33kV and below, or directly connected to the **National Electricity Transmission System** at 33kV and below. The enclosed area within points ABCDEFGH is the required capability range within which the **Slope** and **Setpoint Voltage** can be changed.
- ECC.A.7.2.2.5 Should the operating point of the **OTSDUW Plant and Apparatus** or **Onshore Power Park Module**, or **Onshore HVDC Converter** deviate so that it is no longer a point on the operating characteristic (figure ECC.A.7.2.2a) defined by the target **Setpoint Voltage** and **Slope**, the continuously acting automatic voltage control system shall act progressively to return the value to a point on the required characteristic within 5 seconds.
- ECC.A.7.2.2.6 Should the **Reactive Power** output of the **OTSDUW Plant and Apparatus** or **Onshore Power Park Module** or **Onshore HVDC Converter** reach its maximum lagging limit at a **Onshore Grid Entry Point** voltage (or **Onshore User System Entry Point** voltage if **Embedded** (or **Interface Point** in the case of **OTSDUW Plant and Apparatus** ) above 95%, the **OTSDUW Plant and Apparatus** or **Onshore Power Park Module** or **HVDC System** shall maintain maximum lagging **Reactive Power** output for voltage reductions down to 95%. This requirement is indicated by the line EF in figures ECC.A.7.2.2b and ECC.A.7.2.2c as applicable. Should the **Reactive Power** output of the **OTSDUW Plant and Apparatus** or **Onshore Power Park Module**, or **Onshore HVDC Converter** reach its maximum leading limit at a **Onshore Grid Entry Point** voltage (or **Onshore User System Entry Point** voltage if **Embedded** or **Interface Point** in the case of **OTSDUW Plant and Apparatus**) below 105%, the **OTSDUW Plant and Apparatus** or **Onshore Power Park Module**, or **Onshore HVDC Converter** shall maintain maximum leading **Reactive Power** output for voltage increases up to 105%. This requirement is indicated by the line AB in figures ECC.A.7.2.2b and ECC.A.7.2.2c as applicable.
- ECC.A.7.2.2.7 For **Onshore Grid Entry Point** voltages (or **Onshore User System Entry Point** voltages if **Embedded**-or **Interface Point** voltages) below 95%, the lagging **Reactive Power** capability of the **OTSDUW Plant and Apparatus** or **Onshore Power Park Module** or **Onshore HVDC Converters** should be that which results from the supply of maximum lagging reactive current whilst ensuring the current remains within design operating limits. An example of the capability is shown by the line DE in figures ECC.A.7.2.2b and ECC.A.7.2.2c. For **Onshore Grid Entry Point** voltages (or **User System Entry Point** voltages if **Embedded** or **Interface Point** voltages) above 105%, the leading **Reactive Power** capability of the **OTSDUW Plant and Apparatus** or **Onshore Power Park Module** or **Onshore HVDC System Converter** should be that which results from the supply of maximum leading reactive current whilst ensuring the current remains within design operating limits. An example of the capability is shown by the line AH in figures ECC.A.7.2.2b and ECC.A.7.2.2c as applicable. Should the **Reactive Power** output of the **OTSDUW Plant and Apparatus** or **Onshore Power Park Module** or **Onshore HVDC Converter** reach its maximum lagging limit at an **Onshore Grid Entry Connection Point** voltage (or **Onshore User System Entry Point** voltage if **Embedded** or **Interface Point** in the case of **OTSDUW Plant and Apparatus**) below 95%, the **Onshore Power Park Module, Onshore HVDC Converter** shall maintain maximum lagging reactive current output for further voltage decreases. Should the **Reactive Power** output of the **OTSDUW Plant and Apparatus** or **Onshore Power Park Module** or **Onshore HVDC Converter** reach its maximum leading limit at a **Onshore Grid Entry Point** voltage (or **User System Entry Point** voltage if **Embedded** or **Interface Point** voltage in the case of an **OTSDUW Plant and Apparatus**) above 105%, the **OTSDUW Plant and Apparatus** or **Onshore Power Park Module** or **Onshore HVDC Converter** shall maintain maximum leading reactive current output for further voltage increases.

ECC.A.7.2.2.8 All **OTSDUW Plant and Apparatus** must be capable of enabling **EU Code Users** undertaking **OTSDUW** to comply with an instruction received from **The Company** relating to a variation of the **Setpoint Voltage** at the **Interface Point** within 2 minutes of such instruction being received.

ECC.A.7.2.2.9 For **OTSDUW Plant and Apparatus** connected to a **Network Operator's System** where the **Network Operator** has confirmed to **The Company** that its **System** is restricted in accordance with ECC.A.7.2.1, clause ECC.A.7.2.2.8 will not apply unless **The Company** can reasonably demonstrate that the magnitude of the available change in **Reactive Power** has a significant effect on voltage levels on the **Onshore National Electricity Transmission System**.

ECC.A.7.2.3 Transient Voltage Control

ECC.A.7.2.3.1 For an on-load step change in **Onshore Grid Entry Point** or **Onshore User System Entry Point** voltage, or in the case of **OTSDUW Plant and Apparatus** an on-load step change in **Transmission Interface Point** voltage, the continuously acting automatic control system shall respond according to the following minimum criteria:

- (i) the **Reactive Power** output response of the, **OTSDUW Plant and Apparatus** or **Onshore Power Park Module** or **Onshore HVDC Converter** shall commence within 0.2 seconds of the application of the step. It shall progress linearly although variations from a linear characteristic shall be acceptable provided that the MVar seconds delivered at any time up to 1 second are at least those that would result from the response shown in figure ECC.A.7.2.3.1a.
- (ii) the response shall be such that 90% of the change in the **Reactive Power** output of the, **OTSDUW Plant and Apparatus** or **Onshore Power Park Module**, or **Onshore HVDC Converter** will be achieved within
  - 2 seconds, where the step is sufficiently large to require a change in the steady state **Reactive Power** output from its maximum leading value to its maximum lagging value or vice versa and
  - 1 second where the step is sufficiently large to require a change in the steady state **Reactive Power** output from zero to its maximum leading value or maximum lagging value as required by ECC.6.3.2 (or, if appropriate ECC.A.7.2.2.6 or ECC.A.7.2.2.7);
- (iii) the magnitude of the **Reactive Power** output response produced within 1 second shall vary linearly in proportion to the magnitude of the step change.
- (iv) within 5 seconds from achieving 90% of the response as defined in ECC.A.7.2.3.1 (ii), the peak to peak magnitude of any oscillations shall be less than 5% of the change in steady state maximum **Reactive Power**.
- (v) following the transient response, the conditions of ECC.A.7.2.2 apply.

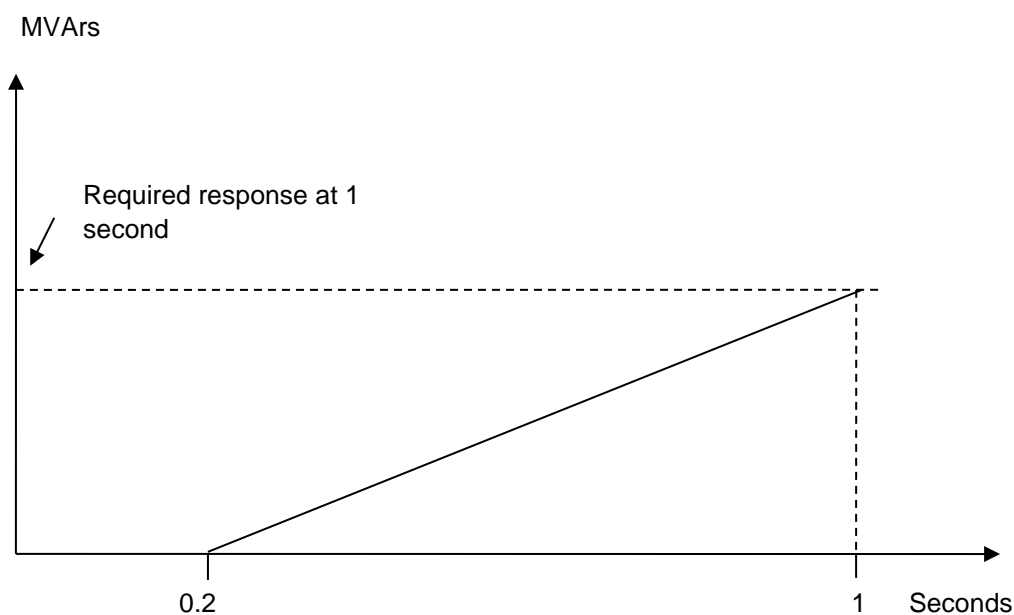

Figure ECC.A.7.2.3.1a

**ECC.A.7.2.3.2 OTSDUW Plant and Apparatus or Onshore Power Park Modules or Onshore HVDC Converters** shall be capable of

- (a) changing its **Reactive Power** output from its maximum lagging value to its maximum leading value, or vice versa, then reverting back to the initial level of **Reactive Power** output once every 15 seconds for at least 5 times within any 5 minute period; and
- (b) changing its **Reactive Power** output from zero to its maximum leading value then reverting back to zero **Reactive Power** output at least 25 times within any 24 hour period and from zero to its maximum lagging value then reverting back to zero **Reactive Power** output at least 25 times within any 24 hour period. Any subsequent restriction on reactive capability shall be notified to **The Company** in accordance with BC2.5.3.2, and BC2.6.1.

In all cases, the response shall be in accordance to ECC.A.7.2.3.1 where the change in **Reactive Power** output is in response to an on-load step change in **Onshore Grid Entry Point** or **Onshore User System Entry Point** voltage, or in the case of **OTSDUW Plant and Apparatus** an on-load step change in **Transmission Interface Point** voltage.

**ECC.A.7.2.4** Power Oscillation Damping

**ECC.A.7.2.4.1** The requirement for the continuously acting voltage control system to be fitted with a **Power System Stabiliser (PSS)** shall be specified if, in **The Company's** view, this is required for system reasons. However if a **Power System Stabiliser** is included in the voltage control system its settings and performance shall be agreed with **The Company** and commissioned in accordance with BC2.11.2. To allow assessment of the performance before on-load commissioning the **Generator** will provide to **The Company** a report covering the areas specified in ECP.A.3.2.2.

**ECC.A.7.2.5** Overall Voltage Control System Characteristics

**ECC.A.7.2.5.1** The continuously acting automatic voltage control system is required to respond to minor variations, steps, gradual changes or major variations in **Onshore Grid Entry Point** voltage (or **Onshore User System Entry Point** voltage if **Embedded** or **Interface Point** voltage in the case of **OTSDUW Plant and Apparatus**).



- ECC.A.7.2.5.2 The overall voltage control system shall include elements that limit the bandwidth of the output signal. The bandwidth limiting must be consistent with the speed of response requirements and ensure that the highest frequency of response cannot excite torsional oscillations on other plant connected to the network. A bandwidth of 0-5Hz would be judged to be acceptable for this application. All other control systems employed within the **OTSDUW Plant and Apparatus** or **Onshore Power Park Module** or **Onshore HVDC Converter** should also meet this requirement
- ECC.A.7.2.5.3 The response of the voltage control system (including the **Power System Stabiliser** if employed) shall be demonstrated by testing in accordance with ECP.A.6.
- ECC.A.7.3 **Reactive Power Control**
- ECC.A.7.3.1 As defined in ECC.6.3.8.3.4, **Reactive Power** control mode of operation is not required in respect of **Onshore Power Park Modules** or **OTSDUW Plant and Apparatus** or **Onshore HVDC Converters** unless otherwise specified by **The Company** in coordination with the relevant **Network Operator**. However where there is a requirement for **Reactive Power** control mode of operation, the following requirements shall apply.
- ECC.A.7.3.2 The **Onshore Power Park Module** or **OTSDUW Plant and Apparatus** or **Onshore HVDC Converter** shall be capable of setting the **Reactive Power** setpoint anywhere in the **Reactive Power** range as specified in ECC.6.3.2.4 with setting steps no greater than 5 MVar or 5% (whichever is smaller) of full **Reactive Power**, controlling the reactive power at the **Grid Entry Point** or **User System Entry Point** if **Embedded** to an accuracy within plus or minus 5MVar or plus or minus 5% (whichever is smaller) of the full **Reactive Power**.
- ECC.A.7.3.3 Any additional requirements for **Reactive Power** control mode of operation shall be specified by **The Company** in coordination with the relevant **Network Operator**..
- ECC.A.7.4 **Power Factor Control**
- ECC.A.7.4.1 As defined in ECC.6.3.8.4.3, **Power Factor** control mode of operation is not required in respect of **Onshore Power Park Modules** or **OTSDUW Plant and Apparatus** or **Onshore HVDC Converters** unless otherwise specified by **The Company** in coordination with the relevant **Network Operator**. However where there is a requirement for **Power Factor** control mode of operation, the following requirements shall apply.
- ECC.A.7.4.2 The **Onshore Power Park Module** or **OTSDUW Plant and Apparatus** or **Onshore HVDC Converter** shall be capable of controlling the **Power Factor** at the **Grid Entry Point** or **User System Entry Point** (if **Embedded**) within the required **Reactive Power** range as specified in ECC.6.3.2.2.1 and ECC.6.3.2.4 to a specified target **Power Factor**. **The Company** shall specify the target **Power Factor** value (which shall be achieved within 0.01 of the set **Power Factor**), its tolerance and the period of time to achieve the target **Power Factor** following a sudden change of **Active Power** output. The tolerance of the target **Power Factor** shall be expressed through the tolerance of its corresponding **Reactive Power**. This **Reactive Power** tolerance shall be expressed by either an absolute value or by a percentage of the maximum **Reactive Power** of the **Onshore Power Park Module** or **OTSDUW Plant and Apparatus** or **Onshore HVDC Converter**. The details of these requirements being pursuant to the terms of the **Bilateral Agreement**.
- ECC.A.7.4.3 Any additional requirements for **Power Factor** control mode of operation shall be specified by **The Company** in coordination with the relevant **Network Operator**.

**APPENDIX E8 - PERFORMANCE REQUIREMENTS FOR CONTINUOUSLY ACTING AUTOMATIC VOLTAGE CONTROL SYSTEMS FOR CONFIGURATION 2 AC CONNECTED OFFSHORE POWER PARK MODULES AND CONFIGURATION 2 DC CONNECTED POWER PARK MODULES**

ECC.A.8.1 Scope

ECC.A.8.1.1 This Appendix sets out the performance requirements of continuously acting automatic voltage control systems for **Configuration 2 AC Connected Offshore Power Park Modules** and **Configuration 2 DC Connected Power Park Modules** that must be complied with by the **EU Code User**. This Appendix does not limit any site specific requirements that may be specified where in **The Company's** reasonable opinion these facilities are necessary for system reasons.

ECC.A.8.1.2 These requirements also apply to **Configuration 2 DC Connected Power Park Modules**. In the case of a **Configuration 1 DC Connected Power Park Module** the technical performance requirements shall be specified by **The Company**. Where the **EU Generator** in respect of a **DC Connected Power Park Module** has agreed to a wider reactive capability range as defined under ECC.6.3.2.5 and ECC.6.2.3.6 then the requirements that apply will be specified by **The Company** and which shall reflect the performance requirements detailed in ECC.A.8.2 below but with different parameters such as droop and **Setpoint Voltage**.

ECC.A.8.1.3 Proposals by **EU Generators** to make a change to the voltage control systems are required to be notified to **The Company** under the **Planning Code** (PC.A.1.2(b) and (c)) as soon as the **Generator** anticipates making the change. The change may require a revision to the **Bilateral Agreement**.

ECC.A.8.2 Requirements

ECC.A.8.2.1 **The Company** requires that the continuously acting automatic voltage control system for the **Configuration 2 AC connected Offshore Power Park Module** and **Configuration 2 DC Connected Power Park Module** shall meet the following functional performance specification.

ECC.A.8.2.2 Steady State Voltage Control

ECC.A.8.2.2.1 The **Configuration 2 AC connected Offshore Power Park Module** and **Configuration 2 DC Connected Power Park Module** shall provide continuous steady state control of the voltage at the **Offshore Connection Point** with a **Setpoint Voltage** and **Slope** characteristic as illustrated in Figure ECC.A.8.2.2a.

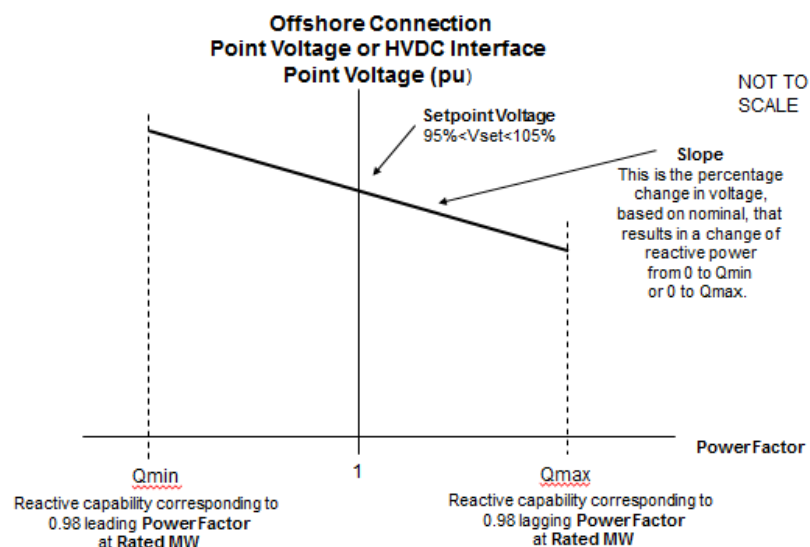

Figure ECC.A.8.2.2a

ECC.A.8.2.2.2 The continuously acting automatic control system shall be capable of operating to a **Setpoint Voltage** between 95% and 105% with a resolution of 0.25% of the nominal voltage. For the avoidance of doubt values of 95%, 95.25%, 95.5% ... may be specified, but not intermediate values. The initial **Setpoint Voltage** will be 100%. The tolerance within which this **Setpoint Voltage** shall be achieved is specified in BC2.A.2.6. For the avoidance of doubt, with a tolerance of 0.25% and a Setpoint Voltage of 100%, the achieved value shall be between 99.75% and 100.25%. **The Company** may request the **EU Generator** to implement an alternative **Setpoint Voltage** within the range of 95% to 105%.

ECC.A.8.2.2.3 The **Slope** characteristic of the continuously acting automatic control system shall be adjustable over the range 2% to 7% (with a resolution of 0.5%). For the avoidance of doubt values of 2%, 2.5%, 3% may be specified, but not intermediate values. The initial **Slope** setting will be 4%. The tolerance within which this **Slope** shall be achieved is specified in BC2.A.2.6. For the avoidance of doubt, with a tolerance of 0.5% and a **Slope** setting of 4%, the achieved value shall be between 3.5% and 4.5%. **The Company** may request the **EU Generator** to implement an alternative slope setting within the range of 2% to 7%.

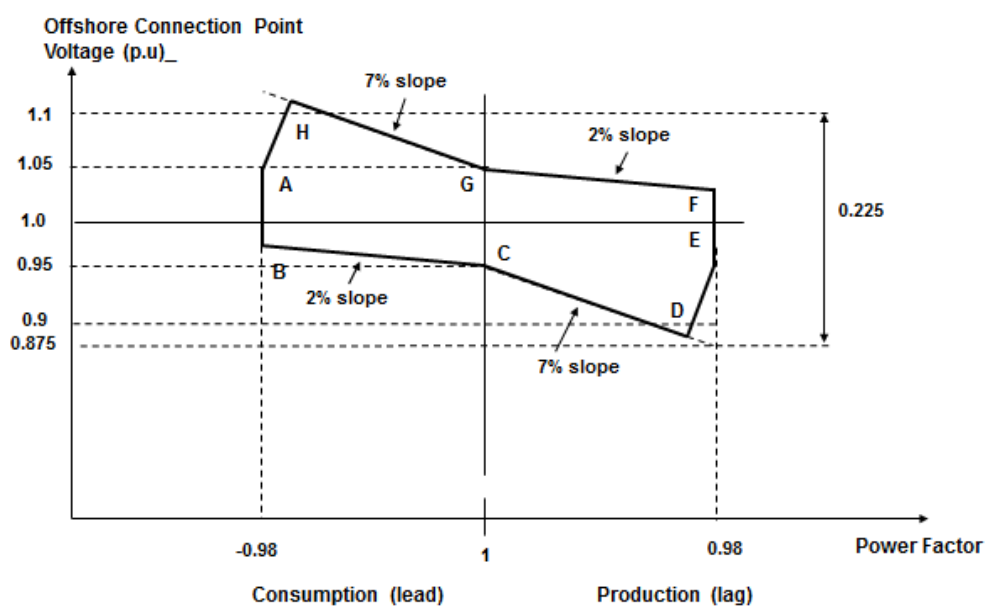

Figure ECC.A.8.2.2b

ECC.A.8.2.2.4 Figure ECC.A.8.2.2b shows the required envelope of operation for **Configuration 2 AC connected Offshore Power Park Module** and **Configuration 2 DC Connected Power Park Module**. The enclosed area within points ABCDEFGH is the required capability range within which the **Slope** and **Setpoint Voltage** can be changed.

ECC.A.8.2.2.5 Should the operating point of the **Configuration 2 AC connected Offshore Power Park or Configuration 2 DC Connected Power Park Module** deviate so that it is no longer a point on the operating characteristic (Figure ECC.A.8.2.2a) defined by the target **Setpoint Voltage** and **Slope**, the continuously acting automatic voltage control system shall act progressively to return the value to a point on the required characteristic within 5 seconds.

ECC.A.8.2.2.6 Should the **Reactive Power** output of the **Configuration 2 AC connected Offshore Power Park Module** or **Configuration 2 DC Connected Power Park Module** reach its maximum lagging limit at an **Offshore Grid Entry Point** or **Offshore User System Entry Point** or **HVDC Interface Point** voltage above 95%, the **Configuration 2 AC connected Offshore Power Park Module** or **Configuration 2 DC Connected Power Park Module** shall maintain maximum lagging **Reactive Power** output for voltage reductions down to 95%. This requirement is indicated by the line EF in figure ECC.A.8.2.2b. Should the **Reactive Power** output of the **Configuration 2 AC connected Offshore Power Park Module** or **Configuration 2 DC Connected Power Park Module** reach its maximum leading limit at the **Offshore Grid Entry Point** or **Offshore User System Entry Point** or **HVDC Interface Point** voltage below 105%, the **Configuration 2 AC connected Offshore Power Park Module** or **Configuration 2 DC Connected Power Park Module** shall maintain maximum leading **Reactive Power** output for voltage increases up to 105%. This requirement is indicated by the line AB in figures ECC.A.8.2.2b.

ECC.A.8.2.2.7 For **Offshore Grid Entry Point** or **User System Entry Point** or **HVDC Interface Point** voltages below 95%, the lagging **Reactive Power** capability of the **Configuration 2 AC connected Offshore Power Park Module** or **Configuration 2 DC Connected Power Park Module** should be that which results from the supply of maximum lagging reactive current whilst ensuring the current remains within design operating limits. An example of the capability is shown by the line DE in figures ECC.A.8.2.2b. For **Offshore Grid Entry Point** or **Offshore User System Entry Point** voltages or **HVDC Interface Point** voltages above 105%, the leading **Reactive Power** capability of the **Configuration 2 AC connected Offshore Power Park Module** or **Configuration 2 DC Connected Power Park Module** should be that which results from the supply of maximum leading reactive current whilst ensuring the current remains within design operating limits. An example of the capability is shown by the line AH in figures ECC.A.8.2.2b. Should the **Reactive Power** output of the **Configuration 2 AC connected Offshore Power Park Module** or **Configuration 2 DC Connected Power Park Module** reach its maximum lagging limit at an **Offshore Grid Entry Point** or **Offshore User System Entry Point** voltage or **HVDC Interface Point** voltage below 95%, the **Configuration 2 AC connected Offshore Power Park Module** or **Configuration 2 DC Connected Power Park Module** shall maintain maximum lagging reactive current output for further voltage decreases. Should the **Reactive Power** output of the **Configuration 2 AC connected Offshore Power Park Module** or **Configuration 2 DC Connected Power Park Module** reach its maximum leading limit at an **Offshore Grid Entry Point** or **Offshore User System Entry Point** voltage or **HVDC Interface Point** voltage above 105%, the **Configuration 2 AC connected Offshore Power Park Module** or **Configuration 2 DC Connected Power Park Module** shall maintain maximum leading reactive current output for further voltage increases.

### ECC.A.8.2.3 Transient Voltage Control

ECC.A.8.2.3.1 For an on-load step change in **Offshore Grid Entry Point** or **Offshore User System Entry Point** voltage or **HVDC Interface Point** voltage, the continuously acting automatic control system shall respond according to the following minimum criteria:

- (i) the **Reactive Power** output response of the **Configuration 2 AC connected Offshore Power Park Module** or **Configuration 2 DC Connected Power Park Module** shall commence within 0.2 seconds of the application of the step. It shall progress linearly although variations from a linear characteristic shall be acceptable provided that the MVar seconds delivered at any time up to 1 second are at least those that would result from the response shown in figure ECC.A.8.2.3.1a.
- (ii) the response shall be such that 90% of the change in the **Reactive Power** output of the **Configuration 2 AC connected Offshore Power Park Module** or **Configuration 2 DC Connected Power Park Module** will be achieved within
  - 2 seconds, where the step is sufficiently large to require a change in the steady state **Reactive Power** output from its maximum leading value to its maximum lagging value or vice versa and

- 1 second where the step is sufficiently large to require a change in the steady state **Reactive Power** output from zero to its maximum leading value or maximum lagging value as required by ECC.6.3.2 (or, if appropriate ECC.A.8.2.2.6 or ECC.A.8.2.2.7);
- (iii) the magnitude of the **Reactive Power** output response produced within 1 second shall vary linearly in proportion to the magnitude of the step change.
- (iv) within 5 seconds from achieving 90% of the response as defined in ECC.A.8.2.3.1 (ii), the peak to peak magnitude of any oscillations shall be less than 5% of the change in steady state maximum **Reactive Power**.
- (v) following the transient response, the conditions of ECC.A.8.2.2 apply.

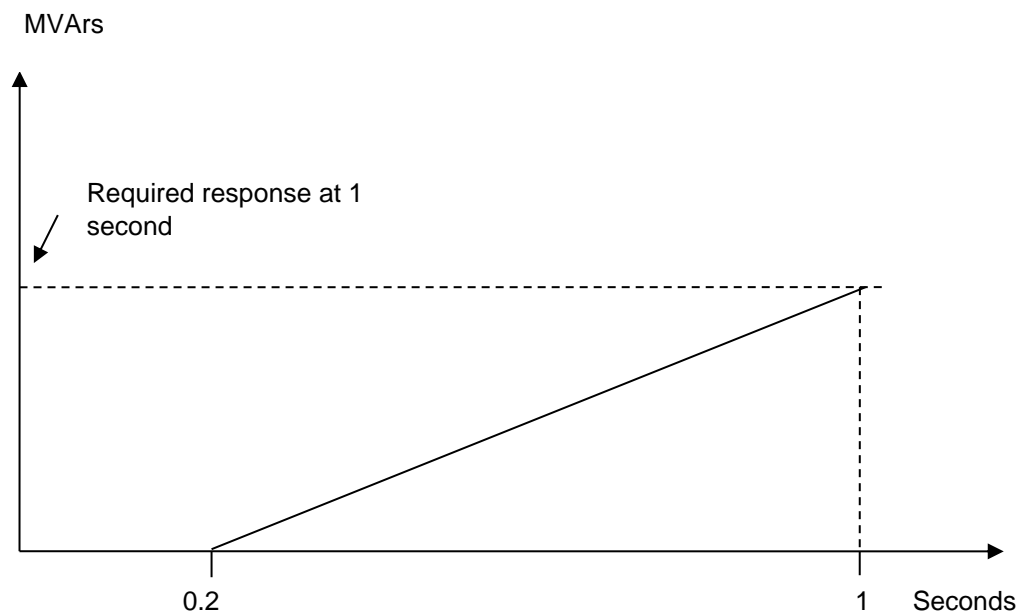

**ECC.A.8.2.3.2 Configuration 2 AC connected Offshore Power Park Module or Configuration 2 DC Connected Power Park Module shall be capable of**

- (a) changing their **Reactive Power** output from maximum lagging value to maximum leading value, or vice versa, then reverting back to the initial level of **Reactive Power** output once every 15 seconds for at least 5 times within any 5 minute period; and
- (b) changing **Reactive Power** output from zero to maximum leading value then reverting back to zero **Reactive Power** output at least 25 times within any 24 hour period and from zero to its maximum lagging value then reverting back to zero **Reactive Power** output at least 25 times within any 24 hour period. Any subsequent restriction on reactive capability shall be notified to **The Company** in accordance with BC2.5.3.2, and BC2.6.1.

In all cases, the response shall be in accordance to ECC.A.8.2.3.1 where the change in **Reactive Power** output is in response to an on-load step change in **Offshore Grid Entry Point** or **Offshore User System Entry Point** voltage or **HVDC Interface Point** voltage.

**ECC.A.8.2.4 Power Oscillation Damping**

- ECC.A.8.2.4.1 The requirement for the continuously acting voltage control system to be fitted with a **Power System Stabiliser (PSS)** shall be specified if, in **The Company's** view, this is required for system reasons. However if a **Power System Stabiliser** is included in the voltage control system its settings and performance shall be agreed with **The Company** and commissioned in accordance with BC2.11.2. To allow assessment of the performance before on-load commissioning the **Generator** or **HVDC System Owner** will provide to **The Company** a report covering the areas specified in ECP.A.3.2.2.
- ECC.A.8.2.5 Overall Voltage Control System Characteristics
- ECC.A.8.2.5.1 The continuously acting automatic voltage control system is required to respond to minor variations, steps, gradual changes or major variations in **Offshore Grid Entry Point** or **Offshore User System Entry Point** or **HVDC Interface Point** voltage.
- ECC.A.8.2.5.2 The overall voltage control system shall include elements that limit the bandwidth of the output signal. The bandwidth limiting must be consistent with the speed of response requirements and ensure that the highest frequency of response cannot excite torsional oscillations on other plant connected to the network. A bandwidth of 0-5Hz would be judged to be acceptable for this application. All other control systems employed within the **Configuration 2 AC connected Offshore Power Park Module** or **Configuration 2 DC Connected Power Park Module** should also meet this requirement
- ECC.A.8.2.5.3 The response of the voltage control system (including the **Power System Stabiliser** if employed) shall be demonstrated by testing in accordance with ECP.A.6.
- ECC.A.8.3 Reactive Power Control
- ECC.A.8.3.1 **Reactive Power** control mode of operation is not required in respect of **Configuration 2 AC connected Offshore Power Park Modules** or **Configuration 2 DC Connected Power Park Modules** unless otherwise specified by **The Company**. However where there is a requirement for **Reactive Power** control mode of operation, the following requirements shall apply.
- ECC.A.8.3.2 **Configuration 2 AC connected Offshore Power Park Modules** or **Configuration 2 DC Connected Power Park Modules** shall be capable of setting the **Reactive Power** setpoint anywhere in the **Reactive Power** range as specified in ECC.6.3.2.8.2 with setting steps no greater than 5 MVar or 5% (whichever is smaller) of full **Reactive Power**, controlling the **Reactive Power** at the **Offshore Grid Entry Point** or **Offshore User System Entry Point** or **HVDC Interface Point** to an accuracy within plus or minus 5MVar or plus or minus 5% (whichever is smaller) of the full **Reactive Power**.
- ECC.A.8.3.3 Any additional requirements for **Reactive Power** control mode of operation shall be specified by **The Company**.
- ECC.A.8.4 Power Factor Control
- ECC.A.8.4.1 **Power Factor** control mode of operation is not required in respect of **Configuration 2 AC connected Offshore Power Park Modules** or **Configuration 2 DC Connected Power Park Modules** unless otherwise specified by **The Company**. However where there is a requirement for **Power Factor** control mode of operation, the following requirements shall apply.
- ECC.A.8.4.2 **Configuration 2 AC connected Offshore Power Park Modules** or **Configuration 2 DC Connected Power Park Modules** shall be capable of controlling the **Power Factor** at the **Offshore Grid Entry Point** or **Offshore User System Entry Point** or **HVDC Interface Point** within the required **Reactive Power** range as specified in ECC.6.3.2.8.2 with a target **Power Factor**. **The Company** shall specify the target **Power Factor** (which shall be achieved to within 0.01 of the set **Power Factor**), its tolerance and the period of time to achieve the target **Power Factor** following a sudden change of **Active Power** output. The tolerance of the target **Power Factor** shall be expressed through the tolerance of its corresponding **Reactive Power**.

This **Reactive Power** tolerance shall be expressed by either an absolute value or by a percentage of the maximum **Reactive Power** of the **Configuration 2 AC connected Offshore Power Park Module** or **Configuration 2 DC Connected Power Park Module**. The details of these requirements being specified by **The Company**.

ECC.A.8.4.3 Any additional requirements for **Power Factor** control mode of operation shall be specified by **The Company**.

< END OF EUROPEAN CONNECTION CONDITIONS >





