

Stage 04: Code Administrator Consultation

Grid Code

GC0106: Data exchange requirements in accordance with Regulation (EU) 2017/1485 (SOGL)

Purpose of Modification: This modification seeks to change the frequency of structural data submissions from Distribution Network Operators (DNOs) from annually to six monthly and to include information on embedded small power stations of registered capacity of less than 1MW in their Week 24 data submission. This change arises from one of a number of workstreams to facilitate changes arising from the EU Regulation System Operation Guideline (SOGL).

The purpose of this document is to consult on GC0106 with industry members. Parties are requested to respond by **5pm on 14 December 2018** to grid.code@nationalgrid.com using the Code Administrator Consultation Response Proforma which can be found via the following link: <https://www.nationalgrideso.com/codes/grid-code/modifications/gc0106-data-exchange-requirements-accordance-regulation-eu-20171485>

Published on: 23 November 2018

Length of consultation: 15 working days

Responses by: 14 December 2018



The Workgroup concluded by majority that the Original solution better facilitates the Grid Code objectives and should be implemented.



High Impact: None



Medium Impact: Independent Distribution Network Operators, Distribution Network Operators, and GB National Electricity Transmission System Operator (NETSO), Distribution connected Generators, Demand response and reserve providers and Interconnectors are potentially affected
WAGCM2 would have a medium impact on Scottish Power Transmission directly connected generation



Low Impact: Interconnectors and Transmission owners (incl OFTOs) and Transmission connected Generators

What stage is this document at?

01	Modification Proposal
02	Workgroup Consultation
03	Workgroup Report
04	Code administrator Consultation
05	Report to the Authority

Contents

Acronyms used in this document and version control	3
1.GC0106 Executive Summary	4
2.Original Proposal to Grid Code Panel – October 2017	7
3.Proposers Original Solution	12
4.Workgroup Discussions Pre-Workgroup Consultation	22
5.Post Workgroup Consultation Workgroup discussions	28
6.Alternative solutions	43
7.Implementation	60
8.Workgroup Vote	60
Annex 1 Workgroup Terms of Reference (ToR)	65
Annex 2 Legal interpretation – Workgroup Action	70
Annex 3 Legal Interpretation – National Grid Legal Department view	77
Annex 4 Draft Grid Code Legal Text.....	78
Annex 5 SOGL and KORRR Code Mapping.....	99
Annex 6 Workgroup Consultation responses	99
Annex 7 Letter to and from Authority under GR21.5	127
Annex 8 WAGCM2 Legal text.....	155



Any Questions?

Contact:

Chrissie Brown

Code Administrator



christine.brown1@nationalgrid.com



01926 653328

Proposer:

Susan Mwape

National Grid ESO

Timetable

The following timetable has been approved by the Grid Code Review Panel:	
Proposal to Grid Code Review Panel	Oct 2017
Proposal to Distribution Code Panel	Oct 2017
Workgroup Meeting 1	Nov 2017
Workgroup Meeting 2	Dec 2017
Workgroup Code Mapping Meeting	Jan 2018
Workgroup Consultation (start/end)	6 April /27 April 2018
Workgroup Report to Grid Code Review Panel	22 November 2018
Code Administration Consultation	23 November 2018
Draft Final Modification Report to Grid Code Review Panel	December 2018

Grid Code Review Panel Recommendation Vote	19 December 2018
Publish/Submit Final Modification Report to the Authority	December 2018
Decision implemented in Grid Code	March 2019
Date of SOGL implementation	<i>EIF+18m</i> (14/03/2019)

Acronyms used in this document and version control

SOGL (TSOG)	System Operation Guideline (Transmission System Operation Guideline)
EIF	Entry Into Force
ESO	Electricity System Operator
SGU	Significant Grid User
PGM	Power Generating Module
KORRR	Key Organisational Requirements, Roles and Responsibilities
DSO (DNO)	Distribution System Operator (Distribution Network Owner)
IGM	Independent Grid Model
DRSC	Demand Response Services Code (refer to GC0104)
CACM	Capacity Allocation Congestion management
STC	System Owner Transmission Owner Code

Version	Date	Author	Change Reference
1	23 February 2018	Code Administrator	Draft Workgroup Consultation to Workgroup
2	21 March 2018	23	Draft Workgroup Consultation to Workgroup
3	5 April 2018	Workgroup	Draft Workgroup Consultation to Workgroup
4	6 April 2018	Workgroup	Workgroup Consultation to Industry
5	3 October 2018	Workgroup	Draft Workgroup Report ahead of issue to Panel
6	14 November 2018	Workgroup	Workgroup Report to Panel
7	23 November 2018	Code Administrator	Code administrator consultation

1.GC0106 Executive Summary

GC0106 was proposed by National Grid and was submitted to the Grid Code Review Panel for its consideration on 18 October 2017. The GC0106 proposal only covers data exchange Articles 40 -53 of SOGL. The Panel decided to send the Proposal to a Workgroup to be developed and assessed against the Grid Code Objectives. The workgroup process, consultation and subsequent submission of this proposal to the Regulator are the means by which the TSO is coordinating and agreeing with parties according to Article 40.5 and 40.7 of SOGL.

The Distribution Code Panel agreed to support GC0106 as a Joint Workgroup and to assess the proposal against the Distribution Code Objectives.

This document is the Code Administrator Consultation for the Grid Code and contains the discussions of the Workgroup which formed in November 2017 to develop and assess the proposal, the responses to the Workgroup Consultation which closed on 27 April 2018 and the voting of the Workgroup held on 8 October 2018. The Panel reviewed the Workgroup Report at their Grid Code Panel meeting on 22 November 2018 and agreed that the Workgroup had met its Terms of Reference and that the Workgroup could be discharged. ***Please note that this Consultation is seeking responses to only the Grid Code elements of the proposed amendments and that there are still some references to the Distribution Code amendments required to assist the reader as the work was completed as a joint workgroup.***

The Grid and Distribution Code Panels agreed the Terms of Reference and scope of work for the GC0106 Workgroup and the specific areas that the Workgroup should consider.

The table below details these specific areas and where the Workgroup have covered them within this Report.

The full Terms of Reference can be found in **Annex 1**.

Table 1: GC0106 Terms of Reference

Specific Area	Location in the report
Articles 40-53 of SOGL	Proposers solution outlines each Article and their solution. The Workgroup discussions and WAGCMs also highlighted differences in how these are being proposed as a solution.
Complete a detailed assessment and code mapping of the KORRR and identify any additional changes that will be required resulting from the reserve requirements section of the SOGL	Annex 5
Legal text	Annex 4

Implementation	Section 8
----------------	-----------

The Workgroup met for a total of twelve times and three Workgroup alternatives were raised during the process.

Original Solution Impacts

The original modification has the following implications for GB users. The changes from the current Grid and Distribution Code are marked in red. The full details of the Proposers solution can be found in **Section 3**.

		Existing Installations		New Installations	
		Distribution Connected	Transmission Connected	Distribution Connected	Transmission Connected
Generation	Type A1 ^{1*}	None – all data requirements remain as is currently	None – all data requirements remain as is currently	Domestic scale generation (ie <16A per phase) will have to provide more granular information about the power source, just once on installation	None – all data requirements remain as is currently
	Type B	None – all data requirements remain as is currently	None – all data requirements remain as is currently	None – all data requirements remain as is currently	None – all data requirements remain as is currently
	Type C forming a Small Power Station ² (E&W)	None – all data requirements remain as is currently – D Code applies	None – all data requirements remain as is currently	None – all data requirements remain as is currently – D Code applies	None – all data requirements remain as is currently
	Type C forming a Large Power Station (Scotland)	None – all data requirements remain as is currently – D and G codes apply	None – all data requirements remain as is currently	None – all data requirements remain as is currently – D and G codes apply	None – all data requirements remain as is currently
	Type D forming a Small Power Station	None – all data requirements remain as is currently – D Code applies	None – all data requirements remain as is currently	None – all data requirements remain as is currently – D Code applies	None – all data requirements remain as is currently

¹ * Note – New Type A power generating modules are not directly included in the scope of the SOGL. However the SOGL does put an obligation on DNOs to report on the primary energy sources employed by Type A generation, which means that new power generating modules in this size range will need to pass on this information to their DNO in accordance with the revised prescribed list of primary energy sources.

² Note that any combination of power generating modules on a single site (ie forming a power station) that breach the existing thresholds for Large (100MW in E&W, 30MW in SP and 10MW in SHETL), or Medium (50MW in E&W) will need to apply the Grid Code.

		Existing Installations		New Installations	
		Distribution Connected	Transmission Connected	Distribution Connected	Transmission Connected
	Type D forming a Medium Power Station	None – all data requirements remain as is currently – D and G codes apply	None – all data requirements remain as is currently	None – all data requirements remain as is currently – D and G codes apply	None – all data requirements remain as is currently
	Type D forming a Large Power Station	None – all data requirements remain as is currently – D and G codes apply	None – all data requirements remain as is currently	None – all data requirements remain as is currently – D and G codes apply	None – all data requirements remain as is currently
Demand	Any Demand facility	None – all data requirements remain as is currently	None – all data requirements remain as is currently	None – all data requirements remain as is currently	None – all data requirements remain as is currently
	HVDC system	None – all data requirements remain as is currently	None – all data requirements remain as is currently	None – all data requirements remain as is currently	None – all data requirements remain as is currently
	DNOs and CDSOs	None – all data requirements remain as is currently	Structural data needs to be refreshed to NG twice per year rather than once	None – all data requirements remain as is currently	Structural data needs to be refreshed to NG twice per year rather than once

Significant Grid User definition

SGU Definition:	<p>Significant Grid Users (SGU) are defined in accordance with Article 2 of SOGL as follows:</p> <ul style="list-style-type: none"> - existing and new power generating modules classified as type B, C and D; - existing and new transmission-connected demand facilities; - existing and new transmission-connected closed distribution systems; - existing and new demand facilities, closed distribution systems and third parties if they provide demand response directly to the TSO; - providers of re-dispatching of power generating modules or demand facilities by means of aggregation and providers of active power reserve; - existing and new high voltage direct current (HVDC)
-----------------	---

Alternative solutions

Following the Workgroup Consultation, on 2 May 2018 SSE Generation Ltd raised three potential alternatives. These were then voted through by the Workgroup to be worked up as full alternatives. Following this decision, the Workgroup sought guidance from the Grid Code Review Panel due to, in their view, a significant amount of work having to be undertaken to fully work them up with proposed text.

The GCRP instructed the Workgroup to not fully work up proposed text for Workgroup Alternative Grid Code Alternative one and three but to fully develop WAGCM2. More information on the alternatives raised can be found in **Section 6**, a summary can be found below:

WAGCM1 Legal interpretation of SOGL. Where the Transmission System Operator to provide where the Distribution System Operator or Significant Grid User do not provide

WAGCM2 Ensuring a non-discriminatory approach by the Transmission System Operator to data provision as well as a 'level playing field' between relevant stakeholders

WAGCM3 A combination of both the alternatives above

Alternatives and their impact

The Workgroup assessed the alternatives raised and concluded that WAGCM2 would have an impact on Generators in the SPT area. It is thought that this would be a medium impact.

The Workgroup concluded that WAGCM1 would have a high impact on Industry as this would mean that new systems would have to be put in place in order to implement this interpretation of the wording within the SOGL. It was noted that this would mean that the modification would not be implemented in time for the compliance deadline of 14 March 2019.

WAGCM3 is a combination of both of the alternatives described above.

Workgroup Conclusions

The Workgroup consulted on this Modification and a total of eight responses were received. These responses can be viewed in **Annex 6** of this Report with the discussions around them being located in **Section 5**. At the final Workgroup meeting, Workgroup members voted on the Original Proposal and WAGCMs. The Workgroup concluded, by majority, that the Original solution better facilitates the Grid Code objectives and should be implemented.

KORRR

The GC0106 Workgroup mapped the KORRR document in Annex 5 on the March 2018 version which was submitted to the regulators in the same month. In August 2018, all National Regulators sent back the KORRR requesting all TSOs to make amendments. The Proposer walked the Workgroup through the anticipated amendments ahead of resubmission in mid-October 2018 and confirmed that no new Grid Code changes would be expected based on the requested amendments. On 9 October 2018, the Workgroup were sent the version which was submitted to NRAs on 12 October 2018.

2.Original Proposal to Grid Code Panel – October 2017

Section 2 (Original Proposal) is sourced directly from the Proposer and any statements or assertions have not been altered or substantiated/supported or refuted by the Workgroup. Section 4 (pre-

workgroup consultation discussions) and 5 (post workgroup consultation discussions) of the Code Administrator Consultation contain the discussion by the Workgroup on the Proposal and the potential Solution.

Please note that this is the original Proposal submitted at the start of the modification process, more detail on the discussions held in the Workgroup and following Workgroup Consultation provide the developments over the course of the Workgroup.

What

Data exchange provisions that already exist in the Grid Code were reviewed to ensure that they are in line with the data exchange requirements listed in EU regulation 2017/1485 also known as SOGL (System Operation Guideline). The proposed changes that are necessary for compliance of the SOGL include submission of an updated DRC Schedule 5 in week 50 and submission of aggregated sub 1 MW embedded generation by DNOs in week 24.

This Regulation requires the creation of a pan-European proposal on the Key Organisational Requirements, Roles and Responsibilities (KORRR) for data exchange across Europe to be developed by all TSOs. This document may subsequently require some additional changes and/or new requirements to be added to the GB Grid Code and Distribution Code. The pan-European proposal has been developed and re-submitted to Ofgem for final approval by December 2018. The Workgroup considered the changes and implications in parallel. Code mapping of the KORRR with GB stakeholders on the requirements of SOGL and how these map to the existing GB frameworks formed part of the Workgroup discussions and helped to develop the solution. The solution is based on the version of KORRR submitted to the Authority in October 2018.

Why

Guidance from BEIS and Ofgem was to apply the new EU requirements within the existing GB regulatory frameworks and to use the existing governance processes. This would provide accessibility and familiarity to GB parties, as well as putting in place a robust governance route to apply the new requirements in a transparent and proportionate way.

The SOGL entered into force (EIF) on 14 September 2017 and as such all countries of the European Union are required to comply with it. Within this regulation there is a section concerned with data exchange requirements (Articles 40-53) which is the scope of this modification proposal. These articles have a specific timeline for implementation, namely 18 months after the SOGL EIF i.e. by 14 March 2019. This is the timescale for implementation of this modification.

How

In line with Ofgem advice, this modification will make only those changes necessary to the relevant industry documents to ensure compliance with the European codes and guidelines. In the case of GC0106, only the necessary changes to existing data exchange provisions in the Grid and Distribution Codes will be made to ensure GB is compliant with the requirements detailed in SOGL and the KORRR.

When

The Data Exchange section of SOGL has a specific timeline meaning that it applies 18 months after entry into force of the SOGL, so by 14 March 2019. The all-TSO KORRR proposal will be re-submitted to all the NRAs on 15 October 2018. Given this interdependency, the modification proposal was run in parallel with the development of the KORRR so that as and when this is available it will allow for the maximum implementation time.

The aim is to submit the GC0106 Report to the Authority during the same period that KORRR is with Ofgem for approval. In this way Ofgem will have the benefit of either approving or rejecting the GC0106 proposals and KORRR at the same time.

Governance

This modification will be subject to Authority decision as it has been agreed by the Panel that it was likely to have a material impact on several different classes of parties. It should also be considered in parallel with the pan-European data exchange agreement (KORRR) by the Authority as this is a major dependency.

Note that some preliminary work was already done under the previous GC0095 SOGL issue group as part of an overall SOGL assessment and mapping. Further details can be found at:

<https://www.nationalgrideso.com/codes/grid-code/modifications/gc0095-gb-implementation-workgroup-transmission-system-operation>

Why Change?

This Proposal is one of a number of Proposals which seek to implement relevant provisions of a number of new EU Network Codes/Guidelines which have been introduced in order to enable progress towards a competitive and efficient internal market in electricity. The EU Network Guidelines have been published resulting in a review of solutions for existing Codes. The full set of EU network guidelines are;

- Regulation 2015/1222 – Capacity Allocation and Congestion Management (CACM) which entered into force 14 August 2015
- Regulation 2016/1719 – Forward Capacity Allocation (FCA) which entered into force 17 October 2016
- Regulation 2016/631 - Requirements for Generators (RfG) which entered into force 17 May 2016
- Regulation 2016/1388 - Demand Connection Code (DCC) which entered into force 7 September 2016
- Regulation 2016/1447 - High Voltage Direct Current (HVDC) which entered into force 28 September 2016
- **Regulation 2017/1485 - Transmission System Operation Guideline (SOGL) - which entered into force 14 September 2017**
- Regulation 2017/2196 - Emergency and Restoration (E&R) Guideline which entered into force 18 December 2017
- Regulation 2017/2195 Electricity Balancing Guideline (EBGL) which entered into force 18 December 2017

This modification is required as part of the implementation of SOGL which, as a whole, aims to determine common minimum operational security requirements and principles which will ensure security of supply whilst enabling cross border exchanges and the single energy market.

Specifically, in SOGL, the data exchange requirements under the heading of Title 2, which includes Articles 40 – 53, sets out a common framework for data exchange between parties in order to ensure operational security during planning timescales and close to real time. Additionally Article 40, paragraph 6, requires an all-TSO pan-European proposal on Key Organisational Requirements, Roles and Responsibilities (KORRR) relating to data exchange to be developed. This proposal sets out how these data exchanges will be organised and determined particularly in relation to different parties' roles and responsibilities.

SOGL Articles 40-53 form the scope of work this modification seeks to address. Whilst there are links to other sections of SOGL that are important to understand they will be out of scope. Other Modifications³ (if required) will be raised in due course to address other sections of SOGL that may entail changes to the GB codes.

Reference Documents

COMMISSION REGULATION (EU) 2017/1485 of 2 August 2017 establishing a guideline on electricity transmission system operation:

<https://publications.europa.eu/en/publication-detail/-/publication/d09a428c-8957-11e7-b5c6-01aa75ed71a1/language-en/format-PDFA1A> (Specifically Articles 40-53)

Pan-European proposal on Key Organisational Requirements, Roles and Responsibilities (KORRR) in accordance with article 40, paragraph 6 of SOGL

March 2018 version:

https://electricity.network-codes.eu/network_codes/sys-ops/methodologies/

NRA request for amendments comments:

<https://www.ofgem.gov.uk/publications-and-updates/decision-request-amendment-transmission-system-operators-proposal-key-organisational-requirements-roles-and-responsibilities-relating-data-exchange>

The amended KORRR was published under SOGL deliverables on ENTSOE's website on the following link:

https://www.entsoe.eu/Documents/nc-tasks/SOGL/SOGL_A40.6_181001_KORRR_181015.pdf?Web=0

Grid Code objectives – Proposers view of Original solution

SOGL is one of the eight EU Connection Codes which derive from the Third Energy Package legislation; focused on setting minimum system security,

³ For example, a new CUSC Modification, CMP291, has been raised to address the Bilateral Agreement changes, in the CUSC, arising from both SOGL and the three connection Network Codes.

operational planning and frequency management standards to ensure safe and coordinated system operation across Europe, creating a standardised framework on which regional cooperation including balancing markets can be implemented. It therefore directly supports three of the five Grid Code Objectives as indicated below.

Impact of the modification on the Relevant Objectives:	
Relevant Objective	Identified impact
To permit the development, maintenance and operation of an efficient, coordinated and economical system for the transmission of electricity	Neutral
To facilitate competition in the generation and supply of electricity (and without limiting the foregoing, to facilitate the national electricity transmission system being made available to persons authorised to supply or generate electricity on terms which neither prevent nor restrict competition in the supply or generation of electricity)	Neutral
Subject to sub-paragraphs (i) and (ii), to promote the security and efficiency of the electricity generation, transmission and distribution systems in the national electricity transmission system operator area taken as a whole	Neutral
To efficiently discharge the obligations imposed upon the licensee by this license and to comply with the Electricity Regulation and any relevant legally binding decisions of the European Commission and/or the Agency; and	Positive
To promote efficiency in the implementation and administration of the Grid Code arrangements	Neutral

Impacts and Considerations

- i. The Grid Code and Distribution Code (and G83 and G98) will bear the primary impact of the SOGL Data exchange modification.
- ii. No network operator system changes are anticipated as a result of implementing the EU Demand Connection Codes.
- iii. Under flexibility accorded in SOGL Article 40.5, this proposal will only consider changes to the mandatory Articles as listed in section
- iv. 3 of this document to achieve full compliance. Future modifications may be raised based on system needs and requirements for the TSO.

- v. The specific requirements in relation to reserve services will be dependent on the outcome of the “Synchronous Area Operation Agreement as detailed in Article 118 on load frequency control and reserves.”
- vi. There are other indirect links to Coordinated Security Analysis (CSA) work under SOGL, for which another modification proposal will likely be raised in the near future and will endeavour to work in parallel as much as possible to best understand this link.
- vii. This proposal is also dependent on the pan-European KORRR which was submitted to all NRAs on 15 October 2018 by all TSO’s with a decision expected by 15 December 2018.

Does this modification impact a Significant Code Review (SCR) or other significant industry change projects, if so, how?

No.

Consumer Impacts

No.

3. Proposers Original Solution

Section 3 (Original Solution) is sourced directly from the Proposer and any statements or assertions have not been altered or substantiated/supported or refuted by the Workgroup. Section 4 and 5 of the Code Administrator Consultation contains the discussion by the Workgroup on the Proposal and the potential Solution.

This modification aims to ensure the Grid and Distribution Codes reflect the technical requirements set out in SOGL Articles 40-53 (data exchange) and KORRR for GB compliance with EU legislation. This will be achieved by retaining the existing Grid Code and Distribution Code text, unless there is a conflict with the SOGL requirements, KORRR or SOGL requirements require new additions which are not reflected in the current GB Grid Code and Distribution Code.

For the purposes of this proposal the following principles have been adopted:

- i) Retain the same structure and format as the current GB Grid and Distribution Codes
- ii) Retain the current requirements of the GB Grid and Distribution Codes unless there is good reason not to do so – for example there is either a conflict between the EU Codes and the GB Codes or the EU Code requires additions to the GB Codes.
- iii) Ensure that the revised GB Codes are easy to understand and use by those parties affected by them.
- iv) Ensure consistency between the Grid and Distribution Codes and associated industry documents.

GC0095 and the subsequent work under GC0106 identified specific changes necessary to the Grid and Distribution Codes. They are highlighted as follows:

- Amend the submission process of offline or ‘structural’ network data from an annual process to a 6 monthly cycle (SOGL Article 43, paragraph 4)

- Include the total aggregated generating capacity for all Embedded Power Stations less than 1MW split per primary energy source (SOGL Article 43, paragraph 5).
- Update EREC G83 and EREC G98 to include capturing all the necessary prime movers/energy sources that the DNOs need to report
- Update the Distribution Code with a paragraph giving Users the right to request data from the DNO.
- No other changes are proposed at this time, i.e. in every other respect the status quo in GB is compatible with the flexible requirements of the SOGL and any future changes will need to be progressed through normal GB governance arrangements.

Applicability and Scope

Given the existing GB variations in data exchange from generators depending on whether they are small, medium or large the exact requirements for the rows marked with flexible in the final column will be maintained as per the Grid Code. Where data is currently provided, that will continue in accordance with the Grid Code requirements and where data is not provided, there is no proposal to change this through GC0106, however, future changes may be necessary as the ESO continues its review of the whole system.

Article 40.5 SOGL allows for TSO discretion on the application of some of the Data exchange Articles. Data exchange requirements in SOGL are necessary to perform security analysis and help ensure operational security in the electricity system. This regulation therefore achieves a certain level of harmonisation between ENTSO-e (TSO-TSO) members and also allows flexibility for vertical exchange of data (TSO-DSO and TSO-SGU) at national level.

This proposal therefore has a focus on making changes only in relation to the mandatory Articles with no TSO discretion to ensure compliance by March 2019. The following section outlines the proposed GB position for each Article, and the solution for ensuring compliance with EU legislation. SOGL and KORRR data requirements are more onerous than existing GB practices and National Grid currently has sufficient data to operate the systems efficiently, so in order to meet SOGL compliance it is sufficient to maintain the status quo. Going beyond the status quo will lead to high financial investment with little benefit to the TSO. Future changes that implement some of the flexible SOGL articles may be raised as the System Operator reviews data requirements through consultation with the wider industry on projects such as wider access, future of balancing services, open networks and review of the future of the ESO.

The issue of harmonisation and discrimination between different SGUs connected to different networks and subject to subtly different requirements was discussed at length as part of the GC0102 modification proposals and through the discussions on alternative proposals for GC0106 (see sections 4). In Great Britain, the biggest source of different requirements stems from the retention of Large, Medium and

Small, and the differences in the boundaries between these classifications in the three transmission owner areas. The current arrangements reflect historic GB legal and policy decisions. National Grid's conclusion from those discussions is that no change to these GB arrangements are necessary for compliance with the introduction of the EU Network Codes. Whilst further harmonisation between the three transmission areas is possible and desirable this can be taken forward as future modifications under normal GB governance arrangements. The EU Network Codes provide that the technical requirements are defined by the relevant system operator. In GB, the Grid and Distribution Codes are aligned so that the minimum data is sought from embedded parties such that DNOs are able to provide appropriate data to National Grid alongside that sought from directly connected parties.

Articles 40 – 53 of SOGL impact all parties as listed in SOGL Article 2. The changes in the original proposal only impact DNOs and to a small extent new Type A generators of <16A per phase as they will be expected to report their capacity by fuel type. All data provisions must continue as per the existing Grid Code requirements and where an Article is said to be flexible (SOGL Articles 44, 47 – 53) only those parties that currently provide data to the TSO will continue to do so in accordance with the Grid Code.

The ESO is engaging and working with the wider industry to review the whole system, industry frameworks and balancing services through cooperation of DNOs which will require changes to existing data exchange frameworks. The issues raised in WAGCM1 and WAGCM2 are already under review in wider industry forums where the ESO is playing an active role in support of Ofgem and the industry in reviewing and reforming network charging and access arrangements to ensure consistency of treatment for all parties. Resolving the issues raised in the three WAGCMs through GC0106 modification would be premature and a duplication of efforts, but most of all, EU code compliance would not be achieved in time. It is inefficient to resolve WAGCM2 through GC0106 as data exchange thresholds cannot be changed without consideration of regional differences. Flexibility in implementing SOGL therefore means that we can focus on making the critical changes now at lower cost and in an efficient manner for EU code compliance. Outputs from the future role of the SO programme will be delivered throughout 2019. Implementation of the changes resulting from the review may have a different timeline. More details can be found on National Grid website:

https://www.nationalgrideso.com/sites/esofiles/documents/The%20Changing%20role%20of%20the%20Electricity%20System%20Operator_July%202017.pdf

The original proposal will require minor process updates for DNOs while the alternative proposals will require process changes and for new system installations to ensure data is exchanged between different parties. WAGCMs 1 and 2 would be better and efficiently addressed through the wider ESO whole system review or alternatively through another modification GC0117 which has been raised by the same proposer to deal with similar issues albeit the later does not consider existing generators but rather new generators.

SOGL Mapping

Article 40 - Organisation, roles, responsibilities and quality of data exchange

There are no identified changes for GB implementation in this Article as it is mainly context setting and interpreting other articles in the 41-53 range. Compliance is met therefore through existing GB frameworks and governance. The applicability and scope of data exchange is based on existing Grid Code obligations. The impact of KORRR has been considered by the Workgroup.

Article 41 - Structural and forecast data exchange

This Article outlines the requirements for neighbouring TSOs to exchange structural information related to their observability areas. National Grid has the capability to exchange structural data with other TSOs through Operational Planning Data Environment implemented by the System Operator as per Article 114 SOGL and CACM requirements.

Based on the consultation methodology for coordinating operational security analysis no changes are proposed to the observability areas for GB in accordance with Article 75. The methodology was developed for public consultation in March 2018 and was submitted to the Regulator in September 2018. The joint proposal recommendation is based on the existing observability areas used for Week 24 data submissions and therefore a Grid Code change is not required for this article. The ESO does not share its observability area with other Transmission SOs hence no structural data exchange is necessary. Exchange with GB TOs is currently done through the Electricity Ten Year Statements (ETYS).

Article 42 - Real-time data exchange between TSOs

Data exchanges within GB will continue to be carried out through existing STC data exchange obligations which are compliant with SOGL requirements. There is no GB requirement for this as the Article refers only to exchanges with neighbouring TSOs. GB code changes are therefore not required for this article.

Article 43 - Structural data exchange between TSOs and DSOs

Grid Code changes are required to ensure compliance with Article 43 paragraphs 4 and 5. The proposals are as follows:

- Changes to the submission process of offline or 'structural' network data from an annual process to a 6-monthly cycle. This will only impact DRC Schedule 5 of the Week 24 submissions in respect to SOGL Article 43, paragraph 4. As this is a Grid Code obligation on DNOs, there is no need to modify the Distribution Code.
- Changes to include a requirement to report on the total aggregated generating capacity for all embedded power stations less than 1MW split per primary energy source. This is in respect to SOGL Article 43, paragraph 5. The fuel type list derived from the Manual of Procedures for the ENTSO-E Central Information Transparency Platform will be used. DNOs currently collect data from generators connected after 2015 connected under the EREC G59 requirements, and will need to use their judgement to determine the fuel type for generators that were connected prior to 2015 or connected under EREC G83 requirements. This is acceptable given that the SOGL requirement is for DNOs to produce their best estimate of the generating

capacity disaggregated by fuel type. However the existing submission of data from modules connected under EREC G83 is not sufficiently detailed and so a change needs to be made to EREC G83 and EREC G98 to collect the right primary energy source data.

The legal text will be amended in the Planning Code section of the Grid Code (Annex 4 – Planning Data Requirements)

Article 44 – Real time data exchange between TSOs and DSOs

This is one of the flexible Articles as real time data exchange between the TSO and DSOs is not a mandatory requirement in the Grid Code. Changes to the Grid Code may be raised in future based on changes to system operational requirements and recommendations from the ENA Open Networks Project. For compliance with SOGL, National Grid will not request an amendment to the Grid Code as it currently has sufficient data to effectively manage the system. Flexibility not to request data beyond existing requirements is provided for in Article 40.5. Therefore, a Grid Code change is not required at this time.

Data exchange between TSOs, owners of interconnectors or other lines and power generating modules connected to the transmission system

Article 45 - Structural data exchange

This defines the requirements for each Significant Grid User (SGU) which is a power generating facility owner of either a Type D, Type C or Type B power generating module connected to the transmission system to provide the TSO with structural data. These requirements are currently covered in the Connection Conditions, European Connection Conditions, Operating Codes and Planning Code sections of the Grid Code and in the Balancing Settlement Code.

The data exchange for reserve services, Frequency Containment Reserves, Frequency Restoration Reserves and Replacement Reserves will continue through contract agreements as per the existing requirements which are currently sufficient for the ESO to operate the system. The technical requirements of GB services will be defined in accordance with the requirements set out in Articles 154, 158 and 161. GB service mapping will be completed through **GC0114 – System Operation Guideline: Pre-qualification processes** at the time of writing the modification has just concluded its Workgroup Consultation (October 2018).

The requirements for AC interconnector owners are not applicable in GB. In summary, a Grid Code change is not required for this article.

Article 46 – Scheduled data exchange

This defines the requirements for each SGU which is a power generating facility owner of either a Type D, Type C or Type B power generating module connected to the transmission system to provide the TSO with scheduled data, depending on their type. These requirements are currently covered in Physical Notification (PN) submissions as part of BC1 Pre-Gate Closure Process and Operating Codes sections of the Grid Code; therefore a Grid Code change is not required for this article.

Article 47 - Real-time data exchange

This defines the requirements for each SGU which is a power generating facility owner of either a Type D, Type C or Type B power generating module connected to the transmission system to provide the TSO with real-time data, depending on their type. Article 47 is flexible so the existing code frameworks and agreements will be maintained as sufficient data is currently exchanged until future modifications driven by system changes are raised in accordance with the Grid Code Governance. A Grid Code change is therefore not required for this article.

Data exchange between TSOs, DSOs and Distribution-connected power generating modules:

Article 48 - Structural data exchange

This is a flexible article as per SOGL Article 40.5, and requirements of this article are sufficiently covered by existing data exchange arrangements. Future modifications can be raised under normal governance arrangements based on changes to system operational requirements; a Grid Code change or DCode changes are not required at this time.

Article 49 - Scheduled data exchange

This is a flexible article as per SOGL Article 40.5, and the requirements of this article are sufficiently covered by existing Distribution Code data exchange arrangements. Future modifications can be raised under normal governance arrangements based on changes to system operational requirements; a Grid Code change or a DCode change are not required at this time.

Article 50 – Real-time data exchange

This is a flexible article as per SOGL Article 40.5, and the requirements of this article are sufficiently covered by existing Distribution Code data exchange requirements. Future modifications can be raised under normal governance arrangements based on changes to system operational requirements; Neither Grid Code and Distribution Code changes are not required at this time.

Article 51 - Data exchange between TSOs and DSOs concerning significant power generating modules

This is a flexible article as per SOGL Article 40.5, and the requirements of this article are sufficiently covered by existing Grid Code and Distribution Code data exchange requirements. Future modifications can be raised under normal governance arrangements based on changes to system operational requirements; Neither Grid Code and Distribution Codes changes are not required at this time.

Article 52 - Data exchange between TSOs and transmission-connected demand facilities

This is a flexible article as per SOGL Article 40.5, and the requirements of this article are sufficiently covered by existing Grid Code data exchange. Future modifications can be raised based on changes to system operational requirements; a Grid Code change is not required at this time.

Article 53 – Data exchange between TSOs and distribution-connected demand facilities or third parties participating in demand response

Article 53 is a flexible article as per SOGL Article 40.5, therefore, no changes are proposed as compliance is met through the existing Transmission Licence C16 process and the standard contract agreements. Grid Code or Distribution Code changes are not required at this time. The prequalification process of existing services is listed for each service on the National Grid external website⁴.

KORRR Mapping

The intention of the KORRR is not to define the detailed information to be exchanged between TSOs and significant stakeholders but to establish the responsibilities at national level around who shall define and approve the detailed information to be exchanged. The methodology (KORRR) recommends TSOs retain the flexibility in the implementation within its own control area to allow flexibility regarding vertical data exchange between TSOs and DSOs and also between TSOs and SGUs.

Whereas

There are no identified changes for GB implementation in this section as it is mainly context setting and interpreting other articles in the KORRR. Paragraph 3 reinforces the national flexibility in implementing SOGL Articles 44, 47 - 53 subject to approval by the Regulator.

Article 1 - Subject matter and scope

There are no identified changes for GB implementation in this Article as it concerns the subject and scope of KORRR. Requirements set out on transparency, efficiency and in respect of the assigned responsibilities are covered through existing GB governance. SGUs that provide services to TSOs shall comply with existing rules set out for each of the services offered in GB as listed on the National Grid Balancing Services website. Data will be exchanged through the contract agreements as it is currently done. A Grid Code change is not required at this time.

Article 2 - Definitions

There are no identified changes to definitions for GB implementation. The definition of 'modification' shall be as defined in the EU network codes while the term 'significant' will be defined at national level. 'Significant modification' in a network element for GB shall be equivalent to the definition of substantial modification as included in the Grid Code in order to implement the EU connection codes.

Article 3 - General Responsibilities

Existing quality for data exchange is as detailed in the Data Registration Code⁵. The required quality may be implicit in some cases and any party can raise concerns if the quality of data exchange does not meet the required state. For example, once the TSO receives week 24 data, internal checks are carried out and if quality criteria

⁴ <https://www.nationalgrid.com/uk/electricity/balancing-services>

⁵ <https://www.nationalgrid.com/sites/default/files/documents/36904-Data%20Registration%20Code.pdf>

set out on the schedules is not followed then a DNO may be requested to re-submit the data.

The default position in GB concerning data from SGUs is that data is provided to the System Operator with whom there is the connection agreement except for Embedded Large Power Stations where it is provided directly to the ESO. No GB changes are proposed to this established practice at this time.

Responsibility for operational metering, system monitoring and communication will be as required in the existing Connection Conditions of the Grid Code.

Article 4 - Confidentiality

There are no changes required as confidentiality is already catered for in current legislation. The SOGL requirements merely re-enforce these rules of data exchange between parties which are no more onerous. GB changes are not proposed to this established practice at this time.

Article 5 - Access to information

Compliance for this Article is met through the Grid Code Planning Code hence no modification to the existing Grid Code is required. The Grid Code has provisions for data exchange to the TSO through the week 24 process as well as from the TSO through the week 42 process.

The Distribution Code is currently silent on connected parties rights to having access to their structural information held by the DNO so it is proposed to add an appropriate obligation on DNOs in DPC8.

Responsibilities of TSOs

Article 6 General responsibilities of TSOs

The proposed methodology for Article 75 SOGL does not require a change to the existing observability areas. The electricity supply system in Great Britain is designed to operate as a single synchronised system. The ESO as sole TSO for the whole of GB does not share observability areas with other TSOs outside the GB area. Based on the draft Coordinated Security Analysis methodology under SOGL Article 75⁶, the GB observability area does not require data from neighbouring TSOs. National Grid confirmed to the Workgroup that other TSO observability areas do not extend into GB.

All data exchange between the ESO and GB Transmission Owners will maintain rules set out in the System Operator Transmission Owner Code and Grid Code. Changes to GB codes are not required at this time. This means that there are no changes proposed to the STC as a consequence of this modification. (add in STC no changes)

Article 7 Structural data used by TSOs

6

https://www.nationalgrideso.com/sites/eso/files/documents/180710_Methodology%20for%20coordinating%20operational%20security%20analysis_clean_0.pdf

No changes are required as there is no requirement to share data with non-GB TSOs. For GB compliance is met through the STC and Electricity Ten Year Statements (ETYS) for exchange of data with GB TSOs. Data format and templates for structural data exchange with DNOs will be as per existing Grid Code Planning Code, Data Registration Code, Connection Condition and CUSC bilateral connection agreements hence no changes are proposed at this time.

Article 8 TSO to TSO Notification of changes

Changes are not required for implementation of these Articles in GB as there's is no requirement to exchange data with neighbouring TSOs. DSOs and transmission connected SGUs may request updates of the structural data as listed in the Grid Code planning code (references can be located in mapping) of the Grid Code.

Article 9 Scheduled data responsibilities of TSOs

Changes are not required for implementation of these Articles in GB as there is no requirement to exchange data with neighbouring TSOs. Grid Code Operating Code and Data Registration Code cover requirements for SGUs. Existing formats for non-BMU significant grid users that provide services to the TSO will be maintained and exchanged through contractual agreements.

Article 10 Provisions of real time information

Changes are not required for implementation of these Articles in GB as there is no requirement to exchange data with other TSOs. The ESO has the responsibility for ensuring that All TSO practices are followed as defined and published at ENTSO-E level.

The real time metering requirements are set out in the connection conditions section of the Grid Code for SGUs and DSOs. The GB Transmission System Operator shall ensure the EU TSO practices are followed. No changes are required as compliance is met through the Grid Code Connection Conditions.

Responsibilities of DSOs

Article 11 Notification of changes

The notification of structural data changes is required only for those SGUs in the observability area of the transmission-connected distribution systems. National Grid has no proposal to make any adjustments to the existing scope of structural data exchanged with DSOs in GB. Only data for those SGUs that are connected to the observability area assets shall be provided by DSOs.

Currently data concerning commissioning and decommissioning of assets in the TSO's observability area is exchanged and updated through the week 24 data in arrears, or in some cases through the Statements of Works process in advance. Updates are currently carried out annually: implementing the proposed changes will ensure 6 monthly updates to the structural data are provided in Week 24 and 50. Changes to the observability areas will be done in agreement with the relevant DSOs as necessary as per existing practice. For errors in the submitted data the DSO shall notify the ESO in writing without delay as per existing requirements set out in the Grid Code Planning Code.

National flexibility in deciding the scope of structural data is also reflected in ENTSO-E's response to the KORRR public consultation where it is clearly stated that this Article 11 is a guide and can be adjusted by each TSO at national level during implementation. The consultation responses have been published on ENTSO-E website: https://electricity.network-codes.eu/network_codes/sys-ops/methodologies/

Article 12 Rights and responsibilities of DSOs

No changes are required as compliance is met through the Grid Code Operating Code No.2. Timelines for exchange of planned and unplanned unavailability of network elements shall be in accordance with Grid Code requirements which are listed in Grid Code OC2.4.1.2.4 and DOC2 of the Distribution Code. These timelines shall also be in line with Regulation 2015/1222 on capacity allocation and congestion management.

Article 13 Real Time data provided by DSOs

Existing Real Time data exchange will be maintained with no changes to Connection Conditions (CC.6.5.6) in accordance with requirements set by the ESO in the Bilateral Agreements. With regards to paragraph 3 which refers to the DNO/SGU interface, where real time data is provided it is generally sourced from the DNOs own SCADA. Only those SGUs with CUSC obligations will continue providing real time data to the ESO. There is no need for changes to existing GB Codes for SOGL compliance, the system operators have sufficient data for operating the distribution and transmission system. Any changes to existing process will lead to high cost against which any benefits must be formally weighed through normal GB governance processes.

Responsibilities of SGUs

Article 14 Structural data provided by SGUs

This article refers to the observability area, not the control area. Changes are not proposed as compliance is met through the Grid Code Planning Code. The ESO has sufficient data to operate the system using the data currently received. Future modifications may be raised as the system evolves.

Article 15 Notification of changes

This article refers in practice to the observability area, not the control area. No changes are proposed, all notification of changes will be in line with existing requirements. System operators have sufficient data to operate the system using the data currently received. Future modifications may be raised as the system evolves.

Article 16 Scheduled data provided by SGUs

No changes are proposed at this time; existing requirements as set out in Balancing Code and Operating Code will be maintained with no changes. System operators have sufficient data to operate the system using the data currently received. Future modifications may be raised as the system evolves.

Article 17 Real time data provided by SGUs

The ESO will maintain existing rules for real time data via CUSC agreements for data provision from large and medium power stations excluding small power stations. There are no changes proposed as compliance will be met through existing Grid Code Connection Conditions and Bilateral Agreements. The ESO will not request real time data from DSOs for distribution connected SGUs. Future modifications may be raised through existing governance. The DNOs will maintain the current Distribution Code arrangements in DPC 6.7, and will maintain the current practice of installing the DNO's own SCADA outstation where real time data is required, generally monitoring parameters at the connexion point via the DNO's own transducers.

4. Workgroup Discussions Pre-Workgroup Consultation

Since its formation by the Grid Code and Distribution Code Review Panels in October 2017 and prior to the issuing of the Workgroup Consultation, the GC0106 Workgroup had convened six⁷ times to develop the solution against the scope and Applicable Objectives for both the Grid Code and the Distribution Code.

At the initial Workgroup in November, the Proposer presented the defect as outlined in the original modification proposal and the scope of GC0106. Through presentational material⁸, the Proposer highlighted the two component parts of the modification as follows:

1. The direct data requirements taken from System Operation Guidelines (SOGL)
2. Changes arising from the all Transmission System Operator proposal on Key Organisational Requirements, Roles and Responsibilities (KORRR)

Legal Interpretation

The Proposer and the majority of Workgroup members agreed that the applicability and scope of the data exchange will be based on the existing Grid Code framework recognising 'flexibility' as accorded in Article 40(5) SOGL. There were lengthy discussions in the first and second Workgroup meetings over the interpretation of how 'flexibility' should indeed be applied under Article 40(5).

Article 40(5) SOGL states that each TSO is to determine, in coordination with Distribution System Operator (DSO) and Significant Grid Users (SGU), the applicability and scope of the data exchange in relation to Articles 44, 47, 48, 49, 50, 51, 52, 53 for which data exchange is to take place. The Proposer clarified their interpretation as one which allows for 'flexibility' in the implementation of those data exchange-related Articles that begin with the wording "*unless otherwise*

⁷ 2 November 2017, 6 December 2017, 12 January 2018, 28 February 2018, 28 March 2018 and 6 April 2018

⁸https://www.nationalgrid.com/sites/default/files/documents/Pr2.%20%20GC0106%20Presentation_1.pdf

provided by the TSO...” Articles 41, 42, 43, 45 and 46 are therefore being treated as mandatory and as a result all proposed changes will be made on the mandatory Articles to ensure compliance.

One Workgroup member noted that the purported ‘flexibility’ suggested by the Proposer and other Workgroup members in Article 40(5) may not actually exist with the SOGL as the Guideline sets out the common minimum requirement needed for system operation including, in their view, the minimum data requirements. This Workgroup member provided their interpretation of the wording “*unless otherwise provided by the TSO...*” The Workgroup put an action on that Workgroup member to set out their concerns. This can be found in Annex 3. In summary, the Workgroup member was concerned that if GC0106 was implemented according to the Proposer’s intention, this would mean that neither the TSO or the DSO/SGU would provide certain data items. However, if the Workgroup’s legal interpretation was to be incorrect then the DSOs and SGUs (but not the Proposer or TSO) would be in breach of the SOGL data exchange obligations in that situation. Whilst another Workgroup member voiced similar reservations about the approach set out by the Proposer in the context of the wording “*unless otherwise provided by the TSO...*”, further legal consultation has aligned this Workgroup member’s position with the Proposer interpretation.

As a result of the initial Workgroup member’s reservations and given the potential consequences of the data exchange requirements on grid users, the Proposer was requested by the Workgroup to provide legal guidance. This legal advice can be found at **Annex 3** Subsequent legal guidance supported the Proposer interpretation of ‘flexibility’. In addition to the legal advice, the Proposer also confirmed views from ENTSOE that the flexibility interpretation was the way in which drafting of the code was intended as also backed up by the German translation. The Proposer pointed out that flexibility at national level was also the view given by EU Commissioner in response to a letter sent to DSOs. There was a consensus for the Workgroup to proceed with the development of the solution on that interpretation, meaning that the same requirements, structure and format as the current GB Grid and Distribution Codes is to be retained.

Workgroup members acknowledged that some of the data exchange Articles have ‘flexibility’ determined by the *Transmission System Operator* as both necessary and legal. The current GC0106 proposal means that existing GB code provisions will remain in place for ‘flexible’ Articles and modifications will be raised as and when necessary in the future.

At the Workgroup meeting held on the 28 March 2018 the Workgroup member with a different interpretation of Article 40(5) of SOGL, requested that this matter was discussed further. The workgroup member suggested that the purported ‘flexibility’ may be illusory in practice given the TSO’s requirement through SOGL to apply an open, transparent, non-discriminatory and harmonised approach. The Proposer stated that they would not be amending their proposed solution from what that was outlined previously based on the legal advice provided and views from other ENTSOE members. The Workgroup member confirmed that an alternative modification proposal with an indemnity clause would be submitted based on their interpretation.

Key Organisational Requirements, Roles and Responsibilities

The SOGL Regulation requires the creation and development of a pan-European proposal by all TSOs on the Key Organisational Requirements, Roles and Responsibilities (KORRR) for data exchange across Europe. Until approved by all EU Regulators (now expected to be by December 2018 and previously outlined in Section 2), this document may subsequently require some additional changes and/or new requirements to be added to the GB Grid Code and Distribution Code. The Workgroup is aware of the interdependency and has considered the KORRR's development and impact in parallel.

At the Workgroup meeting on 17 September the Proposer highlighted that the NRA had sent back the KORRR to the TSOs for amendment. The Proposer outlined the timeline that all the TSO's were working to and that the final KORRR would be submitted back to the respective NRAs by 15 October 2018.

According to the Proposer, the final KORRR methodology submitted to Ofgem on 15 October 2018 does not appear to require any additional changes to the Grid Code. DNO compliance with the structural data requirements would be ensured through the proposed revisions made to G83.

It was noted that there was a risk that should the NRA send back the October 2018 version of the KORRR subsequently that this could also mean a send back of GC0106 to the Workgroup for further consideration. Due to the timescales required the GC0106 modification would need to be finalised and sent to the Authority as soon as possible. This is especially important since should the Authority request for WAGCM1 and WAGCM3 to have full legal text this would also require time for 'send back' ahead of the compliance deadline of 14 March 2019.

Implementation/Timeline

The Workgroup understands the specificity of the timeline referenced in Article 192 of SOGL for Data Exchange which states that Articles 41-53 will apply 18 months after EIF, so by 14 March 2019. The all-TSO KORRR proposal was required 6 months after EIF (14 March 2018) . Given the request for amendment, all TSOs submitted the KORRR in October and expect a decision by December 2018. Given this intrinsic dependency between SOGL and the KORRR, the GC0106 modification proposal is aligned to the development of the KORRR such that both will be submitted to the Authority for approval in the same timeframe. This is important to allow the maximum lead time in implementation and compliance.

SOGL Code mapping

The Workgroup commenced a code mapping exercise of the data exchange Articles of SOGL during the third Workgroup in order to establish how the EU

Regulation mapped to the existing GB frameworks⁹. Through the exercise, Workgroup members agreed that sections of the Grid Code Planning Code (PC) would need to be amended to ensure that they are aligned to the data exchange requirements listed in SOGL. Discussions also focussed on an aspect of work covered by GC0104, specifically a new section to the Grid Code (Demand Response Services Code) that would specifically cater for Demand Response Services.

Comments arising from the Code Mapping exercise can be summarised as follows:

1. General Requirements on data exchange

Article 40: There are no identified changes for GB implementation in this Article as compliance is achieved through existing GB frameworks and governance. The impact of the March 2018 version of the KORRR was considered by the Workgroup. Other changes may result from the establishment of observability areas which will be developed separately in accordance with Article 75. Workgroup discussions on observability were based on existing observability areas used for Week 24 data submissions.

2. Data Exchange between TSOs

Article 41 – 42: According to the Proposer no changes identified as existing TSO data exchange as per the System Operator Transmission Owner Code and Procedures are sufficient for compliance of the listed Articles. Structural Data for the Common Grid models is already exchanged through the Independent Grid Models (IGM) process as per Regulation 2015/1222. Real time Data between TSOs is done through Operational Planning Data Environment by the System Operator as per Article 114.

3. Data Exchange between TSOs and DSOs within the TSOs control area

Article 43: According to the Proposer, Grid Code changes are required to ensure compliance of Article 43 paragraphs 4 and 5. The proposed changes relate to the frequency of DRC Schedule 5 of the Week 24 data submissions and submission of aggregated small generation less than 1MW to be aggregated by fuel type as detailed in the solution section of this proposal.

Article 44 is currently not included in the Grid Code as such there is no real time data exchange between the TSO and DNOs (or DSOs). Changes to the Grid Code may be raised in future based on changes to system operation requirements. According to the Proposer, for compliance of SOGL, National Grid will not request an amendment to the Grid Code as 'flexibility' is provided for in Article 44 (as highlighted in the proposed solution).

⁹ <https://www.nationalgrid.com/uk/electricity/codes/grid-code/modifications/data-exchange-requirements-accordance-regulation-eu> (xls document entitled 'Code Mapping')

4. Data Exchange between TSOs, owners of interconnectors or other lines and power generating modules connected to the transmission system

Article 45 – 47: Articles 45 and 46 are mandatory and according to the Proposer, compliance will be met through the Grid Code and Balancing and Settlement Code. Provision of data from power generating owners that provide Ancillary Services to the TSO will be achieved through the contract agreements¹⁰. Dependencies on Articles 154, 158 and 161 will be handled through Synchronous Area Operation Agreement workstream. Article 47 is flexible hence the existing code frameworks and agreements will be maintained until future modifications are raised in accordance with the Grid Code Governance.

5. Data exchange between TSOs, DSOs and distribution-connected power generating modules

Article 48 – 50: According to the Proposer, these are flexible Articles hence no modifications are proposed. Compliance is met through existing code frameworks and agreements subject to future modifications in accordance with the Grid Code Governance.

6. Data exchange between TSOs, and DSOs concerning significant power generating modules

According to the Proposer, Article 51 is a flexible Article, therefore, no changes are proposed as compliance is met through existing code frameworks and agreements until future modifications are raised in accordance with the Grid Code Governance.

7. Data exchange between TSOs and demand facilities

According to the Proposer, Article 52 is a flexible Article, therefore, no changes are proposed as compliance is met through existing code frameworks and agreements until future modifications are raised in accordance with the Grid Code Governance.

8. Data exchange between TSOs and distribution-connected demand facilities or third parties participating in demand response.

According to the Proposer, Article 53 is a flexible Article, therefore, no changes are proposed as compliance is met through existing C16 process and the standard contract agreements. The Workgroup acknowledged the demand side requirements under GC0104 as driven by the Demand Connection Code (DCC) and noted that further discussions are required and would be carried out through GC0106 and the Power Responsive Flexibility workstream. It has since been agreed that a new Grid Code section is necessary to deal with demand side providers through GC0104.

KORRR submission to NRA and Code Mapping

¹⁰ <https://www.nationalgrid.com/uk/electricity/balancing-services>

The Proposer confirmed that the amended KORRR was approved by TSOs for submission to the NRAs by 15 October 2018. An update was presented to the Joint European Stakeholder Group concerning the March and October 2018 versions

Workgroup members reviewed and discussed the latest iteration of the KORRR Code Mapping in detail on 28 March 2018 and at a high level regarding the request for amendment from NRAs. The request for amendment was published on Ofgem's [website](#).

Workgroup members agreed that a table listing all SGUs (according to SOGL) would support all users (new and existing at transmission and distribution connected) in understanding how and whether they are captured by the data exchange requirements of SOGL and thus GC0106. This now appears in the 'Summary' section of this document.

Workgroup members raised some concerns around how specific the KORRR code mapping was in terms of the need for the complete details, such as the Schedule referencing to be added and also specific areas of, for example, OC2. The Proposer took an action to update the mapping following the meeting on the 28 March 2018 and it is attached to this consultation.

The term **Significant Modification** was noted and the Chair confirmed that there were ongoing discussions occurring within the GC0104 (Demand Connection Code implementation) _Workgroup on the definition of this. The Proposer confirmed that this definition is unchanged from GC0100-102 (RfG and HVDC) modifications in their Original solution. The Code Administrator noted that a formal alternative had been raised and is being developed around the alternative interpretation of Article 4 Paragraph 1 (a) (i), (ii) and (iii) in the GC0104 Workgroup. ***Further to these discussions the alternative solution discussed was not approved by the Authority.***

When reviewing Article 10 (Format of Real Time Information) a Workgroup member questioned where, in GC0106, the Proposer would be specifying the format for real time data exchange. The proposer confirmed that this would be defined at ENTSO-E level for exchange between TSOs. The Proposer noted that ENTSO-E is to clarify requirements to be defined by TSOs and that this piece of work was ongoing. The Workgroup member pointed out that the KORRR states that the TSO *shall* specify this and, therefore, the proposed GC0106 solution for this Article 10 is not discharging this obligation.

The Proposer clarified their position on Article 11 (Responsibilities of DSOs) and that they are proposing to have a six month update in week 50 only for elements and SGUs that are in the TSO's observability area as per existing practice. The proposed legal text for this can be located in Annex 4. In the March version of the KORRR, workgroup members discussed the interpretation of the demand facility wording and noted that this could be very onerous in that it could be shown to apply to every street light, for example, and that DNOs would need to hold up such installations to be able to give the required six months' notice to National Grid before it was implemented literally as written. The majority of Workgroup members stated that a pragmatic approach needed to be taken. The proposer

confirmed that National Grid would not be asking for more data than is currently exchanged with DNOs. Article 11 has to be applied in agreement with the DNOs as there is flexibility at national level. It was noted that if such a 'pragmatic' approach (for Article 11) was to be applied to DSOs that an equality of treatment need to be accorded to all other parties with similar obligations (as set out in Article 15) . The amended KORRR submitted in October was revised by TSOs based on NRA comments. The October version makes it clear that the notification of changes should only include network elements that form the observability area of the TSOs.

The Workgroup discussed Article 13 (Real Time Data provided by DSOs). The Proposer stated that SOGL flexibility allows for the TSO to determine real time data exchange scope and applicability. The Proposer stated that NGET is not requesting new real time data as part of GC0106 and that future modification may be raised when system needs change. A Workgroup member stated that the KORRR states that the TSO *shall* specify and that, therefore the proposed solution for this Article is not discharging this obligation. The Proposer reiterated that in their view it was compliant and much more helpful to Users as a matter of policy not to state a zero compliance requirement. If Users did need to do something to comply, this would need to be clearly stated – but there is no requirement for this as part of this modification. .

A Workgroup member stated that, in their view, the proposed GC0106 solution is, not harmonised, is discriminatory and does not apply a level playing field approach and thus does not discharge the requirements of the KORRR, SOGL or the Third Package. The workgroup member went on to raise three alternatives (please see section 5).

Please note that all presentations provided and discussed at the Workgroup meetings can be found under the 'Workgroup' tab via the following link:
<https://www.nationalgrideso.com/codes/grid-code/modifications/gc0106-data-exchange-requirements-accordance-regulation-eu-20171485>

5. Post Workgroup Consultation Workgroup discussions

The Workgroup Consultation closed on the 27 April 2018 and received eight responses which can be found in **Annex 6**.

The Workgroup met on the 2 May 2018 to discuss the responses that were received.

Summary of Workgroup Consultation responses

- All respondents agreed that the Original Proposal better facilitates the Grid Code Objectives and most respondents support the proposed implementation approach.
- No alternative requests were submitted

- A future review of work to clarify NGET requirements to ensure consistency between the three data submissions and consistency in reporting was proposed (Northern Powergrid)
- One respondent highlighted the limitations of the solution based on the current interpretation of flexibility vs the aims of the 3rd Energy package, and raised concerns with the lack of details around the requirements for real time data exchange from Type B and C generators (SSE).
- One respondent does not believe the solution discharges the legal obligations of SOGL and other relevant EU legislation (SSE)

Discussions

The Workgroup and Proposer concluded that following the legal text comments received the legal text would be updated accordingly and be located in Annex 4.

Workgroup Alternatives

On the 3rd May 2018 one Workgroup member raised three potential Workgroup Alternative Code Modifications with the Workgroup. The full forms can be located in Section 6 of the Report. A summary of these is outlined below:

Potential WAGCM1

This Alternative proposal will use all the same changes in the original GC0106 proposal except where the Original proposal deals with the provision (or non-provision) of the data items related to the Articles listed below; where this Alternative proposal will make it clear that only where the TSO itself provides the said data item(s) does the relevant stakeholder not need to provide that same data item(s).

Articles 44 and 51 (concerning DSOs);
 Article 47 (concerning SGUs);
 Articles 48, 49 and 50 (concerning power generating facility owners of a power generating module which are an SGU);
 Article 52 (concerning transmission connected demand facility owners); and
 Article 53 (concerning distribution connected SGUs which participate in demand response to third parties).

The legal interpretation that this WAGCM is based on can be located in Annex 2.

Potential WAGCM2

This Alternative proposal will use all the same changes in the Original GC0106 proposal except where the Original proposal deals with the data items related to the Articles listed in Section 6 of the Alternative proposal; where this Alternative proposal will make it clear that a harmonised and non-discriminatory approach (as detailed in (1) in the Alternative proposal) will be applied (rather than the GC0106 Original approach).

This alternative was originally drafted to cover all Distribution and Transmission connections but following Workgroup discussions the Proposer amended this to cover just Transmission Connected.

Potential WAGCM 3

This alternative comprises both WAGCM1 and WAGCM2 taken together.

The Workgroup discussed the proposed alternatives and concluded that they would better facilitate the Grid Code Objectives and should be taken forward and developed as formal Workgroup Alternatives that would be submitted to the Authority with the Original Proposal.

Following the Alternative Vote some Workgroup members reflected on the proposed alternatives and whether they better facilitate the Grid Code objectives. Some members fed back that on receiving the full details of the potential alternatives they would not now conclude that they better facilitate the Grid Code objectives.

The Code Administrator noted that the decision and vote had been concluded in respect of the three potential alternatives and that they were now officially WAGCMs that needed to be full developed by the Workgroup.

Some Workgroup members examined the WAGCMs and assessed the work that would need to be completed to fully develop them in their view. This can be found below:

Work to be completed to fully develop WAGCMs and the impact:

Summary:

Significant investment costs are driven by Articles 50, and to a lesser extent 44.

Significant organization and procedural challenges arise from Articles 48, 49, (and possibly 52), as well as 50 and 44.

Grid Code changes likely to be needed for Articles 44, 48, 49, 51 – and also for 50 in relation to data DNOs collect and how to transfer it.

Art	SOGL Text	D Code Implications	Grid Code Implications
40	<p>Organisation, roles, responsibilities and quality of data exchange</p> <p>Art 40.5. In coordination with the DSOs and SGUs, each TSO shall determine the applicability and scope of the data exchange based on the following categories:</p> <p>Art 40.5.a. structural data in accordance with Article 48;</p> <p>Art 40.5.b. scheduling and forecast data in accordance with Article 49;</p>	<p>It becomes unclear how Article 40.5 works in relation to Articles 44, 47, 48, 49, 50, 51, 52, 53.</p> <p>Article 40.7 is unlikely to be implemented by March 19 – although agreement might be made – it cannot be implemented in that timescale. Interesting that 40.7 does not specify when the processes agreed upon need to be implemented – nor does KORRR.</p>	<p>Changes are subject to the interpretation of ‘Each TSO shall determine the applicability and scope’ of the data exchange based on articles 44, 47, 48, 49, 50, 51, 52, 53.</p> <p>Article 41 to 53 shall apply in March 2019, which is 18 months after the entry into force of SOGL per Article 192 of SOGL. The required changes would need to be agreed and implemented by this date otherwise this will not</p>

Art	SOGL Text	D Code Implications	Grid Code Implications
	<p>Art 40.5.c. real-time data in accordance with Article 44, Article 47 and Article 50; and</p> <p>Art 40.5.d. provisions in accordance with Article 51, Article 52 and Article 53.</p> <p>Art 40.7. By 18 months after entry into force of this Regulation, each TSO shall agree with the relevant DSOs on effective, efficient and proportional processes for providing and managing data exchanges between them, including, where required for efficient network operation, the provision of data related to distribution systems and SGUs. Without prejudice to the provisions of paragraph 6(g), each TSO shall agree with the relevant DSOs on the format for the data exchange.</p>		<p>efficiently discharge the obligations imposed upon the licensee.</p> <p>The necessary data exchange is currently achieved with the TSO's through the STC which covers the whole of the GB Synchronous area (i.e. Scotland and OFTO's). Currently there is no requirement for data from TSO's or DSO's outside of the GB Synchronous area. Neighbouring TSO's in other Synchronous areas are unlikely to require data from us as they are outside our synchronous area – NG operates the system today without this data. These requirements are more applicable in other Synchronous areas where there are many TSO's and Member States. If there is a requirement for this to change in the future this can be managed as a GB mod within the framework of SOGL.</p> <p>For DNO's we get the data we need although this may be more complex due to the increase in the volume of Embedded Generation.</p>
44	<p>Data exchange between TSOs and DSOs within the TSO's control area</p> <p>Real-time data exchange</p> <p>Unless otherwise provided by the TSO, each DSO shall provide its TSO, in real-time, the information related to the observability area of the TSO as referred to in Art 43.1 and Art 43.2, including:</p> <ul style="list-style-type: none"> (a) the actual substation topology; (b) the active power and reactive power in line bay; (c) the active power and reactive power in transformer bay; (d) the active power and reactive power injection in power generating facility bay; 	<p>DNOs will have to ensure that transducers etc exist in all substations in the observability area to discharge (a) to (i). This is bound to require some investment.</p> <p>Some information, such as (e) tap positions of transformers (if in fact there are any in the OA) might not exist or be completely inappropriately uneconomic to try to source (ie new tapchanger or even new TX).</p> <p>It is likely that all the substations in question will have SCADA – but both NG and the DNOs will have to agree data transfer arrangements – probably requiring (a) the installation ICC links and (b) potentially new data storage infrastructure.</p> <p>As per 40.7 above it is not clear when the process (that</p>	<p>New system and process for data transfer system between TSO and DNO (ICCP or alternatives) will be required to exchange real time data.</p> <p>This would have to be a new requirement requiring a change to the Grid Code and an inclusion of this requirement in the ECC's section 6.4. The requirements are straightforward but the cost and who pays for it is complex and would require a decision from Ofgem.</p> <p>In this case ICCP links could be used in the same way as the Scottish model for both data provided by SGU's and the DNO data itself. It could be more of an issue for IDNO's which are growing in number.</p>

Art	SOGL Text	D Code Implications	Grid Code Implications
	<p>(e) the tap positions of transformers connected to the transmission system;</p> <p>(f) the busbar voltages;</p> <p>(g) the reactive power in reactor and capacitor bay;</p> <p>(h) the best available data for aggregated generation per primary energy source in the DSO area; and</p> <p>(i) the best available data for aggregated demand in the DSO area.</p>	<p>will be agreed by March 2019) will need to be actually implemented.</p>	<p>The technical impact on observability areas will depend on the outcome of Article 75 of SOGL.</p> <p>Currently we only get operational metering data at the Grid Supply Point which would not really be adequate to meet the requirements of the SOGL requirement.</p> <p>An alignment to the work on open networks will be necessary.</p>
47	<p>Art 47.1. Unless otherwise provided by the TSO, each significant grid user which is a power generating facility owner of type B, C or D power generating module shall provide the TSO, in real-time, at least the following data: Art 47.1.a. position of the circuit breakers at the connection point or another point of interaction agreed with the TSO;</p> <p>Art 47.1.b. active power and reactive power at the connection point or another point of interaction agreed with the TSO; and</p> <p>Art 47.1.c. in the case of power generating facility with consumption other than auxiliary consumption net active power and reactive power.</p>	<p>Only applies to directly connected SGUs</p>	<p>There is an existing real time data exchange provision for all SGUs who are CUSC parties, TSO would have to ensure we are exchanging with all transmission connected SGUs.</p>
48	<p>Data exchange between TSOs, DSOs and distribution-connected power generating modules</p> <p>Structural data exchange</p> <p>Unless otherwise provided by the TSO, each power generating facility owner of a power generating module which is a SGU pursuant to Art 2.1.a and by aggregation of the SGUs pursuant to Art 2.1.e connected to the distribution system shall provide at least the following data to the TSO and to the DSO to which it has a connection point:</p> <p>Art 48.1.a. general data of the power generating module, including installed capacity and primary energy source or fuel type;</p> <p>Art 48.1.b. FCR data according to the definition and requirements of Article 173 for power generating</p>	<p>1.a, 1.e, 1.h and 1.i exist in the existing DNOs data sets – or can be asked for under existing DDRC requirements.</p> <p>1.b, 1.c, 1.d can be provided directly to NG via the relevant contracts (I assume).</p> <p>1.f and 1.g probably need NG to specify in the G Code exactly what is required. Neither of these are thought to be directly captured in the DDRC. For 1.f it is not even clear which CB is meant and although rudimentary information is included in the DDRC for 1.g, this is probably not sufficient.</p>	<p>NG has to work with DNOs to agree exchange of structural data for distribution connected generating modules. Currently this is exchanged directly through contracts but Grid code amendments, new processes for exchanging directly between TSO and DNOs and potentially new roles will be required.</p> <p>For SGU's with a CUSC contract this would already be covered. For SGU's which are not CUSC parties this is more complex. There are two solutions – we either place requirements on non CUSC parties to provide the data to NG similar to the LEEMPS arrangements or place similar requirements on DNO's in the DDRC and then forward that data to us. We would need to</p>

Art	SOGL Text	D Code Implications	Grid Code Implications
	<p>facilities offering or providing the FCR service;</p> <p>Art 48.1.c. FRR data for power generating facilities offering or providing the FRR service;</p> <p>Art 48.1.d. RR data for power generating modules offering or providing the RR service;</p> <p>Art 48.1.e. protection data;</p> <p>Art 48.1.f. reactive power control capability;</p> <p>Art 48.1.g. capability of remote access to the circuit breaker;</p> <p>Art 48.1.h. data necessary for performing dynamic simulation according to the provisions in Regulation (EU) 2016/631; and</p> <p>Art 48.1.i. voltage level and location of each power generating module.</p> <p>Art 48.2. Each power generating facility owner of a power generating module which is a SGU in accordance with Art 2.1.a and Art 2.1.e shall inform the TSO and the DSO to which it has a connection point, within the agreed time and not later than the first commissioning or any changes to the existing installation, about any change in the scope and the contents of the data listed in paragraph 1</p>		<p>make sure that Generators were comfortable for the DNO's to forward that data to us which would be similar to the arrangements in Schedule 3 of the STC.</p> <p>The section on FCR, FRR and RR will require new sections of Grid Code and D Code drafting.</p>
49	<p>Scheduled Data Exchange</p> <p>Unless otherwise provided by the TSO, each power generating facility owner of a power generating module which is a SGU in accordance with Art 2.1.a and Art 2.1.e connected to the distribution system shall provide the TSO and the DSO to which it has the connection point, with at least the following data:</p> <p>(a) its scheduled unavailability, scheduled active power restriction and its forecasted scheduled active power output at the connection point;</p> <p>(b) any forecasted restriction in the reactive power control capability; and</p> <p>(c) as an exception to paragraphs (a) and (b), in regions with a central</p>	<p>For (a) the D Code only applies to HV customers/generators – and to generators >1MW currently – and will need modifying to line up fully with Art 49 requirements (ie Type B generators; demand SGUs probably already covered – although the MW threshold might need removing in DOC1.3 and DOC1.5.4. However this data in general from small power stations is not specified in the Grid Code so it is not clear if all the data that DNOs collect should just be sent to NG, or if NG need to specify what they want per site.</p> <p>For (b) this is probably not asked for specifically – unless it is part of Output Usable – so again NG will need to specify what is required and which will then need to be reflected in the D Code.</p>	<p>NG has to work with DNOs to agree exchange of all scheduled data for distribution connected generating modules. Currently this is exchanged directly through contracts but Grid code amendments, new processes for exchanging directly between TSO and DNOs and potentially new roles will be required.</p> <p>The issue could be resolved if the DDRC was updated to reflect similar requirements to the DRC (Sched 2 and 3) and then forwarded on to NG.</p>

Art	SOGL Text	D Code Implications	Grid Code Implications
	dispatch system, data requested by the TSO for the preparation of its active power output schedule.		
50	<p>Real-time data exchange</p> <p>Art 50.1. Unless otherwise provided by the TSO, each power generating facility owner of a power generating module which is a SGU in accordance with Art 2.1.a and Art 2.1.e connected to the distribution system shall provide the TSO and the DSO to which it has the connection point, in real-time, at least the following data:</p> <p>Art 50.1.a. status of the switching devices and circuit breakers at the connection point; and</p> <p>Art 50.1.b. active and reactive power flows, current, and voltage at the connection point.</p> <p>Art 50.2. Each TSO shall define in coordination with the responsible DSOs which SGUs may be exempted from providing the real-time data listed in paragraph 1 directly to the TSO. In such cases, the responsible TSOs and DSOs shall agree on the aggregated real-time data of the SGUs concerned to be delivered to the TSO.</p>	<p>The first challenge is to agree if the data is to be cascaded via the DNO or provided direct. All the existing assumptions are cascaded – this needs confirming.</p> <p>There is little existing D Code text dealing with this – see DPC6.7. This needs to be reviewed in the light of applying retrospectively to approximately 50k existing installations. How is this information to be handled/managed? How will it be passed between DNO and NG? ie both NG and the DNOs will have to agree data transfer arrangements – probably requiring (a) the installation ICC links and (b) potentially new data storage infrastructure.</p> <p>Or should the current DPC6.7 approach be ceased; DNOs to provide a technical spec and customers provide the data and data coms to the DNO – maybe via the internet?</p> <p>50.1.a – it is a moot point if this information is of any use at all. 50.1.b is reasonable data once the basic infrastructure (ie site comms) is in place, but all sites will need fitting with the relevant transducers in addition.</p> <p>50.2 – this might be a sensible approach to adopt in GB – but it will need NG to specify what is required to satisfy this, and then for DNOs and NG to agree the IT etc and systems implications. This would be a significant non-trivial project. Will need some appropriate expertise to cost it, but needs a high level requirement first from NG.</p> <p>Finally, because of KORRR10.5 all refresh times will need to be <60s which will comms investment and operating costs.</p>	<p>NG has to work with DNOs to agree exchange of all real time data for distribution connected generating modules. A cascading approach would allow for data to be exchanged through Grid code amendments, new systems and new data storage arrangements, new roles would be required to deal with these changes.</p> <p>This issue can be solved by ICCP links as noted for Art 44. This can be addressed by adding a new section to the Grid Code in Section 6.4. Ofgem would need to be involved in apportioning costs.</p>
51	<p>Data exchange between TSOs and DSOs concerning significant power generating modules</p> <p>Art 51.1. Unless otherwise provided by the TSO, each DSO shall provide to its TSO the information specified in Article 48, Article 49 and Article</p>	<p>NG needs to specify this to the DNOs</p>	<p>For structural this would follow the week 24 / week 48 and the proposed submission for week 50.</p> <p>For real time data the requirements are covered in TS.3.24.100 and the Bilateral Agreement which covers issues such as</p>

Art	SOGL Text	D Code Implications	Grid Code Implications
	<p>50 with the frequency and level of detail requested by the TSO.</p> <p>Art 51.2. Each TSO shall make available to the DSO, to whose distribution system SGUs are connected, the information specified in Article 48, Article 49 and Article 50 as requested by the DSO.</p> <p>Art 51.3. A TSO may request further data from a power generating facility owner of a power generating module which is a SGU in accordance with Art 2.1.a and Art 2.1.e connected to the distribution system, if it is necessary for the operational security analysis and for the validation of models.</p>		<p>refresh rate and accuracy etc.</p>
52	<p>Data exchange between TSOs and distribution-connected demand facilities or third parties participating in demand response</p> <p>Art 53.1. Unless otherwise provided by the TSO, each SGU which is a distribution-connected demand facility and which participates in demand response other than through a third party shall provide the following scheduled and real-time data to the TSO and to the DSO:</p> <p>Art 53.1.a. structural minimum and maximum active power available for demand response and the maximum and minimum duration of any potential usage of this power for demand response;</p> <p>Art 53.1.b. a forecast of unrestricted active power available for demand response and any planned demand response;</p> <p>Art 53.1.c. real-time active and reactive power at the connection point; and</p> <p>Art 53.1.d. a confirmation that the estimations of the actual values of demand response are applied.</p> <p>Art 53.2. Unless otherwise provided by the TSO, each SGU which is a third party participating in demand response as defined in Article 27 of Regulation (EU) 2016/1388, shall provide the TSO and the DSO at the day-ahead and close to real-time and on behalf of all of its distribution-connected demand</p>	<p>A first assumption might be that this data could be included in any contract that NG let with a demand service provider.</p> <p>It is a moot point, since this only applies to T contracted DSR, if there is any need at all to include in the D Code.</p> <p>If there is a need to include these provisions in the D Code then it is probably a simple modification to DOC 1.3 to remove the 5MW limit on Suppliers and Customers – and probably to add in aggregators.</p> <p>However there would need to be a Grid Code or similar modification to cause the DNO to then forward this to NG.</p>	<p>Art 52 applies to demand facilities that are directly connected and hence would be a CUSC party. They would be treated as a Non Embedded Customer where the data required is already submitted under the current Grid Code provisions. . If demand response services are to be provided this would be caught under the C16 process.</p> <p>Art 53 is more complex but would be caught under the C16, Standard Contract terms. There is however provision within the DRSC (as introduced for DCC implementation) to add in these additional data items..</p>

Art	SOGL Text	D Code Implications	Grid Code Implications
	<p>facilities, with the following data:</p> <p>Art 53.2.a. structural minimum and maximum active power available for demand response and the maximum and minimum duration of any potential activation of demand response in a specific geographical area defined by the TSO and DSO;</p> <p>Art 53.2.b. a forecast of unrestricted active power available for the demand response and any planned level of demand response in a specific geographical area defined by the TSO and DSO;</p> <p>Art 53.2.c. real-time active and reactive power; and</p> <p>Art 53.2.d. a confirmation that the estimations of the actual values of demand response are applied.</p>		

The Workgroup then met on 16 May 2018 to discuss the way forward with regards to the alternatives. Concerns were raised by some Workgroup members around the scale of work that would need to be completed by the Workgroup to fully work up them up to be submitted to the Authority.

WAGCM1 was the main concern for some workgroup members since it is based on a legal interpretation and requested that advice be sought from the Grid Code Panel around the best way to proceed and whether to fully develop the legal text for the alternative.

Panel direction under GR20.8

The Code Administrator circulated the WAGCMs as outlined in Section 6 of the Report and scope of work required as outlined above to the Panel for their consideration under Governance Rules GR20.8. The presentation provided to the Grid Code Panel with options can be found in the June 2018 Panel papers. <https://www.nationalgrideso.com/codes/grid-code/meetings/grid-code-panel-28-june-2018>

The Panel instructed the Workgroup to fully develop WAGCM2 but not WAGCM1 or 3 since WAGCM1 was based on a legal interpretation and WAGCM3 is a combination of WAGCM1 and WAGCM2. They extended the timeline to accommodate this. This was based on the original drafting of WAGCM2.

WAGCM1 and WAGCM3

Following the Panel's decision to instruct the Workgroup not to fully work up these WAGCMs under GR20.8 it was highlighted by the Code Administrator that

following the conclusion of the Workgroup and ahead of the issuing of the Code Administrator a letter will need to be sent from the Panel to the Authority under GR21.5 outlining the reasoning behind the decision.

WAGCM2 and development

The Workgroup then met a further two times on the 4 July 2018 and the 1 August 2018 to discuss WAGCM2.

NGESO provided a presentation to the Workgroup on the 1 August 2018 that outlined their view on some potential harmonised thresholds for WAGCM2. The presentation also outlined their view on the fact that the defect highlighted under WAGCM2 should be addressed via modification ***GC0117 Improving transparency and consistency of access arrangements across GB by the creation of a pan-GB commonality of PGM requirements*** that has been raised by SSE Generation Ltd.

Second Panel direction under GR20.8

The Workgroup again requested further guidance from the Grid Code Panel following the discussions that they had held on the best way to proceed and whether an extension to the agreed timeline could be made due to the amount of work still required. This presentation, which was drafted by the Workgroup can be located in the August 2018 Panel papers.

<https://www.nationalgrideso.com/codes/grid-code/meetings/grid-code-panel-meeting-15-august-2018>

The presentation outlined some concerns raised around the WAGCM in terms of:

- The Workgroup not agreeing on the threshold to be used to gain a harmonised approach (10MW, 30MW, 100WM or new?)
 - E&W approach results in lower implementation costs compared to Scotland
 - Impact on system operation
- The implementation risk should the WAGCM be approved by the Authority
- The scale of the impact and whether a further workgroup consultation would be required

They also highlighted what had been completed to date:

- Part of the Grid Code legal text had developed, Distribution Code implications were yet to be considered
 - Real time data ECC.6.4.4 text circulated but data transfer mechanism need to be discussed and agreed
 - Structural data PC3.3 text circulated – but detailed consideration of DDRC v DRC not yet started
 - Scheduled data OC2 and BC1/2 changes are more complex and require consideration
 - Table below outlining the potential cost impacts with assumptions outlined below;

	Original Proposal	WAGCM2 (a)	WAGCM2 (b)
DNO/TSO ICCP links	No	No	Yes- approx. £250k per DNO
Generator data links	No	No	Yes – approx £30k per site
Database updates	No	Yes	Yes
Process updates	Yes- DNO	Yes (TSO, DNO, generators)	(TSO, DNO, generators)

Table notes:

Costs very preliminary estimates

Assumes WAGCM2(a) – threshold set at 100MW¹¹; WAGCM2(b) – threshold set at 10MW

At least 2000 generator sites are impacted hence looking at £20m retrospective project

The presentation also outlined that some Workgroup members were of the view that:

- Unable to develop legal text before CA consultation and the RTA because:
 - It will take too long and will mean that the other parts of GC0106 won't be delivered in time for March
 - Data exchange thresholds can't be changed without consideration for regional differences, cost and security
 - there is a significant cost associated with WAGCM2 if a Scottish threshold option is selected - and given the physical work on site there would be a very real risk of multiple party non-compliance
 - The concept of the WAGCM is acceptable but it would be better and efficiently addressed properly in a more considered way as part of GC0117 - or another new proposal just to consider the concept of WAGCM2

The Grid Code Panel discussed this on the 15 August 2018. The Authority stated that they would like to receive the full legal text for WAGCM2. The Panel asked

¹¹ The proposer of WAGCM2 noted that it was not linked to 100MW but to the Type B, Type C and Type D thresholds.

what stage the draft legal text had been developed to in order to understand the scale of work still required to complete the development of the WAGCM.

The Panel requested that the Proposer of the WAGCM circulate a draft of the legal text for the WAGCM ahead of the next Workgroup meeting. They understood that the Workgroup had developed some of this and requested comments be provided on what had already been drafted in order to expedite the process.

WAGCM2 further development

The Proposer of WAGCM2 provided comments on the legal text that had been developed to date and a meeting was facilitated between the Proposer of the WAGCM and NGENSO on the 28 August 2018 to discuss it further.

The Proposer of WAGCM2 made a decision on the 28 August that the WAGCM should only cover the harmonisation of Transmission Connected SGUs. NGENSO provided an overview at the subsequent meeting, on the 17 September outlining the impact of this amendments and what legal text would be required to fully develop the amended WAGCM scope.

NGENSO updated the Workgroup on the discussion held as outlined below:

- That this amendment to the scope makes the process much simpler as any party who is directly connected (irrespective of size) will need to sign the CUSC and satisfy the applicable requirements of the Grid Code in addition to satisfying the requirements of the BSC (ie party to the wholesale market) which is an important element of the Scheduled data.
- It was noted that there would still be a difference between the data requirements for Embedded Power Stations connected in different Transmission areas. It was noted that this issue could be addressed in full through changing the terms of Reference for GC0117.
- SOGL does allow flexibility in selecting the data required from SGUs at a National level.
- For Transmission connected SGUs, across GB, checks would need to be made that the data supplied by Generators in respect of Transmission connected Small, Medium and Large Power Stations are the same, in accordance with the requirement to harmonize, based on the Type B, Type C and Type D data obligation respectively (as set out in SOGL Articles 40-53).

NGENSO representatives went onto explain that:

- Under SOGL the data to be covered includes:
 - Structural Data
 - Scheduled Data
 - Real Time Data
- A review of the Grid Code reveals there are some differences in the data between Transmission Connected Small, Medium and Large Power Stations but these are relatively minor
 - The principle changes relate to structural data and scheduled data with very limited impact on real time data

DRC Schedule	Transmission Connected Small	Transmission Connected Medium	Transmission Connected Large
Schedule 1 – Power Generating Module and HVDC Data	•	•	•
Schedule 2 – Generating Planning Parameters		• (Part)	•
Schedule 3 – Large Power Station Outage Programmes, Output Useable and Flexibility Information			•
Schedule 4 – Large Power Station Droop and Response Data			•
Schedule 5 – Users System Data	•	•	•
Schedule 6 – Users Outage Information	•	•	•
Schedule 7 – Load Characteristics at Grid Supply Points			
Schedule 8 – Data supplied by BM Participants	•	•	•
Schedule 9 – Data supplied by The Company to User's	•	•	•
DRC Schedule			
Schedule 10 – Demand Profiles and Active Energy Data			
Schedule 11 – Connection Point Data			
Schedule 12 – Demand Control			
Schedule 13 – Fault Infeed Data			
Schedule 14 – Fault Infeed Data (Generators)	•	•	•
Schedule 15 – Mothballed Generating and HVDC Data	•	•	•
Schedule 16 – Black Start Information			•
Schedule 17 – Access Period Data			

Schedule 18 – Offshore Transmission System Data			
Schedule 19 – User Data File Structure Data	•	•	•

DRC Structural and Scheduled data differences – Transmission Connected Small, Medium and Large Power Stations (1)

It was concluded that the legal text could now be fully developed and circulated ahead of the final Workgroup meeting for review. The final WAGCM2 legal text and scope can be located in Section 6 (the alternative form)

NGESO summary on limiting WAGCM2 to transmission connected SGUs

The more limited interpretation of WAGCM2 as developed by the proposer applies the harmonisation principle to transmission connected only. It is a more pragmatic interpretation than trying to harmonise between transmission and distribution connected plant which would be a larger task, particularly due to the retrospective application. The actual code changes required in the application to transmission connected only are now relatively minor, although this will still need considerable work with existing stakeholders to understand the differences and ensure compliance. The benefit is not apparent or quantified though, and the WAGCM is not in keeping with the implementation approach of only making those changes necessary. And this harmonisation principle would be better addressed in a more comprehensive rather than selective manner in GC0117.

NGESO views on the need for a full list of all the data items that we weren't going to ask for

National Grid in its role as the GB System Operator has duties under SOGL as clarified and directed by Ofgem in their decision to assign Transmission System Operator (TSO) obligations for this code. In various places in SOGL articles 40-53 which GC0106 implements in GB the requirements for data items are set out as being 'unless otherwise provided by the TSO'. The intent of this clause as drafted by ENTSO-E was to allow the applicable TSO flexibility in applying SOGL nationally to only require from users those items necessary. This is backed up in the German translation which is 'unless otherwise determined by the TSO'. An alternative interpretation proposed by a workgroup member is however explored in WAGCM1.

In keeping with the advice received from Ofgem in 2014 regarding the approach to be taken in the GB implementation of the European Network Codes, National Grid has advocated using the existing GB frameworks and making only those changes necessary to ensure alignment. For the data exchange requirements in GC0106, in general this has meant interpreting the flexible approach allowed in the code to require only those data items from users as currently set out in the GB frameworks.

A workgroup member has set out that they wish a full listing of all additional data items that the TSO has the right to ask for but which are not going to be required

from users or groups of users to be produced. The majority of the workgroup felt that this would not be practical as it is difficult to be exhaustive or accurate in describing the detail of all possible data items that are not required or the subsets of users that are not being required to produce them. This would set an inefficient precedent and is not in keeping with the transmission licence. It adds little value in any case by setting out obligations that are not currently being placed on users given that if at any point in the future the need for further data items covered by SOGL articles 40-53 but for which users are not currently obligated was identified, to place such an additional requirement on users in GB could not be done directly but would have to be achieved by seeking a further modification to the GB frameworks which would need to be separately justified and approved by the Authority. Failure to use the existing GB processes, despite the licence obligations on National Grid and the precedents established, would likely constitute an infringement and would be untenable.

6.Alternative solutions

Please find below the three alternative forms put forward by SSE Generation Ltd. The legal text for WAGCM2 can be located in Annex 8. The Grid Code Panel were consulted twice under GR20.8 as to whether to fully develop the legal text for WAGCM1 and 3, the discussions and decisions on this can be found in the Workgroup discussion section and Annex 7. Please note that no legal text has been developed for WAGCM1.

Alternative request Proposal form

Grid Code

Modification potential alternative submitted to:

What stage is this document at?

GC0106 WAGCM1

Mod Title: As per original (TSO to provide where DSOs/SGUs do not provide)

Purpose of alternative Proposal: As per the Original.

Date submitted to Code Administrator: 9th May 2018

You are: A Workgroup member

Workgroup vote outcome: Formal alternative

01 Proposed Alternative

02 Formal Workgroup Alternative



Any Questions?

Contact:

Chrissie Brown

Code Administrator



christine.brown1@nationalgrid.com



01926 65 3328

Alternative Proposer(s):

Garth Graham

SSE Generation Ltd



Contents

1	Alternative proposed solution for workgroup review.....	2
2	Difference between this proposal and Original	2
3	Justification for alternative proposal against Grid Code objectives.....	3
4	Impacts and Other Considerations.....	3
5	Implementation	4
6	Legal Text.....	4

1 Alternative proposed solution for workgroup review

During the assessment of the GC0106 original proposal questions arose as to the legal position with respect to the form of words that appear in:

Articles 44 and 51 (concerning DSOs);
Article 47 (concerning SGUs);
Articles 48, 49 and 50 (concerning power generating facility owners of a power generating module which are an SGU);
Article 52 (concerning transmission connected demand facility owners); and
Article 53 (concerning distribution connected SGUs which participate in demand response to third parties).

The form of words (which appear in a very closely similar form in the above-mentioned Articles) is:

“Unless otherwise provided by the TSO, each DSO shall provide its TSO, in real-time, the information related to” [taken from Article 44]

The legal questions that arose from this form of wording is detailed in Annex 2, together with the Workgroup discussion in Section 9, of the Workgroup consultation.

This Alternative proposal will set out that, for each of the relevant Articles noted above, that where the TSO can provide one or more of the relevant data items set out in the Article(s) that it will provide that data to itself and thus the relevant stakeholder will not therefore be required to themselves provide that same one (or more) data item(s) to the TSO.

For the avoidance of doubt, where the TSO does not provide the said data item(s) then the relevant stakeholder will provide that same data item(s) themselves to the TSO (and / or DSO, if applicable).

2 Difference between this proposal and Original

This Alternative proposal will use all the same changes in the original GC0106 proposal except where the Original proposal deals with the provision (or non-provision) of the data items related to the Articles listed in (1) above; where this Alternative proposal will make it clear that only where the TSO itself provides the said data item(s) does the relevant stakeholder not need to provide that same data item(s).

3 Justification for alternative proposal against Grid Code objectives

The justification for this Alternative proposal is set out in Annex 2, together with the Workgroup discussion in Section 9, of the Workgroup consultation.

Impact of the modification on the Relevant Objectives:	
Relevant Objective	Identified impact
To permit the development, maintenance and operation of an efficient, coordinated and economical system for the transmission of electricity	Positive
To facilitate competition in the generation and supply of electricity (and without limiting the foregoing, to facilitate the national electricity transmission system being made available to persons authorised to supply or generate electricity on terms which neither prevent nor restrict competition in the supply or generation of electricity)	Positive
Subject to sub-paragraphs (i) and (ii), to promote the security and efficiency of the electricity generation, transmission and distribution systems in the national electricity transmission system operator area taken as a whole	Positive
To efficiently discharge the obligations imposed upon the licensee by this license and to comply with the Electricity Regulation and any relevant legally binding decisions of the European Commission and/or the Agency; and	Positive
To promote efficiency in the implementation and administration of the Grid Code arrangements	Positive/Negative/Neutral

By clarifying the legal questions that arose in the GC0106 Workgroup assessment, as set out in Annex 2 and Annex 3, this Alternative proposal will ensure that the Authority will be able to implement the proposal (be that the Original or the Alternative) that ensures legal compliance with EU law.

4 Impacts and Other Considerations

As per the Original.

Consumer Impacts

As per the Original.

5 Implementation

As per the Original.

6 Legal Text

As per the Original, except with respect to the Articles (see below) where the form of wording used relates to the TSO providing the data item(s) where, in this case it will be clear, in the legal text, that if the TSO does not provide the said data item(s) then the relevant stakeholders shall provide that same data item(s).

Articles 44 and 51 (concerning DSOs);

Article 47 (concerning SGUs);

Articles 48, 49 and 50 (concerning power generating facility owners of a power generating module which are an SGU);

Article 52 (concerning transmission connected demand facility owners); and

Article 53 (concerning distribution connected SGUs which participate in demand response to third parties).

[end]

GC0106 WAGCM2

As per original (Ensuring a non-discriminatory approach by the TSO to data provision as well as a 'level playing field' between relevant stakeholders)

Purpose of alternative Proposal: As per the Original.

What stage is this document at?

- 01 Proposed Workgroup alternative
- 02 Formal Workgroup alternative



Any Questions?

Contact:

Chrissie Brown
Code Administrator



christine.brown1@nationalgrid.com

Alternative Proposer:
Garth Graham
SSE Generation Ltd

Contents

1	Alternative proposed solution for workgroup review.....	2
2	Difference between this proposal and Original	6
3	Justification for alternative proposal against Grid Code objectives	6
4	Impacts and Other Considerations.....	7
5	Implementation	7
6	Legal Text.....	7

1 Alternative proposed solution for workgroup review

During the assessment of the GC0106 Original proposal it was clear that a non-harmonised and discriminatory approach to data exchange was to be applied. This is most simply illustrated by examining the table on page 6 of the Workgroup consultation document which clearly shows that a different, non-harmonised, and discriminatory approach is to be applied (according to GC0106 Original) to the data exchange obligations for Type C and for Type D generators in GB.

As the Scope of SOGL (Article 2) makes clear:

“The rules and requirements set out in this Regulation shall apply to the following SGUs: (a) existing and new power generating modules that are, or would be, classified as type B, C and D in accordance with the criteria set out in Article 5 of Commission Regulation (EU) 2016/631”

This is picked up in the data exchange part of the SOGL, namely Title 2, Chapter 1 (Articles 40-53), which refers to SGUs (as well as DSOs and TSO, as applicable) and, in certain specific parts of the relevant Articles, to Type B, Type C and Type D generators.

This, for example, is illustrated by looking at Article 45 (structural data) Article 46 (scheduled data) and Article 47 (real time data) which sets out the various data exchange obligations for transmission connected generators.

In respect of generators connected at distribution level, the data exchange obligations are set out in Article 48 (structural data) Article 49 (scheduled data) and Article 50 (real time data).

The following two Tables set this out in terms of Transmission and Distribution connected generation respectively:

Red – no obligation to provide data

Green – obligation to provide data

Amber – possible obligation to provide data

Purple – data may possibly be provided in aggregate by DSO to TSO, rather than by the generator

Article	Paragraph	Type B	Type C	Type D
45	1	Red	Red	Green
	2	Green	Green	Red
	3	Amber	Amber	Amber
46	1	Green	Green	Green
47	1	Green	Green	Green

Table 2 - Distribution connected				
Article	Paragraph	Type B	Type C	Type D
48	1			
	2			
49	[1]			
50	1			

That this common minimum requirement, for example, in terms of real time data exchange (for both Transmission and Distribution connected generation) applies to Types B, C and D generators (and not Type A) is not surprising as it was set out by ENTSOE back in November 2016 when; in setting the real data capabilities that newly connecting generator plant had to be equipped to provide; it was noted by ENTSOE that:

“...the mere capability to exchange information is required for all SGU’s, except Type A generators and demand facilities.”

The following paragraph from ENTSOE stated that:

“Through the implementation of the Guideline on transmission system operation (SO GL) a methodology will be created where the generic rules will be specified to the required details.”

As ENTSOE noted, the data exchange aspects, in turn, stem from the ACER Framework Guidelines which established:

“Paragraph 3.1: “... The network code(s) shall set out the procedures and requirements to coordinate and ensure information sharing between ... System operator and significant grid user ...”. “These procedures and requirements shall be defined with the agreement of all affected parties”.

Paragraph 3.2: “... The network code(s) shall set the requirement for every significant grid user to be able and obliged to provide the necessary real-time operational information to the DSO and TSO that their connection has significant impact upon. The network code(s) shall set the requirement for every significant grid user to be able to receive and to execute the instructions sent by the TSO and/or DSO, on a contractual basis or in critical operating state.”

ACER FWGL also states that the network code(s) shall define a harmonized standard according to which information shall be provided for grid connection at the connection point by TSO and DSO.

Similarly, the network code(s) shall define what information and technical data the significant grid user has to provide to the TSO or DSO to which it is connected and how this data is to be provided to ensure the operational security of the system. ”

As set out in GC0100 the proposed size banding¹ in GB for generators will be²:

¹ Any generator connected at 110kV or above would be classified as Type D.

² As at the date of writing this WAGCM, 9th May 2018, Ofgem has still to opine on GC0100.

Either (GC0100 Original):

Type B 1-9.9MW, Type C 10-49.9MW and Type D 50MW+

Or (GC0100 WAGCM1):

Type B 1-49.9MW, Type C 50-74.9MW or Type D 75MW+

This GC0106 Alternative proposal would ensure that, based on the generator Types set out in the SOGL, that all GB generators (be they new or existing³) of the three respective types of generator (Types B, C and D) will provide the requisite scheduled, structural and real time data in accordance with the SOGL (as summarised in the above two tables), depending upon the network they are connected at.

This will ensure that a level playing field, as regards data exchange requirements, is applied to all these new and existing generators across GB.

For transmission connected generators:

All Type B (T connected) generators will be treated the same as any other Type B (T) generator, all Type C (T) generators will be treated the same as any other Type C (T) generator and all Type D (T) generators will be treated the same as any other Type D (T) generator.

For distribution connected generators:

All Type B (D connected) generators will be treated the same as any other Type B (D) generator, all Type C (D) generators will be treated the same as any other Type C (D) generator and all Type D (D) generators will be treated the same as any other Type D (D) generator.

Thus, for example, assuming that Ofgem approves GC0100 (Original) then (with this GC0106 Alternative proposal) any transmission connected generator in GB that is between 10-49.9MW (and not connected at 110kV) would, as Type C, be required to provide the data items set out in Article 45 (2) (and possibly (3)), Article 46 (1) and Article 47(1) irrespective of whether, currently, they are classified as 'small', 'medium' or 'large'.

A similar approach would also be applied in terms of Types B and D generators that are transmission connected.

Equally, assuming that Ofgem approves GC0100 (Original), then (with this GC0106 Alternative proposal) any distribution connected generator in GB that is between 10-49.9MW (and not connected at 110kV) would, as Type C, be required to provide the data items set out in Article 48 (1) & (2), Article 49 (1) and Article 50 (1)⁴ irrespective of whether, currently, they are classified as 'small', 'medium' or 'large'.

³ As defined within the respective EU Network (Codes) Guidelines / Regulations.

⁴ The data may possibly be provided in aggregate by DSO to TSO, rather than by the generator.

A similar approach would also be applied in terms of Types B and D that are distribution connected.

For the avoidance of doubt, this Alternative proposal would only apply the data exchange requirements on GB generators in accordance with the SOGL (as summarised in the above two Tables).

This means, for example, that all Type B and Type C generators (transmission connected) would not need to provide the structural data items listed in paragraph 1 of Article 45 and, equally, all Type D generators (transmission connected) would not need to provide the structural data items listed in paragraph 2 of Article 45.

Currently the GC0106 (Original) proposal, as summarised in the Table on page 6 of the Workgroup consultation document, would treat some Type C generators in GB differently from each other. A similar approach is applied to Type D generators as well. Not only is this a non harmonised approach it is also discriminatory. In addition it is not a level playing field.

In terms of harmonisation, it is a requirement of SOGL that a harmonised approach is applied and the importance of this is witnessed by it being the third Recital of the Regulation:

“(3) Harmonised rules on system operation for transmission system operators (‘TSOs’), distribution system operators (‘DSOs’) and significant grid users (‘SGUs’) should be set out in order to provide a clear legal framework for system operation, facilitate Union-wide trade in electricity, ensure system security, ensure the availability and exchange of necessary data and information between TSOs and between TSOs and all other stakeholders, facilitate the integration of renewable energy sources, allow more efficient use of the network and increase competition for the benefit of consumers.”

In terms of non-discrimination, Recital (13) as Article 4 of SOGL makes clear that:

“(13) The provisions on LFC and reserves, aim at setting out clear, objective and harmonised requirements for TSOs, reserve connecting DSOs, providers' power generating modules and providers' demand facilities in order to ensure system security and to contribute to non-discrimination, effective competition and the efficient functioning of the internal electricity market. The provisions on LFC and reserves provide the technical framework necessary for the development of cross-border balancing markets.”

The linkage of Recital (13) to data exchange is shown by reference, for example, to Article 45 (1) (e), (f) & (g), Article 45 (2) (c), (d) & (e) and Article 48 (1) (b), (c) & (d).

Note: This WAGCM2 assumes that all other aspects of the GC0106 (Original) applies and this means that the ‘TSO to provide where

DSOs/SGUs do not provide' matter (set out in WAGCM1) would not apply to this WAGCM2.

For the avoidance of doubt, this would mean that if the TSO, for example, 'provided' that Type C generators did not need to provide, as per Article 47 (1) (c), "*in the case of power generating facility with consumption other than auxiliary consumption net active and reactive power*" then no Type C generator in GB would need to provide this real time data item.

However, with WAGCM2, it would not permit the TSO to adopt a non-harmonised and/or a discriminatory approach in terms of the TSO 'providing' that certain Type C generators would, and some Type C would not, need to provide (in this example) this real time data item.

Please see the Workgroup discussion section of the GC0106 modification for more information on the evolution of the WAGCM2 solution.

2 Difference between this proposal and Original

This Alternative proposal will use all the same changes in the Original GC0106 proposal except where the Original proposal deals with the data items related to the Articles listed in (1) above; where this Alternative proposal will make it clear that a harmonised and non-discriminatory approach (as detailed in (1) above) will be applied (rather than the GC0106 Original approach).

3 Justification for alternative proposal against Grid Code objectives

The justification for this Alternative proposal is as set out in (1) above in that it applies a harmonised and non-discriminatory solution to the GC0106 defect.

Impact of the modification on the Relevant Objectives:

Relevant Objective	Identified impact
To permit the development, maintenance and operation of an efficient, coordinated and economical system for the transmission of electricity	Positive
To facilitate competition in the generation and supply of electricity (and without limiting the foregoing, to facilitate the national electricity transmission system being made available to persons authorised to supply or generate electricity on terms which neither prevent nor restrict competition in the supply or generation of electricity)	Positive

Subject to sub-paragraphs (i) and (ii), to promote the security and efficiency of the electricity generation, transmission and distribution systems in the national electricity transmission system operator area taken as a whole	Positive
To efficiently discharge the obligations imposed upon the licensee by this license and to comply with the Electricity Regulation and any relevant legally binding decisions of the European Commission and/or the Agency; and	Positive
To promote efficiency in the implementation and administration of the Grid Code arrangements	Neutral

By clarifying that a harmonised and non-discriminatory solution to the GC0106 defect will be applied, this Alternative proposal will ensure that the Authority will be able to implement the proposal (be that the Original or the Alternative) that ensures legal compliance with EU law.

4 Impacts and Other Considerations

Number of users impacted by WAGCM2	Based on TEC from October 2018 there are 40 sites affected as follows: <ul style="list-style-type: none"> - 28 in England and Wales - 12 in SPT area https://www.nationalgrideso.com/connections/registers-reports-and-guidance
------------------------------------	--

5 Implementation

As per the Original.

6 Legal Text

As per the Original, except with respect to those Articles related to:

For transmission connected generators:

Article 45 (structural data);
Article 46 (scheduled data); and
Article 47 (real time data).

For distribution connected generators:

Article 48 (structural data);
Article 49 (scheduled data); and
Article 50 (real time data).

Where it will be clear that a harmonised and non-discriminatory application of the SOGL will be applied, as summarised in Tables 1 and 2:

Table 1 - Transmission connected

Article	Paragraph	Type B	Type C	Type D
45	1			
	2			
	3			
46	1			
47	1			
Table 2 - Distribution connected				
Article	Paragraph	Type B	Type C	Type D
48	1			
	2			
49	[1]			
50	1			

Thus, for example, Type B and Type C generators (transmission connected) would not need to provide the structural data items listed in paragraph 1 of Article 45 and, equally, Type D generators (transmission connected) would not need to provide the structural data items listed in paragraph 2 of Article 45.

Please find the full proposed legal text in Annex 8.

Modification potential alternative submitted to:

What stage is this document at?

GC0106 WAGCM3

Mod Title: As per original (i) TSO to provide where DSOs/SGUs do not provide and (ii) Ensuring a non-discriminatory approach by the TSO to data provision as well as a 'level playing field' between relevant stakeholders.

Purpose of alternative Proposal: As per the Original.

Date submitted to Code Administrator: 9th May 2018

You are: A Workgroup member

Workgroup vote outcome: Formal alternative

01	Proposed alternative
02	Formal Workgroup Alternative



Any Questions?

Contact:

Christine Brown

Code Administrator



christine.brown1@nationalgrid.com

Alternative Proposer:

Garth Graham

SSE Generation Ltd

Contents

1	Alternative proposed solution for workgroup review.....	2
2	Difference between this proposal and Original	3
3	Justification for alternative proposal against Grid Code objectives	3
4	Impacts and Other Considerations.....	4
5	Implementation	4
6	Legal Text.....	4

1 Alternative proposed solution for workgroup review

During the assessment of the GC0106 Original proposal questions arose as to:

(i) the legal position with respect to the form of words that appear in:

Articles 44 and 51 (concerning DSOs);
Article 47 (concerning SGUs);
Articles 48, 49 and 50 (concerning power generating facility owners of a power generating module which are an SGU);
Article 52 (concerning transmission connected demand facility owners); and
Article 53 (concerning distribution connected SGUs which participate in demand response to third parties).

And

(ii) a non harmonised and discriminatory approach to data exchange was to be applied.

Formal WACMs have been raised for each of these two aspects, with item (i) being specifically address in WACM1 and item (ii) being specifically addressed in WACM2.

However, both WACM1 and WACM2 are stand alone proposal.

This WACM3 Alternative is simply a combination of the WACM1 approach in terms of the TSO to provide where DSOs/SGUs do not provide and WACM2 in terms of ensuring a non-discriminatory approach by the TSO to data provision as well as a 'level playing field' between relevant stakeholders.

For the avoidance of doubt the 'note' at the end of Section1 of WACM2 – see below¹ – is, for obvious reasons, the only part of WACM2 that does not apply in terms of WACM3

¹ Note: This WACM2 assumes that all other aspects of the GC0106 (Original) applies and this means that the 'TSO to provide where DSOs/SGUs do not provide' matter (set out in WACM1) would not apply to this WACM2.

For the avoidance of doubt, this would mean that if the TSO, for example, 'provided' that Type C generators did not need to provide, as per Article 47 (1) (c), "*in the case of power generating facility with consumption other than auxiliary consumption net active and reactive power*" then no Type C generator in GB would need to provide this real time data item.

However, with WACM2, it would not permit the TSO to adopt a non harmonised and/or a discriminatory approach in terms of the TSO 'providing' that certain Type C generators would, and some Type C would not, need to provide (in this example) this real time data item."

2 Difference between this proposal and Original

This Alternative proposal will use all the same changes in the original GC0106 proposal except where (i) the Original proposal deals with the provision (or non-provision) of the data items related to the Articles listed in WACM1 and (ii) where the Original proposal deals with the data items related to the Articles listed in WACM2, where this Alternative proposal will make it clear that a harmonised and non-discriminatory approach (as detailed in WACM2) will be applied (rather than the GC0106 Original approach).

3 Justification for alternative proposal against Grid Code objectives

The justification for this Alternative proposal is as set out in WACMs 1 and 2.

Impact of the modification on the Relevant Objectives:	
Relevant Objective	Identified impact
To permit the development, maintenance and operation of an efficient, coordinated and economical system for the transmission of electricity	Positive
To facilitate competition in the generation and supply of electricity (and without limiting the foregoing, to facilitate the national electricity transmission system being made available to persons authorised to supply or generate electricity on terms which neither prevent nor restrict competition in the supply or generation of electricity)	Positive
Subject to sub-paragraphs (i) and (ii), to promote the security and efficiency of the electricity generation, transmission and distribution systems in the national electricity transmission system operator area taken as a whole	Positive
To efficiently discharge the obligations imposed upon the licensee by this license and to comply with the Electricity Regulation and any relevant legally binding decisions of the European Commission and/or the Agency; and	Positive
To promote efficiency in the implementation and administration of the Grid Code arrangements	Neutral

4 Impacts and Other Considerations

As per the Original.

Consumer Impacts

As per the Original.

5 Implementation

As per the Original.

6 Legal Text

As per the Original, except with respect to those Articles as set out in WACMs 1 and 2.

[end]

7.Implementation

This modification must be in place to ensure the data exchange requirements of SOGL are set out in the GB Grid and Distribution codes *by* eighteen months from Entry Into Force (which was on 14 September 2017).

This modification should be implemented by 14 March 2019. The Authority should provide at least ten working days for the Code Administrator to implement from the date of their decision.

8.Workgroup Vote

Workgroup Vote

The Workgroup met for the final time on the 8 October 2018 and concluded by majority that the Original solution best facilitates the Grid Code objectives and should be implemented.

Vote 1 – does the original or WAGCM facilitate the objectives better than the Baseline?

Vote recording guidelines:

“Y” = Yes

“N” = No

“-” = Neutral

Workgroup Member	Better facilitates AGCO (i)	Better facilitates AGCO (ii)?	Better facilitates AGCO (iii)?	Better facilitates AGCO (iv)?	Better facilitates AGCO (v)?	Overall (Y/N)
Mike Kay						
Original	-	-	-	Y	-	Y
WAGCM1	N	-	-	N	N	N
WAGCM2	N	-	-	N	N	N
WAGCM3	N	-	-	N	N	N

Voting Statement:

The original is the minimum necessary set of changes to ensure SOGL compliance. WAGCM1 is based on an incorrect legal and practical interpretation of the SOGL; it would generate significant new real costs and administration that are not warranted for system operation at the present time. WAGCM2 has some merit – but making these changes in isolation is (a) unnecessary from a system operation perspective and (b) only partially deals with the LMS legacy leaving other modifications to be done elsewhere, and in the meant time adding to the complexity of G Code drafting and interpretation.

Workgroup Member	Better facilitates AGCO (i)	Better facilitates AGCO (ii)?	Better facilitates AGCO (iii)?	Better facilitates AGCO (vi)?	Better facilitates AGCO (v)?	Overall (Y/N)
Susan Mwape						
Original	Y	N	Y	Y	-	Y

WAGCM1	N	-	N	N	N	
WAGCM2	N	-	N	Y	N	
WAGCM3	N	-	N	N	N	

Voting Statement:

The original proposal efficiently discharges SOGL data exchange obligations by only implementing the mandatory changes and allowing National Grid ESO to review and propose changes to existing practices in future through ongoing industry forums such as wider access review, future of balancing services review and ENA open networks project. The ESO and DSOs currently have sufficient data to operate the system securely, there is a need to review existing Grid Code requirements but this will require rigorous industry engagement and investment which cannot all be achieved by the required compliance date of 14 March 2018. NGET believe the proposed original solution is sufficient to ensure compliance of SOGL efficiently.

WACMs1&3 are based on a reading of the SOGL requirements that National Grid ESO and most of the workgroup members do not agree with (the 'unless otherwise provided' clause for provision of data). We have checked this with the National Grid legal team and ENTSO-E and it was not the original intent of the drafting. This is supported by the ENTSOE interpretation which for this clause is 'unless otherwise determined' [by the TSO]). WACM2 is a less efficient means of implementation and goes beyond making only those changes necessary as instructed by Ofgem. National Grid welcomes a review of the GB industry structure, WACM2 would be better and efficiently addressed through the wider ESO whole system and level playing field review or alternatively through another modification (GC0117) which is reviewing similar issues. It should also be noted that GC0106 WACM2 only addresses data issues and not the wider issues associated between the regional differences in GB. WACM1&3 are both negative against (iv) as they are based on an incorrect legal interpretation in our view. WACM2 is debatably positive against (iv) as it does implement European Law but it isn't efficient.

KORRR achieves a certain level of harmonisation between ENTSO-e (TSO-TSO) members and also allows flexibility for vertical exchange of data (TSO-DSO and TSO-SGU) at national level. Title 2 of SOGL achieves harmonisation as it addresses the required exchange of information without defining all details at pan-European level. Flexibility in implementing EU codes at national level is not different in how connection codes have been implemented

Workgroup Member	Better facilitates AGCO (i)	Better facilitates AGCO (ii)?	Better facilitates AGCO (iii)?	Better facilitates AGCO (vi)?	Better facilitates AGCO (v)?	Overall (Y/N)
Garth Graham						
Original	-	-	-	Y	-	Y
WAGCM1	-	-	-	Y	-	Y
WAGCM2	-	-	-	Y	-	Y
WAGCM3	-	-	-	Y	-	Y

Voting Statement:

Workgroup Member	Better facilitates AGCO (i)	Better facilitates AGCO (ii)?	Better facilitates AGCO (iii)?	Better facilitates AGCO (vi)?	Better facilitates AGCO (v)?	Overall (Y/N)
Chris Marsland						

Original	Y	-	Y	Y		Y
WAGCM1	N	-	-	N	N	N
WAGCM2	N	-	-	N	N	N
WAGCM3	N	-	-	N	N	N

Voting Statement:

The Original seems to be the minimum impact solution to the implementation of the SOGL assuming the legal advice given in Appendix 3 is robust. WAGCM2 appears to be the best of the other WAGCMs but the implementation time and cost for the overall benefit seems unjustified however some of the underlying issues should be addressed e.g. Large Medium and Small generator classification

Workgroup Member	Better facilitates AGCO (i)	Better facilitates AGCO (ii)?	Better facilitates AGCO (iii)?	Better facilitates AGCO (vi)?	Better facilitates AGCO (v)?	Overall (Y/N)
------------------	-----------------------------	-------------------------------	--------------------------------	-------------------------------	------------------------------	---------------

Alan Creighton

Original	-	-	-	Y	-	Y
WAGCM1	N	-	-	N	N	N
WAGCM2	N	-	-	N	N	N
WAGCM3	N	-	-	N	N	N

Voting Statement:

The original is the minimum necessary set of changes to ensure SOGL compliance. WAGCM1 is based on legal view that is different than that provided by NGET to the Workgroup. The issues in WAGCM2 would be better addressed through GC0117 as it would more holistically address these issues.

Workgroup Member	Better facilitates AGCO (i)	Better facilitates AGCO (ii)?	Better facilitates AGCO (iii)?	Better facilitates AGCO (vi)?	Better facilitates AGCO (v)?	Overall (Y/N)
------------------	-----------------------------	-------------------------------	--------------------------------	-------------------------------	------------------------------	---------------

Graeme Vincent

Original	-	-	-	Y		Y
WAGCM1	N	-	-	N		N
WAGCM2	N	-	-	Y		N
WAGCM3	N	-	-	N		N

Voting Statement:

The Original Proposal implements the SOGL data exchange requirements through the minimal changes necessary to the GB Codes. The WACMs although having benefits are not the most efficient way of implementing the requirements and would impose additional obligations on transmission connected generators greater than 10MW in the South of Scotland currently classified as small. An enduring solution for Large, Medium, Small issues would be preferable to the partial solution offered in WACM2.

Workgroup Member	Better facilitates AGCO (i)	Better facilitates AGCO (ii)?	Better facilitates AGCO (iii)?	Better facilitates AGCO (vi)?	Better facilitates AGCO (v)?	Overall (Y/N)
------------------	-----------------------------	-------------------------------	--------------------------------	-------------------------------	------------------------------	---------------

Alastair Frew

Original	-	-	-	Y	-	Y
WAGCM1	-	-	-	Y	-	Y
WAGCM2	-	-	-	Y	-	Y
WAGCM3	-	-	-	Y	-	Y

Voting Statement:

It is still not clear on the two legal interpretations which is actually correct, on that bases I have opted for the original as it has the least impact.

Workgroup Member	Better facilitates AGCO (i)	Better facilitates AGCO (ii)?	Better facilitates AGCO (iii)?	Better facilitates AGCO (vi)?	Better facilitates AGCO (v)?	Overall (Y/N)
Greg Middleton						
Original	Y	-	Y	Y		Y
WAGCM1	N	-	-	N	N	N
WAGCM2	N	-	-	N	N	N
WAGCM3	N	-	-	N	N	N

Voting Statement:

The Original seems to be the minimum impact solution to the implementation of the SOGL assuming the legal advice given in Appendix 3 is robust. WACM2 appears to be the best of the other WACMs but the implementation time and cost for the overall benefit seems unjustified however some of the underlying issues should be addressed e.g. Large Medium and Small generator classification.

Workgroup Member	Better facilitates AGCO (i)	Better facilitates AGCO (ii)?	Better facilitates AGCO (iii)?	Better facilitates AGCO (vi)?	Better facilitates AGCO (v)?	Overall (Y/N)
Richard Wilson						
Original	-	-	-	-	-	-
WAGCM1	-	-	-	-	-	-
WAGCM2	Y	Y	Y	Y	Y	Y
WAGCM3	--	-	-	-	-	-

Voting Statement:

I agree with WAGCM2 as the most effectively method to implement the requirements of GC0106 due to SOGL. This is based on the change only impacting Transmission customers as per the understanding of the group. An enduring solution for Large. Medium, Small issues would be preferable option to cover all issues which is being addressed in another modification.

Vote 2 – Which option is the best? (Baseline, Original, WAGCM1, WAGCM2, WAGCM3)

Workgroup Member	BEST Option?
Mike Kay	Original
Susan Mwape	Original
Garth Graham	WAGCM2
Chris Marsland	Original
Alan Creighton	Original

Graeme Vincent	Original
Alastair Frew	Original
Greg Middleton	Original
Richard Wilson	WAGCM2

The Workgroup concluded that in their view they had met their Terms of Reference and that their Report should be submitted to the November GCRP meeting for assessment ahead of being issued to wider consultation.

Workgroup Terms of Reference and Membership

TERMS OF REFERENCE FOR GC0106 WORKGROUP

Data exchange requirements in accordance with EU Regulation 2017/1485 (System Operation Guideline – SOGL)

Responsibilities

1. The Workgroup is responsible for assisting the Grid Code Review Panel in the evaluation of Grid Code Modification Proposal **GC0106: Data exchange requirements in accordance with Regulation (EU) 2017/1485 (SOGL)** as tabled by National Grid at the Grid Code Review Panel meeting in October 2017.
2. The proposal must be evaluated to consider whether it better facilitates achievement of the Grid Code Objectives. These can be summarised as follows:
 - (i) *To permit the development, maintenance and operation of an efficient, coordinated and economical system for the transmission of electricity;*
 - (ii) *To facilitate competition in the generation and supply of electricity (and without limiting the foregoing, to facilitate the national electricity transmission system being made available to persons authorised to supply or generate electricity on terms which neither prevent nor restrict competition in the supply or generation of electricity);*
 - (iii) *Subject to sub-paragraphs (i) and (ii), to promote the security and efficiency of the electricity generation, transmission and distribution systems in the national; and*
 - (iv) *To efficiently discharge the obligations imposed upon the licensee by this license and to comply with the Electricity Regulation and any relevant legally binding decisions of the European Commission and/or the Agency. In conducting its business, the Workgroup will at all times endeavour to operate in a manner that is consistent with the Code Administration Code of Practice principles.*

Scope

3. The Workgroup must consider the issues raised by the Modification Proposal and consider if the proposal identified better facilitates achievement of the Grid Code Objectives.
4. In addition to the overriding requirement of point 3 above, the Workgroup shall consider and report on the following specific issues:
 - a) Implementation;
 - b) Review draft legal text should it have been provided. If legal text is not submitted within the Grid Code Modification Proposal the Workgroup should be instructed to assist in the developing of the legal text;
 - c) Consider whether any further Industry experts or stakeholders should be invited to participate within the Workgroup to ensure that all potentially affected stakeholders have the opportunity to be represented in the Workgroup;

- d) Review scope and applicability of requirements within Articles 40-53 (SOGL) for the Grid Code to ensure compliance with a minimal change approach;
 - e) Complete a detailed assessment and code mapping of the KORRR and identify any additional changes that will be required resulting from the reserve requirements section of the SOGL;
 - f) Actively seek input from the Open Networks project to ensure that outputs from all ongoing workgroups are aligned;
 - g) Ensure that any Grid Code impact of Articles 40-53 (from (d) above) are reflected appropriately in modifications to the Distribution Code; and,
 - h) Consider any other impact on documentation within or under the governance of the Distribution Code
5. As per Grid Code GR20.8 (a) and (b) the Workgroup should seek clarification and guidance from the Grid Code Review Panel when appropriate and required.
 6. The Workgroup is responsible for the formulation and evaluation of any Workgroup Alternative Grid Code Modifications (WACM) arising from Group discussions which would, as compared with the Modification Proposal or the current version of the Grid Code, better facilitate achieving the Grid Code Objectives in relation to the issue or defect identified.
 7. The Workgroup should become conversant with the definition of Workgroup Alternative Grid Code Modification which appears in the Governance Rules of the Grid Code. The definition entitles the Group and/or an individual member of the Workgroup to put forward a Workgroup Alternative Code Modification proposal if the member(s) genuinely believes the alternative proposal compared with the Modification Proposal or the current version of the Grid Code better facilitates the Grid Code objectives. The extent of the support for the Modification Proposal or any Workgroup Alternative Modification (WACM) proposal arising from the Workgroup's discussions should be clearly described in the final Workgroup Report to the Grid Code Review Panel.
 8. Workgroup members should be mindful of efficiency and propose the fewest number of WACM proposals as possible. All new alternative proposals need to be proposed using the Alternative Request Proposal form ensuring a reliable source of information for the Workgroup, Panel, Industry participants and the Authority.
 9. All WACM proposals should include the Proposer(s)'s details within the final Workgroup report, for the avoidance of doubt this includes WACM proposals which are proposed by the entire Workgroup or subset of members.
 10. There is an option for the Workgroup to undertake a period of Consultation in accordance with Grid Code GR. 20.11, if defined within the timetable agreed by the Grid Code Panel. Should the Workgroup determine that they see the benefit in a Workgroup Consultation being issued they can recommend this to the Grid Code Review Panel to consider.
 11. Following the Consultation period the Workgroup is required to consider all responses including any Workgroup Consultation Alternative Requests. In undertaking an assessment of any Workgroup Consultation Alternative Request, the Workgroup should consider whether it better facilitates the Grid Code Objectives than the current version of the Grid Code.

12. As appropriate, the Workgroup will be required to undertake any further analysis and update the appropriate sections of the original Modification Proposal and/or WACM proposals (Workgroup members cannot amend the original text submitted by the Proposer of the modification) All responses including any Workgroup Consultation Alternative Requests shall be included within the final report including a summary of the Workgroup's deliberations and conclusions. The report should make it clear where and why the Workgroup chairman has exercised their right under the Grid Code to progress a Workgroup Consultation Alternative Request or a WACM proposal against the majority views of Workgroup members. It should also be explicitly stated where, under these circumstances, the Workgroup chairman is employed by the same organisation who submitted the Workgroup Consultation Alternative Request.
13. The Workgroup is to submit its final report to the Modifications Panel Secretary on 14 November 2018 for circulation to Panel Members. The final report conclusions will be presented to the Grid Code Review Panel meeting on 22 November 2018.

Membership

The Workgroup has the following members:

Role	Name	Representing (User nominated)
Chair	Chrissie Brown	Code Administrator
Technical Secretary	Naomi Davies/Chrissie Brown	Code Administrator
National Grid Representative*	Susan Mwape	NGET
National Grid Observer	Anthony Johnson	NGET
Authority Representative	Leonardo Costa	Ofgem
Authority Representative (Alternate)	Jordan Clarke	Ofgem
Workgroup Member*	Mike Kay	Electricity North West
Workgroup Member*	Chris Marsland	
Workgroup Member*	Greg Middleton	Deep Sea PLC
Workgroup Member*	Garth Graham	SSE
Workgroup Member*	Graeme Vincent	SP Energy Networks
Workgroup Member*	Richard Wilson	UK Power Networks
Workgroup Member*	Alan Creighton	Northern Powergrid
Workgroup Member*	Alastair Frew	Scottish Power Generation Ltd
Observer	Rui Zhang	National Grid
Observer	Rob Wilson	National Grid
Observer	Joaquin Jimenez	National Grid
Observer	Nick Rubin	Elexon
Observer	Peter W. Christensen	Vestas

14. A (*) Workgroup must comprise at least 5 members (who may be Panel Members). The roles identified with an asterisk (*) in the table above contribute toward the required quorum, determined in accordance with paragraph 15 below.
15. The Grid Code Review Panel must agree a number that will be quorum for each Workgroup meeting. The agreed figure for GC0106 is that at least 5 Workgroup members must participate in a meeting for quorum to be met.
16. A vote is to take place by all eligible Workgroup members on the Modification Proposal and each WACM proposal and Workgroup Consultation Alternative Request based on their assessment of the Proposal(s) against the Grid Code objectives when compared against the current Grid Code baseline.

- Do you support the Original or any of the alternative Proposals?
- Which of the Proposals best facilitates the Grid Code Objectives?

The Workgroup chairman shall not have a vote, casting or otherwise.

The results from the vote and the reasons for such voting shall be recorded in the Workgroup report in as much detail as practicable.

17. It is expected that Workgroup members would only abstain from voting under limited circumstances, for example where a member feels that a proposal has been insufficiently developed. Where a member has such concerns, they should raise these with the Workgroup chairman at the earliest possible opportunity and certainly before the Workgroup vote takes place. Where abstention occurs, the reason should be recorded in the Workgroup report.
18. Workgroup members or their appointed alternate are required to attend a minimum of 50% of the Workgroup meetings to be eligible to participate in the Workgroup vote.
19. The Technical Secretary shall keep an Attendance Record for the Workgroup meetings and circulate the Attendance Record with the Action Notes after each meeting. This will be attached to the final Workgroup report.
20. The Workgroup membership can be amended from time to time by the Grid Code Review Panel and the Chairman of the Workgroup.

Appendix 1 – Modification Timeline

Date	Meeting
Workgroup Meeting 1	2 November 2017
Workgroup Meeting 2	6 December 2017
Workgroup Meeting 3	12 January 2018
Workgroup Meeting 4	28 February 2018
Workgroup Meeting 5	28 March 2018
Workgroup Meeting 6	6 April 2018
Workgroup Consultation issued/closes	6 April/27 April 2018
Workgroup meeting 7	2 May 2018
Workgroup Meeting 8 - 12	16 May 2018 – 8 October 2018
Workgroup Report presented to Panel (submission/presented)	22 November 2018

Post Workgroup modification timeline as agreed by GCRP in October 2018;

Date	Meeting
Code Administration Consultation Report issued to the Industry (opens/closes)	22 November 2018/13 December 2018
Draft Final Modification Report presented to Industry and Panel (issued/presented)	14 December/19 December 2018
Modification Panel Recommendation vote	19 December 2018
Final Modification Report issued the Authority	21 December / 2 Jan 2019
Authority decision due (25WDs)	6 February 2019
Decision implemented in Grid Code (10WDs)	Ahead of 14 March 2019

Note, of 8th December 2017, on the legal interpretation aspects requested by the Workgroup.

Background

Following the discussion at the 6th December 2017 GC0106 meeting about the data exchange aspects of the SOGL, a Workgroup Member took an action to set out the concerns they raised at the meeting with a view to National Grid obtain a legal view (from the National Grid legal department) on this matter that could be shared with the Workgroup.

The relevant Articles¹² of the SOGL in respect of data exchange are shown in Appendix 1 for ease of reference.

One workgroup member set out their concerns in the following terms before raising three alternatives.

Introduction

At its core the issue is a simple one, namely whether a ‘broad’ or ‘narrow’ interpretation of the wording used, at various points, in the Data Exchange title of the System Operation Guideline (‘SOGL’) Regulation (namely Articles 40-53 inclusive) is legally correct.

As set out by the Proposer of GC0106 at the December meeting, the ‘broad’ interpretation would mean that the TSO could decide that, for example, no party (be it the TSO or DSO) need provide one or more of, say, the real time data items listed (a)-(i) in 44 or; in respect of 47; neither the TSO or SGU need provide one or more of the items listed in 47(1) (a)-(c). This approach was summarised as ‘flexible’ in the slides for the meeting.

In contrast, the ‘narrow’ interpretation requires that all the data items in, for example, 44(1) (a) to (i) must be provided by someone, the question is by whom.

Put simply, if the TSO does not provide the requisite data item(s) then the DSO must.

This is equally the case with 47 where, likewise, if the TSO does not provide the data item(s) (a)-(c) listed under (1) then the SGU¹³ must.

Taken to its logical extreme, the ‘broad’ interpretation would, hypothetically, allow for TSO ‘X’ to require all data items 44 (a)-(i) and / or 47 (1) (a)-(c) be provided by the DSOs / SGUs (and, for completeness, none of the data items be provided by TSO ‘X’) whilst TSO ‘Y’ might require, say, for half the data items to be provided

¹² 40(5), 44, and 47-53 inclusive.

¹³ The data exchange provisions in SOGL also refer, in addition to DSOs and SGUs, to (i) HVDC system operator and (ii) third parties participating in demand response. The GC0106 December meeting focused on DSOs and SGUs, whilst recognising that the concerns raised could also be applicable to (i) and (ii).

from the respective DSOs / SGUs (and, for completeness, none of the data items be provided by TSO ‘Y’) whilst TSO ‘Z’ could require that none of the data items be provided by any DSOs / SGUs (and, for completeness, none of the data items be provided by TSO ‘Z’ either).

This ‘broad’ interpretation has, on the face of it, a number of redeeming qualities (many of which were mentioned during the December Workgroup meeting). Nevertheless, it seemed to the Workgroup member who raised the concerns that it has a number of potential flaws, which the member set out.

Potential flaws with the ‘broad’ interpretation

First, and foremost it does not ensure that common minimum technical requirements applied across the 28 Member States, as regards data exchange, are met as set out in Recitals (4), (5) and (12)¹⁴ of SOGL as the ‘broad’ interpretation allows for totally different national approaches to data exchange, and thus system operation, to apply in the various Member States (and, potentially, where there are different TSOs within some Member States, different requirements within the Member States as well) - such as illustrated by the TSOs X, Y and Z example above.

Put simply, how does this demonstrate adherence to having ‘common minimum technical requirements’?

Second, it does not ensure that harmonised rules, or harmonised requirements, or harmonised data formats for data exchange applied across the 28 Member States, are met as set out in Recitals (3) and (13) together with Article 114 (2)¹⁵.

¹⁴ “(4) To ensure the operational security of the interconnected transmission system, it is essential to define a **common set of minimum requirements for Union-wide system operation**, for the cross-border cooperation between the TSOs and for utilising the relevant characteristics of the connected DSOs and SGUs.

(5) **All TSOs should comply with the common minimum requirements on procedures necessary to prepare real-time operation**, to develop individual and deliver common grid models, to facilitate the efficient and coordinated use of remedial actions which are necessary for real-time operation in order to maintain the operational security, quality and stability of the interconnected transmission system, and to support the efficient functioning of the European internal electricity market and facilitate the integration of renewable energy sources (‘RES’).

(12) One of the most critical processes in ensuring operational security with a high level of reliability and quality is the load-frequency control (‘LFC’). Effective LFC can be made possible only if there is an obligation for the TSOs and the reserve connecting DSOs to cooperate for the operation of the interconnected transmission systems as one entity **and for providers' power generating modules and providers' demand facilities to meet the relevant minimum technical requirements.**” [emphasis added]

¹⁵ (3) “**Harmonised rules on system operation for transmission system operators (‘TSOs’), distribution system operators (‘DSOs’) and significant grid users (‘SGUs’) should be set out in order to provide a clear legal framework for system operation, facilitate Union-wide trade in electricity, ensure system security, ensure the availability and exchange of necessary data and information between TSOs and between TSOs and all other stakeholders, facilitate the integration of renewable energy sources, allow more efficient use of the network and increase competition for the benefit of consumers.**”

The ‘broad’ interpretation; with its ability for each TSO to do its own thing in terms of allowing DSOs and SGUs not to provide some (all?) of the SOGL data items they, respectively, are listed as having to providing; runs counter to the harmonisation principle.

Put simply, how does this demonstrate adherence to having ‘harmonised rules, or harmonised requirements, or harmonised data formats for data exchange’?

Third, it seems to allow for, effectively, the TSO(s) to just ‘ignore’ some (or all?) of what the SOGL requirements are by mealy carrying on with their (national) status quo position as regards obliging their DSOs or SGUs respectively to meet the SOGL data exchange provision on the basis that this is sufficient for system operation.

If this was the intention of the Regulation then surely the simplest thing to do would have been to draft in (as per Article 2(4)) that the data exchange Articles do not apply in Member State(s) X (such as GB) on the basis that the existing data provisions in the national codes are sufficient to meet all the aims of the SOGL (as summarised in the Recitals).

Fourth, it does not appear to take account of the future possibility that a TSO in a neighbouring Member State (such as RTE, Tennet, SONI and EirGrid) could classify parts (or all??) of the GB network (both by reference to geography and / or network topology, including by voltage down to varying levels of the distribution system) as falling within their own Observability Area: and thus GB DSOs and / or SGUs would need to provide (some or all, in the ‘broad’ interpretation, and all in the ‘narrow’ interpretation) data items listed in the Article(s) to those neighbouring TSOs, although it is not clear if this ‘must’ or ‘may’ or ‘won’t’ be done via the ‘host’ TSO.

This might, for example, apply where the neighbouring TSO has a different IT system - where the ‘host’ TSO, under the ‘broad’ interpretation, does not require / collect the data item(s) from the DSOs /SGUs then, presumably, it has no IT System that (a) captures these data items from these parties or (b) can transfer those data items to the neighbouring TSO(s).

Fifth, it appears to be potentially based on a false premise, namely that as the GB TSO does not have access to the DSO/SGU data items themselves today (under the

(13) The provisions on LFC and reserves, **aim at setting out clear, objective and harmonised requirements for TSOs, reserve connecting DSOs, providers' power generating modules and providers' demand facilities in order to ensure system security and to contribute to non-discrimination, effective competition and the efficient functioning of the internal electricity market.** The provisions on LFC and reserves provide the technical framework necessary for the development of cross-border balancing markets.

114(2) By 6 months after entry into force of this Regulation, **all TSOs shall define a harmonised data format for data exchange, which shall be an integral part of the ENTSO for Electricity operational planning data environment.**” [emphasis added]

existing national arrangements) thus the wording in the Article cannot be applied in the way set out under the ‘narrow’ interpretation (from a GB perspective).

However, this is to not take account of the perhaps more logical position, namely the distinct possibility that the wording was actually put into the SOGL to cater for those Member States where the TSO(s) does already (perhaps because of history) have access, via their existing national arrangements, to some or all of the DSO/SGU data items listed. If that is the case then, in the context of those Member States, the ‘narrow’ interpretation makes eminent sense: it’s there in order not to overburden the DSOs/SGUs in terms of requiring them to send duplicate data items to the TSO, that the TSO already has access to anyway / or can provide themselves via their own systems etc.

Sixth, a further factor to consider is that we are being invited, with the ‘broad’ interpretation, to apply the first use of the word ‘provide’ differently to the second use of the word ‘provide’ in the same sentence - is this realistic?

By way of illustration let us replace ‘provide’ with ‘supply’ in the sentence - the Concise Oxford Dictionary¹⁶ first definition of ‘provide’ is to “supply; furnish”. The second definition (where provide is usually followed by “*for*” or “*against*”) is to “make due preparation” (such as “provided for any eventuality” or “provided against invasion”). The fourth definition (where provide is usually followed by “*that*”) is to “stipulated in a will, statute”.

Thus, if the TSO does not ‘supply’ the data item(s) then the DSOs or SGUs must ‘supply’ the data item(s) - this extrapolation works for the ‘narrow’ approach but does not work in the context of the ‘broad’ approach.

Furthermore, with the ‘broad’ approach we are being invited to define the first ‘provide’ one way; as allowing the TSO to determine if the DSO or SGU does (or does not) have to do something; but then, when it comes to the second ‘provide’ we are to use a different definition (of ‘provide’) to say we do not allow those other parties, in turn, to adopt that same definition as the first ‘provide’ (when it is used just a few words later in the sentence).

Put another way, whilst the first ‘provide’ affords a right of optionality to the party concerned (the TSO) when it is applied to the second ‘provide’ there is no such optionality afforded to the parties concerned (the DSOs and SGUs respectively). It begs the question: is this schizophrenic application of the word ‘provide’, in the same sentence, credible?

Surely, it’s more credible that the drafters intended to use the word ‘provide’ in the same context when used in the same sentence and thus, as illustrated with the use of ‘supply’ instead of ‘provide’ in the sentence, that the ‘narrow’ interpretation works here but the ‘broad’ does not.

Seventh, it was suggested at the December Workgroup meeting that 40(5) permits the ‘broad’ interpretation - this may well be the case. However, it seems equally to be the case that 40(5) permits the ‘narrow’ interpretation to apply as well.

¹⁶ Ninth Edition

Put another way, in terms of 40(5), the ‘broad’ interpretation means that the TSO, in coordination with the DSOs, could decide that rather than provide all the data items for 44(a)-(i), that the neither the DSOs or the TSO need provide, say, (f) the bus bar voltage data.

With the ‘narrow’ interpretation, the 40(5) approach would mean that the TSO, in coordination with the DSOs, agree that the DSOs need only provide items 44(a)-(e) and (g)-(i) because, in this example, the TSO would provide 44(f) the bus bar voltage data item.

Eighth, if the ‘broad’ interpretation is correct then why is the wording in 50(2) required?

Specifically, the wording at 50(1)¹⁷ is basically the same construct as that which appears in the other parts of the data exchange part of the SOGL.

However, the wording in 50(1) is followed with wording in 50(2) which effectively duplicates what (apparently) 50(1) already allows, if the ‘broad’ interpretation is correct, namely:

“Each TSO **shall define** in coordination with the responsible DSOs **which SGUs may be exempted from providing** the real-time data listed in paragraph 1 directly to the TSO” [emphasis added]

If the intention had been that the ‘broad’ interpretation was the correct approach then by far the simplest thing to do was to just amend 50(1), rather than drafting a whole new paragraph 50(2), by adding into 50(1) five additional words (as shown in bold below):

“Unless otherwise provided by the TSO **in coordination with the responsible DSOs**, each power generating facility owner of a power generating module which is a SGU”

Thus the wording, in 50(2), clearly points to the ‘narrow’ interpretation being the correct one, in terms of the Data Exchange parts of SOGL.

Notwithstanding the coordination with DSOs aspect (envisaged in 50(2)) it is important to note that where an exemption from the obligation to provide some data items by the SGUs (covered under 50) is allowed it is explicitly stated in terms of the addition of the wording (in 50(2)) to that effect, namely:

“Each TSO **shall define** which SGUs **may be exempted from** providing...”

Thus it is clear, in the case of 50(1), that the drafters of SOGL did envisage, in limited circumstances, that an exemption (from the need by the SGUs to provide

¹⁷ “Unless otherwise provided by the TSO, each power generating facility owner of a power generating module which is a SGU in accordance with Article 2(1)(a) and (e) connected to the distribution system shall provide the TSO and the DSO to which it has the connection point, in real-time, at least the following data”

certain SOGL data items) should be put in place; and they drafted text accordingly to achieve this. Which begs the question as to why this additional text (in 50(2)) was needed if the ‘broad’ interpretation is correct as the wording in 50(1) (coupled with and 40(5)) already permitted this anyway.

Rather, it could be argued, the drafters of SOGL did not envisage other circumstances (beyond those covered by 50(2)) in term of SOGL data exchange, where other data items would not be provided at all (by the DSOs / SGUs or TSOs) – which is the ‘narrow’ interpretation.

Ninth, in the context of 51(2)¹⁸ it is noticeable that there is no ‘caveat’ of the obligation upon the TSO(s) to provide the data, upon request, to the DSO(s).

If the ‘broad’ interpretation is correct, and the TSO has exempted the SGUs from providing, say, a number of data items under 48(1) and / or 49 then, as read, 52(2) still requires the TSO to, nevertheless, provide the said data items itself. In this scenario it is not clear how the TSO would ‘square this circle’.

If the ‘narrow’ interpretation is the correct approach, then as it’s a ‘binary’ situation (either the TSO provides the data items under 48(1) and / or 49 or the SGU(s) provides it) the data is always available to the TSO and can thus be transferred, if requested, to the DSOs.

Why is this important

In the view of the Workgroup member who raised the concerns, the reason why this matter is of importance to GB stakeholders is that if the ‘broad’ interpretation goes forward into the GB industry codes via GC0106 and it subsequently turns out that the ‘narrow’ interpretation was, instead, correct then it is the DSOs and / or SGUs which will (a) have breached the SOGL data exchange obligations in the various data exchange Articles applicable to them (if the TSO has said one or more data items did not need to be provided, based on the ‘broad’ interpretation) and (b) they will have to put in place potentially costly remedial actions / systems in order to henceforth comply with SOGL going forward.

Furthermore, if the ‘narrow’ interpretation is correct (but the ‘broad’ was applied up to that point) then as the TSO was not itself providing the said data item(s) then they would not themselves be in breach of the SOGL (as in that scenario the default provider obligations fall, under the SOGL, to the DSO(s)/SGU(s) respectively).

Put another way, as the passenger who told the (DSOs/SGUs) driver that the speed limit on the road was 60MPH, when it was actually 40MPH, then the (TSO) passenger would not be the person who is fined for the drivers’ speeding.

The Workgroup Member who raised the concerns mentioned during the December Workgroup meeting that, pending the legal advice received, they were minded to raise an alternative request to GC0106 based on the ‘narrow’ interpretation as a pragmatic solution to there concern.

¹⁸ “(2) **Each TSO shall make available to the DSO**, to whose distribution system SGUs are connected, **the information specified in Articles 48, 49 and 50 as requested by the DSO.**” [emphasis added]

This approach would mean (assuming such an alternative proceeds forward as a WAGCM in due course) that Ofgem would have before them both options and thus we avoid GC0106 being rejected; if it is just limited to the ‘broad’ and not a ‘narrow’ interpretation; if the ‘narrow’ one is considered by Ofgem to be correct. It also means that we avoid, in this rejection scenario, the need to rush through a new ‘narrow’ interpretation based modification at a later date.

Legal Questions

In light of the concerns set out by the Workgroup member they suggested that the following legal questions be raised by National Grid with their legal department, and the answers shared with the Workgroup in due course:

- 1) In the context of the Regulation overall, is the ‘broad’ or ‘narrow’ interpretation legally correct or are both equally correct legally?
- 2) Is there a greater or lesser legal risk in adopting the ‘broad’ or ‘narrow’ interpretation from the perspective of the DSOs and / or SGUs in terms of their compliance with the SOGL data exchange requirements?
- 3) Is there anything in any of the other approved Network Code Regulations which support the ‘broad’ or ‘narrow’ or both interpretations?
- 4) If the TSOs X, Y and Z scenario¹⁹ were to occur would each TSO be equally correct legally in their approach or would one (or two) TSO(s) have stronger legal certainty than the other two (or one) TSO(s) and if so which TSO(s) would that be - X, Y or Z?
- 5) In the context of neighbouring TSOs Observability Areas scenario²⁰ could it in the foreseeable future be legally permissible under the Regulation for a neighbouring TSO ‘A’, where it has declared a part of TSO ‘B’ Network area as falling within their Observability Area ‘A’, to require the DSOs and / or SGUs within that Observability Area ‘A’ located in the TSO ‘B’ Network area to provide data items(s) to TSO ‘A’? If the answer is yes, does the data item(s) have to come only via TSO ‘B’ or can they be obtained, in accordance with the Regulation, directly from the respective DSO(s) or SGU(s), as applicable, by TSO ‘A’
- 6) Does Article 40(5) prevent the ‘broad’ or ‘narrow’ interpretation being applied, or are both approaches equally valid in the context of Article 40(5)?
- 7) Could a legal way of mitigating these concerns be for the GC0106 legal text to include a full indemnity from the TSO to the DSOs and SGUs such that if the ‘narrow’ interpretation was the correct one (but the ‘broad’ interpretation was the only version included in the GC0106 legal text²¹)

¹⁹ Set out in the ‘Introduction’ above.

²⁰ Set out in the Fourth potential flaw above.

²¹ And the TSO had acted accordingly and exempted DSOs/SGUs from providing some SOGL data items.

then the TSO would pay all fines, penalties and costs arising until such times as the DSOs and SGUs, exercising good industry practice, could put in place the necessary remedial actions / systems etc., to comply with ‘narrow’ interpretation of the SOGL?

8) As has happened in the CUSC sphere with CMP251 and CMP261 where there were legal issues arose regarding the interpretation of an EU Regulation and the National Grid legal department sort legal advice (in 2015 and 2016 respectively) on behalf of the Workgroup from their external lawyers (Addleshaw Goddard in both cases) do you believe it would be prudent to do so again in this case?

Annex 3 Legal Interpretation – National Grid Legal Department view

National Grid Legal Advice, provided to the Workgroup on 10th January 2018

- The purpose of the regulation is to “ensure the availability and exchange of necessary data and information between TSO’s and between TSOs and all relevant stakeholders” (recital (3))
- Standard principles of “proportionality” and “optimisation between the highest overall efficiency and lowest total costs for all parties involved” apply (art 4.2)
- At heart is the need for us as a TSO to exchange the data listed at art 41 and art 42 with other TSOs so, if in order to do this we need underlying data from others, we need to have/be able to get that data and more generally perform the operational functions assigned to us.
- Art 40.5 states “In coordination with the DSOs and SGUs, each TSO shall determine the applicability and scope of the data exchange based on the following categories” i.e. Arts 44, 47, 48, 49, 50, 51, 52 and 53. The use of “based on” is odd English but the ref to the arts is clear and all the specific arts referred to are all prefixed with “Unless otherwise provided by the TSO....” and list “at least” the data to be provided.
- Art 40.6 suggests that all TSO will “agree” on “key organisational requirements, roles and responsibilities in relation to data exchange”. The approach on provision of data by others would need to be dealt with in the methodology agreed for 40.6.
- Read in isolation you could read the prefix of “Unless otherwise provided by the TSO” in the relevant articles as meaning the data has to be provided but the requirement is only on the DSO etc. to do so where the TSO itself doesn’t do so. For that to work, it would presuppose that the data is already TSO data/information or data/information held by the TSO about the DSO etc. In fact (and as a matter of fact) it seems that it is DSO etc. information/data about the DSO etc. which the TSO would only have if it got it from the DSO etc.?
- However in my view you have to read it in the wider context of Title 2, and an ordinary reading of the structure of the title, art 40.5 together and the prefix would suggest that those specific articles are linked

and that there is a TSO a discretion as to the “applicability and scope of the data exchange” requirements under those arts. Compare other articles e.g. 45 where the requirements are mandatory and aren’t prefixed/referenced in art 40.5.

- The use of the word “provided” in the prefix of the relevant articles isn’t the most helpful formulation. It could suggest that the discretion afforded by art 40.5 is limited to those circumstances where the TSO doesn’t otherwise provide the data/info but as above this doesn’t seem correct.
- In my view the more appropriate reading is that art 40.5 gives general discretion as to the “applicability and scope” in placing requirements on the listed data/information and that the prefix is there to recognise this i.e. that “unless otherwise provided by the TSO” in effect means “unless and to the extent the TSO determines otherwise”.
- On the basis that there is discretion, in exercising it the effect of that discretion should be considered against the general need/ability of the TSO to meet its obligations under/ the overall aim of the regulation i.e. a degree of harmonisation. Given the intent is to set minimum requirements and articles refer to “at least” there should be clear justification as to why it is not required/appropriate and (as per comment re art 40.6) maybe something that needs to be considered with other TSOs?
- In terms of compliance, regulations effectively form part of GB law and so all parties have an obligation to comply with them to the extent they apply with them and matters of interpretation/consequences of any breach can be decided by the courts. Generally compliance with such regulations is specifically made a requirement for entities licensed under the electricity act and is subject to the same Ofgem compliance/enforcement regime that exists for licence breach.

Advice from ENTSO-E

Advice was also sought from ENTSO-E by National Grid on the intent of the drafting of the relevant Articles of SOGL for this modification. ENTSO-E confirmed that their interpretation aligned with that of the Proposer of GC0106. A further check was made by National Grid by looking at the German translation of the ‘unless otherwise provided’ clause; in German translated back to English this was reproduced as ‘unless otherwise determined [by the TSO]

Annex 4 Draft Grid Code Legal Text

These are the changes associated with the Articles included in the ToR.

Grid Code PC.A.1.2

Submissions by Users

(a) Planning data submissions by **Users** shall be:

(i) with respect to each of the seven succeeding **Financial Years** (other than in the case of **Registered Data** which will reflect the current position and data relating to **Demand** forecasts which relates also to the current year);

(ii) provided by **Users** in connection with a **CUSC Contract** (PC.4.1, PC.4.4 and PC.4.5 refer);

(iii) provided by **Users** on a routine annual basis in calendar week 24 of each year to maintain an up-to-date data bank (although **Network Operators** may delay the submission of data (other than that to be submitted pursuant to PC.3.2(c) and PC.3.2(d)) until calendar week 28). **In addition the structural data in DRC Schedule 5 Tables 5(a), 5(b), 5(d), 5(e), 5(f) and DRC Schedule 13 (Lumped system susceptance (PC.A.2.3) only) provided by Network Operators by calendar week 28 shall be updated by calendar week 50 of each year (again which may be delayed as above until week 2 of the following calendar year).** Where from the date of one annual (or in the case of Schedule 5 or Schedule 13 the calendar week 50) submission to another there is no change in the data (or in some of the data) to be submitted, instead of re-submitting the data, a **User** may submit a written statement that there has been no change from the data (or some of the data) submitted the previous time.; and

(iv) provided by **Network Operators** in connection with **Embedded Development** (PC.4.4 refers).

PC.A.1.2 Text Commentary

The aim of the modified text is simply to change the submission cycle from annually to 6 monthly for static network data in accordance with article 43, 4).

PC.A.3.1.4

(a) PC.A.4.2.4(b) and PC.A.4.3.2(a) explain that the forecast **Demand** submitted by each **Network Operator** must be net of the output of all **Small Power Stations** and **Medium Power Stations** and **Customer Generating Plant** and all installations of direct current converters which do not form a **DC Converter Station, Embedded** within that **Network Operator's System**. The Network Operator must inform ESO of:

- (i) the number of such **Embedded Power Stations** and such **Embedded** installations of direct current converters (including the number of **Generating Units** or **Power Park Modules** or **DC Converters**) together with their summated capacity; and
- (ii) beginning from the 2015 Week 24 data submission, for each **Embedded Small Power Station** of registered capacity (as defined in the **Distribution Code**) of 1MW or more:
 - 1. A reference which is unique to each Network Operator;
 - 2. The production type as follows:
 - a) In the case of an Embedded Small Power Station first connected on or after 1 January 2015, the production type must be selected from

the list below derived from the Manual of Procedures for the ENTSO-E Central Information Transparency Platform:

- Biomass;
- Fossil brown coal/lignite;
- Fossil coal-derived gas;
- Fossil gas;
- Fossil hard coal;
- Fossil oil;
- Fossil oil shale;
- Fossil peat;
- Geothermal;
- Hydro pumped storage;
- Hydro run-of-river and poundage;
- Hydro water reservoir;
- Marine;
- Nuclear;
- Other renewable;
- Solar;
- Waste;
- Wind offshore;
- Wind onshore; or
- Other;

together with a statement as to whether the generation forms part of a CHP scheme;

- (iii) **beginning from the 2019 Week 24 data submission, for Embedded Power Stations with Registered Capacity of 1MW or less, their best estimate of the aggregated capacity of all such Embedded Power Stations per production type as defined in the list in PC.A.3.1.4 (a)(ii)(2)(a).**

PC.A.3.1.4 Text Commentary

The aim of the new text is simply to request submission of aggregated capacity per fuel type for all generation less than 1MW for each Network Operator for the current year.

SCHEDULE 5 - USERS SYSTEM DATA
PAGE 1 OF 11

The data in this Schedule 5 is required from **Users** who are connected to the **National Electricity Transmission System** via a **Connection Point** (or who are seeking such a connection). **Generators** undertaking **OTSDUW** should use **DRC** Schedule 18 although they should still supply data under Schedule 5 in relation to their **User's System** up to the **Offshore Grid Entry Point**.

Table 5(a)

DATA DESCRIPTION	UNITS	DATA to RTL		DATA CATEGORY
		CUSC Contract	CUSC App. Form	
<p>USERS SYSTEM LAYOUT (PC.A.2.2)</p> <p>A Single Line Diagram showing all or part of the User's System is required. This diagram shall include:-</p> <p>(a) all parts of the User's System, whether existing or proposed, operating at Supergrid Voltage, and in Scotland and Offshore, also all parts of the User System operating at 132kV,</p> <p>(b) all parts of the User's System operating at a voltage of 50kV, and in Scotland and Offshore greater than 30kV, or higher which can interconnect Connection Points, or split bus-bars at a single Connection Point,</p> <p>(c) all parts of the User's System between Embedded Medium Power Stations or Large Power Stations or Offshore Transmission Systems connected to the User's Subtransmission System and the relevant Connection Point or Interface Point,</p> <p>(d) all parts of the User's System at a Transmission Site.</p> <p>The Single Line Diagram may also include additional details of the User's Subtransmission System, and the transformers connecting the User's Subtransmission System to a lower voltage. With The Company's agreement, it may also include details of the User's System at a voltage below the voltage of the Subtransmission System.</p> <p>This Single Line Diagram shall depict the arrangement(s) of all of the existing and proposed load current carrying Apparatus relating to both existing and proposed Connection Points, showing electrical circuitry (ie. overhead lines, underground cables, power transformers and similar equipment), operating voltages. In addition, for equipment operating at a Supergrid Voltage, and in Scotland and Offshore also at 132kV, circuit breakers and phasing arrangements shall be shown.</p>		■	■	SPD

SCHEDULE 5 - USERS SYSTEM DATA

PAGE 2 OF 11

Table 5(b)

DATA DESCRIPTION	UNITS	DATA EXCH		DATA CATEGORY
		CUSC Contract	CUSC App. Form	
<p><u>REACTIVE COMPENSATION (PC.A.2.4)</u></p> <p>For independently switched reactive compensation equipment not owned by a Transmission Licensee connected to the User's System at 132kV and above, and also in Scotland and Offshore, connected at 33kV and above, other than power factor correction equipment associated with a customers Plant or Apparatus:</p> <p>Type of equipment (eg. fixed or variable) Capacitive rating; or Inductive rating; or Operating range</p> <p>Details of automatic control logic to enable operating characteristics to be determined</p> <p>Point of connection to User's System (electrical location and system voltage)</p>	<p>Text</p> <p>MVAr</p> <p>MVAr</p> <p>MVAr</p> <p>text and/or diagrams</p> <p>Text</p>	<p>■</p> <p>■</p> <p>■</p> <p>■</p> <p>■</p> <p>■</p> <p>■</p>	<p>■</p> <p>■</p> <p>■</p> <p>■</p> <p>■</p> <p>■</p> <p>■</p>	<p>SPD</p> <p>SPD</p> <p>SPD</p> <p>SPD</p> <p>SPD</p> <p>SPD</p> <p>SPD</p>
<p><u>SUBSTATION INFRASTRUCTURE (PC.A.2.2.6(b))</u></p> <p>For the infrastructure associated with any User's equipment at a Substation owned by a Transmission Licensee or operated or managed by The Company:-</p> <p>Rated 3-phase rms short-circuit withstand current Rated 1-phase rms short-circuit withstand current Rated Duration of short-circuit withstand Rated rms continuous current</p>	<p>kA</p> <p>kA</p> <p>s</p> <p>A</p>	<p>■</p> <p>■</p> <p>■</p> <p>■</p>	<p>■</p> <p>■</p> <p>■</p> <p>■</p>	<p>SPD</p> <p>SPD</p> <p>SPD</p> <p>SPD</p>

SCHEDULE 5 – USERS SYSTEM DATA

PAGE 3 OF 11

Table 5(c)

DATA DESCRIPTION		UNITS	DATA EXCH		DATA CATEGORY
			CUSC Contract	CUSC App. Form	
LUMPED SUSCEPTANCES (<i>PC.A.2.3</i>)					
Equivalent Lumped Susceptance required for all parts of the User's Subtransmission System which are not included in the Single Line Diagram .			■	■	
This should not include:			■	■	
(a)	independently switched reactive compensation equipment identified above.		■	■	
(b)	any susceptance of the User's System inherent in the Demand (Reactive Power) data provided in Schedule 1 (Generator Data) or Schedule 11 (Connection Point data).		■	■	
Equivalent lumped shunt susceptance at nominal Frequency .		% on 100 MVA	■	■	SPD

USER'S SYSTEM DATA

Switchgear Data (PC.A.2.2.6(a)) (CUSC Contract & CUSC Application Form ■)

The data below is all **Standard Planning Data**, and should be provided for all switchgear (ie. circuit breakers, load disconnectors and disconnectors) operating at a **Supergrid Voltage**, and also in Scotland and **Offshore**, operating at 132kV. In addition, data should be provided for all circuit breakers irrespective of voltage located at a **Connection Site** which is owned by a **Transmission Licensee** or operated or managed by **The Company**.

Table 5(f)

Years Valid	Connect-ion Point	Switch No.	Rated Voltage kV rms	Operating Voltage kV rms	Rated short-circuit breaking current		Rated short-circuit peak making current		Rated rms continuous current (A)	DC time constant at testing of asymmetri cal breaking ability(s)
					3 Phase kA rms	1 Phase kA rms	3 Phase kA peak	1 Phase kA peak		

Notes

1. Rated Voltage should be as defined by IEC 694.
2. Data should be supplied for the current, and each of the seven succeeding Financial Years. This should be done by showing for which years the data is valid in the first column of the Table

SCHEDULE 5 –USERS SYSTEM DATA

PAGE 7 OF 11

Table 5(g)

DATA DESCRIPTION	UNITS	DATA to RTL		DATA CATEGORY
<p>PROTECTION SYSTEMS (PC.A.6.3)</p> <p>The following information relates only to Protection equipment which can trip or inter-trip or close any Connection Point circuit breaker or any Transmission circuit breaker. The information need only be supplied once, in accordance with the timing requirements set out in PC.A.1.4 (b) and need not be supplied on a routine annual basis thereafter, although The Company should be notified if any of the information changes.</p>				
(a) A full description, including estimated settings, for all relays and Protection systems installed or to be installed on the User's System ;		■		DPD II
(b) A full description of any auto-reclose facilities installed or to be installed on the User's System , including type and time delays;		■		DPD II
(c) A full description, including estimated settings, for all relays and Protection systems installed or to be installed on the Power Generating Module, Power Park Module or Generating Unit's generator transformer, unit transformer, station transformer and their associated connections;		■		DPD II
(d) For Generating Units (other than Power Park Units) having a circuit breaker at the generator terminal voltage clearance times for electrical faults within the Generating Unit zone must be declared.		■		DPD II
(e) Fault Clearance Times: Most probable fault clearance time for electrical faults on any part of the Users System directly connected to the National Electricity Transmission System .	mSec	■		DPD II

DATA DESCRIPTION	UNITS	DATA to RTL		DATA CATEGORY
<p>POWER PARK MODULE/UNIT PROTECTION SYSTEMS</p> <p>Details of settings for the Power Park Module/Unit protection relays (to include): (PC.A.5.4.2(f))</p>				
(a) Under frequency,		■		DPD II
(b) Over Frequency,		■		DPD II
(c) Under Voltage, Over Voltage,		■		DPD II
(d) Rotor Over current		■		DPD II
(e) Stator Over current,		■		DPD II
(f) High Wind Speed Shut Down Level		■		DPD II
(g) Rotor Underspeed		■		DPD II
(h) Rotor Overspeed		■		DPD II

SCHEDULE 5 - USERS SYSTEM DATA

PAGE 8 OF 11

Information for Transient Overvoltage Assessment (DPD I) (PC.A.6.2 ■ CUSC Contract)

The information listed below may be requested by **The Company** from each **User** with respect to any **Connection Site** between that **User** and the **National Electricity Transmission System**. The impact of any third party **Embedded** within the **Users System** should be reflected.

- (a) Busbar layout plan(s), including dimensions and geometry showing positioning of any current and voltage transformers, through bushings, support insulators, disconnectors, circuit breakers, surge arresters, etc. Electrical parameters of any associated current and voltage transformers, stray capacitances of wall bushings and support insulators, and grading capacitances of circuit breakers;
- (b) Electrical parameters and physical construction details of lines and cables connected at that busbar. Electrical parameters of all plant e.g., transformers (including neutral earthing impedance or zig-zag transformers if any), series reactors and shunt compensation equipment connected at that busbar (or to the tertiary of a transformer) or by lines or cables to that busbar;
- (c) Basic insulation levels (BIL) of all **Apparatus** connected directly, by lines or by cables to the busbar;
- (d) Characteristics of overvoltage **Protection** devices at the busbar and at the termination points of all lines, and all cables connected to the busbar;
- (e) Fault levels at the lower voltage terminals of each transformer connected directly or indirectly to the **National Electricity Transmission System** without intermediate transformation;
- (f) The following data is required on all transformers operating at **Supergrid Voltage** throughout **Great Britain** and, in Scotland and **Offshore**, also at 132kV: three or five limb cores or single phase units to be specified, and operating peak flux density at nominal voltage.
- (g) An indication of which items of equipment may be out of service simultaneously during **Planned Outage** conditions.

Harmonic Studies (DPD I) (PC.A.6.4 ■ CUSC Contract)

The information given below, both current and forecast, where not already supplied in this Schedule 5 may be requested by **The Company** from each **User** if it is necessary for **The Company** to evaluate the production/magnification of harmonic distortion on the **National Electricity Transmission System** and **User's** systems. The impact of any third party **Embedded** within the **User's System** should be reflected:

- (a) Overhead lines and underground cable circuits of the **User's Subtransmission System** must be differentiated and the following data provided separately for each type:
 - Positive phase sequence resistance
 - Positive phase sequence reactance
 - Positive phase sequence susceptance
- (b) for all transformers connecting the **User's Subtransmission System** to a lower voltage:
 - Rated MVA
 - Voltage Ratio
 - Positive phase sequence resistance
 - Positive phase sequence reactance

SCHEDULE 5 – USERS SYSTEM DATA

PAGE 9 OF 11

- (c) at the lower voltage points of those connecting transformers:

Equivalent positive phase sequence susceptance

Connection voltage and MVA_r rating of any capacitor bank and component design parameters if configured as a filter

Equivalent positive phase sequence interconnection impedance with other lower voltage points

The minimum and maximum **Demand** (both MW and MVA_r) that could occur

Harmonic current injection sources in Amps at the Connection voltage points

Details of traction loads, eg connection phase pairs, continuous variation with time, etc.

- (d) an indication of which items of equipment may be out of service simultaneously during **Planned Outage** conditions

Voltage Assessment Studies (DPD I) (PC.A.6.5 ■ CUSC Contract)

The information listed below, where not already supplied in this Schedule 5, may be requested by **The Company** from each **User** with respect to any **Connection Site** if it is necessary for **The Company** to undertake detailed voltage assessment studies (eg to examine potential voltage instability, voltage control co-ordination or to calculate voltage step changes). The impact of any third party **Embedded** within the **Users System** should be reflected:

- (a) For all circuits of the **User's Subtransmission System**:

Positive Phase Sequence Reactance

Positive Phase Sequence Resistance

Positive Phase Sequence Susceptance

MVA_r rating of any reactive compensation equipment

- (b) for all transformers connecting the **User's Subtransmission System** to a lower voltage:

Rated MVA

Voltage Ratio

Positive phase sequence resistance

Positive Phase sequence reactance

Tap-changer range

Number of tap steps

Tap-changer type: on-load or off-circuit

AVC/tap-changer time delay to first tap movement

AVC/tap-changer inter-tap time delay

SCHEDULE 5 – USERS SYSTEM DATA

PAGE 10 OF 11

- (c) at the lower voltage points of those connecting transformers:-
- Equivalent positive phase sequence susceptance
 - MVA_r rating of any reactive compensation equipment
 - Equivalent positive phase sequence interconnection impedance with other lower voltage points
 - The maximum **Demand** (both MW and MVA_r) that could occur
 - Estimate of voltage insensitive (constant power) load content in % of total load at both winter peak and 75% off-peak load conditions

Short Circuit Analyses:(DPD I) (PC.A.6.6 ■ CUSC Contract)

The information listed below, both current and forecast, and where not already supplied under this Schedule 5, may be requested by **The Company** from each **User** with respect to any **Connection Site** where prospective short-circuit currents on equipment owned by a **Transmission Licensee** or operated or managed by **The Company** are close to the equipment rating. The impact of any third party **Embedded** within the **User's System** should be reflected:-

- (a) For all circuits of the **User's Subtransmission System**:
- Positive phase sequence resistance
 - Positive phase sequence reactance
 - Positive phase sequence susceptance
 - Zero phase sequence resistance (both self and mutuals)
 - Zero phase sequence reactance (both self and mutuals)
 - Zero phase sequence susceptance (both self and mutuals)
- (b) for all transformers connecting the **User's Subtransmission System** to a lower voltage:
- Rated MVA
 - Voltage Ratio
 - Positive phase sequence resistance (at max, min and nominal tap)
 - Positive Phase sequence reactance (at max, min and nominal tap)
 - Zero phase sequence reactance (at nominal tap)
 - Tap changer range
 - Earthing method: direct, resistance or reactance
 - Impedance if not directly earthed
- (c) at the lower voltage points of those connecting transformers:-
- The maximum **Demand** (in MW and MVA_r) that could occur
 - Short-circuit infeed data in accordance with PC.A.2.5.6(a) unless the **User's** lower voltage network runs in parallel with the **Subtransmission System**, when to prevent double counting in each node infeed data, a π equivalent comprising the data items of PC.A.2.5.6(a) for each node together with the positive phase sequence interconnection impedance between the nodes shall be submitted.

SCHEDULE 5 – USERS SYSTEM DATA

PAGE 11 OF 11

Dynamic Models:(DPD II) (PC.A.6.7 ■ CUSC Contract)

The information listed below, both current and forecast, and where not already supplied under this Schedule 5, may be requested by **NGET** from each **EU Code User** or in respect of each **EU Grid Supply Point** with respect to any **Connection Site**

- (a) Dynamic model structure and block diagrams including parameters, transfer functions and individual elements (as applicable)
- (b) Power control functions and block diagrams including parameters, transfer functions and individual elements (as applicable)
- (c) Voltage control functions and block diagrams including parameters, transfer functions and individual elements (as applicable)
- (d) Converter control models and block diagrams including parameters, transfer functions and individual elements (as applicable)

SCHEDULE 11 - CONNECTION POINT DATA

The following information is required from each **Network Operator** and from each **Non-Embedded Customer**. The data should be provided in calendar week 24 each year (although **Network Operators** may delay the submission until calendar week 28).

Table 11(a)

Connection Point:

Connection Point Demand at the time of - (select each one in turn) (Provide data for each Access Period associated with the Connection Point)	a) maximum Demand b) peak National Electricity Transmission System Demand (specified by The Company) c) minimum National Electricity Transmission System Demand (specified by The Company) d) maximum Demand during Access Period e) specified by either The Company or an User
Name of Transmission Interface Circuit out of service during Access Period (if reqd).	PC.A.4.1.4.2

DATA DESCRIPTION (CUSC Contract □ & CUSC Application Form ■)	Outturn	Outturn Weather Corrected	F.Yr 1	F.Yr 2	F.Yr 3	F.Yr 4	F.Yr 5	F.Yr 6	F.Yr 7	F.Yr 8	DATA CAT
Date of a), b), c), d) or e) as denoted above.											PC.A.4.3.3
Time of a), b), c), d) or e) as denoted above.											PC.A.4.3.3
Connection Point Demand (MW)											PC.A.4.3.1
Connection Point Demand (MVA _r)											PC.A.4.3.1
Deduction made at Connection Point for Small Power Stations, Medium Power Stations and Customer Generating Plant (MW)											PC.A.4.3.2(a)
Reference to valid Single Line Diagram											PC.A.4.3.5
Reference to node and branch data.											PC.A.2.2

Note: The following data block can be repeated for each post fault network revision that may impact on the Transmission System.

Reference to post-fault revision of Single Line Diagram											PC.A.4.5
Reference to post-fault revision of the node and branch data associated with the Single Line Diagram											PC.A.4.5
Reference to the description of the actions and timescales involved in effecting the post-fault actions (e.g. auto-switching, manual, teleswitching, overload protection operation etc)											PC.A.4.5

Access Group:		
----------------------	--	--

Note: The following data block to be repeated for each Connection Point with the Access Group.

Name of associated Connection Point within the same Access Group:											PC.A.4.3.1
Demand at associated Connection Point (MW)											PC.A.4.3.1
Demand at associated Connection Point (MVA _r)											PC.A.4.3.1
Deduction made at associated Connection Point for Small Power Stations, Medium Power Stations and Customer Generating Plant (MW)											PC.A.4.3.2(a)

SCHEDULE 11 - CONNECTION POINT DATA

Table 11(b)

Embedded Generation Data											
Connection Point:											
DATA DESCRIPTION	Outturn	Outturn Weather Corrected	F.Yr 1	F.Yr 2	F.Yr. 3	F.Yr. 4	F.Yr. 5	F.Yr 6	F.Yr 7	F.Yr 8	DATA CAT
<u>Small Power Station, Medium Power Station and Customer Generation Summary</u>	For each Connection Point where there are Embedded Small Power Stations, Medium Power Stations or Customer Generating Stations the following information is required:										
No. of Small Power Stations, Medium Power Stations or Customer Power Stations											PC.A.3.1.4(a)
Number of Generating Units within these stations											PC.A.3.1.4(a)
Summated Capacity of all these Generating Units											PC.A.3.1.4(a)
Where the Network Operator's System places a constraint on the capacity of an Embedded Large Power Station											
Station Name											PC.A.3.2.2(c)
Generating Unit											PC.A.3.2.2(c)
System Constrained Capacity											PC.A.3.2.2(c)(i)
Reactive Despatch Network Restriction											PC.A.3.2.2(c)(ii)

Where the Network Operator's System places a constraint on the capacity of an Offshore Transmission System at an Interface Point											
Offshore Transmission System Name											PC.A.3.2.2(c)
Interface Point Name											PC.A.3.2.2(c)
Maximum Export Capacity											PC.A.3.2.2(c)
Maximum Import Capacity											PC.A.3.2.2(c)

SCHEDULE 11 - CONNECTION POINT DATA

PAGE 4 OF 5

NOTES:

1. 'F.Yr.' means 'Financial Year'. F.Yr. 1 refers to the current financial year.
2. All **Demand** data should be net of the output (as reasonably considered appropriate by the **User**) of all **Embedded Small Power Stations, Medium Power Stations** and **Customer Generating Plant**. Generation and / or Auxiliary demand of **Embedded Large Power Stations** should not be included in the demand data submitted by the **User**. **Users** should refer to the **PC** for a full definition of the **Demand** to be included.
3. Peak **Demand** should relate to each **Connection Point** individually and should give the maximum demand that in the **User's** opinion could reasonably be imposed on the **National Electricity Transmission System**. **Users** may submit the **Demand** data at each node on the **Single Line Diagram** instead of at a **Connection Point** as long as the **User** reasonably believes such data relates to the peak (or minimum) at the **Connection Point**.

In deriving **Demand** any deduction made by the **User** (as detailed in note 2 above) to allow for **Embedded Small Power Stations, Medium Power Stations** and **Customer Generating Plant** is to be specifically stated as indicated on the Schedule.

4. **The Company** may at its discretion require details of any **Embedded Small Power Stations** or **Embedded Medium Power Stations** whose output can be expected to vary in a random manner (eg. wind power) or according to some other pattern (eg. tidal power)
5. Where more than 95% of the total **Demand** at a **Connection Point** is taken by synchronous motors, values of the **Power Factor** at maximum and minimum continuous excitation may be given instead. **Power Factor** data should allow for series reactive losses on the **User's System** but exclude reactive compensation network susceptance specified separately in Schedule 5.
6. Where a **Reactive Despatch Network Restriction** is in place which requires the generator to maintain a target voltage set point this should be stated as an alternative to the size of the **Reactive Despatch Network Restriction**.

|

SCHEDULE 11 - CONNECTION POINT DATA

Table 11(d)

Embedded Small Power Stations <1MW

<u>Date</u>	
<u>Network Operator</u>	

<u>Fuel Type</u>	<u>Aggregate Registered Capacity Total MW</u>	<u>Number of PGMs</u>	<u>Comments</u>
<u>Biomass</u>	-	-	-
<u>Fossil brown coal/lignite</u>	-	-	-
<u>Fossil coal-derived gas</u>	-	-	-
<u>Fossil gas</u>	-	-	-
<u>Fossil hard coal</u>	-	-	-
<u>Fossil oil</u>	-	-	-
<u>Fossil oil shale</u>	-	-	-
<u>Fossil peat</u>	-	-	-
<u>Geothermal</u>	-	-	-
<u>Hydro pumped storage</u>	-	-	-
<u>Hydro run-of-river and poundage</u>	-	-	-
<u>Hydro water reservoir</u>	-	-	-
<u>Marine</u>	-	-	-
<u>Nuclear</u>	-	-	-
<u>Other renewable</u>	-	-	-
<u>Solar</u>	-	-	-
<u>Waste</u>	-	-	-
<u>Wind offshore</u>	-	-	-
<u>Wind onshore</u>	-	-	-
<u>Other</u>	-	-	-

Annex 5 SOGL and KORRR Code Mapping

This can be found separately uploaded to our website under Annex 5.

Annex 6 Workgroup Consultation responses

Grid Code Workgroup Consultation Response Proforma

GC0106 Data exchange requirements in accordance with Regulation (EU) 2017/1485 (SOGL)

Industry parties are invited to respond to this consultation expressing their views and supplying the rationale for those views, particularly in respect of any specific questions detailed below.

Please send your responses by **5pm on 27 April 2018** to grid.code@nationalgrid.com. Please note that any responses received after the deadline or sent to a different email address may not receive due consideration by the Workgroup.

Any queries on the content of the consultation should be addressed to Chrissie Brown at Christine.brown1@nationalgrid.com

Respondent:	<i>Peter Twomey</i>
Company Name:	<i>Electricity North West</i>
<p>Please express your views regarding the Workgroup Consultation, including rationale.</p> <p>(Please include any issues, suggestions or queries)</p>	<p><i>For reference, the Grid Code objectives are:</i></p> <ul style="list-style-type: none"> i. To permit the development, maintenance and operation of an efficient, coordinated and economical system for the transmission of electricity ii. To facilitate competition in the generation and supply of electricity (and without limiting the foregoing, to facilitate the national electricity transmission system being made available to persons authorised to supply or generate electricity on terms which neither prevent nor restrict competition in the supply or generation of electricity) iii. Subject to sub-paragraphs (i) and (ii), to promote the security and efficiency of the electricity generation, transmission and distribution systems in the national electricity transmission system operator area taken as a whole iv. To efficiently discharge the obligations imposed upon the licensee by this license and to comply with the Electricity Regulation and any relevant legally binding decisions of the European Commission and/or the Agency; and v. To promote efficiency in the implementation and administration of the Grid Code arrangements. <p><i>The Distribution Code objectives are:</i></p> <ul style="list-style-type: none"> i. Permit the development, maintenance, and operation of an efficient, coordinated and economical System for the distribution of electricity. ii. Facilitate competition in the generation and supply of electricity. iii. Efficiently discharge the obligations imposed upon DNOs

	<p>by the Distribution Licence and comply with the Regulation (where Regulation has the meaning defined in the Distribution Licence) and any relevant legally binding decision of the European Commission and/or Agency for the Co-operation of Energy Regulators.</p> <p>iv. Promote efficiency in the implementation and administration of the Distribution Code.</p>
--	---

Standard Workgroup Consultation questions

Q	Question	Response
1	Do you believe that GC0106 Original proposal, or any potential alternatives for change that you wish to suggest, better facilitates the Grid Code Objectives?	Yes
2	Do you support the proposed implementation approach?	Yes
3	Do you have any other comments?	No
4	Do you wish to raise a WG Consultation Alternative Request for the Workgroup to consider?	No

Specific GC0106 questions

Q	Question	Response
5	For those respondents that the Workgroup believes are directly affected by the GC0106 proposal (i.e. (i) new Type A power generating modules of less than 16A per phase, (ii) DNOs and (iii) CDSOs) do you agree with the proposed revised data exchange requirements? Do you have any comments on the drafting of the associated legal text set out in Annexes 4, 6 and 7?	We agree with the revision to data requirements
6	Do you believe that the solution described in this Workgroup Report discharges the legal	Yes – we believe that the proposal correctly interprets and applies SOGL in relation to data requirements.

	obligations of the SOGL and other relevant EU legislation?	
7	For those parties that the Workgroup believes are not directly affected by the GC0106 proposed revised data exchange requirements, do you have any comments on the approach and/or legal drafting?	No comment
8	Do you have any views on the legal interpretation aspects set out in Section 9 together with the explanatory information in Annexes 42 and 43?	We believe that the implications suggested in Annex 2 are incorrect. We believe Annex 3 to be a correct interpretation of the SOGL drafting.
	Legal text comments	
	<i>If you believe there are issues in the legal text, can you please bring these to our attention by using the space provided here. These will then be discussed at the GC0106 Workgroup meetings planned following the closure of this Consultation.</i>	

Grid Code Workgroup Consultation Response Proforma

GC0106 Data exchange requirements in accordance with Regulation (EU) 2017/1485 (SOGL)

Industry parties are invited to respond to this consultation expressing their views and supplying the rationale for those views, particularly in respect of any specific questions detailed below.

Please send your responses by **5pm on 27 April 2018** to grid.code@nationalgrid.com. Please note that any responses received after the deadline or sent to a different email address may not receive due consideration by the Workgroup.

Any queries on the content of the consultation should be addressed to Chrissie Brown at Christine.brown1@nationalgrid.com

Respondent:	<i>Mike Kay</i>
Company Name:	<i>Energy Networks Association</i>
<p>Please express your views regarding the Workgroup Consultation, including rationale.</p> <p>(Please include any issues, suggestions or queries)</p>	<p><i>For reference, the Grid Code objectives are:</i></p> <ul style="list-style-type: none"> i. To permit the development, maintenance and operation of an efficient, coordinated and economical system for the transmission of electricity ii. To facilitate competition in the generation and supply of electricity (and without limiting the foregoing, to facilitate the national electricity transmission system being made available to persons authorised to supply or generate electricity on terms which neither prevent nor restrict competition in the supply or generation of electricity) iii. Subject to sub-paragraphs (i) and (ii), to promote the security and efficiency of the electricity generation, transmission and distribution systems in the national electricity transmission system operator area taken as a whole iv. To efficiently discharge the obligations imposed upon the licensee by this license and to comply with the Electricity Regulation and any relevant legally binding decisions of the European Commission and/or the Agency; and v. To promote efficiency in the implementation and administration of the Grid Code arrangements. <p><i>The Distribution Code objectives are:</i></p> <ul style="list-style-type: none"> i. Permit the development, maintenance, and operation of an efficient, coordinated and economical System for the distribution of electricity. ii. Facilitate competition in the generation and supply of electricity. iii. Efficiently discharge the obligations imposed upon DNOs

	<p>by the Distribution Licence and comply with the Regulation (where Regulation has the meaning defined in the Distribution Licence) and any relevant legally binding decision of the European Commission and/or Agency for the Co-operation of Energy Regulators.</p> <p>iv. Promote efficiency in the implementation and administration of the Distribution Code.</p>
--	---

Standard Workgroup Consultation questions

Q	Question	Response
1	Do you believe that GC0106 Original proposal, or any potential alternatives for change that you wish to suggest, better facilitates the Grid Code Objectives?	Yes
2	Do you support the proposed implementation approach?	Yes
3	Do you have any other comments?	No
4	Do you wish to raise a WG Consultation Alternative Request for the Workgroup to consider?	No

Specific GC0106 questions

Q	Question	Response
5	For those respondents that the Workgroup believes are directly affected by the GC0106 proposal (i.e. (i) new Type A power generating modules of less than 16A per phase, (ii) DNOs and (iii) CDSOs) do you agree with the proposed revised data exchange requirements? Do you have any comments on the drafting of the associated legal text set out in Annexes 4, 6 and 7?	We agree with the revision to data requirements
6	Do you believe that the solution described in this Workgroup Report discharges the legal	Yes – we believe that the proposal correctly interprets and applies SOGL in relation to data requirements.

	obligations of the SOGL and other relevant EU legislation?	
7	For those parties that the Workgroup believes are not directly affected by the GC0106 proposed revised data exchange requirements, do you have any comments on the approach and/or legal drafting?	No comment
8	Do you have any views on the legal interpretation aspects set out in Section 9 together with the explanatory information in Annexes 42 and 43?	We believe that the implications suggested in Annex 2 are incorrect. We believe Annex 3 to be a correct interpretation of the SOGL drafting.
	Legal text comments	
	<i>If you believe there are issues in the legal text, can you please bring these to our attention by using the space provided here. These will then be discussed at the GC0106 Workgroup meetings planned following the closure of this Consultation.</i>	

Grid Code Workgroup Consultation Response Proforma

GC0106 Data exchange requirements in accordance with Regulation (EU) 2017/1485 (SOGL)

Industry parties are invited to respond to this consultation expressing their views and supplying the rationale for those views, particularly in respect of any specific questions detailed below.

Please send your responses by **5pm on 27 April 2018** to grid.code@nationalgrid.com. Please note that any responses received after the deadline or sent to a different email address may not receive due consideration by the Workgroup.

Any queries on the content of the consultation should be addressed to Chrissie Brown at Christine.brown1@nationalgrid.com

Respondent:	<i>Susan Mwape</i> susan.mwape@nationalgrid.com
Company Name:	<i>National Grid</i>
<p>Please express your views regarding the Workgroup Consultation, including rationale.</p> <p>(Please include any issues, suggestions or queries)</p>	<p><i>For reference, the Grid Code objectives are:</i></p> <ul style="list-style-type: none"> i. To permit the development, maintenance and operation of an efficient, coordinated and economical system for the transmission of electricity ii. To facilitate competition in the generation and supply of electricity (and without limiting the foregoing, to facilitate the national electricity transmission system being made available to persons authorised to supply or generate electricity on terms which neither prevent nor restrict competition in the supply or generation of electricity) iii. Subject to sub-paragraphs (i) and (ii), to promote the security and efficiency of the electricity generation, transmission and distribution systems in the national electricity transmission system operator area taken as a whole iv. To efficiently discharge the obligations imposed upon the licensee by this license and to comply with the Electricity Regulation and any relevant legally binding decisions of the European Commission and/or the Agency; and v. To promote efficiency in the implementation and administration of the Grid Code arrangements. <p><i>The Distribution Code objectives are:</i></p> <ul style="list-style-type: none"> i. Permit the development, maintenance, and operation of an efficient, coordinated and economical System for the distribution of electricity. ii. Facilitate competition in the generation and supply of electricity.

	<p>iii. Efficiently discharge the obligations imposed upon DNOs by the Distribution Licence and comply with the Regulation (where Regulation has the meaning defined in the Distribution Licence) and any relevant legally binding decision of the European Commission and/or Agency for the Co-operation of Energy Regulators.</p> <p>iv. Promote efficiency in the implementation and administration of the Distribution Code.</p>
--	--

Standard Workgroup Consultation questions

Q	Question	Response
1	Do you believe that GC0106 Original proposal, or any potential alternatives for change that you wish to suggest, better facilitates the Grid Code Objectives?	The original proposal positively facilitates efficiency in discharging the obligations imposed upon the licensee and all relevant legally binding decisions of the European commission and the Agency. The proposal aligns with guidance from BEIS and Ofgem to apply the new EU requirements within the existing GB regulatory frameworks and to use the existing governance processes. Following this approach provides accessibility and familiarity to all GB parties as well as promoting efficiency in the implementation and administration of the Grid Code arrangements. The key aim of the regulation on data exchange is to allow for TSOs to exchange data with neighbouring TSOs in a harmonised approach. In the case of GB synchronous area the observability area does not currently stretch into neighbouring countries therefore there is benefit in maintaining the existing GB data exchange between TSOs, DSOs and SGUs as that data is currently sufficient for state estimation. GB common grid models are already submitted to the EU platforms using existing data as required by regulation on capacity allocation and congestion management. Future changes are necessary hence there is merit in raising future Grid Code changes through other work streams that are going on to support the change in roles for the distribution and transmission system operator functions.
2	Do you support the proposed implementation approach?	Yes
3	Do you have any other comments?	
4	Do you wish to raise a WG Consultation Alternative Request for the Workgroup to consider?	<i>If yes, please complete a WG Consultation Alternative Request form, available on National Grid's website,</i> https://www.nationalgrid.com/uk/electricity/codes/grid-

		code and return to the Grid Code inbox at grid.code@nationalgrid.com
--	--	--

Specific GC0106 questions

Q	Question	Response
5	For those respondents that the Workgroup believes are directly affected by the GC0106 proposal (i.e. (i) new Type A power generating modules of less than 16A per phase, (ii) DNOs and (iii) CDSOs) do you agree with the proposed revised data exchange requirements? Do you have any comments on the drafting of the associated legal text set out in Annexes 4, 6 and 7?	
6	Do you believe that the solution described in this Workgroup Report discharges the legal obligations of the SOGL and other relevant EU legislation?	<p>Yes. In line with Ofgem advice, the original proposal seeks to make only those changes necessary to the Grid code and Distribution Code to ensure compliance with SOGL and KORRR. Article 40.5 SOGL allows for TSO discretion on the application of some of the Articles through determining the applicability and scope for some of the structural, scheduling and real time data. This proposal therefore has a focus on making changes only in relation to the mandatory Articles with no TSO discretion.</p> <p>The solution builds upon the existing market structure arrangements that apply to large, medium and small providers. National Grid and DNOs currently have sufficient data to operate the transmission and distribution systems respectively in an efficiently and coordinated manner. In order to meet SOGL compliance it is sufficient to maintain the status quo. In GB the Grid and Distribution Codes are aligned to allow for the necessary data exchange between them and for SGUs connected to the respective networks. The proposed changes will ensure compliance of mandatory changes and where flexibility is adopted future changes will be raised in accordance with changes to the system operation roles for both distribution and transmission.</p> <p>Setting stringent data exchange requirements may stifle innovation in growing markets particularly for demand side providers. Implementing non-mandatory changes may lead to financial investments with little benefit to the TSO. This may put compliance at risk as the deadline is 14 March 2019.</p>

7	For those parties that the Workgroup believes are not directly affected by the GC0106 proposed revised data exchange requirements, do you have any comments on the approach and/or legal drafting?	
8	Do you have any views on the legal interpretation aspects set out in Section 9 together with the explanatory information in Annexes 2 and 3?	The wording in articles 44, 47 – 53 in SOGL , “unless otherwise provided by the TSO,…” provides some flexibility in agreement of the applicability and scope of data exchange. The key aim is to exchange data with other TSO in the case of GB, currently there is no requirement to exchange data with a neighbouring TSO so we support the legal interpretation which was echoed in a letter from the European Commission to EU DSOs. This approach and aligns with the Regulator’s guidance on implementing EU code changes.
	Legal text comments	The legal text for PC.A.3.1.4 will be amended such that it does not refer to each embedded power station as suggested below: (iii) beginning from the 2019 Week 24 data submission, for Embedded Small Power Stations with Registered Capacity of 1MW or less, their best estimate of the aggregated capacity of all such Embedded Small Power Stations per production type as defined the list in PC.A.3.1.4 (a)(ii)(2)(a).
	<i>If you believe there are issues in the legal text, can you please bring these to our attention by using the space provided here. These will then be discussed at the GC0106 Workgroup meetings planned following the closure of this Consultation.</i>	

Grid Code Workgroup Consultation Response Proforma

GC0106 Data exchange requirements in accordance with Regulation (EU) 2017/1485 (SOGL)

Industry parties are invited to respond to this consultation expressing their views and supplying the rationale for those views, particularly in respect of any specific questions detailed below.

Please send your responses by **5pm on 27 April 2018** to grid.code@nationalgrid.com. Please note that any responses received after the deadline or sent to a different email address may not receive due consideration by the Workgroup.

Any queries on the content of the consultation should be addressed to Chrissie Brown at Christine.brown1@nationalgrid.com

Respondent:	<i>Alan Creighton</i>
Company Name:	<i>Northern Powergrid</i>
<p>Please express your views regarding the Workgroup Consultation, including rationale.</p> <p>(Please include any issues, suggestions or queries)</p>	<p><i>For reference, the Grid Code objectives are:</i></p> <ul style="list-style-type: none"> i. To permit the development, maintenance and operation of an efficient, coordinated and economical system for the transmission of electricity ii. To facilitate competition in the generation and supply of electricity (and without limiting the foregoing, to facilitate the national electricity transmission system being made available to persons authorised to supply or generate electricity on terms which neither prevent nor restrict competition in the supply or generation of electricity) iii. Subject to sub-paragraphs (i) and (ii), to promote the security and efficiency of the electricity generation, transmission and distribution systems in the national electricity transmission system operator area taken as a whole iv. To efficiently discharge the obligations imposed upon the licensee by this license and to comply with the Electricity Regulation and any relevant legally binding decisions of the European Commission and/or the Agency; and v. To promote efficiency in the implementation and administration of the Grid Code arrangements. <p><i>The Distribution Code objectives are:</i></p> <ul style="list-style-type: none"> i. Permit the development, maintenance, and operation of an efficient, coordinated and economical System for the distribution of electricity. ii. Facilitate competition in the generation and supply of electricity. iii. Efficiently discharge the obligations imposed upon DNOs

	<p>by the Distribution Licence and comply with the Regulation (where Regulation has the meaning defined in the Distribution Licence) and any relevant legally binding decision of the European Commission and/or Agency for the Co-operation of Energy Regulators.</p> <p>iv. Promote efficiency in the implementation and administration of the Distribution Code.</p>
--	---

Standard Workgroup Consultation questions

Q	Question	Response
1	Do you believe that GC0106 Original proposal, or any potential alternatives for change that you wish to suggest, better facilitates the Grid Code Objectives?	Yes
2	Do you support the proposed implementation approach?	Yes
3	Do you have any other comments?	It would be helpful if, following the completion of this Modification Proposal, NGET were to review the DG data requested from DNOs in Schedule 11 (per GSP), Schedule 11 (GC0042 DG >1MV) and the new information forming this GC0106 proposal. The purpose of such a review would be to clarify the information that NGET require and to ensure consistency between the three data submissions. Harmonisation would help DNOs to structure their generation databases and provide consistency in reporting e.g. how to treat a Small Power Station >1MW with multiple energy sources such as PV and Battery.
4	Do you wish to raise a WG Consultation Alternative Request for the Workgroup to consider?	No

Specific GC0106 questions

Q	Question	Response
---	----------	----------

<p>5</p>	<p>For those respondents that the Workgroup believes are directly affected by the GC0106 proposal (i.e. (i) new Type A power generating modules of less than 16A per phase, (ii) DNOs and (iii) CDSOs) do you agree with the proposed revised data exchange requirements? Do you have any comments on the drafting of the associated legal text set out in Annexes 4, 6 and 7?</p>	<p>Comments on Annex 4 – Grid Code text</p> <p>1 The proposed new text in PC. A 1.2 (a) (i) should be supplemented with the additional words underlined:</p> <p>In addition <u>the structural data in DRC Schedule 5 provided by calendar week 28 shall be updated and provided by Network Operators in week 50 of each year (again which may be delayed as above until week 2 of the following calendar year)</u></p> <p>Schedule 5 (page 10 of 10), in part (c) of the Short Circuit Analysis section requires that demand and short circuit data is provided in a DNO week 24 schedule 5 submission. The DNO week 24 Schedule 5 templates include fault level and demand data. We understand that the intent of the DCC Art 43-3 is that the DNO only needs to provide an update of the structural data; the purpose of the additional words above is to clarify this intent.</p> <p>However given that ‘structural data’ is not a defined Grid Code term, this might not be sufficiently clear and it may be necessary to :</p> <ul style="list-style-type: none"> a) Define structural data; b) Include the list of structural data items from Art 43 in the text above; or c) Draft the text to refer explicitly to the parts of the GCode that require the individual components of the Schedule 5 data e.g. line data, transformer data etc. <p>2 The proposed new text in PCA 3.1.4. (iii) should be replaced with :</p> <p>(iii) beginning from the 2019 Week 24 data submission, for Embedded Power Stations with Registered Capacity of 1MW or less, their best estimate of the aggregated capacity of all such Embedded Power Stations per production type as defined the list in PC.A.3.1.4 (a)(ii)(2)(a).</p> <p>The above text clarifies the requirement and also that the DNOs are required to provide their best estimates of the aggregated capacity in accordance with DCC Article 43 - 5.</p> <p>3 The proposed new Schedule 11 should be</p>
----------	--	---

		<p>included in the proposed changes to the Grid Code. Our understanding is that the proposal is as per the schedule below.</p> <p>The proposed reference to 'Network Operator Unique Reference Number' should be deleted. We assume that this has been carried over from the current Schedule 11 GC0042 table, but doesn't have a meaning for aggregated generation capacities.</p>
6	Do you believe that the solution described in this Workgroup Report discharges the legal obligations of the SOGL and other relevant EU legislation?	Yes
7	For those parties that the Workgroup believes are not directly affected by the GC0106 proposed revised data exchange requirements, do you have any comments on the approach and/or legal drafting?	N/A
8	Do you have any views on the legal interpretation aspects set out in Section 9 together with the explanatory information in Annexes 2 and 3?	We believe that the interpretation provide and used to form this Modification is reasonable.
	Legal text comments	
	<i>If you believe there are issues in the legal text, can you please bring these to our attention by using the space provided here. These will then be discussed at the GC0106 Workgroup meetings planned following the closure of this Consultation.</i>	Please see our response to Question 5 above.

Schedule 11 Embedded Small Power Stations <1MW			
Date			
Network Operator			
Network Operator Unique Ref. No.			
Fuel Type	Aggregate Registered Capacity Total MW	Number of PGMs	Comments
Biomass			
Fossil brown coal/lignite			
Fossil coal-derived gas			
Fossil gas			
Fossil hard coal			
Fossil oil			
Fossil oil shale			
Fossil peat			
Geothermal			
Hydro pumped storage			
Hydro run-of-river and poundage			
Hydro water reservoir			
Marine			
Nuclear			
Other renewable			
Solar			
Waste			
Wind offshore			
Wind onshore			
Other			

Grid Code Workgroup Consultation Response Proforma

GC0106 Data exchange requirements in accordance with Regulation (EU) 2017/1485 (SOGL)

Industry parties are invited to respond to this consultation expressing their views and supplying the rationale for those views, particularly in respect of any specific questions detailed below.

Please send your responses by **5pm on 27 April 2018** to grid.code@nationalgrid.com. Please note that any responses received after the deadline or sent to a different email address may not receive due consideration by the Workgroup.

Any queries on the content of the consultation should be addressed to Chrissie Brown at Christine.brown1@nationalgrid.com

Respondent:	<i>Graeme Vincent; graeme.vincent@spenergynetworks.co.uk</i>
Company Name:	<i>SP Energy Networks</i>
<p>Please express your views regarding the Workgroup Consultation, including rationale.</p> <p>(Please include any issues, suggestions or queries)</p>	<p><i>For reference, the Grid Code objectives are:</i></p> <ul style="list-style-type: none"> i. To permit the development, maintenance and operation of an efficient, coordinated and economical system for the transmission of electricity ii. To facilitate competition in the generation and supply of electricity (and without limiting the foregoing, to facilitate the national electricity transmission system being made available to persons authorised to supply or generate electricity on terms which neither prevent nor restrict competition in the supply or generation of electricity) iii. Subject to sub-paragraphs (i) and (ii), to promote the security and efficiency of the electricity generation, transmission and distribution systems in the national electricity transmission system operator area taken as a whole iv. To efficiently discharge the obligations imposed upon the licensee by this license and to comply with the Electricity Regulation and any relevant legally binding decisions of the European Commission and/or the Agency; and v. To promote efficiency in the implementation and administration of the Grid Code arrangements. <p><i>The Distribution Code objectives are:</i></p> <ul style="list-style-type: none"> i. Permit the development, maintenance, and operation of an efficient, coordinated and economical System for the distribution of electricity. ii. Facilitate competition in the generation and supply of electricity. iii. Efficiently discharge the obligations imposed upon DNOs

	<p>by the Distribution Licence and comply with the Regulation (where Regulation has the meaning defined in the Distribution Licence) and any relevant legally binding decision of the European Commission and/or Agency for the Co-operation of Energy Regulators.</p> <p>iv. Promote efficiency in the implementation and administration of the Distribution Code.</p>
--	---

Standard Workgroup Consultation questions

Q	Question	Response
1	Do you believe that GC0106 Original proposal, or any potential alternatives for change that you wish to suggest, better facilitates the Grid Code Objectives?	Yes, as the proposal implements the requirements of the EU System Operations Guideline in relation to the data exchange articles.
2	Do you support the proposed implementation approach?	Yes
3	Do you have any other comments?	No
4	Do you wish to raise a WG Consultation Alternative Request for the Workgroup to consider?	No

Specific GC0106 questions

Q	Question	Response
5	For those respondents that the Workgroup believes are directly affected by the GC0106 proposal (i.e. (i) new Type A power generating modules of less than 16A per phase, (ii) DNOs and (iii) CDSOs) do you agree with the proposed revised data exchange requirements? Do you have any comments on the drafting of the associated legal text set out in Annexes 4, 6 and 7?	We agree with the revision to data requirements
6	Do you believe that the solution described in this Workgroup Report discharges the legal	Yes – we believe that the proposal discharges the SOGL data obligations.

	obligations of the SOGL and other relevant EU legislation?	
7	For those parties that the Workgroup believes are not directly affected by the GC0106 proposed revised data exchange requirements, do you have any comments on the approach and/or legal drafting?	No response
8	Do you have any views on the legal interpretation aspects set out in Section 9 together with the explanatory information in Annexes 2 and 3?	Whilst we acknowledge the views being expressed in Annex2, we believe that based on the evidence and our reading of the relevant sections that the interpretation within Annex 3 to be correct.
	Legal text comments	
	<i>If you believe there are issues in the legal text, can you please bring these to our attention by using the space provided here. These will then be discussed at the GC0106 Workgroup meetings planned following the closure of this Consultation.</i>	In PC.A.3.1.4 (a)(iii) should small be capitalised ie Embedded S mall Power Station

Grid Code Workgroup Consultation Response Proforma

GC0106 Data exchange requirements in accordance with Regulation (EU) 2017/1485 (SOGL)

Industry parties are invited to respond to this consultation expressing their views and supplying the rationale for those views, particularly in respect of any specific questions detailed below.

Please send your responses by **5pm on 27 April 2018** to grid.code@nationalgrid.com. Please note that any responses received after the deadline or sent to a different email address may not receive due consideration by the Workgroup.

Any queries on the content of the consultation should be addressed to Chrissie Brown at Christine.brown1@nationalgrid.com

Respondent:	Alastair Frew
Company Name:	ScottishPower Generation Ltd
<p>Please express your views regarding the Workgroup Consultation, including rationale.</p> <p>(Please include any issues, suggestions or queries)</p>	<p><i>For reference, the Grid Code objectives are:</i></p> <ul style="list-style-type: none"> i. To permit the development, maintenance and operation of an efficient, coordinated and economical system for the transmission of electricity ii. To facilitate competition in the generation and supply of electricity (and without limiting the foregoing, to facilitate the national electricity transmission system being made available to persons authorised to supply or generate electricity on terms which neither prevent nor restrict competition in the supply or generation of electricity) iii. Subject to sub-paragraphs (i) and (ii), to promote the security and efficiency of the electricity generation, transmission and distribution systems in the national electricity transmission system operator area taken as a whole iv. To efficiently discharge the obligations imposed upon the licensee by this license and to comply with the Electricity Regulation and any relevant legally binding decisions of the European Commission and/or the Agency; and v. To promote efficiency in the implementation and administration of the Grid Code arrangements. <p><i>The Distribution Code objectives are:</i></p> <ul style="list-style-type: none"> i. Permit the development, maintenance, and operation of an efficient, coordinated and economical System for the distribution of electricity. ii. Facilitate competition in the generation and supply of electricity. iii. Efficiently discharge the obligations imposed upon DNOs

	<p>by the Distribution Licence and comply with the Regulation (where Regulation has the meaning defined in the Distribution Licence) and any relevant legally binding decision of the European Commission and/or Agency for the Co-operation of Energy Regulators.</p> <p>iv. Promote efficiency in the implementation and administration of the Distribution Code.</p>
--	---

Standard Workgroup Consultation questions

Q	Question	Response
1	Do you believe that GC0106 Original proposal, or any potential alternatives for change that you wish to suggest, better facilitates the Grid Code Objectives?	Yes
2	Do you support the proposed implementation approach?	Yes
3	Do you have any other comments?	No
4	Do you wish to raise a WG Consultation Alternative Request for the Workgroup to consider?	No

Specific GC0106 questions

Q	Question	Response
5	For those respondents that the Workgroup believes are directly affected by the GC0106 proposal (i.e. (i) new Type A power generating modules of less than 16A per phase, (ii) DNOs and (iii) CDSOs) do you agree with the proposed revised data exchange requirements? Do you have any comments on the drafting of the associated legal text set out in Annexes 4, 6 and 7?	N/A
6	Do you believe that the solution described in this Workgroup Report discharges the legal	Yes

	obligations of the SOGL and other relevant EU legislation?	
7	For those parties that the Workgroup believes are not directly affected by the GC0106 proposed revised data exchange requirements, do you have any comments on the approach and/or legal drafting?	No
8	Do you have any views on the legal interpretation aspects set out in Section 9 together with the explanatory information in Annexes 2 and 3?	It is difficult to see with the actual words used which interpretation is actually correct.
	Legal text comments	
	<i>If you believe there are issues in the legal text, can you please bring these to our attention by using the space provided here. These will then be discussed at the GC0106 Workgroup meetings planned following the closure of this Consultation.</i>	No

Grid Code Workgroup Consultation Response Proforma

GC0106 Data exchange requirements in accordance with Regulation (EU) 2017/1485 (SOGL)

Industry parties are invited to respond to this consultation expressing their views and supplying the rationale for those views, particularly in respect of any specific questions detailed below.

Please send your responses by **5pm on 27 April 2018** to grid.code@nationalgrid.com. Please note that any responses received after the deadline or sent to a different email address may not receive due consideration by the Workgroup.

Any queries on the content of the consultation should be addressed to Chrissie Brown at Christine.brown1@nationalgrid.com

Respondent:	<i>Damian Jackman, 07789 551669, Damian.jackman@sse.com</i>
Company Name:	<i>SSE Generation Ltd</i>
<p>Please express your views regarding the Workgroup Consultation, including rationale.</p> <p>(Please include any issues, suggestions or queries)</p>	<p>We do not believe that the solution described in the report discharges the legal obligations in regard to real-time data from Type B, C and D generators.</p> <p>We acknowledge that the TSO has taken legal guidance on the degree of flexibility it believes it is afforded in deciding whether to impose real-time data gathering requirements but we would like to highlight the broader context of the System Operator Guidelines within the context of the current GB balancing costs:</p> <ul style="list-style-type: none"> • The over-arching aims of the 3rd Energy Package were: <ol style="list-style-type: none"> 1. The secure operation of European power systems 2. The integration of large volumes of low carbon generation 3. The creation of a single European electricity market • In parallel with these aims, one of the top government priorities is to reduce costs for the consumer, particularly in light of the rising costs being levied on consumer's bills associated with low-carbon generation. • The proposal in this consultation is to continue with the status-quo with regards to real time data provision as <i>"..going beyond the status quo will lead to high financial investment with little benefit to the TSO"</i> (P.13) • However, this statement of opinion by the TSO is not supported by a cost benefit analysis but yet it has been used to justify the proposed solution of 'minimum change'. • In summary, it would seem the TSO has started from a position of 'minimum change' (without cost benefit justification) and then looked for any possible way to justify this position legally, without consideration of the

	<p>broader context of the 3rd Energy Package or prospect of lower bills for the consumer by having a more efficient system with lower balancing costs .</p> <ul style="list-style-type: none"> Given this context we do not feel the proposed solution - insofar as it does not require real-time data exchange from generators in the Type B and Type C bands – fully supports the Grid Code objectives in that it will lead to higher BSUoS costs due to lack of visibility the TSO will have over embedded generation than could otherwise been the case had real-time data been required from all generator types within bands B & C.
--	---

Standard Workgroup Consultation questions

Q	Question	Response
1	Do you believe that GC0106 Original proposal, or any potential alternatives for change that you wish to suggest, better facilitates the Grid Code Objectives?	Yes
2	Do you support the proposed implementation approach?	
3	Do you have any other comments?	
4	Do you wish to raise a WG Consultation Alternative Request for the Workgroup to consider?	<p><i>If yes, please complete a WG Consultation Alternative Request form, available on National Grid's website,</i></p> <p>https://www.nationalgrid.com/uk/electricity/codes/grid-code and return to the Grid Code inbox at grid.code@nationalgrid.com</p>

Specific GC0106 questions

Q	Question	Response
5	For those respondents that the Workgroup believes are directly affected by the GC0106 proposal (i.e. (i) new Type A power generating modules of less than 16A per phase, (ii) DNOs and (iii) CDSOs) do you agree with the proposed revised data exchange requirements? Do you have any comments on the drafting of the	Yes – we support the proposal for Type A generators

	associated legal text set out in Annexes 4, 6 and 7?	
6	Do you believe that the solution described in this Workgroup Report discharges the legal obligations of the SOGL and other relevant EU legislation?	No.
7	For those parties that the Workgroup believes are not directly affected by the GC0106 proposed revised data exchange requirements, do you have any comments on the approach and/or legal drafting?	<ul style="list-style-type: none"> • Not imposing common requirements on all generator Types runs against the broad vision of the 3rd Energy Package to create <i>harmonised</i> technical requirements for generators of similar capacity. • Instead, the proposed solution continues to impose extra costs on older generators in some parts of the country (e.g. Scotland) by requiring them to continue to provide real time data to the TSO, whereas generators in other parts of the country (England and Wales) continue to be exempt from real time data exchange. • The continued growth of small scale embedded generators powered by ‘renewable’ sources, (whose capacities will typically in the Type B and C bands where there this geographic discrimination occurs), the TSO will increasingly struggle to accurately determine generation output based purely on weather forecasts and forecast the despatch required to balance the system. • This uncertainty in forecasting output will lead to more balancing actions and will continue to push up BSUoS costs in the longer term. • If the TSO had real-time data from all Type B and C generators as is permitted by the SOGL, then it would have far higher certainty in forecasting generation output and therefore would be able to plan further ahead and take more cost-effective system actions to balance the system and manage constraints. • Lower balancing costs will feed through to lower costs for consumers by reducing wholesale energy costs. • We accept that imposing consistent requirements of real-time data submission on <i>all</i> existing and new generators - irrespective of their location within GB – may in some cases incur a cost for some generators to

		<p>install associated communications equipment – mainly those embedded generators in in England and Wales - who do not currently provide this data, as well as a cost to the DNOs and TSO to integrate their communications. However this one-off cost would over time lead to lower costs for generators and consumers in the form of lower BSUoS costs from fewer balancing actions needing to be taken than would otherwise have been the case.</p> <ul style="list-style-type: none"> • It should be noted in this context that National Grid have historically underestimated the growth in capacity of embedded generation (mainly Type B and Type C generators) For example in the 2012 Ten Year Statement National Grid forecasted 11 GW of embedded generation by 2017 when the actual amount proved to be ~26 GW. In the same year it was also forecasting ~17 GW of embedded generation by 2030 when the most recent forecasts of 2017 is now around 40 GW – likely in excess of true demand and will require significant balancing actions to manage. • The TSO should perform a cost-benefit analysis to show why it is not cost-effective to gather real time data from all generators in the Type B and Type C bands (existing and future) given the potential for large annual cost savings in future balancing actions.
8	Do you have any views on the legal interpretation aspects set out in Section 9 together with the explanatory information in Annexes 2 and 3?	We agree with the concern raised by a Workgroup Member that the Proposers’ solution to dealing with the ‘the TSO provides’ issue is legally incorrect and that the consequences of this, for the Proposer, are minimal as these consequences (of non compliance with the SOGL related data exchange requirements) fall upon DNOs and SGUs (and not the TSOs).
	Legal text comments	
	<i>If you believe there are issues in the legal text, can you please bring these to our attention by using the space provided here. These will then be discussed at the GC0106 Workgroup meetings planned following the closure of this Consultation.</i>	

Chrissie Brown
National Grid
1-3 Strand
WC2N 5EH
LONDON

By electronic copy only to: grid.code@nationalgrid.com

27 April 2018

Dear Chrissie

GC0106 Data exchange requirements in accordance with Regulation (EU) 2017/1485 (SOGL) – UK Power Networks response

Thank you for the opportunity to respond to the above consultation. Our response should be treated as consolidated on behalf of UK Power Networks' three distribution licence holding companies: Eastern Power Networks plc, London Power Networks plc, and South Eastern Power Networks plc.

We acknowledge that the modification proposal has been recommended in order to implement changes found in the System Operator Guidelines (SOGL) Code. We have reviewed the consultation and supporting documentation and provide the following feedback with respect to the proposed changes to the Grid Code regarding structural data submissions from Distribution Network Operators (DNOs):

- In the absence of further guidance or consultation documents that may yet be presented, we have no alternative proposal to make.
- We do not object to the proposed implementation approach and legal text in the Grid Code PC.A.1.2 (iii). However, we do require additional information in the form of guidance on how updated Schedule 5 data will be required – in particular with respect to load assumptions and/or considerations for plant commissioned between submissions. This will allow us to understand the changes to and business impacts on our current processes required to produce the Week 24 submissions.

Please could you outline how you envision the current guideline document to change and how you will consult with DNO stakeholders on this.

- We wish to raise the following points with respect to the proposed changes to PC.A.3.1.4, relating to the provision of information on embedded small power stations with a registered capacity below 1MW.
 - Although we agree with the proposed changes to EREC G83 and EREC G98 in order to facilitate DNOs obtaining the data required by the National Grid ETSO, EREC G83 states

that: “The installer is to ensure that the DNO is made aware of the Small Scale Embedded Generators installation at or before the time of commissioning”¹

- We therefore rely on the information provided by customers (or their installers) and until the proposed changes in EREC G83 and EREC G98 are implemented, customers will still use the valid Appendix forms (found on either Appendix 3 on EREC G83 or Form B on ERECG98) to inform DNOs of their installation. The information provided might not have all the information as required by the National Grid.
- As such, it is important to clarify that UK Power Networks will use reasonable endeavours to supply the information requested beginning from the 2019 Week 24 submission, but it may nonetheless be the case that the required information from the plant may be missing. The legal text should clearly recognise such circumstances and not inadvertently risk penalising licensees for not providing information which they have not received.
- Furthermore, we would like to propose that “Electricity Storage” is included in the list of technology types in the EREC G83 and EREC G98 proposed amendments. This would enable DNOs to also gather Electricity Storage data and prevent future modifications if this type of distributed energy resource is to be reported as well.

With regards to the legal text proposed, we would like to put forward the following amendments to the legal wording for PC.A.3.1.4 (iii):

(iii) beginning from the 2019 Week 24 data submission, the aggregated per production types from the list in PC.A.3.1.4 (a)(ii)(2)(a) for all Embedded Small Power Stations of Registered Capacity of 1MW or less advised [under EREC G83] to the Network Operator by the relevant date

In addition we also propose the following amendments to the legal wording for the Distribution Planning and Connection Code:

D.P.C 8.3.2 On request from a User, the DNO will notify the User of all the data submitted by and relating to that User under DPC8 that the DNO is holding and using for Distribution Code purposes.

I hope the above feedback has been constructive. If you have any questions, please do not hesitate to contact Sotiris Georgiopoulos (Sotiris.georgiopoulos@ukpowernetworks.co.uk) in the first instance.

Yours sincerely



James Hope
Head of Regulation & Regulatory Finance
UK Power Networks

Copy Sotiris Georgiopoulos, Head of Smart Grid Development, UK Power Networks
Paul Measday, Regulatory Returns & Compliance Manger

¹ EREC G86 Issue 2. Page 5 – Legal Aspects

Gurpal Singh
Ofgem
By email

Trisha McAuley OBE
Independent Chair
CUSC & Grid Code Panel

6 November 2018

GC0106: Data exchange requirements in accordance with Regulation (EU) 2017/1485 (SOGL)

Workgroup Alternative Grid Code Modifications (WAGCM1 and WAGCM3)

Dear Gurpal

The Grid Code Review Panel are writing to consult with you under the following Governance Rule (GR21.5) ahead of issuing GC0106 to Code Administrator Consultation following the Workgroup Report being presented to the November Grid Code Review Panel meeting:

GR.21.5 *Where the Grid Code Review Panel is of the view that the proposed text to amend the Grid Code for a Grid Code Modification Proposal or Workgroup Alternative Grid Code Modification(s) is not needed in the Grid Code Modification Report, the Grid Code Review Panel shall consult (giving its reasons as to why it is of this view) with the Authority as to whether the Authority would like the Grid Code Modification Report to include the proposed text to amend the Grid Code. If it does not, no text needs to be included. If it does, and no detailed text has yet been prepared, the Code Administrator shall prepare such text to modify the Grid Code in order to give effect to such Grid Code Modification Proposal or Workgroup Alternative Grid Code Modification(s) and shall seek the conclusions of the relevant Workgroup before consulting those identified in GR.21.2.*

The Panel are of the view that proposed text for WAGCM1 and WAGCM3 are not needed in the Grid Code Modification Report due to the fact that WAGCM1 is based on a legal interpretation of the System Operation Guideline (SOGL) that is a simple principle but with wide-reaching consequences. Please note that WAGCM3 is WAGCM1 and 2 combined and that WAGCM2 has been worked up within the Workgroup Report with the proposed text included for submission to you as per our instruction as Panel.

The legal interpretation used for the Original solution, as proposed by National Grid, can be found in Annex 2 of this letter and the interpretation the Proposer (SSE Generation Ltd) of each of the alternative modifications can be found in Annex 1.

Some work was completed by Workgroup members to firstly assess the potential impact of the WAGCMs and secondly around how much time would be required to full develop the proposed

text. This can be located in Annex 3. The Chair of the Workgroup was also of the view that should WACM1/3 have been fully developed that a further Workgroup Consultation would have been required due to the scale of the potential impact on the Industry. It was also noted that should this interpretation be correct it would mean that due the scale of change rather than the original proposal that essentially required no further actions from Users, that the modification would not be implemented in line with the compliance deadline of 14 March 2019, and that Users required to make changes following implementation would also be unable to comply.

The Workgroup sought on two occasions under GR20.8;

1. When the three WAGCMs were raised to seek clarification on whether to proceed with the 'significant amount of work required' to fully develop all three WAGCMs under GR20.8. At this stage, we gave the instruction to fully develop WAGCM2 and not WAGCM1 and WAGCM3. Please note that the Proposer of the WAGCMs was present at the Panel meeting and agreed that this was the correct approach at the time. The slides and minutes from the Panel meeting can be located here.
2. When working on fully developing the proposed text for WAGCM2 at the August 2018 Panel meeting. Following this the Proposer of the WAGCM2 amended their solution to cover just Transmission Connected equipment and this resulted in the proposed text being drafted. The slides presented at the Panel meeting can be located here.

Please can you confirm that you do not require the proposed text for the WAGCM1 and 3 by the 21 November 2018. We will be assessing whether the GC0106 Workgroup have met their Terms of Reference at their meeting on the 22 November 2018 ahead of this modification being issued to Code Administrator Consultation on the 23 November 2018. The modification will then be submitted to you for a decision in late December 2018.

The GCRP would recommend the Authority seek the view of their legal representatives on Annex 1 and 2 and send the Final Modification Report back for development should it be required at that stage but emphasise the compliance deadline of 14 March 2019.

Please note that all documentation for this modification and the alternatives can be located at the following link, including the Workgroup Report:

<https://www.nationalgrideso.com/codes/grid-code/modifications/gc0106-data-exchange-requirements-accordance-regulation-eu-20171485>

Yours sincerely

Trisha McAuley on behalf of the Grid Code Review Panel

Annex 1

Background

Following the discussion at the 6th December 2017 GC0106 meeting about the data exchange aspects of the SOGL, a Workgroup Member took an action to set out the concerns they raised at the meeting with a view to National Grid obtaining a legal view (from the National Grid legal department) on this matter that could be shared with the Workgroup.

The relevant Articles¹ of the SOGL in respect of data exchange are shown in Appendix 1 for ease of reference.

The Workgroup member set out their concerns in the following terms which were then summarised in a series of Workgroup questions which can found at the bottom of this Annex. These questions were then addressed by the National Grid legal department and are presented in Annex 2.

Introduction

At its core the issue is a simple one, namely whether a 'broad' or 'narrow' interpretation of the wording used, at various points, in the Data Exchange title of the System Operation Guideline ('SOGL') Regulation (namely Articles 40-53 inclusive) is legally correct.

As set out by the Proposer of GC0106 at the December meeting, the 'broad' interpretation would mean that the TSO could decide that, for example, no party (be it the TSO or DSO) need provide one or more of, say, the real time data items listed (a)-(i) in 44 or; in respect of 47; neither the TSO or SGU need provide one or more of the items listed in 47(1) (a)-(c). This approach was summarised as 'flexible' in the slides for the meeting.

In contrast, the 'narrow' interpretation requires that all the data items in, for example, 44(1) (a) to (i) must be provided by someone, the question is by whom.

Put simply, if the TSO does not provide the requisite data item(s) then the DSO must.

This is equally the case with 47 where, likewise, if the TSO does not provide the data item(s) (a)-(c) listed under (1) then the SGU² must.

¹ 40(5), 44, and 47-53 inclusive.

² The data exchange provisions in SOGL also refer, in addition to DSOs and SGUs, to (i) HVDC system operator and (ii) third parties participating in demand response. The GC0106 December meeting focused on DSOs and SGUs, whilst recognising that the concerns raised could also be applicable to (i) and (ii).

Taken to its logical extreme, the 'broad' interpretation would, hypothetically, allow for TSO 'X' to require all data items 44 (a)-(i) and / or 47 (1) (a)-(c) be provided by the DSOs / SGUs (and, for completeness, none of the data items be provided by TSO 'X') whilst TSO 'Y' might require, say, for half the data items to be provided from the respective DSOs / SGUs (and, for completeness, none of the data items be provided by TSO 'Y') whilst TSO 'Z' could require that none of the data items be provided by any DSOs / SGUs (and, for completeness, none of the data items be provided by TSO 'Z' either).

This 'broad' interpretation has, on the face of it, a number of redeeming qualities (many of which were mentioned during the December Workgroup meeting). Nevertheless, it seemed to the Workgroup member who raised the concerns that it has a number of potential flaws, which the member set out as follows, noting that the views expressed here are only of the workgroup member and are not a legal opinion, although the workgroup did ask the workgroup member if they had considered seeking their own legal advice.

Potential flaws with the 'broad' interpretation outlined by the Workgroup member

First, and foremost it does not ensure that common minimum technical requirements applied across the 28 Member States, as regards data exchange, are met as set out in Recitals (4), (5) and (12)³ of SOGL as the 'broad' interpretation allows for totally different national approaches to data exchange, and thus system operation, to apply in the various Member States (and, potentially, where there are different TSOs within some Member States, different requirements within the Member States as well) - such as illustrated by the TSOs X, Y and Z example above.

Put simply, how does this demonstrate adherence to having 'common minimum technical requirements'?

Second, it does not ensure that harmonised rules, or harmonised requirements, or harmonised data formats for data exchange applied across the 28 Member States, are met as set out in Recitals (3) and (13) together with Article 114 (2)⁴.

³ "(4) To ensure the operational security of the interconnected transmission system, it is essential to define a **common set of minimum requirements for Union-wide system operation**, for the cross-border cooperation between the TSOs and for utilising the relevant characteristics of the connected DSOs and SGUs.

(5) **All TSOs should comply with the common minimum requirements on procedures necessary to prepare real-time operation**, to develop individual and deliver common grid models, to facilitate the efficient and coordinated use of remedial actions which are necessary for real-time operation in order to maintain the operational security, quality and stability of the interconnected transmission system, and to support the efficient functioning of the European internal electricity market and facilitate the integration of renewable energy sources ('RES').

(12) One of the most critical processes in ensuring operational security with a high level of reliability and quality is the load-frequency control ('LFC'). Effective LFC can be made possible only if there is an obligation for the TSOs and the reserve connecting DSOs to cooperate for the operation of the interconnected transmission systems as one entity **and for providers' power generating modules and providers' demand facilities to meet the relevant minimum technical requirements.**" [emphasis added]

⁴ (3) "**Harmonised rules on system operation for transmission system operators ('TSOs'), distribution system operators ('DSOs') and significant grid users ('SGUs') should be set out in order to provide a clear legal framework for system operation, facilitate Union-wide**

The 'broad' interpretation; with its ability for each TSO to do its own thing in terms of allowing DSOs and SGUs not to provide some (all?) of the SOGL data items they, respectively, are listed as having to providing; runs counter to the harmonisation principle.

Put simply, how does this demonstrate adherence to having 'harmonised rules, or harmonised requirements, or harmonised data formats for data exchange'?

Third, it seems to allow for, effectively, the TSO(s) to just 'ignore' some (or all?) of what the SOGL requirements are by mealy carrying on with their (national) status quo position as regards obliging their DSOs or SGUs respectively to meet the SOGL data exchange provision on the basis that this is sufficient for system operation.

If this was the intention of the Regulation then surely the simplest thing to do would have been to draft in (as per Article 2(4)) that the data exchange Articles do not apply in Member State(s) X (such as GB) on the basis that the existing data provisions in the national codes are sufficient to meet all the aims of the SOGL (as summarised in the Recitals).

Fourth, it does not appear to take account of the future possibility that a TSO in a neighbouring Member State (such as RTE, Tennet, SONI and EirGrid) could classify parts (or all??) of the GB network (both by reference to geography and / or network topology, including by voltage down to varying levels of the distribution system) as falling within their own Observability Area: and thus GB DSOs and / or SGUs would need to provide (some or all, in the 'broad' interpretation, and all in the 'narrow' interpretation) data items listed in the Article(s) to those neighbouring TSOs, although it is not clear if this 'must' or 'may' or 'won't' be done via the 'host' TSO.

This might, for example, apply where the neighbouring TSO has a different IT system - where the 'host' TSO, under the 'broad' interpretation, does not require / collect the data item(s) from the DSOs /SGUs then, presumably, it has no IT System that (a) captures these data items from these parties or (b) can transfer those data items to the neighbouring TSO(s).

Fifth, it appears to be potentially based on a false premise, namely that as the GB TSO does not have access to the DSO/SGU data items themselves today (under the existing national

trade in electricity, ensure system security, ensure the availability and exchange of necessary data and information between TSOs and between TSOs and all other stakeholders, facilitate the integration of renewable energy sources, allow more efficient use of the network and increase competition for the benefit of consumers.

(13) The provisions on LFC and reserves, **aim at setting out clear, objective and harmonised requirements for TSOs, reserve connecting DSOs, providers' power generating modules and providers' demand facilities in order to ensure system security and to contribute to non-discrimination, effective competition and the efficient functioning of the internal electricity market.** The provisions on LFC and reserves provide the technical framework necessary for the development of cross-border balancing markets.

114(2) By 6 months after entry into force of this Regulation, **all TSOs shall define a harmonised data format for data exchange, which shall be an integral part of the ENTSO for Electricity operational planning data environment.**" [emphasis added]

arrangements) thus the wording in the Article cannot be applied in the way set out under the 'narrow' interpretation (from a GB perspective).

However, this is to not take account of the perhaps more logical position, namely the distinct possibility that the wording was actually put into the SOGL to cater for those Member States where the TSO(s) does already (perhaps because of history) have access, via their existing national arrangements, to some or all of the DSO/SGU data items listed. If that is the case then, in the context of those Member States, the 'narrow' interpretation makes eminent sense: it's there in order not to overburden the DSOs/SGUs in terms of requiring them to send duplicate data items to the TSO, that the TSO already has access to anyway / or can provide themselves via their own systems etc.

Sixth, a further factor to consider is that we are being invited, with the 'broad' interpretation, to apply the first use of the word 'provide' differently to the second use of the word 'provide' in the same sentence - is this realistic?

By way of illustration let us replace 'provide' with 'supply' in the sentence - the Concise Oxford Dictionary⁵ first definition of 'provide' is to "supply; furnish". The second definition (where provide is usually followed by "*for*" or "*against*") is to "make due preparation" (such as "provided for any eventuality" or "provided against invasion"). The fourth definition (where provide is usually followed by "*that*") is to "stipulated in a will, statute".

Thus, if the TSO does not 'supply' the data item(s) then the DSOs or SGUs must 'supply' the data item(s) - this extrapolation works for the 'narrow' approach but does not work in the context of the 'broad' approach.

Furthermore, with the 'broad' approach we are being invited to define the first 'provide' one way; as allowing the TSO to determine if the DSO or SGU does (or does not) have to do something; but then, when it comes to the second 'provide' we are to use a different definition (of 'provide') to say we do not allow those other parties, in turn, to adopt that same definition as the first 'provide' (when it is used just a few words later in the sentence).

Put another way, whilst the first 'provide' affords a right of optionality to the party concerned (the TSO) when it is applied to the second 'provide' there is no such optionality afforded to the parties concerned (the DSOs and SGUs respectively). It begs the question: is this schizophrenic application of the word 'provide', in the same sentence, credible?

Surely, it's more credible that the drafters intended to use the word 'provide' in the same context when used in the same sentence and thus, as illustrated with the use of 'supply' instead of 'provide' in the sentence, that the 'narrow' interpretation works here but the 'broad' does not.

⁵ Ninth Edition

Seventh, it was suggested at the December Workgroup meeting that 40(5) permits the 'broad' interpretation - this may well be the case. However, it seems equally to be the case that 40(5) permits the 'narrow' interpretation to apply as well.

Put another way, in terms of 40(5), the 'broad' interpretation means that the TSO, in coordination with the DSOs, could decide that rather than provide all the data items for 44(a)-(i), that the neither the DSOs or the TSO need provide, say, (f) the bus bar voltage data.

With the 'narrow' interpretation, the 40(5) approach would mean that the TSO, in coordination with the DSOs, agree that the DSOs need only provide items 44(a)-(e) and (g)-(i) because, in this example, the TSO would provide 44(f) the bus bar voltage data item.

Eighth, if the 'broad' interpretation is correct then why is the wording in 50(2) required?

Specifically, the wording at 50(1)⁶ is basically the same construct as that which appears in the other parts of the data exchange part of the SOGL.

However, the wording in 50(1) is followed with wording in 50(2) which effectively duplicates what (apparently) 50(1) already allows, if the 'broad' interpretation is correct, namely:

"Each TSO shall define in coordination with the responsible DSOs which SGUs may be exempted from providing the real-time data listed in paragraph 1 directly to the TSO"
[emphasis added]

If the intention had been that the 'broad' interpretation was the correct approach then by far the simplest thing to do was to just amend 50(1), rather than drafting a whole new paragraph 50(2), by adding into 50(1) five additional words (as shown in bold below):

"Unless otherwise provided by the TSO in coordination with the responsible DSOs, each power generating facility owner of a power generating module which is a SGU"

Thus the wording, in 50(2), clearly points to the 'narrow' interpretation being the correct one, in terms of the Data Exchange parts of SOGL.

Notwithstanding the coordination with DSOs aspect (envisaged in 50(2)) it is important to note that where an exemption from the obligation to provide some data items by the SGUs (covered under 50) is allowed it is explicitly stated in terms of the addition of the wording (in 50(2)) to that effect, namely:

⁶ "Unless otherwise provided by the TSO, each power generating facility owner of a power generating module which is a SGU in accordance with Article 2(1)(a) and (e) connected to the distribution system shall provide the TSO and the DSO to which it has the connection point, in real-time, at least the following data"

“Each TSO **shall define** which SGUs **may be exempted from** providing...”

Thus it is clear, in the case of 50(1), that the drafters of SOGL did envisage, in limited circumstances, that an exemption (from the need by the SGUs to provide certain SOGL data items) should be put in place; and they drafted text accordingly to achieve this. Which begs the question as to why this additional text (in 50(2)) was needed if the ‘broad’ interpretation is correct as the wording in 50(1) (coupled with and 40(5)) already permitted this anyway.

Rather, it could be argued, the drafters of SOGL did not envisage other circumstances (beyond those covered by 50(2)) in term of SOGL data exchange, where other data items would not be provided at all (by the DSOs / SGUs or TSOs) – which is the ‘narrow’ interpretation.

Ninth, in the context of 51(2)⁷ it is noticeable that there is no ‘caveat’ of the obligation upon the TSO(s) to provide the data, upon request, to the DSO(s).

If the ‘broad’ interpretation is correct, and the TSO has exempted the SGUs from providing, say, a number of data items under 48(1) and / or 49 then, as read, 52(2) still requires the TSO to, nevertheless, provide the said data items itself. In this scenario it is not clear how the TSO would ‘square this circle’.

If the ‘narrow’ interpretation is the correct approach, then as it’s a ‘binary’ situation (either the TSO provides the data items under 48(1) and / or 49 or the SGU(s) provides it) the data is always available to the TSO and can thus be transferred, if requested, to the DSOs.

Why is this important

In the view of the Workgroup member who raised the concerns, the reason why this matter is of importance to GB stakeholders is that if the ‘broad’ interpretation goes forward into the GB industry codes via GC0106 and it subsequently turns out that the ‘narrow’ interpretation was, instead, correct then it is the DSOs and / or SGUs which will (a) have breached the SOGL data exchange obligations in the various data exchange Articles applicable to them (if the TSO has said one or more data items did not need to be provided, based on the ‘broad’ interpretation) and (b) they will have to put in place potentially costly remedial actions / systems in order to henceforth comply with SOGL going forward.

Furthermore, if the ‘narrow’ interpretation is correct (but the ‘broad’ was applied up to that point) then as the TSO was not itself providing the said data item(s) then they would not themselves be

⁷ “(2) Each TSO shall make available to the DSO, to whose distribution system SGUs are connected, the information specified in Articles 48, 49 and 50 as requested by the DSO.” [emphasis added]

in breach of the SOGL (as in that scenario the default provider obligations fall, under the SOGL, to the DSO(s)/SGU(s) respectively).

Put another way, as the passenger who told the (DSOs/SGUs) driver that the speed limit on the road was 60MPH, when it was actually 40MPH, then the (TSO) passenger would not be the person who is fined for the drivers' speeding.

The Workgroup Member who raised the concerns mentioned during the December Workgroup meeting that, pending the legal advice received, they were minded to raise an alternative request to GC0106 based on the 'narrow' interpretation as a pragmatic solution to their concern.

This approach would mean (assuming such an alternative proceeds forward as a WACM in due course) that Ofgem would have before them both options and thus we avoid GC0106 being rejected; if it is just limited to the 'broad' and not a 'narrow' interpretation; if the 'narrow' one is considered by Ofgem to be correct. It also means that we avoid, in this rejection scenario, the need to rush through a new 'narrow' interpretation based modification at a later date.

Legal Questions

In light of the concerns set out by the Workgroup member they suggested that the following legal questions be raised by National Grid with their legal department, and the answers shared with the Workgroup in due course:

- 1) In the context of the Regulation overall, is the 'broad' or 'narrow' interpretation legally correct or are both equally correct legally?
- 2) Is there a greater or lesser legal risk in adopting the 'broad' or 'narrow' interpretation from the perspective of the DSOs and / or SGUs in terms of their compliance with the SOGL data exchange requirements?
- 3) Is there anything in any of the other approved Network Code Regulations which support the 'broad' or 'narrow' or both interpretations?
- 4) If the TSOs X, Y and Z scenario⁸ were to occur would each TSO be equally correct legally in their approach or would one (or two) TSO(s) have stronger legal certainty than the other two (or one) TSO(s) and if so which TSO(s) would that be - X, Y or Z?
- 5) In the context of neighbouring TSOs Observability Areas scenario⁹ could it in the foreseeable future be legally permissible under the Regulation for a neighbouring TSO 'A',

⁸ Set out in the 'Introduction' above.

⁹ Set out in the Fourth potential flaw above.

where it has declared a part of TSO 'B' Network area as falling within their Observability Area 'A', to require the DSOs and / or SGUs within that Observability Area 'A' located in the TSO 'B' Network area to provide data items(s) to TSO 'A'? If the answer is yes, does the data item(s) have to come only via TSO 'B' or can they be obtained, in accordance with the Regulation, directly from the respective DSO(s) or SGU(s), as applicable, by TSO 'A'

6) Does Article 40(5) prevent the 'broad' or 'narrow' interpretation being applied, or are both approaches equally valid in the context of Article 40(5)?

7) Could a legal way of mitigating these concerns be for the GC0106 legal text to include a full indemnity from the TSO to the DSOs and SGUs such that if the 'narrow' interpretation was the correct one (but the 'broad' interpretation was the only version included in the GC0106 legal text¹⁰) then the TSO would pay all fines, penalties and costs arising until such times as the DSOs and SGUs, exercising good industry practice, could put in place the necessary remedial actions / systems etc., to comply with 'narrow' interpretation of the SOGL?

8) As has happened in the CUSC sphere with CMP251 and CMP261 where there were legal issues arose regarding the interpretation of an EU Regulation and the National Grid legal department sort legal advice (in 2015 and 2016 respectively) on behalf of the Workgroup from their external lawyers (Addleshaw Goddard in both cases) do you believe it would be prudent to do so again in this case?

Appendix1 – Extracts from the Data Exchange Articles of SOGL

The relevant parts of the SOGL are shown below. As the 'broad' and 'narrow' interpretation centres on the word 'provide' / 'provided' these words are underlined in the SOGL extracts below, along with Article 40(5) which was referenced in the December GC0106 meeting.

Article 40

Organisation, roles, responsibilities and quality of data exchange

(5) In coordination with the DSOs and SGUs, each TSO shall determine the applicability and scope of the data exchange based on the following categories:

- (a) structural data in accordance with Article 48;
- (b) scheduling and forecast data in accordance with Article 49;
- (c) real-time data in accordance with Articles 44, 47 and 50; and
- (d) provisions in accordance with Articles 51, 52 and 53.

Article 44

¹⁰ And the TSO had acted accordingly and exempted DSOs/SGUs from providing some SOGL data items.

Real-time data exchange

(1) Unless otherwise provided by the TSO, each DSO shall provide its TSO, in real-time, the information related to the observability area of the TSO as referred to in Article 43(1) and (2), including:

- (a) the actual substation topology;
- (b) the active and reactive power in line bay;
- (c) the active and reactive power in transformer bay;
- (d) the active and reactive power injection in power generating facility bay;
- (e) the tap positions of transformers connected to the transmission system;
- (f) the busbar voltages;
- (g) the reactive power in reactor and capacitor bay;
- (h) the best available data for aggregated generation per primary energy source in the DSO area; and
- (i) the best available data for aggregated demand in the DSO area.

Article 47

Real-time data exchange

(1) Unless otherwise provided by the TSO, each significant grid user which is a power generating facility owner of type B, C or D power generating module shall provide the TSO, in real-time, at least the following data:

- (a) position of the circuit breakers at the connection point or another point of interaction agreed with the TSO;
- (b) active and reactive power at the connection point or another point of interaction agreed with the TSO; and
- (c) in the case of power generating facility with consumption other than auxiliary consumption net active and reactive power.

(2) Unless otherwise provided by the TSO, each HVDC system or AC interconnector owner shall provide, in real-time, at least the following data regarding the connection point of the HVDC system or AC interconnector to the TSOs:

- (a) position of the circuit breakers;
- (b) operational status; and
- (c) active and reactive power.

Article 48

Structural data exchange

(1) Unless otherwise provided by the TSO, each power generating facility owner of a power generating module which is a SGU pursuant to Article 2(1)(a) and by aggregation of the SGUs pursuant to Article 2(1)(e) connected to the distribution system shall provide at least the following data to the TSO and to the DSO to which it has a connection point:

- (a) general data of the power generating module, including installed capacity and primary energy source or fuel type;
- (b) FCR data according to the definition and requirements of Article 173 for power generating facilities offering or providing the FCR service;
- (c) FRR data for power generating facilities offering or providing the FRR service;
- (d) RR data for power generating modules offering or providing the RR service;
- (e) protection data;
- (f) reactive power control capability;
- (g) capability of remote access to the circuit breaker;
- (h) data necessary for performing dynamic simulation according to the provisions in Regulation (EU) 2016/631; and (i) voltage level and location of each power generating module.

(2) Each power generating facility owner of a power generating module which is a SGU in accordance with Article 2(1)(a) and (e) shall inform the TSO and the DSO to which it has a connection point, within the agreed time and not later than the first commissioning or any changes to the existing installation, about any change in the scope and the contents of the data listed in paragraph 1.

Article 49

Scheduled data exchange

[1] Unless otherwise provided by the TSO, each power generating facility owner of a power generating module which is a SGU in accordance with Article 2(1)(a) and 2(1)(e) connected to the distribution system shall provide the TSO and the DSO to which it has the connection point, with at least the following data:

- (a) its scheduled unavailability, scheduled active power restriction and its forecasted scheduled active power output at the connection point;
- (b) any forecasted restriction in the reactive power control capability; and
- (c) as an exception to paragraphs (a) and (b), in regions with a central dispatch system, data requested by the TSO for the preparation of its active power output schedule.

Article 50

Real-time data exchange

(1) Unless otherwise provided by the TSO, each power generating facility owner of a power generating module which is a SGU in accordance with Article 2(1)(a) and (e) connected to the distribution system shall provide the TSO and the DSO to which it has the connection point, in real-time, at least the following data:

- (a) status of the switching devices and circuit breakers at the connection point; and
- (b) active and reactive power flows, current, and voltage at the connection point.

(2).Each TSO shall define in coordination with the responsible DSOs which SGUs may be exempted from providing the real-time data listed in paragraph 1 directly to the TSO. In such cases, the responsible TSOs and DSOs shall agree on the aggregated real-time data of the SGUs concerned to be delivered to the TSO.

Article 51

Data exchange between TSOs and DSOs concerning significant power generating modules

(1) Unless otherwise provided by the TSO, each DSO shall provide to its TSO the information specified in Articles 48, 49 and 50 with the frequency and level of detail requested by the TSO.

(2) Each TSO shall make available to the DSO, to whose distribution system SGUs are connected, the information specified in Articles 48, 49 and 50 as requested by the DSO.

(3) A TSO may request further data from a power generating facility owner of a power generating module which is a SGU in accordance with Article 2(1)(a) and (e) connected to the distribution system, if it is necessary for the operational security analysis and for the validation of models.

Article 52

Data exchange between TSOs and transmission-connected demand facilities

(1) Unless otherwise provided by the TSO, each transmission-connected demand facility owner shall provide the following structural data to the TSO:

- (a) electrical data of the transformers connected to the transmission system;
- (b) characteristics of the load of the demand facility; and
- (c) characteristics of the reactive power control.

(2)Unless otherwise provided by the TSO, each transmission-connected demand facility owner shall provide the following data to the TSO:

- (a) scheduled active and forecasted reactive power consumption on a day-ahead and intraday basis, including any changes of those schedules or forecast;
- (b) any forecasted restriction in the reactive power control capability;
- (c) in case of participation in demand response, a schedule of its structural minimum and maximum power range to be curtailed; and
- (d) by exception to point (a), in regions with a central dispatch system, the data requested by the TSO for the preparation of its active power output schedule.

(3). Unless otherwise provided by the TSO, each transmission-connected demand facility owner shall provide the following data to the TSO in real-time:

- (a) active and reactive power at the connection point; and
- (b) the minimum and maximum power range to be curtailed.

(4) Each transmission-connected demand facility owner shall describe to its TSO its behaviour at the voltage ranges referred to in Article 27.

Article 53

Data exchange between TSOs and distribution-connected demand facilities or third parties participating in demand response

(1). Unless otherwise provided by the TSO, each SGU which is a distribution-connected demand facility and which participates in demand response other than through a third party shall provide the following scheduled and real-time data to the TSO and to the DSO:

- (a) structural minimum and maximum active power available for demand response and the maximum and minimum duration of any potential usage of this power for demand response;
- (b) a forecast of unrestricted active power available for demand response and any planned demand response;
- (c) real-time active and reactive power at the connection point; and
- (d) a confirmation that the estimations of the actual values of demand response are applied.

(2) Unless otherwise provided by the TSO, each SGU which is a third party participating in demand response as defined in Article 27 of Regulation (EU) 2016/1388, shall provide the TSO and the DSO at the day-ahead and close to real-time and on behalf of all of its distribution-connected demand facilities, with the following data:

- (a) structural minimum and maximum active power available for demand response and the maximum and minimum duration of any potential activation of demand response in a specific geographical area defined by the TSO and DSO;
- (b) a forecast of unrestricted active power available for the demand response and any planned level of demand response in a specific geographical area defined by the TSO and DSO;
- (c) real-time active and reactive power; and
- (d) a confirmation that the estimations of the actual values of demand response are applied.

Annex 2

National Grid Legal Advice, provided to the Workgroup on 10th January 2018

- The purpose of the regulation is to “ensure the availability and exchange of necessary data and information between TSO’s and between TSOs and all relevant stakeholders” (recital (3))
- Standard principles of “proportionality” and “optimisation between the highest overall efficiency and lowest total costs for all parties involved” apply (art 4.2)
- At heart is the need for us as a TSO to exchange the data listed at art 41 and art 42 with other TSOs so, if in order to do this we need underlying data from others, we need to have/be able to get that data and more generally perform the operational functions assigned to us.
- Art 40.5 states “In coordination with the DSOs and SGUs, each TSO shall determine the applicability and scope of the data exchange based on the following categories” i.e. Arts 44, 47, 48, 49, 50, 51, 52 and 53. The use of “based on” is odd English but the ref to the arts is clear and all the specific arts referred to are all prefixed with “Unless otherwise provided by the TSO...” and list “at least” the data to be provided.
- Art 40.6 suggests that all TSO will “agree” on “key organisational requirements, roles and responsibilities in relation to data exchange”. The approach on provision of data by others would need to be dealt with in the methodology agreed for 40.6.
- Read in isolation you could read the prefix of “Unless otherwise provided by the TSO” in the relevant articles as meaning the data has to be provided but the requirement is only on the DSO etc. to do so where the TSO itself doesn’t do so. For that to work, it would presuppose that the data is already TSO data/information or data/information held by the TSO about the

DSO etc. In fact (and as a matter of fact) it seems that it is DSO etc. information/data about the DSO etc. which the TSO would only have if it got it from the DSO etc.?

- However in my view you have to read it in the wider context of Title 2, and an ordinary reading of the structure of the title, art 40.5 together and the prefix would suggest that those specific articles are linked and that there is a TSO a discretion as to the “applicability and scope of the data exchange” requirements under those arts. Compare other articles e.g. 45 where the requirements are mandatory and aren’t prefixed/referenced in art 40.5.
- The use of the word “provided” in the prefix of the relevant articles isn’t the most helpful formulation. It could suggest that the discretion afforded by art 40.5 is limited to those circumstances where the TSO doesn’t otherwise provide the data/info but as above this doesn’t seem correct.
- In my view the more appropriate reading is that art 40.5 gives general discretion as to the “applicability and scope” in placing requirements on the listed data/information and that the prefix is there to recognise this i.e. that “unless otherwise provided by the TSO” in effect means “unless and to the extent the TSO determines otherwise”.
- On the basis that there is discretion, in exercising it the effect of that discretion should be considered against the general need/ability of the TSO to meet its obligations under/ the overall aim of the regulation i.e. a degree of harmonisation. Given the intent is to set minimum requirements and articles refer to “at least” there should be clear justification as to why it is not required/appropriate and (as per comment re art 40.6) maybe something that needs to be considered with other TSOs?
- In terms of compliance, regulations effectively form part of GB law and so all parties have an obligation to comply with them to the extent they apply with them and matters of interpretation/consequences of any breach can be decided by the courts. Generally compliance with such regulations is specifically made a requirement for entities licensed under the electricity act and is subject to the same Ofgem compliance/enforcement regime that exists for licence breach.

Advice from ENTSO-E

Advice was also sought from ENTSO-E by National Grid on the intent of the drafting of the relevant Articles of SOGL for this modification. ENTSO-E confirmed that their interpretation aligned with that of the Proposer of GC0106. A further check was made by National Grid by looking at the German translation of the ‘unless otherwise provided’ clause; in German translated back to English this was reproduced as ‘unless otherwise determined [by the TSO]

Annex 3 Workgroup assessment of WAGCMs raised

Art	SOGL Text	D Code Implications	Grid Code Implications
40	<p>Organisation, roles, responsibilities and quality of data exchange</p> <p>Art 40.5. In coordination with the DSOs and SGUs, each TSO shall determine the applicability and scope of the data exchange based on the following categories:</p> <p>Art 40.5.a. structural data in accordance with Article 48;</p> <p>Art 40.5.b. scheduling and forecast data in accordance with Article 49;</p> <p>Art 40.5.c. real-time data in accordance with Article 44, Article 47 and Article 50; and</p> <p>Art 40.5.d. provisions in accordance with Article 51, Article 52 and Article 53.</p> <p>Art 40.7. By 18 months after entry into force of this Regulation, each TSO shall agree with the relevant DSOs on effective, efficient and proportional processes for providing and managing data exchanges between them, including, where required for efficient network operation, the provision of data related to distribution systems and SGUs. Without prejudice to the provisions of paragraph 6(g), each TSO shall agree with the</p>	<p>It becomes unclear how Article 40.5 works in relation to Articles 44, 47, 48, 49, 50, 51, 52, 53.</p> <p>Article 40.7 is unlikely to be implemented by March 19 – although agreement might be made – it cannot be implemented in that timescale. Interesting that 40.7 does not specify when the processes agreed upon need to be implemented – nor does KORRR.</p>	<p>Changes are subject to the interpretation of ‘Each TSO shall determine the applicability and scope’ of the data exchange based on articles 44, 47, 48, 49, 50, 51, 52, 53.</p> <p>Article 41 to 53 shall apply in March 2019, which is 18 months after the entry into force of SOGL per Article 192 of SOGL. The required changes would need to be agreed and implemented by this date otherwise this will not efficiently discharge the obligations imposed upon the licensee.</p> <p>The necessary data exchange is currently achieved with the TSO’s through the STC which covers the whole of the GB Synchronous area (i.e. Scotland and OFTO’s). Currently there is no requirement for data from TSO’s or DSO’s outside of the GB Synchronous area. Neighbouring TSO’s in other Synchronous areas are unlikely to require data from us as they are outside our</p>

Art	SOGL Text	D Code Implications	Grid Code Implications
	<p>relevant DSOs on the format for the data exchange.</p>		<p>synchronous area – NG operates the system today without this data. These requirements are more applicable in other Synchronous areas where there are many TSO's and Member States. If there is a requirement for this to change in the future this can be managed as a GB mod within the framework of SOGL.</p> <p>For DNO's we get the data we need although this may be more complex due to the increase in the volume of Embedded Generation.</p>
44	<p>Data exchange between TSOs and DSOs within the TSO's control area</p> <p>Real-time data exchange</p> <p>Unless otherwise provided by the TSO, each DSO shall provide its TSO, in real-time, the information related to the observability area of the TSO as referred to in Art 43.1 and Art 43.2, including:</p> <ul style="list-style-type: none"> (a) the actual substation topology; (b) the active power and reactive power in line bay; 	<p>DNOs will have to ensure that transducers etc exist in all substations in the observability area to discharge (a) to (i). This is bound to require some investment.</p> <p>Some information, such as (e) tap positions of transformers (if in fact there are any in the OA) might not exist or be completely inappropriately uneconomic to try to source (ie new tapchanger or even new TX).</p> <p>It is likely that all the substations in question will have SCADA – but both NG and the DNOs will have to</p>	<p>New system and process for data transfer system between TSO and DNO (ICCP or alternatives) will be required to exchange real time data.</p> <p>This would have to be a new requirement requiring a change to the Grid Code and an inclusion of this requirement in the ECC's section 6.4. The requirements are straightforward but the cost and who pays for it is complex and would</p>

Art	SOGL Text	D Code Implications	Grid Code Implications
	<p>(c) the active power and reactive power in transformer bay;</p> <p>(d) the active power and reactive power injection in power generating facility bay;</p> <p>(e) the tap positions of transformers connected to the transmission system;</p> <p>(f) the busbar voltages;</p> <p>(g) the reactive power in reactor and capacitor bay;</p> <p>(h) the best available data for aggregated generation per primary energy source in the DSO area; and</p> <p>(i) the best available data for aggregated demand in the DSO area.</p>	<p>agree data transfer arrangements – probably requiring (a) the installation ICC links and (b) potentially new data storage infrastructure.</p> <p>As per 40.7 above it is not clear when the process (that will be agreed by March 2019) will need to be actually implemented.</p>	<p>require a decision from Ofgem.</p> <p>In this case ICCP links could be used in the same way as the Scottish model for both data provided by SGU's and the DNO data itself. It could be more of an issue for IDNO's which are growing in number.</p> <p>The technical impact on observability areas will depend on the outcome of Article 75 of SOGL.</p> <p>Currently we only get operational metering data at the Grid Supply Point which would not really be adequate to meet the requirements of the SOGL requirement.</p> <p>An alignment to the work on open networks will be necessary.</p>
47	<p>Art 47.1. Unless otherwise provided by the TSO, each significant grid user which is a power generating facility owner of type B, C or D power generating module shall provide the TSO, in real-time, at least the following data: Art 47.1.a. position of the circuit breakers at the connection point or another point of interaction agreed with the TSO;</p> <p>Art 47.1.b. active power and reactive power at the</p>	<p>Only applies to directly connected SGUs</p>	<p>There is an existing real time data exchange provision for all SGUs who are CUSC parties, TSO would have to ensure we are exchanging with all transmission connected SGUs.</p>

Art	SOGL Text	D Code Implications	Grid Code Implications
	<p>connection point or another point of interaction agreed with the TSO; and</p> <p>Art 47.1.c. in the case of power generating facility with consumption other than auxiliary consumption net active power and reactive power.</p>		
48	<p>Data exchange between TSOs, DSOs and distribution-connected power generating modules</p> <p>Structural data exchange</p> <p>Unless otherwise provided by the TSO, each power generating facility owner of a power generating module which is a SGU pursuant to Art 2.1.a and by aggregation of the SGUs pursuant to Art 2.1.e connected to the distribution system shall provide at least the following data to the TSO and to the DSO to which it has a connection point:</p> <p>Art 48.1.a. general data of the power generating module, including installed capacity and primary energy source or fuel type;</p> <p>Art 48.1.b. FCR data according to the definition and requirements of Article 173 for power generating facilities offering or providing the FCR service;</p>	<p>1.a, 1.e, 1.h and 1.i exist in the existing DNOs data sets – or can be asked for under existing DDRRC requirements.</p> <p>1.b, 1.c, 1.d can be provided directly to NG via the relevant contracts (I assume).</p> <p>1.f and 1.g probably need NG to specify in the G Code exactly what is required. Neither of these are thought to be directly captured in the DDRRC. For 1.f it is not even clear which CB is meant and although rudimentary information is included in the DDRRC for 1.g, this is probably not sufficient.</p>	<p>NG has to work with DNOs to agree exchange of structural data for distribution connected generating modules. Currently this is exchanged directly through contracts but Grid code amendments, new processes for exchanging directly between TSO and DNOs and potentially new roles will be required.</p> <p>For SGU's with a CUSC contract this would already be covered. For SGU's which are not CUSC parties this is more complex. There are two solutions – we either place requirements on non CUSC parties to provide the data to NG similar to the LEEMPS arrangements or place similar requirements on DNO's in the DDRRC and then forward that data to us. We would need to make sure that Generators were</p>

Art	SOGL Text	D Code Implications	Grid Code Implications
	<p>Art 48.1.c. FRR data for power generating facilities offering or providing the FRR service;</p> <p>Art 48.1.d. RR data for power generating modules offering or providing the RR service;</p> <p>Art 48.1.e. protection data;</p> <p>Art 48.1.f. reactive power control capability;</p> <p>Art 48.1.g. capability of remote access to the circuit breaker;</p> <p>Art 48.1.h. data necessary for performing dynamic simulation according to the provisions in Regulation (EU) 2016/631; and</p> <p>Art 48.1.i. voltage level and location of each power generating module.</p> <p>Art 48.2. Each power generating facility owner of a power generating module which is a SGU in accordance with Art 2.1.a and Art 2.1.e shall inform the TSO and the DSO to which it has a connection point, within the agreed time and not later than the first commissioning or any changes to the existing installation, about any change in the scope and the contents of the data listed in paragraph 1</p>		<p>comfortable for the DNO's to forward that data to us which would be similar to the arrangements in Schedule 3 of the STC.</p> <p>The section on FCR, FRR and RR will require new sections of Grid Code and D Code drafting.</p>
49	<p>Scheduled Data Exchange</p> <p>Unless otherwise provided by the TSO, each power generating facility owner of a power generating module which is a SGU in accordance with Art</p>	<p>For (a) the D Code only applies to HV customers/generators – and to generators >1MW currently – and will need modifying to line up fully with Art 49 requirements (ie Type B</p>	<p>NG has to work with DNOs to agree exchange of all scheduled data for distribution connected generating modules. Currently this is</p>

Art	SOGL Text	D Code Implications	Grid Code Implications
	<p>2.1.a and Art 2.1.e connected to the distribution system shall provide the TSO and the DSO to which it has the connection point, with at least the following data:</p> <p>(a) its scheduled unavailability, scheduled active power restriction and its forecasted scheduled active power output at the connection point;</p> <p>(b) any forecasted restriction in the reactive power control capability; and</p> <p>(c) as an exception to paragraphs (a) and (b), in regions with a central dispatch system, data requested by the TSO for the preparation of its active power output schedule.</p>	<p>generators; demand SGUs probably already covered – although the MW threshold might need removing in DOC1.3 and DOC1.5.4. However this data in general from small power stations is not specified in the Grid Code so it is not clear if all the data that DNOs collect should just be sent to NG, or if NG need to specify what they want per site.</p> <p>For (b) this is probably not asked for specifically – unless it is part of Output Usable – so again NG will need to specify what is required and which will then need to be reflected in the D Code.</p>	<p>exchanged directly through contracts but Grid code amendments, new processes for exchanging directly between TSO and DNOs and potentially new roles will be required.</p> <p>The issue could be resolved if the DDRC was updated to reflect similar requirements to the DRC (Sched 2 and 3) and then forwarded on to NG.</p>
50	<p>Real-time data exchange</p> <p>Art 50.1. Unless otherwise provided by the TSO, each power generating facility owner of a power generating module which is a SGU in accordance with Art 2.1.a and Art 2.1.e connected to the distribution system shall provide the TSO and the DSO to which it has the connection point, in real-time, at least the following data:</p> <p>Art 50.1.a. status of the switching devices and circuit breakers at the connection point; and</p>	<p>The first challenge is to agree if the data is to be cascaded via the DNO or provided direct. All the existing assumptions are cascaded – this needs confirming.</p> <p>There is little existing D Code text dealing with this – see DPC6.7. This needs to be reviewed in the light of applying retrospectively to approximately 50k existing installations. How is this information to be handled/managed? How will it be passed between DNO and NG? ie both NG and the DNOs will have to agree data transfer arrangements – probably requiring (a) the</p>	<p>NG has to work with DNOs to agree exchange of all real time data for distribution connected generating modules. A cascading approach would allow for data to be exchanged through Grid code amendments, new systems and new data storage arrangements, new roles would be required to deal with these changes.</p> <p>This issue can be solved by ICCP links as noted for Art 44. This can be addressed by adding a</p>

Art	SOGL Text	D Code Implications	Grid Code Implications
	<p>Art 50.1.b. active and reactive power flows, current, and voltage at the connection point.</p> <p>Art 50.2. Each TSO shall define in coordination with the responsible DSOs which SGUs may be exempted from providing the real-time data listed in paragraph 1 directly to the TSO. In such cases, the responsible TSOs and DSOs shall agree on the aggregated real-time data of the SGUs concerned to be delivered to the TSO.</p>	<p>installation ICC links and (b) potentially new data storage infrastructure.</p> <p>Or should the current DPC6.7 approach be ceased; DNOs to provide a technical spec and customers provide the data and data coms to the DNO – maybe via the internet?</p> <p>50.1.a – it is a moot point if this information is of any use at all. 50.1.b is reasonable data once the basic infrastructure (ie site comms) is in place, but all sites will need fitting with the relevant transducers in addition.</p> <p>50.2 – this might be a sensible approach to adopt in GB – but it will need NG to specify what is required to satisfy this, and then for DNOs and NG to agree the IT etc and systems implications. This would be a significant non-trivial project. Will need some appropriate expertise to cost it, but needs a high level requirement first from NG.</p>	<p>new section to the Grid Code in Section 6.4. Ofgem would need to be involved in apportioning costs.</p>
51	<p>Data exchange between TSOs and DSOs concerning significant power generating modules</p> <p>Art 51.1. Unless otherwise provided by the TSO, each DSO shall provide to its TSO the information specified in Article 48, Article 49 and Article 50 with the frequency and level of detail requested by the TSO.</p>	<p>NG needs to specify this to the DNOs</p>	<p>For structural this would follow the week 24 / week 48 and the proposed submission for week 50.</p> <p>For real time data the requirements are covered in TS.3.24.100 and the Bilateral Agreement which covers issues such as refresh rate and accuracy etc.</p>

Art	SOGL Text	D Code Implications	Grid Code Implications
	<p>Art 51.2. Each TSO shall make available to the DSO, to whose distribution system SGUs are connected, the information specified in Article 48, Article 49 and Article 50 as requested by the DSO.</p> <p>Art 51.3. A TSO may request further data from a power generating facility owner of a power generating module which is a SGU in accordance with Art 2.1.a and Art 2.1.e connected to the distribution system, if it is necessary for the operational security analysis and for the validation of models.</p>		
52	<p>Data exchange between TSOs and distribution-connected demand facilities or third parties participating in demand response</p> <p>Art 53.1. Unless otherwise provided by the TSO, each SGU which is a distribution-connected demand facility and which participates in demand response other than through a third party shall provide the following scheduled and real-time data to the TSO and to the DSO:</p> <p>Art 53.1.a. structural minimum and maximum active power available for demand response and the maximum and minimum duration of any potential usage of this power for demand response;</p>	<p>A first assumption might be that this data could be included in any contract that NG let with a demand service provider.</p> <p>It is a moot point, since this only applies to T contracted DSR, if there is any need at all to include in the D Code.</p> <p>If there is a need to include these provisions in the D Code then it is probably a simple modification to DOC 1.3 to remove the 5MW limit on Suppliers and Customers – and probably to add in aggregators.</p> <p>However there would need to be a Grid Code or similar modification to cause the DNO to then forward this to NG.</p>	<p>Art 52 applies to demand facilities that are directly connected and hence would be a CUSC party. They would be treated as a Non Embedded Customer where the data required is already submitted under the current Grid Code provisions. . If demand response services are to be provided this would be caught under the C16 process.</p> <p>Art 53 is more complex but would be caught under the C16, Standard Contract terms. There is however provision within the DRSC (as introduced for DCC implementation) to add</p>

Art	SOGL Text	D Code Implications	Grid Code Implications
	<p>Art 53.1.b. a forecast of unrestricted active power available for demand response and any planned demand response;</p> <p>Art 53.1.c. real-time active and reactive power at the connection point; and</p> <p>Art 53.1.d. a confirmation that the estimations of the actual values of demand response are applied.</p> <p>Art 53.2. Unless otherwise provided by the TSO, each SGU which is a third party participating in demand response as defined in Article 27 of Regulation (EU) 2016/1388, shall provide the TSO and the DSO at the day-ahead and close to real-time and on behalf of all of its distribution-connected demand facilities, with the following data:</p> <p>Art 53.2.a. structural minimum and maximum active power available for demand response and the maximum and minimum duration of any potential activation of demand response in a specific geographical area defined by the TSO and DSO;</p> <p>Art 53.2.b. a forecast of unrestricted active power available for the demand response and any planned level of demand response in a</p>		<p>in these additional data items..</p>

Art	SOGL Text	D Code Implications	Grid Code Implications
	<p>specific geographical area defined by the TSO and DSO;</p> <p>Art 53.2.c. real-time active and reactive power; and</p> <p>Art 53.2.d. a confirmation that the estimations of the actual values of demand response are applied.</p>		



Making a positive difference
for energy consumers

Trisha McAuley OBE
Independent Chair
CUSC & Grid Code Panel

E-mail: Leonardo.costa@ofgem.gov.uk
21 November 2018

Dear Trisha,

GC0106: Data exchange requirements in accordance with Regulation (EU) 2017/1485

I am writing in response to your letter dated 06 November 2018, which details the Grid Code Review Panel's decision to consult with Ofgem, under Governance Rule GR21.5.

We understand that the Panel are of the view that proposed legal text for WAGCM1 and WAGCM3 is not needed on the basis that WAGCM1 turns on a question of interpretation and in respect of WAGCM3, that alternative is a combination of WAGCM1 and WAGCM2 (which in turn already has had legal text drafted).

As per GR21.5, the Grid Code Panel has asked the Authority whether it needs the legal text associated with WAGCM1 and WAGCM3. We understand that if we were to request the legal text, this would cause a significant delay in the process, as the Panel would have to instruct the Workgroup to draft the legal text for both WAGCM1 and WAGCM3. We also consider that the justification for not requiring the text as being sufficient on the basis that the issue turns on a question of interpretation of Commission Regulation (EU) 2017/1485 underpinning the changes being proposed.

In light of this, the Authority agrees with the Panel's view that the proposed text for WAGCM1 and WAGCM3 is not required in the Grid Code Modification Report. This is because, National Grid ESO has provided sufficient detail within both Annex 1 and Annex 2 regarding the background of the issue and the different interpretations of the SOGL requirements. Also, we understand that the key question would then be around the Authority's decision on the interpretation of certain aspects of Commission Regulation (EU) 2017/1485. We therefore do not require the legal text for WAGCM1 or WAGCM3 at this stage.

We understand that the GC106 workgroup has given WAGCM2 significant consideration and we expect to receive both the Workgroup Report and the proposed text associated with the submission in December 2018. In the event that the Authority finds that WAGCM1 or WAGCM3 may best facilitate the Grid Code objectives, we would send the modification back to the Panel to draft the legal text. It is important that the Panel is ready to respond quickly to any decision from Ofgem in order to ensure compliance with Commission Regulation (EU) 2017/1485.

If you have any queries regarding the information contained within this letter, please contact Leonardo Costa at Leonardo.costa@ofgem.gov.uk.

Yours Sincerely

Grendon Thompson
Head of SO Regulation

CONNECTION CONDITIONS

(CC)

CONTENTS

WACM2
DATED 09/10/18

(This contents page does not form part of the Grid Code)

<u>Paragraph No/Title</u>	<u>Page Number</u>
CC.1 INTRODUCTION.....	2
CC.2 OBJECTIVE	2
CC.3 SCOPE	2
CC.4 PROCEDURE	4
CC.5 CONNECTION	4
CC.6 TECHNICAL, DESIGN AND OPERATIONAL CRITERIA	6
CC.7 SITE RELATED CONDITIONS	46
CC.8 ANCILLARY SERVICES	52
APPENDIX 1 - SITE RESPONSIBILITY SCHEDULES	54
PROFORMA FOR SITE RESPONSIBILITY SCHEDULE	58
APPENDIX 2 - OPERATION DIAGRAMS.....	62
PART 1A - PROCEDURES RELATING TO OPERATION DIAGRAMS	62
PART 1B - PROCEDURES RELATING TO GAS ZONE DIAGRAMS	65
PART 2 - NON-EXHAUSTIVE LIST OF APPARATUS TO BE INCLUDED ON OPERATION DIAGRAMS.....	66
APPENDIX 3 - MINIMUM FREQUENCY RESPONSE REQUIREMENT PROFILE AND OPERATING RANGE FOR NEW POWER STATIONS AND DC CONVERTER STATIONS	68
APPENDIX 4 - FAULT RIDE THROUGH REQUIREMENTS.....	73
APPENDIX 4A	73
APPENDIX 4B	79
APPENDIX 5 - TECHNICAL REQUIREMENTS LOW FREQUENCY RELAYS FOR THE AUTOMATIC DISCONNECTION OF SUPPLIES AT LOW FREQUENCY	85
APPENDIX 6 - PERFORMANCE REQUIREMENTS FOR CONTINUOUSLY ACTING AUTOMATIC EXCITATION CONTROL SYSTEMS FOR ONSHORE SYNCHRONOUS GENERATING UNITS.....	87
APPENDIX 7 - PERFORMANCE REQUIREMENTS FOR CONTINUOUSLY ACTING AUTOMATIC VOLTAGE CONTROL SYSTEMS FOR ONSHORE NON-SYNCHRONOUS GENERATING UNITS, ONSHORE DC CONVERTERS, ONSHORE POWER PARK MODULES AND OTSDUW PLANT AND APPARATUS AT THE INTERFACE POINT	91

CC.1 INTRODUCTION

CC.1.1 The **Connection Conditions** ("CC") specify both:

- (a) the minimum technical, design and operational criteria which must be complied with by:
 - (i) any **GB Code User** connected to or seeking connection with the **National Electricity Transmission System**, or
 - (ii) **GB Code Users** in respect of **GB Generators** (other than in respect of **Small Power Stations**) or **GB Code Users** in respect of **DC Converter Station** owners connected to or seeking connection to a **User's System** which is located in **Great Britain** or **Offshore**, and
- (b) the minimum technical, design and operational criteria with which **The Company** will comply in relation to the part of the **National Electricity Transmission System** at the **Connection Site** with **GB Code Users**. In the case of any **OTSDUW Plant and Apparatus**, the **CC** also specify the minimum technical, design and operational criteria which must be complied with by those **GB Code Users** when undertaking **OTSDUW**.
- (c) For the avoidance of doubt, the requirements of these **CC's** do not apply to **EU Code Users** for whom the requirements of the **ECC's** shall apply.

CC.2 OBJECTIVE

CC.2.1 The objective of the **CC** is to ensure that by specifying minimum technical, design and operational criteria the basic rules for connection to the **National Electricity Transmission System** and (for certain **GB Code Users**) to a **User's System** are similar for all **GB Code Users** of an equivalent category and will enable **The Company** to comply with its statutory and **Transmission Licence** obligations.

CC.2.2 In the case of any **OTSDUW** the objective of the **CC** is to ensure that by specifying the minimum technical, design and operational criteria the basic rules relating to an **Offshore Transmission System** designed and constructed by an **Offshore Transmission Licensee** and designed and/or constructed by an **GB Code User** under the **OTSDUW Arrangements** are equivalent.

CC.2.3 Provisions of the **CC** which apply in relation to **OTSDUW** and **OTSUA**, and/or a **Transmission Interface Site**, shall (in any particular case) apply up to the **OTSUA Transfer Time**, whereupon such provisions shall (without prejudice to any prior non-compliance) cease to apply, without prejudice to the continuing application of provisions of the **CC** applying in relation to the relevant **Offshore Transmission System** and/or **Connection Site**. It is the case therefore that in cases where the **OTSUA** become operational prior to the **OTSUA Transfer Time** that a **GB Generator** is required to comply with this **CC** both as it applies to its **Plant** and **Apparatus** at a **Connection Site/Connection Point** and the **OTSUA** at the **Transmission Interface Site/Transmission Interface Point** until the **OTSUA Transfer Time** and this **CC** shall be construed accordingly.

CC.2.4 In relation to **OTSDUW**, provisions otherwise to be contained in a **Bilateral Agreement** may be contained in the **Construction Agreement**, and accordingly a reference in the **CC** to a relevant **Bilateral Agreement** includes the relevant **Construction Agreement**.

CC.3 SCOPE

CC.3.1 The **CC** applies to **The Company** and to **GB Code Users**, which in the **CC** means:

- (a) **GB Generators** (other than those which only have **Embedded Small Power Stations**), including those undertaking **OTSDUW**;
- (b) **Network Operators**;

- (c) **Non-Embedded Customers;**
- (d) **DC Converter Station** owners; and
- (e) **BM Participants** and **Externally Interconnected System Operators** in respect of CC.6.5 only.

CC.3.2 The above categories of **GB Code User** will become bound by the **CC** prior to them generating, distributing, supplying or consuming, as the case may be, and references to the various categories should, therefore, be taken as referring to them in that prospective role as well as to **GB Code Users** actually connected.

CC.3.3 **Embedded Medium Power Stations** not subject to a **Bilateral Agreement** and **Embedded DC Converter Stations** not subject to a **Bilateral Agreement** Provisions.

The following provisions apply in respect of **Embedded Medium Power Stations** not subject to a **Bilateral Agreement** and **Embedded DC Converter Stations** not subject to a **Bilateral Agreement**.

CC.3.3.1 The obligations within the **CC** that are expressed to be applicable to **GB Generators** in respect of **Embedded Medium Power Stations** not subject to a **Bilateral Agreement** and **DC Converter Station** Owners in respect of **Embedded DC Converter Stations** not subject to a **Bilateral Agreement** (where the obligations are in each case listed in CC.3.3.2) shall be read and construed as obligations that the **Network Operator** within whose **System** any such **Medium Power Station** or **DC Converter Station** is **Embedded** must ensure are performed and discharged by the **GB Generator** or the **DC Converter Station** owner. **Embedded Medium Power Stations** not subject to a **Bilateral Agreement** and **Embedded DC Converter Stations** not subject to a **Bilateral Agreement** which are located **Offshore** and which are connected to an **Onshore GB Code Users System** will be required to meet the applicable requirements of the Grid Code as though they are an **Onshore GB Generator** or **Onshore DC Converter Station Owner** connected to an **Onshore User System Entry Point**.

CC.3.3.2 The **Network Operator** within whose **System** a **Medium Power Station** not subject to a **Bilateral Agreement** is **Embedded** or a **DC Converter Station** not subject to a **Bilateral Agreement** is **Embedded** must ensure that the following obligations in the **CC** are performed and discharged by the **GB Generator** in respect of each such **Embedded Medium Power Station** or the **DC Converter Station** owner in the case of an **Embedded DC Converter Station**:

CC.5.1

CC.5.2.2

CC.5.3

CC.6.1.3

CC.6.1.5 (b)

CC.6.3.2, CC.6.3.3, CC.6.3.4, CC.6.3.6, CC.6.3.7, CC.6.3.8, CC.6.3.9, CC.6.3.10, CC.6.3.12, CC.6.3.13, CC.6.3.15, CC.6.3.16

CC.6.4.4

CC.6.5.6 (where required by CC.6.4.4)

In respect of CC.6.2.2.2, CC.6.2.2.3, CC.6.2.2.5, CC.6.1.5(a), CC.6.1.5(b) and CC.6.3.11 equivalent provisions as co-ordinated and agreed with the **Network Operator** and **GB Generator** or **DC Converter Station** owner may be required. Details of any such requirements will be notified to the **Network Operator** in accordance with CC.3.5.

CC.3.3.3 In the case of **Embedded Medium Power Stations** not subject to a **Bilateral Agreement** and **Embedded DC Converter Stations** not subject to a **Bilateral Agreement** the requirements in:

- CC.6.1.6
- CC.6.3.8
- CC.6.3.12
- CC.6.3.15
- CC.6.3.16

that would otherwise have been specified in a **Bilateral Agreement** will be notified to the relevant **Network Operator** in writing in accordance with the provisions of the **CUSC** and the **Network Operator** must ensure such requirements are performed and discharged by the **GB Generator** or the **DC Converter Station** owner.

CC.3.4 In the case of **Offshore Embedded Power Stations** connected to an **Offshore GB Code User's System** which directly connects to an **Offshore Transmission System**, any additional requirements in respect of such **Offshore Embedded Power Stations** may be specified in the relevant **Bilateral Agreement** with the **Network Operator** or in any **Bilateral Agreement** between **The Company** and such **Offshore Embedded Power Station**.

CC.3.5 In the case of a **GB Generator** undertaking **OTSDUW** connecting to an **Onshore Network Operator's System**, any additional requirements in respect of such **OTSDUW Plant and Apparatus** will be specified in the relevant **Bilateral Agreement** with the **GB Generator**. For the avoidance of doubt, requirements applicable to **GB Generators** undertaking **OTSDUW** and connecting to a **Network Operator's User System**, shall be consistent with those applicable requirements of **GB Generators** undertaking **OTSDUW** and connecting to a **Transmission Interface Point**.

CC.4 PROCEDURE

CC.4.1 The **CUSC** contains certain provisions relating to the procedure for connection to the **National Electricity Transmission System** or, in the case of **Embedded Power Stations** or **Embedded DC Converter Stations**, becoming operational and includes provisions relating to certain conditions to be complied with by **GB Code Users** prior to and during the course of **The Company** notifying the **GB Code User** that it has the right to become operational. The procedure for a **GB Code User** to become connected is set out in the **Compliance Processes**.

CC.5 CONNECTION

CC.5.1 The provisions relating to connecting to the **National Electricity Transmission System** (or to a **User's System** in the case of a connection of an **Embedded Large Power Station** or **Embedded Medium Power Station** or **Embedded DC Converter Station**) are contained in:

- (a) the **CUSC** and/or **CUSC Contract** (or in the relevant application form or offer for a **CUSC Contract**);
- (b) or, in the case of an **Embedded Development**, the relevant **Distribution Code** and/or the **Embedded Development Agreement** for the connection (or in the relevant application form or offer for an **Embedded Development Agreement**),

and include provisions relating to both the submission of information and reports relating to compliance with the relevant **Connection Conditions** for that **GB Code User**, **Safety Rules**, commissioning programmes, **Operation Diagrams** and approval to connect (and their equivalents in the case of **Embedded Medium Power Stations** not subject to a **Bilateral Agreement** or **Embedded DC Converter Stations** not subject to a **Bilateral Agreement**). References in the **CC** to the "**Bilateral Agreement**" and/or "**Construction Agreement**" and/or "**Embedded Development Agreement**" shall be deemed to include references to the application form or offer therefor.

CC.5.2 Items For Submission

CC.5.2.1

Prior to the **Completion Date** (or, where the **GB Generator** is undertaking **OTSDUW**, any later date specified) under the **Bilateral Agreement** and/or **Construction Agreement**, the following is submitted pursuant to the terms of the **Bilateral Agreement** and/or **Construction Agreement**:

- (a) updated **Planning Code** data (both **Standard Planning Data** and **Detailed Planning Data**), with any estimated values assumed for planning purposes confirmed or, where practical, replaced by validated actual values and by updated estimates for the future and by updated forecasts for **Forecast Data** items such as **Demand**, pursuant to the requirements of the **Planning Code**;
- (b) details of the **Protection** arrangements and settings referred to in CC.6;
- (c) copies of all **Safety Rules** and **Local Safety Instructions** applicable at **Users' Sites** which will be used at **The Company/User** interface (which, for the purpose of **OC8**, must be to **The Company's** satisfaction regarding the procedures for **Isolation** and **Earthing**. For **User Sites** in Scotland and **Offshore The Company** will consult the **Relevant Transmission Licensee** when determining whether the procedures for **Isolation** and **Earthing** are satisfactory);
- (d) information to enable **The Company** to prepare **Site Responsibility Schedules** on the basis of the provisions set out in Appendix 1;
- (e) an **Operation Diagram** for all **HV Apparatus** on the **User** side of the **Connection Point** as described in CC.7;
- (f) the proposed name of the **User Site** (which shall not be the same as, or confusingly similar to, the name of any **Transmission Site** or of any other **User Site**);
- (g) written confirmation that **Safety Co-ordinators** acting on behalf of the **User** are authorised and competent pursuant to the requirements of **OC8**;
- (h) **RISSP** prefixes pursuant to the requirements of **OC8**. **The Company** is required to circulate prefixes utilising a proforma in accordance with **OC8**;
- (i) a list of the telephone numbers for **Joint System Incidents** at which senior management representatives nominated for the purpose can be contacted and confirmation that they are fully authorised to make binding decisions on behalf of the **User**, pursuant to **OC9**;
- (j) a list of managers who have been duly authorised to sign **Site Responsibility Schedules** on behalf of the **User**;
- (k) information to enable **The Company** to prepare **Site Common Drawings** as described in CC.7;
- (l) a list of the telephone numbers for the **Users** facsimile machines referred to in CC.6.5.9; and
- (m) for **Sites** in Scotland and **Offshore** a list of persons appointed by the **User** to undertake operational duties on the **User's System** (including any **OTSDUW** prior to the **OTSUA Transfer Time**) and to issue and receive operational messages and instructions in relation to the **User's System** (including any **OTSDUW** prior to the **OTSUA Transfer Time**); and an appointed person or persons responsible for the maintenance and testing of **User's Plant** and **Apparatus**.

CC.5.2.2

Prior to the **Completion Date** the following must be submitted to **The Company** by the **Network Operator** in respect of an **Embedded Development**:

- (a) updated **Planning Code** data (both **Standard Planning Data** and **Detailed Planning Data**), with any estimated values assumed for planning purposes confirmed or, where practical, replaced by validated actual values and by updated estimates for the future and by updated forecasts for **Forecast Data** items such as **Demand**, pursuant to the requirements of the **Planning Code**;

- (b) details of the **Protection** arrangements and settings referred to in CC.6;
 - (c) the proposed name of the **Embedded Medium Power Station** or **Embedded DC Converter Station Site** (which shall be agreed with **The Company** unless it is the same as, or confusingly similar to, the name of other **Transmission Site** or **User Site**);
- CC.5.2.3 Prior to the **Completion Date** contained within an **Offshore Transmission Distribution Connection Agreement** the following must be submitted to **The Company** by the **Network Operator** in respect of a proposed new **Interface Point** within its **User System**:
- (a) updated **Planning Code** data (both **Standard Planning Data** and **Detailed Planning Data**), with any estimated values assumed for planning purposes confirmed or, where practical, replaced by validated actual values and by updated estimates for the future and by updated forecasts for **Forecast Data** items such as **Demand**, pursuant to the requirements of the **Planning Code**;
 - (b) details of the **Protection** arrangements and settings referred to in CC.6;
 - (c) the proposed name of the **Interface Point** (which shall not be the same as, or confusingly similar to, the name of any **Transmission Site** or of any other **User Site**);
- CC.5.2.4 In the case of **OTSDUW Plant and Apparatus** (in addition to items under CC.5.2.1 in respect of the **Connection Site**), prior to the **Completion Date** (or any later date specified) under the **Construction Agreement** the following must be submitted to **The Company** by the **GB Code User** in respect of the proposed new **Connection Point** and **Interface Point**:
- (a) updated **Planning Code** data (**Standard Planning Data**, **Detailed Planning Data** and **OTSDUW Data and Information**), with any estimated values assumed for planning purposes confirmed or, where practical, replaced by validated actual values and by updated estimates for the future and by updated forecasts for **Forecast Data** items such as **Demand**, pursuant to the requirements of the **Planning Code**;
 - (b) details of the **Protection** arrangements and settings referred to in CC.6;
 - (c) information to enable preparation of the **Site Responsibility Schedules** at the **Transmission Interface Site** on the basis of the provisions set out in Appendix 1.
 - (d) the proposed name of the **Interface Point** (which shall not be the same as, or confusingly similar to, the name of any **Transmission Site** or of any other **User Site**);
- CC.5.3
- (a) Of the items CC.5.2.1 (c), (e), (g), (h), (k) and (m) need not be supplied in respect of **Embedded Power Stations** or **Embedded DC Converter Stations**,
 - (b) item CC.5.2.1(i) need not be supplied in respect of **Embedded Small Power Stations** and **Embedded Medium Power Stations** or **Embedded DC Converter Stations** with a **Registered Capacity** of less than 100MW, and
 - (c) items CC.5.2.1(d) and (j) are only needed in the case where the **Embedded Power Station** or the **Embedded DC Converter Station** is within a **Connection Site** with another **User**.
- CC.5.4 In addition, at the time the information is given under CC.5.2(g), **The Company** will provide written confirmation to the **User** that the **Safety Co-ordinators** acting on behalf of **The Company** are authorised and competent pursuant to the requirements of **OC8**.
- CC.6 TECHNICAL, DESIGN AND OPERATIONAL CRITERIA
- CC.6.1 National Electricity Transmission System Performance Characteristics

CC.6.1.1

The Company shall ensure that, subject as provided in the **Grid Code**, the **National Electricity Transmission System** complies with the following technical, design and operational criteria in relation to the part of the **National Electricity Transmission System** at the **Connection Site** with a **GB Code User** and in the case of **OTSDUW Plant and Apparatus**, a **Transmission Interface Point** (unless otherwise specified in CC.6) although in relation to operational criteria **The Company** may be unable (and will not be required) to comply with this obligation to the extent that there are insufficient **Power Stations** or **User Systems** are not available or **Users** do not comply with **The Company's** instructions or otherwise do not comply with the **Grid Code** and each **GB Code User** shall ensure that its **Plant** and **Apparatus** complies with the criteria set out in CC.6.1.5.

Grid Frequency Variations

CC.6.1.2 The **Frequency** of the **National Electricity Transmission System** shall be nominally 50Hz and shall be controlled within the limits of 49.5 - 50.5Hz unless exceptional circumstances prevail.

CC.6.1.3 The **System Frequency** could rise to 52Hz or fall to 47Hz in exceptional circumstances. Design of **GB Code User's Plant and Apparatus** and **OTSDUW Plant and Apparatus** must enable operation of that **Plant** and **Apparatus** within that range in accordance with the following:

<u>Frequency Range</u>	<u>Requirement</u>
51.5Hz - 52Hz	Operation for a period of at least 15 minutes is required each time the Frequency is above 51.5Hz.
51Hz - 51.5Hz	Operation for a period of at least 90 minutes is required each time the Frequency is above 51Hz.
49.0Hz - 51Hz	Continuous operation is required
47.5Hz - 49.0Hz	Operation for a period of at least 90 minutes is required each time the Frequency is below 49.0Hz.
47Hz - 47.5Hz	Operation for a period of at least 20 seconds is required each time the Frequency is below 47.5Hz.

For the avoidance of doubt, disconnection, by frequency or speed based relays is not permitted within the frequency range 47.5Hz to 51.5Hz, unless agreed with **The Company** in accordance with CC.6.3.12.

Grid Voltage Variations

CC.6.1.4 Subject as provided below, the voltage on the 400kV part of the **National Electricity Transmission System** at each **Connection Site** with a **GB Code User** (and in the case of **OTSDUW Plant and Apparatus**, a **Transmission Interface Point**) will normally remain within $\pm 5\%$ of the nominal value unless abnormal conditions prevail. The minimum voltage is -10% and the maximum voltage is $+10\%$ unless abnormal conditions prevail, but voltages between $+5\%$ and $+10\%$ will not last longer than 15 minutes unless abnormal conditions prevail. Voltages on the 275kV and 132kV parts of the **National Electricity Transmission System** at each **Connection Site** with a **User** (and in the case of **OTSDUW Plant and Apparatus**, a **Transmission Interface Point**) will normally remain within the limits $\pm 10\%$ of the nominal value unless abnormal conditions prevail. At nominal **System** voltages below 132kV the voltage of the **National Electricity Transmission System** at each **Connection Site** with a **User** (and in the case of **OTSDUW Plant and Apparatus**, a **Transmission Interface Point**) will normally remain within the limits $\pm 6\%$ of the nominal value unless abnormal conditions prevail. Under fault conditions, voltage may collapse transiently to zero at the point of fault until the fault is cleared. The normal operating ranges of the **National Electricity Transmission System** are summarised below:

<u>National Electricity Transmission System Nominal Voltage</u>	<u>Normal Operating Range</u>
400kV	400kV $\pm 5\%$
275kV	275kV $\pm 10\%$
132kV	132kV $\pm 10\%$

The Company and a **GB Code User** may agree greater or lesser variations in voltage to those set out above in relation to a particular **Connection Site**, and insofar as a greater or lesser variation is agreed, the relevant figure set out above shall, in relation to that **GB Code User** at the particular **Connection Site**, be replaced by the figure agreed.

Voltage Waveform Quality

CC.6.1.5

All **Plant** and **Apparatus** connected to the **National Electricity Transmission System**, and that part of the **National Electricity Transmission System** at each **Connection Site** or, in the case of **OTSDUW Plant and Apparatus**, at each **Interface Point**, should be capable of withstanding the following distortions of the voltage waveform in respect of harmonic content and phase unbalance:

(a) Harmonic Content

The **Electromagnetic Compatibility Levels** for harmonic distortion on the **Onshore Transmission System** from all sources under both **Planned Outage** and fault outage conditions, (unless abnormal conditions prevail) shall comply with the levels shown in the tables of Appendix A of **Engineering Recommendation G5/4**. The **Electromagnetic Compatibility Levels** for harmonic distortion on an **Offshore Transmission System** will be defined in relevant **Bilateral Agreements**.

Engineering Recommendation G5/4 contains planning criteria which **The Company** will apply to the connection of non-linear **Load** to the **National Electricity Transmission System**, which may result in harmonic emission limits being specified for these **Loads** in the relevant **Bilateral Agreement**. The application of the planning criteria will take into account the position of **GB Code** and **EU Code Users' Plant and Apparatus** (and **OTSDUW Plant and Apparatus**) in relation to harmonic emissions. **GB Code Users** must ensure that connection of distorting loads to their **User Systems** do not cause any harmonic emission limits specified in the **Bilateral Agreement**, or where no such limits are specified, the relevant planning levels specified in **Engineering Recommendation G5/4** to be exceeded.

(b) Phase Unbalance

Under **Planned Outage** conditions, the weekly 95 percentile of **Phase (Voltage) Unbalance**, calculated in accordance with IEC 61000-4-30 and IEC 61000-3-13, on the **National Electricity Transmission System** for voltages above 150kV should remain, in England and Wales, below 1.5%, and in Scotland, below 2%, and for voltages of 150kV and below, across GB below 2%, unless abnormal conditions prevail and **Offshore** (or in the case of **OTSDUW, OTSDUW Plant and Apparatus**) will be defined in relevant **Bilateral Agreements**.

The Phase Unbalance is calculated from the ratio of root mean square (rms) of negative phase sequence voltage to rms of positive phase sequence voltage, based on 10-minute average values, in accordance with IEC 61000-4-30.

CC.6.1.6

Across GB, under the **Planned Outage** conditions stated in CC.6.1.5(b) infrequent short duration peaks with a maximum value of 2% are permitted for **Phase (Voltage) Unbalance**, for voltages above 150kV, subject to the prior agreement of **The Company** under the **Bilateral Agreement** and in relation to **OTSDUW**, the **Construction Agreement**. **The Company** will only agree following a specific assessment of the impact of these levels on **Transmission Apparatus** and other **Users Apparatus** with which it is satisfied.

Voltage Fluctuations

CC.6.1.7

Voltage changes at a **Point of Common Coupling** on the **Onshore Transmission System** shall not exceed:

(a) The limits specified in Table CC.6.1.7 with the stated frequency of occurrence, where:

(i)

$$\% \Delta V_{\text{steadystate}} = \left| 100 \times \frac{\Delta V_{\text{steadystate}}}{V_0} \right|$$

and

$$\% \Delta V_{\text{max}} = 100 \times \frac{\Delta V_{\text{max}}}{V_0} ;$$

- (ii) V_0 is the initial steady state system voltage;
- (iii) $V_{\text{steadystate}}$ is the system voltage reached when the rate of change of system voltage over time is less than or equal to 0.5% over 1 second and $\Delta V_{\text{steadystate}}$ is the absolute value of the difference between $V_{\text{steadystate}}$ and V_0 ;
- (iv) ΔV_{max} is the absolute value of the maximum change in the system voltage relative to the initial steady state system voltage of V_0 ;
- (v) All voltages are the root mean square of the voltage measured over one cycle refreshed every half a cycle as per IEC 61000-4-30;
- (vi) The voltage changes specified are the absolute maximum allowed, applied to phase to ground or phase to phase voltages whichever is the highest change;
- (vii) Voltage changes in category 3 do not exceed the limits depicted in the time dependant characteristic shown in Figure CC.6.1.7;
- (viii) Voltage changes in category 3 only occur infrequently, typically not planned more than once per year on average over the lifetime of a connection, and in circumstances notified to **The Company**, such as for example commissioning in accordance with a commissioning programme, implementation of a planned outage notified in accordance with **OC2** or an **Operation** or **Event** notified in accordance with **OC7**; and
- (ix) For connections with a **Completion Date** after 1st September 2015 and where voltage changes would constitute a risk to the **National Electricity Transmission System** or, in **The Company's** view, the **System** of any **GB Code User**, **Bilateral Agreements** may include provision for **The Company** to reasonably limit the number of voltage changes in category 2 or 3 to a lower number than specified in Table CC.6.1.7 to ensure that the total number of voltage changes at the **Point of Common Coupling** across multiple **Users** remains within the limits of Table CC.6.1.7.

Category	Maximum number of Occurrences	$\% \Delta V_{\text{max}}$ & $\% \Delta V_{\text{steadystate}}$
1	No Limit	$ \% \Delta V_{\text{max}} \leq 1\% \&$ $ \% \Delta V_{\text{steadystate}} \leq 1\%$
2	$\frac{3600}{0.304 \sqrt{2.5 \times \% \Delta V_{\text{max}}}}$ occurrences per hour with events evenly distributed	$1\% < \% \Delta V_{\text{max}} \leq 3\% \&$ $ \% \Delta V_{\text{steadystate}} \leq 3\%$
3	No more than 4 per day for Commissioning, Maintenance and Fault Restoration	For decreases in voltage: $\% \Delta V_{\text{max}} \leq 12\%^1 \&$ $\% \Delta V_{\text{steadystate}} \leq 3\%$ For increases in voltage: $\% \Delta V_{\text{max}} \leq 5\%^2 \&$ $\% \Delta V_{\text{steadystate}} \leq 3\%$ (see Figure CC6.1.7)

Table CC.6.1.7 - Limits for Rapid Voltage Changes

- ¹ A decrease in voltage of up to 12% is permissible for up to 80ms, as highlighted in the shaded area in Figure CC.6.1.7, reducing to up to 10% after 80ms and to up to 3% after 2 seconds.
- ² An increase in voltage of up to 5% is permissible if it is reduced to up to 3% after 0.5 seconds.

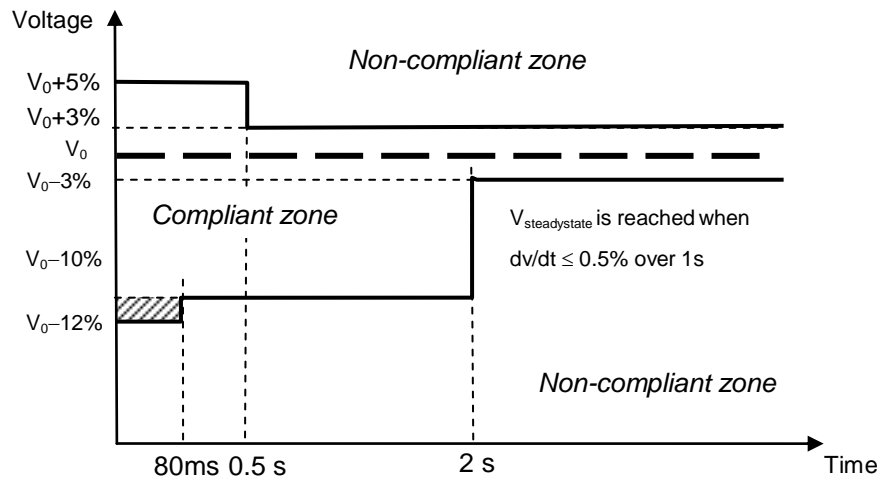

Figure CC.6.1.7 -
Time and magnitude limits for a category 3 Rapid Voltage Change

- (b) For voltages above 132kV, **Flicker Severity (Short Term)** of 0.8 Unit and a **Flicker Severity (Long Term)** of 0.6 Unit, for voltages 132kV and below, **Flicker Severity (Short Term)** of 1.0 Unit and a **Flicker Severity (Long Term)** of 0.8 Unit, as set out in **Engineering Recommendation P28** as current at the **Transfer Date**.

CC.6.1.8 Voltage fluctuations at a **Point of Common Coupling** with a fluctuating **Load** directly connected to an **Offshore Transmission System** (or in the case of **OTSDUW, OTSDUW Plant and Apparatus**) shall not exceed the limits set out in the **Bilateral Agreement**.

Sub-Synchronous Resonance and Sub-Synchronous Torsional Interaction

CC.6.1.9 **The Company** shall ensure that **GB Code Users' Plant and Apparatus** will not be subject to unacceptable Sub-Synchronous Oscillation conditions as specified in the relevant **Licence Standards**.

CC.6.1.10 **The Company** shall ensure where necessary, and in consultation with **Transmission Licensees** where required, that any relevant site specific conditions applicable at a **GB Code User's Connection Site**, including a description of the Sub-Synchronous Oscillation conditions considered in the application of the relevant **Licence Standards**, are set out in the **GB Code User's Bilateral Agreement**.

CC.6.2 Plant and Apparatus relating to Connection Site and Interface Point

The following requirements apply to **Plant** and **Apparatus** relating to the **Connection Point**, and **OTSDUW Plant and Apparatus** relating to the **Interface Point** (until the **OTSUA Transfer Time**) and **Connection Point** which (except as otherwise provided in the relevant paragraph) each **GB Code User** must ensure are complied with in relation to its **Plant** and **Apparatus** and which in the case of CC.6.2.2.2.2, CC.6.2.3.1.1 and CC.6.2.1.1(b) only, **The Company** must ensure are complied with in relation to **Transmission Plant and Apparatus**, as provided in those paragraphs.

CC.6.2.1 General Requirements

- CC.6.2.1.1 (a) The design of connections between the **National Electricity Transmission System** and:
- (i) any **Generating Unit** (other than a **CCGT Unit** or **Power Park Unit**) **DC Converter**, **Power Park Module** or **CCGT Module**, or
 - (ii) any **Network Operator's System**, or
 - (iii) **Non-Embedded Customers** equipment;
- will be consistent with the **Licence Standards**.

In the case of **OTSDUW**, the design of the **OTSUA's** connections at the **Interface Point** and **Connection Point** will be consistent with **Licence Standards**.

- (b) The **National Electricity Transmission System** (and any **OTSDUW Plant and Apparatus**) at nominal **System** voltages of 132kV and above is/shall be designed to be earthed with an **Earth Fault Factor** of, in England and Wales or **Offshore**, below 1.4 and in Scotland, below 1.5. Under fault conditions the rated **Frequency** component of voltage could fall transiently to zero on one or more phases or, in England and Wales, rise to 140% phase-to-earth voltage, or in Scotland, rise to 150% phase-to-earth voltage. The voltage rise would last only for the time that the fault conditions exist. The fault conditions referred to here are those existing when the type of fault is single or two phase-to-earth.
- (c) For connections to the **National Electricity Transmission System** at nominal **System** voltages of below 132kV the earthing requirements and voltage rise conditions will be advised by **The Company** as soon as practicable prior to connection and in the case of **OTSDUW Plant and Apparatus** shall be advised to **The Company** by the **GB Code User**.

CC.6.2.1.2 Substation Plant and Apparatus

- (a) The following provisions shall apply to all **Plant** and **Apparatus** which is connected at the voltage of the **Connection Point** (and **OTSDUW Plant and Apparatus** at the **Interface Point**) and which is contained in equipment bays that are within the **Transmission** busbar **Protection** zone at the **Connection Point**. This includes circuit breakers, switch disconnectors, disconnectors, **Earthing Devices**, power transformers, voltage transformers, reactors, current transformers, surge arresters, bushings, neutral equipment, capacitors, line traps, coupling devices, external insulation and insulation co-ordination devices. Where necessary, this is as more precisely defined in the **Bilateral Agreement**.

- (i) Plant and/or Apparatus prior to 1st January 1999

Each item of such **Plant** and/or **Apparatus** which at 1st January 1999 is either :

- installed; or
- owned (but is either in storage, maintenance or awaiting installation); or
- ordered;

and is the subject of a **Bilateral Agreement** with regard to the purpose for which it is in use or intended to be in use, shall comply with the relevant standards/specifications applicable at the time that the **Plant** and/or **Apparatus** was

designed (rather than commissioned) and any further requirements as specified in the **Bilateral Agreement**.

- (ii) Plant and/or Apparatus post 1st January 1999 for a new Connection Point (including OTSDUW Plant and Apparatus at the Interface Point)

Each item of such **Plant** and/or **Apparatus** installed in relation to a new **Connection Point** (or **OTSDUW Plant and Apparatus at the Interface Point**) after 1st January 1999 shall comply with the relevant **Technical Specifications** and any further requirements identified by **The Company**, acting reasonably, to reflect the options to be followed within the **Technical Specifications** and/or to complement if necessary the **Technical Specifications** so as to enable **The Company** to comply with its obligations in relation to the **National Electricity Transmission System** or, in Scotland or **Offshore**, the **Relevant Transmission Licensee** to comply with its obligations in relation to its **Transmission System**. This information, including the application dates of the relevant **Technical Specifications**, will be as specified in the **Bilateral Agreement**.

- (iii) New Plant and/or Apparatus post 1st January 1999 for an existing Connection Point (including OTSDUW Plant and Apparatus at the Interface Point)

Each new additional and/or replacement item of such **Plant** and/or **Apparatus** installed in relation to a change to an existing **Connection Point** (or **OTSDUW Plant and Apparatus at the Interface Point and Connection Point**) after 1st January 1999 shall comply with the standards/specifications applicable when the change was designed, or such other standards/specifications as necessary to ensure that the item of **Plant** and/or **Apparatus** is reasonably fit for its intended purpose having due regard to the obligations of **The Company**, the relevant **GB Code User** and, in Scotland, or **Offshore**, also the **Relevant Transmission Licensee** under their respective **Licences**. Where appropriate this information, including the application dates of the relevant standards/specifications, will be as specified in the varied **Bilateral Agreement**.

- (iv) Used Plant and/or Apparatus being moved, re-used or modified

If, after its installation, any such item of **Plant** and/or **Apparatus** is subsequently:

- moved to a new location; or
- used for a different purpose; or
- otherwise modified;

then the standards/specifications as described in (i), (ii), or (iii) above or in ECC.6.2.1.2 (as applicable) will apply as appropriate to such **Plant** and/or **Apparatus**, which must be reasonably fit for its intended purpose having due regard to the obligations of **The Company**, the relevant **GB Code User** or **EU Code User** (as applicable) and, in Scotland or **Offshore**, also the **Relevant Transmission Licensee** under their respective **Licences**.

- (b) **The Company** shall at all times maintain a list of those **Technical Specifications** and additional requirements which might be applicable under this CC.6.2.1.2 and which may be referenced by **The Company** in the **Bilateral Agreement**. **The Company** shall provide a copy of the list upon request to any **User**.
- (c) Where the **GB Code User** provides **The Company** with information and/or test reports in respect of **Plant** and/or **Apparatus** which the **GB Code User** reasonably believes demonstrate the compliance of such items with the provisions of a **Technical Specification** then **The Company** shall promptly and without unreasonable delay give due and proper consideration to such information.

- (d) **Plant** and **Apparatus** shall be designed, manufactured and tested in premises with an accredited certificate in accordance with the quality assurance requirements of the relevant standard in the BS EN ISO 9000 series (or equivalent as reasonably approved by **The Company**) or in respect of test premises which do not include a manufacturing facility premises with an accredited certificate in accordance with BS EN 45001.
- (e) Each connection between an **GB Code User** and the **National Electricity Transmission System** must be controlled by a circuit-breaker (or circuit breakers) capable of interrupting the maximum short circuit current at the point of connection. The **Seven Year Statement** gives values of short circuit current and the rating of **Transmission** circuit breakers at existing and committed **Connection Points** for future years.
- (f) Each connection between a **GB Generator** undertaking **OTSDUW** or an **Onshore Transmission Licensee**, must be controlled by a circuit breaker (or circuit breakers) capable of interrupting the maximum short circuit current at the **Transmission Interface Point**. The **Seven Year Statement** gives values of short circuit current and the rating of **Transmission** circuit breakers at existing and committed **Transmission Interface Points** for future years.

CC.6.2.2 Requirements at Connection Points or, in the case of OTSDUW at Interface Points that relate to GB Generators or OTSDUW Plant and Apparatus or DC Converter Station owners

CC.6.2.2.1 Not Used.

CC.6.2.2.2 Generating Unit, OTSDUW Plant and Apparatus and Power Station Protection Arrangements

CC.6.2.2.2.1 Minimum Requirements

Protection of Generating Units (other than **Power Park Units**), **DC Converters**, **OTSDUW Plant and Apparatus** or **Power Park Modules** and their connections to the **National Electricity Transmission System** shall meet the requirements given below. These are necessary to reduce the impact on the **National Electricity Transmission System** of faults on **OTSDUW Plant and Apparatus** circuits or circuits owned by **GB Generators** or **DC Converter Station** owners.

CC.6.2.2.2.2 Fault Clearance Times

- (a) The required fault clearance time for faults on the **GB Generator's** or **DC Converter Station** owner's equipment directly connected to the **National Electricity Transmission System** or **OTSDUW Plant and Apparatus** and for faults on the **National Electricity Transmission System** directly connected to the **GB Generator** or **DC Converter Station** owner's equipment or **OTSDUW Plant and Apparatus**, from fault inception to the circuit breaker arc extinction, shall be set out in the **Bilateral Agreement**. The fault clearance time specified in the **Bilateral Agreement** shall not be shorter than the durations specified below:

- (i) 80ms at 400kV
- (ii) 100ms at 275kV
- (iii) 120ms at 132kV and below

but this shall not prevent the **GB Code User** or **The Company** or the **GB Generator** (including in respect of **OTSDUW Plant and Apparatus**) from selecting a shorter fault clearance time on their own **Plant** and **Apparatus** provided **Discrimination** is achieved.

A longer fault clearance time may be specified in the **Bilateral Agreement** for faults on the **National Electricity Transmission System**. A longer fault clearance time for faults on the **GB Generator** or **DC Converter Station** owner's equipment or **OTSDUW Plant and Apparatus** may be agreed with **The Company** in accordance with the terms of the **Bilateral Agreement** but only if **System** requirements, in **The Company's** view, permit. The probability that the fault clearance time stated in the **Bilateral Agreement** will be exceeded by any given fault, must be less than 2%.

- (b) In the event that the required fault clearance time is not met as a result of failure to operate on the **Main Protection System(s)** provided, the **GB Generators** or **DC Converter Station** owners or **GB Generators** in the case of **OTSDUW Plant and Apparatus** shall, except as specified below provide **Independent Back-Up Protection**. The Company will also provide **Back-Up Protection** and The Company's and the **GB Code User's Back-Up Protections** will be co-ordinated so as to provide **Discrimination**.

On a **Generating Unit** (other than a **Power Park Unit**), **DC Converter** or **Power Park Module** or **OTSDUW Plant and Apparatus** in respect of which the **Completion Date** is after 20 January 2016 and connected to the **National Electricity Transmission System** at 400kV or 275kV and where two **Independent Main Protections** are provided to clear faults on the **HV Connections** within the required fault clearance time, the **Back-Up Protection** provided by **GB Generators** (including in respect of **OTSDUW Plant and Apparatus**) and **DC Converter Station** owner shall operate to give a fault clearance time of no longer than 300ms at the minimum infeed for normal operation for faults on the **HV Connections**. Where two **Independent Main Protections** are installed the **Back-Up Protection** may be integrated into one (or both) of the **Independent Main Protection** relays.

On a **Generating Unit** (other than a **Power Park Unit**), **DC Converter** or **Power Park Module** or **OTSDUW Plant and Apparatus** in respect of which the **Completion Date** is after 20 January 2016 and connected to the **National Electricity Transmission System** at 132 kV and where only one **Main Protection** is provided to clear faults on the **HV Connections** within the required fault clearance time, the **Independent Back-Up Protection** provided by the **GB Generator** (including in respect of **OTSDUW Plant and Apparatus**) and the **DC Converter Station** owner shall operate to give a fault clearance time of no longer than 300ms at the minimum infeed for normal operation for faults on the **HV Connections**.

On a **Generating Unit** (other than a **Power Park Unit**), **DC Converter** or **Power Park Module** or **OTSDUW Plant and Apparatus** connected to the **National Electricity Transmission System** and on **Generating Units** (other than a **Power Park Unit**), **DC Converters** or **Power Park Modules** or **OTSDUW Plant and Apparatus** connected to the **National Electricity Transmission System** at 400 kV or 275 kV or 132 kV, in respect of which the **Completion Date** is before the 20 January 2016, the **Back-Up Protection** or **Independent Back-Up Protection** shall operate to give a fault clearance time of no longer than 800ms in England and Wales or 300ms in Scotland at the minimum infeed for normal operation for faults on the **HV Connections**.

A **Generating Unit** (other than a **Power Park Unit**), **DC Converter** or **Power Park Module** or **OTSDUW Plant and Apparatus**) with **Back-Up Protection** or **Independent Back-Up Protection** will also be required to withstand, without tripping, the loading incurred during the clearance of a fault on the **National Electricity Transmission System** by breaker fail **Protection** at 400kV or 275kV or of a fault cleared by **Back-Up Protection** where the **GB Generator** (including in the case of **OTSDUW Plant and Apparatus**) or **DC Converter** is connected at 132kV and below. This will permit **Discrimination** between **GB Generator** in respect of **OTSDUW Plant and Apparatus** or **DC Converter Station** owners' **Back-Up Protection** or **Independent Back-Up Protection** and the **Back-Up Protection** provided on the **National Electricity Transmission System** and other **Users' Systems**.

- (c) When the **Generating Unit** (other than **Power Park Units**), or the **DC Converter** or **Power Park Module** or **OTSDUW Plant and Apparatus** is connected to the **National Electricity Transmission System** at 400kV or 275kV, and in Scotland and **Offshore** also at 132kV, and a circuit breaker is provided by the **GB Generator** (including in respect of **OTSDUW Plant and Apparatus**) or the **DC Converter Station** owner, or **The Company**, as the case may be, to interrupt fault current interchange with the **National Electricity Transmission System**, or **GB Generator's System**, or **DC Converter Station** owner's **System**, as the case may be, circuit breaker fail **Protection** shall be provided by the **GB Generator** (including in respect of **OTSDUW Plant and Apparatus**) or **DC Converter Station** owner, or **The Company**, as the case may be, on this circuit breaker. In the event, following operation of a **Protection** system, of a failure to interrupt fault current by these circuit-breakers within the **Fault Current Interruption Time**, the circuit breaker fail **Protection** is required to initiate tripping of all the necessary electrically adjacent circuit-breakers so as to interrupt the fault current within the next 200ms.
- (d) The target performance for the **System Fault Dependability Index** shall be not less than 99%. This is a measure of the ability of **Protection** to initiate successful tripping of circuit breakers which are associated with the faulty item of **Apparatus**.

CC.6.2.2.3 Equipment to be provided

CC.6.2.2.3.1 Protection of Interconnecting Connections

The requirements for the provision of **Protection** equipment for interconnecting connections will be specified in the **Bilateral Agreement**. In this **CC** the term "interconnecting connections" means the primary conductors from the current transformer accommodation on the circuit side of the circuit breaker to the **Connection Point** or the primary conductors from the current transformer accommodation on the circuit side of the **OTSDUW Plant and Apparatus** of the circuit breaker to the **Transmission Interface Point**.

CC.6.2.2.3.2 Circuit-breaker fail Protection

The **GB Generator** or **DC Converter Station** owner will install circuit breaker fail **Protection** equipment in accordance with the requirements of the **Bilateral Agreement**. The **GB Generator** or **DC Converter Station** owner will also provide a back-trip signal in the event of loss of air from its pressurised head circuit breakers, during the **Generating Unit** (other than a **CCGT Unit** or **Power Park Unit**) or **CCGT Module** or **DC Converter** or **Power Park Module** run-up sequence, where these circuit breakers are installed.

CC.6.2.2.3.3 Loss of Excitation

The **GB Generator** must provide **Protection** to detect loss of excitation on a **Generating Unit** and initiate a **Generating Unit** trip.

CC.6.2.2.3.4 Pole-Slipping Protection

Where, in **The Company's** reasonable opinion, **System** requirements dictate, **The Company** will specify in the **Bilateral Agreement** a requirement for **GB Generators** to fit pole-slipping **Protection** on their **Generating Units**.

CC.6.2.2.3.5 Signals for Tariff Metering

GB Generators and **DC Converter Station** owners will install current and voltage transformers supplying all tariff meters at a voltage to be specified in, and in accordance with, the **Bilateral Agreement**.

CC.6.2.2.4 Work on Protection Equipment

No busbar **Protection**, mesh corner **Protection**, circuit-breaker fail **Protection** relays, AC or DC wiring (other than power supplies or DC tripping associated with the **Generating Unit**, **DC Converter** or **Power Park Module** itself) may be worked upon or altered by the **GB Generator** or **DC Converter Station** owner personnel in the absence of a representative of **The Company** or in Scotland or **Offshore**, a representative of **The Company**, or written authority from **The Company** to perform such work or alterations in the absence of a representative of **The Company**.

CC.6.2.2.5 Relay Settings

Protection and relay settings will be co-ordinated (both on connection and subsequently) across the **Connection Point** in accordance with the **Bilateral Agreement** and in relation to **OTSDUW Plant and Apparatus**, across the **Interface Point** in accordance with the **Bilateral Agreement** to ensure effective disconnection of faulty **Apparatus**.

CC.6.2.3 Requirements at Connection Points relating to Network Operators and Non-Embedded Customers

CC.6.2.3.1 Protection Arrangements for Network Operators and Non-Embedded Customers

CC.6.2.3.1.1 **Protection of Network Operator and Non-Embedded Customers Systems** directly connected to the **National Electricity Transmission System**, shall meet the requirements given below:

Fault Clearance Times

(a) The required fault clearance time for faults on **Network Operator** and **Non-Embedded Customer** equipment directly connected to the **National Electricity Transmission System**, and for faults on the **National Electricity Transmission System** directly connected to the **Network Operator's** or **Non-Embedded Customer's** equipment, from fault inception to the circuit breaker arc extinction, shall be set out in each **Bilateral Agreement**. The fault clearance time specified in the **Bilateral Agreement** shall not be shorter than the durations specified below:

- (i) 80ms at 400kV
- (ii) 100ms at 275kV
- (iii) 120ms at 132kV and below

but this shall not prevent the **GB Code User** or **The Company** from selecting a shorter fault clearance time on its own **Plant** and **Apparatus** provided **Discrimination** is achieved.

For the purpose of establishing the **Protection** requirements in accordance with CC.6.2.3.1.1 only, the point of connection of the **Network Operator** or **Non-Embedded Customer** equipment to the **National Electricity Transmission System** shall be deemed to be the low voltage busbars at a **GB Grid Supply Point**, irrespective of the ownership of the equipment at the **GB Grid Supply Point**.

A longer fault clearance time may be specified in the **Bilateral Agreement** for faults on the **National Electricity Transmission System**. A longer fault clearance time for faults on the **Network Operator** and **Non-Embedded Customers** equipment may be agreed with **The Company** in accordance with the terms of the **Bilateral Agreement** but only if **System** requirements in **The Company's** view permit. The probability that the fault clearance time stated in the **Bilateral Agreement** will be exceeded by any given fault must be less than 2%.

- (b) (i) For the event of failure of the **Protection** systems provided to meet the above fault clearance time requirements, **Back-Up Protection** shall be provided by the **Network Operator** or **Non-Embedded Customer** as the case may be.
- (ii) **The Company** will also provide **Back-Up Protection**, which will result in a fault clearance time longer than that specified for the **Network Operator** or **Non-Embedded Customer Back-Up Protection** so as to provide **Discrimination**.
- (iii) For connections with the **National Electricity Transmission System** at 132kV and below, it is normally required that the **Back-Up Protection** on the **National Electricity Transmission System** shall discriminate with the **Network Operator** or **Non-Embedded Customer's Back-Up Protection**.
- (iv) For connections with the **National Electricity Transmission System** at 400kV or 275kV, the **Back-Up Protection** will be provided by the **Network Operator** or **Non-**

Embedded Customer, as the case may be, with a fault clearance time not longer than 300ms for faults on the **Network Operator's** or **Non-Embedded Customer's Apparatus**.

- (v) Such **Protection** will also be required to withstand, without tripping, the loading incurred during the clearance of a fault on the **National Electricity Transmission System** by breaker fail **Protection** at 400kV or 275kV. This will permit **Discrimination** between **Network Operator's Back-Up Protection** or **Non-Embedded Customer's Back-Up Protection**, as the case may be, and **Back-Up Protection** provided on the **National Electricity Transmission System** and other **User Systems**. The requirement for and level of **Discrimination** required will be specified in the **Bilateral Agreement**.
- (c) (i) Where the **Network Operator** or **Non-Embedded Customer** is connected to the **National Electricity Transmission System** at 400kV or 275kV, and in Scotland also at 132kV, and a circuit breaker is provided by the **Network Operator** or **Non-Embedded Customer**, or **The Company**, as the case may be, to interrupt the interchange of fault current with the **National Electricity Transmission System** or the **System** of the **Network Operator** or **Non-Embedded Customer**, as the case may be, circuit breaker fail **Protection** will be provided by the **Network Operator** or **Non-Embedded Customer**, or **The Company**, as the case may be, on this circuit breaker.
- (ii) In the event, following operation of a **Protection** system, of a failure to interrupt fault current by these circuit-breakers within the **Fault Current Interruption Time**, the circuit breaker fail **Protection** is required to initiate tripping of all the necessary electrically adjacent circuit-breakers so as to interrupt the fault current within the next 200ms.
- (d) The target performance for the **System Fault Dependability Index** shall be not less than 99%. This is a measure of the ability of **Protection** to initiate successful tripping of circuit breakers which are associated with the faulty items of **Apparatus**.

CC.6.2.3.2 Fault Disconnection Facilities

- (a) Where no **Transmission** circuit breaker is provided at the **GB Code User's** connection voltage, the **GB Code User** must provide **The Company** with the means of tripping all the **GB Code User's** circuit breakers necessary to isolate faults or **System** abnormalities on the **National Electricity Transmission System**. In these circumstances, for faults on the **GB Code User's System**, the **GB Code User's Protection** should also trip higher voltage **Transmission** circuit breakers. These tripping facilities shall be in accordance with the requirements specified in the **Bilateral Agreement**.
- (b) **The Company** may require the installation of a **System to Generator Operational Intertripping Scheme** in order to enable the timely restoration of circuits following power **System** fault(s). These requirements shall be set out in the relevant **Bilateral Agreement**.

CC.6.2.3.3 Automatic Switching Equipment

Where automatic reclosure of **Transmission** circuit breakers is required following faults on the **GB Code User's System**, automatic switching equipment shall be provided in accordance with the requirements specified in the **Bilateral Agreement**.

CC.6.2.3.4 Relay Settings

Protection and relay settings will be co-ordinated (both on connection and subsequently) across the **Connection Point** in accordance with the **Bilateral Agreement** to ensure effective disconnection of faulty **Apparatus**.

CC.6.2.3.5 Work on Protection equipment

Where a **Transmission Licensee** owns the busbar at the **Connection Point**, no busbar **Protection**, mesh corner **Protection** relays, AC or DC wiring (other than power supplies or DC tripping associated with the **Network Operator** or **Non-Embedded Customer's Apparatus** itself) may be worked upon or altered by the **Network Operator** or **Non-Embedded Customer** personnel in the absence of a representative of **The Company** or in Scotland, a representative of **The Company**, or written authority from **The Company** to perform such work or alterations in the absence of a representative of **The Company**.

CC.6.2.3.6 Equipment to be provided

CC.6.2.3.6.1 Protection of Interconnecting Connections

The requirements for the provision of **Protection** equipment for interconnecting connections will be specified in the **Bilateral Agreement**.

CC.6.3 GENERAL GENERATING UNIT (AND OTSDUW) REQUIREMENTS

CC.6.3.1 This section sets out the technical and design criteria and performance requirements for **Generating Units, DC Converters** and **Power Park Modules** (whether directly connected to the **National Electricity Transmission System** or **Embedded**) and (where provided in this section) **OTSDUW Plant and Apparatus** which each **GB Generator** or **DC Converter Station** owner must ensure are complied with in relation to its **Generating Units, DC Converters** and **Power Park Modules** and **OTSDUW Plant and Apparatus** but does not apply to **Small Power Stations** or individually to **Power Park Units**. References to **Generating Units, DC Converters** and **Power Park Modules** in this CC.6.3 should be read accordingly. The performance requirements that **OTSDUW Plant and Apparatus** must be capable of providing at the **Interface Point** under this section may be provided using a combination of **GB Generator Plant and Apparatus** and/or **OTSDUW Plant and Apparatus**.

Plant Performance Requirements

- (a) When supplying **Rated MW** all **Onshore Synchronous Generating Units** must be capable of continuous operation at any point between the limits 0.85 **Power Factor** lagging and 0.95 **Power Factor** leading at the **Onshore Synchronous Generating Unit** terminals. At **Active Power** output levels other than **Rated MW**, all **Onshore Synchronous Generating Units** must be capable of continuous operation at any point between the **Reactive Power** capability limits identified on the **Generator Performance Chart**.

In addition to the above paragraph, where **Onshore Synchronous Generating Unit(s)**:

- (i) have a **Connection Entry Capacity** which has been increased above **Rated MW** (or the **Connection Entry Capacity** of the **CCGT module** has increased above the sum of the **Rated MW** of the **Generating Units** comprising the **CCGT module**), and such increase takes effect after 1st May 2009, the minimum lagging **Reactive Power** capability at the terminals of the **Onshore Synchronous Generating Unit(s)** must be 0.9 **Power Factor** at all **Active Power** output levels in excess of **Rated MW**. Further, the **User** shall comply with the provisions of and any instructions given pursuant to BC1.8 and the relevant **Bilateral Agreement**; or
- (ii) have a **Connection Entry Capacity** in excess of **Rated MW** (or the **Connection Entry Capacity** of the **CCGT module** exceeds the sum of **Rated MW** of the **Generating Units** comprising the **CCGT module**) and a **Completion Date** before 1st May 2009, alternative provisions relating to **Reactive Power** capability may be specified in the **Bilateral Agreement** and where this is the case such provisions must be complied with.

The short circuit ratio of **Onshore Synchronous Generating Units** with an **Apparent Power** rating of less than 1600MVA shall be not less than 0.5. The short circuit ratio of **Onshore Synchronous Generating Units** with a rated **Apparent Power** of 1600MVA or above shall be not less than 0.4.

- (b) Subject to paragraph (c) below, all **Onshore Non-Synchronous Generating Units**, **Onshore DC Converters** and **Onshore Power Park Modules** must be capable of maintaining zero transfer of **Reactive Power** at the **Onshore Grid Entry Point** (or **User System Entry Point** if **Embedded**) at all **Active Power** output levels under steady state voltage conditions. For **Onshore Non-Synchronous Generating Units** and **Onshore Power Park Modules** the steady state tolerance on **Reactive Power** transfer to and from the **National Electricity Transmission System** expressed in MVA_r shall be no greater than 5% of the **Rated MW**. For **Onshore DC Converters** the steady state tolerance on **Reactive Power** transfer to and from the **National Electricity Transmission System** shall be specified in the **Bilateral Agreement**.

- (c) Subject to the provisions of CC.6.3.2(d) below, all **Onshore Non-Synchronous Generating Units, Onshore DC Converters** (excluding current source technology) and **Onshore Power Park Modules** (excluding those connected to the **Total System** by a current source **Onshore DC Converter**) and **OTSDUW Plant and Apparatus** at the **Interface Point** with a **Completion Date** on or after 1 January 2006 must be capable of supplying **Rated MW** output or **Interface Point Capacity** in the case of **OTSDUW Plant and Apparatus** at any point between the limits 0.95 **Power Factor** lagging and 0.95 **Power Factor** leading at the **Onshore Grid Entry Point** in England and Wales or **Interface Point** in the case of **OTSDUW Plant and Apparatus** or at the HV side of the 33/132kV or 33/275kV or 33/400kV transformer for **GB Generators** directly connected to the **Onshore Transmission System** in Scotland (or **User System Entry Point** if **Embedded**). With all **Plant** in service, the **Reactive Power** limits defined at **Rated MW** or **Interface Point Capacity** in the case of **OTSDUW Plant and Apparatus** at Lagging **Power Factor** will apply at all **Active Power** output levels above 20% of the **Rated MW** or **Interface Point Capacity** in the case of **OTSDUW Plant and Apparatus** output as defined in Figure 1. With all **Plant** in service, the **Reactive Power** limits defined at **Rated MW** at Leading **Power Factor** will apply at all **Active Power** output levels above 50% of the **Rated MW** output or **Interface Point Capacity** in the case of **OTSDUW Plant and Apparatus** as defined in Figure 1. With all **Plant** in service, the **Reactive Power** limits will reduce linearly below 50% **Active Power** output as shown in Figure 1 unless the requirement to maintain the **Reactive Power** limits defined at **Rated MW** or **Interface Point Capacity** in the case of **OTSDUW Plant and Apparatus** at Leading **Power Factor** down to 20% **Active Power** output is specified in the **Bilateral Agreement**. These **Reactive Power** limits will be reduced pro rata to the amount of **Plant** in service.

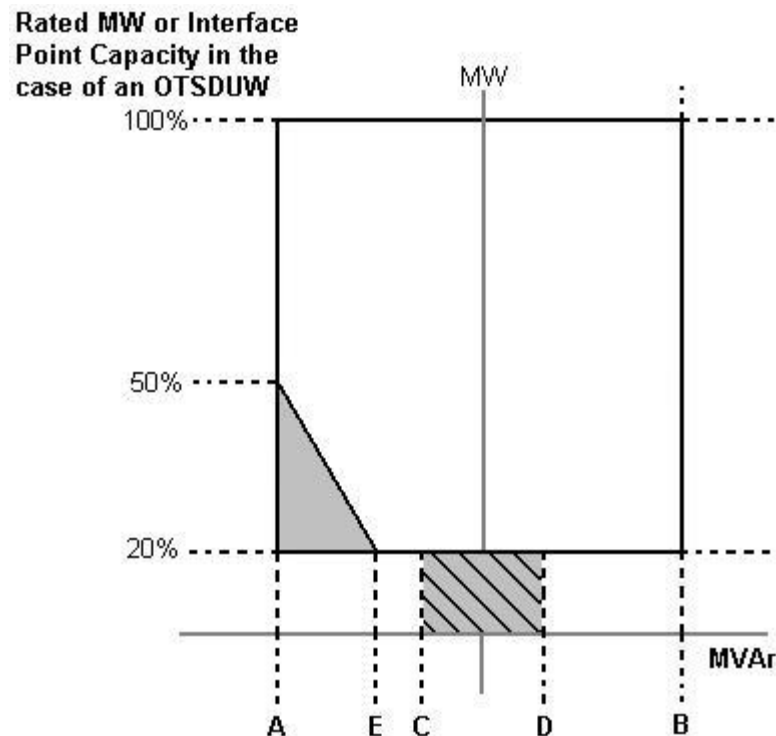

- | | |
|-------------------------------------|--|
| Point A is equivalent (in MVar) to | 0.95 leading Power Factor at Rated MW output or Interface Point Capacity in the case of OTSDUW Plant and Apparatus |
| Point B is equivalent (in MVar) to: | 0.95 lagging Power Factor at Rated MW output or Interface Point Capacity in the case of OTSDUW Plant and Apparatus |
| Point C is equivalent (in MVar) to: | -5% of Rated MW output or Interface Point Capacity in the case of OTSDUW Plant and Apparatus |
| Point D is equivalent | +5% of Rated MW output or Interface Point Capacity in the case |

(in MVAR) to: of **OTSDUW Plant and Apparatus**

Point E is equivalent -12% of Rated MW output or **Interface Point Capacity** in the
(in MVAR) to: case of **OTSDUW Plant and Apparatus**

- (d) All **Onshore Non-Synchronous Generating Units** and **Onshore Power Park Modules** in Scotland with a **Completion Date** after 1 April 2005 and before 1 January 2006 must be capable of supplying **Rated MW** at the range of power factors either:
- (i) from 0.95 lead to 0.95 lag as illustrated in Figure 1 at the **User System Entry Point** for **Embedded GB Generators** or at the HV side of the 33/132kV or 33/275kV or 33/400kV transformer for **GB Generators** directly connected to the **Onshore Transmission System**. With all **Plant** in service, the **Reactive Power** limits defined at **Rated MW** will apply at all **Active Power** output levels above 20% of the **Rated MW** output as defined in Figure 1. These **Reactive Power** limits will be reduced pro rata to the amount of **Plant** in service, or
 - (ii) from 0.95 lead to 0.90 lag at the **Onshore Non-Synchronous Generating Unit** (including **Power Park Unit**) terminals. For the avoidance of doubt **GB Generators** complying with this option (ii) are not required to comply with CC.6.3.2(b).
- (e) The short circuit ratio of **Offshore Synchronous Generating Units** at a **Large Power Station** shall be not less than 0.5. At a **Large Power Station** all **Offshore Synchronous Generating Units**, **Offshore Non-Synchronous Generating Units**, **Offshore DC Converters** and **Offshore Power Park Modules** must be capable of maintaining:
- (i) zero transfer of **Reactive Power** at the **Offshore Grid Entry Point** for all **GB Generators** with an **Offshore Grid Entry Point** at the **LV Side of the Offshore Platform** at all **Active Power** output levels under steady state voltage conditions. The steady state tolerance on **Reactive Power** transfer to and from an **Offshore Transmission System** expressed in MVAR shall be no greater than 5% of the **Rated MW**, or
 - (ii) a transfer of **Reactive Power** at the **Offshore Grid Entry Point** at a value specified in the **Bilateral Agreement** that will be equivalent to zero at the **LV Side of the Offshore Platform**. In addition, the steady state tolerance on **Reactive Power** transfer to and from an **Offshore Transmission System** expressed in MVAR at the **LV Side of the Offshore Platform** shall be no greater than 5% of the **Rated MW**, or
 - (iii) the **Reactive Power** capability (within associated steady state tolerance) specified in the **Bilateral Agreement** if any alternative has been agreed with the **GB Generator**, **Offshore Transmission Licensee** and **The Company**.
- (f) In addition, a Genset shall meet the operational requirements as specified in BC2.A.2.6.

CC.6.3.3

Each **Generating Unit**, **DC Converter** (including an **OTSDUW DC Converter**), **Power Park Module** and/or **CCGT Module** must be capable of:

- (a) continuously maintaining constant **Active Power** output for **System Frequency** changes within the range 50.5 to 49.5 Hz; and

- (b) (subject to the provisions of CC.6.1.3) maintaining its **Active Power** output at a level not lower than the figure determined by the linear relationship shown in Figure 2 for **System Frequency** changes within the range 49.5 to 47 Hz, such that if the **System Frequency** drops to 47 Hz the **Active Power** output does not decrease by more than 5%. In the case of a **CCGT Module**, the above requirement shall be retained down to the **Low Frequency Relay** trip setting of 48.8 Hz, which reflects the first stage of the **Automatic Low Frequency Demand Disconnection** scheme notified to **Network Operators** under OC6.6.2. For **System Frequency** below that setting, the existing requirement shall be retained for a minimum period of 5 minutes while **System Frequency** remains below that setting, and special measure(s) that may be required to meet this requirement shall be kept in service during this period. After that 5 minutes period, if **System Frequency** remains below that setting, the special measure(s) must be discontinued if there is a materially increased risk of the **Gas Turbine** tripping. The need for special measure(s) is linked to the inherent **Gas Turbine Active Power** output reduction caused by reduced shaft speed due to falling **System Frequency**.

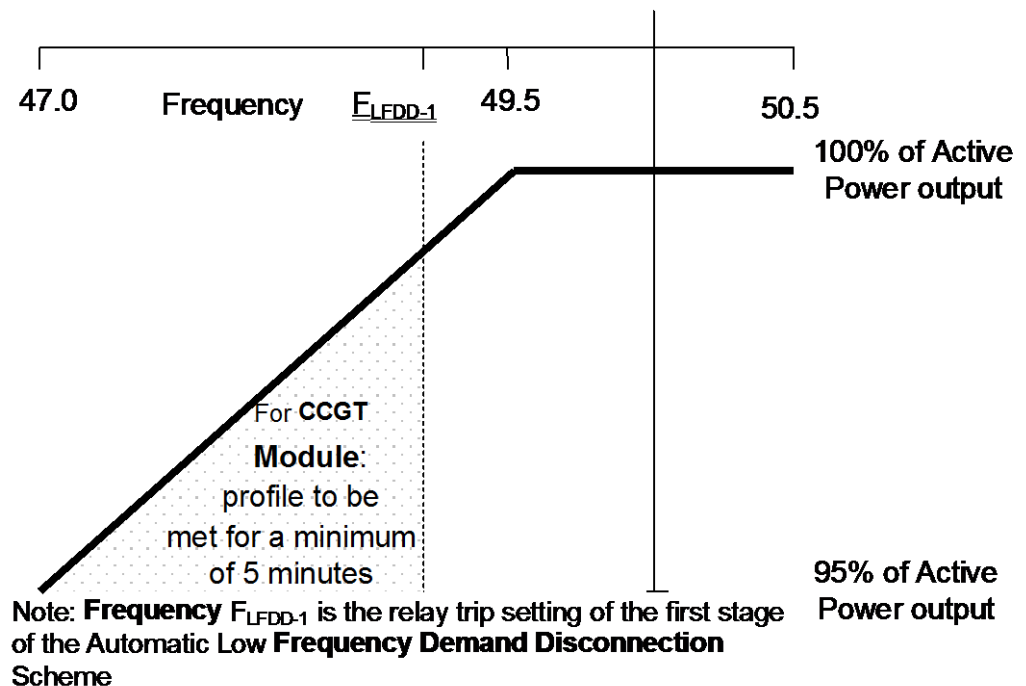

Figure 2

- (c) For the avoidance of doubt in the case of a **Generating Unit** or **Power Park Module** (or **OTSDUW DC Converters** at the **Interface Point**) using an **Intermittent Power Source** where the mechanical power input will not be constant over time, the requirement is that the **Active Power** output shall be independent of **System Frequency** under (a) above and should not drop with **System Frequency** by greater than the amount specified in (b) above.
- (d) A **DC Converter Station** must be capable of maintaining its **Active Power** input (i.e. when operating in a mode analogous to **Demand**) from the **National Electricity Transmission System** (or **User System** in the case of an **Embedded DC Converter Station**) at a level not greater than the figure determined by the linear relationship shown in Figure 3 for **System Frequency** changes within the range 49.5 to 47 Hz, such that if the **System Frequency** drops to 47.8 Hz the **Active Power** input decreases by more than 60%.

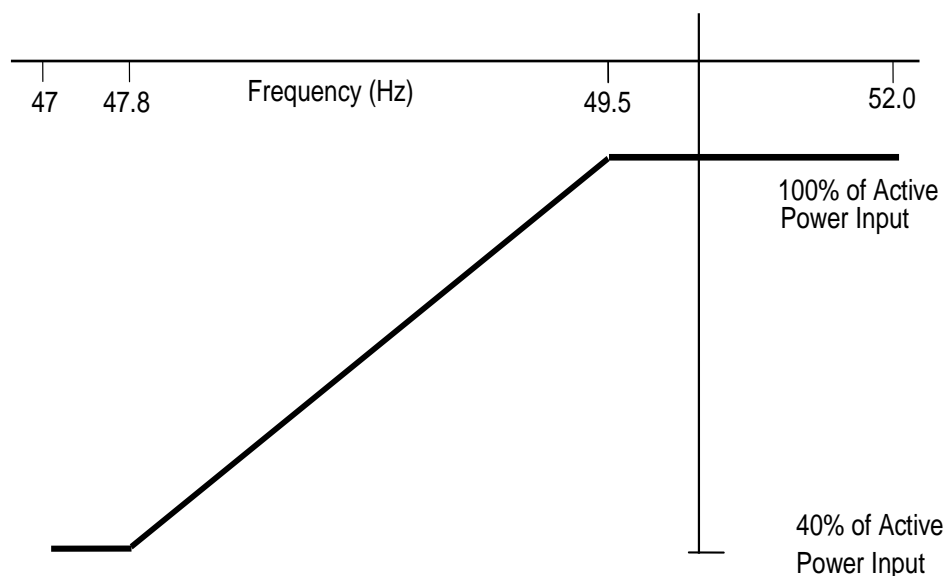

Figure 3

- (e) At a **Large Power Station**, in the case of an **Offshore Generating Unit, Offshore Power Park Module, Offshore DC Converter** and **OTSDUW DC Converter**, the **GB Generator** shall comply with the requirements of CC.6.3.3. **GB Generators** should be aware that Section K of the **STC** places requirements on **Offshore Transmission Licensees** which utilise a **Transmission DC Converter** as part of their **Offshore Transmission System** to make appropriate provisions to enable **GB Generators** to fulfil their obligations.
- (f) In the case of an **OTSDUW DC Converter** the **OTSDUW Plant and Apparatus** shall provide a continuous signal indicating the real time frequency measured at the **Interface Point** to the **Offshore Grid Entry Point**.

CC.6.3.4

At the **Grid Entry Point**, the **Active Power** output under steady state conditions of any **Generating Unit, DC Converter** or **Power Park Module** directly connected to the **National Electricity Transmission System** or in the case of **OTSDUW**, the **Active Power** transfer at the **Interface Point**, under steady state conditions of any **OTSDUW Plant and Apparatus** should not be affected by voltage changes in the normal operating range specified in paragraph CC.6.1.4 by more than the change in **Active Power** losses at reduced or increased voltage. In addition:

- (a) For any **Onshore Generating Unit, Onshore DC Converter** and **Onshore Power Park Module** or **OTSDUW** the **Reactive Power** output under steady state conditions should be fully available within the voltage range $\pm 5\%$ at 400kV, 275kV and 132kV and lower voltages, except for an **Onshore Power Park Module** or **Onshore Non-Synchronous Generating Unit** if **Embedded** at 33kV and below (or directly connected to the **Onshore Transmission System** at 33kV and below) where the requirement shown in Figure 4 applies.
- (b) At a **Large Power Station**, in the case of an **Offshore Generating Unit, Offshore DC Converter** and **Offshore Power Park Module** where an alternative reactive capability has been agreed with the **GB Generator**, as specified in CC.6.3.2(e) (iii), the voltage / **Reactive Power** requirement shall be specified in the **Bilateral Agreement**. The **Reactive Power** output under steady state conditions shall be fully available within the voltage range $\pm 5\%$ at 400kV, 275kV and 132kV and lower voltages.

Voltage at an **Onshore Grid Entry Point** or **User System Entry Point** if **Embedded** (% of Nominal) at 33 kV and below

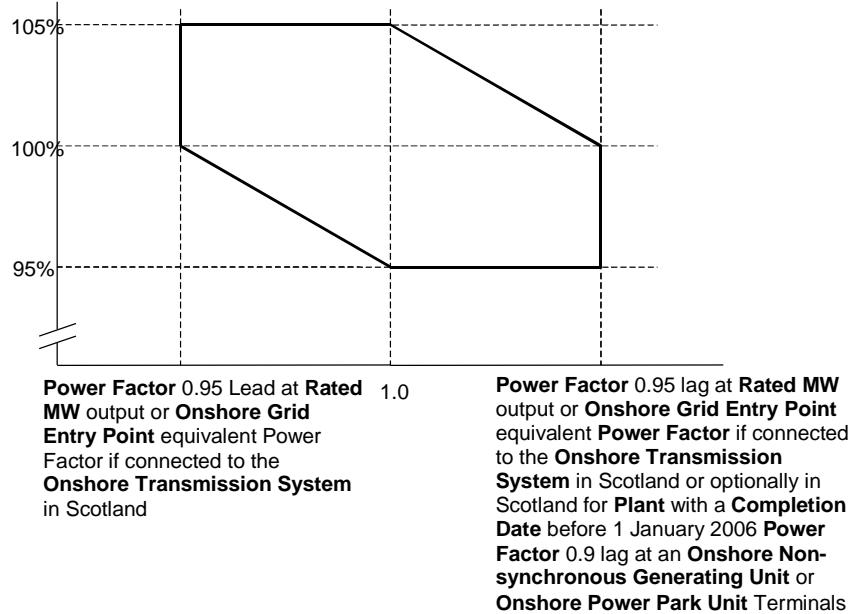

Figure 4

CC.6.3.5 It is an essential requirement that the **National Electricity Transmission System** must incorporate a **Black Start Capability**. This will be achieved by agreeing a **Black Start Capability** at a number of strategically located **Power Stations**. For each **Power Station** The **Company** will state in the **Bilateral Agreement** whether or not a **Black Start Capability** is required.

Control Arrangements

- CC.6.3.6 (a) Each:
- (i) **Offshore Generating Unit** in a **Large Power Station** or **Onshore Generating Unit**; or,
 - (ii) **Onshore DC Converter** with a **Completion Date** on or after 1 April 2005 or **Offshore DC Converter** at a **Large Power Station**; or,
 - (iii) **Onshore Power Park Module** in England and Wales with a **Completion Date** on or after 1 January 2006; or,
 - (iv) **Onshore Power Park Module** in operation in Scotland on or after 1 January 2006 (with a **Completion Date** after 1 July 2004 and in a **Power Station** with a **Registered Capacity** of 50MW or more); or,
 - (v) **Offshore Power Park Module** in a **Large Power Station** with a **Registered Capacity** of 50MW or more;

must be capable of contributing to **Frequency** control by continuous modulation of **Active Power** supplied to the **National Electricity Transmission System** or the **User System** in which it is **Embedded**. For the avoidance of doubt each **OTSDUW DC Converter** shall provide each **GB Code User** in respect of its **Offshore Power Stations** connected to and/or using an **Offshore Transmission System** a continuous signal indicating the real time **Frequency** measured at the **Transmission Interface Point**.

- (b) Each:
- (i) **Onshore Generating Unit**; or,
 - (ii) **Onshore DC Converter** (with a **Completion Date** on or after 1 April 2005 excluding current source technologies); or
 - (iii) **Onshore Power Park Module** in England and Wales with a **Completion Date** on

or after 1 January 2006; or,

- (iv) **Onshore Power Park Module** in Scotland irrespective of **Completion Date**; or,
- (v) **Offshore Generating Unit** at a **Large Power Station**, **Offshore DC Converter** at a **Large Power Station** or **Offshore Power Park Module** at a **Large Power Station** which provides a reactive range beyond the minimum requirements specified in CC.6.3.2(e) (iii); or,
- (vi) **OTSDUW Plant and Apparatus** at a **Transmission Interface Point**

must be capable of contributing to voltage control by continuous changes to the **Reactive Power** supplied to the **National Electricity Transmission System** or the **User System** in which it is **Embedded**.

CC.6.3.7

- (a) Each **Generating Unit**, **DC Converter** or **Power Park Module** (excluding **Onshore Power Park Modules** in Scotland with a **Completion Date** before 1 July 2004 or **Onshore Power Park Modules** in a **Power Station** in Scotland with a **Registered Capacity** less than 50MW or **Offshore Power Park Modules** in a **Large Power Station** located **Offshore** with a **Registered Capacity** less than 50MW) must be fitted with a fast acting proportional **Frequency** control device (or turbine speed governor) and unit load controller or equivalent control device to provide **Frequency** response under normal operational conditions in accordance with **Balancing Code 3 (BC3)**. In the case of a **Power Park Module** the **Frequency** or speed control device(s) may be on the **Power Park Module** or on each individual **Power Park Unit** or be a combination of both. The **Frequency** control device(s) (or speed governor(s)) must be designed and operated to the appropriate:

- (i) **European Specification**; or
- (ii) in the absence of a relevant **European Specification**, such other standard which is in common use within the European Community (which may include a manufacturer specification);

as at the time when the installation of which it forms part was designed or (in the case of modification or alteration to the **Frequency** control device (or turbine speed governor)) when the modification or alteration was designed.

The **European Specification** or other standard utilised in accordance with subparagraph CC.6.3.7 (a) (ii) will be notified to **The Company** by the **GB Generator** or **DC Converter Station** owner or, in the case of an **Embedded Medium Power Station** not subject to a **Bilateral Agreement** or **Embedded DC Converter Station** not subject to a **Bilateral Agreement**, the relevant **Network Operator**:

- (i) as part of the application for a **Bilateral Agreement**; or
 - (ii) as part of the application for a varied **Bilateral Agreement**; or
 - (iii) in the case of an **Embedded Development**, within 28 days of entry into the **Embedded Development Agreement** (or such later time as agreed with **The Company**); or
 - (iv) as soon as possible prior to any modification or alteration to the **Frequency** control device (or governor); and
- (b) The **Frequency** control device (or speed governor) in co-ordination with other control devices must control the **Generating Unit**, **DC Converter** or **Power Park Module Active Power Output** with stability over the entire operating range of the **Generating Unit**, **DC Converter** or **Power Park Module**; and
 - (c) The **Frequency** control device (or speed governor) must meet the following minimum requirements:
 - (i) Where a **Generating Unit**, **DC Converter** or **Power Park Module** becomes isolated from the rest of the **Total System** but is still supplying **Customers**, the **Frequency**

control device (or speed governor) must also be able to control **System Frequency** below 52Hz unless this causes the **Generating Unit, DC Converter or Power Park Module** to operate below its **Designed Minimum Operating Level** when it is possible that it may, as detailed in BC 3.7.3, trip after a time. For the avoidance of doubt the **Generating Unit, DC Converter or Power Park Module** is only required to operate within the **System Frequency** range 47 - 52 Hz as defined in CC.6.1.3;

- (ii) the **Frequency** control device (or speed governor) must be capable of being set so that it operates with an overall speed **Droop** of between 3% and 5%. For the avoidance of doubt, in the case of a **Power Park Module** the speed **Droop** should be equivalent of a fixed setting between 3% and 5% applied to each **Power Park Unit** in service;
- (iii) in the case of all **Generating Units, DC Converter or Power Park Module** other than the **Steam Unit** within a **CCGT Module** the **Frequency** control device (or speed governor) deadband should be no greater than 0.03Hz (for the avoidance of doubt, $\pm 0.015\text{Hz}$). In the case of the **Steam Unit** within a **CCGT Module**, the speed **Governor Deadband** should be set to an appropriate value consistent with the requirements of CC.6.3.7(c)(i) and the requirements of BC3.7.2 for the provision of **Limited High Frequency Response**;

For the avoidance of doubt, the minimum requirements in (ii) and (iii) for the provision of **System Ancillary Services** do not restrict the negotiation of **Commercial Ancillary Services** between **The Company** and the **GB Code User** using other parameters; and

- (d) A facility to modify, so as to fulfil the requirements of the **Balancing Codes**, the **Target Frequency** setting either continuously or in a maximum of 0.05 Hz steps over at least the range 50 ± 0.1 Hz should be provided in the unit load controller or equivalent device.
- (e)
 - (i) Each **Onshore Generating Unit** and/or **CCGT Module** which has a **Completion Date** after 1 January 2001 in England and Wales, and after 1 April 2005 in Scotland, must be capable of meeting the minimum **Frequency** response requirement profile subject to and in accordance with the provisions of Appendix 3.
 - (ii) Each **DC Converter** at a **DC Converter Station** which has a **Completion Date** on or after 1 April 2005 and each **Offshore DC Converter** at a **Large Power Station** must be capable of meeting the minimum **Frequency** response requirement profile subject to and in accordance with the provisions of Appendix 3.
 - (iii) Each **Onshore Power Park Module** in operation in England and Wales with a **Completion Date** on or after 1 January 2006 must be capable of meeting the minimum **Frequency** response requirement profile subject to and in accordance with the provisions of Appendix 3.
 - (iv) Each **Onshore Power Park Module** in operation on or after 1 January 2006 in Scotland (with a **Completion Date** on or after 1 April 2005 and a **Registered Capacity** of 50MW or more) must be capable of meeting the minimum **Frequency** response requirement profile subject to and in accordance with the provisions of Appendix 3.
 - (v) Each **Offshore Generating Unit** in a **Large Power Station** must be capable of meeting the minimum **Frequency** response requirement profile subject to and in accordance with the provisions of Appendix 3.
 - (vi) Each **Offshore Power Park Module** in a **Large Power Station** with a **Registered Capacity** of 50 MW or greater, must be capable of meeting the minimum **Frequency** response requirement profile subject to and in accordance with the provisions of Appendix 3.
 - (vii) Subject to the requirements of CC.6.3.7(e), **Offshore Generating Units** at a **Large Power Station**, **Offshore Power Park Modules** at a **Large Power Station** and **Offshore DC Converters** in a **Large Power Station** shall comply with the requirements of CC.6.3.7. **GB Generators** should be aware that Section K of the **STC** places requirements on **Offshore Transmission Licensees** which utilise a

Transmission DC Converter as part of their **Offshore Transmission System** to make appropriate provisions to enable **GB Generators** to fulfil their obligations.

- (viii) Each **OTSDUW DC Converter** must be capable of providing a continuous signal indicating the real time frequency measured at the **Interface Point** to the **Offshore Grid Entry Point**.
- (f) For the avoidance of doubt, the requirements of Appendix 3 do not apply to:
- (i) **Generating Units** and/or **CCGT Modules** which have a **Completion Date** before 1 January 2001 in England and Wales, and before 1 April 2005 in Scotland, for whom the remaining requirements of this clause CC.6.3.7 shall continue to apply unchanged; or
 - (ii) **DC Converters** at a **DC Converter Station** which have a **Completion Date** before 1 April 2005; or
 - (iii) **Onshore Power Park Modules** in England and Wales with a **Completion Date** before 1 January 2006 for whom only the requirements of **Limited Frequency Sensitive Mode** (BC3.5.2) operation shall apply; or
 - (iv) **Onshore Power Park Modules** in operation in Scotland before 1 January 2006 for whom only the requirements of **Limited Frequency Sensitive Mode** (BC3.5.2) operation shall apply; or
 - (v) **Onshore Power Park Modules** in operation after 1 January 2006 in Scotland which have a **Completion Date** before 1 April 2005 for whom the remaining requirements of this clause CC.6.3.7 shall continue to apply unchanged; or
 - (vi) **Offshore Power Park Modules** which are in a **Large Power Station** with a **Registered Capacity** less than 50MW for whom only the requirements of **Limited Frequency Sensitive Mode** (BC3.5.2) operation shall apply; or

Excitation and Voltage Control Performance Requirements

CC.6.3.8

- (a) Excitation and voltage control performance requirements applicable to **Onshore Generating Units, Onshore Power Park Modules, Onshore DC Converters** and **OTSDUW Plant and Apparatus**.
- (i) A continuously-acting automatic excitation control system is required to provide constant terminal voltage control of the **Onshore Synchronous Generating Unit** without instability over the entire operating range of the **Onshore Generating Unit**.
 - (ii) In respect of **Onshore Synchronous Generating Units** with a **Completion Date** before 1 January 2009, the requirements for excitation control facilities, including **Power System Stabilisers**, where in **The Company's** view these are necessary for system reasons, will be specified in the **Bilateral Agreement**. If any **Modification** to the excitation control facilities of such **Onshore Synchronous Generating Units** is made on or after 1 January 2009 the requirements that shall apply may be specified in the **Bilateral Agreement** as varied. To the extent that the **Bilateral Agreement** does not specify, the requirements given or referred to in CC.A.6 shall apply. The performance requirements for a continuously acting automatic excitation control system that shall be complied with by the **GB Code User** in respect of such **Onshore Synchronous Generating Units** with a **Completion Date** on or after 1 January 2009 are given or referred to in CC.A.6. Reference is made to on-load commissioning witnessed by **The Company** in BC2.11.2.
 - (iii) In the case of an **Onshore Non-Synchronous Generating Unit, Onshore DC Converter, Onshore Power Park Module** or **OTSDUW Plant and Apparatus** at the **Interface Point** a continuously-acting automatic control system is required to provide control of the voltage (or zero transfer of **Reactive Power** as applicable to CC.6.3.2) at the **Onshore Grid Entry Point** or **User System Entry Point** or in the case of **OTSDUW Plant and Apparatus at the Interface Point** without instability over the entire operating range of the **Onshore Non-Synchronous Generating Unit, Onshore DC Converter, Onshore Power Park Module** or **OTSDUW Plant**

and Apparatus. Any **Plant** or **Apparatus** used in the provisions of such voltage control within an **Onshore Power Park Module** may be located at the **Power Park Unit** terminals, an appropriate intermediate busbar or the **Connection Point**. **OTSDUW Plant and Apparatus** used in the provision of such voltage control may be located at the **Offshore Grid Entry Point**, an appropriate intermediate busbar or at the **Interface Point**. In the case of an **Onshore Power Park Module** in Scotland with a **Completion Date** before 1 January 2009, voltage control may be at the **Power Park Unit** terminals, an appropriate intermediate busbar or the **Connection Point** as specified in the **Bilateral Agreement**. When operating below **20% Rated MW** the automatic control system may continue to provide voltage control utilising any available reactive capability. If voltage control is not being provided the automatic control system shall be designed to ensure a smooth transition between the shaded area bound by CD and the non shaded area bound by AB in Figure 1 of CC.6.3.2 (c).

- (iv) The performance requirements for a continuously acting automatic voltage control system in respect of **Onshore Power Park Modules, Onshore Non-Synchronous Generating Units** and **Onshore DC Converters** with a **Completion Date** before 1 January 2009 will be specified in the **Bilateral Agreement**. If any **Modification** to the continuously acting automatic voltage control system of such **Onshore Power Park Modules, Onshore Non-Synchronous Generating Units** and **Onshore DC Converters** is made on or after 1 January 2009 the requirements that shall apply may be specified in the **Bilateral Agreement** as varied. To the extent that the **Bilateral Agreement** does not specify, the requirements given or referred to in CC.A.7 shall apply. The performance requirements for a continuously acting automatic voltage control system that shall be complied with by the **GB Code User** in respect of **Onshore Power Park Modules, Onshore Non-Synchronous Generating Units** and **Onshore DC Converters** or **OTSDUW Plant and Apparatus** at the **Interface Point** with a **Completion Date** on or after 1 January 2009 are given or referred to in CC.A.7.
- (v) Unless otherwise required for testing in accordance with OC5.A.2, the automatic excitation control system of an **Onshore Synchronous Generating Unit** shall always be operated such that it controls the **Onshore Synchronous Generating Unit** terminal voltage to a value that is
- equal to its rated value; or
 - only where provisions have been made in the **Bilateral Agreement**, greater than its rated value.
- (vi) In particular, other control facilities, including constant **Reactive Power** output control modes and constant **Power Factor** control modes (but excluding VAR limiters) are not required. However, if present in the excitation or voltage control system they will be disabled unless the **Bilateral Agreement** records otherwise. Operation of such control facilities will be in accordance with the provisions contained in **BC2**.
- (b) Excitation and voltage control performance requirements applicable to **Offshore Generating Units** at a **Large Power Station, Offshore Power Park Modules** at a **Large Power Station** and **Offshore DC Converters** at a **Large Power Station**.

A continuously acting automatic control system is required to provide either:

- (i) control of **Reactive Power** (as specified in CC.6.3.2(e) (i) (ii)) at the **Offshore Grid Entry Point** without instability over the entire operating range of the **Offshore Generating Unit, Offshore DC Converter** or **Offshore Power Park Module**. The performance requirements for this automatic control system will be specified in the **Bilateral Agreement** or;
- (ii) where an alternative reactive capability has been specified in the **Bilateral Agreement**, in accordance with CC.6.3.2 (e) (iii), the **Offshore Generating Unit, Offshore Power Park Module** or **Offshore DC Converter** will be required to control

voltage and / or **Reactive Power** without instability over the entire operating range of the **Offshore Generating Unit, Offshore Power Park Module** or **Offshore DC Converter**. The performance requirements of the control system will be specified in the **Bilateral Agreement**.

In addition to CC.6.3.8(b) (i) and (ii) the requirements for excitation control facilities, including **Power System Stabilisers**, where in **The Company's** view these are necessary for system reasons, will be specified in the **Bilateral Agreement**. Reference is made to on-load commissioning witnessed by **The Company** in BC2.11.2.

Steady state Load Inaccuracies

CC.6.3.9 The standard deviation of **Load** error at steady state **Load** over a 30 minute period must not exceed 2.5 per cent of a **Genset's Registered Capacity**. Where a **Genset** is instructed to **Frequency** sensitive operation, allowance will be made in determining whether there has been an error according to the governor droop characteristic registered under the **PC**.

For the avoidance of doubt in the case of a **Power Park Module** allowance will be made for the full variation of mechanical power output.

Negative Phase Sequence Loadings

CC.6.3.10 In addition to meeting the conditions specified in CC.6.1.5(b), each **Synchronous Generating Unit** will be required to withstand, without tripping, the negative phase sequence loading incurred by clearance of a close-up phase-to-phase fault, by **System Back-Up Protection** on the **National Electricity Transmission System** or **User System** located **Onshore** in which it is **Embedded**.

Neutral Earthing

CC.6.3.11 At nominal **System** voltages of 132kV and above the higher voltage windings of a transformer of a **Generating Unit, DC Converter, Power Park Module** or transformer resulting from **OTSDUW** must be star connected with the star point suitable for connection to earth. The earthing and lower voltage winding arrangement shall be such as to ensure that the **Earth Fault Factor** requirement of paragraph CC.6.2.1.1 (b) will be met on the **National Electricity Transmission System** at nominal **System** voltages of 132kV and above.

Frequency Sensitive Relays

CC.6.3.12 As stated in CC.6.1.3, the **System Frequency** could rise to 52Hz or fall to 47Hz. Each **Generating Unit, DC Converter, OTSDUW Plant and Apparatus, Power Park Module** or any constituent element must continue to operate within this **Frequency** range for at least the periods of time given in CC.6.1.3 unless **The Company** has agreed to any **Frequency**-level relays and/or rate-of-change-of-**Frequency** relays which will trip such **Generating Unit, DC Converter, OTSDUW Plant and Apparatus, Power Park Module** and any constituent element within this **Frequency** range, under the **Bilateral Agreement**.

CC.6.3.13 **GB Generators** (including in respect of **OTSDUW Plant and Apparatus**) and **DC Converter Station** owners will be responsible for protecting all their **Generating Units** (and **OTSDUW Plant and Apparatus**), **DC Converters** or **Power Park Modules** against damage should **Frequency** excursions outside the range 52Hz to 47Hz ever occur. Should such excursions occur, it is up to the **GB Generator** or **DC Converter Station** owner to decide whether to disconnect his **Apparatus** for reasons of safety of **Apparatus, Plant** and/or personnel.

CC.6.3.14 It may be agreed in the **Bilateral Agreement** that a **Genset** shall have a **Fast-Start Capability**. Such **Gensets** may be used for **Operating Reserve** and their **Start-Up** may be initiated by **Frequency**-level relays with settings in the range 49Hz to 50Hz as specified pursuant to **OC2**.

CC.6.3.15 Fault Ride Through

This section sets out the fault ride through requirements on **Generating Units, Power Park Modules, DC Converters** and **OTSDUW Plant and Apparatus**. **Onshore Generating Units, Onshore Power Park Modules, Onshore DC Converters** (including **Embedded Medium Power Stations** and **Embedded DC Converter Stations** not subject to a **Bilateral Agreement** and with an **Onshore User System Entry Point** (irrespective of whether they are located **Onshore** or **Offshore**)) and **OTSDUW Plant and Apparatus** are required to operate through **System** faults and disturbances as defined in CC.6.3.15.1 (a), CC.6.3.15.1 (b) and CC.6.3.15.3. **Offshore GB Generators** in respect of **Offshore Generating Units** at a **Large Power Station**, **Offshore Power Park Modules** at a **Large Power Station** and **DC Converter Station** owners in respect of **Offshore DC Converters** at a **Large Power Station** shall have the option of meeting either:

- (i) CC.6.3.15.1 (a), CC.6.3.15.1 (b) and CC.6.3.15.3, or:
- (ii) CC.6.3.15.2 (a), CC.6.3.15.2 (b) and CC.6.3.15.3

Offshore GB Generators and **Offshore DC Converter** owners, should notify **The Company** which option they wish to select within 28 days (or such longer period as **The Company** may agree, in any event this being no later than 3 months before the **Completion Date** of the offer for a final **CUSC Contract** which would be made following the appointment of the **Offshore Transmission Licensee**).

CC.6.3.15.1 Fault Ride through applicable to **Generating Units, Power Park Modules** and **DC Converters** and **OTSDUW Plant and Apparatus**

- (a) Short circuit faults on the **Onshore Transmission System** (which may include an **Interface Point**) at **Supergrid Voltage** up to 140ms in duration.
 - (i) Each **Generating Unit, DC Converter, or Power Park Module** and any constituent **Power Park Unit** thereof and **OTSDUW Plant and Apparatus** shall remain transiently stable and connected to the **System** without tripping of any **Generating Unit, DC Converter or Power Park Module** and / or any constituent **Power Park Unit, OTSDUW Plant and Apparatus**, and for **Plant and Apparatus** installed on or after 1 December 2017, reactive compensation equipment, for a close-up solid three-phase short circuit fault or any unbalanced short circuit fault on the **Onshore Transmission System** (including in respect of **OTSDUW Plant and Apparatus**, the **Interface Point**) operating at **Supergrid Voltages** for a total fault clearance time of up to 140 ms. A solid three-phase or unbalanced earthed fault results in zero voltage on the faulted phase(s) at the point of fault. The duration of zero voltage is dependent on local **Protection** and circuit breaker operating times. This duration and the fault clearance times will be specified in the **Bilateral Agreement**. Following fault clearance, recovery of the **Supergrid Voltage** on the **Onshore Transmission System** to 90% may take longer than 140ms as illustrated in Appendix 4A Figures CC.A.4A.1 (a) and (b). It should be noted that in the case of an **Offshore Generating Unit, Offshore DC Converter or Offshore Power Park Module** (including any **Offshore Power Park Unit** thereof) which is connected to an **Offshore Transmission System** which includes a **Transmission DC Converter** as part of that **Offshore Transmission System**, the **Offshore Grid Entry Point** voltage may not indicate the presence of a fault on the **Onshore Transmission System**. The fault will affect the level of **Active Power** that can be transferred to the **Onshore Transmission System** and therefore subject the **Offshore Generating Unit, Offshore DC Converter or Offshore Power Park Module** (including any **Offshore Power Park Unit** thereof) to a load rejection.
 - (ii) Each **Generating Unit, Power Park Module** and **OTSDUW Plant and Apparatus**, shall be designed such that upon both clearance of the fault on the **Onshore Transmission System** as detailed in CC.6.3.15.1 (a) (i) and within 0.5 seconds of the restoration of the voltage at the **Onshore Grid Entry Point** (for **Onshore Generating Units or Onshore Power Park Modules**) or **Interface Point** (for **Offshore Generating Units, Offshore Power Park Modules or OTSDUW Plant**

and Apparatus) to the minimum levels specified in CC.6.1.4 (or within 0.5 seconds of restoration of the voltage at the **User System Entry Point** to 90% of nominal or greater if **Embedded**), **Active Power** output or in the case of **OTSDUW Plant and Apparatus**, **Active Power** transfer capability, shall be restored to at least 90% of the level available immediately before the fault. Once the **Active Power** output, or in the case of **OTSDUW Plant and Apparatus**, **Active Power** transfer capability, has been restored to the required level, **Active Power** oscillations shall be acceptable provided that:

- the total **Active Energy** delivered during the period of the oscillations is at least that which would have been delivered if the **Active Power** was constant
- the oscillations are adequately damped

During the period of the fault as detailed in CC.6.3.15.1 (a) (i) for which the voltage at the **Grid Entry Point** (or **Interface Point** in the case of **OTSDUW Plant and Apparatus**) is outside the limits specified in CC.6.1.4, each **Generating Unit** or **Power Park Module** or **OTSDUW Plant and Apparatus** shall generate maximum reactive current without exceeding the transient rating limit of the **Generating Unit**, **OTSDUW Plant and Apparatus** or **Power Park Module** and / or any constituent **Power Park Unit** or reactive compensation equipment. For **Plant and Apparatus** installed on or after 1 December 2017, switched reactive compensation equipment (such as mechanically switched capacitors and reactors) shall be controlled such that it is not switched in or out of service during the fault but may act to assist in post fault voltage recovery.

- (iii) Each **DC Converter** shall be designed to meet the **Active Power** recovery characteristics (and **OTSDUW DC Converter** shall be designed to meet the **Active Power** transfer capability at the **Interface Point**) as specified in the **Bilateral Agreement** upon clearance of the fault on the **Onshore Transmission System** as detailed in CC.6.3.15.1 (a) (i).
- (b) **Supergrid Voltage** dips on the **Onshore Transmission System** greater than 140ms in duration
- (1b) Requirements applicable to **Synchronous Generating Units** subject to **Supergrid Voltage** dips on the **Onshore Transmission System** greater than 140ms in duration.

In addition to the requirements of CC.6.3.15.1 (a) each **Synchronous Generating Unit**, each with a **Completion Date** on or after **1 April 2005** shall:

- (i) remain transiently stable and connected to the **System** without tripping of any **Synchronous Generating Unit** for balanced **Supergrid Voltage** dips and associated durations on the **Onshore Transmission System** (which could be at the **Interface Point**) anywhere on or above the heavy black line shown in Figure 5a. Appendix 4A and Figures CC.A.4A.3.2 (a), (b) and (c) provide an explanation and illustrations of Figure 5a; and,

NOT TO SCALE

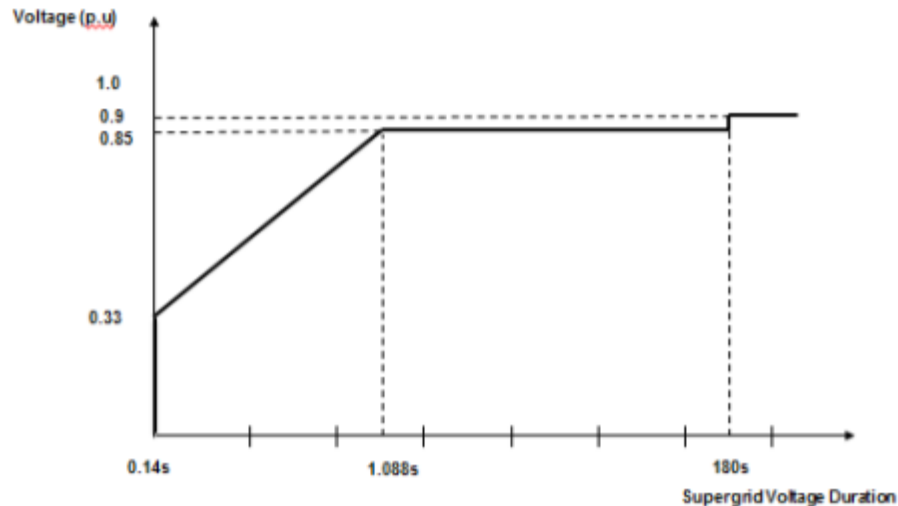

Figure 5a

- (ii) provide **Active Power** output at the **Grid Entry Point**, during **Supergrid Voltage** dips on the **Onshore Transmission System** as described in Figure 5a, at least in proportion to the retained balanced voltage at the **Onshore Grid Entry Point** (for **Onshore Synchronous Generating Units**) or **Interface Point** (for **Offshore Synchronous Generating Units**) (or the retained balanced voltage at the **User System Entry Point** if **Embedded**) and shall generate maximum reactive current (where the voltage at the **Grid Entry Point** is outside the limits specified in CC.6.1.4) without exceeding the transient rating limits of the **Synchronous Generating Unit** and,
- (iii) restore **Active Power** output following **Supergrid Voltage** dips on the **Onshore Transmission System** as described in Figure 5a, within 1 second of restoration of the voltage to 1.0p.u of the nominal voltage at the:

Onshore Grid Entry Point for directly connected **Onshore Synchronous Generating Units** or,

Interface Point for **Offshore Synchronous Generating Units** or,

User System Entry Point for **Embedded Onshore Synchronous Generating Units** or,

User System Entry Point for **Embedded Medium Power Stations** not subject to a **Bilateral Agreement** which comprise **Synchronous Generating Units** and with an **Onshore User System Entry Point** (irrespective of whether they are located **Onshore** or **Offshore**)

to at least 90% of the level available immediately before the occurrence of the dip. Once the **Active Power** output has been restored to the required level, **Active Power** oscillations shall be acceptable provided that:

- the total **Active Energy** delivered during the period of the oscillations is at least that which would have been delivered if the **Active Power** was constant
- the oscillations are adequately damped.

For the avoidance of doubt a balanced **Onshore Transmission System Supergrid Voltage** meets the requirements of CC.6.1.5 (b) and CC.6.1.6.

- (2b) Requirements applicable to **OTSDUW Plant and Apparatus** and **Power Park Modules** subject to **Supergrid Voltage** dips on the **Onshore Transmission System** greater than 140ms in duration

In addition to the requirements of CC.6.3.15.1 (a) each **OTSDUW Plant and Apparatus** or each **Power Park Module** and / or any constituent **Power Park Unit**, each with a **Completion Date** on or after the 1 April 2005 shall:

- (i) remain transiently stable and connected to the **System** without tripping of any **OTSDUW Plant and Apparatus**, or **Power Park Module** and / or any constituent **Power Park Unit**, for balanced **Supergrid Voltage** dips and associated durations on the **Onshore Transmission System** (which could be at the **Interface Point**) anywhere on or above the heavy black line shown in Figure 5b. Appendix 4A and Figures CC.A.4A.3.4 (a), (b) and (c) provide an explanation and illustrations of Figure 5b; and,

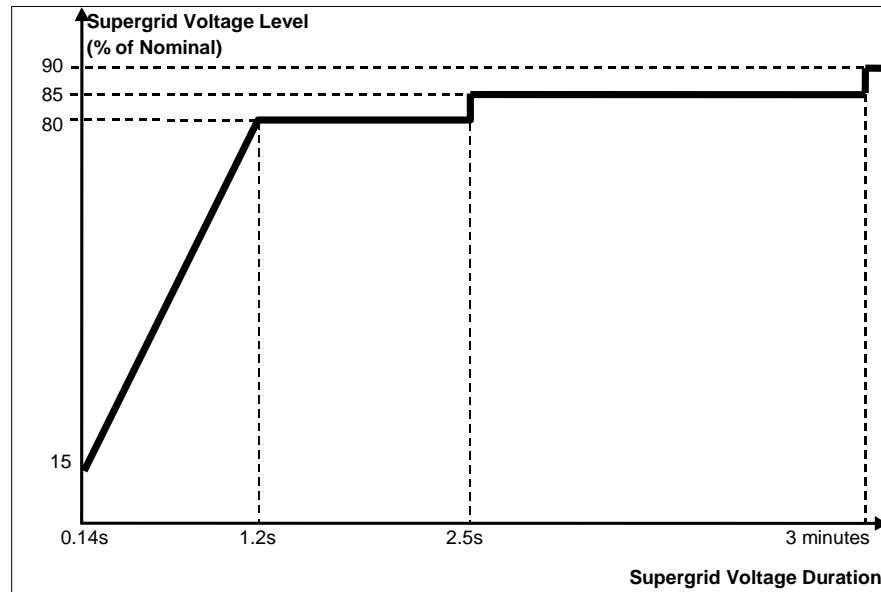

Figure 5b

- (ii) provide **Active Power** output at the **Grid Entry Point** or in the case of an **OTSDUW**, **Active Power** transfer capability at the **Transmission Interface Point**, during **Supergrid Voltage** dips on the **Onshore Transmission System** as described in Figure 5b, at least in proportion to the retained balanced voltage at the **Onshore Grid Entry Point** (for **Onshore Power Park Modules**) or **Interface Point** (for **OTSDUW Plant and Apparatus** and **Offshore Power Park Modules**) (or the retained balanced voltage at the **User System Entry Point** if **Embedded**) except in the case of a **Non-Synchronous Generating Unit** or **OTSDUW Plant and Apparatus** or **Power Park Module** where there has been a reduction in the **Intermittent Power Source** or in the case of **OTSDUW Active Power** transfer capability in the time range in Figure 5b that restricts the **Active Power** output or in the case of an **OTSDUW Active Power** transfer capability below this level and shall generate maximum reactive current (where the voltage at the **Grid Entry Point**, or in the case of an **OTSDUW Plant and Apparatus**, the **Interface Point** voltage, is outside the limits specified in CC.6.1.4) without exceeding the transient rating limits of the **OTSDUW Plant and Apparatus** or **Power Park Module** and any constituent **Power Park Unit**; and,
- (iii) restore **Active Power** output (or, in the case of **OTSDUW**, **Active Power** transfer capability), following **Supergrid Voltage** dips on the **Onshore Transmission System** as described in Figure 5b, within 1 second of restoration of the voltage at the:

Onshore Grid Entry Point for directly connected **Onshore Power Park Modules** or,

Interface Point for OTSDUW Plant and Apparatus and Offshore Power Park Modules or,

User System Entry Point for Embedded Onshore Power Park Modules or,

User System Entry Point for Embedded Medium Power Stations which comprise **Power Park Modules** not subject to a **Bilateral Agreement** and with an **Onshore User System Entry Point** (irrespective of whether they are located **Onshore** or **Offshore**)

to the minimum levels specified in CC.6.1.4 to at least 90% of the level available immediately before the occurrence of the dip except in the case of a **Non-Synchronous Generating Unit, OTSDUW Plant and Apparatus** or **Power Park Module** where there has been a reduction in the **Intermittent Power Source** in the time range in Figure 5b that restricts the **Active Power** output or, in the case of **OTSDUW, Active Power** transfer capability below this level. Once the **Active Power** output or, in the case of **OTSDUW, Active Power** transfer capability has been restored to the required level, **Active Power** oscillations shall be acceptable provided that:

- the total **Active Energy** delivered during the period of the oscillations is at least that which would have been delivered if the **Active Power** was constant
- the oscillations are adequately damped.

For the avoidance of doubt a balanced **Onshore Transmission System Supergrid Voltage** meets the requirements of CC.6.1.5 (b) and CC.6.1.6.

CC.6.3.15.2 Fault Ride Through applicable to **Offshore Generating Units** at a **Large Power Station, Offshore Power Park Modules** at a **Large Power Station** and **Offshore DC Converters** at a **Large Power Station** who choose to meet the fault ride through requirements at the **LV side of the Offshore Platform**

- (a) Requirements on **Offshore Generating Units, Offshore Power Park Modules** and **Offshore DC Converters** to withstand voltage dips on the **LV Side of the Offshore Platform** for up to 140ms in duration as a result of faults and / or voltage dips on the **Onshore Transmission System** operating at **Supergrid Voltage**
 - (i) Each **Offshore Generating Unit, Offshore DC Converter, or Offshore Power Park Module** and any constituent **Power Park Unit** thereof shall remain transiently stable and connected to the **System** without tripping of any **Offshore Generating Unit, or Offshore DC Converter or Offshore Power Park Module** and / or any constituent **Power Park Unit** or, in the case of **Plant and Apparatus** installed on or after 1 December 2017, reactive compensation equipment, for any balanced or unbalanced voltage dips on the **LV Side of the Offshore Platform** whose profile is anywhere on or above the heavy black line shown in Figure 6. For the avoidance of doubt, the profile beyond 140ms in Figure 6 shows the minimum recovery in voltage that will be seen by the generator following clearance of the fault at 140ms. Appendix 4B and Figures CC.A.4B.2 (a) and (b) provide further illustration of the voltage recovery profile that may be seen. It should be noted that in the case of an **Offshore Generating Unit, Offshore DC Converter or Offshore Power Park Module** (including any **Offshore Power Park Unit** thereof) which is connected to an **Offshore Transmission System** which includes a **Transmission DC Converter** as part of that **Offshore Transmission System**, the **Offshore Grid Entry Point** voltage may not indicate the presence of a fault on the **Onshore Transmission System**. The voltage dip will affect the level of **Active Power** that can be transferred to the **Onshore Transmission System** and therefore subject the **Offshore Generating Unit, Offshore DC Converter or Offshore Power Park Module** (including any **Offshore Power Park Unit** thereof) to a load rejection.

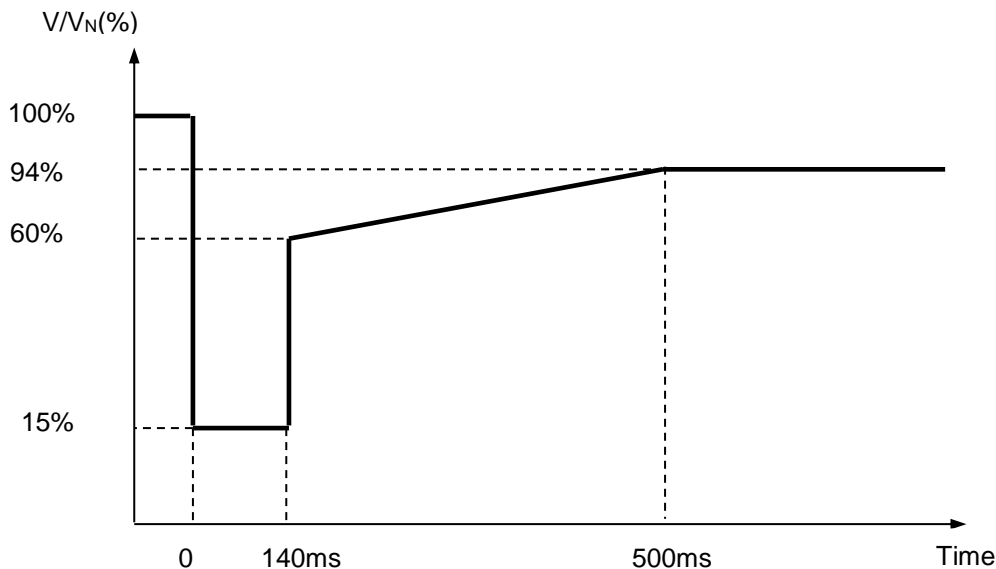

Figure 6

V/V_N is the ratio of the actual voltage on one or more phases at the **LV Side of the Offshore Platform** to the nominal voltage of the **LV Side of the Offshore Platform**.

- (ii) Each **Offshore Generating Unit**, or **Offshore Power Park Module** and any constituent **Power Park Unit** thereof shall provide **Active Power** output, during voltage dips on the **LV Side of the Offshore Platform** as described in Figure 6, at least in proportion to the retained voltage at the **LV Side of the Offshore Platform** except in the case of an **Offshore Non-Synchronous Generating Unit** or **Offshore Power Park Module** where there has been a reduction in the **Intermittent Power Source** in the time range in Figure 6 that restricts the **Active Power** output below this level and shall generate maximum reactive current without exceeding the transient rating limits of the **Offshore Generating Unit** or **Offshore Power Park Module** and any constituent **Power Park Unit** or, in the case of **Plant and Apparatus** installed on or after 1 December 2017, reactive compensation equipment. Once the **Active Power** output has been restored to the required level, **Active Power** oscillations shall be acceptable provided that:
- the total **Active Energy** delivered during the period of the oscillations is at least that which would have been delivered if the **Active Power** was constant
 - the oscillations are adequately damped
- and;
- (iii) Each **Offshore DC Converter** shall be designed to meet the **Active Power** recovery characteristics as specified in the **Bilateral Agreement** upon restoration of the voltage at the **LV Side of the Offshore Platform**.

- (b) Requirements of **Offshore Generating Units, Offshore Power Park Modules**, to withstand voltage dips on the **LV Side of the Offshore Platform** greater than 140ms in duration.
- (1b) Requirements applicable to **Offshore Synchronous Generating Units** to withstand voltage dips on the **LV Side of the Offshore Platform** greater than 140ms in duration.

In addition to the requirements of CC.6.3.15.2. (a) each **Offshore Synchronous Generating Unit** shall:

- (i) remain transiently stable and connected to the **System** without tripping of any

Offshore Synchronous Generating Unit for any balanced voltage dips on the **LV side of the Offshore Platform** and associated durations anywhere on or above the heavy black line shown in Figure 7a. Appendix 4B and Figures CC.A.4B.3.2 (a), (b) and (c) provide an explanation and illustrations of Figure 7a. It should be noted that in the case of an **Offshore Synchronous Generating Unit** which is connected to an **Offshore Transmission System** which includes a **Transmission DC Converter** as part of that **Offshore Transmission System**, the **Offshore Grid Entry Point** voltage may not indicate the presence of a voltage dip on the **Onshore Transmission System**. The voltage dip will affect the level of **Active Power** that can be transferred to the **Onshore Transmission System** and therefore subject the **Offshore Generating Unit**, to a load rejection.

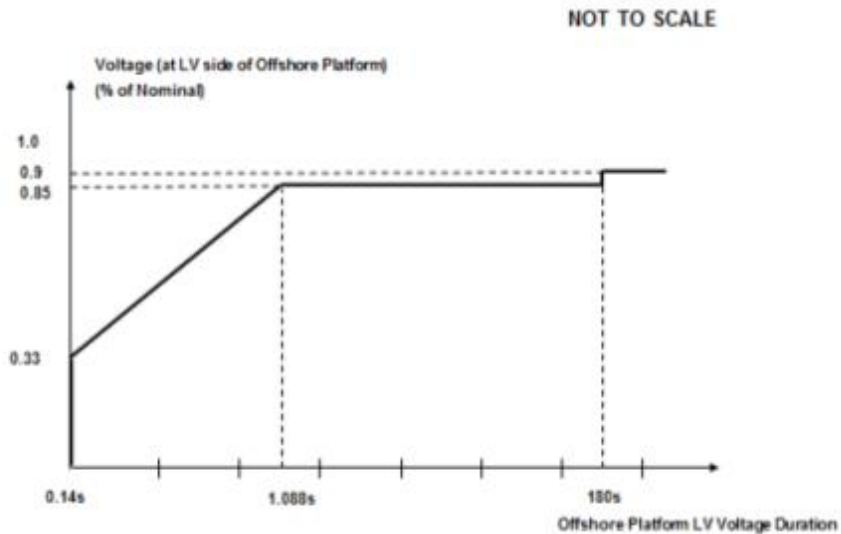

- (ii) provide **Active Power** output, during voltage dips on the **LV Side of the Offshore Platform** as described in Figure 7a, at least in proportion to the retained balanced or unbalanced voltage at the **LV Side of the Offshore Platform** and shall generate maximum reactive current (where the voltage at the **Offshore Grid Entry Point** is outside the limits specified in CC.6.1.4) without exceeding the transient rating limits of the **Offshore Synchronous Generating Unit** and,
 - (iii) within 1 second of restoration of the voltage to 1.0p.u of the nominal voltage at the **LV Side of the Offshore Platform**, restore **Active Power** to at least 90% of the **Offshore Synchronous Generating Unit's** immediate pre-disturbed value, unless there has been a reduction in the **Intermittent Power Source** in the time range in Figure 7a that restricts the **Active Power** output below this level. Once the **Active Power** output has been restored to the required level, **Active Power** oscillations shall be acceptable provided that:
 - the total **Active Energy** delivered during the period of the oscillations is at least that which would have been delivered if the **Active Power** was constant
 - the oscillations are adequately damped
- (2b) Requirements applicable to **Offshore Power Park Modules** to withstand voltage dips on the **LV Side of the Offshore Platform** greater than 140ms in duration.

In addition to the requirements of CC.6.3.15.2. (a) each **Offshore Power Park Module** and / or any constituent **Power Park Unit**, shall:

- (i) remain transiently stable and connected to the **System** without tripping of any **Offshore Power Park Module** and / or any constituent **Power Park Unit**, for any balanced voltage dips on the **LV side of the Offshore Platform** and associated durations anywhere on or above the heavy black line shown in Figure 7b. Appendix 4B and Figures CC.A.4B.5. (a), (b) and (c) provide an explanation and illustrations of Figure 7b. It should be noted that in the case of an **Offshore Power Park Module** (including any **Offshore Power Park Unit** thereof) which is connected to an **Offshore Transmission System** which includes a **Transmission DC Converter** as part of that **Offshore Transmission System**, the **Offshore Grid Entry Point** voltage may not indicate the presence of a voltage dip on the **Onshore Transmission System**. The voltage dip will affect the level of **Active Power** that can be transferred to the **Onshore Transmission System** and therefore subject the **Offshore Power Park Module** (including any **Offshore Power Park Unit** thereof) to a load rejection.

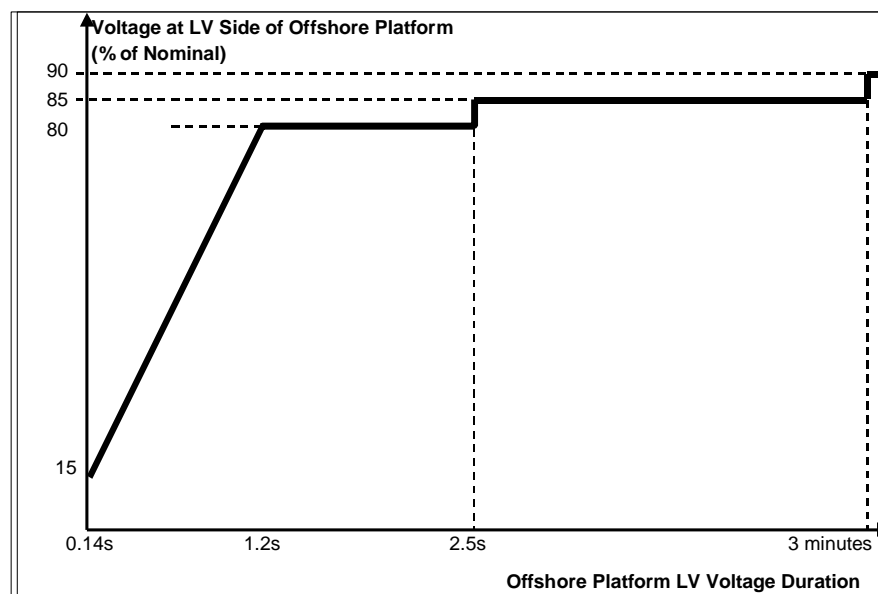

Figure 7b

- (ii) provide **Active Power** output, during voltage dips on the **LV Side of the Offshore Platform** as described in Figure 7b, at least in proportion to the retained balanced or unbalanced voltage at the **LV Side of the Offshore Platform** except in the case of an **Offshore Non-Synchronous Generating Unit** or **Offshore Power Park Module** where there has been a reduction in the **Intermittent Power Source** in the time range in Figure 7b that restricts the **Active Power** output below this level and shall generate maximum reactive current (where the voltage at the **Offshore Grid Entry Point** is outside the limits specified in CC.6.1.4) without exceeding the transient rating limits of the **Offshore Power Park Module** and any constituent **Power Park Unit** or reactive compensation equipment. For **Plant and Apparatus** installed on or after 1 December 2017, switched reactive compensation equipment (such as mechanically switched capacitors and reactors) shall be controlled such that it is not switched in or out of service during the fault but may act to assist in post fault voltage recovery; and,
- (iii) within 1 second of the restoration of the voltage at the **LV Side of the Offshore Platform** (to the minimum levels specified in CC.6.1.4) restore **Active Power** to at least 90% of the **Offshore Power Park Module's** immediate pre-disturbed value, unless there has been a reduction in the **Intermittent Power Source** in the time range in Figure 7b that restricts the **Active Power** output below this level. Once the **Active Power** output has been restored to the required level, **Active Power** oscillations shall be acceptable provided that:

- the total **Active Energy** delivered during the period of the oscillations is at least that which would have been delivered if the **Active Power** was constant
- the oscillations are adequately damped

CC.6.3.15.3 Other Requirements

- (i) In the case of a **Power Park Module** (comprising of wind-turbine generator units), the requirements in CC.6.3.15.1 and CC.6.3.15.2 do not apply when the **Power Park Module** is operating at less than 5% of its **Rated MW** or during very high wind speed conditions when more than 50% of the wind turbine generator units in a **Power Park Module** have been shut down or disconnected under an emergency shutdown sequence to protect **GB Code User's Plant and Apparatus**.
- (ii) In addition to meeting the conditions specified in CC.6.1.5(b) and CC.6.1.6, each **Non-Synchronous Generating Unit, OTSDUW Plant and Apparatus** or **Power Park Module** with a **Completion Date** after 1 April 2005 and any constituent **Power Park Unit** thereof will be required to withstand, without tripping, the negative phase sequence loading incurred by clearance of a close-up phase-to-phase fault, by **System Back-Up Protection** on the **Onshore Transmission System** operating at **Supergrid Voltage**.
- (iii) In the case of an **Onshore Power Park Module** in Scotland with a **Completion Date** before 1 January 2004 and a **Registered Capacity** less than 30MW the requirements in CC.6.3.15.1 (a) do not apply. In the case of an **Onshore Power Park Module** in Scotland with a **Completion Date** on or after 1 January 2004 and before 1 July 2005 and a **Registered Capacity** less than 30MW the requirements in CC.6.3.15.1 (a) are relaxed from the minimum **Onshore Transmission System Supergrid Voltage** of zero to a minimum **Onshore Transmission System Supergrid Voltage** of 15% of nominal. In the case of an **Onshore Power Park Module** in Scotland with a **Completion Date** before 1 January 2004 and a **Registered Capacity** of 30MW and above the requirements in CC.6.3.15.1 (a) are relaxed from the minimum **Onshore Transmission System Supergrid Voltage** of zero to a minimum **Onshore Transmission System Supergrid Voltage** of 15% of nominal.
- (iv) To avoid unwanted island operation, **Non-Synchronous Generating Units** in Scotland (and those directly connected to a **Scottish Offshore Transmission System**), **Power Park Modules** in Scotland (and those directly connected to a **Scottish Offshore Transmission System**), or **OTSDUW Plant and Apparatus** with an **Interface Point** in Scotland shall be tripped for the following conditions:
 - (1) **Frequency** above 52Hz for more than 2 seconds
 - (2) **Frequency** below 47Hz for more than 2 seconds
 - (3) Voltage as measured at the **Onshore Connection Point** or **Onshore User System Entry Point** or **Offshore Grid Entry Point** or **Interface Point** in the case of **OTSDUW Plant and Apparatus** is below 80% for more than 2.5 seconds
 - (4) Voltage as measured at the **Onshore Connection Point** or **Onshore User System Entry Point** or **Offshore Grid Entry Point** or **Interface Point** in the case of **OTSDUW Plant and Apparatus** is above 120% (115% for 275kV) for more than 1 second.

The times in sections (1) and (2) are maximum trip times. Shorter times may be used to protect the **Non-Synchronous Generating Units, or OTSDUW Plant and Apparatus** or **Power Park Modules**.

Additional Damping Control Facilities for DC Converters

- CC.6.3.16
- (a) **DC Converter** owners, or **GB Generators** in respect of **OTSDUW DC Converters** or **Network Operators** in the case of an **Embedded DC Converter Station** not subject to a **Bilateral Agreement** must ensure that any of their **Onshore DC Converters** or **OTSDUW DC Converters** will not cause a sub-synchronous resonance problem on the **Total System**. Each **DC Converter** or **OTSDUW DC Converter** is required to be provided with sub-synchronous resonance damping control facilities.
 - (b) Where specified in the **Bilateral Agreement**, each **DC Converter** or **OTSDUW DC Converter** is required to be provided with power oscillation damping or any other identified additional control facilities.

System to Generator Operational Intertripping Scheme

- CC.6.3.17
- The Company** may require that a **System to Generator Operational Intertripping Scheme** be installed as part of a condition of the connection of the **GB Generator**. Scheme specific details shall be included in the relevant **Bilateral Agreement** and shall, in respect of **Bilateral Agreements** entered into on or after 16th March 2009 include the following information:
- (1) the relevant category(ies) of the scheme (referred to as Category 1 Intertripping Scheme, Category 2 Intertripping Scheme, Category 3 Intertripping Scheme and Category 4 Intertripping Scheme);
 - (2) the **Generating Unit(s)** or **CCGT Module(s)** or **Power Park Module(s)** to be either permanently armed or that can be instructed to be armed in accordance with BC2.8;
 - (3) the time within which the **Generating Unit(s)** or **CCGT Module(s)** or **Power Park Module(s)** circuit breaker(s) are to be automatically tripped;
 - (4) the location to which the trip signal will be provided by **The Company**. Such location will be provided by **The Company** prior to the commissioning of the **Generating Unit(s)** or **CCGT Module(s)** or **Power Park Module(s)**.

Where applicable, the **Bilateral Agreement** shall include the conditions on the **National Electricity Transmission System** during which **The Company** may instruct the **System to Generator Operational Intertripping Scheme** to be armed and the conditions that would initiate a trip signal.

- CC.6.3.18
- The time within which the **Generating Unit(s)** or **CCGT Module** or **Power Park Module** circuit breaker(s) need to be automatically tripped is determined by the specific conditions local to the **GB Generator**. This 'time to trip' (defined as time from provision of the trip signal by **The Company** to the specified location, to circuit breaker main contact opening) can typically range from 100ms to 10sec. A longer time to trip may allow the initiation of an automatic reduction in the **Generating Unit(s)** or **CCGT Module(s)** or **Power Park Module(s)** output prior to the automatic tripping of the **Generating Unit(s)** or **CCGT Module(s)** or **Power Park Module(s)** circuit breaker. Where applicable **The Company** may provide separate trip signals to allow for either a longer or shorter 'time to trip' to be initiated.

CC.6.4 General Network Operator And Non-Embedded Customer Requirements

- CC.6.4.1 This part of the **Grid Code** describes the technical and design criteria and performance requirements for **Network Operators** and **Non-Embedded Customers**.

Neutral Earthing

- CC.6.4.2 At nominal **System** voltages of 132kV and above the higher voltage windings of three phase transformers and transformer banks connected to the **National Electricity Transmission System** must be star connected with the star point suitable for connection to earth. The earthing and lower voltage winding arrangement shall be such as to ensure that the **Earth Fault Factor** requirement of paragraph CC.6.2.1.1 (b) will be met on the **National Electricity Transmission System** at nominal **System** voltages of 132kV and above.

Frequency Sensitive Relays

- CC.6.4.3 As explained under **OC6**, each **Network Operator**, will make arrangements that will facilitate automatic low **Frequency Disconnection of Demand** (based on **Annual ACS Conditions**). CC.A.5.5. of Appendix 5 includes specifications of the local percentage **Demand** that shall be disconnected at specific frequencies. The manner in which **Demand** subject to low **Frequency** disconnection will be split into discrete MW blocks is specified in OC6.6. Technical requirements relating to **Low Frequency Relays** are also listed in Appendix 5.

Operational Metering

- CC.6.4.4 Where **The Company** can reasonably demonstrate that an **Embedded Medium Power Station** or **Embedded DC Converter Station** has a significant effect on the **National Electricity Transmission System**, it may require the **Network Operator** within whose **System** the **Embedded Medium Power Station** or **Embedded DC Converter Station** is situated to ensure that the operational metering equipment described in CC.6.5.6 is installed such that **The Company** can receive the data referred to in CC.6.5.6. In the case of an **Embedded Medium Power Station** subject to, or proposed to be subject to a **Bilateral Agreement** **The Company** shall notify such **Network Operator** of the details of such installation in writing within 3 months of being notified of the application to connect under **CUSC** and in the case of an **Embedded Medium Power Station** not subject to, or not proposed to be subject to a **Bilateral Agreement** in writing as a **Site Specific Requirement** in accordance with the timescales in CUSC 6.5.5. In either case the **Network Operator** shall ensure that the data referred to in CC.6.5.6 is provided to **The Company**.

CC.6.5 Communications Plant

- CC.6.5.1 In order to ensure control of the **National Electricity Transmission System**, telecommunications between **GB Code Users** and **The Company** must (including in respect of any **OTSDUW Plant and Apparatus** at the **OTSUA Transfer Time**), if required by **The Company**, be established in accordance with the requirements set down below.

CC.6.5.2 Control Telephony and System Telephony

- CC.6.5.2.1 **Control Telephony** is the principle method by which a **User's Responsible Engineer/Operator** and **The Company's Control Engineers** speak to one another for the purposes of control of the **Total System** in both normal and emergency operating conditions. **Control Telephony** provides secure point to point telephony for routine **Control Calls**, priority **Control Calls** and emergency **Control Calls**.

- CC.6.5.2.2 **System Telephony** is an alternate method by which a **User's Responsible Engineer/Operator** and **The Company's Control Engineers** speak to one another for the purposes of control of the **Total System** in both normal operating conditions and where practicable, emergency operating conditions. **System Telephony** uses the Public Switched Telephony Network to provide telephony for **Control Calls**, inclusive of emergency **Control Calls**.

- CC.6.5.2.3 Calls made and received over **Control Telephony** and **System Telephony** may be recorded and subsequently replayed for commercial and operational reasons.

CC.6.5.3 Supervisory Tones

- CC.6.5.3.1 **Control Telephony** supervisory tones indicate to the calling and receiving parties dial, engaged, ringing, secondary engaged (signifying that priority may be exercised) and priority disconnect tones.

- CC.6.5.3.2 **System Telephony** supervisory tones indicate to the calling and receiving parties dial, engaged and ringing tones.
- CC.6.5.4 Obligations in respect of Control Telephony and System Telephony
- CC.6.5.4.1 Where **The Company** requires **Control Telephony**, **Users** are required to use the **Control Telephony** with **The Company** in respect of all **Connection Points** with the **National Electricity Transmission System** and in respect of all **Embedded Large Power Stations** and **Embedded DC Converter Stations**. **The Company** will install **Control Telephony** at the **GB Code User's Control Point** where the **GB Code User's** telephony equipment is not capable of providing the required facilities or is otherwise incompatible with the **Transmission Control Telephony**. Details of and relating to the **Control Telephony** required are contained in the **Bilateral Agreement**.
- CC.6.5.4.2 Where in **The Company's** sole opinion the installation of **Control Telephony** is not practicable at a **GB Code User's Control Point(s)**, **The Company** shall specify in the **Bilateral Agreement** whether **System Telephony** is required. Where **System Telephony** is required by **The Company**, the **GB Code User** shall ensure that **System Telephony** is installed.
- CC.6.5.4.3 Where **System Telephony** is installed, **GB Code Users** are required to use the **System Telephony** with **The Company** in respect of those **Control Point(s)** for which it has been installed. Details of and relating to the **System Telephony** required are contained in the **Bilateral Agreement**.
- CC.6.5.4.4 Where **Control Telephony** or **System Telephony** is installed, routine testing of such facilities may be required by **The Company** (not normally more than once in any calendar month). The **GB Code User** and **The Company** shall use reasonable endeavours to agree a test programme and where **The Company** requests the assistance of the **GB Code User** in performing the agreed test programme the **User** shall provide such assistance.
- CC.6.5.4.5 **Control Telephony** and **System Telephony** shall only be used for the purposes of operational voice communication between **The Company** and the relevant **User**.
- CC.6.5.4.6 **Control Telephony** contains emergency calling functionality to be used for urgent operational communication only. Such functionality enables **The Company** and **Users** to utilise a priority call in the event of an emergency. **The Company** and **GB Code Users** shall only use such priority call functionality for urgent operational communications.
- CC.6.5.5 Technical Requirements for Control Telephony and System Telephony
- CC.6.5.5.1 Detailed information on the technical interfaces and support requirements for **Control Telephony** applicable in **The Company's Transmission Area** is provided in the **Control Telephony Electrical Standard** identified in the Annex to the **General Conditions**. Where additional information, or information in relation to **Control Telephony** applicable in Scotland, is requested by **GB Code Users**, this will be provided, where possible, by **The Company**.
- CC.6.5.5.2 **System Telephony** shall consist of a dedicated Public Switched Telephone Network telephone line that shall be installed and configured by the relevant **GB Code User**. **The Company** shall provide a dedicated free phone number (UK only), for the purposes of receiving incoming calls to **The Company**, which **GB Code Users** shall utilise for **System Telephony**. **System Telephony** shall only be utilised by **The Company's Control Engineer** and the **GB Code User's Responsible Engineer/Operator** for the purposes of operational communications.

Operational Metering

- (a) **The Company** shall provide system control and data acquisition (SCADA) outstation interface equipment. The **GB Code User** shall provide such voltage, current, **Frequency**, **Active Power** and **Reactive Power** measurement outputs and plant status indications and alarms to the **Transmission SCADA** outstation interface equipment as required by **The Company** in accordance with the terms of the **Bilateral Agreement**. In the case of **OTSDUW**, the **GB Code User** shall provide such SCADA outstation interface equipment and voltage, current, **Frequency**, **Active Power** and **Reactive Power** measurement outputs and plant status indications and alarms to the SCADA outstation interface equipment as required by **The Company** in accordance with the terms of the **Bilateral Agreement**.
- (b) For the avoidance of doubt, for **Active Power** and **Reactive Power** measurements, circuit breaker and disconnect status indications from:
- (i) **CCGT Modules** at **Large Power Stations** and at directly connected **Power Stations** where the **CCGT Module** each **CCGT Unit** is part of forms a **Type C** or **Type D Power Generating Module**, the outputs and status indications must each be provided to **The Company** on an individual **CCGT Unit** basis. In addition, where identified in the **Bilateral Agreement**, **Active Power** and **Reactive Power** measurements from **Unit Transformers** and/or **Station Transformers** must be provided.
 - (ii) **DC Converters** at **DC Converter Stations** and **OTSDUW DC Converters**, the outputs and status indications must each be provided to **The Company** on an individual **DC Converter** basis. In addition, where identified in the **Bilateral Agreement**, **Active Power** and **Reactive Power** measurements from converter and/or station transformers must be provided.
 - (iii) **Power Park Modules** at **Embedded Large Power Stations** and at directly connected **Power Stations**, the outputs and status indications must each be provided to **The Company** on an individual **Power Park Module** basis. In addition, where identified in the **Bilateral Agreement**, **Active Power** and **Reactive Power** measurements from station transformers must be provided.
 - (iv) In respect of **OTSDUW Plant and Apparatus**, the outputs and status indications must be provided to **The Company** for each piece of electrical equipment. In addition, where identified in the **Bilateral Agreement**, **Active Power** and **Reactive Power** measurements at the **Interface Point** must be provided.
- (c) For the avoidance of doubt, the requirements of CC.6.5.6(a) in the case of a **Cascade Hydro Scheme** will be provided for each **Generating Unit** forming part of that **Cascade Hydro Scheme**. In the case of **Embedded Generating Units** forming part of a **Cascade Hydro Scheme** the data may be provided by means other than **The Company** SCADA outstation located at the **Power Station**, such as, with the agreement of the **Network Operator** in whose system such **Embedded Generating Unit** is located, from the **Network Operator's** SCADA system to **The Company**. Details of such arrangements will be contained in the relevant **Bilateral Agreements** between **The Company** and the **GB Generator** and the **Network Operator**.
- (d) In the case of a **Power Park Module**, additional energy input signals (e.g. wind speed, and wind direction) may be specified in the **Bilateral Agreement**. For **Power Park Modules** with a **Completion Date** on or after 1st April 2016 a **Power Available** signal will also be specified in the **Bilateral Agreement**. The signals would be used to establish the potential level of energy input from the **Intermittent Power Source** for monitoring pursuant to CC.6.6.1 and **Ancillary Services** and will, in the case of a wind farm, be used to provide **The Company** with advanced warning of excess wind speed shutdown and to determine the level of **Headroom** available from **Power Park Modules** for the purposes of calculating response and reserve. For the avoidance of doubt, the **Power Available** signal would be automatically provided to **The Company** and represent the sum of the potential output of all available and operational **Power Park Units** within the **Power Park Module**. The refresh rate of the **Power Available** signal shall be specified in the **Bilateral Agreement**.

Instructor Facilities

CC.6.5.7 The **User** shall accommodate **Instructor Facilities** provided by **The Company** for the receipt of operational messages relating to **System** conditions.

Electronic Data Communication Facilities

CC.6.5.8 (a) All **BM Participants** must ensure that appropriate electronic data communication facilities are in place to permit the submission of data, as required by the **Grid Code**, to **The Company**.

(b) In addition,

(1) any **GB Code User** that wishes to participate in the **Balancing Mechanism**;

or

(2) any **BM Participant** in respect of its **BM Units** at a **Power Station** where the **Construction Agreement** and/or a **Bilateral Agreement** has a **Completion Date** on or after 1 January 2013 and the **BM Participant** is required to provide all **Part 1 System Ancillary Services** in accordance with CC.8.1 (unless **The Company** has otherwise agreed)

must ensure that appropriate automatic logging devices are installed at the **Control Points** of its **BM Units** to submit data to and to receive instructions from **The Company**, as required by the **Grid Code**. For the avoidance of doubt, in the case of an **Interconnector User** the **Control Point** will be at the **Control Centre** of the appropriate **Externally Interconnected System Operator**.

(c) Detailed specifications of these required electronic facilities will be provided by **The Company** on request and they are listed as **Electrical Standards** in the Annex to the **General Conditions**.

Facsimile Machines

CC.6.5.9 Each **GB Code User** and **The Company** shall provide a facsimile machine or machines:

(a) in the case of **GB Generators**, at the **Control Point** of each **Power Station** and at its **Trading Point**;

(b) in the case of **The Company** and **Network Operators**, at the **Control Centre(s)**; and

(c) in the case of **Non-Embedded Customers** and **DC Converter Station** owners at the **Control Point**.

Each **GB Code User** shall notify, prior to connection to the **System** of the **GB Code User's Plant and Apparatus**, **The Company** of its or their telephone number or numbers, and will notify **The Company** of any changes. Prior to connection to the **System** of the **GB Code User's Plant and Apparatus** **The Company** shall notify each **GB Code User** of the telephone number or numbers of its facsimile machine or machines and will notify any changes.

CC.6.5.10 Busbar Voltage

The Company shall, subject as provided below, provide each **GB Generator** or **DC Converter Station** owner at each **Grid Entry Point** where one of its **Power Stations** or **DC Converter Stations** is connected with appropriate voltage signals to enable the **GB Generator** or **DC Converter Station** owner to obtain the necessary information to permit its **Gensets** or **DC Converters** to be **Synchronised** to the **National Electricity Transmission System**. The term "voltage signal" shall mean in this context, a point of connection on (or wire or wires from) a relevant part of **Transmission Plant** and/or **Apparatus** at the **Grid Entry Point**, to which the **GB Generator** or **DC Converter Station** owner, with **The Company's** agreement (not to be unreasonably withheld) in relation to the **Plant** and/or **Apparatus** to be attached, will be able to attach its **Plant** and/or **Apparatus** (normally a wire or wires) in order to obtain measurement outputs in relation to the busbar.

CC.6.5.11 Bilingual Message Facilities

- (a) A Bilingual Message Facility is the method by which the **User's Responsible Engineer/Operator**, the **Externally Interconnected System Operator** and **The Company's Control Engineers** communicate clear and unambiguous information in two languages for the purposes of control of the **Total System** in both normal and emergency operating conditions.
- (b) A Bilingual Message Facility, where required, will provide up to two hundred pre-defined messages with up to five hundred and sixty characters each. A maximum of one minute is allowed for the transmission to, and display of, the selected message at any destination. The standard messages must be capable of being displayed at any combination of locations and can originate from any of these locations. Messages displayed in the UK will be displayed in the English language.
- (c) Detailed information on a Bilingual Message Facility and suitable equipment required for individual **GB Code User** applications will be provided by **The Company** upon request.

CC.6.6 System Monitoring

- CC.6.6.1 Monitoring equipment is provided on the **National Electricity Transmission System** to enable **The Company** to monitor its power system dynamic performance conditions. Where this monitoring equipment requires voltage and current signals on the **Generating Unit** (other than **Power Park Unit**), **DC Converter** or **Power Park Module** circuit from the **GB Code User** or from **OTSDUW Plant and Apparatus**, **The Company** will inform the **GB Code User** and they will be provided by the **GB Code User** with both the timing of the installation of the equipment for receiving such signals and its exact position being agreed (the **GB Code User's** agreement not to be unreasonably withheld) and the costs being dealt with, pursuant to the terms of the **Bilateral Agreement**.
- CC.6.6.2 For all on site monitoring by **The Company** of witnessed tests pursuant to the **CP** or **OC5** the **GB Code User** shall provide suitable test signals as outlined in OC5.A.1.
- CC.6.6.2.1 The signals which shall be provided by the **GB Code User** to **The Company** for onsite monitoring shall be of the following resolution, unless otherwise agreed by **The Company**:
 - (i) 1 Hz for reactive range tests
 - (ii) 10 Hz for frequency control tests
 - (iii) 100 Hz for voltage control tests
- CC.6.6.2.2 The **GB Code User** will provide all relevant signals for this purpose in the form of d.c. voltages within the range -10V to +10V. In exceptional circumstances some signals may be accepted as d.c. voltages within the range -60V to +60V with prior agreement between the **GB Code User** and **The Company**. All signals shall:
 - (i) in the case of an **Onshore Power Park Module, DC Converter Station** or **Synchronous Generating Unit**, be suitably terminated in a single accessible location at the **GB Generator** or **DC Converter Station** owner's site.
 - (ii) in the case of an **Offshore Power Park Module** and **OTSDUW Plant and Apparatus**, be transmitted onshore without attenuation, delay or filtering which would result in the inability to fully demonstrate the objectives of the test, or identify any potential safety or plant instability issues, and be suitably terminated in a single robust location normally located at or near the onshore **Interface Point** of the **Offshore Transmission System** to which it is connected.
- CC.6.6.2.3 All signals shall be suitably scaled across the range. The following scaling would (unless **The Company** notify the **GB Code User** otherwise) be acceptable to **The Company**:
 - (a) 0MW to **Registered Capacity** or **Interface Point Capacity** 0-8V dc
 - (b) Maximum leading **Reactive Power** to maximum lagging **Reactive Power** -8 to 8V dc
 - (c) 48 – 52Hz as -8 to 8V dc
 - (d) Nominal terminal or connection point voltage -10% to +10% as -8 to 8V dc

CC.6.6.2.4 The **GB Code User** shall provide to **The Company** a 230V power supply adjacent to the signal terminal location.

CC.7 SITE RELATED CONDITIONS

CC.7.1 Not used.

CC.7.2 Responsibilities For Safety

CC.7.2.1 In England and Wales, any **User** entering and working on its **Plant** and/or **Apparatus** (including, until the **OTSUA Transfer Time**, any **OTSUA**) on a **Transmission Site** will work to the **Safety Rules** of **The Company**.

In Scotland or **Offshore**, any **User** entering and working on its **Plant** and/or **Apparatus** (including, until the **OTSUA Transfer Time**, any **OTSUA**) on a **Transmission Site** will work to the **Safety Rules** of the **Relevant Transmission Licensee**, as advised by **The Company**.

CC.7.2.2 **The Company** entering and working on **Transmission Plant** and/or **Apparatus** on a **User Site** will work to the **User's Safety Rules**. For **User Sites** in Scotland or **Offshore**, **The Company** shall procure that the **Relevant Transmission Licensee** entering and working on **Transmission Plant** and/or **Apparatus** on a **User Site** will work to the **User's Safety Rules**.

CC.7.2.3 A **User** may, with a minimum of six weeks notice, apply to **The Company** for permission to work according to that **Users** own **Safety Rules** when working on its **Plant** and/or **Apparatus** on a **Transmission Site** rather than those set out in CC.7.2.1. If **The Company** is of the opinion that the **User's Safety Rules** provide for a level of safety commensurate with those set out in CC.7.2.1, **The Company** will notify the **User**, in writing, that, with effect from the date requested by the **User**, the **User** may use its own **Safety Rules** when working on its **Plant** and/or **Apparatus** on the **Transmission Site**. For a **Transmission Site** in Scotland or **Offshore**, in forming its opinion, **The Company** will seek the opinion of the **Relevant Transmission Licensee**. Until receipt of such written approval from **The Company**, the **GB Code User** will continue to use the **Safety Rules** as set out in CC.7.2.1.

CC.7.2.4 In the case of a **User Site** in England and Wales, **The Company** may, with a minimum of six weeks notice, apply to a **User** for permission to work according to **The Company's Safety Rules** when working on **Transmission Plant** and/or **Apparatus** on that **User Site**, rather than the **User's Safety Rules**. If the **User** is of the opinion that **The Company's Safety Rules** provide for a level of safety commensurate with that of that **User's Safety Rules**, it will notify **The Company**, in writing, that, with the effect from the date requested by **The Company**, **The Company** may use its own **Safety Rules** when working on its **Transmission Plant** and/or **Apparatus** on that **User Site**. Until receipt of such written approval from the **User**, **The Company** shall continue to use the **User's Safety Rules**.

In the case of a **User Site** in Scotland or **Offshore**, **The Company** may, with a minimum of six weeks notice, apply to a **User** for permission for the **Relevant Transmission Licensee** to work according to the **Relevant Transmission Licensee's Safety Rules** when working on **Transmission Plant** and/or **Apparatus** on that **User Site**, rather than the **User's Safety Rules**. If the **User** is of the opinion that the **Relevant Transmission Licensee's Safety Rules**, provide for a level of safety commensurate with that of that **User's Safety Rules**, it will notify **The Company**, in writing, that, with effect from the date requested by **The Company**, that the **Relevant Transmission Licensee** may use its own **Safety Rules** when working on its **Transmission Plant** and/or **Apparatus** on that **User's Site**. Until receipt of such written approval from the **User**, **The Company** shall procure that the **Relevant Transmission Licensee** shall continue to use the **User's Safety Rules**.

CC.7.2.5 For a **Transmission Site** in England and Wales, if **The Company** gives its approval for the **User's Safety Rules** to apply to the **User** when working on its **Plant** and/or **Apparatus**, that does not imply that the **User's Safety Rules** will apply to entering the **Transmission Site** and access to the **User's Plant** and/or **Apparatus** on that **Transmission Site**. Bearing in mind **The Company's** responsibility for the whole **Transmission Site**, entry and access will always be in accordance with **The Company's** site access procedures. For a **User Site** in England and Wales, if the **User** gives its approval for **The Company's Safety Rules** to apply to **The Company** when working on its **Plant** and **Apparatus**, that does not imply that **The Company's Safety Rules** will apply to entering the **User Site**, and access to the **Transmission Plant** and **Apparatus** on that **User Site**. Bearing in mind the **User's** responsibility for the whole **User Site**, entry and access will always be in accordance with the **User's** site access procedures.

For a **Transmission Site** in Scotland or **Offshore**, if **The Company** gives its approval for the **User's Safety Rules** to apply to the **User** when working on its **Plant** and/or **Apparatus**, that does not imply that the **User's Safety Rules** will apply to entering the **Transmission Site** and access to the **User's Plant** and/or **Apparatus** on that **Transmission Site**. Bearing in mind the **Relevant Transmission Licensee's** responsibility for the whole **Transmission Site**, entry and access will always be in accordance with the **Relevant Transmission Licensee's** site access procedures. For a **User Site** in Scotland or **Offshore**, if the **User** gives its approval for **Relevant Transmission Licensee Safety Rules** to apply to the **Relevant Transmission Licensee** when working on its **Plant** and **Apparatus**, that does not imply that the **Relevant Transmission Licensee's Safety Rules** will apply to entering the **User Site**, and access to the **Transmission Plant** and **Apparatus** on that **User Site**. Bearing in mind the **User's** responsibility for the whole **User Site**, entry and access will always be in accordance with the **User's** site access procedures.

CC.7.2.6 For **User Sites** in England and Wales, **Users** shall notify **The Company** of any **Safety Rules** that apply to **The Company's** staff working on **User Sites**. For **Transmission Sites** in England and Wales, **The Company** shall notify **Users** of any **Safety Rules** that apply to the **User's** staff working on the **Transmission Site**.

For **User Sites** in Scotland or **Offshore**, **Users** shall notify **The Company** of any **Safety Rules** that apply to the **Relevant Transmission Licensee's** staff working on **User Sites**. For **Transmission Sites** in Scotland or **Offshore** **The Company** shall procure that the **Relevant Transmission Licensee** shall notify **Users** of any **Safety Rules** that apply to the **User's** staff working on the **Transmission Site**.

CC.7.2.7 Each **Site Responsibility Schedule** must have recorded on it the **Safety Rules** which apply to each item of **Plant** and/or **Apparatus**.

CC.7.2.8 In the case of **OTSUA** a **User Site** or **Transmission Site** shall, for the purposes of this CC.7.2, include a site at which there is an **Interface Point** until the **OTSUA Transfer Time** when it becomes part of the **National Electricity Transmission System**.

CC.7.3 Site Responsibility Schedules

CC.7.3.1 In order to inform site operational staff and **The Company's Control Engineers** of agreed responsibilities for **Plant** and/or **Apparatus** at the operational interface, a **Site Responsibility Schedule** shall be produced for **Connection Sites** (and in the case of **OTSUA**, until the **OTSUA Transfer Time, Interface Sites**) in England and Wales for **The Company** and **Users** with whom they interface, and for **Connection Sites** (and in the case of **OTSUA**, until the **OTSUA Transfer Time, Interface Sites**) in Scotland or **Offshore** for **The Company**, the **Relevant Transmission Licensee** and **Users** with whom they interface.

CC.7.3.2 The format, principles and basic procedure to be used in the preparation of **Site Responsibility Schedules** are set down in Appendix 1.

CC.7.4 Operation And Gas Zone Diagrams

Operation Diagrams

CC.7.4.1 An **Operation Diagram** shall be prepared for each **Connection Site** at which a **Connection Point** exists (and in the case of **OTSDUW Plant and Apparatus**, by **User's** for each **Interface Point**) using, where appropriate, the graphical symbols shown in Part 1A of Appendix 2. **Users** should also note that the provisions of **OC11** apply in certain circumstances.

CC.7.4.2 The **Operation Diagram** shall include all **HV Apparatus** and the connections to all external circuits and incorporate numbering, nomenclature and labelling, as set out in **OC11**. At those **Connection Sites** (or in the case of **OTSDUW Plant and Apparatus**, **Interface Points**) where gas-insulated metal enclosed switchgear and/or other gas-insulated **HV Apparatus** is installed, those items must be depicted within an area delineated by a chain dotted line which intersects gas-zone boundaries. The nomenclature used shall conform with that used on the relevant **Connection Site** and circuit (and in the case of **OTSDUW Plant and Apparatus**, **Interface Point** and circuit). The **Operation Diagram** (and the list of technical details) is intended to provide an accurate record of the layout and circuit interconnections, ratings and numbering and nomenclature of **HV Apparatus** and related **Plant**.

CC.7.4.3 A non-exhaustive guide to the types of **HV Apparatus** to be shown in the **Operation Diagram** is shown in Part 2 of Appendix 2, together with certain basic principles to be followed unless equivalent principles are approved by **The Company**.

Gas Zone Diagrams

CC.7.4.4 A **Gas Zone Diagram** shall be prepared for each **Connection Site** at which a **Connection Point** (and in the case of **OTSDUW Plant and Apparatus**, by **User's** for an **Interface Point**) exists where gas-insulated switchgear and/or other gas-insulated **HV Apparatus** is utilised. They shall use, where appropriate, the graphical symbols shown in Part 1B of Appendix 2.

CC.7.4.5 The nomenclature used shall conform with that used in the relevant **Connection Site** and circuit (and in the case of **OTSDUW Plant and Apparatus**, relevant **Interface Point** and circuit).

CC.7.4.6 The basic principles set out in Part 2 of Appendix 2 shall be followed in the preparation of **Gas Zone Diagrams** unless equivalent principles are approved by **The Company**.

Preparation of Operation and Gas Zone Diagrams for Users' Sites and Transmission Interface Sites

CC.7.4.7 In the case of a **User Site**, the **User** shall prepare and submit to **The Company**, an **Operation Diagram** for all **HV Apparatus** on the **User** side of the **Connection Point** (and in the case of **OTSDUW Plant and Apparatus**, on what will be the **Offshore Transmission** side of the **Connection Point** and the **Interface Point**) and **The Company** shall provide the **User** with an **Operation Diagram** for all **HV Apparatus** on the **Transmission** side of the **Connection Point** (and in the case of **OTSDUW Plant and Apparatus** on what will be the **Onshore Transmission** side of the **Interface Point**, in accordance with the timing requirements of the **Bilateral Agreement** and/or **Construction Agreement** prior to the **Completion Date** under the **Bilateral Agreement** and/or **Construction Agreement**.

CC.7.4.8 The **User** will then prepare, produce and distribute, using the information submitted on the **User's Operation Diagram** and **The Company Operation Diagram**, a composite **Operation Diagram** for the complete **Connection Site** (and in the case of **OTSDUW Plant and Apparatus**, **Interface Point**), also in accordance with the timing requirements of the **Bilateral Agreement** and/or **Construction Agreement** .

CC.7.4.9 The provisions of CC.7.4.7 and CC.7.4.8 shall apply in relation to **Gas Zone Diagrams** where gas-insulated switchgear and/or other gas-insulated **HV Apparatus** is utilised.

Preparation of Operation and Gas Zone Diagrams for Transmission Sites

CC.7.4.10 In the case of an **Transmission Site**, the **User** shall prepare and submit to **The Company** an **Operation Diagram** for all **HV Apparatus** on the **User** side of the **Connection Point**, in accordance with the timing requirements of the **Bilateral Agreement** and/or **Construction Agreement**.

- CC.7.4.11 **The Company** will then prepare, produce and distribute, using the information submitted on the **User's Operation Diagram**, a composite **Operation Diagram** for the complete **Connection Site**, also in accordance with the timing requirements of the **Bilateral Agreement** and/or **Construction Agreement** .
- CC.7.4.12 The provisions of CC.7.4.10 and CC.7.4.11 shall apply in relation to **Gas Zone Diagrams** where gas-insulated switchgear and/or other gas-insulated **HV Apparatus** is utilised.
- CC.7.4.13 Changes to Operation and Gas Zone Diagrams
- CC.7.4.13.1 When **The Company** has decided that it wishes to install new **HV Apparatus** or it wishes to change the existing numbering or nomenclature of **Transmission HV Apparatus** at a **Transmission Site**, **The Company** will (unless it gives rise to a **Modification** under the **CUSC**, in which case the provisions of the **CUSC** as to the timing apply) one month prior to the installation or change, send to each such **User** a revised **Operation Diagram** of that **Transmission Site**, incorporating the new **Transmission HV Apparatus** to be installed and its numbering and nomenclature or the changes, as the case may be. **OC11** is also relevant to certain **Apparatus**.
- CC.7.4.13.2 When a **User** has decided that it wishes to install new **HV Apparatus**, or it wishes to change the existing numbering or nomenclature of its **HV Apparatus** at its **User Site**, the **User** will (unless it gives rise to a **Modification** under the **CUSC**, in which case the provisions of the **CUSC** as to the timing apply) one month prior to the installation or change, send to **The Company** a revised **Operation Diagram** of that **User Site** incorporating the new **User HV Apparatus** to be installed and its numbering and nomenclature or the changes as the case may be. **OC11** is also relevant to certain **Apparatus**.
- CC.7.4.13.3 The provisions of CC.7.4.13.1 and CC.7.4.13.2 shall apply in relation to **Gas Zone Diagrams** where gas-insulated switchgear and/or other gas-insulated **HV Apparatus** is installed.
- Validity
- CC.7.4.14 (a) The composite **Operation Diagram** prepared by **The Company** or the **User**, as the case may be, will be the definitive **Operation Diagram** for all operational and planning activities associated with the **Connection Site**. If a dispute arises as to the accuracy of the composite **Operation Diagram**, a meeting shall be held at the **Connection Site**, as soon as reasonably practicable, between **The Company** and the **User**, to endeavour to resolve the matters in dispute.
- (b) The composite **Operation Diagram** prepared by **The Company** or the **User**, as the case may be, will be the definitive **Operation Diagram** for all operational and planning activities associated with the **Interface Point** until the **OTSUA Transfer Time**. If a dispute arises as to the accuracy of the composite **Operation Diagram** prior to the **OTSUA Transfer Time**, a meeting shall be held at the **Interface Point**, as soon as reasonably practicable, between **The Company** and the **User**, to endeavour to resolve the matters in dispute.
- (c) An equivalent rule shall apply for **Gas Zone Diagrams** where they exist for a **Connection Site**.
- CC.7.4.15 In the case of **OTSUA**, a **User Site** and **Transmission Site** shall, for the purposes of this CC.7.4, include a site at which there is an **Interface Point** until the **OTSUA Transfer Time** when it becomes part of the **National Electricity Transmission System** and references to **HV Apparatus** in this CC.7.4 shall include references to **HV OTSUA**.
- CC.7.5 Site Common Drawings
- CC.7.5.1 **Site Common Drawings** will be prepared for each **Connection Site** (and in the case of **OTSDUW**, each **Interface Point**) and will include **Connection Site** (and in the case of **OTSDUW**, **Interface Point**) layout drawings, electrical layout drawings, common **Protection/control** drawings and common services drawings.
- Preparation of Site Common Drawings for a User Site and Transmission Interface Site

CC.7.5.2 In the case of a **User Site**, **The Company** shall prepare and submit to the **User**, **Site Common Drawings** for the **Transmission** side of the **Connection Point** (and in the case of **OTSDUW Plant and Apparatus**, on what will be the **Onshore Transmission** side of the **Interface Point**), and the **User** shall prepare and submit to **The Company**, **Site Common Drawings** for the **User** side of the **Connection Point** (and in the case of **OTSDUW**, on what will be the **Offshore Transmission** side of the **Interface Point**) in accordance with the timing requirements of the **Bilateral Agreement** and/or **Construction Agreement**.

CC.7.5.3 The **User** will then prepare, produce and distribute, using the information submitted on the **Transmission Site Common Drawings**, **Site Common Drawings** for the complete **Connection Site** (and in the case of **OTSDUW**, **Interface Point**) in accordance with the timing requirements of the **Bilateral Agreement** and/or **Construction Agreement** .

Preparation of Site Common Drawings for a Transmission Site

CC.7.5.4 In the case of a **Transmission Site**, the **User** will prepare and submit to **The Company Site Common Drawings** for the **User** side of the **Connection Point** in accordance with the timing requirements of the **Bilateral Agreement** and/or **Construction Agreement**.

CC.7.5.5 **The Company** will then prepare, produce and distribute, using the information submitted in the **User's Site Common Drawings**, **Site Common Drawings** for the complete **Connection Site** in accordance with the timing requirements of the **Bilateral Agreement** and/or **Construction Agreement**.

CC.7.5.6 When a **User** becomes aware that it is necessary to change any aspect of the **Site Common Drawings** at a **Connection Site** (and in the case of **OTSDUW**, **Interface Point**) it will:

- (a) if it is a **User Site**, as soon as reasonably practicable, prepare, produce and distribute revised **Site Common Drawings** for the complete **Connection Site** (and in the case of **OTSDUW**, **Interface Point**); and
- (b) if it is a **Transmission Site**, as soon as reasonably practicable, prepare and submit to **The Company** revised **Site Common Drawings** for the **User** side of the **Connection Point** (and in the case of **OTSDUW**, **Interface Point**) and **The Company** will then, as soon as reasonably practicable, prepare, produce and distribute, using the information submitted in the **User's Site Common Drawings**, revised **Site Common Drawings** for the complete **Connection Site** (and in the case of **OTSDUW**, **Interface Point**).

In either case, if in the **User's** reasonable opinion the change can be dealt with by it notifying **The Company** in writing of the change and for each party to amend its copy of the **Site Common Drawings** (or where there is only one set, for the party holding that set to amend it), then it shall so notify and each party shall so amend. If the change gives rise to a **Modification** under the **CUSC**, the provisions of the **CUSC** as to timing will apply.

CC.7.5.7 When **The Company** becomes aware that it is necessary to change any aspect of the **Site Common Drawings** at a **Connection Site**(and in the case of **OTSDUW**, **Interface Point**) it will:

- (a) if it is a **Transmission Site**, as soon as reasonably practicable, prepare, produce and distribute revised **Site Common Drawings** for the complete **Connection Site** (and in the case of **OTSDUW**, **Interface Point**); and
- (b) if it is a **User Site**, as soon as reasonably practicable, prepare and submit to the **User** revised **Site Common Drawings** for the **Transmission** side of the **Connection Point** (in the case of **OTSDUW**, **Interface Point**) and the **User** will then, as soon as reasonably practicable, prepare, produce and distribute, using the information submitted in the **Transmission Site Common Drawings**, revised **Site Common Drawings** for the complete **Connection Site** (and in the case of **OTSDUW**, **Interface Point**).

In either case, if in **The Company's** reasonable opinion the change can be dealt with by it notifying the **User** in writing of the change and for each party to amend its copy of the **Site Common Drawings** (or where there is only one set, for the party holding that set to amend it), then it shall so notify and each party shall so amend. If the change gives rise to a **Modification** under the **CUSC**, the provisions of the **CUSC** as to timing will apply.

Validity

- CC.7.5.8 (a) The **Site Common Drawings** for the complete **Connection Site** prepared by the **User** or **The Company**, as the case may be, will be the definitive **Site Common Drawings** for all operational and planning activities associated with the **Connection Site**. If a dispute arises as to the accuracy of the **Site Common Drawings**, a meeting shall be held at the **Site**, as soon as reasonably practicable, between **The Company** and the **User**, to endeavour to resolve the matters in dispute.
- (b) The **Site Common Drawing** prepared by **The Company** or the **User**, as the case may be, will be the definitive **Site Common Drawing** for all operational and planning activities associated with the **Interface Point** until the **OTSUA Transfer Time**. If a dispute arises as to the accuracy of the composite **Operation Diagram** prior to the **OTSUA Transfer Time**, a meeting shall be held at the **Interface Point**, as soon as reasonably practicable, between **The Company** and the **User**, to endeavour to resolve the matters in dispute.

CC.7.5.9 In the case of **OTSUA**, a **User Site** and **Transmission Site** shall, for the purposes of this CC.7.5, include a site at which there is an **Interface Point** until the **OTSUA Transfer Time** when it becomes part of the **National Electricity Transmission System**.

CC.7.6 Access

CC.7.6.1 The provisions relating to access to **Transmission Sites** by **Users**, and to **Users' Sites** by **Transmission Licensees**, are set out in each **Interface Agreement** (or in the case of **Interfaces Sites** prior to the **OTSUA Transfer Time** agreements in similar form) with, for **Transmission Sites** in England and Wales, **The Company** and each **User**, and for **Transmission Sites** in Scotland and **Offshore**, the **Relevant Transmission Licensee** and each **User**.

CC.7.6.2 In addition to those provisions, where a **Transmission Site** in England and Wales contains exposed **HV** conductors, unaccompanied access will only be granted to individuals holding an **Authority for Access** issued by **The Company** and where a **Transmission Site** in Scotland or **Offshore** contains exposed **HV** conductors, unaccompanied access will only be granted to individuals holding an **Authority for Access** issued by the **Relevant Transmission Licensee**.

CC.7.6.3 The procedure for applying for an **Authority for Access** is contained in the **Interface Agreement**.

CC.7.7 Maintenance Standards

CC.7.7.1 It is the **User's** responsibility to ensure that all its **Plant** and **Apparatus** (including, until the **OTSUA Transfer Time**, any **OTSUA**) on a **Transmission Site** is tested and maintained adequately for the purpose for which it is intended, and to ensure that it does not pose a threat to the safety of any **Transmission Plant, Apparatus** or personnel on the **Transmission Site**. **The Company** will have the right to inspect the test results and maintenance records relating to such **Plant** and **Apparatus** at any time

CC.7.7.2 For **User Sites** in England and Wales, **The Company** has a responsibility to ensure that all **Transmission Plant** and **Apparatus** on a **User Site** is tested and maintained adequately for the purposes for which it is intended and to ensure that it does not pose a threat to the safety of any **User's Plant, Apparatus** or personnel on the **User Site**.

For **User Sites** in Scotland and **Offshore**, **The Company** shall procure that the **Relevant Transmission Licensee** has a responsibility to ensure that all **Transmission Plant** and **Apparatus** on a **User Site** is tested and maintained adequately for the purposes for which it is intended and to ensure that it does not pose a threat to the safety of any **User's Plant, Apparatus** or personnel on the **User Site**.

The **User** will have the right to inspect the test results and maintenance records relating to such **Plant** and **Apparatus** on its **User Site** at any time.

CC.7.8 Site Operational Procedures

CC.7.8.1 **The Company** and **Users** with an interface with **The Company**, must make available staff to take necessary **Safety Precautions** and carry out operational duties as may be required to enable work/testing to be carried out and for the operation of **Plant** and **Apparatus** (including, prior to the **OTSUA Transfer Time**, any **OTSUA**) connected to the **Total System**.

CC.7.9 **GB Generators** and **DC Converter Station** owners shall provide a **Control Point** in respect of each **Power Station** directly connected to the **National Electricity Transmission System** and **Embedded Large Power Station** or **DC Converter Station** to receive an act upon instructions pursuant to OC7 and BC2 at all times that **Generating Units** or **Power Park Modules** at the **Power Station** are generating or available to generate or **DC Converters** at the **DC Converter Station** are importing or exporting or available to do so. The **Control Point** shall be continuously manned except where the **Bilateral Agreement** in respect of such **Embedded Power Station** specifies that compliance with BC2 is not required, where the **Control Point** shall be manned between the hours of 0800 and 1800 each day.

CC.8 ANCILLARY SERVICES

CC.8.1 System Ancillary Services

The **CC** contain requirements for the capability for certain **Ancillary Services**, which are needed for **System** reasons ("**System Ancillary Services**"). There follows a list of these **System Ancillary Services**, together with the paragraph number of the **CC** (or other part of the **Grid Code**) in which the minimum capability is required or referred to. The list is divided into two categories: Part 1 lists the **System Ancillary Services** which

- (a) **GB Generators** in respect of **Large Power Stations** are obliged to provide (except **GB Generators** in respect of **Large Power Stations** which have a **Registered Capacity** of less than 50MW and comprise **Power Park Modules**); and,
- (b) **GB Generators** in respect of **Large Power Stations** with a **Registered Capacity** of less than 50MW and comprise **Power Park Modules** are obliged to provide in respect of **Reactive Power** only; and,
- (c) **DC Converter Station** owners are obliged to have the capability to supply; and
- (d) **GB Generators** in respect of **Medium Power Stations** (except **Embedded Medium Power Stations**) are obliged to provide in respect of **Reactive Power** only:

and Part 2 lists the **System Ancillary Services** which **GB Generators** will provide only if agreement to provide them is reached with **The Company**:

Part 1

- (a) **Reactive Power** supplied (in accordance with CC.6.3.2) otherwise than by means of synchronous or static compensators (except in the case of a **Power Park Module** where synchronous or static compensators within the **Power Park Module** may be used to provide **Reactive Power**)
- (b) **Frequency** Control by means of **Frequency** sensitive generation - CC.6.3.7 and BC3.5.1

Part 2

- (c) **Frequency** Control by means of **Fast Start** - CC.6.3.14
- (d) **Black Start Capability** - CC.6.3.5
- (e) **System to Generator Operational Intertipping**

CC.8.2

Commercial Ancillary Services

Other **Ancillary Services** are also utilised by **The Company** in operating the **Total System** if these have been agreed to be provided by a **GB Code User** (or other person) under an **Ancillary Services Agreement** or under a **Bilateral Agreement**, with payment being dealt with under an **Ancillary Services Agreement** or in the case of **Externally Interconnected System Operators** or **Interconnector Users**, under any other agreement (and in the case of **Externally Interconnected System Operators** and **Interconnector Users** includes ancillary services equivalent to or similar to **System Ancillary Services**) ("**Commercial Ancillary Services**"). The capability for these **Commercial Ancillary Services** is set out in the relevant **Ancillary Services Agreement** or **Bilateral Agreement** (as the case may be).

APPENDIX 1 - SITE RESPONSIBILITY SCHEDULES

FORMAT, PRINCIPLES AND BASIC PROCEDURE TO BE USED IN THE PREPARATION OF SITE RESPONSIBILITY SCHEDULES

CC.A.1.1 Principles

Types of Schedules

CC.A.1.1.1 At all **Complexes** (which in the context of this CC shall include, **Interface Sites** until the **OTSUA Transfer Time**) the following **Site Responsibility Schedules** shall be drawn up using the relevant proforma attached or with such variations as may be agreed between **The Company** and **Users**, but in the absence of agreement the relevant proforma attached will be used. In addition, in the case of **OTSDUW Plant and Apparatus**, and in readiness for the **OTSUA Transfer Time**, the **User** shall provide **The Company** with the necessary information such that **Site Responsibility Schedules** in this form can be prepared by the **Relevant Transmission Licensees** for the **Transmission Interface Site**:

- (a) Schedule of **HV Apparatus**
- (b) Schedule of **Plant, LV/MV Apparatus**, services and supplies;
- (c) Schedule of telecommunications and measurements **Apparatus**.

Other than at **Generating Unit, DC Converter, Power Park Module** and **Power Station** locations, the schedules referred to in (b) and (c) may be combined.

New Connection Sites

CC.A.1.1.2 In the case of a new **Connection Site** each **Site Responsibility Schedule** for a **Connection Site** shall be prepared by **The Company** in consultation with relevant **GB Code Users** at least 2 weeks prior to the **Completion Date** (or, where the **OTSUA** is to become **Operational** prior to the **OTSUA Transfer Time**, an alternative date) under the **Bilateral Agreement** and/or **Construction Agreement** for that **Connection Site** (which may form part of a **Complex**). In the case of a new **Interface Site** where the **OTSUA** is to become **Operational** prior to the **OTSUA Transfer Time** each **Site Responsibility Schedule** for an **Interface Site** shall be prepared by **The Company** in consultation with relevant **GB Code Users** at least 2 weeks prior to the **Completion Date** under the **Bilateral Agreement** and/or **Construction Agreement** for that **Interface Site** (which may form part of a **Complex**) (and references to and requirements placed on “**Connection Site**” in this CC shall also be read as “**Interface Site**” where the context requires and until the **OTSUA Transfer Time**). Each **GB Code User** shall, in accordance with the timing requirements of the **Bilateral Agreement** and/or **Construction Agreement**, provide information to **The Company** to enable it to prepare the **Site Responsibility Schedule**.

Sub-division

CC.A.1.1.3 Each **Site Responsibility Schedule** will be subdivided to take account of any separate **Connection Sites** on that **Complex**.

Scope

CC.A.1.1.4 Each **Site Responsibility Schedule** shall detail for each item of **Plant** and **Apparatus**:

- (a) **Plant/Apparatus** ownership;
- (b) Site Manager (Controller) (except in the case of **Plant/Apparatus** located in **SPT's Transmission Area**);
- (c) Safety issues comprising applicable **Safety Rules** and **Control Person** or other responsible person (**Safety Co-ordinator**), or such other person who is responsible for safety;
- (d) Operations issues comprising applicable **Operational Procedures** and control engineer;
- (e) Responsibility to undertake statutory inspections, fault investigation and maintenance.

Each **Connection Point** shall be precisely shown.

Detail

- CC.A.1.1.5 (a) In the case of **Site Responsibility Schedules** referred to in CC.A.1.1.1(b) and (c), with the exception of **Protection Apparatus** and **Intertrip Apparatus** operation, it will be sufficient to indicate the responsible **User** or **Transmission Licensee**, as the case may be.
- (b) In the case of the **Site Responsibility Schedule** referred to in CC.A.1.1.1(a) and for **Protection Apparatus** and **Intertrip Apparatus**, the responsible management unit must be shown in addition to the **User** or **Transmission Licensee**, as the case may be.
- CC.A.1.1.6 The **HV Apparatus Site Responsibility Schedule** for each **Connection Site** must include lines and cables emanating from or traversing¹ the **Connection Site**.

Issue Details

- CC.A.1.1.7 Every page of each **Site Responsibility Schedule** shall bear the date of issue and the issue number.

Accuracy Confirmation

- CC.A.1.1.8 When a **Site Responsibility Schedule** is prepared it shall be sent by **The Company** to the **Users** involved for confirmation of its accuracy.
- CC.A.1.1.9 The **Site Responsibility Schedule** shall then be signed on behalf of **The Company** by its **Responsible Manager** (see CC.A.1.1.16) and on behalf of each **User** involved by its **Responsible Manager** (see CC.A.1.1.16), by way of written confirmation of its accuracy. For **Connection Sites** in Scotland or **Offshore**, the **Site Responsibility Schedule** will also be signed on behalf of the **Relevant Transmission Licensee** by its **Responsible Manager**.

Distribution and Availability

- CC.A.1.1.10 Once signed, two copies will be distributed by **The Company**, not less than two weeks prior to its implementation date, to each **User** which is a party on the **Site Responsibility Schedule**, accompanied by a note indicating the issue number and the date of implementation.
- CC.A.1.1.11 **The Company** and **Users** must make the **Site Responsibility Schedules** readily available to operational staff at the **Complex** and at the other relevant control points.

Alterations to Existing Site Responsibility Schedules

- CC.A.1.1.12 Without prejudice to the provisions of CC.A.1.1.15 which deals with urgent changes, when a **User** identified on a **Site Responsibility Schedule** becomes aware that an alteration is necessary, it must inform **The Company** immediately and in any event 8 weeks prior to any change taking effect (or as soon as possible after becoming aware of it, if less than 8 weeks remain when the **User** becomes aware of the change). This will cover the commissioning of new **Plant** and/or **Apparatus** at the **Connection Site**, whether requiring a revised **Bilateral Agreement** or not, de-commissioning of **Plant** and/or **Apparatus**, and other changes which affect the accuracy of the **Site Responsibility Schedule**.
- CC.A.1.1.13 Where **The Company** has been informed of a change by an **GB Code User**, or itself proposes a change, it will prepare a revised **Site Responsibility Schedule** by not less than six weeks prior to the change taking effect (subject to it having been informed or knowing of the change eight weeks prior to that time) and the procedure set out in CC.A.1.1.8 shall be followed with regard to the revised **Site Responsibility Schedule**.

¹ Details of circuits traversing the **Connection Site** are only needed from the date which is the earlier of the date when the **Site Responsibility Schedule** is first updated and 15th October 2004. In Scotland or **Offshore**, from a date to be agreed between **The Company** and the **Relevant Transmission Licensee**.

CC.A 1.1.14 The revised **Site Responsibility Schedule** shall then be signed in accordance with the procedure set out in CC.A.1.1.9 and distributed in accordance with the procedure set out in CC.A.1.1.10, accompanied by a note indicating where the alteration(s) has/have been made, the new issue number and the date of implementation.

Urgent Changes

CC.A.1.1.15 When an **GB Code User** identified on a **Site Responsibility Schedule**, or **The Company**, as the case may be, becomes aware that an alteration to the **Site Responsibility Schedule** is necessary urgently to reflect, for example, an emergency situation which has arisen outside its control, the **GB Code User** shall notify **The Company**, or **The Company** shall notify the **GB Code User**, as the case may be, immediately and will discuss:

- (a) what change is necessary to the **Site Responsibility Schedule**;
- (b) whether the **Site Responsibility Schedule** is to be modified temporarily or permanently;
- (c) the distribution of the revised **Site Responsibility Schedule**.

The Company will prepare a revised **Site Responsibility Schedule** as soon as possible, and in any event within seven days of it being informed of or knowing the necessary alteration. The **Site Responsibility Schedule** will be confirmed by **GB Code Users** and signed on behalf of **The Company** and **GB Code Users** (by the persons referred to in CC.A.1.1.9) as soon as possible after it has been prepared and sent to **GB Code Users** for confirmation.

Responsible Managers

CC.A.1.1.16 Each **GB Code User** shall, prior to the **Completion Date** under each **Bilateral Agreement** and/or **Construction Agreement**, supply to **The Company** a list of Managers who have been duly authorised to sign **Site Responsibility Schedules** on behalf of the **GB Code User** and **The Company** shall, prior to the **Completion Date** under each **Bilateral Agreement** and/or **Construction Agreement**, supply to that **GB Code User** the name of its **Responsible Manager** and for **Connection Sites** in Scotland or **Offshore**, the name of the **Relevant Transmission Licensee's Responsible Manager** and each shall supply to the other any changes to such list six weeks before the change takes effect where the change is anticipated, and as soon as possible after the change, where the change was not anticipated.

De-commissioning of Connection Sites

CC.A.1.1.17 Where a **Connection Site** is to be de-commissioned, whichever of **The Company** or the **GB Code User** who is initiating the de-commissioning must contact the other to arrange for the **Site Responsibility Schedule** to be amended at the relevant time.

PROFORMA FOR SITE RESPONSIBILITY SCHEDULE

_____ AREA

COMPLEX: _____

SCHEDULE: _____

CONNECTION SITE: _____

ITEM OF PLANT/ APPARATUS	PLANT APPARATUS OWNER	SITE MANAGER	SAFETY		OPERATIONS		PARTY RESPONSIBLE FOR UNDERTAKING STATUTORY INSPECTIONS, FAULT INVESTIGATION & MAINTENANCE	REMARKS
			SAFETY RULES	CONTROL OR OTHER RESPONSIBLE PERSON (SAFETY CO-ORDINATOR)	OPERATIONAL PROCEDURES	CONTROL OR OTHER RESPONSIBLE ENGINEER		

PAGE: _____ ISSUE NO: _____ DATE: _____

PROFORMA FOR SITE RESPONSIBILITY SCHEDULE

_____ AREA

COMPLEX: _____

SCHEDULE: _____

CONNECTION SITE: _____

ITEM OF PLANT/ APPARATUS	PLANT APPARATUS OWNER	SITE MANAGER	SAFETY		OPERATIONS		PARTY RESPONSIBLE FOR UNDERTAKING STATUTORY INSPECTIONS, FAULT INVESTIGATION & MAINTENANCE	REMARKS
			SAFETY RULES	CONTROL OR OTHER RESPONSIBLE PERSON (SAFETY CO-ORDINATOR)	OPERATIONAL PROCEDURES	CONTROL OR OTHER RESPONSIBLE ENGINEER		

NOTES:

SIGNED: _____ NAME: _____ COMPANY: _____ DATE: _____

SIGNED: _____ NAME: _____ COMPANY: _____ DATE: _____

SIGNED: _____ NAME: _____ COMPANY: _____ DATE: _____

SIGNED: _____ NAME: _____ COMPANY: _____ DATE: _____

PAGE: _____ ISSUE NO: _____ DATE: _____

**SP TRANSMISSION Ltd
 SITE RESPONSIBILITY SCHEDULE
 OWNERSHIP, MAINTENANCE AND OPERATIONS OF EQUIPMENT
 IN JOINT USER SITUATIONS**

Sheet No. _____
 Revision: _____
 Date: _____

Network Area: _____

SECTION 'A' BUILDING AND SITE		SECTION 'B' CUSTOMER OR OTHER PARTY			
OWNER	ACCESS REQUIRED:-	NAME:-			
LESSEE	SPECIAL CONDITIONS:-	ADDRESS:-			
MAINTENANCE	LOCATION OF SUPPLY TERMINALS:-	TEL NO:-			
SAFETY		SUB STATION:-			
SECURITY		LOCATION:-			

SECTION 'C' PLANT

ITEM Nos.	EQUIPMENT	IDENTIFICATION	OWNER	SAFETY RULES APPLICABLE	OPERATION			MAINTENANCE		FAULT INVESTIGATION		TESTING		RELAY SETTINGS	REMARKS
					Tripping	Closing	Isolating	Earthing	Primary Equip.	Protection Equip.	Primary Equip.	Protection Equip.	Trip and Alarm		

SECTION 'D' CONFIGURATION AND CONTROL

ITEM No.	CONFIGURATION RESPONSIBILITY	TELEPHONE NUMBER	REMARKS

ABBREVIATIONS:-
 D - SP AUTHORISED PERSON - DISTRIBUTION SYSTEM
 NGC - NATIONAL GRID COMPANY
 SPD - SP DISTRIBUTION Ltd
 SPPS - POWERSYSTEMS
 SPT - SP TRANSMISSION Ltd
 ST - SCOTTISH POWER TELECOMMUNICATIONS
 T - SP AUTHORISED PERSON - TRANSMISSION SYSTEM
 U - USER

SECTION 'E' ADDITIONAL INFORMATION

--

SIGNED _____ FOR _____ SP Transmission DATE _____
 SIGNED _____ FOR _____ SP Distribution DATE _____
 SIGNED _____ FOR _____ PowerSystems/User DATE _____

Scottish Hydro-Electric Transmission Limited

Site Responsibility Schedule

Substation Type							Number:			Revision:		
Equipment	Owner	Controller	Maintainer	Responsible System User	Responsible Management Unit	Control Authority	Safety Rules	Operational Procedures	Notes			

APPENDIX 2 - OPERATION DIAGRAMS

PART 1A - PROCEDURES RELATING TO OPERATION DIAGRAMS

FIXED CAPACITOR		SWITCH DISCONNECTOR	
EARTH		SWITCH DISCONNECTOR WITH INCORPORATED EARTH SWITCH	
EARTHING RESISTOR		DISCONNECTOR (CENTRE ROTATING POST)	
LIQUID EARTHING RESISTOR		DISCONNECTOR (SINGLE BREAK DOUBLE ROTATING)	
ARC SUPPRESSION COIL		DISCONNECTOR (SINGLE BREAK)	
FIXED MAINTENANCE EARTHING DEVICE		DISCONNECTOR (NON-INTERLOCKED)	
CARRIER COUPLING EQUIPMENT (WITHOUT VT)		DISCONNECTOR (POWER OPERATED)	
CARRIER COUPLING EQUIPMENT (WITH VT ON ONE PHASE)		DISCONNECTOR (NON-AUTOMATIC)	
CARRIER COUPLING EQUIPMENT (WITH VT ON 3 PHASES)		DISCONNECTOR (AUTOMATIC)	
AC GENERATOR		DISCONNECTOR (SEQUENTIAL OPERATION)	
SYNCHRONOUS COMPENSATOR		DISCONNECTOR (FAULT INTERFERING OPERATION)	
CIRCUIT BREAKER		EARTH SWITCH	
CIRCUIT BREAKER WITH DELAYED AUTO RECLOSE		FAULT THROWING SWITCH (PHASE TO PHASE)	
WITHDRAWABLE METALCLAD SWITCHGEAR		FAULT THROWING SWITCH (EARTH FAULT)	
		SURGE ARRESTOR	
		THYRISTOR	

TRANSFORMERS
(VECTORS TO INDICATE
WINDING CONFIGURATION)

TWO WINDING



THREE WINDING

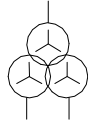

AUTO



AUTO WITH DELTA TERTIARY

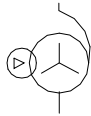

EARTHING OR AUX. TRANSFORMER

(-) INDICATE REMOTE SITE
IF APPLICABLE

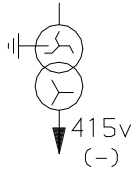

VOLTAGE TRANSFORMERS

SINGLE PHASE WOUND



THREE PHASE WOUND



SINGLE PHASE CAPACITOR



TWO SINGLE PHASE CAPACITOR

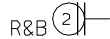

THREE PHASE CAPACITOR



* CURRENT TRANSFORMER
(WHERE SEPARATE PRIMARY
APPARATUS)



* COMBINED VT/CT UNIT
FOR METERING

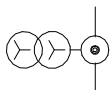

REACTOR



* BUSBARS



* OTHER PRIMARY CONNECTIONS



* CABLE & CABLE SEALING END

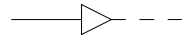

* THROUGH WALL BUSHING

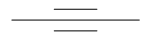

* BYPASS FACILITY



* CROSSING OF CONDUCTORS
(LOWER CONDUCTOR
TO BE BROKEN)

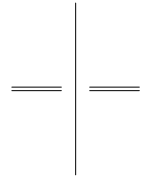

PREFERENTIAL ABBREVIATIONS

AUXILIARY TRANSFORMER	Aux T
EARTHING TRANSFORMER	ET
GAS TURBINE	Gas T
GENERATOR TRANSFORMER	Gen T
GRID TRANSFORMER	Gr T
SERIES REACTOR	Ser Reac
SHUNT REACTOR	Sh Reac
STATION TRANSFORMER	Stn T
SUPERGRID TRANSFORMER	SGT
UNIT TRANSFORMER	UT

* NON-STANDARD SYMBOL

PORTABLE MAINTENANCE
EARTH DEVICE



DISCONNECTOR
(PANTOGRAPH TYPE)



QUADRATURE BOOSTER

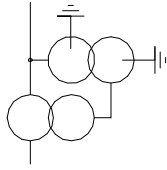

DISCONNECTOR
(KNEE TYPE)



SHORTING/DISCHARGE SWITCH

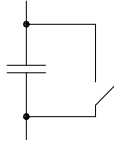

CAPACITOR
(INCLUDING HARMONIC FILTER)



SINGLE PHASE TRANSFORMER (BR)
NEUTRAL AND PHASE CONNECTIONS

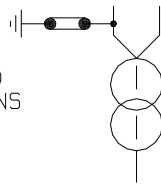

RESISTOR WITH INHERENT
NON-LINEAR VARIABILITY,
VOLTAGE DEPENDANT

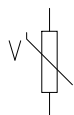

PART 1B - PROCEDURES RELATING TO GAS ZONE DIAGRAMS

GAS INSULATED
BUSBAR

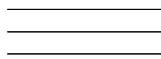

DOUBLE-BREAK
DISCONNECTOR

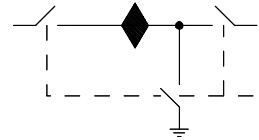

GAS BOUNDARY



EXTERNAL MOUNTED
CURRENT TRANSFORMER
(WHERE SEPARATE
PRIMARY APPARATUS)

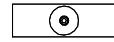

GAS/GAS BOUNDARY



STOP VALVE
NORMALLY CLOSED



GAS/CABLE BOUNDARY



STOP VALVE
NORMALLY OPEN



GAS/AIR BOUNDARY



GAS MONITOR



GAS/TRANSFORMER BOUNDARY



FILTER



MAINTENANCE VALVE

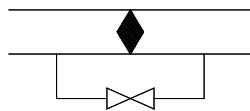

QUICK ACTING COUPLING



PART 2 - NON-EXHAUSTIVE LIST OF APPARATUS TO BE INCLUDED ON OPERATION DIAGRAMS

Basic Principles

- (1) Where practicable, all the **HV Apparatus** on any **Connection Site** shall be shown on one **Operation Diagram**. Provided the clarity of the diagram is not impaired, the layout shall represent as closely as possible the geographical arrangement on the **Connection Site**.
- (2) Where more than one **Operation Diagram** is unavoidable, duplication of identical information on more than one **Operation Diagram** must be avoided.
- (3) The **Operation Diagram** must show accurately the current status of the **Apparatus** e.g. whether commissioned or decommissioned. Where decommissioned, the associated switchbay will be labelled "spare bay".
- (4) Provision will be made on the **Operation Diagram** for signifying approvals, together with provision for details of revisions and dates.
- (5) **Operation Diagrams** will be prepared in A4 format or such other format as may be agreed with **The Company**.
- (6) The **Operation Diagram** should normally be drawn single line. However, where appropriate, detail which applies to individual phases shall be shown. For example, some **HV Apparatus** is numbered individually per phase.

Apparatus To Be Shown On Operation Diagram

- (1) Busbars
- (2) Circuit Breakers
- (3) Disconnecter (Isolator) and Switch Disconnecters (Switching Isolators)
- (4) Disconnectors (Isolators) - Automatic Facilities
- (5) Bypass Facilities
- (6) Earthing Switches
- (7) Maintenance Earths
- (8) Overhead Line Entries
- (9) Overhead Line Traps
- (10) Cable and Cable Sealing Ends
- (11) Generating Unit
- (12) Generator Transformers
- (13) Generating Unit Transformers, Station Transformers, including the lower voltage circuit-breakers.
- (14) Synchronous Compensators
- (15) Static Variable Compensators
- (16) Capacitors (including Harmonic Filters)
- (17) Series or Shunt Reactors (Referred to as "Inductors" at nuclear power station sites)
- (18) Supergrid and Grid Transformers
- (19) Tertiary Windings
- (20) Earthing and Auxiliary Transformers
- (21) Three Phase VT's

- (22) Single Phase VT & Phase Identity
- (23) High Accuracy VT and Phase Identity
- (24) Surge Arrestors/Diverter
- (25) Neutral Earthing Arrangements on HV Plant
- (26) Fault Throwing Devices
- (27) Quadrature Boosters
- (28) Arc Suppression Coils
- (29) Single Phase Transformers (BR) Neutral and Phase Connections
- (30) Current Transformers (where separate plant items)
- (31) Wall Bushings
- (32) Combined VT/CT Units
- (33) Shorting and Discharge Switches
- (34) Thyristor
- (35) Resistor with Inherent Non-Linear Variability, Voltage Dependent
- (36) Gas Zone

APPENDIX 3 - MINIMUM FREQUENCY RESPONSE REQUIREMENT PROFILE AND OPERATING RANGE FOR NEW POWER STATIONS AND DC CONVERTER STATIONS

CC.A.3.1 Scope

The frequency response capability is defined in terms of **Primary Response**, **Secondary Response** and **High Frequency Response**. This appendix defines the minimum frequency response requirement profile for:

- (a) each **Onshore Generating Unit** and/or **CCGT Module** which has a **Completion Date** after 1 January 2001 in England and Wales and 1 April 2005 in Scotland and **Offshore Generating Unit** in a **Large Power Station**,
- (b) each **DC Converter** at a **DC Converter Station** which has a **Completion Date** on or after 1 April 2005 or each **Offshore DC Converter** which is part of a **Large Power Station**.
- (c) each **Onshore Power Park Module** in England and Wales with a **Completion Date** on or after 1 January 2006.
- (d) each **Onshore Power Park Module** in operation in Scotland after 1 January 2006 with a **Completion Date** after 1 April 2005 and in **Power Stations** with a **Registered Capacity** of 50MW or more.
- (e) each **Offshore Power Park Module** in a **Large Power Station** with a **Registered Capacity** of 50MW or more.

For the avoidance of doubt, this appendix does not apply to:

- (i) **Generating Units** and/or **CCGT Modules** which have a **Completion Date** before 1 January 2001 in England and Wales and before 1 April 2005 in Scotland,
- (ii) **DC Converters** at a **DC Converter Station** which have a **Completion Date** before 1 April 2005.
- (iii) **Power Park Modules** in England and Wales with a **Completion Date** before 1 January 2006.
- (iv) **Power Park Modules** in operation in Scotland before 1 January 2006.
- (v) **Power Park Modules** in Scotland with a **Completion Date** before 1 April 2005.
- (vi) **Power Park Modules** in **Power Stations** with a **Registered Capacity** less than 50MW.
- (vii) **Small Power Stations** or individually to **Power Park Units**; or.
- (viii) an **OTSDUW DC Converter** where the **Interface Point Capacity** is less than 50MW.

OTSDUW Plant and Apparatus should facilitate the delivery of frequency response services provided by **Offshore Generating Units** and **Offshore Power Park Modules** at the **Interface Point**.

The functional definition provides appropriate performance criteria relating to the provision of Frequency control by means of Frequency sensitive generation in addition to the other requirements identified in CC.6.3.7.

In this Appendix 3 to the **CC**, for a **CCGT Module** or a **Power Park Module** with more than one **Generating Unit**, the phrase **Minimum Generation** applies to the entire **CCGT Module** or **Power Park Module** operating with all **Generating Units Synchronised** to the **System**.

The minimum **Frequency** response requirement profile is shown diagrammatically in Figure CC.A.3.1. The capability profile specifies the minimum required levels of **Primary Response**, **Secondary Response** and **High Frequency Response** throughout the normal plant operating range. The definitions of these **Frequency** response capabilities are illustrated diagrammatically in Figures CC.A.3.2 & CC.A.3.3.

CC.A.3.2 Plant Operating Range

The upper limit of the operating range is the **Registered Capacity** of the **Generating Unit** or **CCGT Module** or **DC Converter** or **Power Park Module**.

The **Minimum Generation** level may be less than, but must not be more than, 65% of the **Registered Capacity**. Each **Generating Unit** and/or **CCGT Module** and/or **Power Park Module** and/or **DC Converter** must be capable of operating satisfactorily down to the **Designed Minimum Operating Level** as dictated by **System** operating conditions, although it will not be instructed to below its **Minimum Generation** level. If a **Generating Unit** or **CCGT Module** or **Power Park Module** or **DC Converter** is operating below **Minimum Generation** because of high **System Frequency**, it should recover adequately to its **Minimum Generation** level as the **System Frequency** returns to **Target Frequency** so that it can provide **Primary** and **Secondary Response** from **Minimum Generation** if the **System Frequency** continues to fall. For the avoidance of doubt, under normal operating conditions steady state operation below **Minimum Generation** is not expected. The **Designed Minimum Operating Level** must not be more than 55% of **Registered Capacity**.

In the event of a **Generating Unit** or **CCGT Module** or **Power Park Module** or **DC Converter** load rejecting down to no less than its **Designed Minimum Operating Level** it should not trip as a result of automatic action as detailed in BC3.7. If the load rejection is to a level less than the **Designed Minimum Operating Level** then it is accepted that the condition might be so severe as to cause it to be disconnected from the **System**.

CC.A.3.3 Minimum Frequency Response Requirement Profile

Figure CC.A.3.1 shows the minimum **Frequency** response requirement profile diagrammatically for a 0.5 Hz change in **Frequency**. The percentage response capabilities and loading levels are defined on the basis of the **Registered Capacity** of the **Generating Unit** or **CCGT Module** or **Power Park Module** or **DC Converter**. Each **Generating Unit** and/or **CCGT Module** and/or **Power Park Module** and/or **DC Converter** must be capable of operating in a manner to provide **Frequency** response at least to the solid boundaries shown in the figure. If the **Frequency** response capability falls within the solid boundaries, the **Generating Unit** or **CCGT Module** or **Power Park Module** or **DC Converter** is providing response below the minimum requirement which is not acceptable. Nothing in this appendix is intended to prevent a **Generating Unit** or **CCGT Module** or **Power Park Module** or **DC Converter** from being designed to deliver a **Frequency** response in excess of the identified minimum requirement.

The **Frequency** response delivered for **Frequency** deviations of less than 0.5 Hz should be no less than a figure which is directly proportional to the minimum **Frequency** response requirement for a **Frequency** deviation of 0.5 Hz. For example, if the **Frequency** deviation is 0.2 Hz, the corresponding minimum **Frequency** response requirement is 40% of the level shown in Figure CC.A.3.1. The **Frequency** response delivered for **Frequency** deviations of more than 0.5 Hz should be no less than the response delivered for a **Frequency** deviation of 0.5 Hz.

Each **Generating Unit** and/or **CCGT Module** and/or **Power Park Module** and/or **DC Converter** must be capable of providing some response, in keeping with its specific operational characteristics, when operating between 95% to 100% of **Registered Capacity** as illustrated by the dotted lines in Figure CC.A.3.1.

At the **Minimum Generation** level, each **Generating Unit** and/or **CCGT Module** and/or **Power Park Module** and/or **DC Converter** is required to provide high and low frequency response depending on the **System Frequency** conditions. Where the **Frequency** is high, the **Active Power** output is therefore expected to fall below the **Minimum Generation** level.

The **Designed Minimum Operating Level** is the output at which a **Generating Unit** and/or **CCGT Module** and/or **Power Park Module** and/or **DC Converter** has no **High Frequency Response** capability. It may be less than, but must not be more than, 55% of the **Registered Capacity**. This implies that a **Generating Unit** or **CCGT Module** or **Power Park Module** or **DC Converter** is not obliged to reduce its output to below this level unless the **Frequency** is at or above 50.5 Hz (cf BC3.7).

CC.A.3.4 Testing Of Frequency Response Capability

The response capabilities shown diagrammatically in Figure CC.A.3.1 are measured by taking the responses as obtained from some of the dynamic response tests specified by **The Company** and carried out by **GB Generators** and **DC Converter Station** owners for compliance purposes and to validate the content of **Ancillary Services Agreements** using an injection of a **Frequency** change to the plant control system (i.e. governor and load controller). The injected signal is a linear ramp from zero to 0.5 Hz **Frequency** change over a ten second period, and is sustained at 0.5 Hz **Frequency** change thereafter, as illustrated diagrammatically in figures CC.A.3.2 and CC.A.3.3. In the case of an **Embedded Medium Power Station** not subject to a **Bilateral Agreement** or **Embedded DC Converter Station** not subject to a **Bilateral Agreement**, **The Company** may require the **Network Operator** within whose **System** the **Embedded Medium Power Station** or **Embedded DC Converter Station** is situated, to ensure that the **Embedded Person** performs the dynamic response tests reasonably required by **The Company** in order to demonstrate compliance within the relevant requirements in the **CC**.

The **Primary Response** capability (P) of a **Generating Unit** or a **CCGT Module** or **Power Park Module** or **DC Converter** is the minimum increase in **Active Power** output between 10 and 30 seconds after the start of the ramp injection as illustrated diagrammatically in Figure CC.A.3.2. This increase in **Active Power** output should be released increasingly with time over the period 0 to 10 seconds from the time of the start of the **Frequency** fall as illustrated by the response from Figure CC.A.3.2.

The **Secondary Response** capability (S) of a **Generating Unit** or a **CCGT Module** or **Power Park Module** or **DC Converter** is the minimum increase in **Active Power** output between 30 seconds and 30 minutes after the start of the ramp injection as illustrated diagrammatically in Figure CC.A.3.2.

The **High Frequency Response** capability (H) of a **Generating Unit** or a **CCGT Module** or **Power Park Module** or **DC Converter** is the decrease in **Active Power** output provided 10 seconds after the start of the ramp injection and sustained thereafter as illustrated diagrammatically in Figure CC.A.3.3. This reduction in **Active Power** output should be released increasingly with time over the period 0 to 10 seconds from the time of the start of the **Frequency** rise as illustrated by the response in Figure CC.A.3.2.

CC.A.3.5 Repeatability Of Response

When a **Generating Unit** or **CCGT Module** or **Power Park Module** or **DC Converter** has responded to a significant **Frequency** disturbance, its response capability must be fully restored as soon as technically possible. Full response capability should be restored no later than 20 minutes after the initial change of **System Frequency** arising from the **Frequency** disturbance.

Figure CC.A.3.1 - Minimum Frequency Response Requirement Profile for a 0.5 Hz frequency change from Target Frequency

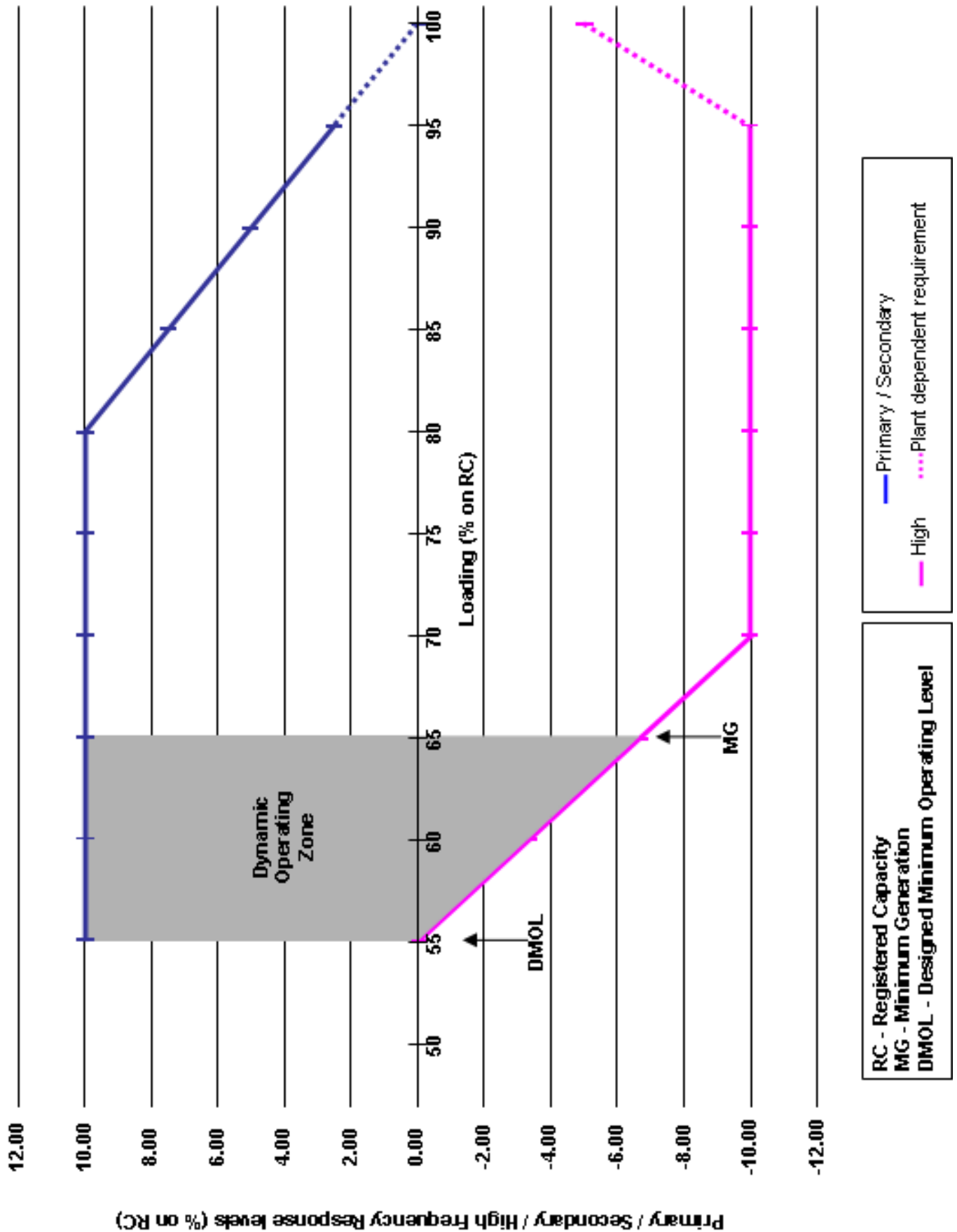

Figure CC.A.3.2 - Interpretation of Primary and Secondary Response Values

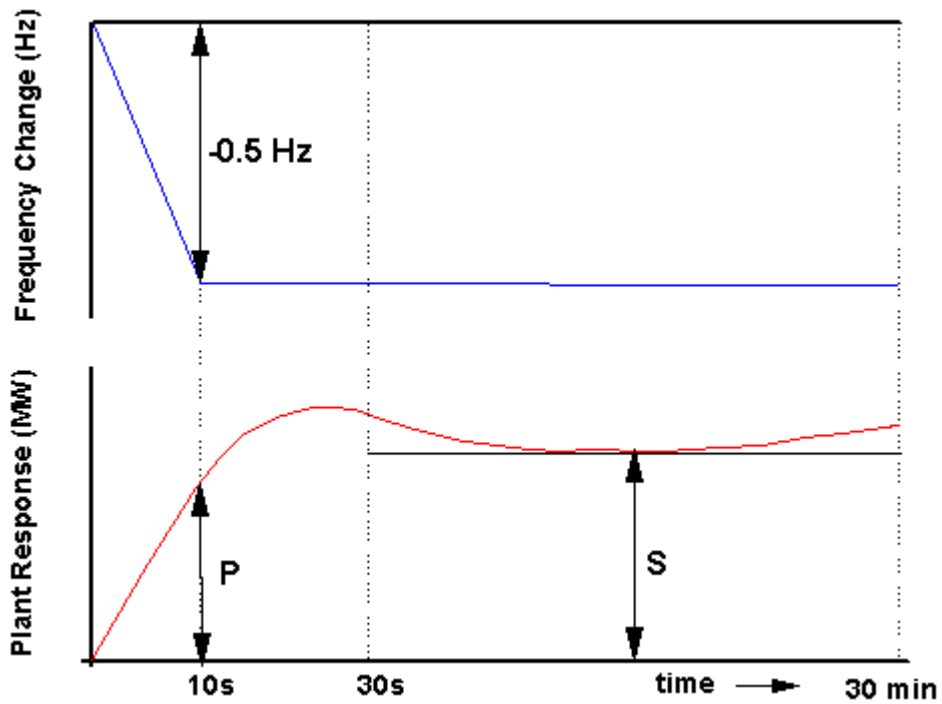
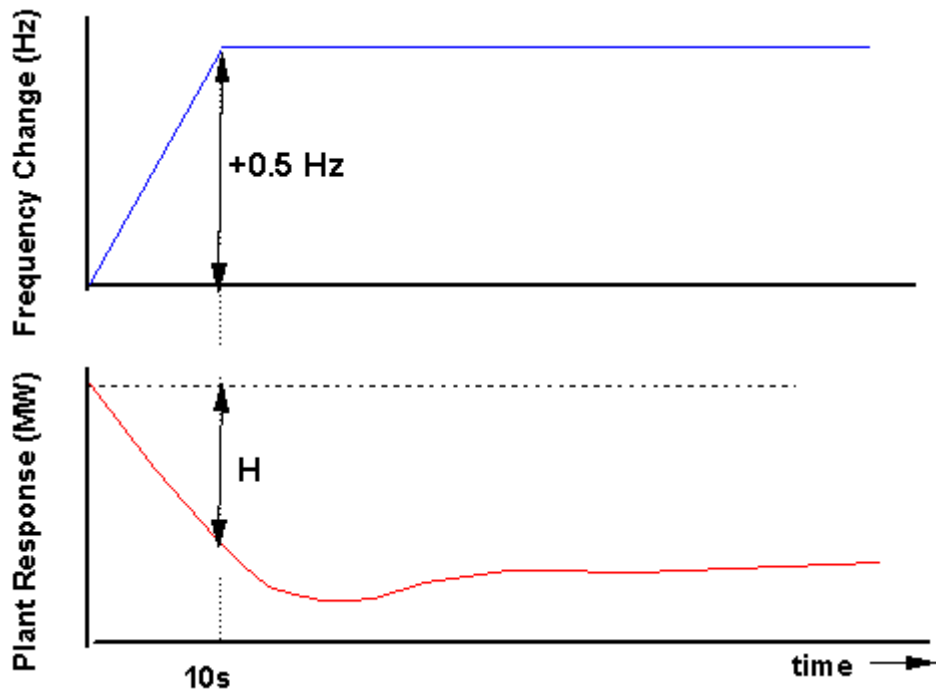

Figure CC.A.3.3 - Interpretation of High Frequency Response Values



APPENDIX 4 - FAULT RIDE THROUGH REQUIREMENTS

APPENDIX 4A - FAULT RIDE THROUGH REQUIREMENTS FOR ONSHORE SYNCHRONOUS GENERATING UNITS, ONSHORE POWER PARK MODULES, ONSHORE DC CONVERTERS OTSDUW PLANT AND APPARATUS AT THE INTERFACE POINT, OFFSHORE SYNCHRONOUS GENERATING UNITS IN A LARGE POWER STATION, OFFSHORE POWER PARK MODULES IN A LARGE POWER STATION AND OFFSHORE DC CONVERTERS IN A LARGE POWER STATION WHICH SELECT TO MEET THE FAULT RIDE THROUGH REQUIREMENTS AT THE INTERFACE POINT

CC.A.4A.1 Scope

The fault ride through requirement is defined in CC.6.3.15.1 (a), (b) and CC.6.3.15.3. This Appendix provides illustrations by way of examples only of CC.6.3.15.1 (a) (i) and further background and illustrations to CC.6.3.15.1 (1b) (i) and CC.6.3.15.1 (2b) (i) and is not intended to show all possible permutations.

CC.A.4A.2 Short Circuit Faults At Supergrid Voltage On The Onshore Transmission System Up To 140ms In Duration

For short circuit faults at **Supergrid Voltage** on the **Onshore Transmission System** (which could be at an **Interface Point**) up to 140ms in duration, the fault ride through requirement is defined in CC.6.3.15.1 (a) (i). Figures CC.A.4A.1 (a) and (b) illustrate two typical examples of voltage recovery for short-circuit faults cleared within 140ms by two circuit breakers (a) and three circuit breakers (b) respectively.

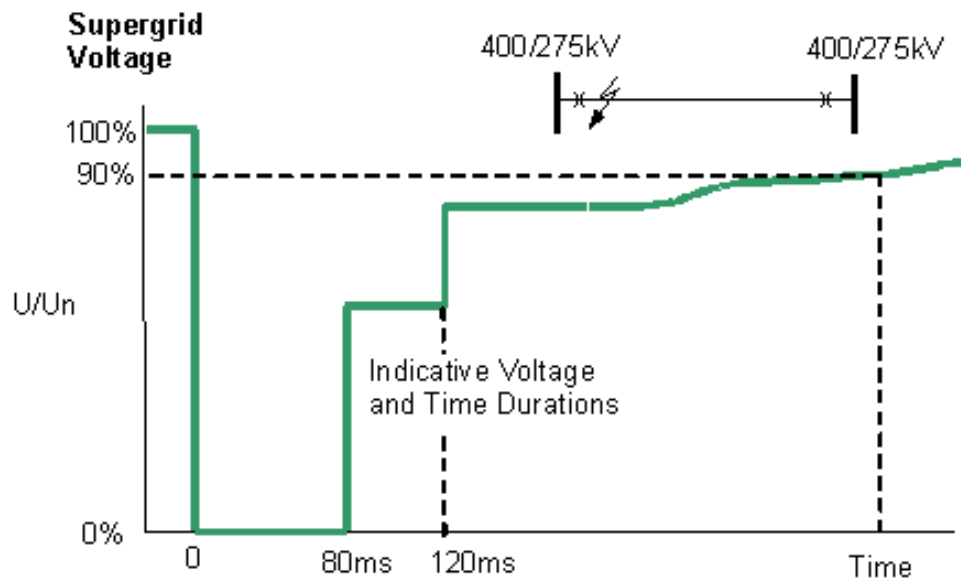

Typical fault cleared in less than 140ms: 2 ended circuit

Figure CC.A.4A.1 (a)

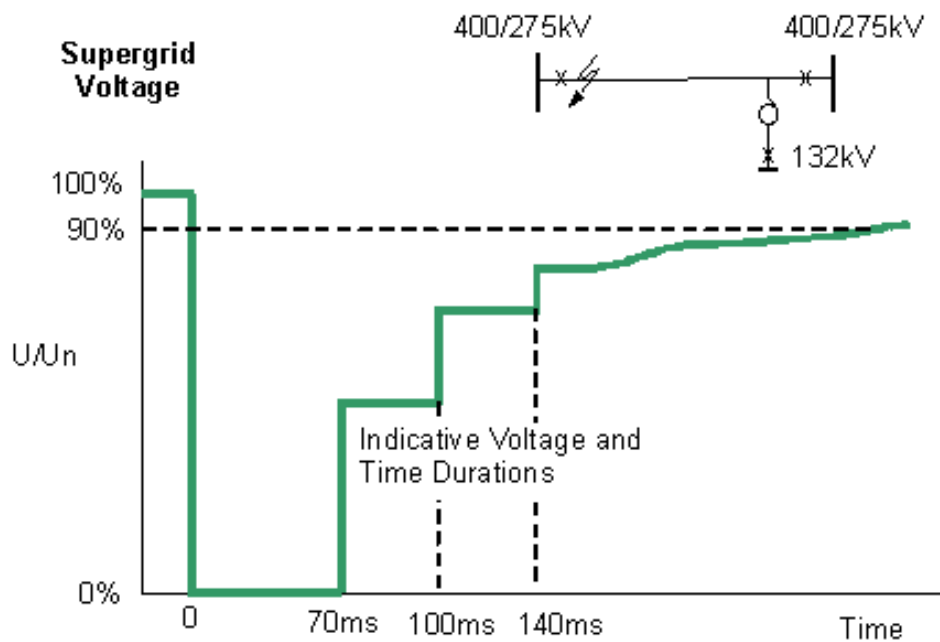

Typical fault cleared in 140ms:- 3 ended circuit

Figure CC.A.4A.1 (b)

CC.A.4A.3 Supergrid Voltage Dips On The Onshore Transmission System Greater Than 140ms In Duration

CC.A.4A3.1 Requirements applicable to **Synchronous Generating Units** subject to **Supergrid Voltage** dips on the **Onshore Transmission System** greater than 140ms in duration.

For balanced **Supergrid Voltage** dips on the **Onshore Transmission System** having durations greater than 140ms and up to 3 minutes, the fault ride through requirement is defined in CC.6.3.15.1 (1b) and Figure 5a which is reproduced in this Appendix as Figure CC.A.4A3.1 and termed the voltage–duration profile.

This profile is not a voltage-time response curve that would be obtained by plotting the transient voltage response at a point on the **Onshore Transmission System** (or **User System** if located **Onshore**) to a disturbance. Rather, each point on the profile (i.e. the heavy black line) represents a voltage level and an associated time duration which connected **Synchronous Generating Units** must withstand or ride through.

Figures CC.A.4A3.2 (a), (b) and (c) illustrate the meaning of the voltage-duration profile for voltage dips having durations greater than 140ms.

NOT TO SCALE

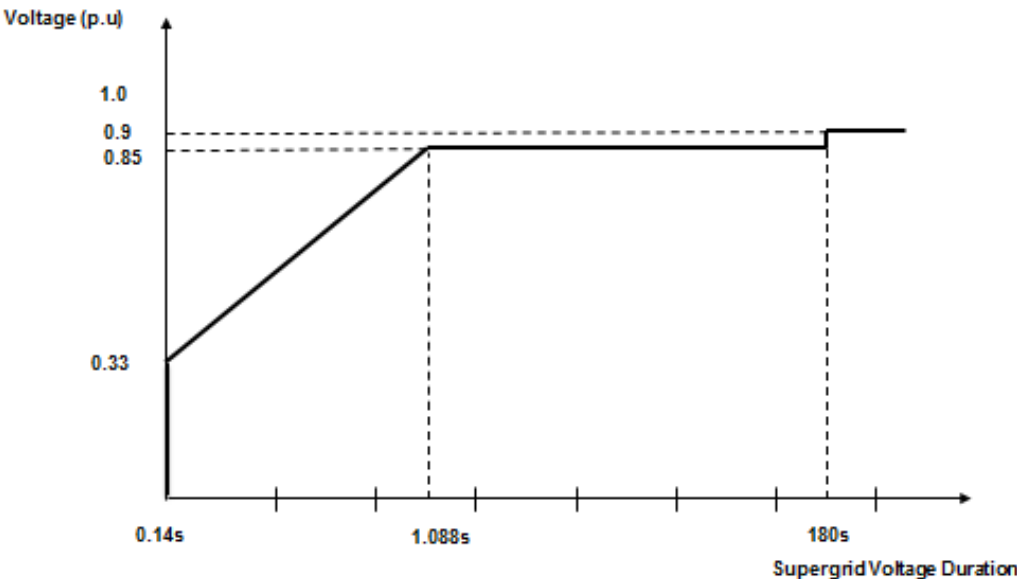

Figure CC.A.4A3.1

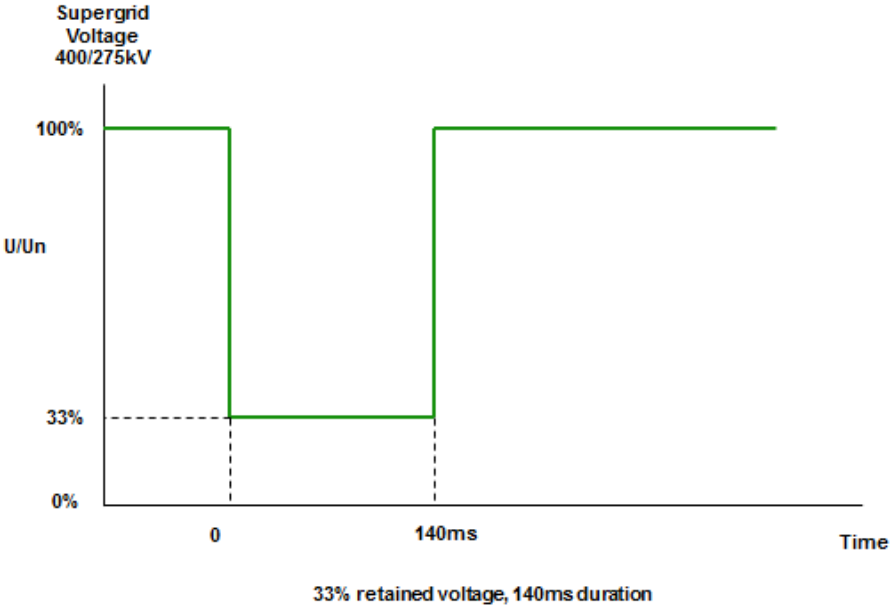

Figure CC.A.4A3.2 (a)

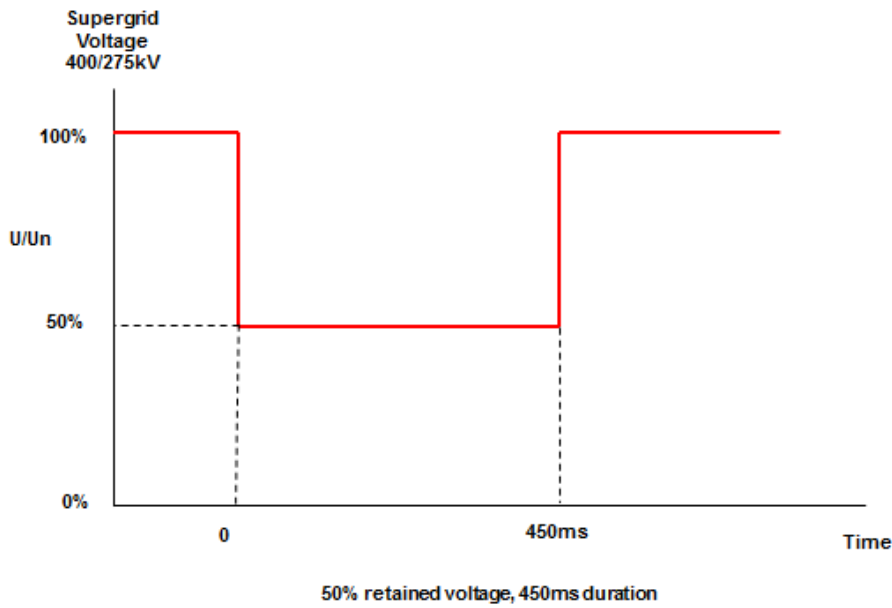

Figure CC.A.4A3.2 (b)

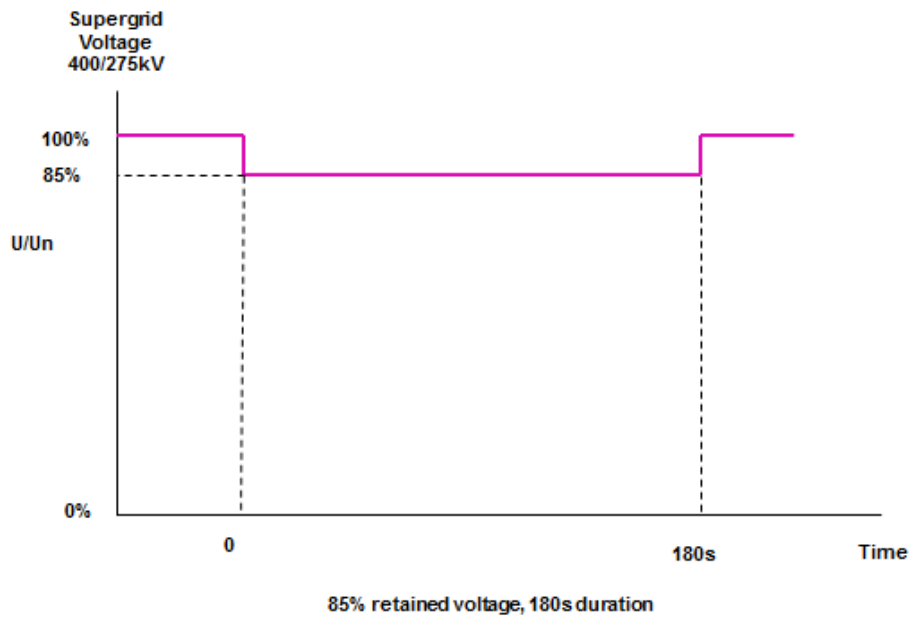

Figure CC.A.4A3.2 (c)

CC.A.4A3.2 Requirements applicable to **Power Park Modules** or **OTSDUW Plant and Apparatus** subject to **Supergrid Voltage** dips on the **Onshore Transmission System** greater than 140ms in duration

For balanced **Supergrid Voltage** dips on the **Onshore Transmission System** (which could be at an **Interface Point**) having durations greater than 140ms and up to 3 minutes the fault ride through requirement is defined in CC.6.3.15.1 (2b) and Figure 5b which is reproduced in this Appendix as Figure CC.A.4A3.3 and termed the voltage–duration profile.

This profile is not a voltage-time response curve that would be obtained by plotting the transient voltage response at a point on the **Onshore Transmission System** (or **User System** if located **Onshore**) to a disturbance. Rather, each point on the profile (i.e. the heavy black line) represents a voltage level and an associated time duration which connected **Power Park Modules** or **OTSDUW Plant and Apparatus** must withstand or ride through.

Figures CC.A.4A.4 (a), (b) and (c) illustrate the meaning of the voltage-duration profile for voltage dips having durations greater than 140ms.

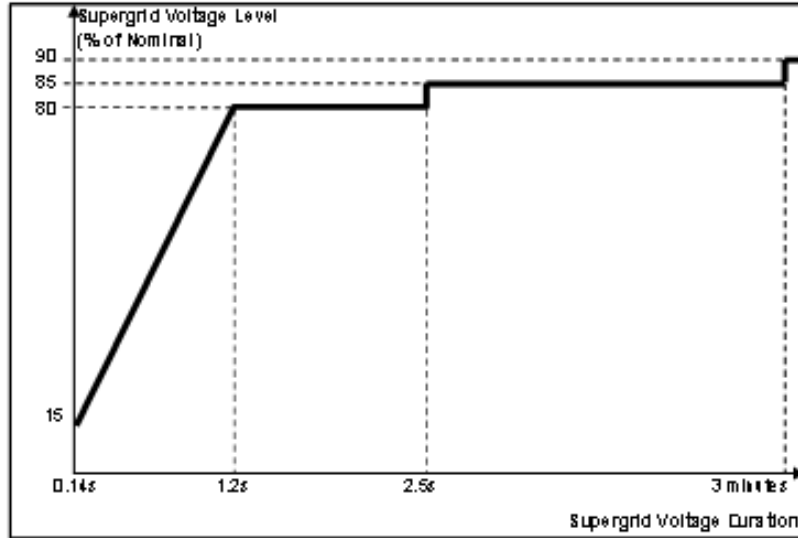
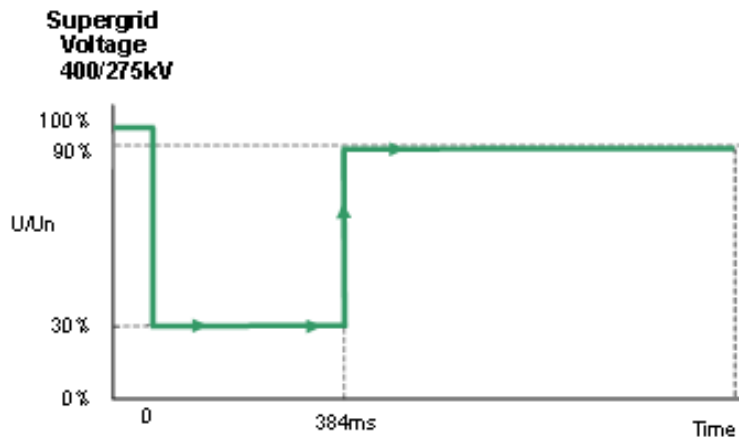

Figure CC.A.4A3.3



30 % retained voltage, 384ms duration

Figure CC.A.4A3.4 (a)

**Supergrid
Voltage
400/275kV**

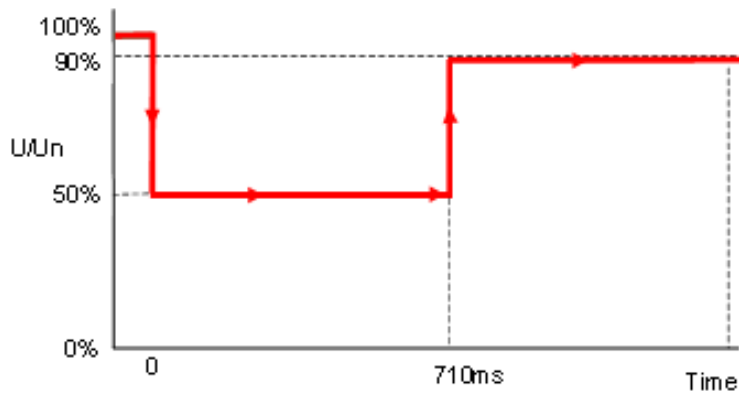

50% retained voltage, 710ms duration

Figure CC.A.4A3.4 (b)

**Supergrid
Voltage
400/275kV**

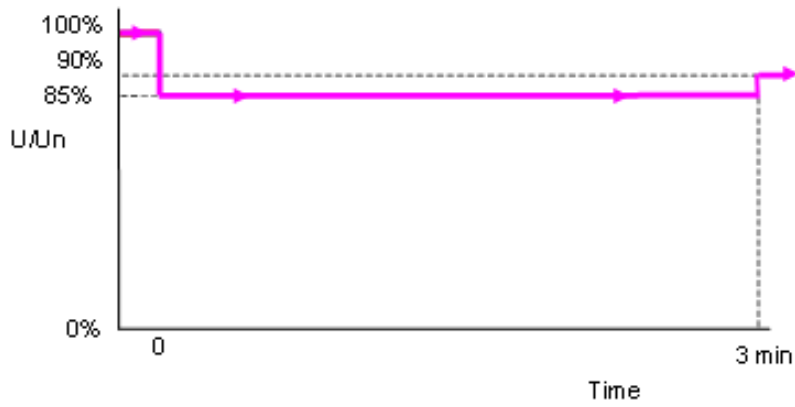

85% retained voltage, 3 minutes duration

Figure CC.A.4A3.4 (c)

APPENDIX 4B - FAULT RIDE THROUGH REQUIREMENTS FOR OFFSHORE GENERATING UNITS IN A LARGE POWER STATION, OFFSHORE POWER PARK MODULES IN A LARGE POWER STATION AND OFFSHORE DC CONVERTERS IN A LARGE POWER STATION WHICH SELECT TO MEET THE FAULT RIDE THROUGH REQUIREMENTS AT THE LV SIDE OF THE OFFSHORE PLATFORM AS SPECIFIED IN CC.6.3.15.2

CC.A.4B.1 Scope

The fault ride through requirement is defined in CC.6.3.15.2 (a), (b) and CC.6.3.15.3. This Appendix provides illustrations by way of examples only of CC.6.3.15.2 (a) (i) and further background and illustrations to CC.6.3.15.2 (1b) and CC.6.3.15.2 (2b) and is not intended to show all possible permutations.

CC.A.4B.2 Voltage Dips On The LV Side Of The Offshore Platform Up To 140ms In Duration

For voltage dips on the **LV Side of the Offshore Platform** which last up to 140ms in duration, the fault ride through requirement is defined in CC.6.3.15.2 (a) (i). This includes Figure 6 which is reproduced here in Figure CC.A.4B.1. The purpose of this requirement is to translate the conditions caused by a balanced or unbalanced fault which occurs on the **Onshore Transmission System** (which may include the **Interface Point**) at the **LV Side of the Offshore Platform**.

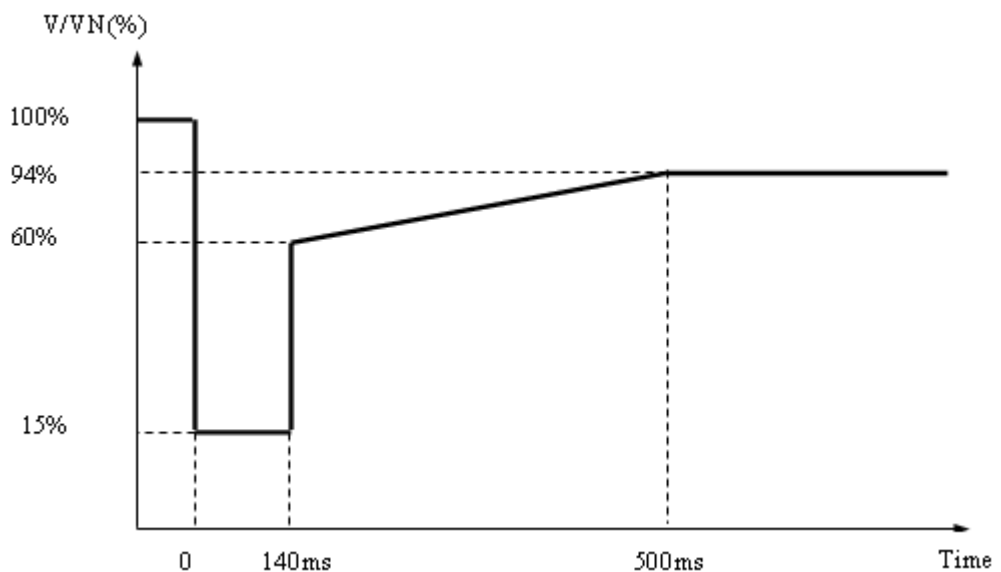

V/V_N is the ratio of the voltage at the **LV side of the Offshore Platform** to the nominal voltage of the LV side of the **Offshore Platform**.

Figure CC.A.4B.1

Figures CC.A.4B.2 (a) and CC.A.4B.2 (b) illustrate two typical examples of the voltage recovery seen at the **LV Side of the Offshore Platform** for a short circuit fault cleared within 140ms by (a) two circuit breakers and (b) three circuit breakers on the **Onshore Transmission System**.

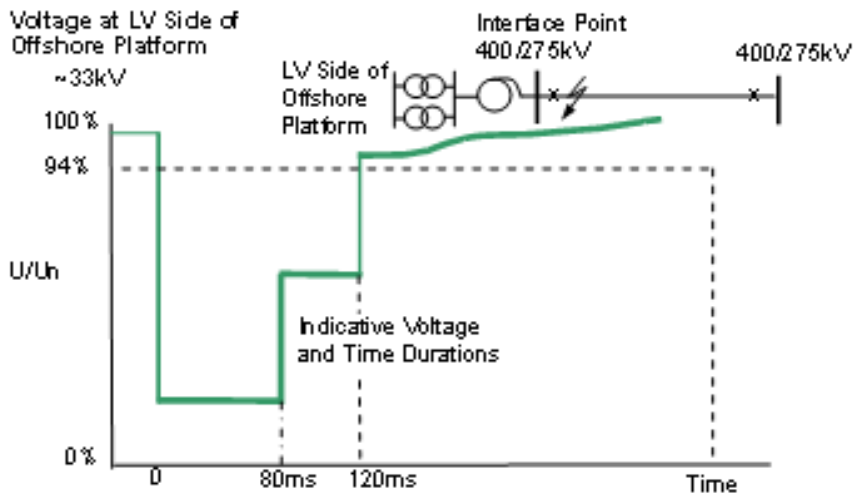

Typical fault cleared in less than 140ms: 2 ended circuit

Figure CC.A.4B.2 (a)

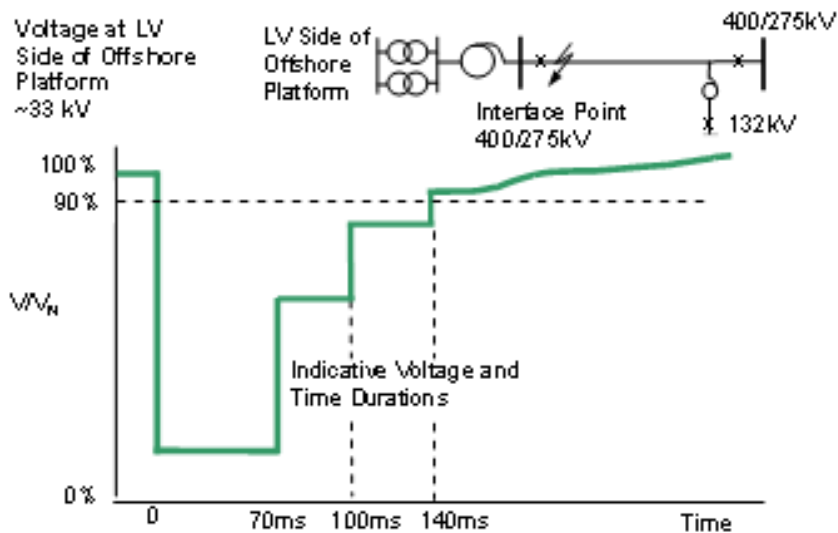

Typical fault cleared in 140ms:- 3 ended circuit

Figure CC.A.4B.2 (b)

CCA.4B.3 Voltage Dips Which Occur On The LV Side Of The Offshore Platform Greater Than 140ms In Duration

CC.A.4B.3.1 Requirements applicable to **Offshore Synchronous Generating Units** subject to voltage dips which occur on the **LV Side of the Offshore Platform** greater than 140ms in duration.

In addition to CC.A.4B.2 the fault ride through requirements applicable to **Offshore Synchronous Generating Units** during balanced voltage dips which occur at the **LV Side of the Offshore Platform** and having durations greater than 140ms and up to 3 minutes are defined in CC.6.3.15.2 (1b) and Figure 7a which is reproduced in this Appendix as Figure CC.A.4B.3.1 and termed the voltage-duration profile.

This profile is not a voltage-time response curve that would be obtained by plotting the transient voltage response at the **LV Side of the Offshore Platform** to a disturbance. Rather, each point on the profile (i.e. the heavy black line) represents a voltage level and an associated time duration which connected **Offshore Synchronous Generating Units** must withstand or ride through.

Figures CC.A.4B3.2 (a), (b) and (c) illustrate the meaning of the voltage-duration profile for voltage dips having durations greater than 140ms.

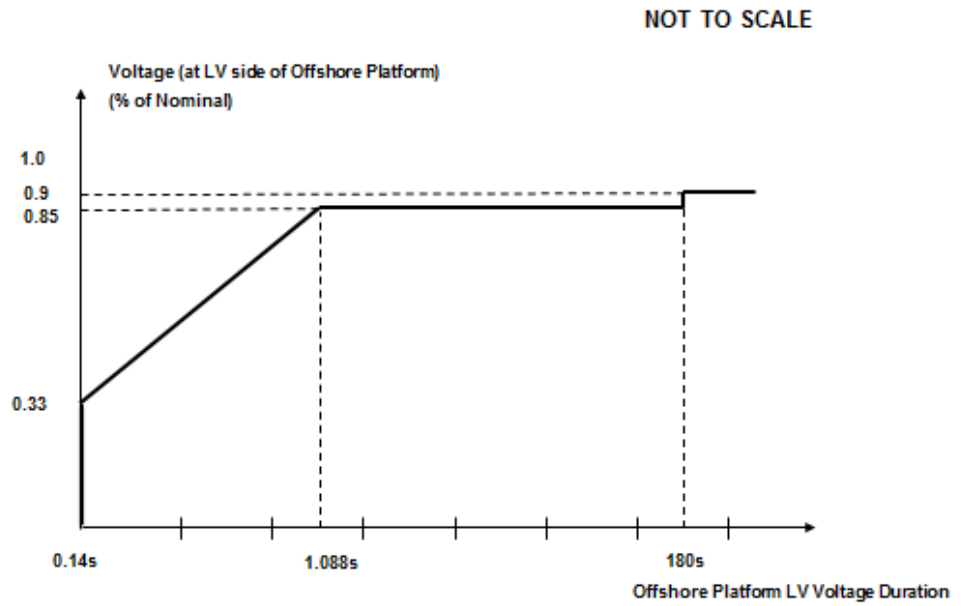

Figure CC.A.4B3.1

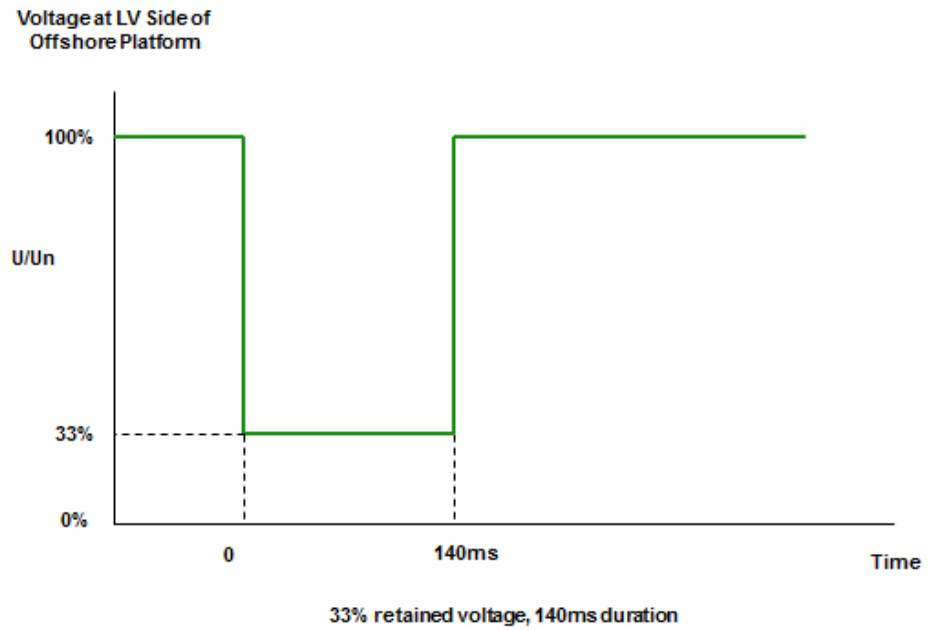
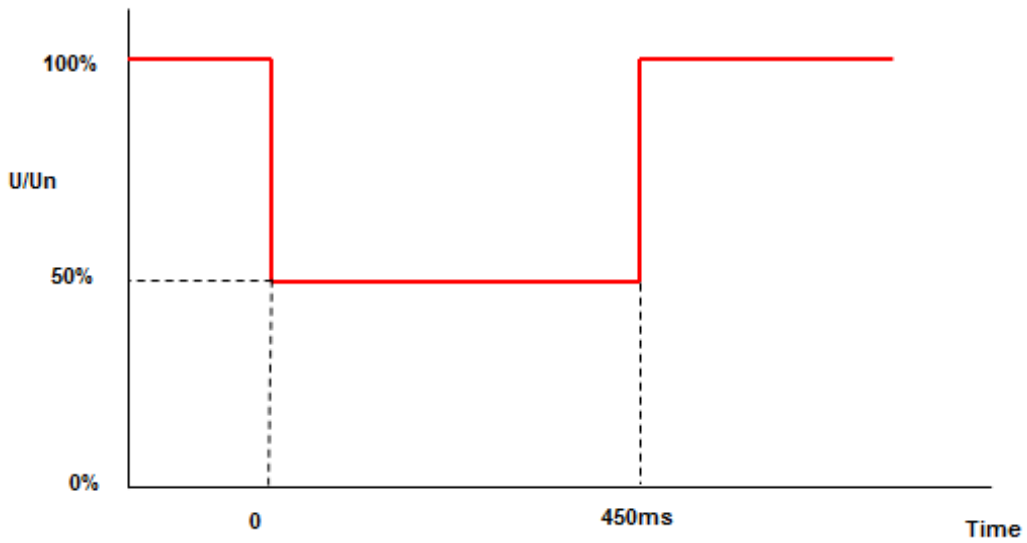

Figure CC.A.4B3.2 (a)

Voltage at LV Side of Offshore Platform



50% retained voltage, 450ms duration

Figure CC.A.4B3.2 (b)

Voltage at LV Side of Offshore Platform

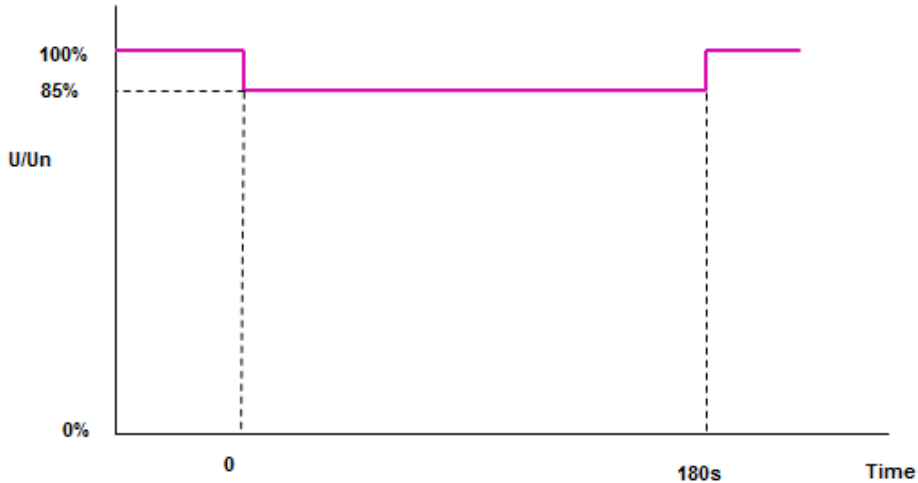

85% retained voltage, 180s duration

Figure CC.A.4B3.2 (c)

CC.A.4B.3.2 Requirements applicable to **Offshore Power Park Modules** subject to Voltage Dips Which Occur On The LV Side Of The Offshore Platform Greater Than 140ms in Duration.

In addition to CCA.4B.2 the fault ride through requirements applicable for **Offshore Power Park Modules** during balanced voltage dips which occur at the **LV Side of the Offshore Platform** and have durations greater than 140ms and up to 3 minutes are defined in CC.6.3.15.2 (2b) (i) and Figure 7b which is reproduced in this Appendix as Figure CC.A.4B.4 and termed the voltage–duration profile.

This profile is not a voltage-time response curve that would be obtained by plotting the transient voltage response at the **LV Side of the Offshore Platform** to a disturbance. Rather, each point on the profile (i.e. the heavy black line) represents a voltage level and an associated time duration which connected **Offshore Power Park Modules** must withstand or ride through.

Figures CC.A.4B.5 (a), (b) and (c) illustrate the meaning of the voltage-duration profile for voltage dips having durations greater than 140ms.

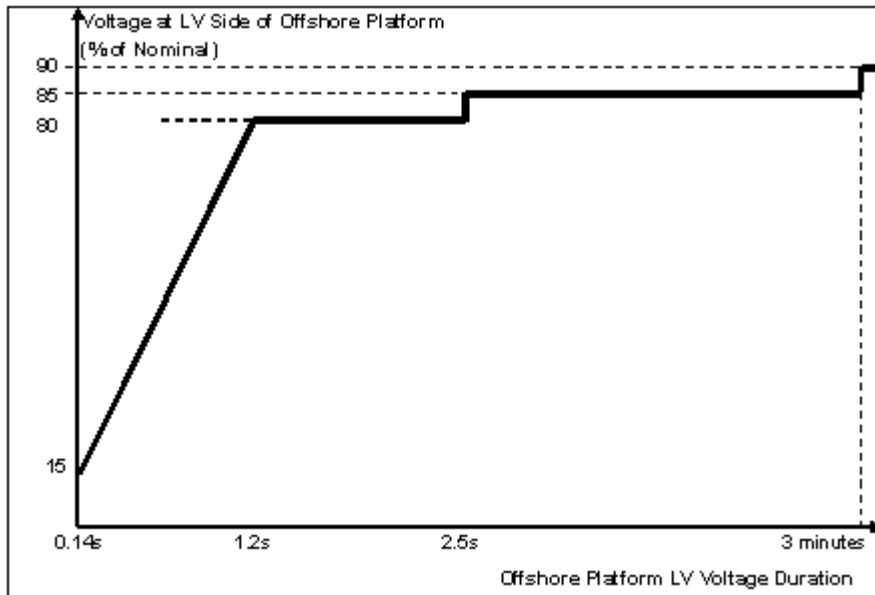

Figure CC.A.4B.4

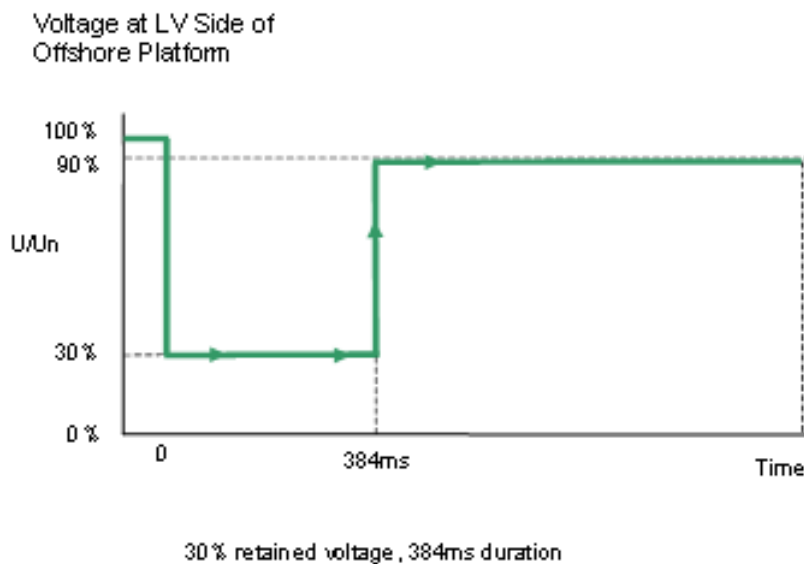
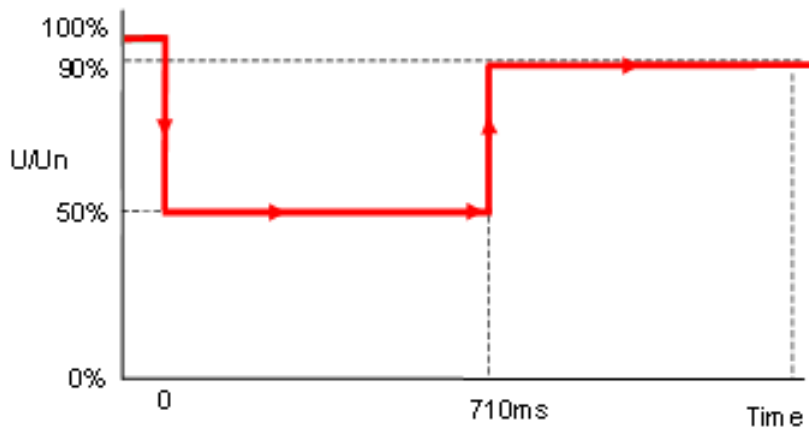

Figure CC.A.4B.5 (a)

Voltage at LV Side of Offshore Platform



50% retained voltage, 710ms duration

Figure CC.A.4B.5(b)

Voltage at LV Side of Offshore Platform

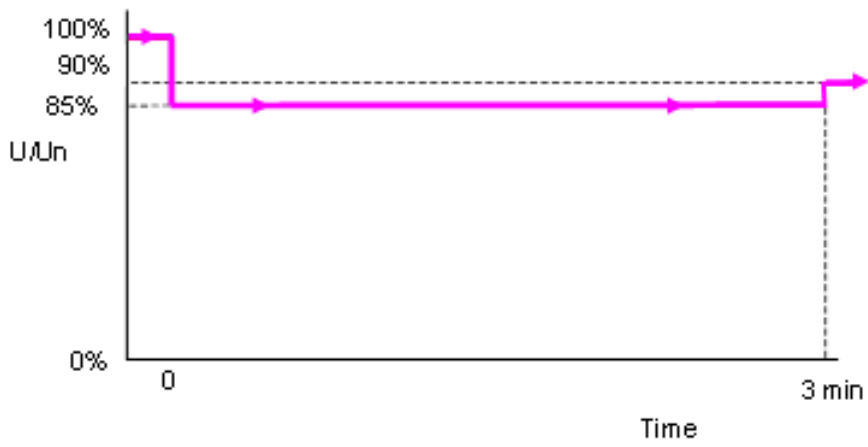

85% retained voltage, 3 minutes duration

Figure CC.A.4B.5(c)

APPENDIX 5 - TECHNICAL REQUIREMENTS

LOW FREQUENCY RELAYS FOR THE AUTOMATIC DISCONNECTION OF SUPPLIES AT LOW FREQUENCY

CC.A.5.1 Low Frequency Relays

CC.A.5.1.1 The **Low Frequency Relays** to be used shall have a setting range of 47.0 to 50Hz and be suitable for operation from a nominal AC input of 63.5, 110 or 240V. The following general parameters specify the requirements of approved **Low Frequency Relays** for automatic installations installed and commissioned after 1st April 2007 and provide an indication, without prejudice to the provisions that may be included in a **Bilateral Agreement**, for those installed and commissioned before 1st April 2007:

- (a) **Frequency** settings: 47-50Hz in steps of 0.05Hz or better, preferably 0.01Hz;
- (b) Operating time: Relay operating time shall not be more than 150 ms;
- (c) Voltage lock-out: Selectable within a range of 55 to 90% of nominal voltage;
- (d) Facility stages: One or two stages of **Frequency** operation;
- (e) Output contacts: Two output contacts per stage to be capable of repetitively making and breaking for 1000 operations;
- (f) Accuracy: 0.01 Hz maximum error under reference environmental and system voltage conditions.
0.05 Hz maximum error at 8% of total harmonic distortion
Electromagnetic Compatibility Level.

CC.A.5.2 Low Frequency Relay Voltage Supplies

CC.A.5.2.1 It is essential that the voltage supply to the **Low Frequency Relays** shall be derived from the primary **System** at the supply point concerned so that the **Frequency** of the **Low Frequency Relays** input voltage is the same as that of the primary **System**. This requires either:

- (a) the use of a secure supply obtained from voltage transformers directly associated with the grid transformer(s) concerned, the supply being obtained where necessary via a suitable automatic voltage selection scheme; or
- (b) the use of the substation 240V phase-to-neutral selected auxiliary supply, provided that this supply is always derived at the supply point concerned and is never derived from a standby supply **Generating Unit** or from another part of the **User System**.

CC.A.5.3 Scheme Requirements

CC.A.5.3.1 The tripping facility should be engineered in accordance with the following reliability considerations:

(a) Dependability

Failure to trip at any one particular **Demand** shedding point would not harm the overall operation of the scheme. However, many failures would have the effect of reducing the amount of **Demand** under low **Frequency** control. An overall reasonable minimum requirement for the dependability of the **Demand** shedding scheme is 96%, i.e. the average probability of failure of each **Demand** shedding point should be less than 4%. Thus the **Demand** under low **Frequency** control will not be reduced by more than 4% due to relay failure.

(b) Outages

Low **Frequency Demand** shedding schemes will be engineered such that the amount of **Demand** under control is as specified in Table CC.A.5.5.1a and is not reduced unacceptably during equipment outage or maintenance conditions.

CC.A.5.3.2 The total operating time of the scheme, including circuit breakers operating time, shall where reasonably practicable, be less than 200 ms. For the avoidance of doubt, the replacement of plant installed prior to October 2009 will not be required in order to achieve lower total scheme operating times.

CC.A.5.4 Low Frequency Relay Testing

CC.A.5.4.1 **Low Frequency Relays** installed and commissioned after 1st January 2007 shall be type tested in accordance with and comply with the functional test requirements for **Frequency Protection** contained in Energy Networks Association Technical Specification 48-6-5 Issue 1 dated 2005 “**ENA Protection Assessment Functional Test Requirements – Voltage and Frequency Protection**”.

For the avoidance of doubt, **Low Frequency Relays** installed and commissioned before 1st January 2007 shall comply with the version of CC.A.5.1.1 applicable at the time such **Low Frequency Relays** were commissioned.

CC.A.5.5 Scheme Settings

CC.A.5.5.1 Table CC.A.5.5.1a shows, for each **Transmission Area**, the percentage of **Demand** (based on **Annual ACS Conditions**) at the time of forecast **National Electricity Transmission System** peak **Demand** that each **Network Operator** whose **System** is connected to the **Onshore Transmission System** within such **Transmission Area** shall disconnect by **Low Frequency Relays** at a range of frequencies. Where a **Network Operator’s System** is connected to the **National Electricity Transmission System** in more than one **Transmission Area**, the settings for the **Transmission Area** in which the majority of the **Demand** is connected shall apply.

Frequency Hz	% Demand disconnection for each Network Operator in Transmission Area		
	The Company	SPT	SHETL
48.8	5		
48.75	5		
48.7	10		
48.6	7.5		10
48.5	7.5	10	
48.4	7.5	10	10
48.2	7.5	10	10
48.0	5	10	10
47.8	5		
Total % Demand	60	40	40

Table CC.A.5.5.1a

Note – the percentages in table CC.A.5.5.1a are cumulative such that, for example, should the frequency fall to 48.6 Hz in **The Company Transmission Area**, 27.5% of the total **Demand** connected to the **National Electricity Transmission System** in **The Company Transmission Area** shall be disconnected by the action of **Low Frequency Relays**.

The percentage **Demand** at each stage shall be allocated as far as reasonably practicable. The cumulative total percentage **Demand** is a minimum.

APPENDIX 6 - PERFORMANCE REQUIREMENTS FOR CONTINUOUSLY ACTING AUTOMATIC EXCITATION CONTROL SYSTEMS FOR ONSHORE SYNCHRONOUS GENERATING UNITS

CC.A.6.1 Scope

CC.A.6.1.1 This Appendix sets out the performance requirements of continuously acting automatic excitation control systems for **Onshore Synchronous Generating Units** that must be complied with by the **GB Code User**. This Appendix does not limit any site specific requirements that may be included in a **Bilateral Agreement** where in **The Company's** reasonable opinion these facilities are necessary for system reasons.

CC.A.6.1.2 Where the requirements may vary the likely range of variation is given in this Appendix. It may be necessary to specify values outside this range where **The Company** identifies a system need, and notwithstanding anything to the contrary **The Company** may specify in the **Bilateral Agreement** values outside of the ranges provided in this Appendix 6. The most common variations are in the on-load excitation ceiling voltage requirements and the response time required of the **Exciter**. Actual values will be included in the **Bilateral Agreement**.

CC.A.6.1.3 Should a **GB Generator** anticipate making a change to the excitation control system it shall notify **The Company** under the **Planning Code** (PC.A.1.2(b) and (c)) as soon as the **GB Generator** anticipates making the change. The change may require a revision to the **Bilateral Agreement**.

CC.A.6.2 Requirements

CC.A.6.2.1 The **Excitation System** of an **Onshore Synchronous Generating Unit** shall include an excitation source (**Exciter**), a **Power System Stabiliser** and a continuously acting **Automatic Voltage Regulator (AVR)** and shall meet the following functional specification.

CC.A.6.2.2 In respect of **Onshore Synchronous Generating Units** with a **Completion Date** on or after 1 January 2009, and **Onshore Synchronous Generating Units** with a **Completion Date** before 1 January 2009 subject to a **Modification** to the excitation control facilities where the **Bilateral Agreement** does not specify otherwise, the continuously acting automatic excitation control system shall include a **Power System Stabiliser (PSS)** as a means of supplementary control. The functional specification of the **Power System Stabiliser** is included in CC.A.6.2.5.

CC.A.6.2.3 Steady State Voltage Control

CC.A.6.2.3.1 An accurate steady state control of the **Onshore Generating Unit** pre-set terminal voltage is required. As a measure of the accuracy of the steady-state voltage control, the **Automatic Voltage Regulator** shall have static zero frequency gain, sufficient to limit the change in terminal voltage to a drop not exceeding 0.5% of rated terminal voltage, when the **Onshore Generating Unit** output is gradually changed from zero to rated MVA output at rated voltage, **Active Power** and **Frequency**.

CC.A.6.2.4 Transient Voltage Control

CC.A.6.2.4.1 For a step change from 90% to 100% of the nominal **Onshore Generating Unit** terminal voltage, with the **Onshore Generating Unit** on open circuit, the **Excitation System** response shall have a damped oscillatory characteristic. For this characteristic, the time for the **Onshore Generating Unit** terminal voltage to first reach 100% shall be less than 0.6 seconds. Also, the time to settle within 5% of the voltage change shall be less than 3 seconds.

CC.A.6.2.4.2 To ensure that adequate synchronising power is maintained, when the **Onshore Generating Unit** is subjected to a large voltage disturbance, the **Exciter** whose output is varied by the **Automatic Voltage Regulator** shall be capable of providing its achievable upper and lower limit ceiling voltages to the **Onshore Generating Unit** field in a time not exceeding that specified in the **Bilateral Agreement**. This will normally be not less than 50 ms and not greater than 300 ms. The achievable upper and lower limit ceiling voltages may be dependent on the voltage disturbance.

- CC.A.6.2.4.3 The **Exciter** shall be capable of attaining an **Excitation System On Load Positive Ceiling Voltage** of not less than a value specified in the **Bilateral Agreement** that will be:
- not less than 2 per unit (pu)
 - normally not greater than 3 pu
 - exceptionally up to 4 pu
- of **Rated Field Voltage** when responding to a sudden drop in voltage of 10 percent or more at the **Onshore Generating Unit** terminals. **The Company** may specify a value outside the above limits where **The Company** identifies a system need.
- CC.A.6.2.4.4 If a static type **Exciter** is employed:
- (i) the field voltage should be capable of attaining a negative ceiling level specified in the **Bilateral Agreement** after the removal of the step disturbance of CC.A.6.2.4.3. The specified value will be 80% of the value specified in CC.A.6.2.4.3. **The Company** may specify a value outside the above limits where **The Company** identifies a system need.
 - (ii) the **Exciter** must be capable of maintaining free firing when the **Onshore Generating Unit** terminal voltage is depressed to a level which may be between 20% to 30% of rated terminal voltage
 - (iii) the **Exciter** shall be capable of attaining a positive ceiling voltage not less than 80% of the **Excitation System On Load Positive Ceiling Voltage** upon recovery of the **Onshore Generating Unit** terminal voltage to 80% of rated terminal voltage following fault clearance. **The Company** may specify a value outside the above limits where **The Company** identifies a system need.
 - (iv) The requirement to provide a separate power source for the **Exciter** will be specified in the **Bilateral Agreement** if **NGET** identifies a **Transmission System** need.
- CC.A.6.2.5 Power Oscillations Damping Control
- CC.A.6.2.5.1 To allow the **Onshore Generating Unit** to maintain second and subsequent swing stability and also to ensure an adequate level of low frequency electrical damping power, the **Automatic Voltage Regulator** shall include a **Power System Stabiliser** as a means of supplementary control.
- CC.A.6.2.5.2 Whatever supplementary control signal is employed, it shall be of the type which operates into the **Automatic Voltage Regulator** to cause the field voltage to act in a manner which results in the damping power being improved while maintaining adequate synchronising power.
- CC.A.6.2.5.3 The arrangements for the supplementary control signal shall ensure that the **Power System Stabiliser** output signal relates only to changes in the supplementary control signal and not the steady state level of the signal. For example, if generator electrical power output is chosen as a supplementary control signal then the **Power System Stabiliser** output should relate only to changes in generator electrical power output and not the steady state level of power output. Additionally the **Power System Stabiliser** should not react to mechanical power changes in isolation for example during rapid changes in steady state load or when providing frequency response.
- CC.A.6.2.5.4 The output signal from the **Power System Stabiliser** shall be limited to not more than $\pm 10\%$ of the **Onshore Generating Unit** terminal voltage signal at the **Automatic Voltage Regulator** input. The gain of the **Power System Stabiliser** shall be such that an increase in the gain by a factor of 3 shall not cause instability.
- CC.A.6.2.5.5 The **Power System Stabiliser** shall include elements that limit the bandwidth of the output signal. The bandwidth limiting must ensure that the highest frequency of response cannot excite torsional oscillations on other plant connected to the network. A bandwidth of 0-5Hz would be judged to be acceptable for this application.

- CC.A.6.2.5.6 The **GB Generator** will agree **Power System Stabiliser** settings with **NGET The Company** prior to the on-load commissioning detailed in BC2.11.2(d). To allow assessment of the performance before on-load commissioning the **GB Generator** will provide to **The Company** a report covering the areas specified in CP.A.3.2.1.
- CC.A.6.2.5.7 The **Power System Stabiliser** must be active within the **Excitation System** at all times when **Synchronised** including when the **Under Excitation Limiter** or **Over Excitation Limiter** are active. When operating at low load when **Synchronising** or **De-Synchronising** an **Onshore Generating Unit**, the **Power System Stabiliser** may be out of service.
- CC.A.6.2.5.8 Where a **Power System Stabiliser** is fitted to a **Pumped Storage Unit** it must function when the **Pumped Storage Unit** is in both generating and pumping modes.
- CC.A.6.2.6 Overall **Excitation System** Control Characteristics
- CC.A.6.2.6.1 The overall **Excitation System** shall include elements that limit the bandwidth of the output signal. The bandwidth limiting must be consistent with the speed of response requirements and ensure that the highest frequency of response cannot excite torsional oscillations on other plant connected to the network. A bandwidth of 0-5 Hz will be judged to be acceptable for this application.
- CC.A.6.2.6.2 The response of the **Automatic Voltage Regulator** combined with the **Power System Stabiliser** shall be demonstrated by injecting similar step signal disturbances into the **Automatic Voltage Regulator** reference as detailed in OC5A.2.2 and OC5.A.2.4. The **Automatic Voltage Regulator** shall include a facility to allow step injections into the **Automatic Voltage Regulator** voltage reference, with the **Onshore Generating Unit** operating at points specified by **The Company** (up to rated MVA output). The damping shall be judged to be adequate if the corresponding **Active Power** response to the disturbances decays within two cycles of oscillation.
- CC.A.6.2.6.3 A facility to inject a band limited random noise signal into the **Automatic Voltage Regulator** voltage reference shall be provided for demonstrating the frequency domain response of the **Power System Stabiliser**. The tuning of the **Power System Stabiliser** shall be judged to be adequate if the corresponding **Active Power** response shows improved damping with the **Power System Stabiliser** in combination with the **Automatic Voltage Regulator** compared with the **Automatic Voltage Regulator** alone over the frequency range 0.3Hz – 2Hz.
- CC.A.6.2.7 Under-Excitation Limiters
- CC.A.6.2.7.1 The security of the power system shall also be safeguarded by means of MVAR **Under Excitation Limiters** fitted to the generator **Excitation System**. The **Under Excitation Limiter** shall prevent the **Automatic Voltage Regulator** reducing the generator excitation to a level which would endanger synchronous stability. The **Under Excitation Limiter** shall operate when the excitation system is providing automatic control. The **Under Excitation Limiter** shall respond to changes in the **Active Power** (MW) and the **Reactive Power** (MVAR), and to the square of the generator voltage in such a direction that an increase in voltage will permit an increase in leading MVAR. The characteristic of the **Under Excitation Limiter** shall be substantially linear from no-load to the maximum **Active Power** output of the **Onshore Generating Unit** at any setting and shall be readily adjustable.
- CC.A.6.2.7.2 The performance of the **Under Excitation Limiter** shall be independent of the rate of change of the **Onshore Generating Unit** load and shall be demonstrated by testing as detailed in OC5.A.2.5. The resulting maximum overshoot in response to a step injection which operates the **Under Excitation Limiter** shall not exceed 4% of the **Onshore Generating Unit** rated MVA. The operating point of the **Onshore Generating Unit** shall be returned to a steady state value at the limit line and the final settling time shall not be greater than 5 seconds. When the step change in **Automatic Voltage Regulator** reference voltage is reversed, the field voltage should begin to respond without any delay and should not be held down by the **Under Excitation Limiter**. Operation into or out of the preset limit levels shall ensure that any resultant oscillations are damped so that the disturbance is within 0.5% of the **Onshore Generating Unit** MVA rating within a period of 5 seconds.

- CC.A.6.2.7.3 The **GB Generator** shall also make provision to prevent the reduction of the **Onshore Generating Unit** excitation to a level which would endanger synchronous stability when the **Excitation System** is under manual control.
- CC.A.6.2.8 Over-Excitation Limiters
- CC.A.6.2.8.1 The settings of the **Over-Excitation Limiter**, where it exists, shall ensure that the generator excitation is not limited to less than the maximum value that can be achieved whilst ensuring the **Onshore Generating Unit** is operating within its design limits. If the generator excitation is reduced following a period of operation at a high level, the rate of reduction shall not exceed that required to remain within any time dependent operating characteristics of the **Onshore Generating Unit**.
- CC.A.6.2.8.2 The performance of the **Over-Excitation Limiter**, where it exists, shall be demonstrated by testing as described in OC5.A.2.6. Any operation beyond the **Over-Excitation Limit** shall be controlled by the **Over-Excitation Limiter** without the operation of any **Protection** that could trip the **Onshore Generating Unit**.
- CC.A.6.2.8.3 The **GB Generator** shall also make provision to prevent any over-excitation restriction of the generator when the **Excitation System** is under manual control, other than that necessary to ensure the **Onshore Generating Unit** is operating within its design limits.

APPENDIX 7 - PERFORMANCE REQUIREMENTS FOR CONTINUOUSLY ACTING AUTOMATIC VOLTAGE CONTROL SYSTEMS FOR ONSHORE NON-SYNCHRONOUS GENERATING UNITS, ONSHORE DC CONVERTERS, ONSHORE POWER PARK MODULES AND OTSDUW PLANT AND APPARATUS AT THE INTERFACE POINT

CC.A.7.1 Scope

CC.A.7.1.1 This Appendix sets out the performance requirements of continuously acting automatic voltage control systems for **Onshore Non-Synchronous Generating Units, Onshore DC Converters, Onshore Power Park Modules** and **OTSDUW Plant and Apparatus** at the **Interface Point** that must be complied with by the **GB Code User**. This Appendix does not limit any site specific requirements that may be included in a **Bilateral Agreement** where in **The Company's** reasonable opinion these facilities are necessary for system reasons.

CC.A.7.1.2 Proposals by **GB Generators** to make a change to the voltage control systems are required to be notified to **The Company** under the **Planning Code** (PC.A.1.2(b) and (c)) as soon as the **GB Generator** anticipates making the change. The change may require a revision to the **Bilateral Agreement**.

CC.A.7.2 Requirements

CC.A.7.2.1 **The Company** requires that the continuously acting automatic voltage control system for the **Onshore Non-Synchronous Generating Unit, Onshore DC Converter** or **Onshore Power Park Module** or **OTSDUW Plant and Apparatus** shall meet the following functional performance specification. If a **Network Operator** has confirmed to **The Company** that its network to which an **Embedded Onshore Non-Synchronous Generating Unit, Onshore DC Converter, Onshore Power Park Module** or **OTSDUW Plant and Apparatus** is connected is restricted such that the full reactive range under the steady state voltage control requirements (CC.A.7.2.2) cannot be utilised, **The Company** may specify in the **Bilateral Agreement** alternative limits to the steady state voltage control range that reflect these restrictions. Where the **Network Operator** subsequently notifies **The Company** that such restriction has been removed, **The Company** may propose a **Modification** to the **Bilateral Agreement** (in accordance with the **CUSC** contract) to remove the alternative limits such that the continuously acting automatic voltage control system meets the following functional performance specification. All other requirements of the voltage control system will remain as in this Appendix.

CC.A.7.2.2 Steady State Voltage Control

CC.A.7.2.2.1 The **Onshore Non-Synchronous Generating Unit, Onshore DC Converter, Onshore Power Park Module** or **OTSDUW Plant and Apparatus** shall provide continuous steady state control of the voltage at the **Onshore Grid Entry Point** (or **Onshore User System Entry Point** if **Embedded**) (or the **Interface Point** in the case of **OTSDUW Plant and Apparatus**) with a **Setpoint Voltage** and **Slope** characteristic as illustrated in Figure CC.A.7.2.2a. It should be noted that where the **Reactive Power** capability requirement of a directly connected **Onshore Non-Synchronous Generating Unit, Onshore DC Converter, Onshore Power Park Module** in Scotland, or **OTSDUW Plant and Apparatus** in Scotland as specified in CC.6.3.2 (c), is not at the **Onshore Grid Entry Point** or **Interface Point**, the values of Q_{min} and Q_{max} shown in this figure will be as modified by the 33/132kV or 33/275kV or 33/400kV transformer.

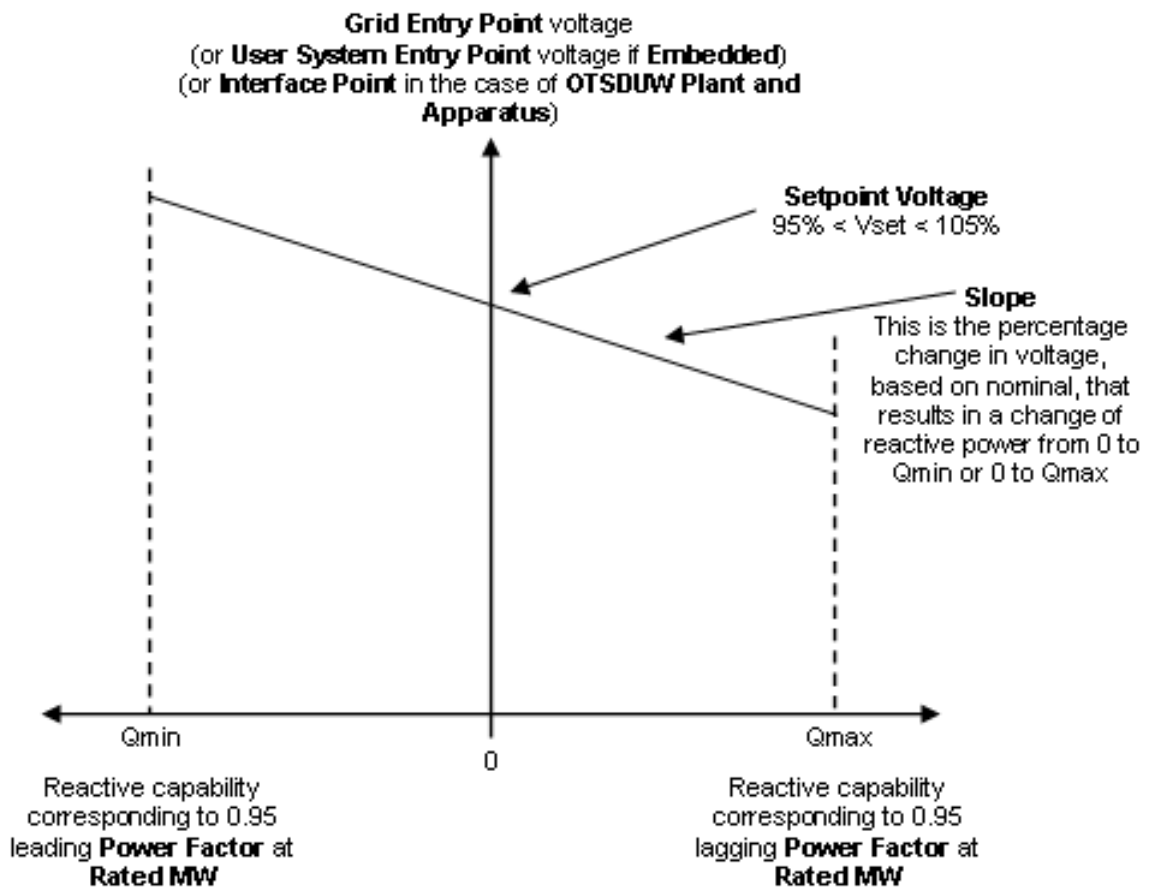

Figure CC.A.7.2.2a

- CC.A.7.2.2.2 The continuously acting automatic control system shall be capable of operating to a **Setpoint Voltage** between 95% and 105% with a resolution of 0.25% of the nominal voltage. For the avoidance of doubt values of 95%, 95.25%, 95.5% ... may be specified, but not intermediate values. The initial **Setpoint Voltage** will be 100%. The tolerance within which this **Setpoint Voltage** shall be achieved is specified in BC2.A.2.6. For the avoidance of doubt, with a tolerance of 0.25% and a Setpoint Voltage of 100%, the achieved value shall be between 99.75% and 100.25%. **The Company** may request the **GB Generator** to implement an alternative **Setpoint Voltage** within the range of 95% to 105%. For **Embedded GB Generators** the **Setpoint Voltage** will be discussed between **The Company** and the relevant **Network Operator** and will be specified to ensure consistency with CC.6.3.4.
- CC.A.7.2.2.3 The **Slope** characteristic of the continuously acting automatic control system shall be adjustable over the range 2% to 7% (with a resolution of 0.5%). For the avoidance of doubt values of 2%, 2.5%, 3% may be specified, but not intermediate values. The initial **Slope** setting will be 4%. The tolerance within which this **Slope** shall be achieved is specified in BC2.A.2.6. For the avoidance of doubt, with a tolerance of 0.5% and a **Slope** setting of 4%, the achieved value shall be between 3.5% and 4.5%. **The Company** may request the **GB Generator** to implement an alternative slope setting within the range of 2% to 7%. For **Embedded GB Generators** the **Slope** setting will be discussed between **The Company** and the relevant **Network Operator** and will be specified to ensure consistency with CC.6.3.4.

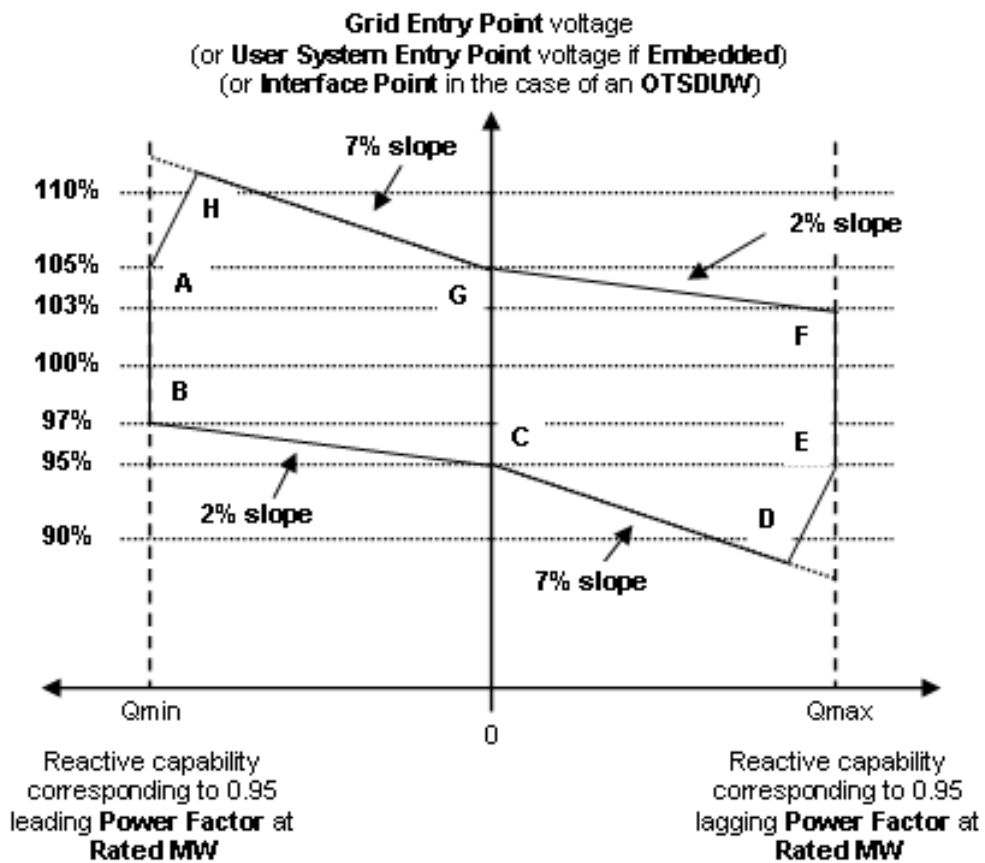

Figure CC.A.7.2.2b

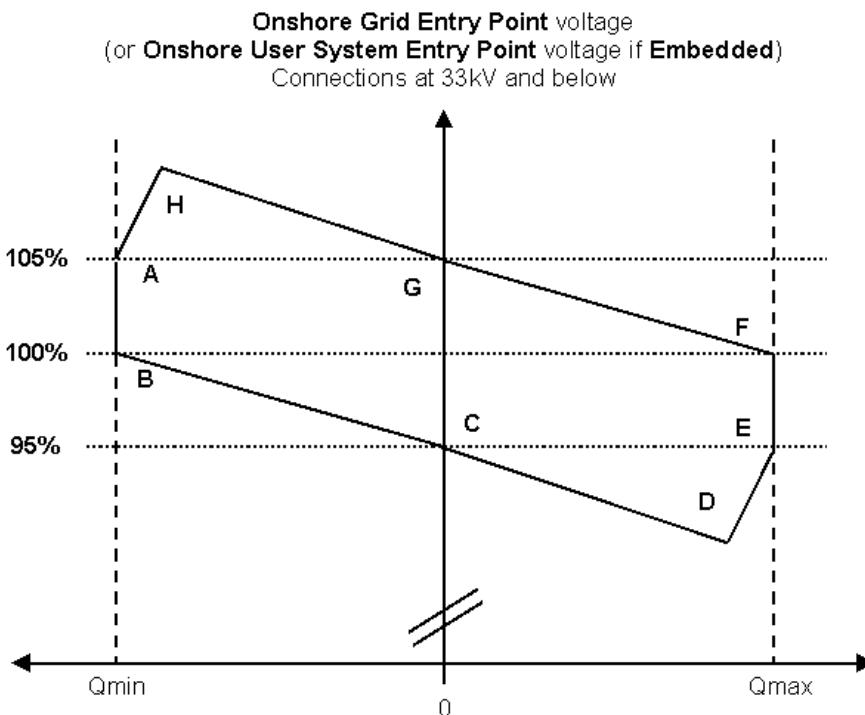

Figure CC.A.7.2.2c

- CC.A.7.2.2.4 Figure CC.A.7.2.2b shows the required envelope of operation for **Onshore Non-Synchronous Generating Units, Onshore DC Converters, OTSDUW Plant and Apparatus** and **Onshore Power Park Modules** except for those **Embedded** at 33kV and below or directly connected to the **National Electricity Transmission System** at 33kV and below. Figure CC.A.7.2.2c shows the required envelope of operation for **Onshore Non-Synchronous Generating Units, Onshore DC Converters** and **Onshore Power Park Modules Embedded** at 33kV and below or directly connected to the **National Electricity Transmission System** at 33kV and below. Where the **Reactive Power** capability requirement of a directly connected **Onshore Non-Synchronous Generating Unit, Onshore DC Converter, OTSDUW Plant and Apparatus** or **Onshore Power Park Module** in Scotland, as specified in CC.6.3.2 (c), is not at the **Onshore Grid Entry Point** or **Interface Point** in the case of **OTSDUW Plant and Apparatus**, the values of Q_{min} and Q_{max} shown in this figure will be as modified by the 33/132kV or 33/275kV or 33/400kV transformer. The enclosed area within points ABCDEFGH is the required capability range within which the **Slope** and **Setpoint Voltage** can be changed.
- CC.A.7.2.2.5 Should the operating point of the **Onshore Non-Synchronous Generating Unit, Onshore DC Converter, OTSDUW Plant and Apparatus** or **Onshore Power Park Module** deviate so that it is no longer a point on the operating characteristic (figure CC.A.7.2.2a) defined by the target **Setpoint Voltage** and **Slope**, the continuously acting automatic voltage control system shall act progressively to return the value to a point on the required characteristic within 5 seconds.
- CC.A.7.2.2.6 Should the **Reactive Power** output of the **Onshore Non-Synchronous Generating Unit, Onshore DC Converter, OTSDUW Plant and Apparatus** or **Onshore Power Park Module** reach its maximum lagging limit at a **Onshore Grid Entry Point** voltage (or **Onshore User System Entry Point** voltage if **Embedded** or **Interface Point** in the case of **OTSDUW Plant and Apparatus**) above 95%, the **Onshore Non-Synchronous Generating Unit, Onshore DC Converter, OTSDUW Plant and Apparatus** or **Onshore Power Park Module** shall maintain maximum lagging **Reactive Power** output for voltage reductions down to 95%. This requirement is indicated by the line EF in figures CC.A.7.2.2b and CC.A.7.2.2c. Should the **Reactive Power** output of the **Onshore Non-Synchronous Generating Unit, Onshore DC Converter, OTSDUW Plant and Apparatus** or **Onshore Power Park Module** reach its maximum leading limit at a **Onshore Grid Entry Point** voltage (or **Onshore User System Entry Point** voltage if **Embedded** or **Interface Point** in the case of **OTSDUW Plant and Apparatus**) below 105%, the **Onshore Non-Synchronous Generating Unit, Onshore DC Converter, OTSDUW Plant and Apparatus** or **Onshore Power Park Module** shall maintain maximum leading **Reactive Power** output for voltage increases up to 105%. This requirement is indicated by the line AB in figures CC.A.7.2.2b and CC.A.7.2.2c.

CC.A.7.2.2.7 For **Onshore Grid Entry Point** voltages (or **Onshore User System Entry Point** voltages if **Embedded** or **Interface Point** voltages) below 95%, the lagging **Reactive Power** capability of the **Onshore Non-Synchronous Generating Unit, Onshore DC Converter, OTSDUW Plant and Apparatus** or **Onshore Power Park Module** should be that which results from the supply of maximum lagging reactive current whilst ensuring the current remains within design operating limits. An example of the capability is shown by the line DE in figures CC.A.7.2.2b and CC.A.7.2.2c. For **Onshore Grid Entry Point** voltages (or **User System Entry Point** voltages if **Embedded** or **Interface Point** voltages) above 105%, the leading **Reactive Power** capability of the **Onshore Non-Synchronous Generating Unit, Onshore DC Converter, OTSDUW Plant and Apparatus** or **Onshore Power Park Module** should be that which results from the supply of maximum leading reactive current whilst ensuring the current remains within design operating limits. An example of the capability is shown by the line AH in figures CC.A.7.2.2b and CC.A.7.2.2c. Should the **Reactive Power** output of the **Onshore Non-Synchronous Generating Unit, Onshore DC Converter, OTSDUW Plant and Apparatus** or **Onshore Power Park Module** reach its maximum lagging limit at an **Onshore Grid Entry Point** voltage (or **Onshore User System Entry Point** voltage if **Embedded** or **Interface Point** in the case of **OTSDUW Plant and Apparatus**) below 95%, the **Onshore Non-Synchronous Generating Unit, Onshore DC Converter** or **Onshore Power Park Module** shall maintain maximum lagging reactive current output for further voltage decreases. Should the **Reactive Power** output of the **Onshore Non-Synchronous Generating Unit, Onshore DC Converter, OTSDUW Plant and Apparatus** or **Onshore Power Park Module** reach its maximum leading limit at a **Onshore Grid Entry Point** voltage (or **User System Entry Point** voltage if **Embedded** or **Interface Point** voltage in the case of an **OTSDUW Plant and Apparatus**) above 105%, the **Onshore Non-Synchronous Generating Unit, Onshore DC Converter, OTSDUW Plant and Apparatus** or **Onshore Power Park Module** shall maintain maximum leading reactive current output for further voltage increases.

CC.A.7.2.2.8 All **OTSDUW Plant and Apparatus** must be capable of enabling **GB Code Users** undertaking **OTSDUW** to comply with an instruction received from **The Company** relating to a variation of the **Setpoint Voltage** at the **Interface Point** within 2 minutes of such instruction being received.

CC.A.7.2.2.9 For **OTSDUW Plant and Apparatus** connected to a **Network Operator's System** where the **Network Operator** has confirmed to **The Company** that its **System** is restricted in accordance with CC.A.7.2.1, clause CC.A.7.2.2.8 will not apply unless **The Company** can reasonably demonstrate that the magnitude of the available change in **Reactive Power** has a significant effect on voltage levels on the **Onshore National Electricity Transmission System**.

CC.A.7.2.3 Transient Voltage Control

CC.A.7.2.3.1 For an on-load step change in **Onshore Grid Entry Point** or **Onshore User System Entry Point** voltage, or in the case of **OTSDUW Plant and Apparatus** an on-load step change in **Transmission Interface Point** voltage, the continuously acting automatic control system shall respond according to the following minimum criteria:

- (i) the **Reactive Power** output response of the **Onshore Non-Synchronous Generating Unit, Onshore DC Converter, OTSDUW Plant and Apparatus** or **Onshore Power Park Module** shall commence within 0.2 seconds of the application of the step. It shall progress linearly although variations from a linear characteristic shall be acceptable provided that the MVA_r seconds delivered at any time up to 1 second are at least those that would result from the response shown in figure CC.A.7.2.3.1a.
- (ii) the response shall be such that 90% of the change in the **Reactive Power** output of the **Onshore Non-Synchronous Generating Unit, Onshore DC Converter, OTSDUW Plant and Apparatus** or **Onshore Power Park Module**, will be achieved within
 - 1 second, where the step is sufficiently large to require a change in the steady state **Reactive Power** output from zero to its maximum leading value or maximum lagging value, as required by CC.6.3.2 (or, if appropriate, CC.A.7.2.2.6 or CC.A.7.2.2.7); and

- 2 seconds, for **Plant and Apparatus** installed on or after 1 December 2017, where the step is sufficiently large to require a change in the steady state **Reactive Power** output from its maximum leading value to its maximum lagging value or vice versa.
- (iii) the magnitude of the **Reactive Power** output response produced within 1 second shall vary linearly in proportion to the magnitude of the step change.
- (iv) within 2 seconds from achieving 90% of the response as defined in CC.A.7.2.3.1 (ii), the peak to peak magnitude of any oscillations shall be less than 5% of the change in steady state **Reactive Power**.
- (v) following the transient response, the conditions of CC.A.7.2.2 apply.

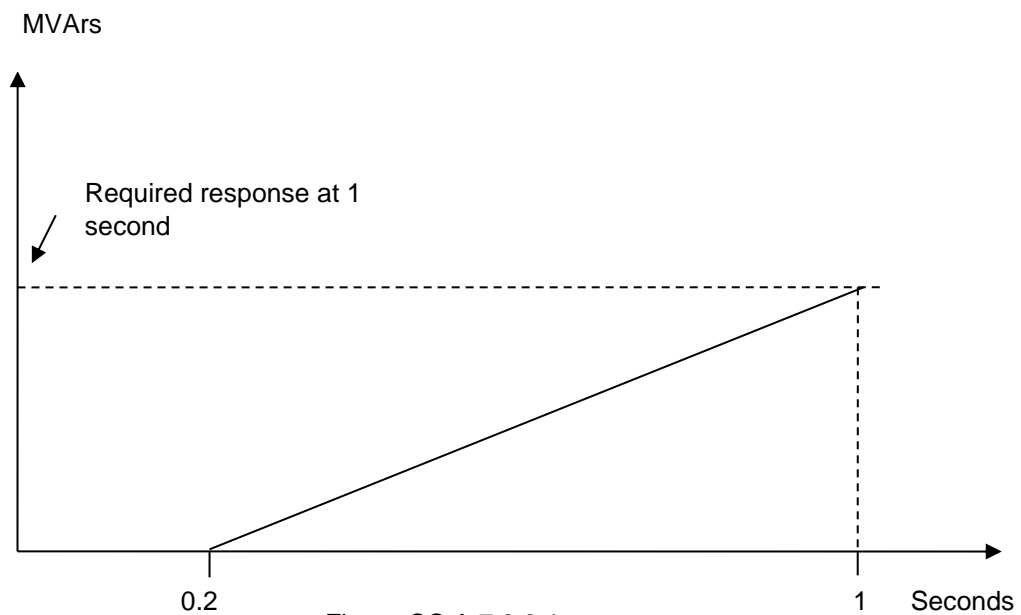

CC.A.7.2.3.2 An **Onshore Non-Synchronous Generating Unit, Onshore DC Converter, OTSDUW Plant and Apparatus** or **Onshore Power Park Module** installed on or after 1 December 2017 shall be capable of

- (a) changing its **Reactive Power** output from its maximum lagging value to its maximum leading value, or vice versa, then reverting back to the initial level of **Reactive Power** output once every 15 seconds for at least 5 times within any 5 minute period; and
- (b) changing its **Reactive Power** output from zero to its maximum leading value then reverting back to zero **Reactive Power** output at least 25 times within any 24 hour period and from zero to its maximum lagging value then reverting back to zero **Reactive Power** output at least 25 times within any 24 hour period. Any subsequent restriction on reactive capability shall be notified to **The Company** in accordance with BC2.5.3.2, and BC2.6.1.

In all cases, the response shall be in accordance to CC.A.7.2.3.1 where the change in **Reactive Power** output is in response to an on-load step change in **Onshore Grid Entry Point** or **Onshore User System Entry Point** voltage, or in the case of **OTSDUW Plant and Apparatus** an on-load step change in **Transmission Interface Point** voltage.

CC.A.7.2.4 Power Oscillation Damping

- CC.A.7.2.4.1 The requirement for the continuously acting voltage control system to be fitted with a **Power System Stabiliser (PSS)** shall be specified in the **Bilateral Agreement** if, in **The Company's** view, this is required for system reasons. However if a **Power System Stabiliser** is included in the voltage control system its settings and performance shall be agreed with **The Company** and commissioned in accordance with BC2.11.2. To allow assessment of the performance before on-load commissioning the **GB Generator** will provide to **The Company** a report covering the areas specified in CP.A.3.2.2.
- CC.A.7.2.5 Overall Voltage Control System Characteristics
- CC.A.7.2.5.1 The continuously acting automatic voltage control system is required to respond to minor variations, steps, gradual changes or major variations in **Onshore Grid Entry Point** voltage (or **Onshore User System Entry Point** voltage if **Embedded** or **Interface Point** voltage in the case of **OTSDUW Plant and Apparatus**).
- CC.A.7.2.5.2 The overall voltage control system shall include elements that limit the bandwidth of the output signal. The bandwidth limiting must be consistent with the speed of response requirements and ensure that the highest frequency of response cannot excite torsional oscillations on other plant connected to the network. A bandwidth of 0-5Hz would be judged to be acceptable for this application. All other control systems employed within the **Onshore Non-Synchronous Generating Unit, Onshore DC Converter, OTSDUW Plant and Apparatus** or **Onshore Power Park Module** should also meet this requirement
- CC.A.7.2.5.3 The response of the voltage control system (including the **Power System Stabiliser** if employed) shall be demonstrated by testing in accordance with OC5A.A.3.

< END OF CONNECTION CONDITIONS >

DATA REGISTRATION CODE

(DRC)

GC0106-WACM2

Dated 09/10/18

CONTENTS

(This contents page does not form part of the Grid Code)

<u>Paragraph No/Title</u>	<u>Page Number</u>
DRC.1 INTRODUCTION	3
DRC.2 OBJECTIVE	3
DRC.3 SCOPE	3
DRC.4 DATA CATEGORIES AND STAGES IN REGISTRATION	3
DRC.4.2 Standard Planning Data	4 43
DRC.4.3 Detailed Planning Data	4
DRC.4.4 Operational Data	4
DRC.5 PROCEDURES AND RESPONSIBILITIES	4
DRC.5.1 Responsibility For Submission And Updating Of Data	4
DRC.5.2 Methods Of Submitting Data	4
DRC.5.3 Changes To Users Data	5
DRC.5.4 Data Not Supplied	5
DRC.5.5 Substituted Data	5
DRC.6 DATA TO BE REGISTERED	5
SCHEDULE 1 - GENERATING UNIT (OR CCGT MODULE), POWER PARK MODULE AND DC CONVERTER TECHNICAL DATA	119 119
SCHEDULE 2 - GENERATION PLANNING PARAMETERS	3634 3634
SCHEDULE 3 - LARGE POWER STATION OUTAGE PROGRAMMES, OUTPUT USABLE AND INFLEXIBILITY INFORMATION	4038 4038
SCHEDULE 4 - LARGE POWER STATION DROOP AND RESPONSE DATA	4341 4341
SCHEDULE 5 - USERS SYSTEM DATA	4442 4442
SCHEDULE 6 - USERS OUTAGE INFORMATION	53
SCHEDULE 7 - LOAD CHARACTERISTICS AT GRID SUPPLY POINTS	56
SCHEDULE 8 - DATA SUPPLIED BY BM PARTICIPANTS	57
SCHEDULE 9 - DATA SUPPLIED BY THE COMPANY TO USERS	58
SCHEDULE 10 - DEMAND PROFILES AND ACTIVE ENERGY DATA	59
SCHEDULE 11 - CONNECTION POINT DATA	61
SCHEDULE 12 - DEMAND CONTROL	66
SCHEDULE 13 - FAULT INFEEED DATA	69
SCHEDULE 14 - FAULT INFEEED DATA (GENERATORS INCLUDING UNIT TRANSFORMERS AND STATION TRANSFORMERS)	71
SCHEDULE 15 - MOTHBALLED GENERATING UNIT, MOTHBALLED POWER PARK MODULE, MOTHBALLED DC CONVERTERS AT A DC CONVERTER STATION AND ALTERNATIVE FUEL DATA)	76

SCHEDULE 16 - BLACK START INFORMATION.....	<u>8279</u>
SCHEDULE 17 - ACCESS PERIOD DATA.....	<u>8380</u>
SCHEDULE 18 - OFFSHORE TRANSMISSION SYSTEM DATA.....	<u>8481</u>
SCHEDULE 19 - USER DATA FILE STRUCTURE	<u>108105</u>

- DRC.1 INTRODUCTION
- DRC.1.1 The **Data Registration Code ("DRC")** presents a unified listing of all data required by **The Company** from **Users** and by **Users** from **The Company**, from time to time under the **Grid Code**. The data which is specified in each section of the **Grid Code** is collated here in the **RC**. Where there is any inconsistency in the data requirements under any particular section of the **Grid Code** and the **Data Registration Code** the provisions of the particular section of the **Grid Code** shall prevail.
- DRC.1.2 The **DRC** identifies the section of the **Grid Code** under which each item of data is required .
- DRC.1.3 The Code under which any item of data is required specifies procedures and timings for the supply of that data, for routine updating and for recording temporary or permanent changes to that data. All timetables for the provision of data are repeated in the **DRC**.
- DRC.1.4 Various sections of the **Grid Code** also specify information which **Users** will receive from **The Company**. This information is summarised in a single schedule in the **DRC** (Schedule 9).
- DRC.1.5 The categorisation of data into **DPD I** and **DPD II** is indicated in the **DRC** below.
- DRC.2 OBJECTIVE
- The objective of the **DRC** is to:
- DRC.2.1 List and collate all the data to be provided by each category of **User** to **The Company** under the **Grid Code**.
- DRC.2.2 List all the data to be provided by **The Company** to each category of **User** under the **Grid Code**.
- DRC.3 SCOPE
- DRC.3.1 The **DRC** applies to **The Company** and to **Users**, which in this **DRC** means:-
- (a) **Generators** (including those undertaking **OTSDUW** and/or those who own and/or operate **DC Connected Power Park Modules**);
- (b) **Network Operators**;
- (c) **DC Converter Station** owners and **HVDC System Owners**;
- (d) **Suppliers**;
- (e) **Non-Embedded Customers** (including, for the avoidance of doubt, a **Pumped Storage Generator** in that capacity);
- (f) **Externally Interconnected System Operators**;
- (g) **Interconnector Users**; and
- (h) **BM Participants**.
- DRC.3.2 For the avoidance of doubt, the **DRC** applies to both **GC Code Users** and **EU Code Users User's**.
- DRC.4 DATA CATEGORIES AND STAGES IN REGISTRATION
- DRC.4.1.1 Within the **DRC** each data item is allocated to one of the following three categories:
- (a) **Standard Planning Data (SPD)**
- (b) **Detailed Planning Data (DPD)**
- (c) **Operational Data**

- DRC.4.2 Standard Planning Data (SPD)
- DRC.4.2.1 The **Standard Planning Data** listed and collated in this **DRC** is that data listed in Part 1 of the Appendix to the **PC**.
- DRC.4.2.2 **Standard Planning Data** will be provided to **The Company** in accordance with PC.4.4 and PC.A.1.2.
- DRC.4.3 Detailed Planning Data (DPD)
- DRC.4.3.1 The **Detailed Planning Data** listed and collated in this **DRC** is categorised as **DPD I** and **DPD II** and is that data listed in Part 2 of the Appendix to the **PC**.
- DRC.4.3.2 **Detailed Planning Data** will be provided to **The Company** in accordance with PC.4.4, PC.4.5 and PC.A.1.2.
- DRC.4.4 Operational Data
- DRC.4.4.1 **Operational Data** is data which is required by the **Operating Codes** and the **Balancing Codes**. Within the **DRC**, **Operational Data** is sub-categorised according to the Code under which it is required, namely **OC1**, **OC2**, **BC1** or **BC2**.
- DRC.4.4.2 **Operational Data** is to be supplied in accordance with timetables set down in the relevant **Operating Codes** and **Balancing Codes** and repeated in tabular form in the schedules to the **DRC**.
- DRC.5 PROCEDURES AND RESPONSIBILITIES
- DRC.5.1 Responsibility For Submission And Updating Of Data
- In accordance with the provisions of the various sections of the **Grid Code**, each **User** must submit data as summarised in DRC.6 and listed and collated in the attached schedules.
- DRC.5.2 Methods Of Submitting Data
- DRC.5.2.1 Wherever possible the data schedules to the **DRC** are structured to serve as standard formats for data submission and such format must be used for the written submission of data to **The Company**.
- DRC.5.2.2 Data must be submitted to the **Transmission Control Centre** notified by **The Company** or to such other department or address as **The Company** may from time to time advise. The name of the person at the **User Site** who is submitting each schedule of data must be included.
- DRC.5.2.3 Where a computer data link exists between a **User** and **The Company**, data may be submitted via this link. **The Company** will, in this situation, provide computer files for completion by the **User** containing all the data in the corresponding **DRC** schedule.
- Data submitted can be in an electronic format using a proforma to be supplied by **The Company** or other format to be agreed annually in advance with **The Company**. In all cases the data must be complete and relate to, and relate only to, what is required by the relevant section of the **Grid Code**.
- DRC.5.2.4 Other modes of data transfer, such as magnetic tape, may be utilised if **The Company** gives its prior written consent.
- DRC.5.2.5 **Generators, HVDC System Owners and DC Converter Station** owners submitting data for a **Power Generating Module, Generating Unit, DC Converter, HVDC System, Power Park Module** (including **DC Connected Power Park Modules**) or **CCGT Module** before the issue of a **Final Operational Notification** should submit the **DRC** data schedules and compliance information required under the **CP** electronically using the **User Data File Structure** unless otherwise agreed with **The Company**.

- DRC.5.3 Changes To Users' Data
- DRC.5.3.1 Whenever a **User** becomes aware of a change to an item of data which is registered with **The Company** the **User** must notify **The Company** in accordance with each section of the Grid Code. The method and timing of the notification to **The Company** is set out in each section of the Grid Code.
- DRC.5.4 Data Not Supplied
- DRC.5.4.1 **Users** and **The Company** are obliged to supply data as set out in the individual sections of the **Grid Code** and repeated in the **DRC**. If a **User** fails to supply data when required by any section of the **Grid Code**, **The Company** will estimate such data if and when, in **The Company's** view, it is necessary to do so. If **The Company** fails to supply data when required by any section of the **Grid Code**, the **User** to whom that data ought to have been supplied, will estimate such data if and when, in that **User's** view, it is necessary to do so. Such estimates will, in each case, be based upon data supplied previously for the same **Plant** or **Apparatus** or upon corresponding data for similar **Plant** or **Apparatus** or upon such other information as **The Company** or that **User**, as the case may be, deems appropriate.
- DRC.5.4.2 **The Company** will advise a **User** in writing of any estimated data it intends to use pursuant to DRC.5.4.1 relating directly to that **User's Plant** or **Apparatus** in the event of data not being supplied.
- DRC.5.4.3 A **User** will advise **The Company** in writing of any estimated data it intends to use pursuant to DRC.5.4.1 in the event of data not being supplied.
- DRC.5.5 Substituted Data
- DRC.5.5.1 In the case of PC.A.4 only, if the data supplied by a **User** does not in **The Company's** reasonable opinion reflect the equivalent data recorded by **The Company**, **The Company** may estimate such data if and when, in the view of **The Company**, it is necessary to do so. Such estimates will, in each case, be based upon data supplied previously for the same **Plant** or **Apparatus** or upon corresponding data for similar **Plant** or **Apparatus** or upon such other information as **The Company** deems appropriate.
- DRC.5.5.2 **The Company** will advise a **User** in writing of any estimated data it intends to use pursuant to DRC.5.5.1 relating directly to that **User's Plant** or **Apparatus** where it does not in **The Company's** reasonable opinion reflect the equivalent data recorded by **The Company**. Such estimated data will be used by **The Company** in place of the appropriate data submitted by the **User** pursuant to PC.A.4 and as such shall be deemed to accurately represent the **User's** submission until such time as the **User** provides data to **The Company's** reasonable satisfaction.
- DRC.6 DATA TO BE REGISTERED
- DRC.6.1 Schedules 1 to 19 attached cover the following data areas.
- DRC.6.1.1 Schedule 1 – Power Generating Module, Generating Unit (or CCGT Module), Power Park Module (including DC Connected Power Park Module and Power Park Unit), HVDC System and DC Converter Technical Data.
Comprising **Power Generating Module, Generating Unit** (and **CCGT Module**), **Power Park Module** (including **DC Connected Power Park Module** and **Power Park Unit**) and **DC Converter** fixed electrical parameters.
- DRC.6.1.2 Schedule 2 - Generation Planning Parameters
Comprising the **Genset** parameters required for **Operational Planning** studies.
- DRC.6.1.3 Schedule 3 - ~~Large~~Power Station Outage Programmes, Output Usable And Inflexibility Information.

Comprising generation at Large Power Stations and directly connected Medium Power Stations comprising of any Type C or Type D Power Generating Module and directly connected Small Power Stations comprising of any Type C or Type D Power Generating Module outage planning, **Output Usable** and inflexibility information at timescales down to the daily **BM Unit Data** submission.

- DRC.6.1.4 Schedule 4 - ~~Large~~ Power Station Droop And Response Data.
 Comprising data on governor **Droop** settings and **Primary, Secondary and High Frequency Response** data for **Large Power Stations** and any directly connected **Medium Power Stations** comprising of any **Type C** or **Type D Power Generating Modules** and any directly connected **Small Power Stations** comprising of any **Type C** or **Type D Power Generating Modules**.
- DRC.6.1.5 Schedule 5 – User's System Data.
 Comprising electrical parameters relating to **Plant** and **Apparatus** connected to the **National Electricity Transmission System**.
- DRC.6.1.6 Schedule 6 – Users Outage Information.
 Comprising the information required by **The Company** for outages on the **User System**, including outages at **Power Stations** other than outages of **Gensets**
- DRC.6.1.7 Schedule 7 - Load Characteristics.
 Comprising the estimated parameters of load groups in respect of, for example, harmonic content and response to frequency.
- DRC.6.1.8 Schedule 8 - BM Unit Data.
- DRC.6.1.9 Schedule 9 - Data Supplied By The Company To Users.
- DRC.6.1.10 Schedule 10 - Demand Profiles And Active Energy Data
 Comprising information relating to the **Network Operators'** and **Non-Embedded Customers'** total **Demand** and **Active Energy** taken from the **National Electricity Transmission System**
- DRC.6.1.11 Schedule 11 - Connection Point Data
 Comprising information relating to **Demand**, demand transfer capability and the **Small Power Station, Medium Power Station** and **Customer** generation connected to the **Connection Point**
- DRC.6.1.12 Schedule 12 - Demand Control Data
 Comprising information related to **Demand Control**
- DRC.6.1.13 Schedule 13 - Fault Infeed Data
 Comprising information relating to the short circuit contribution to the **National Electricity Transmission System** from **Users** other than **Generators, HVDC System Owners** and **DC Converter Station** owners.
- DRC.6.1.14 Schedule 14 - Fault Infeed Data (Generators Including Unit And Station Transformers)
 Comprising information relating to the Short Circuit contribution to the **National Electricity Transmission System** from **Generators, HVDC System Owners** and **DC Converter Station** owners.
- DRC.6.1.15 Schedule 15 – Mothballed Power Generating Module, Mothballed Generating Unit, Mothballed Power Park Module (including Mothballed DC Connected Power Park Modules), Mothballed HVDC Systems, Mothballed HVDC Converters, Mothballed DC Converters at a DC Converter Station and Alternative Fuel Data
 Comprising information relating to estimated return to service times for **Mothballed Power Generating Modules, Mothballed Generating Units, Mothballed Power Park Modules** (including **Mothballed DC Connected Power Park Modules**), **Mothballed HVDC Systems, Mothballed HVDC Converters** and **Mothballed DC Converters at a DC Converter Station** and the capability of gas-fired **Generating Units** to operate using alternative fuels.
- DRC.6.1.16 Schedule 16 – Black Start Information
 Comprising information relating to **Black Start**.
- DRC.6.1.17 Schedule 17 – Access Period Schedule

Comprising **Access Period** information for **Transmission Interface Circuits** within an **Access Group**.

DRC.6.1.18 Schedule 18 – Generators Undertaking OTSDUW Arrangements

Comprising electrical parameters relating to **OTSDUW Plant and Apparatus** between the **Offshore Grid Entry Point** and **Transmission Interface Point**.

DRC.6.1.19 Schedule 19 – User Data File Structure

Comprising information relating to the **User Data File Structure**.

DRC.6.2 The **Schedules** applicable to each class of **User** are as follows:

<u>User</u>	<u>Schedule</u>
Generators with Large Power Stations	1, 2, 3, 4, 9, 14, 15, 16, 19
Generators with Medium Power Stations (see notes 2, 3, 4)	1, 2 (part), 9, 14, 15, 19
Generators with Small Power Stations directly connected to the National Electricity Transmission System	1, 6, 14, 15, 19
Generators directly connected to the National Electricity Transmission System with Medium Power Stations comprising of Type C or Type D Power Generating Modules and directly connected to the National Electricity Transmission System or Generators with Small Power Stations comprising of Type C or Type D Power Generating Modules and directly connected to the National Electricity Transmission System	1, 2, 3, 4, 5, 6, 9, 14, 15, 16, 19
Generators undertaking OTSDUW (see note 5)	18, 19
All Users connected directly to the National Electricity Transmission System	5, 6, 9
All Users connected directly to the National Electricity Transmission System other than Generators	10,11,13,17
All Users connected directly to the National Electricity Transmission System with Demand	7, 9
A Pumped Storage Generator, Externally Interconnected System Operator and Interconnector Users	12 (as marked)
All Suppliers	12
All Network Operators	12
All BM Participants	8
All DC Converter Station owners	1, 4, 9, 14, 15, 19

Notes:

- (1) **Network Operators** must provide data relating to **Small Power Stations** and/or **Customer Generating Plant Embedded** in their **Systems** when such data is requested by **The Company** pursuant to PC.A.3.1.4 or PC.A.5.1.4.
- (2) The data in schedules 1, 14 and 15 need not be supplied in relation to **Medium Power Stations** connected at a voltage level below the voltage level of the **Subtransmission System** except in connection with a **CUSC Contract** or unless specifically requested by **The Company**.

- (3) Each **Network Operator** within whose **System** an **Embedded Medium Power Station** not subject to a **Bilateral Agreement** or **Embedded DC Converter Station** not subject to a **Bilateral Agreement** is situated shall provide the data to **The Company** in respect of each such **Embedded Medium Power Station** or **Embedded DC Converter Station** or **HVDC System**.
- (4) In the case of Schedule 2, **Generators**, **HVDC System Owners**, **DC Converter Station** owners or **Network Operators** in the case of **Embedded Medium Power Stations** not subject to a **Bilateral Agreement** or **Embedded DC Converter Stations** not subject to a **Bilateral Agreement**, would only be expected to submit data in relation to **Standard Planning Data** as required by the **Planning Code**.
- (5) In the case of **Generators** undertaking **OTSDUW**, the **Generator** will need to supply **User** data in accordance with the requirements of **Large** or **Small Power Stations** (as defined in DRC.6.2) up to the **Offshore Grid Entry Point**. In addition, the **User** will also need to submit **Offshore Transmission System** data in between the **Interface Point** and its **Connection Points** in accordance with the requirements of Schedule 18.

SCHEDULE 1 – POWER GENERATING MODULE, GENERATING UNIT (OR CCGT MODULE), POWER PARK MODULE, DC CONNECTED POWER PARK MODULE, HVDC SYSTEM AND DC CONVERTER TECHNICAL DATA

PAGE 1 OF 19

ABBREVIATIONS:

SPD = Standard Planning Data

% on MVA = % on Rated MVA

% on 100 = % on 100 MVA

DPD = Detailed Planning Data

RC = Registered Capacity

MC = Maximum Capacity

OC1, BC1, etc = Grid Code
for which data is required

CUSC Contract = User data which may be submitted to the **Relevant Transmission Licensees** by **The Company**, following the acceptance by a **User** of a **CUSC Contract**.

CUSC App. Form = User data which may be submitted to the **Relevant Transmission Licensees** by **The Company**, following an application by a **User** for a **CUSC Contract**.

Note:

All parameters, where applicable, are to be measured at nominal **System Frequency**

+ these **SPD** items should only be given in the data supplied with the application for a **CUSC Contract**.

* Asterisk items are not required for **Small Power Stations** and **Medium Power Stations** unless such **Small or Medium Power Stations** are directly connected to the **National Electricity Transmission System** and comprise of a **Type C** and/or **Type D Power Generating Module**

Information is to be given on a **Unit** basis, unless otherwise stated. Where references to **CCGT Modules** are made, the columns "G1" etc should be amended to read "M1" etc, as appropriate

□ These data items may be submitted to the **Relevant Transmission Licensees** from **The Company** in respect of the **National Electricity Transmission System**. The data may be submitted to the **Relevant Transmission Licensees** in a summarised form e.g. network model; the data transferred will have been originally derived from data submitted by **Users** to **The Company**.

■ these data items may be submitted to the **Relevant Transmission Licensee** from **The Company** in respect to **Relevant Units** only. The data may be submitted to the **Relevant Transmission Licensee** in a summarised form e.g. network model; the data transferred will have been originally derived from data submitted by **Users** to **The Company**.

SCHEDULE 1 – POWER GENERATING MODULE, GENERATING UNIT (OR CCGT MODULE), POWER PARK MODULE, DC CONNECTED POWER PARK MODULE, HVDC SYSTEM AND DC CONVERTER TECHNICAL DATA

POWER STATION NAME: _____

DATE: _____

DATA DESCRIPTION	UNITS	DATA to		DATA CAT.	GENERATING UNIT OR STATION DATA							
		CUSC Cont ract	CUSC App. Form		F.Yr. 0	F.Yr. 1	F.Yr. 2	F.Yr. 3	F.Yr. 4	F.Yr. 5	F.Yr. 6	
<p>GENERATING STATION DEMANDS:</p> <p>Demand associated with the Power Station supplied through the National Electricity Transmission System or the Generator's User System (PC.A.5.2)</p> <ul style="list-style-type: none"> - The maximum Demand that could occur. - Demand at specified time of annual peak half hour of National Electricity Transmission System Demand at Annual ACS Conditions. - Demand at specified time of annual minimum half-hour of National Electricity Transmission System Demand. <p>(Additional Demand supplied through the unit transformers to be provided below)</p> <p><u>INDIVIDUAL GENERATING UNIT (OR AS THE CASE MAY BE, SYNCHRONOUS POWER GENERATING MODULE OR CCGT MODULE) DATA</u></p> <p>Point of connection to the National Electricity Transmission System (or the Total System if embedded) of the Generating Unit or Synchronous Power Generating Module (other than a CCGT Unit) or the CCGT Module, as the case may be in terms of geographical and electrical location and system voltage (PC.A.3.4.1)</p> <p>If the busbars at the Connection Point are normally run in separate sections identify the section to which the Generating Unit (other than a CCGT Unit) or Synchronous Power Generating Module or CCGT Module, as the case may be is connected (PC.A.3.1.5)</p>	<p>MW MVA MW MVA</p> <p>MW MVA</p>	<p><input type="checkbox"/></p> <p><input type="checkbox"/></p> <p><input type="checkbox"/></p> <p><input type="checkbox"/></p> <p><input type="checkbox"/></p> <p><input type="checkbox"/></p>	<p><input type="checkbox"/></p> <p><input type="checkbox"/></p>	<p>DPD I DPD I DPD II DPD II</p> <p>DPD II DPD II</p>								
					G1	G2	G3	G4	G5	G6	STN	
	Text	<input type="checkbox"/>	<input checked="" type="checkbox"/>	SPD								
	Section Number	<input type="checkbox"/>	<input checked="" type="checkbox"/>	SPD								

Type of **Unit** (steam, **Gas Turbine
Combined Cycle Gas Turbine Unit**,
tidal, wind, etc.)
(PC.A.3.2.2 (h))

□

SCHEDULE 1 – POWER GENERATING MODULE, GENERATING UNIT (OR CCGT MODULE), POWER PARK MODULE, DC CONNECTED POWER PARK MODULE, HVDC SYSTEM AND DC CONVERTER TECHNICAL DATA

<u>INDIVIDUAL SYNCHRONOUS POWER GENERATING MODULE GENERATING UNIT (OR AS THE CASE MAY BE, CCGT MODULE) DATA</u>				G1	G2	G3	G4	G5	G6	STN
<p>A list of the Generating Units and CCGT Units within a Synchronous Power Generating Module or CCGT Module, identifying each CCGT Unit, and the Power Generating Module or CCGT Module of which it forms part, unambiguously. In the case of a Range CCGT Module, details of the possible configurations should also be submitted. <i>(P.C.A.3.2.2 (g))</i></p>	□	■	SPD							

SCHEDULE 1 – POWER GENERATING MODULE, GENERATING UNIT (OR CCGT MODULE), POWER PARK MODULE, DC CONNECTED POWER PARK MODULE, HVDC SYSTEM AND DC CONVERTER TECHNICAL DATA

DATA DESCRIPTION	UNITS	DATA to RTL		DATA CAT.	GENERATING UNIT (OR CCGT MODULE, AS THE CASE MAY BE)							
		CUSC Cont ract	CUSC App. Form		G1	G2	G3	G4	G5	G6	STN	
Rated MVA (PC.A.3.3.1)	MVA	<input type="checkbox"/>	<input checked="" type="checkbox"/>	SPD+								
Rated MW (PC.A.3.3.1)	MW	<input type="checkbox"/>	<input checked="" type="checkbox"/>	SPD+								
Rated terminal voltage (PC.A.5.3.2.(a) & PC.A.5.4.2 (b))	kV	<input type="checkbox"/>		DPD I								
*Performance Chart at Onshore Synchronous Generating Unit stator terminals (PC.A.3.2.2(f)(i))				SPD	(see OC2 for specification)							
* Performance Chart of the Offshore Synchronous Generating Unit at the Offshore Grid Entry Point (PC.A.3.2.2(f)(ii))												
* Synchronous Generating Unit Performance Chart (PC.A.3.2.2(f))												
* Power Generating Module Performance Chart of the Synchronous Power Generating Module (PC.A.3.2.2(f))												
* Maximum terminal voltage set point(PC.A.5.3.2.(a) & PC.A.5.4.2 (b))	kV	<input type="checkbox"/>		DPD I								
* Terminal voltage set point step resolution – if not continuous (PC.A.5.3.2.(a) & PC.A.5.4.2 (b))	kV	<input type="checkbox"/>		DPD I								
* Output Usable (on a monthly basis) (PC.A.3.2.2(b))	MW			SPD	(except in relation to CCGT Modules when required on a unit basis under the Grid Code , this data item may be supplied under Schedule 3)							
Turbo-Generator inertia constant (for synchronous machines) (PC.A.5.3.2(a))	MW secs /MVA	<input type="checkbox"/>	<input checked="" type="checkbox"/>	SPD+								
Short circuit ratio (synchronous machines) (PC.A.5.3.2(a))		<input type="checkbox"/>	<input checked="" type="checkbox"/>	SPD+								
Normal auxiliary load supplied by the Generating Unit at rated MW output (PC.A.5.2.1)	MW	<input type="checkbox"/>		DPD II								
	MVA	<input type="checkbox"/>		DPD II								
Rated field current at rated MW and MVA output and at rated terminal voltage (PC.A.5.3.2 (a))	A	<input type="checkbox"/>		DPD II								
Field current open circuit saturation curve (as derived from appropriate manufacturers' test certificates): (PC.A.5.3.2 (a))												
	A	<input type="checkbox"/>		DPD II								
120% rated terminal volts	A	<input type="checkbox"/>		DPD II								
110% rated terminal volts	A	<input type="checkbox"/>		DPD II								
100% rated terminal volts	A	<input type="checkbox"/>		DPD II								
90% rated terminal volts	A	<input type="checkbox"/>		DPD II								
80% rated terminal volts	A	<input type="checkbox"/>		DPD II								
70% rated terminal volts	A	<input type="checkbox"/>		DPD II								
60% rated terminal volts	A	<input type="checkbox"/>		DPD II								
50% rated terminal volts	A	<input type="checkbox"/>		DPD II								
<u>IMPEDANCES:</u>												
(Unsaturated)												
Direct axis synchronous reactance (PC.A.5.3.2(a))	% on MVA	<input type="checkbox"/>		DPD I								
Direct axis transient reactance (PC.A.3.3.1(a)& PC.A.5.3.2(a))	% on MVA	<input type="checkbox"/>	<input checked="" type="checkbox"/>	SPD+								
Direct axis sub-transient reactance (PC.A.5.3.2(a))	% on MVA	<input type="checkbox"/>		DPD I								
Quad axis synch reactance (PC.A.5.3.2(a))	% on MVA	<input type="checkbox"/>		DPD I								
Quad axis sub-transient reactance (PC.A.5.3.2(a))	% on MVA	<input type="checkbox"/>		DPD I								
Stator leakage reactance (PC.A.5.3.2(a))	% on MVA	<input type="checkbox"/>		DPD I								
Armature winding direct current resistance. (PC.A.5.3.2(a))	% on MVA	<input type="checkbox"/>		DPD I								

SCHEDULE 1 – POWER GENERATING MODULE, GENERATING UNIT (OR CCGT MODULE), POWER PARK MODULE DC CONNECTED POWER PARK MODULE, HVDC SYSTEM AND DC CONVERTER TECHNICAL DATA

DATA DESCRIPTION	UNITS	DATA to RTL		DATA CAT.	GENERATING UNIT OR STATION DATA						
		CUSC Contract	CUSC App. Form		G1	G2	G3	G4	G5	G6	STN
TIME CONSTANTS (Short-circuit and Unsaturated)											
Direct axis transient time constant (PC.A.5.3.2(a))	S	<input type="checkbox"/>		DPD I							
Direct axis sub-transient time constant (PC.A.5.3.2(a))	S	<input type="checkbox"/>		DPD I							
Quadrature axis sub-transient time constant (PC.A.5.3.2(a))	S	<input type="checkbox"/>		DPD I							
Stator time constant (PC.A.5.3.2(a))	S	<input type="checkbox"/>		DPD I							
MECHANICAL PARAMETERS (PC.A.5.3.2(a))											
The number of turbine generator masses		<input type="checkbox"/>		DPD II							
Diagram showing the Inertia and parameters for each turbine generator mass for the complete drive train	Kgm ²	<input type="checkbox"/>		DPD II							
Diagram showing Stiffness constants and parameters between each turbine generator mass for the complete drive train	Nm/rad	<input type="checkbox"/>		DPD II							
Number of poles		<input type="checkbox"/>		DPD II							
Relative power applied to different parts of the turbine	%	<input type="checkbox"/>		DPD II							
Torsional mode frequencies	Hz	<input type="checkbox"/>		DPD II							
Modal damping decrement factors for the different mechanical modes		<input type="checkbox"/>		DPD II							
GENERATING UNIT STEP-UP TRANSFORMER											
Rated MVA (PC.A.3.3.1 & PC.A.5.3.2)	MVA	<input type="checkbox"/>	<input checked="" type="checkbox"/>	SPD+							
Voltage Ratio (PC.A.5.3.2)	-	<input type="checkbox"/>		DPD I							
Positive sequence reactance: (PC.A.5.3.2)											
Max tap	% on MVA	<input type="checkbox"/>	<input checked="" type="checkbox"/>	SPD+							
Min tap	% on MVA	<input type="checkbox"/>	<input checked="" type="checkbox"/>	SPD+							
Nominal tap	% on MVA	<input type="checkbox"/>	<input checked="" type="checkbox"/>	SPD+							
Positive sequence resistance: (PC.A.5.3.2)											
Max tap	% on MVA	<input type="checkbox"/>		DPD II							
Min tap	% on MVA	<input type="checkbox"/>		DPD II							
Nominal tap	% on MVA	<input type="checkbox"/>		DPD II							
Zero phase sequence reactance (PC.A.5.3.2)	% on MVA	<input type="checkbox"/>		DPD II							
Tap change range (PC.A.5.3.2)	+% / -%	<input type="checkbox"/>		DPD II							
Tap change step size (PC.A.5.3.2)	%	<input type="checkbox"/>		DPD II							
Tap changer type: on-load or off-circuit (PC.A.5.3.2)	On/Off	<input type="checkbox"/>		DPD II							

SCHEDULE 1 – POWER GENERATING MODULE, GENERATING UNIT (OR CCGT MODULE), POWER PARK MODULE, DC CONNECTED POWER PARK MODULE, HVDC SYSTEM AND DC CONVERTER TECHNICAL DATA

DATA DESCRIPTION	UNITS	DATA to		DATA CAT.	GENERATING UNIT OR STATION DATA						
		CUSC Contract	CUSC App. Form		G1	G2	G3	G4	G5	G6	STN
<u>EXCITATION:</u>											
<p><u>Note:</u> The data items requested under Option 1 below may continue to be provided by Generators in relation to Generating Units on the System at 9 January 1995 (in this paragraph, the "relevant date") or they may provide the new data items set out under Option 2. Generators must supply the data as set out under Option 2 (and not those under Option 1) for Generating Unit and Synchronous Power Generating Unit excitation control systems commissioned after the relevant date, those Generating Unit or Synchronous Power Generating Unit excitation control systems recommissioned after the relevant date, those Generating Unit or Synchronous Power Generating Unit excitation control systems where, as a result of testing or other process, the Generator is aware of the data items listed under Option 2 in relation to that Generating Unit or Synchronous Power Generating Unit.</p>											
Option 1											
DC gain of Excitation Loop (PC.A.5.3.2(c))			<input type="checkbox"/>	DPD II							
Max field voltage (PC.A.5.3.2(c))	V		<input type="checkbox"/>	DPD II							
Min field voltage (PC.A.5.3.2(c))	V		<input type="checkbox"/>	DPD II							
Rated field voltage (PC.A.5.3.2(c))	V		<input type="checkbox"/>	DPD II							
Max rate of change of field volts: (PC.A.5.3.2(c))											
Rising	V/Sec		<input type="checkbox"/>	DPD II							
Falling	V/Sec		<input type="checkbox"/>	DPD II							
Details of Excitation Loop (PC.A.5.3.2(c)) Described in block diagram form showing transfer functions of individual elements	Diagram		<input type="checkbox"/>	DPD II	(please attach)						
Dynamic characteristics of over- excitation limiter (PC.A.5.3.2(c))			<input type="checkbox"/>	DPD II							
Dynamic characteristics of under-excitation limiter (PC.A.5.3.2(c))			<input type="checkbox"/>	DPD II							
Option 2											
Exciter category, e.g. Rotating Exciter , or Static Exciter etc (PC.A.5.3.2(c))	Text		<input type="checkbox"/>	SPD							
Excitation System Nominal Response (PC.A.5.3.2(c))	V_E		<input type="checkbox"/>	DPD II							
Rated Field Voltage (PC.A.5.3.2(c)) U_{fN}	V		<input type="checkbox"/>	DPD II							
No-load Field Voltage (PC.A.5.3.2(c)) U_{f0}	V		<input type="checkbox"/>	DPD II							
Excitation System On-Load Positive Ceiling Voltage (PC.A.5.3.2(c)) U_{pL+}	V		<input type="checkbox"/>	DPD II							
Excitation System No-Load Positive Ceiling Voltage (PC.A.5.3.2(c)) U_{p0+}	V		<input type="checkbox"/>	DPD II							
Excitation System No-Load Negative Ceiling Voltage (PC.A.5.3.2(c)) U_{p0-}	V		<input type="checkbox"/>	DPD II							
Power System Stabiliser (PSS) fitted (PC.A.3.4.2)	Yes/No		<input type="checkbox"/>	SPD							
Stator Current Limit (PC.A.5.3.2(c))	A		<input type="checkbox"/>	DPD II							
Details of Excitation System (PC.A.5.3.2(c)) (including PSS if fitted) described in block diagram form showing transfer functions of individual elements.	Diagram		<input type="checkbox"/>	DPD II							
Details of Over-excitation Limiter (PC.A.5.3.2(c)) described in block diagram form showing transfer functions of individual elements.	Diagram		<input type="checkbox"/>	DPD II							
Details of Under-excitation Limiter (PC.A.5.3.2(c)) described in block diagram form showing transfer functions of individual elements.	Diagram		<input type="checkbox"/>	DPD II							

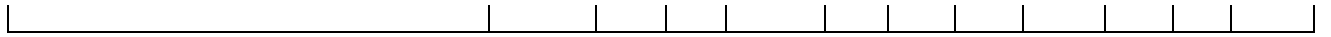

SCHEDULE 1 – POWER GENERATING MODULE, GENERATING UNIT (OR CCGT MODULE), POWER PARK MODULE, DC CONNECTED POWER PARK MODULE, HVDC SYSTEM AND DC CONVERTER TECHNICAL DATA

DATA DESCRIPTION	UNITS	DATA to		DATA CAT.	GENERATING UNIT OR STATION DATA								
		RTL			G1	G2	G3	G4	G5	G6	STN		
		CUSC Contract	CUSC App. Form										
<u>GOVERNOR AND ASSOCIATED PRIME MOVER PARAMETERS</u>													
<p><u>Note:</u> The data items requested under Option 1 below may continue to be provided by Generators in relation to Generating Units on the System at 9 January 1995 (in this paragraph, the "relevant date") or they may provide the new data items set out under Option 2. Generators must supply the data as set out under Option 2 (and not those under Option 1) for Generating Unit and Synchronous Power Generating Unit governor control systems commissioned after the relevant date, those Generating Unit and Synchronous Power Generating Unit governor control systems recommissioned for any reason such as refurbishment after the relevant date and Generating Unit and Synchronous Power Generating Unit governor control systems where, as a result of testing or other process, the Generator is aware of the data items listed under Option 2 in relation to that Generating Unit and Synchronous Power Generating Unit.</p>													
Option 1													
<u>GOVERNOR PARAMETERS (REHEAT UNITS) (PC.A.5.3.2(d) – Option 1(i))</u>													
HP Governor average gain	MW/Hz	<input type="checkbox"/>		DPD II									
Speeder motor setting range	Hz	<input type="checkbox"/>		DPD II									
HP governor valve time constant	S	<input type="checkbox"/>		DPD II									
HP governor valve opening limits		<input type="checkbox"/>		DPD II									
HP governor valve rate limits		<input type="checkbox"/>		DPD II									
Re-heat time constant (stored Active Energy in reheater)	S	<input type="checkbox"/>		DPD II									
IP governor average gain	MW/Hz	<input type="checkbox"/>		DPD II									
IP governor setting range	Hz	<input type="checkbox"/>		DPD II									
IP governor time constant	S	<input type="checkbox"/>		DPD II									
IP governor valve opening limits		<input type="checkbox"/>		DPD II									
IP governor valve rate limits		<input type="checkbox"/>		DPD II									
Details of acceleration sensitive elements HP & IP in governor loop		<input type="checkbox"/>		DPD II	(please attach)								
Governor block diagram showing transfer functions of individual elements		<input type="checkbox"/>		DPD II	(please attach)								
<u>GOVERNOR (Non-reheat steam and Gas Turbines) (PC.A.5.3.2(d) – Option 1(ii))</u>													
Governor average gain	MW/Hz	<input type="checkbox"/>		DPD II									
Speeder motor setting range		<input type="checkbox"/>		DPD II									
Time constant of steam or fuel governor valve	S	<input type="checkbox"/>		DPD II									
Governor valve opening limits		<input type="checkbox"/>		DPD II									
Governor valve rate limits		<input type="checkbox"/>		DPD II									
Time constant of turbine	S	<input type="checkbox"/>		DPD II									
Governor block diagram		<input type="checkbox"/>		DPD II	(please attach)								

SCHEDULE 1 – POWER GENERATING MODULE, GENERATING UNIT (OR CCGT MODULE), POWER PARK MODULE DC CONNECTED POWER PARK MODULE, HVDC SYSTEM AND DC CONVERTER TECHNICAL DATA

DATA DESCRIPTION	UNITS	DATA to RTL		DATA CAT.	GENERATING UNIT OR STATION DATA						
		CUSC Contract	CUSC App. Form		G1	G2	G3	G4	G5	G6	STN
<i>(PC.A.5.3.2(d) – Option 1(iii))</i>											
BOILER & STEAM TURBINE DATA*											
Boiler time constant (Stored Active Energy)	S			DPD II							
HP turbine response ratio: (Proportion of Primary Response arising from HP turbine)	%			DPD II							
HP turbine response ratio: (Proportion of High Frequency Response arising from HP turbine)	%			DPD II							
End of Option 1											
Option 2											
<u>All Generating Units</u> and Synchronous Power Generating Units											
Governor Block Diagram showing transfer function of individual elements including acceleration sensitive elements			<input type="checkbox"/>	DPD II							
Governor Time Constant <i>(PC.A.5.3.2(d) – Option 2(i))</i>	Sec		<input type="checkbox"/>	DPD II							
#Governor Deadband <i>(PC.A.5.3.2(d) – Option 2(i))</i>											
- Maximum Setting	±Hz			DPD II							
- Normal Setting	±Hz			DPD II							
- Minimum Setting	±Hz			DPD II							
Speeder Motor Setting Range <i>(PC.A.5.3.2(d) – Option 2(i))</i>	%		<input type="checkbox"/>	DPD II							
Average Gain <i>(PC.A.5.3.2(d) – Option 2(i))</i>	MW/Hz		<input type="checkbox"/>	DPD II							
Steam Units											
<i>(PC.A.5.3.2(d) – Option 2(ii))</i>											
HP Valve Time Constant	sec		<input type="checkbox"/>	DPD II							
HP Valve Opening Limits	%		<input type="checkbox"/>	DPD II							
HP Valve Opening Rate Limits	%/sec		<input type="checkbox"/>	DPD II							
HP Valve Closing Rate Limits	%/sec		<input type="checkbox"/>	DPD II							
HP Turbine Time Constant <i>(PC.A.5.3.2(d) – Option 2(ii))</i>	sec		<input type="checkbox"/>	DPD II							
IP Valve Time Constant	sec		<input type="checkbox"/>	DPD II							
IP Valve Opening Limits	%		<input type="checkbox"/>	DPD II							
IP Valve Opening Rate Limits	%/sec		<input type="checkbox"/>	DPD II							
IP Valve Closing Rate Limits	%/sec		<input type="checkbox"/>	DPD II							
IP Turbine Time Constant <i>(PC.A.5.3.2(d) – Option 2(ii))</i>	sec		<input type="checkbox"/>	DPD II							
LP Valve Time Constant	sec		<input type="checkbox"/>	DPD II							
LP Valve Opening Limits	%		<input type="checkbox"/>	DPD II							
LP Valve Opening Rate Limits	%/sec		<input type="checkbox"/>	DPD II							
LP Valve Closing Rate Limits	%/sec		<input type="checkbox"/>	DPD II							
LP Turbine Time Constant <i>(PC.A.5.3.2(d) – Option 2(ii))</i>	sec		<input type="checkbox"/>	DPD II							
Reheater Time Constant	sec			DPD II							
Boiler Time Constant	sec			DPD II							
HP Power Fraction	%			DPD II							
IP Power Fraction	%			DPD II							

Where the generating unit or synchronous power generating unit governor does not have a selectable deadband facility, then the actual value of the deadband need only be provided.

SCHEDULE 1 – POWER GENERATING MODULE, GENERATING UNIT (OR CCGT MODULE), POWER PARK MODULE, DC CONNECTED POWER PARK MODULE, HVDC SYSTEM AND DC CONVERTER TECHNICAL DATA

DATA DESCRIPTION	UNITS	DATA to RTL		DATA CAT.	GENERATING UNIT OR STATION DATA						
		CUSC Contract	CUSC App. Form		G1	G2	G3	G4	G5	G6	STN
Gas Turbine Units											
<i>(PC.A.5.3.2(d) – Option 2(iii))</i>											
Inlet Guide Vane Time Constant	sec		<input type="checkbox"/>	DPD II							
Inlet Guide Vane Opening Limits	%		<input type="checkbox"/>	DPD II							
Inlet Guide Vane Opening Rate Limits	%/sec		<input type="checkbox"/>	DPD II							
Inlet Guide Vane Closing Rate Limits	%/sec		<input type="checkbox"/>	DPD II							
<i>(PC.A.5.3.2(d) – Option 2(iii))</i>											
Fuel Valve Time Constant	sec		<input type="checkbox"/>	DPD II							
Fuel Valve Opening Limits	%		<input type="checkbox"/>	DPD II							
Fuel Valve Opening Rate Limits	%/sec		<input type="checkbox"/>	DPD II							
Fuel Valve Closing Rate Limits	%/sec		<input type="checkbox"/>	DPD II							
<i>(PC.A.5.3.2(d) – Option 2(iii))</i>											
Waste Heat Recovery Boiler Time Constant											
Hydro Generating Units											
<i>(PC.A.5.3.2(d) – Option 2(iv))</i>											
Guide Vane Actuator Time Constant	sec		<input type="checkbox"/>	DPD II							
Guide Vane Opening Limits	%		<input type="checkbox"/>	DPD II							
Guide Vane Opening Rate Limits	%/sec		<input type="checkbox"/>	DPD II							
Guide Vane Closing Rate Limits	%/sec		<input type="checkbox"/>	DPD II							
Water Time Constant	sec		<input type="checkbox"/>	DPD II							
End of Option 2											
UNIT CONTROL OPTIONS*											
<i>(PC.A.5.3.2(e))</i>											
Maximum droop	%			DPD II							
Normal droop	%		<input type="checkbox"/>	DPD II							
Minimum droop	%			DPD II							
Maximum frequency deadband	±Hz			DPD II							
Normal frequency deadband	±Hz			DPD II							
Minimum frequency deadband	±Hz			DPD II							
Maximum frequency Insensitivity ¹ Normal	±Hz			DPDII							
frequency Insensitivity ¹	±Hz			DPDII							
Minimum frequency Insensitivity ¹	±Hz			DPDII							
Maximum Output deadband	±MW			DPD II							
Normal Output deadband	±MW			DPD II							
Minimum Output deadband	±MW			DPD II							
Maximum Output Insensitivity ¹	±Hz			DPDII							
Normal Output Insensitivity ¹	±Hz			DPDII							
Minimum Output Insensitivity ¹	±Hz			DPDII							
Frequency settings between which Unit Load Controller droop applies:											
Maximum	Hz			DPD II							
Normal	Hz			DPD II							
Minimum	Hz			DPD II							
Sustained response normally selected	Yes/No			DPD II							
1 Data required only in respect of Power Generating Modules											

SCHEDULE 1 – POWER GENERATING MODULE, GENERATING UNIT (OR CCGT MODULE), POWER PARK MODULE, DC CONNECTED POWER PARK MODULE, HVDC SYSTEM AND DC CONVERTER TECHNICAL DATA

DATA DESCRIPTION	UNITS	DATA to RTL		DATA CAT.	POWER PARK UNIT (OR POWER PARK MODULE, AS THE CASE MAY BE)								
		CUSC Contract	CUSC App. Form		G1	G2	G3	G4	G5	G6	STN		
Power Park Module Rated MVA (PC.A.3.3.1(a))	MVA	<input type="checkbox"/>	<input checked="" type="checkbox"/>	SPD+									
Power Park Module Rated MW (PC.A.3.3.1(a))	MW	<input type="checkbox"/>	<input checked="" type="checkbox"/>	SPD+									
*Performance Chart of a Power Park Module at the connection point (PC.A.3.2.2(f)(ii))				SPD	(see OC2 for specification)								
* Output Usable (on a monthly basis) (PC.A.3.2.2(b))	MW			SPD	(except in relation to CCGT Modules when required on a unit basis under the Grid Code , this data item may be supplied under Schedule 3)								
Number & Type of Power Park Units within each Power Park Module (PC.A.3.2.2(k))		<input type="checkbox"/>		SPD									
Number & Type of Offshore Power Park Units within each Offshore Power Park String and the number of Offshore Power Park Strings and connection point within each Offshore Power Park Module (PC.A.3.2.2.(k))				SPD									
In the case where an appropriate Manufacturer's Data & Performance Report is registered with The Company then subject to The Company's agreement, the report reference may be given as an alternative to completion of the following sections of this Schedule 1 to the end of page 11 with the exception of the sections marked thus # below.	Reference the Manufacturer's Data & Performance Report			SPD									
Power Park Unit Model - A validated mathematical model in accordance with PC.5.4.2 (a)	Transfer function block diagram and algebraic equations, simulation and measured test results	<input type="checkbox"/>		DPD II									

SCHEDULE 1 – POWER GENERATING MODULE, GENERATING UNIT (OR CCGT MODULE), POWER PARK MODULE DC CONNECTED POWER PARK MODULE, HVDC SYSTEM AND DC CONVERTER TECHNICAL DATA

DATA DESCRIPTION	UNITS	DATA to		DATA CAT.	POWER PARK UNIT (OR POWER PARK MODULE, AS THE CASE MAY BE)							
		CUSC Contract	CUSC App. Form		G1	G2	G3	G4	G5	G6	STN	
Power Park Unit Data (where applicable)												
Rated MVA (PC.A.3.3.1(e))	MVA	<input type="checkbox"/>	<input checked="" type="checkbox"/>	SPD+								
Rated MW (PC.A.3.3.1(e))	MW	<input type="checkbox"/>	<input checked="" type="checkbox"/>	SPD+								
Rated terminal voltage (PC.A.3.3.1(e))	V	<input type="checkbox"/>	<input checked="" type="checkbox"/>	SPD+								
Site minimum air density (PC.A.5.4.2(b))	kg/m ³	<input type="checkbox"/>	<input checked="" type="checkbox"/>	DPD II								
Site maximum air density	kg/m ³	<input type="checkbox"/>	<input checked="" type="checkbox"/>	DPD II								
Site average air density	kg/m ³	<input type="checkbox"/>	<input checked="" type="checkbox"/>	DPD II								
Year for which air density data is submitted		<input type="checkbox"/>	<input checked="" type="checkbox"/>	DPD II								
Number of pole pairs		<input type="checkbox"/>	<input checked="" type="checkbox"/>	DPD II								
Blade swept area	m ²	<input type="checkbox"/>	<input checked="" type="checkbox"/>	DPD II								
Gear Box Ratio		<input type="checkbox"/>	<input checked="" type="checkbox"/>	DPD II								
Stator Resistance (PC.A.5.4.2(b))	% on MVA	<input type="checkbox"/>	<input checked="" type="checkbox"/>	SPD+								
Stator Reactance (PC.A.3.3.1(e))	% on MVA	<input type="checkbox"/>	<input checked="" type="checkbox"/>	SPD+								
Magnetising Reactance (PC.A.3.3.1(e))	% on MVA	<input type="checkbox"/>	<input checked="" type="checkbox"/>	SPD+								
Rotor Resistance (at starting). (PC.A.5.4.2(b))	% on MVA	<input type="checkbox"/>	<input checked="" type="checkbox"/>	DPD II								
Rotor Resistance (at rated running) (PC.A.3.3.1(e))	% on MVA	<input type="checkbox"/>	<input checked="" type="checkbox"/>	SPD+								
Rotor Reactance (at starting). (PC.A.5.4.2(b))	% on MVA	<input type="checkbox"/>	<input checked="" type="checkbox"/>	DPD II								
Rotor Reactance (at rated running) (PC.A.3.3.1(e))	% on MVA	<input type="checkbox"/>	<input checked="" type="checkbox"/>	SPD								
Equivalent inertia constant of the first mass (e.g. wind turbine rotor and blades) at minimum speed (PC.A.5.4.2(b))	MW secs /MVA	<input type="checkbox"/>	<input checked="" type="checkbox"/>	SPD+								
Equivalent inertia constant of the first mass (e.g. wind turbine rotor and blades) at synchronous speed (PC.A.5.4.2(b))	MW secs /MVA	<input type="checkbox"/>	<input checked="" type="checkbox"/>	SPD+								
Equivalent inertia constant of the first mass (e.g. wind turbine rotor and blades) at rated speed (PC.A.5.4.2(b))	MW secs /MVA	<input type="checkbox"/>	<input checked="" type="checkbox"/>	SPD+								
Equivalent inertia constant of the second mass (e.g. generator rotor) at minimum speed (PC.A.5.4.2(b))	MW secs /MVA	<input type="checkbox"/>	<input checked="" type="checkbox"/>	SPD+								
Equivalent inertia constant of the second mass (e.g. generator rotor) at synchronous speed (PC.A.5.4.2(b))	MW secs /MVA	<input type="checkbox"/>	<input checked="" type="checkbox"/>	SPD+								
Equivalent inertia constant of the second mass (e.g. generator rotor) at rated speed (PC.A.5.4.2(b))	MW secs /MVA	<input type="checkbox"/>	<input checked="" type="checkbox"/>	SPD+								
Equivalent shaft stiffness between the two masses (PC.A.5.4.2(b))	Nm / electrical radian	<input type="checkbox"/>	<input checked="" type="checkbox"/>	SPD+								

SCHEDULE 1 – POWER GENERATING MODULE, GENERATING UNIT (OR CCGT MODULE), POWER PARK MODULE, DC CONNECTED POWER PARK MODULE, HVDC SYSTEM AND DC CONVERTER TECHNICAL DATA

DATA DESCRIPTION	UNITS	DATA to RTL		DATA CAT.	POWER PARK UNIT (OR POWER PARK MODULE, AS THE CASE MAY BE)						
		CUSC Contract	CUSC App. Form		G1	G2	G3	G4	G5	G6	STN
Minimum generator rotor speed (Doubly Fed Induction Generators) (PC.A.3.3.1(e))	RPM	<input type="checkbox"/>	<input checked="" type="checkbox"/>	SPD+							
Maximum generator rotor speed (Doubly Fed Induction Generators) (PC.A.3.3.1(e))	RPM	<input type="checkbox"/>	<input checked="" type="checkbox"/>	SPD+							
The optimum generator rotor speed versus wind speed (PC.A.5.4.2(b))	tabular format	<input type="checkbox"/>		DPD II							
Power Converter Rating (Doubly Fed Induction Generators) (PC.A.5.4.2(b))	MVA	<input type="checkbox"/>	<input checked="" type="checkbox"/>	DPD II							
The rotor power coefficient (C_p) versus tip speed ratio (λ) curves for a range of blade angles (where applicable) (PC.A.5.4.2(b))	Diagram + tabular format	<input type="checkbox"/>		DPD II							
# The electrical power output versus generator rotor speed for a range of wind speeds over the entire operating range of the Power Park Unit . (PC.A.5.4.2(b))	Diagram + tabular format	<input type="checkbox"/>		DPD II							
The blade angle versus wind speed curve (PC.A.5.4.2(b))	Diagram + tabular format	<input type="checkbox"/>		DPD II							
The electrical power output versus wind speed over the entire operating range of the Power Park Unit . (PC.A.5.4.2(b))	Diagram + tabular format	<input type="checkbox"/>		DPD II							
Transfer function block diagram, parameters and description of the operation of the power electronic converter including fault ride through capability (where applicable). (PC.A.5.4.2(b))	Diagram	<input type="checkbox"/>		DPD II							
For a Power Park Unit consisting of a synchronous machine in combination with a back to back DC Converter or HVDC Converter , or for a Power Park Unit not driven by a wind turbine, the data to be supplied shall be agreed with The Company in accordance with PC.A.7. (PC.A.5.4.2(b))		<input type="checkbox"/>									

SCHEDULE 1 – POWER GENERATING MODULE, GENERATING UNIT (OR CCGT MODULE), POWER PARK MODULE, DC CONNECTED POWER PARK MODULE, HVDC SYSTEM AND DC CONVERTER TECHNICAL DATA

DATA DESCRIPTION	UNITS	DATA to RTL		DATA CAT.	POWER PARK UNIT (OR POWER PARK MODULE, AS THE CASE MAY BE)						
		CUSC Contract	CUSC App. Form		G1	G2	G3	G4	G5	G6	STN
Torque / Speed and blade angle control systems and parameters (PC.A.5.4.2(c)) For the Power Park Unit , details of the torque / speed controller and blade angle controller in the case of a wind turbine and power limitation functions (where applicable) described in block diagram form showing transfer functions and parameters of individual elements	Diagram	<input type="checkbox"/>		DPD II							
# Voltage/Reactive Power/Power Factor control system parameters (PC.A.5.4.2(d)) # For the Power Park Unit and Power Park Module details of Voltage/Reactive Power/Power Factor controller (and PSS if fitted) described in block diagram form including parameters showing transfer functions of individual elements.	Diagram	<input type="checkbox"/>		DPD II							
# Frequency control system parameters (PC.A.5.4.2(e)) # For the Power Park Unit and Power Park Module details of the Frequency controller described in block diagram form showing transfer functions and parameters of individual elements.	Diagram	<input type="checkbox"/>		DPD II							
As an alternative to PC.A.5.4.2 (a), (b), (c), (d), (e) and (f), is the submission of a single complete model that consists of the full information required under PC.A.5.4.2 (a), (b), (c), (d) (e) and (f) provided that all the information required under PC.A.5.4.2 (a), b), (c), (d), (e) and (f) individually is clearly identifiable. (PC.A.5.4.2(g))	Diagram	<input type="checkbox"/>		DPD II							
# Harmonic Assessment Information (PC.A.5.4.2(h)) (as defined in IEC 61400-21 (2001)) for each Power Park Unit :-											
# Flicker coefficient for continuous operation		<input type="checkbox"/>		DPD I							
# Flicker step factor		<input type="checkbox"/>		DPD I							
# Number of switching operations in a 10 minute window		<input type="checkbox"/>		DPD I							
# Number of switching operations in a 2 hour window		<input type="checkbox"/>		DPD I							
# Voltage change factor		<input type="checkbox"/>		DPD I							
# Current Injection at each harmonic for each Power Park Unit and for each Power Park Module	Tabular format	<input type="checkbox"/>		DPD I							
Note:- Generators who own or operate DC Connected Power Park Modules shall supply all data for their DC Connected Power Park Modules as applicable to Power Park Modules .											

SCHEDULE 1 – POWER GENERATING MODULE, GENERATING UNIT (OR CCGT MODULE), POWER PARK MODULE, DC CONNECTED POWER PARK MODULE, HVDC SYSTEM AND DC CONVERTER TECHNICAL DATA

HVDC SYSTEM AND DC CONVERTER STATION TECHNICAL DATA

HVDC SYSTEM OR DC CONVERTER STATION NAME _____

DATE: _____

Data Description	Units	DATA to RTL		Data Category	DC Converter Station Data
		CUSC Contract	CUSC App. Form		
<i>(PC.A.4)</i>					
HVDC SYSTEM AND DC CONVERTER STATION DEMANDS:					
Demand supplied through Station Transformers associated with the DC Converter Station and HVDC System [PC.A.4.1]	MW MVA _r	<input type="checkbox"/>		DPD II DPD II	
- Demand with all DC Converters and HVDC Converters within and HVDC System operating at Rated MW import.	MW MVA _r	<input type="checkbox"/>	<input type="checkbox"/>	DPD II DPD II	
- Demand with all DC Converters and HVDC Converters within an HVDC System operating at Rated MW export.					
Additional Demand associated with the DC Converter Station or HVDC System supplied through the National Electricity Transmission System. [PC.A.4.1]	MW MVA _r	<input type="checkbox"/>	<input type="checkbox"/>	DPD II DPD II	
- The maximum Demand that could occur.	MW MVA _r	<input type="checkbox"/>	<input type="checkbox"/>	DPD II DPD II	
- Demand at specified time of annual peak half hour of The Company Demand at Annual ACS Conditions.	MW MVA _r	<input type="checkbox"/>	<input type="checkbox"/>	DPD II DPD II	
- Demand at specified time of annual minimum half-hour of The Company Demand.	Text	<input type="checkbox"/>	<input checked="" type="checkbox"/>	SPD+	
DC CONVERTER STATION AND HVDC SYSTEM DATA	Text	<input type="checkbox"/>	<input checked="" type="checkbox"/>	SPD+	
Number of poles, i.e. number of DC Converters or HVDC Converters within the HVDC System		<input type="checkbox"/>	<input checked="" type="checkbox"/>	SPD+	
Pole arrangement (e.g. monopole or bipole)		<input type="checkbox"/>	<input checked="" type="checkbox"/>		
Details of each viable operating configuration		<input type="checkbox"/>	<input checked="" type="checkbox"/>	SPD	
Configuration 1	Diagram		<input checked="" type="checkbox"/>		
Configuration 2	Diagram				
Configuration 3	Diagram				
Configuration 4	Diagram				
Configuration 5	Diagram				

Configuration 6					
Remote ac connection arrangement	Diagram				

**SCHEDULE 1 – POWER PARK MODULE, GENERATING UNIT (OR CCGT MODULE),
POWER PARK MODULE, DC CONNECTED POWER PARK MODULE, HVDC SYSTEM
AND DC CONVERTER TECHNICAL DATA**

Data Description	Units	DATA to RTL		Data Category	Operating Configuration					
		CUSC Contract	CUSC App. Form		1	2	3	4	5	6
DC CONVERTER STATION AND HVDC SYSTEM DATA (PC.A.3.3.1d)										
DC Converter or HVDC Converter Type (e.g. current or Voltage source)	Text	<input type="checkbox"/>	<input checked="" type="checkbox"/>	SPD						
	Text	<input type="checkbox"/>	<input checked="" type="checkbox"/>	SPD						
Point of connection to The Company's Transmission System (or the Total System if Embedded) of the DC Converter Station or HVDC System configuration in terms of geographical and electrical location and system voltage	Section Number	<input type="checkbox"/>	<input checked="" type="checkbox"/>	SPD						
If the busbars at the Connection Point are normally run in separate sections identify the section to which the DC Converter Station or HVDC System configuration is connected										
Rated MW import per pole [PC.A.3.3.1]	MW	<input type="checkbox"/>	<input checked="" type="checkbox"/>	SPD +						
Rated MW export per pole [PC.A.3.3.1]	MW	<input type="checkbox"/>	<input checked="" type="checkbox"/>	SPD +						
ACTIVE POWER TRANSFER CAPABILITY (PC.A.3.2.2)										
Registered Capacity	MW	<input type="checkbox"/>	<input checked="" type="checkbox"/>	SPD						
Registered Import Capacity	MW	<input type="checkbox"/>	<input checked="" type="checkbox"/>	SPD						
Minimum Generation	MW	<input type="checkbox"/>	<input checked="" type="checkbox"/>	SPD						
Minimum Import Capacity	MW	<input type="checkbox"/>	<input checked="" type="checkbox"/>	SPD						
Maximum HVDC Active Power Transmission Capacity	MW	<input type="checkbox"/>	<input checked="" type="checkbox"/>	SPD						
Minimum Active Power Transmission Capacity	MW	<input type="checkbox"/>	<input checked="" type="checkbox"/>	SPD						
Import MW available in excess of Registered Import Capacity and Maximum Active Power Transmission Capacity	MW	<input type="checkbox"/>	<input checked="" type="checkbox"/>	SPD						
Time duration for which MW in excess of Registered Import Capacity is available	Min	<input type="checkbox"/>	<input checked="" type="checkbox"/>	SPD						
Export MW available in excess of Registered Capacity and Maximum Active Power Transmission Capacity .	MW	<input type="checkbox"/>	<input checked="" type="checkbox"/>	SPD						
Time duration for which MW in excess of Registered Capacity is available	Min	<input type="checkbox"/>	<input checked="" type="checkbox"/>	SPD						

SCHEDULE 1 –POWER GENERATING MODULE, GENERATING UNIT (OR CCGT MODULE), POWER PARK MODULE, DC CONNECTED POWER PARK MODULE, HVDC SYSTEM AND DC CONVERTER TECHNICAL DATA

Data Description	Units	DATA to		Data Category	Operating Configuration						
		RTL			1	2	3	4	5	6	
		CUSC Contract	CUSC App. Form								
DC CONVERTER AND HVDC CONVERTER TRANSFORMER [PC.A.5.4.3.1				DPD II							
Rated MVA	MVA	<input type="checkbox"/>		DPD II							
Winding arrangement	kV	<input type="checkbox"/>		DPD II							
Nominal primary voltage	kV	<input type="checkbox"/>									
Nominal secondary (converter-side) voltage(s)		<input type="checkbox"/>		DPD II							
Positive sequence reactance	% on	<input type="checkbox"/>		DPD II							
Maximum tap	MVA	<input type="checkbox"/>		DPD II							
Nominal tap	% on										
Minimum tap	MVA			DPD II							
Positive sequence resistance	% on	<input type="checkbox"/>		DPD II							
Maximum tap	MVA	<input type="checkbox"/>		DPD II							
Nominal tap		<input type="checkbox"/>		DPD II							
Minimum tap	% on	<input type="checkbox"/>		DPD II							
Zero phase sequence reactance	MVA	<input type="checkbox"/>		DPD II							
Tap change range	% on										
Number of steps	MVA										
	% on										
	MVA										
	% on										
	MVA										
	+% / -%										

SCHEDULE 1 – POWER GENERATING MODULE, GENERATING UNIT (OR CCGT MODULE), DC CONNECTED POWER PARK MODULE, HVDC SYSTEM, POWER PARK MODULE AND DC CONVERTER TECHNICAL DATA

Data Description	Units	DATA to RTL		Data Category	Operating configuration						
		CUSC Contract	CUSC App. Form		1	2	3	4	5	6	
<p>DC NETWORK [PC.A.5.4.3.1 (c)]</p> <p>Rated DC voltage per pole Rated DC current per pole</p> <p>Details of the DC Network described in diagram form including resistance, inductance and capacitance of all DC cables and/or DC lines. Details of any line reactors (including line reactor resistance), line capacitors, DC filters, earthing electrodes and other conductors that form part of the DC Network should be shown.</p>	<p>kV A</p> <p>Diagram</p>	<p><input type="checkbox"/> <input type="checkbox"/> <input type="checkbox"/></p>		<p>DPD II DPD II DPD II</p>							
<p>DC CONVERTER STATION AND HVDC SYSTEM AC HARMONIC FILTER AND REACTIVE COMPENSATION EQUIPMENT [PC.A.5.4.3.1 (d)]</p> <p>For all switched reactive compensation equipment</p> <p>Total number of AC filter banks Diagram of filter connections Type of equipment (e.g. fixed or variable) Capacitive rating; or Inductive rating; or Operating range</p> <p>Reactive Power capability as a function of various MW transfer levels</p>	<p>Diagram</p> <p>Text Diagram Text MVar MVar MVar</p> <p>Table</p>	<p><input type="checkbox"/> <input type="checkbox"/> <input type="checkbox"/> <input type="checkbox"/> <input type="checkbox"/> <input type="checkbox"/> <input type="checkbox"/></p>	<p>■ ■ ■ ■</p>	<p>DPD II DPD II DPD II DPD II DPD II DPD II DPD II</p>							

SCHEDULE 1 – POWER GENERATING MODULE, GENERATING UNIT (OR CCGT MODULE), POWER PARK MODULE, DC CONNECTED POWER PARK MODULE, HVDC SYSTEM AND DC CONVERTER TECHNICAL DATA

PAGE 18 OF 19

Data Description	Units	DATA to		Data Category	Operating configuration						
		RTL			1	2	3	4	5	6	
		CUSC Contract	CUSC App. Form								

Data Description	Units	DATA to RTL		Data Category	Operating configuration					
		CUSC Contract	CUSC App. Form		1	2	3	4	5	6
CONTROL SYSTEMS [PC.A.5.4.3.2]										
Static $V_{DC} - P_{DC}$ (DC voltage – DC power) or Static $V_{DC} - I_{DC}$ (DC voltage – DC current) characteristic (as appropriate) when operating as –Rectifier –Inverter	Diagram Diagram	<input type="checkbox"/>		DPD II DPD II						
Details of rectifier mode control system, in block diagram form together with parameters showing transfer functions of individual elements.	Diagram	<input type="checkbox"/>		DPD II						
Details of inverter mode control system, in block diagram form showing transfer functions of individual elements including parameters.	Diagram	<input type="checkbox"/>		DPD II						
Details of converter transformer tap changer control system in block diagram form showing transfer functions of individual elements including parameters. (Only required for DC Converters and HVDC Systems connected to the National Electricity Transmission System .)	Diagram	<input type="checkbox"/>		DPD II						
Details of AC filter and reactive compensation equipment control systems in block diagram form showing transfer functions of individual elements including parameters. (Only required for DC Converters and HVDC Systems connected to the National Electricity Transmission System .)	Diagram	<input type="checkbox"/>		DPD II						
Details of any frequency and/or load control systems in block diagram form showing transfer functions of individual elements including parameters.	Diagram	<input type="checkbox"/>		DPD II						
Details of any large or small signal modulating controls, such as power oscillation damping controls or sub-synchronous oscillation damping controls, that have not been submitted as part of the above control system data.	Diagram	<input type="checkbox"/>		DPD II						
Details of HVDC Converter unit models and/or control systems in block diagram form showing transfer functions of individual elements including parameters.	Diagram	<input type="checkbox"/>		DPD II						
Details of AC component models and/or control systems in block diagram form showing transfer functions of individual elements including parameters.	Diagram	<input type="checkbox"/>		DPD II						
Details of DC Grid models and/or control systems in block diagram form showing transfer functions of individual elements including parameters.	Diagram	<input type="checkbox"/>		DPD II						
Details of Voltage and power controller and/or control systems in block diagram form showing transfer functions of individual elements including parameters.	Diagram	<input type="checkbox"/>		DPD II						
Details of Special control features if applicable (eg power oscillation damping (POD) function, subsynchronous torsional interaction (SSTI) control and/or control systems in block diagram form showing transfer functions of individual elements including parameters.	Diagram	<input type="checkbox"/>		DPD II						
Details of Multi terminal control, if applicable and/or control systems in block diagram form showing transfer functions of individual elements including parameters.	Diagram	<input type="checkbox"/>		DPD II						
Details of HVDC System protection models as agreed between The Company the HVDC System Owner and/or control systems in block diagram form showing transfer functions of individual elements including parameters.	Diagram	<input type="checkbox"/>		DPD II						
Transfer block diagram representation of the reactive power control at converter ends for a voltage source converter	Diagram	<input type="checkbox"/>		DPD II						
Transfer block diagram representation of the reactive power control at converter ends for a voltage source converter.										

SCHEDULE 1 – POWER GENERATING MODULE, GENERATING UNIT (OR CCGT MODULE), POWER PARK MODULE, DC CONNECTED POWER PARK MODULE, HVDC SYSTEM AND DC CONVERTER TECHNICAL DATA

Data Description	Units	DATA to RTL		Data Category	Operating configuration						
		CUSC Contract	CUSC App. Form		1	2	3	4	5	6	
LOADING PARAMETERS [PC.A.5.4.3.3]											
MW Export											
Nominal loading rate	MW/s			DPD I							
Maximum (emergency) loading rate	MW/s			DPD I							
MW Import											
Nominal loading rate	MW/s			DPD I							
Maximum (emergency) loading rate	MW/s			DPD I							
Maximum recovery time, to 90% of pre-fault loading, following an AC system fault or severe voltage depression.	s	□		DPD II							
Maximum recovery time, to 90% of pre-fault loading, following a transient DC Network fault.	s	□		DPD II							

NOTE: **Users** are referred to Schedules 5 & 14 which set down data required for all **Users** directly connected to the **National Electricity Transmission System**, including **Power Stations**. **Generators** undertaking **OTSDUW Arrangements** and are utilising an **OTSDUW DC Converter** are referred to Schedule 18.

SCHEDULE 2 - GENERATION PLANNING PARAMETERS

PAGE 1 OF 3

This schedule contains the **Genset Generation Planning Parameters** required by **The Company** to facilitate studies in **Operational Planning** timescales.

For a **Generating Unit**, including those within a **Power Generating Module** (other than a **Power Park Unit**) at a **Large Power Station** or **Generating Unit** including those within a **Power Generating Module** (other than a **Power Park Unit**) directly connected to the **National Electricity Transmission System**, the information is to be submitted on a unit basis and for a **CCGT Module** or **Power Park Module** at a **Large Power Station** or directly connected to the **National Electricity Transmission System** the information is to be submitted on a module basis, unless otherwise stated.

Where references to **CCGT Modules** or **Power Park Modules** at a **Large Power Station** or which are directly connected to the **National Electricity Transmission System** are made, the columns "G1" etc should be amended to read "M1" etc, as appropriate.

Power Station: _____

Generation Planning Parameters

DATA DESCRIPTION	UNITS	DATA to RTL		DATA CAT.	GENSET OR STATION DATA							
		CUSC Contract	CUSC App. Form		G1	G2	G3	G4	G5	G6	STN	
<u>OUTPUT CAPABILITY</u> (PC.A.3.2.2) Registered Capacity on a station and unit basis (on a station and module basis in the case of a CCGT Module or Power Park Module at a Large Power Station <u>or at any other Power Station directly connected to the National Electricity Transmission System</u>) Maximum Capacity on a Power Generating Module basis and Synchronous Generating Unit basis and Registered Capacity on a Power Station basis) Minimum Generation (on a module basis in the case of a CCGT Module or Power Park Module at a Large Power Station <u>or at a Power Station directly connected to the National Electricity Transmission System</u>) Minimum Stable Operating Level (on a module basis in the case of a Power Generating Module at a Large Power Station <u>or at a Power Station directly connected to the National Electricity Transmission System</u>) MW available from Power Generating Modules and Generating Units or Power Park Modules in excess of Registered Capacity or Maximum Capacity	MW	<input type="checkbox"/>	<input checked="" type="checkbox"/>	SPD								
<u>REGIME UNAVAILABILITY</u> These data blocks are provided to allow fixed periods of unavailability to be registered. <u>Expected Running Regime.</u> Is Power Station normally available for full output 24 hours per day, 7 days per week? If No please provide details of unavailability below. (PC.A.3.2.2.) Earliest Synchronising time: OC2.4.2.1(a) Monday Tuesday – Friday Saturday – Sunday	MW	<input type="checkbox"/>	<input checked="" type="checkbox"/>	SPD								
	hr/min	<input checked="" type="checkbox"/>	<input checked="" type="checkbox"/>	OC2								-
	hr/min	<input checked="" type="checkbox"/>	<input checked="" type="checkbox"/>	OC2								-
	hr/min	<input checked="" type="checkbox"/>	<input checked="" type="checkbox"/>	OC2								-

Latest De-Synchronising time: OC2.4.2.1(a)													
Monday – Thursday	hr/min	■											-
Friday	hr/min	■											-
Saturday – Sunday	hr/min	■											-
<u>SYNCHRONISING PARAMETERS</u>													
OC2.4.2.1(a)													
Notice to Deviate from Zero (NDZ) after 48 hour Shutdown	Mins	■											OC2
Station Synchronising Intervals (SI) after 48 hour Shutdown	Mins	■				-	-	-	-	-	-	-	-
Synchronising Group (if applicable)	1 to 4	■											OC2

SCHEDULE 2 - GENERATION PLANNING PARAMETERS

PAGE 2 OF 3

DATA DESCRIPTION	UNITS	DATA to RTL		DATA CAT.	GENSET OR STATION DATA							
		CUSC Contract	CUSC App. Form		G1	G2	G3	G4	G5	G6	STN	
Synchronising Generation (SYG) after 48 hour Shutdown <i>PC.A.5.3.2(f) & OC2.4.2.1(a)</i>	MW	■		DPD II & OC2								-
De-Synchronising Intervals (Single value) <i>OC2.4.2.1(a)</i>	Mins	■		OC2	-	-	-	-	-	-	-	
<u>RUNNING AND SHUTDOWN PERIOD LIMITATIONS:</u>												
Minimum Non Zero time (MNZT) after 48 hour Shutdown <i>OC2.4.2.1(a)</i>	Mins	■		OC2								
Minimum Zero time (MZT) <i>OC2.4.2.1(a)</i>	Mins			OC2								
Existing AGR Plant Flexibility Limit (Existing AGR Plant only)	No.			OC2								
80% Reactor Thermal Power (expressed as Gross-Net MW) (Existing AGR Plant only)	MW			OC2								
Frequency Sensitive AGR Unit Limit (Frequency Sensitive AGR Units only)	No.			OC2								
<u>RUN-UP PARAMETERS</u> <i>PC.A.5.3.2(f) & OC2.4.2.1(a)</i>												
<u>Run-up rates (RUR) after 48 hour Shutdown:</u> (See note 2 page 3) MW Level 1 (MWL1) MW Level 2 (MWL2)	MW MW	■ ■		OC2 OC2								- -
RUR from Synch. Gen to MWL1	MW/Mins	■		DPD II & OC2								
RUR from MWL1 to MWL2	MW/Mins	■		OC2								
RUR from MWL2 to RC	MW/Mins	■		OC2								
<u>Run-Down Rates (RDR):</u> (Note that for DPD only a single value of run-down rate from Registered Capacity to de-synch is required)												
MWL2 RDR from RC to MWL2	MW MW/Min	■ ■		OC2 DPD II								
MWL1 RDR from MWL2 to MWL1	MW MW/Min	■ ■		OC2 OC2								
RDR from MWL1 to de-synch	MW/Min	■		OC2								

SCHEDULE 2 - GENERATION PLANNING PARAMETERS

PAGE 3 OF 3

DATA DESCRIPTION	UNITS	DATA to		DATA CAT.	GENSET OR STATION DATA						
		CUSC Contract	CUSC App. Form		G1	G2	G3	G4	G5	G6	STN
REGULATION PARAMETERS											
<i>OC2.4.2.1(a)</i>											
Regulating Range	MW	■		DPD II							
Load rejection capability while still Synchronised and able to supply Load .	MW	■		DPD II							
<u>GAS TURBINE LOADING PARAMETERS:</u>											
<i>OC2.4.2.1(a)</i>											
Fast loading	MW/Min	■		OC2							
Slow loading	MW/Min	■		OC2							
<u>CCGT MODULE PLANNING MATRIX</u>											
				OC2	(please attach)						
<u>POWER PARK MODULE PLANNING MATRIX</u>											
				OC2	(please attach)						
Power Park Module Active Power Output/ Intermittent Power Source Curve (eg MW output / Wind speed)				OC2	(please attach)						

NOTES:

- (1) To allow for different groups of **Gensets** within a **Power Station** (eg. **Gensets** with the same operator) each **Genset** may be allocated to one of up to four **Synchronising Groups**. Within each such **Synchronising Group** the single synchronising interval will apply but between **Synchronising Groups** a zero synchronising interval will be assumed.
- (2) The run-up of a **Genset** from synchronising block load to **Registered Capacity** or **Maximum Capacity** is represented as a three stage characteristic in which the run-up rate changes at two intermediate loads, MWL1 and MWL2. The values MWL1 & MWL2 can be different for each **Genset**.

SCHEDULE 3 - ~~LARGE~~ POWER STATION OUTAGE PROGRAMMES, OUTPUT USABLE AND INFLEXIBILITY INFORMATION

PAGE 1 OF 3

(Also outline information on contracts involving **External Interconnections**)

For a **Generating Unit** at a **Large Power Station** or at a **Small or Medium Power Station** directly connected to the **National Electricity Transmission System** and comprising a **Type C** or **Type D Power Generating Module** the information is to be submitted on a unit basis —and for a **CCGT Module** or **Power Park Module** at a **Large Power Station** at a **Small or Medium Power Station** directly connected to the **National Electricity Transmission System** and comprising a **Type C** or **Type D Power Generating Module** the information is to be —submitted on a module _basis, unless otherwise _____ stated.

DATA DESCRIPTION		UNITS	TIME COVERED	UPDATE TIME	DATA CAT.	DATA to RTL	
Power Station name:..... Generating Unit (or CCGT Module or Power Park Module at a Large Power Station) number:.... Registered Capacity :..... Large Power Station OUTAGE PROGRAMME Large Power Station OUTPUT USABLE							
<u>PLANNING FOR YEARS 3 - 7 AHEAD (OC2.4.1.2.1(a)(i), (e) & (j))</u>							
Monthly average OU		MW	F. yrs 5 - 7	Week 24	SPD	CUSC Contract	CUSC App. Form
Provisional outage programme comprising:			C. yrs 3 - 5	Week 2	OC2		
duration		weeks	"	"	"	■	
preferred start		date	"	"	"	■	
earliest start		date	"	"	"	■	
latest finish		date	"	"	"	■	
Weekly OU		MW	"	"	"	■	
(The Company response as detailed in OC2			C. yrs 3 - 5	Week12)		■	
(Users' response to The Company suggested changes or potential outages)			C. yrs 3 - 5	Week14)		■	
Updated provisional outage programme comprising:			C. yrs 3 - 5	Week 25	OC2		
duration		weeks	"	"	"	■	
preferred start		date	"	"	"	■	
earliest start		date	"	"	"	■	
latest finish		date	"	"	"	■	
Updated weekly OU		MW	"	"	"	■	
(The Company response as detailed in OC2 for (Users' response to The Company suggested changes or update of potential outages)			C. yrs 3 - 5	Week28)		■	
(The Company further suggested revisions etc. (as detailed in OC2 for			C. yrs 3 - 5	Week31)		■	
			C. yrs 3 - 5	Week42)		■	
Agreement of final Generation Outage Programme			C. yrs 3 - 5	Week 45	OC2	■	
<u>PLANNING FOR YEARS 1 - 2 AHEAD (OC2.4.1.2.2(a) & OC2.4.1.2.2(i))</u>							
Update of previously agreed Final Generation Outage Programme			C. yrs 1 - 2	Week 10	OC2		
Weekly OU		MW	"	"		■	

**SCHEDULE 3 - ~~LARGE~~ POWER STATION OUTAGE PROGRAMMES, OUTPUT
USABLE AND INFLEXIBILITY INFORMATION**

DATA DESCRIPTION	UNITS	TIME COVERED	UPDATE TIME	DATA CAT	DATA to RTL
(The Company response as detailed in OC2 for (Users' response to The Company suggested changes or update of potential outages)		C. yrs 1 – 2	Week 12)		■
		C. yrs 1 – 2	Week 14)		■
Revised weekly OU		C. yrs 1 – 2	Week 34	OC2	■
(The Company response as detailed in OC2 for (Users' response to The Company suggested changes or update of potential outages)		C. yrs 1 – 2	Week 39)		■
		C. yrs 1 – 2	Week 46)		■
Agreement of final Generation Outage Programme		C. yrs 1 – 2	Week 48	OC2	■
<u>PLANNING FOR YEAR 0</u>					
Updated Final Generation Outage Programme		C. yr 0 Week 2 ahead to year end	1600 Weds.	OC2	
OU at weekly peak	MW	"	"	"	
(The Company response as detailed in OC2 for ((C. yrs 0 Weeks 2 to 52 ahead	1600) Friday))		
(The Company response as detailed in OC2 for (Weeks 2 - 7 ahead	1600) Thurs)		
Forecast return to services (Planned Outage or breakdown)	date	days 2 to 14 ahead	0900 daily	OC2	
OU (all hours)	MW	"	"	OC2	
(The Company response as detailed in OC2 for (days 2 to 14 ahead	1600) daily)		
<u>INFLEXIBILITY</u>					
Genset inflexibility	Min MW (Weekly)	Weeks 2 - 8 ahead	1600 Tues	OC2	
(The Company response on Negative Reserve Active (Power Margin		"	1200) Friday)		
Genset inflexibility	Min MW (daily)	days 2 -14 ahead	0900 daily	OC2	
(The Company response on Negative Reserve Active (Power Margin		"	1600) daily)		

**SCHEDULE 3 - ~~LARGE~~ POWER STATION OUTAGE PROGRAMMES, OUTPUT
USABLE AND INFLEXIBILITY INFORMATION
PAGE 3 OF 3**

DATA DESCRIPTION	UNITS	TIME COVERED	UPDATE TIME	DATA CAT	DATA to RTL	
<u>OUTPUT PROFILES</u>						
					CUSC Contract	CUSC App. Form
In the case of Large Power Stations or Power Stations directly connected to the National Electricity Transmission System comprising of any Type C or Type D Power Generating Module whose output may be expected to vary in a random manner (eg. wind power) or to some other pattern (eg. Tidal) sufficient information is required to enable an understanding of the possible profile	MW	F. yrs 1 - 7	Week 24	SPD		

Notes: 1. The week numbers quoted in the Update Time column refer to standard weeks in the current year.

SCHEDULE 4 - ~~LARGE~~ POWER STATION DROOP AND RESPONSE DATA

PAGE 1 OF 1

GOVERNOR DROOP AND RESPONSE (PC.A.5.5 ■ CUSC Contract)

The Data in this Schedule 4 is to be supplied by **Generators** with respect to all **Large Power Stations, Power Stations directly connected to the National Electricity Transmission System and comprising of any Type C or Type D Power Generating Module, HVDC System Owners and by DC Converter Station owners (where agreed) whether directly connected or Embedded**

DATA DESCRIPTION	NORMAL VALUE	MW	DATA CAT	DROOP%			RESPONSE CAPABILITY		
				Unit 1	Unit 2	Unit 3	Primary	Secondary	High Frequency
MLP1	Designed Minimum Operating Level or Minimum Regulating Level (for a CCGT Module or Power Park Module, on a modular basis assuming all units are Synchronised)								
MLP2	Minimum Generation or Minimum Stable Operating Level (for a CCGT Module or Power Park Module, or Power Generating Module on a modular basis assuming all units are Synchronised)								
MLP3	70% of Registered Capacity or Maximum Capacity								
MLP4	80% of Registered Capacity or Maximum Capacity								
MLP5	95% of Registered Capacity or Maximum Capacity								
MLP6	Registered Capacity or Maximum Capacity								

Notes:

- The data provided in this Schedule 4 is not intended to constrain any **Ancillary Services Agreement**. For the avoidance of doubt **Generators in respect of Small Power Stations directly connected to the National Electricity Transmission System and Medium Power Stations directly connected to the National Electricity Transmission System need only be supplied with respect to the Type C and Type D Power Generating Modules forming part of those Power Stations**.
- Registered Capacity or Maximum Capacity** should be identical to that provided in Schedule 2.
- The Governor Droop should be provided for each **Generating Unit (excluding Power Park Units), Power Park Module, HVDC Converter or DC Converter**. The Response Capability should be provided for each **Genset or DC Converter**.
- Primary, Secondary and High Frequency Response** are defined in CC.A.3.2 and are based on a frequency ramp of 0.5Hz over 10 seconds. **Primary Response** is the minimum value of response between 10s and 30s after the frequency ramp starts, **Secondary Response** between 30s and 30 minutes, and **High Frequency Response** is the minimum value after 10s on an indefinite basis.
- For plants which have not yet **Synchronised**, the data values of MLP1 to MLP6 should be as described above. For plants which have already **Synchronised**, the values of MLP1 to MLP6 can take any value between **Designed Operating Minimum Level or Minimum Regulating Level and Registered Capacity or Maximum Capacity**. If MLP1 is not provided at the **Designed Minimum Operating Level**, the value of the **Designed Minimum Operating Level** should be separately stated.
- For the avoidance of doubt **Transmission DC Converters and OTSDUW DC Converters** must be capable of providing a continuous signal indicating the real time frequency measured at the **Transmission Interface Point to the Offshore Grid Entry Point** (as detailed in CC.6.3.7(vii) and CC.6.3.7(viii)) to enable **Offshore Power Generating Modules Offshore Generating Units, Offshore Power Park Modules and/or Offshore DC Converters** to satisfy the frequency response requirements of CC.6.3.7.

SCHEDULE 5 - USERS SYSTEM DATA

PAGE 1 OF 11

The data in this Schedule 5 is required from **Users** who are connected to the **National Electricity Transmission System** via a **Connection Point** (or who are seeking such a connection). **Generators** undertaking **OTSDUW** should use **DRC** Schedule 18 although they should still supply data under Schedule 5 in relation to their **User's System** up to the **Offshore Grid Entry Point**.

DATA DESCRIPTION	UNITS	DATA to RTL		DATA CATEGORY
		CUSC Contract	CUSC App. Form	
<p>USERS SYSTEM LAYOUT (PC.A.2.2)</p> <p>A Single Line Diagram showing all or part of the User's System is required. This diagram shall include:-</p> <p>(a) all parts of the User's System, whether existing or proposed, operating at Supergrid Voltage, and in Scotland and Offshore, also all parts of the User System operating at 132kV,</p> <p>(b) all parts of the User's System operating at a voltage of 50kV, and in Scotland and Offshore greater than 30kV, or higher which can interconnect Connection Points, or split bus-bars at a single Connection Point,</p> <p>(c) all parts of the User's System between Embedded Medium Power Stations or Large Power Stations or Offshore Transmission Systems connected to the User's Subtransmission System and the relevant Connection Point or Interface Point,</p> <p>(d) all parts of the User's System at a Transmission Site.</p> <p>The Single Line Diagram may also include additional details of the User's Subtransmission System, and the transformers connecting the User's Subtransmission System to a lower voltage. With The Company's agreement, it may also include details of the User's System at a voltage below the voltage of the Subtransmission System.</p> <p>This Single Line Diagram shall depict the arrangement(s) of all of the existing and proposed load current carrying Apparatus relating to both existing and proposed Connection Points, showing electrical circuitry (ie. overhead lines, underground cables, power transformers and similar equipment), operating voltages. In addition, for equipment operating at a Supergrid Voltage, and in Scotland and Offshore also at 132kV, circuit breakers and phasing arrangements shall be shown.</p>		<p>■</p> <p>■</p> <p>■</p> <p>■</p> <p>■</p> <p>■</p> <p>■</p>	<p>■</p> <p>■</p> <p>■</p> <p>■</p> <p>■</p> <p>■</p> <p>■</p>	<p>SPD</p>

SCHEDULE 5 - USERS SYSTEM DATA

PAGE 2 OF 11

DATA DESCRIPTION	UNITS	DATA EXCH		DATA CATEGORY
		CUSC Contract	CUSC App. Form	
REACTIVE COMPENSATION (PC.A.2.4)				
For independently switched reactive compensation equipment not owned by a Transmission Licensee connected to the User's System at 132kV and above, and also in Scotland and Offshore , connected at 33kV and above, other than power factor correction equipment associated with a customers Plant or Apparatus :				
Type of equipment (eg. fixed or variable)	Text	■	■	SPD
Capacitive rating; or	MVAr	■	■	SPD
Inductive rating; or	MVAr	■	■	SPD
Operating range	MVAr	■	■	SPD
Details of automatic control logic to enable operating characteristics to be determined	text and/or diagrams	■	■	SPD
Point of connection to User's System (electrical location and system voltage)	Text	■	■	SPD
SUBSTATION INFRASTRUCTURE (PC.A.2.2.6(b))				
For the infrastructure associated with any User's equipment at a Substation owned by a Transmission Licensee or operated or managed by The Company :-				
Rated 3-phase rms short-circuit withstand current	kA	■	■	SPD
Rated 1-phase rms short-circuit withstand current	kA	■	■	SPD
Rated Duration of short-circuit withstand	s	■	■	SPD
Rated rms continuous current	A	■	■	SPD

SCHEDULE 5 – USERS SYSTEM DATA

PAGE 3 OF 11

DATA DESCRIPTION		UNITS	DATA EXCH		DATA CATEGORY
LUMPED SUSCEPTANCES (PC.A.2.3)			CUSC Contract	CUSC App. Form	
Equivalent Lumped Susceptance required for all parts of the User's Subtransmission System which are not included in the Single Line Diagram .			■	■	
This should not include:			■	■	
(a)	independently switched reactive compensation equipment identified above.		■	■	
(b)	any susceptance of the User's System inherent in the Demand (Reactive Power) data provided in Schedule 1 (Generator Data) or Schedule 11 (Connection Point data).		■	■	
Equivalent lumped shunt susceptance at nominal Frequency .		% on 100 MVA	■	■	SPD

USERS SYSTEM DATA

Transformer Data (PC.A.2.2.5) (■ CUSC Contract & ■ CUSC Application Form)

SCHEDULE 5 – USERS SYSTEM DATA

The data below is all **Standard Planning Data**, and details should be shown below of all transformers shown on the **Single Line Diagram**. Details of Winding Arrangement, Tap Changer and earthing details are only required for transformers connecting the **User's** higher voltage system with its **Primary Voltage System**.

Years valid	Name of Node or Connection Point	Transformer	Rating MVA	Voltage Ratio		Positive Phase Sequence Reactance % on Rating			Positive Phase Sequence Resistance % on Rating			Zero Sequence Reactance % on Rating	Winding Arr.	Tap Changer			Earthing Details (delete as app.) *
				HV	LV	Max. Tap	Min. Tap	Norm. Tap	Max. Tap	Min. Tap	Norm. Tap			range +% to -%	step size %	type (delete)	
																	Direct/Res/Rea
																	Direct/Res/Rea
																	Direct/Res/Rea
																	Direct/Res/Rea
																	Direct/Res/Rea
																	Direct/Res/Rea
																	Direct/Res/Rea
																	Direct/Res/Rea

*If Resistance or Reactance please give impedance value

Notes

1. Data should be supplied for the current, and each of the seven succeeding Financial Years. This should be done by showing for which years the data is valid in the first column of the Table
2. For a transformer with two secondary windings, the positive and zero phase sequence leakage impedances between the HV and LV1, HV and LV2, and LV1 and LV2 windings are required.

SCHEDULE 5 –USERS SYSTEM DATA

PAGE 6 OF 11

USER'S SYSTEM DATA

Switchgear Data (PC.A.2.2.6(a)) (■ CUSC Contract & CUSC Application Form ■)

The data below is all **Standard Planning Data**, and should be provided for all switchgear (ie. circuit breakers, load disconnectors and disconnectors) operating at a **Supergrid Voltage**, and also in Scotland and **Offshore**, operating at 132kV. In addition, data should be provided for all circuit breakers irrespective of voltage located at a **Connection Site** which is owned by a **Transmission Licensee** or operated or managed by **The Company**.

Years Valid	Connect-ion Point	Switch No.	Rated Voltage kV rms	Operating Voltage kV rms	Rated short-circuit breaking current		Rated short-circuit making current		Rated rms continuous current (A)	DC time constant at testing of asymmetrical breaking ability(s)
					3 Phase kA rms	1 Phase kA rms	3 Phase kA peak	1 Phase kA peak		

Notes

1. Rated Voltage should be as defined by IEC 694.
2. Data should be supplied for the current, and each of the seven succeeding Financial Years. This should be done by showing for which years the data is valid in the first column of the Table

SCHEDULE 5 –USERS SYSTEM DATA

PAGE 7 OF 11

DATA DESCRIPTION	UNITS	DATA to RTL		DATA CATEGORY
		CUSC Contract	CUSC App. Form	
<p>PROTECTION SYSTEMS (PC.A.6.3)</p> <p>The following information relates only to Protection equipment which can trip or inter-trip or close any Connection Point circuit breaker or any Transmission circuit breaker. The information need only be supplied once, in accordance with the timing requirements set out in PC.A.1.4 (b) and need not be supplied on a routine annual basis thereafter, although The Company should be notified if any of the information changes.</p> <p>(a) A full description, including estimated settings, for all relays and Protection systems installed or to be installed on the User's System;</p> <p>(b) A full description of any auto-reclose facilities installed or to be installed on the User's System, including type and time delays;</p> <p>(c) A full description, including estimated settings, for all relays and Protection systems installed or to be installed on the Power Generating Module, Power Park Module or Generating Unit's generator transformer, unit transformer, station transformer and their associated connections;</p> <p>(d) For Generating Units (other than Power Park Units) having a circuit breaker at the generator terminal voltage clearance times for electrical faults within the Generating Unit zone must be declared.</p> <p>(e) Fault Clearance Times: Most probable fault clearance time for electrical faults on any part of the Users System directly connected to the National Electricity Transmission System.</p>				
	mSec	▪		DPD II
		▪		DPD II
		▪		DPD II
		▪		DPD II
		▪		DPD II

DATA DESCRIPTION	UNITS	DATA to RTL		DATA CATEGORY
		CUSC Contract	CUSC App. Form	
<p>POWER PARK MODULE/UNIT PROTECTION SYSTEMS</p> <p>Details of settings for the Power Park Module/Unit protection relays (to include): (PC.A.5.4.2(f))</p> <p>(a) Under frequency,</p> <p>(b) Over Frequency,</p> <p>(c) Under Voltage, Over Voltage,</p> <p>(d) Rotor Over current</p> <p>(e) Stator Over current,.</p> <p>(f) High Wind Speed Shut Down Level</p> <p>(g) Rotor Underspeed</p> <p>(h) Rotor Overspeed</p>				
		▪		DPD II
		▪		DPD II
		▪		DPD II
		▪		DPD II
		▪		DPD II
		▪		DPD II
		▪		DPD II
		▪		DPD II

SCHEDULE 5 - USERS SYSTEM DATA

PAGE 8 OF 11

Information for Transient Overvoltage Assessment (DPD I) (PC.A.6.2 ■ CUSC Contract)

The information listed below may be requested by **The Company** from each **User** with respect to any **Connection Site** between that **User** and the **National Electricity Transmission System**. The impact of any third party **Embedded** within the **Users System** should be reflected.

- (a) Busbar layout plan(s), including dimensions and geometry showing positioning of any current and voltage transformers, through bushings, support insulators, disconnectors, circuit breakers, surge arresters, etc. Electrical parameters of any associated current and voltage transformers, stray capacitances of wall bushings and support insulators, and grading capacitances of circuit breakers;
- (b) Electrical parameters and physical construction details of lines and cables connected at that busbar. Electrical parameters of all plant e.g., transformers (including neutral earthing impedance or zig-zag transformers if any), series reactors and shunt compensation equipment connected at that busbar (or to the tertiary of a transformer) or by lines or cables to that busbar;
- (c) Basic insulation levels (BIL) of all **Apparatus** connected directly, by lines or by cables to the busbar;
- (d) Characteristics of overvoltage **Protection** devices at the busbar and at the termination points of all lines, and all cables connected to the busbar;
- (e) Fault levels at the lower voltage terminals of each transformer connected directly or indirectly to the **National Electricity Transmission System** without intermediate transformation;
- (f) The following data is required on all transformers operating at **Supergrid Voltage** throughout **Great Britain** and, in Scotland and **Offshore**, also at 132kV: three or five limb cores or single phase units to be specified, and operating peak flux density at nominal voltage.
- (g) An indication of which items of equipment may be out of service simultaneously during **Planned Outage** conditions.

Harmonic Studies (DPD I) (PC.A.6.4 ■ CUSC Contract)

The information given below, both current and forecast, where not already supplied in this Schedule 5 may be requested by **The Company** from each **User** if it is necessary for **The Company** to evaluate the production/magnification of harmonic distortion on the **National Electricity Transmission System** and **User's** systems. The impact of any third party **Embedded** within the **User's System** should be reflected:

- (a) Overhead lines and underground cable circuits of the **User's Subtransmission System** must be differentiated and the following data provided separately for each type:
 - Positive phase sequence resistance
 - Positive phase sequence reactance
 - Positive phase sequence susceptance
- (b) for all transformers connecting the **User's Subtransmission System** to a lower voltage:
 - Rated MVA
 - Voltage Ratio
 - Positive phase sequence resistance
 - Positive phase sequence reactance

SCHEDULE 5 – USERS SYSTEM DATA

PAGE 9 OF 11

- (c) at the lower voltage points of those connecting transformers:

Equivalent positive phase sequence susceptance

Connection voltage and MVA_r rating of any capacitor bank and component design parameters if configured as a filter

Equivalent positive phase sequence interconnection impedance with other lower voltage points

The minimum and maximum **Demand** (both MW and MVA_r) that could occur

Harmonic current injection sources in Amps at the Connection voltage points

Details of traction loads, eg connection phase pairs, continuous variation with time, etc.

- (d) an indication of which items of equipment may be out of service simultaneously during **Planned Outage** conditions

Voltage Assessment Studies (DPD I) (PC.A.6.5 ■ CUSC Contract)

The information listed below, where not already supplied in this Schedule 5, may be requested by **The Company** from each **User** with respect to any **Connection Site** if it is necessary for **The Company** to undertake detailed voltage assessment studies (eg to examine potential voltage instability, voltage control co-ordination or to calculate voltage step changes). The impact of any third party **Embedded** within the **Users System** should be reflected:

- (a) For all circuits of the **User's Subtransmission System**:

Positive Phase Sequence Reactance

Positive Phase Sequence Resistance

Positive Phase Sequence Susceptance

MVA_r rating of any reactive compensation equipment

- (b) for all transformers connecting the **User's Subtransmission System** to a lower voltage:

Rated MVA

Voltage Ratio

Positive phase sequence resistance

Positive Phase sequence reactance

Tap-changer range

Number of tap steps

Tap-changer type: on-load or off-circuit

AVC/tap-changer time delay to first tap movement

AVC/tap-changer inter-tap time delay

SCHEDULE 5 – USERS SYSTEM DATA

PAGE 10 OF 11

- (c) at the lower voltage points of those connecting transformers:-

Equivalent positive phase sequence susceptance

MVA_r rating of any reactive compensation equipment

Equivalent positive phase sequence interconnection impedance with other lower voltage points

The maximum **Demand** (both MW and MVA_r) that could occur

Estimate of voltage insensitive (constant power) load content in % of total load at both winter peak and 75% off-peak load conditions

Short Circuit Analyses:(DPD I) (PC.A.6.6 ■ CUSC Contract)

The information listed below, both current and forecast, and where not already supplied under this Schedule 5, may be requested by **The Company** from each **User** with respect to any **Connection Site** where prospective short-circuit currents on equipment owned by a **Transmission Licensee** or operated or managed by **The Company** are close to the equipment rating. The impact of any third party **Embedded** within the **User's System** should be reflected:-

- (a) For all circuits of the **User's Subtransmission System**:

Positive phase sequence resistance

Positive phase sequence reactance

Positive phase sequence susceptance

Zero phase sequence resistance (both self and mutuals)

Zero phase sequence reactance (both self and mutuals)

Zero phase sequence susceptance (both self and mutuals)

- (b) for all transformers connecting the **User's Subtransmission System** to a lower voltage:

Rated MVA

Voltage Ratio

Positive phase sequence resistance (at max, min and nominal tap)

Positive Phase sequence reactance (at max, min and nominal tap)

Zero phase sequence reactance (at nominal tap)

Tap changer range

Earthing method: direct, resistance or reactance

Impedance if not directly earthed

- (c) at the lower voltage points of those connecting transformers:-

The maximum **Demand** (in MW and MVA_r) that could occur

Short-circuit infeed data in accordance with PC.A.2.5.6(a) unless the **User's** lower voltage network runs in parallel with the **Subtransmission System**, when to prevent double counting in each node infeed data, a π equivalent comprising the data items of PC.A.2.5.6(a) for each node together with the positive phase sequence interconnection impedance between the nodes shall be submitted.

SCHEDULE 5 – USERS SYSTEM DATA

PAGE 11 OF 11

Dynamic Models:(DPD II) (PC.A.6.7 ■ CUSC Contract)

The information listed below, both current and forecast, and where not already supplied under this Schedule 5, may be requested by **NGET** from each **EU Code User** or in respect of each **EU Grid Supply Point** with respect to any **Connection Site**

- (a) Dynamic model structure and block diagrams including parameters, transfer functions and individual elements (as applicable)
- (b) Power control functions and block diagrams including parameters, transfer functions and individual elements (as applicable)
- (c) Voltage control functions and block diagrams including parameters, transfer functions and individual elements (as applicable)
- (d) Converter control models and block diagrams including parameters, transfer functions and individual elements (as applicable)

SCHEDULE 6 – USERS OUTAGE INFORMATION

PAGE 1 OF 2

DATA DESCRIPTION	UNITS	DATA to RTL		TIMESCALE COVERED	UPDATE TIME	DATA CAT.	
<p>Details are required from Network Operators of proposed outages in their User Systems and from Generators with respect to their outages, which may affect the performance of the Total System (eg. at a Connection Point or constraining Embedded Large Power Stations or constraints to the Maximum Import Capacity or Maximum Export Capacity at an Interface Point) (OC2.4.1.3.2(a) & (b))</p> <p>(The Company advises Network Operators of National Electricity Transmission System outages affecting their Systems)</p> <p>Network Operator informs The Company if unhappy with proposed outages)</p> <p>(The Company draws up revised National Electricity Transmission System (outage plan advises Users of operational effects)</p> <p>Generators and Non-Embedded Customers provide Details of Apparatus owned by them (other than Gensets) at each Grid Supply Point (OC2.4.1.3.3)</p> <p>(The Company advises Network Operators of outages affecting their Systems) (OC2.4.1.3.3)</p> <p>Network Operator details of relevant outages affecting the Total System (OC2.4.1.3.3)</p> <p>Details of:- Maximum Import Capacity for each Interface Point Maximum Export Capacity for each Interface Point Changes to previously declared values of the Interface Point Target Voltage/Power Factor (OC2.4.1.3.3(c)).</p> <p>(The Company informs Users of aspects that may affect their Systems) (OC2.4.1.3.3)</p> <p>Users inform The Company if unhappy with aspects as notified (OC2.4.1.3.3)</p> <p>(The Company issues final National Electricity Transmission System (outage plan with advice of operational) (OC2.4.1.3.3) (effects on Users System)</p> <p>Generator, Network Operator and Non-Embedded Customers to inform The Company of changes to outages previously requested</p> <p>Details of load transfer capability of 12MW or more between Grid Supply Points in England and Wales and 10MW or more between Grid Supply Points in Scotland.</p> <p>Details of:- Maximum Import Capacity for each Interface Point Maximum Export Capacity for each Interface Point Changes to previously declared values of the Interface Point Target Voltage/Power Factor</p>		CUSC Contract	CUSC App. Form	Years 2-5	Week 8 (Network Operator etc) Week 13 (Generators)	OC2 OC2	
	Years 2-5	Week 28)					
	"	Week 30					OC2
	"	Week 34)					
	Year 1	Week 13					OC2
	Year 1	Week 28)					
	Year 1	Week 32					OC2
	Year 1	Week 32					OC2
	Year 1	Week 34)					
	Year 1	Week 36					OC2
	Year 1	Week 49					OC2
	Week 8 ahead to year end	As occurring					OC2
	Within Yr 0	As The Company request					OC2
	Within Yr 0	As occurring					OC2

Note: **Users** should refer to **OC2** for full details of the procedure summarised above and for the information which **The Company** will provide on the **Programming Phase**.

SCHEDULE 6 – USERS OUTAGE INFORMATION
PAGE 2 OF 2

The data below is to be provided to **The Company** as required for compliance with the European Commission Regulation No 543/2013 (OC2.4.2.3). Data provided under Article Numbers 7.1(a), 7.1(b), 15.1(a), 15.1(b), and 15.1(c) and 15.1(d) is to be provided using **MODIS**.

ECR ARTICLE No.	DATA DESCRIPTION	USERS PROVIDING DATA	FREQUENCY OF SUBMISSION
7.1(a)	<p>Planned unavailability of the Apparatus belonging to a Non-Embedded Customer where OC2.4.7 (a) applies</p> <ul style="list-style-type: none"> - Energy Identification Code (EIC)* - Unavailable demand capacity during the event (MW) - Estimated start date and time (dd.mm.yy hh:mm) - Estimated end date and time (dd.mm.yy hh:mm) - Reason for unavailability from the list below: <ul style="list-style-type: none"> . Maintenance . Failure . Shutdown . Other 	Non-Embedded Customer	To be received by The Company as soon as reasonably possible but in any case to facilitate publication of data no later than 1 hour after a decision has been made by the Non-Embedded Customer regarding the planned unavailability
7.1(b)	<p>Changes in actual availability of the Apparatus belonging to a Non-Embedded Customer where OC2.4.7 (b) applies</p> <ul style="list-style-type: none"> - Energy Identification Code (EIC)* - Unavailable demand capacity during the event (MW) - Start date and time (dd.mm.yy hh:mm) - Estimated end date and time (dd.mm.yy hh:mm) - Reason for unavailability from the list below : <ul style="list-style-type: none"> . Maintenance . Failure . Shutdown . Other 	Non-Embedded Customer	To be received by The Company as soon as reasonably possible but in any case to facilitate publication of data no later than 1 hour after the change in actual availability
8.1	<p>Year Ahead Forecast Margin information as provided in accordance with OC2.4.1.2.2</p> <ul style="list-style-type: none"> - Output Usable 	Generator	In accordance with OC2.4.1.2.2
14.1(a)	<p>Registered Capacity or Maximum Capacity for Generating Units or Power Generating Modules with greater than 1 MW Registered Capacity or Maximum Capacity provided in accordance with PC.4.3.1 and PC.A.3.4.3 or PC.A.3.1.4</p> <ul style="list-style-type: none"> - Registered Capacity or Maximum Capacity (MW) - Production type (from that listed under PC.A.3.4.3) 	Generator	Week 24
14.1(b)	<p>Power Station Registered Capacity for units with equal or greater than 100 MW Registered Capacity provided in accordance with PC.4.3.1 and PC.A.3.4.3</p> <ul style="list-style-type: none"> - Power Station name - Location of Generating Unit - Production type (from that listed under PC.A.3.4.3) - Voltage connection levels - Registered Capacity or Maximum Capacity (MW) 	Generator	Week 24
14.1(c)	<p>Estimated output of Active Power of a BM Unit or Generating Unit for each per Settlement Period of the next Operational Day provided in accordance with BC1.4.2</p> <ul style="list-style-type: none"> - Physical Notification 	Generator	In accordance with BC1.4.2

15.1(a)	<p>Planned unavailability of a Generating Unit where OC2.4.7(c) applies</p> <ul style="list-style-type: none"> - Power Station name - Generating Unit and/or Power Generating Module name - Location of Generating Unit and/or Power Generating Module - Generating Unit Registered Capacity (MW) - Production type (from that listed under PC.A.3.4.3) - Output Usable (MW) during the event - Start date and time (dd.mm.yy hh:mm) - Estimated end date and time (dd.mm.yy hh:mm) - Reason for unavailability from the list below: <ul style="list-style-type: none"> . Maintenance . Shutdown . Other 	Generator	To be received by The Company as soon as reasonably possible but in any case to facilitate publication of data no later than 1 hour after a decision has been made by the Generator regarding the planned unavailability
15.1(b)	<p>Changes in availability of a Generating Unit and/or Power Generating Module where OC2.4.7 (d) applies</p> <ul style="list-style-type: none"> - Power Station name - Generating Unit and/or Power Generating Module name - Location of Generating Unit and/or Power Generating Module - Generating Unit Registered Capacity and Power Generating Module Maximum Capacity (MW) - Production type (from that listed under PC.A.3.4.3) - Maximum Export Limit (MW) during the event - Start date and time (dd.mm.yy hh:mm) - Estimated end date and time (dd.mm.yy hh:mm) - Reason for unavailability from the list below: <ul style="list-style-type: none"> . Maintenance . Shutdown . Other 	Generator	To be received by The Company as soon as reasonably possible but in any case to facilitate publication of data no later than 1 hour after the change in actual availability
15.1(c)	<p>Planned unavailability of a Power Station where OC2.4.7(e) applies</p> <ul style="list-style-type: none"> - Power Station name - Location of Power Station - Power Station Registered Capacity (MW) - Production type (from that listed under PC.A.3.4.3) - Power Station aggregated Output Usable (MW) during the event - Start date and time (dd.mm.yy hh:mm) - Estimated end date and time (dd.mm.yy hh:mm) - Reason for unavailability from the list below: <ul style="list-style-type: none"> . Maintenance . Shutdown . Other 	Generator	To be received by The Company as soon as reasonably possible but in any case to facilitate publication of data no later than 1 hour after a decision has been made by the Generator regarding the planned unavailability
15.1(d)	<p>Changes in actual availability of a Power Station where OC2.4.7 (f) applies</p> <ul style="list-style-type: none"> - Power Station name - Location of Power Station - Power Station Registered Capacity (MW) - Production type (from that listed under PC.A.3.4.3) - Power Station aggregated Maximum Export Limit (MW) during the event - Start date and time (dd.mm.yy hh:mm) - Estimated end date and time (dd.mm.yy hh:mm) - Reason for unavailability from the list below: <ul style="list-style-type: none"> . Maintenance . Shutdown . Other 	Generator	To be received by The Company as soon as reasonably possible but in any case to facilitate publication of data no later than 1 hour after the change in actual availability

* Energy Identification Coding (EIC) is a coding scheme that is approved by ENTSO-E for standardised electronic data interchanges and is utilised for reporting to the Central European Transparency Platform. The Company will act as the Local Issuing Office for IEC in respect of GB.

SCHEDULE 7 - LOAD CHARACTERISTICS AT GRID SUPPLY POINTS

PAGE 1 OF 1

All data in this schedule 7 is categorised as **Standard Planning Data (SPD)** and is required for existing and agreed future connections. This data is only required to be updated when requested by **The Company**.

DATA DESCRIPTION	UNITS	DATA to		DATA FOR FUTURE YEARS						
		RTL		Yr 1	Yr 2	Yr 3	Yr 4	Yr 5	Yr 6	Yr 7
FOR ALL TYPES OF DEMAND FOR EACH GRID SUPPLY POINT		CUSC Contract	CUSC App. Form							
The following information is required infrequently and should only be supplied, wherever possible, when requested by The Company (PC.A.4.7)		<input type="checkbox"/>								
Details of individual loads which have Characteristics significantly different from the typical range of domestic or commercial and industrial load supplied: (PC.A.4.7(a))		<input type="checkbox"/>		(Please Attach)						
Sensitivity of demand to fluctuations in voltage And frequency on National Electricity Transmission System at time of peak Connection Point Demand (Active Power) (PC.A.4.7(b))		<input type="checkbox"/>								
Voltage Sensitivity (PC.A.4.7(b))	MW/kV MVar/kV	<input type="checkbox"/>								
Frequency Sensitivity (PC.A.4.7(b))	MW/Hz MVar/Hz	<input type="checkbox"/>								
Reactive Power sensitivity should relate to the Power Factor information given in Schedule 11 (or for Generators , Schedule 1) and note 6 on Schedule 11 relating to Reactive Power therefore applies: (PC.A.4.7(b))		<input type="checkbox"/>								
Phase unbalance imposed on the National Electricity Transmission System (PC.A.4.7(d))										
- maximum	%	<input type="checkbox"/>								
- average	%	<input type="checkbox"/>								
Maximum Harmonic Content imposed on National Electricity Transmission System (PC.A.4.7(e))	%	<input type="checkbox"/>								
Details of any loads which may cause Demand Fluctuations greater than those permitted under Engineering Recommendation P28, Stage 1 at the Point of Common Coupling including Flicker Severity (Short Term) and Flicker Severity (Long Term) (PC.A.4.7(f))		<input type="checkbox"/>								

SCHEDULE 8 - DATA SUPPLIED BY BM PARTICIPANTS
PAGE 1 OF 1

CODE	DESCRIPTION
BC1	Physical Notifications
BC1	Quiescent Physical Notifications
BC1 & BC2	Export and Import Limits
BC1	Bid-Offer Data
BC1	Dynamic Parameters (Day Ahead)
BC2	Dynamic Parameters (For use in Balancing Mechanism)
BC1 & BC2	Other Relevant Data
BC1	Joint BM Unit Data

- No information collated under this Schedule will be transferred to the **Relevant Transmission Licensees**

SCHEDULE 9 - DATA SUPPLIED BY THE COMPANY TO USERS

PAGE 1 OF 1

(Example of data to be supplied)

CODE	DESCRIPTION
CC	Operation Diagram
CC	Site Responsibility Schedules
PC	Day of the peak National Electricity Transmission System Demand Day of the minimum National Electricity Transmission System Demand
OC2	Surpluses and OU requirements for each Generator over varying timescales Equivalent networks to Users for Outage Planning Negative Reserve Active Power Margins (when necessary) Operating Reserve information
BC1	Demand Estimates, Indicated Margin and Indicated Imbalance , indicative Synchronising and Desynchronising times of Embedded Power Stations to Network Operators , special actions.
BC2	Bid-Offer Acceptances, Ancillary Services instructions to relevant Users, Emergency Instructions
BC3	Location, amount, and Low Frequency Relay settings of any Low Frequency Relay initiated Demand reduction for Demand which is Embedded .

- No information collated under this Schedule will be transferred to the **Relevant Transmission Licensees**

DATA TO BE SUPPLIED BY THE COMPANY TO USERS

PURSUANT TO THE TRANSMISSION LICENCE

1. The **Transmission Licence** requires **The Company** to publish annually the **Seven Year Statement** which is designed to provide **Users** and potential **Users** with information to enable them to identify opportunities for continued and further use of the **National Electricity Transmission System**.

When an **User** is considering a development at a specific site, certain additional information may be required in relation to that site which is of such a level of detail that it is inappropriate to include it in the **Seven Year Statement**. In these circumstances the **User** may contact **The Company** who will be pleased to arrange a discussion and the provision of such additional information relevant to the site under consideration as the **User** may reasonably require.

2. The **Transmission Licence** also requires **The Company** to offer terms for an agreement for connection to and use of the **National Electricity Transmission System** and further information will be given by **The Company** to the potential **User** in the course of the discussions of the terms of such an agreement.

SCHEDULE 10 - DEMAND PROFILES AND ACTIVE ENERGY DATA

The following information is required from each **Network Operator** and from each **Non-Embedded Customer**. The data should be provided in calendar week 24 each year (although **Network Operators** may delay the submission until calendar week 28).

DATA DESCRIPTION	F. Yr.	F. Yr.	F. Yr.	F. Yr.	F. Yr.	F. Yr.	F. Yr.	F. Yr.	F. Yr.	UPDATE TIME	DATA CAT
	0	1	2	3	4	5	6	7			
<u>Demand Profiles</u>	(PC.A.4.2) (■ – CUSC Contract & ■ CUSC Application Form)										
Total User's system profile (please delete as applicable)	Day of User's annual Maximum demand at Annual ACS Conditions (MW)										
	Day of annual peak of National Electricity Transmission System Demand at Annual ACS Conditions (MW)										
	Day of annual minimum National Electricity Transmission System Demand at average conditions (MW)										
0000 : 0030										Wk.24	SPD
0030 : 0100										:	:
0100 : 0130										:	:
0130 : 0200										:	:
0200 : 0230										:	:
0230 : 0300										:	:
0300 : 0330										:	:
0330 : 0400										:	:
0400 : 0430										:	:
0430 : 0500										:	:
0500 : 0530										:	:
0530 : 0600										:	:
0600 : 0630										:	:
0630 : 0700										:	:
0700 : 0730										:	:
0730 : 0800										:	:
0800 : 0830										:	:
0830 : 0900										:	:
0900 : 0930										:	:
0930 : 1000										:	:
1000 : 1030										:	:
1030 : 1100										:	:
1100 : 1130										:	:
1130 : 1200										:	:
1200 : 1230										:	:
1230 : 1300										:	:
1300 : 1330										:	:
1330 : 1400										:	:
1400 : 1430										:	:
1430 : 1500										:	:
1500 : 1530										:	:
1530 : 1600										:	:
1600 : 1630										:	:
1630 : 1700										:	:
1700 : 1730										:	:
1730 : 1800										:	:
1800 : 1830										:	:
1830 : 1900										:	:
1900 : 1930										:	:
1930 : 2000										:	:
2000 : 2030										:	:
2030 : 2100										:	:
2100 : 2130										:	:
2130 : 2200										:	:
2200 : 2230										:	:
2230 : 2300										:	:
2300 : 2330										:	:
2330 : 0000										:	:

SCHEDULE 10 - DEMAND PROFILES AND ACTIVE ENERGY DATA

PAGE 2 OF 2

DATA DESCRIPTION	Out-turn		F. Yr. 0	Update Time	Data Cat	DATA to RTL	
	Actual	Weather Corrected.				CUSC Contract	CUSC App. Form
<p>(PC.A.4.3)</p> <p>Active Energy Data</p> <p>Total annual Active Energy requirements under average conditions of each Network Operator and each Non-Embedded Customer in the following categories of Customer Tariff:-</p> <p style="padding-left: 40px;">LV1 LV2 LV3 EHV HV Traction Lighting User System Losses</p> <p>Active Energy from Embedded Small Power Stations and Embedded Medium Power Stations</p>				Week 24	SPD	<p>■</p> <p>■</p> <p>■</p> <p>■</p> <p>■</p> <p>■</p> <p>■</p> <p>■</p> <p>■</p> <p>■</p> <p>■</p>	<p>■</p> <p>■</p> <p>■</p> <p>■</p> <p>■</p> <p>■</p> <p>■</p> <p>■</p> <p>■</p> <p>■</p>

NOTES:

1. 'F. yr.' means 'Financial Year'
2. Demand and Active Energy Data (General)

Demand and Active Energy data should relate to the point of connection to the **National Electricity Transmission System** and should be net of the output (as reasonably considered appropriate by the **User**) of all **Embedded Small Power Stations, Medium Power Stations** and **Customer Generating Plant**. Auxiliary demand of **Embedded Power Stations** should be included in the demand data submitted by the **User** at the **Connection Point**. **Users** should refer to the **PC** for a full definition of the **Demand** to be included.

3. **Demand** profiles and **Active Energy** data should be for the total **System** of the **Network Operator**, including all **Connection Points**, and for each **Non-Embedded Customer**. **Demand Profiles** should give the numerical maximum demand that in the **User's** opinion could reasonably be imposed on the **National Electricity Transmission System**.
4. In addition the demand profile is to be supplied for such days as **The Company** may specify, but such a request is not to be made more than once per calendar year.

SCHEDULE 11 - CONNECTION POINT DATA

PAGE 1 OF 3

The following information is required from each **Network Operator** and from each **Non-Embedded Customer**. The data should be provided in calendar week 24 each year (although **Network Operators** may delay the submission until calendar week 28).

Connection Point:

Connection Point Demand at the time of - (select each one in turn) (Provide data for each Access Period associated with the Connection Point)	a) maximum Demand b) peak National Electricity Transmission System Demand (<i>specified by The Company</i>) c) minimum National Electricity Transmission System Demand (<i>specified by The Company</i>) d) maximum Demand during Access Period e) specified by either The Company or an User
Name of Transmission Interface Circuit out of service during Access Period (<i>if reqd.</i>).	PC.A.4.1.4.2

DATA DESCRIPTION (CUSC Contract □ & CUSC Application Form ■)	Outturn	Outturn Weather Corrected	F.Yr	F.Yr	F.Yr	F.Yr	F.Yr	F.Yr	F.Yr	F.Yr	DATA CAT
			1	2	3	4	5	6	7	8	
Date of a), b), c), d) or e) as denoted above.											PC.A.4.3.3
Time of a), b), c), d) or e) as denoted above.											PC.A.4.3.3
Connection Point Demand (MW)											PC.A.4.3.1
Connection Point Demand (MVA _r)											PC.A.4.3.1
Deduction made at Connection Point for Embedded Small Power Stations, Medium Power Stations and Customer Generating Plant (MW)											PC.A.4.3.2(a)
Reference to valid Single Line Diagram											PC.A.4.3.5
Reference to node and branch data.											PC.A.2.2

Note: The following data block can be repeated for each post fault network revision that may impact on the Transmission System.

Reference to post-fault revision of Single Line Diagram											PC.A.4.5
Reference to post-fault revision of the node and branch data associated with the Single Line Diagram											PC.A.4.5
Reference to the description of the actions and timescales involved in effecting the post-fault actions (e.g. auto-switching, manual, teleswitching, overload protection operation etc)											PC.A.4.5

Access Group:	
----------------------	--

Note: The following data block to be repeated for each **Connection Point** with the **Access Group**.

Name of associated Connection Point within the same Access Group:		PC.A.4.3.1
Demand at associated Connection Point (MW)		PC.A.4.3.1
Demand at associated Connection Point (MVA _r)		PC.A.4.3.1
Deduction made at associated Connection Point for Embedded Small Power Stations, Medium Power Stations and Customer Generating Plant (MW)		PC.A.4.3.2(a)

SCHEDULE 11 - CONNECTION POINT DATA

PAGE 2 OF 3

Embedded Generation Data											
Connection Point:											
DATA DESCRIPTION	Outturn	Outturn Weather Corrected	F.Yr 1	F.Yr 2	F.Yr 3	F.Yr 4	F.Yr 5	F.Yr 6	F.Yr 7	F.Yr 8	DATA CAT
<u>Embedded Small Power Station, Embedded Medium Power Station and Customer Generation Summary</u>	For each Connection Point where there are Embedded Small Power Stations, Medium Power Stations or Customer Generating Stations the following information is required:										
No. of <u>Embedded Small Power Stations, Embedded Medium Power Stations</u> or Customer Power Stations											PC.A.3.1.4(a)
Number of Generating Units within these stations											PC.A.3.1.4(a)
Summated Capacity of all these Generating Units											PC.A.3.1.4(a)
Where the Network Operator's System places a constraint on the capacity of an Embedded Large Power Station											
Station Name											PC.A.3.2.2(c)
Generating Unit											PC.A.3.2.2(c)
System Constrained Capacity											PC.A.3.2.2(c)(i)
Reactive Despatch Network Restriction											PC.A.3.2.2(c)(ii)

DATA DESCRIPTION	<p>An Embedded Small Power Station reference unique to each Network Operator</p>
DATA CAT	PC.A.3.1.4 (a)

SCHEDULE 11 - CONNECTION POINT DATA

PAGE 3 OF 3

NOTES:

1. 'F.Yr.' means '**Financial Year**'. F.Yr. 1 refers to the current financial year.
2. All **Demand** data should be net of the output (as reasonably considered appropriate by the **User**) of all **Embedded Small Power Stations**, **Embedded Medium Power Stations** and **Customer Generating Plant**. Generation and / or Auxiliary demand of **Embedded Large Power Stations** should not be included in the demand data submitted by the **User**. **Users** should refer to the **PC** for a full definition of the **Demand** to be included.
3. Peak **Demand** should relate to each **Connection Point** individually and should give the maximum demand that in the **User's** opinion could reasonably be imposed on the **National Electricity Transmission System**. **Users** may submit the **Demand** data at each node on the **Single Line Diagram** instead of at a **Connection Point** as long as the **User** reasonably believes such data relates to the peak (or minimum) at the **Connection Point**.

In deriving **Demand** any deduction made by the **User** (as detailed in note 2 above) to allow for **Embedded Small Power Stations**, **Embedded Medium Power Stations** and **Customer Generating Plant** is to be specifically stated as indicated on the Schedule.

4. **The Company** may at its discretion require details of any **Embedded Small Power Stations** or **Embedded Medium Power Stations** whose output can be expected to vary in a random manner (eg. wind power) or according to some other pattern (eg. tidal power)
5. Where more than 95% of the total **Demand** at a **Connection Point** is taken by synchronous motors, values of the **Power Factor** at maximum and minimum continuous excitation may be given instead. **Power Factor** data should allow for series reactive losses on the **User's System** but exclude reactive compensation network susceptance specified separately in Schedule 5.
6. Where a **Reactive Despatch Network Restriction** is in place which requires the generator to maintain a target voltage set point this should be stated as an alternative to the size of the **Reactive Despatch Network Restriction**.

SCHEDULE 12 - DEMAND CONTROL

PAGE 1 OF 2

The following information is required from each **Network Operator** and where indicated with an asterisk from **Externally Interconnected System Operators** and/or **Interconnector Users** and a **Pumped Storage Generator**. Where indicated with a double asterisk, the information is only required from **Suppliers**.

DATA DESCRIPTION	UNITS		UPDATE TIME	
<u>Demand Control</u>				
Demand met or to be relieved by Demand Control (averaging at the Demand Control Notification Level or more over a half hour) at each Connection Point .				
Demand Control at time of National Electricity Transmission System weekly peak demand				
Amount	MW)F.yrs 0 to 5	Week 24	OC1
Duration	Min)		
For each half hour	MW	Wks 2-8 ahead	1000 Mon	OC1
For each half hour	MW	Days 2-12 ahead	1200 Wed	OC1
For each half hour	MW	Previous calendar day	0600 daily	OC1
<u>**Customer Demand Management</u> (at the <u>Customer Demand Management Notification Level</u> or more at the <u>Connection Point</u>)				
For each half hour	MW	Any time in Control Phase		OC1
For each half hour	MW	Remainder of period	When changes occur to previous plan	OC1
For each half hour	MW	Previous calendar day	0600 daily	OC1
**In Scotland, Load Management Blocks For each block of 5MW or more, for each half hour	MW	For the next day	11:00	OC1

SCHEDULE 12 - DEMAND CONTROL

PAGE 1 OF 2

DATA DESCRIPTION	UNITS	TIME COVERED	UPDATE TIME	DATA CAT.
*Demand Control or Pump				
<u>Tripping Offered as Reserve</u>				
Magnitude of Demand or pumping load which is tripped	MW	Year ahead from week 24	Week 24	DPD I
System Frequency at which tripping is initiated	Hz	"	"	"
Time duration of System Frequency below trip setting for tripping to be initiated	S	"	"	"
Time delay from trip initiation to Tripping	S	"	"	"
<u>Emergency Manual Load</u>				
<u>Disconnection</u>				
Method of achieving load disconnection	Text	Year ahead from week 24	Annual in week 24	OC6
Annual ACS Peak Demand (Active Power) at Connection Point (requested under Schedule 11 - repeated here for reference)	MW	"	"	"
Cumulative percentage of Connection Point Demand (Active Power) which can be disconnected by the following times from an instruction from The Company				
5 mins	%	"	"	"
10 mins	%	"	"	"
15 mins	%	"	"	"
20 mins	%	"	"	"
25 mins	%	"	"	"
30 mins	%	"	"	"

Notes:

1. **Network Operators** may delay the submission until calendar week 28.
2. No information collated under this Schedule will be transferred to the **Relevant Transmission Licensees** (or **Generators** undertaking **OTSDUW**).

SCHEDULE 12A - AUTOMATIC LOW FREQUENCY DEMAND DISCONNECTION

PAGE 1 OF 1

Time Covered: Year ahead from week 24

Data Category: OC6

Update Time: Annual in week 24

Grid Supply Point	GSP Demand MW	Low Frequency Demand Disconnection Blocks MW									Residual demand MW
		1 48.8Hz	2 48.75Hz	3 48.7Hz	4 48.6Hz	5 48.5Hz	6 48.4Hz	7 48.2Hz	8 48.0Hz	9 47.8Hz	
GSP1											
GSP2											
GSP3											
Total demand disconnected per block		MW	%								
Total demand disconnection		MW (% of aggregate demand of MW)									

Note: All demand refers to that at the time of forecast **National Electricity Transmission System** peak demand.

Network Operators may delay the submission until calendar week 28

No information collated under this schedule will be transferred to the **Relevant Transmission Licensees** (or **Generators** undertaking **OTSDUW**).

SCHEDULE 13 - FAULT INFEED DATA

PAGE 1 OF 2

The data in this Schedule 13 is all **Standard Planning Data**, and is required from all **Users** other than **Generators** who are connected to the **National Electricity Transmission System** via a **Connection Point** (or who are seeking such a connection). A data submission is to be made each year in Week 24 (although **Network Operators** may delay the submission until Week 28). A separate submission is required for each node included in the **Single Line Diagram** provided in Schedule 5.

DATA DESCRIPTION	UNITS	F.Yr	F.Yr.	F.Yr.	F.Yr.	F.Yr.	F.Yr.	F.Yr.	F.Yr.	DATA to		
		0	1	2	3	4	5	6	7	RTL		
SHORT CIRCUIT INFEED TO THE NATIONAL ELECTRICITY TRANSMISSION SYSTEM FROM USERS SYSTEM AT A CONNECTION POINT											CUSC Contract	CUSC App. Form
<i>(PC.A.2.5)</i>												
Name of node or Connection Point											□	■
Symmetrical three phase short-circuit current infeed												
- at instant of fault	kA										□	■
- after subtransient fault current contribution has substantially decayed	Ka										□	■
Zero sequence source impedances as seen from the Point of Connection or node on the Single Line Diagram (as appropriate) consistent with the maximum infeed above:												
- Resistance	% on 100										□	■
- Reactance	% on 100										□	■
Positive sequence X/R ratio at instance of fault											□	■
Pre-Fault voltage magnitude at which the maximum fault currents were calculated	p.u.										□	■

SCHEDULE 13 - FAULT INFEED DATA

PAGE 2 OF 2

DATA DESCRIPTION	UNITS	F.Yr	F.Yr.	F.Yr.	F.Yr.	F.Yr.	F.Yr.	F.Yr.	F.Yr.	F.Yr.	DATA to		
		0	1	2	3	4	5	6	7	RTL			
SHORT CIRCUIT INFEED TO THE NATIONAL ELECTRICITY TRANSMISSION SYSTEM FROM USERS SYSTEM AT A CONNECTION POINT												CUSC Contract	CUSC App. Form
Negative sequence impedances of User's System as seen from the Point of Connection or node on the Single Line Diagram (as appropriate). If no data is given, it will be assumed that they are equal to the positive sequence values.													
- Resistance	% on 100											<input type="checkbox"/>	<input checked="" type="checkbox"/>
- Reactance	% on 100											<input type="checkbox"/>	<input checked="" type="checkbox"/>

SCHEDULE 14 - FAULT INFEED DATA (GENERATORS INCLUDING UNIT TRANSFORMERS AND STATION TRANSFORMERS)

PAGE 1 OF 5

The data in this Schedule 14 is all **Standard Planning Data**, and is to be provided by **Generators**, with respect to all directly connected **Power Stations**, all **Embedded Large Power Stations** and all **Embedded Medium Power Stations** connected to the **Subtransmission System**. A data submission is to be made each year in Week 24.

Fault infeeds via Unit Transformers

A submission should be made for each **Generating Unit** (including those which are part of a **Synchronous Power Generating Module**) with an associated **Unit Transformer**. Where there is more than one **Unit Transformer** associated with a **Generating Unit**, a value for the total infeed through all **Unit Transformers** should be provided. The infeed through the **Unit Transformer(s)** should include contributions from all motors normally connected to the **Unit Board**, together with any generation (eg **Auxiliary Gas Turbines**) which would normally be connected to the **Unit Board**, and should be expressed as a fault current at the **Generating Unit** terminals for a fault at that location.

DATA DESCRIPTION	UNITS	F.Yr. 0	F.Yr. 1	F.Yr. 2	F.Yr. 3	F.Yr. 4	F.Yr. 5	F.Yr. 6	F.Yr. 7	DATA to RTL	
(PC.A.2.5)										CUSC Contract	CUSC App. Form
Name of Power Station										<input type="checkbox"/>	<input checked="" type="checkbox"/>
Number of Unit Transformer										<input type="checkbox"/>	<input checked="" type="checkbox"/>
Symmetrical three phase short-circuit current infeed through the Unit Transformers(s) for a fault at the Generating Unit terminals											
- at instant of fault	kA									<input type="checkbox"/>	<input checked="" type="checkbox"/>
- after subtransient fault current contribution has substantially decayed	kA									<input type="checkbox"/>	<input checked="" type="checkbox"/>
Positive sequence X/R ratio at instance of fault										<input type="checkbox"/>	<input checked="" type="checkbox"/>
Subtransient time constant (if significantly different from 40ms)	ms									<input type="checkbox"/>	<input checked="" type="checkbox"/>
Pre-fault voltage at fault point (if different from 1.0 p.u.)										<input type="checkbox"/>	<input checked="" type="checkbox"/>
The following data items need only be supplied if the Generating Unit Step-up Transformer can supply zero sequence current from the Generating Unit side to the National Electricity Transmission System											
Zero sequence source impedances as seen from the Generating Unit terminals consistent with the maximum infeed above:											
- Resistance	% on 100									<input type="checkbox"/>	<input checked="" type="checkbox"/>
- Reactance	% on 100									<input type="checkbox"/>	<input checked="" type="checkbox"/>

SCHEDULE 14 - FAULT INFEED DATA (GENERATORS INCLUDING UNIT TRANSFORMERS AND STATION TRANSFORMERS)

PAGE 2 OF 5

Fault infeeds via Station Transformers

A submission is required for each **Station Transformer** directly connected to the **National Electricity Transmission System**. The submission should represent normal operating conditions when the maximum number of **Gensets** are **Synchronised** to the **System**, and should include the fault current from all motors normally connected to the **Station Board**, together with any Generation (eg **Auxiliary Gas Turbines**) which would normally be connected to the **Station Board**. The fault infeed should be expressed as a fault current at the hv terminals of the **Station Transformer** for a fault at that location.

If the submission for normal operating conditions does not represent the worst case, then a separate submission representing the maximum fault infeed that could occur in practice should be made.

DATA DESCRIPTION	UNITS	F.Yr. 0	F.Yr. 1	F.Yr. 2	F.Yr. 3	F.Yr. 4	F.Yr. 5	F.Yr. 6	F.Yr. 7	DATA to RTL	
(PC.A.2.5)										CUSC Contract	CUSC App. Form
Name of Power Station										<input type="checkbox"/>	<input checked="" type="checkbox"/>
Number of Station Transformer										<input type="checkbox"/>	<input checked="" type="checkbox"/>
Symmetrical three phase short-circuit current infeed for a fault at the Connection Point											
- at instant of fault	kA									<input type="checkbox"/>	<input checked="" type="checkbox"/>
- after subtransient fault current contribution has substantially decayed	kA									<input type="checkbox"/>	<input checked="" type="checkbox"/>
Positive sequence X/R ratio At instance of fault										<input type="checkbox"/>	<input checked="" type="checkbox"/>
Subtransient time constant (if significantly different from 40ms)	mS									<input type="checkbox"/>	<input checked="" type="checkbox"/>
Pre-fault voltage (if different from 1.0 p.u.) at fault point (See note 1)										<input type="checkbox"/>	<input checked="" type="checkbox"/>
Zero sequence source Impedances as seen from the Point of Connection Consistent with the maximum Infeed above:											
- Resistance	% on 100									<input type="checkbox"/>	<input checked="" type="checkbox"/>
- Reactance	% on 100									<input type="checkbox"/>	<input checked="" type="checkbox"/>

Note 1. The pre-fault voltage provided above should represent the voltage within the range 0.95 to 1.05 that gives the highest fault current

Note 2. % on 100 is an abbreviation for % on 100 MVA

SCHEDULE 14 - FAULT INFEED DATA (GENERATORS INCLUDING UNIT TRANSFORMERS AND STATION TRANSFORMERS)

Fault infeeds from Power Park Modules

A submission is required for the whole **Power Park Module** and for each **Power Park Unit** type or equivalent. The submission shall represent operating conditions that result in the maximum fault infeed. The fault current from all motors normally connected to the **Power Park Unit's** electrical system shall be included. The fault infeed shall be expressed as a fault current at the terminals of the **Power Park Unit**, or the **Common Collection Busbar** if an equivalent **Single Line Diagram** and associated data as described in PC.A.2.2.2 is provided, and the **Grid Entry Point**, or **User System Entry Point** if **Embedded**, for a fault at the **Grid Entry Point**, or **User System Entry Point** if **Embedded**.

Should actual data in respect of fault infeeds be unavailable at the time of the application for a **CUSC Contract** or **Embedded Development Agreement**, a limited subset of the data, representing the maximum fault infeed that may result from all of the plant types being considered, shall be submitted. This data will, as a minimum, represent the root mean square of the positive, negative and zero sequence components of the fault current for both single phase and three phase solid faults at the **Grid Entry Point** (or **User System Entry Point** if **Embedded**) at the time of fault application and 50ms following fault application. Actual data in respect of fault infeeds shall be submitted to **The Company** as soon as it is available, in line with PC.A.1.2

DATA DESCRIPTION	UNITS	F.Yr.	F.Yr.	F.Yr.	F.Yr.	F.Yr.	F.Yr.	F.Yr.	F.Yr.	DATA to		
		<u>0</u>	<u>1</u>	<u>2</u>	<u>3</u>	<u>4</u>	<u>5</u>	<u>6</u>	<u>7</u>	RTL		
(PC.A.2.5)										CUSC Contract	CUSC App. Form	
Name of Power Station											<input type="checkbox"/>	<input checked="" type="checkbox"/>
Name of Power Park Module											<input type="checkbox"/>	<input checked="" type="checkbox"/>
Power Park Unit type											<input type="checkbox"/>	<input checked="" type="checkbox"/>
A submission shall be provided for the contribution of the entire Power Park Module and each type of Power Park Unit or equivalent to the positive, negative and zero sequence components of the short circuit current at the Power Park Unit terminals, or Common Collection Busbar , and Grid Entry Point or User System Entry Point if Embedded for												
(i) a solid symmetrical three phase short circuit											<input type="checkbox"/>	<input checked="" type="checkbox"/>
(ii) a solid single phase to earth short circuit											<input type="checkbox"/>	<input checked="" type="checkbox"/>
(iii) a solid phase to phase short circuit											<input type="checkbox"/>	<input checked="" type="checkbox"/>
(iv) a solid two phase to earth short circuit											<input type="checkbox"/>	<input checked="" type="checkbox"/>
at the Grid Entry Point or User System Entry Point if Embedded .											<input type="checkbox"/>	<input checked="" type="checkbox"/>
If protective controls are used and active for the above conditions, a submission shall be provided in the limiting case where the protective control is not active. This case may require application of a non-solid fault, resulting in a retained voltage at the fault point.											<input type="checkbox"/>	<input checked="" type="checkbox"/>

SCHEDULE 14 - FAULT INFEEED DATA (GENERATORS INCLUDING UNIT TRANSFORMERS AND STATION TRANSFORMERS)

<u>DATA DESCRIPTION</u>	<u>UNITS</u>	<u>F.Yr.</u> <u>0</u>	<u>F.Yr.</u> <u>1</u>	<u>F.Yr.</u> <u>2</u>	<u>F.Yr.</u> <u>3</u>	<u>F.Yr.</u> <u>4</u>	<u>F.Yr.</u> <u>5</u>	<u>F.Yr.</u> <u>6</u>	<u>F.Yr.</u> <u>7</u>	<u>DATA to RTL</u>	<u>DATA DESCRIPTION</u>
										CUSC Contract	CUSC App. Form
- A continuous time trace and table showing the root mean square of the positive, negative and zero sequence components of the fault current from the time of fault inception to 140ms after fault inception at 10ms intervals	Graphical and tabular kA versus s									□	■
- A continuous time trace and table showing the positive, negative and zero sequence components of retained voltage at the terminals or Common Collection Busbar , if appropriate	p.u. versus s									□	■
- A continuous time trace and table showing the root mean square of the positive, negative and zero sequence components of retained voltage at the fault point, if appropriate	p.u. versus s									□	■

SCHEDULE 14 - FAULT INFEED DATA (GENERATORS INCLUDING UNIT TRANSFORMERS AND STATION TRANSFORMERS)

PAGE 5 OF 5

DATA DESCRIPTION	UNITS	F.Yr. 0	F.Yr. 1	F.Yr. 2	F.Yr. 3	F.Yr. 4	F.Yr. 5	F.Yr. 6	F.Yr. 7	DATA to RTL	DATA DESCRIPTION
										CUSC Contract	CUSC App. Form
<p>For Power Park Units that utilise a protective control, such as a crowbar circuit,</p> <ul style="list-style-type: none"> - additional rotor resistance applied to the Power Park Unit under a fault situation - additional rotor reactance applied to the Power Park Unit under a fault situation. <p>Positive sequence X/R ratio of the equivalent at time of fault at the Common Collection Busbar</p> <p>Minimum zero sequence impedance of the equivalent at a Common Collection Busbar</p> <p>Active Power generated pre-fault</p> <p>Number of Power Park Units in equivalent generator</p> <p>Power Factor (lead or lag)</p> <p>Pre-fault voltage (if different from 1.0 p.u.) at fault point (See note 1)</p> <p>Items of reactive compensation switched in pre-fault</p>	<p>% on MVA</p> <p>% on MVA</p> <p>MW</p> <p>p.u.</p>									<p style="text-align: center;"><input type="checkbox"/></p> <p style="text-align: center;"><input type="checkbox"/></p> <p style="text-align: center;"><input type="checkbox"/></p> <p style="text-align: center;"><input type="checkbox"/></p> <p style="text-align: center;"><input type="checkbox"/></p> <p style="text-align: center;"><input type="checkbox"/></p> <p style="text-align: center;"><input type="checkbox"/></p> <p style="text-align: center;"><input type="checkbox"/></p> <p style="text-align: center;"><input type="checkbox"/></p>	<p style="text-align: center;">■</p> <p style="text-align: center;">■</p> <p style="text-align: center;">■</p> <p style="text-align: center;">■</p> <p style="text-align: center;">■</p> <p style="text-align: center;">■</p> <p style="text-align: center;">■</p> <p style="text-align: center;">■</p>

Note 1. The pre-fault voltage provided above should represent the voltage within the range 0.95 to 1.05 that gives the highest fault current

SCHEDULE 15 – MOTHBALLED POWER GENERATING MODULE, MOTHBALLED GENERATING UNIT, MOTHBALLED POWER PARK MODULE (INCLUDING MOTHBALLED DC CONNECTED POWER PARK MODULES), MOTHBALLED HVDC SYSTEMS, MOTHBALLED HVDC CONVERTERS, MOTHBALLED DC CONVERTERS AT A DC CONVERTER STATION AND ALTERNATIVE FUEL DATA

MOTHBALLED POWER GENERATING MODULES, MOTHBALLED GENERATING UNIT, MOTHBALLED POWER PARK MODULE (INCLUDING MOTHBALLED DC CONNECTED POWER PARK MODULES), MOTHBALLED HVDC SYSTEMS, MOTHBALLED HVDC CONVERTERS OR MOTHBALLED DC CONVERTER AT A DC CONVERTER STATION AND ALTERNATIVE FUEL DATA
 The following data items must be supplied with respect to each **Mothballed Power Generating Module, Mothballed Generating Unit, Mothballed Power Park Module** (including **Mothballed DC Connected Power Park Modules**), **Mothballed HVDC Systems, Mothballed HVDC Converters** or **Mothballed DC Converters** at a DC Converter station

Power Station _____ **Generating Unit, Power Park Module or DC Converter Name** (e.g. Unit 1)

DATA DESCRIPTION	UNITS	DATA CAT	GENERATING UNIT DATA					Total MW being returned
			<1 month	1-2 months	2-3 months	3-6 months	6-12 months	
MW output that can be returned to service	MW	DPD II						

Notes

- The time periods identified in the above table represent the estimated time it would take to return the **Mothballed Power Generating Module, Mothballed Generating Unit, Mothballed Power Park Module (Mothballed DC Connected Power Park Modules), Mothballed HVDC Systems, Mothballed HVDC Converters** or **Mothballed DC Converter** at a **DC Converter Station** to service once a decision to return has been made.
- Where a **Mothballed Power Generating Module, Mothballed Generating Unit, Mothballed Power Park Module** (including a **Mothballed DC Connected Power Park Module**), **Mothballed HVDC System, Mothballed HVDC Converter** or **Mothballed DC Converter** at a **DC Converter Station** can be physically returned in stages covering more than one of the time periods identified in the above table then information should be provided for each applicable time period.
- The estimated notice to physically return MW output to service should be determined in accordance with **Good Industry Practice** assuming normal working arrangements and normal plant procurement lead times.
- The MW output values in each time period should be incremental MW values, e.g. if 150MW could be returned in 2 – 3 months and an additional 50MW in 3 – 6 months then the values in the columns should be Nil, Nil, 150, 50, Nil, Nil, 200 respectively.
- Significant factors which may prevent the **Mothballed Power Generating Module, Mothballed Generating Unit, Mothballed Power Park Module (Mothballed DC Connected Power Park Module), Mothballed HVDC System, Mothballed HVDC Converter** or **Mothballed DC Converter** at a **DC Converter Station** achieving the estimated values provided in this table, excluding factors relating to **Transmission Entry Capacity**, should be appended separately.

SCHEDULE 15 – MOTHBALLED POWER GENERATING MODULES, MOTHBALLED GENERATING UNIT, MOTHBALLED POWER PARK MODULE (INCLUDING DC CONNECTED POWER PARK MODULES), MOTHBALLED HVDC SYSTEMS, MOTHBALLED HVDC CONVERTERS, MOTHBALLED DC CONVERTERS AT A DC CONVERTER STATION AND ALTERNATIVE FUEL DATA

ALTERNATIVE FUEL INFORMATION

The following data items for alternative fuels need only be supplied with respect to each **Generating Unit** whose primary fuel is gas including those which form part of a **Power Generating Module**.

Power Station		Generating Unit Name (e.g. Unit 1)				
DATA DESCRIPTION	UNITS	DATA CAT	GENERATING UNIT DATA			
			1	2	3	4
Alternative Fuel Type (*please specify)	Text	DPD II	Oil distillate	Other gas*	Other*	Other*
CHANGEOVER TO ALTERNATIVE FUEL						
For off-line changeover:						
Time to carry out off-line fuel changeover	Minutes	DPD II				
Maximum output following off-line changeover	MW	DPD II				
For on-line changeover:						
Time to carry out on-line fuel changeover	Minutes	DPD II				
Maximum output during on-line fuel changeover	MW	DPD II				
Maximum output following on-line changeover	MW	DPD II				
Maximum operating time at full load assuming:						
Typical stock levels	Hours	DPD II				
Maximum possible stock levels	Hours	DPD II				
Maximum rate of replacement of depleted stocks of alternative fuels on the basis of Good Industry Practice	MWh(electrical) /day	DPD II				
Is changeover to alternative fuel used in normal operating arrangements?	Text	DPD II				
Number of successful changeovers carried out in the last NGET Financial Year (** delete as appropriate)	Text	DPD II	0 / 1-5 / 6-10 / 11-20 / >20 **	0 / 1-5 / 6-10 / 11-20 / >20 **	0 / 1-5 / 6-10 / 11-20 / >20 **	0 / 1-5 / 6-10 / 11-20 / >20 **

SCHEDULE 15 – MOTHBALLED POWER GENERATING MODULES, MOTHBALLED GENERATING UNIT, MOTHBALLED POWER PARK MODULE (INCLUDING MOTHBALLED DC CONNECTED POWER PARK MODULES), MOTHBALLED HVDC SYSTEMS, MOTHBALLED HVDC CONVERTERS MOTHBALLED DC CONVERTERS AT A DC CONVERTER STATION AND ALTERNATIVE FUEL DATA

DATA DESCRIPTION	UNITS	DATA CAT	GENERATING UNIT DATA			
			1	2	3	4
CHANGEOVER BACK TO MAIN FUEL						
For off-line changeover: Time to carry out off-line fuel changeover	Minutes					
For on-line changeover: Time to carry out on-line fuel changeover	Minutes					
Maximum output during on-line fuel changeover	MW					

Notes

1. Where a **Generating Unit** has the facilities installed to generate using more than one alternative fuel type details of each alternative fuel should be given.
2. Significant factors and their effects which may prevent the use of alternative fuels achieving the estimated values provided in this table (e.g. emissions limits, distilled water stocks etc.) should be appended separately.

SCHEDULE 16 - BLACK START INFORMATION

PAGE 1 OF 1

BLACK START INFORMATION		Units	Data Category
<p>The following data/text items are required from each Generator for each BM Unit at a Large Power Station or Medium Power Station directly connecting to the National Electricity Transmission System and comprising a Type C or Type D Power Generating Module or Small Power Station directly connected to the National Electricity Transmission System and comprising a Type C or Type D Power Generating Module, as detailed in PC.A.5.7. Data is not required for Generating Units that are contracted to provide Black Start Capability, Power Generating Modules, Power Park Modules or Generating Units that have an Intermittent Power Source. The data should be provided in accordance with PC.A.1.2 and also, where possible, upon request from The Company during a Black Start.</p>			
<p>Data Description (PC.A.5.7) (■ CUSC Contract)</p>			
<p>Assuming all BM Units were running immediately prior to the Total Shutdown or Partial Shutdown and in the event of loss of all external power supplies, provide the following information:</p>			
<p>a) Expected time for the first and subsequent BM Units to be Synchronised, from the restoration of external power supplies, assuming external power supplies are not available for up to 24hrs</p>		Tabular or Graphical	DPD II
<p>b) Describe any likely issues that would have a significant impact on a BM Unit's time to be Synchronised arising as a direct consequence of the inherent design or operational practice of the Power Station and/or BM Unit, e.g. limited barring facilities, time from a Total Shutdown or Partial Shutdown at which batteries would be discharged.</p>		Text	DPD II
<p>Block Loading Capability:</p>			
<p>c) Provide estimated Block Loading Capability from 0MW to Registered Capacity of each BM Unit based on the unit being 'hot' (run prior to shutdown) and also 'cold' (not run for 48hrs or more prior to the shutdown). The Block Loading Capability should be valid for a frequency deviation of 49.5Hz – 50.5Hz. The data should identify any required 'hold' points.</p>		Tabular or Graphical	DPD II

SCHEDULE 17 - ACCESS PERIOD DATA

PAGE 1 OF 1

(PC.A.4 - CUSC Contract ■)

Submissions by Users using this Schedule 17 shall commence in 2011 and shall ~~—~~ then continue in each year thereafter

Access Group	
---------------------	--

Asset Identifier	Start Week	End Week	Maintenance Year (1, 2 or 3)	Duration	Potential Concurrent Outage (Y/N)

Comments

SCHEDULE 18 - OFFSHORE TRANSMISSION SYSTEM DATA

PAGE 1 OF 24

The data in this Schedule 18 is required from **Generators** who are undertaking **OTSDUW** and connecting to a **Transmission Interface Point**.

DATA DESCRIPTION	UNITS	DATA to		DATA CAT.	GENERATING UNIT OR STATION DATA						
		RTL CUSC Cont ract	CUSC App. Form		F.Yr0	F.Yr1	F.Yr2	F.Yr3	F.Yr4	F.Yr5	F.Yr 6
INDIVIDUAL OTSDUW DATA											
Interface Point Capacity (PC.A.3.2.2 (a)) Performance Chart at the Transmission Interface Point for OTSDUW Plant and Apparatus (PC.A.3.2.2(f)(iv))	MW MVA _r	<input type="checkbox"/>	<input checked="" type="checkbox"/>								
OTSDUW DEMANDS Demand associated with the OTSDUW Plant and Apparatus (excluding OTSDUW DC Converters – see Note 1)) supplied at each Interface Point . The User should also provide the Demand supplied to each Connection Point on the OTSDUW Plant and Apparatus . (PC.A.5.2.5)											
- The maximum Demand that could occur. - Demand at specified time of annual peak half hour of National Electricity Transmission System Demand at Annual ACS Conditions .	MW MVA _r MW MVA _r	<input type="checkbox"/>	<input type="checkbox"/>	DPD I DPD I DPD II DPD II							
- Demand at specified time of annual minimum half-hour of National Electricity Transmission System Demand .	MW MVA _r	<input type="checkbox"/>	<input type="checkbox"/>	DPD II DPD II							
(Note 1 – Demand required from OTSDUW DC Converters should be supplied under page 2 of Schedule 18).											

SCHEDULE 18 - OFFSHORE TRANSMISSION SYSTEM DATA

PAGE 2 OF 24

OTSDUW USERS SYSTEM DATA

DATA DESCRIPTION	UNITS	DATA to RTL		DATA CATEGORY
		CUSC Contract	CUSC App. Form	
OFFSHORE TRANSMISSION SYSTEM LAYOUT (PC.A.2.2.1, PC.A.2.2.2 and P.C.A.2.2.3)				
A Single Line Diagram showing connectivity of all of the Offshore Transmission System including all Plant and Apparatus between the Interface Point and all Connection Points is required.		■	■	SPD
This Single Line Diagram shall depict the arrangement(s) of all of the existing and proposed load current carrying Apparatus relating to both existing and proposed Interface Points and Connection Points , showing electrical circuitry (ie. overhead lines, underground cables (including subsea cables), power transformers and similar equipment), operating voltages, circuit breakers and phasing arrangements		■	■	SPD
Operational Diagrams of all substations within the OTSDUW Plant and Apparatus		■	■	SPD
SUBSTATION INFRASTRUCTURE (PC.A.2.2.6)				
For the infrastructure associated with any OTSDUW Plant and Apparatus				
Rated 3-phase rms short-circuit withstand current	kA	■	■	SPD
Rated 1-phase rms short-circuit withstand current	kA	■	■	SPD
Rated Duration of short-circuit withstand	s	■	■	SPD
Rated rms continuous current	A	■	■	SPD
LUMPED SUSCEPTANCES (PC.A.2.3)				
Equivalent Lumped Susceptance required for all parts of the User's Subtransmission System (including OTSDUW Plant and Apparatus) which are not included in the Single Line Diagram.		■	■	
This should not include:		■	■	
(a) independently switched reactive compensation equipment identified above.		■	■	
(b) any susceptance of the OTSDUW Plant and Apparatus inherent in the Demand (Reactive Power) data provided on Page 1 and 2 of this Schedule 14.		■	■	
Equivalent lumped shunt susceptance at nominal Frequency .	% on 100 MVA	■	■	

SCHEDULE 18 - OFFSHORE TRANSMISSION SYSTEM DATA

OFFSHORE TRANSMISSION SYSTEM DATA

Branch Data (PC.A.2.2.4)

Node 1	Node 2	Rated Voltage (kV)	Operating Voltage (kV)	Circuit	PPS PARAMETERS			ZPS PARAMETERS			Maximum Continuous Ratings				Length (km)
					R1 %100 MVA	X1 %100 MVA	B 1 %100 MVA	R0 %100 MVA	X0 %100M VA	B0 %100M VA	Winter (MVA)	Spring Autumn (MVA)	Summer (MVA)		

Notes

1. For information equivalent STC Reference: STCP12-1m Part 3 – 2.1 Branch Data
2. In the case where an overhead line exists within the OTSDUW Plant and Apparatus the Mutual inductances should also be provided.

SCHEDULE 18 - OFFSHORE TRANSMISSION SYSTEM DATA

OFFSHORE TRANSMISSION SYSTEM DATA

2 Winding Transformer Data (PC.A.2.2.5)

The data below is **Standard Planning Data**, and details should be shown below of all transformers shown on the **Single Line Diagram**

HV Node	HV (kV)	LV Node	LV (kV)	Rating (MVA)	Trans-former	Positive Phase Sequence Reactance % on 100MVA			Positive Phase Sequence Resistance % on 100 MVA			Tap Changer			Winding Arr.	Earthing Method (Direct /Res /Reac)	Earthing Impedance method
						Max Tap	Min Tap	Nom Tap	Max Tap	Min Tap	Nom Tap	Range +% to -%	Step size %	type			

Notes

1 For information the corresponding STC Reference is STCP12-1: Part 3 – 2.4 Transformers

SCHEDULE 18 - OFFSHORE TRANSMISSION SYSTEM DATA

OFFSHORE TRANSMISSION SYSTEM DATA

Circuit Breaker Data (PC.A.2.2.6(a))

The data below is all **Standard Planning Data**, and should be provided for all **OTSUA** switchgear (ie. circuit breakers, load disconnectors and disconnectors)

Location	Circuit Breaker Data						Assumed Operating Times			3 Phase				1 Phase				DC time constant at testing of asymmetrical breaking ability (s)		
	Name	Rated Voltage	Operating Voltage	Make	Model	Type	Year Commissioned	Circuit Breaker (mS)	Minimum Protection & Trip Relay (mS)	Total Time (mS)	Continuous Rating (A)	Fault Rating (RMS Symmetrical) (3 phase) (MVA)	Fault Break Rating (Peak Asymmetrical) (3 phase) (kA)	Fault Make Rating (Peak Asymmetrical) (3 phase) (kA)	Fault Rating (RMS Symmetrical) (1 phase) (MVA)	Fault Break Rating (Peak Asymmetrical) (1 phase) (kA)	Fault Break Rating (Peak Asymmetrical) (1 phase) (kA)		Fault Make Rating (Peak Asymmetrical) (1 phase) (kA)	

SCHEDULE 18 - OFFSHORE TRANSMISSION SYSTEM DATA

PAGE 7 OF 24

OFFSHORE TRANSMISSION SYSTEM DATA

REACTIVE COMPENSATION EQUIPMENT (PC.A.2.4(e))

Item	Node	kV	Device No.	Rating (MVar)	P Loss (kW)	Tap range	Connection Arrangement

Notes:

1. For information STC Reference: STCP12-1: Part 3 - 2.5 Reactive Compensation Equipment
2. Data relating to continuously variable reactive compensation equipment (such as statcoms or SVCs) should be entered on the SVC Modelling table.
3. For the avoidance of doubt this includes any AC Reactive Compensation equipment included within the OTSDUW DC Converter other than harmonic filter data which is to be entered in the harmonic filter data table.

<i>PC.A.2.4.1(e)</i>	A mathematical representation in block diagram format to model the control of any dynamic compensation plant. The model should be suitable for RMS dynamic stability type studies in which the time constants used should not be less than 10ms.
----------------------	--

SCHEDULE 18 - OFFSHORE TRANSMISSION SYSTEM DATA

OFFSHORE TRANSMISSION SYSTEM DATA

REACTIVE COMPENSATION - SVC Modelling Data (P.C.A.2.4.1(e)(iii))

HV Node	LV Node	Control Node	Normal Voltage (kV)	Target Voltage (kV)	Max MVAR at HV	Min MVAR at HV	Slope %	Voltage Dependant Q Limit	Normal Running Mode	R1 PPS_R	X1 PPS_X	R0 ZPS_R	X0 ZPS_X	Transf. Winding Type	Connection (Direct/Tertiary)

Notes:

1. For information the equivalent STC Reference is: STCP12-1: Part 3 - 2.7 SVC Modelling Data

SCHEDULE 18 - OFFSHORE TRANSMISSION SYSTEM DATA

PAGE 10 OF 24

Information for Transient Overvoltage Assessment (DPD I) (PC.A.6.2 ■ CUSC Contract)

The information listed below may be requested by **The Company** from each **User** undertaking **OTSDUW** with respect to any **Interface Point** or **Connection Point** to enable **The Company** to assess transient overvoltage on the **National Electricity Transmission System**.

- (a) Busbar layout plan(s), including dimensions and geometry showing positioning of any current and voltage transformers, through bushings, support insulators, disconnectors, circuit breakers, surge arresters, etc. Electrical parameters of any associated current and voltage transformers, stray capacitances of wall bushings and support insulators, and grading capacitances of circuit breakers;
- (b) Electrical parameters and physical construction details of lines and cables connected at that busbar. Electrical parameters of all plant e.g., transformers (including neutral earthing impedance or zig-zag transformers if any), series reactors and shunt compensation equipment connected at that busbar (or to the tertiary of a transformer) or by lines or cables to that busbar;
- (c) Basic insulation levels (BIL) of all **Apparatus** connected directly, by lines or by cables to the busbar;
- (d) Characteristics of overvoltage **Protection** devices at the busbar and at the termination points of all lines, and all cables connected to the busbar;
- (e) Fault levels at the lower voltage terminals of each transformer connected to each **Interface Point** or **Connection Point** without intermediate transformation;
- (f) The following data is required on all transformers within the **OTSDUW Plant and Apparatus**.
- (g) An indication of which items of equipment may be out of service simultaneously during **Planned Outage** conditions.

Harmonic Studies (DPD I) (PC.A.6.4 ■ CUSC Contract)

The information given below, both current and forecast, where not already supplied in this Schedule 14 may be requested by **The Company** from each **User** if it is necessary for **The Company** to evaluate the production/magnification of harmonic distortion on **National Electricity Transmission System**. The impact of any third party **Embedded** within the **User's System** should be reflected:-

- (a) Overhead lines and underground cable circuits (including subsea cables) of the **User's OTSDUW Plant and Apparatus** must be differentiated and the following data provided separately for each type:-
 - Positive phase sequence resistance
 - Positive phase sequence reactance
 - Positive phase sequence susceptance
- (b) for all transformers connecting the **OTSDUW Plant and Apparatus** to a lower voltage:-
 - Rated MVA
 - Voltage Ratio
 - Positive phase sequence resistance
 - Positive phase sequence reactance

SCHEDULE 18 - OFFSHORE TRANSMISSION SYSTEM DATA

PAGE 11 OF 24

- (c) at the lower voltage points of those connecting transformers:-

Equivalent positive phase sequence susceptance

Connection voltage and MVA rating of any capacitor bank and component design parameters if configured as a filter

Equivalent positive phase sequence interconnection impedance with other lower voltage points

The minimum and maximum **Demand** (both MW and MVA) that could occur

Harmonic current injection sources in Amps at the Connection Points and Interface Points

- (d) an indication of which items of equipment may be out of service simultaneously during **Planned Outage** conditions

Voltage Assessment Studies (DPD I) (PC.A.6.5 ■ CUSC Contract)

The information listed below, where not already supplied in this Schedule 14, may be requested by **The Company** from each **User** undertaking **OTSDUW** with respect to any **Connection Point** or **Interface Point** if it is necessary for **The Company** to undertake detailed voltage assessment studies (eg to examine potential voltage instability, voltage control co-ordination or to calculate voltage step changes on the **National Electricity Transmission System**).

- (a) For all circuits of the **User's OTSDUW Plant and Apparatus**:-

Positive Phase Sequence Reactance

Positive Phase Sequence Resistance

Positive Phase Sequence Susceptance

MVA rating of any reactive compensation equipment

- (b) for all transformers connecting the **User's OTSDUW Plant and Apparatus** to a lower voltage:-

Rated MVA

Voltage Ratio

Positive phase sequence resistance

Positive Phase sequence reactance

Tap-changer range

Number of tap steps

Tap-changer type: on-load or off-circuit

AVC/tap-changer time delay to first tap movement

AVC/tap-changer inter-tap time delay

- (c) at the lower voltage points of those connecting transformers

Equivalent positive phase sequence susceptance

MVA rating of any reactive compensation equipment

Equivalent positive phase sequence interconnection impedance with other lower voltage points

The maximum **Demand** (both MW and MVA) that could occur

Estimate of voltage insensitive (constant power) load content in % of total load at both winter peak and 75% off-peak load conditions

SCHEDULE 18 - OFFSHORE TRANSMISSION SYSTEM DATA

PAGE 12 OF 24

Short Circuit Analyses:(DPD I) (PC.A.6.6 ■ CUSC Contract)

The information listed below, both current and forecast, and where not already supplied under this Schedule 14, may be requested by **The Company** from each **User** undertaking **OTSDUW** with respect to any **Connection Point or Interface Point** where prospective short-circuit currents on equipment owned by a **Transmission Licensee** or operated or managed by **The Company** are close to the equipment rating.

(a) For all circuits of the **User's OTSDUW Plant and Apparatus**:-

- Positive phase sequence resistance
- Positive phase sequence reactance
- Positive phase sequence susceptance
- Zero phase sequence resistance (both self and mutuals)
- Zero phase sequence reactance (both self and mutuals)
- Zero phase sequence susceptance (both self and mutuals)

(b) for all transformers connecting the **User's OTSDUW Plant and Apparatus** to a lower voltage:-

- Rated MVA
- Voltage Ratio
- Positive phase sequence resistance (at max, min and nominal tap)
- Positive Phase sequence reactance (at max, min and nominal tap)
- Zero phase sequence reactance (at nominal tap)
- Tap changer range
- Earthing method: direct, resistance or reactance
- Impedance if not directly earthed

(c) at the lower voltage points of those connecting transformers:-

The maximum **Demand** (in MW and MVA_r) that could occur
Short-circuit infeed data in accordance with PC.A.2.5.6(a) unless the **User's OTSDUW Plant and Apparatus** runs in parallel with the **Subtransmission System**, when to prevent double counting in each node infeed data, a π equivalent comprising the data items of PC.A.2.5.6(a) for each node together with the positive phase sequence interconnection impedance between the nodes shall be submitted.

SCHEDULE 18 - OFFSHORE TRANSMISSION SYSTEM DATA

Fault infeed data to be submitted by **OTSDUW Plant and Apparatus** providing a fault infeed (including **OTSDUW DC Converters**) (PC.A.2.5.5)

A submission is required for **OTSDUW Plant and Apparatus** (including **OTSDUW DC Converters** at each **Transmission Interface Point** and **Connection Point**. The submission shall represent operating conditions that result in the maximum fault infeed. The fault current from all auxiliaries of the **OTSDUW Plant and Apparatus** at the **Transmission Interface Point** and **Connection Point** shall be included. The fault infeed shall be expressed as a fault current at the **Transmission Interface Point** and also at each **Connection Point**.

Should actual data in respect of fault infeeds be unavailable at the time of the application for a **CUSC Contract** or **Embedded Development Agreement**, a limited subset of the data, representing the maximum fault infeed that may result from the **OTSDUW Plant and Apparatus**, shall be submitted. This data will, as a minimum, represent the root mean square of the positive, negative and zero sequence components of the fault current for both single phase and three phase solid faults at each **Connection Point** and **Interface Point** at the time of fault application and 50ms following fault application. Actual data in respect of fault infeeds shall be submitted to **The Company** as soon as it is available, in line with PC.A.1.2.

DATA DESCRIPTION	UNITS	F.Yr.	F.Yr.	F.Yr.	F.Yr.	F.Yr.	F.Yr.	F.Yr.	F.Yr.	DATA to RTL	
		<u>0</u>	<u>1</u>	<u>2</u>	<u>3</u>	<u>4</u>	<u>5</u>	<u>6</u>	<u>7</u>	CUSC Contract	CUSC App. Form
(PC.A.2.5)											
Name of OTSDUW Plant and Apparatus											
OTSDUW DC Converter type (ie voltage or current source)											
<p>A submission shall be provided for the contribution of each OTSDUW Plant and Apparatus to the positive, negative and zero sequence components of the short circuit current at the Interface Point and each Connection Point for</p> <p>(i) a solid symmetrical three phase short circuit</p> <p>(ii) a solid single phase to earth short circuit</p> <p>(iii) a solid phase to phase short circuit</p> <p>(iv) a solid two phase to earth short circuit</p> <p>If protective controls are used and active for the above conditions, a submission shall be provided in the limiting case where the protective control is not active. This case may require application of a non-solid fault, resulting in a retained voltage at the fault point.</p>										<input type="checkbox"/> <input checked="" type="checkbox"/> <input type="checkbox"/> <input checked="" type="checkbox"/> <input type="checkbox"/> <input checked="" type="checkbox"/> <input type="checkbox"/> <input checked="" type="checkbox"/> <input type="checkbox"/> <input checked="" type="checkbox"/>	

SCHEDULE 18 - OFFSHORE TRANSMISSION SYSTEM DATA

PAGE 14 OF 24

DATA DESCRIPTION	UNITS	F. Yr. <u>0</u>	F. Yr. <u>1</u>	F. Yr. <u>2</u>	F. Yr. <u>3</u>	F. Yr. <u>4</u>	F. Yr. <u>5</u>	F. Yr. <u>6</u>	F. Yr. <u>7</u>	DATA to RTL	
										CUSC Contract	CUSC App. Form
- A continuous time trace and table showing the root mean square of the positive, negative and zero sequence components of the fault current from the time of fault inception to 140ms after fault inception at 10ms intervals	Graphical and tabular kA versus s									<input type="checkbox"/>	<input checked="" type="checkbox"/>
- A continuous time trace and table showing the positive, negative and zero sequence components of retained voltage at the Interface Point and each Connection Point , if appropriate - A continuous time trace and table showing the root mean square of the positive, negative and zero sequence components of retained voltage at the fault point, if appropriate Positive sequence X/R ratio of the equivalent at time of fault at the Interface Point and each Connection Point Minimum zero sequence impedance of the equivalent at the Interface Point and each Connection Point Active Power transfer at the Interface Point and each Connection Point pre-fault Power Factor (lead or lag) Pre-fault voltage (if different from 1.0 p.u.) at fault point (See note 1) Items of reactive compensation switched in pre-fault	p.u. versus s p.u. versus s MW p.u.									<input type="checkbox"/>	<input checked="" type="checkbox"/>
										<input type="checkbox"/>	<input checked="" type="checkbox"/>
										<input type="checkbox"/>	<input checked="" type="checkbox"/>
										<input type="checkbox"/>	<input checked="" type="checkbox"/>
										<input type="checkbox"/>	<input checked="" type="checkbox"/>
										<input type="checkbox"/>	<input checked="" type="checkbox"/>
										<input type="checkbox"/>	<input checked="" type="checkbox"/>
										<input type="checkbox"/>	<input checked="" type="checkbox"/>

Note 1. The pre-fault voltage provided above should represent the voltage within the range 0.95 to 1.05 that gives the highest fault current

SCHEDULE 18 - OFFSHORE TRANSMISSION SYSTEM DATA

Thermal Ratings Data (PC.A.2.2.4)

--

CIRCUIT RATING SCHEDULE

--	--

Voltage
132kV

Offshore TO Name

Issue Date

CIRCUIT Name from Site A – Site B

OVERALL CCT RATINGS		Winter				Spring/Autumn				Summer			
		%Nom	Limit	Amps	MVA	%Nom	Limit	Amps	MVA	%Nom	Limit	Amps	MVA
Pre-Fault Continuous		84%	Line	485	111	84%	Line	450	103	84%	Line	390	89
Post-Fault Continuous		100%	Line	580	132	100%	Line	540	123	100%	Line	465	106
Prefault load exceeds line prefault continuous rating	6hr	95%	Line	580	132	95%	Line	540	123	95%	Line	465	106
	20m		Line	580	132		Line	540	123		Line	465	106
	10m	mva	Line	580	132	mva	Line	540	123	mva	Line	465	106
	5m	125	Line	580	132	116	Line	540	123	100	Line	465	106
	3m		Line	580	132		Line	540	123		Line	465	106
Short Term Overloads	6hr	90%	Line	580	132	90%	Line	540	123	90%	Line	465	106
	20m		Line	580	132		Line	540	123		Line	465	106
	10m	mva	Line	580	132	mva	Line	540	123	mva	Line	465	106
	5m	118	Line	580	132	110	Line	540	123	95	Line	465	106
	3m		Line	580	132		Line	540	123		Line	465	106
Limiting Item and permitted overload values for different times and pre-fault loads	6hr	84%	Line	580	132	84%	Line	540	123	84%	Line	465	106
	20m		Line	590	135		Line	545	125		Line	470	108
	10m	mva	Line	630	144	mva	Line	580	133	mva	Line	495	113
	5m	110	Line	710	163	103	Line	655	149	89	Line	555	126
	3m		Line	810	185		Line	740	170		Line	625	143
	6hr	75%	Line	580	132	75%	Line	540	123	75%	Line	465	106
	20m		Line	595	136		Line	555	126		Line	475	109
	10m	mva	Line	650	149	mva	Line	600	137	mva	Line	510	116
	5m	99	Line	760	173	92	Line	695	159	79	Line	585	134
	3m		Line	885	203		Line	810	185		Line	685	156
	6hr	60%	Line	580	132	60%	Line	540	123	60%	Line	465	106
	20m		Line	605	138		Line	560	128		Line	480	110
	10m	mva	Line	675	155	mva	Line	620	142	mva	Line	530	121
	5m	79	Line	820	187	73	Line	750	172	63	Line	635	145
	3m		Line	985	226		Line	900	206		Line	755	173
	6hr	30%	Line	580	132	30%	Line	540	123	30%	Line	465	106
	20m		Line	615	141		Line	570	130		Line	490	112
	10m	mva	Line	710	163	mva	Line	655	150	mva	Line	555	127
	5m	39	Line	895	205	36	Line	820	187	31	Line	690	158
	3m		Line	1110	255		Line	1010	230		Line	845	193

SCHEDULE 18 - OFFSHORE TRANSMISSION SYSTEM DATA

PAGE 16 OF 24

6hr												
20m												
10m												
5m												
3m												
6hr												
20m												
10m												
5m												
3m												
Notes or Restrictions Detailed												

Notes: 1. For information the equivalent STC Reference: STCP12-1: Part 3 - 2.6 Thermal Ratings
 2. The values shown in the above table is example data.

SCHEDULE 18 - OFFSHORE TRANSMISSION SYSTEM DATA
PAGE 17 OF 24

Protection Policy (PC.A.6.3)

To include details of the protection policy

Protection Schedules(PC.A.6.3)

Data schedules for the protection systems associated with each primary plant item including:

Protection, Intertrip Signalling & operating times
Intertripping and protection unstabilisation initiation
Synchronising facilities
Delayed Auto Reclose sequence schedules

Automatic Switching Scheme Schedules (PC.A.2.2.7)

A diagram of the scheme and an explanation of how the system will operate and what plant will be affected by the scheme's operation.

SCHEDULE 18 - OFFSHORE TRANSMISSION SYSTEM DATA
PAGE 18 OF 24

GENERATOR INTERTRIP SCHEMES (PC.A.2.2.7(b))

Substation: _____

Details of Generator Intertrip Schemes:

A diagram of the scheme and an explanation of how the system will operate and what plant will be effected by the schemes operation.

DEMAND INTERTRIP SCHEMES (PC.A.2.2.7(b))

Substation: _____

Details of Demand Intertrip Schemes:

A diagram of the scheme and an explanation of how the system will operate and what plant will be effected by the schemes operation

SCHEDULE 18 - OFFSHORE TRANSMISSION SYSTEM DATA

PAGE 19 OF 24

Specific Operating Requirements (CC.5.2.1)

SUBSTATION OPERATIONAL GUIDE

Substation: _____

Location Details:

Postal Address:	Telephone Nos.	Map Ref.
National Grid Interface		
Generator Interface		

- 1. Substation Type:**
- 2. Voltage Control:** *(short description of voltage control system. To include mention of modes ie Voltage, manual etc. Plus control step increments ie 0.5%-0.33kV?)*
- 3. Energisation Switching Information:** *(The standard energisation switching process from dead.)*
- 4. Intertrip Systems:**
- 5. Reactive Plant Outage:** *(A short explanation of any system re-configurations required to facilitate the outage of any reactive plant which form part of the OTSDUW Plant and Apparatus equipment. Also any generation restrictions required).*
- 6. Harmonic Filter Outage:** *(An explanation as to any OTSDUW Plant and Apparatus reconfigurations required to facilitate the outage and maintain the system within specified Harmonic limits, also any generation restrictions required).*

SCHEDULE 18 - OFFSHORE TRANSMISSION SYSTEM DATA

OTSDUW DC CONVERTER TECHNICAL DATA

OTSDUW DC CONVERTER NAME

DATE: _____

Data Description	Units	DATA to RTL		Data Category	DC Converter Station Data
<i>(PC.A.4 and PC.A.5.2.5)</i>		CUSC Contract	CUSC App. Form		
OTSDUW DC CONVERTER (CONVERTER DEMANDS):					
Demand supplied through Station Transformers associated with the OTSDUW DC Converter at each Interface Point and each Offshore Connection Point Grid Entry Point [PC.A.4.1]					
- Demand with all OTSDUW DC Converters operating at Interface Point Capacity .	MW MVA	<input type="checkbox"/> <input type="checkbox"/>		DPD II DPD II	
- Demand with all OTSDUW DC Converters operating at maximum Interface Point flow from the Interface Point to each Offshore Grid Entry Point .	MW MVA	<input type="checkbox"/> <input type="checkbox"/>		DPD II DPD II	
- The maximum Demand that could occur.	MW MVA	<input type="checkbox"/> <input type="checkbox"/>		DPD II DPD II	
- Demand at specified time of annual peak half hour of The Company Demand	MW MVA	<input type="checkbox"/> <input type="checkbox"/>		DPD II DPD II	
at Annual ACS Conditions.	MW MVA	<input type="checkbox"/> <input type="checkbox"/>		DPD II	
- Demand at specified time of annual minimum half-hour of The Company Demand.					
OTSDUW DC CONVERTER DATA	Text	<input type="checkbox"/>	■	SPD+	
Number of poles, i.e. number of OTSDUW DC Converters	Text	<input type="checkbox"/>	■	SPD+	
Pole arrangement (e.g. monopole or bipole)	Diagram	<input type="checkbox"/>			
Return path arrangement					
Details of each viable operating configuration					
Configuration 1	Diagram	<input type="checkbox"/>	■	SPD+	
Configuration 2	Diagram	<input type="checkbox"/>	■		
Configuration 3	Diagram	<input type="checkbox"/>	■		
Configuration 4	Diagram	<input type="checkbox"/>	■		
Configuration 5	Diagram	<input type="checkbox"/>	■		
Configuration 6	Diagram	<input type="checkbox"/>	■		

SCHEDULE 18 - OFFSHORE TRANSMISSION SYSTEM DATA

PAGE 21 OF 24

Data Description	Units	DATA to RTL		Data Category	Operating Configuration					
		CUSC Contract	CUSC App. Form		1	2	3	4	5	6
OTSDUW DC CONVERTER DATA <i>(PC.A.3.3.1(d))</i>										
OTSDUW DC Converter Type (e.g. current or Voltage source)	Text	<input type="checkbox"/>	<input checked="" type="checkbox"/>	SPD						
If the busbars at the Interface Point or Connection Point are normally run in separate sections identify the section to which the OTSDUW DC Converter configuration is connected	Section Number	<input type="checkbox"/>	<input checked="" type="checkbox"/>	SPD						
Rated MW import per pole (PC.A.3.3.1)	MW	<input type="checkbox"/>	<input checked="" type="checkbox"/>	SPD+						
Rated MW export per pole (PC.A.3.3.1)	MW	<input type="checkbox"/>	<input checked="" type="checkbox"/>	SPD+						
ACTIVE POWER TRANSFER CAPABILITY <i>(PC.A.3.2.2)</i>										
Interface Point Capacity	MW MVAr	<input type="checkbox"/> <input type="checkbox"/>	<input checked="" type="checkbox"/> <input checked="" type="checkbox"/>	SPD SPD						
OTSDUW DC CONVERTER TRANSFORMER <i>(PC.A.5.4.3.1)</i>										
Rated MVA	MVA	<input type="checkbox"/>		DPD II						
Winding arrangement	kV	<input type="checkbox"/>		DPD II						
Nominal primary voltage	kV	<input type="checkbox"/>		DPD II						
Nominal secondary (converter-side) voltage(s)		<input type="checkbox"/>								
Positive sequence reactance	% on	<input type="checkbox"/>		DPD II						
Maximum tap	MVA	<input type="checkbox"/>		DPD II						
Nominal tap	% on			DPD II						
Minimum tap	MVA									
Positive sequence resistance	% on	<input type="checkbox"/>		DPD II						
Maximum tap	MVA	<input type="checkbox"/>		DPD II						
Nominal tap	% on	<input type="checkbox"/>		DPD II						
Minimum tap	MVA	<input type="checkbox"/>		DPD II						
Zero phase sequence reactance	MVA	<input type="checkbox"/>		DPD II						
Tap change range	% on			DPD II						
Number of steps	MVA									
	% on									
	MVA									
	% on									
	MVA									
	+% / -%									

SCHEDULE 18 - OFFSHORE TRANSMISSION SYSTEM DATA

Data Description	Units	DATA to RTL		Data Category	Operating configuration						
		CUSC Contract	CUSC App. Form		1	2	3	4	5	6	
<p>OTSDUW DC CONVERTER NETWORK DATA (PC.A.5.4.3.1 (c))</p> <p>Rated DC voltage per pole Rated DC current per pole</p> <p>Details of the OTSDUW DC Network described in diagram form including resistance, inductance and capacitance of all DC cables and/or DC lines. Details of any line reactors (including line reactor resistance), line capacitors, DC filters, earthing electrodes and other conductors that form part of the OTSDUW DC Network should be shown.</p>	<p>kV</p> <p>A</p> <p>Diagram</p>	<p><input type="checkbox"/></p> <p><input type="checkbox"/></p> <p><input type="checkbox"/></p>		<p>DPD II</p> <p>DPD II</p> <p>DPD II</p>							

SCHEDULE 18 - OFFSHORE TRANSMISSION SYSTEM DATA

Data Description	Units	DATA to RTL		Data Category	Operating configuration					
		CUSC Contract	CUSC App. Form		1	2	3	4	5	6
OTSDUW DC CONVERTER CONTROL SYSTEMS (PC.A.5.4.3.2)										
Static $V_{DC} - P_{DC}$ (DC voltage – DC power) or Static $V_{DC} - I_{DC}$ (DC voltage – DC current) characteristic (as appropriate) when operating as –Rectifier –Inverter	Diagram	<input type="checkbox"/>		DPD II DPD II						
	Diagram	<input type="checkbox"/>			DPD II					
Details of rectifier mode control system, in block diagram form together with parameters showing transfer functions of individual elements.	Diagram	<input type="checkbox"/>		DPD II						
	Diagram	<input type="checkbox"/>		DPD II						
Details of inverter mode control system, in block diagram form showing transfer functions of individual elements including parameters (as applicable).	Diagram	<input type="checkbox"/>		DPD II						
Details of OTSDUW DC Converter transformer tap changer control system in block diagram form showing transfer functions of individual elements including parameters.	Diagram	<input type="checkbox"/>		DPD II						
Details of AC filter control systems in block diagram form showing transfer functions of individual elements including parameters	Diagram	<input type="checkbox"/>		DPD II						
Details of any frequency and/or load control systems in block diagram form showing transfer functions of individual elements including parameters.	Diagram	<input type="checkbox"/>		DPD II						
Details of any large or small signal modulating controls, such as power oscillation damping controls or sub-synchronous oscillation damping controls, that have not been submitted as part of the above control system data.	Diagram	<input type="checkbox"/>		DPD II						
Transfer block diagram representation of the reactive power control at converter ends for a voltage source converter.										

SCHEDULE 18 - OFFSHORE TRANSMISSION SYSTEM DATA

PAGE 24 OF 24

Data Description	Units	DATA to RTL		Data Category	Operating configuration					
		CUSC Contract	CUSC App. Form		1	2	3	4	5	6
LOADING PARAMETERS (PC.A.5.4.3.3)										
MW Export from the Offshore Grid Entry Point to the Transmission Interface Point										
Nominal loading rate	MW/s			DPD I						
Maximum (emergency) loading rate	MW/s	□		DPD I						
Maximum recovery time, to 90% of pre-fault loading, following an AC system fault or severe voltage depression.	s			DPD II						
Maximum recovery time, to 90% of pre-fault loading, following a transient DC Network fault.	s	□		DPD II						

SCHEDULE 19 – USER DATA FILE STRUCTURE

PAGE 1 OF 2

The structure of the **User Data File Structure** is given below.

i.d.	Folder name	Description of contents
Part A: Commercial & Legal		
A2	Commissioning	Commissioning & Test Programmes
A3	Statements	Statements of Readiness
A9	AS Monitoring	Ancillary Services Monitoring
A10	Self Certification	User Self Certification of Compliance
A11	Compliance statements	Compliance Statement
Part 1: Safety & System Operation		
1.1	Interface Agreements	Interface Agreements
1.2	Safety Rules	Safety Rules
1.3	Switching Procedures	Local Switching Procedures
1.4	Earthing	Earthing
1.5	SRS	Site Responsibility Schedules
1.6	Diagrams	Operational and Gas Zone Diagrams
1.7	Drawings	Site Common Drawings
1.8	Telephony	Control Telephony
1.9	Safety Procedures	Local Safety Procedures
1.10	Co-ordinators	Safety Co-ordinators
1.11	RISSP	Record of Inter System Safety Precautions
1.12	Tel Numbers	Telephone Numbers for Joint System Incidents
1.13	Contact Details	Contact Details (fax, tel, email)
1.14	Restoration Plan	Local Joint Restoration Plan (incl. black start if applicable)
1.15	Maintenance	Maintenance Standards
Part 2: Connection Technical Data		
2.1	DRC Schedule 5	DRC Schedule 5 – Users System Data
2.2	Protection Report	Protection Settings Reports
2.3	Special Automatic Facilities	Special Automatic Facilities e.g. intertrip
2.4	Operational Metering	Operational Metering
2.5	Tariff Metering	Tariff Metering
2.6	Operational Comms	Operational Communications
2.7	Monitoring	Performance Monitoring
2.8	Power Quality	Power Quality Test Results (if required)

SCHEDULE 19 – USER DATA FILE STRUCTURE

PAGE 2 OF 2

Part 3: Generator Technical Data		
3.1	DRC Schedule 1	DRC Schedule 1 - Generating Unit, Power Generating Module, HVDC System and DC Converter Technical Data
3.2	DRC Schedule 2	DRC Schedule 2 - Generation Planning Data
3.3	DRC Schedule 4	DRC Schedule 4 – Frequency Droop & Response
3.4	DRC Schedule 14	DRC Schedule 14 – Fault Infeed Data – Generators
3.5	Special Generator Protection	Special Generator Protection eg Pole slipping; islanding
3.6	Compliance Tests	Compliance Tests & Evidence
3.7	Compliance Studies	Compliance Simulation Studies
3.8	Site Specific	Bilateral Connections Agreement Technical Data & Compliance
Part 4: General DRC Schedules		
4.1	DRC Schedule 3	DRC Schedule 3 – Large Power Station Outage Information
4.2	DRC Schedule 6	DRC Schedule 6 – Users Outage Information
4.3	DRC Schedule 7	DRC Schedule 7 – Load Characteristics
4.4	DRC Schedule 8	DRC Schedule 8 – BM Unit Data (if applicable)
4.5	DRC Schedule 10	DRC Schedule 10 – Demand Profiles
4.6	DRC Schedule 11	DRC Schedule 11 – Connection Point Data
Part 5: OTSDUW Data And Information (if applicable and prior to OTSUA Transfer Time)		
		Diagrams Circuits Plant and Apparatus Circuit Parameters Protection Operation and Autoswitching Automatic Control Systems
		Mathematical model of dynamic compensation plant

< END OF DATA REGISTRATION CODE >

OPERATING CODE NO. 2

(OC2)

GC0106 – WACM2

DATED 09/10/18

OPERATIONAL PLANNING AND DATA PROVISION

CONTENTS

(This contents page does not form part of the Grid Code)

<u>Paragraph No/Title</u>	<u>Page Number</u>
OC2.1 INTRODUCTION.....	2
OC2.2 OBJECTIVE	4
OC2.3 SCOPE.....	4
OC2.4 PROCEDURE	5
OC2.4.1 Co-ordination of outages	5
OC2.4.2 Data Requirements	22 23
OC2.4.3 Negative Reserve Active Power Margins	25 26
OC2.4.4 Frequency Sensitive Operation	27 28
OC2.4.6 Operating Margin Data Requirements	28 29
APPENDIX 1 - PERFORMANCE CHART EXAMPLES	28
APPENDIX 2 - GENERATION PLANNING PARAMETERS.....	30
APPENDIX 3 - CCGT MODULE PLANNING MATRIX	32
APPENDIX 4 - POWER PARK MODULE PLANNING MATRIX	33
APPENDIX 5 - SYNCHRONOUS POWER GENERATING MODULE PLANNING MATRIX	34

OC2.1 INTRODUCTION

OC2.1.1 **Operating Code No. 2 ("OC2")** is concerned with:

- (a) the co-ordination of the release of **Power Generating Modules** (including **DC Connected Power Park Modules**), **Synchronous Generating Units** and **Power Park Modules**, **External Interconnections**, the **National Electricity Transmission System** and **Network Operators' Systems** for construction, repair and maintenance;
- (b) provision by **The Company** of the **Surpluses** both for the **National Electricity Transmission System** and **System Zones**;
- (c) the provision by **Generators** of **Generation Planning Parameters** for **Gensets**, including **Synchronous Power Generating Module Planning Matrices**, **CCGT Module Planning Matrices** and **Power Park Module Planning Matrices**, to **The Company** for planning purposes only; and
- (d) the agreement for release of **Existing Gas Cooled Reactor Plant** for outages in certain circumstances.

OC2.1.2 (a) **Operational Planning** involves planning, through various timescales, the matching of generation output with forecast **National Electricity Transmission System Demand** together with a reserve of generation to provide a margin, taking into account outages of certain **Power Generating Modules** (including **DC Connected Power Park Modules**), **Generating Units**, **Power Park Modules**, **External Interconnections**, **HVDC Systems** and **DC Converters**, and of parts of the **National Electricity Transmission System** and of parts of **Network Operators' Systems** which is carried out to achieve, so far as possible, the standards of security set out in **The Company's Transmission Licence**, each **Relevant Transmission Licensee's Transmission Licence** or **Electricity Distribution Licence** as the case may be.

- (b) In general terms there is an "envelope of opportunity" for the release of **Power Generating Modules** (including **DC Connected Power Park Modules**), **Synchronous Generating Units**, **Power Park Modules** and **External Interconnections**, and for the release of parts of the **National Electricity Transmission System** and parts of the **Network Operator's User Systems** for outages. The envelope is defined by the difference between the total generation output expected from **Large Power Stations**, **Medium Power Stations** and **Demand**, the operational planning margin and taking into account **External Interconnections**.

OC2.1.3 In this **OC2** for the purpose of **Generator** and **Interconnector Owner** outage co-ordination Year 0 means the current calendar year at any time, Year 1 means the next calendar year at any time, Year 2 means the calendar year after Year 1, etc. For the purpose of **Transmission** outage planning Year 0 means the current **Financial Year** at any time, Year 1 means the next **Financial Year** at any time, Year 2 means the **Financial Year** after Year 1, etc. References to 'weeks' in **OC2** are to calendar weeks as defined in ISO 8601.

OC2.1.4 References in **OC2** to a **Generator's** and **Interconnector Owner's** "best estimate" shall be that **Generator's** or **Interconnector Owner's** best estimate acting as a reasonable and prudent **Generator** or **Interconnector Owner** in all the circumstances.

OC2.1.5 References to **The Company** planning the **National Electricity Transmission System** outage programme on the basis of the **Final Generation Outage Programme**, are to **The Company** planning against the **Final Generation Outage Programme** current at the time it so plans.

OC2.1.6 Where in **OC2** data is required to be submitted or information is to be given on a particular day, that data does not need to be submitted and that information does not need to be given on that day if it is not a **Business Day** or it falls within a holiday period (the occurrence and length of which shall be determined by **The Company**, in its reasonable discretion, and notified to **Users**). Instead, that data shall be submitted and/or that information shall be given on such other **Business Day** as **The Company** shall, in its reasonable discretion, determine. However, **The Company** may determine that that data and/or information need not be submitted or given at all, in which case it shall notify each **User** as appropriate.

OC2.1.7

In Scotland, it may be possible with the agreement of **The Company** to reduce the administrative burden for **Users** in producing planning information where either the output or demand is small.

OC2.2 OBJECTIVE

- OC2.2.1 (a) The objective of **OC2** is to seek to enable **The Company** to harmonise outages of **Power Generating Modules** (including **DC Connected Power Park Modules**), **Synchronous Generating Units**, **Power Park Modules** and **External Interconnections** in order that such outages are co-ordinated (taking account of **Embedded Medium Power Stations**) between **Generators** and **Network Operators**, and that such outages are co-ordinated taking into account **National Electricity Transmission System** outages and other **System** outages, so far as possible to minimise the number and effect of constraints on the **National Electricity Transmission System** or any other **System**.
- (b) In the case of **Network Operator' User Systems** directly connected to the **National Electricity Transmission System** this means in particular that there will also need to be harmonisation of outages of **Embedded Power Generating Modules**, **Embedded Synchronous Generating Units** and **Embedded Power Park Modules**, and **National Electricity Transmission System** outages, with **Network Operators** in respect of their outages on those **Systems**.

OC2.2.2 The objective of **OC2** is also to enable the provision by **The Company** of the **Surpluses** both for the **National Electricity Transmission System** and **System Zones**.

OC2.2.3 A further objective of **OC2** is to provide for the agreement for outages for **Existing Gas Cooled Reactor Plant** in certain circumstances and to enable a process to be followed in order to provide for that.

OC2.2.4 The boundaries of the **System Zones** will be determined by **The Company** from time to time taking into account the disposition of **Generators' Power Stations** and **Interconnector Owners' External Interconnections** within the **System Zones**. The location of the boundaries will be made available to all **Users**. Any **User** may request that **The Company** reviews any of the **System Zonal** boundaries if that **User** considers that the current boundaries are not appropriate, giving the reasons for their concerns. On receipt of such a request **The Company** will review the boundaries if, in **The Company's** reasonable opinion, such a review is justified.

OC2.3 SCOPE

OC2.3.1 **OC2** applies to **The Company** and to **Users** which in **OC2** means:

- (a) **Generators**, only in respect of their **Large Power Stations** or their **Power Stations** which are directly connected to **National Electricity Transmission System** (and the term **Generator** in this **OC2** shall be construed accordingly);
- (b) **Network Operators**; and
- (c) **Non-Embedded Customers**; and
- (d) **HVDC System Owners** and **DC Converter Station** owners; and
- (e) **Interconnector Owners** in respect of their **External Interconnections**.

OC2.3.2 **The Company** may provide to the **Relevant Transmission Licensees** any data which has been submitted to **The Company** by any **Users** in respect of **Relevant Units** pursuant to the following paragraphs of the **OC2**.

OC2.4.1.2.1 (a)

OC2.4.1.2.1 (e)

OC2.4.1.2.1 (j)

OC2.4.1.2.2 (a)

OC2.4.1.2.2 (i)

OC2.4.1.3.2 (a)

OC2.4.1.3.2 (b)

OC2.4.1.3.3

OC2.4.2.1 (a)

OC2.3.3 For the purpose of **OC2** only, the term **Output Usable** shall include the terms **Interconnector Export Capacity** and **Interconnector Import Capacity** where the term **Output Usable** is being applied to an **External Interconnection**.

OC2.4 PROCEDURE

OC2.4.1 Co-ordination of Outages

OC2.4.1.1 Under **OC2** the interaction between **The Company** and **Users** will be as follows:

- | | |
|---|--|
| (a) Each Generator , and each Interconnector Owner and The Company | In respect of outages of Power Generating Modules (including DC Connected Power Park Modules), Synchronous Generating Units , Power Park Modules and External Interconnection Circuits and in respect of outages of other Plant and/or Apparatus directly connected to the National Electricity Transmission System ; |
| (b) The Company and each Generator and each Interconnector Owner | in respect of National Electricity Transmission System outages relevant to each Generator (other than in respect of Embedded Small Power Stations or Embedded Medium Power Stations) and Interconnector Owner ; |
| (c) The Company and each Network Operator | in respect of outages of all Embedded Large Power Stations and in respect of outages of other Plant and/or Apparatus relating to such Embedded Large Power Stations ; |
| (d) The Company and each Network Operator and each Non-Embedded Customer | in respect of National Electricity Transmission System outages relevant to the particular Network Operator or Non-Embedded Customers ; |
| (e) Each Network Operator and each Non-Embedded Customer and The Company | in respect of User System outages relevant to The Company ; and
in respect of Network Operators only, outages of the Network Operator's User System that may impact upon an Offshore Transmission System connected to that Network Operator's User System . |

OC2.4.1.2 Planning of **Power Generating Modules, Synchronous Generating Unit** And **External Interconnection** and **Power Park Module** Outages

OC2.4.1.2.1 Operational Planning Phase - Planning for Calendar Years 3 to 5 inclusive – Weekly Resolution

In each calendar year:

- (a) By the end of week 2

Each **Generator** and each **Interconnector Owner** will provide **The Company** in writing with:

- (i) a provisional **Power Generating Module** (including **DC Connected Power Park Module**) and **Synchronous Generating Unit** and **Power Park Module** outage programme (covering all non-**Embedded Power Stations** and **Embedded Large Power Stations**) for Year 3 to Year 5 (inclusive) specifying the **Power Generating Module** (including **DC Connected Power Park Modules**) and/or **Synchronous Generating Unit** and/or **Power Park Module** and **External Interconnection Circuits** and MW concerned, duration of proposed outages, the preferred date for each outage and where there is a possibility of flexibility, the earliest start date and latest finishing date; and
- (ii) a best estimate weekly **Output Usable** forecast of all its **Gensets** and **External Interconnections** for Year 3 to Year 5.

(b) Between the end of week 2 and the end of week 12

The Company will be:

- (i) calculating total winter peak generating capacity assumed to be available to the **Total System**;
- (ii) calculating the total winter peak generating capacity expected from **Large Power Stations**, taking into account **Demand** forecasts and details of proposed use of **Demand Control** received under **OC1**, and an operational planning margin set by **The Company** (the "**Operational Planning Margin**");
- (iii) calculating the weekly peak generating capacity expected from **Large Power Stations** taking into account demand forecasts and details of proposed use of **Demand Control** received under **OC1**, and the **Operational Planning Margin** and **Zonal System Security Requirements**. The total weekly peak MW needed to be available is the "weekly total MW required".

The calculation under (iii) will effectively define the envelope of opportunity for outages of **Power Generating Modules** (including **DC Connected Power Park Modules**), **Synchronous Generating Units** and **Power Park Modules**.

During this period, **The Company** may, as appropriate, contact each **Generator** and each **Interconnector Owner** who has supplied information to seek clarification on points.

(c) By the end of week 12

The Company will:

- (i) having taken into account the information notified to it by **Generators** and **Interconnector Owners** and taking into account:
 - (1) **National Electricity Transmission System** constraints and outages,
 - (2) **Network Operator System** constraints and outages, known to **The Company**, and
 - (3) the **Output Usable** required, in its view, to meet weekly total MW requirements,
 provide each **Generator** and each **Interconnector Owner** in writing with any suggested amendments to the provisional outage programme supplied by the **Generator** and **Interconnector Owner** which **The Company** believes necessary, and will advise **Generators** with **Large Power Stations** of the **Surpluses** both for the **National Electricity Transmission System** and **System Zones** and potential export limitations, on a weekly basis, which would occur without such amendments;

- (ii) provide each **Network Operator** in writing with potential outages of **Power Generating Modules** (including **DC Connected Power Park Modules**), **Synchronous Generating Units**, **External Interconnection Circuits** and/or **Power Park Modules** which may, in the reasonable opinion of **The Company** and the **Network Operator**, affect the integrity of that **Network Operator's User System** provided that, in such circumstances **The Company** has notified the **Generator** concerned at least 48 hours beforehand of its intention to do so (including identifying the **Power Generating Modules** (including **DC Connected Power Park Modules**) **Synchronous Generating Unit** and/or **Power Park Module** concerned).
- (d) By the end of week 14
- (i) Where a **Generator** or **Interconnector Owner** or a **Network Operator** is unhappy with the suggested amendments to its provisional outage programme (in the case of a **Generator** or **Interconnector Owner**) or such potential outages (in the case of a **Network Operator**) it may contact **The Company** to explain its concerns and **The Company** and that **Generator** or an **Interconnector Owner** or **Network Operator** will then discuss the problem and seek to resolve it.
- (ii) The possible resolution of the problem may require **The Company** or a **User** to contact other **Generators** and **Network Operators**, and joint meetings of all parties may, if any **User** feels it would be helpful, be convened by **The Company**. The need for further discussions, be they on the telephone or at meetings, can only be determined at the time.
- (e) By the end of week 25
- Each **Generator** will provide **The Company** in writing with an updated provisional **Power Generating Modules** (including **DC Connected Power Park Modules**), **Synchronous Generating Unit** and **Power Park Module** outage programme covering both **Embedded** and non-**Embedded Large Power Stations** together with the best estimate weekly **Output Usable** forecasts for each **Genset**, in all cases for Year 3 to Year 5 (inclusive). The updated provisional **Power Generating Modules** (including **DC Connected Power Park Modules**), **Synchronous Generating Unit** and **Power Park Module** outage programme will contain the MW concerned, duration of proposed outages, the preferred date for each outage and, where applicable, earliest start date and latest finishing date, together with an update of the **Output Usable** estimate supplied under (a)(ii) above.
- Each **Interconnector Owner** will provide **The Company** in writing with an updated provisional **External Interconnection Circuit** outage programme together with best estimate weekly **Output Usable** forecast for each **External Interconnection**, in all cases for Year 3 to Year 5 (inclusive). The updated provisional **External Interconnection Circuit** outage programme will contain the MW concerned, duration of proposed outages, the preferred date for each outage and, where applicable, earliest start date and latest finishing date, together with an update of the **Output Usable** estimate supplied under (a)(ii) above.
- (f) Between the end of week 25 and the end of week 28
- The Company** will be considering the updated provisional **Power Generating Modules** (including **DC Connected Power Park Modules**), **Synchronous Generating Unit**, **Power Park Module** and **External Interconnection Circuit** outage programmes, together with the best estimate weekly **Output Usable** forecasts supplied to it by **Generators** and **Interconnector Owners** under (e) and their **Registered Capacity** or **Maximum Capacity** (as applicable) and will be analysing **Operational Planning Margins** for the period.
- (g) By the end of week 28
- The Company** will:

- (i) provide each **Generator** and each **Interconnector Owner** in writing with details of any suggested revisions considered by **The Company** as being necessary to the updated provisional **Power Generating Module** (including **DC Connected Power Park Modules**) **Synchronous Generating Unit**, **Power Park Module** and **External Interconnection Circuit** outage programmes supplied to **The Company** under (e) and will advise **Generators** with **Large Power Stations** and **Interconnector Owners** of the **Surpluses** for the **National Electricity Transmission System** and **System Zones** and potential export limitations on a weekly basis which would occur without such revisions; and
 - (ii) provide each **Network Operator** in writing with the update of potential outages of **Power Generating Modules** (including **DC Connected Power Park Modules**), **Synchronous Generating Units**, **External Interconnection Circuits** and/or **Power Park Modules** which, in the reasonable opinion of **The Company** and the **Network Operator**, affect the integrity of that **Network Operator's User System**.
- (h) By the end of week 31

Where a **Generator**, **Interconnector Owner** or a **Network Operator** is unhappy with the revisions suggested to the updated provisional **Power Generating Modules** (including **DC Connected Power Park Modules**), **Synchronous Generating Unit**, **Power Park Module** and **External Interconnector Circuit** outage programme (in the case of a **Generator**) or such update of potential outages (in the case of an **Interconnector Owner** or **Network Operator**) under (g) it may contact **The Company** to explain its concerns and the provisions set out in (d) above will apply to that process.

(i) By the end of week 42

The Company will:

- (1) provide each **Generator** and each **Interconnector Owner** in writing with details of suggested revisions considered by **The Company** as being necessary to the updated provisional **Power Generating Modules** (including **DC Connected Power Park Modules**), **Synchronous Generating Unit**, **Power Park Module** and **External Interconnection Circuit** outage programmes supplied to **The Company** and will advise **Generators** with **Large Power Stations** and **Interconnector Owners** of the **Surpluses** for the **National Electricity Transmission System** and **System Zones** and potential export limitations, on a weekly basis which would occur without such revisions;
- (2) provide each **Network Operator** in writing with the update of potential outages of **Power Generating Modules** (including **DC Connected Power Park Modules**), **Synchronous Generating Units** and/or **Power Park Modules** which may, in the reasonable opinion of **The Company** and the **Network Operator**, affect the integrity of that **Network Operator's User System** provided that, in such circumstances **The Company** has notified the **Generator** or, as appropriate, the **Interconnector Owner** concerned at least 48 hours beforehand of its intention to do so (including identifying the **Power Generating Modules** (including **DC Connected Power Park Modules**), **Synchronous Generating Units** and/or **Power Park Modules** concerned).

(j) By the end of week 45

The Company will seek to agree a **Final Generation Outage Programme** for Year 3 to Year 5. If agreement cannot be reached on all aspects, **The Company** and each **Generator** and each **Interconnector Owner** will record their agreement on as many aspects as have been agreed and **The Company** will advise each **Generator** with **Large Power Stations**, **Interconnector Owner** and each **Network Operator**, of the **Surpluses** for the **National Electricity Transmission System** and **System Zones** on a weekly basis which would occur in relation to those aspects not agreed. It is accepted that agreement of the **Final Generation Outage Programme** is not a commitment on **Generators**, **Interconnector Owners** or **The Company** to abide by it, but **The Company** will be planning the **National Electricity Transmission System** outage programme on the basis of the **Final Generation Outage Programme** and if in the event the **Generator's** or the **Interconnector Owner's** outages differ from those contained in the **Final Generation Outage Programme**, or in any way conflict with the **National Electricity Transmission System** outage programme, **The Company** need not alter the **National Electricity Transmission System** outage programme.

OC2.4.1.2.2 Operational Planning Phase - Planning for Calendar Year 1 and Calendar Year 2 – Weekly Resolution

The basis for **Operational Planning** for Year 1 and Year 2 will be the **Final Generation Outage Programmes** agreed for Years 2 and 3:

In each calendar year:

(a) By the end of week 10

Each **Generator** and each **Interconnector Owner** will provide **The Company** in writing with its previously agreed **Final Generation Outage Programme** updated and best estimate weekly **Output Usable** forecasts for each **Genset** and for each **External Interconnection Circuit** for weeks 1-52 of Years 1 and 2.

- (b) Between the end of week 10 and the end of week 12

The Company will be considering the updated proposed **Power Generating Modules** (including **DC Connected Power Park Modules**), **Synchronous Generating Unit**, **Power Park Module** and **External Interconnection Circuit** outage programme together with the estimate of **Output Usable** supplied by **Generators** and **Interconnector Owners** under (a) and will be analysing **Operational Planning Margins** for the period. Taking these into account together with **National Electricity Transmission System** constraints and outages and **Network Operator User System** constraints and outages known to **The Company**, **The Company** will assess whether the estimates of **Output Usable** supplied by **Generators** and **Interconnector Owners** are sufficient to meet forecast **National Electricity Transmission System Demand** plus the **Operational Planning Margin**.

- (c) By the end of week 12

The Company will:

- (i) notify each **Generator** and each **Interconnector Owner** in writing whether the **Output Usable** estimates are adequate for weeks 1-52 of Years 1 and 2, together with suggested changes to its **Final Generation Outage Programme** where necessary and will advise each **Generator** with **Large Power Stations** and each **Interconnector Owner** of the **Surpluses** both for the **National Electricity Transmission System** and **System Zones** and potential export limitations, on a weekly resolution which would occur without such changes;
- (ii) provide each **Network Operator** in writing with weekly **Output Usable** estimates of **Generators** and **Interconnector Owners** for weeks 1-52 of Years 1 and 2, and updated details of potential outages of **Power Generating Modules** (including **DC Connected Power Park Modules**), **Synchronous Generating Units**, **Power Park Modules** and/or **External Interconnection Circuits** which may, in the reasonable opinion of **The Company** and the **Network Operator**, affect the integrity of that **Network Operator's User System** provided that, in such circumstances, **The Company** has notified the **Generator** or, as appropriate, the **Interconnector Owner** concerned at least 48 hours beforehand of its intention to do so (including identifying the affected **Generators** or **Power Generating Modules** (including **DC Connected Power Park Modules**), **Synchronous Generating Units** or **Power Park Modules** and/or **External Interconnection Circuits**, as appropriate).

- (d) By the end of week 14

Where a **Generator**, **Interconnector Owner** or a **Network Operator** is unhappy with any suggested changes to its **Final Generation Outage Programme** (in the case of a **Generator**) or such update of potential outages (in the case of an **Interconnector Owner** or **Network Operator**), equivalent provisions to those set out in OC2.4.1.2.1(d) will apply.

- (e) By the end of week 34

Each **Generator** and each **Interconnector Owner** will provide **The Company** in writing with revised best estimate weekly **Output Usable** forecasts for each **Genset** or **External Interconnection**, as appropriate, for weeks 1-52 of Years 1 and 2.

- (f) Between the end of week 34 and the end of week 39

The Company will be analysing the revised estimates of **Output Usable** supplied by **Generators** and **Interconnector Owners** under (e) and will be analysing **Operational Planning Margins** for the period. Taking these into account together with **National Electricity Transmission System** constraints and outages and **Network Operator User System** constraints and outages known to **The Company**, **The Company** will assess whether the estimates of **Output Usable** supplied by **Generators** and **Interconnector Owners** are sufficient to meet forecast **National Electricity Transmission System Demand** plus the **Operational Planning Margin**.

(g) By the end of week 39

The Company will:

- (i) notify each **Generator** and each **Interconnector Owner** in writing whether it accepts the **Output Usable** estimates for weeks 1-52 of Years 1 and 2, and of any suggested changes to its **Final Generation Outage Programme** where necessary and will advise **Generators** with **Large Power Stations** and **Interconnector Owners** of the **Surpluses** both for the **National Electricity Transmission System** and **System Zones** and potential export limitations on a weekly basis which would occur without such changes;
- (ii) provide each **Network Operator** in writing with **Output Usable** estimates of **Generators** and **Interconnector Owners** for weeks 1-52 of Years 1 and 2, and updated details of potential outages of **Power Generating Modules** (including **DC Connected Power Park Modules**), **Synchronous Generating Units**, **Power Park Modules** and/or **External Interconnection Circuits** which may, in the reasonable opinion of **The Company** and the **Network Operator**, affect the integrity of that **Network Operator's User System** provided that, in such circumstances, **The Company** has notified the **Generator** or, as appropriate, **Interconnector Owner** concerned at least 48 hours beforehand of its intention to do so (including identifying the affected **Gensets** or **Power Generating Modules** (including **DC Connected Power Park Modules**) or **Synchronous Generating Units** or **Power Park Modules** and/or **External Interconnection** as appropriate).

(h) By the end of week 46

Where a **Generator**, an **Interconnector Owner** or a **Network Operator**, is unhappy with any suggested changes to its **Final Generation Outage Programme** (in the case of a **Generator**) or such update of potential outages (in the case of an **Interconnector Owner** or **Network Operator**), equivalent provisions to those set out in OC2.4.1.2.1(d) will apply.

(i) By the end of week 48

The Company will seek to agree the revised **Final Generation Outage Programme** for Year 1 and Year 2. If agreement cannot be reached on all aspects, **The Company** and each **Interconnector Owner** and each **Generator** will record their agreement on as many aspects as have been agreed and **The Company** will advise each **Generator** with **Large Power Stations**, **Interconnector Owner** and each **Network Operator**, of **Generating Plant Demand Margins** for national and zonal groups, on a weekly basis, which would occur in relation to those aspects not agreed. It is accepted that agreement of the **Final Generation Outage Programme** is not a commitment on **Generators**, **Interconnector Owners** or **The Company** to abide by it, but **The Company** will be planning the **National Electricity Transmission System** outage programme on the basis of the **Final Generation Outage Programme** and if, in the event, a **Generator's** and/or **Interconnector Owner's** outages differ from those contained in the **Final Generation Outage Programme**, or in any way conflict with the **National Electricity Transmission System** outage programme, **The Company** need not alter the **National Electricity Transmission System** outage programme.

OC2.4.1.2.3 Planning for Calendar Year 0 – Weekly Resolution

The basis for **Operational Planning** for Year 0 will be the revised **Final Generation Outage Programme** agreed for Year 1:

In each week:

(a) By 1600 hours each Wednesday – Weekly Resolution

Each **Generator** and each **Interconnector Owner** will provide **The Company** in writing with an update of the **Final Generation Outage Programme** and a best estimate weekly **Output Usable** forecast for each of its **Gensets** or its **External Interconnection Circuits**, as appropriate, from the 2nd week ahead to the 52nd week ahead.

- (b) Between 1600 hours Wednesday and 1600 hours Friday

The Company will be analysing the revised estimates of **Output Usable** supplied by **Generators** and **Interconnector Owners** under (a) and will be analysing **Operational Planning Margins** for the period. Taking into account **National Electricity Transmission System** constraints and outages and **Network Operator User System** constraints and outages known to **The Company**, **The Company** will assess whether the estimates of **Output Usable** supplied by **Generators** and **Interconnector Owners** are sufficient to meet forecast **National Electricity Transmission System Demand** plus the **Operational Planning Margin**.

- (c) By 1600 hours each Friday

The Company will:

- (i) notify each **Generator** with **Large Power Stations**, **Interconnector Owner** and **Network Operator**, in writing if it considers the **Output Usable** forecasts will give **Surpluses** and potential export limitations both for the **National Electricity Transmission System** and **System Zones** from the 2nd week ahead to the 52nd week ahead;
- (ii) provide each **Network Operator**, in writing with weekly **Output Usable** estimates of **Gensets** and **External Interconnection** from the 2nd week ahead to the 52nd week ahead and updated outages of **Power Generating Modules** (including **DC Connected Power Park Modules**), **Synchronous Generating Units**, **Power Park Modules** and/or **External Interconnection Circuits** which may, in the reasonable opinion of **The Company** and the **Network Operator**, affect the integrity of that **Network Operator's User System** and in such circumstances, **The Company** shall notify the **Generator** and **Interconnector Owner** concerned within 48 hours of so providing (including identifying the affected **Gensets** or **Power Generating Modules** (including **DC Connected Power Park Modules**), **Synchronous Generating Units** and/or **Power Park Modules** and/or **External Interconnection Circuits**, as appropriate), from the 2nd week ahead to the 52nd week ahead.

OC2.4.1.2.4 Programming Phase – 2-49 Days Ahead – Daily Resolution

- (a) By 1200 hours each Friday

The Company will notify in writing each **Generator** with **Large Power Stations**, **Interconnector Owner** and **Network Operator** if it considers the **Output Usable** forecasts will give MW shortfalls both nationally and for constrained groups for the period 2-7 weeks ahead.

- (b) By 1100 hours each Business Day

Each **Generator** and each **Interconnector Owner** shall provide **The Company** in writing with the best estimate of daily **Output Usable** for each **Genset** or each **External Interconnection Circuit** as appropriate for the period from and including day 2 ahead to day 14 ahead, including the forecast return to service date for any such **Power Generating Modules** (including **DC Connected Power Park Modules**), **Generating Unit**, **Power Park Module** or **External Interconnection** subject to **Planned Outage** or breakdown.

- (c) By 1100 hours each Wednesday

For the period 2 to 49 days ahead, every Wednesday by 11:00 hours, each **Generator** and each **Interconnector Owner** shall provide **The Company** in writing best estimate daily **Output Usable** forecasts for each **Genset** or **External Interconnection**, and changes (start and finish dates) to **Planned Outage** or to the return to service times of each **Power Generating Modules** (including **DC Connected Power Park Modules**), **Synchronous Generating Unit**, **Power Park Module** and/or **External Interconnection Circuit** which is subject to breakdown.

(d) Between 1100 hours and 1600 hours each Business Day

The Company will be analysing the revised estimates of **Output Usable** supplied by **Generators** and **Interconnector Owners** under (b) and will be analysing **Operational Planning Margins** for the period 2-14 days ahead. Taking into account **National Electricity Transmission System** constraints and outages and **Network Operator User System** constraints and outages known to **The Company**, **The Company** will assess whether the estimates of **Output Usable** are sufficient to meet forecast **National Electricity Transmission System Demand** plus the **Operational Planning Margin**.

(e) By 1600 hours each Business Day

(i) **The Company** will notify in writing each **Generator** with **Large Power Stations**, each **Interconnector Owner** and each **Network Operator**, of the **Surpluses** both for the **National Electricity Transmission System** and **System Zones** and potential export limitations, for the period from and including day 2 ahead to day 14 ahead which it considers the **Output Usable** forecasts will give. The time of 1600 hours can only be met in respect of any **Generator**, **Interconnector Owner** or **Network Operator** if all the information from all **Generators** and **Interconnector Owners** was made available to **The Company** by 1100 hours and if a suitable electronic data transmission facility is in place between **The Company** and the **Generator**, or the **Interconnector Owner** or the **Network Operator**, as the case may be, and if it is fully operational. In the event that any of these conditions is not met, or if it is necessary to revert to a manual system for analysing the information supplied and otherwise to be considered, **The Company** reserve the right to extend the timescale for issue of the information required under this sub-paragraph to each, or the relevant, **Generator**, **Interconnector Owner** and/or **Network Operator** (as the case may be) provided that such information will in any event be issued by 1800 hours.

(ii) **The Company** will provide each **Network Operator**, where it has an effect on that **User**, in writing with **Output Usable** estimates of **Gensets** and **External Interconnections** from and including day 2 ahead to day 14 ahead and updated outages of **Power Generating Modules** (including **DC Connected Power Park Modules**), **Synchronous Generating Units**, **Power Park Modules** and/or **External Interconnection Circuits** which are either in its **User System** or which may, in the reasonable opinion of **The Company** and the **Network Operator**, affect the integrity of that **Network Operator's User System** and in such circumstances, **The Company** shall notify the **Generator** and **Interconnector Owner** concerned within 48 hours of so providing (including identifying the affected **Gensets** or **Power Generating Modules** (including **DC Connected Power Park Modules**) or **Synchronous Generating Units** or **Power Park Modules** and/or **External Interconnection Circuits**, as appropriate), for the period from and including day 2 ahead to day 14 ahead.

OC2.4.1.3 Planning of National Electricity Transmission System Outages

OC2.4.1.3.1 Operational Planning Phase - Planning for Financial Years 2 to 5 inclusive ahead

The Company shall plan **National Electricity Transmission System** outages required in Years 2 to 5 inclusive required as a result of construction or refurbishment works. This contrasts with the planning of **National Electricity Transmission System** outages required in Years 0 and 1 ahead, when **The Company** also takes into account **National Electricity Transmission System** outages required as a result of maintenance.

Users should bear in mind that **The Company** will be planning the **National Electricity Transmission System** outage programme on the basis of the previous year's **Final Generation Outage Programme** and if in the event a **Generator's**, an **Interconnector Owner's** or **Network Operator's** outages differ from those contained in the **Final Generation Outage Programme**, or in the case of **Network Operators**, those known to **The Company**, or in any way conflict with the **National Electricity Transmission System** outage programme, **The Company** need not alter the **National Electricity Transmission System** outage programme.

OC2.4.1.3.2 In each calendar year:

(a) By the end of week 8

Each **Network Operator** will notify **The Company** in writing of details of proposed outages in Years 2-5 ahead in its **User System** which may affect the performance of the **Total System** (which includes but is not limited to outages of **User System Apparatus** at **Grid Supply Points** and outages which constrain the output of **Power Generating Modules** (including **DC Connected Power Park Modules**) and/or **Synchronous Generating Units** and/or **Power Park Modules Embedded** within that **User System**).

Each **Network Operator** will notify **The Company** in writing of details of proposed outages in Years 2-5 ahead in its **User System** which may affect the declared values of **Maximum Export Capacity** and/or **Maximum Import Capacity** for each **Interface Point** within its **User System** together with the **Network Operator's** revised best estimate of the **Maximum Export Capacity** and/or **Maximum Import Capacity** during such outages. **Network Operators** will also notify **The Company** of any automatic and/or manual post fault actions that it intends to utilise or plans to utilise during such outages.

(b) By the end of week 13

Each **Generator** will inform **The Company** in writing of proposed outages in Years 2 - 5 ahead of **Generator** owned **Apparatus** (eg. busbar selectors) other than **Power Generating Modules** (including **DC Connected Power Park Modules**) and/or **Synchronous Generating Units**, and/or **Power Park Modules**, at each **Grid Entry Point**.

The Company will provide to each **Network Operator** and to each **Generator** and each **Interconnector Owner** a copy of the information given to **The Company** under paragraph (a) above (other than the information given by that **Network Operator**). In relation to a **Network Operator**, the data must only be used by that **User** in planning and operating that **Network Operator's User System** and must not be used for any other purpose or passed on to, or used by, any other business of that **User** or to, or by, any person within any other such business or elsewhere.

(c) By the end of week 28

The Company will provide each **Network Operator** in writing with details of proposed outages in Years 2-5 ahead which may, in **The Company's** reasonable judgement, affect the performance of that **Network Operator's User System**.

(d) By the end of week 30

Where **The Company** or a **Network Operator** is unhappy with the proposed outages notified to it under (a), (b) or (c) above, as the case may be, equivalent provisions to those set out in OC2.4.1.2.1 (d) will apply.

(e) By the end of week 34

The Company will draw up a draft **National Electricity Transmission System** outage plan covering the period Years 2 to 5 ahead and **The Company** will notify each **Generator**, **Interconnector Owner** and **Network Operator** in writing of those aspects of the plan which may operationally affect such **Generator** (other than those aspects which may operationally affect **Embedded Small Power Stations** or **Embedded Medium Power Stations**), **Interconnector Owner** or **Network Operator**. **The Company** will also indicate where a need may exist to issue other operational instructions or notifications (including but not limited to the requirement for the arming of an **Operational Intertripping** scheme) or **Emergency Instructions** to **Users** in accordance with **BC2** to allow the security of the **National Electricity Transmission System** to be maintained within the **Licence Standards**.

OC2.4.1.3.3 Operational Planning Phase - Planning for Financial Year 1 ahead

Each calendar year **The Company** shall update the draft **National Electricity Transmission System** outage plan prepared under OC2.4.1.3.2 above and shall in addition take into account outages required as a result of maintenance work.

In each calendar year:

- (a) By the end of week 13

Generators and **Non-Embedded Customers** will inform **The Company** in writing of proposed outages for Year 1 of **Generator** owned **Apparatus** at each **Grid Entry Point** (e.g. busbar selectors) other than **Power Generating Modules** (including **DC Connected Power Park Modules**), **Synchronous Generating Units** and/or **Power Park Modules** or **Non-Embedded Customer** owned **Apparatus**, as the case may be, at each **Grid Supply Point**.

- (b) By the end of week 28

The Company will provide each **Network Operator** and each **Non-Embedded Customer** in writing with details of proposed outages in Year 1 ahead which may, in **The Company's** reasonable judgement, affect the performance of its **User System** or the **Non-Embedded Customer Apparatus** at the **Grid Supply Point**.

- (c) By the end of week 32

Each **Network Operator** will notify **The Company** in writing with details of proposed outages in Year 1 in its **User System** which may affect the performance of the **Total System** (which includes but is not limited to outages of **User System Apparatus** at **Grid Supply Points** and outages which constrain the output of **Power Generating Modules** (including **DC Connected Power Park Modules**), **Synchronous Generating Units** and/or **Power Park Modules Embedded** within that **User System**).

Each **Network Operator** will notify **The Company** in writing of details of proposed outages in Year 1 in its **User System** which may affect the declared values of **Maximum Export Capacity** and/or **Maximum Import Capacity** for each **Interface Point** within its **User System** together with the **Network Operator's** revised best estimate of the **Maximum Export Capacity** and/or **Maximum Import Capacity** during such outages. **Network Operators** will also notify **The Company** of any automatic and/or manual post fault actions that it intends to utilise or plans to utilise during such outages.

Each **Network Operator** will also notify **The Company** in writing of any revisions to **Interface Point Target Voltage/Power Factor** data submitted pursuant to PC.A.2.5.4.2.

- (d) Between the end of week 32 and the end of week 34

The Company will draw up a revised **National Electricity Transmission System** outage plan (which for the avoidance of doubt includes **Transmission Apparatus** at the **Connection Points**).

- (e) By the end of week 34

The Company will notify each **Generator**, **Interconnector Owner**, and **Network Operator**, in writing, of those aspects of the **National Electricity Transmission System** outage programme which may, in **The Company's** reasonable opinion, operationally affect that **Generator** (other than those aspects which may operationally affect **Embedded Small Power Stations** or **Embedded Medium Power Stations**), **Interconnector Owner**, or **Network Operator** including in particular proposed start dates and end dates of relevant **National Electricity Transmission System** outages.

The Company will provide to each **Network Operator** and to each **Generator** and each **Interconnector Owner** a copy of the information given to **The Company** under paragraph (c) above (other than the information given by that **Network Operator**). In relation to a **Network Operator**, the data must only be used by that **User** in planning and operating that **Network Operator's User System** and must not be used for any other purpose or passed on to, or used by, any other business of that **User** or to, or by, any person within any other such business or elsewhere.

(f) By the end of week 36

Where a **Generator**, **Interconnector Owner** or **Network Operator** is unhappy with the proposed aspects notified to it under (e) above, equivalent provisions to those set out in OC2.4.1.2.1 (d) will apply.

(g) Between the end of week 34 and 49

The Company will draw up a final **National Electricity Transmission System** outage plan covering Year 1.

(h) By the end of week 49

(i) **The Company** will complete the final **National Electricity Transmission System** outage plan for Year 1. The plan for Year 1 becomes the final plan for Year 0 when by expiry of time Year 1 becomes Year 0.

(ii) **The Company** will notify each **Generator**, each **Interconnector Owner** and each **Network Operator** in writing of those aspects of the plan which may operationally affect such **Generator** (other than those aspects which may operationally affect **Embedded Small Power Stations** or **Embedded Medium Power Stations**), **Interconnector Owner** or **Network Operator** including in particular proposed start dates and end dates of relevant **National Electricity Transmission System** outages. **The Company** will also indicate where a need may exist to issue other operational instructions or notifications (including but not limited to the requirement for the arming of an **Operational Intertripping** scheme) or **Emergency Instructions to Users** in accordance with **BC2** to allow the security of the **National Electricity Transmission System** to be maintained within the **Licence Standards**. **The Company** will also inform each relevant **Non-Embedded Customer** of the aspects of the plan which may affect it.

(iii) In addition, in relation to the final **National Electricity Transmission System** outage plan for Year 1, **The Company** will provide to each **Generator** and each **Interconnector Owner** a copy of the final **National Electricity Transmission System** outage plan for that year. OC2.4.1.3.4 contains provisions whereby updates of the final **National Electricity Transmission System** outage plan are provided. The plan and the updates will be provided in writing. It should be noted that the final **National Electricity Transmission System** outage plan for Year 1 and the updates will not give a complete understanding of how the **National Electricity Transmission System** will operate in real time, where the **National Electricity Transmission System** operation may be affected by other factors which may not be known at the time of the plan and the updates. Therefore, **Users** should place no reliance on the plan or the updates showing a set of conditions which will actually arise in real time.

(i) Information Release Or Exchange

This paragraph (i) contains alternative requirements on **The Company**, paragraph (z) being an alternative to a combination of paragraphs (x) and (y). Paragraph (z) will only apply in relation to a particular **User** if **The Company** and that **User** agree that it should apply, in which case paragraphs (x) and (y) will not apply. In the absence of any relevant agreement between **The Company** and the **User**, **The Company** will only be required to comply with paragraphs (x) and (y).

Information Release To Each Network Operator And Non-Embedded Customer

Between the end of Week 34 and 49 **The Company** will upon written request:

- (x) for radial systems, provide each **Network Operator** and **Non Embedded Customer** with data to allow the calculation by the **Network Operator**, and each **Non Embedded Customer**, of symmetrical and asymmetrical fault levels; and
- (y) for interconnected **Systems**, provide to each **Network Operator** an equivalent network, sufficient to allow the identification of symmetrical and asymmetrical fault levels, and power flows across interconnecting **User Systems** directly connected to the **National Electricity Transmission System**; or

System Data Exchange

- (z) as part of a process to facilitate understanding of the operation of the **Total System**,

- (1) **The Company** will make available to each **Network Operator**, the **National Electricity Transmission System Study Network Data Files** covering Year 1 which are of relevance to that **User's System**;
- (2) where **The Company** and a **User** have agreed to the use of data links between them, the making available will be by way of allowing the **User** access to take a copy of the **National Electricity Transmission System Study Network Data Files** once during that period. The **User** may, having taken that copy, refer to the copy as often as it wishes. Such access will be in a manner agreed by **The Company** and may be subject to separate agreements governing the manner of access. In the absence of agreement, the copy of the **National Electricity Transmission System Study Network Data Files** will be given to the **User** on a disc, or in hard copy, as determined by **The Company**;
- (3) the data contained in the **National Electricity Transmission System Study Network Data Files** represents **The Company's** view of operating conditions although the actual conditions may be different;
- (4) **The Company** will notify each **Network Operator**, as soon as reasonably practicable after it has updated the **National Electricity Transmission System Study Network Data Files** covering Year 1 that it has done so, when this update falls before the next annual update under this OC2.4.1.3.3(i). **The Company** will then make available to each **Network Operator** who has received an earlier version (and in respect of whom the agreement still exists), the updated **National Electricity Transmission System Study Network Files** covering the balance of Years 1 and 2 which remain given the passage of time, and which are of relevance to that **User's System**. The provisions of paragraphs (2) and (3) above shall apply to the making available of these updates;
- (5) the data from the **National Electricity Transmission System Study Network Data Files** received by each **Network Operator** must only be used by that **User** in planning and operating that **Network Operator's User System** and must not be used for any other purpose or passed on to, or used by, any other business of that **User** or to, or by, any person within any other such business or elsewhere.

OC2.4.1.3.4 Operational Planning Phase - Planning In Financial Year 0 Down To The Programming Phase (And In The Case Of Load Transfer Capability, Also During The Programming Phase)

- (a) The **National Electricity Transmission System** outage plan for Year 1 issued under OC2.4.1.3.3 shall become the plan for Year 0 when by expiry of time Year 1 becomes Year 0.
- (b) Each **Generator** or **Interconnector Owner** or **Network Operator** or **Non-Embedded Customer** may at any time during Year 0 request **The Company** in writing for changes to the outages requested by them under OC2.4.1.3.3. In relation to that part of Year 0, excluding the period 1-7 weeks from the date of request, **The Company** shall determine whether the changes are possible and shall notify the **Generator**, **Interconnector Owner**, **Network Operator** or **Non-Embedded Customer** in question whether this is the case as soon as possible, and in any event within 14 days of the date of receipt by **The Company** of the written request in question.

Where **The Company** determines that any change so requested is possible and notifies the relevant **User** accordingly, **The Company** will provide to each **Network Operator**, each **Interconnector Owner**, and each **Generator** a copy of the request to which **The Company** has agreed which relates to outages on **Systems of Network Operators** (other than any request made by that **Network Operator**). The information must only be used by that **Network Operator** in planning and operating that **Network Operator's User System** and must not be used for any other purpose or passed on to, or used by, any other business of that **User** or to, or by, any person within any other such business or elsewhere.

- (c) During Year 0 (including the **Programming Phase**) each **Network Operator** shall at **The Company's** request make available to **The Company** such details of automatic and manual load transfer capability of:
- (i) 12MW or more (averaged over any half hour) for England and Wales
 - (ii) 10MW or more (averaged over any half hour) for Scotland
- between Grid Supply Points.

During Year 0 (including the **Programming Phase**) each **Network Operator** shall notify **The Company** of any revisions to the information provided pursuant to OC2.4.1.3.3 (c) for **Interface Points** as soon as reasonably practicable after the **Network Operator** becomes aware of the need to make such revisions.

- (d) When necessary during Year 0, **The Company** will notify each **Generator**, each **Interconnector Owner** and **Network Operator** and each **Non-Embedded Customer**, in writing of those aspects of the **National Electricity Transmission System** outage programme in the period from the 8th week ahead to the 52nd week ahead, which may, in **The Company's** reasonable opinion, operationally affect that **Generator** (other than those aspects which may operationally affect **Embedded Small Power Stations** or **Embedded Medium Power Stations**) **Interconnector Owner** or **Network Operator** or **Non-Embedded Customer** including in particular proposed start dates and end dates of relevant **National Electricity Transmission System** outages.

The Company will also notify changes to information supplied by **The Company** pursuant to OC2.4.1.3.3(i)(x) and (y) except where in relation to a **User** information was supplied pursuant to OC2.4.1.3.3(i)(z). In that case:-

- (i) **The Company** will, by way of update of the information supplied by it pursuant to OC2.4.1.3.3(i)(z), make available at the first time in Year 0 that it updates the **National Electricity Transmission System Study Network Data Files** in respect of Year 0 (such update being an update on what was shown in respect of Year 1 which has then become Year 0) to each **Network Operator** who has received an earlier version under OC2.4.1.3.3(i)(z) (and in respect of whom the agreement still exists), the **National Electricity Transmission System Study Network Data Files** covering Year 0 which are of relevance to that **User's System**.
- (ii) **The Company** will notify each relevant **Network Operator**, as soon as reasonably practicable after it has updated the **National Electricity Transmission System Study Network Data Files** covering Year 0, that it has done so. **The Company** will then make available to each such **Network Operator**, the updated **National Electricity Transmission System Study Network Data Files** covering the balance of Year 0 which remains given the passage of time, and which are of relevance to that **User's System**.
- (iii) The provisions of OC2.4.1.3.3(i)(z)(2), (3) and (5) shall apply to the provision of data under this part of OC2.4.1.3.4(d) as if set out in full.

The Company will also indicate where a need may exist to issue other operational instructions or notifications (including but not limited to the requirement for the arming of an **Operational Intertripping** scheme) or **Emergency Instructions** to **Users** in accordance with **BC2** to allow the security of the **National Electricity Transmission System** to be maintained within the **Licence Standards**.

- (e) In addition, by the end of each month during Year 0, **The Company** will provide to each **Generator** and each **Interconnector Owner** a notice containing any revisions to the final **National Electricity Transmission System** outage plan for Year 1, provided to the **Generator** or the **Interconnector Owner** under OC2.4.1.3.3 or previously under this provision, whichever is the more recent.

OC2.4.1.3.5 Programming Phase

(a) By 1600 hours each Thursday

- (i) **The Company** shall continue to update a preliminary **National Electricity Transmission System** outage programme for the eighth week ahead, a provisional **National Electricity Transmission System** outage programme for the next week ahead and a final day ahead **National Electricity Transmission System** outage programme for the following day.
- (ii) **The Company** will notify each **Generator, Interconnector Owner** and **Network Operator** and each **Non-Embedded Customer**, in writing of those aspects of the preliminary **National Electricity Transmission System** outage programme which may operationally affect each **Generator** (other than those aspects which may operationally affect **Embedded Small Power Stations** or **Embedded Medium Power Stations**) or **Interconnector Owner** or **Network Operator** and each **Non-Embedded Customer** including in particular proposed start dates and end dates of relevant **National Electricity Transmission System** outages.

The Company will also notify changes to information supplied by **The Company** pursuant to OC2.4.1.3.3(i)(x) and (y) except where in relation to a **User** information was supplied pursuant to OC2.4.1.3.3(i)(z). In that case:

- (1) **The Company** will, by way of update of the information supplied by it pursuant to OC2.4.1.3.3(i)(z), make available the **National Electricity Transmission System Study Network Data Files** for the next week ahead and
- (2) **The Company** will notify each relevant **Network Operator**, as soon as reasonably practicable after it has updated the **National Electricity Transmission System Study Network Data Files** covering the next week ahead that it has done so, and
- (3) The provisions of OC2.4.1.3.3(i)(z)(2), (3) and (5) shall apply to the provision of data under this part of OC2.4.1.3.5(a)(ii) as if set out in full.

The Company may make available the **National Electricity Transmission System Study Network Data Files** for the next week ahead where **The Company** and a particular **User** agree, and in such case the provisions of OC2.4.1.1.3.3(i)(x) and (y) and the provisions of OC2.4.1.3.4(d) and OC2.4.1.3.5(a) which relate to OC2.4.1.1.3.3(i)(x) and (y) shall not apply. In such case the provisions of this OC2.4.1.3.5(a)(ii)2 and 3 shall apply to the provision of the data under this part of OC2.4.1.3.5(a)(ii) as if set out in full.

The Company will also indicate where a need may exist to arm an **Operational Intertripping** scheme, emergency switching, emergency **Demand** management or other measures including the issuing of other operational instructions or notifications or **Emergency Instructions** to **Users** in accordance with **BC2** to allow the security of the **National Electricity Transmission System** to be maintained within the **Licence Standards**.

(b) By 1000 hours each Friday

Generators, Interconnector Owners and **Network Operators** will discuss with **The Company** and confirm in writing to **The Company**, acceptance or otherwise of the requirements detailed under OC2.4.1.3.5.

Network Operators shall confirm for the following week:

- (i) the details of any outages of its **User System** that will restrict the **Maximum Export Capacity** and/or **Maximum Import Capacity** at any **Interface Points** within its **User System** for the following week; and
- (ii) any changes to the previously declared values of the **Interface Point Target Voltage/Power Factor**.

- (c) By 1600 hours each Friday
- (i) **The Company** shall finalise the preliminary **National Electricity Transmission System** outage programme up to the seventh week ahead. **The Company** will endeavour to give as much notice as possible to a **Generator** with nuclear **Large Power Stations** which may be operationally affected by an outage which is to be included in such programme.
 - (ii) **The Company** shall finalise the provisional **National Electricity Transmission System** outage programme for the next week ahead.
 - (iii) **The Company** shall finalise the **National Electricity Transmission System** outage programme for the weekend through to the next normal working day.
 - (iv) In each case **The Company** will indicate the factors set out in (a)(ii) above (other than those aspects which may operationally affect **Embedded Small Power Stations** or **Embedded Medium Power Stations**) to the relevant **Generators** and **Network Operators** and **Non-Embedded Customers**.
 - (v) Where a **Generator** with nuclear **Large Power Stations** which may be operationally affected by the preliminary **National Electricity Transmission System** outage programme referred to in (i) above (acting as a reasonable operator) is concerned on grounds relating to safety about the effect which an outage within such outage programme might have on one or more of its nuclear **Large Power Stations**, it may contact **The Company** to explain its concerns and discuss whether there is an alternative way of taking that outage (having regard to technical feasibility). If there is such an alternative way, but **The Company** refuses to adopt that alternative way in taking that outage, that **Generator** may involve the **Disputes Resolution Procedure** to decide on the way the outage should be taken. If there is no such alternative way, then **The Company** may take the outage despite that **Generator's** concerns.
- (d) By 1600 hours each Monday, Tuesday, Wednesday and Thursday
- (i) **The Company** shall prepare a final **National Electricity Transmission System** outage programme for the following day.
 - (ii) **The Company** shall notify each **Generator** and **Network Operator** and **Non-Embedded Customer** in writing of the factors set out in (a)(ii) above (other than those aspects which may operationally affect **Embedded Small Power Stations** or **Embedded Medium Power Stations**).

OC2.4.2 DATA REQUIREMENTS

OC2.4.2.1 When a **Statement of Readiness** under the **Bilateral Agreement** and/or **Construction Agreement** is submitted, and thereafter in calendar week 24 in each calendar year,

- (a) each **Generator** shall (subject to OC2.4.2.1(k)) in respect of each of its:-
 - (i) **Gensets** (in the case of the **Generation Planning Parameters**); and
 - (ii) **CCGT Units** within each of its **CCGT Modules** at a **Large Power Station** (in the case of the **Generator Performance Chart**)
 - (iii) **Generating Units** within each of its **Synchronous Power Generating Modules** at a **Large Power Station** (in the case of the **Power Generating Module Performance Chart** and **Synchronous Generating Unit Performance Chart**)
 submit to **The Company** in writing the **Generation Planning Parameters** and the **Generator Performance Charts** as required.
- (b) Each shall meet the requirements of CC.6.3.2 and shall reasonably reflect the true operating characteristics of the **Genset**.

- (c) They shall be applied (unless revised under this **OC2** or (in the case of the **Generator Performance Chart** only) **BC1** in relation to **Other Relevant Data**) from the **Completion Date**, in the case of the ones submitted with the **Statement of Readiness**, and in the case of the ones submitted in calendar week 24, from the beginning of week 25 onwards.
- (d) They shall be in the format indicated in Appendix 1 for these charts and as set out in Appendix 2 for the **Generation Planning Parameters**.
- (e) Any changes to the **Generator Performance Chart** or **Generation Planning Parameters** should be notified to **The Company** promptly.
- (f) **Generators** should note that amendments to the composition of the **Power Generating Module**, **CCGT Module** or **Power Park Module** at **Large Power Stations** and directly connected Power Stations comprising a Type C or Type D Power Generating Module may only be made in accordance with the principles set out in PC.A.3.2.3 or PC.A.3.2.4 respectively. If in accordance with PC.A.3.2.3 or PC.A.3.2.4 an amendment is made, any consequential changes to the **Generation Planning Parameters** should be notified to **The Company** promptly.
- (g) **The Generator Performance Chart** must be as described below and demonstrate the limitation on reactive capability of the **System** voltage at 3% above nominal. It must also include any limitations on output due to the prime mover (both maximum and minimum), **Generating Unit** step up transformer or **User System**.
 - (i) For a **Synchronous Generating Unit** on a **Generating Unit** specific basis at the **Generating Unit** Stator Terminals. It must include details of the **Generating Unit** transformer parameters.
 - (ii) For a **Non-Synchronous Generating Unit** (excluding a **Power Park Unit**) on a **Generating Unit** specific basis at the **Grid Entry Point** (or **User System Entry Point** if Embedded).
 - (iii) For a **Power Park Module**, on a **Power Park Module** specific basis at the **Grid Entry Point** (or **User System Entry Point** if Embedded).
 - (iv) For a **DC Converter** on a **DC Converter** specific basis at the **Grid Entry Point** (or **User System Entry Point** if Embedded).
 - (v) For a **Synchronous Generating Unit** within a **Synchronous Power Generating Module**, both the **Power Generating Module Performance Chart** and **Synchronous Generating Unit Performance Chart** should be provided.
- (h) For each **CCGT Unit**, and any other **Generating Unit** or **Power Park Module** or **Power Generating Module** whose performance varies significantly with ambient temperature, the **Generator Performance Chart** (including the **Power Generating Module Performance Chart** and **Synchronous Generating Unit Performance Chart** in the case of **Synchronous Power Generating Modules**) shall show curves for at least two values of ambient temperature so that **The Company** can assess the variation in performance over all likely ambient temperatures by a process of linear interpolation or extrapolation. One of these curves shall be for the ambient temperature at which the **Generating Unit's** output, or **CCGT Module** or **Power Generating Module** at a **Large Power Station** output or **Power Park Module's** output, or directly connected Medium Power Station output comprising a Type C or Type D Power Generating Module or directly connected Small Power Station output comprising a Type C or Type D Power Generating Module output as appropriate, equals its **Registered Capacity**.
- (i) The **Generation Planning Parameters** supplied under OC2.4.2.1 shall be used by **The Company** for operational planning purposes only and not in connection with the operation of the **Balancing Mechanism** (subject as otherwise permitted in the **BC**).

- (j) Each **Generator** shall in respect of each of its **Synchronous Power Generating Modules** or **CCGT Modules** (including those which are part of a **Synchronous Power Generating Module**) at **Large Power Stations** and/or directly connected Power Stations comprising a Type C or Type D Synchronous Power Generating Module submit to **The Company** in writing a **CCGT Module Planning Matrix** and/or a **Synchronous Power Generating Module Planning Matrix**. It shall be prepared on a best estimate basis relating to how it is anticipated the **Synchronous Power Generating Module** or **CCGT Module** will be running and which shall reasonably reflect the true operating characteristics of the **Power Generating Module** or **CCGT Module**. It will be applied (unless revised under this OC2) from the **Completion Date**, in the case of the one submitted with the **Statement of Readiness**, and in the case of the one submitted in calendar week 24, from the beginning of week 31 onwards. It must show the combination of **CCGT Units** or **Synchronous Power Generating Units** which would be running in relation to any given MW output, in the format indicated in Appendix 3.

Any changes must be notified to **The Company** promptly. **Generators** should note that amendments to the composition of the **CCGT Module** or **Synchronous Power Generating Module** at **Large Power Stations** and/or directly connected Power Stations comprising a Type C or Type D Synchronous Power Generating Module may only be made in accordance with the principles set out in PC.A.3.2.3. If in accordance with PC.A.3.2.3 an amendment is made, an updated **CCGT Module Planning Matrix** or **Synchronous Power Generating Module Planning Matrix** must be immediately submitted to **The Company T** in accordance with this OC2.4.2.1(b).

The **CCGT Module Planning Matrix** or **Synchronous Power Generating Module Planning Matrix** will be used by **The Company** for operational planning purposes only and not in connection with the operation of the **Balancing Mechanism**.

- (k) Each **Generator** shall in respect of each of its **Cascade Hydro Schemes** also submit the **Generation Planning Parameters** detailed at OC2.A.2.6 to OC2.A.2.10 for each **Cascade Hydro Scheme**. Such parameters need not also be submitted for the individual **Gensets** within such **Cascade Hydro Scheme**.

- (l) Each **Generator** shall in respect of each of its **Power Park Modules** at **Large Power Stations** and/or directly connected Power Stations comprising a Type C or Type D Power Park Module submit to **The Company** in writing a **Power Park Module Planning Matrix**. It shall be prepared on a best estimate basis relating to how it is anticipated the **Power Park Module** will be running and which shall reasonably reflect the operating characteristics of the **Power Park Module** and the **BM Unit** of which it forms part. It will be applied (unless revised under this OC2) from the **Completion Date**, in the case of the one submitted with the **Statement of Readiness**, and in the case of the one submitted in calendar week 24, from the beginning of week 31 onwards. It must show the number of each type of **Power Park Unit** in the **Power Park Module** typically expected to be available to generate and the **BM Unit** of which it forms part, in the format indicated in Appendix 4. The **Power Park Module Planning Matrix** shall be accompanied by a graph showing the variation in MW output with **Intermittent Power Source** (e.g. MW vs wind speed) for the **Power Park Module**. The graph shall indicate the typical value of the **Intermittent Power Source** for the **Power Park Module**.

Any changes must be notified to **The Company** promptly. **Generators** should note that amendments to the composition of the **Power Park Module** at **Large Power Stations** and/or directly connected Power Stations comprising a Type C or Type D Power Park Module may only be made in accordance with the principles set out in PC.A.3.2.4. If in accordance with PC.A.3.2.4 an amendment is made, an updated **Power Park Module Planning Matrix** must be immediately submitted to **The Company** in accordance with this OC2.4.2.1(a).

The **Power Park Module Planning Matrix** will be used by **The Company** for operational planning purposes only and not in connection with the operation of the **Balancing Mechanism**.

(m) For each **Synchronous Generating Unit** (including **Synchronous Generating Units** within a **Power Generating Module**) where the **Generator** intends to adjust the **Generating Unit** terminal voltage in response to a MVA_r Output Instruction or a Target Voltage Level instruction in accordance with BC2.A.2.6 the **Generator Performance Chart** including the **Synchronous Generating Unit Performance Chart** shall show curves corresponding to the **Generating Unit** terminal voltage being controlled to its rated value and to its maximum value.

OC2.4.2.2 Each **Network Operator** shall by 1000 hrs on the day falling seven days before each **Operational Day** inform **The Company** in writing of any changes to the circuit details called for in PC.A.2.2.1 which it is anticipated will apply on that **Operational Day** (under **BC1** revisions can be made to this data).

OC2.4.2.3 Under European Commission Regulation No. 543/2013, **Users** are required to submit certain data for publication on the Central European Transparency Platform managed by the European Network of Transmission System Operators for Electricity (ENTSO-E). **The Company** is required to facilitate the collection, verification and processing of data from **Users** for onward transmission to the Central European Transparency Platform.

Each **Generator** and each **Non-Embedded Customer** connected to or using the **National Electricity Transmission System** shall provide **The Company** with such information as required by and set out in **DRC** Schedule 6 (Users' Outage Data **EU Transparency Availability Data**) in the timescales detailed therein.

OC2.4.3 NEGATIVE RESERVE ACTIVE POWER MARGINS

OC2.4.3.1 In each calendar year, by the end of week 39 **The Company** will, taking into account the **Final Generation Outage Programme** and forecast of **Output Usable** supplied by each **Generator** and by each **Interconnector Owner**, issue a notice in writing to:-

- (a) all **Generators** with **Large Power Stations** and directly connected Power Stations comprising a Type C or Type D Power Generating Module and to all **Interconnector Owners** listing any period in which there is likely to be an unsatisfactory **System NRAPM**; and
- (b) all **Generators** with **Large Power Stations** and to all directly connected Power Stations comprising a Type C or Type D Power Generating Module and to all **Interconnector Owners** which may, in **The Company**'s reasonable opinion be affected, listing any period in which there is likely to be an unsatisfactory **Localised NRAPM**, together with the identity of the relevant **System Constraint Group** or **Groups**,

within the next calendar year, together with the margin. **The Company** and each **Generator** and each **Interconnector Owner** will take these into account in seeking to co-ordinate outages for that period.

OC2.4.3.2 (a) By 0900 hours each Business Day

Each **Generator** shall provide **The Company** in writing with a best estimate of **Genset** inflexibility on a daily basis for the period 2 to 14 days ahead (inclusive).

(b) By 1600 hours each Wednesday

Each **Generator** shall provide **The Company** in writing with a best estimate of **Genset** inflexibility on a weekly basis for the period 2 to 7 weeks ahead (inclusive).

(c) Between 1600 hours each Wednesday and 1200 hours each Friday

(i) If **The Company**, taking into account the estimates supplied by **Generators** under (b) above, and forecast **Demand** for the period, foresees that:

- (1) the level of the **System NRAPM** for any period within the period 2 to 7 weeks ahead (inclusive) is too low, it will issue a notice in writing to all **Generators**, **Interconnector Owners**, and **Network Operators** listing any periods and levels of **System NRAPM** within that period; and/or

- (2) having also taken into account the appropriate limit on transfers to and from a **System Constraint Group**, the level of **Localised NRAPM** for any period within the period 2 to 7 weeks ahead (inclusive) is too low for a particular **System Constraint Group**, it will issue a notice in writing to all **Generators**, **Interconnector Owners**, and **Network Operators** which may, in **The Company's** reasonable opinion be affected by that **Localised NRAPM**, listing any periods and levels of **Localised NRAPM** within that period. A separate notice will be given in respect of each affected **System Constraint Group**.

Outages Adjustments

- (ii) **The Company** will then contact **Generators** in respect of their **Large Power Stations** and directly connected Power Stations comprising a Type C or Type D Power Generating Module and **Interconnector Owners** to discuss outages as set out in the following paragraphs of this OC2.4.3.2.
- (iii) **The Company** will contact all **Generators** and **Interconnector Owners** in the case of low **System NRAPM** and will contact **Generators** in relation to relevant **Large Power Stations** and directly connected Power Stations comprising a Type C or Type D Power Generating Module and **Interconnector Owners** in the case of low **Localised NRAPM**. **The Company** will raise with each **Generator** and **Interconnector Owner** the problems it is anticipating due to the low **System NRAPM** or **Localised NRAPM** and will discuss:
- (1) whether any change is possible to the estimate of **Genset** inflexibility given under (b) above; and
 - (2) whether **Genset** or **External Interconnection** outages can be taken to coincide with the periods of low **System NRAPM** or **Localised NRAPM** (as the case may be).

In relation to **Generators** with nuclear **Large Power Stations** the discussions on outages can include the issue of whether outages can be taken for re-fuelling purposes to coincide with the relevant low **System NRAPM** and/or **Localised NRAPM** periods.

- (iv) If agreement is reached with a **Generator** or an **Interconnector Owner** (which unlike the remainder of **OC2** will constitute a binding agreement), then such **Generator** or **Interconnector Owner** will take such outage, as agreed with **The Company**, and **The Company** will issue a revised notice in writing to the **Generators**, **Interconnector Owners**, and **Network Operators** to which it sent notices under (i) above, reflecting the changes brought about to the periods and levels of **System NRAPM** and/or **Localised NRAPM** by the agreements with **Generators** or **Interconnector Owners**.
- (d) By 1600 hours each day
- (i) If **The Company**, taking into account the estimates supplied under (a) above, and forecast **Demand** for the period, foresees that:
- (1) the level of **System NRAPM** for any period within the period of 2 to 14 days ahead (inclusive) is too low, it will issue a notice in writing to all **Generators**, **Interconnector Owners**, and **Network Operators** listing the periods and levels of **System NRAPM** within those periods; and/or
 - (2) having also taken into account the appropriate limit on transfers to and from a **System Constraint Group**, the level of **Localised NRAPM** for any period within the period of 2 to 14 days ahead (inclusive) is too low for a particular **System Constraint Group**, it will issue a notice in writing to all **Generators**, **Interconnector Owners**, and **Network Operators** which may, in **The Company's** reasonable opinion be affected by that **Localised NRAPM**, listing any periods and levels of **Localised NRAPM** within that period. A separate notice will be given in respect of each affected **System Constraint Group**.

- (ii) **The Company** will contact all **Generators** in respect of their **Large Power Stations and directly connected Power Stations comprising a Type C or Type D Power Generating Module** (or in the case of **Localised NRAPM**, all **Generators** which may, in **The Company's** reasonable opinion be affected, in respect of their relevant **Large Power Stations and directly connected Power Stations comprising a Type C or Type D Power Generating Module**) to discuss whether any change is possible to the estimate of **Genset** inflexibility given under (a) above and to consider **Large Power Station and directly connected Power Stations comprising a Type C or Type D Power Generating Module** outages to coincide with the periods of low **System NRAPM** and/or **Localised NRAPM** (as the case may be).

In the case of **External Interconnections**, **The Company** may contact **Interconnector Owners** to discuss outages during the periods of low **System NRAPM** and/or **Localised NRAPM** (as the case may be).

- (e) If on the day prior to a **Operational Day**, it is apparent from the **BM Unit Data** submitted by **Users** under **BC1** that **System NRAPM** and/or **Localised NRAPM** (as the case may be) is, in **The Company's** reasonable opinion, too low, then in accordance with the procedures and requirements set out in BC1.5.5 **The Company** may contact **Users** to discuss whether changes to **Physical Notifications** are possible, and if they are, will reflect those in the operational plans for the next following **Operational Day** or will, in accordance with BC2.9.4 instruct **Generators** to **De-Synchronise** a specified **Genset** for such period. In determining which **Genset** to so instruct, **BC2** provides that **The Company** will not (other than as referred to below) consider in such determination (and accordingly shall not instruct to **De-Synchronise**) any **Genset** within an **Existing Gas Cooled Reactor Plant**. **BC2** further provides that:-
- (i) **The Company** is permitted to instruct to **De-Synchronise** any **Gensets** within an **Existing AGR Plant** if those **Gensets** within an **Existing AGR Plant** have failed to offer to be flexible for the relevant instance at the request of **The Company** provided the request is within the **Existing AGR Plant Flexibility Limit**.
- (ii) **The Company** will only instruct to **De-Synchronise** any **Gensets** within an **Existing Magnox Reactor Plant** or within an **Existing AGR Plant** (other than under (i) above) if the level of **System NRAPM** (taken together with **System** constraints) and/or **Localised NRAPM** is such that it is not possible to avoid **De-Synchronising** such **Generating Unit** or **Power Generating Module**, and provided the power flow across each **External Interconnection** is either at zero or results in an export of power from the **Total System**. This proviso applies in all cases in the case of **System NRAPM** and in the case of **Localised NRAPM**, only when the power flow would have a relevant effect.

OC2.4.4 FREQUENCY SENSITIVE OPERATION

By 1600 hours each Wednesday

- OC2.4.4.1 Using such information as **The Company** shall consider relevant including, if appropriate, forecast **Demand**, any estimates provided by **Generators** of **Genset** inflexibility and anticipated plant mix relating to operation in **Frequency Sensitive Mode**, **The Company** shall determine for the period 2 to 7 weeks ahead (inclusive) whether it is possible that there will be insufficient **Gensets** (other than those **Gensets** within **Existing Gas Cooled Reactor Plant** which are permitted to operate in **Limited Frequency Sensitive Mode** at all times under BC3.5.3) to operate in **Frequency Sensitive Mode** for all or any part of that period.
- OC2.4.4.2 BC3.5.3 explains that **The Company** permits **Existing Gas Cooled Reactor Plant** other than **Frequency Sensitive AGR Units** to operate in a **Limited Frequency Sensitive Mode** at all times.

OC2.4.4.3 If **The Company** foresees that there will be an insufficiency in **Gensets** operating in a **Frequency Sensitive Mode**, it will contact **Generators** in order to seek to agree (as soon as reasonably practicable) that all or some of the **Gensets** (the MW amount being determined by **The Company** but the **Gensets** involved being determined by the **Generator**) will take outages to coincide with such period as **The Company** shall specify to enable replacement by other **Gensets** which can operate in a **Frequency Sensitive Mode**. If agreement is reached (which unlike the remainder of **OC2** will constitute a binding agreement) then such **Generator** will take such outage as agreed with **The Company**. If agreement is not reached, then the provisions of BC2.9.5 may apply.

OC2.4.5 If in **The Company 's** reasonable opinion it is necessary for both the procedure set out in OC2.4.3 (relating to **System NRAPM** and **Localised NRAPM**) and in OC2.4.4 (relating to operation in **Frequency Sensitive Mode**) to be followed in any given situation, the procedure set out in OC2.4.3 will be followed first, and then the procedure set out in OC2.4.4. For the avoidance of doubt, nothing in this paragraph shall prevent either procedure from being followed separately and independently of the other.

OC2.4.6 OPERATING MARGIN DATA REQUIREMENTS

OC2.4.6.1 Modifications to relay settings

'Relay settings' in this OC2.4.6.1 refers to the settings of **Low Frequency Relays** in respect of **Gensets** that are available for start from standby by **Low Frequency Relay** initiation with **Fast Start Capability** agreed pursuant to the **Bilateral Agreement**.

By 1600 hours each Wednesday

A change in relay settings will be sent by **The Company** no later than 1600 hours on a Wednesday to apply from 1000 hours on the Monday following. The settings allocated to particular **Large Power Stations** and directly connected Power Stations comprising a Type C or Type D Power Generating Module may be interchanged between 49.70Hz and 49.60Hz (or such other **System Frequencies** as **The Company** may have specified) provided the overall capacity at each setting and **System** requirements can, in **The Company 's** view, be met.

Between 1600 hours each Wednesday and 1200 hours each Friday

If a **Generator** wishes to discuss or interchange settings it should contact **The Company** by 1200 hours on the Friday prior to the Monday on which it would like to institute the changes to seek **The Company 's** agreement. If **The Company** agrees, **The Company** will then send confirmation of the agreed new settings.

By 1500 hours each Friday

If any alterations to relay settings have been agreed, then the updated version of the current relay settings will be sent to affected **Users** by 1500 hours on the Friday prior to the Monday on which the changes will take effect. Once accepted, each **Generator** (if that **Large Power Station** and directly connected Power Stations comprising a Type C or Type D Power Generating Module is not subject to forced outage or **Planned Outage**) will abide by the terms of its latest relay settings.

In addition, **The Company** will take account of any **Large Power Station** and directly connected Power Stations comprising a Type C or Type D Power Generating Module unavailability (as notified under OC2.4.1.2 submissions) in its total **Operating Reserve** policy.

The Company may from time to time, for confirmation purposes only, issue the latest version of the current relay settings to each affected **Generator**

OC2.4.6.2 Operating Margins

By 1600 hours each Wednesday

No later than 1600 hours on a Wednesday, **The Company** will provide an indication of the level of **Operating Reserve** to be utilised by **The Company** in connection with the operation of the **Balancing Mechanism** in the week beginning with the **Operational Day** commencing during the subsequent Monday, which level shall be purely indicative.

This **Operating Margin** indication will also note the possible level of **Operating Reserve** (if any) which may be provided by **Interconnector Users** in the week beginning with the **Operational Day** commencing during the subsequent Monday.

This **Operating Margin** indication will also note the possible level of **High Frequency Response** to be utilised by **The Company** in connection with the operation of the **Balancing Mechanism** in the week beginning with the **Operational Day** commencing during the subsequent Monday, which level shall be purely indicative.

OC2.4.7

In the event that:

- a) a **Non-Embedded Customer** experiences the planned unavailability of its **Apparatus** resulting in the reduction of Demand of 100MW or more, or a change to the planned unavailability of its **Apparatus** resulting in a change in Demand of 100MW or more, for one Settlement Period or longer; or
- b) a **Non-Embedded Customer** experiences a change in the actual availability of its **Apparatus** resulting in a change in Demand of 100MW or greater; or
- c) a **Generator** experiences a planned unavailability of a **Generating Unit** and/or **Power Generating Module** resulting in a change of 100MW or more in the **Output Usable** of that **Generating Unit** and/or **Power Generating Module** below its previously notified availability, which is expected to last one **Settlement Period** or longer and up to three years ahead; or
- d) a **Generator** experiences a change of 100MW or more in the Maximum Export Limit of a **Generating Unit** which is expected to last one **Settlement Period** or longer; or
- e) a **Generator** experiences a planned unavailability resulting in a change of 100MW or more in its aggregated **Output Usable** below its previously notified availability for a **Power Station** with a **Registered Capacity** of 200MW or more and which is expected to last one **Settlement Period** or longer and up to three years ahead, save where data has been provided pursuant to OC.2.4.7(c) above; or
- f) a **Generator** experiences a change of 100MW or more in the aggregated Maximum Export Limit of a **Power Station** with a **Registered Capacity** of 200MW or more, which is expected to last one **Settlement Period** or longer, save where data has been provided pursuant to OC.2.4.7(d) above;

such **Non-Embedded Customer** or **Generator** shall provide **The Company** with the **EU Transparency Availability Data** in accordance with **DRC** Schedule 6 (Users' Outage Data) using **MODIS** and, with reference to points OC2.4.7(a) to (f), EU Transparency Regulation articles 7.1(a), 7.1(b), 15.1(a), 15.1(b), 15.1(c) and 15.1(d) respectively.

APPENDIX 1 - PERFORMANCE CHART EXAMPLES

GENERATOR PERFORMANCE CHART

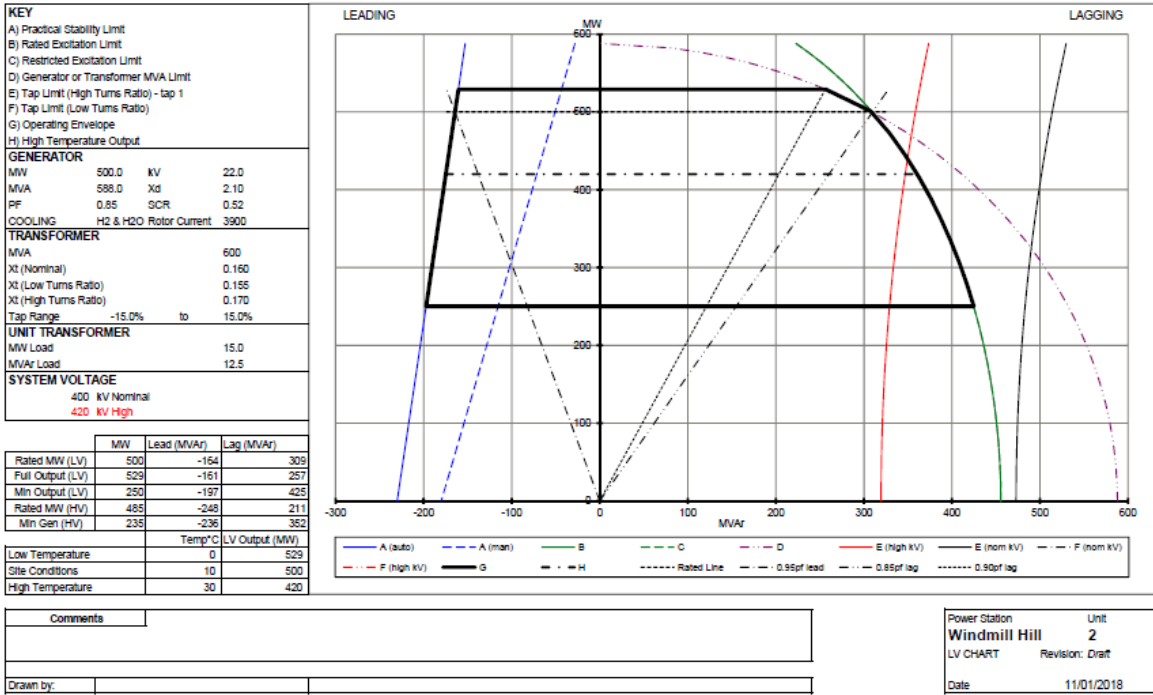

Synchronous Generating Unit Performance Chart within a Synchronous Power Generating Module

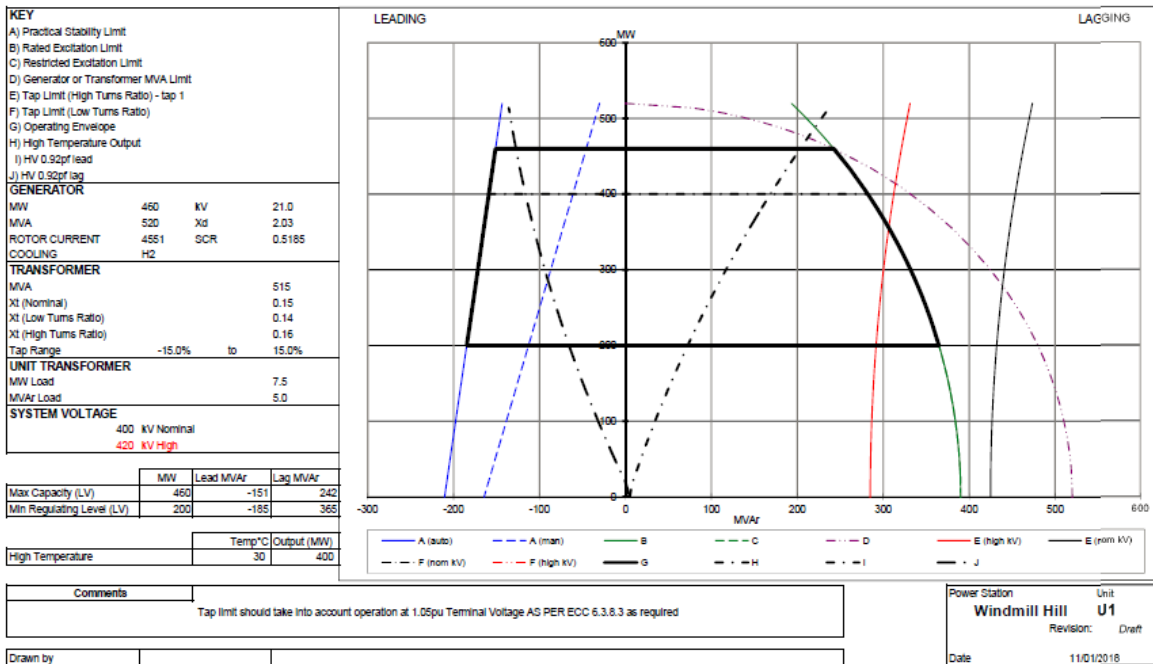

POWER PARK MODULE PERFORMANCE CHART AT THE CONNECTION POINT OR USER'S SYSTEM ENTRY POINT

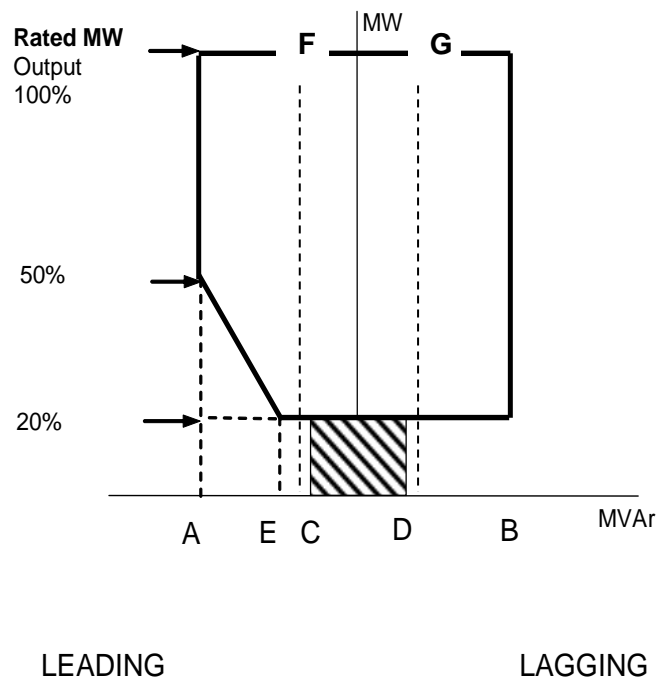

- Point A is equivalent (in MVAR) to: 0.95 leading **Power Factor** at **Rated MW** output
- Point B is equivalent (in MVAR) to: 0.95 lagging **Power Factor** at **Rated MW** output
- Point C is equivalent (in MVAR) to: -5% of **Rated MW** output
- Point D is equivalent (in MVAR) to: +5% of **Rated MW** output
- Point E is equivalent (in MVAR) to: -12% of **Rated MW** output
- Line F is equivalent (in MVAR) to: Leading **Power Factor Reactive Despatch Network Restriction**
- Line G is equivalent (in MVAR) to: Lagging **Power Factor Reactive Despatch Network Restriction**



Where a **Reactive Despatch Network Restriction** is in place which requires following of local voltage conditions, alternatively to Line F and G, please check this box.

APPENDIX 2 - GENERATION PLANNING PARAMETERS

OC2.A.2 Generation Planning Parameters

The following parameters are required in respect of each **Genset**.

OC2.A.2.1 Regime Unavailability

Where applicable the following information must be recorded for each **Genset**.

- Earliest synchronising time:
 - Monday
 - Tuesday to Friday
 - Saturday to Sunday
- Latest de-synchronising time:
 - Monday to Thursday
 - Friday
 - Saturday to Sunday

OC2.A.2.2 Synchronising Intervals

- (a) The synchronising interval between **Gensets** in a **Synchronising Group** assuming all **Gensets** have been **Shutdown** for 48 hours;
- (b) The **Synchronising Group** within the **Power Station** to which each **Genset** should be allocated.

OC2.A.2.3 De-Synchronising Interval

A fixed value **De-Synchronising** interval between **Gensets** within a **Synchronising Group**.

OC2.A.2.4 Synchronising Generation

The amount of MW produced at the moment of **Synchronising** assuming the **Genset** has been **Shutdown** for 48 hours.

OC2.A.2.5 Minimum Non-zero time (MNZT)

The minimum period on-load between **Synchronising** and **De-Synchronising** assuming the **Genset** has been **Shutdown** for 48 hours.

OC2.A.2.6 Run-Up rates

A run-up characteristic consisting of up to three stages from **Synchronising Generation** to **Output Usable** with up to two intervening break points assuming the **Genset** has been **Shutdown** for 48 hours.

OC2.A.2.7 Run-down rates

A run down characteristic consisting of up to three stages from **Output Usable** to **De-Synchronising** with breakpoints at up to two intermediate load levels.

OC2.A.2.8 Notice to Deviate from Zero (NDZ)

The period of time normally required to **Synchronise** a **Genset** following instruction from **The Company** assuming the **Genset** has been **Shutdown** for 48 hours.

OC2.A.2.9 Minimum Zero time (MZT)

The minimum interval between **De-Synchronising** and **Synchronising** a **Genset**.

OC2.A.2.10 Not used.

OC2.A.2.11 Gas Turbine Units loading parameters

- Loading rate for fast starting
- Loading rate for slow starting

APPENDIX 3 - CCGT MODULE PLANNING MATRIX

CCGT Module Planning Matrix Example Form

CCGT MODULE OUTPUT USABLE MW	CCGT GENERATING UNITS AVAILABLE								
	1st GT	2nd GT	3rd GT	4th GT	5th GT	6th GT	1st ST	2nd ST	3rd ST
	OUTPUT USABLE								
	150	150	150				100		
0MW to 150MW	/								
151MW to 250MW	/						/		
251MW to 300MW	/	/							
301MW to 400MW	/	/					/		
401MW to 450MW	/	/	/						
451MW to 550MW	/	/	/				/		

APPENDIX 4 - POWER PARK MODULE PLANNING MATRIX

Power Park Module Planning Matrix Example Form

BM Unit Name				
Power Park Module [unique identifier]				
POWER PARK UNIT AVAILABILITY	POWER PARK UNITS			
	Type A	Type B	Type C	Type D
Description (Make/Model)				
Number of units				
Power Park Module [unique identifier]				
POWER PARK UNIT AVAILABILITY	POWER PARK UNITS			
	Type A	Type B	Type C	Type D
Description (Make/Model)				
Number of units				

The **Power Park Module Planning Matrix** may have as many columns as are required to provide information on the different make and model for each type of **Power Park Unit** in a **Power Park Module** and as many rows as are required to provide information on the **Power Park Modules** within each **BM Unit**. The description is required to assist identification of the **Power Park Units** within the **Power Park Module** and correlation with data provided under the **Planning Code**.

APPENDIX 5 – SYNCHRONOUS POWER GENERATING MODULE PLANNING MATRIX

Synchronous Power Generating Module Planning Matrix Example Form

SYNCHRONOUS POWER GENERATING MODULE	SYNCHRONOUS POWER GENERATING UNITS AVAILABLE								
	1st GT	2nd GT	3rd GT	4th GT	5th GT	6th GT	1st ST	2nd ST	3rd ST
	OUTPUT USABLE								
OUTPUT USABLE	150	150	150				100		
MW									
0MW to 150MW	/								
151MW to 250MW	/						/		
251MW to 300MW	/	/							
301MW to 400MW	/	/					/		
401MW to 450MW	/	/	/						
451MW to 550MW	/	/	/				/		

< END OF OPERATING CODE NO. 2 >

PLANNING CODE

(PC)

CONTENTS

GC0106 – WACM2

DATED 09/10/18

(This contents page does not form part of the Grid Code)

<u>Paragraph No/Title</u>	<u>Page Number</u>
PC.1 INTRODUCTION.....	2
PC.2 OBJECTIVE.....	3
PC.3 SCOPE.....	3
PC.4 PLANNING PROCEDURES.....	6
PC.5 PLANNING DATA.....	10
PC.6 PLANNING STANDARDS.....	13
PC.7 PLANNING LIAISON.....	14
PC.8 OTSDUW PLANNING LIAISON.....	15
APPENDIX A - PLANNING DATA REQUIREMENTS	16
PART 1 - STANDARD PLANNING DATA.....	20
PC.A.2 USER'S SYSTEM (AND OTSUA) DATA	20
PC.A.3 GENERATING UNIT AND DC CONVERTER DATA.....	28
PC.A.4 DEMAND AND ACTIVE ENERGY DATA	37
PART 2 - DETAILED PLANNING DATA.....	43
PC.A.5 GENERATING UNIT, POWER PARK MODULE, DC CONVERTER AND OTSDUW PLANT AND APPARATUS DATA.....	43
PC.A.6 USERS' SYSTEM DATA.....	59
PC.A.7 ADDITIONAL DATA FOR NEW TYPES OF POWER STATIONS, DC CONVERTER STATIONS, OTSUA AND CONFIGURATIONS.....	63
PART 3 – DETAILED PLANNING DATA	64
APPENDIX B - SINGLE LINE DIAGRAMS	66
APPENDIX C - TECHNICAL AND DESIGN CRITERIA.....	69
PART 1 – SHETL's TECHNICAL AND DESIGN CRITERIA.....	69
PART 2 - SPT's TECHNICAL AND DESIGN CRITERIA	71
APPENDIX D - DATA NOT DISCLOSED TO A RELEVANT TRANSMISSION LICENSEE	72
APPENDIX E - OFFSHORE TRANSMISSION SYSTEM AND OTSDUW PLANT AND APPARATUS TECHNICAL AND DESIGN CRITERIA.....	75
APPENDIX F - OTSDUW DATA AND INFORMATION AND OTSDUW NETWORK DATA AND INFORMATION	76

- PC.1 INTRODUCTION
- PC.1.1 The **Planning Code ("PC")** specifies the technical and design criteria and procedures to be applied by **The Company** in the planning and development of the **National Electricity Transmission System** and to be taken into account by **Users** in the planning and development of their own **Systems**. In the case of **OTSUA**, the **PC** also specifies the technical and design criteria and procedures to be applied by the **User** in the planning and development of the **OTSUA**. It details information to be supplied by **Users** to **The Company**, and certain information to be supplied by **The Company** to **Users**. In Scotland and **Offshore**, **The Company** has obligations under the **STC** to inform **Relevant Transmission Licensees** of data required for the planning of the **National Electricity Transmission System**. In respect of **PC** data, **The Company** may pass on **User** data to a **Relevant Transmission Licensee**, as detailed in PC.3.4 and PC.3.5.
- PC.1.1A Provisions of the **PC** which apply in relation to **OTSDUW** and **OTSUA** shall apply up to the **OTSUA Transfer Time**, whereupon such provisions shall (without prejudice to any prior non-compliance) cease to apply, without prejudice to the continuing application of provisions of the **PC** applying in relation to the relevant **Offshore Transmission System** and/or **Connection Site**.
- PC.1.1B As used in the **PC**:
- (a) **National Electricity Transmission System** excludes **OTSDUW Plant and Apparatus** (prior to the **OTSUA Transfer Time**) unless the context otherwise requires;
 - (b) and User Development includes **OTSDUW** unless the context otherwise requires.
- PC.1.2 The **Users** referred to above are defined, for the purpose of the **PC**, in PC.3.1.
- PC.1.3 Development of the **National Electricity Transmission System**, involving its reinforcement or extension, will arise for a number of reasons including, but not limited to:
- (a) a development on a **User System** already connected to the **National Electricity Transmission System**;
 - (b) the introduction of a new **Connection Site** or the **Modification** of an existing **Connection Site** between a **User System** and the **National Electricity Transmission System**;
 - (c) the cumulative effect of a number of such developments referred to in (a) and (b) by one or more **Users**.
- PC.1.4 Accordingly, the reinforcement or extension of the **National Electricity Transmission System** may involve work:
- (a) at a substation at a **Connection Site** where **User's Plant** and/or **Apparatus** is connected to the **National Electricity Transmission System** (or in the case of **OTSDUW**, at a substation at an **Interface Point**);
 - (b) on transmission lines or other facilities which join that **Connection Site** (or in the case of **OTSDUW**, **Interface Point**) to the remainder of the **National Electricity Transmission System**;
 - (c) on transmission lines or other facilities at or between points remote from that **Connection Site** (or in the case of **OTSDUW**, **Interface Point**).
- PC.1.5 The time required for the planning and development of the **National Electricity Transmission System** will depend on the type and extent of the necessary reinforcement and/or extension work, the need or otherwise for statutory planning consent, the associated possibility of the need for a public inquiry and the degree of complexity in undertaking the new work while maintaining satisfactory security and quality of supply on the existing **National Electricity Transmission System**.
- PC.1.6 For the avoidance of doubt and the purposes of the Grid Code, **DC Connected Power Park Modules** are treated as belonging to **Generators**. **Generators** who own **DC Connected Power Park Modules** would therefore be expected to supply the same data as required under this PC in respect of **Power Stations** comprising **Power Park Modules** other than where specific references to **DC Connected Power Park Modules** are made.

PC.2

OBJECTIVE

PC.2.1

The objectives of the **PC** are:

- (a) to promote **The Company/User** interaction in respect of any proposed development on the **User System** which may impact on the performance of the **National Electricity Transmission System** or the direct connection with the **National Electricity Transmission System**;
- (b) to provide for the supply of information to **The Company** from **Users** in order that planning and development of the **National Electricity Transmission System** can be undertaken in accordance with the relevant **Licence Standards**, to facilitate existing and proposed connections, and also to provide for the supply of certain information from **The Company** to **Users** in relation to short circuit current contributions and **OTSUA**; and
- (c) to specify the **Licence Standards** which will be used in the planning and development of the **National Electricity Transmission System**; and
- (d) to provide for the supply of information required by **The Company** from **Users** in respect of the following to enable **The Company** to carry out its duties under the **Act** and the **Transmission Licence**:
 - (i) **Mothballed Generating Units, Mothballed Power Generating Modules**; and
 - (ii) capability of gas-fired **Synchronous Power Generating Modules** or **Generating Units** to run using alternative fuels.

The Company will use the information provided under PC.2.1(d) in providing reports to the **Authority** and the **Secretary of State** and, where directed by the **Authority** or the **Secretary of State** to do so, **The Company** may publish the information. Where it is known by **The Company** that such information is intended for wider publication the information provided under PC.2.1(d) shall be aggregated such that individual data items should not be identifiable.

- (e) in the case of **OTSUA**:
 - (i) to specify the minimum technical and design criteria and procedures to be applied by **Users** in the planning and development of **OTSUA**; and thereby
 - (ii) to ensure that the **OTSUA** can from the **OTSUA Transfer Time** be operated as part of the **National Electricity Transmission System**; and
 - (iii) to provide for the arrangements and supply of information and data between **The Company** and a **User** to ensure that the **User** is able to undertake **OTSDUW**; and
 - (iv) to promote **The Company/User** interaction and co-ordination in respect of any proposed development on the **National Electricity Transmission System** or the **OTSUA**, which may impact on the **OTSUA** or (as the case may be) the **National Electricity Transmission System**.

PC.3

SCOPE

PC.3.1

The **PC** applies to **The Company** and to **Users**, which in the **PC** means:

- (a) **Generators**;
- (b) **Generators** undertaking **OTSDUW**;
- (c) **Network Operators**;
- (d) **Non-Embedded Customers**;
- (e) **DC Converter Station** owners; and
- (f) **HVDC System Owners**

The above categories of **User** will become bound by the **PC** prior to them generating, operating, or consuming or importing/exporting, as the case may be, and references to the various categories (or to the general category) of **User** should, therefore, be taken as referring to them in that prospective role as well as to **Users** actually connected.

PC.3.2

In the case of **Embedded Power Stations, Embedded DC Converter Stations** and **Embedded HVDC Systems**, unless provided otherwise, the following provisions apply with regard to the provision of data under this **PC**:

- (a) each **Generator** shall provide the data direct to **The Company** in respect of (i) **Embedded Large Power Stations**, (ii) **Embedded Medium Power Stations** subject to a **Bilateral Agreement** and (iii) **Embedded Small Power Stations** which form part of a **Cascade Hydro Scheme**;
- (b) each **DC Converter** owner or **HVDC System Owner** shall provide the data direct to **The Company** in respect of **Embedded DC Converter Stations** and **Embedded HVDC Systems** subject to a **Bilateral Agreement**;
- (c) each **Network Operator** shall provide the data to **The Company** in respect of each **Embedded Medium Power Station** not subject to a **Bilateral Agreement** or **Embedded DC Converter Station** not subject to a **Bilateral Agreement** or **Embedded HVDC System** not subject to a **Bilateral Agreement** connected, or proposed to be connected within such **Network Operator's System**;
- (d) although data is not normally required specifically on **Embedded Small Power Stations** or on **Embedded** installations of direct current converters which do not form a **DC Converter Station** or **HVDC System** under this **PC**, each **Network Operator** in whose **System** they are **Embedded** should provide the data (contained in the Appendix) to **The Company** in respect of **Embedded Small Power Stations** or **Embedded** installations of direct current converters which do not form a **DC Converter Station** or **Embedded** installations of **HVDC Systems** if:
 - (i) it falls to be supplied pursuant to the application for a **CUSC Contract** or in the **Statement of Readiness** to be supplied in connection with a **Bilateral Agreement** and/or **Construction Agreement**, by the **Network Operator**; or
 - (ii) it is specifically requested by **The Company** in the circumstances provided for under this **PC**.

PC.3.3

Certain data does not normally need to be provided in respect of certain **Embedded Power Stations, Embedded DC Converter Stations** or **Embedded HVDC Systems**, as provided in PC.A.1.12.

In summary, **Network Operators** are required to supply the following data in respect of **Embedded Medium Power Stations** not subject to a **Bilateral Agreement** or **Embedded DC Converter Stations** not subject to a **Bilateral Agreement** or **Embedded HVDC Systems** not subject to a **Bilateral Agreement** connected, or is proposed to be connected, within such **Network Operator's System**:

- PC.A.2.1.1
- PC.A.2.2.2
- PC.A.2.5.5.2
- PC.A.2.5.5.7
- PC.A.2.5.6
- PC.A.3.1.5
- PC.A.3.2.2
- PC.A.3.3.1
- PC.A.3.4.1
- PC.A.3.4.2

PC.A.5.2.2

PC.A.5.3.2

PC.A.5.4

PC.A.5.5.1

PC.A.5.6

For the avoidance of doubt **Network Operators** are required to supply the above data in respect of **Embedded Medium Power Stations** not subject to a **Bilateral Agreement** and **Embedded DC Converter Stations** not subject to a **Bilateral Agreement** and **Embedded HVDC Systems** not subject to a **Bilateral Agreement** which are located **Offshore** and which are connected or proposed to be connected within such **Network Operator's System**. This is because **Embedded Medium Power Stations** not subject to a **Bilateral Agreement** and **Embedded DC Converter Stations** not subject to a **Bilateral Agreement** and **Embedded HVDC Systems** not subject to a **Bilateral Agreement** are treated as **Onshore Generators** or **Onshore DC Converter Station** owners or **HVDC System Owners** connected to an **Onshore User System Entry Point**.

PC.3.4 **The Company** may provide to the **Relevant Transmission Licensees** any data which has been submitted to **The Company** by any **Users** pursuant to the following paragraphs of the **PC**. For the avoidance of doubt, **The Company** will not provide to the **Relevant Transmission Licensees**, the types of data specified in Appendix D. The **Relevant Transmission Licensees'** use of such data is detailed in the **STC**.

PC.A.2.2

PC.A.2.5

PC.A.3.1

PC.A.3.2.1

PC.A.3.2.2

PC.A.3.3

PC.A.3.4

PC.A.4

PC.A.5.1

PC.A.5.2

PC.A.5.3.1

PC.A.5.3.2

PC.A.5.4.1

PC.A.5.4.2

PC.A.5.4.3.1

PC.A.5.4.3.2

PC.A.5.4.3.3

PC.A.5.4.3.4

PC.A.7

(and in addition in respect of the data submitted in respect of the **OTSUA**)

PC.A.2.2

PC.A.2.3

PC.A.2.4

PC.A.2.5

PC.A.3.2.2
PC.A.3.3.1(d)
PC.A.4
PC.A.5.4.3.1
PC.A.5.4.3.2
PC.A.6.2
PC.A.6.3
PC.A.6.4
PC.A.6.5
PC.A.6.6
PC.A.7

PC.3.5 In addition to the provisions of PC.3.4 **The Company** may provide to the **Relevant Transmission Licensees** any data which has been submitted to **The Company** by any **Users** in respect of **Relevant Units** pursuant to the following paragraphs of the **PC**.

PC.A.2.3
PC.A.2.4
PC.A.5.5
PC.A.5.7
PC.A.6.2
PC.A.6.3
PC.A.6.4
PC.A.6.5
PC.A.6.6

PC.3.6 In the case of **Offshore Embedded Power Stations** connected to an **Offshore User System** which directly connects to an **Offshore Transmission System**, any additional data requirements in respect of such **Offshore Embedded Power Stations** may be specified in the relevant **Bilateral Agreement** with the **Network Operator** or in any **Bilateral Agreement** between **The Company** and such **Offshore Embedded Power Station**.

PC.3.7 In the case of a **Generator** undertaking **OTSDUW** connecting to an **Onshore Network Operator's System**, any additional requirements in respect of such **OTSDUW Plant and Apparatus** will be specified in the relevant **Bilateral Agreement** with the **Generator**. For the avoidance of doubt, requirements applicable to **Generators** undertaking **OTSDUW** and connecting to a **Network Operator's User System**, shall be consistent with those applicable requirements of **Generators** undertaking **OTSDUW** and connecting to a **Transmission Interface Point**.

PC.4 PLANNING PROCEDURES

PC.4.1 Pursuant to Condition C11 of **The Company's Transmission Licence**, the means by which **Users** and proposed **Users** of the **National Electricity Transmission System** are able to assess opportunities for connecting to, and using, the **National Electricity Transmission System** comprise two distinct parts, namely:

- (a) a statement, prepared by **The Company** under its **Transmission Licence**, showing for each of the seven succeeding **Financial Years**, the opportunities available for connecting to and using the **National Electricity Transmission System** and indicating those parts of the **National Electricity Transmission System** most suited to new connections and transport of further quantities of electricity (the "**Seven Year Statement**"); and

- (b) an offer, in accordance with its **Transmission Licence**, by **The Company** to enter into a **CUSC Contract**. A **Bilateral Agreement** is to be entered into for every **Connection Site** (and for certain **Embedded Power Stations** and **Embedded DC Converter Stations** and **Embedded HVDC Systems**) within the first two of the following categories and the existing **Bilateral Agreement** may be required to be varied in the case of the third category:
- (i) existing **Connection Sites** (and for certain **Embedded Power Stations**) as at the **Transfer Date**;
 - (ii) new **Connection Sites** (and for certain **Embedded Power Stations**, **Embedded DC Converter Stations** and **Embedded HVDC Systems**) with effect from the **Transfer Date**;
 - (iii) a **Modification** at a **Connection Site** (or in relation to the connection of certain **Embedded Power Stations**, **Embedded DC Converter Stations** and **Embedded HVDC Systems** whether or not the subject of a **Bilateral Agreement**) (whether such **Connection Site** or connection exists on the **Transfer Date** or is new thereafter) with effect from the **Transfer Date**.

In this **PC**, unless the context otherwise requires, "connection" means any of these 3 categories.

PC.4.2 Introduction to Data

User Data

PC.4.2.1 Under the **PC**, two types of data to be supplied by **Users** are called for:

- (a) **Standard Planning Data**; and
- (b) **Detailed Planning Data**,

as more particularly provided in PC.A.1.4.

PC.4.2.2 The **PC** recognises that these two types of data, namely **Standard Planning Data** and **Detailed Planning Data**, are considered at three different levels:

- (a) **Preliminary Project Planning Data**;
- (b) **Committed Project Planning Data**; and
- (c) **Connected Planning Data**,

as more particularly provided in PC.5

PC.4.2.3 **Connected Planning Data** is itself divided into:

- (a) **Forecast Data**;
- (b) **Registered Data**; and
- (c) **Estimated Registered Data**,

as more particularly provided in PC.5.5

PC.4.2.4 Clearly, an existing **User** proposing a new **Connection Site** (or **Embedded Power Station** or **Embedded DC Converter Station** or **Embedded HVDC System**) in the circumstances outlined in PC.4.1) will need to supply data both in an application for a **Bilateral Agreement** and under the **PC** in relation to that proposed new **Connection Site** (or **Embedded Power Station** or **Embedded DC Converter Station** or **Embedded HVDC System** in the circumstances outlined in PC.4.1) and that will be treated as **Preliminary Project Planning Data** or **Committed Project Planning Data** (as the case may be), but the data it supplies under the **PC** relating to its existing **Connection Sites** will be treated as **Connected Planning Data**.

Network Data

PC.4.2.5 In addition, there is **Network Data** supplied by **The Company** in relation to short circuit current contributions and in relation to **OTSUA**.

PC.4.3 Data Provision

PC.4.3.1 Seven Year Statement

To enable the **Seven Year Statement** to be prepared, each **User** is required to submit to **The Company** (subject to the provisions relating to **Embedded Power Stations** and **Embedded DC Converter Stations** and **Embedded HVDC Systems** in PC.3.2) both the **Standard Planning Data** and the **Detailed Planning Data** as listed in parts 1 and 2 of the Appendix. This data should be submitted in calendar week 24 of each year (although **Network Operators** may delay the submission of data (other than that to be submitted pursuant to PC.3.2(c) and PC.3.2(d)) until calendar week 28) and should cover each of the seven succeeding **Financial Years** (and in certain instances, the current year). Where, from the date of one submission to another, there is no change in the data (or in some of the data) to be submitted, instead of re-submitting the data, a **User** may submit a written statement that there has been no change from the data (or in some of the data) submitted the previous time. In addition, **The Company** will also use the **Transmission Entry Capacity** and **Connection Entry Capacity** data from the **CUSC Contract**, and any data submitted by **Network Operators** in relation to an **Embedded Medium Power Station** not subject to a **Bilateral Agreement** or **Embedded DC Converter Station** not subject to a **Bilateral Agreement**, or **Embedded HVDC System** not subject to a **Bilateral Agreement** in the preparation of the **Seven Year Statement** and to that extent the data will not be treated as confidential.

PC.4.3.2 Network Data

To enable **Users** to model the **National Electricity Transmission System** in relation to short circuit current contributions, **The Company** is required to submit to **Users** the **Network Data** as listed in Part 3 of the Appendix. The data will be submitted in week 42 of each year and will cover that **Financial Year**.

PC.4.3.3 To enable **Users** to model the **National Electricity Transmission System** in relation to **OTSUA**, **The Company** is required to submit to **Users** the **Network Data** as listed in Part 3 of Appendix A and Appendix F. **The Company** shall provide the **Network Data** with the offer of a CUSC Contract in the case of the data in PC F2.1 and otherwise in accordance with the **OTSDUW Development and Data Timetable**.

PC.4.4 Offer of Terms for Connection

PC.4.4.1 CUSC Contract – Data Requirements/Offer Timing

The completed application form for a **CUSC Contract** to be submitted by a **User** when making an application for a **CUSC Contract** will include:

- (a) a description of the **Plant** and/or **Apparatus** (excluding **OTSDUW Plant and Apparatus**) to be connected to the **National Electricity Transmission System** or of the **Modification** relating to the **User's Plant** and/or **Apparatus** (and prior to the **OTSUA Transfer Time**, any **OTSUA**) already connected to the **National Electricity Transmission System** or, as the case may be, of the proposed new connection or **Modification** to the connection within the **User System** of the **User**, each of which shall be termed a "**User Development**" in the **PC**;
- (b) the relevant **Standard Planning Data** as listed in Part 1 of the Appendix (except in respect of any **OTSUA**); and
- (c) the desired **Completion Date** of the proposed **User Development**.
- (d) the desired **Connection Entry Capacity** and **Transmission Entry Capacity**.

The completed application form for a **CUSC Contract** will be sent to **The Company** as more particularly provided in the application form.

PC.4.4.2 Any offer of a **CUSC Contract** will provide that it must be accepted by the applicant **User** within the period stated in the offer, after which the offer automatically lapses. Except as provided in the **CUSC Contract**, acceptance of the offer renders the **National Electricity Transmission System** works relating to that **User Development**, reflected in the offer, committed and binds both parties to the terms of the offer. The User shall then provide the **Detailed Planning Data** as listed in Part 2 of the Appendix (and in the case of **OTSUA** the **Standard Planning Data** as listed in Part 1 of Appendix A within the timeline provided in PC.A.1.4). In respect of **DPD I** this shall generally be provided within 28 days (or such shorter period as **The Company** may determine, or such longer period as **The Company** may agree, in any particular case) of acceptance of the offer and in respect of **DPD II** this shall generally be provided at least two years (or such longer period as **The Company** may determine, or such shorter period as **The Company** may agree, in any particular case or in the case of **OTSUA** such shorter period as **The Company** shall require) prior to the **Completion Date** of the **User Development**.

PC.4.4.3 Embedded Development Agreement - Data Requirements

The **Network Operator** shall submit the following data in relation to an **Embedded Medium Power Station** not subject to, or proposed to be subject to, a **Bilateral Agreement** or **Embedded DC Converter Station** not subject to, or proposed to be subject to, a **Bilateral Agreement** as soon as reasonably practicable after receipt of an application from an **Embedded Person** to connect to its **System**:

- (a) details of the proposed new connection or variation (having a similar effect on the **Network Operator's System** as a **Modification** would have on the **National Electricity Transmission System**) to the connection within the **Network Operator's System**, each of which shall be termed an "**Embedded Development**" in the **PC** (where a **User Development** has an impact on the **Network Operator's System** details shall be supplied in accordance with PC.4.4 and PC.4.5);
- (b) the relevant **Standard Planning Data** as listed in Part 1 of the Appendix;
- (c) the proposed completion date (having a similar meaning in relation to the **Network Operator's System** as **Completion Date** would have in relation to the **National Electricity Transmission System**) of the **Embedded Development**; and
- (d) upon the request of **The Company**, the relevant **Detailed Planning Data** as listed in Part 2 of the Appendix.

PC.4.4.4 The **Network Operator** shall provide the **Detailed Planning Data** as listed in Part 2 of the Appendix. In respect of **DPD I** this shall generally be provided within 28 days (or such shorter period as **The Company** may determine, or such longer period as **The Company** may agree, in any particular case) of entry into the **Embedded Development Agreement** and in respect to **DPD II** this shall generally be provided at least two years (or such longer period as **The Company** may determine, or such shorter period as **The Company** may agree, in any particular case) prior to the **Completion Date** of the **Embedded Development**.

PC.4.5 Complex Connections

PC.4.5.1 The magnitude and complexity of any **National Electricity Transmission System** extension or reinforcement will vary according to the nature, location and timing of the proposed **User Development** which is the subject of the application and it may, in the event, be necessary for **The Company** to carry out additional more extensive system studies to evaluate more fully the impact of the proposed **User Development** on the **National Electricity Transmission System**. Where **The Company** judges that such additional more detailed studies are necessary the offer may indicate the areas that require more detailed analysis and before such additional studies are required, the **User** shall indicate whether it wishes **The Company** to undertake the work necessary to proceed to make a revised offer within the 3 month period normally allowed or, where relevant, the timescale consented to by the **Authority**.

PC.4.5.2 To enable **The Company** to carry out any of the above mentioned necessary detailed system studies, the **User** may, at the request of **The Company**, be required to provide some or all of the **Detailed Planning Data** listed in part 2 of the Appendix in advance of the normal timescale referred in PC.4.4.2 provided that **The Company** can reasonably demonstrate that it is relevant and necessary.

PC.4.5.3 To enable **The Company** to carry out any necessary detailed system studies, the relevant **Network Operator** may, at the request of **The Company**, be required to provide some or all of the **Detailed Planning Data** listed in Part 2 of the Appendix in advance of the normal timescale referred in PC.4.4.4 provided that **The Company** can reasonably demonstrate that it is relevant and necessary.

PC.5 PLANNING DATA

PC.5.1 As far as the **PC** is concerned, there are three relevant levels of data in relation to **Users**. These levels, which relate to levels of confidentiality, commitment and validation, are described in the following paragraphs.

Preliminary Project Planning Data

PC.5.2 At the time the **User** applies for a **CUSC Contract** but before an offer is made and accepted by the applicant **User**, the data relating to the proposed **User Development** will be considered as **Preliminary Project Planning Data**. Data relating to an **Embedded Development** provided by a **Network Operator** in accordance with PC.4.4.3, and PC.4.4.4 if requested, will be considered as **Preliminary Project Planning Data**. All such data will be treated as confidential within the scope of the provisions relating to confidentiality in the **CUSC**.

PC.5.3 **Preliminary Project Planning Data** will normally only contain the **Standard Planning Data** unless the **Detailed Planning Data** is required in advance of the normal timescale to enable **The Company** to carry out additional detailed system studies as described in PC.4.5.

Committed Project Planning Data

PC.5.4 Once the offer for a **CUSC Contract** is accepted, the data relating to the **User Development** already submitted as **Preliminary Project Planning Data**, and subsequent data required by **The Company** under this **PC**, will become **Committed Project Planning Data**. Once an **Embedded Person** has entered into an **Embedded Development Agreement**, as notified to **The Company** by the **Network Operator**, the data relating to the **Embedded Development** already submitted as **Preliminary Project Planning Data**, and subsequent data required by **The Company** under the **PC**, will become **Committed Project Planning Data**. Such data, together with **Connection Entry Capacity** and **Transmission Entry Capacity** data from the **CUSC Contract** and other data held by **The Company** relating to the **National Electricity Transmission System** will form the background against which new applications by any **User** will be considered and against which planning of the **National Electricity Transmission System** will be undertaken. Accordingly, **Committed Project Planning Data**, **Connection Entry Capacity** and **Transmission Entry Capacity** data will not be treated as confidential to the extent that **The Company**:

- (a) is obliged to use it in the preparation of the **Seven Year Statement** and in any further information given pursuant to the **Seven Year Statement**;
- (b) is obliged to use it when considering and/or advising on applications (or possible applications) of other **Users** (including making use of it by giving data from it, both orally and in writing, to other **Users** making an application (or considering or discussing a possible application) which is, in **The Company's** view, relevant to that other application or possible application);
- (c) is obliged to use it for operational planning purposes;
- (d) is obliged under the terms of an **Interconnection Agreement** to pass it on as part of system information on the **Total System**;
- (e) is obliged to disclose it under the **STC**;

- (f) is obliged to use and disclose it in the preparation of the **Offshore Development Information Statement**;
- (g) is obliged to use it in order to carry out its **EMR Functions** or is obliged to disclose it under an **EMR Document**.

To reflect different types of data, **Preliminary Project Planning Data** and **Committed Project Planning Data** are themselves divided into:

- (a) those items of **Standard Planning Data** and **Detailed Planning Data** which will always be forecast, known as **Forecast Data**; and
- (b) those items of **Standard Planning Data** and **Detailed Planning Data** which relate to **Plant** and/or **Apparatus** which upon connection will become **Registered Data**, but which prior to connection, for the seven succeeding **Financial Years**, will be an estimate of what is expected, known as **Estimated Registered Data**.

Connected Planning Data

PC.5.5

The **PC** requires that, at the time that a **Statement of Readiness** is submitted under the **Bilateral Agreement** and/or **Construction Agreement**, any estimated values assumed for planning purposes are confirmed or, where practical, replaced by validated actual values and by updated estimates for the future and by updated forecasts for forecast data items such as **Demand**. In the case of an **Embedded Development** the relevant **Network Operator** will update any estimated values assumed for planning purposes with validated actual values as soon as reasonably practicable after energisation. This data is then termed **Connected Planning Data**.

To reflect the three types of data referred to above, **Connected Planning Data** is itself divided into:

- (a) those items of **Standard Planning Data** and **Detailed Planning Data** which will always be forecast data, known as **Forecast Data**; and
- (b) those items of **Standard Planning Data** and **Detailed Planning Data** which upon connection become fixed (subject to any subsequent changes), known as **Registered Data**; and
- (c) those items of **Standard Planning Data** and **Detailed Planning Data** which for the purposes of the **Plant** and/or **Apparatus** concerned as at the date of submission are **Registered Data** but which for the seven succeeding **Financial Years** will be an estimate of what is expected, known as **Estimated Registered Data**,

as more particularly provided in the Appendix.

PC.5.6

Connected Planning Data, together with **Connection Entry Capacity** and **Transmission Entry Capacity** data from the **CUSC Contract**, and other data held by **The Company** relating to the **National Electricity Transmission System**, will form the background against which new applications by any **User** will be considered and against which planning of the **National Electricity Transmission System** will be undertaken. Accordingly, **Connected Planning Data**, **Connection Entry Capacity** and **Transmission Entry Capacity** data will not be treated as confidential to the extent that **The Company**:

- (a) is obliged to use it in the preparation of the **Seven Year Statement** and in any further information given pursuant to the **Seven Year Statement**;
- (b) is obliged to use it when considering and/or advising on applications (or possible applications) of other **Users** (including making use of it by giving data from it, both orally and in writing, to other **Users** making an application (or considering or discussing a possible application) which is, in **The Company's** view, relevant to that other application or possible application);
- (c) is obliged to use it for operational planning purposes;
- (d) is obliged under the terms of an **Interconnection Agreement** to pass it on as part of system information on the **Total System**.

- (e) is obliged to disclose it under the **STC**;
- (f) is obliged to use it in order to carry out its **EMR Functions** or is obliged to disclose it under an **EMR Document**.

PC.5.7 **Committed Project Planning Data** and **Connected Planning Data** will each contain both **Standard Planning Data** and **Detailed Planning Data**.

PC.6 PLANNING STANDARDS

PC.6.1 **The Company** shall apply the **Licence Standards** relevant to planning and development, in the planning and development of its **Transmission System**. **The Company** shall procure that each **Relevant Transmission Licensee** shall apply the **Licence Standards** relevant to planning and development, in the planning and development of the **Transmission System** of each **Relevant Transmission Licensee** and that a **User** shall apply the **Licence Standards** relevant to planning and development, in the planning and development of the **OTSUA**.

PC.6.2 In relation to Scotland, Appendix C lists the technical and design criteria applied in the planning and development of each **Relevant Transmission Licensee's Transmission System**. The criteria are subject to review in accordance with each **Relevant Transmission Licensee's Transmission Licence** conditions. Copies of these documents are available from **The Company** on request. **The Company** will charge an amount sufficient to recover its reasonable costs incurred in providing this service.

PC.6.3 In relation to **Offshore**, Appendix E lists the technical and design criteria applied in the planning and development of each **Offshore Transmission System**. The criteria are subject to review in accordance with each **Offshore Transmission Licensee's Transmission Licence** conditions. Copies of these documents are available from **The Company** on request. **The Company** will charge an amount sufficient to recover its reasonable costs incurred in providing this service.

PC.6.4 In planning and developing the **OTSUA**, the **User** shall comply with (and shall ensure that (as at the **OTSUA Transfer Time**) the **OTSUA** comply with):

- (a) the **Licence Standards**; and
- (b) the technical and design criteria in Appendix E.

PC.6.5 In addition the **User** shall, in the planning and development of the **OTSUA**, to the extent it is reasonable and practicable to do so, take into account the reasonable requests of **The Company** (in the context of its obligation to develop an efficient, co-ordinated and economical system) relating to the planning and development of the **National Electricity Transmission System**.

PC.6.6 In planning and developing the **OTSUA** the **User** shall take into account the **Network Data** provided to it by **The Company** under Part 3 of Appendix A and Appendix F, and act on the basis that the **Plant** and **Apparatus** of other **Users** complies with:

- (a) the minimum technical design and operational criteria and performance requirements set out in either CC.6.1, CC.6.2, CC.6.3 and CC.6.4 or ECC.6.1, ECC.6.2, ECC.6.3 and ECC.6.4 ; or
- (b) such other criteria or requirements as **The Company** may from time to time notify the **User** are applicable to specified **Plant** and **Apparatus** pursuant to PC.6.7.

PC.6.7 Where the **OTSUA** are likely to be materially affected by the design or operation of another **User's Plant** and **Apparatus** and **The Company**:

- (a) becomes aware that such other **User** has or is likely to apply for a derogation under the Grid Code;
- (b) is itself applying for a derogation under the Grid Code in relation to the **Connection Site** on which such other **User's Plant** and **Apparatus** is located or to which it otherwise relates; or
- (c) is otherwise notified by such other **User** that specified **Plant** or **Apparatus** is normally capable of operating at levels better than those set out in CC.6.1, CC.6.2, CC.6.3 and CC.6.4 or ECC.6.1, ECC.6.2, ECC.6.3 and ECC.6.4,

The Company shall notify the **User**.

PC.7 PLANNING LIAISON

PC.7.1 This PC.7 applies to **The Company** and **Users**, which in PC.7 means

- (a) **Network Operators**
- (b) **Non-Embedded Customers**

PC.7.2 As described in PC.2.1 (b) an objective of the **PC** is to provide for the supply of information to **The Company** by **Users** in order that planning and development of the **National Electricity Transmission System** can be undertaken in accordance with the relevant **Licence Standards**.

PC.7.3 **Grid Code** amendment B/07 (“Amendment B/07”) implemented changes to the **Grid Code** which included amendments to the datasets provided by both **The Company** and **Users** to inform the planning and development of the **National Electricity Transmission System**. The **Authority** has determined that these changes are to have a phased implementation. Consequently the provisions of Appendix A to the **PC** include specific years (ranging from 2009 to 2011) with effect from which certain of the specific additional obligations brought about by Amendment B/07 on **The Company** and **Users** are to take effect. Where specific provisions of paragraphs PC.A.4.1.4, PC.A.4.2.2 and PC.A.4.3.1 make reference to a year, then the obligation on **The Company** and the **Users** shall be required to be met by the relevant calendar week (as specified within such provision) in such year.

In addition to the phased implementation of aspects of Amendment B/07, **Users** must discuss and agree with **The Company** by no later than 31 March 2009 a more detailed implementation programme to facilitate the implementation of **Grid Code** amendment B/07.

It shall also be noted by **The Company** and **Users** that the dates set out in PC.A.4 are intended to be minimum requirements and are not intended to restrict a **User** and **The Company** from the earlier fulfilment of the new requirements prior to the specified years. Where **The Company** and a **User** wish to follow the new requirements from earlier dates than those specified, this will be set out in the more detailed implementation programme agreed between **The Company** and the **User**.

The following provisions of PC.7 shall only apply with effect from 1 January 2011.

PC.7.4 Following the submission of data by a **User** in or after week 24 of each year **The Company** will provide information to **Users** by calendar week 6 of the following year regarding the results of any relevant assessment that has been made by **The Company** based upon such data submissions to verify whether **Connection Points** are compliant with the relevant **Licence Standards**.

PC.7.5 Where the result of any assessment identifies possible future non-compliance with the relevant **Licence Standards**, **The Company** shall notify the relevant **User(s)** of this fact as soon as reasonably practicable and shall agree with **Users** any opportunity to resubmit data to allow for a reassessment in accordance with PC.7.6.

PC.7.6 Following any notification by **The Company** to a **User** pursuant to PC.7.5 and following any further discussions held between the **User** and **The Company**:

- (i) **The Company** and the **User** may agree revisions to the **Access Periods** for relevant **Transmission Interface Circuits**, such revisions shall not however permit an **Access Period** to be less than 4 continuous weeks in duration or to occur other than between calendar weeks 10 and 43 (inclusive); and/or,
- (ii) The **User** shall as soon as reasonably practicable
 - (a) submit further relevant data to **The Company** that is to **The Company’s** reasonable satisfaction; and/or,
 - (b) modify data previously submitted pursuant to this **PC**, such modified data to be to **The Company’s** reasonable satisfaction; and/or
 - (c) notify **The Company** that it is the intention of the **User** to leave the data as originally submitted to **The Company** to stand as its submission.

- PC.7.7 Where an **Access Period** is amended pursuant to PC.7.6 (i) **The Company** shall notify **The Authority** that it has been necessary to do so.
- PC.7.8 When it is agreed that any resubmission of data is unlikely to confirm future compliance with the relevant **Licence Standards** the **Modification** process in the **CUSC** may apply.
- PC.7.9 A **User** may at any time, in writing, request further specified **National Electricity Transmission System** network data in order to provide **The Company** with viable **User** network data (as required under this **PC**). Upon receipt of such request **The Company** shall consider, and where appropriate provide such **National Electricity Transmission System** network data to the **User** as soon as reasonably practicable following the request.
- PC.8 OTSDUW PLANNING LIAISON
- PC.8.1 This PC.8 applies to **The Company** and **Users**, which in PC.8 means **Users** undertaking **OTSDUW**
- PC.8.2 As described in PC.2.1 (e) an objective of the **PC** is to provide for the supply of information between **The Company** and a **User** undertaking **OTSDUW** in order that planning and development of the **National Electricity Transmission System** can be co-ordinated.
- PC.8.3 Where the **OTSUA** also require works to be undertaken by **The Company** and/or any **Relevant Transmission Licensee** on its **Transmission System** **The Company** and the **User** shall throughout the construction and commissioning of such works:
- (a) co-operate and assist each other in the development of co-ordinated construction programmes or any other planning or, in the case of **The Company**, analysis it undertakes in respect of the works; and
 - (b) provide to each other all information relating to its own works (and in the case of **The Company** the works on other **Transmission Systems**) reasonably necessary to assist each other in the performance of that other's part of the works, and shall use all reasonable endeavours to co-ordinate and integrate their respective part of the works; and
- the **User** shall plan and develop the **OTSUA**, taking into account to the extent that it is reasonable and practicable to do so the reasonable requests of **The Company** relating to the planning and development of the **National Electricity Transmission System**.
- PC.8.4 Where **The Company** becomes aware that changes made to the investment plans of **The Company** and any **Relevant Transmission Licensee** may have a material effect on the **OTSUA**, **The Company** shall notify the **User** and provide the **User** with the necessary information about the relevant **Transmission Systems** sufficient for the **User** to assess the impact on the **OTSUA**.

APPENDIX A - PLANNING DATA REQUIREMENTS

PC.A.1 INTRODUCTION

PC.A.1.1 The Appendix specifies data requirements to be submitted to **The Company** by **Users**, and in certain circumstances to **Users** by **The Company**.

PC.A.1.2 Submissions by Users

- (a) Planning data submissions by **Users** shall be:
- (i) with respect to each of the seven succeeding **Financial Years** (other than in the case of **Registered Data** which will reflect the current position and data relating to **Demand** forecasts which relates also to the current year);
 - (ii) provided by **Users** in connection with a **CUSC Contract** (PC.4.1, PC.4.4 and PC.4.5 refer);
 - (iii) provided by **Users** on a routine annual basis in calendar week 24 of each year to maintain an up-to-date data bank (although **Network Operators** may delay the submission of data (other than that to be submitted pursuant to PC.3.2(c) and PC.3.2(d)) until calendar week 28). Where from the date of one annual submission to another there is no change in the data (or in some of the data) to be submitted, instead of re-submitting the data, a **User** may submit a written statement that there has been no change from the data (or some of the data) submitted the previous time; and
 - (iv) provided by **Network Operators** in connection with **Embedded Development** (PC.4.4 refers).
- (b) Where there is any change (or anticipated change) in **Committed Project Planning Data** or a significant change in **Connected Planning Data** in the category of **Forecast Data** or any change (or anticipated change) in **Connected Planning Data** in the categories of **Registered Data** or **Estimated Registered Data** supplied to **The Company** under the **PC**, notwithstanding that the change may subsequently be notified to **The Company** under the **PC** as part of the routine annual update of data (or that the change may be a **Modification** under the **CUSC**), the **User** shall, subject to PC.A.3.2.3 and PC.A.3.2.4, notify **The Company** in writing without delay.
- (c) The notification of the change will be in the form required under this **PC** in relation to the supply of that data and will also contain the following information:
- (i) the time and date at which the change became, or is expected to become, effective;
 - (ii) if the change is only temporary, an estimate of the time and date at which the data will revert to the previous registered form.
- (d) The routine annual update of data, referred to in (a)(iii) above, need not be submitted in respect of **Small Power Stations** (unless such **Small Power Station** is directly connected to the **National Electricity Transmission System** and comprises a **Type C** or **Type D Power Generating Module**) or **Embedded** installations of direct current converters which do not form a **DC Converter Station** or **HVDC System** (except as provided in PC.3.2.(c)), or unless specifically requested by **The Company**, or unless otherwise specifically provided.

PC.A.1.3 Submissions by The Company

Network Data release by **The Company** shall be:

- (a) with respect to the current **Financial Year**;
- (b) provided by **The Company** on a routine annual basis in calendar week 42 of each year. Where from the date of one annual submission to another there is no change in the data (or in some of the data) to be released, instead of repeating the data, **The Company** may release a written statement that there has been no change from the data (or some of the data) released the previous time.

The three parts of the Appendix

PC.A.1.4 The data requirements listed in this Appendix are subdivided into the following four parts:

(a) Standard Planning Data

This data (as listed in Part 1 of the Appendix) is first to be provided by a **User** at the time of an application for a **CUSC Contract** or in accordance with PC.4.4.3. It comprises data which is expected normally to be sufficient for **The Company** to investigate the impact on the **National Electricity Transmission System** of any **User Development** or **Embedded Development** associated with an application by the **User** for a **CUSC Contract**. **Users** should note that the term **Standard Planning Data** also includes the information referred to in PC.4.4.1.(a) and PC.4.4.3.(a). In the case of **OTSUA**, this data is first to be provided by a **User** in accordance with the time line in Appendix F.

(b) Detailed Planning Data

This data (as listed in Part 2 of the Appendix) includes both **DPD I** and **DPD II** and is to be provided in accordance with PC.4.4.2 and PC.4.4.4. It comprises additional, more detailed, data not normally expected to be required by **The Company** to investigate the impact on the **National Electricity Transmission System** of any **User Development** associated with an application by the **User** for a **CUSC Contract** or **Embedded Development Agreement**. **Users** and **Network Operators** in respect of **Embedded Developments** should note that the term **Detailed Planning Data** also includes **Operation Diagrams** and **Site Common Drawings** produced in accordance with the **CC** and **ECC**.

The **User** may, however, be required by **The Company** to provide the **Detailed Planning Data** in advance of the normal timescale before **The Company** can make an offer for a **CUSC Contract**, as explained in PC.4.5.

(c) Network Data

The data requirements for **The Company** in this Appendix are in Part 3.

(d) Offshore Transmission System (OTSDUW) Data

Generators who are undertaking **OTSDUW** are required to submit data in accordance with Appendix A as summarised in Schedule 18 of the **Data Registration Code**.

Forecast Data, Registered Data and Estimated Registered Data

PC.A.1.5 As explained in PC.5.4 and PC.5.5, **Planning Data** is divided into:

- (i) those items of **Standard Planning Data** and **Detailed Planning Data** known as **Forecast Data**; and
- (ii) those items of **Standard Planning Data** and **Detailed Planning Data** known as **Registered Data**; and
- (iii) those items of **Standard Planning Data** and **Detailed Planning Data** known as **Estimated Registered Data**.

PC.A.1.6 The following paragraphs in this Appendix relate to **Forecast Data**:

3.2.2(b), (h), (i) and (j)

4.2.1

4.3.1

4.3.2

4.3.3

4.3.4

4.3.5

4.5

4.7.1

5.2.1

5.2.2

5.6.1

PC.A.1.7 The following paragraphs in this Appendix relate to **Registered Data** and **Estimated Registered Data**:

2.2.1

2.2.4

2.2.5

2.2.6

2.3.1

2.4.1

2.4.2

3.2.2(a), (c), (d), (e), (f), (g), (i)(part) and (j)

3.4.1

3.4.2

4.2.3

4.5(a)(i), (a)(iii), (b)(i) and (b)(iii)

4.6

5.3.2

5.4

5.4.2

5.4.3

5.5

5.6.3

6.2

6.3

PC.A.1.8 The data supplied under PC.A.3.3.1, although in the nature of **Registered Data**, is only supplied either upon application for a **CUSC Contract**, or in accordance with PC.4.4.3, and therefore does not fall to be **Registered Data**, but is **Estimated Registered Data**.

PC.A.1.9 **Forecast Data** must contain the **User's** best forecast of the data being forecast, acting as a reasonable and prudent **User** in all the circumstances.

PC.A.1.10 **Registered Data** must contain validated actual values, parameters or other information (as the case may be) which replace the estimated values, parameters or other information (as the case may be) which were given in relation to those data items when they were **Preliminary Project Planning Data** and **Committed Project Planning Data**, or in the case of changes, which replace earlier actual values, parameters or other information (as the case may be). Until amended pursuant to the Grid Code, these actual values, parameters or other information (as the case may be) will be the basis upon which the **National Electricity Transmission System** is planned, designed, built and operated in accordance with, amongst other things, the **Transmission Licences**, the **STC** and the Grid Code, and on which **The Company** therefore relies. In following the processes set out in the **BC**, **The Company** will use the data which has been supplied to it under the **BC** and the data supplied under **OC2** in relation to **Gensets**, but the provision of such data will not alter the data supplied by **Users** under the **PC**, which may only be amended as provided in the **PC**.

- PC.A.1.11 **Estimated Registered Data** must contain the **User's** best estimate of the values, parameters or other information (as the case may be), acting as a reasonable and prudent **User** in all the circumstances.
- PC.A.1.12 Certain data does not need to be supplied in relation to **Embedded Power Stations** or **Embedded DC Converter Stations** or **Embedded HVDC Systems** where these are connected at a voltage level below the voltage level directly connected to the **National Electricity Transmission System** except in connection with a **CUSC Contract**, or unless specifically requested by **The Company**.
- PC.A.1.13 In the case of **OTSUA**, Schedule 18 of the **Data Registration Code** shall be construed in such a manner as to achieve the intent of such provisions by reference to the **OTSUA** and the **Interface Point** and all **Connection Points**.

PART 1 - STANDARD PLANNING DATA

PC.A.2 USER'S SYSTEM (AND OTSUA) DATA

PC.A.2.1 Introduction

PC.A.2.1.1 Each **User**, whether connected directly via an existing **Connection Point** to the **National Electricity Transmission System**, or seeking such a direct connection, or providing terms for connection of an **Offshore Transmission System** to its **User System** to **The Company**, shall provide **The Company** with data on its **User System** (and any **OTSUA**) which relates to the **Connection Site** (and in the case of **OTSUA**, the **Interface Point**) and/or which may have a system effect on the performance of the **National Electricity Transmission System**. Such data, current and forecast, is specified in PC.A.2.2 to PC.A.2.5. In addition each **Generator** in respect of its **Embedded Large Power Stations** and its **Embedded Medium Power Stations** subject to a **Bilateral Agreement** and each **Network Operator** in respect of **Embedded Medium Power Stations** within its **System** not subject to a **Bilateral Agreement** connected to the **Subtransmission System**, shall provide **The Company** with fault infeed data as specified in PC.A.2.5.5 and each **DC Converter** owner with **Embedded DC Converter Stations** subject to a **Bilateral Agreement** and **Embedded HVDC System Owner** subject to a **Bilateral Agreement**, or **Network Operator** in the case of **Embedded DC Converter Stations** not subject to a **Bilateral Agreement** or **Embedded HVDC Systems** not subject to a **Bilateral Agreement**, connected to the **Subtransmission System** shall provide **The Company** with fault infeed data as specified in PC.A.2.5.6.

PC.A.2.1.2 Each **User** must reflect the system effect at the **Connection Site(s)** of any third party **Embedded** within its **User System** whether existing or proposed.

PC.A.2.1.3 Although not itemised here, each **User** with an existing or proposed **Embedded Small Power Station**, **Embedded Medium Power Station**, **Embedded DC Converter Station** or **HVDC System** with a **Registered Capacity** of less than 100MW or an **Embedded** installation of direct current converters which does not form a **DC Converter Station** or **HVDC System** in its **User System** may, at **The Company's** reasonable discretion, be required to provide additional details relating to the **User's System** between the **Connection Site** and the existing or proposed **Embedded Small Power Station**, **Embedded Medium Power Station**, **Embedded DC Converter Station**, **Embedded HVDC System** or **Embedded** installation of direct current converters which does not form a **DC Converter Station** or **Embedded** installation which does not form an **HVDC System**.

PC.A.2.1.4 At **The Company's** reasonable request, additional data on the **User's System** (or **OTSUA**) will need to be supplied. Some of the possible reasons for such a request, and the data required, are given in PC.A.6.2, PC.A.6.4, PC.A.6.5 and PC.A.6.6.

PC.A.2.2 User's System (and OTSUA) Layout

PC.A.2.2.1 Each **User** shall provide a **Single Line Diagram**, depicting both its existing and proposed arrangement(s) of load current carrying **Apparatus** relating to both existing and proposed **Connection Points** (including in the case of **OTSUA**, **Interface Points**).

PC.A.2.2.2 The **Single Line Diagram** (three examples are shown in Appendix B) must include all parts of the **User System** operating at **Supergrid Voltage** throughout **Great Britain** and, in Scotland and **Offshore**, also all parts of the **User System** operating at 132kV, and those parts of its **Subtransmission System** at any **Transmission Site**. In the case of **OTSDUW**, the **Single Line Diagram** must also include the **OTSUA**. In addition, the **Single Line Diagram** must include all parts of the **User's Subtransmission System** (and any **OTSUA**) throughout **Great Britain** operating at a voltage greater than 50kV, and, in Scotland and **Offshore**, also all parts of the **User's Subtransmission System** (and any **OTSUA**) operating at a voltage greater than 30kV, which, under either intact network or **Planned Outage** conditions:-

- (a) normally interconnects separate **Connection Points**, or busbars at a **Connection Point** which are normally run in separate sections; or

- (b) connects **Embedded Large Power Stations**, or **Embedded Medium Power Stations**, or **Embedded DC Converter Stations**, or **Embedded HVDC Systems** or **Offshore Transmission Systems** connected to the **User's Subtransmission System**, to a **Connection Point** or **Interface Point**.

At the **User's** discretion, the **Single Line Diagram** can also contain additional details of the **User's Subtransmission System** (and any **OTSUA**) not already included above, and also details of the transformers connecting the **User's Subtransmission System** to a lower voltage. With **The Company's** agreement, the **Single Line Diagram** can also contain information about the **User's System** (and any **OTSUA**) at a voltage below the voltage of the **Subtransmission System**.

The **Single Line Diagram** for a **Power Park Module** (including **DC Connected Power Park Modules**) must include all parts of the System connecting generating equipment to the **Grid Entry Point** (or **User System Entry Point** if **Embedded**). As an alternative the **User** may choose to submit a **Single Line Diagram** with the equipment between the equivalent **Power Park Unit** and the **Common Collection Busbar** reduced to an electrically equivalent network. The format for a **Single Line Diagram** for a **Power Park Module** (including **DC Connected Power Park Modules**) electrically equivalent system is shown in Appendix B.

The **Single Line Diagram** must include the points at which **Demand** data (provided under PC.A.4.3.4 and PC.A.4.3.5, or in the case of **Generators**, PC.A.5.) and fault infeed data (provided under PC.A.2.5) are supplied.

PC.A.2.2.3 The above mentioned **Single Line Diagram** shall include:

- (a) electrical circuitry (ie. overhead lines, identifying which circuits are on the same towers, underground cables, power transformers, reactive compensation equipment and similar equipment); and
- (b) substation names (in full or abbreviated form) with operating voltages.

In addition, for all load current carrying **Apparatus** operating at **Supergrid Voltage** throughout **Great Britain** and, in Scotland and **Offshore**, also at 132kV, (and any **OTSUA**) the **Single Line Diagram** shall include:-

- (a) circuit breakers
- (b) phasing arrangements.

PC.A.2.2.3.1 For the avoidance of doubt, the **Single Line Diagram** to be supplied is in addition to the **Operation Diagram** supplied pursuant to CC.7.4 [and ECC.7.4](#).

PC.A.2.2.4 For each circuit shown on the **Single Line Diagram** provided under PC.A.2.2.1, each **User** shall provide the following details relating to that part of its **User System** and **OTSUA**:

Circuit Parameters:

Rated voltage (kV)

Operating voltage (kV)

Positive phase sequence reactance

Positive phase sequence resistance

Positive phase sequence susceptance

Zero phase sequence reactance (both self and mutual)

Zero phase sequence resistance (both self and mutual)

Zero phase sequence susceptance (both self and mutual)

In the case of a **Single Line Diagram** for a **Power Park Module** (including **DC Connected Power Park Modules**) electrically equivalent system the data should be on a 100MVA base. Depending on the equivalent system supplied an equivalent tap changer range may need to be supplied. Similarly mutual values, rated voltage and operating voltage may be inappropriate. Additionally in the case of **OTSUA**, seasonal maximum continuous ratings and circuit lengths are to be provided in addition to the data required under PC.A.2.2.4.

PC.A.2.2.5 For each transformer shown on the **Single Line Diagram** provided under PC.A.2.2.1, each **User** (including those undertaking **OTSDUW**) shall provide the following details:

Rated MVA

Voltage Ratio

Winding arrangement

Positive sequence reactance (max, min and nominal tap)

Positive sequence resistance (max, min and nominal tap)

Zero sequence reactance

PC.A.2.2.5.1. In addition, for all interconnecting transformers between the **User's Supergrid Voltage System** and the **User's Subtransmission System** throughout **Great Britain** and, in Scotland and **Offshore**, also for all interconnecting transformers between the **User's 132kV System** and the **User's Subtransmission System** (and any **OTSUA**) the **User** shall supply the following information:-

Tap changer range

Tap change step size

Tap changer type: on load or off circuit

Earthing method: Direct, resistance or reactance

Impedance (if not directly earthed)

PC.A.2.2.6 Each **User** shall supply the following information about the **User's** equipment installed at a **Transmission Site** (or in the case of **OTSUA**, all **OTSDUW Plant and Apparatus**):-

(a) Switchgear. For all circuit breakers:-

Rated voltage (kV)

Operating voltage (kV)

Rated 3-phase rms short-circuit breaking current, (kA)

Rated 1-phase rms short-circuit breaking current, (kA)

Rated 3-phase peak short-circuit making current, (kA)

Rated 1-phase peak short-circuit making current, (kA)

Rated rms continuous current (A)

DC time constant applied at testing of asymmetrical breaking abilities (secs)

In the case of **OTSDUW Plant and Apparatus** operating times for circuit breaker, **Protection**, trip relay and total operating time should be provided.

(b) Substation Infrastructure. For the substation infrastructure (including, but not limited to, switch disconnectors, disconnectors, current transformers, line traps, busbars, through bushings, etc):-

Rated 3-phase rms short-circuit withstand current (kA)

Rated 1-phase rms short-circuit withstand current (kA).

Rated 3-phase short-circuit peak withstand current (kA)

Rated 1- phase short-circuit peak withstand current (kA)

Rated duration of short circuit withstand (secs)

Rated rms continuous current (A)

A single value for the entire substation may be supplied, provided it represents the most restrictive item of current carrying apparatus.

PC.A.2.2.7 In the case of **OTSUA** the following should also be provided

- (a) Automatic switching scheme schedules including diagrams and an explanation of how the **System** will operate and what plant will be affected by the schemes **Operation**.
- (b) **Intertripping** schemes both Generation and **Demand**. In each case a diagram of the scheme and an explanation of how the **System** will operate and what **Plant** will be affected by the schemes **Operation**.

PC.A.2.3 Lumped System Susceptance

PC.A.2.3.1 For all parts of the **User's Subtransmission System** (and any **OTSUA**) which are not included in the **Single Line Diagram** provided under PC.A.2.2.1, each **User** shall provide the equivalent lumped shunt susceptance at nominal **Frequency**.

PC.A.2.3.1.1 This should include shunt reactors connected to cables which are not normally in or out of service independent of the cable (ie. they are regarded as part of the cable).

PC.A.2.3.1.2 This should not include:

- (a) independently switched reactive compensation equipment connected to the **User's System** specified under PC.A.2.4, or;
- (b) any susceptance of the **User's System** inherent in the **Demand (Reactive Power)** data specified under PC.A.4.3.1.

PC.A.2.4 Reactive Compensation Equipment

PC.A.2.4.1 For all independently switched reactive compensation equipment (including any **OTSUA**), including that shown on the **Single Line Diagram**, not operated by **The Company** and connected to the **User's System** at 132kV and above in England and Wales and 33kV and above in Scotland and **Offshore** (including any **OTSDUW Plant and Apparatus** operating at **High Voltage**), other than **Power Factor** correction equipment associated directly with **Customers' Plant and Apparatus**, the following information is required:

- (a) type of equipment (eg. fixed or variable);
- (b) capacitive and/or inductive rating or its operating range in MVAR;
- (c) details of any automatic control logic to enable operating characteristics to be determined;
- (d) the point of connection to the **User's System** (including **OTSUA**) in terms of electrical location and **System** voltage.
- (e) In the case of **OTSDUW Plant and Apparatus** the **User** should also provide:-
 - (i) Connection node, voltage, rating, power loss, tap range and connection arrangement.
 - (ii) A mathematical representation in block diagram format to model the control of any dynamic compensation plant. The model should be suitable for RMS dynamic stability type studies where each time constant should be no less than 10ms.
 - (iii) For Static Var Compensation equipment the **User** should provide:

HV Node

LV Node

Control Node

Nominal Voltage (kV)

Target Voltage (kV)

Maximum MVA_r at HV
Minimum MVA_r at HV
Slope %
Voltage dependant Q Limit
Normal Running Mode
Positive and zero phase sequence resistance and reactance
Transformer winding type
Connection arrangements

PC.A.2.4.2 **DC Converter Station** owners, **HVDC System Owners** (and a **User** where the **OTSUA** includes an **OTSDUW DC Converter**) are also required to provide information about the reactive compensation and harmonic filtering equipment required to ensure that their **Plant** and **Apparatus** (and the **OTSUA**) complies with the criteria set out in CC.6.1.5 or ECC.6.1.5 (as applicable).

PC.A.2.5 Short Circuit Contribution to National Electricity Transmission System

PC.A.2.5.1 General

- (a) To allow **The Company** to calculate fault currents, each **User** is required to provide data, calculated in accordance with **Good Industry Practice**, as set out in the following paragraphs of PC.A.2.5.
- (b) The data should be provided for the **User's System** with all **Generating Units** (including **Synchronous Generating Units**), **Power Park Units**, **HVDC Systems** and **DC Converters Synchronised** to that **User's System** (and any **OTSUA** where appropriate). The **User** must ensure that the pre-fault network conditions reflect a credible **System** operating arrangement.
- (c) The list of data items required, in whole or part, under the following provisions, is set out in PC.A.2.5.6. Each of the relevant following provisions identifies which data items in the list are required for the situation with which that provision deals.

The fault currents in sub-paragraphs (a) and (b) of the data list in PC.A.2.5.6 should be based on an a.c. load flow that takes into account any pre-fault current flow across the **Point of Connection** (and in the case of **OTSUA**, **Interface Points** and **Connection Points**) being considered.

Measurements made under appropriate **System** conditions may be used by the **User** to obtain the relevant data.

- (d) **The Company** may at any time, in writing, specifically request for data to be provided for an alternative **System** condition, for example minimum plant, and the **User** will, insofar as such request is reasonable, provide the information as soon as reasonably practicable following the request.

PC.A.2.5.2 **Network Operators** and **Non-Embedded Customers** are required to submit data in accordance with PC.A.2.5.4. **Generators**, **DC Converter Station** owners, **HVDC System Owners** and **Network Operators**, in respect of **Embedded Medium Power Stations** not subject to a **Bilateral Agreement** and **Embedded DC Converter Stations** not subject to a **Bilateral Agreement** and **Embedded HVDC Systems** within such **Network Operator's Systems** are required to submit data in accordance with PC.A.2.5.5.

PC.A.2.5.3 Where prospective short-circuit currents on equipment owned, operated or managed by **The Company** are close to the equipment rating, and in **The Company's** reasonable opinion more accurate calculations of the prospective short circuit currents are required, then **The Company** will request additional data as outlined in PC.A.6.6 below.

PC.A.2.5.4 Data from Network Operators and Non-Embedded Customers

PC.A.2.5.4.1 Data is required to be provided at each node on the **Single Line Diagram** provided under PC.A.2.2.1 at which motor loads and/or **Embedded Small Power Stations** and/or **Embedded Medium Power Stations** and/or **Embedded** installations of direct current converters which do not form a **DC Converter Station** or **HVDC System** are connected, assuming a fault at that location, as follows:-

The data items listed under the following parts of PC.A.2.5.6:-

(a) (i), (ii), (iii), (iv), (v) and (vi);

and the data items shall be provided in accordance with the detailed provisions of PC.A.2.5.6(c) - (f).

PC.A.2.5.4.2 **Network Operators** shall provide the following data items in respect of each **Interface Point** within their **User System**:

(a) **Maximum Export Capacity**;

(b) **Maximum Import Capacity**; and,

(c) **Interface Point Target Voltage/Power Factor**

Network Operators shall alongside these parameters include details of any manual or automatic post fault actions to be taken by the owner / operator of the **Offshore Transmission System** connected to such **Interface Point** that are required by the **Network Operator**.

PC.A.2.5.5 Data from **Generators** (including **Generators** undertaking **OTSDUW** and those responsible for **DC Connected Power Park Modules**), **DC Converter Station** owners, **HVDC System Owners** and from **Network Operators** in respect of **Embedded Medium Power Stations** not subject to a **Bilateral Agreement** and **Embedded DC Converter Stations** not subject to a **Bilateral Agreement** and **Embedded HVDC Systems** within such **Network Operator's Systems**.

PC.A.2.5.5.1 For each **Generating Unit** (including **Synchronous Generating Units** forming part of a **Synchronous Power Generating Module**) with one or more associated **Unit Transformers**, the **Generator**, or the **Network Operator** in respect of **Embedded Medium Power Stations** not subject to a **Bilateral Agreement** and **Embedded DC Converter Stations** not subject to a **Bilateral Agreement** and **Embedded HVDC Systems** within such **Network Operator's System** is required to provide values for the contribution of the **Power Station Auxiliaries** (including **Auxiliary Gas Turbines** or **Auxiliary Diesel Engines**) to the fault current flowing through the **Unit Transformer(s)**.

The data items listed under the following parts of PC.A.2.5.6(a) should be provided:-

(i), (ii) and (v);

(iii) if the associated **Generating Unit** (including **Synchronous Generating Units** forming part of a **Synchronous Power Generating Module**) step-up transformer can supply zero phase sequence current from the **Generating Unit** side to the **National Electricity Transmission System**;

(iv) if the value is not 1.0 p.u;

and the data items shall be provided in accordance with the detailed provisions of PC.A.2.5.6(c) - (f), and with the following parts of this PC.A.2.5.5.

PC.A.2.5.5.2 Auxiliary motor short circuit current contribution and any **Auxiliary Gas Turbine Unit** contribution through the **Unit Transformers** must be represented as a combined short circuit current contribution at the **Generating Unit's** (including **Synchronous Generating Units** forming part of a **Synchronous Power Generating Module**) terminals, assuming a fault at that location.

PC.A.2.5.5.3 If the **Power Station** or **HVDC System** or **DC Converter Station** (or **OTSDUW Plant and Apparatus** which provides a fault infeed) has separate **Station Transformers**, data should be provided for the fault current contribution from each transformer at its high voltage terminals, assuming a fault at that location, as follows:-

The data items listed under the following parts of PC.A.2.5.6

- (a) (i), (ii), (iii), (iv), (v) and (vi);

and the data items shall be provided in accordance with the detailed provisions of PC.A.2.5.6(b) - (f).

- PC.A.2.5.5.4 Data for the fault infeeds through both **Unit Transformers** and **Station Transformers** shall be provided for the normal running arrangement when the maximum number of **Generating Units** (including **Synchronous Generating Units** forming part of a **Synchronous Power Generating Module**) are **Synchronised** to the **System** or when all the **DC Converters** at a **DC Converter Station** or **HVDC Converters** within an **HVDC System** are transferring **Rated MW** in either direction. Where there is an alternative running arrangement (or transfer in the case of a **DC Converter Station** or **HVDC System**) which can give a higher fault infeed through the **Station Transformers**, then a separate data submission representing this condition shall be made.
- PC.A.2.5.5.5 Unless the normal operating arrangement within the **Power Station** is to have the **Station** and **Unit Boards** interconnected within the **Power Station**, no account should be taken of the interconnection between the **Station Board** and the **Unit Board**.
- PC.A.2.5.5.6 Auxiliary motor short circuit current contribution and any auxiliary **DC Converter Station** contribution or **HVDC System** contribution through the **Station Transformers** must be represented as a combined short circuit current contribution through the **Station Transformers**.
- PC.A.2.5.5.7 Where a **Manufacturer's Data & Performance Report** exists in respect of the model of the **Power Park Unit**, the **User** may opt to reference the **Manufacturer's Data & Performance Report** as an alternative to the provision of data in accordance with this PC.A.2.5.5.7. For the avoidance of doubt, all other data provision pursuant to the Grid Code shall still be provided including a Single Line Diagram and those data pertaining thereto.

For each **Power Park Module** (including **DC Connected Power Park Modules**) and each type of **Power Park Unit** (eg. Doubly Fed Induction Generator) (and any **OTSDUW Plant and Apparatus** which provides a fault infeed), including any **Auxiliaries**, positive, negative and zero sequence root mean square current values are to be provided of the contribution to the short circuit current flowing at:

- (i) the **Power Park Unit** terminals, or the **Common Collection Busbar** if an equivalent **Single Line Diagram** and associated data as described in PC.A.2.2.2 is provided, and
- (ii) the **Grid Entry Point** (and in case of **OTSUA, Transmission Interface Point**), or **User System Entry Point** if **Embedded**

for the following solid faults at the **Grid Entry Point** (and in case of **OTSUA, Interface Point**), or **User System Entry Point** if **Embedded**:

- (i) a symmetrical three phase short circuit
- (ii) a single phase to earth short circuit
- (iii) a phase to phase short circuit
- (iv) a two phase to earth short circuit

For a **Power Park Module** (including **DC Connected Power Park Modules**) in which one or more of the **Power Park Units** utilise a protective control such as a crowbar circuit, the data should indicate whether the protective control will act in each of the above cases and the effects of its action shall be included in the data. For any case in which the protective control will act, the data for the fault shall also be submitted for the limiting case in which the protective circuit will not act, which may involve the application of a non-solid fault, and the positive, negative and zero sequence retained voltages at

- (i) the **Power Park Unit** terminals, or the **Common Collection Busbar** if an equivalent **Single Line Diagram** and associated data is provided and
- (ii) the **Grid Entry Point**, or **User System Entry Point** if **Embedded**

in this limiting case shall be provided.

For each fault for which data is submitted, the data items listed under the following parts of PC.A.2.5.6(a) shall be provided:-

(iv), (vii), (viii), (ix), (x);

In addition, if an equivalent **Single Line Diagram** has been provided the data items listed under the following parts of PC.A.2.5.6(a) shall be provided:-

(xi), (xii), (xiii);

In addition, for a **Power Park Module** (including **DC Connected Power Park Modules**) in which one or more of the **Power Park Units** utilise a protective control such as a crowbar circuit:-

the data items listed under the following parts of PC.A.2.5.6(a) shall be provided:-

(xiv), (xv);

All of the above data items shall be provided in accordance with the detailed provisions of PC.A.2.5.6(c), (d), (f).

Should actual data in respect of fault infeeds be unavailable at the time of the application for a **CUSC Contract** or **Embedded Development Agreement**, a limited subset of the data, representing the maximum fault infeed that may result from all of the plant types being considered, shall be submitted. This data will, as a minimum, represent the root mean square of the positive, negative and zero sequence components of the fault current for both single phase and three phase solid faults at the **Grid Entry Point** (or **User System Entry Point** if **Embedded**) at the time of fault application and 50ms following fault application. Actual data in respect of fault infeeds shall be submitted to **The Company** as soon as it is available, in line with PC.A.1.2

PC.A.2.5.6

Data Items

- (a) The following is the list of data utilised in this part of the **PC**. It also contains rules on the data which generally apply:-
- (i) Root mean square of the symmetrical three-phase short circuit current infeed at the instant of fault, (I_1'');
 - (ii) Root mean square of the symmetrical three-phase short circuit current after the subtransient fault current contribution has substantially decayed, (I_1');
 - (iii) the zero sequence source resistance and reactance values of the **User's System** as seen from the node on the **Single Line Diagram** provided under PC.A.2.2.1 (or **Power Generating Module** or **Station Transformer** high voltage terminals or **Generating Unit** terminals or **DC Converter** terminals or **HVDC System** terminals, as appropriate) consistent with the infeed described in PC.A.2.5.1.(b);
 - (iv) root mean square of the pre-fault voltage at which the maximum fault currents were calculated;
 - (v) the positive sequence X/R ratio at the instant of fault;
 - (vi) the negative sequence resistance and reactance values of the **User's System** seen from the node on the **Single Line Diagram** provided under PC.A.2.2.1 (or **Power Generating Module** or **Station Transformer** high voltage terminals, or **Generating Unit** terminals or **DC Converter** terminals or **HVDC System** terminals as appropriate) if substantially different from the values of positive sequence resistance and reactance which would be derived from the data provided above;
 - (vii) A continuous trace and a table showing the root mean square of the positive, negative and zero sequence components of the short circuit current between zero and 140ms at 10ms intervals;

- (viii) The **Active Power** (or **Interface Point Capacity** being exported pre-fault by the **OTSDUW Plant and Apparatus**) being generated pre-fault by the **Power Park Module** (including **DC Connected Power Park Modules**) and by each type of **Power Park Unit**;
 - (ix) The reactive compensation shown explicitly on the **Single Line Diagram** that is switched in;
 - (x) The **Power Factor** of the **Power Park Module** (including **DC Connected Power Park Modules**) and of each **Power Park Unit** type;
 - (xi) The positive sequence X/R ratio of the equivalent at the **Common Collection Busbar** or **Interface Point** in the case of **OTSUA**;
 - (xii) The minimum zero sequence impedance of the equivalent seen from the **Common Collection Busbar** or **Interface Point** in the case of **OTSUA** ;
 - (xiii) The number of **Power Park Units** represented in the equivalent **Power Park Unit**;
 - (xiv) The additional rotor resistance and reactance (if any) that is applied to the **Power Park Unit** under a fault condition;
 - (xv) A continuous trace and a table showing the root mean square of the positive, negative and zero sequence components of the retained voltage at the fault point and **Power Park Unit** terminals, or the **Common Collection Busbar** if an equivalent **Single Line Diagram** and associated data as described in **PC.A.2.2.2** is provided or **Interface Point** in the case of **OTSUA**, representing the limiting case, which may involve the application of a non-solid fault, required to not cause operation of the protective control;
- (b) In considering this data, unless the **User** notifies **The Company** accordingly at the time of data submission, **The Company** will assume that the time constant of decay of the subtransient fault current corresponding to the change from I_1'' to I_1' , (T'') is not significantly different from 40ms. If that assumption is not correct in relation to an item of data, the **User** must inform **The Company** at the time of submission of the data.
 - (c) The value for the X/R ratio must reflect the rate of decay of the d.c. component that may be present in the fault current and hence that of the sources of the initial fault current. All shunt elements and loads must therefore be deleted from any system model before the X/R ratio is calculated.
 - (d) In producing the data, the **User** may use "time step analysis" or "fixed-point-in-time analysis" with different impedances.
 - (e) If a fixed-point-in-time analysis with different impedances method is used, then in relation to the data submitted under (a) (i) above, the data will be required for "time zero" to give I_1'' . The figure of 120ms is consistent with a decay time constant T'' of 40ms, and if that figure is different, then the figure of 120ms must be changed accordingly.
 - (f) Where a "time step analysis" is carried out, the X/R ratio may be calculated directly from the rate of decay of the d.c. component. The X/R ratio is not that given by the phase angle of the fault current if this is based on a system calculation with shunt loads, but from the Thévenin equivalent of the system impedance at the instant of fault with all non-source shunts removed.

PC.A.3 POWER GENERATING MODULE, GENERATING UNIT, HVDC SYSTEM AND DC CONVERTER DATA

PC.A.3.1 Introduction

Directly Connected

PC.A.3.1.1 Each **Generator, HVDC System Owner and DC Converter Station** owner (and a **User** where the **OTSUA** includes an **OTSDUW DC Converter**) with an existing, or proposed, **Power Station or DC Converter Station or HVDC System** directly connected, or to be directly connected, to the **National Electricity Transmission System** (or in the case of **OTSUA**, the **Interface Point**), shall provide **The Company** with data relating to that **Power Station or DC Converter Station or HVDC System**, both current and forecast, as specified in PC.A.3.2 to PC.A.3.4.

Embedded

PC.A.3.1.2 (a) Each **Generator, HVDC System Owner and DC Converter Station** owner in respect of its existing, and/or proposed, **Embedded Large Power Stations** and/or **Embedded HVDC Systems** and/or **Embedded DC Converter Stations** and/or its **Embedded Medium Power Stations** subject to a **Bilateral Agreement** and each **Network Operator** in respect of its **Embedded Medium Power Stations** not subject to a **Bilateral Agreement** and/or **Embedded DC Converter Stations** not subject to a **Bilateral Agreement** and/or **Embedded HVDC Systems** not subject to a **Bilateral Agreement** within such **Network Operator's System** in each case connected to the **Subtransmission System**, shall provide **The Company** with data relating to that **Power Station or DC Converter Station or HVC System**, both current and forecast, as specified in PC.A.3.2 to PC.A.3.4.

(b) No data need be supplied in relation to any **Small Power Station** or any **Medium Power Station** or installations of direct current converters which do not form a **DC Converter Station or HVDC System**, connected at a voltage level below the voltage level of the **Subtransmission System** except:-

(i) in connection with an application for, or under, a **CUSC Contract**, or

(ii) unless specifically requested by **The Company** under PC.A.3.1.4.

PC.A.3.1.3 (a) Each **Network Operator** shall provide **The Company** with the data specified in PC.A.3.2.2(c)(i) and (ii) and PC.A.3.2.2(i).

(b) **Network Operators** need not submit planning data in respect of an **Embedded Small Power Station** unless required to do so under PC.A.1.2(b) or unless specifically requested under PC.A.3.1.4 below, in which case they will supply such data.

PC.A.3.1.4 (a) PC.A.4.2.4(b) and PC.A.4.3.2(a) explain that the forecast **Demand** submitted by each **Network Operator** must be net of the output of all **Embedded Small Power Stations** and **Embedded Medium Power Stations** and **Customer Generating Plant** and all installations of direct current converters which do not form a **DC Converter Station or HVDC System**, **Embedded** within that **Network Operator's System**. The **Network Operator** must inform **The Company** of:

(i) the number of such **Embedded Power Stations** and such **Embedded** installations of direct current converters (including the number of **Generating Units or Power Park Modules** (including **DC Connected Power Park Modules**) or **DC Converters or HVDC Systems**) together with their summated capacity; and

(ii) beginning from the 2015 Week 24 data submission, for each **Embedded Small Power Station** of registered capacity (as defined in the **Distribution Code**) of 1MW or more:

1. A reference which is unique to each **Network Operator**;

2. The production type as follows:

a) In the case of an **Embedded Small Power Station** first connected on or after 1 January 2015, the production type must be selected from the list below derived from the Manual of Procedures for the ENTSO-E Central Information Transparency Platform:

- Biomass;

- Fossil brown coal/lignite;

- Fossil coal-derived gas;
- Fossil gas;
- Fossil hard coal;
- Fossil oil;
- Fossil oil shale;
- Fossil peat;
- Geothermal;
- Hydro pumped storage;
- Hydro run-of-river and poundage;
- Hydro water reservoir;
- Marine;
- Nuclear;
- Other renewable;
- Solar;
- Waste;
- Wind offshore;
- Wind onshore; or
- Other;

together with a statement as to whether the generation forms part of a CHP scheme;

- b) In the case of an **Embedded Small Power Station** first connected to the **Users' System** before 1 January 2015, as an alternative to the production type, the technology type(s) used, selected from the list set out at paragraph 2.23 in Version 2 of the Regulatory Instructions and Guidance relating to the distributed generation incentive, innovation funding incentive and registered power zones, reference 83/07, published by Ofgem in April 2007;
3. The registered capacity (as defined in the **Distribution Code**) in MW;
 4. The lowest voltage level node that is specified on the most up-to-date **Single Line Diagram** to which it connects or where it will export most of its power;
 5. Where it generates electricity from wind or PV, the geographical location using either latitude or longitude or grid reference coordinates of the primary or higher voltage substation to which it connects;
 6. The reactive power and voltage control mode, including the voltage set-point and reactive range, where it operates in voltage control mode, or the target **Power Factor**, where it operates in **Power Factor** mode;
 7. Details of the types of loss of mains **Protection** in place and their relay settings which in the case of **Embedded Small Power Stations** first connected to the **Users' System** before 1 January 2015 shall be provided on a reasonable endeavours basis.

- (b) On receipt of this data, the **Network Operator** or **Generator** (if the data relates to **Power Stations** referred to in PC.A.3.1.2) may be further required, at **The Company's** reasonable discretion, to provide details of **Embedded Small Power Stations** and **Embedded Medium Power Stations** and **Customer Generating Plant** and **Embedded** installations of direct current converters which do not form a **DC Converter Station** or **HVDC System**, both current and forecast, as specified in PC.A.3.2 to PC.A.3.4. Such requirement would arise where **The Company** reasonably considers that the collective effect of a number of such **Embedded Power Stations** and **Customer Generating Plants** and **Embedded** installations of direct current converters may have a significant system effect on the **National Electricity Transmission System**.

Busbar Arrangements

PC.A.3.1.5 Where **Generating Units**, which term includes **CCGT Units** and **Synchronous Generating Units** within a **Synchronous Power Generating Module** and **Power Park Modules** (including **DC Connected Power Park Modules**), and **DC Converters**, and **HVDC Systems** are connected to the **National Electricity Transmission System** via a busbar arrangement which is or is expected to be operated in separate sections, the section of busbar to which each **Generating Unit** (including **Synchronous Generating Units** within a **Synchronous Power Generating Module**), **DC Converter**, **HVDC System** or **Power Park Module** (including **DC Connected Power Park Modules**) is connected is to be identified in the submission.

PC.A.3.2 Output Data

PC.A.3.2.1 (a) **Large Power Stations** and **Gensets**

Data items PC.A.3.2.2 (a), (b), (c), (d), (e), (f) and (h) are required with respect to each **Large Power Station** and each **Generating Unit** (including **Synchronous Generating Units** within a **Synchronous Power Generating Module**) and **Power Park Module** (including **DC Connected Power Park Modules**) of each **Large Power Station** and for each **Genset** (although (a) is not required for **CCGT Units** and (b), (d) and (e) are not normally required for **CCGT Units** and (a), (b), (c), (d), (e), (f) and (h) are not normally required for **Power Park Units**).

(b) **Embedded Small Power Stations** and **Embedded Medium Power Stations**

Data item PC.A.3.2.2 (a) is required with respect to each **Embedded Small Power Station** and **Embedded Medium Power Station** and each **Generating Unit** (including **Synchronous Generating Units** within a **Synchronous Power Generating Module**) and **Power Park Module** (including **DC Connected Power Park Modules**) of each **Embedded Small Power Station** and **Embedded Medium Power Station** (although (a) is not required for **CCGT Units** or **Power Park Units**). In addition, data item PC.A.3.2.2(c)(ii) is required with respect to each **Embedded Medium Power Station**.

(c) **CCGT Units/Modules**

- (i) Data item PC.A.3.2.2 (g) is required with respect to each **CCGT Unit**;
- (ii) data item PC.A.3.2.2 (a) is required with respect to each **CCGT Module**; and
- (iii) data items PC.A.3.2.2 (b), (c), (d) and (e) are required with respect to each **CCGT Module** unless **The Company** informs the relevant **User** in advance of the submission that it needs the data items with respect to each **CCGT Unit** for particular studies, in which case it must be supplied on a **CCGT Unit** basis.

Where any definition utilised or referred to in relation to any of the data items does not reflect **CCGT Units**, such definition shall be deemed to relate to **CCGT Units** for the purposes of these data items. Any **Schedule** in the DRC which refers to these data items shall be interpreted to incorporate the **CCGT Unit** basis where appropriate;

(d) **Cascade Hydro Schemes**

Data item PC.A.3.2.2(i) is required with respect to each **Cascade Hydro Scheme**.

(e) **Power Park Units/Modules**

Data items PC.A.3.2.2 (k) is required with respect to each **Power Park Module** (including **DC Connected Power Park Modules**).

(f) **DC Converters and HVDC Systems**

Data items PC.A.3.2.2 (a), (b), (c), (d) (e) (f) (h) and (i) are required with respect of each **HVDC System**, each **DC Converter Station** and each **DC Converter** in each **DC Converter Station**. For installations of direct current converters which do not form a **DC Converter Station** only data item PC.A.3.2.2.(a) is required.

PC.A.3.2.2 Items (a), (b), (d), (e), (f), (g), (h), (i), (j) and (k) are to be supplied by each **Generator, DC Converter Station owner, HVDC System Owner or Network Operator** (as the case may be) in accordance with PC.A.3.1.1, PC.A.3.1.2, PC.A.3.1.3 and PC.A.3.1.4. Items (a), and (f)(iv) are to be supplied (as applicable) by a **User** in the case of **OTSUA** which includes an **OTSDUW DC Converter**. Item (c) is to be supplied by each **Network Operator** in all cases:-

- (a) **Registered Capacity (MW), Maximum Capacity** (in the case of **Power Generating Modules** in addition to **Registered Capacity** on a **Power Station** basis) or **Interface Point Capacity** in the case of **OTSDUW**;
- (b) **Output Usable (MW)** on a monthly basis;
- (c) (i) **System Constrained Capacity (MW)** ie. any constraint placed on the capacity of the **Embedded Generating Unit** (including a **Synchronous Generating Unit** within a **Synchronous Power Generating Module**), **Embedded Power Park Module** (including **DC Connected Power Park Modules**) an **Offshore Transmission System** at an **Interface Point, Embedded HVDC System** or **DC Converter** at an **Embedded DC Converter Station** due to the **Network Operator's System** in which it is **Embedded**. Where **Generating Units** (which term includes **CCGT Units** and **Synchronous Generating Units** within a **Synchronous Power Generating Module**), **Power Park Modules** (including **DC Connected Power Park Modules**), **Offshore Transmission Systems** at an **Interface Point, HVDC Systems** or **DC Converters** are connected to a **Network Operator's User System** via a busbar arrangement which is or is expected to be operated in separate sections, details of busbar running arrangements and connected circuits at the substation to which the **Embedded Generating Unit** (including **Synchronous Generating Units** within a **Embedded Synchronous Power Generating Module**), **Embedded Power Park Module** (including **DC Connected Power Park Modules**), **Offshore Transmission System** at an **Interface Point, or Embedded HVDC System** or **Embedded DC Converter** is connected sufficient for **The Company** to determine where the MW generated by each **Generating Unit** (including **Synchronous Generating Units** within a **Synchronous Power Generating Module**), **Power Park Module** (including **DC Connected Power Park Modules**), **HVDC System** or **DC Converter** at that **Power Station** or **DC Converter Station** or **Offshore Transmission System** at an **Interface Point** would appear onto the **National Electricity Transmission System**;
- (ii) any **Reactive Despatch Network Restrictions**;
- (d) **Minimum Generation (MW)**, and in the case of **Power Generating Modules** only **Minimum Stable Operating Level (MW)** and **Minimum Regulating Level** ;
- (e) MW obtainable from **Generating Units** (including **Synchronous Generating Units** within a **Synchronous Power Generating Module**), **Power Park Modules** (including **DC Connected Power Park Modules**), **HVDC Systems** or **DC Converters** at a **DC Converter Station** in excess of **Registered Capacity** or **Maximum Capacity**;
- (f) **Generator Performance Chart**:
 - (i) **GB Code User(s)** in respect of **Generating Units** shall provide a **Generator Performance Chart** and **EU Code Users** in respect of **Power Generating Modules** shall provide a **Power Generating Module Performance Chart** and a **Synchronous Generating Unit Performance Chart** .
 - (ii) at the electrical point of connection to the **Offshore Transmission System** for an **Offshore Synchronous Generating Unit** and **Offshore Synchronous Power**

Generating Module.

(iii) at the electrical point of connection to the **National Electricity Transmission System** (or **User System** if **Embedded**) for a **Non Synchronous Generating Unit** (excluding a **Power Park Unit**), **Power Park Module** (including **DC Connected Power Park Modules**), **HVDC System** and **DC Converter** at a **DC Converter Station**;

(iv) at the **Interface Point** for **OTSDUW Plant and Apparatus**

Where a **Reactive Despatch Network Restriction** applies, its existence and details should be highlighted on the **Generator Performance Chart**, in sufficient detail for **The Company** to determine the nature of the restriction.

(g) a list of the **CCGT Units** within a **CCGT Module**, identifying each **CCGT Unit**, and the **CCGT Module** of which it forms part, unambiguously. In the case of a **Range CCGT Module**, details of the possible configurations should also be submitted, together:-

(i) (in the case of a **Range CCGT Module** connected to the **National Electricity Transmission System**) with details of the single **Grid Entry Point** (there can only be one) at which power is provided from the **Range CCGT Module**;

(ii) (in the case of an **Embedded Range CCGT Module**) with details of the single **User System Entry Point** (there can only be one) at which power is provided from the **Range CCGT Module**;

Provided that, nothing in this sub-paragraph (g) shall prevent the busbar at the relevant point being operated in separate sections;

(h) expected running regime(s) at each **Power Station**, **HVDC System** or **DC Converter Station** and type of **Power Generating Module** or **Generating Unit** (as applicable), eg. **Steam Unit**, **Gas Turbine Unit**, **Combined Cycle Gas Turbine Unit**, **Power Park Module** (including **DC Connected Power Park Modules**), **Novel Units** (specify by type), etc;

(i) a list of **Power Stations** and **Generating Units** within a **Cascade Hydro Scheme**, identifying each **Generating Unit** (including **Synchronous Generating Units** within a **Synchronous Power Generating Module**) and **Power Station** and the **Cascade Hydro Scheme** of which each form part unambiguously. In addition:

(i) details of the **Grid Entry Point** at which **Active Power** is provided, or if **Embedded** the **Grid Supply Point(s)** within which the **Generating Unit** (including **Synchronous Generating Units** within a **Synchronous Power Generating Module**) is connected;

(ii) where the **Active Power** output of a **Generating Unit** is split between more than one **Grid Supply Points** the percentage that would appear under normal and outage conditions at each **Grid Supply Point**.

(j) The following additional items are only applicable to **DC Converters** at **DC Converter Stations** and **HVDC Systems**.

Registered Import Capacity (MW);

Import Usable (MW) on a monthly basis;

Minimum Import Capacity (MW);

MW that may be absorbed by a **DC Converter** or **HVDC System** in excess of **Registered Import Capacity** and **Maximum HVDC Active Power Transmission Capacity** under importing conditions and the duration for which this is available;

- (k) the number and types of the **Power Park Units** within a **Power Park Module** (including **DC Connected Power Park Modules**), identifying each **Power Park Unit**, the **Power Park Module** of which it forms part and identifying the **BM Unit** of which each **Power Park Module** forms part, unambiguously. In the case of a **Power Station** directly connected to the **National Electricity Transmission System** with multiple **Power Park Modules** (including **DC Connected Power Park Modules**) where **Power Park Units** can be selected to run in different **Power Park Modules** and/or **Power Park Modules** can be selected to run in different **BM Units**, details of the possible configurations should also be submitted. In addition for **Offshore Power Park Modules** (including **DC Connected Power Park Modules**), the number of **Offshore Power Park Strings** that are aggregated into one **Offshore Power Park Module** should also be submitted.
- (l) the number and types of the **Synchronous Generating Units** within a **Synchronous Power Generating Module**, identifying each **Synchronous Generating Unit**, the **Synchronous Power Generating Module** of which it forms part and identifying the **BM Unit** of which each **Synchronous Power Generating Module** forms part, unambiguously. In the case of a **Power Station** directly connected to the **National Electricity Transmission System** with multiple **Synchronous Power Generating Modules** where **Synchronous Generating Units** can be selected to run in different **Synchronous Power Generating Modules** and/or **Synchronous Power Generating Modules** can be selected to run in different **BM Units**, details of the possible configurations should also be submitted.

PC.A.3.2.3 Notwithstanding any other provision of this PC, the **CCGT Units** within a **CCGT Module**, details of which are required under paragraph (g) of PC.A.3.2.2, can only be amended in accordance with the following provisions:-

- (a) if the **CCGT Module** is a **Normal CCGT Module**, the **CCGT Units** within that **CCGT Module** can only be amended such that the **CCGT Module** comprises different **CCGT Units** if **The Company** gives its prior consent in writing. Notice of the wish to amend the **CCGT Units** within such a **CCGT Module** must be given at least 6 months before it is wished for the amendment to take effect;
- (b) if the **CCGT Module** is a **Range CCGT Module**, the **CCGT Units** within that **CCGT Module** and the **Grid Entry Point** at which the power is provided can only be amended as described in BC1.A1.6.4.

PC.A.3.2.4 Notwithstanding any other provision of this PC, the **Power Park Units** within a **Power Park Module** (including **DC Connected Power Park Modules**), and the **Power Park Modules** (including **DC Connected Power Park Modules**) within a **BM Unit**, details of which are required under paragraph (k) of PC.A.3.2.2, can only be amended in accordance with the following provisions:-

- (a) if the **Power Park Units** within that **Power Park Module** can only be amended such that the **Power Park Module** comprises different **Power Park Units** due to repair/replacement of individual **Power Park Units** if **The Company** gives its prior consent in writing. Notice of the wish to amend a **Power Park Unit** within such a **Power Park Module** (including **DC Connected Power Park Modules**) must be given at least 4 weeks before it is wished for the amendment to take effect;
- (b) if the **Power Park Units** within that **Power Park Module** (including **DC Connected Power Park Modules**) and/or the **Power Park Modules** (including **DC Connected Power Park Modules**) within that **BM Unit** can be selected to run in different **Power Park Modules** and/or **BM Units** as an alternative operational running arrangement the **Power Park Units** within the **Power Park Module**, the **BM Unit** of which each **Power Park Module** forms part, and the **Grid Entry Point** at which the power is provided can only be amended as described in BC1.A.1.8.4.

PC.A.3.2.5 Notwithstanding any other provision of this PC, the **Synchronous Generating Units** within a **Synchronous Power Generating Module**, and the **Synchronous Power Generating Modules** within a **BM Unit**, details of which are required under paragraph (l) of PC.A.3.2.2, can only be amended in accordance with the following provisions:-

- (a) if the **Synchronous Generating Units** within that **Synchronous Power Generating Module** can only be amended such that the **Synchronous Power Generating Module** comprises different **Synchronous Generating Units** due to repair/replacement of individual **Synchronous Generating Units** if **The Company** gives its prior consent in writing. Notice of the wish to amend a **Synchronous Generating Unit** within such a **Synchronous Power Generating Module** must be given at least 4 weeks before it is wished for the amendment to take effect;
- (b) if the **Synchronous Generating Units** within that **Synchronous Power Generating Module** and/or the **Synchronous Power Generating Modules** within that **BM Unit** can be selected to run in different **Synchronous Power Generating Modules** and/or **BM Units** as an alternative operational running arrangement the **Synchronous Generating Units** within the **Synchronous Power Generating Module**, the **BM Unit** of which each **Synchronous Power Generating Module** forms part, and the **Grid Entry Point** at which the power is provided can only be amended as described in BC1.A.1.9.4(c). The requirements of PC.A.3.2.5 need not be satisfied if **Generators** have already submitted data in respect of PC.A.3.2.3, PC.A.3.2.4 and PC.A.3.2.5 for the same **Power Generating Module**.

PC.A.3.3. Rated Parameters Data

PC.A.3.3.1 The following information is required to facilitate an early assessment, by **The Company**, of the need for more detailed studies;

- (a) for all **Generating Units** (excluding **Power Park Units**) and **Power Park Modules** (including **DC Connected Power Park Modules**):

Rated MVA

Rated MW;

- (b) for each **Synchronous Generating Unit** (including **Synchronous Generating Units** within a **Synchronous Power Generating Module**):

Short circuit ratio

Direct axis transient reactance;

Inertia constant (for whole machine), MWsecs/MVA;

- (c) for each **Synchronous Generating Unit** step-up transformer (including the step up transformer of a **Synchronous Generating Unit** within a **Synchronous Power Generating Module**):

Rated MVA

Positive sequence reactance (at max, min and nominal tap);

- (d) for each **DC Converter** at a **DC Converter Station, HVDC System, DC Converter** connecting an existing **Power Park Module** (including **DC Connected Power Park Modules**) and **Transmission DC Converter** (forming part of an **OTSUA**).

DC Converter or **HVDC Converter** type (e.g. current/voltage sourced)

Rated MW per pole for import and export

Number of poles and pole arrangement

Rated DC voltage/pole (kV)

Return path arrangement

Remote AC connection arrangement (excluding **OTSDUW DC Converters**)

Maximum HVDC Active Power Transmission Capacity

Minimum Active Power Transmission Capacity

- (e) for each type of **Power Park Unit** in a **Power Park Module** not connected to the **Total System** by a **DC Converter** or **HVDC System**:

Rated MVA

Rated MW

Rated terminal voltage

Inertia constant, (MWsec/MVA)

Additionally, for **Power Park Units** that are squirrel-cage or doubly-fed induction generators driven by wind turbines:

Stator reactance.

Magnetising reactance.

Rotor resistance (at rated running)

Rotor reactance (at rated running)

The generator rotor speed range (minimum and maximum speeds in RPM) (for doubly-fed induction generators only)

Converter MVA rating (for doubly-fed induction generators only)

For a **Power Park Unit** consisting of a synchronous machine in combination with a back-to-back **DC Converter** or **HVDC Converter**, or for a **Power Park Unit** not driven by a wind turbine, the data to be supplied shall be agreed with **The Company** in accordance with PC.A.7.

This information should only be given in the data supplied in accordance with PC.4.4 and PC.4.5.

PC.A.3.4 General Generating Unit, Power Park Module (including **DC Connected Power Park Modules**), Power Generating Module, HVDC System and DC Converter Data

PC.A.3.4.1 The point of connection to the **National Electricity Transmission System** or the **Total System**, if other than to the **National Electricity Transmission System**, in terms of geographical and electrical location and system voltage is also required.

PC.A.3.4.2 (a) Type of **Generating Unit** (ie **Synchronous Power Generating Unit** within a **Power Generating Module**, **Synchronous Generating Unit**, **Non-Synchronous Generating Unit**, **DC Converter**, **Power Park Module** (including **DC Connected Power Park Modules**) or **HVDC System**).

(b) In the case of a **Synchronous Generating Unit** (including **Synchronous Generating Units** within a **Synchronous Power Generating Module**) details of the **Exciter** category, for example whether it is a rotating **Exciter** or a static **Exciter** or in the case of a **Non-Synchronous Generating Unit** the voltage control system.

(c) Whether a **Power System Stabiliser** is fitted.

PC.A.3.4.3 Each **Generator** shall supply **The Company** with the production type(s) used as the primary source of power in respect of each **Generating Unit** (including **Synchronous Generating Units** within a **Synchronous Power Generating Module**), selected from the list set out below:

- Biomass
- Fossil brown coal/lignite
- Fossil coal-derived gas
- Fossil gas
- Fossil hard coal
- Fossil oil
- Fossil oil shale
- Fossil peat
- Geothermal
- Hydro pumped storage

- Hydro run-of-river and poundage
- Hydro water reservoir
- Marine
- Nuclear
- Other renewable
- Solar
- Waste
- Wind offshore
- Wind onshore
- Other

PC.A.4 DEMAND AND ACTIVE ENERGY DATA

PC.A.4.1 Introduction

PC.A.4.1.1 Each **User** directly connected to the **National Electricity Transmission System** with **Demand** shall provide **The Company** with the **Demand** data, historic, current and forecast, as specified in PC.A.4.2 and PC.A.4.3. Paragraphs PC.A.4.1.2 and PC.A.4.1.3 apply equally to **Active Energy** requirements as to **Demand** unless the context otherwise requires.

PC.A.4.1.2 Data will need to be supplied by:

- (a) each **Network Operator**, in relation to **Demand** and **Active Energy** requirements on its **User System**;
- (b) each **Non-Embedded Customer** (including **Pumped Storage Generators** with respect to Pumping **Demand**) in relation to its **Demand** and **Active Energy** requirements.
- (c) each **DC Converter Station** owner or **HVDC System Owner** in relation to **Demand** and **Active Energy** transferred (imported) to its **DC Converter Station** or **HVDC System**.
- (d) each **OTSDUW DC Converter** in relation to the Demand at each **Interface Point** and **Connection Point**.

Demand of **Power Stations** directly connected to the **National Electricity Transmission System** is to be supplied by the **Generator** under PC.A.5.2.

PC.A.4.1.3 References in this **PC** to data being supplied on a half hourly basis refer to it being supplied for each period of 30 minutes ending on the hour or half-hour in each hour.

PC.A.4.1.4 **Access Periods** and **Access Groups**

PC.A.4.1.4.1 Each **Connection Point** must belong to one, and only one, **Access Group**.

PC.A.4.1.4.2 Each **Transmission Interface Circuit** must have an **Access Period**.

PC.A.4.1.4.3 The **Access Period** shall

- (a) normally be a minimum of 8 continuous weeks and can occur in any one of three maintenance years during the period from calendar week 13 to calendar week 43 (inclusive) in each year; or,
- (b) exceptionally and provided that agreement is reached between **The Company** and the relevant **User(s)**, such agreement to be sought in accordance with PC.7, the **Access Period** may be of a period not less than 4 continuous weeks and can occur in any one of three maintenance years during the period from calendar week 10 to calendar week 43 (inclusive) in each year.

PC.A.4.1.4.4 **The Company** shall submit in writing no later than calendar week 6 in each year:

- (a) the calendar weeks defining the proposed start and finish of each **Access Period** for each **Transmission Interface Circuit**; and

(b) the **Connection Points** in each **Access Group**.

The submission by **The Company** under PC.A.4.1.4.4 (a) above shall commence in 2010 and shall then continue each year thereafter. The submission by **The Company** under PC.A.4.1.4.4 (b) shall commence in 2009 and then continue each year thereafter.

PC.A.4.1.4.5 It is permitted for **Access Periods** to overlap in the same **Access Group** and in the same maintenance year. However, where possible **Access Periods** will be sought by **The Company** that do not overlap with any other **Access Period** within that **Access Group** for each maintenance year. Where it is not possible to avoid overlapping **Access Periods**, **The Company** will indicate to **Users** by calendar week 6 its initial view of which **Transmission Interface Circuits** will need to be considered out of service concurrently for the purpose of assessing compliance to **Licence Standards**. The obligation on **The Company** to indicate which **Transmission Interface Circuits** will need to be considered out of service concurrently for the purpose of assessing compliance to **Licence Standards** shall commence in 2010 and shall continue each year thereafter.

PC.A.4.1.4.6 Following the submission(s) by **The Company** by week 6 in each year and where required by either party, both **The Company** and the relevant **User(s)** shall use their reasonable endeavours to agree the appropriate **Access Group(s)** and **Access Period** for each **Transmission Interface Circuit** prior to week 17 in each year. The requirement on **The Company** and the relevant **User(s)** to agree, shall commence in respect of **Access Groups** only in 2010. This paragraph PC.A.4.1.4.6 shall apply in its entirety in 2011 and shall then continue each year thereafter.

PC.A.4.1.4.7 In exceptional circumstances, and with the agreement of all parties concerned, where a **Connection Point** is specified for the purpose of the **Planning Code** as electrically independent **Subtransmission Systems**, then data submissions can be on the basis of two (or more) individual **Connection Points**.

PC.A.4.2 User's User System Demand (Active Power) and Active Energy Data

PC.A.4.2.1 Forecast daily **Demand (Active Power)** profiles, as specified in (a), (b) and (c) below, in respect of each of the **User's User Systems** (each summated over all **Grid Supply Points** in each **User System**) are required for:

- (a) peak day on each of the **User's User Systems** (as determined by the **User**) giving the numerical value of the maximum **Demand (Active Power)** that in the **Users'** opinion could reasonably be imposed on the **National Electricity Transmission System**;
- (b) day of peak **National Electricity Transmission System Demand (Active Power)** as notified by **The Company** pursuant to PC.A.4.2.2;
- (c) day of minimum **National Electricity Transmission System Demand (Active Power)** as notified by **The Company** pursuant to PC.A.4.2.2.

In addition, the total **Demand (Active Power)** in respect of the time of peak **National Electricity Transmission System Demand** in the preceding **Financial Year** in respect of each of the **User's User Systems** (each summated over all **Grid Supply Points** in each **User System**) both outturn and weather corrected shall be supplied.

PC.A.4.2.2 No later than calendar week 17 each year **The Company** shall notify each **Network Operator** and **Non-Embedded Customer** in writing of the following, for the current **Financial Year** and for each of the following seven **Financial Years**, which will, until replaced by the following year's notification, be regarded as the relevant specified days and times under PC.A.4.2.1:

- (a) the date and time of the annual peak of the **National Electricity Transmission System Demand**;
- (b) the date and time of the annual minimum of the **National Electricity Transmission System Demand**;
- (c) the relevant **Access Period** for each **Transmission Interface Circuit**; and,
- (d) Concurrent **Access Periods** of two or more **Transmission Interface Circuits** (if any) that are situated in the same **Access Group**.

The submissions by **The Company** made under PC.A.4.2.1 (c) and PC.A.4.2.1 (d) above shall commence in 2010 and shall then continue in respect of each year thereafter.

PC.A.4.2.3 The total **Active Energy** used on each of the **Network Operators'** or **Non-Embedded Customers' User Systems** (each summated over all **Grid Supply Points** in each **User System**) in the preceding **Financial Year**, both outturn and weather corrected, together with a prediction for the current financial year, is required. Each **Active Energy** submission shall be subdivided into the following categories of **Customer** tariff:

LV1

LV2

LV3

HV

EHV

Traction

Lighting

In addition, the total **User System** losses and the **Active Energy** provided by **Embedded Small Power Stations** and **Embedded Medium Power Stations** shall be supplied.

PC.A.4.2.4 All forecast **Demand (Active Power)** and **Active Energy** specified in PC.A.4.2.1 and PC.A.4.2.3 shall:

- (a) in the case of PC.A.4.2.1(a), (b) and (c), be such that the profiles comprise average **Active Power** levels in 'MW' for each time marked half hour throughout the day;
- (b) in the case of PC.A.4.2.1(a), (b) and (c), be that remaining after any deductions reasonably considered appropriate by the **User** to take account of the output profile of all **Embedded Small Power Stations** and **Embedded Medium Power Stations** and **Customer Generating Plant** and imports across **Embedded External Interconnections** including imports across **Embedded** installations of direct current converters which do not form a **DC Converter Station** or **HVDC System** and **Embedded DC Converter Stations** and **Embedded HVDC Systems** with a **Registered Capacity** or **HVDC Active Power Transmission Capacity** of less than 100MW;
- (c) be based upon **Annual ACS Conditions** for times that occur during week 44 through to week 12 (inclusive) and based on **Average Conditions** for weeks 13 to 43 (inclusive).

PC.A.4.3 Connection Point Demand (Active and Reactive Power)

PC.A.4.3.1 Forecast **Demand (Active Power)** and **Power Factor** (values of the **Power Factor** at maximum and minimum continuous excitation may be given instead where more than 95% of the total **Demand** at a **Connection Point** is taken by synchronous motors) to be met at each **Connection Point** within each **Access Group** is required for:

- (a) the time of the maximum **Demand (Active Power)** at the **Connection Point** (as determined by the **User**) that in the **User's** opinion could reasonably be imposed on the **National Electricity Transmission System**;
- (b) the time of peak **National Electricity Transmission System Demand** as provided by **The Company** under PC.A.4.2.2;
- (c) the time of minimum **National Electricity Transmission System Demand** as provided by **The Company** under PC.A.4.2.2;
- (d) the time of the maximum **Demand (Apparent Power)** at the **Connection Point** (as determined by the **User**) during the **Access Period** of each **Transmission Interface Circuit**;
- (e) at a time specified by either **The Company** or a **User** insofar as such a request is reasonable.

Instead of such forecast **Demand** to be met at each **Connection Point** within each **Access Group** the **User** may (subject to PC.A.4.3.4) submit such **Demand** at each node on the **Single Line Diagram**.

In addition, the **Demand** in respect of each of the time periods referred to in PC.A.4.3.1 (a) to (e) in the preceding **Financial Year** in respect of each **Connection Point** within each **Access Group** both outturn and weather corrected shall be supplied. The "weather correction" shall normalise outturn figures to **Annual ACS Conditions** for times that occur during calendar week 44 through to calendar week 12 (inclusive) or **Average Conditions** for the period calendar weeks 13 to calendar week 43 (inclusive) and shall be performed by the relevant **User** on a best endeavours basis.

The submission by a **User** pursuant to PC.A.4.3.1 (d) shall commence in 2011 and shall then continue each year thereafter.

PC.A.4.3.2 All forecast **Demand** specified in PC.A.4.3.1 shall:

- (a) be that remaining after any deductions reasonably considered appropriate by the **User** to take account of the output of all **Embedded Small Power Stations** and **Embedded Medium Power Stations** and **Customer Generating Plant** and imports across **Embedded External Interconnections**, including **Embedded** installations of direct current converters which do not form a **DC Converter Station**, **HVDC System** and **Embedded DC Converter Stations** and **Embedded HVDC Systems** and such deductions should be separately stated;
- (b) include any **User's System** series reactive losses but exclude any reactive compensation equipment specified in PC.A.2.4 and exclude any network susceptance specified in PC.A.2.3;
- (c) be based upon **Annual ACS Conditions** for times that occur during calendar week 44 through to calendar week 12 (inclusive) and based on **Average Conditions** for calendar weeks 13 to calendar week 43 (inclusive), both corrections being made on a best endeavours basis;
- (d) reflect the **User's** opinion of what could reasonably be imposed on the **National Electricity Transmission System**.

PC.A.4.3.3 The date and time of the forecast maximum **Demand (Apparent Power)** at the **Connection Point** as specified in PC.A.4.3.1 (a) and (d) is required.

PC.A.4.3.4 Each **Single Line Diagram** provided under PC.A.2.2.2 shall include the **Demand (Active Power)** and **Power Factor** (values of the **Power Factor** at maximum and minimum continuous excitation may be given instead where more than 95% of the **Demand** is taken by synchronous motors) at the time of the peak **National Electricity Transmission System Demand** (as provided under PC.A.4.2.2) at each node on the **Single Line Diagram**. These **Demands** shall be consistent with those provided under PC.A.4.3.1(b) above for the relevant year.

PC.A.4.3.5 The **Single Line Diagram** must represent the **User's User System** layout under the period specified in PC.A.4.3.1(b) (at the time of peak **National Electricity Transmission System Demand**). Should the **User's User System** layout during the other times specified in PC.A.4.3.1 be planned to be materially different from the **Single Line Diagram** submitted to **The Company** pursuant to PC.A.2.2.1 the **User** shall in respect of such other times submit:

- (i) an alternative **Single Line Diagram** that accurately reflects the revised layout and in such case shall also include appropriate associated data representing the relevant changes, or;
- (ii) submit an accurate and unambiguous description of the changes to the **Single Line Diagram** previously submitted for the time of peak **National Electricity Transmission System Demand**.

Where a **User** does not submit any changes, **The Company** will assume that the **Single Line Diagram** (and associated circuit and node data) provided at the time of peak **National Electricity Transmission System Demand** will be valid for all other times. In respect of such other times, where the **User** does not submit such nodal demands at the times defined in PC.A.4.3.1(a), (c), (d) and (e), the nodal demands will be pro-rata, to be consistent with the submitted **Connection Point Demands**.

PC.A.4.4 **The Company** will assemble and derive in a reasonable manner, the forecast information supplied to it under PC.A.4.2.1, PC.A.4.3.1, PC.A.4.3.4 and PC.A.4.3.5 above into a cohesive forecast and will use this in preparing **Forecast Demand** information in the **Seven Year Statement** and for use in **The Company's Operational Planning**. If any **User** believes that the cohesive forecast **Demand** information in the **Seven Year Statement** does not reflect its assumptions on **Demand**, it should contact **The Company** to explain its concerns and may require **The Company**, on reasonable request, to discuss these forecasts. In the absence of such expressions, **The Company** will assume that **Users** concur with **The Company's** cohesive forecast.

PC.A.4.5 Post Fault User System Layout

PC.A.4.5.1 Where for the purposes of **The Company** assessing against the Licence Standards an **Access Group**, the **User** reasonably considers it appropriate that revised post fault **User System** layouts should be taken into account by **The Company**, the following information is required to be submitted by the **User**:

- (i) the specified **Connection Point** assessment period (PC.A.4.3.1,(a)-(e)) that is being evaluated;
- (ii) an accurate and unambiguous description of the **Transmission Interface Circuits** considered to be switched out due to a fault;
- (iii) appropriate revised **Single Line Diagrams** and/or associated revised nodal **Demand** and circuit data detailing the revised **User System(s)** conditions;
- (iv) where the **User's** planned post fault action consists of more than one component, each component must be explicitly identified using the **Single Line Diagram** and associated nodal **Demand** and circuit data;
- (v) the arrangements for undertaking actions (eg the time taken, automatic or manual and any other appropriate information);.

The **User** must not submit any action that it does not have the capability or the intention to implement during the assessment period specified (subject to there being no further unplanned outages on the **User's User System**).

PC.A.4.6 Control of Demand or Reduction of Pumping Load Offered as Reserve

Magnitude of Demand or pumping load which is tripped	MW
System Frequency at which tripping is initiated	Hz
Time duration of System Frequency below trip setting for tripping to be initiated	s
Time delay from trip initiation to tripping	s

PC.A.4.7 General Demand Data

PC.A.4.7.1 The following information is infrequently required and should be supplied (wherever possible) when requested by **The Company**:

- (a) details of any individual loads which have characteristics significantly different from the typical range of Domestic, Commercial or Industrial loads supplied;
- (b) the sensitivity of the **Demand (Active and Reactive Power)** to variations in voltage and **Frequency** on the **National Electricity Transmission System** at the time of the peak **Demand (Active Power)**. The sensitivity factors quoted for the **Demand (Reactive Power)** should relate to that given under PC.A.4.3.1 and, therefore, include any **User's System** series reactive losses but exclude any reactive compensation equipment specified in PC.A.2.4 and exclude any network susceptance specified in PC.A.2.3;

- (c) details of any traction loads, e.g. connection phase pairs and continuous load variation with time;
- (d) the average and maximum phase unbalance, in magnitude and phase angle, which the **User** would expect its **Demand** to impose on the **National Electricity Transmission System**;
- (e) the maximum harmonic content which the **User** would expect its **Demand** to impose on the **National Electricity Transmission System**;
- (f) details of all loads which may cause **Demand** fluctuations greater than those permitted under **Engineering Recommendation P28**, Stage 1 at a **Point of Common Coupling** including the **Flicker Severity (Short Term)** and the **Flicker Severity (Long Term)**.

PART 2 - DETAILED PLANNING DATA

PC.A.5 POWER GENERATING MODULE, GENERATING UNIT, POWER PARK MODULE (INCLUDING DC CONNECTED POWER PARK MODULES), DC CONVERTER, HVDC EQUIPMENT AND OTSDUW PLANT AND APPARATUS DATA

PC.A.5.1 Introduction

Directly Connected

PC.A.5.1.1 Each **Generator** (including those undertaking **OTSDUW**), with existing or proposed **Power Stations** directly connected, or to be directly connected, to the **National Electricity Transmission System**, shall provide **The Company** with data relating to that **Plant** and **Apparatus**, both current and forecast, as specified in PC.A.5.2, PC.A.5.3, PC.A.5.4 and PC.A.5.7 as applicable.

Each **DC Converter Station** owner or **HVDC System Owner**, with existing or proposed **DC Converter Stations** or **HVDC Systems** (including **Generators** undertaking **OTSDUW** which includes an **OTSDUW DC Converter**) directly connected, or to be directly connected, to the **National Electricity Transmission System**, shall provide **The Company** with data relating to that **Plant** and **Apparatus**, both current and forecast, as specified in PC.A.5.2 and PC.A.5.4.

GB Generators, **DC Converter Station** owners, **EU Generators** and **HVDC System Owners** shall ensure that the models supplied in respect of their **Plant** and **Apparatus** provide a true and accurate behaviour of the plant as built as required under PC.A.5.3.2(c), PC.A.5.4.2(a) and PC.A.5.4.3 and verified through the **Compliance Processes (CP)** or **European Compliance Processes (ECP)** as applicable.

Embedded

PC.A.5.1.2 Each **Generator**, in respect of its existing, or proposed, **Embedded Large Power Stations** and its **Embedded Medium Power Stations** subject to a **Bilateral Agreement** and each **Network Operator** in respect of **Embedded Medium Power Stations** not subject to a **Bilateral Agreement** within its **System** shall provide **The Company** with data relating to each of those **Large Power Stations** and **Medium Power Stations**, both current and forecast, as specified in PC.A.5.2, PC.A.5.3, PC.A.5.4 and PC.A.5.7 as applicable.

Each **DC Converter Station** owner or **HVDC System Owner**, or **Network Operator** in the case of an **Embedded DC Converter Station** or **Embedded HVDC System** not subject to a **Bilateral Agreement** within its **System** with existing or proposed **HVDC Systems** or **DC Converter Stations** shall provide **The Company** with data relating to each of those **HVDC Systems** or **DC Converter Stations**, both current and forecast, as specified in PC.A.5.2 and PC.A.5.4.

However, no data need be supplied in relation to those **Embedded Medium Power Stations** or **Embedded DC Converter Stations** or **Embedded HVDC Systems** if they are connected at a voltage level below the voltage level of the **Subtransmission System** except in connection with an application for, or under a, **CUSC Contract** or unless specifically requested by **The Company** under PC.A.5.1.4.

GB Generators, **DC Converter Station** owners, **EU Generators** and **HVDC System Owners** shall ensure that the models supplied in respect of their **Plant** and **Apparatus** provide a true and accurate behaviour of the plant as built as required under PC.A.5.3.2(c), PC.A.5.4.2(a) and PC.A.5.4.3 and verified through the **Compliance Processes (CP)** or **European Compliance Processes (ECP)** as applicable

PC.A.5.1.3 Each **Network Operator** need not submit **Planning Data** in respect of **Embedded Small Power Stations** unless required to do so under PC.A.1.2(b), PC.A.3.1.4 or unless specifically requested under PC.A.5.1.4 below, in which case they will supply such data.

PC.A.5.1.4 PC.A.4.2.4(b) and PC.A.4.3.2(a) explained that the forecast **Demand** submitted by each **Network Operator** must be net of the output of all **Medium Power Stations** and **Small Power Stations** and **Customer Generating Plant Embedded** within that **User's System**. In such cases, the **Network Operator** must provide **The Company** with the relevant information specified under PC.A.3.1.4 . On receipt of this data further details may be required at **The Company's** discretion as follows:

- (i) in the case of details required from the **Network Operator** for **Embedded Medium Power Stations** not subject to a **Bilateral Agreement** and **Embedded DC Converter Stations** not subject to a **Bilateral Agreement** and **Embedded HVDC Systems** not subject to a **Bilateral Agreement** and **Embedded Small Power Stations** and **Embedded DC Converters** and **Embedded HVDC Systems** in each case within such **Network Operator's System** and **Customer Generating Plant**; and
- (ii) in the case of details required from the **Generator** of **Embedded Large Power Stations** and **Embedded Medium Power Stations** subject to a **Bilateral Agreement**; and
- (iii) in the case of details required from the **DC Converter Station** owner of an **Embedded DC Converter** or **DC Converter Station** or **HVDC System Owner** of an **Embedded HVDC System Owner** subject to a **Bilateral Agreement**.

both current and forecast, as specified in PC.A.5.2 and PC.A.5.3. Such requirement would arise when **The Company** reasonably considers that the collective effect of a number of such **Embedded Small Power Stations**, **Embedded Medium Power Stations**, **Embedded DC Converter Stations**, **Embedded HVDC Systems**, **DC Converters** and **Customer Generating Plants** may have a significant system effect on the **National Electricity Transmission System**.

PC.A.5.1.5 DPD I and DPD II

The **Detailed Planning Data** described in this Part 2 of the Appendix comprises both **DPD I** and **DPD II**. The required data is listed and collated in the **Data Registration Code**. The **Users** need to refer to the **DRC** to establish whether data referred to here is **DPD I** or **DPD II**.

PC.A.5.2 Demand

PC.A.5.2.1 For each **Generating Unit** (including **Synchronous Generating Units** within a **Synchronous Power Generating Module**) which has an associated **Unit Transformer**, the value of the **Demand** supplied through this **Unit Transformer** when the **Generating Unit** is at **Rated MW** output is to be provided.

PC.A.5.2.2 Where the **Power Station** or **DC Converter Station** or **HVDC System** has associated **Demand** additional to the unit-supplied **Demand** of PC.A.5.2.1 which is supplied from either the **National Electricity Transmission System** or the **Generator's User System** the **Generator**, **DC Converter Station** owner, **HVDC System Owner** or the **Network Operator** (in the case of **Embedded Medium Power Stations** not subject to a **Bilateral Agreement** within its **System**), as the case may be, shall supply forecasts for each **Power Station** or **DC Converter Station** or **HVDC System** of:

- (a) the maximum **Demand** that, in the **User's** opinion, could reasonably be imposed on the **National Electricity Transmission System** or the **Generator's User System** as appropriate;
- (b) the **Demand** at the time of the peak **National Electricity Transmission System Demand**
- (c) the **Demand** at the time of minimum **National Electricity Transmission System Demand**.

PC.A.5.2.3 No later than calendar week 17 each year **The Company** shall notify each **Generator** in respect of its **Large Power Stations** and its **Medium Power Stations** and its directly connected Small Power Stations comprising of a Type C or Type D Power Generating Module and each **DC Converter** owner in respect of its **DC Converter Station** and each **HVDC System Owner** in respect of its **HVDC System** subject to a **Bilateral Agreement** and each **Network Operator** in respect of each **Embedded Medium Power Station** not subject to a **Bilateral Agreement** and each **Embedded DC Converter Station** or **Embedded HVDC System** not subject to a **Bilateral Agreement** within such **Network Operator's System** in writing of the following, for the current **Financial Year** and for each of the following seven **Financial Years**, which will be regarded as the relevant specified days and times under PC.A.5.2.2:

- (a) the date and time of the annual peak of the **National Electricity Transmission System Demand** at **Annual ACS Conditions**;
- (b) the date and time of the annual minimum of the **National Electricity Transmission System Demand** at **Average Conditions**.

PC.A.5.2.4 At its discretion, **The Company** may also request further details of the **Demand** as specified in PC.A.4.6

PC.A.5.2.5 In the case of **OTSDUW Plant and Apparatus** the following data shall be supplied:

- (a) The maximum **Demand** that could occur at the **Interface Point** and each **Connection Point** (in MW and MVA);
- (b) **Demand** at specified time of annual peak half hour of **National Electricity Transmission System Demand** at **Annual ACS Conditions** (in MW and MVA); and
- (c) **Demand** at specified time of annual minimum half-hour of **National Electricity Transmission System Demand** (in MW and MVA).

For the avoidance of doubt, **Demand** data associated with **Generators** undertaking **OTSDUW** which utilise an **OTSDUW DC Converter** should supply data under PC.A.4.

PC.A.5.3 Synchronous Power Generating Modules, Synchronous Generating Unit and Associated Control System Data

PC.A.5.3.1 The data submitted below are not intended to constrain any **Ancillary Services Agreement**

PC.A.5.3.2 The following **Synchronous Generating Unit** (including **Synchronous Generating Units** within a **Synchronous Power Generating Module**) and **Power Station** data should be supplied:

- (a) **Synchronous Generating Unit** Parameters

Rated terminal volts (kV)

Maximum terminal voltage set point (kV)

Terminal voltage set point step resolution – if not continuous (kV)

* Rated MVA

* **Rated MW**

* Minimum Generation MW

* Short circuit ratio

Direct axis synchronous reactance

* Direct axis transient reactance

Direct axis sub-transient reactance

Direct axis short-circuit transient time constant.

Direct axis short-circuit sub-transient time constant.

Quadrature axis synchronous reactance
Quadrature axis sub-transient reactance
Quadrature axis short-circuit sub-transient time constant.
Stator time constant
Stator leakage reactance
Armature winding direct-current resistance.

Note: The above data item relating to armature winding direct-current resistance need only be supplied with respect to **Generating Units** commissioned after 1st March 1996 and in cases where, for whatever reason, the **Generator** or the **Network Operator**, as the case may be is aware of the value of the relevant parameter.

- * Turbogenerator inertia constant (MWsec/MVA)
Rated field current (amps) at **Rated MW** and MVA_r output and at rated terminal voltage.
Field current (amps) open circuit saturation curve for **Generating Unit** terminal voltages ranging from 50% to 120% of rated value in 10% steps as derived from appropriate manufacturers test certificates.

(b) Parameters for **Generating Unit** Step-up Transformers

- * Rated MVA
Voltage ratio
- * Positive sequence reactance (at max, min, & nominal tap)
Positive sequence resistance (at max, min, & nominal tap)
Zero phase sequence reactance
Tap changer range
Tap changer step size
Tap changer type: on load or off circuit

(c) Excitation Control System parameters

Note: The data items requested under Option 1 below may continue to be provided in relation to **Generating Units** connected to the **System** at 09 January 1995 (in this paragraph, the "relevant date") or the new data items set out under Option 2 may be provided. **Generators** or **Network Operators**, as the case may be, must supply the data as set out under Option 2 (and not those under Option 1) for **Generating Unit** excitation control systems commissioned after the relevant date, those **Generating Unit** excitation control systems recommissioned for any reason such as refurbishment after the relevant date and **Generating Unit** excitation control systems where, as a result of testing or other process, the **Generator** or **Network Operator**, as the case may be, is aware of the data items listed under Option 2 in relation to that **Generating Unit**.

Option 1

DC gain of Excitation Loop
Rated field voltage
Maximum field voltage
Minimum field voltage
Maximum rate of change of field voltage (rising)
Maximum rate of change of field voltage (falling)

Details of Excitation Loop described in block diagram form showing transfer functions of individual elements.

Dynamic characteristics of **Over-excitation Limiter**.

Dynamic characteristics of **Under-excitation Limiter**

Option 2

Excitation System Nominal Response

Rated Field Voltage

No-Load Field Voltage

Excitation System On-Load Positive Ceiling Voltage

Excitation System No-Load Positive Ceiling Voltage

Excitation System No-Load Negative Ceiling Voltage

Stator Current Limiter (applicable only to **Synchronous Power Generating Modules**)

Details of **Excitation System** (including **PSS** if fitted) described in block diagram form showing transfer functions of individual elements.

Details of **Over-excitation Limiter** described in block diagram form showing transfer functions of individual elements.

Details of **Under-excitation Limiter** described in block diagram form showing transfer functions of individual elements.

The block diagrams submitted after 1 January 2009 in respect of the **Excitation System** (including the **Over-excitation Limiter** and the **Under-excitation Limiter**) for **Generating Units** with a **Completion date** after 1 January 2009 or subject to a **Modification** to the **Excitation System** after 1 January 2009, should have been verified as far as reasonably practicable by simulation studies as representing the expected behaviour of the system.

(d) Governor Parameters

Incremental Droop values (in %) are required for each **Generating Unit** at six MW loading points (MLP1 to MLP6) as detailed in PC.A.5.5.1 (this data item needs only be provided for **Large Power Stations** and directly connected **Medium Power Stations** comprising **Type C** or **Type D Power Generating Modules** and directly connected **Small Power Stations** comprising **Type C** or **Type D Power Generating Modules**))

Note: The data items requested under Option 1 below may continue to be provided by **Generators** in relation to **Generating Units** on the **System** at 09 January 1995 (in this paragraph, the "relevant date") or they may provide the new data items set out under Option 2. **Generators** must supply the data as set out under Option 2 (and not those under Option 1) for **Generating Unit** governor control systems commissioned after the relevant date, those **Generating Unit** governor control systems recommissioned for any reason such as refurbishment after the relevant date and **Generating Unit** governor control systems where, as a result of testing or other process, the **Generator** is aware of the data items listed under Option 2 in relation to that **Generating Unit**. **EU Generators** are also required to submit the data as set out in option 2. Additional data required from **EU Generators** which own or operate **Type C** or **Type D Power Generating Modules** are marked in brackets with an asterisk (eg (*)). For the avoidance of doubt, items marked as (*) need not be supplied by **GB Generators**.

Option 1

(i) Governor Parameters (for Reheat **Steam Units**)

HP governor average gain MW/Hz

Speeder motor setting range

HP governor valve time constant
HP governor valve opening limits
HP governor valve rate limits
Reheater time constant (**Active Energy** stored in reheater)

IP governor average gain MW/Hz
IP governor setting range
IP governor valve time constant
IP governor valve opening limits
IP governor valve rate limits

Details of acceleration sensitive elements in HP & IP governor loop.
A governor block diagram showing transfer functions of individual elements.

(ii) Governor Parameters (for Non-Reheat **Steam Units** and **Gas Turbine Units**)

Governor average gain
Speeder motor setting range
Time constant of steam or fuel governor valve
Governor valve opening limits
Governor valve rate limits
Time constant of turbine
Governor block diagram

The following data items need only be supplied for **Large Power Stations** and directly connected **Medium Power Stations** comprising **Type C** or **Type D Power Generating Modules** and directly connected **Small Power Stations** comprising **Type C** or **Type D Power Generating Modules**:

(iii) Boiler & Steam Turbine Data

Boiler Time Constant (Stored Active Energy)	s
HP turbine response ratio:	
proportion of Primary Response arising from HP turbine	%
HP turbine response ratio:	
proportion of High Frequency Response arising from HP turbine	%

[End of Option 1]

Option 2

(i) Governor and associated prime mover Parameters - All **Generating Units** (including **Synchronous Generating Units** within a **Synchronous Power Generating Module**)

Governor Block Diagram showing transfer function of individual elements including acceleration sensitive elements.

Governor Time Constant (in seconds)

Speeder Motor Setting Range (%)

Average Gain (MW/Hz)

Governor Deadband (and **Governor Insensitivity Governor Deadband***) need only be provided for **Large Power Stations** and directly connected Medium Power Stations comprising Type C or Type D Power Generating Modules and directly connected Small Power Stations comprising Type C and Type D Power Generating Modules (and both **Governor Deadband** and **Governor Insensitivity** should be supplied by EU Generators in respect of **Type C** and **D Power Generating Modules** within **Large Power Station** and **Medium Power Stations** excluding **Embedded Medium Power Stations** not subject to a **Bilateral Agreement***)

- Maximum Setting ±Hz
- Normal Setting ±Hz
- Minimum Setting ±Hz

Where the **Generating Unit** governor does not have a selectable **Governor Deadband** (or **Governor Insensitivity***) facility as specified above, then the actual value of the **Governor Deadband** (or **Governor Insensitivity***) need only be provided.

The block diagrams submitted after 1 January 2009 in respect of the Governor system for **Generating Units** with a **Completion date** after 1 January 2009 or subject to a **Modification** to the governor system after 1 January 2009, should have been verified as far as reasonably practicable by simulation studies as representing the expected behaviour of the system.

(ii) Governor and associated prime mover Parameters - **Steam Units**

- HP Valve Time Constant (in seconds)
- HP Valve Opening Limits (%)
- HP Valve Opening Rate Limits (%/second)
- HP Valve Closing Rate Limits (%/second)
- HP Turbine Time Constant (in seconds)

- IP Valve Time Constant (in seconds)
- IP Valve Opening Limits (%)
- IP Valve Opening Rate Limits (%/second)
- IP Valve Closing Rate Limits (%/second)
- IP Turbine Time Constant (in seconds)

- LP Valve Time Constant (in seconds)
- LP Valve Opening Limits (%)
- LP Valve Opening Rate Limits (%/second)
- LP Valve Closing Rate Limits (%/second)
- LP Turbine Time Constant (in seconds)
- Reheater Time Constant (in seconds)
- Boiler Time Constant (in seconds)
- HP Power Fraction (%)
- IP Power Fraction (%)

(iii) Governor and associated prime mover Parameters - **Gas Turbine Units**

- Inlet Guide Vane Time Constant (in seconds)
- Inlet Guide Vane Opening Limits (%)
- Inlet Guide Vane Opening Rate Limits (%/second)
- Inlet Guide Vane Closing Rate Limits (%/second)
- Fuel Valve Constant (in seconds)
- Fuel Valve Opening Limits (%)
- Fuel Valve Opening Rate Limits (%/second)
- Fuel Valve Closing Rate Limits (%/second)
- Waste Heat Recovery Boiler Time Constant (in seconds)

(iv) Governor and associated prime mover Parameters - Hydro Generating Units

- Guide Vane Actuator Time Constant (in seconds)
- Guide Vane Opening Limits (%)
- Guide Vane Opening Rate Limits (%/second)
- Guide Vane Closing Rate Limits (%/second)
- Water Time Constant (in seconds)

[End of Option 2]

(e) Unit Control Options

The following data items need only be supplied with respect to **Large Power Stations and directly connected Medium Power Stations comprising Type C or Type D Power Generating Modules and directly connected Small Power Stations comprising Type C or Type D Power Generating Modules:**

Maximum Droop	%
Normal Droop	%
Minimum Droop	%
Maximum Governor Deadband (and Governor Insensitivity*)	±Hz
Normal Governor Deadband (and Governor Insensitivity*)	±Hz
Minimum Governor Deadband (and Governor Insensitivity*)	±Hz
Maximum output Governor Deadband (and Governor Insensitivity*)	±MW
Normal output Governor Deadband (and Governor Insensitivity*)	±MW
Minimum output Governor Deadband (and Governor Insensitivity*)	±MW

Frequency settings between which Unit Load Controller **Droop** applies:

- Maximum Hz
- Normal Hz
- Minimum Hz

State if sustained response is normally selected.

(* **GB Generators** which are not required to satisfy the requirements of the **European Connection Conditions** are not required to supply **Governor Insensitivity** data).

(f) Plant Flexibility Performance

The following data items need only be supplied with respect to **Large Power Stations**, ~~and should be provided~~ with respect to each **Genset**:

- # Run-up rate to **Registered Capacity**,
- # Run-down rate from **Registered Capacity**,
- # **Synchronising Generation**,
Regulating range
Load rejection capability while still **Synchronised** and able to supply **Load**.

Data items marked with a hash (#) should be applicable to a **Genset** which has been **Shutdown** for 48 hours.

- * Data items marked with an asterisk are already requested under partx1, PC.A.3.3.1, to facilitate an early assessment by **The Company** as to whether detailed stability studies will be required before an offer of terms for a **CUSC Contract** can be made. Such data items have been repeated here merely for completeness and need not, of course, be resubmitted unless their values, known or estimated, have changed.

(g) Generating Unit Mechanical Parameters

It is occasionally necessary for **The Company** to assess the interaction between the **Total System** and the mechanical components of **Generating Units**. For **Generating Units** (including **Synchronous Generating Units** within a **Synchronous Power Generating Module**) with a **Completion Date** on or after 01 April 2015, the following data items should be supplied:

The number of turbine generator masses.

Diagram showing the Inertia and parameters for each turbine generator mass (kgm²) and Stiffness constants and parameters between each turbine generator mass for the complete drive train (Nm/rad).

Number of poles.

Relative power applied to different parts of the turbine (%).

Torsional mode frequencies (Hz).

Modal damping decrement factors for the different mechanical modes.

PC.A.5.4 Power Park Module, Non-Synchronous Generating Unit and Associated Control System Data

PC.A.5.4.1 The data submitted below are not intended to constrain any **Ancillary Services Agreement**

PC.A.5.4.2 The following **Power Park Unit**, **Power Park Module** and **Power Station** data should be supplied in the case of a **Power Park Module** not connected to the **Total System** by a **DC Converter** or **HVDC System** (and in the case of PC.A.5.4.2(f) any **OTSUA**):

Where a **Manufacturer's Data & Performance Report** exists in respect of the model of the **Power Park Unit**, the **User** may subject to **The Company's** agreement, opt to reference the **Manufacturer's Data & Performance Report** as an alternative to the provision of data in accordance with PC.A.5.4.2 except for:

- (1) the section marked thus # at sub paragraph (b); and
- (2) all of the harmonic and flicker parameters required under sub paragraph (h); and

- (3) all of the site specific model parameters relating to the voltage or frequency control systems required under sub paragraphs (d) and (e),

which must be provided by the **User** in addition to the **Manufacturer's Data & Performance Report** reference.

(a) **Power Park Unit** model

A mathematical model of each type of **Power Park Unit** capable of representing its transient and dynamic behaviour under both small and large disturbance conditions. The model shall include non-linear effects and represent all equipment relevant to the dynamic performance of the **Power Park Unit** as agreed with **The Company**. The model shall be suitable for the study of balanced, root mean square, positive phase sequence time-domain behaviour, excluding the effects of electromagnetic transients, harmonic and sub-harmonic frequencies.

The model shall accurately represent the overall performance of the **Power Park Unit** over its entire operating range including that which is inherent to the **Power Park Unit** and that which is achieved by use of supplementary control systems providing either continuous or stepwise control. Model resolution should be sufficient to accurately represent **Power Park Unit** behaviour both in response to operation of **Transmission System** protection and in the context of longer-term simulations.

The overall structure of the model shall include:

- (i) any supplementary control signal modules not covered by (c), (d) and (e) below.
- (ii) any blocking, deblocking and protective trip features that are part of the **Power Park Unit** (e.g. "crowbar").
- (iii) any other information required to model the **Power Park Unit** behaviour to meet the model functional requirement described above.

The model shall be submitted in the form of a transfer function block diagram and may be accompanied by dynamic and algebraic equations.

This model shall display all the transfer functions and their parameter values, any non wind-up logic, signal limits and non-linearities.

The submitted **Power Park Unit** model and the supplementary control signal module models covered by (c), (d) and (e) below shall have been validated and this shall be confirmed by the **Generator**. The validation shall be based on comparing the submitted model simulation results against measured test results. Validation evidence shall also be submitted and this shall include the simulation and measured test results. The latter shall include appropriate short-circuit tests. In the case of an **Embedded Medium Power Station** not subject to a **Bilateral Agreement** the **Network Operator** will provide **The Company** with the validation evidence if requested by **The Company**. The validation of the supplementary control signal module models covered by (c), (d) and (e) below applies only to a **Power Park Module** with a **Completion Date** after 1 January 2009 or **Power Park Modules** within a **Power Generating Module**.

(b) **Power Park Unit** parameters

- * Rated MVA
- * **Rated MW**
- * Rated terminal voltage
- * Average site air density (kg/m^3), maximum site air density (kg/m^3) and minimum site air density (kg/m^3) for the year
Year for which the air density is submitted
Number of pole pairs
Blade swept area (m^2)

Gear box ratio

Mechanical drive train

For each **Power Park Unit**, details of the parameters of the drive train represented as an equivalent two mass model should be provided. This model should accurately represent the behaviour of the complete drive train for the purposes of power system analysis studies and should include the following data items:-

Equivalent inertia constant (MWsec/MVA) of the first mass (e.g. wind turbine rotor and blades) at minimum, synchronous and rated speeds

Equivalent inertia constant (MWsec/MVA) of the second mass (e.g. generator rotor) at minimum, synchronous and rated speeds

Equivalent shaft stiffness between the two masses (Nm/electrical radian)

Additionally, for **Power Park Units** that are induction generators (e.g. squirrel cage, doubly-fed) driven by wind turbines:

- * Stator resistance
- * Stator reactance
- * Magnetising reactance.
- * Rotor resistance.(at starting)
- * Rotor resistance.(at rated running)
- * Rotor reactance (at starting)
- * Rotor reactance (at rated running)

Additionally for doubly-fed induction generators only:

The generator rotor speed range (minimum and maximum speeds in RPM)

The optimum generator rotor speed versus wind speed submitted in tabular format

Power converter rating (MVA)

The rotor power coefficient (C_p) versus tip speed ratio (λ) curves for a range of blade angles (where applicable) together with the corresponding values submitted in tabular format. The tip speed ratio (λ) is defined as $\Omega R/U$ where Ω is the angular velocity of the rotor, R is the radius of the wind turbine rotor and U is the wind speed.

The electrical power output versus generator rotor speed for a range of wind speeds over the entire operating range of the **Power Park Unit**, together with the corresponding values submitted in tabular format.

The blade angle versus wind speed curve together with the corresponding values submitted in tabular format.

The electrical power output versus wind speed over the entire operating range of the **Power Park Unit**, together with the corresponding values submitted in tabular format.

Transfer function block diagram, including parameters and description of the operation of the power electronic converter and fault ride through capability (where applicable).

For a **Power Park Unit** consisting of a synchronous machine in combination with a back to back **DC Converter** or **HVDC System**, or for a **Power Park Unit** not driven by a wind turbine, the data to be supplied shall be agreed with **The Company** in accordance with PC.A.7.

- (c) Torque / speed and blade angle control systems and parameters

For the **Power Park Unit**, details of the torque / speed controller and blade angle controller in the case of a wind turbine and power limitation functions (where applicable) described in block diagram form showing transfer functions and parameters of individual elements.

- (d) Voltage/**Reactive Power/Power Factor** control system parameters

For the **Power Park Unit** and **Power Park Module** details of voltage/**Reactive Power/Power Factor** controller (and **PSS** if fitted) described in block diagram form showing transfer functions and parameters of individual elements.

- (e) **Frequency** control system parameters

For the **Power Park Unit** and **Power Park Module** details of the **Frequency** controller described in block diagram form showing transfer functions and parameters of individual elements.

- (f) **Protection**

Details of settings for the following **Protection** relays (to include): Under **Frequency**, over **Frequency**, under voltage, over voltage, rotor over current, stator over current, high wind speed shut down level.

- (g) Complete **Power Park Unit** model, parameters and controls

An alternative to PC.A.5.4.2 (a), (b), (c), (d), (e) and (f), is the submission of a single complete model that consists of the full information required under PC.A.5.4.2 (a), (b), (c), (d), (e) and (f) provided that all the information required under PC.A.5.4.2 (a), (b), (c), (d), (e) and (f) individually is clearly identifiable.

- (h) Harmonic and flicker parameters

When connecting a **Power Park Module**, it is necessary for **The Company** to evaluate the production of flicker and harmonics on **The Company's** and **User's Systems**. At **The Company's** reasonable request, the **User** (a **Network Operator** in the case of an **Embedded Power Park Module** not subject to a **Bilateral Agreement**) is required to submit the following data (as defined in IEC 61400-21 (2001)) for each **Power Park Unit**:-

Flicker coefficient for continuous operation.

Flicker step factor.

Number of switching operations in a 10 minute window.

Number of switching operations in a 2 hour window.

Voltage change factor.

Current Injection at each harmonic for each **Power Park Unit** and for each **Power Park Module**

* Data items marked with an asterisk are already requested under part 1, PC.A.3.3.1, to facilitate an early assessment by **The Company** as to whether detailed stability studies will be required before an offer of terms for a **CUSC Contract** can be made. Such data items have been repeated here merely for completeness and need not, of course, be resubmitted unless their values, known or estimated, have changed.

PC.A.5.4.3 DC Converter and HVDC Systems

PC.A.5.4.3.1 For a **DC Converter** at a **DC Converter Station** or an **HVDC System** or **Power Park Module** connected to the **Total System** by a **DC Converter** or **HVDC System** (or in the case of **OTSUA** which includes an **OTSDUW DC Converter**) the following information for each **DC Converter**, **HVDC System** and **DC Network** should be supplied:

- (a) **DC Converter** and **HVDC System** parameters

- * **Rated MW** per pole for transfer in each direction;
- * **DC Converter** type (i.e. current or voltage source (including a **HVDC Converter** in an **HVDC System**));
- * Number of poles and pole arrangement;
- * Rated DC voltage/pole (kV);
- * Return path arrangement;

(b) **DC Converter** and **HVDC System** transformer parameters

Rated MVA

Nominal primary voltage (kV);

Nominal secondary (converter-side) voltage(s) (kV);

Winding and earthing arrangement;

Positive phase sequence reactance at minimum, maximum and nominal tap;

Positive phase sequence resistance at minimum, maximum and nominal tap;

Zero phase sequence reactance;

Tap-changer range in %;

number of tap-changer steps;

(c) **DC Network** parameters

Rated DC voltage per pole;

Rated DC current per pole;

Single line diagram of the complete **DC Network** and **HVDC System**;

Details of the complete **DC Network**, including resistance, inductance and capacitance of all DC cables and/or DC lines and **HVDC System**;

Details of any DC reactors (including DC reactor resistance), DC capacitors and/or DC-side filters that form part of the **DC Network** and/or **HVDC System**;

(d) AC filter reactive compensation equipment parameters

Note: The data provided pursuant to this paragraph must not include any contribution from reactive compensation plant owned or operated by **The Company**.

Total number of AC filter banks.

Type of equipment (e.g. fixed or variable)

Single line diagram of filter arrangement and connections;

Reactive Power rating for each AC filter bank, capacitor bank or operating range of each item of reactive compensation equipment, at rated voltage;

Performance chart showing **Reactive Power** capability of the **DC Converter** and **HVDC System**, as a function of MW transfer, with all filters and reactive compensation plant, belonging to the **DC Converter Station** or **HVDC System** working correctly.

Note: Details in PC.A.5.4.3.1 are required for each **DC Converter** connected to the **DC Network** and **HVDC System**, unless each is identical or where the data has already been submitted for an identical **DC Converter** or **HVDC System** at another **Connection Point**.

Note: For a **Power Park Module** and **DC Connected Power Park Module** connected to the **Grid Entry Point** or (**User System Entry Point** if **Embedded**) by a **DC Converter** or **HVDC System** the equivalent inertia and fault infeed at the **Power Park Unit** should be given.

DC Converter and HVDC System Control System Models

PC.A.5.4.3.2 The following data is required by **The Company** to represent **DC Converters** and associated **DC Networks** and **HVDC Systems** (and including **OTSUA** which includes an **OTSDUW DC Converter**) in dynamic power system simulations, in which the AC power system is typically represented by a positive sequence equivalent. **DC Converters** and **HVDC Systems** are represented by simplified equations and are not modelled to switching device level.

- (i) Static $V_{DC}-I_{DC}$ (DC voltage - DC current) characteristics, for both the rectifier and inverter modes for a current source converter. Static $V_{DC}-P_{DC}$ (DC voltage - DC power) characteristics, for both the rectifier and inverter modes for a voltage source converter. Transfer function block diagram including parameters representation of the control systems of each **DC Converter** and of the **DC Converter Station** and the **HVDC System**, for both the rectifier and inverter modes. A suitable model would feature the **DC Converter** or **HVDC Converter** firing angle as the output variable.
- (ii) Transfer function block diagram representation including parameters of the **DC Converter** or **HVDC Converter** transformer tap changer control systems, including time delays
- (iii) Transfer function block diagram representation including parameters of AC filter and reactive compensation equipment control systems, including any time delays.
- (iv) Transfer function block diagram representation including parameters of any **Frequency** and/or load control systems.
- (v) Transfer function block diagram representation including parameters of any small signal modulation controls such as power oscillation damping controls or sub-synchronous oscillation damping controls, that have not been submitted as part of the above control system data.
- (vi) Transfer block diagram representation of the **Reactive Power** control at converter ends for a voltage source converter.

In addition and where not provided for above, **HVDC System Owners** shall also provide the following dynamic simulation sub-models

- (i) **HVDC Converter** unit models
- (ii) AC component models
- (iii) DC Grid models
- (iv) Voltage and power controller
- (v) Special control features if applicable (eg power oscillation damping (POD) function, subsynchronous torsional interaction (SSTI) control;
- (vi) Multi terminal control, if applicable
- (vii) **HVDC System** protection models as agreed between **The Company** and the **HVDC System Owner**

HVDC System Owners are also required to supply an equivalent model of the control system when adverse control interactions may result with **HVDC Converter Stations** and other connections in close proximity if requested by **The Company**. The equivalent model shall contain all necessary data for the realistic simulation of the adverse control interactions.

Plant Flexibility Performance

PC.A.5.4.3.3 The following information on plant flexibility and performance should be supplied (and also in respect of **OTSUA** which includes an **OTSDUW DC Converter**):

- (i) Nominal and maximum (emergency) loading rate with the **DC Converter** or **HVDC Converter** in rectifier mode.
- (ii) Nominal and maximum (emergency) loading rate with the **DC Converter** or **HVDC Converter** in inverter mode.
- (iii) Maximum recovery time, to 90% of pre-fault loading, following an AC system fault or severe voltage depression.

- (iv) Maximum recovery time, to 90% of pre-fault loading, following a transient **DC Network** fault.

Harmonic Assessment Information

PC.A.5.4.3.4 **DC Converter** owners and **HVDC System Owners** shall provide such additional further information as required by **The Company** in order that compliance with CC.6.1.5 and ECC.6.1.5 can be demonstrated.

* Data items marked with an asterisk are already requested under part 1, PC.A.3.3.1, to facilitate an early assessment by **The Company** as to whether detailed stability studies will be required before an offer of terms for a **CUSC Contract** can be made. Such data items have been repeated here merely for completeness and need not, of course, be resubmitted unless their values, known or estimated, have changed.

PC.A.5.5 Response Data For Frequency Changes

The information detailed below is required to describe the actual frequency response capability profile as illustrated in Figure CC.A.3.1 and ECC.A.3.1 of the **Connection Conditions**, and need only be provided for each:

- (i) ~~**Genset at Large Power Stations and directly connected Medium Power Stations comprising Type C or Type D Power Generating Modules and directly connected Small Power Stations comprising Type C and Type D Power Generating Modules;**~~ and
- (ii) **Generating Unit** (including **Synchronous Generating Units** within a **Synchronous Power Generating Module**), **Power Park Module** (including a **DC Connected Power Park Module**) or **CCGT Module** at a **Medium Power Station** or **DC Converter Station** or **HVDC System** that has agreed to provide **Frequency** response in accordance with a **CUSC Contract**.

In the case of (ii) above for the rest of this PC.A.5.5 where reference is made to **Gensets**, it shall include such **Generating Units** (including **Synchronous Generating Units** within a **Synchronous Power Generating Module**), **CCGT Modules**, **Power Park Modules** (including **DC Connected Power Park Modules**), **HVDC Systems** and **DC Converters** as appropriate, but excludes **OTSDUW Plant and Apparatus** utilising **OTSDUW DC Converters**.

In this **PC.A.5.5**, for a **CCGT Module** with more than one **Generating Unit**, the phrase **Minimum Generation** or **Minimum Regulating Level** applies to the entire **CCGT Module** operating with all **Generating Units** (including **Synchronous Generating Units** within a **Synchronous Power Generating Module**) **Synchronised** to the **System**. Similarly for a **Power Park Module** (including a **DC Connected Power Park Module**) with more than one **Power Park Unit**, the phrase **Minimum Generation** or **Minimum Regulating Level** applies to the entire **Power Park Module** operating with all **Power Park Units Synchronised** to the **System**.

PC.A.5.5.1 MW Loading Points At Which Data Is Required

Response values are required at six MW loading points (MLP1 to MLP6) for each **Genset**. **Primary** and **Secondary Response** values need not be provided for MW loading points which are below **Minimum Generation** or **Minimum Stable Operating Level**. MLP1 to MLP6 must be provided to the nearest MW.

Prior to the **Genset** being first **Synchronised**, the MW loading points must take the following values :

MLP1	Designed Minimum Operating Level or Minimum Regulating Level
MLP2	Minimum Generation or Minimum Stable Operating Level
MLP3	70% of Registered Capacity or Maximum Capacity
MLP4	80% of Registered Capacity or Maximum Capacity
MLP5	95% of Registered Capacity or Maximum Capacity

MLP6 Registered Capacity or Maximum Capacity

When data is provided after the **Genset** is first **Synchronised**, the MW loading points may take any value between the **Designed Minimum Operating Level** or **Minimum Regulating Level** and **Registered Capacity** or **Minimum Regulating Level** and **Maximum Capacity** but the value of the **Designed Minimum Operating Level** or **Minimum Regulating Level** must still be provided if it does not form one of the MW loading points.

PC.A.5.5.2 Primary And Secondary Response To Frequency Fall

Primary and **Secondary Response** values for a -0.5Hz ramp are required at six MW loading points (MLP1 to MLP6) as detailed above

PC.A.5.5.3 High Frequency Response To Frequency Rise

High Frequency Response values for a +0.5Hz ramp are required at six MW loading points (MLP1 to MLP6) as detailed above.

PC.A.5.6 Mothballed Power Generating Module, Mothballed Generating Unit, Mothballed Power Park Module (including DC Connected Power Park Modules), Mothballed HVDC Systems or Mothballed DC Converter At A DC Converter Station And Alternative Fuel Information

Data identified under this section PC.A.5.6 must be submitted as required under PC.A.1.2 and at **The Company's** reasonable request.

In the case of **Embedded Medium Power Stations** not subject to a **Bilateral Agreement**, **Embedded HVDC Systems** not subject to a **Bilateral Agreement** and **Embedded DC Converter Stations** not subject to a **Bilateral Agreement**, upon request from **The Company** each **Network Operator** shall provide the information required in PC.A.5.6.1, PC.A.5.6.2, PC.A.5.6.3 and PC.A.5.6.4 on respect of such **Embedded Medium Power Stations** and **Embedded DC Converters Stations** and **Embedded HVDC Systems** with their **System**.

PC.A.5.6.1 Mothballed Generating Unit Information

Generators, HVDC System Owners and **DC Converter Station** owners must supply with respect to each **Mothballed Power Generating Module, Mothballed Generating Unit, Mothballed Power Park Module** (including a **DC Connected Power Park Module**), **Mothballed HVDC System** or **Mothballed DC Converter** at a **DC Converter Station** the estimated **MW** output which could be returned to service within the following time periods from the time that a decision to return was made:

- < 1 month;
- 1-2 months;
- 2-3 months;
- 3-6 months;
- 6-12 months; and
- >12 months.

The return to service time should be determined in accordance with **Good Industry Practice** assuming normal working arrangements and normal plant procurement lead times. The MW output values should be the incremental values made available in each time period as further described in the **DRC**.

PC.A.5.6.2 **Generators, HVDC System Owners** and **DC Converter Station** owners must also notify **The Company** of any significant factors which may prevent the **Mothballed Power Generating Module, Mothballed Generating Unit, Mothballed Power Park Module** (including **DC Connected Power Park Modules**), **Mothballed HVDC Systems** or **Mothballed DC Converter** at a **DC Converter Station** achieving the estimated values provided under PC.A.5.6.1 above, excluding factors relating to **Transmission Entry Capacity**.

PC.A.5.6.3 Alternative Fuel Information

The following data items must be supplied with respect to each **Generating Unit** (including **Synchronous Generating Units** within a **Synchronous Power Generating Module**) whose main fuel is gas.

For each alternative fuel type (if facility installed):

- (a) Alternative fuel type e.g. oil distillate, alternative gas supply
- (b) For the changeover from main to alternative fuel:
 - Time to carry out off-line and on-line fuel changeover (minutes).
 - Maximum output following off-line and on-line changeover (MW).
 - Maximum output during on-line fuel changeover (MW).
 - Maximum operating time at full load assuming typical and maximum possible stock levels (hours).
 - Maximum rate of replacement of depleted stocks (MWh electrical/day) on the basis of **Good Industry Practice**.
 - Is changeover to alternative fuel used in normal operating arrangements?
 - Number of successful changeovers carried out in the last of **The Company's Financial Year** (choice of 0, 1-5, 6-10, 11-20, >20).
- (c) For the changeover back to main fuel:
 - Time to carry out off-line and on-line fuel changeover (minutes).
 - Maximum output during on-line fuel changeover (MW).

PC.A.5.6.4 **Generators** must also notify **The Company** of any significant factors and their effects which may prevent the use of alternative fuels achieving the estimated values provided under PC.A.5.6.3 above (e.g. emissions limits, distilled water stocks etc.)

PC.A.5.7 Black Start Related Information

Data identified under this section PC.A.5.7 must be submitted as required under PC.A.1.2. This information may also be requested by **The Company** during a **Black Start** and should be provided by **Generators** where reasonably possible. **Generators** in this section PC.A.5.7 means **Generators** only in respect of their **Large Power Stations** or **Medium Power Stations** directly connecting to the **National Electricity Transmission System** and comprising a **Type C** or **Type D Power Generating Module** or **Small Power Stations** directly connected to the **National Electricity Transmission System** and comprising a **Type C** or **Type D Power Generating Module**.

The following data items/text must be supplied, from each **Generator** to **The Company**, with respect to each **BM Unit** at a **Large Power Station** (excluding the **Generating Units** (including **Synchronous Generating Units** within a **Synchronous Power Generating Module**) that are contracted to provide **Black Start Capability**, **Power Park Modules** (including **DC Connected Power Park Modules**) or **Generating Units** with an **Intermittent Power Source**);

- (a) Expected time for each **BM Unit** to be **Synchronised** following a **Total Shutdown** or **Partial Shutdown**. The assessment should include the **Power Station's** ability to re-synchronise all **BM Units**, if all were running immediately prior to the **Total Shutdown** or **Partial Shutdown**. Additionally this should highlight any specific issues (i.e. those that would impact on the **BM Unit's** time to be **Synchronised**) that may arise, as time progresses without external supplies being restored.
- (b) **Block Loading Capability**. This should be provided in either graphical or tabular format showing the estimated block loading capability from 0MW to **Registered Capacity**. Any particular 'hold' points should also be identified. The data of each **BM Unit** should be provided for the condition of a 'hot' unit that was **Synchronised** just prior to the **Total Shutdown** or **Partial Shutdown** and also for the condition of a 'cold' unit. The block loading assessment should be done against a frequency variation of 49.5Hz – 50.5Hz.

PC.A.6 USERS' SYSTEM DATA

PC.A.6.1 Introduction

PC.A.6.1.1 Each **User**, whether connected directly via an existing **Connection Point** to the **National Electricity Transmission System** or seeking such a direct connection, or providing terms for connection of an **Offshore Transmission System** to its **User System** to **The Company** or undertaking **OTSDUW**, shall provide **The Company** with data on its **User System** or **OTSDUW Plant and Apparatus** which relates to the **Connection Site** containing the **Connection Point** (or **Interface Points** or **Connection Points** in the case of **OTSUA**) both current and forecast, as specified in PC.A.6.2 to PC.A.6.6.

PC.A.6.1.2 Each **User** must reflect the system effect at the **Connection Site(s)** of any third party **Embedded** within its **User System** whether existing or proposed.

PC.A.6.1.3 PC.A.6.2, and PC.A.6.4 to PC.A.6.7 consist of data which is only to be supplied to **The Company** at **The Company's** reasonable request. In the event that **The Company** identifies a reason for requiring this data, **The Company** shall write to the relevant **User(s)**, requesting the data, and explaining the reasons for the request. If the **User(s)** wishes, **The Company** shall also arrange a meeting at which the request for data can be discussed, with the objective of identifying the best way in which **The Company's** requirements can be met. In respect of **EU Code User(s)** only, **The Company** may request the need for electromagnetic transient simulations at **The Company's** reasonable request. **User(s)** with **EU Grid Supply Points** may be required to provide electromagnetic transient simulations in relation to those **EU Grid Supply Points** at **NGET's** reasonable request.

Where **NGET** makes a request to a **User** or **EU Code User** for dynamic models under PC.A.6.7, each relevant **User** shall ensure that the models supplied in respect of their **Plant** and **Apparatus** reflect the true and accurate behaviour of the **Plant** and **Apparatus** as built and verified through the **European Compliance Processes (ECP)**.

PC.A.6.2 Transient Overvoltage Assessment Data

PC.A.6.2.1 It is occasionally necessary for **The Company** to undertake transient overvoltage assessments (e.g. capacitor switching transients, switchgear transient recovery voltages, etc). At **The Company's** reasonable request, each **User** is required to provide the following data with respect to the **Connection Site** (and in the case of **OTSUA**, **Interface Points** and **Connection Points**), current and forecast, together with a **Single Line Diagram** where not already supplied under PC.A.2.2.1, as follows:

- (a) busbar layout plan(s), including dimensions and geometry showing positioning of any current and voltage transformers, through bushings, support insulators, disconnectors, circuit breakers, surge arresters, etc. Electrical parameters of any associated current and voltage transformers, stray capacitances of wall bushings and support insulators, and grading capacitances of circuit breakers;
- (b) Electrical parameters and physical construction details of lines and cables connected at that busbar. Electrical parameters of all plant e.g., transformers (including neutral earthing impedance or zig-zag transformers, if any), series reactors and shunt compensation equipment connected at that busbar (or to the tertiary of a transformer) or by lines or cables to that busbar;
- (c) Basic insulation levels (BIL) of all **Apparatus** connected directly, by lines or by cables to the busbar;
- (d) characteristics of overvoltage **Protection** devices at the busbar and at the termination points of all lines, and all cables connected to the busbar;
- (e) fault levels at the lower voltage terminals of each transformer connected directly or indirectly to the **National Electricity Transmission System** (including **OTSUA** at each **Interface Point** and **Connection Point**) without intermediate transformation;

- (f) the following data is required on all transformers operating at **Supergrid Voltage** throughout **Great Britain** and, in Scotland and **Offshore**, also at 132kV (including **OTSUA**): three or five limb cores or single phase units to be specified, and operating peak flux density at nominal voltage;
- (g) an indication of which items of equipment may be out of service simultaneously during **Planned Outage** conditions.

PC.A.6.3 User's Protection Data

PC.A.6.3.1 Protection

The following information is required which relates only to **Protection** equipment which can trip or inter-trip or close any **Connection Point** circuit-breaker or any **Transmission** circuit-breaker (or in the case of **OTSUA**, any **Interface Point** or **Connection Point** circuit breaker). This information need only be supplied once, in accordance with the timing requirements set out in PC.A.1.4(b), and need not be supplied on a routine annual basis thereafter, although **The Company** should be notified if any of the information changes

- (a) a full description, including estimated settings, for all relays and **Protection** systems installed or to be installed on the **User's System**;
- (b) a full description of any auto-reclose facilities installed or to be installed on the **User's System**, including type and time delays;
- (c) a full description, including estimated settings, for all relays and **Protection** systems or to be installed on the generator, generator transformer, **Station Transformer** and their associated connections;
- (d) for **Generating Units** (including **Synchronous Generating Units** forming part of a **Synchronous Power Generating Module** but excluding **Power Park Units**) or **Power Park Modules** (including **DC Connected Power Park Modules**) or **HVDC Systems** or **DC Converters** at a **DC Converter Station** or **OTSDUW Plant and Apparatus** having (or intended to have) a circuit breaker at the generator terminal voltage, clearance times for electrical faults within the **Generating Unit** (including **Synchronous Generating Units** forming part of a **Synchronous Power Generating Module** but excluding a **Power Park Unit**) or **Power Park Module** (including **DC Connected Power Park Modules**) zone, or within the **OTSDUW Plant and Apparatus**;
- (e) the most probable fault clearance time for electrical faults on any part of the **User's System** directly connected to the **National Electricity Transmission System** including **OTSDUW Plant and Apparatus**; and
- (f) in the case of **OTSDUW Plant and Apparatus**, synchronisation facilities and delayed auto reclose sequence schedules (where applicable).

PC.A.6.4 Harmonic Studies

PC.A.6.4.1 It is occasionally necessary for **The Company** to evaluate the production/magnification of harmonic distortion on **The Company's** and **User's Systems** (and **OTSUA**), especially when **The Company** is connecting equipment such as capacitor banks. At **The Company's** reasonable request, each **User** is required to submit data with respect to the **Connection Site** (and in the case of **OTSUA**, each **Interface Point** and **Connection Point**), current and forecast, and where not already supplied under PC.A.2.2.4 and PC.A.2.2.5, as follows:

PC.A.6.4.2 Overhead lines and underground cable circuits of the **User's Subtransmission System** must be differentiated and the following data provided separately for each type:

- Positive phase sequence resistance;
- Positive phase sequence reactance;
- Positive phase sequence susceptance;

and for all transformers connecting the **User's Subtransmission System** and **OTSDUW Plant and Apparatus** to a lower voltage:

- Rated MVA;

Voltage Ratio;

Positive phase sequence resistance;

Positive phase sequence reactance;

and at the lower voltage points of those connecting transformers:

Equivalent positive phase sequence susceptance;

Connection voltage and MVA rating of any capacitor bank and component design parameters if configured as a filter;

Equivalent positive phase sequence interconnection impedance with other lower voltage points;

The minimum and maximum **Demand** (both MW and MVA) that could occur;

Harmonic current injection sources in Amps at the Connection voltage points. Where the harmonic injection current comes from a diverse group of sources, the equivalent contribution may be established from appropriate measurements;

Details of traction loads, eg connection phase pairs, continuous variation with time, etc;

An indication of which items of equipment may be out of service simultaneously during **Planned Outage** conditions.

PC.A.6.5

Voltage Assessment Studies

It is occasionally necessary for **The Company** to undertake detailed voltage assessment studies (e.g., to examine potential voltage instability, voltage control co-ordination or to calculate voltage step changes). At **The Company's** reasonable request, each **User** is required to submit the following data where not already supplied under PC.A.2.2.4 and PC.A.2.2.5:

For all circuits of the User's Subtransmission System (and any OTSUA):-

Positive Phase Sequence Reactance;

Positive Phase Sequence Resistance;

Positive Phase Sequence Susceptance;

MVA rating of any reactive compensation equipment;

and for all transformers connecting the **User's Subtransmission System** to a lower voltage (and any **OTSUA**):

Rated MVA;

Voltage Ratio;

Positive phase sequence resistance;

Positive Phase sequence reactance;

Tap-changer range;

Number of tap steps;

Tap-changer type: on-load or off-circuit;

AVC/tap-changer time delay to first tap movement;

AVC/tap-changer inter-tap time delay;

and at the lower voltage points of those connecting transformers (and any **OTSUA**):-

Equivalent positive phase sequence susceptance;

MVA rating of any reactive compensation equipment;

Equivalent positive phase sequence interconnection impedance with other lower voltage points;

The maximum **Demand** (both MW and MVA) that could occur;

Estimate of voltage insensitive (constant power) load content in % of total load at both winter peak and 75% off-peak load conditions.

PC.A.6.6 Short Circuit Analysis

PC.A.6.6.1 Where prospective short-circuit currents on equipment owned, operated or managed by **The Company** are greater than 90% of the equipment rating, and in **The Company's** reasonable opinion more accurate calculations of short-circuit currents are required, then at **The Company's** request each **User** is required to submit data with respect to the **Connection Site** (and in the case of **OTSUA**, each **Interface Point** and **Connection Point**), current and forecast, and where not already supplied under PC.A.2.2.4 and PC.A.2.2.5, as follows:

PC.A.6.6.2 For all circuits of the **User's Subtransmission System** (and any **OTSUA**):

Positive phase sequence resistance;

Positive phase sequence reactance;

Positive phase sequence susceptance;

Zero phase sequence resistance (both self and mutuals);

Zero phase sequence reactance (both self and mutuals);

Zero phase sequence susceptance (both self and mutuals);

and for all transformers connecting the **User's Subtransmission System** to a lower voltage (and any **OTSUA**):

Rated MVA;

Voltage Ratio;

Positive phase sequence resistance (at max, min and nominal tap);

Positive Phase sequence reactance (at max, min and nominal tap);

Zero phase sequence reactance (at nominal tap);

Tap changer range;

Earthing method: direct, resistance or reactance;

Impedance if not directly earthed;

and at the lower voltage points of those connecting transformers (and any **OTSUA**):

The maximum **Demand** (in MW and MVA_r) that could occur;

Short-circuit infeed data in accordance with PC.A.2.5.6 unless the **User's** lower voltage network runs in parallel with the **User's Subtransmission System**, when to prevent double counting in each node infeed data, a π equivalent comprising the data items of PC.A.2.5.6 for each node together with the positive phase sequence interconnection impedance between the nodes shall be submitted.

PC.A.6.7 Dynamic Models

PC.A.6.7.1 It is occasionally necessary for **NGET** to evaluate the dynamic performance of **User's Plant** and **Apparatus** at each **EU Grid Supply Point** or in the case of **EU Code Users**, their **System**. At **NGET's** reasonable request and as agreed between **NGET** and the relevant **Network Operator** or **Non-Embedded Customer**, each **User** is required to provide the following data. Where such data is required, **NGET** will work with the **Network Operator** or **Non-Embedded Customer** to establish the scope of the dynamic modelling work and share the required information where it is available:-

(a) Dynamic model structure and block diagrams including parameters, transfer functions and individual elements (as applicable);

(b) Power control functions and block diagrams including parameters, transfer functions and individual elements (as applicable);

- (c) Voltage control functions and block diagrams including parameters, transfer functions and individual elements (as applicable);
- (d) Converter control models and block diagrams including parameters, transfer functions and individual elements (as applicable).

PC.A.7 ADDITIONAL DATA FOR NEW TYPES OF POWER STATIONS, DC CONVERTER STATIONS, OTSUA AND CONFIGURATIONS

Notwithstanding the **Standard Planning Data** and **Detailed Planning Data** set out in this Appendix, as new types of configurations and operating arrangements of **Power Stations, HVDC Systems, DC Converter Stations and OTSUA** emerge in future, **The Company** may reasonably require additional data to represent correctly the performance of such **Plant** and **Apparatus** on the **System**, where the present data submissions would prove insufficient for the purpose of producing meaningful **System** studies for the relevant parties.

PART 3 - DETAILED PLANNING DATA

PC.A.8 To allow a **User** to model the **National Electricity Transmission System**, **The Company** will provide, upon request, the following **Network Data** to **Users**, calculated in accordance with **Good Industry Practice**:

To allow a **User** to assess undertaking **OTSDUW** and except where provided for in Appendix F, **The Company** will provide upon request the following **Network Data** to **Users**, calculated in accordance with **Good Industry Practice**:

PC.A.8.1 Single Point of Connection

For a **Single Point of Connection** to a **User's System** (and **OTSUA**), as an equivalent 400kV or 275kV source and also in Scotland and **Offshore** as an equivalent 132kV source, the data (as at the HV side of the **Point of Connection** (and in the case of **OTSUA**, each **Interface Point** and **Connection Point**) reflecting data given to **The Company** by **Users**) will be given to a **User** as follows:

The data items listed under the following parts of PC.A.8.3:

(a) (i), (ii), (iii), (iv), (v) and (vi)

and the data items shall be provided in accordance with the detailed provisions of PC.A.8.3 (b) - (e).

PC.A.8.2 Multiple Point of Connection

For a **Multiple Point of Connection** to a **User's System** equivalents suitable for use in loadflow and fault level analysis shall be provided. These equivalents will normally be in the form of a π model or extension with a source (or demand for a loadflow equivalent) at each node and a linking impedance. The boundary nodes for the equivalent shall be either at the **Connection Point** (and in the case of **OTSDUW**, each **Interface Point** and **Connection Point**) or (where **The Company** agrees) at suitable nodes (the nodes to be agreed with the **User**) within the **National Electricity Transmission System**. The data at the **Connection Point** (and in the case of **OTSDUW**, each **Interface Point** and **Connection Point**) will be given to a **User** as follows:

The data items listed under the following parts of PC.A.8.3:-

(a) (i), (ii), (iv), (v), (vi), (vii), (viii), (ix), (x) and (xi)

and the data items shall be provided in accordance with the detailed provisions of PC.A.8.3 (b) - (e).

When an equivalent of this form is not required **The Company** will not provide the data items listed under the following parts of PC.A.8.3:-

(a) (vii), (viii), (ix), (x) and (xi)

PC.A.8.3 Data Items

(a) The following is a list of data utilised in this part of the **PC**. It also contains rules on the data which generally apply.

- (i) symmetrical three-phase short circuit current infeed at the instant of fault from the **National Electricity Transmission System**, (I_1'');
- (ii) symmetrical three-phase short circuit current from the **National Electricity Transmission System** after the subtransient fault current contribution has substantially decayed, (I_1');
- (iii) the zero sequence source resistance and reactance values at the **Point of Connection** (and in case of **OTSUA**, each **Interface Point** and **Connection Point**), consistent with the maximum infeed below;
- (iv) the pre-fault voltage magnitude at which the maximum fault currents were calculated;
- (v) the positive sequence X/R ratio at the instant of fault;
- (vi) the negative sequence resistance and reactance values of the **National Electricity**

Transmission System seen from the (**Point of Connection** and in case of **OTSUA**, each **Interface Point** and **Connection Point**), if substantially different from the values of positive sequence resistance and reactance which would be derived from the data provided above;

- (vii) the initial positive sequence resistance and reactance values of the two (or more) sources and the linking impedance(s) derived from a fault study constituting the (π) equivalent and evaluated without the **User** network and load and where appropriate without elements of the **National Electricity Transmission System** between the **User** network and agreed boundary nodes (and in case of **OTSUA**, each **Interface Point** and **Connection Point**);
 - (viii) the positive sequence resistance and reactance values of the two (or more) sources and the linking impedance(s) derived from a fault study, considering the short circuit current contributions after the subtransient fault current contribution has substantially decayed, constituting the (π) equivalent and evaluated without the **User** network and load, and where appropriate without elements of the **National Electricity Transmission System** between the **User** network and agreed boundary nodes (and in case of **OTSUA**, each **Interface Point** and **Connection Point**);
 - (ix) the corresponding zero sequence impedance values of the (π) equivalent produced for use in fault level analysis;
 - (x) the **Demand** and voltage at the boundary nodes and the positive sequence resistance and reactance values of the linking impedance(s) derived from a loadflow study considering **National Electricity Transmission System** peak **Demand** constituting the (π) loadflow equivalent; and,
 - (xi) where the agreed boundary nodes are not at a **Connection Point** (and in case of **OTSUA**, **Interface Point** or **Connection Point**), the positive sequence and zero sequence impedances of all elements of the **National Electricity Transmission System** between the **User** network and agreed boundary nodes that are not included in the equivalent (and in case of **OTSUA**, each **Interface Point** and **Connection Point**).
- (b) To enable the model to be constructed, **The Company** will provide data based on the following conditions.
- (c) The initial symmetrical three phase short circuit current and the transient period three phase short circuit current will normally be derived from the fixed impedance studies. The latter value should be taken as applying at times of 120ms and longer. Shorter values may be interpolated using a value for the subtransient time constant of 40ms. These fault currents will be obtained from a full **System** study based on load flow analysis that takes into account any existing flow across the point of connection being considered.
- (d) Since the equivalent will be produced for the 400kV or 275kV and also in Scotland and **Offshore** 132kV parts of the **National Electricity Transmission System** **The Company** will provide the appropriate supergrid transformer data.
- (e) The positive sequence X/R ratio and the zero sequence impedance value will correspond to the **The Company's** source network only, that is with the section of network if any with which the equivalent is to be used excluded. These impedance values will be derived from the condition when all **Generating Units** (including **Synchronous Generating Units** forming part of a **Synchronous Power Generating Module**) are **Synchronised** to the **National Electricity Transmission System** or a **User's System** and will take account of active sources only including any contribution from the load to the fault current. The passive component of the load itself or other system shunt impedances should not be included.
- (f) A **User** may at any time, in writing, specifically request for an equivalent to be prepared for an alternative **System** condition, for example where the **User's System** peak does not correspond to the **National Electricity Transmission System** peak, and **The Company** will, insofar as such request is reasonable, provide the information as soon as reasonably practicable following the request.

APPENDIX B - SINGLE LINE DIAGRAMS

PC.B.1

The diagrams below show three examples of single line diagrams, showing the detail that should be incorporated in the diagram. The first example is for an **Network Operator** connection, the second for a **Generator** connection, the third for a **Power Park Module** electrically equivalent system.

Network Operator Single Line Diagram

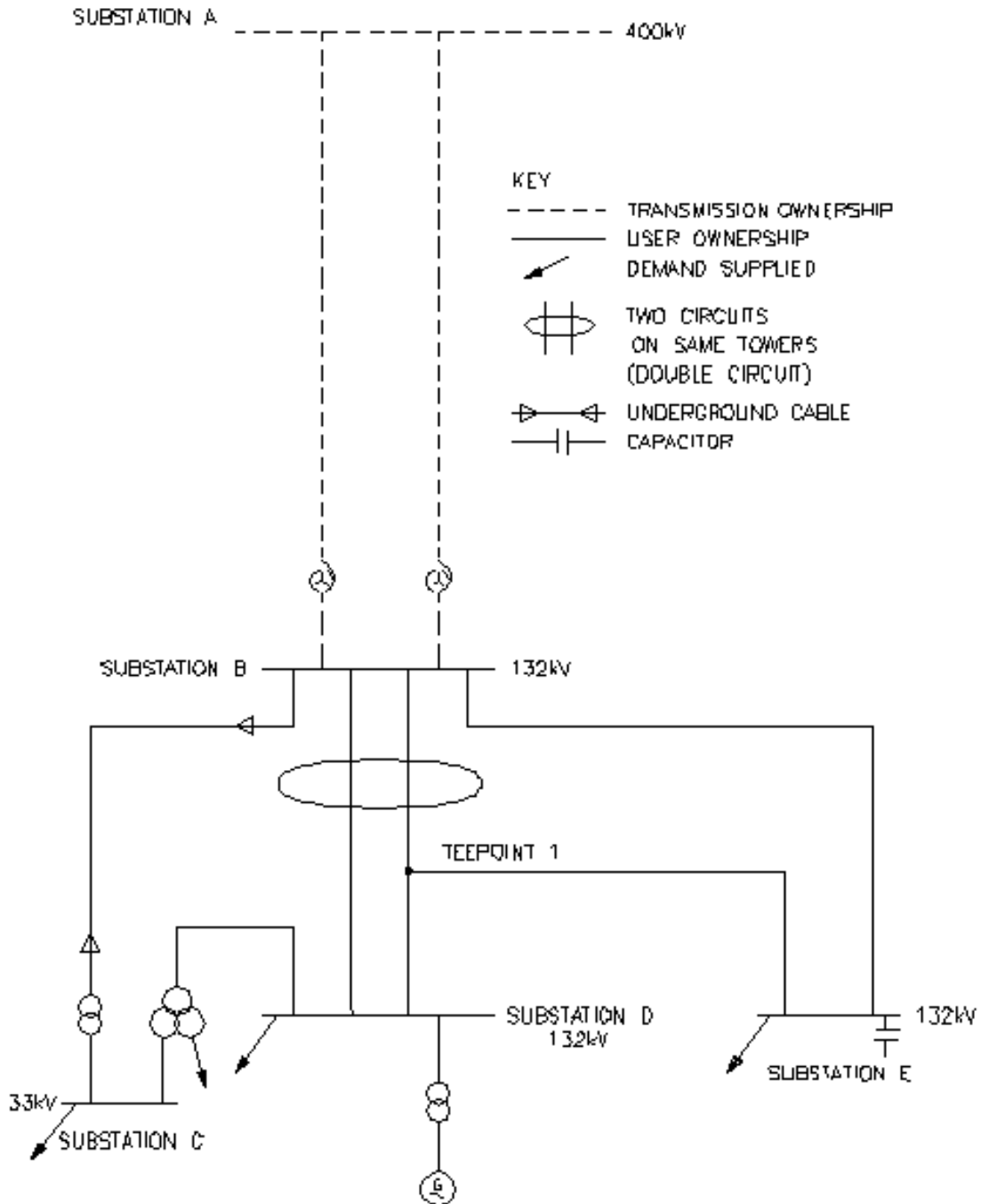

DISSEMINATED BY COMPTON
FOR THE USE OF THE
GENERAL PUBLIC

ISS D
41/18826_1_1 29-07-04

Generator Single Line Diagram

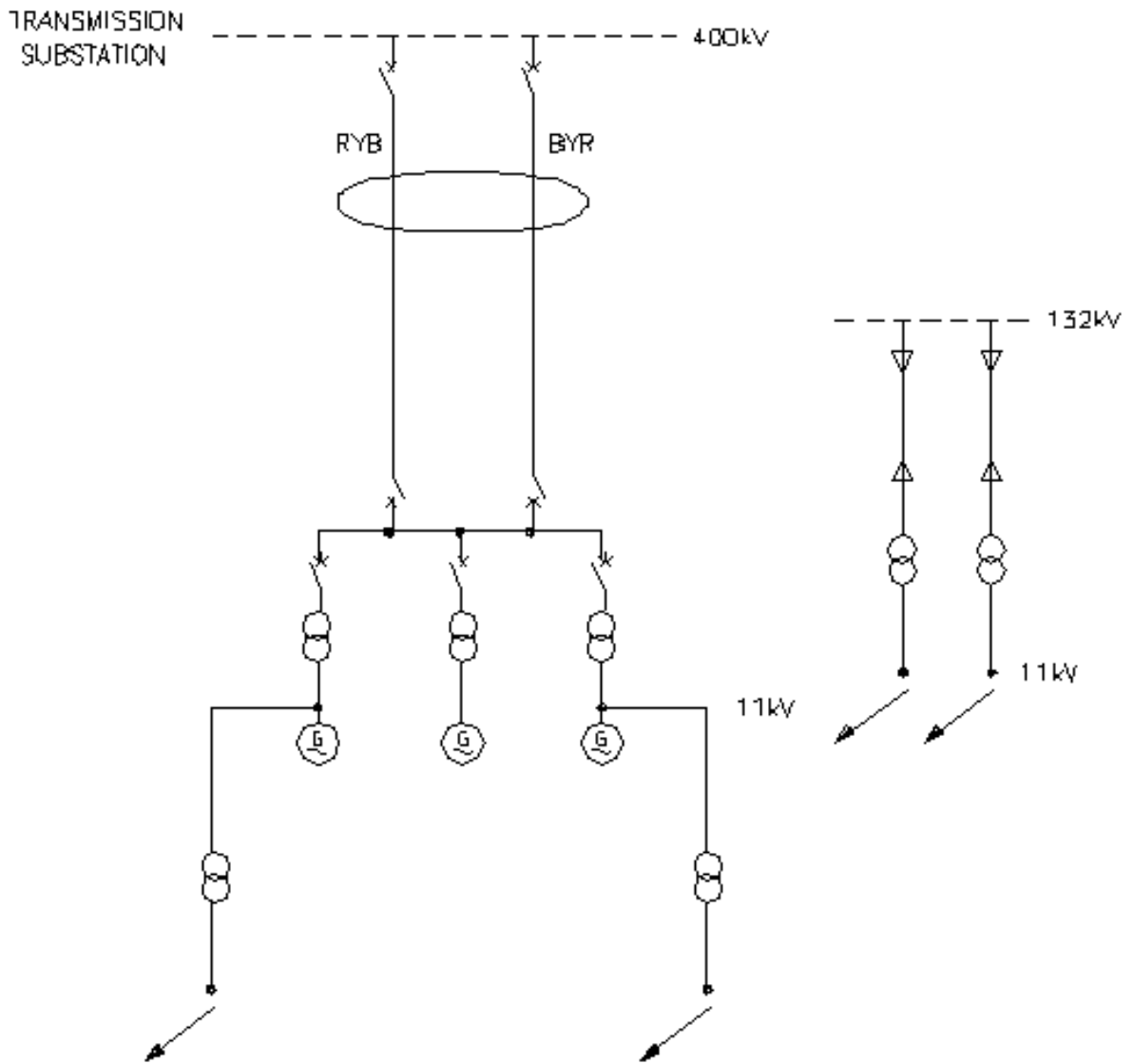

KEY

- TRANSMISSION OWNERSHIP
- USER OWNERSHIP
- ↙ DEMAND SUPPLIED
- ⊃ TWO CIRCUITS ON SAME TOWERS (DOUBLE CIRCUIT)
- ⇄ UNDERGROUND CABLE

TECHNICAL DRAWING
NET ENERGY INC
EPCON DESIGN

41 / 19468_1_1

ISS D
29-07-04

Power Park Module Single Line Diagram

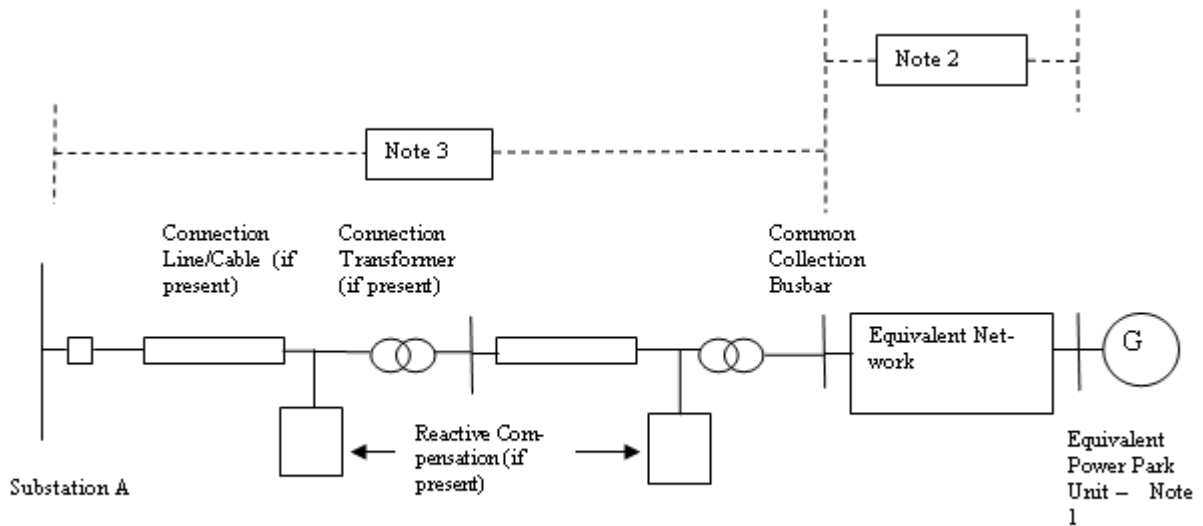

Notes:

- (1) The electrically equivalent **Power Park Unit** consists of a number of actual **Power Park Units** of the same type ie. any equipment external to the **Power Park Unit** terminals is considered as part of the Equivalent Network. **Power Park Units** of different types shall be included in separate electrically equivalent **Power Park Units**. The total number of equivalent **Power Park Units** shall represent all of the actual **Power Park Units** in the **Power Park Module** (which could be a **DC Connected Power Park Module**).
- (2) Separate electrically equivalent networks are required for each different type of electrically equivalent **Power Park Unit**. The electrically equivalent network shall include all equipment between the **Power Park Unit** terminals and the **Common Collection Busbar**.
- (3) All **Plant** and **Apparatus** including the circuit breakers, transformers, lines, cables and reactive compensation plant between the **Common Collection Busbar** and Substation A shall be shown.

APPENDIX C - TECHNICAL AND DESIGN CRITERIA

- PC.C.1 Planning and design of the **SPT** and **SHETL Transmission Systems** is based generally, but not totally, on criteria which evolved from joint consultation among various **Transmission Licensees** responsible for design of the **National Electricity Transmission System**.
- PC.C.2 The above criteria are set down within the standards, memoranda, recommendations and reports and are provided as a guide to system planning. It should be noted that each scheme for reinforcement or modification of the **Transmission System** is individually designed in the light of economic and technical factors associated with the particular system limitations under consideration.
- PC.C.3 The tables below identify the literature referred to above, together with the main topics considered within each document.

PART 1 – SHETL's TECHNICAL AND DESIGN CRITERIA

ITEM No.	DOCUMENT	REFERENCE No.
1	National Electricity Transmission System Security and Quality of Supply Standard	Version []
2	System Phasing	TPS 13/4
3	Not used	
4	Planning Limits for Voltage Fluctuations Caused by Industrial, Commercial and Domestic Equipment in the United Kingdom	ER P28
5	EHV or HV Supplies to Induction Furnaces Voltage unbalance limits. Harmonic current limits.	ER P16 (Supported by ACE Report No.48)
6	Planning Levels for Harmonic Voltage Distortion and the Connection of Non-Linear Loads to Transmission Systems and Public Electricity Supply Systems in the United Kingdom Harmonic distortion (waveform). Harmonic voltage distortion. Harmonic current distortion. Stage 1 limits. Stage 2 limits. Stage 3 Limits Addition of Harmonics Short Duration Harmonics Site Measurements	ER G5/4 (Supported by ACE Report No.73)
7	AC Traction Supplies to British Rail Type of supply point to railway system. Estimation of traction loads. Nature of traction current. System disturbance estimation. Earthing arrangements.	ER P24

ITEM No.	DOCUMENT	REFERENCE No.
8	Operational Memoranda Main System operating procedure. Operational standards of security. Voltage and reactive control on main system. System warnings and procedures for instructed load reduction. Continuous tape recording of system control telephone messages and instructions. Emergency action in the event of an exceptionally serious breakdown of the main system.	(SOM) SOM 1 SOM 3 SOM 4 SOM 7 SOM 10 SOM 15
9	Planning Limits for Voltage Unbalance in the United Kingdom.	ER P29

PART 2 - SPT's TECHNICAL AND DESIGN CRITERIA

ITEM No.	DOCUMENT	REFERENCE No.
1	National Electricity Transmission System Security and Quality of Supply Standard	Version []
2	System Phasing	TDM 13/10,002 Issue 4
3	Not used	
4	Planning Limits for Voltage Fluctuations Caused by Industrial, Commercial and Domestic Equipment in the United Kingdom	ER P28
5	EHV or HV Supplies to Induction Furnaces Voltage Unbalance limits. Harmonic current limits.	ER P16 (Supported by ACE Report No.48)
6	Planning Levels for Harmonic Voltage Distortion and the Connection of Non-Linear Loads to Transmission Systems and Public Electricity Supply Systems in the United Kingdom Harmonic distortion (waveform). Harmonic voltage distortion. Harmonic current distortion. Stage 1 limits. Stage 2 limits. Stage 3 Limits Addition of Harmonics Short Duration Harmonics Site Measurements	ER G5/4 (Supported by ACE Report No.73)
7	AC Traction Supplies to British Rail Type of supply point to railway system. Estimation of traction loads. Nature of traction current. System disturbance estimation. Earthing arrangements.	ER P24

APPENDIX D - DATA NOT DISCLOSED TO A RELEVANT TRANSMISSION LICENSEE

PC.D.1 Pursuant to PC.3.4, **The Company** will not disclose to a **Relevant Transmission Licensee** data items specified in the below extract:

PC REFERENCE	DATA DESCRIPTION	UNITS	DATA CATEGORY
PC.A.3.2.2 (f) (i)	<p>(i) For GB Code Users</p> <p>The Generator Performance Chart at the Generating Unit stator terminals</p> <p>(ii) For EU Code Users:-</p> <p>The Power Generating Module Performance Chart, and Synchronous Generating Unit Performance Chart;</p>		SPD
PC.A.3.2.2 (b)	Output Usable (on a monthly basis)	MW	SPD
PC.A.5.3.2 (d) Option 1 (iii)	<p>GOVERNOR AND ASSOCIATED PRIME MOVER PARAMETERS</p> <p>Option 1</p> <p>BOILER & STEAM TURBINE DATA</p> <p>Boiler time constant (Stored Active Energy)</p> <p>HP turbine response ratio: (Proportion of Primary Response arising from HP turbine)</p> <p>HP turbine response ratio: (Proportion of High Frequency Response arising from HP turbine)</p>	<p>S</p> <p>%</p> <p>%</p>	<p>DPD II</p> <p>DPD II</p> <p>DPD II</p>
Part of PC.A.5.3.2 (d) Option 2 (i)	<p>Option 2</p> <p>All Generating Units (including Synchronous Generating Units forming part of a Synchronous Power Generating Module)</p> <p>Governor Deadband and Governor Insensitivity*</p> <p>- Maximum Setting</p> <p>- Normal Setting</p> <p>- Minimum Setting</p> <p>(Note Generators who are not required to satisfy the requirements of the European Connection Conditions do not need to supply Governor Insensitivity data).</p>	<p>±Hz</p> <p>±Hz</p> <p>±Hz</p>	<p>DPD II</p> <p>DPD II</p> <p>DPD II</p>
Part of PC.A.5.3.2 (d) Option 2 (ii)	<p>Steam Units</p> <p>Reheater Time Constant</p> <p>Boiler Time Constant</p> <p>HP Power Fraction</p>	<p>sec</p> <p>sec</p> <p>%</p>	<p>DPD II</p> <p>DPD II</p> <p>DPD II</p>

PC REFERENCE	DATA DESCRIPTION	UNITS	DATA CATEGORY
	IP Power Fraction	%	DPD II
Part of PC.A.5.3.2 (d) Option 2 (iii)	Gas Turbine Units Waste Heat Recovery Boiler Time Constant		
Part of PC.A.5.3.2 (e)	UNIT CONTROL OPTIONS Maximum droop Minimum droop Maximum frequency Governor Deadband and Governor Insensitivity* Normal frequency Governor Deadband and Governor Insensitivity* Minimum frequency Governor Deadband and Governor Insensitivity* Maximum Output Governor Deadband and Governor Insensitivity* Normal Output Governor Deadband and Governor Insensitivity* Minimum Output Governor Deadband and Governor Insensitivity* (Note Generators who are not required to satisfy the requirements of the European Connection Conditions do not need to supply Governor Insensitivity data). Frequency settings between which Unit Load Controller droop applies: Maximum Normal Minimum Sustained response normally selected	 % % ±Hz ±Hz ±Hz ±MW ±MW ±MW Hz Hz Hz Yes/No	 DPD II DPD II DPD II DPD II DPD II DPD II DPD II DPD II DPD II DPD II DPD II DPD II
PC.A.3.2.2 (f) (ii)	Performance Chart of a Power Park Modules (including DC Connected Power Park Modules) at the connection point		SPD
PC.A.3.2.2 (b)	Output Usable (on a monthly basis)	MW	SPD
PC.A.3.2.2 (e) and (j)	DC CONVERTER STATION AND HVDC SYSTEM DATA ACTIVE POWER TRANSFER CAPABILITY (PC.A.3.2.2) Import MW available in excess of Registered Import Capacity . Time duration for which MW in excess of Registered Import Capacity is available	 MW Min	 SPD SPD

PC REFERENCE	DATA DESCRIPTION	UNITS	DATA CATEGORY
	Export MW available in excess of Registered Capacity .	MW	SPD
	Time duration for which MW in excess of Registered Capacity is available	Min	SPD
Part of PC.A.5.4.3.3	LOADING PARAMETERS		
	MW Export		
	Nominal loading rate	MW/s	DPD I
	Maximum (emergency) loading rate	MW/s	DPD I
	MW Import		
	Nominal loading rate	MW/s	DPD I
	Maximum (emergency) loading rate	MW/s	DPD I

APPENDIX E - OFFSHORE TRANSMISSION SYSTEM AND OTSDUW PLANT AND APPARATUS TECHNICAL AND DESIGN CRITERIA

PC.E.1 In the absence of any relevant **Electrical Standards, Offshore Transmission Licensees** and **Generators** undertaking **OTSDUW** are required to ensure that all equipment used in the construction of their network is:

- (i) Fully compliant and suitably designed to any relevant **Technical Specification**;
- (ii) Suitable for use and operation in an **Offshore** environment, where such parts of the **Offshore Transmission System** and **OTSDUW Plant and Apparatus** are located in **Offshore Waters** and are not installed in an area that is protected from that **Offshore** environment, and
- (iii) Compatible with any relevant **Electrical Standards** or **Technical Specifications** at the **Offshore Grid Entry Point** and **Interface Point**.

PC.E.2 The table below identifies the technical and design criteria that will be used in the design and development of an **Offshore Transmission System** and **OTSDUW Plant and Apparatus**.

ITEM No.	DOCUMENT	REFERENCE No.
1	National Electricity Transmission System Security and Quality of Supply Standard	Version []
2*	Planning Limits for Voltage Fluctuations Caused by Industrial, Commercial and Domestic Equipment in the United Kingdom	ER P28
3*	Planning Levels for Harmonic Voltage Distortion and the Connection of Non-Linear Loads to Transmission Systems and Public Electricity Supply Systems in the United Kingdom	ER G5/4
4*	Planning Limits for Voltage Unbalance in the United Kingdom	ER P29

* Note:- Items 2, 3 and 4 above shall only apply at the **Interface Point**.

APPENDIX F - OTSDUW DATA AND INFORMATION AND OTSDUW NETWORK DATA AND INFORMATION

- PC.F.1 Introduction
- PC.F.1.1 Appendix F specifies data requirements to be submitted to **The Company** by **Users** and **Users** by **The Company** in respect of **OTSDUW**.
- PC.F.1.2 Such **User** submissions shall be in accordance with the **OTSDUW Development and Data Timetable** in a **Construction Agreement**.
- PC.F.1.3 Such **The Company** submissions shall be issued with the offer of a **CUSC Contract** in the case of the data in Part 1 and otherwise in accordance with the **OTSDUW Development and Data Timetable** in a **Construction Agreement**.
- PC.F.2. OTSDUW Network Data and Information
- PC.F.2.1 With the offer of a **CUSC Contract** under the **OTSDUW Arrangements** **The Company** shall provide:
- (a) the site specific technical design and operational criteria for the **Connection Site**;
 - (b) the site specific technical design and operational criteria for the **Interface Point**, and
 - (c) details of **The Company's** preliminary identification and consideration of the options available for the **Interface Point** in the context of the **User's** application for connection or modification, the preliminary costs used by **The Company** in assessing such options and the **Offshore Works Assumptions** including the assumed **Interface Point** identified during these preliminary considerations.
- PC.F.2.2 In accordance with the **OTSDUW Development and Data Timetable** in a **Construction Agreement** **The Company** shall provide the following information and data to a **User**:
- (a) equivalent of the fault infeed or fault level ratings at the Interface Point (as identified in the **Offshore Works Assumptions**)
 - (b) notification of numbering and nomenclature of the **HV Apparatus** comprised in the **OTSDUW**;
 - (i) past or present physical properties, including both actual and designed physical properties, of **Plant** and **Apparatus** forming part of the **National Electricity Transmission System** at the Interface Point at which the **OTSUA** will be connected to the extent it is required for the design and construction of the **OTSDUW**, including but not limited to:
 - (ii) the voltage of any part of such **Plant** and **Apparatus**;
 - (iii) the electrical current flowing in or over such **Plant** and **Apparatus**;
 - (iv) the configuration of any part of such **Plant** and **Apparatus**
 - (v) the temperature of any part of such **Plant** and **Apparatus**;
 - (vi) the pressure of any fluid forming part of such **Plant** and **Apparatus**
 - (vii) the electromagnetic properties of such **Plant** and **Apparatus**; and
 - (viii) the technical specifications, settings or operation of any **Protection Systems** forming part of such **Plant** and **Apparatus**.
 - (c) information necessary to enable the **User** to harmonise the **OTSDUW** with construction works elsewhere on the **National Electricity Transmission System** that could affect the **OTSDUW**
 - (d) information related to the current or future configuration of any circuits of the **Onshore Transmission System** with which the **OTSUA** are to connect;
 - (e) any changes which are planned on the **National Electricity Transmission System** in the current or following six **Financial Years** and which will materially affect the planning or development of the **OTSDUW**.

- PC.F.2.3 At the **User's** reasonable request additional information and data in respect of the **National Electricity Transmission System** shall be provided.
- PC.F.2.4 OTSDUW Data And Information
- PC.F.2.4.1 In accordance with the **OTSDUW Development and Data Timetable** in a **Construction Agreement** the **User** shall provide to **The Company** the following information and data relating to the **OTSDUW Plant and Apparatus** in accordance with Appendix A of the **Planning Code**.

< END OF PLANNING CODE >

