

Stage 03: Report to the Authority

Grid Code

GC0062 – Fault Ride Through

01 Workgroup Report

02 Industry Consultation

03 Report to the Authority

This report describes proposals to modify the Grid Code and summarises the feedback received on these proposals following an industry consultation. The modifications are intended to clarify the fault ride through requirements applicable to Synchronous Generating Units when subject to faults and voltage dips in excess of 140ms. The proposals contain new provisions for these requirements which set a more achievable voltage duration characteristic against which compliance can be assessed. The new provisions do not materially affect the robustness and integrity of the Transmission System.

This report is submitted to the Authority to assist its decision in relation to the implementation of the Grid Code Modification proposed.

Published on: 15 April 2016



National Grid recommends:

Implementation of the changes proposed to the Grid Code.



High Impact:

Owners, developers and manufacturers of Onshore Synchronous Generating Units



Medium Impact:

None



Low Impact:

None

Contents

1	Executive Summary	4
2	Purpose and Scope of Workgroup.....	7
3	Background to Fault Ride Through and System Requirements.....	9
4	Grid Code Deficiencies	11
5	Mode B Fault Ride Through Requirements	12
6	Specific Issues for Transmission Licensees	20
7	Specific Issues for Synchronous Generating Units	21
8	Conclusions and Recommendations.....	22
9	Assessment	24
10	Consultation Responses	27
	Grid Code Industry Consultation Response Proforma	28
	Annex 1 – Grid Code Issue	32
	Annex 2 – Terms of Reference	36
	Fault Ride Through Workgroup.....	36
	TERMS OF REFERENCE	36
	Background.....	36
	Governance.....	37
	Membership	38
	Annex 3 - Proposed Legal Text	40
	Annex 4 – Grid Code Industry Consultation Responses	57
	Grid Code Industry Consultation Response Proforma CR-01	58
	Grid Code Industry Consultation Response Proforma CR-02	60
	Grid Code Industry Consultation Response Proforma CR-03	61
	Grid Code Industry Consultation Response Proforma CR-04	63
	Grid Code Industry Consultation Response Proforma CR-05	64
	Grid Code Industry Consultation Response Proforma CR-06	65
	Appendix 1 - Study Evidence	66



Any Questions?

Contact:

Antony Johnson



[Antony.Johnson](mailto:Antony.Johnson@nationalgrid.com)

[@nationalgrid.com](mailto:Antony.Johnson@nationalgrid.com)



01926 655466

Proposer:

National Grid Electricity
Transmission plc

About this document

This document is a Report to the Authority in relation to the findings of the GC0062 Workgroup, the modification proposed to the Grid Code based on these findings, and the feedback received on the proposal following an Industry Consultation. This report is intended to provide the Authority with the information necessary to inform their decision on the implementation of the modification proposed.

The revisions to the Grid Code proposed by National Grid and sent to the Authority require approval by that body and will, if approved, come into force from such date (or dates) of which Authorised Electricity Operators will be notified by National Grid, in accordance with the Authority's approval.

Document Control

Version	Date	Author	Change Reference
1.0	15/04/2016	Antony Johnson, National Grid	Report to the Authority

1 Executive Summary

- 1.1 It is proposed to modify the Grid Code relating to the fault ride through requirements applicable to synchronous generating Units subject to faults and voltage dips in excess of 140ms. The proposals include revisions to the voltage duration curve defined in Figure 5 of CC.6.3.15.1(b) and consequentially updates to Appendix 4 of the Connection Conditions.
- 1.2 'Fault Ride Through' is the ability of generating units and power park modules to ride through supergrid transmission system faults and disturbances whilst connected to a healthy system circuit. This is a fundamental requirement to maintain system security and avoid cascade tripping of generation causing wider system issues such as frequency collapse and potential system shut down.
- 1.3 Fault ride through was introduced to the GB Grid Code in June 2005 following Grid Code consultation H/04 (Changes to Incorporate New Generation Technologies and DC Inter-connectors H/04). At the time of this Grid Code modification, the new generation of power park modules (which includes wind farms) struggled to remain connected following a transmission system fault even if connected to a healthy circuit for normal protection operating times. To ensure consistency, fairness and non-discrimination, equivalent requirements were applied to both synchronous generating units and power park modules.
- 1.4 The fault ride through requirements are defined in CC.6.3.15 of the Grid Code and comprise of two parts. CC.6.3.15.1(a) defines the fault ride through requirements for balanced and unbalanced transmission system faults which last up to 140ms in duration, whilst CC.6.3.15.1(b) refers to balanced faults and disturbances in excess of 140ms. For the purposes of this report and as referred to in the Guidance Notes for Power Park Modules, Issue 3 September 2012 (see [6] in the References section of this report), the term "Mode A" is used to refer to faults up to 140ms in duration and "Mode B" to refer to faults / voltage dips in excess of 140ms in duration.
- 1.5 For Mode B faults, CC.6.3.15.1(b) of the Grid Code requires synchronous generating units and power park modules to be capable of withstand against a defined voltage duration curve. Examples of these requirements are detailed in Appendix 4 of the Grid Code Connection Conditions.
- 1.6 In January 2012 (see Annex 1), EDF raised issue paper reference pp12/04 requesting a revision to CC.6.3.15.1(b) of the Grid Code in relation to Mode B faults on the basis that a number of synchronous generators struggled to meet this requirement, particularly for voltage depressions of between 15 – 50% of nominal voltage lasting up to several hundred milliseconds. The solution suggested by EDF was the introduction of a Mode B requirement on a site specific basis.
- 1.7 In response and following discussion amongst the Grid Code Review Panel, National Grid held three industry workshops in September 2012, November 2012 and January 2013. Attendees of the workshops comprised developers and interested participants from both the synchronous and asynchronous sectors.
- 1.8 To address the issue, participants at the final workshop in January 2013 concluded that it should be progressed to a Grid Code Industry Working Group but should only consider synchronous plant. This was on the basis that whilst the current Grid Code requirements were not ideal in respect of asynchronous plant, such developers would not wish to implement a change to the requirements for their plant and then have to apply further changes following the introduction of the European Network Code – Requirements for Generators (RfG) which is due to become European law during 2016 and will apply to generators connecting to the system after approximately 2019. On the other hand, it was recognised that the issue continues to be a significant concern for synchronous plant and therefore some more immediate action needed to be taken.
- 1.9 In consideration of this issue, the workshop considered the following options:-
 - Do nothing

- Consider early adoption of the European Commission RfG fault ride through requirements only (Article 14(3), Article 16(3) and Article 17(3)).
 - Adopt the Mode B fault ride through requirements on a site specific basis
- 1.10 In view of the impending introduction of the RfG requirements, it was proposed that early adoption of the RfG requirements in the GB Grid Code ahead of RfG implementation would be the preferred option and that this should proceed to an industry workgroup.
- 1.11 These issues and a draft set of Terms of Reference were presented to the GCRP in March 2013 (Paper Reference pp13/18) and following a number of comments were resubmitted and approved by the GCRP at the July 2013 meeting (Paper Reference pp13/41). At that stage, the aim and intention of the workgroup was to amend the GB Grid Code using the RfG fault ride through requirements for synchronous plant as a vehicle to address the identified Grid Code deficiency. The work would be addressed in two phases, the first being applicable to directly connected synchronous plant and the second being the development of requirements for embedded synchronous plant.
- 1.12 During the course of the workgroup it was established that the RfG fault ride through requirements only apply to secured faults (ie those cleared in main protection operating times). Since Mode B faults are unsecured (ie cleared in backup protection operating times), and the RfG fault ride through requirements do not cover this issue, the workgroup agreed that the current GB Grid Code Mode B voltage duration curve should be amended (Figure 5 CC.6.3.15.1(b)(i)). It is important to note that the RfG fault ride through requirements apply to synchronous and asynchronous generation and define the requirement on the basis of a voltage against time profile where the voltage is as seen at the connection point rather than stating a requirement that the generator must remain connected and stable for a fault lasting 140ms. As such, it was noted that the RfG fault ride through requirements are quite fundamentally different from the current GB Mode A fault ride through requirements.
- 1.13 In addition and following discussions amongst the workgroup, it was also agreed that greater clarity should be provided with regard to the demonstration of fault ride through compliance. This is a particular feature of this report although not included in the legal text. The reason is that demonstration of fault ride through compliance through simulation studies is not a requirement for synchronous generators in the current GB Grid Code. Since the draft legal text proposed is a relaxation to the current Grid Code requirements (including equipment already connected) it would not be appropriate to introduce this requirement due to the possible consequences upon existing generators.
- 1.14 The study work has been extensive. This has covered a wide range of synchronous generator sizes (up to 2000MVA) fitted with different types of excitation system under different pre-fault operating conditions and connected to different parts of the network with varying system strength. Full details of the analysis are covered in Appendix 1 of this consultation document.
- 1.15 In summary this report provides the following:
- Proposed revisions to the GB Mode B fault ride through requirements (CC.6.3.15.1(b)(i)) following detailed modelling of large synchronous generating units (note that these revisions do not propose a change to the active power recovery characteristics)
 - Examples of simulations for demonstration of compliance considered by the workgroup in its discussions, and which the workgroup believes are useful examples for generation developers
 - A summary of the workgroup's interpretation of the RfG requirements as only applicable to directly connected synchronous generating units. The workgroup concluded that the RfG requirements do not address the original Grid Code defect. However as this solution was originally proposed in the workgroup's terms of reference, Appendix 2 of this consultation document contains an interpretation of how a directly connected Type D synchronous generator would be treated under the RfG fault ride through requirements. The workgroup believes this information will be valuable to the GC0048 workgroup which is dealing with the GB implementation of RfG but it should not be underestimated that there is still a significant amount of work

required by the GC0048 workgroup to fully integrate the RfG fault ride through requirements into the GB Grid Code and Distribution Code which Appendix 2 of this consultation document does not address.

- 1.16 National Grid believes that as part of the GC0062 workgroup the deficiencies identified in EDF's paper pp12/04 have been investigated and addressed by the proposed legal text. In summary, the only changes necessary are to the GB Mode B fault ride through requirements (CC.6.3.15.1(b)) as detailed in Annex 3 of this report.
- 1.17 National Grid believe these proposed requirements strike the right balance between maintaining the safety, security and economy of the transmission system whilst at the same time defining a set of requirements which a synchronous generating unit can reasonably achieve. National Grid did not identify any material negative impact on the reliability of the transmission system or synchronous generating units as a result of these proposals. The GC0062 workgroup concluded that there is a benefit to generators in implementing the proposed changes as new generators are better able to achieve compliance with the proposed new requirements using standard design approaches. The proposals are not believed to cause any conflict with the RfG provisions which will be dealt with elsewhere.
- 1.18 The draft legal text in Annex 3 shows the proposed changes to CC.6.3.15.1(b) which advocates new provisions for synchronous generating units in setting a more achievable voltage duration characteristic (Figure 5 of CC.6.3.15.1(b)) against which compliance can be assessed whilst also maintaining the robustness and integrity of the transmission system.
- 1.19 These proposals and the Workgroup Report were presented to the January 2016 GCRP who approved the findings and recommended it for industry consultation.
- 1.20 The industry consultation ran from 9th February 2016 to 9th March 2016. The consultation document was based on the views represented by the workgroup which has sought to find a solution that strikes the right balance between the minimum needs of the Transmission System and the achievable capability of synchronous generators.
- 1.21 Following the industry consultation, six responses were received all of which were supportive. Of these responses, two additional comments were raised (RWE and Uniper Energy). RWE raised a number of queries in relation to the report which have been addressed and a formal response provided. A summary of this response is covered in Section 10.22 of this report. EoN raised the point that the proposals inadvertently deleted the requirements for Offshore Synchronous Generating Units and the requirements applicable offshore should be explicitly defined. In response to the second set of comments, the legal text has been updated to include this requirement which is reflected in Annex 3 of this report.
- 1.22 Based on the findings of the Workgroup and the responses received as part of the consultation, National Grid recommends that the Grid Code is changed to include the modifications proposed in Annex 3 of this report.

2 Purpose and Scope of Workgroup



Workgroup Meeting

Dates

M1 - 3 December 2013
M2 - 06 February 2014
M3 - 08 May 2014
M4 - 15 July 2014
M5 - 30 September 2014
M6 - 21 November 2014
M7 - 24 April 2015
M8 - 29 July 2015
M9 - 30 October 2015

Overview

- 2.1 EDF raised an issue at the Grid Code Review Panel in January 2012 in relation to CC.6.3.15.1(b) of the Grid Code and the ability of synchronous generating units to satisfy the fault ride through requirements for voltage dips in excess of 140ms. The principle area of concern related to the ability of Synchronous Generators to ride through voltage depressions of between 15 – 50% over a time frame of between 140 – 500ms. EDF proposed that a possible solution to this would be an amendment to CC.6.3.15.1(b) of the Grid Code which introduced a site specific requirement rather than the current mandatory requirement in the Grid Code. A copy of this GCRP Issue Paper (Ref pp12/04) is included in Annex 1 for reference.
- 2.2 The Grid Code Review Panel recommended the formation of an industry workshop to address this issue. In response, three industry workshops were held (September 2012, November 2012 and January 2013). Workshop attendees included representatives of both synchronous and asynchronous Generators. The key options considered during the workshops were:-
- Do nothing
 - Consider early adoption of the RfG fault ride through requirements only (Article 14(3), Article 16(3) and Article 17(3)).
 - Adopt Mode B fault ride through requirement on a site specific basis
- 2.3 In consideration of these options, workshop participants concluded that with the impending introduction of the European Network Codes (including the Requirements for Generators code), early adoption of RfG would be the best course of action. Workshop participants also concluded that any proposed change to the Grid Code should only consider changes to the requirements associated with synchronous plant. This was on the basis that whilst the current requirements are not ideal, asynchronous generation can already meet the existing requirements and developers would not wish to introduce new requirements to this plant which could potentially change again when the RfG requirements are formally introduced.
- 2.4 It was therefore concluded that an industry workgroup should be established to consider early adoption of the RfG requirements for synchronous generators only as a vehicle for addressing the Grid Code deficiency. The intention was for the work to be considered in two phases, the first being the requirements applicable to directly connected synchronous generating units and the second being the requirements applicable to embedded synchronous generating units.
- 2.5 The draft terms of reference were presented to the March 2013 Grid Code Review Panel (GCRP) (paper ref 13/18). Following a number of revisions the terms of reference were approved at the July 2013 GCRP meeting (paper ref pp13/41 as attached in Annex 2).
- 2.6 During the progress of the workgroup it was realised that the RfG fault ride through requirements only captured secured faults, in other words faults cleared in main protection operating times. As such, the RfG fault ride through requirements, by themselves, would be unable to address the deficiencies raised in the issue paper (Annex 1).
- 2.7 At this stage, the workgroup discussed if the terms of reference should be formally changed and re-presented to the GCRP. In summary, the workgroup agreed that the scope of work should include a review of the RfG fault ride through requirements, as applicable to directly connected synchronous generating units only, including suggested GB parameters for the voltage against time curve. However, it was agreed that such proposals should be taken out of the main body of the report and included as an Appendix (see Appendix 2 of this consultation document). The workgroup re-emphasised that so far as RfG is concerned fault ride through remains a significant amount of work that the GC0048 RfG implementation workgroup would need to address. Notwithstanding this, it is acknowledged that the work undertaken

as part of this GC0062 workgroup will provide a useful guide for RfG fault ride through implementation by the GC0048 workgroup.

- 2.8 The workgroup agreed that based on the analysis completed, the existing GB Grid Code fault ride through requirements (CC.6.3.15.1(b)) should be revised, in particular the voltage duration curve defined in Figure 5. An output of the consultation document and this report is therefore proposed revisions to the legal text associated with CC.6.3.15.1(b), and any corresponding consequential changes.
- 2.9 As part of this work, a key requirement was to ensure that clarifications for demonstrating fault ride through compliance were clearly articulated.

Timescales

- 2.10 Nine workgroup meetings were held between December 2013 and October 2015 with a final teleconference held on 14 December 2015.
- 2.11 A verbal update on progress was regularly provided to the GCRP. The final workgroup report was presented to the GCRP at the January 2016 Panel meeting.
- 2.12 An industry consultation was held between 9 February and 9 March with six responses being received, all of which were supportive.

3 Background to Fault Ride Through and System Requirements

- 3.1 The requirements for fault ride through were introduced to the GB Grid Code in June 2005 following Consultation H/04 (the development of technical requirements for new and renewable forms of Generation including DC Converters). Full details of the need for fault ride through are detailed in Section 5.1 Appendix 2 of Consultation H/04. A link to this consultation document is available in Reference [1].
- 3.2 It is beyond the scope of this consultation document to duplicate the information in consultation H/04, however the key points and requirements are summarised here for information, particularly in respect of the Grid Code deficiencies highlighted in pp12/04 and the subsequent workshops noted in section 2.2 above. A copy of all the material presented at the workshops is available on the National Grid website from the following link: <http://www2.nationalgrid.com/UK/Industry-information/Electricity-codes/Grid-code/Modifications/GC0062/>
- 3.3 Fault ride through was initially identified as an issue with wind generation. As noted in section 5.1 of Reference [1] (see References section of this Consultation document), in the event of a fault on the transmission system, a solid three phase short circuit fault will result in zero voltage at the point of fault until it has been cleared by power system protection. For faults at 400kV and 275kV, the main protection would be expected to clear the fault within 80 – 100ms for a two ended circuit and typically within 140ms for a three ended circuit. Since the impedance of the transmission network is low, then the voltage as seen across the transmission system will be significantly depressed until the fault has been cleared. This characteristic is clearly shown in Figures 5.1 (a) – 5.1(d) of Section 5.1 of Reference [1].
- 3.4 The early generation of wind farms, particularly those employing power electronic converters, had a tendency to trip if the voltage at the turbine terminals dropped even below 90% of nominal for a time duration of a few tens of milliseconds. Clearly under these conditions, there is a risk that during a transmission system fault (for which it is possible to lose up to 1800MW of generation) there is a possibility that the wind generation connected to the transmission system would also trip as a result of the transient fall in voltage during the fault period, even if connected to a healthy circuit. The consequence of this would be cascade tripping of generation, potential frequency collapse and ultimately blackout. In addition, to maintain transmission system integrity there is also a requirement for generation to remain connected and stable for transmission system voltage dips which are cleared in backup protection operating times.
- 3.5 In order to address these issues, fault ride through requirements were introduced as a fundamental requirement of the H/04 Grid Code consultation provisions which ultimately became part of the Grid Code in June 2005. At its heart the Grid Code fault ride through requirements can be summarised as follows:-
- (a) Generating units and power park modules are required to remain connected and stable for any balanced and unbalanced fault cleared in main protection operating times (up to 140ms in duration).
 - (b) During the period of the fault, the generator or power park module is required to generate maximum reactive current without exceeding the transient rating of the generating unit or power park module in order to support the transmission system voltage.
 - (c) Following restoration of the voltage to the nominal levels defined in CC.6.1.4 of the Grid Code (ie upon clearance of the fault), each generating unit and power park module is required to restore active power to 90% of its pre-fault output within 0.5 seconds. This is required to ensure maintenance of active power following the fault and prevent frequency collapse.
 - (d) The requirements outlined in 3.5 (a) – (c) above are detailed in CC.6.3.5.15.1(a) of the Grid Code and referred to as Mode A requirements.
 - (e) In order to ensure adequate system robustness to remote faults cleared in backup protection operating times, there is also a requirement for generating units and power park modules to remain connected and stable

for any voltage dip on or above the heavy black line shown in Figure 5 of CC.6.3.15.1(b). An example of these requirements are detailed in Appendix 4 of the Grid Code Connection Conditions.

- (f) For transmission system voltage dips lasting longer than 140ms as noted in section 3.5 (e) above, each generating unit and power park module is required to remain connected and stable and inject maximum reactive current during the period of the voltage dip without exceeding the transient rating of the generating unit or power park module.
- (g) Following restoration of the voltage to the nominal levels defined in CC.6.1.4 of the Grid Code (ie upon clearance of the voltage dip) each generating unit is required to restore active power within 1 second.
- (h) The requirements outlined above in section 3.5 (e) – (g) are detailed in section CC.6.3.15.1(b) of the Grid Code and referred to as Mode B faults.

- 3.6 For Mode A faults, the Grid Code defines that the maximum protection operating time on the transmission system shall not be more than 140ms. In practice this value is specified in the bilateral connection agreement although at the connection offer stage it is generally common practice to set the value to 140ms unless system conditions or generator performance dictates otherwise.
- 3.7 Whilst consultation H/04 was specifically aimed at connection requirements for new and renewable forms of generation, including HVDC Converters, the requirement to extend the proposals to synchronous generation was not actually included until quite late on in the H/04 development process due to the need to ensure equitability between all classes of generator.
- 3.8 The issue was further compounded by an unclear compliance process which under CP.A.3.5 only requires non-synchronous generating units, DC converters and power park modules to supply simulations for balanced and unbalanced faults lasting up to 140ms in duration (ie Mode A faults) and voltage dips in excess of 140ms (ie Mode B faults). In addition, there is no Grid Code requirement for testing fault ride through performance of synchronous plant (OC5.A.2.1).

4 Grid Code Deficiencies

4.1 The issue was originally specified in Grid Code Issue Paper pp12/04 however the Grid Code deficiencies are split into two fundamental parts;

- A significant volume of synchronous generators, and particularly larger units, struggle to meet the Mode B fault ride through requirements.
- The compliance process for synchronous plant is unclear and not well documented.

5 Mode B Fault Ride Through Requirements

- 5.1 Section 3.5 (e) – (h) of this report describes the performance expected of Synchronous Generating Units and Power Park Modules when subject to voltage dips in excess of 140ms. More specifically, these requirements are defined in CC.6.3.15.1(b) of the Grid Code through. At its heart, the requirement centres around a voltage duration curve which is defined in Figure 5 of CC.6.3.15.1(b) which is re-produced as Figure 5.1 below.

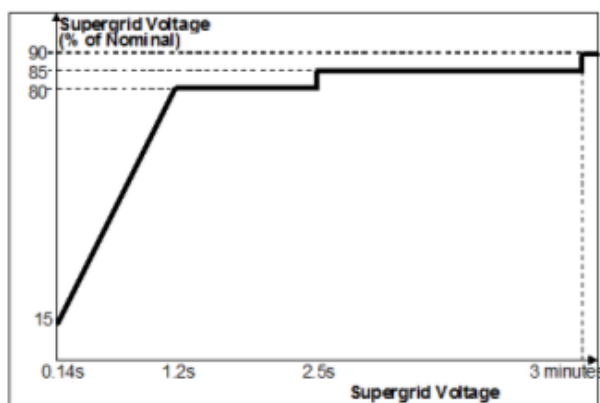

Figure 5.1 – Current GB Grid Code Mode B Voltage Duration Curve Fault Ride Through Requirements

- 5.2 Figure 5 of CC.6.3.15.1(b) of the Grid Code is a voltage duration curve which is not to be confused with a voltage against time curve as defined in RfG. In summary the GB voltage duration curve is not a voltage - time response curve that would be obtained by plotting the transient voltage response at a point on the Transmission System to a disturbance, rather each point on the profile represents the voltage level and associated time duration a Generating Unit must withstand or ride through. A set of examples of the interpretation of Figure 5 of the Grid Code are covered in Appendix 4 of the GB Grid Code Connection Conditions (Figures CC.A.4A.3(a), CC.A.4A.3(b) and CC.A.4A.3(c) – see Reference [5].
- 5.3 Since the introduction of these requirements in June 2005, one of the principle issues of concern has been the ability of larger Synchronous Generators to satisfy the Mode B fault ride through requirements, particularly for arduous voltage dips such as a retained voltage of 30% for 384ms or 50% for 710ms. These areas of difficulty are shown in Figure 5.3 below.

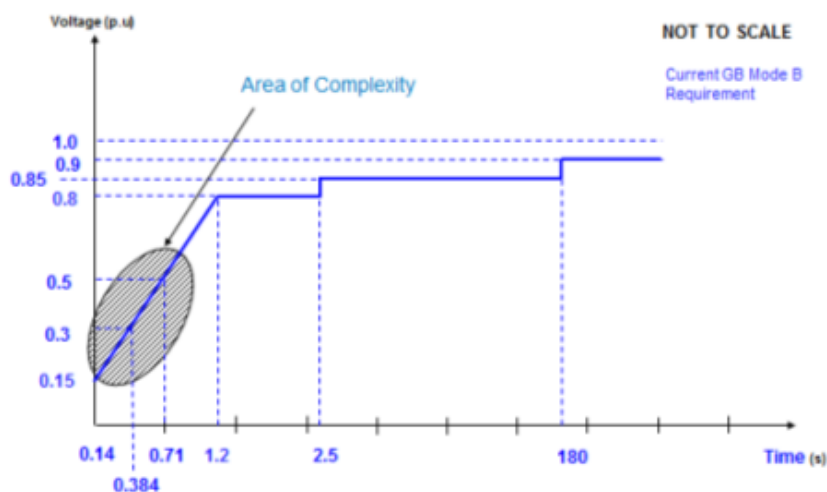

Figure 5.3 – GB Grid Code – Mode B Fault Ride Through Requirements – Area of Complexity

- 5.4 As the RfG document does not cover faults cleared beyond main protection operating times, this provides a further degree of freedom in developing a revised Mode B requirement. It was therefore proposed to re-evaluate the GB Mode B voltage duration curve through extensive study work. The remaining part of this section details the high level requirements and conclusions with the accompanying detailed study work covered in Appendix 1, whilst at the same time giving some background as to why the derived voltage duration curve is the shape it is.
- 5.5 Under worst case conditions, Generating Units would be exposed to a fault on the Transmission System cleared in backup operating times, typically within 500ms. It is accepted that generation local to the fault would be permitted to trip (generally through observed instability), but the purpose of this requirement is to ensure that the Generation remote from the disturbance remains connected and stable. It is acknowledged that generation would be likely to be lost in excess of the infrequent infeed loss (currently 1800MW - as defined under the SQSS) and whilst it is accepted that the low frequency demand disconnection scheme would operate the Transmission System would at least retain some form of robustness against a total blackout.
- 5.6 An example of such a situation is shown in Figure 5.6(a) and Figure 5.6(b) below which gives an indication of the situation that could arise on the Transmission System in the event of a protection or breaker failure.

A double circuit fault, with a failure of a local breaker

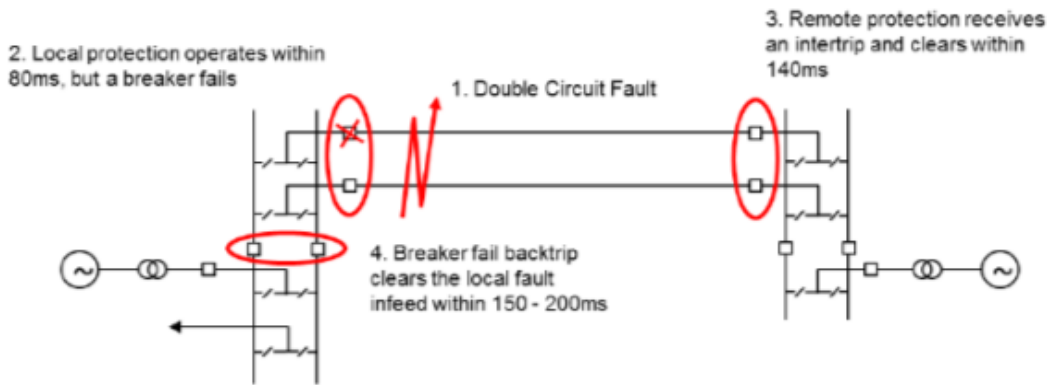

Figure 5.6(a)

A double circuit fault, with a failure of a remote breaker

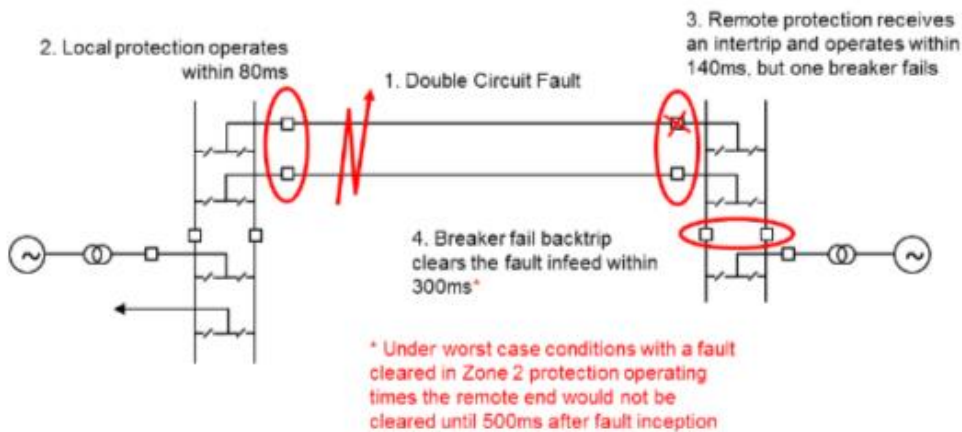

Figure 5.6(b)

- 5.7 A multi machine simulation study modelling this exact situation was run on a number of parts on the network including the Drax - Eggborough group which is known to have high concentrations of generation during peak demand conditions. The results of this study are fully detailed in Appendix 1.
- 5.8 To determine the Mode B requirements there are two important criteria that need to be established. These are:-
- The minimum needs of the Transmission System on the basis of safety, security and economic grounds
 - An achievable requirement that Generators can meet.
- 5.9 In view of this, the following studies and sensitivities were run. These are summarised below and detailed in Appendix 1 of the report.
- The effect on Generators and System voltage remote from a severe Transmission System fault cleared in backup operating times.
 - The effect on Generator stability by varying the and pre and post fault short circuit ratio.
 - Determination of the critical fault clearance time over a range of operating scenarios and fault levels.
 - Variation in results upon Generator MW size. The more sensitive results were identified with higher MW output plant. Studies were run up to a maximum Generator size of 1800MW.
- 5.10 From these studies some important results were derived. These being:-
- Determination of the Mode B fault ride through voltage duration curve.
 - Determination of pre and post fault voltage requirements
 - Determination of pre and post fault short circuit levels
 - Methods of determining Mode B compliance via simulation.
- 5.11 The first stage of this process was to determine the voltage duration curve. Based on initial study work, three options were initially proposed with a fourth being presented based on amendments to option 3. All four options were presented to the workgroup which are shown in Figure 5.11 below.

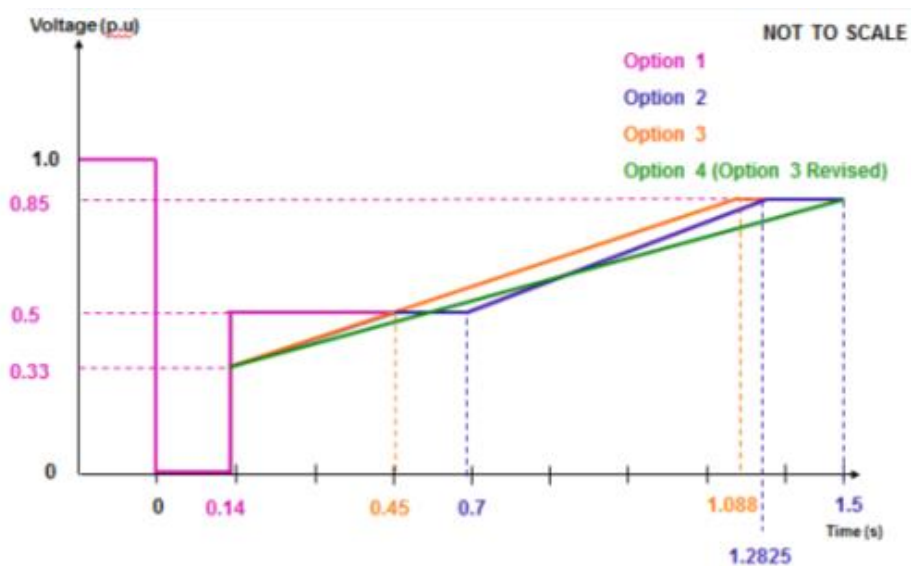

Figure 5.11 – Options Considered for Mode B Voltage Duration Curves based on initial studies.

- 5.12 Following further internal and external analysis it was confirmed that Option 3 would be the most appropriate option based on both the minimum needs of the Transmission System and the ability of Generators to satisfy the above requirements based on critical fault clearance times against minimum short circuit levels.
- 5.13 Options 1 and 2 were quickly discounted on the basis that system studies demonstrated that the majority of Generators would be able to survive a voltage depression from 0.33p.u at 140ms to 0.5p.u at 450ms. In other words Options 1 and 2 (which included a vertical rise in voltage to 0.5p.u and then a sustained voltage deviation of 0.5 p.u for 700ms) had two issues. The first being that the period from 140ms to 450ms was too lenient and in all cases Synchronous Generators could easily satisfy these requirements. However voltage depressions of 0.5p.u for more than 450ms resulted in severe issues with pole slipping frequently observed. More detailed studies demonstrated that the pinch point was largely around a retained voltage of 0.5p.u for approximately 450ms (see Figure 5.14 below).
- 5.14 These studies resulted in the need to refine the proposed voltage duration curve further resulting in the development of Option 3. Option 4 (a revision of Option 3) was also investigated by extending the time at which the voltage recovers to 0.85 p.u to 1.5 seconds. This also resulted in instability as it transgressed the critical point of 0.5p.u at 450ms. These results are shown in Figure 5.14 where Option 4 is shown as proposal 2 in Figure 5.14. These results were run were run by a Workgroup member and also consistent with the results obtained by National Grid. A full summary of these results together with sensitivities to fault level and voltage are covered in Appendix 1 of this Consultation document.

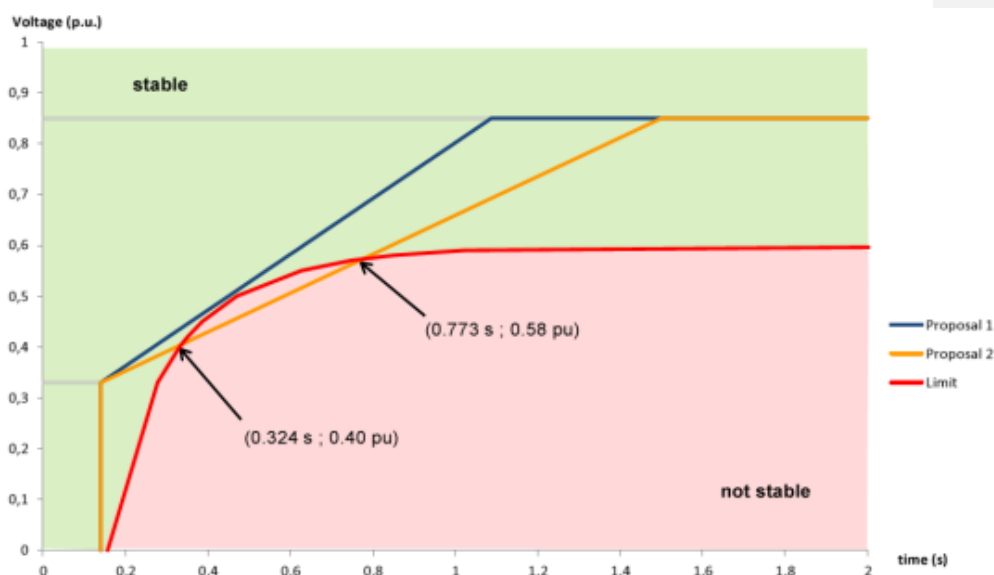

Figure 5.14 – Critical Fault Clearing Times for a 1780 MW Generator against proposed Mode B voltage duration curve.

- 5.15 The results from these studies (and the corresponding evidence shown in Appendix 1) show that Proposal 1 which is equivalent to Option 3 shown in Figure 5.11 above clearly, demonstrate this to be the optimum requirement. Further analysis was also conducted where Generators under test were subject to long duration voltage dips

were the retained voltage was in the order of 0.85p.u for a period of 180 seconds (3minutes). Under these scenario's, generator stability was observed. Taking these results into account, then enables the voltage duration curve to be finalised as shown in Figure 5.15(a) which removing the 140ms period results in Figure 5.15(b) below.

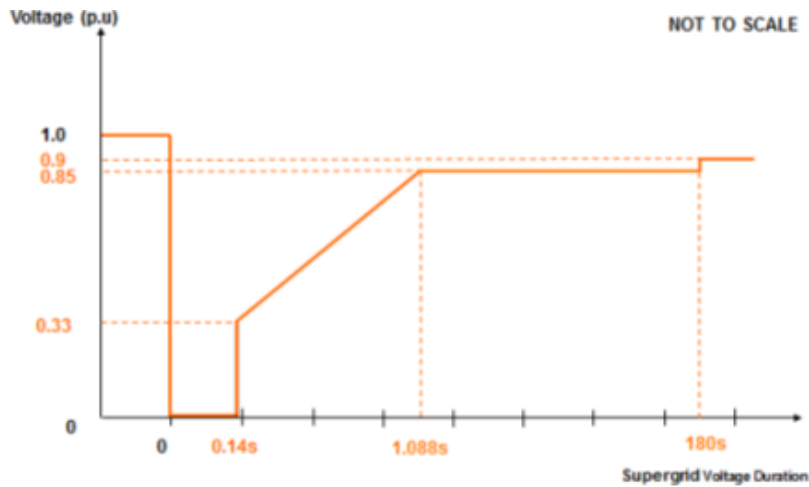

Figure 5.15(a) – Final Proposed Mode B Voltage Duration Curve.

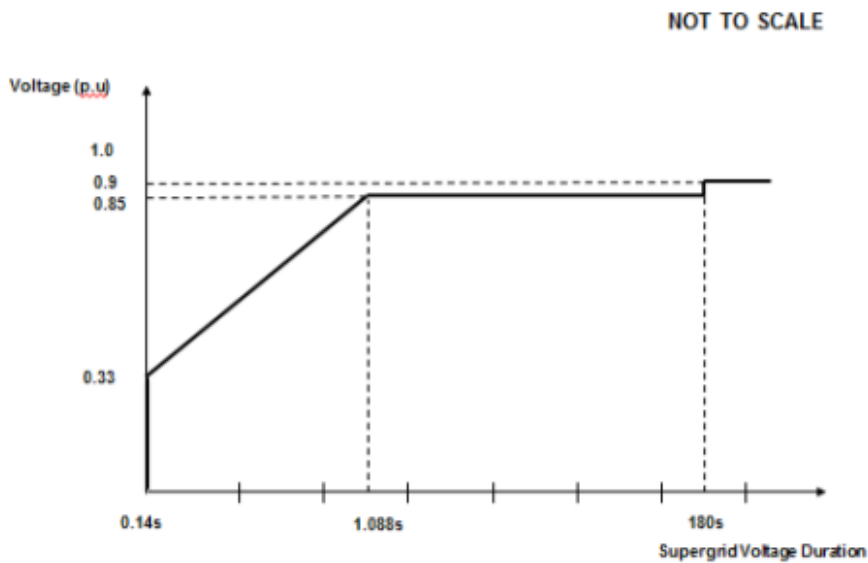

Figure 5.15(b) – Final Proposed Mode B Voltage Duration Curve.

5.16 The implications of these results and proposed requirements also need to be put in context. It is important to note that under a Mode B fault, the Generator is expected to remain connected and stable for a remote fault cleared in backup operating times. This criteria has important assumptions that needs to be considered when compliance is undertaken.

- The Pre and post fault short circuit level would be expected to remain the same
- The pre fault voltage would be assumed to be 1.0p.u. Equally on clearance of the voltage dip, the post fault voltage would be assumed to recover to 1.0p.u. Analysis showed recovery back to 0.9p.u rather than 1.0p.u to be particularly onerous.
- The fault level was critical in determining these results and on average the post fault Transmission System short circuit level needs to be about 10

times larger than the machine MVA rating for stability to be retained for a Mode B fault.

- For the purposes of demonstrating compliance, National Grid will advise the Generator of the short circuit level required for study purposes during the Compliance process. This has the flexibility of reflecting the fault level at the connection point but equally the number of machines connected at site.

5.17 Figure 5.17 below shows some examples of a voltage dip that a Generating Unit would be expected ride through. For the purposes of clarity they have been superimposed on the revised voltage duration curve.

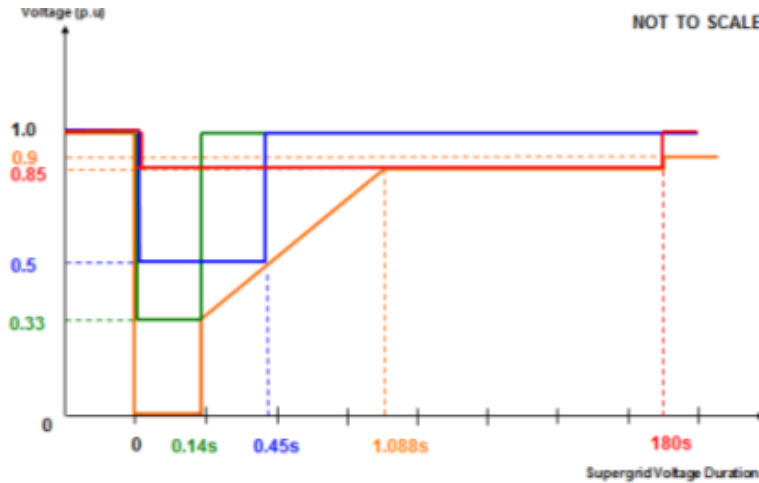

Figure 5.17 – Examples of Voltage dips as seen on the Transmission System superimposed on the proposed voltage against time curve.

5.18 The workgroup discussed in detail how compliance should be demonstrated in particular the straight line voltage dips as shown in Figure 5.17 which can be quite complex to replicate. The workgroup noted that under a faulted condition, a non-linear busbar voltage will be observed as the fault is modelled behind a switched fixed impedance. This will cause the initial dip and the change in generator reactance over time then causes the bus voltage to reduce further until the fault is cleared. To address this concern two methods were proposed for demonstration of compliance.

5.19 The first method for demonstrating Mode B compliance is by simulation of a fault applied to the HV terminals of the Generator Transformer with the Generator set to operate at full output, full MVar lead. National Grid will provide the fault level at the Connection Point as part of the Compliance Process. This will enable the value of the fault level to be adjusted depending upon the strength of the network but more importantly the number of machines at the connection site.

Model built as shown below

Pre Fault conditions:
 0.95PF Leading at rated MW Load
 1pu at Gen Terminals and TX HT Terminals
 Line Z to achieve required Fault Level
 External Grid Voltage determined by balance

During Fault:
 Fault of appropriate impedance applied to TX HT to achieve voltage & time duration in Table 1

Post Fault Conditions
 Fault removed
 Generator must remain stable, connected and not pole slip
 Post fault voltage returns to 1.0p.u

Duration (s)	Retained volts (p.u)
0.14	0
0.25	0.39
0.45	0.5
0.514	0.535
0.7	0.637
1.088	0.85
180	0.85

Table 1

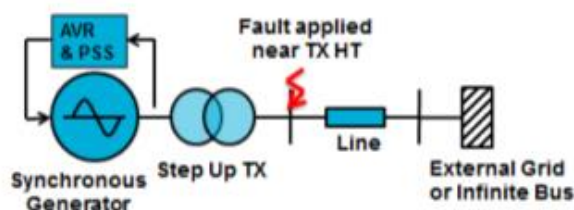

Figure 5.19 – Method 1 – demonstration of Mode B Fault Ride Through compliance

5.20 Under this method, a fault will result in a voltage decay during the period of the fault as a result of the machine dynamics. This method will not produce a constant voltage during the period of the voltage dip as highlighted in Figure 5.20 and therefore the fault impedance is adjusted to give the required average volt drop. An example of this is shown in Figure 5.20 below.

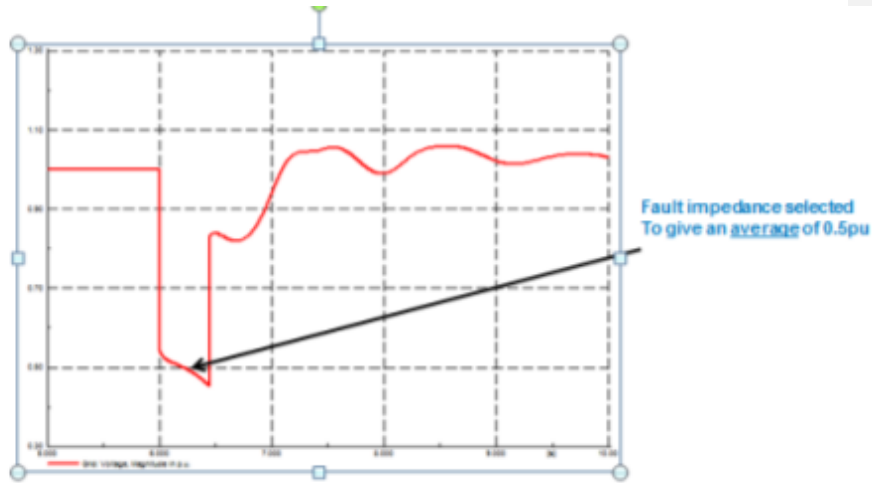

Figure 5.20 – Method 1 - Mode B Fault Ride Through Compliance – Method to obtain an average volt drop.

5.21 An alternative to this approach, referred as Method 2, uses an infinite capacity transformer in parallel with a line as shown in Figure 5.21 below. Under pre fault conditions, the impedance of the line is set to give the required fault level. To simulate the voltage dip, the infinite capacity transformer is switched into service with the taps set to achieve the desired voltage dip and then switched out again following the required duration in accordance with Table 1 of Figure 5.21. This method enables a constant voltage dip to be maintained (as shown in Figure 5.22) throughout the period of the voltage dip and there is no risk of varying voltage as a result of the machine dynamics. Again, the pre-fault condition is that the machine is running at Rated MW output and full MVAR lead.

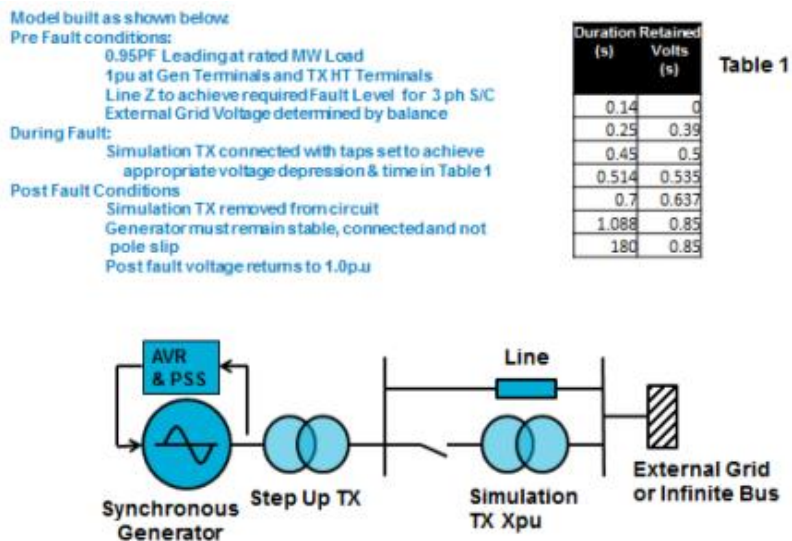

Figure 5.21 – Method 2 – demonstration of Mode B Fault Ride Through compliance

5.22 Using Method 2, the corresponding voltage dip is shown in Figure 5.22 below.

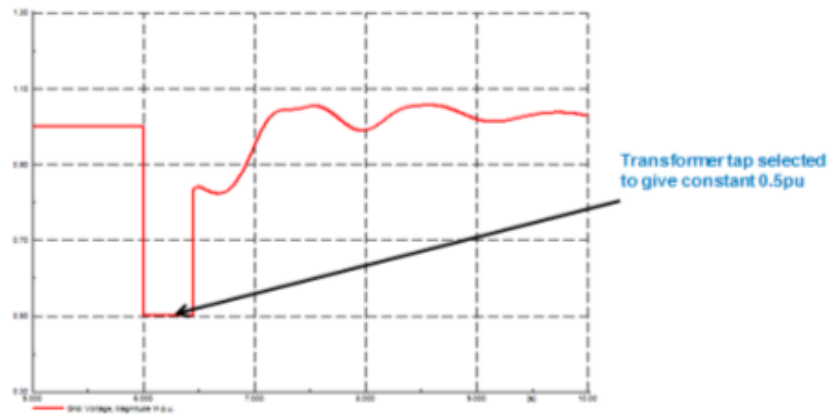

Figure 5.22 – Method 2 - Mode B Fault Ride Through Compliance – Method to obtain volt drop.

- 5.23 As highlighted earlier in the report, the Grid Code does not currently mandate Generators to demonstrate fault ride through compliance for Synchronous Generating Units. It is therefore proposed that CP.A.3.5 and OC5.A.2.1 remain unchanged until implementation of RfG under GC0048 (which would include compliance provisions for both Mode A and Mode B faults). However it is intended that the contents of this Consultation document will provide a useful guide to the process that could be used to demonstrate compliance.

6 Specific Issues for Transmission Licensees

- 6.1 The proposed changes to the legal text are summarised in Annex 3 and only affect the Mode B requirements. In summary these proposals redefine the voltage duration curve and seek to provide a clear interpretation of how the requirements should be interpreted for synchronous generating units. These changes are articulated in Appendix 4 of the Grid Code Connection Conditions.
- 6.2 It is acknowledged that the package of measures that these proposals introduce (revised voltage duration curve, restoration of voltage back to 1.0p.u instead of 0.9 p.u) do result in some relaxations. However it must be recalled that the Mode B fault ride through requirements are already beyond the requirements of the SQSS and simply act in a last resort to maintain the integrity of the transmission system rather than allow a complete system shut down to propagate. As such, it is believed and recognised that these new proposals provide an optimum balance between the security and robustness of the Transmission System against the capability of Synchronous Generating Units.

7 Specific Issues for Synchronous Generating Units

- 7.1 This modification impacts the owners of synchronous generating units.
- 7.2 As noted in section 6.2, this package of measures provides i) a relaxation to the current voltage duration curve and revisions to the post fault behaviour to which synchronous generating units will be subject. In addition, this report provides clear guidance as to how compliance can be demonstrated although it is not proposed to amend CP.A.3.5 and OC5.A.2.1 of the Grid Code due to the unintended consequences that this change could have on existing Generators.
- 7.3 So far as generators are concerned, this package of measures should provide greater clarity of the obligations required and reduce risk, particularly those which are in the development stage. It is also believed these requirements address the Grid Code deficiencies identified in EDF's paper pp12/04.

8 Conclusions and Recommendations

- 8.1 This report summarises the findings of the GC0062 fault ride through workgroup following the issues raised in EDF's paper pp12/04. The issue stems from the fact that a number of synchronous generators were struggling to satisfy the fault ride through requirements particularly for faults cleared in backup operating times where the retained voltage was in the region of between 15 – 50% and the corresponding time duration was in the region of between 140ms – 710ms. The suggestion in paper reference pp/12/04 was the introduction of a site specific requirement.
- 8.2 In response, three industry workshops were held in September 2012, November 2012 and January 2013. Attendees of these workshops comprised representatives from both the synchronous and asynchronous communities, with the conclusion at that stage being that early adoption of the fault ride through requirements in the European Network Code 'Requirements for Generators' would provide a solution to the issues raised. The view from the asynchronous (wind farm) community was that whilst the current fault ride through requirements were not ideal, they would not wish to introduce a change and then be exposed to a further requirements if there was a subsequent amendment to the proposed RfG requirements. On this basis, it was proposed that a fault ride through workgroup was established specifically for synchronous generation, the intention being to consider early adoption of the RfG fault ride through requirements as a vehicle to address the issue. The work was originally proposed to take place in two phases, the first addressing the requirements for directly connected synchronous generation and the second to address the requirements for embedded synchronous generation.
- 8.3 Following detailed analysis, the workgroup identified that the RfG fault ride through requirements only applied to secured faults (ie faults cleared in main protection operating times) and as such would be unable to address the Grid Code deficiencies identified in EDF's issue paper. It was also identified that the parameters available for TSO's to select as part of the RfG voltage against time curve also had limitations. It was further noted by the workgroup that the interpretation of the RfG fault ride through requirements as detailed in Appendix 2 of this report only considered the implications for directly connected synchronous generators subject to a transmission system fault. The research undertaken did not cover the effect on embedded synchronous generation, embedded and non-embedded asynchronous generation or the effect on the connection point voltage. As such it was noted that there is still quite a volume of work to be undertaken by the GC0048 workgroup in fully implementing the RfG fault ride through requirements into the GB Grid Code. However, the workgroup has acknowledged that the initial research conducted will be invaluable for the GC0048 workgroup rather than starting from scratch.
- 8.4 In view of these findings, the workgroup considered whether or not it would be appropriate to change their terms of reference. However, as much of the analysis had been completed and noting this work would have to be addressed by the RfG implementation workgroup (GC0048), it was felt that this element should be included as an appendix to this report (see Appendix 2).
- 8.5 It is therefore recommended that the proposed Mode B text in Annex 3 of this report is adopted. It is recognised that this is a relaxation from the current requirements and therefore it seems appropriate that these requirements would apply to all synchronous generators which had a completion date from 1 April 2005 (ie when the Mode B fault ride through requirements were introduced) and not just those having a completion date in the future. This is on the basis that those generators who can satisfy the current requirements would be capable of meeting the proposed requirements and it also offers a potential resolution to those generators who have had to apply for a derogation against the existing requirements.
- 8.6 As part of the workgroup discussions, it was also noted that the requirements for demonstration of compliance in the Grid Code in relation to synchronous plant were not well defined. This consultation document has attempted to clarify this issue and the simulations that should be applied. In view of the points raised above, that the proposed Mode B requirements would apply to all generators, it is not appropriate that the compliance section at this stage should be updated as National Grid would not wish existing generators to undertake addition compliance simulations. However

it is envisaged that these requirements for new generators will be clarified when the RfG requirements are implemented.

- 8.7 In summary, it is believed that the main output of this consultation document addresses the original Grid Code defect. In addition, an interpretation of the RfG fault ride through requirements as applicable to directly connected synchronous generators has been provided as an appendix to this report which it is believed will be useful to the GC0048 workgroup although it is acknowledged that there remains significant work to be undertaken.
- 8.8 The draft legal text in Annex 3 shows the proposed changes to CC.6.3.15.1(b) which advocates new provisions for synchronous generating units in setting a more achievable voltage duration characteristic (Figure 5 of CC.6.3.15.1(b)) against which compliance can be assessed whilst also maintaining the robustness and integrity of the transmission system.
- 8.9 It is considered that the proposals are fair and proportionate, balancing on one hand the security and robustness of the transmission system, and on the other the capability of synchronous generating units.

Impact on the Grid Code

- 9.1 The workgroup recommended modifications to Figure 5 of CC.6.3.15.1(b) and Appendix 4 of the Grid Code Connection Conditions which has also been reflected by the comments received as part of the industry consultation.
- 9.2 The modifications proposed to the Grid Code Connection Conditions are detailed in Annex 3.

Impact on Grid Code Users

- 9.3 This modification impacts owners, developers and manufacturers of synchronous generating units.
- 9.4 The main implication for owners, developers and manufacturers of synchronous generating units is that the Mode B fault ride through requirements are more achievable than currently required. This was seen as a major barrier, especially to new potential entrants to the GB system.

Impact on the National Electricity Transmission System (NETS)

- 9.5 National Grid believe these proposed requirements strike the right balance between maintaining the safety, security and economy of the transmission system whilst at the same time defining a set of requirements which a synchronous generating unit can reasonably achieve. National Grid did not identify any material negative impact on the reliability of the transmission system or synchronous generating units as a result of these proposals. The workgroup believes there is a benefit to generators in implementing the proposed changes as new generators are better able to achieve compliance with the proposed new requirements using standard design approaches. The workgroup concluded that the proposals will not cause any conflict with the RfG provisions

Impact on Greenhouse Gas emissions

- 9.6 The proposal facilitates the connection for all sizes of synchronous generating units to the National Electricity Transmission System (NETS). This will increase competition allowing a greater variation in primary energy sources thereby reducing greenhouse gas emissions.

Assessment against Grid Code Objectives

- 9.7 The change proposed better facilitates the Grid Code objectives:
- (i) **to permit the development, maintenance and operation of an efficient, coordinated and economical system for the transmission of electricity;**

This proposals provide clarity on how Mode B fault ride through compliance should be demonstrated.

- (ii) **to facilitate competition in the generation and supply of electricity (and without limiting the foregoing, to facilitate the national electricity transmission system being made available to persons authorised to supply or generate electricity on terms which neither prevent nor restrict competition in the supply or generation of electricity);**

This modification allows relaxation to the Mode B fault ride through requirements which are currently believed to be excessively onerous to the point they are unachievable. This proposal provides generators with much easier access to the transmission system and facilitates competition.

- (iii) subject to sub-paragraphs (i) and (ii), to promote the security and efficiency of the electricity generation, transmission and distribution systems in the national electricity transmission system operator area taken as a whole; and

It is considered that the proposals are fair and proportionate, balancing on one hand the security and robustness of the transmission system, and on the other the capability of synchronous generating units.

- (iv) to efficiently discharge the obligations imposed upon the licensee by this license and to comply with the Electricity Regulation and any relevant legally binding decisions of the European Commission and/or the Agency.

There is not believed to be any conflict with the RfG requirements as a result of these proposals and these will be considered separately.

Impact on core industry documents

9.8 The GB Grid Code

Impact on other industry documents

9.9 None

Impact on Bilateral Agreements

9.10 None

Impact on European Network Codes

9.11 There will be no conflict with the European Network Codes (including RfG) as a result of these proposals.

Implementation

9.12 It is suggested that, should the proposals be taken forward, the proposed changes be implemented 10 business days after an Authority decision.

References

[1] – H/04 Consultation available at :-

<http://www2.nationalgrid.com/WorkArea/DownloadAsset.aspx?id=13419>

[2] – Requirements for Generators available at:-

https://www.entsoe.eu/Documents/Network%20codes%20documents/NC%20RfG/draft_ec_networkCodesJune.pdf

[3] – Network Code for Requirements for Grid Connection Applicable to all Generators frequently asked questions - 19 June 2012 – available at:-

[https://www.entsoe.eu/fileadmin/user_upload/library/consultations/Network_Code_RfG/12_0626 - NC_RfG - Frequently Asked Questions.pdf](https://www.entsoe.eu/fileadmin/user_upload/library/consultations/Network_Code_RfG/12_0626_-_NC_RfG_-_Frequently_Asked_Questions.pdf)

[4] – RTE Documentation technique de reference, Article 4.3 – Stabilité, Installation raccordée au réseau d'interconnexion: <http://clients.rte>

france.com/htm/fr/mediatheque/telecharge/reftech/01-09-14_complet.pdf available at:-

https://clients.rte-france.com/htm/fr/mediatheque/telecharge/reftech/01-09-14_complet.pdf

[5] – GB Grid Code Issue 5, Revision 14 – available at:-
<http://www2.nationalgrid.com/UK/Industry-information/Electricity-codes/Grid-code/The-Grid-code/>

[6] – Guidance Notes for Power Park Modules, Issue 3, September 2012 available at:-
<http://www2.nationalgrid.com/WorkArea/DownloadAsset.aspx?id=32082>

10 Consultation Responses

- 10.1 Views were invited upon the proposals. Responses were requested to be E-Mailed to grid.code@nationalgrid.com by Wednesday 9th March 2016 using the proforma provided.
- 10.2 The proposals set out in this consultation are intended to better meet the Grid Code objectives. To achieve this, they are intended to facilitate efficient and economic connection arrangements whilst ensuring there is no impact on the safety and security of the transmission system, and no discernible impact on the visual disturbance to electricity consumers.
- 10.3 Responses were invited to the following questions:
- (i) Do you support the proposed approach? Please clarify why.
 - (ii) Do the proposed changes facilitate the appropriate Grid Code objectives? If not, why do they fail to do so?
 - (iii) Do the proposed changes facilitate efficient connection and operation of new and/or existing synchronous generating units? If not, why do they fail to do so?
 - (iv) Do the proposed changes impose any additional material risks on the System Operator, e.g. reduced stability margins, reduced reactive capability margins, or difficulty in managing the robustness of the transmission system? If yes, please highlight these risks.
 - (v) Do the proposed changes impose any additional material risks on Transmission Owners, e.g. additional investment that might be neither economic nor efficient? If yes, please highlight these risks.
 - (vi) Do the proposed changes impose any additional material risks on generators, e.g. additional investment that might be neither economic nor efficient? If yes, please highlight these risks.
 - (vii) Do the proposed changes adequately protect the interests of all transmission system users? If not, why do they fail to do so?
 - (viii) Are there further technical considerations to be taken into account? If yes, please highlight these technical considerations.
 - (ix) Is there any evidence that users will be inappropriately or adversely affected by the changes proposed? If so, please provide details.
 - (x) Do the proposed changes strike an appropriate balance between the needs of generators, transmission licensees, and other interested parties? If not, why do they fail to do so?
 - (xi) Please provide any other comments you feel are relevant to the proposed change.
- 10.5 If you wish to submit a confidential response please note the following:
- (xii) Information provided in response to this consultation will be published on National Grid's website unless the response is clearly marked "Private and Confidential", we will contact you to establish the extent of the confidentiality. A response marked "Private and Confidential" will be disclosed to the Authority in full but, unless agreed otherwise, will not be shared with the Grid Code Review Panel or the industry and may therefore not influence the debate to the same extent as a non-confidential response.
 - (xiii) Please note an automatic confidentiality disclaimer generated by your IT System will not in itself mean that your response is treated as if it had been marked "Private and Confidential".

Grid Code Industry Consultation Response Proforma

GC0062 – Fault Ride Through

Industry parties are invited to respond to this consultation expressing their views and supplying the rationale for those views, particularly in respect of any specific questions detailed below.

Please send your responses by 9 March 2016 to Grid.Code@nationalgrid.com.

Please note that any responses received after the deadline or sent to a different email address may not receive due consideration.

These responses will be included in the Report to the Authority which is drafted by National Grid and submitted to the Authority for a decision.

Respondent:	<i>Please insert your name and contact details (phone number or email address)</i>
Company Name:	<i>Please insert Company Name</i>
Do you support the proposed implementation approach?	
Do you believe that GC0062 better facilitates the appropriate Grid Code objectives?	<p><i>For reference the applicable Grid Code objectives are:</i></p> <p><i>(i) to permit the development, maintenance and operation of an efficient, coordinated and economical system for the transmission of electricity;</i></p> <p><i>(ii) to facilitate competition in the generation and supply of electricity (and without limiting the foregoing, to facilitate the national electricity transmission system being made available to persons authorised to supply or generate electricity on terms which neither prevent nor restrict competition in the supply or generation of electricity);</i></p> <p><i>(iii) subject to sub-paragraphs (i) and (ii), to promote the security and efficiency of the electricity generation, transmission and distribution systems in the national electricity transmission system operator area taken as a whole; and</i></p> <p><i>(iv) to efficiently discharge the obligations imposed upon the licensee by this license and to comply with the Electricity Regulation and any relevant legally binding decisions of the European Commission and/or the Agency.</i></p>
Do you have any additional comments?	

Summary of Responses

- 10.6 An industry consultation upon the GC0062 proposals was held between 9 February 2016 and 9 March 2016. Six responses were received, all of which were fully supportive.
- 10.15 Of the responses received, two comments were noted from RWE and EON.
- 10.16 RWE noted that the report did not make a conclusion / recommendation on compliance simulations on the basis that it will be addressed via the RfG workgroup. RWE correctly pointed out that the scope of the RfG work only applies to Mode A faults (ie less than 140ms) and consideration should be given to Grid Code amendments to cater for compliance for Mode B faults (greater than 140ms).
- 10.17 This issue has been discussed with RWE and it has been highlighted that the current Grid Code (CP.A.3.5) only requires compliance to be demonstrated for non Synchronous Generating Units, Power Park Modules and HVDC Converters, not Synchronous Power Generating Modules. The proposals in this report effectively replace the existing Mode B requirements for Synchronous Generating Units (which apply from 2005). In summary any plant that can meet the current Mode B fault ride through requirements would be capable of satisfying the new proposals, however if such proposals were to be included in the Grid Code it could effectively mean that currently connected plant would have to satisfy the additional compliance requirements which is not the intention.
- 10.18 This issue has been highlighted in section 3.8 and 5.18 - 5.23 of the report with additional clarifications made to section 5.23. In summary, this report (section 5.18 – 5.23) demonstrates how compliance for Mode B faults should be demonstrated. When RfG is implemented there is a requirement for Power Generating Modules to demonstrate “Mode A” fault ride through compliance. Section 5.23 of the report notes that when RfG is implemented, the GB Code will also be updated to indicate how “Mode B” fault ride through compliance should be demonstrated but in the interim period the report provides an indication of how this should be achieved.
- 10.19 RWE also noted Tables 5.19 and 5.21 had incorrect headings. These errors have been corrected in this report.
- 10.20 In response to the second set of material comments received, EON noted that the proposals appeared to delete the requirements for Offshore Synchronous Generating Units and clear requirements should be defined in respect of Offshore Synchronous Generating Units. The proposed legal text in Annex 3 has therefore been updated to address this issue.
- 10.21 National Grid wish to thank all of the respondents for their comments regarding GC0062, and for their ongoing support during the discussion of these proposals.

Ref	Company	Supportive	Main Comments
CR-01	SHE Transmission	Yes	<ul style="list-style-type: none"> The proposal adopts a pragmatic approach taking account of the capabilities of existing large synchronous generators. Although we believe this will have a finite impact on stability margins, the studies undertaken by the working group give the expectation that adequate system security will be maintained following adoption of the proposed change to the FRT requirement. The proposed modification makes grid code compliance more achievable and should facilitate clearer demonstration of compliance.

Ref	Company	Supportive	Main Comments
CR-02	SSE Generation	Yes	<ul style="list-style-type: none"> SSE welcomes the proposal by the GC0062 workgroup to relax the requirements which will avoid extra costs for generators whilst maintaining the security of the transmission system. The further detail on the voltage profile during fault simulations is also welcome to provide clarity for grid compliance studies for new generators.
CR-03	EDF	Yes	<ul style="list-style-type: none"> Yes, EDF Energy supports the proposed implementation approach. We believe that the GC0062 workgroup addressed the Grid Code deficiencies in the original proposal and that the appropriate remedies are included in the proposed amendment to the Grid Code text.
CR-04	RWE Group of GB companies including RWE Generation UK plc, RWE Innogy UK Limited and RWE Supply & Trading GmbH	Yes	<ul style="list-style-type: none"> The consultation paper does not appear to contain a conclusion / recommendation regarding the required compliance simulations on the basis that it will be addressed via the RfG workgroup. However, we understand that the RfG workgroup will now only consider this with respect to mode A (less than 140ms) faults. We therefore suggest that the GC0062 workgroup consider the required compliance studies for mode B (more than 140ms) faults and recommend appropriate Grid Code changes. Typographical comment – it appears that the tables in 5.19 and 5.21 have incorrect headings
CR-05	Scottish Power Generation	Yes	<ul style="list-style-type: none"> Yes, the proposal moves the requirements into an area where synchronous generators are more likely to be compliant.
CR-06	Uniper Energy	Yes	<ul style="list-style-type: none"> The modification (accidentally) appears to delete the mode B FRT requirements for offshore synchronous generating units? It is not clear why these proposals are only limited to onshore synchronous generating units.

10.22 In relation to CR-04 comments, the following response was provided to RWE via E-Mail on 11 April.

- 1) The current Grid Code (CP.A.3.5) only requires compliance to be demonstrated for non Synchronous Generating Units, Power Park Modules and HVDC Converters, not Synchronous Generating Units. So far as the proposals are structured, they would effectively replace the existing Mode B requirements for Synchronous Generating Units (which apply from 2005). In summary any plant that can meet the current Mode B fault ride through requirements would be capable of satisfying the new proposals, however if such requirements were to be included in the code, it could effectively mean that currently connected plant would have to satisfy the additional compliance requirements which is not the

intention. This issue was discussed in the workgroup and documented in section 3.8 and 5.23 of the report.

- 2) In summary, the report (section 5.18 – 5.23) demonstrates how compliance for Mode B faults should be demonstrated. When RfG is implemented there is a requirement for Power Generating Modules to demonstrate “Mode A” fault ride through compliance. Section 5.23 of the report notes that when RfG is implemented the GB Code will also be updated to indicate how “Mode B” fault ride through compliance should be demonstrated but in the interim period the report provides an indication of how this should be achieved.
- 3) We note the titles in the tables of 5.19 and 5.21 are incorrect and thank you for pointing this out. This issue will be corrected in “The Report to the Authority”.

10.23 With regard to GR-06 response, an E-Mail was sent to Uniper Energy on 11 April advising that the proposed legal text would be updated to ensure Offshore Synchronous Generating Units are not excluded. The legal text has been updated to include these provisions and included in Annex 3 of this report.

Grid Code Review Panel – Issue Assessment Proforma

Fault Ride Through

Date Raised: 18 January 2012

GCRP Ref: pp12/04¹

A Panel Paper by John Morris

EDF Energy

Summary

Fault ride through requirements are set out in Grid Code Connection Condition CC.6.3.15.

Users Impacted

High - Generating Units, Power Park Modules, DC Converters and OTSDUW Plant and Apparatus

Medium - None Identified

Low - None Identified

Description & Background

Grid Code Connection Conditions CC.6.3.15 specifies the fault ride through capability of Generating Units, Power Park Modules, DC Converters and OTSDUW Plant and Apparatus.

For short circuit faults at Supergrid Voltage on the Onshore Transmission System up to 140ms in duration, the fault ride through requirement is defined in CC.6.3.15.1 (a) (i). The BCA specifies the duration of zero voltage and fault clearance times based on the technical particulars at the local connection point.

For balanced Supergrid Voltage dips on the Onshore Transmission System having durations greater than 140ms and up to 3 minutes the fault ride through requirement is defined in CC6.3.15.1 (b) (i). This is by reference to a generic voltage–duration profile for which plant should remain transiently stable and connected to the System without tripping.

For synchronous generating plant compliance with CC6.3.15.1(b) (i) is by self-certification through the production of simulation studies that are included in the User Data File Structure. Should these studies reveal that the synchronous generating unit cannot meet all potential voltage-duration profiles defined by Figure 5 envelope then NGET will treat this as non-compliance.

This Issue Identification Assessment proposes that both the User and NGET can agree at this stage to review the voltage-duration profile at the point of connection of the synchronous generating unit to see if this allows compliance to be achieved. This is analogous to compliance with CC6.3.15(a)(i) for short circuit faults of less than 140ms where the BCA specifies the duration of zero voltage and fault clearance times based on the technical particulars at the local connection point.

¹ The Code Administrator will provide the paper reference following submission to National Grid.

It should be noted that the ENTSO-E draft network code requirements for generators currently includes a modified voltage-duration profile with a minimum and maximum boundaries. The current example voltage dips in CCA.4A.3 for 30% and 50% would not lie within the boundaries defined by Figure 7 in the ENTSO-E draft code for synchronous generators connected at greater than 100kV voltage level. The timetable for adoption of the ENTSO-E requirements may still be protracted and it is suggested that this proposal be considered on its own merits. It would be possible to use the proposed boundaries as the limiting case for any site specific voltage-duration profile if this was deemed necessary by comitology. See attached comparison of ENTSO-E RfG and the current GB Grid Code requirements.

Proposed Solution/Next Steps

It is proposed to insert an additional clause in CC.6.3.15.15(b) to allow the option to meet a connection point specific voltage-duration profile where the generic profile cannot be met.

CC.6.3.15.1 (b)(iii) Where the generic envelope defined in Figure 5 cannot be fully met for all combinations of voltage-duration profile then the User may request a location specific profile which may be used as an alternative to the generic profile for compliance purposes.

A similar clause could be included in CC.6.3.15.2 (b) to provide the same option on a non-discriminatory basis for Offshore Generating Units, Offshore Power Park Modules to withstand voltage dips on the LV Side of the Offshore Platform greater than 140ms in duration.

Impact & Assessment

Impact on the National Electricity Transmission System (NETS)

The proposer has not identified any impacts that the proposed modification will have on the National Electricity Transmission System as power quality will be maintained to current standards.

Impact on Greenhouse Gas Emissions

The proposer has not identified any impacts that the proposed modification will have on Greenhouse Gas emissions.

Impact on core industry documents

The proposed modification does not impact on any core industry documents

Impact on other industry documents

The proposed modification does not impact on any other industry documents

Assessment against Grid Code Objectives

Will the proposed changes to the Grid Code better facilitate any of the Grid Code Objectives:

- (i) to permit the development, maintenance and operation of an efficient, coordinated and economical system for the transmission of electricity;
- (ii) to facilitate competition in the generation and supply of electricity (and without limiting the foregoing, to facilitate the national electricity transmission system being made available to persons authorised to supply or generate electricity on terms which neither prevent nor restrict competition in the supply or generation of electricity);
- (iii) subject to sub-paragraphs (i) and (ii), to promote the security and efficiency of the electricity generation, transmission and distribution systems in the national electricity transmission system operator area taken as a whole; and
- (iv) to efficiently discharge the obligations imposed upon the licensee by this license and to comply with the Electricity Regulation and any relevant legally binding decisions of the European Commission and/or the Agency.

This proposal will better facilitate objectives (i) and (ii) by providing an option to use a specific voltage-duration profile at the point of connection for synchronous generating plant where the generic profile of CC6.3.15(b)(i) cannot fully met. This results in a more efficient outcome early on in the generation procurement process, removing uncertainty for the generator with no impact on objective (iii) security of supply.

Supporting Documentation

Have you attached any supporting documentation **YES**
If Yes, please provide the title of the attachment: **RfG v GBGC requirements**

Recommendation

The Grid Code Review Panel is invited to **approve this issue for progression to an Industry Consultation**

GCRP Decision (to be completed by the Committee Secretary following the GCRP)

The Grid Code Review Panel determined that this issue should:

INSERT GCRP DECISION

RFG v GBGC Requirements

Fault Ride Through - Transmission Connected Synchronous Generator

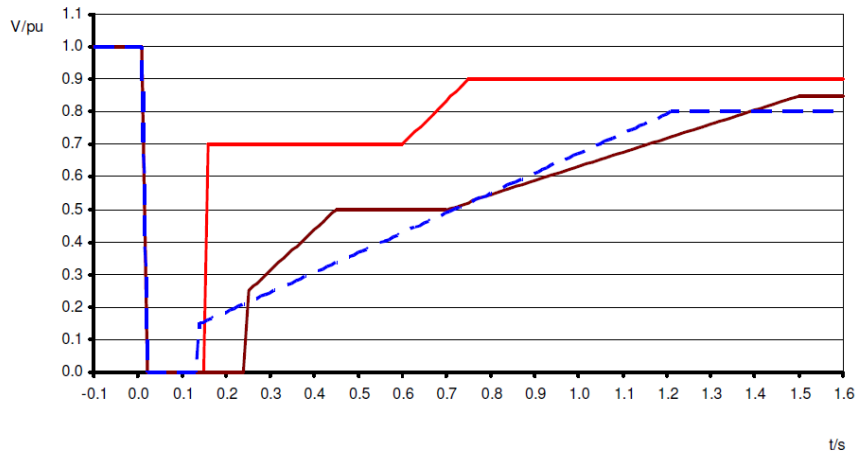

Legend: RfG min (red solid line), RfG max (brown solid line), GBGC (blue dashed line).
GBGC defines period of zero volts in BCA up to max 140ms

Fault Ride Through Workgroup TERMS OF REFERENCE

Background

1. In January 2012, EDF Energy submitted Paper reference PP12/04 to the Grid Code Review Panel on the issues relating to the ability of synchronous Generators to meet the current Grid Code Fault Ride Through requirements. In summary the paper proposed that where a Generator was unable to satisfy the voltage duration profile defined in Figure 5 of CC.6.3.15, the Grid Code be amended to propose where the generic profile could not be met, the User may request a location specific profile which may be used for compliance purposes.
2. National Grid welcomed the suggested paper and whilst acknowledging that some synchronous generating plant struggles to demonstrate compliance against CC.6.3.15 of the Grid Code, was concerned that by adopting an agreed voltage duration profile on a connection site specific bilateral basis, it would not be fully transparent to all Generators. To address the issue raised by EDF Energy, National Grid held a set of industry stakeholder Workshops in September / November 2012 and January 2013 to discuss the issues and propose a way forward...
3. Full details of the presentations and notes of the Workshops including the background, issues, options and possible solutions are available on National Grid's website from the following link:-
<http://www.nationalgrid.com/uk/Electricity/Codes/gridcode/workingsgroups/Fault+Ride+Through/>
4. In summary the key conclusions drawn from the Workshops were:-
 - i) Adopting a site specific voltage duration profile as initially suggested in paper PP12/04 would not be fully transparent and risks potential discrimination between Generators. It was however recognised that Synchronous Generators demonstrating compliance against CC.6.3.15 of the Grid Code has in the past, and continues to be problematical.
 - ii) Of all the options considered workshop participants concluded that further consideration should be given to early adoption of the Network Code Requirements for Generators (RfG) Fault Ride Through Requirements, specifically targeted at Large Synchronous Generators. This is on the basis that a) The GB Industry Codes will need to be aligned to the European Codes by 2016 / 2017 as required under European law, b) Under the current provisions of the RfG, Synchronous Generators are required to meet different fault ride through requirements as compared to Power Park Modules c) The voltage duration curve for synchronous plant under the RfG Fault Ride Through Requirements is considered less onerous than the current GB Grid Code resulting in a more straight forward compliance process and d) the National parameters selected for fault ride through would be subject to the full GB Governance arrangements and therefore transparent.
 - iii) Workshop participants acknowledged that whilst there were still issues associated with Asynchronous Generation, the fault ride through issues as presented in PP12/04 were largely associated with Synchronous Plant and wind farm developers and manufacturers were not keen to undergo a full set of additional research and type tests when they were broadly happy with the current GB Grid Code fault ride through requirements.

iv) A formal Grid Code Fault Ride Through Working Group should be established to examine the implications of early adoption of the Requirements for Generators in respect of Synchronous Generation, including the specification of GB Parameters.

v) The scope of the work will initially consider the fault ride through issues associated with Large Directly Connected Synchronous Generators (as defined in the Grid Code), and then consider the application to Embedded Generation. For the purposes of this working group, only Synchronous Generation within the current GB Framework definitions¹ shall be considered (ie Large and Medium Power Stations). For the avoidance of doubt, the RfG Fault Ride Through requirements are simply being used as a solution to the issues raised in Paper PP12/04 and are not part of an RfG / GB implementation programme.

5. A summary of these workshops, and the intention to establish a formal Grid Code Working Group was presented to the January 2013 GCRP.

6. In addition to the discussions held during the Fault Ride Through Workshops, there have also been two additional RfG developments which are considered to fit well with this work. These are summarised as follows:-

a. As part of ongoing work to consider options for applying the EU network codes to the GB regulatory framework, National Grid together with DNO representatives and Ofgem have been considering options for integrating the RfG and GB Grid Code. As part of this process, Fault Ride Through has been selected as an example of how the RfG and GB Codes can be integrated. The results of this work will be presented to JESG Members for their consideration and feedback

b. As a separate element of work, ENTSO-E is also aiming to develop a pilot to explore specific examples of how the National Choices within RfG will be established under the different regulatory arrangements of EU Member States. Since the terms of Reference of this Fault Ride Through Working Group were initially prepared, National Grid has subsequently learnt that the pilot scheme as initially proposed has been delayed due to limited interest amongst EU TSO's members. As a TSO member, National Grid is fully supportive of this work and sees Fault Ride Through as an excellent example to submit as part of this pilot exercise should it be held in the future, not least because of the synergy with this GCRP Working Group.

7. In summary, the RfG is expected to enter the Comitology phase later this year with approval in 2014. There will then be a 2 - 3 year implementation period in which the National Codes will be updated to ensure consistency with the European Code. As one recommendation of the Fault Ride Through Workshops was to consider early adoption of the RfG for Synchronous Plant these additional European developments fit well with this stream of work.

Governance

8 The Workgroup shall formally report to the GCRP in March 2014. For the avoidance of doubt, this Workgroup and any proposed changes to the Grid Code will be under the full auspices of the Grid Code Review Panel Governance process. In other words, the RfG Fault Ride Through requirements are seen as a potential solution for addressing the issues raised in paper reference PP12/04 and not part of the wider RfG / GB Grid Code implementation or regulatory process.

¹ The GB Grid Code requirements are classified on the basis of Large (100MW and above in England and Wales, 30MW and above in SPT's Area and 10MW and above in SHETL's Area). Medium Power Stations exist only in England and Wales of between 50 – 100MW. In Europe RfG classifies Generation into Type A (400W – 1MW and connected below 110kV), Type B (1MW – 10MW and connected below 110kV), Type C (10MW – 30MW and connected below 110kV) and Type D (above 30MW and connected above 110kV).

Membership

9. The Workgroup shall comprise a suitable and appropriate cross-section of experience and expertise from across the industry, which shall include:

Name	Role	Representing
Graham Stein	Chair	National Grid
Paul Wakeley	Technical Secretary (1)	National Grid
Richard Woodward	Technical Secretary (2)	National Grid
Antony Johnson	National Grid Representative	National Grid
Richard Ierna	National Grid Representative	National Grid
Hervé Meljac	Industry Representative	EDF
David Draper	Industry Representative	Horizon
Philip Belben	Industry Representative	Horizon
Karim Karoui	Industry Representative	ENGIE
Campbell McDonald	Industry Representative	SSE Generation
Marc Barbier	Industry Representative	GE
Maxime Buquet	Industry Representative	GE
Hervé Biellmann	Industry Representative	GE

Richard Woodward (2) took over from Paul Wakeley (1) as Technical Secretary part way through the workgroup.

10. As the initial work will concentrate on Large Directly connected Synchronous Generators, and then subsequently consider Embedded Synchronous Generation, it is recommended that in order to minimise delays, the work group initially comprises of members whose interests are associated with directly connected plant and then once this element of work is completed, the membership is expanded to include stakeholders with an interest in Large and Medium Embedded Synchronous Plant.

Meeting Administration

11. The frequency of Workgroup meetings shall be defined as necessary by the Workgroup chair to meet the scope and objectives of the work being undertaken at that time.
12. National Grid will provide technical secretary resource to the Workgroup and handle administrative arrangements such as venue, agenda and minutes.
13. The Workgroup will have a dedicated section on the National Grid website to enable information such as minutes, papers and presentations to be available to a wider audience.

Scope

14. The Workgroup shall consider and report on the following:
15. Using information currently available, understand the interpretation of the RfG Fault Ride Through requirements and its ability to address the issues raised in Grid Code paper PP12/04.
16. Develop GB specific requirements and parameters initially for directly connected Synchronous Generation to then be immediately followed by Embedded Synchronous Generation. It is the intention of this working group that it will provide clarity to Generators and ensure consistency with the RfG Code. The output of this work will feed into the RfG pilot programme (should it proceed) which is specifically aimed at implementing the RfG and National Code in addition to the selection of National parameters.

17. The scope of the work will only cover the GB Grid Code and be applicable to Directly Connected and Embedded Large and Medium Power Stations. Any changes (if proposed) would only use existing terms within the GB Grid Code eg Large, Medium and Small Power Stations rather than Type A, Type B, Type C and Type D Power Generating Modules. There is no intention to introduce RfG terms into this drafting unless there is a specific reason to do so.
18. The Workgroup will inform GCRP and JESG Members of the progress of the work and the developments (if such work proceeds) of the ENTSO-E pilot programme.

Annex 3 - Proposed Legal Text

CC.6.3.15.1

- (b) **Supergrid Voltage** dips on the **Onshore Transmission System** greater than 140ms in duration.

(1b) Requirements applicable to **Synchronous Generating Units** subject to **Supergrid Voltage** dips on the **Onshore Transmission System** greater than 140ms in duration

In addition to the requirements of CC.6.3.15.1 (a) each **Synchronous Generating Unit**, each with a **Completion Date** on or after **1 April 2005** shall:

- (i) remain transiently stable and connected to the **System** without tripping of any **Synchronous Generating Unit** for balanced **Supergrid Voltage** dips and associated durations on the **Onshore Transmission System** (which could be at the **Interface Point**) anywhere on or above the heavy black line shown in Figure 5a. Appendix 4A and Figures CC.A.4A.3.2 (a), (b) and (c) provide an explanation and illustrations of Figure 5a; and,

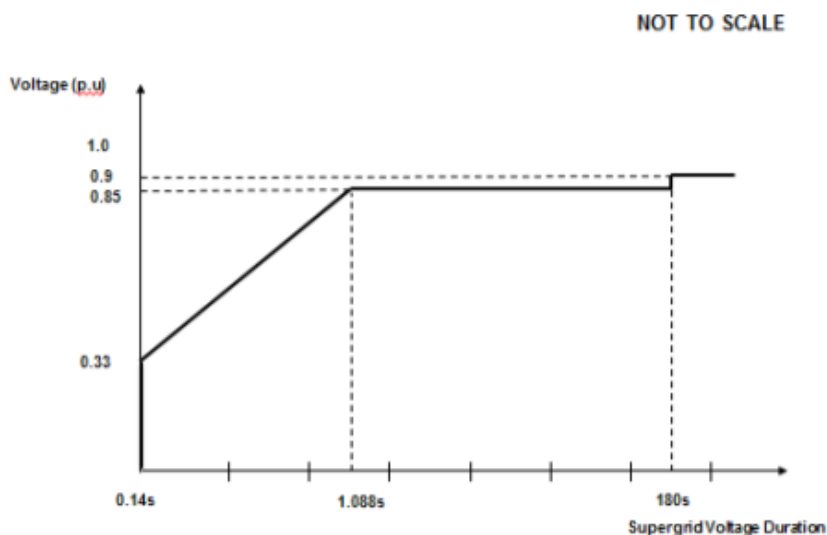

Figure 5a

- (ii) provide **Active Power** output at the **Grid Entry Point**, during **Supergrid Voltage** dips on the **Onshore Transmission System** as described in Figure 5a, at least in proportion to the retained balanced voltage at the **Onshore Grid Entry Point** (for **Onshore Synchronous Generating Units**) or **Interface Point** (for **Offshore Synchronous Generating Units**) (or the retained balanced voltage at the **User System Entry Point** if **Embedded**) and shall generate maximum reactive current (where the voltage at the **Grid Entry Point** is outside the limits specified in CC.6.1.4) without exceeding the transient rating limits of the **Synchronous Generating Unit** and,

- (iii) restore **Active Power** output following **Supergrid Voltage** dips on the **Onshore Transmission System** as described in Figure 5a, within 1 second of restoration of the voltage to 1.0p.u of the

nominal voltage at the:

Onshore Grid Entry Point for directly connected Onshore Synchronous Generating Units or,

Interface Point for Offshore Synchronous Generating Units or,

User System Entry Point for Embedded Onshore Synchronous Generating Units or,

User System Entry Point for Embedded Medium Power Stations not subject to a Bilateral Agreement which comprise Synchronous Generating Units and with an Onshore User System Entry Point (irrespective of whether they are located Onshore or Offshore)

to at least 90% of the level available immediately before the occurrence of the dip. Once the Active Power output has been restored to the required level, Active Power oscillations shall be acceptable provided that:

- the total Active Energy delivered during the period of the oscillations is at least that which would have been delivered if the Active Power was constant
- the oscillations are adequately damped.

For the avoidance of doubt a balanced Onshore Transmission System Supergrid Voltage meets the requirements of CC.6.1.5 (b) and CC.6.1.6.

(2b) Requirements applicable to OTSDUW Plant and Apparatus and Power Park Modules subject to Supergrid Voltage dips on the Onshore Transmission System greater than 140ms in duration

In addition to the requirements of CC.6.3.15.1 (a) each **Generating Unit, OTSDUW Plant and Apparatus,** or each **Power Park Module** and / or any constituent **Power Park Unit**, each with a **Completion Date** on or after the 1 April 2005 shall:

- (i) remain transiently stable and connected to the **System** without tripping of any **Generating Unit, OTSDUW Plant and Apparatus,** or **Power Park Module** and / or any constituent **Power Park Unit**, for balanced **Supergrid Voltage** dips and associated durations on the **Onshore Transmission System** (which could be at the **Interface Point**) anywhere on or above the heavy black line shown in Figure 5b. Appendix 4A and Figures CC.A.4A.3.4 (a), (b) and (c) provide an explanation and illustrations of Figure 5b; and,

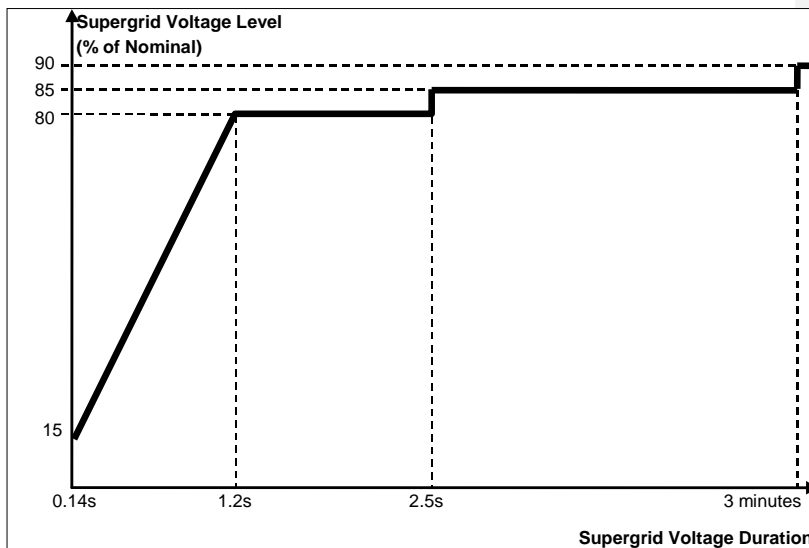

Figure 5b

- (ii) provide **Active Power** output at the **Grid Entry Point** or in the case of an **OTSDUW**, **Active Power** transfer capability at the **Transmission Interface Point**, during **Supergrid Voltage** dips on the **Onshore Transmission System** as described in Figure 5b, at least in proportion to the retained balanced voltage at the **Onshore Grid Entry Point** (for ~~Onshore Generating Units~~ **Onshore Power Park Modules**) or **Interface Point** (for ~~Offshore Generating Units~~, **OTSDUW Plant and Apparatus** and **Offshore Power Park Modules**) (or the retained balanced voltage at the **User System Entry Point** if **Embedded**) except in the case of a **Non-Synchronous Generating Unit** or **OTSDUW Plant and Apparatus** or **Power Park Module** where there has been a reduction in the **Intermittent Power Source** or in the case of an **OTSDUW Active Power** transfer capability in the time range in Figure 5b that restricts the **Active Power** output or in the case of an **OTSDUW Active Power** transfer capability below this level and shall generate maximum reactive current (where the voltage at the **Grid Entry Point**, or in the case of an **OTSDUW Plant and Apparatus**, the **Interface Point** voltage, is outside the limits specified in CC.6.1.4) without exceeding the transient rating limits of the ~~Generating Unit~~, **OTSDUW Plant and Apparatus** or **Power Park Module** and any constituent **Power Park Unit**; and,
- (iii) restore **Active Power** output (or, in the case of **OTSDUW**, **Active Power** transfer capability), following **Supergrid Voltage** dips on the **Onshore Transmission System** as described in Figure 5b, within 1 second of restoration of the voltage at the:
- Onshore Grid Entry Point** for directly connected ~~Onshore Generating Units and~~ **Onshore Power Park Modules** or,
 - Interface Point** for ~~Offshore Generating Units~~, **OTSDUW Plant and Apparatus** and **Offshore Power Park Modules** or,
 - User System Entry Point** for ~~Embedded Onshore Generating Units and~~ **Embedded Onshore Power Park Modules** or,
 - User System Entry Point** for **Embedded Medium Power Stations** which comprise **Power Park Modules** and **Embedded DC Converter Stations** not subject to a

Comment [A1]: This should be removed as CC.6.3.15.(b) does not apply to HVDC Converters

Bilateral Agreement and with an **Onshore User System Entry Point** (irrespective of whether they are located **Onshore** or **Offshore**)

to the minimum levels specified in CC.6.1.4 to at least 90% of the level available immediately before the occurrence of the dip except in the case of a **Non-Synchronous Generating Unit, OTSDUW Plant and Apparatus** or **Power Park Module** where there has been a reduction in the **Intermittent Power Source** in the time range in Figure 5b that restricts the **Active Power** output or, in the case of **OTSDUW, Active Power** transfer capability below this level. Once the **Active Power** output or, in the case of **OTSDUW, Active Power** transfer capability has been restored to the required level, **Active Power** oscillations shall be acceptable provided that:

- the total **Active Energy** delivered during the period of the oscillations is at least that which would have been delivered if the **Active Power** was constant
- the oscillations are adequately damped.

For the avoidance of doubt a balanced **Onshore Transmission System Supergrid Voltage** meets the requirements of CC.6.1.5 (b) and CC.6.1.6.

CC.6.3.15.2

- (b) Requirements of **Offshore Generating Units, Offshore Power Park Modules**, to withstand voltage dips on the **LV Side of the Offshore Platform** greater than 140ms in duration.

(1b) Requirements applicable to **Offshore Synchronous Generating Units** to withstand voltage dips on the **LV Side of the Offshore Platform** greater than 140ms in duration.

In addition to the requirements of CC.6.3.15.2. (a) each **Offshore Synchronous Generating Unit** shall:

- (i) remain transiently stable and connected to the **System** without tripping of any **Offshore Synchronous Generating Unit** for any balanced voltage dips on the **LV side of the Offshore Platform** and associated durations anywhere on or above the heavy black line shown in Figure 7a. Appendix 4B and Figures CC.A.4B.3.2 (a), (b) and (c) provide an explanation and illustrations of Figure 7a. It should be noted that in the case of an **Offshore Synchronous Generating Unit** which is connected to an **Offshore Transmission System** which includes a **Transmission DC Converter** as part of that **Offshore Transmission System**, the **Offshore Grid Entry Point** voltage may not indicate the presence of a voltage dip on the **Onshore Transmission System**. The voltage dip will affect the level of **Active Power** that can be transferred to the **Onshore Transmission System** and therefore subject the **Offshore Generating Unit**, to a load rejection.

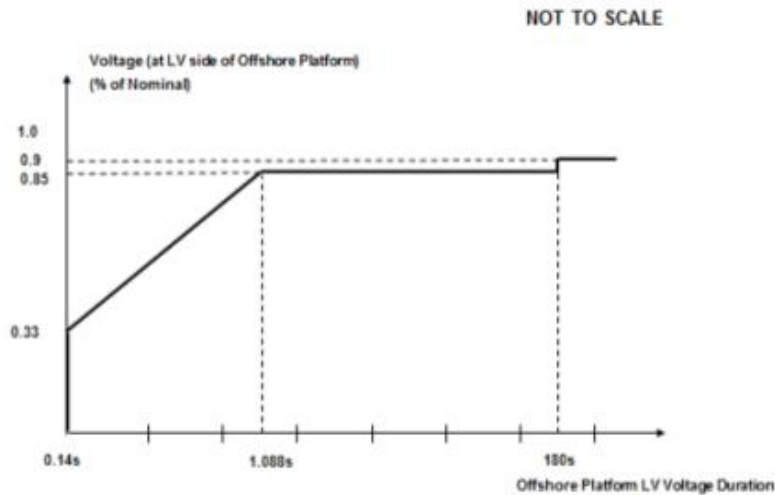

Figure 7a

- (ii) provide **Active Power** output, during voltage dips on the **LV Side of the Offshore Platform** as described in Figure 7a, at least in proportion to the retained balanced or unbalanced voltage at the **LV Side of the Offshore Platform** and shall generate maximum reactive current (where the voltage at the **Offshore Grid Entry Point** is outside the limits specified in CC.6.1.4) without exceeding the transient rating limits of the **Offshore Synchronous Generating Unit** and,
- (iii) within 1 second of the restoration of the voltage at the **LV Side of the Offshore Platform** (to the minimum levels specified in CC.6.1.4) restore **Active Power** to at least 90% of the **Offshore Synchronous Generating Unit's** immediate pre-disturbed value, unless there has been a reduction in the **Intermittent Power Source** in the time range in Figure 7a that restricts the **Active Power** output below this level. Once the **Active Power** output has been restored to the required level, **Active Power** oscillations shall be acceptable provided that:
- the total **Active Energy** delivered during the period of the oscillations is at least that which would have been delivered if the **Active Power** was constant
 - the oscillations are adequately damped
- (2b) Requirements ~~applicable to~~ ~~**Offshore Generating Units**~~, **Offshore Power Park Modules** to withstand voltage dips on the **LV Side of the Offshore Platform** greater than 140ms in duration.

In addition to the requirements of CC.6.3.15.2. (a) each ~~**Offshore Generating Unit**~~ ~~or~~ **Offshore Power Park Module** and / or any constituent **Power Park Unit**, shall:

- (i) remain transiently stable and connected to the **System** without tripping of any ~~**Offshore Generating Unit**~~ ~~or~~ **Offshore Power Park Module** and / or any constituent **Power Park Unit**, for any balanced voltage dips on the **LV side of the Offshore Platform** and associated durations anywhere on or above the heavy black line shown in Figure 7b. Appendix 4B and Figures CC.A.4B.5. (a), (b) and (c) provide an explanation and illustrations of Figure 7b. It should be noted that in the case of an ~~**Offshore Generating Unit**~~ ~~or~~ **Offshore Power Park Module** (including any **Offshore Power Park Unit** thereof) which is connected to an **Offshore Transmission System** which includes a **Transmission DC**

Converter as part of that **Offshore Transmission System**, the **Offshore Grid Entry Point** voltage may not indicate the presence of a voltage dip on the **Onshore Transmission System**. The voltage dip will affect the level of **Active Power** that can be transferred to the **Onshore Transmission System** and therefore subject the ~~Offshore Generating Unit, or~~ **Offshore Power Park Module** (including any **Offshore Power Park Unit** thereof) to a load rejection.

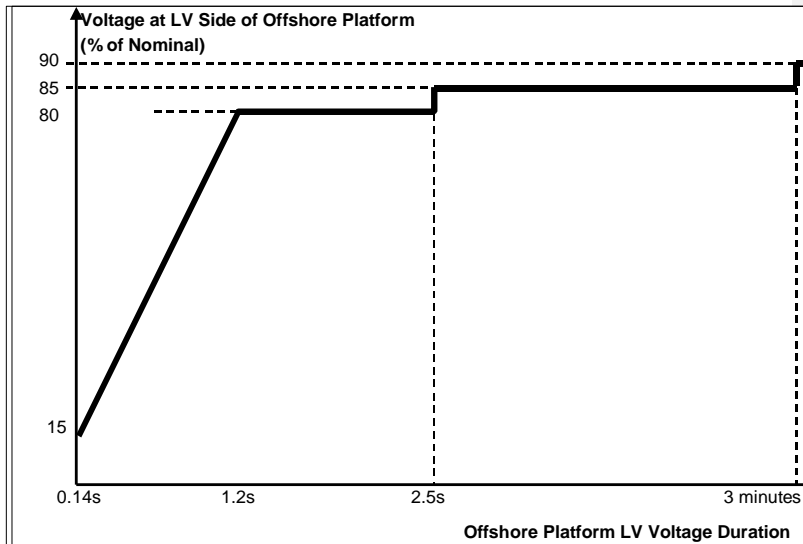

Figure 7b

- (ii) provide **Active Power** output, during voltage dips on the **LV Side of the Offshore Platform** as described in Figure 7b, at least in proportion to the retained balanced or unbalanced voltage at the **LV Side of the Offshore Platform** except in the case of an **Offshore Non-Synchronous Generating Unit** or **Offshore Power Park Module** where there has been a reduction in the **Intermittent Power Source** in the time range in Figure 7b that restricts the **Active Power** output below this level and shall generate maximum reactive current (where the voltage at the **Offshore Grid Entry Point** is outside the limits specified in CC.6.1.4) without exceeding the transient rating limits of the ~~Offshore Generating Unit or~~ **Offshore Power Park Module** and any constituent **Power Park Unit**; and,
- (iii) within 1 second of the restoration of the voltage at the **LV Side of the Offshore Platform** (to the minimum levels specified in CC.6.1.4) restore **Active Power** to at least 90% of the ~~Offshore Generating Unit's or~~ **Offshore Power Park Module's** immediate pre-disturbed value, unless there has been a reduction in the **Intermittent Power Source** in the time range in Figure 7b that restricts the **Active Power** output below this level. Once the **Active Power** output has been restored to the required level, **Active Power** oscillations shall be acceptable provided that:
- the total **Active Energy** delivered during the period of the oscillations is at least that which would have been delivered if the **Active Power** was constant
 - the oscillations are adequately damped

APPENDIX 4 - FAULT RIDE THROUGH REQUIREMENTS

APPENDIX 4A - FAULT RIDE THROUGH REQUIREMENTS FOR ONSHORE **SYNCHRONOUS** GENERATING UNITS, ONSHORE POWER PARK MODULES, ONSHORE DC CONVERTERS OTSDUW PLANT AND APPARATUS AT THE INTERFACE POINT, **OFFSHORE SYNCHRONOUS GENERATING UNITS IN A LARGE POWER STATION**, OFFSHORE POWER PARK MODULES IN A LARGE POWER STATION AND OFFSHORE DC CONVERTERS IN A LARGE POWER STATION WHICH SELECT TO MEET THE FAULT RIDE THROUGH REQUIREMENTS AT THE INTERFACE POINT

CC.A.4A.1 Scope

The fault ride through requirement is defined in CC.6.3.15.1 (a), (b) and CC.6.3.15.3. This Appendix provides illustrations by way of examples only of CC.6.3.15.1 (a) (i) and further background and illustrations to CC.6.3.15.1 (1b) (i), and [CC.6.3.15.1 \(2b\) \(i\) and](#) is not intended to show all possible permutations.

CC.A.4A.2 Short Circuit Faults At Supergrid Voltage On The Onshore Transmission System Up To 140ms In Duration

For short circuit faults at **Supergrid Voltage** on the **Onshore Transmission System** (which could be at an **Interface Point**) up to 140ms in duration, the fault ride through requirement is defined in CC.6.3.15.1 (a) (i). Figures CC.A.4A.1 (a) and (b) illustrate two typical examples of voltage recovery for short-circuit faults cleared within 140ms by two circuit breakers (a) and three circuit breakers (b) respectively.

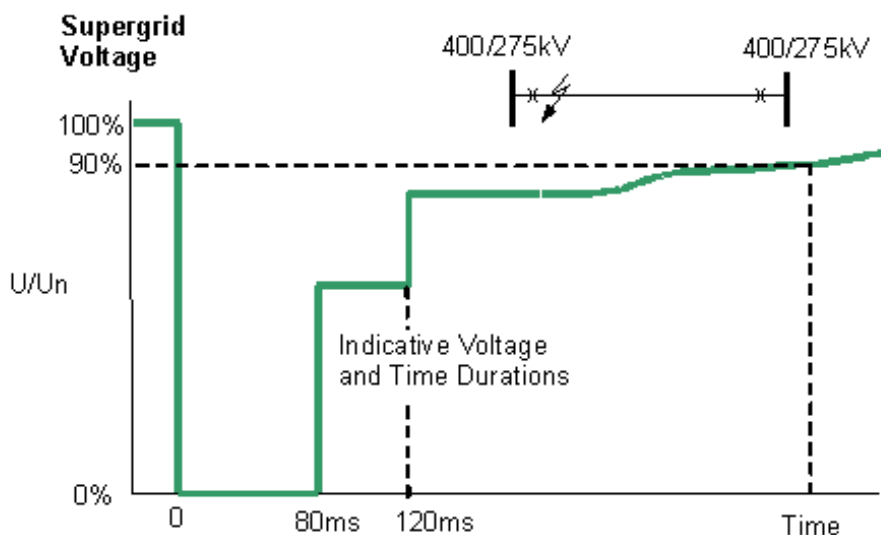

Typical fault cleared in less than 140ms: 2 ended circuit

Figure CC.A.4A.1 (a)

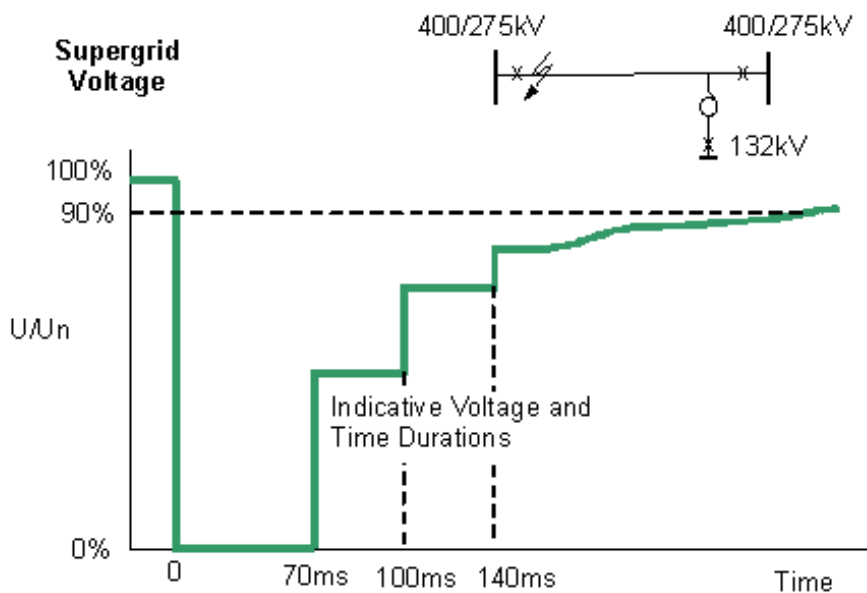

Typical fault cleared in 140ms:- 3 ended circuit

Figure CC.A.4A.1 (b)

CC.A.4A.3 Supergrid Voltage Dips On The Onshore Transmission System Greater Than 140ms In Duration

CC.A.4A3.1 Requirements applicable to Synchronous Generating Units subject to Supergrid Voltage dips on the Onshore Transmission System greater than 140ms in duration.

For balanced Supergrid Voltage dips on the Onshore Transmission System having durations greater than 140ms and up to 3 minutes, the fault ride through requirement is defined in CC.6.3.15.1 (1b) and Figure 5a which is reproduced in this Appendix as Figure CC.A.4A3.1 and termed the voltage-duration profile.

This profile is not a voltage-time response curve that would be obtained by plotting the transient voltage response at a point on the Onshore Transmission System (or User System if located Onshore) to a disturbance. Rather, each point on the profile (i.e. the heavy black line) represents a voltage level and an associated time duration which connected Synchronous Generating Units must withstand or ride through.

Figures CC.A.4A3.2 (a), (b) and (c) illustrate the meaning of the voltage-duration profile for voltage dips having durations greater than 140ms.

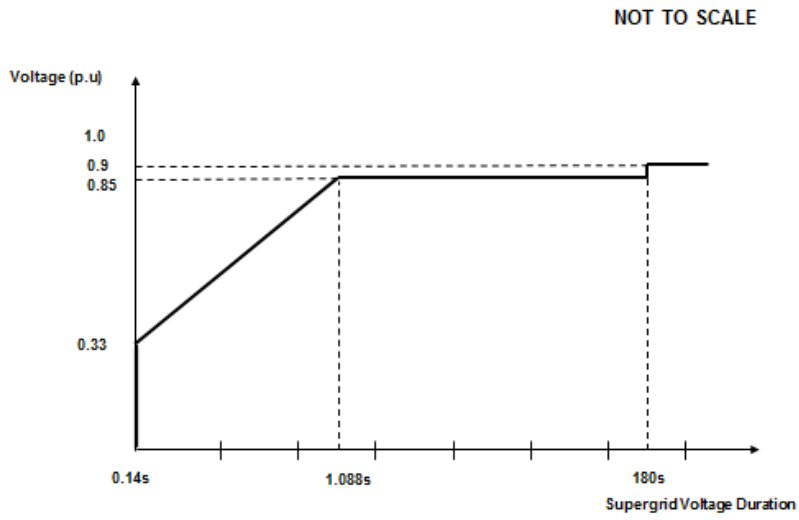

[Figure CC.A.4A3.1](#)

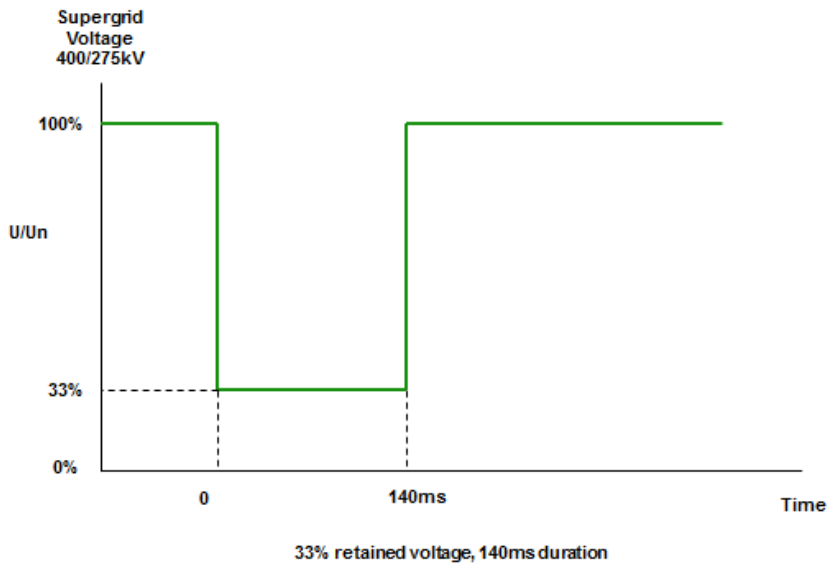

[Figure CC.A.4A3.2 \(a\)](#)

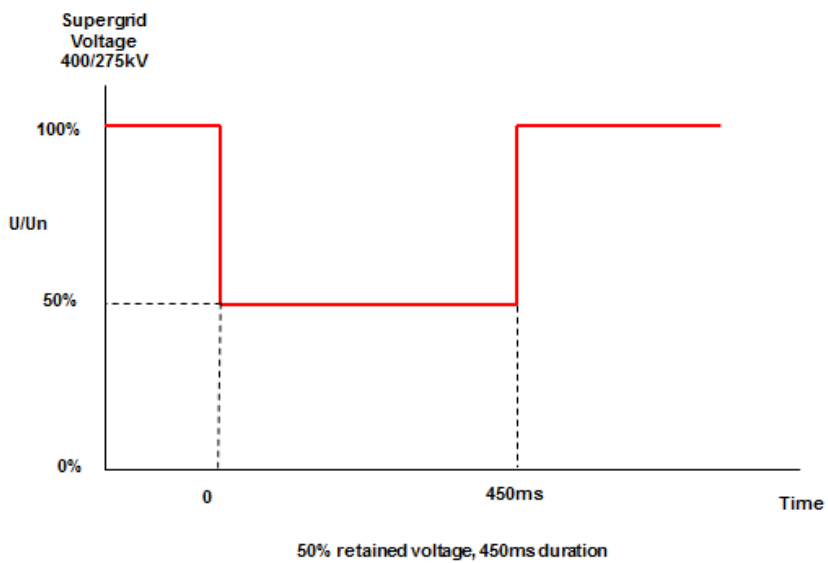

[Figure CC.A.4A3.2 \(b\)](#)

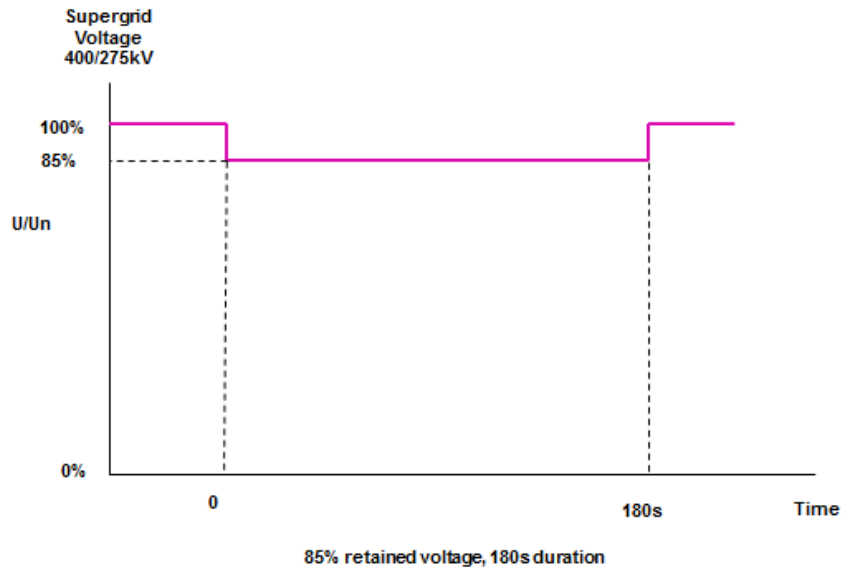

Figure CC.A.4A3.2 (c)

CC.A.4A3.2 Requirements applicable to Power Park Modules or OTSDUW Plant and Apparatus subject to Supergrid Voltage dips on the Onshore Transmission System greater than 140ms in duration

For balanced **Supergrid Voltage** dips on the **Onshore Transmission System** (which could be at an **Interface Point**) having durations greater than 140ms and up to 3 minutes the fault ride through requirement is defined in CC.6.3.15.1 (2b) and Figure 5b which is reproduced in this Appendix as Figure CC.A.4A3.32 and termed the voltage-duration profile.

This profile is not a voltage-time response curve that would be obtained by plotting the transient voltage response at a point on the **Onshore Transmission System** (or **User System** if located **Onshore**) to a disturbance. Rather, each point on the profile (i.e. the heavy black line) represents a voltage level and an associated time duration which connected **Generating Units, Power Park Modules** or **OTSDUW Plant and Apparatus** must withstand or ride through.

Figures CC.A.4A.3.43 (a), (b) and (c) illustrate the meaning of the voltage-duration profile for voltage dips having durations greater than 140ms.

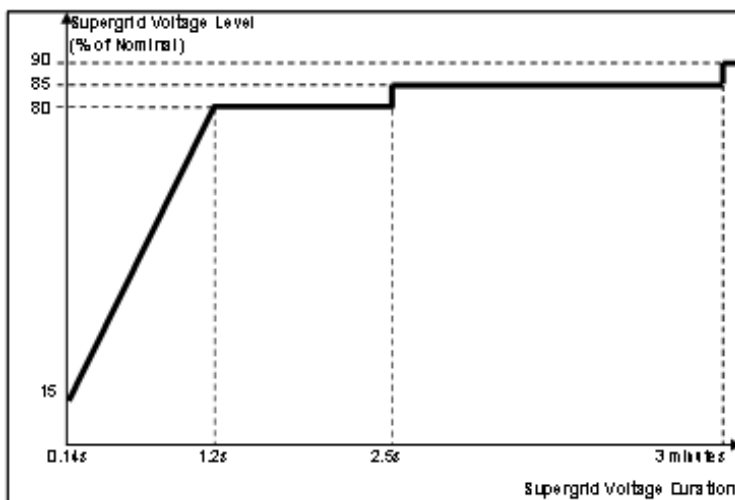
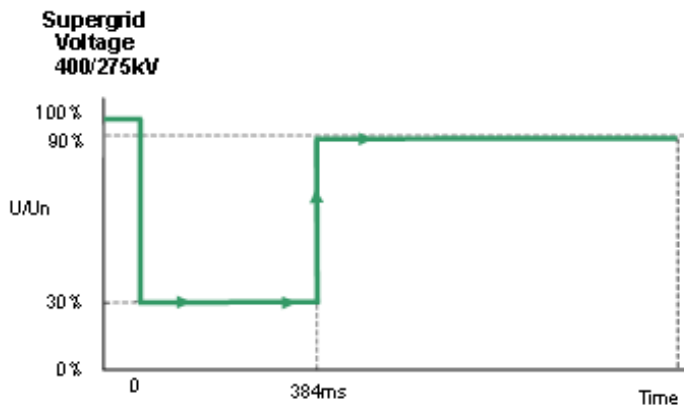
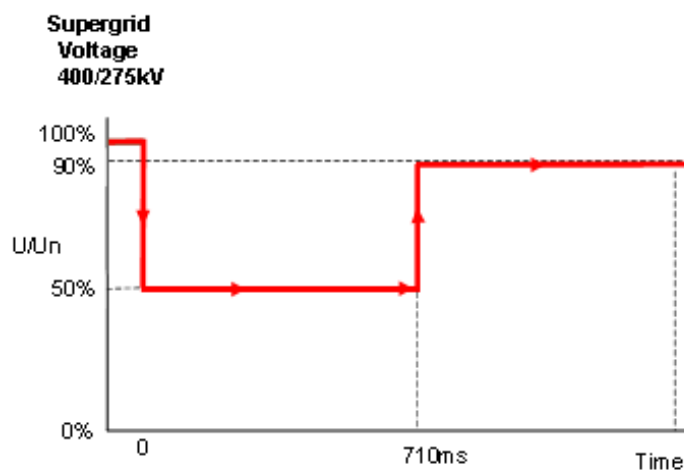

Figure CC.A.4A3.32-2



30% retained voltage, 384ms duration

Figure CC.A.4A3.4 (a)



50% retained voltage, 710ms duration

Figure CC.A.4A3.4 (b)

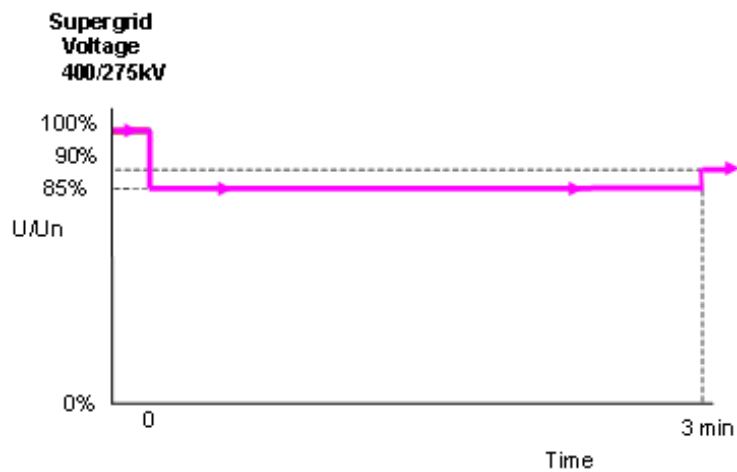

85% retained voltage, 3 minutes duration

Figure CC.A.4A3.4 (c)

APPENDIX 4B - FAULT RIDE THROUGH REQUIREMENTS FOR OFFSHORE GENERATING UNITS IN A LARGE POWER STATION, OFFSHORE POWER PARK MODULES IN A LARGE POWER STATION AND OFFSHORE DC CONVERTERS IN A LARGE POWER STATION WHICH SELECT TO MEET THE FAULT RIDE THROUGH REQUIREMENTS AT THE LV SIDE OF THE OFFSHORE PLATFORM AS SPECIFIED IN CC.6.3.15.2

CC.A.4B.1 Scope

The fault ride through requirement is defined in CC.6.3.15.2 (a), (b) and CC.6.3.15.3. This Appendix provides illustrations by way of examples only of CC.6.3.15.2 (a) (i) and further background and illustrations to CC.6.3.15.2 (1b) [\(1b\)](#) and [CC.6.3.15.2 \(2b\)](#) and is not intended to show all possible permutations.

CC.A.4B.2 Voltage Dips On The LV Side Of The Offshore Platform Up To 140ms In Duration

For voltage dips on the **LV Side of the Offshore Platform** which last up to 140ms in duration, the fault ride through requirement is defined in CC.6.3.15.2 (a) (i). This includes Figure 6 which is reproduced here in Figure CC.A.4B.1. The purpose of this requirement is to translate the conditions caused by a balanced or unbalanced fault which occurs on the **Onshore Transmission System** (which may include the **Interface Point**) at the **LV Side of the Offshore Platform**.

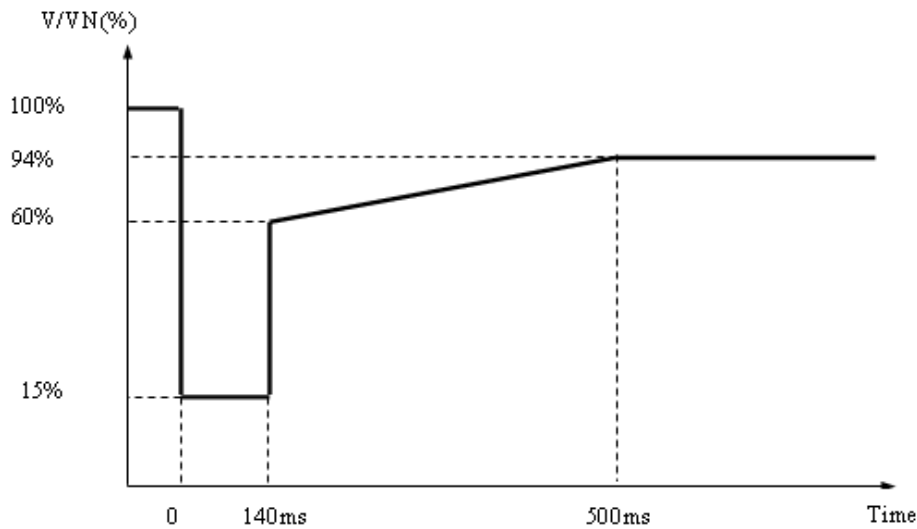

V/V_N is the ratio of the voltage at the **LV side of the Offshore Platform** to the nominal voltage of the LV side of the **Offshore Platform**.

Figure CC.A.4B.1

Figures CC.A.4B.2 (a) and CC.A.4B.2 (b) illustrate two typical examples of the voltage recovery seen at the **LV Side of the Offshore Platform** for a short circuit fault cleared within 140ms by (a) two circuit breakers and (b) three circuit breakers on the **Onshore Transmission System**.

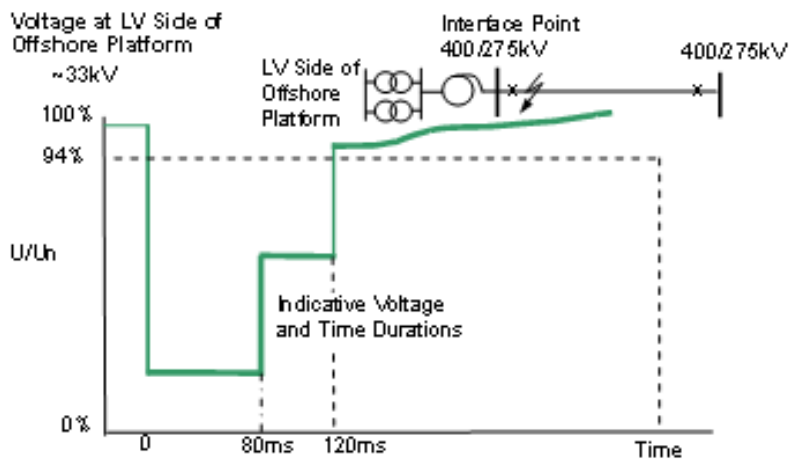

Typical fault cleared in less than 140ms: 2 ended circuit

Figure CC.A.4B.2 (a)

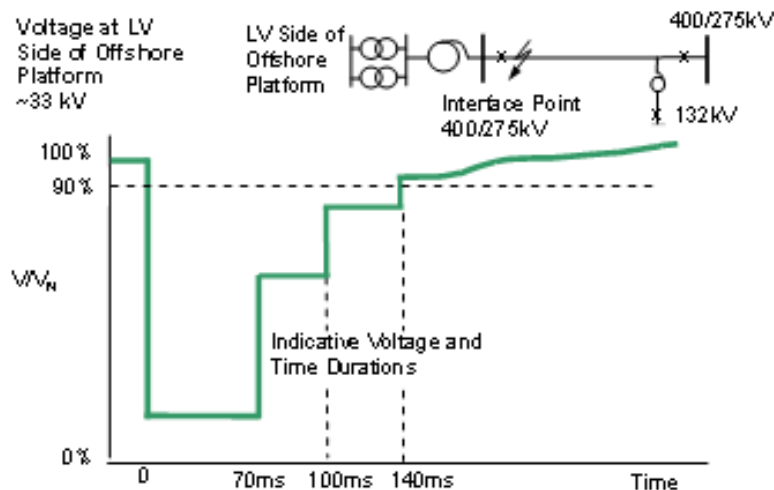

Typical fault cleared in 140ms:- 3 ended circuit

Figure CC.A.4B.2 (b)

CCA.4B.3 Voltage Dips Which Occur On the LV Side Of The Offshore Platform Greater Than 140ms In Duration

Comment [A2]: house keeping change text placed in bold

CC.A.4B.3.1 Requirements applicable to Offshore Synchronous Generating Units subject to voltage dips which occur on the LV Side of the Offshore Platform greater than 140ms in duration.

In addition to CC.A.4B.2 the fault ride through requirements applicable to Offshore Synchronous Generating Units during balanced voltage dips which occur at the LV Side of the Offshore Platform and having durations greater than 140ms and up to 3 minutes are defined in CC.6.3.15.2 (1b) and Figure 7a which is reproduced in this Appendix as Figure CC.A.4B3.1 and termed the voltage-duration profile.

This profile is not a voltage-time response curve that would be obtained by plotting the transient voltage response at the LV Side of the Offshore Platform to a disturbance. Rather, each point on the profile (i.e. the heavy black line) represents a voltage level and an associated time duration which connected Offshore Synchronous Generating Units must withstand or ride through.

Figures CC.A.4B3.2 (a), (b) and (c) illustrate the meaning of the voltage-duration profile for voltage dips having durations greater than 140ms.

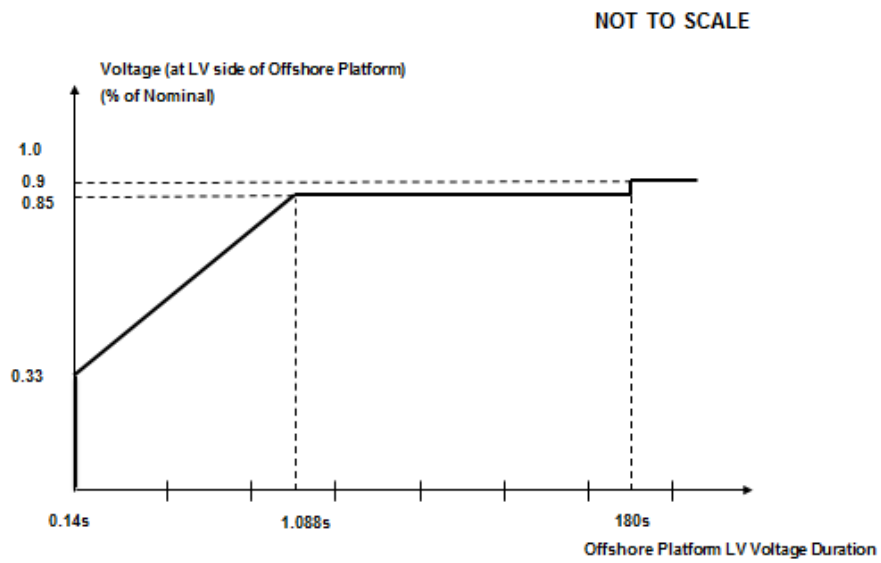

Figure CC.A.4B3.1

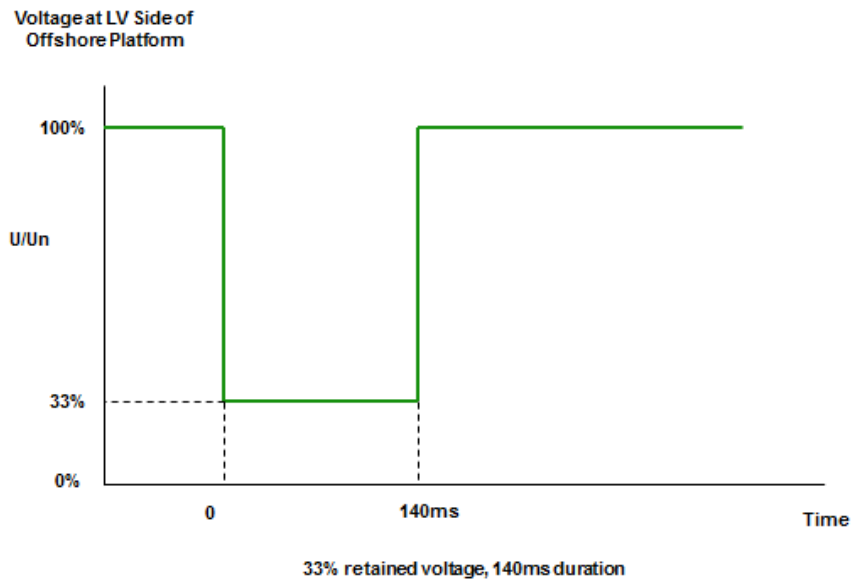

Figure CC.A.4B3.2 (a)

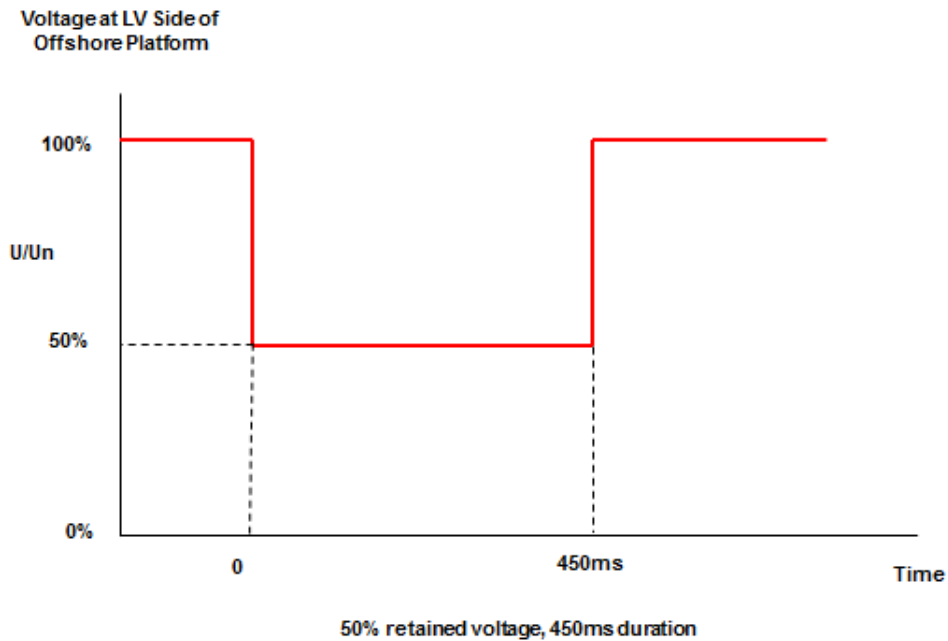

Figure CC.A.4B3.2 (b)

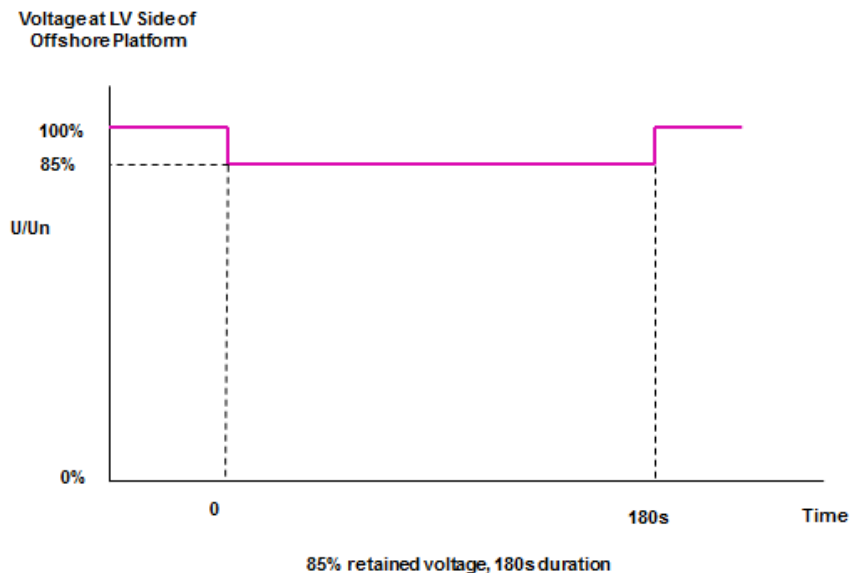

Figure CC.A.4B3.2 (c)

CC.A.4B.3.2 Requirements applicable to Offshore Power Park Modules subject to Voltage Dips Which Occur On The LV Side Of The Offshore Platform Greater Than 140ms in Duration.

Comment [A3]: House keeping change - text placed in bold as it is a defined term.

In addition to CCA.4B.2 the fault ride through requirements applicable for ~~Offshore Generating Units, and~~ **Offshore Power Park Modules** during balanced voltage dips which occur at the **LV Side of the Offshore Platform** and have durations greater than 140ms and up to 3 minutes are defined in CC.6.3.15.2 (2b) (i) and Figure 7b which is reproduced in this Appendix as Figure CC.A.4B.43 and termed the voltage-duration profile.

This profile is not a voltage-time response curve that would be obtained by plotting the transient voltage response at the **LV Side of the Offshore Platform** to a disturbance. Rather, each point on the profile (i.e. the heavy black line) represents a voltage level and an associated time duration which connected ~~Offshore Generating Units, or~~ **Offshore Power Park Modules** must withstand or ride through.

Figures CC.A.4B.53 (a), (b) and (c) illustrate the meaning of the voltage-duration profile for voltage dips having durations greater than 140ms.

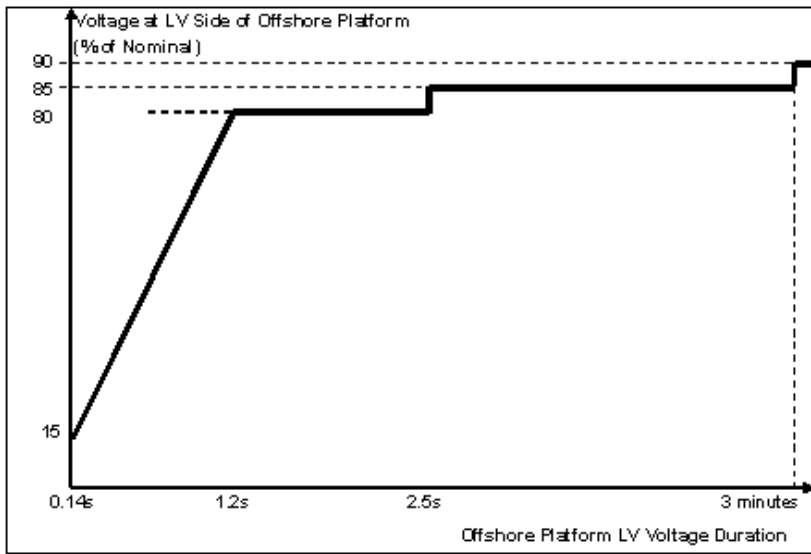
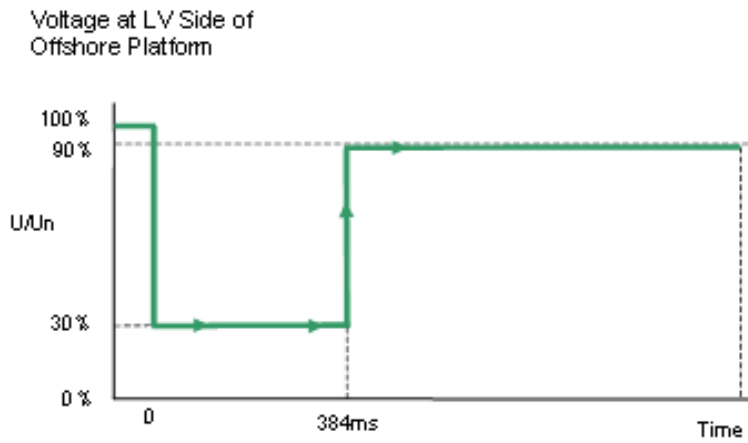

Figure CC.A.4B.43



30 % retained voltage , 384ms duration

Figure CC.A.4B.53 (a)

Voltage at LV Side of Offshore Platform

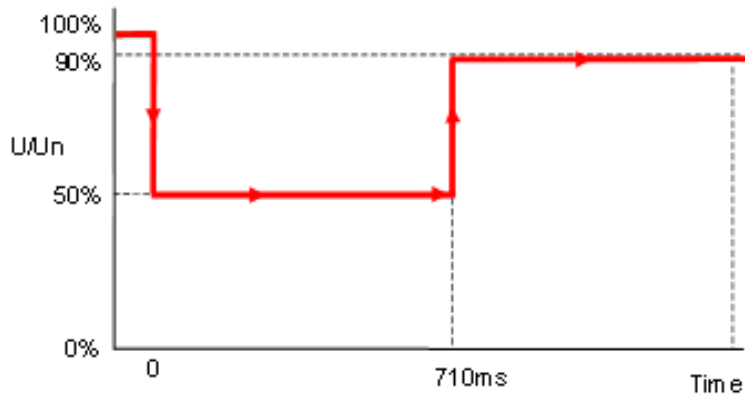

50% retained voltage, 710ms duration

Figure CC.A.4B.53(b)

Voltage at LV Side of Offshore Platform

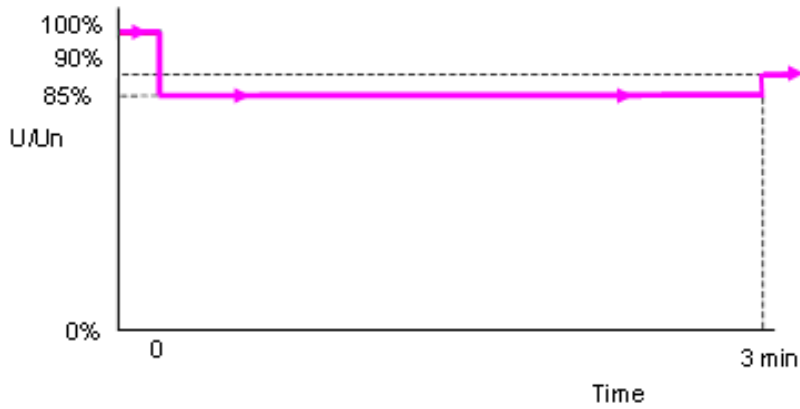

85% retained voltage, 3 minutes duration

Figure CC.A.4B.53(c)

GC0062 – Fault Ride Through

Respondent:	<i>Please insert your name and contact details (phone number or email address)</i>
Company Name:	<i>Please insert Company Name</i>
Do you support the proposed implementation approach?	Yes. The proposal maintains low retained voltage ride through capability in a pragmatic manner that recognises achievable synchronous generator capabilities and balances these against the transmission system requirements.
Do you believe that GC0062 better facilitates the appropriate Grid Code objectives?	<p><i>For reference the applicable Grid Code objectives are:</i></p> <p><i>(i) to permit the development, maintenance and operation of an efficient, coordinated and economical system for the transmission of electricity;</i></p> <p><i>(ii) to facilitate competition in the generation and supply of electricity (and without limiting the foregoing, to facilitate the national electricity transmission system being made available to persons authorised to supply or generate electricity on terms which neither prevent nor restrict competition in the supply or generation of electricity);</i></p> <p><i>(iii) subject to sub-paragraphs (i) and (ii), to promote the security and efficiency of the electricity generation, transmission and distribution systems in the national electricity transmission system operator area taken as a whole; and</i></p> <p><i>(iv) to efficiently discharge the obligations imposed upon the licensee by this license and to comply with the Electricity Regulation and any relevant legally binding decisions of the European Commission and/or the Agency.</i></p> <p>We believe the proposal facilitates the Grid Code objectives in that it is more efficient, economic and promotes competition in the generation market, while having no identified negative impact on system security. We do not believe there to be any conflict with RfG requirements.</p>
Do you have any additional comments?	
<i>The questions below are taken from the working group report section 10.4. Our responses to these questions are included as additional comments.</i>	

(iii) Do the proposed changes facilitate efficient connection and operation of new and/or existing synchronous generating units? If not, why do they fail to do so?	Yes. The proposed modification makes grid code compliance more achievable and should facilitate clearer demonstration of compliance.
(iv) Do the proposed changes impose any additional material risks on the System Operator, e.g. reduced stability margins, reduced reactive capability margins, or difficulty in managing the robustness of the transmission system? If yes, please highlight these risks.	The proposal adopts a pragmatic approach taking account of the capabilities of existing large synchronous generators. Although we believe this will have a finite impact on stability margins, the studies undertaken by the working group give the expectation that adequate system security will be maintained following adoption of the proposed change to the FRT requirement.
(v) Do the proposed changes impose any additional material risks on Transmission Owners, e.g. additional investment that might be neither economic nor efficient? If yes, please highlight these risks.	We do not envisage an increase in material risk.
(vi) Do the proposed changes impose any additional material risks on generators, e.g. additional investment that might be neither economic nor efficient? If yes, please highlight these risks.	No.
(vii) Do the proposed changes adequately protect the interests of all transmission system users? If not, why do they fail to do so?	Yes.
(viii) Are there further technical considerations to be taken into account? If yes, please highlight these technical considerations.	No.
(ix) Is there any evidence that users will be inappropriately or adversely affected by the changes proposed? If so, please provide details.	No.
(x) Do the proposed changes strike an appropriate balance between the needs of generators, transmission licensees, and other interested parties? If not, why do they fail to do so?	Yes. An appropriate balance between the obligations placed on generators and the maintenance of an economic and secure transmission system is reflected in the proposal.
(xi) Please provide any other comments you feel are relevant to the proposed change.	

Grid Code Industry Consultation Response Proforma CR-02

Respondent:	<i>Damian Jackman, 0141 224 7107 damian.jackman@sse.com</i>
Company Name:	<i>SSE Generation</i>
Do you support the proposed implementation approach?	Yes
Do you believe that GC0062 better facilitates the appropriate Grid Code objectives?	Yes
Do you have any additional comments?	<p>SSE welcomes the proposal by the GC0062 workgroup to relax the requirements which will avoid extra costs for generators whilst maintaining the security of the transmission system.</p> <p>The further detail on the voltage profile during fault simulations is also welcome to provide clarity for grid compliance studies for new generators.</p>

Grid Code Industry Consultation Response Proforma CR-03

Respondent:	<p><i>Andy Vaudin</i></p> <p><i>andrew.vaudin@edfenergy.com</i></p>
Company Name:	<p><i>EDF Energy</i></p>
Do you support the proposed implementation approach?	<p><i>Yes, EDF Energy supports the proposed implementation approach.</i></p> <p><i>We believe that the GC0062 workgroup has addressed the Grid Code deficiencies identified in the original proposal and that the appropriate remedies are included in the proposed amendment to the Grid Code text.</i></p>
Do you believe that GC0062 better facilitates the appropriate Grid Code objectives?	<p>(i) to permit the development, maintenance and operation of an efficient, coordinated and economical system for the transmission of electricity;</p> <p><i>This proposal would clarify and rationalise the Fault Ride Through requirements based on the realisable physical capabilities of synchronous generators.</i></p> <p>(ii) to facilitate competition in the generation and supply of electricity (and without limiting the foregoing, to facilitate the national electricity transmission system being made available to persons authorised to supply or generate electricity on terms which neither prevent nor restrict competition in the supply or generation of electricity);</p> <p><i>This proposal facilitates access to the NETS for synchronous generators by clarifying and rationalising the FRT requirements.</i></p> <p>(iii) subject to sub-paragraphs (i) and (ii), to promote the security and efficiency of the electricity generation, transmission and distribution systems in the national electricity transmission system operator area taken as a whole; and</p> <p><i>The proposal promotes the security and efficiency of the NETS by requiring comprehensive FRT requirements that cover the NETS requirements and that are achievable using the full capabilities of synchronous generators.</i></p> <p>(iv) to efficiently discharge the obligations imposed upon the licensee by this license and to comply with the Electricity Regulation and any relevant legally binding decisions of the European Commission and/or the Agency.</p>

	<i>This proposal and workgroup work provides input into the implementation of RFG requirements in GB.</i>
Do you have any additional comments?	

Grid Code Industry Consultation Response Proforma CR-04

Respondent:	John Norbury Network Connections Manager RWE Supply & Trading GmbH Windmill Hill Business Park Whitehill Way Swindon SN5 6PB T +44 (0)1793 89 2667 M +44 (0)7795 354 382 john.norbury@rwe.com
Company Name:	RWE Group of GB companies including RWE Generation UK plc, RWE Innogy UK Limited and RWE Supply & Trading GmbH
Do you support the proposed implementation approach?	We agree with the proposed implementation given in paragraph 9.12
Do you believe that GC0062 better facilitates the appropriate Grid Code objectives?	<p><i>For reference the applicable Grid Code objectives are:</i></p> <p><i>(i) to permit the development, maintenance and operation of an efficient, coordinated and economical system for the transmission of electricity;</i></p> <p><i>(ii) to facilitate competition in the generation and supply of electricity (and without limiting the foregoing, to facilitate the national electricity transmission system being made available to persons authorised to supply or generate electricity on terms which neither prevent nor restrict competition in the supply or generation of electricity);</i></p> <p><i>(iii) subject to sub-paragraphs (i) and (ii), to promote the security and efficiency of the electricity generation, transmission and distribution systems in the national electricity transmission system operator area taken as a whole; and</i></p> <p><i>(iv) to efficiently discharge the obligations imposed upon the licensee by this license and to comply with the Electricity Regulation and any relevant legally binding decisions of the European Commission and/or the Agency.</i></p> <p>We believe that GC0062 will better facilitate Grid Code objective (iii) by helping to prevent or reduce the risk of a synchronous generating unit from pole slipping during a transmission system event.</p>
Do you have any additional comments?	<p>1. We note that the consultation paper does not appear to contain a conclusion / recommendation regarding the required compliance simulations on the basis that it will be addressed via the RfG workgroup. However, we understand that the RfG workgroup will now only consider this with respect to mode A (less than 140ms) faults. We therefore suggest that the GC0062 workgroup consider the required compliance studies for mode B (more than 140ms) faults and recommend appropriate Grid Code changes.</p> <p>2. Typographical comment – it appears that the tables in 5.19 and 5.21 have incorrect headings.</p>

Grid Code Industry Consultation Response Proforma CR-05

Respondent:	Alastair Frew
Company Name:	ScottishPower Generation
Do you support the proposed implementation approach?	Yes, the proposal moves the requirements into an area where synchronous generators are more likely to be compliant.
Do you believe that GC0062 better facilitates the appropriate Grid Code objectives?	Yes
Do you have any additional comments?	No

GC0062 – Fault Ride Through

From: Newton, Paul [<mailto:Paul.A.Newton@uniper.energy>]
Sent: 07 March 2016 16:50
To: Johnson, Antony
Subject: EXT || FW: GC0062 Fault Ride Through - Industry Consultation

Hi Tony,

Hope you are well

Quick question - does this modification (accidentally) delete the mode B FRT requirements for offshore synchronous generating units? Also, I'm not sure why these proposals are only limited to onshore synchronous generating units.

Kind regards,

Paul Newton
Electrical Engineering
Uniper

M +44 (0) 7843 002053
paul.a.newton@uniper.energy

<http://www.uniper-engineering.com/>

Uniper Technologies Limited, Technology Centre, Ratcliffe-on-Soar, Nottingham, NG11 0EE, UK
Registered address of Westwood Way, Westwood Business Park, Coventry, CV4 8LG
Registered in England and Wales Company Number 2902387

Please consider the environment: don't print this e-mail unless you really need to.

This message and any attachments are confidential and should only be read by those to whom they are addressed. If you are not the intended recipient, please contact us, delete the message from your computer and destroy any copies. Any distribution or copying without our prior permission is prohibited. Internet communications are not always secure and therefore the Uniper Group does not accept legal responsibility for this message. The recipient is responsible for verifying its authenticity before acting on the contents. Any views or opinions presented are solely those of the author and do not necessarily represent those of the Uniper Group.

Appendix 1 - Study Evidence

- A.1 This section includes the results of various studies performed by National Grid and Generators to demonstrate the effects of mainly Mode B faults where short circuits are cleared in backup protection times.
- A.2 Mode A faults were also considered but were not generally as onerous as the Mode B faults. Generators performed some very interesting critical clearing time studies which demonstrate 0pu and 0.5pu retained volts are the two areas where the tolerance between the requirements and the physics of the machines are at their smallest.
- A.3 The study work is generally presented in the chronological order that it was produced and presented to the work group. The accompanying text describes the objectives of the studies and what is demonstrated by them.
- A.4 Initially the studies considered the effects of various trips in back up protection times at Eggborough and Seabank. These included summer and winter cases with low and high renewable content based on contracted positions similar to the current network.
- A.5 It was expected that summer minimum with high wind penetration would be the worst case as this would represent the weakest system. However at current network penetration of renewable technology, the results were similar and the effects observed on the synchronous generation under consideration were not significant.
- A.6 Studies were also carried out to determine the conditions developers, generators and manufactures could reasonably be expected to encounter and would be required to prove compliance against. The method of compliance, single machine against an infinite bus was also validated against the equivalent study performed on the full GB system.

Effects of Trip at Seabank

- A.7 The initial studies carried out at Seabank considered the effects of a double circuit trip on the OHL from Imperial Park to Melksham and Clifynydd to Whitson and Seabank for low wind winter peak conditions, as shown in the diagram below. As stated earlier, studies were performed at summer minimum and winter peak with different generation profiles but these didn't have significant effects on the results.

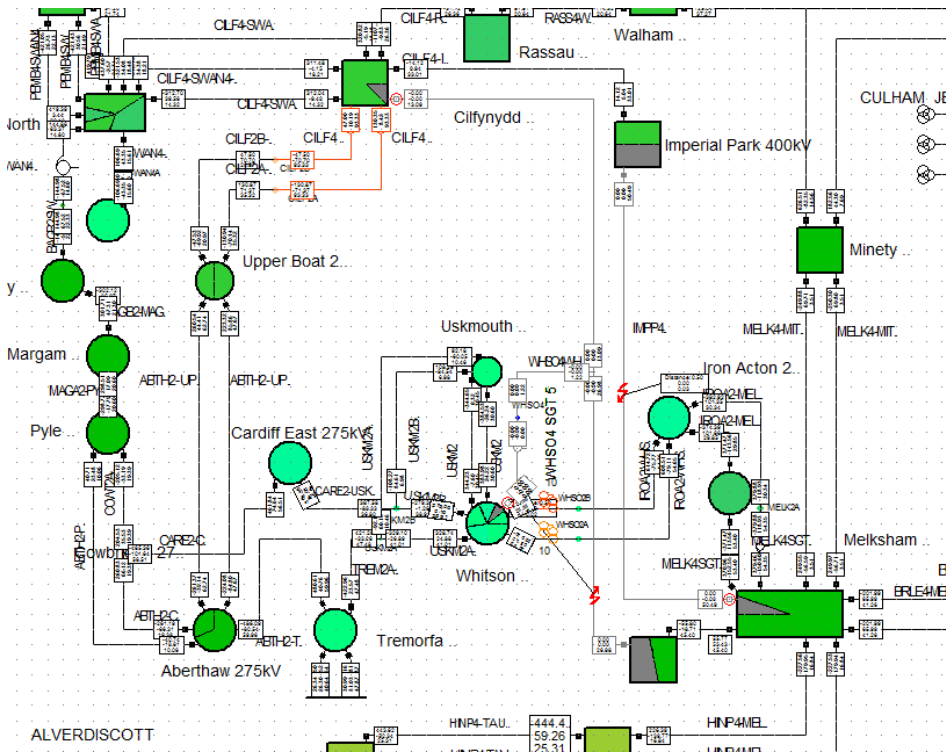

Figure A.7 – Location of faults for Seabank 700ms 50% Fault

A.8 The fault applied to the line depressed the volts at Seabank to 50% for 700ms. Most of the breakers tripped within 140ms but one breaker was assumed to fail and remained closed requiring the backup protection to operate after 700ms and clear the fault by isolating the bus bar connected to the other side of the failed breaker.

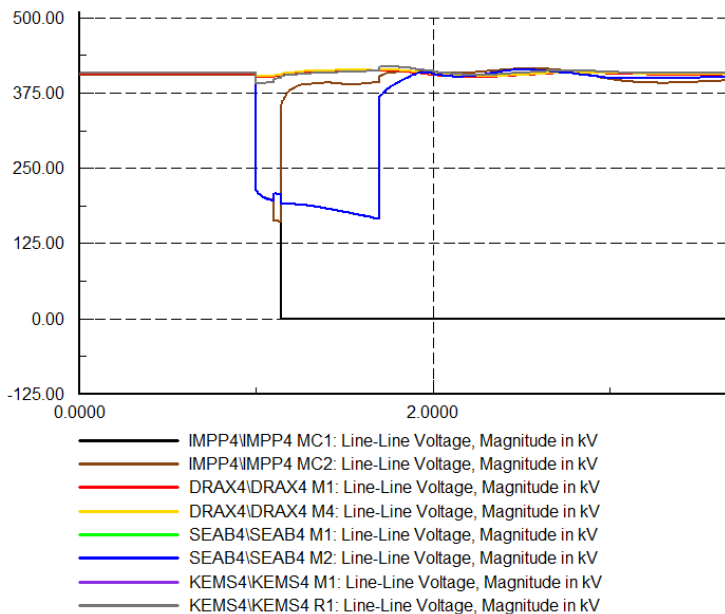

Figure A.8 – Voltage depression at Seabank 400kV and various other locations.

A.9 Various voltages were monitored around the system to see how the voltage depression affects the rest of the system.

A.10 As a result of breaker X105 failing to open and the backup protection opening (X410, X305 and X130), three generators SEAB_8A, SEAB_8B and SEAB_8C are lost at Seabank. However this is around 700MW and is under the SQSS infrequent infeed loss and no load disconnection is required.

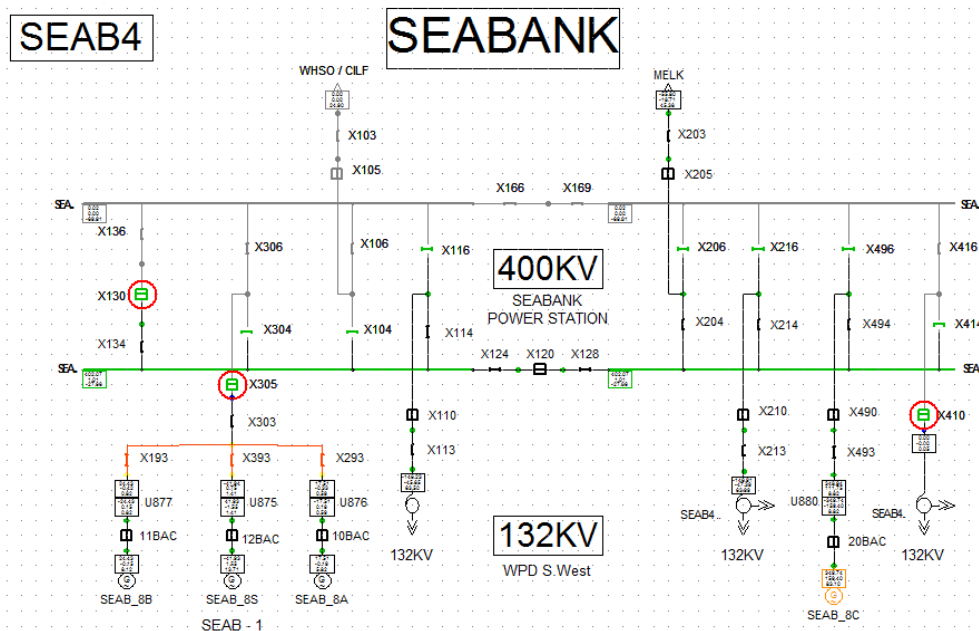

Figure A.10 – Breakers opened by back up protection.

A.11 The results show the remaining machine SEAB_8C survives this onerous fault condition and doesn't pole slip, and all other machines on the system also survive. The rotor angle deviation is contained to within about $\pm 60^\circ$.

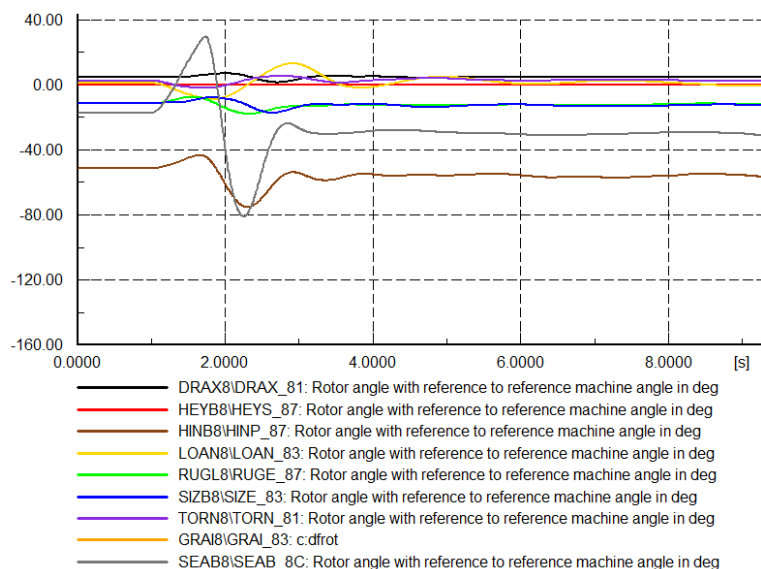

Figure A.11 – Rotor angle deviation at Seabank and various other locations.

A.12 Most back up protection is expected to operate in less than 500ms. The study however, considered a more onerous case of 700ms to ensure a margin existed between the requirement and the worst case backup protection time. (Note: The model used was: “FRT Base Case - Post GC WG Aug 2014” and study case “001 Working Group Jul 2014 (As Actions)\ Mon Winter DP2014-15-FRT-SEAB-700ms50%”).

Effects of Trip at Eggborough

A.13 The Eggborough generator was tested at 0.5pu for 550ms, 600ms and 700ms with all disturbances initially starting with a voltage dip to 0.pu for 140ms. The fault was applied to both Eggborough to Drax circuits with circuit breaker X505 failing at Eggborough resulting in the longer fault conditions.

EGGB4

EGGBOROUGH

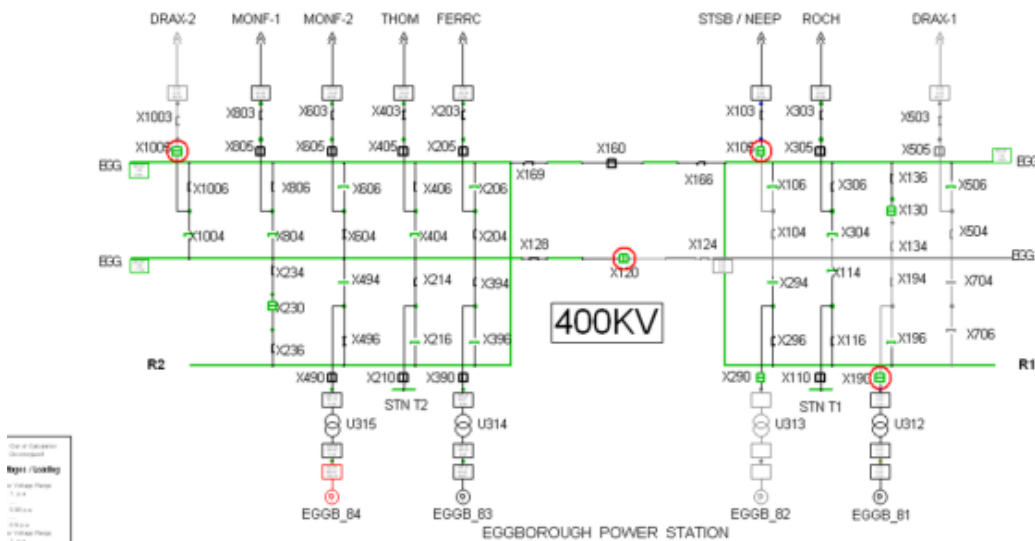

Figure A.13 – Eggborough substation and running arrangement showing breakers which operate to clear stuck breaker X505.

- A.14 Only the 550ms simulation survived without pole slipping. Unlike Seabank, Eggborough has a slow rotating exciter, no PSS and relatively low gain AVR although with voltage depressions of this size, it is still likely to produce timely field forcing. However the above, particularly the exciter, probably accounts for much of the performance.
- A.15 **Note:** Under winter peak conditions, additional generation (EGGB_81) was connected at Eggborough and lost as part of the stuck breaker as the bus bar it was connected to tripped. In addition to the initial double circuit lost as part of the fault on the DRAX-EGGB lines, a further additional line (EGGB-STSB/NEEP) was lost as part of the bus bar trip although this is a three ended circuit and the other two nodes do remain connected.

Worst case breaker stuck at Seabank and Drax

- A.16 Following the initial studies carried out at Eggborough and Seabank it was noted that with the standard default running arrangement, more severe conditions could be achieved by simply selecting different fault locations and stuck breakers.
- A.17 Under these conditions it is possible to produce failures which result in large losses of generation, which cannot be contained by frequency response and reserve which ultimately leads to load disconnection. However as Mode B is only intended to prevent a total system collapse and is not covered by the SQSS requirements, this is nonetheless considered acceptable.
- A.18 Under these more severe conditions Seabank and surrounding machines performed well and survived without significant loss of generation and therefore maintained all loads. However because of the quantity of generators in the Drax region, in particular located at Eggborough and Ferrybridge a different picture emerged.
- A.19 The worst case that was created incurred a loss of approximately 3.5GW of generation which would probably result in about 1.7 to 2.2GW of load disconnection. However the disturbance was contained and the machines beyond Ferrybridge did not pole slip.
- A.20 The following two sub sections describe the worst case studies for Seabank and Drax/Eggborough respectively.

Winter Peak Study at Seabank with fault on MELK-SEAB and IMPP-MELK

A.21 It was noted that a fault on the double circuit from Melksham to Seabank and Imperial Park would be more onerous with the standard running arrangements, as this would leave the three CCGT machines to export about 750MW down a single circuit. Furthermore these machines have fast response static exciters together with a PSS installed. Consequently if they cannot achieve the requirement it might be considered unreasonable.

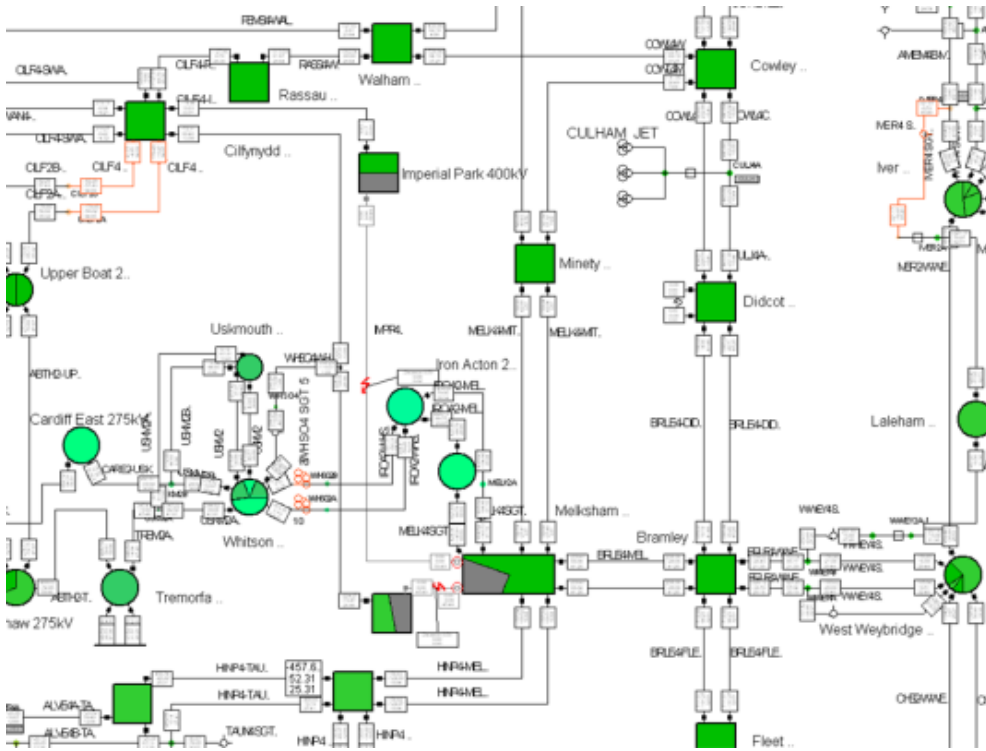

Figure A.21 – Double Circuit Fault for more severe Seabank study

A.22 At 0.5pu retained volts for 700ms with an initial dip to 0pu at HV bus bar for 140ms the machines did not survive all pole slipping. However for both 0.5pu for 550ms with an initial dip to 0pu for 140ms and 0.5pu for 700ms with no dip to 0pu the machines survive. From the results it was observed that the latter of the two was the less severe with the best response.

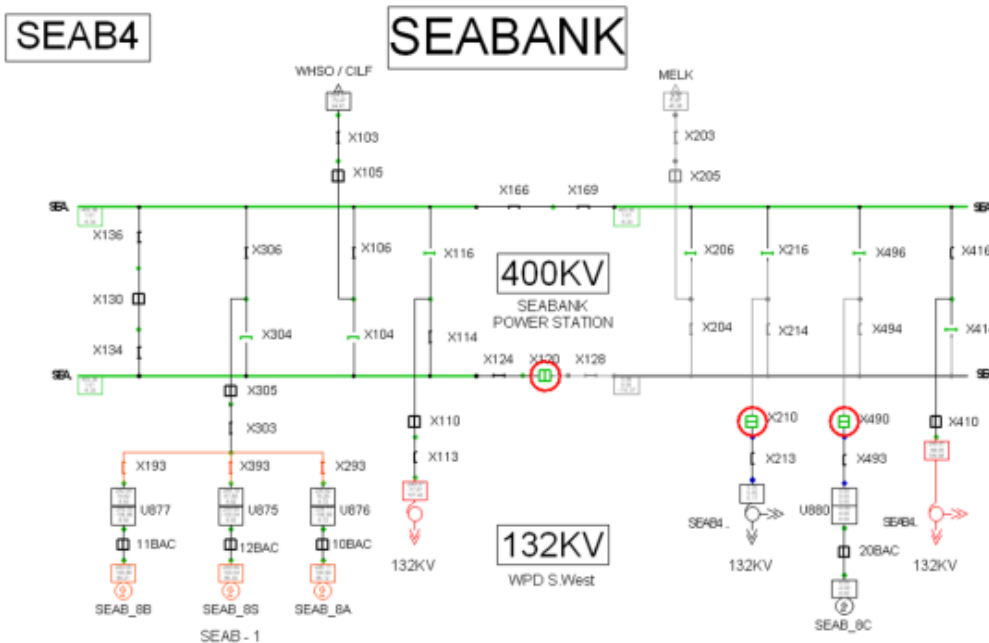

Figure A.22 – Running arrangement and clearing breakers for more severe Seabank study (NB X205 is the stuck breaker)

A.23 In the case of the 550ms example, the results are presented below. The excitation was also monitored when the 400kV bus bar volts were 0 and around 0.5pu. It should be noted that the excitation system is a modern self-excited fast excitation system with a high forcing margin, operating towards the extremes of what the Grid Code stipulates (2.59 forcing margin with 1pu volts at the generator terminals).

A.24 With 0pu on the 400kV bus bar there was 0.31pu on the generator terminals and 2.17pu excitation (where 1pu represents the required excitation to achieve no load open circuit volts and is not the full load continuous rating). With 0.5pu on the 400kV bus bar there was 0.52pu on the generator terminals and 3.62pu excitation (where 1pu represents the required excitation to achieve no load open circuit volts). *Note: The model/study used was: Mon Winter DP2014-15-FRT-SEAB-3xCCGT*

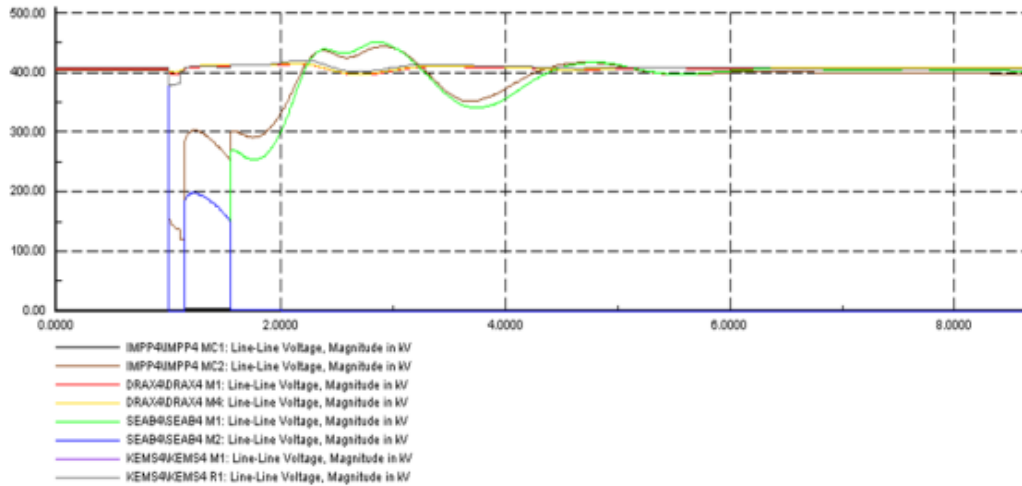

Figure A.24a – Voltage profile for more severe Seabank study (NB SEAB M2 doesn't recover as it's tripped by backup protection)

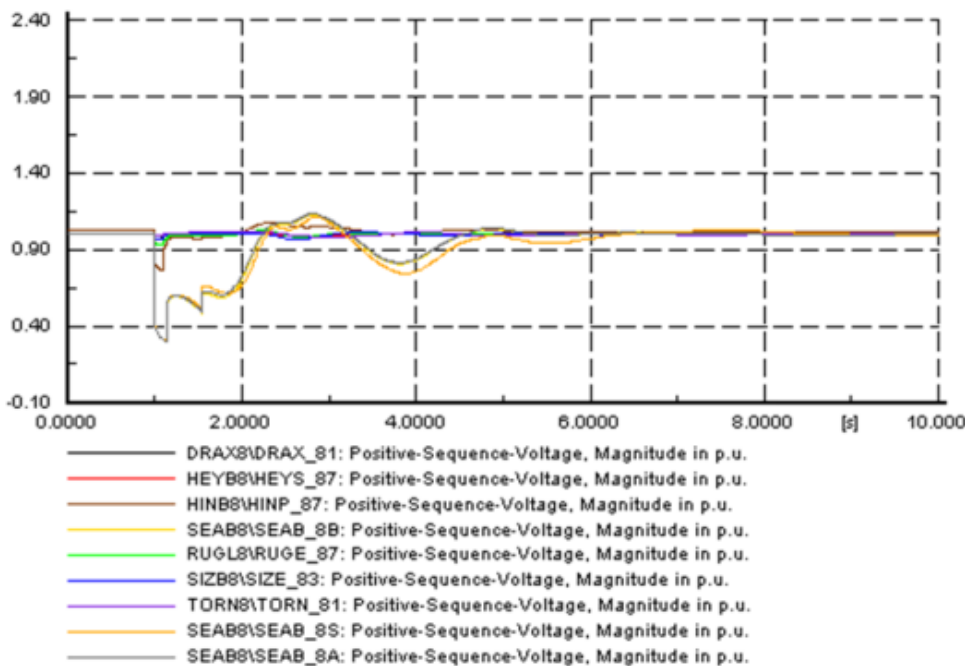

Figure 24b – Voltage profile as seen at generator terminals of various machines for more severe Seabank study

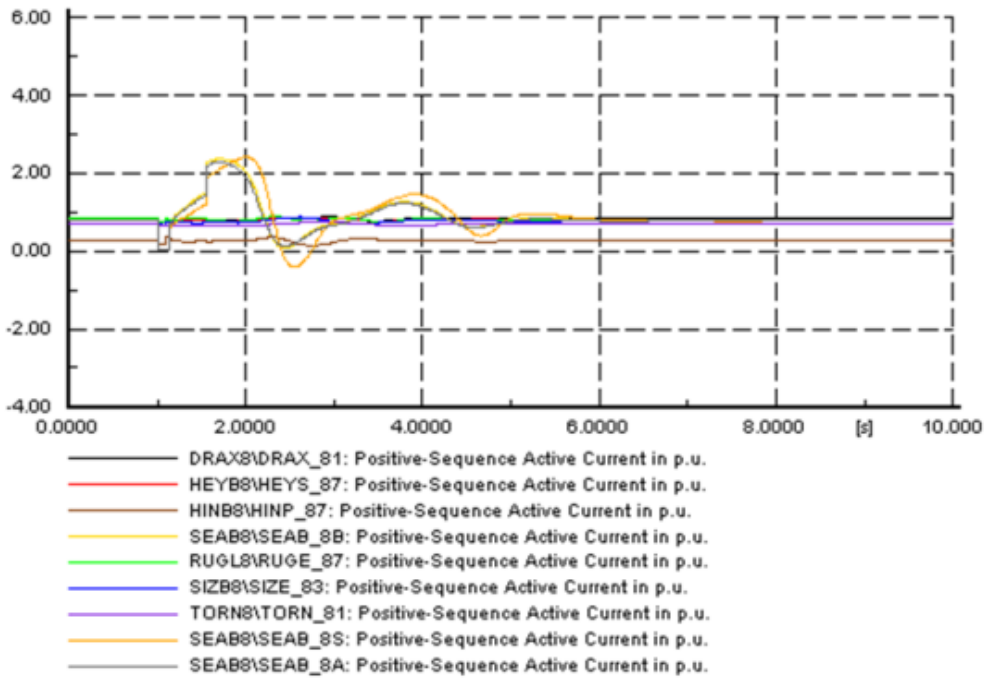

Figure A.24c – Active Current (i.e. Power at 1pu volts) as seen at generator terminals of various machines for more severe Seabank study

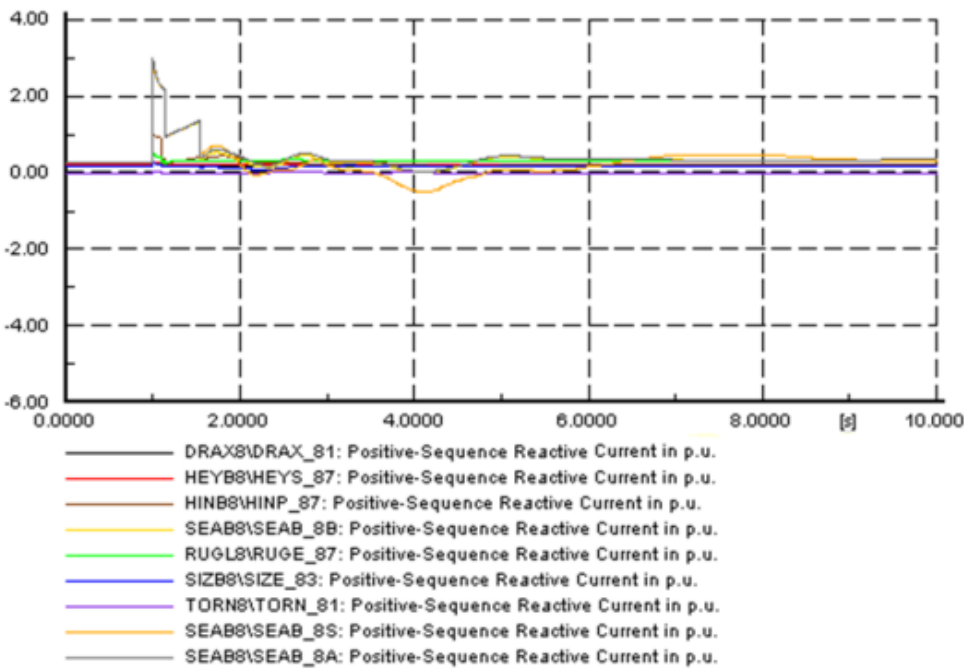

Figure A.24d – Reactive Current (i.e. Reactive Power at 1pu volts) as seen at generator terminals of various machines for more severe Seabank study

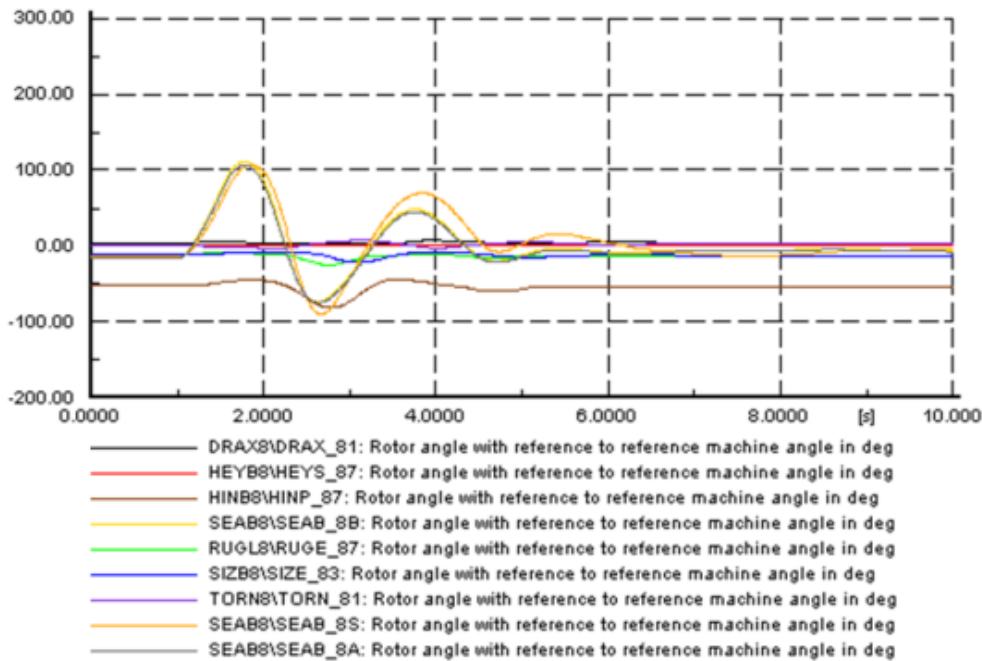

Figure A.24e – Rotor Angle deviation as seen at various machines for more severe Seabank study

Winter Peak Study with fault on DRAX–THOM/KEAD 1 and 2 with a fault Impedance of 0 Ohms for 550ms

A.25 This study considered what would happen if there was a fault on the DRAX-THOM/KEAD circuits near Drax with no fault impedance and a stuck breaker at Drax. At DRAX, G2 is lost as a result of the stuck breaker, G1 and G3 pole slip and are lost as do EGGB G1 and G3 which are also lost along with Ferrybridge G3 and G4 which also pole slip.

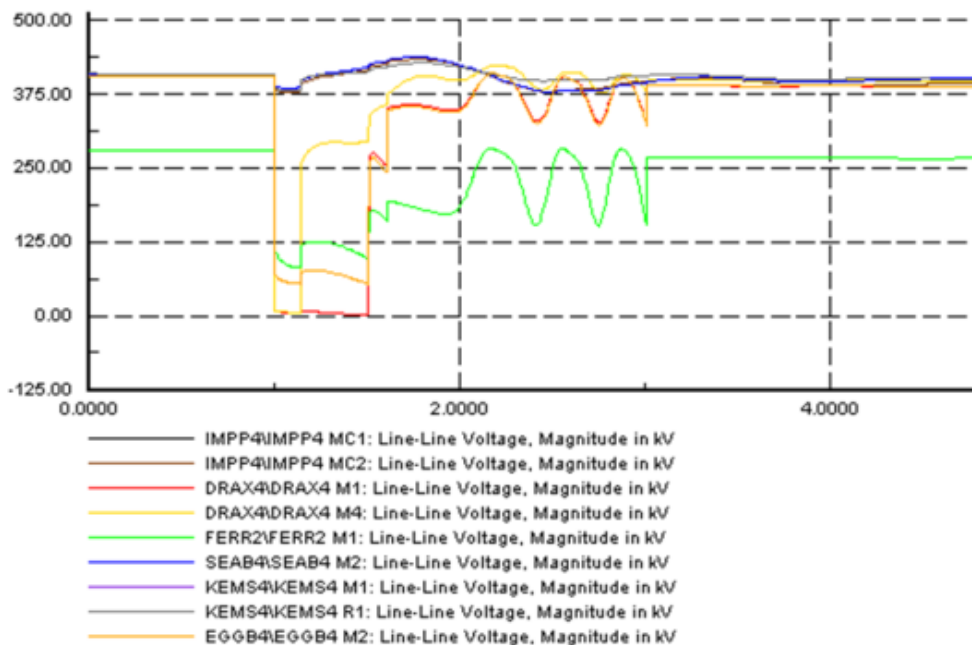

Figure A.25 – Voltage profile for more severe Drax / Eggborough study

A.26 The study demonstrates the potential loss of approximately 3.5GW of generation. This exceeds the contingency limit of 1800MW by approximately 1700MW and is therefore going to result in low frequency demand disconnection and possible system collapse.

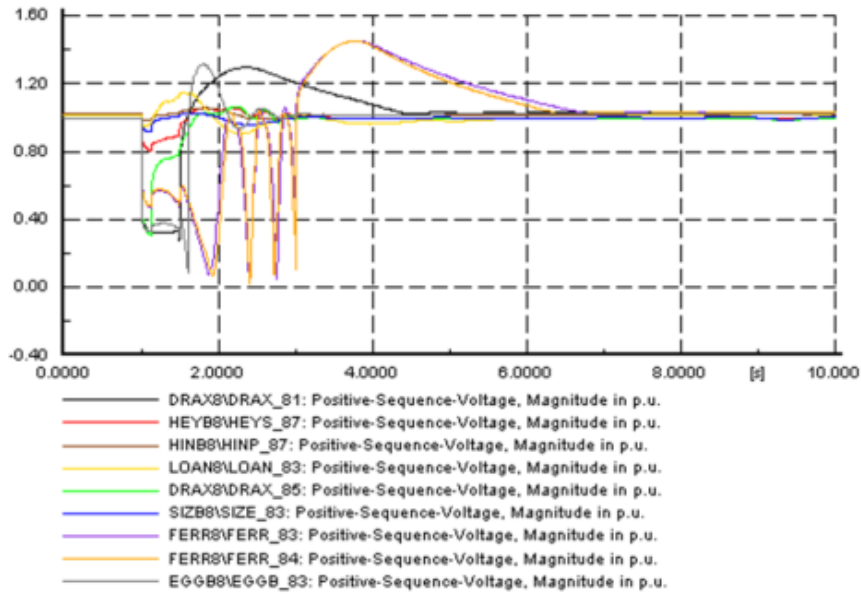

Figure A.26a – Voltage profile as seen at generator terminals of various machines for more severe Eggborough / Drax study

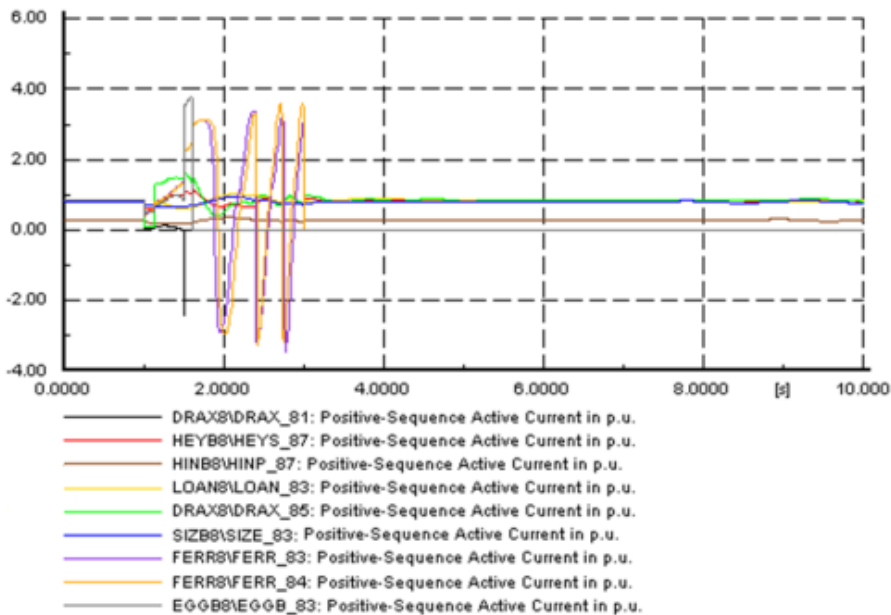

Figure A.26b – Active Current (i.e. Power at 1pu volts) as seen at generator terminals of various machines for more severe Eggborough / Drax study

A.27 The voltage depression at Drax M1 is approximately 0pu and at Drax M4 is 0pu for 140ms and 0.73pu for the remaining 550ms. After the initial 140ms the retained voltage at Eggborough is between 0.14-0.19pu and at Ferrybridge is between 0.35-0.45pu which are both below 0.5pu for 500ms. The study clearly demonstrates contagion from one substation to the next. In practice a real fault may not be as severe as it may have higher impedance or not involve all phases.

Note: The model/study used was: Mon Winter DP2014-15-FRT-DRAX-550msSC

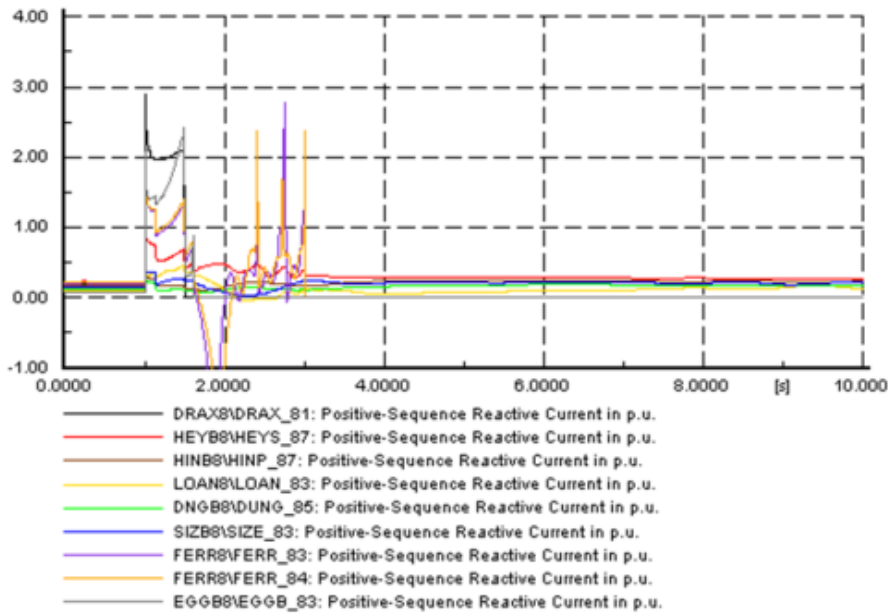

Figure A.27a – Reactive Active Current (i.e. Reactive Power at 1pu volts) as seen at generator terminals of various machines for more severe Eggborough / Drax study

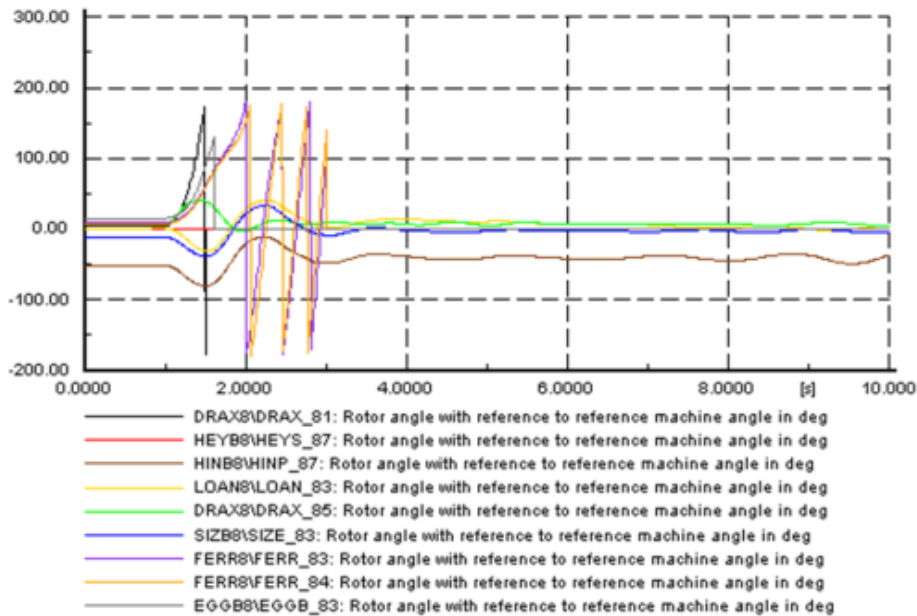

Figure A.27b – Change in Rotor Angle as seen at generator terminals of various machines for more severe Eggborough / Drax study

Winter Peak Study with fault on DRAX–THOM/KEAD 1 with a fault Impedance of 0 Ohms for 550ms

A.28 This study considered what would happen if there was a fault on the DRAX-THOM/KEAD circuit near Drax with no fault impedance and a stuck breaker at Drax. It differs from the previous study as only one circuit has a fault (in the previous study both circuits had experienced a fault). A similar result is obtained but this time the Ferrybridge machines do not pole slip.

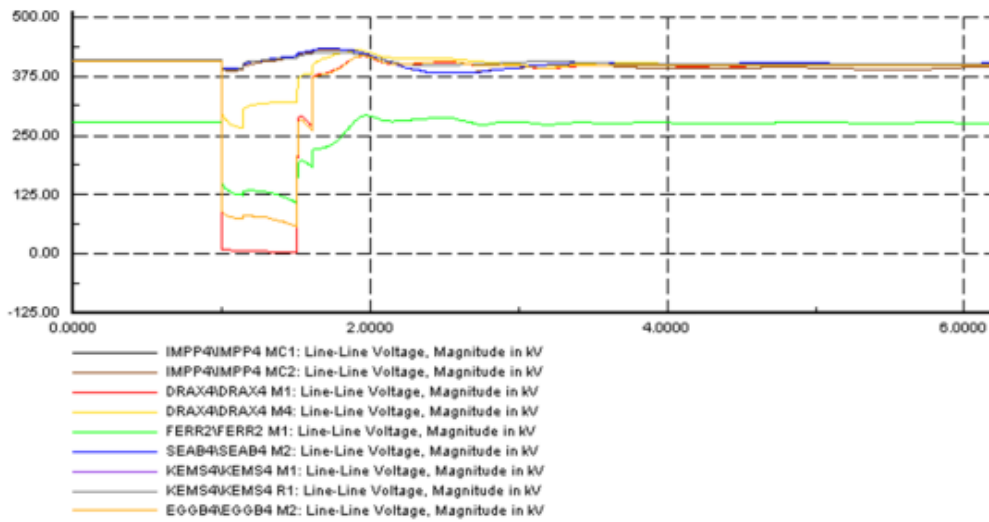

Figure A.28 – Voltage profile for more severe single circuit Drax / Eggborough study

- A.29 The study demonstrates the potential loss of approximately 2.5GW of generation. This exceeds the contingency limit of 1800MW by approximately 700MW and is therefore going to result in low frequency disconnection.
- A.30 At DRAX G2 is lost as a result of the stuck breaker, G1 and G3 pole slip and are lost as do EGGB G1 and G3 which are also lost.
- A.31 The voltage depression at Drax M1 is approximately 0pu and at Drax M4 is 0pu for 140ms and 0.77-0.79pu for the remaining 550ms. After the initial 140ms the retained voltage at Eggborough are between 0.15-0.2pu and at Ferrybridge 0.4-0.48pu. The study clearly demonstrates contagion from one station to the next and that for Ferrybridge 0.5pu at 550ms is close to its limit.

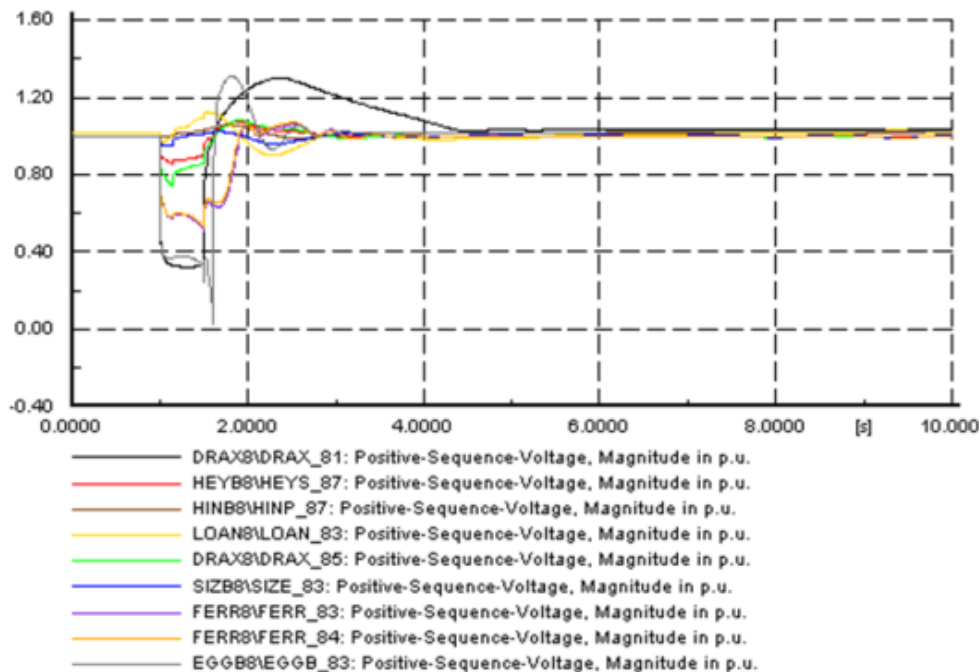

Figure A.31a – Voltage profile as seen at generator terminals of various machines for more severe single circuit Eggborough / Drax study

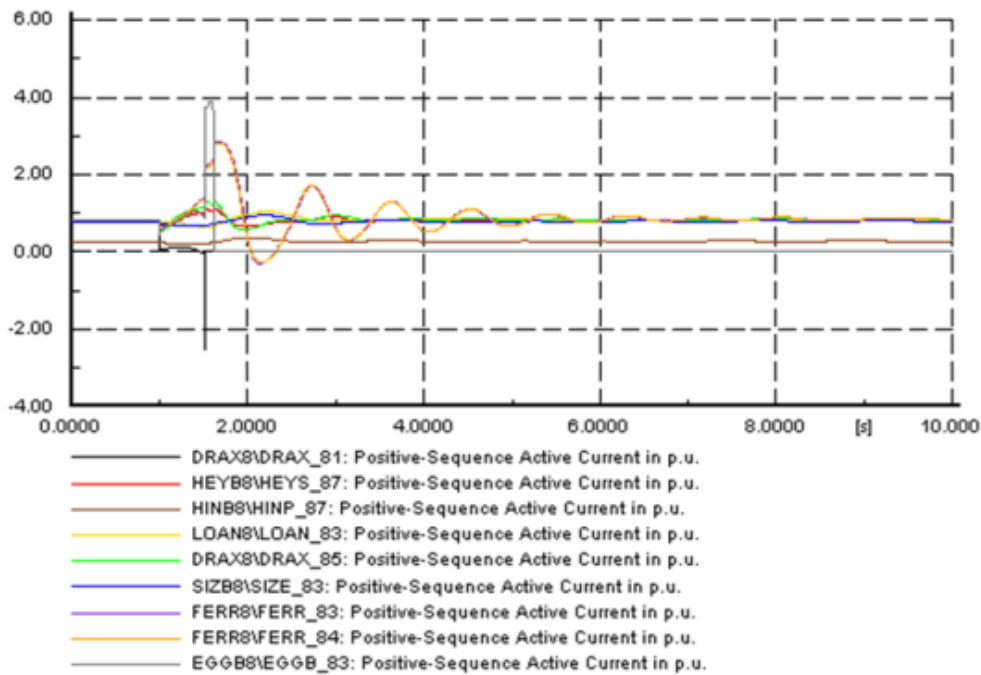

Figure A.31b – Active Current (i.e. Power at 1pu volts) as seen at generator terminals of various machines for more severe single circuit Eggborough / Drax study

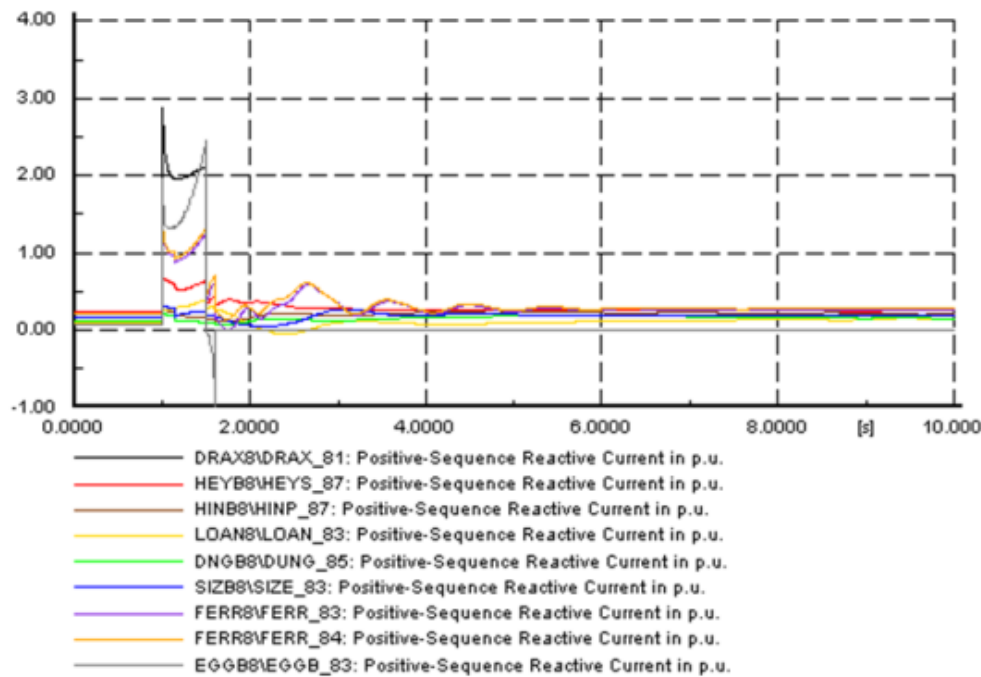

Figure A.31c – Reactive Active Current (i.e. Reactive Power at 1pu volts) as seen at generator terminals of various machines for more severe single circuit Eggborough / Drax study

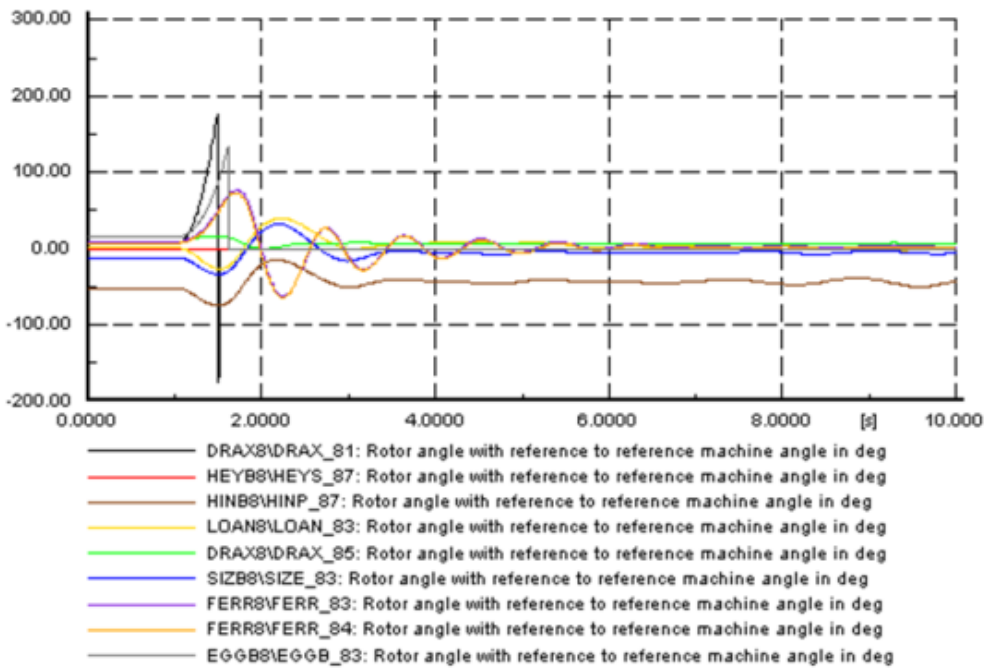

Figure A.31d – Change in Rotor Angle as seen at generator terminals of various machines for more severe single circuit Eggborough / Drax study

Note: The model/study used was: Mon Winter DP2014-15-FRT-DRAX-550msSC-1L

Comparison of Single Machine and Multi Machine Studies

A.32 For generators to test their machines are compliant they need to produce a single machine model and subject it to the applicable study conditions and must be confident that these models accurately represent what would happen in if all machines were modelled.

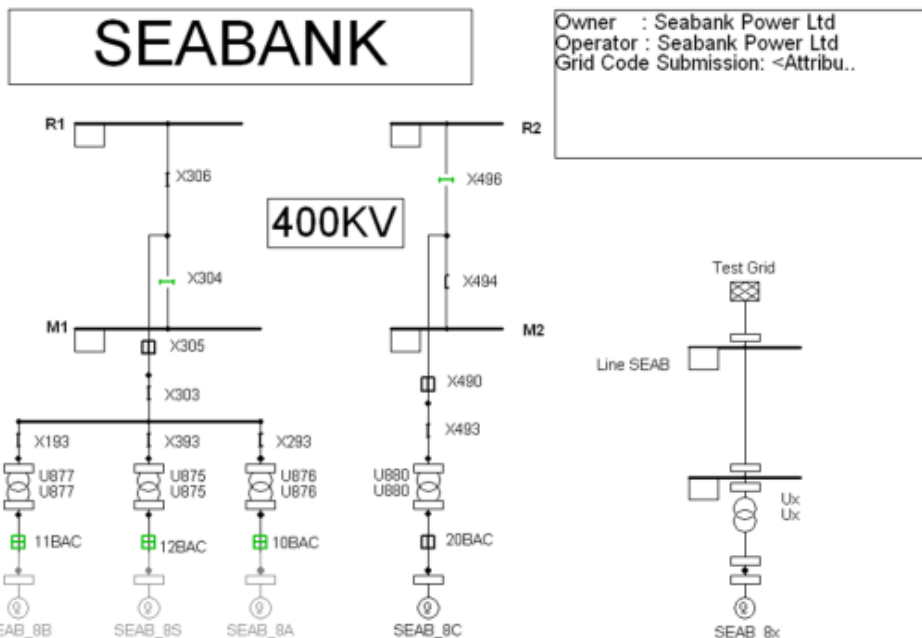

Figure A.32 – Seabank single machine model SEAB_8x compared simultaneously with SEAB_8C connected to GB system

A.33 The following studies test the Eggborough and Seabank machines on single Machine models comparing the results against the full GB model. These studies demonstrate that single machine models are reasonably accurate and can be used to demonstrate compliance.

EGGBOROUGH

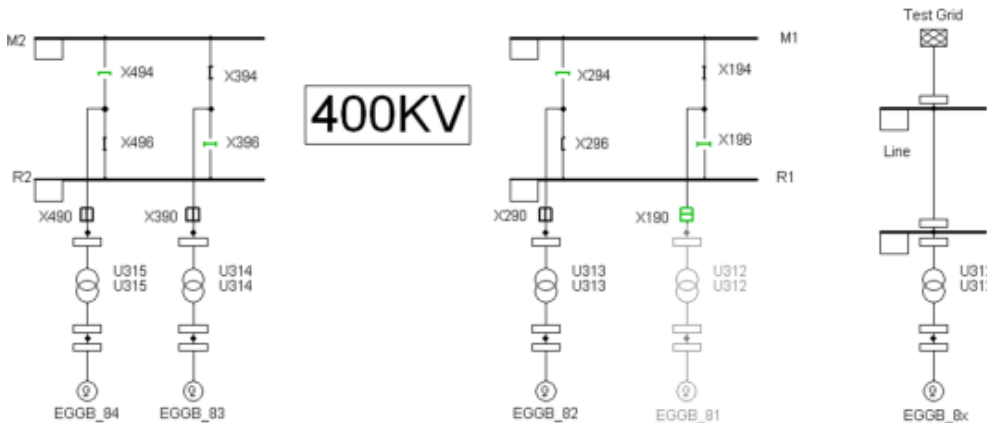

Figure A.33 – Eggborough single machine model EGGB_8x compared simultaneously with EGGB_83 connected to GB system

A.34 The study conditions tested were as follows:

1. 140ms 0pu retained volts at the generator transformer HV with the machine starting fully leading with approximately 1pu volts before and after the fault.
2. 270ms at ≤ 0.4 pu retained volts at the generator transformer HV with the machine starting fully leading with approximately 1pu volts before and after the fault.
3. 700ms at ≤ 0.5 pu retained volts at the generator transformer HV with the machine starting fully leading with approximately 1pu volts before and after the fault.
4. 1000ms at ≤ 0.68 pu retained volts at the generator transformer HV with the machine starting fully leading with approximately 1pu volts before and after the fault.
5. 10s at ≤ 0.85 pu retained volts at the generator transformer HV with the machine starting fully leading with approximately 1pu volts before and after the fault.

A.35 As stated previously the above conditions were tested on both the Eggborough and Seabank machines and compared with results from a single machine model which used the same generator controllers and transformer.

A.36 The results were comparable and both machines passed all tests and are presented below.

Note: The model/study used was: MayBnkHol-SD-FRT-EGGB-LW 700ms0.5pu0.5km

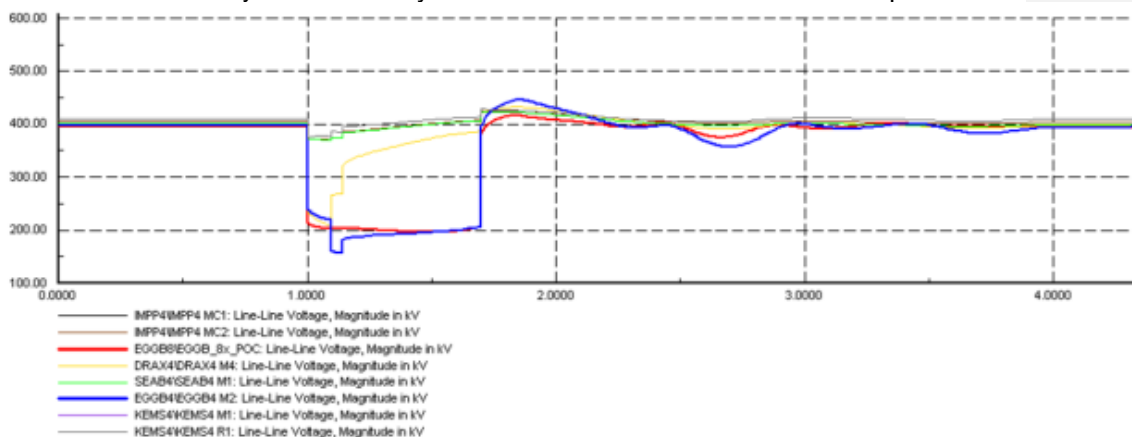

Figure 36a – Voltage trace comparison at Point Connection to Transmission System for Eggborough EGGB_8x compared with EGGB_83

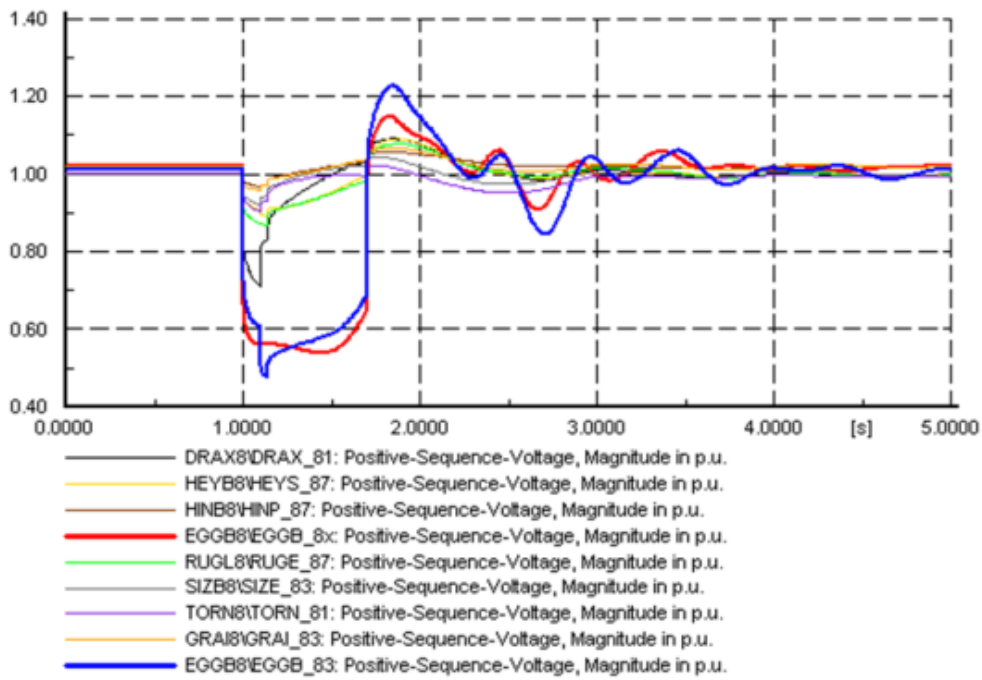

Figure A.36b – Voltage trace comparison at LV / Stator for Eggborough EGGB_8x compared with EGGB_83

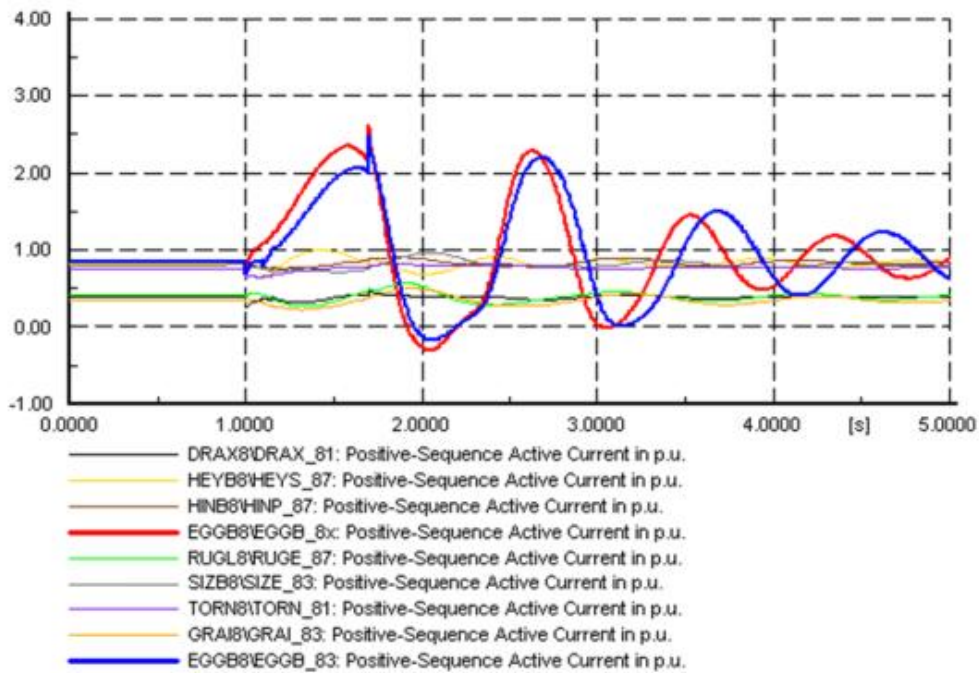

Figure A36c – Active Current (i.e. Power at 1pu volts) as seen at generator terminals comparing EGGB_8x (single machine) with EGGB_83 (full system)

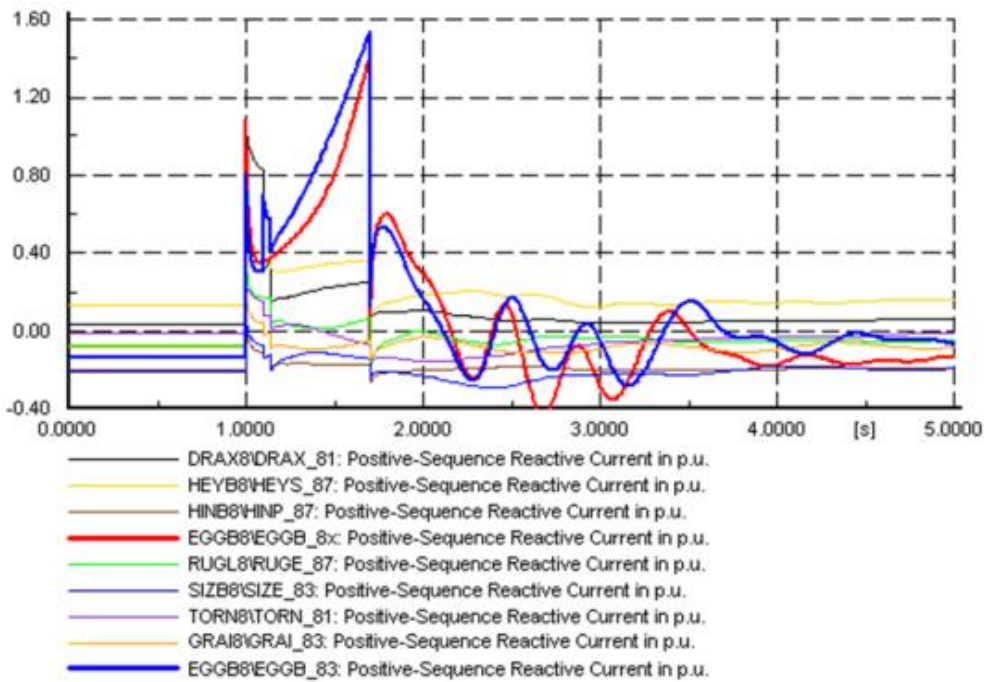

Figure A.36d – Reactive Current (i.e. Reactive Power at 1pu volts) as seen at generator terminals comparing EGGB_8x (single machine) with EGGB_83 (full system)

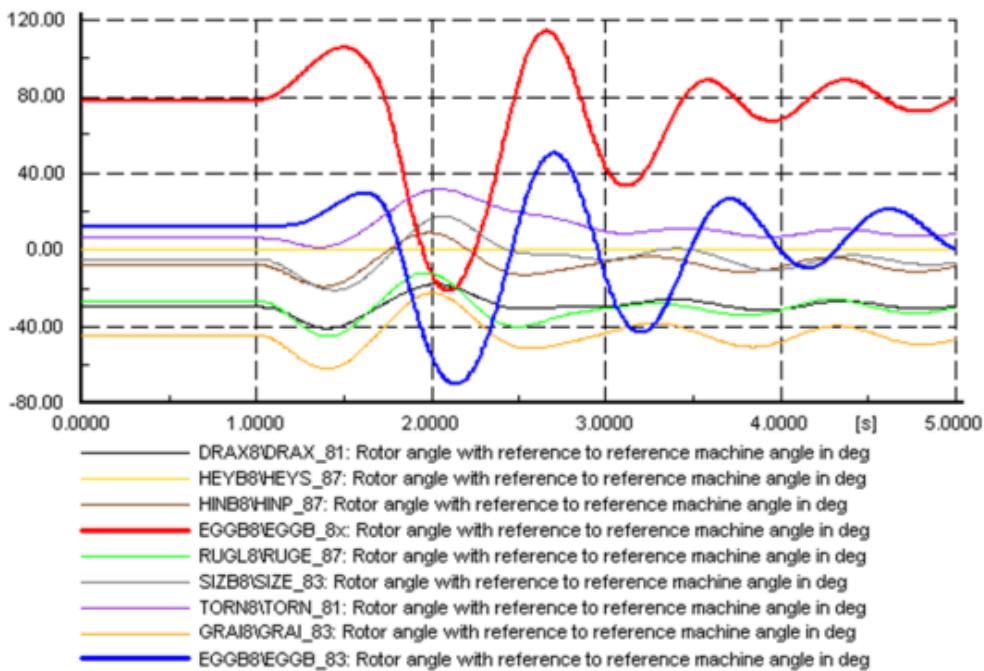

Figure A36e – Deviation in Rotor Angle as seen at generator terminals comparing EGGB_8x (single machine) with EGGB_83 (full system)

Considerations for Static Exciters

- A.37 Static Exciters and Rotary Exciters are the two main types of excitation system in general use on Synchronous Generators connected to the GB Transmission System.
- A.38 For Rotary Excitation Systems, the field of the synchronous machine is supplied by a second generator mounted on the same shaft known as the exciter. The field winding of the exciter is in turn controlled by the voltage regulator to produce constant terminal voltage at the stator of the main machine. The supply for the voltage regulator is typically supplied by a third generator also mounted on the shaft which has permanent magnets and known as a Permanent Magnet Generator (PMG) or

Pilot Exciter. It doesn't require any control system, its output voltage is typically variable and dependant on the machine speed and he load on it.

- A.39 In a static excitation system the field of the synchronous machine is directly supplied by the voltage regulator electronics through an excitation transformer which is supplied from the terminals of the Generator. This is necessary as the supply can be many hundreds or thousands of amps.
- A.40 Static exciters are much quicker at responding because they only have to overcome the inductance of the main field winding whereas the rotary excitation system encounters the delay of a second machine. However the rotary exciter has a secure supply, which is not affected by the fault. In contrast, for a static exciter, a close up fault to the synchronous machine terminals suppresses the voltage and therefore the supply to the excitation system which can affect its performance.
- A.41 For secured Mode A faults, the static exciters ability to respond quickly is typically more advantageous as the fault duration is short. However for Mode B faults where the fault duration is longer, the loss of supply may significantly affect performance.
- A.42 A series of studies were performed on the Eggborough (Rotary) and Seabank (Static) excitation systems where a single bus model was compared to the full system results but the line length in the single machine model was gradually increased. The intention was to study the effects of introducing additional line impedance.
- A.43 The additional line impedance has little effect on the rotary excitation system but a significant effect on the static exciter, which largely appeared to be due to the post fault voltage recovery which also was believed to affect the voltage regulator performance.
- A.44 The two studies below demonstrate the effect on the rotary excitation system from Eggborough where the line was extended from 0.5km to 20km and 30km respectively. Whilst the waveforms change, with the original 0.5km results (see Figures A36a-e) there is no major impact on the response. *(Note: The model/study used was: MayBnkHol-SD-FRT-EGGB-LW 700ms0.5pu20km).*

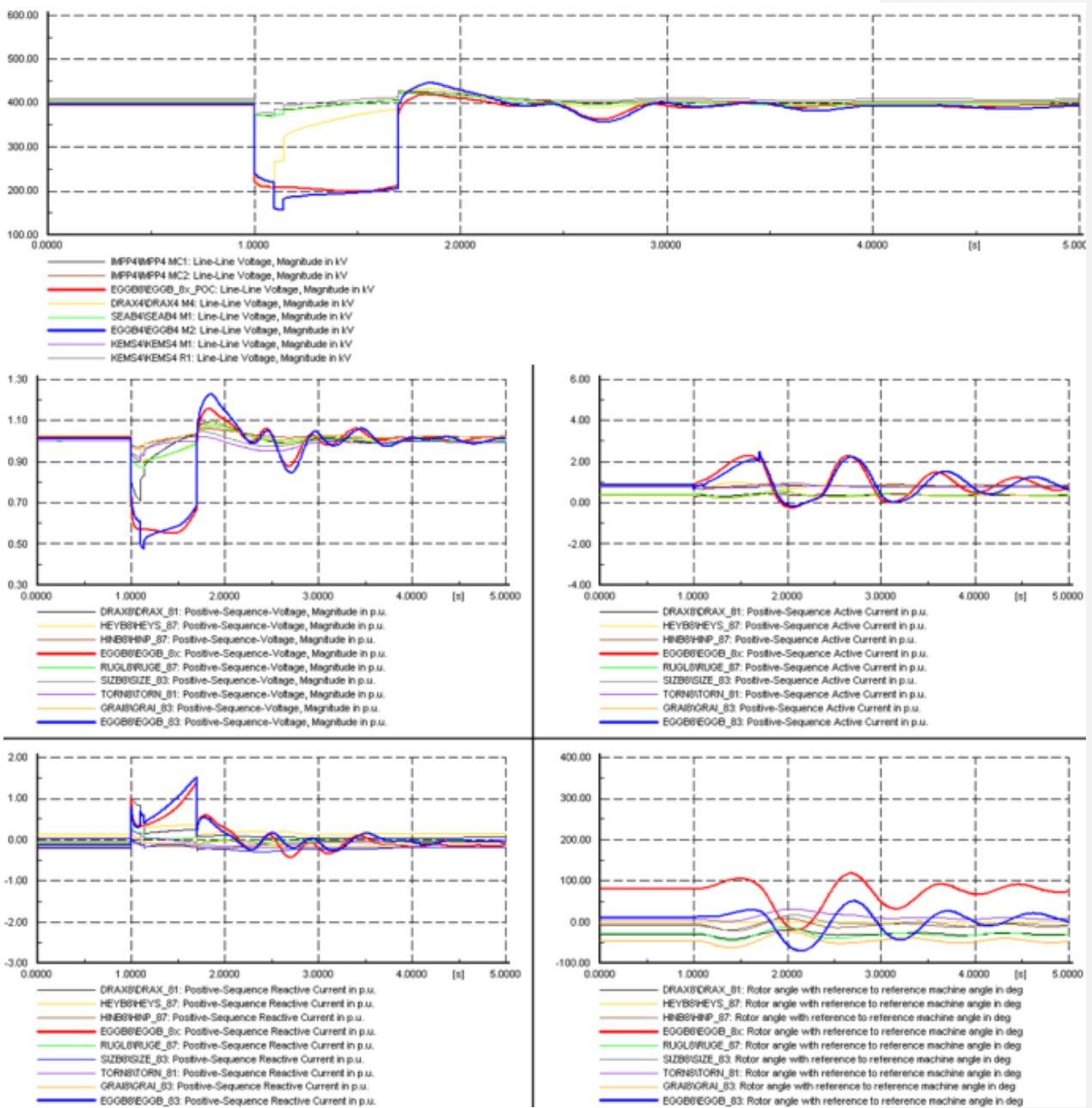

Figure A.44a Eggborough single M/C study (same as figure 0a-e but with 20km of OHL).
 Top to Bottom and Left to Right, Volts on HV of TX, Stator Volts, Active Current, Reactive Current & Rotor Angle.

Note: The model/study used was: MayBnkHol-SD-FRT-EGGB-LW 700ms0.5pu30km

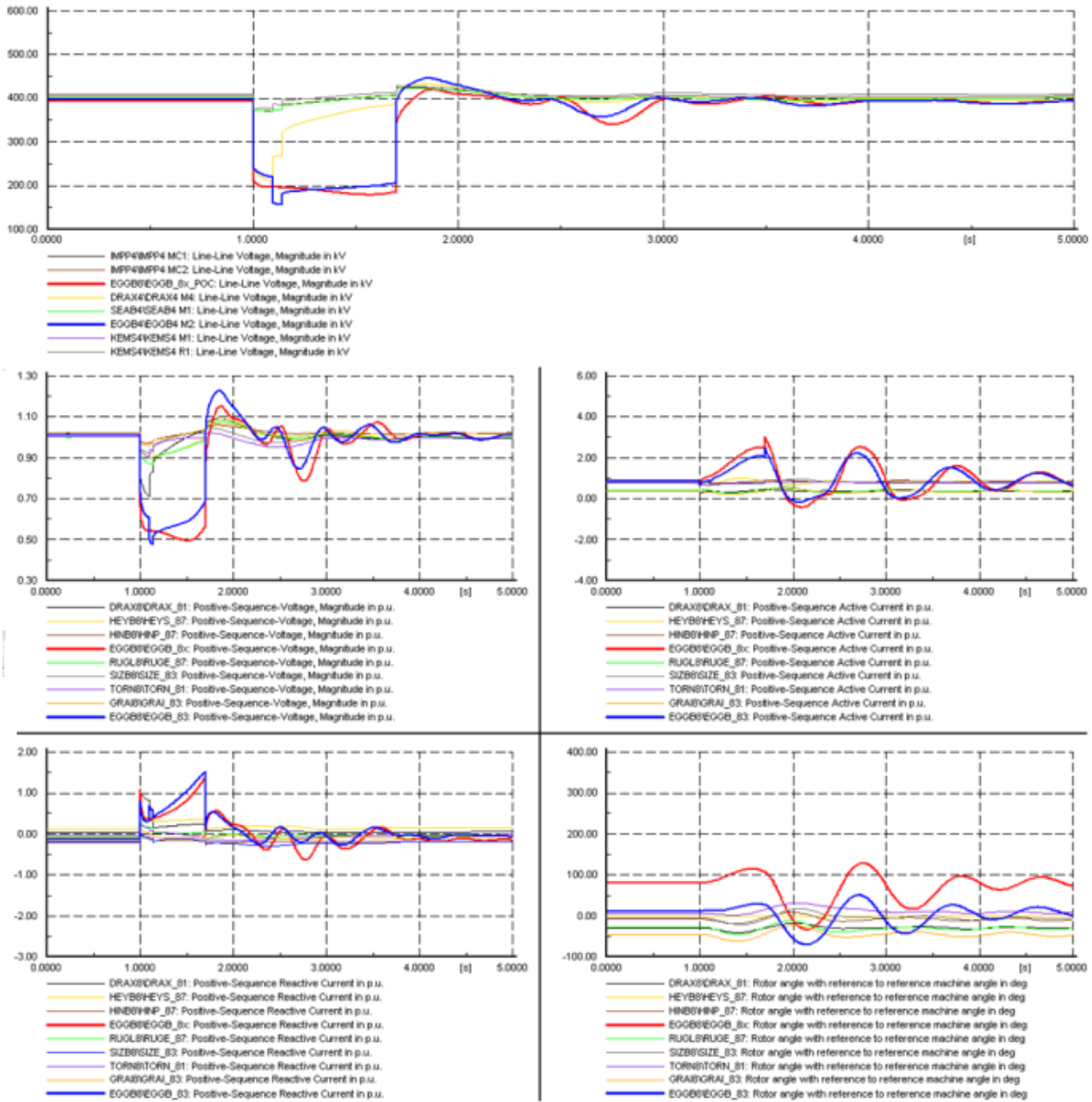

Figure A.44b Eggborough single M/C study (same as figure A.36a-e but with 30km of OHL).
 Top to Bottom and Left to Right, Volts on HV of TX, Stator Volts, Active Current, Reactive Current & Rotor Angle.

A.45 The three studies below demonstrate the effect on the static excitation system from Seabank where the line was extended from 0.5km to 20km and 30km respectively. Unlike the rotary exciter system there is a considerable effect on the static excitation system response post fault.

Note: The model/study used was: MayBnkHol-SD-FRT-SEAB-LW500ms0.4pu 0.5km

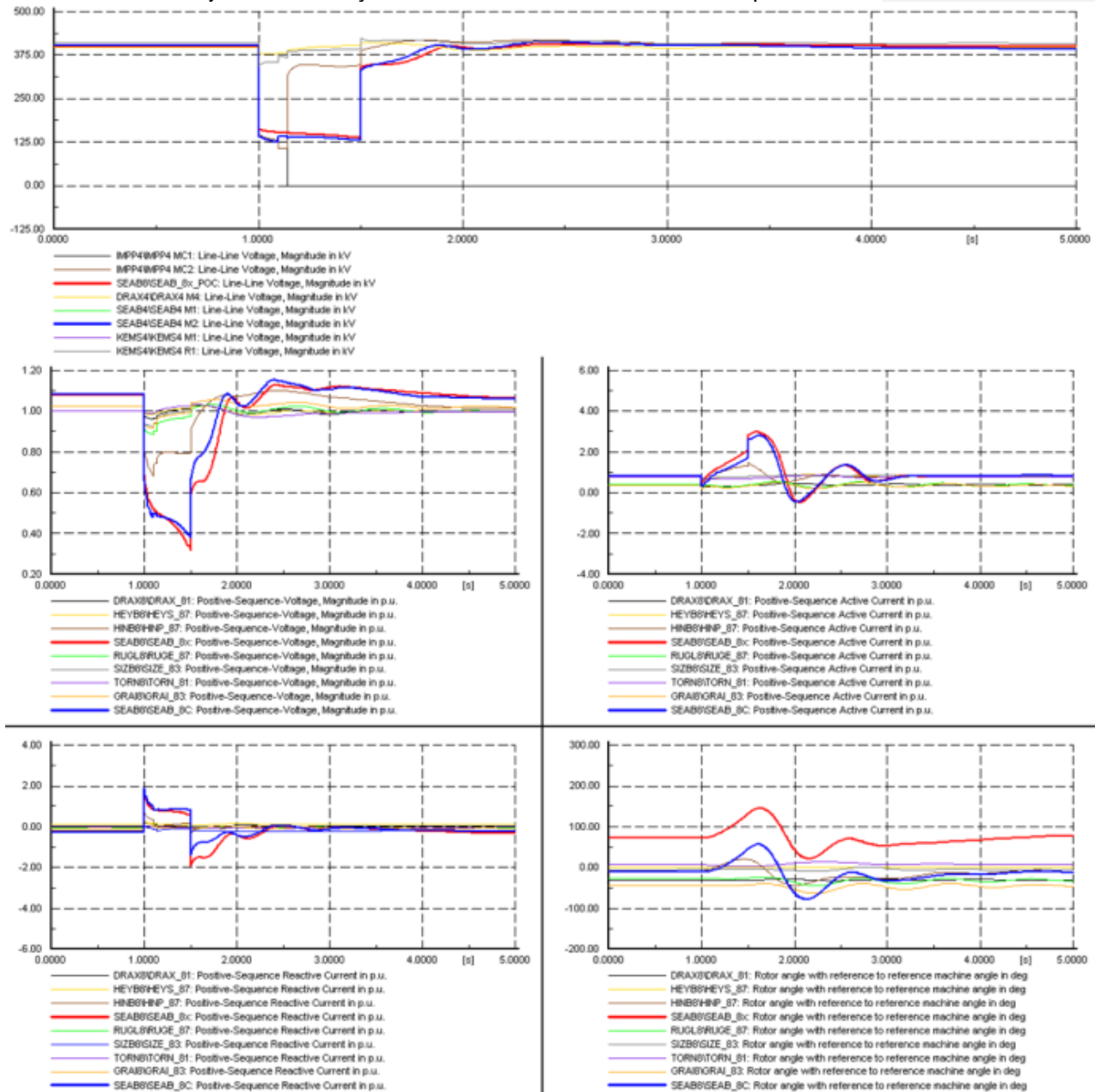

Figure A.45a Seabank single M/C study with 0.5km of OHL. Top to Bottom and Left to Right, Volts on HV of TX, Stator Volts, Active Current, Reactive Current & Rotor Angle.

Note: The model/study used was: MayBnkHol-SD-FRT-SEAB-LW500ms0.4pu20km

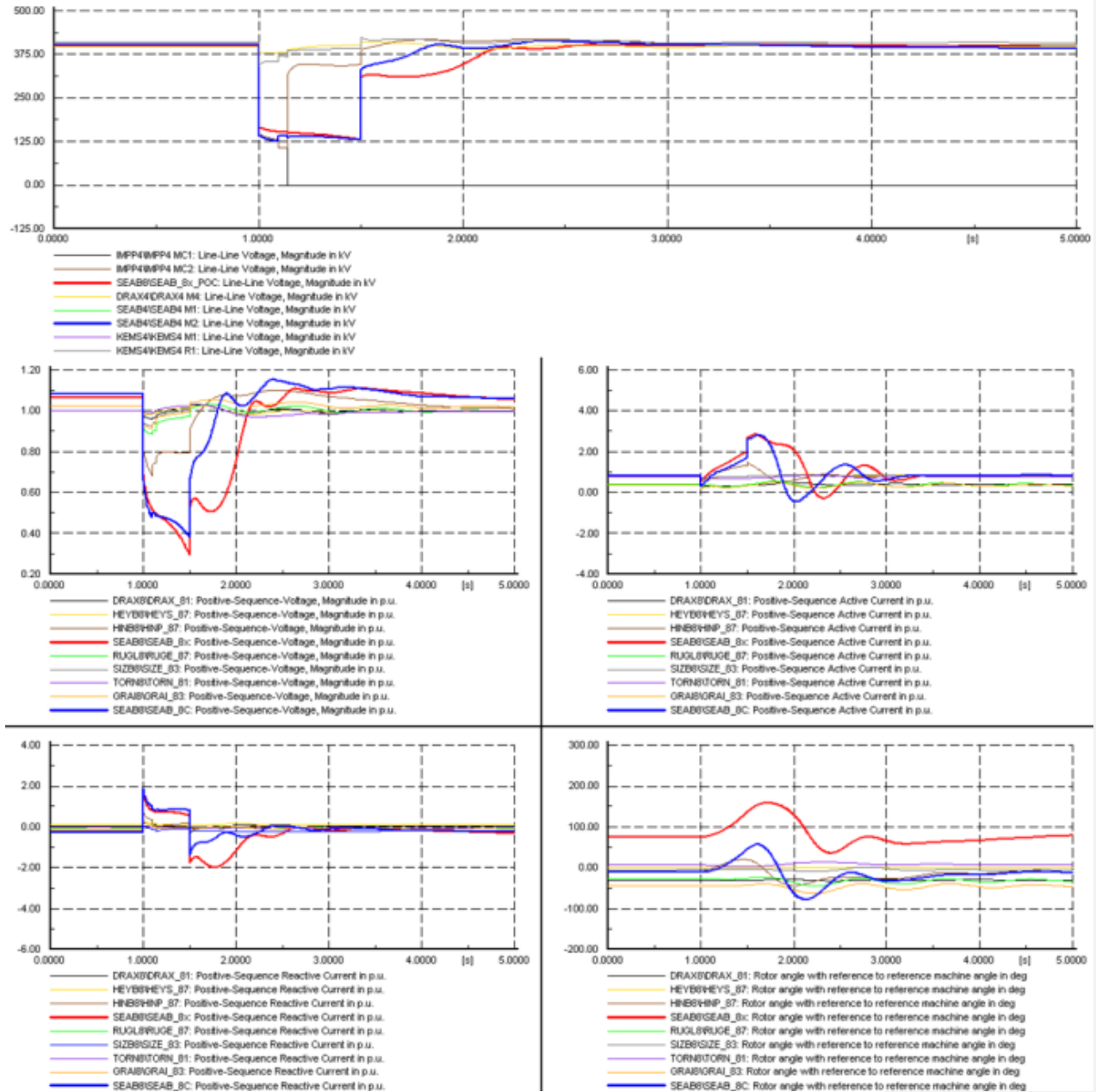

Figure A.45b Seabank single M/C study with 20km of OHL. Top to Bottom and Left to Right, Volts on HV of TX, Stator Volts, Active Current, Reactive Current & Rotor Angle.

Note: The model/study used was: MayBnkHol-SD-FRT-SEAB-LW500ms0.4pu30km

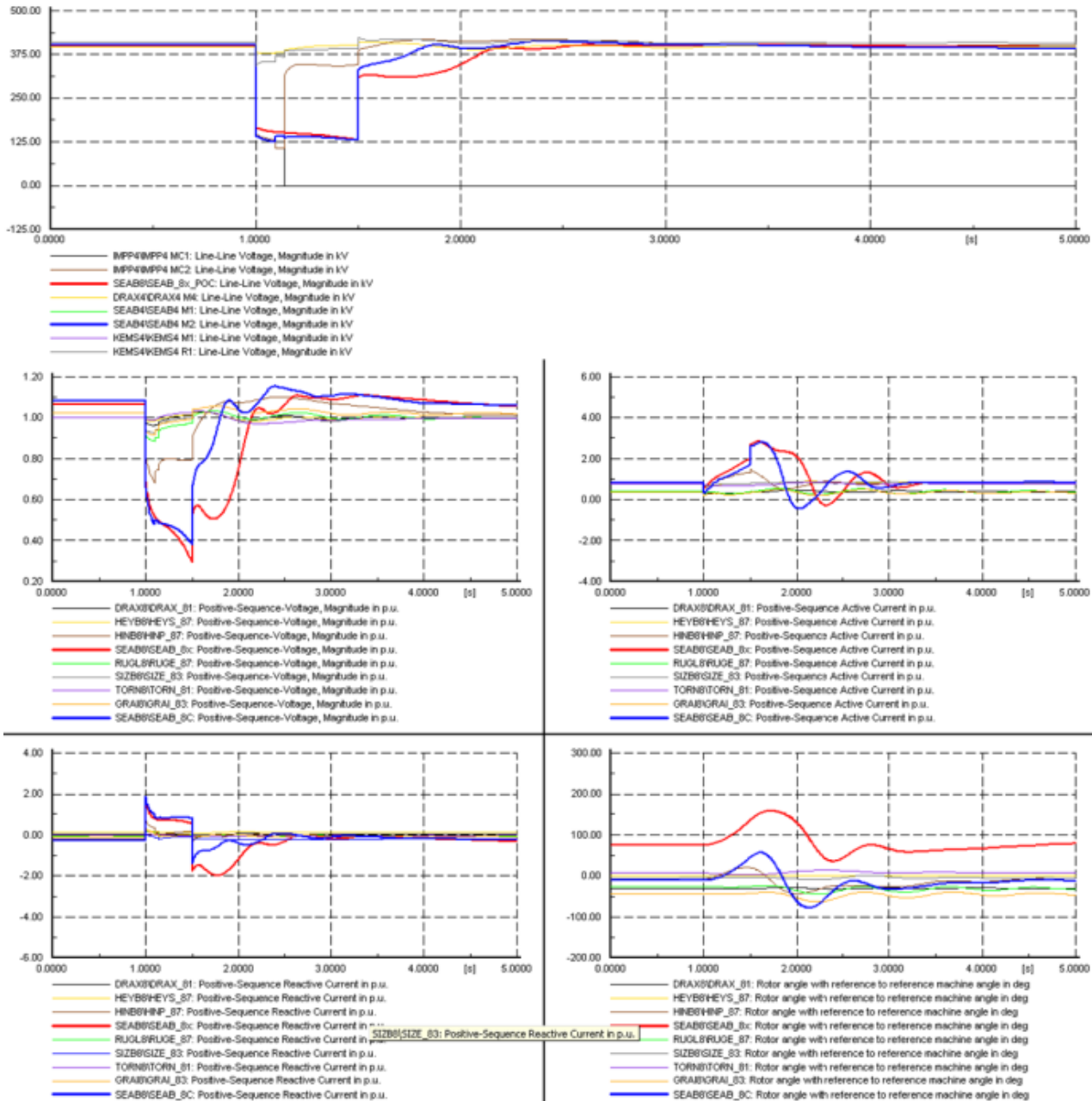

Figure A.45c Seabank single M/C study with 30km of OHL. Top to Bottom and Left to Right, Volts on HV of TX, Stator Volts, Active Current, Reactive Current & Rotor Angle.

Test cases for a range of machines including 1800MW

- A.46 In addition to the various studies presented, many additional studies were also performed including studies on the new generation of larger machines whose ratings exceed 1600MVA. These machines typically encounter lower fault levels relative to their MVA rating simply because the machine rating is so high.
- A.47 In addition, machines above 1600MVA are permitted a lower short circuit ratio of 0.4 as opposed to the 0.5 required by machines below this rating. This rule is implemented for practical reasons, as it reduces the iron required in the stator reducing cost weight and the associated transportation problems. However the lower short circuit ratio also reduces the stability limit of the machine making it more susceptible to pole slipping.
- A.48 Two different machine and excitation system designs were therefore tested using machine ratings of 2082MVA and 1466MVA. The first used a conventional rotating

exciter the other a static exciter. Both machines were tested with initial conditions of 1pu volts, a 1500MVA fault level return to 1pu volts post fault.

A.49 The machines were tested with the following voltage dips and durations:

1. 0.00pu 140ms
2. 0.39pu 250ms
3. 0.50pu 450ms
4. 0.64pu 700ms
5. 0.80pu 2500ms
6. 0.85pu until steady state

NB for the last test, the voltage reference was changed once the system had settled to simulate the over excitation limit operating.

A.50 The voltage dips were induced using two different methods. The first method applied a short circuit of appropriate impedance to bring the voltage down to the correct level. The second applied a zero (or near zero) impedance voltage source at the HV terminal of the generator transformer. Both methods were applied at all voltage dips and durations.

A.51 Both machines passed all the tests and it was found that the results were pretty much the same and that no advantage was gained by using either of the two methods to set the voltage depression. However the low impedance voltage source does ensure the voltage depression is constant throughout the test. In contrast the voltage depression changes for the short circuit method.

A.52 It should be noted that because the voltage changes when using the short circuit method it is important that the short circuit impedance is chosen such that average voltage achieved is equivalent to the level used for the voltage source.

Machine capability vs System Requirements

A.53 The following study results were produced by a Generator currently building Power Stations utilising larger Synchronous Machine (i.e. 1500MW or larger). As previously stated, Machines of this size are typically worst case in terms of Fault Ride Through requirements, mainly due to the lower short circuit ratio (typically 0.4 as opposed to 0.5) and lower system strength (i.e. system Fault Level relative to M/C MVA rating).

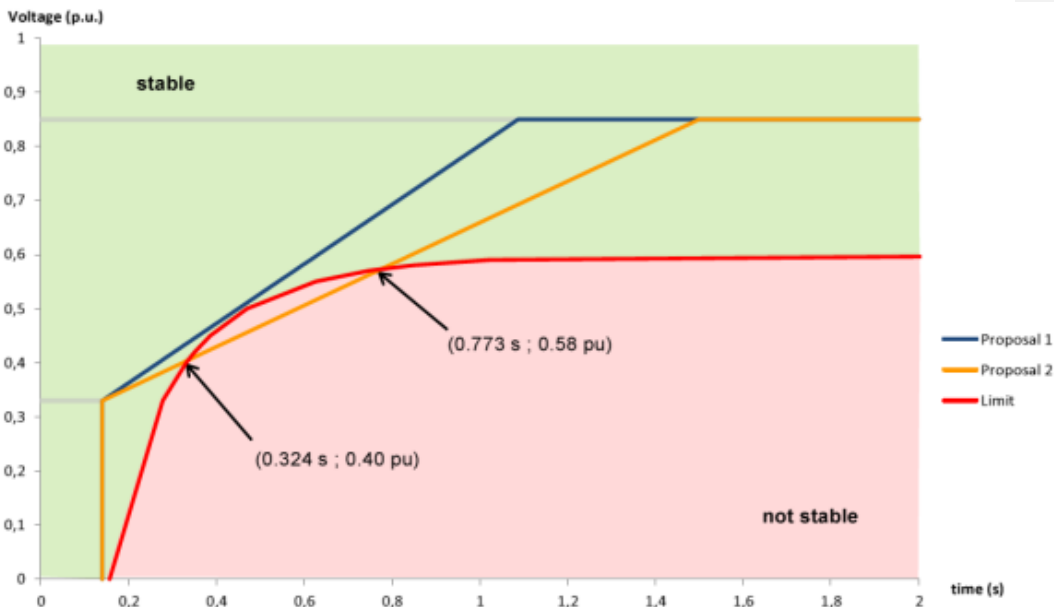

Figure A.53 – Typical Capability for M/C \geq 1500MW

A.54 The studies were conducted looking from the perspective of machine capability. They were performed using a single machine model similar to the type utilised in the National Grid studies. They show the critical clearance times of the machine model verses various requirements discussed during the work group meetings.

A.55 The graphs show the most onerous requirements occur at 0.5pu for a Mode B fault and the 0pu case which is related to the Mode A fault, as these areas are where the requirement and capability lines are most likely to initially cross.

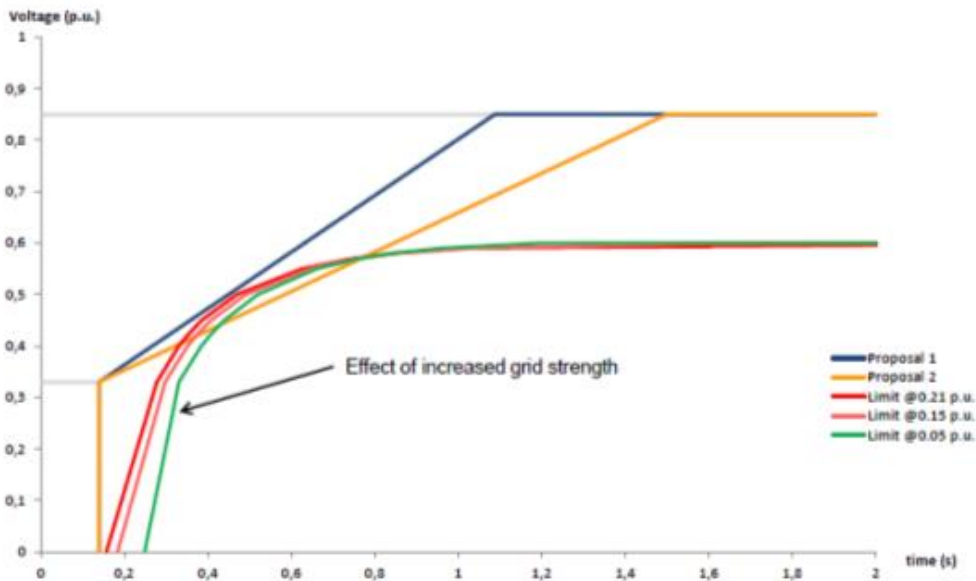

Figure A.55 – Sensitivity to Grid Strength

A.56 Figure A.55 shows how the same Synchronous Machines capability varies with Grid strength. NB the 0.21, 0.15 and 0.05pu refers to the fault infeed from the system where 1pu is 10GVA at 400kV.

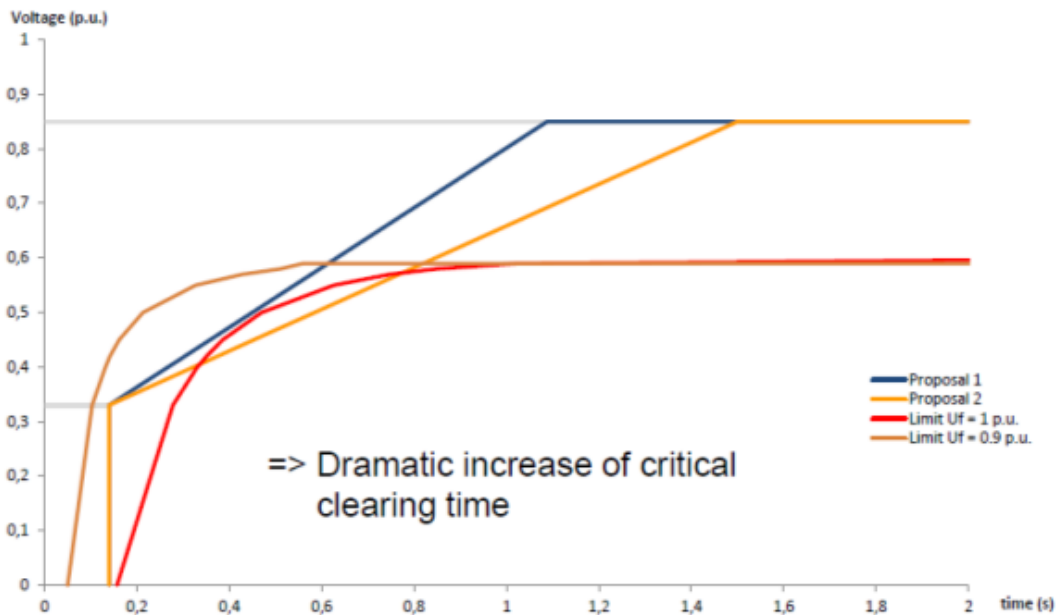

Figure A.56 – Sensitivity to Final Voltage

A.57 Figure A.56 shows how the same Synchronous Machines capability varies with final voltage. In the two examples given the generator HV terminal starts at 1pu then reduces to a voltage and for a time dictated by the proposals (the line represents a series of rectangular capability pulses) after which it either returns to 1pu or 0.9pu.

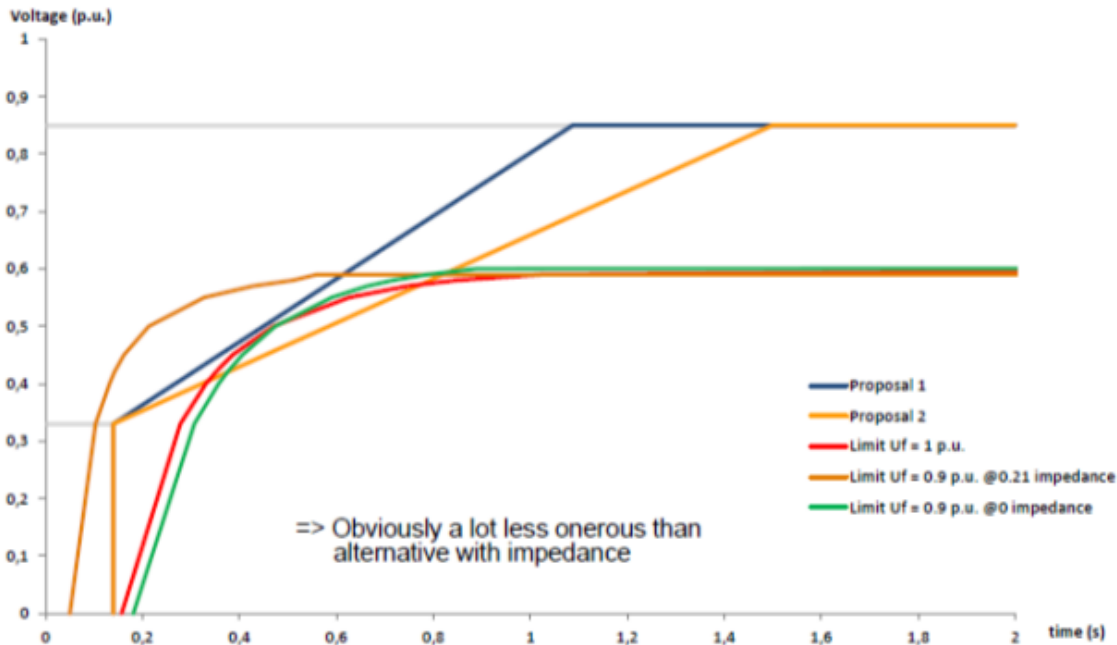

Figure A.57 – Sensitivity to Final Voltage and Grid Strength

A.58 Figure A.57 shows how the same Synchronous Machines capability varies with both final voltage and grid strength.

Leading Power Factor under High Voltage Conditions

A.59 In order to estimate the likelihood of particular machines operating with a leading power factor, the GB Transmission System model was dispatched for a summer minimum condition with 99 generators connected and running.

M/C 1-20	MW O/P	MVAr O/P	Rated MW	Rated MVAr	% MVAr Dispatch	Notes
Maximum	661.1	-191.0	685.0	251.7	93.3%	% on 0.95PF
Average	328.4	-123.8	479.5	174.3	72.6%	- " -
Median	352.6	-124.0	397.1	145.9	66.9%	- " -
Minimum	-278.1	-64.0	292.0	97.4	58.1%	Pump Storage in Pump Mode
M/C 21-40	MW O/P	MVAr O/P	Rated MW	Rated MVAr	% MVAr Dispatch	Notes
Maximum	660.0	-112.0	672.0	246.8	53.0%	% on 0.95PF
Average	303.5	-57.7	474.9	173.7	32.6%	- " -
Median	270.8	-47.4	500.0	183.6	34.7%	- " -
Minimum	120.4	-15.1	138.1	50.7	14.9%	- " -
M/C 41-60	MW O/P	MVAr O/P	Rated MW	Rated MVAr	% MVAr Dispatch	Notes
Maximum	612.9	-30.3	685.0	251.7	14.9%	% on 0.95PF
Average	125.2	-5.0	163.1	59.6	3.5%	- " -
Median	16.0	0.0	20.4	6.9	0.0%	- " -
Minimum	-72.8	0.0	3.3	1.2	0.0%	- " -
M/C 61-80	MW O/P	MVAr O/P	Rated MW	Rated MVAr	% MVAr Dispatch	Notes
Maximum	58.3	0.0	58.1	21.4	0.0%	% on 0.95PF
Average	14.3	0.0	18.4	6.5	0.0%	- " -
Median	11.5	0.0	15.3	5.3	0.0%	- " -
Minimum	1.9	0.0	6.7	2.3	0.0%	- " -
M/C 81-99	MW O/P	MVAr O/P	Rated MW	Rated MVAr	% MVAr Dispatch	Notes
Maximum	656.0	0.0	672.0	416.4	0.0%	% on 0.85PF
Average	146.6	14.9	215.8	133.2	-5.1%	- " -

Median	20.1	0.0	20.7	12.1	0.0%	- " -
Minimum	8.0	105.7	7.5	4.6	-25.4%	- " -

A.60 The dispatched MVAR operating point of the machines was then listed with the most leading listed first. The table below summarises the results breaking them down into five groups of approximately 20 Machines (M/C's).

A.61 From the results, for the top 20 machines the dispatch range was 58.1% to 93.3% with an average of 72.6%. These machines varied in size from 292MW to 685MW. *(NOTE: Whilst many figures are quoted for each group of 20 machines the numbers in each row are not necessarily related to the same machine. Positive values of the %MVAR dispatch, this is calculated against a rated value of 0.95PF leading, whereas the negative values represent lagging power factors and are calculated against a rated value of 0.85PF).*

A.62 The table indicates that there is a significant possibility of machines being dispatched for leading Power Factor operation and that it is therefore reasonable to test the worst case where the machine is operating in the lead.

Fault level vs Machine Size

A.63 Studies were performed at various generation sites to establish the ratio of machine MVA to the Fault Level at the respective site. The model was configured for a typical summer minimum dispatch.

A.64 From these results we can see the fault infeed varies from 1105MVA to 29272MVA with an average of 13484MVA. The machine size is proportional to the MVA fault level which varies from 0.35% to 8.42% with an average of 3.52%.

A.65 The worst case fault level is therefore 1/0.0842 or 11.88 times greater than the MVA rating of the machine.

A.66 The table below shows typical values for about a third of the machines dispatched.

A.67 Whilst these results typically demonstrate a ratio of >10 for Machine Rating to fault infeed measured in MVA, we must bear in mind:

- A. There are conceivable scenarios which may result in lower ratios.
- B. More than one machine may connect at a specific site and under these conditions the MVA of the machines may need to be aggregated effectively lowering the ratio and stability margin.

M/C Name	Power Station	MW (0.85MVA)	M/C MVA	Fault Infeed MVA	Relative Size MC%	Relative Size
CORY_81	Cory	79.05	93.00	1105.11	8.42%	11.9
HUER_81	Hunterston B	659.60	776.00	9394.56	8.26%	12.1
ABTH_89	Aberthaw B	499.80	588.00	7686.24	7.65%	13.1
ABTH_89	Aberthaw B	499.80	588.00	8034.61	7.32%	13.7
FIDF_83	Fiddlers Ferry	499.80	588.00	8430.68	6.97%	14.3
TORN_81	Torness B	685.10	806.00	12020.52	6.71%	14.9
HATL_81	Hartlepool	659.60	776.00	13288.06	5.84%	17.1
HINP_87	Hinkley Point B	659.60	776.00	14167.41	5.48%	18.3
SAES_8A	Saltend South	401.20	472.00	8630.65	5.47%	18.3
SIZE_84	Sizewell B	660.45	777.00	15032.22	5.17%	19.3
ESSO_81	ESSO Fawley	138.13	162.50	3179.77	5.11%	19.6
HEYS_87	Heysham 2	671.93	790.50	17980.14	4.40%	22.7
SEAB_8C	Seabank	393.13	462.50	12287.00	3.76%	26.6
DRAX_86	Drax	659.60	776.00	23323.06	3.33%	30.1
GRAI_83	Grain	660.03	776.50	24470.05	3.17%	31.5
RUGE_86	Rugeley B	499.80	588.00	18907.26	3.11%	32.2
COTT_83	Cottam	499.80	588.00	19352.77	3.04%	32.9
EGGB_82	Eggborough	499.80	588.00	21379.27	2.75%	36.4
RATS_81	Ratcliffe-On-Soar	499.80	588.00	21861.68	2.69%	37.2
DRAX_82	Drax	659.60	776.00	29272.70	2.65%	37.7
BPGR_81	BP Grangemouth	144.50	170.00	6517.63	2.61%	38.3
DINO_82	Dinorwig	280.50	330.00	13931.29	2.37%	42.2
EGGB_83	Eggborough	499.80	588.00	25472.40	2.31%	43.3
WBUR_81	West Burton	499.80	588.00	25648.76	2.29%	43.6
RATS_81	Ratcliffe-On-Soar	499.80	588.00	27564.99	2.13%	46.9
CONQ_8A	Connahs Quay	363.04	427.10	22813.72	1.87%	53.4
WYLF_81	Wylfa	316.20	372.00	20255.38	1.84%	54.4
CLUN_81	Clunie 11kV	19.55	23.00	1569.08	1.47%	68.2
CEAN_81	Ceannocroc 11kV	16.15	19.00	1334.68	1.42%	70.2
DAMC_8A	Damhead Creek	274.55	323.00	25712.65	1.26%	79.6
DEAN_82	Deanie 11kV	17.85	21.00	2942.31	0.71%	140.1
PITL_81	Pitlochry Hydro	7.50	8.82	1624.52	0.54%	184.2
KIOR_81	Kilmorack 11kV	9.35	11.00	2688.28	0.41%	244.4
KIOR_81	Kilmorack 11kV	9.35	11.00	2971.38	0.37%	270.1
CASS-1	Cassley Hydro PS	3.34	3.93	1120.16	0.35%	285.4
Max		685.10	806.00	29272.70	8.42%	285.4
Min		3.34	3.93	1105.11	0.35%	11.9
Average		384.20	452.00	13484.88	3.52%	60.7
Median		499.80	588.00	13288.06	2.75%	36.4

Figure A.68 – Reactive Dispatch of Machines for Low Load

A.68 Any studies performed by Generators in order to prove compliance with the Grid Code, Fault Ride Through, Mode B requirements are likely to be performed on a single machine infinite bus model or equivalent. Based on the evidence of the table presented and for the reasons described above, it was decided a machine to system fault in feed ratio of 10:1 (fault level to machine size) or slightly greater was sensible.

Appendix 2 - Recommendations on Mode A Fault Ride Through

A2.1 The fault ride through Mode A requirements are designed to cater for faults cleared in main protection operating times. This is illustrated below in Figure 0 below.

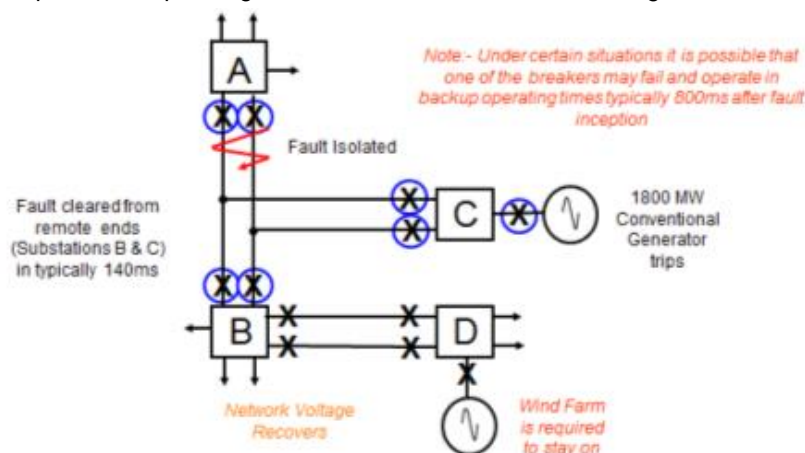

Figure A2.1

A2.2 At 400kV, a fault applied at circuits adjacent to substation A would typically be cleared within 80ms. The remote end circuit breakers (at substations B and C) would also trip within 80ms for a unit protection scheme. For main protection schemes where intertripping is used to trip the remote end circuit breakers, they would typically trip within 60ms of the fault being cleared at the local end (total fault clearance time of 140ms). For a three ended circuit, the total fault clearance time (for fault ride through purposes) is specified as 140ms.

A2.3 The current GB Mode A fault ride through requirements for Onshore Synchronous Generating Units are detailed in CC.6.3.15.1(a). It is important to note that these requirements only apply to faults on the Transmission System operating at Supergrid Voltage (ie 200kV or above).

A2.4 In general, the majority of synchronous plant does not experience a problem with the current GB Fault Ride Through requirements. However with the impending introduction of the RfG requirements the current requirements will need to change. Details of these amendments are covered in the latter part of this Appendix.

Background to the RfG Fault Ride Through Requirements

A2.5 On 26 June 2015, the Network Code Requirements for Generators (RfG) Reference [2] was approved by the European Commission. It will now take some 6 months for the approved document to be enshrined into European law so an Entry Into Force date is now expected in the first quarter of 2016. This means that Generators who have not placed contracts for major plant items by 2 years after Entry Into Force (ie the first quarter of 2018) will need to comply with the European requirements. The GB Grid Code will also need to be updated by this date but it is envisaged that it will be well before this date to ensure developers have appropriate time to ensure their plant is capable of meeting the new requirements.

A2.6 The RfG Fault Ride Through requirements for Synchronous Generators are detailed in Article 14(3), Article 16(3) and Article 17(3). Unlike the GB Grid Code, the RfG requirements segregate the requirements between Synchronous Plant and Asynchronous Plant. They are also graded dependent upon size of Generator. Under RfG, rather than classifying Generators on Power Station Size (Large, Medium and Small) as per GB practice, RfG classifies Generators on the basis of Band A – Band D.

A2.7 RfG Banding is assessed against the Power Generating Module size rather than the Power Station size. The European Commission has assigned the maximum thresholds for each Band based on Synchronous Areas of which GB is one. These maximum Bands are covered in Article 5 of RfG (Reference [2]) and replicated below

in Table A2.7 below. Whilst these define the maximum generation thresholds in each band, member states will need to determine the exact level of each band through the normal Governance and consultation process. This work is currently progressing through the GC0048 Grid Code Working Group and a full consultation on this issue is due to be published later in the year. Full details of this workgroup are available from the following link:- <http://www2.nationalgrid.com/UK/Industry-information/Electricity-codes/Grid-code/Modifications/GC0048/>

Synchronous areas	Limit for maximum capacity threshold from which a power generating module is of type B	Limit for maximum capacity threshold from which a power generating module is of type C	Limit for maximum capacity threshold from which a power generating module is of type D
Continental Europe	1 MW	50 MW	75 MW
Great Britain	1 MW	50 MW	75 MW
Nordic	1.5 MW	10 MW	30 MW
Ireland and Northern Ireland	0.1 MW	5 MW	10 MW
Baltic	0.5 MW	10 MW	15 MW

Table A2.7 – RfG Banding Thresholds

A2.8 A further complication of the RfG structure is that the requirements are graded. In other words the requirements that apply to Band D (ie 75MW or above and / or connected above 110kV) also include the requirements applicable to Bands A – C. Taking another example, the requirements applicable to Type B Power Generating Modules also include the requirements applicable to Type A Power Generating Modules

RfG Fault Ride Through Requirements

A2.9 This section of the report details National Grid’s understanding and interpretation of the RfG Fault Ride Through requirements based on Articles 14(3), 16(3) and 17(3). Whilst the fundamental need for Fault Ride Through is similar to that in GB, the way in which it is defined in Europe is very different to those requirements defined in CC.6.3.15.1(a).

A2.10 The fundamental RfG fault ride through principles are defined for Type B Power Generating Modules (Article 14 (3)). The requirements applicable to Type D Power Generating Modules are in summary an extension of the Type B requirements but with different parameters.

A2.11 Under RfG, the fault ride through requirement is assessed by a voltage against time profile (RfG Article 14(3)(a) – Figure 3) which applies at the Connection Point. For Type D Power Generating Modules the Connection Point would be at or above the 110kV level. The voltage against time profile describes the conditions in which the power generating module is capable of staying connected to the network and continuing to operate stably after the power system has been disturbed by secured faults on the Transmission System. A copy of RfG Article 14(3)(a)(i) – Figure 3 is reproduced below as Figure A2.11 below.

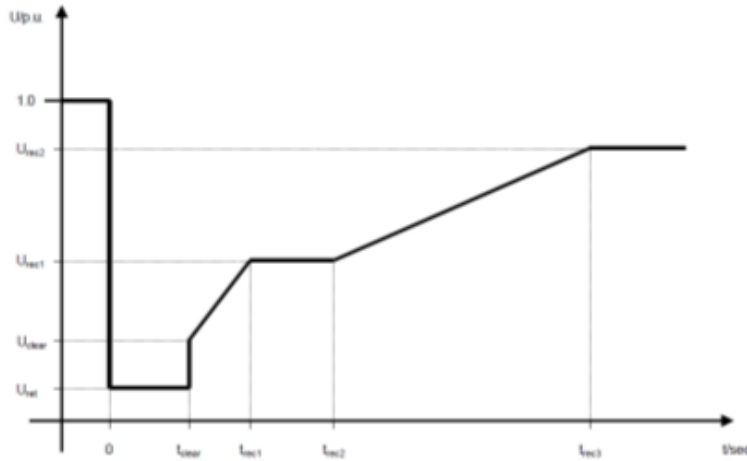

Figure A2.11 – Voltage Against Time Curve – Reproduction of RfG Fig 3

A2.12 The Voltage against time curve is designed to express the lower limit of the actual phase to phase voltage at the Connection Point during a symmetrical fault, as a function of time before, during and after the fault.

A2.13 For a Type D Synchronous Power Generating Module, the range of voltage limits available for the TSO to select in accordance with Article 14(3)(a) – Figure 3 (ie Figure A3.11 above) is defined in Table 7.1 of Article 16(3) which is reproduced below as Table A2.13.

Voltage parameters [pu]		Time parameters [seconds]	
U_{ret} :	0	t_{clear} :	0.14 – 0.15 (or 0.14 - 0.25 if system protection and secure operation so require)
U_{clear} :	0.25	t_{rec1} :	$t_{clear} + 0.45$
U_{rec1} :	0.5 – 0.7	t_{rec2} :	$t_{rec1} + 0.7$
U_{rec2} :	0.85 – 0.9	t_{rec3} :	$t_{rec2} + 1.5$

Table A2.13 – Extract of Table 7.1 from RfG

A2.14 In accordance with the RfG requirements, each TSO is required to make publicly available the pre and post fault conditions for fault ride through in terms of:-

- The pre-fault minimum short circuit capacity at the Connection Point
- The pre- fault operating point of the power generating module at the connection point and voltage (ie Maximum MW output, Full MVA lead and typical operating voltage).
- The post fault minimum short circuit capacity at the connection point.

A2.15 At the request of the Generator, the relevant Transmission System Operator shall provide the pre fault and post fault conditions for fault ride through as a result of the calculations at the connection point as referenced in section A2.14 above.

- The pre-fault minimum short circuit capacity at each Connection Point expressed in MVA

- The pre- fault operating point of the power generating module expressed in active power output and reactive power output at the connection point and voltage at the Connection Point and
- The post fault minimum short circuit capacity at each connection point expressed in MVA.

A2.16 The requirements covered in RfG Article 16(3)(a) and Article 16(3)(b) (in addition to Articles 14(3)(a)(iv) and Articles 14(3)(a)(v)) would require further assessment however it is envisaged that general maximum and minimum short circuit data would be included in the Electricity Ten Year Statement (ETYS) and the exact calculated figures would be included within the Bilateral Connection Agreement.

A2.17 The protection settings of the Power Generating Facility should not jeopardise fault ride through performance which includes the under voltage protection at the Connection Point.

A2.18 Under RfG Article 16(3)(c) the fault ride through capabilities for unbalanced faults shall be specified by the TSO.

A2.19 Under RfG, Article 17(3), the TSO shall specify the active power recovery requirements from Type B Synchronous Power Generating Modules.

Interpretation and Implementation of RfG Fault Ride Through Requirements at a GB Level as applicable to any Synchronous Generating Unit directly connected to the Transmission System operating at Supergrid Voltage (Mode A)

A2.20 This section details how the RfG Fault Ride Through requirements can be applied in GB. It should be noted that for the purposes of this work, these requirements will only apply to Synchronous Generators directly connected to the Transmission System operating at or above Supergrid voltage (ie 200kV).

A2.21 As a general principle, the GB requirements will remain as they are unless there is good reason not to do so, for example a conflict with the RfG requirements or a genuine need to change the code as a result of a deficiency within the existing GB requirements.

A2.22 As noted, the current RfG requirements apply only to secured faults. As such, they conflict with the existing GB requirements and therefore it is necessary to change the Mode A requirements. On this basis the requirements for unbalanced faults and active power recovery would remain unchanged. So far as the Mode B requirements are concerned, these can remain as they are but with the necessary amendments to address the deficiency raised in PP12/04.

A2.23 To ensure the correct interpretation of the RfG Requirements, ENTSO-E have also produced a “Frequency asked Questions Document” Reference [3] which outlines the principles which TSO’s should consider when implementing the RfG. The examples which relate to Fault Ride Through are covered in Question 24.

A2.24 The RfG Fault Ride Through requirements centre on the voltage against time curve. Based on Reference [3], the criteria would imply that the TSO should specify the pre and post fault short circuit level at the Connection Point and the pre fault operating conditions of the Generator (eg full MW output and maximum lead). A three phase solid short circuit fault should then be applied at the Connection Point and the Generator should remain connected and stable with the voltage profile remaining above the defined voltage against time curve set by the TSO.

A2.25 A complexity with this approach is that the post fault voltage profile is dictated largely by the strength of the network and its topology rather than the Generation at the Connection Point. The Generator will have an impact on the voltage profile at the connection point but it is important to note that this is a more second order effect with pre and post fault system strength playing a more dominant role.

A2.26 The issue of how compliance is assessed was discussed in detail amongst the workgroup. There was also discussion as to whether clearer obligations needs to

be specified in terms of a design requirement and an operational requirement. There was some confusion as to whether the Generator should control the post fault voltage so as to ensure it would never trip. The post fault voltage profile is largely a function of the pre and post fault short circuit level and whilst influenced by the Generator this will only result in a second order effect. This issue will be addressed later in this Appendix.

Determination of RfG Mode A Parameters as applicable to Synchronous Generating Units directly connected to the Transmission System operating at Supergrid Voltage (Mode A)

- A2.27 A fundamental requirement of the fault ride through requirements is that on one hand they should ensure the requirements are sufficiently robust to meet the minimum needs of the Transmission System and on the other be realistic and achievable without placing excessive burden on the Generator.
- A2.28 The RfG requirements are quite specific although there is a requirement for the voltage against time curve (Figure A2.11 above) and parameters (Table A2.13) are to be derived at a National level.
- A2.29 Taking the extreme ends of these parameter ranges (Table A2.13 above), it is possible to plot a graph showing the parameter ranges available to TSO's at a National level. This is shown in Figure A2.29 below.

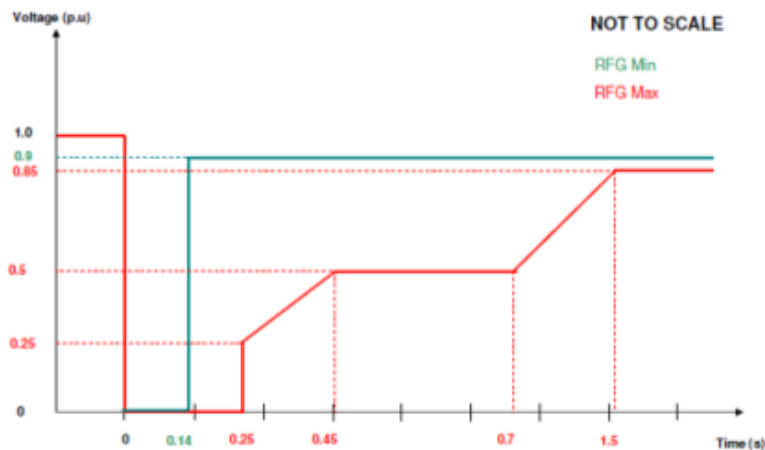

Figure A2.29 – Range of RfG Voltage Against Time Parameters

- A2.30 The green curve (RfG Min) refers to the minimum voltage against time curve. Under this case, the post fault voltage profile would require a reasonably stiff system. The implication being that Generator tripping would be permitted under the least onerous of conditions. On the other hand, the red curve is the most onerous requiring the generating unit to remain connected and stable for quite severe post fault voltage recovery.
- A2.31 At first glance and reading RfG it would appear that the TSO should be able to select a voltage against time profile anywhere between the Green and Red line. In practice this is not strictly true as the range of parameters in Table 7.1 of RfG (Table A2.13 of this Appendix) do limit the ability of the TSO to select certain values between these ranges. These restrictions are shown in Figure A2.31 below. This limitation was also reflected back to ENTSO-E but it is not believed it will cause an issue.

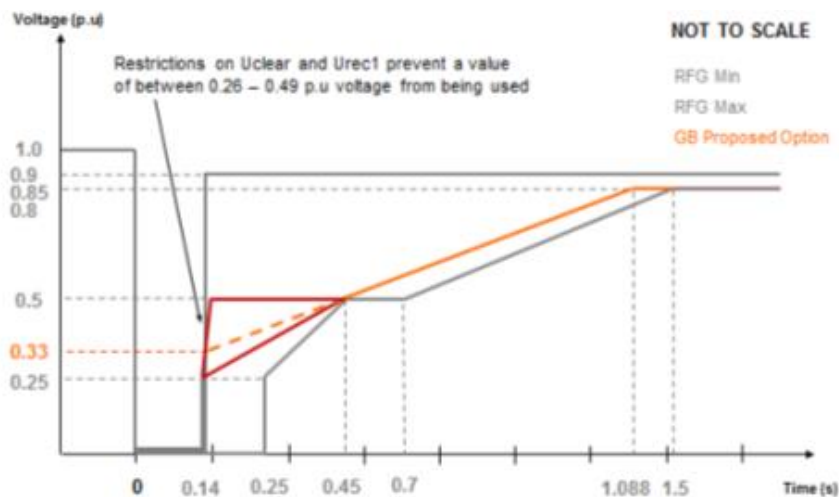
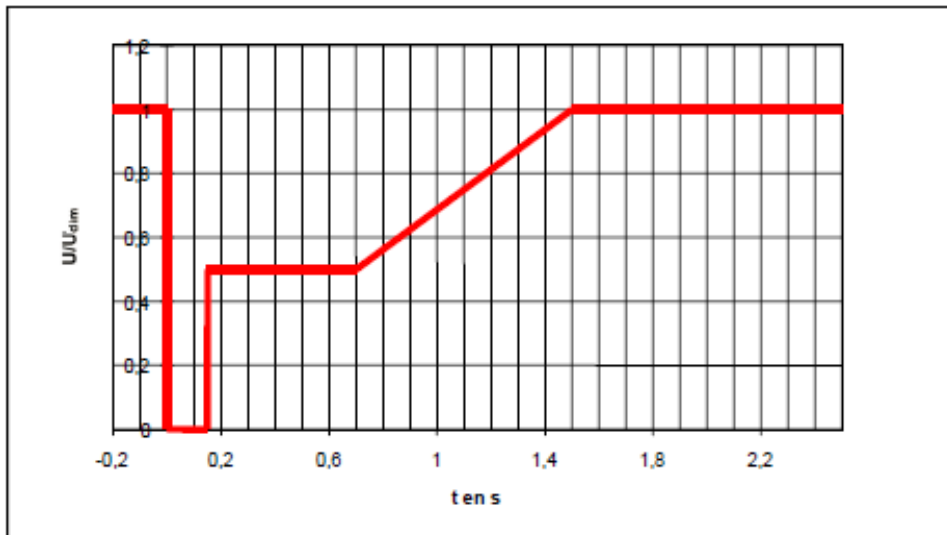

Figure A2.31 – Limitations on voltage against time curves

- A2.32 The workgroup debated the interpretation and implications of the voltage against time curve in some considerable detail. In summary, when a Synchronous Generator is subject to a close up short circuit fault cleared in main protection operating times it should remain connected and stable.
- A2.33 The workgroup queried as to whether the Generator has to ensure the post fault voltage profile is maintained above the defined voltage against time curve. The general understanding is that the post fault voltage profile will be dictated largely by the System rather than the performance of the synchronous generator. For the purposes of compliance, a 140ms three phase short circuit fault would be applied at the Connection Point of the Generator. Provided the Generator remains connected and stable and the post fault voltage profile remains above the defined voltage against time curve the Generator would be deemed compliant. In the event that the Generator were to pole slip, then the post fault voltage as seen from the Generator would result in oscillations beyond the defined voltage against time curve under which generator tripping would be permitted. Details of the assessment of Compliance for Mode A faults is covered in this Appendix below.
- A2.34 In covering the rudiments of the RfG requirements, this now brings us to the issues that need to be taken into account in deriving the voltage against time curve for a directly connected synchronous generator. Under CC.6.3.15.1(a) of the Grid Code, a directly connected generator would be required to remain connected and stable for a solid three phase short circuit fault for up to 140ms in duration. In other words, the Generator should remain connected and stable when the voltage at the connection point is set at zero volts for 140ms. Translating this into the RfG voltage against time curve therefore sets the value of U_{ret} to zero and t_{clear} to 0.14 seconds.
- A2.35 The subsequent points are more complex to determine as they are potentially more ambiguous in nature. In general, the post fault voltage profile is more a function of the pre and post fault short circuit level at the connection point rather than the characteristics of the Synchronous Generator itself. However, it is important that an achievable characteristic is set, which on hand is not so onerous that it could result in the generator to pole slip whilst on the other that is so lenient that the generator would be permitted to trip for the most minor of faults.
- A2.36 In practice, an assessment of stability will be made at the Transmission Connection application stage. The Transmission System Owner will design the Transmission Network in accordance with the requirements of the Security and Quality of Supply Standards (SQSS). During the application stage, stability studies will be run which will detail the specification of the excitation system (eg onload ceiling voltage and rise time). This specification being an important criteria upon which the stability requirements are assessed.
- A2.37 So far as the voltage against time curve is concerned, the curve needs to cater for credible system events but not those which would either be unduly pessimistic or beyond the requirements of the SQSS as these are covered under Mode B faults. It is also vitally important that the Generator does not set its under-voltage protection

settings to the same value as the voltage against time curve as this would result in premature tripping. As such, the voltage against time curve needs to consider credible voltage sags and dwells caused by high MVA_r demands.

- A2.38 Returning back to the derivation of the voltage against time curve, the value of U_{clear} is fixed at 0.25. As this marks the start of the voltage recovery (ie immediately on fault clearance) this point would also take place at 140ms, and therefore is set by t_{clear} .
- A2.39 The next stage is to consider the remaining parameters of the voltage against time curve, U_{rec1} , U_{rec2} , t_{rec1} , t_{rec2} and t_{rec3} . These are more complex due to the potential arbitrary nature of the points that can be selected for the voltage against time curve. Taking into account the effect of post fault voltage oscillations, particularly where there may be high MVA_r demands and the analysis undertaken, the voltage against time curve needs to be robust enough to cater for system disturbances cleared in main protection operating times whilst ensuring it is not sufficiently onerous that the requirement is not achievable. An example of the current RTE voltage against time curve is shown in Figure 10.13. In summary this requires the generator to withstand a 100% voltage dip for a period of 150ms, a 50% voltage dip for a further 550ms (total 700ms) and restoration to 1.0p.u volts a further 800ms (total 1500ms) later.



Gabarit de creux de tension pour les réseaux d'interconnexion

Figure A2.39 – French RTE Low Voltage Ride Through Voltage Against Time Curve

- A2.40 In deriving a GB voltage against time curve, there is always a concern under high MVA_r demands the post fault voltage could struggle to return to 0.5 p.u at 140ms instantaneously. On this basis and to take this effect into account the value of U_{rec1} was set at 0.5p.u and t_{rec1} set at 0.25s. Should the voltage still struggle further to recover, then a plateau needs to be introduced but it becomes fairly straight forward to determine these values in terms of time and voltage. As a plateau is introduced the value of U_{rec1} remains at 0.5 p.u and the time t_{rec1} would need to be at or less than the breaker fail operating time of typically 500ms. Based on the fact that the Mode B fault ride through requirements are considered separately from RfG and the study work conducted in Appendix 1 of this report it was deemed a value of 450ms would be appropriate for t_{rec2} . The last and final section is to consider the values of U_{rec2} and t_{rec3} . The RfG requirements only cover secured faults which would be cleared within 140ms. As Mode B faults are designed to cover unsecured faults which could result in potentially small voltage deviations (say a voltage dip of 0.15p.u (retained voltage 0.85p.u) for a considerable length of time (eg 3 minutes) and based on the analysis conducted in Appendix 1 of the report, it seems reasonable that the voltage against time curve should be set to a condition of 1.0p.u at 1.5 seconds. This therefore sets the time t_{rec3} . Based on the analysis completed and the approach adopted internationally, a value of 1.5s for t_{rec3} would not be seemed to be unreasonable. This is not however to be confused with compliance

however where a solid three phase short circuit fault should be applied for 140ms with the post fault voltage returning to 1.0p.u and 0.9p.u.

A2.41 To summarise, the GB RfG Fault Ride Through Parameters are therefore shown in Table A2.41 and represented graphically in Figure A2.41.

Voltage Parameters [p.u]		Time Parameters [seconds]	
U_{ret} :	0	t_{clear} :	0.14
U_{clear} :	0.25	t_{rec1} :	0.25
U_{rec1} :	0.5	t_{rec2} :	0.45
U_{rec2} :	1.0	t_{rec3} :	1.5

Table A2.41 – Proposed GB Parameters for the Fault Ride Through Capability of a Synchronous Generating Unit connected at Supergrid Voltage

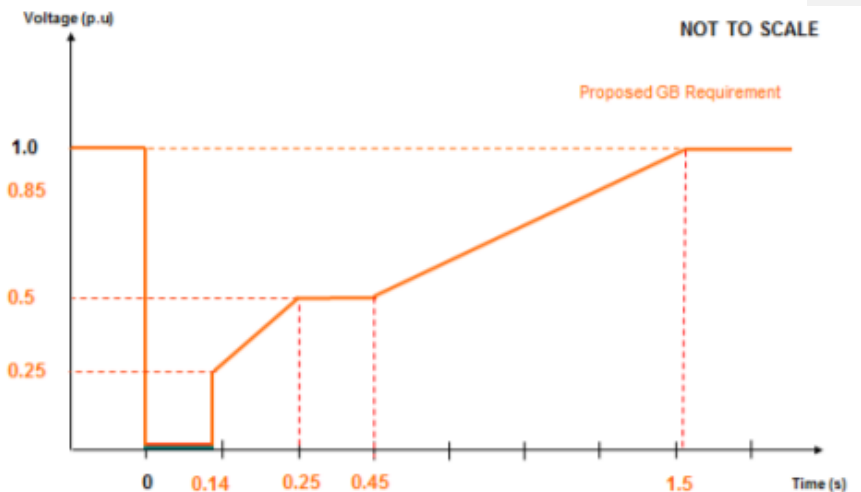

Figure A2.41 – Proposed GB Voltage against time curve for the Fault Ride Through Capability of a Synchronous Generating Unit connected at Supergrid Voltage

A2.42 The existing GB requirements which RfG leaves to the discretion of the TSO would remain as they are. For completeness these are summarised as follows:-

- Active power should be restored to 90% of the pre- fault active power level within 0.5 seconds of restoration of the voltage. Allowances will be made for oscillations in active power output as currently defined in CC.6.3.5.1(a)(ii).
- During the period of the fault each, Generating Unit shall supply maximum reactive current without exceeding the transient rating of the Generating Unit.

A2.43 It is not the purpose of this report to include corresponding legal text to reflect the above proposals. This element will be addressed by the GC0048 Workgroup.

Mode A – Demonstration of RfG Fault Ride Through Compliance at a GB Level as applicable to any Synchronous Generating Unit directly connected to the Transmission System operating at Supergrid Voltage

- A2.44 This section of the Appendix details how compliance should be assessed against the RfG Mode A proposals by a statement of the principles to be adopted and then through the use of an example.
- A2.45 It should also be noted that RfG Articles 51(3), 51(4) (Type B and C Synchronous Power Generating Modules) and RfG Articles 53(3) (Type D Synchronous Power Generating Modules) define the simulation requirements for fault ride through assessment. There is no requirement for actual tests to be completed on Synchronous Power Generating Modules to demonstrate compliance.
- A2.46 The general process for assessment and subsequent compliance would be expected to proceed through the following stages.
- A2.47 At the Generator application stage, National Grid will undertake a stability assessment to ensure compliance with the SQSS and determine the excitation parameters of the Generator. These studies would generally be undertaken during minimum demand conditions and would also identify if any reinforcement is necessary. The excitation performance requirements would then be reflected in the Bilateral Connection Agreement but it is assumed at this stage that the Generator is fully compliant with the requirements of the Grid Code. Any high level stability issues would generally be identified at this stage. The Bilateral Agreement would also specify the following information to enable the Generator to undertake the necessary compliance work:-
- The Maximum and Minimum Pre Fault Short Circuit Level at the Connection Point.
 - The pre fault operating conditions of the Generator (eg Full MW output, maximum lead)
 - The Maximum and Minimum Post Fault Short Circuit level at the Connection Point.
- A2.48 With details of the Short Circuit levels and Generating Unit parameters available, the Generator should be in a position to run system studies to assess Mode A Fault Ride Through Compliance.
- A2.49 During the Workgroup, it was noted that the pre and post fault short circuit level would be very different as a result of the loss of the line and consequent change in system topology – see Figure A2.1 above. One suggestion was that NGET should provide an equivalent based on the representations shown in Figures A2.49(a) – (c).

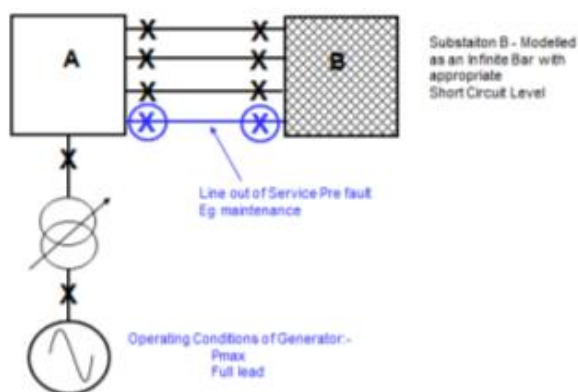

Figure A2.49(a) – Pre Fault Test Network Equivalent

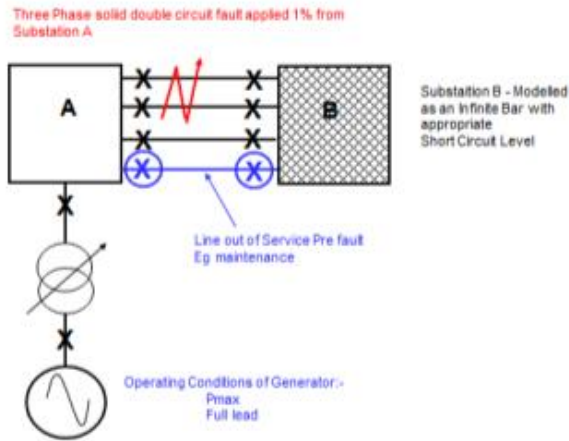

Figure A2.49(b) – Test Network Equivalent under Fault Conditions

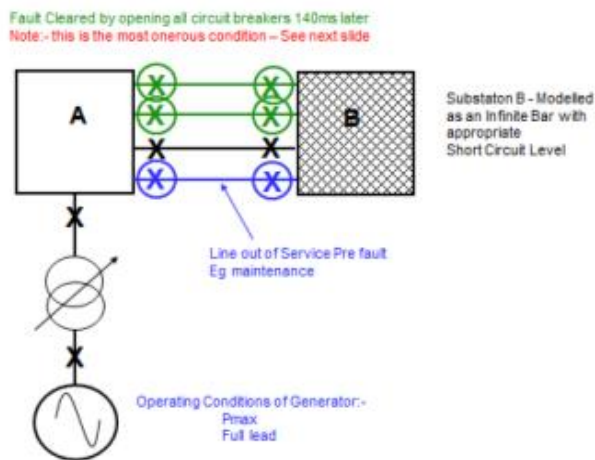

Figure A2.49(c) – Post Fault Network as an Equivalent

A2.50 This approach is adopted by RTE of France as documented in Reference [4]. An example of the RTE model is shown in Figure A2.50 below.

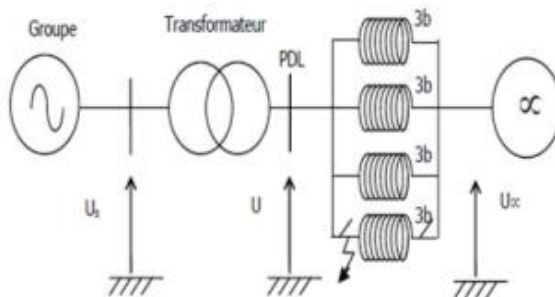

Figure A2.50 – RTE to Modelling Low Voltage Fault Ride Through

A2.51 Following internal research and discussion with the National Grid System Design department, it was considered that it would be more straight forward to provide a simple model simply quoting the pre and post short circuit level. This simplifies the process and also reduces need to produce an equivalent. It also enables a fault level to be provided with is reflective of the number of Generators connected at a specific site.

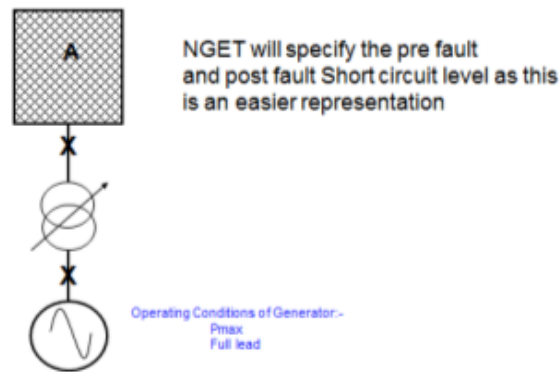

Figure A2.51 – Equivalent Network provided by NGET for Assessment of Fault Ride Through

- A2.52 Under this arrangement the Generator will need to model the infinite busbar reflecting the pre-fault short circuit level and the post fault short circuit level. As mentioned above both these values will be provided by National Grid.
- A2.53 The Workgroup discussed i) the type of model that should be used for compliance purposes and ii) the requirement for the post fault voltage conditions. For compliance purposes and to ensure adequate robustness of the Generating Unit, a 140ms 3 phase solid short circuit fault should be applied with simulation results showing the post fault voltage returning to both 1.0p.u and 0.9p.u.
- A2.54 To demonstrate this process, the following example is shown as to how compliance would be expected to be demonstrated. It needs to be noted that the Generator only needs to apply a fault for 140ms at the point of connection. Under these conditions the Generating Unit should remain connected and stable for a solid three phase balanced or unbalanced fault at the connection point, with active power being restored within 0.5 seconds of fault clearance.

Example – Compliance demonstration of a Mode A fault using the RfG parameters

- A2.55 This section of the Appendix seeks to give an example of how a Generator would be expected to undertake Mode A fault ride through compliance if the RfG requirements had been adopted. A recommendation from this GC0062 Workgroup is that the GC0048 Workgroup take the information contained in this report for subsequent coding and ultimate implementation into the GB code.
- A2.56 For the purposes of this example we are going to assume that a 2082MVA Synchronous Generator is seeking a connection to the Transmission System at 400kV. National Grid will provide the pre and post fault circuit level to the Generator as part of the compliance process. This will enable the fault level provided to reflect different operating configurations in particular where there is more than one Generator connected at a specific site.
- A2.57 The Connection Contract has been signed and under the terms of the Contract the Generator is required to satisfy the requirements of the Connection and Use of System Code (CUSC) which in turns obligates them to satisfy the requirements of the Grid Code and Bilateral Agreement, the technical requirements being covered in Appendix F which would specify the excitation ceiling parameters. In this example a static excitation system has been specified with an on load positive ceiling voltage of 2.0 p.u, a rise time of 50ms and a negative ceiling level of no less than 1.6.p.u and the installation of a Power System Stabiliser.
- A2.58 In order for the Generator to assess compliance National Grid will provide the following data and model as shown in Figure A2.58 below.

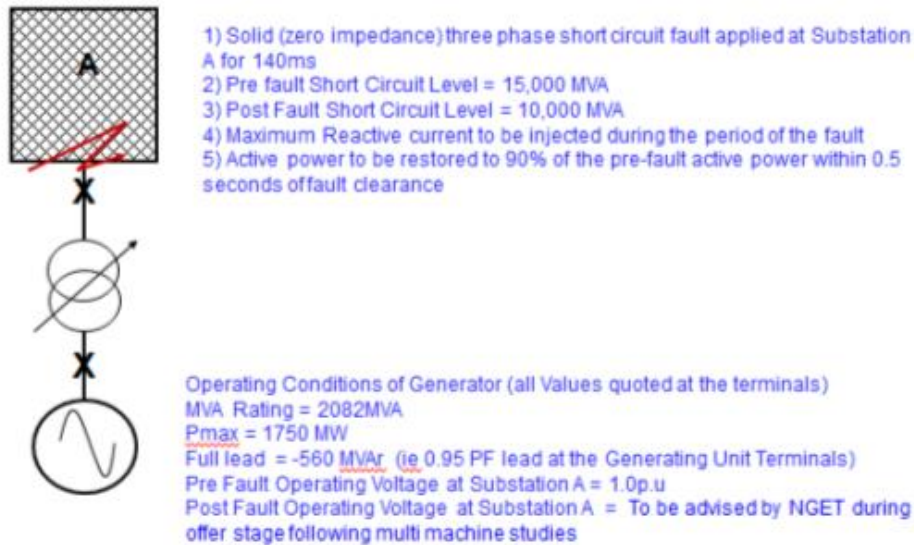
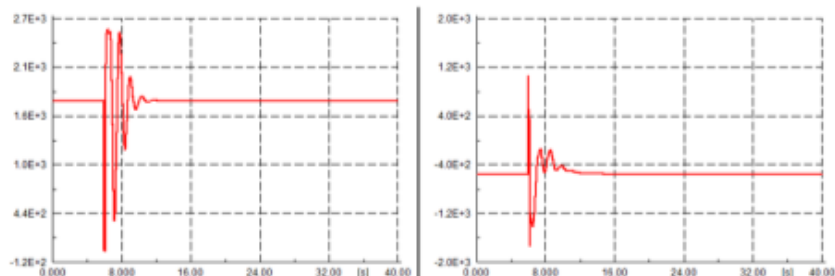

Figure A2.58 – Parameters and model issued by NGET for the Generator to undertake Mode A (RfG Compliant) Fault Ride Through Compliance Studies

A2.59 The Generator will then be responsible for inserting their detailed Generating Unit model into the single machine equivalent. There is no restriction on the type of software modelling tool (eg Power Factory, PSS/E, Eurostag, EMTDC / PSCAD / Matlab) used so long as the Generator can supply traces of Active Power, Voltage, and rotor angle can be provided.

A2.60 An example of a 140ms fault (based on a machine with parameters shown in Figure A2.58) with the post fault voltage returning to 1.0p.u are shown in Figure A2.60 (a) – (e) below.



(a) Active Power (MW)

(b) Reactive Power (MVar)

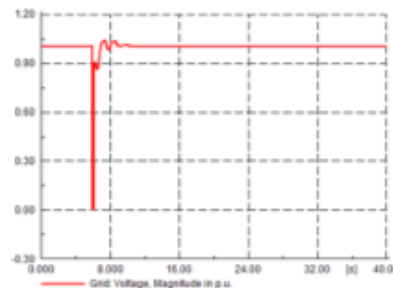

(c) Grid Voltage (p.u)

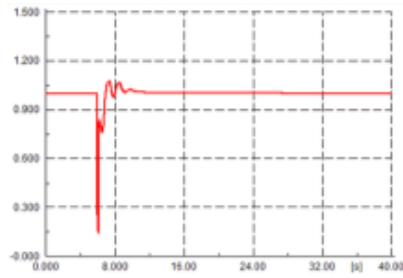

(d) Terminal voltage (p.u)

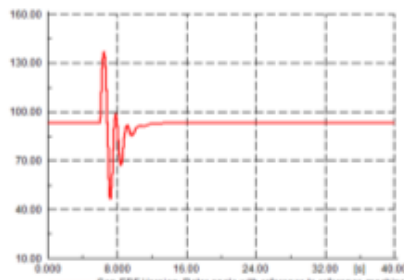

(e) Rotor Angle (degrees)

Figure A2.60 – Example of a 2082MVA machine subject to 140ms three phase fault with the post fault voltage returning to 1.0 p.u

- A2.61 So far as the requirement to restore Active Power within 0.5 seconds of fault clearance is concerned, the existing GB Grid Code requirement would apply as detailed in CC.6.3.15.1(a)(ii) where the assessment is based on the total active energy during the period immediately after the fault. This requirement is necessary to account for the potential oscillatory nature of the post fault active power generated.
- A2.62 A question raised on a number of occasions during the Workgroup was what would happen in the event that compliance could not be demonstrated. For Mode A faults, the initial stability assessment is carried out by NGET at the application stage which is then used to derive the excitation system requirements necessary. In extreme cases it may be necessary for other measures such as system reinforcement. There have and continue to be cases where an offer has been released showing stable results which when tested by the Generator have resulted in unstable results. These issues are generally down to modelling assumptions and under such circumstances NGET will work with the Generator to ensure consistency of models and results.
- A2.63 For the purposes of compliance, simulation studies will only be necessary. There will be no requirement to complete real tests or type tests. Under RfG, compliance simulations for Synchronous Power Generating Modules would be required as defined in Article 51 (3), 51 (4) and Article 53(3). In summary these simply refer to demonstration of compliance through simulation studies to demonstrate that the requirements of RfG Article 16 (3) and Article 17(3) can be demonstrated. In practice when the GB Grid Code is updated through the GC0048 Workgroup, additional information will be included in CC.A.4 and CP.A.3.5 which would be along the lines of the simulations highlighted above.