

Stage 03: Report to the Authority

National Electricity Transmission System Security and Quality of Supply Standards (NETS SQSS)

GSR024: National Grid Legal Separation SQSS Changes

| | |
|----|---------------------------|
| 01 | Workgroup Report |
| 02 | Industry Consultation |
| 03 | Final Report to Authority |

This proposal seeks to modify the NETS SQSS to ensure that the National Grid legal separation changes are updated in the NETS SQSS and the SQSS Industry Governance Framework.

This report is submitted to the Authority to assist in its decision in relation to the implementation of the NETS SQSS Modification proposed.

Published on: 24 August 2018



High Impact:
National Grid



Medium Impact:
None



Low Impact:
Transmission Owners, Generators and Distribution Network Operators

Contents

| | |
|--|-----|
| 1. Executive Summary | 4 |
| 2. Why Change? | 4 |
| 3. Proposed Solution | 4 |
| 4. Assessment Against NETS SQSS Objectives | 5 |
| 5. Impact on Core Industry Documents..... | 5 |
| 6. Implementation..... | 5 |
| 7. Summary of Consultation Responses..... | 6 |
| 8. SQSS Panel Recommendation..... | 6 |
| Annex 1 Proposed Legal Text - SQSS..... | 7 |
| Annex 2 Proposed Legal Text – SQSS Industry Governance Framework 101 | |
| Annex 3 Consultation Responses | 136 |



Any Questions?

Contact:

Shazia Akhtar

Code Administrator



Shazia.Akhtar2@nationalgrid.com



07787266972

Proposer:

John Martin

National Grid



John.Martin2@nationalgrid.com



07794 050359

About this Document

This report outlines information required for interested parties to form an understanding of the proposed changes to the NETS SQSS and SQSS Industry Governance Framework that are required to reflect the creation of the National Grid Electricity System Operator (NGESO) as a legally separate entity to National Grid Electricity Transmission Limited (NGET) WHICH will continue to perform the functions of the transmission owner after legal separation in April 2019. Feedback from an industry consultation is included at Section 7. The NETS SQSS Panels views are included within Section 8.

This report is intended to provide the Authority with the information necessary to inform their decision on the implementation of the proposed modification.

The revisions to the NETS SQSS as proposed by National Grid and sent to the Authority require approval and will, if approved, come into force from such date (or dates) of which Authorised Electricity Operators will be notified by National Grid, in accordance with the Authority's approval.

Document Control

| Version | Date | Author | Change Reference |
|---------|------------|-------------|--------------------------------|
| 00.01 | 21/05/2018 | John Martin | Initial Draft |
| 1.0 | 08/06/18 | Code Admin | Final Version for Consultation |

GSR024

Report to Authority

24/08/2018

Version 4.0

Page 2 of 140

| | | | |
|-----|------------|------------|------------------------------------|
| 2.0 | 05/07/18 | Code Admin | Draft Final Modification Report v1 |
| 3.0 | 13/08/2018 | Code Admin | Draft Final Modification Report v2 |
| 4.0 | 24/08/2018 | Code Admin | Final Modification Report |

1. Executive Summary

- 1.1 The GSR024 Proposal was presented to the SQSS Panel at the May NETS SQSS Review Panel. The Panel recommended the Report to be issued for an Industry Consultation on the changes proposed to the NETS SQSS and NETS SQSS Industry Governance Framework.
- 1.2 This Consultation closed on 5 July 2018, with two responses received. A summary of the responses can be accessed within Section 7 of this report.
- 1.3 At the NETS SQSS Panel meeting on 20 August 2018, the Panel members considered the representations made in response to the Industry Consultation along with the subsequent amendments to the legal text. The Panel unanimously recommended that the modification should be implemented.

2. Why Change?

- 2.1 Changes are required to NGET's existing licence required to implement legal separation; all system operator obligations will be transferred into a new transmission licence for the NGESO and as such need to be reflected accordingly within the electricity codes. The licence changes are the subject of ongoing consultation.

3. Proposed Solution

Impact on the NETS SQSS

- 3.1 The following sections of the NETS SQSS are being proposed to be changed; full legal text is available within Annex 1 of the consultation:
 - 3.1.1 New definition for 'NGESO'.
 - 3.1.2 Change the 'Transmission Licensees' definition so that it includes reference to 'NGESO'.
 - 3.1.3 In multiple Clauses change 'NGET' to 'NGESO'.

Impact on the NETS SQSS Industry Governance Framework

- 3.2 The following sections of the NETS SQSS Industry Governance Framework are being proposed to be changed; full legal text is available within Annex 2 of the consultation:
 - 3.2.1 New definition for 'NGESO'.
 - 3.2.2 Add 'NGESO' to the following definition 'Panel' and Clause 4.1.1.
 - 3.2.3 In multiple Clauses change 'NGET' to 'NGESO'.
 - 3.2.4 New Clauses to encompass the proposed new NGESO membership of the Panel i.e. 4.6.2, 4.6.2.1, 4.6.8.2 and 4.9.2.
 - 3.2.5 Amend Clause 4.6.3.1 to clarify NGET's role.

4. Assessment Against NETS SQSS Objectives

Assessment against NETS SQSS Objectives

4.1 The Proposer considers that the proposed amendments would better facilitate the NETS SQSS objectives:

- (i) **facilitate the planning, development and maintenance of an efficient, coordinated and economical system of electricity transmission, and the operation of that system in an efficient, economic and coordinated manner;**

The modification will ensure that post legal separation the applicable parties are facilitating the planning, development, maintenance and operation of the electricity transmission system. By ensuring that the appropriate obligations are with NGESO as System Operator and the Transmission Owners in accordance with the new NGESO Transmission Licence and modified NGET Transmission Licence obligations.

- (ii) **ensure an appropriate level of security and quality of supply and safe operation of the National Electricity Transmission System;**

Neutral

- (iii) **facilitate effective competition in the generation and supply of electricity, and (so far as consistent therewith) facilitating such competition in the distribution of electricity; and**

Neutral

- (iv) **facilitate electricity Transmission Licensees to comply with their obligations under EU law.**

Neutral

5. Impact on Core Industry Documents

Impact on Core Industry Documents

5.1 Although this modification proposal does not directly impact other industry codes, other proposed modifications to industry codes (BSC, CUSC, DCUSA, Distribution Code, Grid Code and STC) are being raised in parallel to this modification proposal as a result of creating a legally separate system operator.

Impact on Other Industry Documents

5.2 No impact.

6. Implementation

Implementation

6.1 The legal text for GSR024 has been drafted using the baseline of April 2018 text and as the modification progresses through the governance process, the text may need to

be revised in light of other outstanding SQSS Modifications. The Code Administrator will ensure that the Proposer is aware of the approval of any of the other SQSS Modifications and the Proposer will take into account any relevant amendments.

- 6.2 The SQSS changes once approved will be introduced but “suspended” until the transfer of the transmission licence to NGESO, which is currently planned for 01 April 2019.

7. Summary of Consultation Responses

- 7.1 During the period 8 June 2018 to 5 July 2018, industry was invited to respond to the consultation paper and the following questions:

1. Do you agree with the general approach to account for the legal separation of the system operator and transmission owner within the SQSS?
2. Do you believe that GSR024 better facilitates the appropriate NETS SQSS objectives?
3. Do you generally support the Modification proposal to amend the SQSS and the Industry Governance Framework as set out? If not, please clarify your concerns.
4. Are there any further technical or commercial considerations that need to be taken into account?
5. Please provide any other comments you feel are relevant to the proposed changes.
6. The definition of ‘Onshore Transmission Licensee’ has been amended by this proposal so that it makes reference to both the named parties and the specific type of license held. Do you think this additional clarification assist parties when reviewing the SQSS?

- 7.2 Two consultation responses were received from National Grid and Northern Powergrid. These can be read in full in Annex 3. Both respondents supported the modification but Northern Powergrid suggested two alterations. An amendment to the text at paragraph 2.2 of the Industry Governance Framework to clarify NGESO’s role under the Transmission Licence as distinct to that of NGET, SHETL, and SPT. The other change was to ensure consistency between both documents in terms of the company address.

- 7.3 This recommended change is supported by the Proposer of GSR024.

8. SQSS Panel Recommendation

- 8.1 The SQSS Panel considered the proposal, consultation responses received and subsequent legal text changes when it convened on 20 August 2018.
- 8.2 The Panel unanimously agreed that the modification to the NETS SQSS was required and instructed the Panel Secretary to send the Final Modification Report to the Authority recommending that the modification be implemented.

National Electricity Transmission System Security and Quality of Supply Standard

Version 2.3

8th February 2017

Contents

| | | Page |
|------------|---|------|
| 1 | Introduction | 4 |
| 2 | Generation Connection Criteria Applicable to the <i>Onshore Transmission System</i> | 11 |
| 3 | Demand Connection Criteria Applicable to the <i>Onshore Transmission System</i> | 16 |
| 4 | Design of the <i>Main Interconnected Transmission System</i> | 22 |
| 5 | Operation of the <i>Onshore Transmission System</i> | 26 |
| 6 | Voltage Limits in Planning and Operating the <i>Onshore Transmission System</i> | 30 |
| 7 | Generation Connection Criteria Applicable to an <i>Offshore Transmission System</i> | 34 |
| 8 | Demand Connection Criteria Applicable to an <i>Offshore Transmission System</i> | 44 |
| 9 | Operation of an <i>Offshore Transmission System</i> | 48 |
| 10 | Voltage Limits in Planning and Operating an <i>Offshore Transmission System</i> | 50 |
| 11 | Terms and Definitions | 51 |
| Appendix A | Recommended Substation Configuration and Switching Arrangements | 72 |
| Appendix B | Circuit Complexity on the <i>Onshore Transmission System</i> | 77 |
| Appendix C | Modelling of <i>Security Planned Transfer</i> | 80 |

| | | |
|-------------------|--|-----------|
| Appendix D | Application of the <i>Interconnection Allowance</i> | 82 |
| Appendix E | Modelling of <i>Economy Planned Transfer</i> | 85 |
| Appendix F | Application of the <i>Boundary Allowance</i> | 87 |
| Appendix G | Guidance on Economic Justification | 89 |

1. Introduction

Role and Scope

- 1.1 Pursuant to conditions C17, D3 and E16 of the Transmission Licences, this document sets out a coordinated set of criteria and methodologies (for example cost-benefit techniques and weather related operation) that *transmission licensees* shall use in the planning and operation of the *national electricity transmission system* of *Great Britain*. For the avoidance of doubt the *national electricity transmission system* is made up of both the *onshore transmission system* and the *offshore transmission systems*.
- 1.2 Both planning and operational criteria are set out in this Standard and these will determine the need for services provided to the relevant *transmission licensees*, e.g. reactive power as well as transmission equipment. The planning criteria set out the requirements for the *transmission capacity* (either investment or purchase of services) for the *national electricity transmission system*. The planning criteria also require consideration to be given to the operation and maintenance of the *national electricity transmission system* and so refer to the associated operational criteria where appropriate. The operational criteria are used in real time and in the development of plans for using the *national electricity transmission system* to permit satisfactory operation.
- 1.3 Additional criteria, for example covering more detailed and other aspects of quality of supply, are contained in the Grid Code and the SO-TO Code, which should be read in conjunction with this document.
- 1.4 *External interconnections* between the *onshore transmission system* and *external systems* (e.g. in Ireland & France) are covered by separate agreements, which will normally be consistent with this Standard. This Standard may be specifically referenced in the relevant agreements and shall apply to the extent of that reference.
- 1.5 The consideration of *secured events* as defined in this Standard may lead to the identification of inadequate capability of equipment or systems not owned or operated by the *transmission licensees* (for example, the overloading of lower voltage connections between *grid supply points*). In such cases the *transmission licensees* will notify the *network operators* affected. Reinforcement or alternative operation of the *national electricity transmission system* to alleviate inadequacies of equipment or systems not owned or operated by the *transmission licensees* would be undertaken where it is agreed by the *network operators* affected and the relevant *transmission licensees*.
- 1.6 The criteria presented in this Standard represent the minimum requirements for the planning and operation of the *national electricity transmission system*. While it is a requirement for *transmission capacity* to meet the planning criteria, it does not follow that the *transmission capacity* should be reduced so that it only meets the minimum requirement of those criteria. For example, it

Comment [NG1]: Assume will be same refs but double check licence cross refs when licence settled

Comment [NG2]: def of TL edited to include SO.

may not be beneficial to reduce the ratings of lines to reflect lower loading levels which have arisen due to changes in the generation or demand patterns.

Document Structure

- 1.7 This Standard contains technical terms and phrases specific to *transmission systems* and the Electricity Supply Industry. The meanings of some terms or phrases in this Standard may also differ from those commonly used. For this reason a 'Terms and Definitions' has been included as Section 11 to this document. All defined terms have been identified in the text by the use of *italics*.
- 1.8 The criteria and methodologies applicable to the *onshore transmission system* differ in certain respects from those applicable to the *offshore transmission systems*. In view of this, the two sets of criteria and methodologies are presented separately for clarity. The criteria and methodologies applicable to the *onshore transmission system* are presented in Sections 2 to 6 and the criteria and methodologies applicable to *offshore transmission systems* are presented in Sections 7 to 10.

Onshore Criteria and Methodologies

- 1.9 For ease of use, the criteria and methodologies relating to the planning of the *onshore transmission system* have been presented according to the functional parts of the *onshore transmission system* to which they primarily apply. These parts are the *generation points of connection* at which *power stations* feed into the *Main Interconnected Transmission System (MITS)* through the remainder of the *MITS* to the *Grid Supply Points (GSP)* where demand is connected. These parts are illustrated schematically in Figure 1.1.

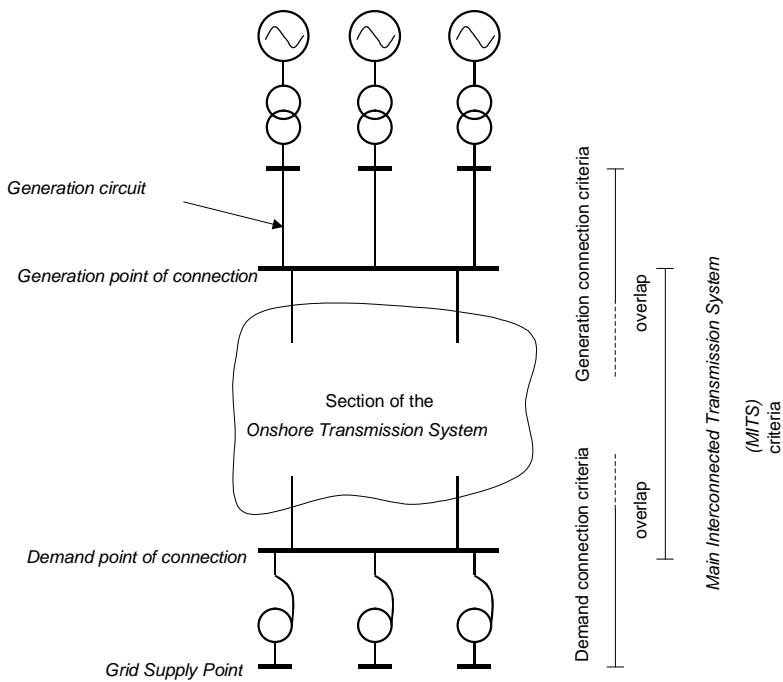

Figure 1.1 The *onshore transmission system* with a directly connected *power station*

- 1.10 The generation connection criteria applicable to the *onshore transmission system* are set out in Section 2 and cover the connections which extend from the *grid entry points (GEPS)* and reach into the *MITS*. The criteria also cover the risks affecting the *national electricity transmission system* arising from the *generation circuits*.
- 1.11 The demand connection criteria applicable to the *onshore transmission system* are given in Section 3 and cover the connections which extend from the lower voltage side of the *GSP* transformers and again reach into the *MITS*.
- 1.12 Section 4 sets out the criteria for minimum *transmission capacity* on the *MITS*, which extends from the *generation points of connection* through to the *demand points of connection* on the high voltage side of the *GSP* transformers.
- 1.13 The criteria relating to the operation of the *onshore transmission system* are presented in Section 5.

Offshore Criteria and Methodologies

- 1.14 For ease of use, the criteria and methodologies relating to the planning of the *offshore transmission systems* have also been presented according to the functional parts of an *offshore transmission system* to which they primarily

apply. An *offshore transmission system* extends from the *offshore grid entry point/s (GEP)* at which *offshore power stations* feed into the *offshore transmission system* through the remainder of the *offshore transmission system* to the point of connection of the *offshore transmission system* at the *first onshore substation*. This point of connection at the *first onshore substation* is the *interface point (IP)* in the case of a direct connection to the *onshore transmission system* or the *user system interface point (USIP)* in the case of a connection to an *onshore user system*.

1.15 The *first onshore substation* may be owned by the *offshore transmission licensee*, the *onshore transmission licensee* or *onshore user system owner*. Ownership boundaries are determined by the relevant *transmission licensees* and/or *distribution licensees* (as the case may be). Normally, and unless otherwise agreed, in the case of there being AC transformation or DC conversion facilities at the *first onshore substation* if the *offshore transmission owner* owns the *first onshore substation*, the *interface point* or *user system interface point* (as the case may be) would be on the *HV busbars*. If the *first onshore substation* is owned by the *onshore transmission owner* or *onshore user system owner*, the *interface point* or *user system interface point* (as the case may be) would be on the *LV busbars*. In the case of the former, the *first onshore substation* must meet the criteria relating to *offshore transmission systems* and, in the case of the latter the *first onshore substation* must meet the appropriate *onshore criteria*.

1.16 The functional parts of an *offshore transmission system* include:

the *offshore connection facilities* on the *offshore platform/s*, which may include:

1.16.1 the *offshore grid entry point/s (GEP)* at which *offshore power stations* feed into an *offshore transmission system*,

1.16.2 any *offshore supply point/s (OSP)* where *offshore power station demand* is supplied from an *offshore transmission system*

1.16.3 *AC or DC offshore transmission circuits*

the *cable circuit/s*, which may include:

1.16.4 *AC or DC cable offshore transmission circuits* connecting an *offshore platform* either directly to an *onshore overhead line* forming part of the *offshore transmission system* or to *onshore connection facilities* forming part of the *offshore transmission system*.

an *overhead line section*, which may include:

1.16.5 *AC or DC overhead line offshore transmission circuits* connecting the *cable offshore transmission circuits* either directly to the *first onshore substation* or to *onshore AC transformation* or *AC/DC conversion facilities* not forming part of the *first onshore substation*.

onshore connection facilities, which may include:

- 1.16.6 AC/DC conversion facilities connecting DC overhead line or DC cable offshore transmission circuits to the interface point or user system interface point (as the case may be). Such facilities may constitute the first onshore substation
- 1.16.7 AC transformation facilities connecting AC overhead line or AC cable offshore transmission circuits to the interface point or user system interface point (as the case may be). Such facilities may constitute the first onshore substation.

1.17 The above functional parts of an offshore transmission system are illustrated schematically in Figure 1.2. There are many variations to the form of an offshore transmission system. Figure 1.2, and Figure 1.3, illustrate just two such examples. The offshore generator has the option to connect to an offshore transmission system at a voltage level (in that system) of his choosing. Accordingly, the offshore GEP can be at a voltage level of the generator's choosing and the extent of the offshore generation connection criteria would vary accordingly. However, under the default arrangements, the offshore generator's circuits cannot be wholly or mainly at a voltage level of 132kV or above since such a combination of circuits would then constitute part of an offshore transmission system. Please note that, while Figure 1.2, and subsequent Figure 1.3, have been drawn such that they represent the functional parts of an AC offshore transmission system, they are equally representative of the functional parts of a DC offshore transmission system.

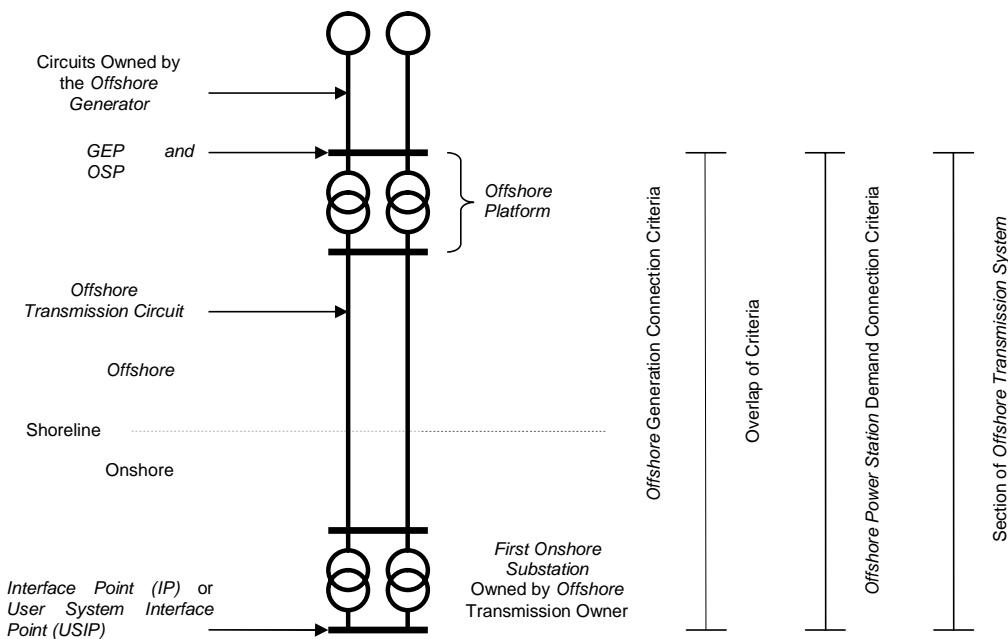

Figure 1.2 An offshore transmission system with a directly connected power station and first onshore substation owned by the offshore transmission owner

1.18 The boundaries between functional parts of an *offshore transmission system* will vary according to circumstances. In the example illustrated in Figure 1.3, the *first onshore substation* is owned by the *onshore transmission system* owner or *user system* owner. Accordingly, the *interface point* or *user system interface point*, as the case may be, would be at the lower voltage side rather than the higher voltage side of the transformers at the *first onshore substation*. Similarly, the extent of the *offshore* generation and demand connection criteria also move with the *interface point* or *user system interface point*. The *first onshore substation* forms part of the *onshore transmission system* or *onshore user system* as the case may be.

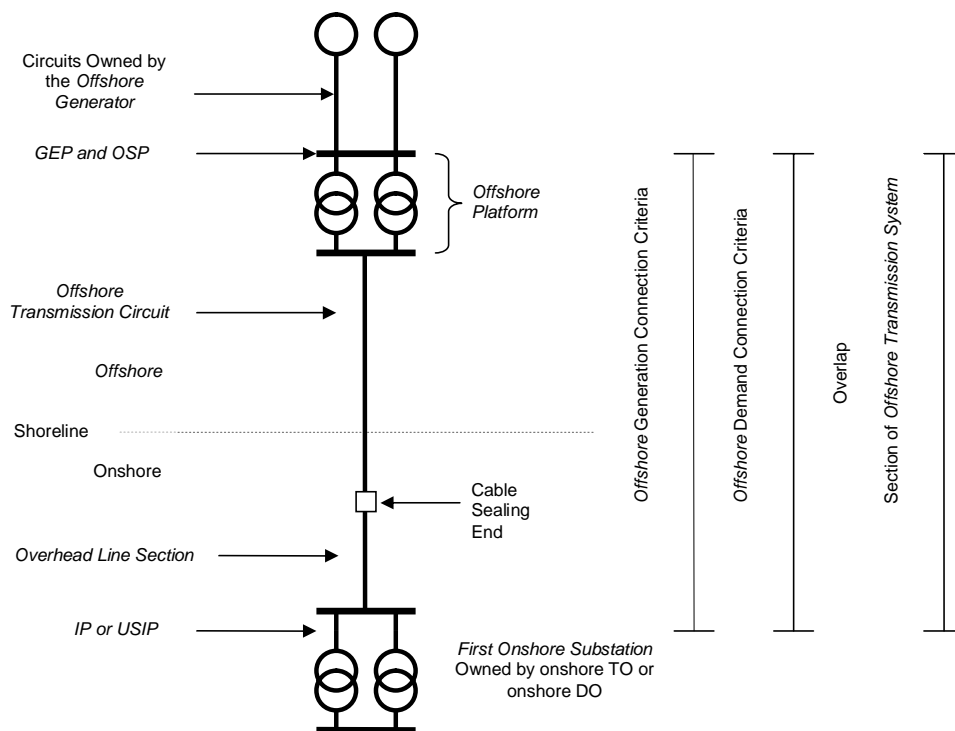

Figure 1.3 The *offshore transmission system* with a directly connected *power station* and *first onshore substation* owned by the onshore TO or onshore DO

1.19 The generation connection criteria applicable to an *offshore transmission system* are set out in Section 7 and cover the connections which extend from the *offshore grid entry points (GEP)*, through the *offshore transmission system*, to the *interface point (IP)* or *onshore user system interface point (USIP)*, as the case may be.

1.20 The demand connection criteria applicable to an *offshore transmission system* are given in Section 8 and cover the connection of station demand at the *offshore platform*. These criteria extend from the *offshore supply point (OSP)* on the *offshore platform* through the *offshore transmission system* to the

onshore *interface point (IP)* or onshore *user system interface point (USIP)*, as the case may be.

- 1.21 The criteria relating to the operation of an *offshore transmission system* are presented in Section 9.
- 1.22 Voltage limits for use in planning and operating an *offshore transmission system* are presented in Section 10.

Overlap of Criteria

- 1.23 As described above, and illustrated in Figures 1.1, 1.2 and 1.3, there will be parts of the *national electricity transmission system* where more than one set of criteria apply. In such places the requirements of all relevant criteria must be met. Particular examples are:

- 1.23.1 should an *offshore transmission system* be connected to the onshore *MITS* by two or more *AC offshore transmission circuits* routed to different onshore substations or to separate *busbar* sections at the same onshore substation, those *AC offshore transmission circuits* would parallel the *MITS*. In such cases the onshore criteria would also apply to the relevant sections of the *offshore transmission system*;

- 1.23.2 where sites are composite and have a mixture of demand connections and generation connections, the security afforded to the block of demand customers shall be not less than that provided for a standard demand connection of an identical size. The applicable security standard should therefore be the more secure of the corresponding criteria of Section 2 or Section 3. Specifically excluded from this category is a generation site with on-site station demand. Such sites shall be treated as a generation site connected to the *onshore transmission system* with appropriate security levels.

2. Generation Connection Criteria Applicable to the *Onshore Transmission System*

- 2.1 This section presents the planning criteria applicable to the connection of one or more *power stations* to the *onshore transmission system*. The criteria in this section will also apply to the connections from a GSP to the *onshore transmission system* by which *power stations* embedded within a customer's network (e.g. distribution network) are connected to the *onshore transmission system*.
- 2.2 In those parts of the *onshore transmission system* where the criteria of Section 3 and/or Section 4 also apply, those criteria must also be met.
- 2.3 In planning generation connections, this Standard is met if the connection design either:
- 2.3.1 satisfies the deterministic criteria detailed in paragraphs 2.5 to 2.13; or
 - 2.3.2 varies from the design necessary to meet paragraph 2.3.1 above in a manner which satisfies the conditions detailed in paragraphs 2.15 to 2.18.
- 2.4 It is permissible to design to standards higher than those set out in paragraphs 2.5 to 2.13 provided the higher standards can be economically justified. Guidance on economic justification is given in Appendix G.

Limits to *Loss of Power Infeed Risks*

- 2.5 For the purpose of applying the criteria of paragraph 2.6, the *loss of power infeed* resulting from a *secured event* on the *onshore transmission system* shall be calculated as follows:
- 2.5.1 the sum of the *registered capacities* of the *generating units* disconnected from the system by a *secured event*, plus
 - 2.5.2 the planned import from any *external systems* disconnected from the system by the same event, less
 - 2.5.3 the *forecast minimum demand* disconnected from the system by the same event but excluding (from the deduction) any demand forming part of the *forecast minimum demand* which may be automatically tripped for system frequency control purposes and excluding (from the deduction) the demand of the largest single end customer.
- 2.6 Generation connections shall be planned such that, starting with an *intact system*, the consequences of *secured events* on the *onshore transmission system* shall be as follows:

- 2.6.1 following a *fault outage* of any single *transmission circuit*, no *loss of power infeed* shall occur;
 - 2.6.2 following the *planned outage* of any single section of *busbar* or mesh corner, no *loss of power infeed* shall occur;
 - 2.6.3 following a *fault outage* of any single *generation circuit* or single section of *busbar* or mesh corner, the *loss of power infeed* shall not exceed the *infrequent infeed loss risk*;
 - 2.6.4 following the concurrent *fault outage* of any two *transmission circuits*, or any two *generation circuits* on the same *double circuit overhead line*, or the *fault outage* of any single *busbar* coupler circuit breaker or *busbar* section circuit breaker or mesh circuit breaker, the *loss of power infeed* shall not exceed the *infrequent infeed loss risk*;
 - 2.6.5 following the *fault outage* of any single *transmission circuit*, single section of *busbar* or mesh corner, during the *planned outage* of any other single *transmission circuit* or single section of *busbar* or mesh corner, the *loss of power infeed* shall not exceed the *infrequent infeed loss risk*;
 - 2.6.6 following the *fault outage* of any single *busbar* coupler circuit breaker or *busbar* section circuit breaker or mesh circuit breaker, during the *planned outage* of any single section of *busbar* or mesh corner, the *loss of power infeed* shall not exceed the *infrequent infeed loss risk*.
- 2.7 The maximum length of overhead line connections in a *generation circuit* for *generating units* which are directly connected to the *onshore transmission system* shall not exceed:
- 2.7.1 5km for *generating units* of expected annual energy output greater than or equal to 2000GWh; otherwise
 - 2.7.2 20km

Generation Connection Capacity Requirements

Background conditions

- 2.8 The connection of a particular *power station* shall meet the criteria set out in paragraphs 2.9 to 2.13 under the following background conditions:
- 2.8.1 the active power output of the *power station* shall be set equal to its *registered capacity*;
 - 2.8.2 the reactive power output of the *power station* shall be set to the full leading or lagging output that corresponds to an active power output

equal to *registered capacity*, or for the purpose of assessment of system stability and voltage control issues, that which may reasonably be expected under the conditions described in paragraph 2.8.4;

- 2.8.3 for connections to an *offshore transmission system*, the reactive power output of the *offshore power station/s* shall normally, and unless otherwise agreed, be set to deliver zero reactive power at the *offshore grid entry point* with active power output equal to *registered capacity*; and the reactive power delivered at the *interface point* shall be set in accordance with the reactive requirements placed on the *offshore transmission licensee* set out in Section K of the STC (System Operator – Transmission Owner Code); and
- 2.8.4 conditions on the *onshore transmission system* shall be set to those which ought reasonably to be expected to arise in the course of a year of operation. Such conditions shall include forecast demand cycles, typical *power station* operating regimes and typical *planned outage* patterns modified where appropriate by the provisions of paragraph 2.11.

Pre-fault criteria

- 2.9 The *transmission capacity* for the connection of a *power station* shall be planned such that, for the background conditions described in paragraph 2.8, prior to any fault there shall not be any of the following:
 - 2.9.1 equipment loadings exceeding the *pre-fault rating*;
 - 2.9.2 voltages outside the *pre-fault planning voltage limits* or *insufficient voltage performance margins*; or
 - 2.9.3 *system instability*.

Post-fault criteria – background condition of no *local system outage*

- 2.10 The *transmission capacity* for the connection of a *power station* shall also be planned such that for the background conditions described in paragraph 2.8 with no *local system outage* and for the *secured event* of a *fault outage* on the *onshore transmission system* of any of the following:
 - 2.10.1 a single *transmission circuit*, a single *generation circuit*, a single *generating unit* (or several *generating units* sharing a common circuit breaker), a single *Power Park Module*, or a single *DC converter*, a reactive compensator or other reactive power provider;
 - 2.10.2 a *double circuit overhead line* on the *supergrid*;
 - 2.10.3 a *double circuit overhead line* where any part of either circuit is in *NGET's transmission system* or *SHETL's transmission system*;

- 2.10.4 a single *transmission circuit* with the prior outage of another *transmission circuit*;
- 2.10.5 a section of *busbar* or mesh corner; or
- 2.10.6 a single *transmission circuit* with the prior outage of a *generation circuit*, *generating unit* (or several *generating units*, sharing a common circuit breaker, that cannot be separately isolated), a *Power Park Module*, a *DC converter*, a reactive compensator or other reactive power provider, or;
- 2.10.7 a single *generation circuit*, a single *generating unit* (or several *generating units*, sharing a common circuit breaker), a single *Power Park Module*, a single *DC converter*, a reactive compensator or other reactive power provider with the prior outage of a single *transmission circuit*

there shall not be any of the following:

- 2.10.8 a *loss of supply capacity* except as permitted by the demand connection criteria detailed in Section 3;
 - 2.10.9 *unacceptable overloading* of any *primary transmission equipment*;
 - 2.10.10 *unacceptable voltage conditions* or *insufficient voltage performance margins*; or
 - 2.10.11 *system instability*.
- 2.11 Under *planned outage* conditions it shall be assumed that the prior circuit outage specified in paragraphs 2.10.3, 2.10.5 and 2.10.6 reasonably forms part of the typical outage pattern referred to in paragraph 2.8.4 rather than in addition to that typical outage pattern.

Post-fault criteria – background condition with a *local system outage*

- 2.12 The *transmission capacity* for the connection of a *power station* shall also be planned such that for the background conditions described in paragraph 2.8 with a *local system outage* on the *onshore transmission system*, the operational security criteria set out in Section 5 and Section 9 can be met.
- 2.13 Where necessary to satisfy the criteria set out in paragraph 2.13, investment should be made in *transmission capacity* except where operational measures suffice to meet the criteria in paragraph 2.13 provided that maintenance access for each *transmission circuit* can be achieved and provided that such measures are economically justified. The operational measures to be considered include rearrangement of transmission outages and appropriate reselection of *generating units* from those expected to be available, for

example through *balancing services*. Guidance on economic justification is given in Appendix G.

Switching Arrangements

- 2.14 Guidance on substation configurations and switching arrangements are described in Appendix A. These guidelines provide an acceptable way towards meeting the criteria of paragraph 2.6. However, other configurations and switching arrangements which meet those criteria are also acceptable.

Variations to Connection Designs

- 2.15 Variations, arising from a generation customer's request, to the generation connection design necessary to meet the requirements of paragraphs 2.5 to 2.14 shall also satisfy the requirements of this Standard provided that the varied design satisfies the conditions set out in paragraphs 2.17.1 to 2.17.3. For example, such a generation connection design variation may be used to take account of the particular characteristics of a *power station*.
- 2.16 Any generation connection design variation must not, other than in respect of the generation customer requesting the variation, either immediately or in the foreseeable future:
- 2.16.1 reduce the security of the *MITS* to below the minimum planning criteria specified in Section 4; or
 - 2.16.2 result in additional investment or operational costs to any particular customer or overall, or a reduction in the security and quality of supply of the affected customers' connections to below the planning criteria in this section or Section 3, unless specific agreements are reached with affected customers; or
 - 2.16.3 compromise any *transmission licensee's* ability to meet other statutory obligations or licence obligations.
- 2.17 Should system conditions subsequently change, for example due to the proposed connection of a new customer, such that either immediately or in the foreseeable future, the conditions set out in paragraphs 2.17.1 to 2.17.3 are no longer satisfied, then alternative arrangements and/or agreements must be put in place such that this Standard continues to be satisfied.
- 2.18 The additional operational costs referred to in paragraph 2.17.2 and/or any potential reliability implications shall be calculated by simulating the expected operation of the *national electricity transmission system* in accordance with the operational criteria set out in Section 5 and Section 9. Guidance on economic justification is given in Appendix G.

3. Demand Connection Criteria Applicable to the *Onshore Transmission System*

- 3.1 This section presents the planning criteria for the connection of *demand groups* to the remainder of the *onshore transmission system*.
- 3.2 In those parts of the *onshore transmission system* where the criteria of Section 2 and/or Section 4 also apply, those criteria must also be met.
- 3.3 In planning demand connections, this standard is met if the connection design either:
 - 3.3.1 satisfies the deterministic criteria detailed in paragraphs 3.5 to 3.12; or
 - 3.3.2 varies from the design necessary to meet paragraph 3.3.1 above in a manner which satisfies the conditions detailed in paragraphs 3.17 to 3.20.
- 3.4 It is permissible to design to standards higher than those set out in paragraphs 3.5 to 3.12 provided the higher standards can be economically justified. Guidance on economic justification is given in Appendix G.

Demand Connection Capacity Requirements

- 3.5 The *group demand* which is applicable for the assessment of connection capacity requirements is dependent on the nature of the associated connections, i.e.:
 - 3.5.1 where the network associated with a transmission connection comprises demand connections and connections to *small* or *medium power stations* (including those in composite-user sites), *group demand* for future years is equal to the *Network Operator's* estimated maximum demand for the group which they believe could reasonably be imposed on the *onshore transmission system*, after taking due cognisance of demand diversity and the expected operation of any embedded *small* or *medium power stations*.
 - 3.5.2 where the network associated with a transmission connection hosts the connection of one or more *large power stations*, irrespective of whether the *large power station* is connected at the transmission interface point or embedded within the *Network Operator's* system, the *group demand* at the date and time of the system/site maximum demand or other relevant assessment period is equal to:
 - 3.5.2.1 the *Network Operator's group demand* in accordance with paragraph 3.5.1, plus:
 - 3.5.2.2 the output of *large power station(s)*
- 3.6 Where considered appropriate, diversity may be applied to the summation of the power flows arising from consideration of paragraphs 3.5.2.1 and 3.5.2.2

- 3.7 The *transmission capacity* for the connection of a particular *demand group* shall meet the criteria set out in paragraphs 3.7 to 3.11 under the following background conditions:
- 3.7.1 when there are no *planned outages*, the demand of the *demand group* shall be set equal to *group demand*;
 - 3.7.2 when there is a *planned outage* local to the *demand group*, the demand of the *demand group* shall be set equal to *maintenance period demand*;
 - 3.7.3 the security contribution of *small* and *medium power stations* embedded is implicitly accounted for in the group demand established by the Network Operator as in paragraph 3.5.1 and need not be considered separately;
 - 3.7.4 the security contribution of a *large power station* embedded within a customer's network (e.g. distribution network) or connected at the transmission interface point shall be as specified in paragraphs 3.13 to 3.15 and Table 3.2;
 - 3.7.5 any *transfer capacity* (i.e. the ability to transfer demand from one demand group to another) declared by *Network Operators* shall be represented taking account of any restrictions on the timescales in which the *transfer capacity* applies. Any *transfer capacity* declared by the *Network Operators* for use in planning timescales must be reflective of that which could practically be used in operational timescales; and
 - 3.7.6 demand and generation outside the *demand group* shall be set in accordance with the *planned transfer conditions* using the appropriate method described in Appendix C.
- 3.8 The *transmission capacity* for the connection of a *demand group* shall be planned such that, for the background conditions described in paragraph 3.7, under intact system conditions there shall not be any of the following:
- 3.8.1 equipment loadings exceeding the *pre-fault rating*;
 - 3.8.2 voltages outside the *pre-fault planning voltage limits* or *insufficient voltage performance margins*; or
 - 3.8.3 *system instability*
- 3.9 The *transmission capacity* for the connection of a *demand group* shall also be planned such that for the background conditions described in paragraph 3.7 and for the *planned outage* of a single *transmission circuit* or a single section of *busbar* or mesh corner, there shall not be any of the following:
- 3.9.1 a *loss of supply capacity* for a *group demand* of greater than 1MW;
 - 3.9.2 unacceptable overloading of any primary transmission equipment;

- 3.9.3 voltages outside the pre-fault planning voltage limits or insufficient voltage performance margins; or
 - 3.9.4 *system instability*
- 3.10 The *transmission capacity* for the connection of a *demand group* shall also be planned such that for the background conditions described in paragraph 3.7 and the initial conditions of:
- 3.10.1 an *intact system condition*; or
 - 3.10.2 the single *planned outage* of another *transmission circuit*, a *generation circuit*, a *generating unit* (or several *generating units*, sharing a common circuit breaker, that cannot be separately isolated), a *power park module*, a *DC converter*, a reactive compensator or other reactive power provider,
- for the *secured event* of a *fault outage* of:
- 3.10.3 a single *transmission circuit*,
 - 3.10.4 a single *generation circuit*, a single *generating unit* (or several *generating units* sharing a common circuit breaker), *power park module* or a *DC converter*,
- there shall not be any of the following:
- 3.10.5 a *loss of supply capacity* such that the provisions set out in Table 3.1 are not met;
 - 3.10.6 *unacceptable overloading* of any *primary transmission equipment*;
 - 3.10.7 *unacceptable voltage conditions* or *insufficient voltage performance margins*; or
 - 3.10.8 *system instability*
- 3.11 In addition to the requirements of paragraphs 3.7 to 3.9 for the background conditions described in paragraph 3.7, the system shall also be planned such that:
- 3.11.1 *operational switching* or *infrequent operational switching* shall not cause *unacceptable voltage conditions*
- 3.12 For a *secured event* on connections to more than one *demand group*, the permitted *loss of supply capacity* for that *secured event* is the maximum of the permitted *loss of supply capacities* set out in Table 3.1 for each of these *demand groups*.

Table 3.1 Minimum Planning Supply Capacity Following *Secured Events*

| Class | Group Demand | | Initial System Conditions | |
|-------|--------------|----------|--|--|
| | Minimum | Maximum | Intact System | With Single <i>Planned Outage</i> ^{Note 1} |
| A | 0 | ≤1 MW | In repair time <i>Group Demand</i> | Nil |
| B | >1 MW | ≤12 MW | Within 3 hours <i>Group Demand</i> minus 1MW In repair time <i>Group Demand</i> | Nil |
| C | >12 MW | ≤60 MW | Within 15 minutes Smaller of (<i>Group Demand</i> minus 12MW) and two-thirds of <i>Group Demand</i> Within 3 hours <i>Group Demand</i> | Nil |
| D | >60 MW | ≤300 MW | Immediately <i>Group Demand</i> minus 20MW ^{Note 2} Within 3 hours <i>Group Demand</i> | Within 3 hours Smaller of (<i>Group Demand</i> minus 100MW) and one-third of <i>Group Demand</i> Within time to restore planned outage <i>Group Demand</i> |
| E | >300 MW | ≤1500 MW | Immediately <i>Group Demand</i> ^{Note 3} | Immediately <i>Maintenance Period Demand</i> Within time to restore planned outage <i>Group Demand</i> |
| F | >1500 MW | ∞ | Immediately <i>Group Demand</i> | Immediately <i>Group Demand</i> |

Note 1 The planned outage may be of a transmission circuit, generation circuit, generating unit, reactive compensator or other reactive power provider

Note 2 The group demand may be lost for up to 60 seconds if this leads to significant economies

Note 3 Up to 60MW may be lost for up to 60 seconds if this leads to significant economies

Assessment of Contribution to Security from Generation

- 3.13 Where network assets are insufficient to meet the security requirements, it is necessary to assess the contribution to security from *large power stations* connected at either the transmission connection interface or embedded within the *Networks Operator's* system. This will identify whether the aggregate generation capacity of the *large power station* connected to the network has the potential to meet any deficit in system security from network assets.
- 3.14 The combined contribution by *large power stations* shall never have a greater impact on system security than the loss of the largest circuit infeed to the group. The contributions from embedded *small* and *medium power stations* provide additional capacity to enable the supply of demand which may not otherwise be met following a *secured event*, but shall not replace the requirement for system connection. The assessment of contribution of generation to group security will therefore consider;
- 3.14.1 the generation *annual load factor*;
 - 3.14.2 the availability of generation under outage conditions;
 - 3.14.3 the fuel source availability, i.e. whether energy is continuous, stored, storable or predictable;
 - 3.14.4 common-mode failure mechanisms such as common fuel source, connections or plant stability / ride-through capability;
 - 3.14.5 capping of generation contribution in the event that the generation contribution is dominant with respect to circuit infeed capability
- 3.15 The effective contribution of *large power stations* to *demand group* importing capacity, shall not exceed the levels indicated in Table 3.2 while taking due account of the considerations detailed in paragraph 3.13.

Table 3.2 Effective contribution of embedded *large power stations* to *demand group* importing capacity in *NGET's transmission system*

| Expected <i>annual load factor</i> of generation | Initial system conditions | |
|--|---|---|
| | <i>Intact system</i> | with single <i>Planned Outage</i> |
| Over 30% | 67% of <i>Registered Capacity</i> | For demand groups greater than 60MW only 67% of <i>Registered Capacity</i> |
| Over 10% to 30% | Smaller of 67% of <i>Registered Capacity</i> and 20% of <i>Group Demand</i> | For demand groups greater than 300MW only Smaller of 67% of <i>Registered Capacity</i> and 13% of <i>Group Demand</i> |
| up to 10% | Smaller of 67% of <i>Registered Capacity</i> and 10% of <i>Group Demand</i> | For demand groups greater than 300MW only Smaller of 67% of <i>Registered Capacity</i> and 7% of <i>Group Demand</i> |

Switching Arrangements

- 3.16 Guidance on substation configurations and switching arrangements are described in Appendix A. These guidelines provide an acceptable way towards meeting the criteria of this chapter. However, other configurations and switching arrangements which meet the criteria are also acceptable.

Variations to Connection Designs

- 3.17 Variations, arising from a demand customers request, to the demand connection design necessary to meet the requirements of paragraphs 3.5 to 3.12 shall also satisfy the requirements of this standard provided that the varied design satisfies the conditions set out in paragraphs 3.18.1 to 3.18.3. For example, such a demand connection design variation may be used to reflect the nature of connection of embedded generation or particular load cycles.
- 3.18 Any demand connections design variation must not, other than in respect of the demand customer requesting the variation, either immediately or in the foreseeable future:
- 3.18.1 reduce the security of the *MITS* to below the minimum planning criteria specified in Section 4; or
 - 3.18.2 result in additional investment or operational costs to any particular customer or overall, or a reduction in the security and quality of supply of the affected customers' connections to below the planning criteria in the section or Section 2, unless specific agreements are reached with affected customers; or
 - 3.18.3 compromise any *transmission licensee's* ability to meet other statutory obligations or license obligations.
- 3.19 Should system conditions change, for example due to the proposed connection of a new customer, such that either immediately or in the foreseeable future, the conditions set out in paragraphs 3.18.1 to 3.18.3 are no longer satisfied, then alternative arrangements and/or agreements must be put in place such that this standard continues to be satisfied.
- 3.20 The additional operational costs referred to in paragraph 3.18.2 and/or any potential reliability implications shall be calculated by simulating the expected operation of the *onshore transmission system* in accordance with the operational criteria set out in Section 5 and Section 9. Guidance on economic justification is given in Appendix G.

4. Design of the *Main Interconnected Transmission System*

- 4.1 This section presents the planning criteria for the *Main Interconnected Transmission System (MITS)*.
- 4.2 In those parts of the *onshore transmission system* where the criteria of Section 2 and/or Section 3 also apply, those criteria must also be met. In those parts of the *offshore transmission system* where the criteria of Section 7 and/or Section 8 also apply, those criteria must also be met.
- 4.3 In planning the *MITS*, this Standard is met if the design satisfies the minimum deterministic criteria detailed in paragraphs 4.4 to 4.12. It is permissible to design to standards higher than those set out in paragraphs 4.4 to 4.12 provided the higher standards can be economically justified. Guidance on economic justification is given in Appendix G.

Minimum *Transmission Capacity Requirements*

At ACS peak demand with an intact system

- 4.4 The *MITS* shall meet the criteria set out in paragraphs 4.5 to 4.6 under both the Security and Economy background conditions below:

Security Background

- 4.4.1 *generating units'* outputs shall be set to those arising from the *security planned transfer condition* described in Appendix C;
- 4.4.2 power flows shall be set to those arising from the *security planned transfer condition* (using the appropriate method described in Appendix C) prior to any fault, and such power flows modified by an appropriate application of the *interconnection allowance* (using the methods described in Appendix D) under *secured events*;

Economy Background

- 4.4.3 *generating units'* outputs shall be set to those arising from the *economy planned transfer condition* described in Appendix E;
- 4.4.4 power flows shall be set to those arising from the *economy planned transfer condition* (using the appropriate method described in Appendix E) prior to any fault, and such power flows modified by an appropriate application of the *boundary allowance* (using the methods described in Appendix F) under *secured events*;

Security and Economy Backgrounds

- 4.4.5 sensitivity cases on the conditions described in 4.4.2 and 4.4.4 shall comprise *generating units* with output equal to their *registered capacities* such that the required power transfers described in 4.4.2 and 4.4.4 above are approximated by selection of individual units; and

- 4.4.6 the expected availability of generation reactive capability shall be set to that which ought reasonably to be expected to arise. This shall take into account the variation of reactive capability with the active power output (for example, as defined in the machine performance chart). In the absence of better data the expected available capability shall not exceed 90% of the Grid Code specified capability, (unless modified by a direction of the *Authority*) or 90% of the contracted capability for the active power output level, whichever is relevant.
- 4.5 The minimum *transmission capacity* of the *MITS* shall be planned such that, for the background conditions described in paragraph 4.4, prior to any fault there shall not be:
- 4.5.1 equipment loadings exceeding the *pre-fault rating*;
 - 4.5.2 voltages outside the *pre-fault planning voltage limits* or *insufficient voltage performance margins*; or
 - 4.5.3 *system instability*.
- 4.6 The minimum *transmission capacity* of the *MITS* shall also be planned such that for the conditions described in paragraph 4.4 and for the *secured event* of a *fault outage* of any of the following:
- 4.6.1 a single *transmission circuit*, a reactive compensator or other reactive power provider;
 - 4.6.2 a single *generation circuit*, a single *generating unit* (or several *generating units* sharing a common circuit breaker), a single *power park module*, or a single *DC converter*;
 - 4.6.3 a double circuit overhead line on the supergrid;
 - 4.6.4 a double circuit overhead line where any part of either circuit is in *NGET's* transmission system or *SHETL's* transmission system;
 - 4.6.5 a section of *busbar* or mesh corner; or
 - 4.6.6 provided both the *fault outage* and prior outage involve plant in *NGET's* transmission area, any single *transmission circuit* with the prior outage of another *transmission circuit* containing either a transformer in series or a cable section located wholly or mainly outside a substation, or a *generating unit* (or several *generating units*, sharing a common circuit breaker, that cannot be separately isolated), reactive compensator or other reactive power provider,
- there shall not be any of the following:
- 4.6.7 *loss of supply capacity* (except as permitted by the demand connection criteria detailed in Section 3 and Section 8);
 - 4.6.8 *unacceptable overloading* of any *primary transmission equipment*;

4.6.9 *unacceptable voltage conditions or insufficient voltage performance margins; or*

4.6.10 *system instability.*

Under conditions in the course of a year of operation

4.7 The *MITS* shall meet the criteria set out in paragraphs 4.8 to 4.10 under the following background conditions:

4.7.1 conditions on the *national electricity transmission system* shall be set to those which ought reasonably to be foreseen to arise in the course of a year of operation. Such conditions shall include forecast demand cycles, typical *power station* operating regimes and typical *planned outage* patterns; and

4.7.2 the expected availability of generation reactive capability shall be set to that which ought reasonably to be expected to arise. This shall take into account the variation of reactive capability with the active power output (for example, as defined in the machine performance chart). In the absence of better data the expected available capability shall not exceed 90% of the Grid Code specified capability, (unless modified by a direction of the *Authority*) or 90% of the contracted capability for the active power output level, whichever is relevant.

4.8 The minimum *transmission capacity* of the *MITS* shall be planned such that, for the background conditions described in paragraph 4.7, prior to any fault there shall not be:

4.8.1 equipment loadings exceeding the *pre-fault rating*;

4.8.2 voltages outside the *pre-fault planning voltage limits or insufficient voltage performance margins; or*

4.8.3 *system instability.*

4.9 The minimum *transmission capacity* of the *MITS* shall also be planned such that, for the background conditions described in paragraph 4.7, the operational security criteria set out in Section 5 can be met.

4.10 Where necessary to satisfy the criteria set out in paragraphs 4.8 and 4.9, investment should be made in *transmission capacity* except where operational measures suffice to meet the criteria in paragraphs 4.8 and 4.9 provided that maintenance access for each *transmission circuit* can be achieved and provided that such measures are economically justified. The operational measures to be considered include rearrangement of transmission outages and appropriate reselection of *generating units* from those expected to be available, for example through *balancing services*. Guidance on economic justification is given in Appendix G.

General Criteria

- 4.11 In addition to the requirements set out in paragraphs 4.4 to 4.10, the system shall also be planned such that:
- 4.11.1 *operational switching* or *infrequent operational switching* shall not cause *unacceptable voltage conditions*,
- 4.12 *Transmission circuits* comprising the *supergrid* part of the *MITS* shall not exceed the circuit complexity limit defined in paragraphs B.3 to B.7 of Appendix B.
- 4.13 Guidance on complexity of *transmission circuits* on the *MITS* operated at a nominal voltage of 132kV is given in paragraphs B.8 to B.13 of Appendix B. Relaxation of the restrictions cited in paragraphs B.8 to B.13 may be justified in certain circumstances following appropriate liaison between the relevant *transmission licensees* responsible for the design of the circuits and their operation.

Switching Arrangements

- 4.14 Guidance on substation configurations and switching arrangements are described in Appendix A. These guidelines provide an acceptable way towards meeting the criteria of this section. However, other configurations and switching arrangements which meet the criteria are also acceptable.

5. Operation of the Onshore Transmission System

Normal Operational Criteria

- 5.1 The *onshore transmission system* shall be operated under *prevailing system conditions* so that for the *secured event* of a *fault outage* on the *onshore transmission system* of any of the following:
- 5.1.1 a single *transmission circuit*, a reactive compensator or other reactive power provider; or
 - 5.1.2 a single *generation circuit*, a single *generating unit* (or several *generating units* sharing a common circuit breaker), a single *power park module*, or a single *DC converter*; or
 - 5.1.3 the most onerous *loss of power infeed*; or
 - 5.1.4 where the system is designed to be secure against a *fault outage* of a section of *busbar* or mesh corner under *planned outage* conditions, a section of *busbar* or mesh corner,
- there shall not be any of the following:
- 5.1.5 a *loss of supply capacity* except as specified in Table 5.1
 - 5.1.6 unacceptable frequency conditions;
 - 5.1.7 unacceptable overloading of any primary transmission equipment;
 - 5.1.8 unacceptable voltage conditions; or
 - 5.1.9 *system instability*
- 5.2 For a *secured event* on the *onshore transmission system* on connections to more than one *demand group* the permitted *loss of supply capacity* for that *secured event* is the maximum of the permitted loss of supply capacities set out in Table 5.1 for each of these *demand groups*.
- 5.3 The *onshore transmission system* shall be operated under *prevailing system conditions* so that for the *secured event* on the *onshore transmission system* of a *fault outage* of:
- 5.3.1 a *double circuit overhead line*; or
 - 5.3.2 a section of *busbar* or mesh corner,
- there shall not be any of the following:
- 5.3.3 a *loss of supply capacity* greater than 1500 MW;
 - 5.3.4 *unacceptable frequency conditions*; or
 - 5.3.5 *unacceptable voltage conditions* affecting one or more *Grid Supply Points* for which the total *group demand* is greater than 1500 MW; or

5.3.6 *system instability* of one or more *generating units* connected to the *supergrid*.

5.4 The *onshore transmission system* shall be operated under *prevailing system conditions* so that for the *secured event* on the *supergrid* of a *fault outage* of:

5.4.1 a *double circuit overhead line* where any part of either circuit is in *NGET's transmission system*; or

5.4.2 a section of *busbar* or mesh corner in *NGET's transmission system*,

there shall not be:

5.4.3 *unacceptable overloading* of *primary transmission equipment* in *NGET's transmission system*;

5.4.4 *unacceptable voltage conditions* in *NGET's transmission system*.

Table 5.1 Maximum permitted *loss of supply capacity* following *secured events*

| Group Demand | Initial system conditions | |
|------------------------|--|---|
| | <i>Prevailing system conditions</i> with no <i>local system outage</i> Note 1,2 | <i>Prevailing system conditions</i> with a <i>local system outage</i> Note 1 |
| over 1500 MW | None | None Note 3 |
| over 300 MW to 1500 MW | None Note 4 | None Note 3 |
| over 60 MW to 300 MW | None except that where such facilities and suitable measures for restoration are available, up to 20 MW by automatic disconnection Note 5 | Whole group up to <i>Group Demand</i> for up to the operational specified time to restore supply capacity |
| over 12 MW to 60 MW | None except that where such facilities and suitable measures for restoration are available, up to 12 MW by automatic disconnection for up to 15 minutes. | Whole group up to <i>Group Demand</i> |
| over 1 MW to 12 MW | Whole group up to <i>Group Demand</i> for up to the operational specified time to restore supply capacity | Whole group up to <i>Group Demand</i> |
| up to 1 MW | Whole group up to <i>Group Demand</i> for up to the operational specified time to restore supply capacity | Whole group up to <i>Group Demand</i> |

Notes

1. The time to restore any lost supply capacity shall be as short as practicable. If any part of any lost supply capacity can be restored in less than the specified maximum time to restore all of it, it shall be restored.
2. Where the supply capacity was designed in such a way, there should be no *loss of supply capacity*.

3. Where the supply capacity to the *Grid Supply Point* was designed in accordance with the demand connection criteria in Section 3 in such a way as to permit it, a *loss of supply capacity* equal to any amount by which the prevailing demand exceeds the *maintenance period demand* may be permitted up to a maximum of 1500 MW for no longer than the operational specified time to restore supply capacity.
4. Where the supply capacity to the *Grid Supply Point* was designed in accordance with the demand connection criteria in Section 3 in such a way as to permit it, up to 60 MW may be lost for up to 60 seconds.
5. Where the supply capacity to the *Grid Supply Point* was designed in accordance with the demand connection criteria in Section 3 in such a way as to permit it, up to the *group demand* may be lost for up to 60 seconds.

Conditional Further Operational Criteria

5.5 If:

5.5.1 there are *adverse conditions* such that the likelihood of a *double circuit overhead line* fault is significantly higher than normal; or

5.5.2 there is no significant economic justification for failing to secure the *onshore transmission system* to this criterion and the probability of *loss of supply capacity* is not increased by following this criterion,

the *onshore transmission system* shall be operated under *prevailing system conditions* so that for the *secured event of*

5.5.3 a *fault outage* on the *supergrid* of a *double circuit overhead line*

there shall not be:

5.5.4 where possible and there is no significant economic penalty, any *loss of supply capacity* greater than 300 MW;

5.5.5 *unacceptable overloading* of any *primary transmission equipment*;

5.5.6 *unacceptable voltage conditions*;

5.5.7 *system instability*.

5.6 During periods of *major system risk*, ~~NGET~~ NGESO may implement measures to mitigate the consequences of this risk. Such measures may include: providing additional reserve; reducing system-to-*generator* intertrip risks, securing as far as possible appropriate two-circuit combinations, or reducing system transfers, for example through *balancing services*.

5.7 In the case that neither of the conditions in paragraphs 5.5.1 and 5.5.2 is met, it is acceptable to utilise short term post fault actions to avoid *unacceptable overloading* of *primary transmission equipment* which may include a requirement for demand reduction; however, this will not be used as a method of increasing reserve to cover abnormal post fault generation reduction. Where possible these post fault actions shall be notified to the appropriate *Network Operator* or *Generator*. Normally the provisions of the Grid Code, in respect of Emergency Manual Demand Disconnection and/or, for example through *balancing services*, will be applied. Additional post fault actions

beyond the Grid Code provisions may be applied, but only where they have been agreed in advance with the appropriate *Network Operator* or *Generator*.

Post-fault Restoration of System Security

- 5.8 Following the occurrence of a *secured event* on the *onshore transmission system*, measures shall be taken to re-secure the system to the above operational criteria as soon as reasonably practicable. To this end, it is permissible to put operational measures in place pre-fault to facilitate the speedy restoration of system security.

Authorised Variations from the Operational Criteria

- 5.9 Provided it is in accordance with the appropriate requirements of the demand connection criteria in Section 3, there may be associated *loss of supply capacity* due to a *secured event*, for example by virtue of the design of the generation connections and/or the designed switching arrangements at the substations concerned.
- 5.10 Exceptions to the criteria in paragraphs 5.1 to 5.8 may be required where variations to the connection designs as per paragraphs 3.12 to 3.15 have been agreed.
- 5.11 The principles of these operational criteria shall be applied at all times except in special circumstances where ~~NGETNGESO~~, following consultation with the appropriate *Network Operator*, *Generator* or *Non-Embedded Customer*, may need to give instructions to the contrary to preserve overall system integrity.

6. Voltage Limits in Planning and Operating the *Onshore Transmission System*

Voltage and Voltage Performance Margins in Planning Timescales

6.1. A voltage condition is unacceptable in planning timescales if:

6.1.1. There is any inability to achieve pre-fault steady-state voltages as specified in Table 6.1 at *onshore transmission system* substations or *GSPs*,

or

6.1.2. if, after either:

6.1.2.1. a *secured event*,

or

6.1.2.2. *operational switching*,

and the affected site remains directly connected to the *onshore transmission system* in the *steady state* after the relevant event above, any of the following conditions applies:

6.1.2.3. the *voltage step change* at an interface between the *onshore transmission system* and a *User System* exceeds that specified in Table 6.5

or

6.1.2.4. there is any inability following such an event to achieve a *steady state* voltage as specified in Table 6.2 at *onshore transmission system* substations or *GSPs* using manual and/or automatic facilities available, including the switching in or out of relevant equipment,

or

6.1.3. if, pre-fault, or after either:

6.1.3.1. a *secured event*,

or

6.1.3.2. *operational switching*

there are *insufficient voltage performance margins*, as evidenced by:

- i) *voltage collapse*;
- ii) over-sensitivity of system voltage; or
- iii) unavoidably exceeding the continuous reactive capability expected to be available from *generating units* or other reactive sources, so that accessible reactive reserves are exhausted;

under any of the following conditions:

- i) credible demand sensitivities;
 - ii) the unavailability of any single reactive compensator or other reactive power provider; or
 - iii) the loss of any one automatic switching system or any automatic voltage control system for on-load tap changing.
- 6.2. The *steady state* voltages are to be achieved without widespread post-fault re-despatch of *generating unit* reactive output or changes to set-points of SVCs or automatic reactive switching schemes and without exceeding the available reactive capability of generation or SVCs. In particular, following a *secured event*, the target voltages at Grid Supply Points should be achieved after the operation of local reactive switching and auto-switching schemes, and after the operation of Grid Supply Transformer tap-changers.
- 6.3. The *pre-fault planning voltage limits* and targets on the *onshore transmission system* are as shown in Table 6.1.

Table 6.1 Pre-Fault Steady State Voltage Limits and Requirements in Planning Timescales

| (a) Voltage Limits on Transmission Networks | | |
|---|---|------------------------------|
| Nominal Voltage | Minimum (Note 1) | Maximum |
| 400kV | 390kV (97.5%) | 410kV (102.5%) Note 2 |
| 275kV | 261kV (95%) | 289kV (105%) |
| 132kV | 125kV (95%) | 139kV (105%) |
| (b) Voltages to be Achievable at Interfaces to Distribution Networks | | |
| Nominal Voltage | | |
| Any | 105% at forecast <i>Group Demand</i> ; 100% at forecast <i>Minimum Demand</i> , or as otherwise agreed with the relevant Network Operator | |

Notes

1. It is permissible to relax these to the limits specified in Table 6.2 if:
 - (i) following a *secured event*, the voltage limits specified in Table 6.2 can be achieved, and
 - (ii) there is judged to be sufficient certainty of meeting Security and Quality of Supply Standards in operational timescales.
 2. It is permissible to relax this to 420kV (105%) if there is judged to be sufficient certainty that the limit of 420kV (105%) can be met in operational timescales.
- 6.4. The voltage limits in Table 6.2 are to be observed following any *secured event*.

Table 6.2 Steady State Voltage Limits and Requirements in Planning Timescales

| (a) Voltage Limits on Transmission Networks | | |
|---|--|---------------------------------|
| Nominal Voltage | Minimum | Maximum |
| 400kV | 380kV (95%) Note 3 | 410kV (102.5%) Note 4 |
| 275kV | 248kV (90%) | 289kV (105%) |
| 132kV | 119kV (90%) | 139kV (105%) |
| (b) Voltage Limits at Interfaces to Distribution Networks | | |
| Nominal Voltage | | |
| Any | See below for the minimum voltage that must be achievable. Must always exceed lower limits of Table 6.4(b) | 105% |
| (c) Voltages to be Achievable at Interfaces to Distribution Networks | | |
| Nominal Voltage | - | |
| Any | 100% at any demand level Note 5 or as otherwise agreed with the relevant Network Operator | |

Notes

3. It is permissible to relax this to 360kV (-10%) if the affected substations are on the same radially fed spur post-fault, and:
 - (i) there is no lower voltage interconnection from these substations to other *supergrid* substations; and
 - (ii) no auxiliaries of *large power stations* are derived from them.
4. It is permissible to relax this to 420kV (+5%) if there is judged to be sufficient certainty of meeting Security and Quality of Supply Standards in operational timescales, and operational measures to achieve these are identified at the planning stage.
5. May be relaxed downwards following a secured event involving the outage of a Grid Supply Transformer, provided that there is judged to be sufficient certainty that the limits of Table 6.4(b) can be met in operational timescales.
- 6.5. For a site or a group of sites with a combined *group demand* of less than 1500MW, operational measures shall be identified at the planning stage to ensure that the requirements of Table 6.3 and 6.4 can be met in operational timescales for all sites remaining connected following any *secured event* for which it is not required to secure the full *group demand*.

Voltage Limits in Operational Timescales

- 6.6. A voltage condition is unacceptable in operational timescales if:
 - 6.6.1. there is any inability to achieve pre-fault *steady-state* voltages as specified in Table 6.3 at *onshore transmission system* substations or *GSPs*
 - or
 - 6.6.2. if, after either

6.6.2.1. a *secured event*,

or

6.6.2.2. *operational switching*

and the affected site remains directly connected to the *onshore transmission system* in the *steady state* after the relevant event above, either of the following conditions applies:

6.6.2.3. the *voltage step change* at an interface between the *onshore transmission system* and a *User System* exceeds that specified in Table 6.5,

or

6.6.2.4. there is any inability following such an event to achieve a *steady state* voltage as specified in Table 6.4 at *onshore transmission system* substations or *GSPs* using manual and/or automatic facilities available, including the switching in or out of relevant equipment.

Table 6.3 Pre-Fault Steady State Voltage Limits and Targets in Operational Timescales

| (a) Voltage Limits on Transmission Networks | | |
|---|---|--------------|
| Nominal Voltage | Minimum | Maximum |
| 400kV | 380kV (95%) Note 6 | 420kV (105%) |
| 275kV | 261kV (95%) Note 6 | 300kV (109%) |
| 132kV | 125kV (95%) Note 6 | 145kV (110%) |
| (b) Voltages to be Achievable at Interfaces to Distribution Networks | | |
| Nominal Voltage | - | |
| Any | Target voltages and voltage ranges as agreed with the relevant Distribution Network Operators, within the limits of Table 6.4 | |

Notes

6. It is permissible to relax this to 90% at substations if no auxiliaries of *large power stations* are derived from them.

Table 6.4 Steady State Voltage Limits and Targets in Operational Timescales

| (a) Voltage Limits on Transmission Networks | | |
|--|-------------|----------------------------|
| Nominal Voltage | Minimum | Maximum |
| 400kV | 360kV (90%) | 420kV (105%) Note 7 |
| 275kV | 248kV (90%) | 300kV (109%) |
| 132kV | 119kV (90%) | 145kV (110%) |
| (b) Voltage Limits at Interfaces to Distribution Networks | | |
| Nominal Voltage | | |
| 132kV | 119kV (90%) | 145kV (110%) |
| At less than 132kV | 94% | 106% |

Notes

7. May be relaxed to 440kV (110%) for no longer than 15 minutes following a *secured event*.

Voltage Step Change Limits in All Timescales

- 6.7. *Voltage step change* limits must be observed at every interface point between the *national electricity transmission system* and Users' plant. The *voltage step change* limits do not apply where no User is connected.
- 6.8. The *voltage step change* limits must be applied with load response taken into account.

Table 6.5 Voltage Step Change Limits in Planning and Operational Timescales

| Type of Event | Voltage Fall | Voltage Rise |
|---|-------------------------------|--------------|
| (a) At substations supplying User Systems at any voltage | | |
| 1. Following <i>operational switching</i> at intervals of less than 10 minutes | In accordance with Figure 6.1 | |
| 2. Following <i>operational switching</i> at intervals of more than 10 minutes, | -3% | +3% |
| 3. except for <i>infrequent operational switching</i> events as described below | | |
| 4. Following <i>infrequent operational switching</i> (Notes 8, 9) | -6% | +6% |
| 5. In planning timescales, following a <i>fault outage of a double circuit supergrid</i> overhead line (Note 10) | -6% | +6% |

| | | |
|--|------|-----|
| 6. Following any other <i>secured event</i> , (Note 11) <u>except as detailed below:</u> | -6% | +6% |
| (b) At substations supplying User Systems at voltages above 132kV | | |
| 7. Following a <i>secured event</i> involving a <i>fault outage</i> of a section of <i>busbar</i> or a mesh corner | -12% | +6% |
| 8. In operational timescales, following a <i>secured event</i> involving a <i>fault outage</i> of a <i>double circuit</i> overhead line | -12% | +6% |
| (c) At substations supplying User Systems at 132kV As (a) and (b) plus: | | |
| 9. Following a <i>secured event</i> involving loss of a double circuit transmission overhead line, and one or more <i>supergrid</i> transformers stepping down to 132 kV | -12% | +6% |
| 10. Following a <i>secured event</i> involving loss of a single <i>transmission circuit</i> and one or more <i>supergrid</i> transformers stepping down to 132kV, with a prior outage of another circuit connected to the substation or of another mesh corner at the substation | -12% | +6% |
| 11. Following a <i>secured event</i> involving loss of a <i>double circuit</i> transmission overhead line operating at 132kV (Note 12) | -12% | +6% |
| (d) At substations supplying User Systems at voltages below 132kV As (a), (b) and (c) plus: | | |
| 12. Following a <i>secured event</i> involving the loss of one or more Grid Supply Transformers | -12% | +6% |

Notes

8. An individual User must not experience voltage steps exceeding $\pm 3\%$ due to infrequent operational switching:
- on a regular basis, and / or
 - at intervals of less than two hours,
 - unless abnormal conditions prevail
- Infrequent operational switching* would typically include disconnection of circuits for routine maintenance. It would not include switching out of circuits for voltage control, or switching out of circuits to allow safe access to other plant, where it is foreseen that such switching may be a regular practice; such events would be classed as *operational switching*.
9. Voltage steps exceeding $\pm 3\%$ due to *infrequent operational switching* may be accepted only on busbars or circuits fed directly by the *transmission circuits* involved in the *infrequent operational switching*.
10. It is permissible to relax this to -12%, +6% in Scotland if the aggregate demand of sites experiencing voltage falls between 6% and 12% and does not exceed 1500MW.
11. Operationally, the -6% requirement may be relaxed to -12% at a site or sites with a combined group demand of less than 1500MW, provided all other NETS SQSS requirements are met, if the -6% requirement may only be met by shedding load.

12. In planning timescales, for demand groups with aggregate demand less than 1500MW, this criterion applies to any demand left connected post-fault. Operationally, this criterion only applies for demand groups with aggregate demand greater than 1500MW.

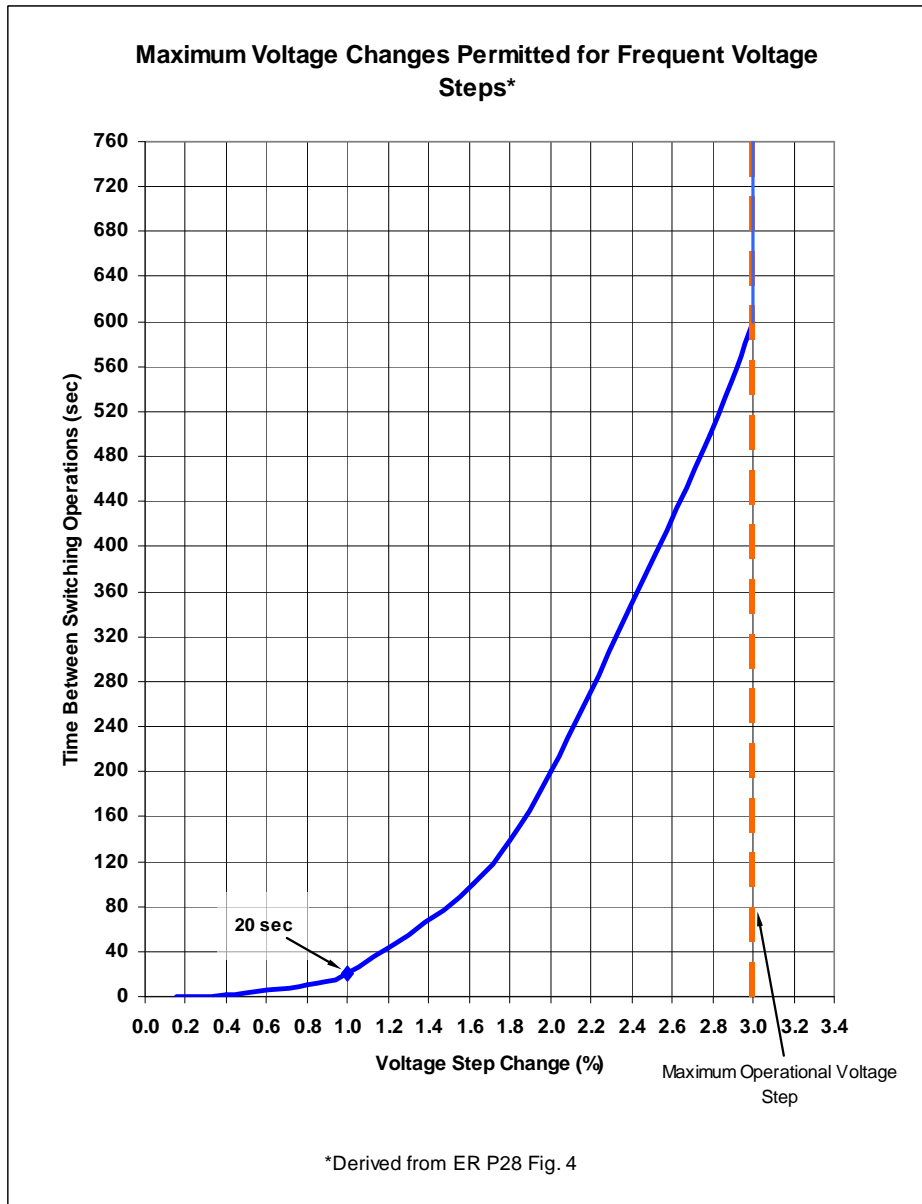

Figure 6.1 Maximum Voltage Step Changes Permitted for *Operational Switching*

7. Generation Connection Criteria Applicable to an Offshore Transmission System

- 7.1 This section presents the planning criteria applicable to the connection of one or more *offshore power stations* to an *offshore transmission system*. The criteria in this section apply from the *offshore grid entry point/s (GEP)* at which each *offshore power station* connects to an *offshore transmission system*, through the remainder of the *offshore transmission system* to the point of connection at the *first onshore substation*, which is the *interface point (IP)* in the case of a direct connection to the *onshore transmission system* or the *user system interface point (USIP)* in the case of a connection to an onshore *user system*.
- 7.2 Planning criteria are defined for all elements of an *offshore transmission system* including: the *offshore transmission circuits* and equipment on the *offshore platform* (whether AC or DC); the *offshore transmission circuits* from the *offshore platform* to the *interface point* or *user system interface point* (as the case may be) including undersea cables and any overhead lines (whether AC or DC); and any onshore AC voltage transformation facilities or *DC converter* facilities.
- 7.3 In those parts of the *national electricity transmission system* where the criteria of Section 8 and/or Section 4 also apply, those criteria must also be met.
- 7.4 In planning *offshore* generation connections, this Standard is met if the connection design either:
- 7.4.1 satisfies the deterministic criteria detailed in paragraphs 7.6 to 7.18; or
 - 7.4.2 varies from the design necessary to meet paragraph 7.4.1 above in a manner which satisfies the conditions detailed in paragraphs 7.20 to 7.23.
- 7.5 It is permissible to design to standards higher than those set out in paragraphs 7.6 to 7.18 provided the higher standards can be economically justified. Guidance on economic justification is given in Appendix G.

Limits to Loss of Power Infeed Risks

- 7.6 For the purpose of applying the criteria of paragraphs 7.7 to 7.12, the *loss of power infeed* resulting from a *secured event* shall be calculated as follows:
- 7.6.1 the sum of the *registered capacities* of the *offshore power park modules* or *offshore gas turbines* disconnected from the system by a *secured event*, less
 - 7.6.2 the *forecast minimum demand* disconnected from the system by the same event but excluding (from the deduction) any demand forming part of the *forecast minimum demand* which may be automatically tripped for system frequency control purposes and excluding (from the deduction) the demand of the largest single end customer.

Offshore Platforms (AC and DC)

7.7 Offshore generation connections on offshore platforms shall be planned such that, starting with an *intact system*, the consequences of *secured events* on the offshore transmission system shall be as follows;

7.7.1 AC Circuits on an offshore platform

7.7.1.1 in the case of *offshore power park module* only connections, and where the *offshore grid entry point capacity* is 90MW or more, following a *planned outage* or a *fault outage* of a single AC *offshore* transformer circuit on the *offshore platform*, the *loss of power infeed* shall not exceed the smaller of either:

50% of the *offshore grid entry point capacity*; or
the full *normal infeed loss risk*.

7.7.1.2 in the case of gas turbine only connections, and where the *offshore grid entry point capacity* is 90MW or more, following a *planned outage* or a *fault outage* of a single AC *offshore transmission circuit* on the *offshore platform*, there shall be no *loss of power infeed*;

7.7.1.3 following a *fault outage* of a single AC *offshore transmission circuit* on the *offshore platform*, during a *planned outage* of another AC *offshore transmission circuit* on the *offshore platform*, the further *loss of power infeed* shall not exceed the *infrequent infeed loss risk*.

7.7.2 DC Circuits on an offshore platform

7.7.2.1 following a *planned outage* or a *fault outage* of a single DC *converter* on the *offshore platform*, the *loss of power infeed* shall not exceed the *normal infeed loss risk*;

7.7.2.2 following a *fault outage* of a single DC *converter* on the *offshore platform*, during a *planned outage* of another DC *converter* on the *offshore platform*, the further *loss of power infeed* shall not exceed the *infrequent infeed loss risk*.

7.7.3 Busbars and Switchgear on an offshore platform

7.7.3.1 following a *planned outage* of any single section of *busbar* or mesh corner, the *loss of power infeed* shall not exceed the *normal infeed loss risk*;

7.7.3.2 following a *fault outage* of any single section of *busbar* or mesh corner, the *loss of power infeed* shall not exceed the *infrequent infeed loss risk*;

7.7.3.3 following a *fault outage* of any single *busbar* coupler circuit breaker or *busbar* section circuit breaker or mesh circuit

breaker, the *loss of power infeed* shall not exceed the *infrequent infeed loss risk*;

7.7.3.4 following a *fault outage* of any single section of *busbar* or mesh corner, during a *planned outage* of any other single section of *busbar* or mesh corner, the *loss of power infeed* shall not exceed the *infrequent infeed loss risk*;

7.7.3.5 following a *fault outage* of any single *busbar* coupler circuit breaker or *busbar* section circuit breaker or mesh circuit breaker, during a *planned outage* of any single section of *busbar* or mesh corner, the *loss of power infeed* shall not exceed the *infrequent infeed loss risk*.

Cable Circuits (AC and DC)

7.8 The transmission connections between one *offshore platform* and another *offshore platform* or from an *offshore platform* to the *interface point* or *user system interface point* at the *first onshore substation* shall be planned such that, starting with an *intact system* and for the full *offshore grid entry point capacity* at the *offshore grid entry point*, the consequences of *secured events* shall be as follows:

7.8.1 following a *planned outage* or a *fault outage* of a single cable *offshore transmission circuit*, the *loss of power infeed* shall not exceed the *infrequent infeed loss risk*; and

7.8.2 following a *fault outage* of a single cable *offshore transmission circuit* during a *planned outage* of another cable *offshore transmission circuit* the further *loss of power infeed* shall not exceed the *infrequent infeed loss risk*.

Overhead Line Sections (AC and DC)

7.9 In the case AC overhead line connections of 132kV, between the incoming AC cable *offshore transmission circuits* and the *first onshore substation* or the onshore AC transformation facilities (as the case may be), the justification for a minimum of one circuit or two circuits is illustrated in Figure 7.1. In Figure 7.1 the justification is presented as a function of route length and *offshore grid entry point capacity*. The area above the line represents justification for a minimum of two circuits and the area below the line represents justification for a minimum of one circuit.

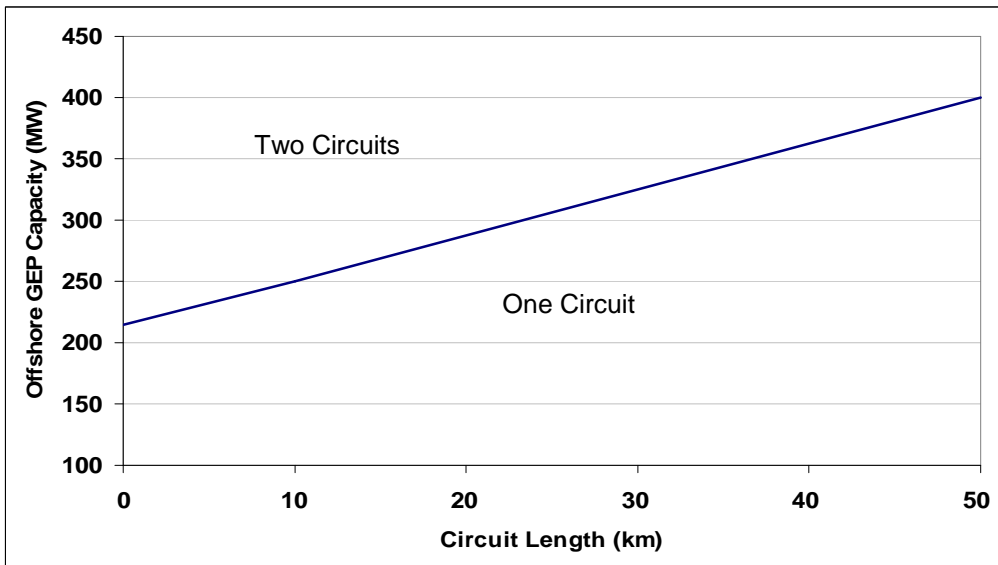

Figure 7.1 Justification for a Minimum of One Circuit or a Minimum of Two Circuits for 132kV AC Overhead Lines

- 7.10 In the case of AC overhead line connections of 220kV or above, between the incoming AC cable *offshore transmission circuits* and the *first onshore substation* or the onshore AC transformation facilities (as the case may be), a single circuit is justified as a minimum for *offshore grid entry point capacities* of 1250MW or less and two circuits are justified as a minimum for *offshore grid entry point capacities* greater than 1250MW.
- 7.11 Overhead line (AC or DC) connections between the cable (AC or DC) *offshore transmission circuits* and the *first onshore substation* or the onshore AC transformation facilities or DC conversion facilities, as the case may be, shall be planned such that, starting with an *intact system* and for the full *offshore grid entry point capacity* at the *offshore grid entry point*, the consequences of a *secured event* on the *offshore transmission system* shall be as follows:
 - 7.11.1 following a *planned outage* or a *fault outage* of a single overhead line circuit, the *loss of power infeed* shall not exceed the *infrequent infeed loss risk*;
 - 7.11.2 following a *fault outage* of a single overhead line circuit during a *planned outage* of another overhead line circuit, the further *loss of power infeed* shall not exceed the *infrequent infeed loss risk*.

Onshore Connection Facilities (AC and DC)

- 7.12 The transmission connections at the onshore AC transformation or DC conversion facilities shall be planned such that, starting with an *intact system*,

the consequences of *secured events* on the *offshore transmission system* shall be as follows;

7.12.1 AC Circuits

7.12.1.1 in the case of *offshore power park module* only connections, and where the *offshore grid entry point capacity* is 120MW or more, following a *planned outage* or a *fault outage* of a single AC *offshore* transformer circuit at the onshore AC transformation facilities, the *loss of power infeed* shall not exceed the smaller of either:

50% of the *offshore grid entry point capacity*; or
the full *normal infeed loss risk*.

7.12.1.2 in the case of gas turbine only connections, following a *planned outage* or a *fault outage* of a single AC *offshore transmission circuit* at the onshore AC transformation facilities, the *loss of power infeed* shall not exceed the *normal infeed loss risk*;

7.12.1.3 following a *fault outage* of a single AC *offshore transmission circuit* at the onshore AC transformation facilities, during a *planned outage* of another AC *offshore transmission circuit* at the onshore AC transformation facilities, the further *loss of power infeed* shall not exceed the *infrequent infeed loss risk*.

7.12.2 DC Circuits

7.12.2.1 following a *planned outage* or a *fault outage* of a single DC *converter* at the onshore DC conversion facilities, the *loss of power infeed* shall not exceed the *normal infeed loss risk*;

7.12.2.2 following a *fault outage* of a single DC *converter* at the onshore DC conversion facilities, during a *planned outage* of another DC *converter* at the onshore DC conversion facilities, the further *loss of power infeed* shall not exceed the *infrequent infeed loss risk*.

7.12.3 Busbars and Switchgear

7.12.3.1 in the case of *offshore power park module* connections or multiple gas turbine connections, following a *planned outage* of any single section of *busbar* or mesh corner, *no loss of power infeed* shall occur;

7.12.3.2 in the case of a single gas turbine connection, following a *planned outage* of any single section of *busbar* or mesh corner, the *loss of power infeed* shall not exceed the *infrequent infeed loss risk*;

- 7.12.3.3 following a *fault outage* of any single section of *busbar* or mesh corner, the *loss of power infeed* shall not exceed the *infrequent infeed loss risk*;
- 7.12.3.4 following a *fault outage* of any single *busbar* coupler circuit breaker or *busbar* section circuit breaker or mesh circuit breaker, the *loss of power infeed* shall not exceed the *infrequent infeed loss risk*;
- 7.12.3.5 following a *fault outage* of any single section of *busbar* or mesh corner, during a *planned outage* of any other single section of *busbar* or mesh corner, the *loss of power infeed* shall not exceed the *infrequent infeed loss risk*;
- 7.12.3.6 following a *fault outage* of any single *busbar* coupler circuit breaker or *busbar* section circuit breaker or mesh circuit breaker, during a *planned outage* of any single section of *busbar* or mesh corner, the *loss of power infeed* shall not exceed the *infrequent infeed loss risk*.

Generation Connection Capacity Requirements

Background conditions

- 7.13 The connection of a particular *offshore power station* shall meet the criteria set out in paragraphs 7.14 to 7.23 under the following background conditions:
 - 7.13.1 the active power output of the *offshore power station* shall be set to deliver active power at the *offshore grid entry point* equal to its *registered capacity*;
 - 7.13.2 the reactive power output of the *offshore power station* shall normally, and unless otherwise agreed, be set to deliver zero reactive power at the *offshore grid entry point* with active power output equal to *registered capacity*; and the reactive power delivered at the *interface point* shall be set in accordance with the reactive requirements placed on the *offshore transmission licensee* set out in Section K of the STC (System Operator – Transmission Owner Code); and
 - 7.13.3 conditions on the *national electricity transmission system* shall be set to those which ought reasonably to be expected to arise in the course of a year of operation. Such conditions shall include forecast demand cycles, typical *power station* operating regimes and typical *planned outage* patterns modified where appropriate by the provisions of paragraph 7.16.

Pre-Fault Criteria – background conditions of no *local system outage*

- 7.14 The *transmission capacity* of the *offshore transmission circuits* for the connection of one or more *offshore power stations* shall be planned such that,

for the background conditions described in paragraph 7.13, with *no local system outage* and prior to any fault, there shall not be any of the following:

- 7.14.1 equipment loadings exceeding the *pre-fault rating*;
- 7.14.2 voltages outside the *pre-fault planning voltage limits* or *insufficient voltage performance margins*; or
- 7.14.3 *system instability*

Post-Fault Criteria – background conditions of no *local system outage*

7.15 The *transmission capacity* of the *offshore transmission circuits* for the connection of one or more *offshore power stations* shall also be planned such that for the background conditions described in paragraph 7.13 with *no local system outage* and for the *secured event* on the *offshore transmission system* of any of the following:

- 7.15.1 in the case of an *offshore power park module* connection with an *OffGEP capacity* of 90MW or more, with the *OffGEP capacity* reduced by 50%, a *fault outage* or *planned outage* of a single AC *offshore transmission circuit* on the *offshore platform*;
- 7.15.2 in the case of an *offshore power park module* connection with an *OffGEP capacity* of 120MW or more, with the *OffGEP capacity* reduced to 50%, a *fault outage* or a *planned outage* of a single AC *offshore transmission circuit* at the onshore transformation facilities

And in all cases other than specified in 7.15.1 and 7.15.2 above:

- 7.15.3 a *fault outage* or a *planned outage* of a single *offshore transmission circuit*;

And in all cases:

- 7.15.4 a *fault outage* or a *planned outage* of a *generation circuit*, a *generating unit* (or *several generating units sharing* a common circuit breaker), a *power park module*, a *DC converter*, single reactive compensator or other reactive provider;
- 7.15.5 a *fault outage* of a single *offshore transmission circuit* during a *planned outage* of another *offshore transmission circuit*, *generation circuit*, a *generating unit* (or *several generating units sharing* a common circuit breaker), a *power park module*, a *DC converter*, a reactive compensator or other reactive power provider;
- 7.15.6 a *fault outage* or a *planned outage* of a single section of *busbar* or mesh corner;

There shall not be any of the following:

7.15.7 a *loss of supply capacity* except as permitted by the demand connection criteria detailed in Section 8;

7.15.8 *unacceptable overloading* of any *primary transmission equipment*;

7.15.9 *unacceptable voltage conditions* or *insufficient voltage performance margins*; or

7.15.10 *system instability*

7.16 Under *planned outage* conditions it shall be assumed that the *planned outage* specified in paragraphs 7.15.5 reasonably forms part of the typical outage pattern referred to in paragraph 7.13 rather than in addition to the typical outage pattern.

Post-fault criteria – background conditions with a *local system outage*

7.17 The *transmission capacity* of the *offshore transmission circuits* for the connection of one or more *offshore power stations* to an *offshore transmission system* shall also be planned such that, for the background conditions described in paragraph 7.13 with a *local system outage*, the operational security criteria set out in Section 9 can be met.

- 7.18 Where necessary to satisfy the criteria set out in paragraph 7.17, investment should be made in *transmission capacity* except where operational measures suffice to meet the criteria in paragraph 7.17 provided that maintenance access for each *offshore transmission circuit* can be achieved and provided that such measures are economically justified. The operational measures to be considered include rearrangement of transmission outages and appropriate reselection of *generating units* from those expected to be available, for example through *balancing services*. Guidance on economic justification is given in Appendix G.

Switching Arrangements

- 7.19 Guidance on *offshore* substation configurations and switching arrangements are described in Appendix A. These guidelines provide an acceptable way towards meeting the criteria of paragraphs 7.7 to 7.12. However, other configurations and switching arrangements which meet those criteria are also acceptable.

Variations to Connection Designs

- 7.20 Variations, arising from a generation customer's request, to the generation connection design necessary to meet the requirements of paragraphs 7.6 to 7.18 shall also satisfy the requirements of this Standard provided that the varied design satisfies the conditions set out in paragraphs 7.21.1 to 7.21.3. For example, such a generation connection design variation may be used to take account of the particular characteristics of an *offshore power station*.
- 7.21 Any generation connection design variation must not, other than in respect of the generation customer requesting the variation, either immediately or in the foreseeable future:
- 7.21.1 reduce the security of the *MITS* to below the minimum planning criteria specified in Section 4; or
 - 7.21.2 result in additional investment or operational costs to any particular customer or overall, or a reduction in the security and quality of supply of the affected customers' connections to below the planning criteria in this section or Section 8, unless specific agreements are reached with affected customers; or
 - 7.21.3 compromise any *transmission licensee's* ability to meet other statutory obligations or licence obligations.
- 7.22 Should system conditions subsequently change, for example due to the proposed connection of a new customer, such that either immediately or in the foreseeable future, the conditions set out in paragraphs 7.21.1 to 7.21.3 are no longer satisfied, then alternative arrangements and/or agreements must be put in place such that this Standard continues to be satisfied.
- 7.23 The additional operational costs referred to in paragraph 7.21.2 and/or any potential reliability implications shall be calculated by simulating the expected operation of the *national electricity transmission system* in accordance with

the operational criteria set out in Section 5 and Section 9. Guidance on economic justification is given in Appendix G.

8. Demand Connection Criteria Applicable to an *Offshore Transmission System*

- 8.1 This section presents the planning criteria applicable to the connection of *offshore power station demand groups* to the remainder of the *national electricity transmission system*.
- 8.2 In those parts of an *offshore transmission system* where the criteria of Section 7 also apply, those criteria must also be met.
- 8.3 In planning demand connections, this Standard is met if the connection design either:
 - 8.3.1 satisfies the deterministic criteria detailed in paragraphs 8.5 to 8.10; or
 - 8.3.2 varies from the design necessary to meet paragraph 8.3.1 above in a manner which satisfies the conditions detailed in paragraphs 8.12 to 8.15.
- 8.4 It is permissible to design to standards higher than those set out in paragraphs 8.5 to 8.10 provided the higher standards can be economically justified. Guidance on economic justification is given in Appendix G.

Offshore Power Station Demand Connection Capacity Requirements

- 8.5 The connection of a particular *offshore power station demand group* shall meet the criteria set out in paragraphs 8.6 to 8.10 under the following background conditions:
 - 8.5.1 when the power output of the *offshore power station* is set to zero and there are no *planned outages*, the demand of the *offshore power station demand group* shall be set equal to *group demand*; and
 - 8.5.2 demand and generation outside the *offshore power station demand group* shall be set in accordance with the *planned transfer conditions* using the appropriate method described in Appendix C.
- 8.6 The *transmission capacity* for the connection of an *offshore power station demand group* shall be planned such that, for the background conditions described in paragraph 8.5, under *intact system* conditions there shall not be any of the following:
 - 8.6.1 equipment loadings exceeding the *pre-fault rating*;
 - 8.6.2 voltages outside the *pre-fault planning voltage limits* or *insufficient voltage performance margins*; or
 - 8.6.3 *system instability*.
- 8.7 The *transmission capacity* for the connection of an *offshore power station demand group* shall also be planned such that for the background conditions described in paragraph 8.5 and for the *planned outage* of a single

transmission circuit or a single section of *busbar* or mesh corner, there shall not be any of the following:

- 8.7.1 a *loss of supply capacity* for a *group demand* of greater than 1 MW;
- 8.7.2 *unacceptable overloading* of any *primary transmission equipment*;
- 8.7.3 voltages outside the *pre-fault planning voltage limits* or *insufficient voltage performance margins*; or
- 8.7.4 *system instability*.

8.8 The *transmission capacity* for the connection of an *offshore power station demand group* shall also be planned such that for the background conditions described in paragraph 8.5 and the initial conditions of

- 8.8.1 an *intact system* condition; or
- 8.8.2 the single *planned outage* of another *transmission circuit* or a *generating unit* (or several *generating units*, sharing a common circuit breaker, that cannot be separately isolated), a *power park module*, or a *DC converter*, a reactive compensator or other reactive power provider,

for the *secured event* of a *fault outage* of

- 8.8.3 a single *transmission circuit*, or
- 8.8.4 a single *generating unit* (or several *generating units* sharing a common circuit breaker), a single *power park module*, or a single *DC converter*

there shall not be any of the following:

- 8.8.5 a *loss of supply capacity* such that the provisions set out in Table 8.1 are not met;
- 8.8.6 *unacceptable overloading* of any *primary transmission equipment*;
- 8.8.7 *unacceptable voltage conditions* or *insufficient voltage performance margins*; or
- 8.8.8 *system instability*.

8.9 In addition to the requirements of paragraphs 8.6 to 8.8, for the background conditions described in paragraph 8.5, the system shall also be planned such that operational switching does not cause *unacceptable voltage conditions*.

8.10 For a *secured event* on connections to more than one *offshore power station demand group*, the permitted *loss of supply capacity* for that *secured event* is the maximum of the permitted *loss of supply capacities* set out in Table 8.1 for each of these *offshore power station demand groups*.

Table 8.1 Minimum planning supply capacity following *secured events*

| Group Demand | Initial system conditions | |
|--------------------|---|--|
| | Intact system | With single <i>planned outage</i> Note 1 |
| over 1 MW to 12 MW | Within 3 hours <i>Group Demand</i> minus 1 MW In repair time <i>Group Demand</i> | Nil |
| up to 1 MW | In repair time <i>Group Demand</i> | Nil |

Notes

1. The planned outage may be of a transmission circuit, generating unit, reactive compensator or other reactive power provider.

Switching Arrangements

8.11 Guidance on substation configurations and switching arrangements are described in Appendix A. These guidelines provide an acceptable way towards meeting the criteria of this chapter. However, other configurations and switching arrangements which meet the criteria are also acceptable.

Variations to Connection Designs

8.12 Variations, arising from a *generator's* request, to the demand connection design necessary to meet the requirements of paragraphs 8.5 to 8.10 shall also satisfy the requirements of this Standard provided that the varied design satisfies the conditions set out in paragraphs 8.13.1 to 8.13.3. For example, such a demand connection design variation may be used to limit overall costs.

8.13 Any demand connection design variation must not, other than in respect of the *generator* requesting the variation, either immediately or in the foreseeable future:

8.13.1 reduce the security of the *MITS* to below the minimum planning criteria specified in Section 4; or

8.13.2 result in additional investment or operational costs to any particular customer or overall, or a reduction in the security and quality of supply of the affected customers' connections to below the planning criteria in this section or Section 7, unless specific agreements are reached with affected customers; or

8.13.3 compromise any *transmission licensee's* ability to meet other statutory obligations or licence obligations.

8.14 Should system conditions change, for example due to the proposed connection of a new customer, such that either immediately or in the foreseeable future, the conditions set out in paragraphs 8.13.1 to 8.13.3 are no longer satisfied, then alternative arrangements and/or agreements must be put in place such that this Standard continues to be satisfied.

- 8.15 The additional operational costs referred to in paragraph 8.13.2 and/or any potential reliability implications shall be calculated by simulating the expected operation of the *national electricity transmission system* in accordance with the operational criteria set out in Section 5 and Section 9. Guidance on economic justification is given in Appendix G.

9. Operation of an *Offshore Transmission System*

Normal Operational Criteria

9.1 An *offshore transmission system* shall be operated under *prevailing system conditions* so that for the *secured event* on the *offshore transmission system* of a *fault outage* of any of the following:

- 9.1.1 a single *transmission circuit*, a reactive compensator or other reactive power provider; or
- 9.1.2 a single generation circuit, a *single generating unit* (or several *generating units* sharing a common circuit breaker), a single *power park module*, or a *single DC converter*, or
- 9.1.3 the most onerous *loss of power infeed*; or
- 9.1.4 a section of *busbar* or mesh corner, or
- 9.1.5 a *double circuit overhead line*

there shall not be any of the following:

- 9.1.6 a *loss of supply capacity* except as specified in Table 9.1;
- 9.1.7 *unacceptable frequency conditions*;
- 9.1.8 *unacceptable overloading* of any *primary transmission equipment*;
- 9.1.9 *unacceptable voltage conditions*; or
- 9.1.10 *system instability*.

Table 9.1 Maximum permitted *loss of supply capacity* following *secured events*

| <i>Group Demand</i> | <i>Initial system conditions</i> | |
|---------------------|---|--|
| | <i>Prevailing system conditions with no local system outage</i> | <i>Prevailing system conditions with a local system outage</i> |
| over 1 MW to 12 MW | Whole group up to <i>Group Demand</i> for up to the operational specified time to restore supply capacity | Whole group up to <i>Group Demand</i> |
| up to 1 MW | Whole group up to <i>Group Demand</i> for up to the operational specified time to restore supply capacity | Whole group up to <i>Group Demand</i> |

Notes

1. The time to restore any lost supply capacity shall be as short as practicable. If any part of any lost supply capacity can be restored in less than the specified maximum time to restore all of it, it shall be restored.

Post-fault Restoration of System Security

- 9.2 Following the occurrence of a *secured event*, measures shall be taken to re-secure an *offshore transmission system* to the above operational criteria as soon as reasonably practicable. To this end, it is permissible to put operational measures in place pre-fault to facilitate the speedy restoration of system security.

Authorised Variations from the Operational Criteria

- 9.3 Exceptions to the criteria in paragraphs 9.1 and 9.2 may be required where variations to the connection designs as per paragraphs 7.21 to 7.24 and paragraphs 8.12 to 8.15 have been agreed.
- 9.4 The principles of these operational criteria shall be applied at all times except in special circumstances where ~~NGE~~**NGESO**, following consultation with the appropriate *Generator*, may need to give instructions to the contrary to preserve overall system integrity.

10. Voltage Limits in Planning and Operating an *Offshore Transmission System*

Voltage Limits

10.1 The *pre-fault planning voltage limits* and *steady state* voltage limits on an *offshore transmission system* are as shown in Table 10.1.

Table 10.1 *Pre-fault planning voltage limits* and *steady state* voltage limits in both planning and operational timescales

| Nominal voltage | Minimum | Maximum |
|---|---------|---------|
| 400kV Note 1 | - 10% | + 5% |
| Less than 400kV down to 132kV inclusive | - 10% | + 10% |
| Less than 132kV | - 6% | + 6% |

Notes

1. For 400kV, the maximum limit is aligned with the equivalent onshore limit pending review in the light of technological developments.
- 10.2 A voltage condition on an *offshore transmission system* is unacceptable in both planning and operational timescales if, after either
- 10.2.1 a *secured event*, or
 - 10.2.2 operational switching,
- and the affected site remains directly connected to the *national electricity transmission system* in the *steady state* after the relevant event above, the following condition applies:
- 10.2.3 there is any inability following such an event to achieve a *steady state* voltage as specified in Table 10.1 at *offshore transmission system* substations or *OSPs* using manual and/or automatic facilities available, including the switching in or out of relevant equipment.
- 10.3 In planning timescales, the *steady state* voltages are to be achieved without widespread post-fault generation transformer re-tapping or post-fault adjustment of SVC set points to increase the reactive power output or to avoid exceeding the available reactive capability of generation or SVCs.

11. Terms and Definitions

| | |
|--------------------------|--|
| ACS Peak Demand | The estimated unrestricted winter peak demand (MW and MVar) on the <i>national electricity transmission system</i> for the <i>average cold spell (ACS)</i> condition. This represents the demand to be met by <i>large power stations</i> (directly connected or embedded), <i>medium power stations</i> and <i>small power stations</i> which are directly connected to the <i>national electricity transmission system</i> and by electricity imported into the <i>onshore transmission system</i> from <i>external systems</i> across <i>external interconnections</i> (and which is not adjusted to take into account demand management or other techniques that could modify demand). |
| Adverse Conditions | For the purpose of this Standard, those conditions that significantly increase the likelihood of an overhead line fault, e.g. high winds, lightning, very high or very low ambient temperatures, high precipitation levels, high insulator or atmospheric pollution, flooding. |
| Ancillary Services | This means: (a) such services as any authorised electricity operator may be required to have available as <i>Ancillary Services</i> pursuant to the Grid Code; and (b) such services as any authorised electricity operator or person making transfers on <i>external interconnections</i> may have agreed to have available as being <i>ancillary services</i> pursuant to agreement made with <i>NGET-NGESO</i> and which may be offered for purchase by <i>NGET-NGESO</i> . |
| Annual Load Factor | The ratio of the actual energy output of a <i>generating unit</i> , CCGT module or <i>power station</i> (as the case may be) to the maximum possible energy output of that <i>generating unit</i> , CCGT module or <i>power station</i> (as the case may be) over a year. It is often expressed in percentage terms. |
| Authority | This means the Gas and Electricity Markets Authority established by section 1(1) of the Utilities Act 2000. |
| Average Cold Spell (ACS) | A particular combination of weather elements which give rise to a level of peak demand within a financial year (1 April to 31 March) which has a 50% chance of being exceeded as a result of weather variation alone. |
| Balancing Mechanism | This is the mechanism for the making and acceptance of offers and bids pursuant to the arrangements contained in the Balancing and Settlement Code (BSC) |

| | |
|-------------------------------|--|
| Balancing Services | <p>This means:</p> <p>(a) <i>Ancillary Services</i>;</p> <p>(b) Offers and bids in the <i>Balancing Mechanism</i>; and</p> <p>(c) Other services available to NGETNGESO, which serve to assist NGETNGESO in operating the <i>national electricity transmission system</i> in accordance with the Electricity Act 1989 (Act) or the Conditions of the Transmission Licence granted under Section 6(1) (b) of the Act and/or in doing so efficiently and economically.</p> |
| Boundary Allowance | <p>An allowance in MW to be added in whole or in part to transfers arising out of the <i>Economy planned transfer condition</i> to take some account of year round variations in levels of generation and demand. This allowance is calculated by an empirical method described in Appendix F of this Standard.</p> |
| Busbar | <p>The common connection point of two or more <i>transmission circuits</i>.</p> |
| Corrective Action | <p>Manual and automatic action taken after an outage or switching action to assist recovery of satisfactory system conditions; for example, tap changing or switching of plant.</p> |
| Credible Demand Sensitivities | <p>Such variations in demands above those forecast as are appropriate to the locations and the forecast error for the number of years ahead for which the forecast has been produced, e.g. that which corresponds to an 80% demand forecast confidence level.</p> |
| DC Converter | <p>Any apparatus used as part of the <i>national electricity transmission system</i> to convert alternating current electricity to direct current electricity, or vice-versa. A <i>DC Converter</i> is a standalone operative configuration at a single site comprising one or more converter bridges, together with one or more converter transformers, converter control equipment, essential protective and switching devices and auxiliaries, if any, used for conversion. In a bipolar arrangement, a <i>DC Converter</i> represents the bipolar configuration.</p> |
| Demand Group | <p>A site or group of sites which collectively take power from the remainder of the <i>onshore transmission system</i>.</p> |

| | | |
|------------------------------|---------------------|--|
| Demand Point of Connection | | For the purpose of defining the boundaries between the MITS and <i>Grid Supply Point</i> transformer circuits, the <i>Demand Point of Connection</i> is taken to be the <i>Busbar</i> clamp in the case of an air insulated substation, gas zone separator in the case of a gas insulated substation, or other equivalent point as may be determined by the relevant <i>transmission licensees</i> for new types of substation. |
| Distribution Licensee | | Means the holder of a Distribution Licence in respect of an onshore distribution system granted under Section 6 (1) (c) of the Electricity Act 1989 (as amended under the Utilities Act 2000 and the Energy Act 2004). |
| Double Circuit Overhead Line | | <p>In the case of the <i>onshore transmission system</i>, this is a transmission line which consists of two circuits sharing the same towers for at least one span in <i>SHETL's transmission system</i> or <i>NGET's transmission system</i> or for at least 2 miles in <i>SPT's transmission system</i>.</p> <p>In the case of an <i>offshore transmission system</i>, this is a transmission line which consists of two circuits sharing the same towers for at least one span.</p> |
| Economy Conditions | Planned Transfer | The condition arising from scaling the <i>registered capacity</i> of each directly connected <i>power station</i> and embedded <i>large power station</i> according to the type of generation such that the total of the scaled capacities is equal to the <i>ACS peak demand</i> . This scaling shall follow the techniques described in Appendix E. |
| External Interconnection | | Apparatus for the transmission of electricity to or from the <i>onshore transmission system</i> into or out of an <i>external system</i> . |
| External System | | A transmission or distribution system located outside the <i>national electricity transmission system operator area</i> , which is electrically connected to the <i>onshore transmission system</i> by an <i>external interconnection</i> |
| Fault Outage | | An outage of one or more items of <i>primary transmission apparatus</i> and/or generation plant initiated by automatic action unplanned at that time, which may or may not involve the passage of fault current. |

First Onshore Substation

The *first onshore substation* defines the onshore limit of an *offshore transmission system*. An *offshore transmission system* cannot extend beyond the *first onshore substation*.

Accordingly, the security criteria relating to an *offshore transmission system* extend from the *offshore GEP* up to the *interface point* or *user system interface point* (as the case may be), which is located at the *first onshore substation*.

The security criteria relating to the *onshore transmission system* extend from the *interface point* located at the *first onshore substation* and extend across the remainder of the *onshore transmission system*.

The security criteria relating to an onshore *user system* extend from the *user system interface point* located at the *first onshore substation* and extend across the remainder of the relevant *user system*.

The *first onshore substation* will comprise, inter alia, facilities for the connection between, or isolation of, *transmission circuits* and/or distribution circuits. These facilities will include at least one *busbar* to which the *offshore transmission system* connects and one or more circuit breakers and disconnectors. For the avoidance of doubt, if the substation does not include these elements, then it does not constitute the *first onshore substation*.

The *first onshore substation* may be owned by the *offshore transmission owner*, the onshore transmission owner or onshore *user system* owner as determined by the relevant *transmission licensee* and/or *distribution licensee* as the case may be.

Normally, in the case of there being transformation facilities at the *first onshore substation* and unless otherwise agreed, if the *offshore transmission owner* owns the *first onshore substation*, the *interface point* would be on the HV *busbars* and, if the *first onshore substation* is owned by the onshore transmission owner or onshore *user system* owner, the *interface point* or *user system interface point* (as the case may be) would be on the LV *busbars*.

Forecast Minimum Demand

This is the minimum demand level expected at a *GSP* or *OSP* or a group of *GSPs* or group of *OSPs*. Unless more specific data are available, this is the expected demand at the time of the annual minimum demand on the *national electricity transmission system* as provided under the Grid Code. In the case of a group of *GSPs* or group of *OSPs*, the demand diversity within the group should be taken into account.

Generating Plant Type

A type of *generating unit* classified by the type of prime move, e.g. thermal hydro.

| | |
|--------------------------------|---|
| Generating Units | An <i>onshore generating unit</i> or an <i>offshore generating unit</i> . |
| Generation Circuit | The sole electrical connection between one or more <i>generating units</i> and the <i>Main Interconnected Transmission System</i> i.e. a radial circuit which if removed would disconnect the <i>generating units</i> . |
| Generation Point of Connection | For the purpose of defining the boundaries between the <i>MITS</i> and <i>generation circuits</i> , the <i>generation point of connection</i> is taken to be the <i>busbar</i> clamp in the case of an air insulated substation, gas zone separator in the case of a gas insulated substation, or other equivalent point as may be determined by the relevant <i>transmission licensees</i> for new types of substation |
| Generator | A person who generates electricity under licence or exemption under the Electricity Act 1989 as amended by the Utilities Act 2000 and the Energy Act 2004 as a <i>generator</i> in <i>Great Britain</i> or <i>Offshore</i> . |
| Great Britain (GB) | The landmass of England and Wales and Scotland, including internal waters. |
| Grid Entry Point (GEP) | A point at which a <i>generating unit</i> or a <i>CCGT module</i> or an <i>offshore power park module</i> , as the case may be, which is directly connected to the <i>national electricity transmission system</i> , connects to the <i>national electricity transmission system</i> . The default point of connection is taken to be the <i>busbar</i> clamp in the case of an air insulated substation, gas zone separator in the case of a gas insulated substation, or equivalent point as may be determined by the relevant <i>transmission licensees</i> for new types of substation. |
| Grid Supply Point (GSP) | A point of supply from the <i>onshore transmission system</i> to <i>network operators</i> or <i>non-embedded customers</i> . |
| Group Demand | For a single <i>GSP</i> or <i>OSP</i> : The forecast maximum demand for the <i>GSP</i> or <i>OSP</i> provided in accordance with the requirements of the Grid Code by the <i>network operators</i> or <i>non-embedded customers</i> taking demand from the <i>national electricity transmission system</i> . For multiple <i>GSPs</i> or <i>OSPs</i> : The sum of the forecast maximum demands for the <i>GSPs</i> or <i>OSPs</i> as provided by the <i>network operators</i> or <i>non-embedded customers</i> taking demand from the <i>national electricity transmission system</i> . |

| | |
|--|--|
| Infrequent Infeed Loss Risk | Until 31st March 2014, this is a <i>loss of power infeed</i> risk of 1320MW. From April 1st 2014, this is a <i>loss of power infeed</i> risk of 1800MW. |
| Infrequent Operational Switching | <i>Operational switching</i> associated with rare or infrequent events rather than routine management of the system. <i>Infrequent operational switching</i> includes, for example, isolation of circuits for maintenance and subsequent re-energisation, and operation of intertrip schemes consequent upon <i>secured events</i> . It would not include switching out of circuits for voltage control, or switching out of circuits to allow safe access to other plant, where it is foreseen that such switching may be a regular practice; such events would be classed as <i>operational switching</i> . |
| Insufficient Voltage Performance Margins | <p>In all timescales and in particular the post-fault periods (i.e. before, during and after the automatic controls take place), there are <i>insufficient voltage performance margins</i> when the following occurs:</p> <ul style="list-style-type: none"> i) <i>voltage collapse</i>; ii) over-sensitivity of system voltage; or iii) unavoidably exceeds the reactive capability of <i>generating units</i> such that accessible reactive reserves are exhausted; <p>under any of the following conditions:</p> <ul style="list-style-type: none"> i) <i>credible demand sensitivities</i>; ii) the unavailability of any single reactive compensator or other reactive power provider; or iii) the loss of any one automatic switching system or any automatic voltage control system for on-load tap changing. |
| Intact System | This is the <i>national electricity transmission system</i> with no system outages i.e. with no <i>planned outages</i> (e.g. for maintenance) and no <i>unplanned outages</i> (e.g. subsequent to a fault). |

| | |
|---------------------------|---|
| Interconnection Allowance | An allowance in MW to be added in whole or in part to transfers arising out of the <i>Security planned transfer condition</i> to take some account of non-average conditions (e.g. <i>power station</i> availability, weather and demand). This allowance is calculated by an empirical method described in Appendix D of this Standard. |
| Interface Point (IP) | A point at which an <i>offshore transmission system</i> , which is directly connected to an <i>onshore transmission system</i> , connects to the <i>onshore transmission system</i> . The <i>Interface Point</i> is located at the <i>first onshore substation</i> which the <i>offshore transmission circuits</i> reach onshore. The default point of connection, within the <i>first onshore substation</i> , is taken to be the <i>busbar</i> clamp in the case of an air insulated substation, gas zone separator in the case of a gas insulated substation, on either the lower voltage (LV) <i>busbars</i> or the higher voltage (HV) <i>busbars</i> as may be determined by the relevant <i>transmission licensees</i> . Normally, and unless otherwise agreed, if the <i>offshore transmission</i> owner owns the <i>first onshore substation</i> , the <i>interface point</i> would be on the HV <i>busbars</i> and, if the <i>first onshore substation</i> is owned by the onshore transmission owner, the <i>interface point</i> would be on the LV <i>busbars</i> . |
| Large Power Station | <p>A power station which is:</p> <ol style="list-style-type: none"> 1. directly connected to <ol style="list-style-type: none"> a. NGET's transmission system where such power station has a registered capacity of 100MW or more; b. SPT's transmission system where such power station has a registered capacity of 30MW or more; or c. SHETL's transmission system where such power station has a registered capacity of 10MW or more; <p>Or</p> <ol style="list-style-type: none"> 2. Embedded within a user system (or part thereof) where such user system (or part thereof) is connected under normal operating conditions to: <ol style="list-style-type: none"> a. NGET's transmission system where such power station has a registered capacity of 100MW or more; or b. SPT's transmission system where such power station has a registered capacity of 30MW or more; or c. SHETL's transmission system where such power station has a registered capacity of 10MW or more. <p>Or</p> <ol style="list-style-type: none"> 3. In offshore waters, a power station connected to an offshore transmission system with a registered capacity of 10MW or more. |

| | |
|-------------------------|---|
| Local System Outage | In the context of a <i>demand group</i> or <i>offshore power station demand group</i> , a <i>planned outage</i> or <i>unplanned outage</i> local to a <i>demand group</i> or <i>offshore power station demand group</i> , as the case may be, such that it has a direct effect on the supply capacity to that <i>demand group</i> or <i>offshore power station demand group</i> . In the context of planning generation connections, a <i>planned outage</i> local to a <i>power station</i> such that it has a direct effect on the generation connection capacity requirements for that <i>power station</i> |
| Loss of Power Infeed | The output of a <i>generating unit</i> or a group of <i>generating units</i> or the import from <i>external systems</i> disconnected from the system by a <i>secured event</i> , less the demand disconnected from the system by the same <i>secured event</i> . For the avoidance of doubt if, following such a <i>secured event</i> , demand associated with the normal operation of the affected <i>generating unit</i> or <i>generating units</i> is automatically transferred to a supply point which is not disconnected from the system, e.g. the station board, then this shall not be deducted from the total <i>loss of power infeed</i> to the system. For the purpose of the operational criteria, the <i>loss of power infeed</i> includes the output of a single <i>generating unit</i> , CCGT Module, boiler, nuclear reactor or DC Link bi-pole lost as a result of an event. In the case of an <i>offshore generating unit</i> or group of <i>offshore generating units</i> , the <i>loss of power infeed</i> is measured at the <i>interface point</i> , or <i>user system interface point</i> , as appropriate. In the case of an <i>offshore generating unit</i> or group of <i>offshore generating units</i> for which infeed will be automatically re-distributed to one or more <i>interface points</i> or <i>user system interface points</i> through one or more interlinks, the re-distribution should be taken into account in determining the total generation capacity that is disconnected. However, in assessing this re-distribution, consequential losses of infeed that might occur in the re-distribution timescales due to wider generation instability or tripping, including losses at distribution voltage levels, should be taken into account. |
| Loss of Supply Capacity | This is the reduction in the supply capacity at a <i>Grid Supply Point</i> or <i>offshore supply point</i> as a result of the <i>transmission licensees' failure</i> to maintain the potential to provide the supply capacity in full. For the avoidance of doubt, where the <i>transmission licensees</i> do maintain the potential to provide a supply but, following an outage, demand is lost because of circuit configurations not under the control of the <i>transmission licensees</i> , that lost supply does not constitute <i>loss of supply capacity</i> . |

| | |
|--|---|
| Main Interconnected Transmission System (MITS) | This comprises all the 400kV and 275kV elements of the <i>onshore transmission system</i> and, in Scotland, the 132kV elements of the <i>onshore transmission system</i> operated in parallel with the <i>supergrid</i> , and any elements of an <i>offshore transmission system</i> operated in parallel with the <i>supergrid</i> , but excludes <i>generation circuits</i> , transformer connections to lower voltage systems, <i>external interconnections</i> between the <i>onshore transmission system</i> and <i>external systems</i> , and any <i>offshore transmission systems</i> radially connected to the <i>onshore transmission system</i> via single <i>interface points</i> . |
| Maintenance Period Demand | This is the demand level experienced at a <i>GSP</i> and is the maximum demand level expected during the normal maintenance period. This level is such that the period in which maintenance could be undertaken is not unduly limited. Unless better data are available this should be 67% of the <i>group demand</i> . |
| Major System Fault | An event or sequence of events so fast that it is not practically possible to re-secure the system between each one, more onerous than those included in the normal set of <i>secured events</i> . |
| Major System Risk | A period of <i>major system risk</i> is one in which <i>secured events</i> are judged to be significantly more likely than under the circumstances addressed by the normal criteria of this Standard, or they are judged to have a significantly greater impact than normal, or events not normally secured against are judged to be significantly more likely than normal such that measures should be taken to mitigate their impact. |
| Marshalling Substation | A substation which connects circuits from more than two line routes. |
| Medium Power Station | <p>A <i>power station</i> which is:</p> <ol style="list-style-type: none"> 1. directly connected to <i>NGET's transmission system</i> where such <i>power station</i> has a <i>registered capacity</i> of 50MW or more, but less than 100MW; or 2. embedded within an <i>user system</i> (or part thereof) where such <i>user system</i> (or part thereof) is connected under normal operating conditions to <i>NGET's transmission system</i> where such <i>power station</i> has a <i>registered capacity</i> of 50MW or more but less than 100MW; <p>The <i>medium power station</i> category does not exist in <i>SPT's transmission system</i> and <i>SHETL's transmission system</i>.</p> |

| | |
|--|---|
| National Electricity Transmission System | The <i>national electricity transmission system</i> comprises the <i>onshore transmission system</i> and the <i>offshore transmission systems</i> . |
| National Electricity Transmission System Operator Area | Has the meaning set out in Schedule 1 of NGET's NGENSO's Transmission Licence |
| Network Operator | A person with a system directly connected to the <i>onshore transmission system</i> to which customers and/or <i>power stations</i> (not forming part of that system) are connected, acting in its capacity as an operator of that system, but shall not include a person who operates an <i>external system</i> . |
| NGESO | National Grid Electricity Transmission Limited (No. 11014226) whose registered office is 1-3 Strand, London WC2N 5EH as the holder of the transmission licence granted, or treated as granted, pursuant to Section 6(1)(b) of the Act and in which section C of the standard transmission licence conditions applies. |
| NGET | National Grid Electricity Transmission plc (No. 2366977) whose registered office is 1-3 Strand, London WC2N 5EH |
| Non-Embedded Customer | A customer, except for a <i>Network Operator</i> acting in its capacity as such receiving electricity direct from the <i>national electricity transmission system</i> irrespective of from whom it is supplied. |
| Normal Infeed Loss Risk | Until 31st March 2014, this is a <i>loss of power infeed</i> risk of 1000MW. From April 1st 2014, this is a <i>loss of power infeed</i> risk of 1320MW. |
| Offshore | Means wholly or partly in <i>offshore waters</i> , and when used in conjunction with another term and not defined means that the associated term is to be read accordingly. |
| Offshore Generating Unit | Any apparatus, which produces electricity including, a synchronous <i>offshore generating unit</i> and non-synchronous <i>offshore generating unit</i> and which is located in <i>offshore waters</i> . |

| | |
|--|---|
| Offshore Grid Entry Point Capacity (OffGEP Capacity) | The cumulative <i>registered capacity</i> of all <i>offshore power stations</i> connected at a single <i>offshore grid entry point</i> and/or the cumulative <i>registered capacity</i> of all <i>offshore power stations</i> connected to all the <i>offshore grid entry points</i> of an <i>offshore transmission system</i> |
| Offshore Platform | A platform, located in <i>offshore waters</i> , which contains plant and apparatus associated with the generation and/or transmission of electricity including high voltage electrical circuits which form part of an <i>offshore transmission system</i> and which may include one or more <i>offshore grid entry points</i> . |
| Offshore Power Park Module | A collection of one or more <i>offshore power park strings</i> , located in <i>offshore waters</i> , registered as an <i>offshore power park module</i> under the provisions of the Grid Code. There is no limit to the number of <i>offshore power park strings</i> within the <i>offshore power park module</i> , so long as they either: <ul style="list-style-type: none"> a) connect to the same <i>busbar</i> which cannot be electrically split; or b) connect to a collection of directly electrically connected <i>busbars</i> of the same nominal voltage and are configured in accordance with the operating arrangements set out in the relevant Bilateral Agreement. |
| Offshore Power Park String | A collection of non-synchronous <i>offshore generating units</i> , located in <i>offshore waters</i> that are powered by an intermittent power source joined together by cables with a single point of connection to an <i>offshore transmission system</i> . |
| Offshore Power Station | An installation, located in <i>offshore waters</i> , comprising one or more <i>offshore generating units</i> or <i>offshore power park modules</i> or <i>offshore gas turbines</i> (even where sited separately) owned and/or controlled by the same <i>generator</i> , which may reasonably be considered as being managed as one <i>offshore power station</i> . |
| Offshore Power Station Demand Group | An <i>offshore site</i> or group of <i>offshore sites</i> located on an <i>offshore platform/s</i> which collectively take power from the remainder of an <i>offshore transmission system</i> for the purpose of supplying <i>offshore power station</i> demand. |
| Offshore Supply Point (OSP) | A point of supply from an <i>offshore transmission system</i> to an <i>offshore power station</i> . |

Offshore Transmission Circuit Part of an *offshore transmission system* between two or more circuit-breakers which includes, for example, transformers, reactors, cables, overhead lines and *DC converters* but excludes *busbars and onshore transmission circuits*.

Offshore Transmission Licensee Means the holder of a Transmission Licence in respect of an *offshore transmission system* granted under Section 6 (1) (b) of the Electricity Act 1989 (as amended by the Utilities Act 2000 and the Energy Act 2004).

Comment [NG3]: Add "and in which section E of the standard transmission licence conditions applies"

Offshore Transmission System A system consisting (wholly or mainly) of high voltage lines of 132kV or greater owned and/or operated by an *offshore transmission licensee* and used for the transmission of electricity to or from an *offshore power station* to or from an *interface point*, or *user system interface point* if embedded, or to or from another *offshore power station* and includes equipment, plant and apparatus and meters owned or operated by an *offshore transmission licensee* in connection with the transmission of electricity. An *offshore transmission system* extends from the *interface point* or *user system interface point*, as the case may be, to the *offshore grid entry point/s* and may include plant and apparatus located onshore and *offshore*. For the avoidance of doubt, the *offshore transmission systems*, together with the *onshore transmission system*, form the *national electricity transmission system*.

Offshore Waters Has the meaning given to "*offshore waters*" in Section 90(9) of the Energy Act 2004.

Onshore Generating Unit Any apparatus which produces electricity including a synchronous *generating unit* and non-synchronous *generating unit* but excluding an *offshore generating unit*.

Onshore Power Park Module A collection of non-synchronous *generating units* (registered as a *power park module* under the Planning Code in the Grid Code) that are powered by an intermittent power source, joined together by a system with a single point of electrical connection to the *onshore transmission system* (or *user system* if embedded). The connection to the *onshore transmission system* (or *user system* if embedded) may include a *DC converter*.

| | |
|-------------------------------|---|
| Onshore Power Station | An installation comprising one or more <i>onshore generating units or onshore power park module</i> (even where sited separately) owned and/or controlled by the same <i>generator</i> , which may reasonably be considered as being managed as one <i>onshore power station</i> . |
| Onshore Transmission Circuit | Part of the <i>onshore transmission system</i> between two or more circuit-breakers which include, for example, transformers, reactors, cables and overhead lines and <i>DC converters</i> , but excludes <i>busbars, generation circuits and offshore transmission circuits</i> . |
| Onshore Transmission Licensee | NGET, SPT and SHETL |
| Onshore Transmission System | The system consisting (wholly or mainly) of high voltage electric lines owned or operated by <i>onshore transmission licensees</i> and used for the transmission of electricity from one <i>power station</i> to a substation or to another <i>power station</i> or between substations or to or from <i>offshore transmission systems</i> or to or from any <i>external interconnections</i> and includes any plant and apparatus and meters owned or operated by <i>onshore transmission licensees</i> within <i>Great Britain</i> in connection with the transmission of electricity. The <i>onshore transmission system</i> does not include any <i>remote transmission assets</i> . For the avoidance of doubt, the <i>onshore transmission system</i> , together with the <i>offshore transmission systems</i> form the <i>national electricity transmission system</i> . |
| Operational Intertripping | The automatic tripping of circuit breakers to remove <i>generating units</i> and/or demand. It does not provide additional <i>transmission capacity</i> and must not lead to <i>unacceptable frequency conditions</i> for any <i>secured event</i> . |
| Operational Switching | Operation of plant and/or apparatus within the <i>onshore transmission system</i> or <i>offshore transmission system</i> to the instruction of the relevant control engineer. For the avoidance of doubt, <i>operational switching</i> includes manual actions and automatic actions including tap-changing, auto-switching schemes and automatic reactive switching schemes. |

Comment [NG4]: Alternatively replace with
 "Means the holder of a Transmission Licence in respect of an *onshore transmission system* granted under Section 6 (1) (b) of the Electricity Act 1989 (as amended by the Utilities Act 2000 and the Energy Act 2004) [and in which section D of the standard transmission licence conditions applies - if make change to offshore TL as comment above]"

or, leave the named parties but add at end
 and any other holders of a Transmission Licence in respect of an *onshore transmission system* granted under Section 6 (1) (b) of the Electricity Act 1989 (as amended by the Utilities Act 2000 and the Energy Act 2004) [and in which section D of the standard transmission licence conditions applies -- if make change to offshore TL as comment above]

"

| | |
|-----------------------------------|---|
| Planned Outage | An outage of one or more items of primary transmission apparatus and/or generation plant, initiated by manually instructed action which has been subject to the recognised <i>national electricity transmission system operator area</i> outage planning process. |
| Planned Transfer Conditions | The condition arising from scaling the <i>registered capacities</i> of each directly connected <i>power station</i> and embedded <i>large power station</i> such that the total of the scaled capacities is equal to the <i>ACS peak demand</i> minus imports from <i>external systems</i> . This scaling shall follow the techniques described in Appendix C. |
| Plant Margin | The amount by which the total installed capacity of directly connected <i>power stations</i> and embedded <i>large power stations</i> exceeds the net amount of the <i>ACS peak demand</i> minus the total imports from <i>external systems</i> . This is often expressed as a percentage (e.g. 20%) or as a decimal fraction (e.g. 0.2) of the net amount of the <i>ACS peak demand</i> minus the total imports from <i>external systems</i> . |
| Power Park Module | An <i>onshore power park module</i> and/or an <i>offshore power park module</i> |
| Power Station | Means an <i>onshore power station</i> or an <i>offshore power station</i> . |
| Pre-Fault Planning Voltage Limits | The voltage limits for use in planning timescales for circumstances before a fault. |
| Pre-Fault Rating | The specified pre-fault capability of transmission equipment. Due allowance shall be made for specific conditions (e.g. ambient/seasonal temperature), agreed time-dependent loading cycles of equipment and any additional relevant procedures. In operational timeframes dynamic ratings may also be used where available. |
| Prevailing System Conditions | These are conditions on the <i>national electricity transmission system</i> prevailing at any given time and will therefore normally include <i>planned outages</i> and <i>unplanned outages</i> . |
| Primary Transmission Equipment | Any equipment installed on the <i>national electricity transmission system</i> to enable bulk transfer of power. This will include <i>transmission circuits</i> , <i>busbars</i> , and switchgear. |

Registered Capacity

- a) In the case of a *generating unit* other than that forming part of a CCGT module or *power park module*, the normal full load capacity of a *generating unit* as declared by the *generator*, less the MW consumed by the *generating unit* through the *generating unit's* unit transformer when producing the same (the resultant figure being expressed in whole MW).
- b) In the case of a CCGT module or *offshore* gas turbine or *power park module*, the normal full load capacity of the CCGT module or *offshore* gas turbine or *power park module* (as the case may be) as declared by the *generator*, being the active power declared by the *generator* as being deliverable by the CCGT module or *offshore* gas turbine or *power park module* at the *GEP* (or in the case of a CCGT module or *offshore* gas turbine or *power park module* embedded in a *user system*, at the *user system* entry point), expressed in whole MW.
- c) In the case of a *power station*, the maximum amount of active power deliverable by the *power station* at the *GEP* (or in the case of a *power station* embedded in a *user system*, at the *user system* entry point), as declared by the *generator*, expressed in whole MW. The maximum active power deliverable is the maximum amount deliverable simultaneously by the *generating units* and/or CCGT modules and/or *offshore* gas turbines and/or *power park modules* less the MW consumed by the *generating units* and/or CCGT modules and/or *offshore* gas turbines and/or *power park modules* in producing that active power.
- d) In the case of a *DC converter* at a *DC converter* station, supplying active power to the *national electricity transmission system*, or a *user system*, from an *external system* or *generating unit(s)*, the normal full load amount of active power transferable from a *DC converter* at the *GEP* (or in the case of an embedded *DC converter* station at the *user system* entry point), as declared by the *DC converter* station owner, expressed in whole MW, or in MW to one decimal place.
- e) In the case of a *DC converter* station supplying active power to the *national electricity transmission system*, or a *user system*, from an *external system* or *generating unit(s)*, the maximum amount of active power transferable from a *DC converter* station at the *GEP* (or in the case of an embedded *DC converter* station at the *user system* entry point), as declared by the *DC converter* station owner, expressed in whole MW, or in MW to one decimal place.

| | |
|--------------------------------------|--|
| Secured Event | <p>A contingency which would be considered for the purposes of assessing system security and which must not result in the remaining <i>national electricity transmission system</i> being in breach of the security criteria. <i>Secured events</i> are individually specified throughout the text of this Standard. It is recognised that more onerous unsecured events may occur and additional operational measures within the requirements of the Grid Code may be utilised to maintain overall <i>national electricity transmission system</i> integrity.</p> |
| Security Planned Transfer Conditions | <p>The condition arising from scaling the <i>registered capacity</i> of each directly connected <i>power station</i> and embedded <i>large power station</i> that is considered able to reliably contribute to peak demand security such that the total of the scaled capacities is equal to the <i>ACS peak demand</i>. Generation powered by intermittent sources (e.g. wind, wave, solar) and imports from <i>external systems</i> are not included in this condition. This scaling shall follow the techniques described in Appendix C.</p> |
| SHETL | <p>Scottish Hydro-Electric Transmission Limited (No. SC213461) whose registered office is situated at Inveralmond HS, 200 Dunkeld Road, Perth, Perthshire PH1 3AQ.</p> |

Small Power Station

A *power station* which is:

1. directly connected to:

- a. *NGET's transmission system* where such *power station* has a *registered capacity* of less than 50MW;
- or
- b. *SPT's transmission system* where such *power station* has a *registered capacity* of less than 30MW;
- c. *SHETL's transmission system* where such *power station* has a *registered capacity* of less than 10 MW;

Or

2. embedded within a *user system* (or part thereof) where such *user system* (or part thereof) is connected under normal operating conditions to:

- a. *NGET's transmission system* where such *power station* has a *registered capacity* of less than 50MW;
- b. *SPT's transmission system* where such *power station* has a *registered capacity* of less than 30MW;
- c. *SHETL's transmission system* where such *power station* has a *registered capacity* of less than 10MW;

Or

3. In *offshore waters*, a *power station* connected to an *offshore transmission system* with a *registered capacity* of less than 10MW.

SPT

SP Transmission Limited (No. SC189126) whose registered office is situated at 1 Atlantic Quay, Robertson Street, Glasgow G2 8SP.

Steady State

A condition of a power system in which all automatic and manual *corrective actions* have taken place and all of the operating quantities that characterise it can be considered constant for the purpose of analysis.

Supergrid

That part of the *national electricity transmission system* operated at a nominal voltage of 275kV and above.

System Instability

i) poor damping - where electromechanical oscillations of *generating units* are such that the resultant peak deviations in machine rotor angle and/or speed at the end of a 20 second period remain in excess of 15% of the peak deviations at the outset (i.e. the time constant of the slowest mode of oscillation exceeds 12 seconds); or

ii) pole slipping - where one or more transmission connected synchronous *generating units* lose synchronism with the remainder of the system to which it is connected

For the purpose of assessing the existence of *system instability*, a *fault outage* is taken to include a solid three phase to earth fault (or faults) anywhere on the *national electricity transmission system* with an appropriate clearance time.

The appropriate clearance time is identified as follows:

i) In *NGET's transmission system* and on other circuits identified by agreement between the relevant *transmission licensees*, clearance times consistent with the fault location together with the worst single failure in the main protection system should be used;

ii) elsewhere, clearance times should be consistent with the fault location and appropriate to the actual protection, signalling equipment, trip and interposing relays, and circuit breakers involved in clearing the fault.

Transfer Capacity

That circuit capacity from adjacent *demand groups* which can be made available within the times stated in Table 3.1

Transient Time Phase

The time within which fault clearance or initial system switching, the transient decay and recovery, auto switching schemes, *generator* inter-tripping, and fast, automatic responses of controls such as *generator* AVR and SVC take place. Load response may be assumed to have taken place. Typically 0 to 5 seconds after an initiating event.

Transmission Capacity

The ability of a network to transmit electricity. It does not include the use of *operational intertripping* except in respect of paragraph 2.13 in Section 2, paragraph 4.10 in Section 4 and paragraphs 7.7 to 7.13 & 7.16 in Section 7.

Transmission Circuit

This is either an *onshore transmission circuit* or an *offshore transmission circuit*.

| | |
|-----------------------------------|--|
| Transmission Licensee | Means an <i>onshore transmission licensee</i> or an <i>offshore transmission licensee</i> <u>or NGESO and shall be construed accordingly.</u> |
| Transmission System | Has the same meaning as the term “ <i>licensee’s transmission system</i> ” in the Transmission licence of a <i>Transmission licensee</i> . |
| Unacceptable Frequency Conditions | <p>These are conditions where:</p> <p>i) the <i>steady state</i> frequency falls outside the statutory limits of 49.5Hz to 50.5Hz; or</p> <p>ii) a transient frequency deviation on the <i>MITS</i> persists outside the above statutory limits and does not recover to within 49.5Hz to 50.5Hz within 60 seconds.</p> <p>Transient frequency deviations outside the limits of 49.5Hz and 50.5Hz shall only occur at intervals which ought to reasonably be considered as infrequent.</p> <p>In order to avoid the occurrence of <i>Unacceptable Frequency Conditions</i>:</p> <p>a) The minimum level of <i>loss of power infeed</i> risk which is covered over long periods operationally by frequency response to avoid frequency deviations below 49.5Hz or above 50.5Hz will be the actual <i>loss of power infeed</i> risk present at connections planned in accordance with the <i>normal infeed loss</i> risk criteria;</p> <p>b) The minimum level of <i>loss of power infeed</i> risk which is covered over long periods operationally by frequency response to avoid frequency deviations below 49.5Hz or above 50.5Hz for more than 60 seconds will be the actual <i>loss of power infeed</i> risk present at connections planned in accordance with the <i>infrequent infeed loss</i> risk criteria.</p> <p>It is not possible to be prescriptive with regard to the type of <i>secured event</i> which could lead to transient deviations since this will depend on the extant frequency response characteristics of the system which <u>NGET NGESO</u> shall adjust from time to time to meet the security and quality requirements of this Standard.</p> |
| Unacceptable Overloading | The overloading of any <i>primary transmission equipment</i> beyond its specified time-related capability. Due allowance shall be made for specific conditions (e.g. ambient/seasonal temperature), pre-fault loading, agreed time-dependent loading cycles of equipment and any additional relevant procedures. In operational timeframes dynamic ratings may also be used where available. |

| | |
|---------------------------------|---|
| Unacceptable Voltage Conditions | <p>Voltages out with those specified in Section 6, Voltage Limits in Planning and Operating the <i>Onshore Transmission System</i> and/or outside the limits specified in Section 10, Voltage Limits in Planning and Operating an <i>Offshore Transmission System</i>, as applicable.</p> |
| Unacceptably High Voltage | <p>Steady state voltages above the maximum values specified in Section 6, Voltage Limits In Planning and Operating the <i>Onshore Transmission System</i> and/or above the maximum values specified in Section 10, Voltage Limits In Planning and Operating an <i>Offshore Transmission System</i>, as applicable.</p> |
| Unplanned Outage | <p>An outage of one or more items of <i>primary transmission apparatus</i> and/or generation plant, initiated by manually instructed action which has not been subject to the recognised <i>national electricity transmission system operator area</i> outage planning process.</p> |
| User System | <p>Any system owned or operated by a user of the <i>national electricity transmission system</i> other than a <i>transmission licensee</i> comprising:</p> <ul style="list-style-type: none"> a) <i>generating units</i>; and/or b) systems consisting wholly or mainly of electric circuits used for the distribution of electricity from <i>grid supply points</i> or <i>offshore supply points</i> or <i>generating units</i> or other entry points to the point of delivery to customers or other users. <p>and plant and/or apparatus connecting:</p> <ul style="list-style-type: none"> c) the system described above; or d) <i>non-embedded customers'</i> equipment; <p>to the <i>national electricity transmission system</i> or to the relevant other <i>user system</i>, as the case may be.</p> <p>The <i>user system</i> includes any <i>remote transmission assets</i> operated by such user or other person and any plant and/or apparatus and meters owned or operated by the user or other person in connection with the distribution of electricity but do not include any part of the <i>national electricity transmission system</i>.</p> |

User System Interface Point (USIP)

A point at which an *offshore transmission system*, which is directly connected to a *user system*, connects to the *user system*. The *user system interface point* is located at the *first onshore substation* which the *offshore transmission circuits* reach onshore. The default point of connection, within the *first onshore substation*, is taken to be the *busbar* clamp in the case of an air insulated substation, gas zone separator in the case of a gas insulated substation, or equivalent point on either the lower voltage (LV) busbars or the higher voltage (HV) *busbars* as may be determined by the relevant *transmission licensee* and *distribution licensee*. Normally, and unless otherwise agreed, if the *offshore* transmission owner owns the *first onshore substation*, the *user system interface point* would be on the HV *busbars* and if the *first onshore substation* is owned by the onshore distribution owner, the *user system interface point* would be on the LV *busbars*.

Voltage Collapse

Where progressive, fast or slow voltage decrease or increase develops such that it can lead to either tripping of *generating units* and/or loss of demand.

Voltage Step Change

The difference in voltage between that immediately before a *secured event* or operational switching and that at the end of the *transient time phase* after the event.

Appendix A Recommended Substation Configuration and Switching Arrangements

Part 1 – Onshore Transmission System

- A.1 The recommendations set out in paragraphs A.2 to A.6 apply to the *onshore transmission system*
- A.2 The key factors which must be considered when planning the *onshore transmission system* substation include:
- A.2.1 Security and Quality of Supply - Relevant criteria are presented in Sections 2, 3 and 4.
 - A.2.2 Extendibility - The design should allow for the forecast need for future extensions.
 - A.2.3 Maintainability - The design must take account of the practicalities of maintaining the substation and associated circuits.
 - A.2.4 Operational Flexibility - The physical layout of individual circuits and groups of circuits must permit the required power flow control.
 - A.2.5 Protection Arrangements - The design must allow for adequate protection of each system element.
 - A.2.6 Short Circuit Limitations - In order to contain short circuit currents to acceptable levels, *busbar* arrangements with sectioning facilities may be required to allow the system to be split or re-connected through a fault current limiting reactor.
 - A.2.7 Land Area - The low availability and/or high cost of land particularly in densely populated areas may place a restriction on the size and consequent layout of the substation.
 - A.2.8 Cost
- A.3 Accordingly the design of a substation is a function of prevailing circumstances and future requirements as perceived in the planning time phase. This appendix is intended as a functional guidance for substation layout design and switchgear arrangements. Variations away from this guidance are permissible provided that such variations comply with the requirements of the criteria set out in the main text of this Standard.

Generation Point of Connection Substations

- A.4 In accordance with the planning criteria for generation connection set out in Section 2, *generation point of connection* substations should:
- A.4.1 have a double *busbar* design (i.e. with main and reserve *busbars* such that *generation circuits* and *onshore transmission circuits* may be selected to either);

- A.4.2 have sufficient *busbar* sections to permit the requirements of paragraph 2.6 to be met without splitting the substation during maintenance of *busbar* sections;
- A.4.3 have sufficient *busbar* coupler and/or *busbar* section circuit breakers so that each section of the main and reserve *busbar* may be energised using either a *busbar* coupler or *busbar* section circuit breaker;
- A.4.4 have *generation circuits* and *onshore transmission circuits* disposed between *busbar* sections such that the main *busbar* may be operated split for fault level control purposes; and
- A.4.5 have sufficient facilities to permit the transfer of *generation circuits* and *onshore transmission circuits* from one section of the main *busbar* to another.

Marshalling Substations

- A.5 Marshalling substations should:
 - A.5.1 have a double *busbar* design (i.e. with main and reserve *busbars* such that *onshore transmission circuits* may be selected to either);
 - A.5.2 have sufficient *busbar* sections to permit the requirements of paragraphs 2.6, 4.6 and 4.9 to be met;
 - A.5.3 have *onshore transmission circuits* disposed between *busbar* sections such that the main *busbar* may be operated split for fault level control purposes; and
 - A.5.4 have sufficient facilities to permit the transfer of *onshore transmission circuits* from one section of *busbar* to another.

Grid Supply Point Substations

- A.6 In accordance with the planning criteria for demand connection set out in Section 3, *GSP* substations configurations range from a single transformer teed into an *onshore transmission circuit* to a four switched mesh substation or a double *busbar* substation. The choice and need for the extendibility will depend on the circumstances as perceived in the planning time phase.

Part 2 – Offshore Transmission Systems

- A.7 The recommendations set out in paragraphs A.7 to A.15 apply to *offshore transmission systems*
- A.8 The key factors which must be considered when planning an *offshore transmission system* substation include:
- A.8.1 Security and Quality of Supply - Relevant criteria are presented in Sections 7 and 8.
 - A.8.2 Maintainability - The design must take account of the practicalities of maintaining the substation and associated circuits.
 - A.8.3 Operational Flexibility - The physical layout of individual circuits and groups of circuits must permit the required power flow control.
 - A.8.4 Protection Arrangements - The design must allow for adequate protection of each system element.
 - A.8.5 Short Circuit Limitations - In order to contain short circuit currents to acceptable levels, *busbar* arrangements with sectioning facilities may be required to allow the system to be split or re-connected through a fault current limiting reactor.
 - A.8.6 Available Area –The high cost of the *offshore platform* may place a restriction on the size and consequent layout of the substation.
 - A.8.7 Cost.
- A.9 Accordingly the design of a substation is a function of prevailing circumstances and future requirements as perceived in the planning time phase. This appendix is intended as a functional guidance for substation layout design and switchgear arrangements. Variations away from this guidance are permissible provided that such variations comply with the requirements of the criteria set out in the main text of this Standard.

Offshore Transmission System Substations

Offshore GEP Substations (on an Offshore Platform)

- A.10 In accordance with the planning criteria for *offshore* generation connection set out in Section 7, the substation should:
- A.10.1 have sufficient *busbar* sections to permit the requirements of paragraph 7.8 to be met without splitting the substation during maintenance of *busbar* sections; and
 - A.10.2 have sufficient *busbar* coupler and/or *busbar* section circuit breakers so that each *busbar* section may be energised using either a *busbar* coupler or *busbar* section circuit breaker.

IP and USIP Substations

- A.11 The following recommendations apply equally to substations at the:

- A.11.1 Onshore *Interface Point* (at the *First Onshore Substation*); and
- A.11.2 Onshore *User System Interface Point* (at the *First Onshore Substation*)
- A.12 In accordance with the planning criteria for *offshore* generation connection set out in Section 7, the substation should in the case of an *offshore power park module* and multiple gas turbine connections:
 - A.12.1 have a double *busbar* design (i.e. with main and reserve *busbars* such that *offshore generation circuits* owned by the *generator* and *offshore transmission circuits* may be selected to either);
 - A.12.2 have sufficient *busbar* sections to permit the requirements of paragraph 7.13 to be met without splitting the substation during maintenance of *busbar* sections;
 - A.12.3 have sufficient *busbar* coupler and/or *busbar* section circuit breakers so that each section of the main and reserve *busbar* may be energised using either a *busbar* coupler or *busbar* section circuit breaker; and
 - A.12.4 have sufficient facilities to permit the transfer of *offshore generation circuits* owned by the *generator* and *offshore transmission circuits* from one section of the main *busbar* to another.
- A.13 In the case of a single gas turbine connection and in accordance with the planning criteria for *offshore* generation connection set out in Section 7, the substation should have a single *busbar* design;

Marshalling Substations

- A.14 The following recommendations apply to *offshore marshalling substations*, which interconnect *offshore transmission circuits* from two or more *offshore platforms*, where *offshore grid entry points* are located, and the *first onshore substation*, where the *interface point* or *user system interface point* is located.
- A.15 *Marshalling Substations* should:
 - A.15.1 have a double *busbar* design (i.e. with main and reserve *busbars* such that *offshore transmission circuits* may be selected to either);
 - A.15.2 have sufficient *busbar* sections to permit the requirements of Section 7 to be met;
 - A.15.3 have *transmission circuits* disposed between *busbar* sections such that the main *busbar* may be operated split for fault level control purposes; and
 - A.15.4 have sufficient facilities to permit the transfer of *offshore transmission circuits* from one section of *busbar* to another.

Offshore Supply Point Substations

- A.16 *Offshore supply point substations* should be designed to meet the requirements of Section 8. The actual design will depend on the circumstances as perceived in the planning time phase.

Appendix B Circuit Complexity on the *Onshore Transmission System*

- B.1 This appendix defines restrictions to be applied by the relevant *onshore transmission licensee* when *onshore transmission circuits* are designed, constructed or extended. These restrictions are intended to ensure that the time required to isolate and earth circuits in preparation for maintenance work is kept to a minimum and is not disproportionate to the time required to carry out maintenance work. The restrictions also limit the potential for human error.
- B.2 This appendix is divided into two parts. The first defines those restrictions that apply to *transmission circuits* on the *supergrid* part of the *MITS*. The second gives guidance on those restrictions that may be applied to *transmission circuits* on that part of the *MITS* operated at a nominal voltage of 132kV.

Restrictions for *Transmission Circuits* on the *Supergrid*

- B.3 The three restrictions to be applied to *transmission circuits* on the *supergrid* part of the *MITS* are as follows.
- B.3.1 The facilities, for the isolation and earthing of *transmission circuits* and Transmission Equipment, shall not be located at more than three individual sites;
- B.3.2 The normal operational procedure, for the isolation and earthing of *transmission circuits* and Transmission Equipment, shall not require the operation of more than five circuit-breakers; and
- B.3.3 No more than three transformers shall be connected together and controlled by the same circuit breaker.
- B.4 A site, in this context, is defined as being where the points of isolation at one end of a *transmission circuit* are within the same substation such that only one authorised person is required, at the site, to enable the efficient and effective release and restoration of the circuit.
- B.5 If the design of a substation is such that two circuit-breakers of the same voltage are used to control a circuit (e.g. in a mesh type of substation), for the purposes of the above restrictions the two circuit-breakers are to be considered as a single circuit breaker. This also applies where duplicate circuit-breakers control a circuit including those used for *busbar* selection.

- B.6 Switch disconnectors that are not rated for fault breaking duty should not be included in the design of new *transmission circuits* and substations for the purpose of reducing complexity. Where the extension of an existing *transmission circuit* includes an existing switch disconnector and that switch disconnector is not rated for fault breaking duty, that switch disconnector can be considered for use in planned switching procedures only.
- B.7 For the purposes of restriction in B.3.3 a transformer which includes two low voltage windings in its construction shall be considered as single transformer.

Guidance for *Transmission Circuits* Operated at a Nominal Voltage of 132kV

- B.8 The restrictions recommended below should be regarded as being in general the limits of good planning. The majority of 132 kV circuits do not reach this limit nor will they be expected to do so.
- B.9 Any proposals which would result in these limits being exceeded should be fully explained and agreed with operational engineers.
- B.10 Care must be observed in the application of these recommendations to “Active Circuits” to ensure that protective gear clearance times and discrimination are satisfactory and that the security of lower voltage connected generation is not unduly prejudiced.

Restriction A

- B.11 The normal operating procedure or protective gear operation for making dead any 132 kV circuit shall not require the opening of more than seven circuit-breakers. These circuit-breakers shall not be located on more than four different sites.
- B.11.1 The circuit-breakers to be counted include all those which connect the circuit to other parts of the system.
- B.11.2 In a mesh or similar type substation, two circuit-breakers of the same voltage in the mesh controlling a circuit count as one circuit-breaker.
- B.11.3 Where a circuit is controlled by two circuit-breakers which select between main and reserve *busbars*, these count as one circuit-breaker.
- B.11.4 Switching isolators are not regarded as circuit-breakers for the purpose of this restriction.

Restriction B

- B.12 Not more than three transformers shall be banked together on any one circuit at any one site.
- B.12.1 A transformer with two lower voltage windings counts as one transformer.

Restriction C

- B.13 No item of equipment shall have isolating facilities on more than four different sites.
- B.13.1 Isolating facilities will normally be provided by means of circuit-breakers and their associated isolators.
 - B.13.2 Points of isolation on a circuit within an agreed reasonable walking distance to permit the efficient and effective use of one authorised person only at those points during the release and restoration of the circuit shall be regarded as being on one site.
 - B.13.3 Switching isolators having a “fault make, load break” capability shall be regarded as circuit-breakers for the purpose of this restriction.
 - B.13.4 In special circumstances a plain-break normally-open isolator may be counted as an isolating facility for the equipment on either side of it. An example of this is an isolator in the route of a circuit bridging two *supergrid* zones which would be closed only for emergencies of greater severity than those covered by the security standards for 132 kV planning.

Appendix C Modelling of Security Planned Transfer

- C.1 There are two techniques relevant to the determination of *Security planned transfer conditions*. For circumstances in which apparent future *plant margins* exceed 20%, the 'Ranking Order technique' should be applied. Where the apparent future *plant margin* is 20% or less, the 'Straight Scaling Technique' should be applied. These techniques are described below.
- C.2 Imports from *external systems* (e.g. in France or Ireland) shall not be scaled under either of these two scaling techniques because they result from tranches of generation rather than single *power stations*.

Availability Factors

- C.3 In derivation of *Security planned transfer conditions*, the registered capacities of *power stations* are scaled by availability factors, known as A_T , for classes T of *power station*. For the *Security planned transfer condition*, these factors are set as follows:
- C.3.1 For stations powered by wind, wave, or tides, $A_T = 0$. This zero factor is set for the *Security planned transfer condition* so that there is confidence that there is sufficient *transmission capacity* to meet demand securely in the absence of this class of generation.
- C.3.2 For imports or exports from / to *external systems*, $A_T = 0$.
- C.3.3 For all other *power stations*, $A_T = 1.0$

Ranking Order Technique

- C.4 In some circumstances apparent future *plant margins* may exceed 20%. This may arise where ~~NGET-NGESO~~ has been notified of increases in future generation capacity but has not yet been formally notified of future reductions in generation capacity due to plant closures. The ranking order technique maintains the output of directly connected *power stations* and embedded *large power stations* considered more likely to operate at times of *ACS peak demand* at more realistic levels and treats those less likely to operate as non-contributory.
- C.5 This is achieved by ranking all directly connected *power stations* and embedded *large power stations* in order of likelihood of operation at times of *ACS peak demand*. Those *power stations* considered least likely to operate at peak are progressively removed and treated as non-contributory until a *plant margin* of 20% or just below is achieved. The output of the remainder is then calculated using the same scaling method as used in the straight scaling technique described in paragraphs C.5 and C.6 below.

Straight Scaling Technique

- C.6 In this technique, all directly connected *power stations* and embedded *large power stations* on the system at the time of the *ACS peak demand* are considered contributory and their output is calculated by applying a scaling

factor to their *registered capacity* proportional to an availability representative of the *generating plant type* at the time of *ACS peak demand* such that their aggregate output is equal to the forecast *ACS peak demand* minus total imports from *external systems*.

C.7 Thus,

$$P_{T_i} = S \cdot A_T \cdot R_{T_i}$$

Where

$$S = \frac{P_{\text{loss}} + \sum_j L_j}{\sum_T \left(A_T \cdot \sum_i R_{T_i} \right)}$$

and

- P_{T_i} = the output of the *i*th directly connected or *embedded large power station* of *generating plant type T*
- A_T = an availability representative of *generating plant type T* at the time of *ACS peak demand*
- R_{T_i} = the *registered capacity* of the *i*th directly connected or *embedded large power station* of *generating plant type T*
- P_{loss} = total *national electricity transmission system* active power losses at time of *ACS peak demand*
- L_j = the active power demand at the *j*th *national electricity transmission system* demand site at the time of *ACS peak demand*

Appendix D Application of the *Interconnection Allowance*

- D.1 This appendix outlines the techniques underlying the use of the *interconnection allowance* under paragraphs 4.4.2 and 4.4.5.
- D.2 The modification of the *MITS Security planned transfer condition* power flow pattern to reflect an *interconnection allowance* shall apply to the *national electricity transmission system* divided into any two contiguous parts provided that
- D.2.1 the smaller part contains more than 1500MW of demand at the time of the *ACS peak demand*; and
 - D.2.2 the boundary between the two parts lies on the boundary between *SHETL's transmission system* and *SPT's transmission system*, or between *SPT's transmission system* and *NGET's transmission system*, or entirely within *NGET's transmission system*.
- D.3 The *interconnection allowance* is then applied by:-
- D.3.1 summing the demand and the total active power generation output (including imports from *external systems*) under the *Security planned transfer condition* within the smaller of the two parts and expressing this sum as a percentage of twice the *ACS peak demand*;
 - D.3.2 using Figure D.1, traditionally known as the 'Circle Diagram', to determine the *interconnection allowance* (in MW) by taking the appropriate percentage of the *ACS peak demand*;
 - D.3.3 finding the total active power generation output and total demand in each part of the system when applying the *interconnection allowance* or half *interconnection allowance* (as appropriate) as described in paragraphs D.4 and D.5;
 - D.3.4 for the conditions described under paragraph 4.4.2, proportionally scaling all the generation and demand in both parts of the system, as described in paragraphs D.4 and D.5 below, such that the transfer between the two parts increases by: first, the full *interconnection allowance* when considering the single *fault outages* in 4.6.1; and second, half the *interconnection allowance* for all other *secured events* in paragraph 4.6;
 - D.3.5 for the conditions described under paragraph 4.4.5, proportionally scaling demand in both parts of the system and setting *generating units* with their outputs such that their totals are as described in paragraphs D.4 and D.5 below such that the transfer between the two parts increases by: first, the full *interconnection allowance* when considering the single *fault outages* in item 4.6.1; and second, half the *interconnection allowance* for all other *secured events* in paragraph 4.6.
- D.4 Suppose that the two contiguous parts of the system in question are areas 1 and 2 and that area 1 exports to area 2. Let G_1 and G_2 be the total generation in areas 1 and 2 respectively and D_1 and D_2 be the total demand in areas 1 and 2 under the *Security planned transfer condition*. Let I be the transfer required in addition to that under the *Security planned transfer condition* (i.e. the value of I is equal to the *interconnection allowance* or half the *interconnection allowance* as specified in paragraphs D.3.4 and D.3.5).

D.5 The additional transfer is proportionally divided between the generation and demand in the two areas as follows:

the total demands after application of the *interconnection allowance* or half *interconnection allowance* in areas 1 and 2 are

$$D'_1 = k_{d1}D_1$$
$$D'_2 = k_{d2}D_2$$

and the total amounts of generation in areas 1 and 2 are

$$G'_1 = k_{g1}G_1$$
$$G'_2 = k_{g2}G_2$$

where

$$k_{d1} = 1 - \frac{I}{D_1 + G_1}$$
$$k_{g1} = 1 + \frac{I}{D_1 + G_1}$$

and

$$k_{d2} = 1 + \frac{I}{D_2 + G_2}$$
$$k_{g2} = 1 - \frac{I}{D_2 + G_2}$$

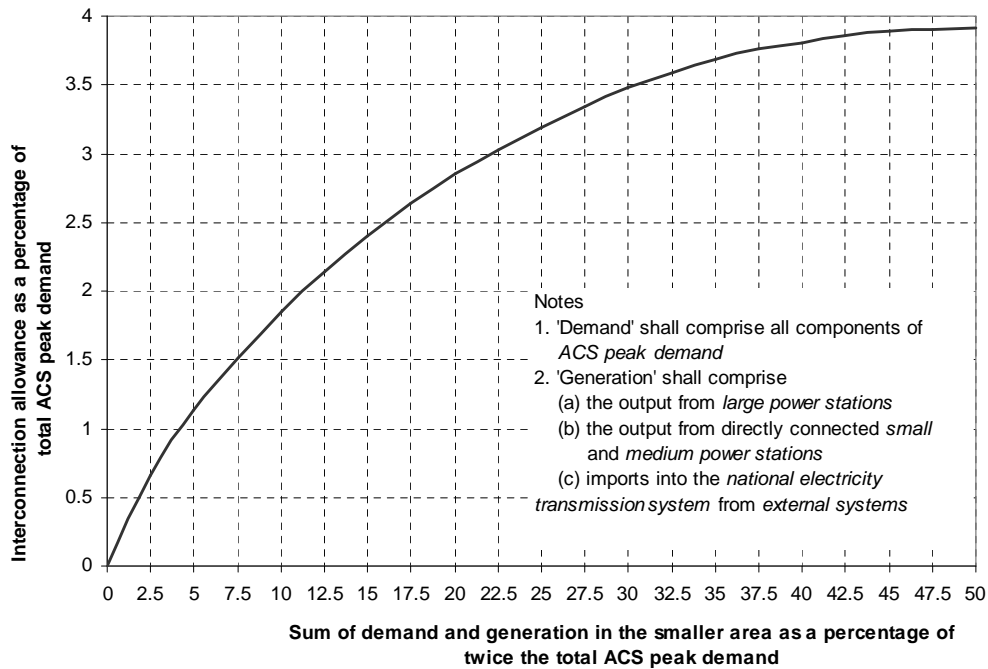

Figure D.1 Interconnection allowance as a function of area size (the 'circle diagram')

Appendix E Modelling of *Economy Planned Transfer*

E.1 For the determination of *Economy planned transfer conditions* plant is categorised in three groups:

E.1.1 non-contributory generation. This plant, such as OCGTs, does not form part of the generation background

E.1.2 directly scaled plant. The output of plant in this category is determined by a fixed scaling factor, described in E.3

E.1.3 variably scaled plant. The output of plant in this category is uniformly scaled by a variable factor that is calculated to ensure that generation and demand balance. This is described in E.5.

E.2 ~~The NETS SONGESO~~ will from time-to-time review, consult on, and publish the categorisation of plant.

Directly Scaled Plant

E.3 In the *Economy planned transfer condition* the *registered capacities* of certain classes of *power station* are scaled by fixed factors, known as D_T , for classes T of *power station*. These factors are set as follows:

E.3.1 For nuclear stations, and for coal-fired and gas-fired stations fitted with Carbon Capture and Storage, $D_T = 0.85$

E.3.2 For stations powered by wind, wave, or tides, $D_T = 0.70$.

E.3.3 For pumped storage based stations, $D_T = 0.5$

E.3.4 For interconnectors to *external systems* regarded as importing into GB at the time of peak demand, $D_T = 1.0$

E.4 ~~The NETS SONGESO~~ will review the appropriateness of these factors and revise them where necessary, based on alignment with cost benefit analysis. The period between reviews shall be no more than five years, but may be less if required.

Variably Scaled Plant

E.5 All remaining directly connected *power stations* and embedded *large power stations* on the system at the time of the *ACS peak demand* are considered contributory and their output is calculated by applying a scaling factor to their *registered capacity* such that their aggregate output is equal to the forecast *ACS peak demand* minus the total output of directly scaled plant.

E.6 Thus,

$$P_{T_i} = \begin{cases} 0 & \text{for non - contributory plant} \\ D_T \times R_{DT_i} & \text{for directly scaled plant} \\ S \times R_{VT_i} & \text{for variably scaled plant} \end{cases}$$

where

$$S = \frac{P_{\text{loss}} + \sum_j L_j - \sum_{DT} \left(\sum_k (D_T \times R_{DT_k}) \right)}{\sum_{VT} \left(\sum_n R_{VTn} \right)}$$

and

- P_{T_i} = the output of the i^{th} directly connected or *embedded large power station* of generation plant type T
- D_T = the direct scaling factor for directly scaled generation of plant type T
- R_{DT_k} = the *registered capacity* of the k^{th} directly connected or *embedded large power station* of generation plant type DT in the directly scaled category
- R_{VTn} = the *registered capacity* of the n^{th} directly connected or *embedded large power station* of generation plant type VT in the variably scaled category
- P_{loss} = total *national electricity transmission system* active power losses at time of *ACS peak demand*
- L_j = the active power demand at the j^{th} *national electricity transmission system* demand site at the time of *ACS peak demand*

Appendix F Application of the *Boundary Allowance*

- F.1 This appendix outlines the techniques underlying the use of the *boundary allowance* under paragraphs 4.4.4 and 4.4.5.
- F.2 The modification of the *MITS Economy planned transfer condition* power flow pattern to reflect a *boundary allowance* shall apply to the *national electricity transmission system* divided into any two contiguous parts, irrespective of the size or location of the parts.
- F.3 The *boundary allowance* is applied by:-
- F.3.1 summing the demand and the total active power generation output (including imports from *external systems*) under the *Economy planned transfer condition* within the smaller of the two parts;
 - F.3.2 using Figure F.1 to determine the *boundary allowance* (in MW)
 - F.3.3 finding the total active power generation output and total demand in each part of the system when applying the *boundary allowance* or half *boundary allowance* (as appropriate) as described in paragraphs F.4 and F.5;
 - F.3.4 for the conditions described under paragraph 4.4.4, proportionally scaling all the generation and demand in both parts of the system, as described in paragraphs F.4 and F.5 below, such that the transfer between the two parts increases by: first, the full *boundary allowance* when considering the single *fault outages* in 4.6.1; and second, half the *boundary allowance* for all other *secured events* in paragraph 4.6;
 - F.3.5 for the conditions described under paragraph 4.4.5, proportionally scaling demand in both parts of the system and setting *generating units* with their outputs such that their totals are as described in paragraphs F.4 and F.5 below such that the transfer between the two parts increases by: first, the full *boundary allowance* when considering the single *fault outages* in item 4.6.1; and second, half the *boundary allowance* for all other *secured events* in paragraph 4.6.
- F.4 Suppose that the two contiguous parts of the system in question are areas 1 and 2 and that area 1 exports to area 2. Let G_1 and G_2 be the total generation in areas 1 and 2 respectively and D_1 and D_2 be the total demand in areas 1 and 2 under the *planned transfer condition*. Let B be the transfer required in addition to that under the *planned transfer condition* (i.e. the value of B is equal to the *boundary allowance* or half the *boundary allowance* as specified in paragraphs F.3.4 and F.3.5).
- F.5 The additional transfer is proportionally divided between the generation and demand in the two areas as follows:

the total demands after application of the *boundary allowance* or half *boundary allowance* in areas 1 and 2 are

$$D'_1 = k_{d1}D_1$$

$$D'_2 = k_{d2}D_2$$

and the total amounts of generation in areas 1 and 2 are

$$G'_1 = k_{g1}G_1$$

$$G'_2 = k_{g2}G_2$$

where

$$k_{d1} = 1 - \frac{B}{D_1 + G_1}$$

$$k_{g1} = 1 + \frac{B}{D_1 + G_1}$$

and

$$k_{d2} = 1 + \frac{B}{D_2 + G_2}$$

$$k_{g2} = 1 - \frac{B}{D_2 + G_2}$$

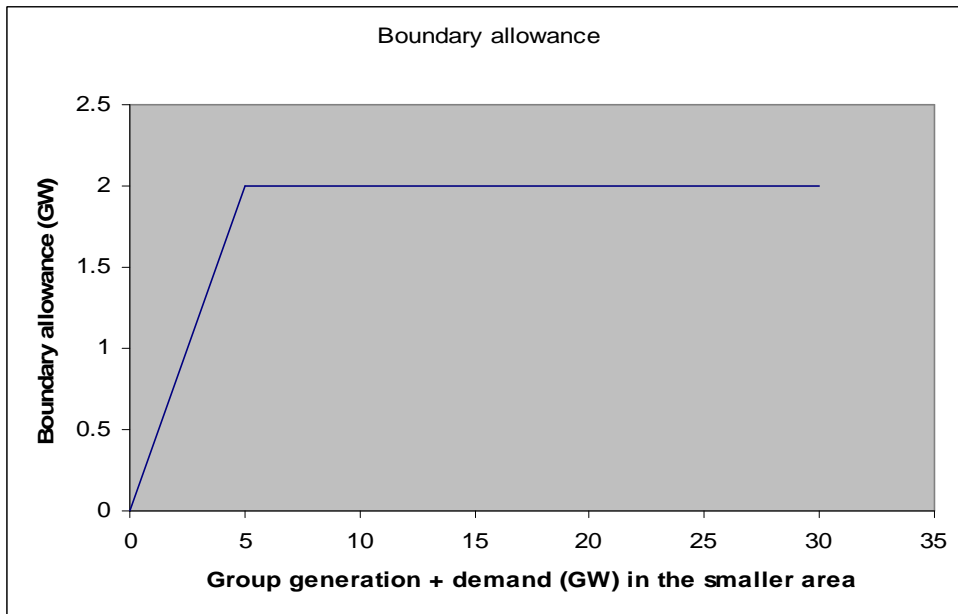

Figure F.1 *Boundary allowance*

Appendix G Guidance on Economic Justification

- G.1 These guidelines may be used to assist in the:
- G.1.1 economic justification of investment in transmission equipment and/or purchase of services such as reactive power in addition to that required to meet the planning criteria of Sections 2, 3, 4, 7 or 8.
 - G.1.2 economic justification of the rearrangement of typical *planned outage* patterns and appropriate re-selection of *generating units*, for example through *balancing services*, from those expected to be available under the provisions of paragraph 2.13 in Section 2, paragraph 4.10 in Section 4 and 7.19 in Section 7; and
 - G.1.3 evaluation of any expected additional operational costs or investments resulting from a proposed variation in connection design under the provisions of paragraphs 2.15 to 2.18 and/or paragraphs 3.12 to 3.15 and/or paragraphs 7.21 to 7.24.
- G.2 Guidelines:
- G.2.1 additional investment in transmission equipment and/or the purchase of services would normally be justified if the net present value of the additional investment and/or service cost is less than the net present value of the expected operational or unreliability cost that would otherwise arise.
 - G.2.2 the assessment of expected operational costs and the potential reliability implications shall normally require simulation of the expected operation of the *national electricity transmission system* in accordance with the operational criteria set out in Section 5 and Section 9 of the Standard.
 - G.2.3 due regard should be given to the expected duration of an appropriate range of prevailing conditions and the relevant *secured events* under those conditions as defined in section 5 and Section 9.
 - G.2.4 the operational costs to be considered shall normally include those arising from:
 - transmission power losses;
 - frequency response;
 - reserve;
 - reactive power requirements; and
 - system constraints,and may also include costs arising from:
 - rearrangement of transmission maintenance times; or
 - modified or additional contracts for other services.
 - G.2.5 all costs should take account of future uncertainties
 - G.2.6 the evaluation of unreliability costs expected from operation of the *national electricity transmission system* shall normally take account of the number and type of customers affected by supply interruptions

and use appropriate information available to facilitate a reasonable assessment of the economic consequences of such interruptions.

**National Electricity Transmission System
Security and Quality of Supply Standard
(NETS SQSS)
Industry Governance Framework**

(Revised ~~30 April~~ 30 March 2019~~2~~)

Table of Contents

| | | |
|------|---|-------------|
| 1 | Definitions and Interpretations | 3 |
| 1.1 | Definitions | 3 |
| 1.2 | Interpretations | 4 |
| 2 | Introduction | 5 |
| 3 | SQSS Objectives..... | 6 |
| 4 | Establishment and Composition | 7 |
| 4.1 | Establishment | 7 |
| 4.2 | Functions of the Panel | 7 |
| 4.3 | Chair | 7 |
| 4.4 | Secretary | 8 |
| 4.5 | Authority | 8 |
| 4.6 | Membership..... | 8 |
| 4.7 | Meeting Frequency | <u>109</u> |
| 4.8 | Meeting Administration..... | 10 |
| 4.9 | Quorum..... | 10 |
| 4.10 | Attendance by Other Persons | <u>1140</u> |
| 4.11 | Removal from Office | 11 |
| 5 | Modification of the SQSS | <u>1342</u> |
| 5.1 | General..... | <u>1342</u> |
| 5.2 | The SQSS Modification Process | <u>1342</u> |
| | Annex 1 - Offshore Transmission Owner Election Process..... | A1 |
| | Annex 2 - SQSS Modification Process Flow Chart | B1 |
| | Annex 3 - Modification Proposal Form..... | C1 |

1 Definitions and Interpretations

1.1 Definitions

1.1.1 The following words and expressions shall have the following meanings in this document:-

| | |
|---|---|
| Authority | shall mean the Gas and Electricity Markets Authority. Ofgem is the office of “the Authority”; |
| Business Day | means any weekday (other than a Saturday) on which banks are open for domestic business in the City of London; |
| Chair | shall mean the chairman of the Review Panel appointed in accordance with Paragraph 4.3; |
| Core Industry Documents | shall have the same definition as in the Standard Condition A1 of the Transmission License; |
| Distribution Network Operator or DNO | shall mean the holder for the time being of a Distribution Licence; |
| Generator | shall mean a person who generates electricity under licence or exemption under the Act; |
| Governance Framework | shall mean this NETS SQSS Industry Governance Framework; |
| Member | shall mean a person duly appointed in accordance with Paragraph 4.6 to be a Member of the Panel; |
| NETS SQSS or SQSS | means the National Electricity Transmission System Security and Quality of Supply Standard. The SQSS sets out a co-ordinated set of criteria and methodologies that the Transmission Licensees shall use in the planning and operation of the national electricity transmission system; |
| <u>NGESO</u> | <u>shall mean National Grid Electricity System Operator Limited with company number 11014226;</u> |
| NGET | shall mean National Grid Electricity Transmission plc with company number 2366977; |

| | |
|--|--|
| Offshore Transmission Owner or OFTO | means a Transmission Licensee in relation to whose Transmission Licence the Standard Conditions in Section E (offshore transmission owner standard conditions) have been given effect; |
| Panel | shall mean the SQSS Review Panel established by NGESO , NGET, SHETL and SPT which shall be constituted in accordance with Section 4; |
| Secretary | shall mean the secretary of the Review Panel appointed in accordance with Paragraph 4.4; |
| SHETL | shall mean Scottish Hydro Electric Transmission Limited with company number SC213461; |
| SPT | shall mean Scottish Power Transmission Limited with company number SC189126; |
| Transmission Licence | shall mean a transmission licence granted or treated as granted under Section 6(1)(b) of the Electricity Act 1989 (as amended by the Utilities Act 2000 and the Energy Act 2004) ; |
| Transmission Licensee | shall mean the holder for the time being of a Transmission Licence; |

1.2 Interpretations

- 1.2.1 Except as otherwise provided herein and unless the context otherwise admits, words and expressions used herein shall have the same meaning as defined in the SQSS.
- 1.2.2 Words importing the singular only also include the plural and vice versa where the context requires. Words importing the masculine only also include the feminine.
- 1.2.3 Headings and titles shall not be taken into consideration in the interpretation or construction of the words and expressions used in this Governance Framework.

2 Introduction

- 2.1 The Electricity Act 1989 requires Transmission Licensees to develop and maintain an efficient, co-ordinated and economical system of electricity transmission.
- 2.2 ~~The Transmission Licences NGET, SHETL and SPT have place~~ an obligation upon the Transmission Licensees to plan, develop and operate their systems in accordance with, amongst other things, the SQSS. NGESO has an obligation under the Transmission Licence to plan, develop and operate the NETS in accordance with, amongst other things, the SQSS. In addition, ~~NGET's~~ NGESO's Transmission Licence places an obligation on ~~NGET~~ NGESO to co-ordinate and direct the flow of electricity onto and over the National Electricity Transmission System, in accordance with, amongst other things, the SQSS.
- 2.3 In order to facilitate these requirements, the SQSS may need, from time to time, to be revised to reflect changes in both the GB Electricity Supply Industry and technological advances.
- 2.4 The Panel is the co-ordinator, not a decision making body. The purpose of the Panel is to consider developments to the SQSS and recommend SQSS changes to the Authority.
- 2.5 The SQSS Governance Framework sets out:
 - 2.5.1 arrangements for the establishment and composition of the Panel; and
 - 2.5.2 the procedure for proposing Modifications to the SQSS.
- 2.6 The SQSS Governance Framework governs the industry led process for reviewing, and proposing Modifications to, the SQSS. This is based on voluntary industry co-operation. The SQSS Governance Framework is not intended to reflect upon the powers and decisions of the Authority in relation to the SQSS.

3 SQSS Objectives

3.1 The Panel shall endeavour at all times to perform its functions to ensure efficient discharge by each of the Transmission Licensees of the obligations imposed upon it under the Electricity Act and its associated licences, specifically focusing on the following objectives:

- (i) facilitate the planning, development and maintenance of an efficient, coordinated and economical system of electricity transmission, and the operation of that system in an efficient, economic and coordinated manner;
- (ii) ensure an appropriate level of security and quality of supply and safe operation of the National Electricity Transmission System;
- (iii) facilitate effective competition in the generation and supply of electricity, and (so far as consistent therewith) facilitating such competition in the distribution of electricity; and
- (iv) facilitate electricity Transmission Licensees to comply with their obligations under EU law.

4 Establishment and Composition

4.1 Establishment

4.1.1 [NGESO](#), NGET, SPT and SHETL shall establish the Panel which shall be constituted in accordance with the further provisions of this Section 4.

4.1.2 Subject as expressly provided in this Governance Framework, the Members may regulate the conduct of and adjourn and convene Panel meetings as they deem fit.

4.2 Functions of the Panel

4.2.1 The Panel shall consider all reasonable requests to modify the SQSS. Such requests may be made by any of the Members, the Authority or any relevant interested person. SQSS Modification Proposals shall be raised via the Secretary.

4.2.2 The functions of the Panel shall be to:

4.2.2.1 keep the SQSS and its working under review;

4.2.2.2 evaluate and administrate modifications to the SQSS in accordance with procedures set out in the SQSS Governance Framework;

4.2.2.3 keep the SQSS Governance Framework and its working under review;

4.2.2.4 publish recommendations to modify the SQSS and the reasons for the recommendations;

4.2.2.5 recommend to the Authority any modifications of the SQSS; and

4.2.2.6 the Panel shall endeavour at all time to perform its functions:

(a) in an efficient, economical and expeditious manner, taking account of the complexity, importance and urgency of a particular modification to the SQSS; and

(b) with a view to ensuring the SQSS facilitates achievement of its objectives.

4.3 Chair

4.3.1 There shall be a Chair of the Panel who shall be appointed every second year, by the agreement of all Members, from 01 April 2012 or as otherwise agreed by the Members and who shall, taking into account the functions set out in subparagraph 4.3.2, carry out such activities as may be agreed between the Members from time to time.

4.3.2 The functions of the Chair include:

4.3.2.1 to ensure that meetings are conducted in a professional, proper, impartial and efficient manner;

4.3.2.2 to ensure that each Member, any person invited to speak or any representative of the Authority have been given a reasonable opportunity to speak on any matter contained in the agenda for the meeting.

4.3.3 In the event that the Chair is not present within fifteen minutes of the scheduled start of any meeting and has not nominated another person to take the position of Chair, those Members present shall appoint one of their number to act as Chair.

4.4 Secretary

4.4.1 The Panel shall be assisted by a Secretary who shall be a person appointed by ~~NGET~~NGESO. ~~NGET-NGESO~~ may remove and reappoint the Secretary by giving notice to the Panel.

4.4.2 The Secretary shall carry out such activities as are specified in this Governance Framework and as are otherwise agreed between the Members from time to time.

4.5 Authority

4.5.1 A representative of the Authority shall be entitled to attend Panel meetings as an observer and may speak at any meeting. The Authority shall from time to time notify the Secretary of the identity of the observer. For the avoidance of doubt the Authority representative shall not be considered a Member of the Panel.

4.6 Membership

4.6.1 The Panel shall consist of:-

- (a) a Chair;
- (b) a Secretary appointed by ~~NGET~~NGESO;
- (c) a person appointed by the Authority; and
- (d) the following Members

(i) two persons representing NGESO;

~~(i)~~(ii) two persons representing NGET ;

~~(ii)~~(iii) two persons representing SHETL;

~~(iii)~~(iv) two persons representing SPT;

~~(iv)~~(v) two persons representing Offshore Transmission Owners

~~(v)~~(vi) a person representing Generators

~~(vi)~~(vii) a person representing Distribution Network Operators

4.6.2 NGESO Members

4.6.2.1 NGESO is entitled to nominate two Members to attend Panel meetings and may appoint, remove and reappoint Members by giving notice to the Secretary.

4.6.24.6.3 NGET Members

4.6.2.14.6.3.1 NGET is entitled to nominate two Members to attend Panel meetings and may appoint, remove and reappoint Members by giving notice to the Secretary. ~~For the avoidance of doubt NGET is fulfilling a System Operator and Transmission Owner role.~~

4.6.34.6.4 SHETL Members

4.6.3.14.6.4.1 SHETL is entitled to nominate two Members to attend Panel meetings and may appoint, remove and reappoint Members by giving notice to the Secretary.

4.6.44.6.5 SPT Members

4.6.4.14.6.5.1 SPT is entitled to nominate two Members to attend Panel meetings and may appoint, remove and reappoint Members by giving notice to the Secretary.

4.6.54.6.6 Offshore Transmission Owner Members

4.6.5.14.6.6.1 Offshore Transmission Owners may appoint not more than two Members and not more than two Alternate Members every second year from 01 April 2012 in accordance with Annex 1. Any person shall be eligible for reappointment on expiry of his term.

4.6.5.24.6.6.2 Offshore Transmission Owner Members shall have the duty to impartially represent the views of the Offshore Transmission Owners that they represent.

4.6.64.6.7 Generator Member

4.6.6.14.6.7.1 The Panel will agree on an appropriate representative body within the electricity industry to represent the interests of Generators.

4.6.6.24.6.7.2 The agreed representative body is entitled to nominate a Member to attend Panel meetings. The agreed representative body may appoint, remove and reappoint their Member by giving notice to the Secretary.

4.6.74.6.8 Distribution Network Operator Member

4.6.7.14.6.8.1 The Panel will agree on an appropriate representative body within the electricity industry to represent the interests of Distribution Network Operators.

~~4.6.7.2~~~~4.6.8.2~~ The agreed representative body is entitled to nominate a Member to attend Panel meetings. The agreed representative body may appoint, remove and reappoint their Member by giving notice to the Secretary.

For the avoidance of doubt the Generator and DNO representative bodies, [NGESO](#), NGET, SHETL and SPT are not required to identify Alternate Members as Members are appointed, removed and reappointed by giving notice to the Secretary.

4.7 Meeting Frequency

4.7.1 All meetings shall be called by the Secretary giving notice to Members at least 15 Business Days before that date of the next meeting or such other shorter period as all the Members may agree. The notice shall set out the date, time and place of the meeting.

4.7.2 The Panel shall hold a minimum of 4 meetings per calendar year at regular intervals as agreed by the Members. Attendance at such meetings may be in person, by teleconference or video conference or in any alternative manner as all the Members may agree and such Members will be counted as present for the purposes of the quorum.

4.8 Meeting Administration

4.8.1 The Secretary will make available to the Panel, not less than 10 Business Days before the date of the meeting or such other shorter period as the Members may agree, an agenda of the matters for consideration at the meeting and any supporting papers for discussion.

4.8.2 An omission to send Panel documents to a person entitled to receive them under sub-paragraph 4.9.2 shall not prevent a Panel meeting from proceeding unless otherwise directed by the Authority.

4.8.3 As soon as is practicable after each Panel meeting, the Secretary shall prepare and send to the Members and the Authority the minutes of such Panel meeting, which shall be approved (or amended and approved) by the Panel at the next Panel meeting after they were so sent and, when approved, the Panel Secretary shall publish the approved minutes (excluding any matter which it was agreed at such Panel meeting was not appropriate for such publication) on the [NGET](#) [NGESO](#) website.

4.9 Quorum

4.9.1 Subject to sub-paragraph 4.9.3, no business shall be transacted at any Panel meeting unless a Quorum (as defined in sub-paragraph 4.9.2) is present.

4.9.2 A quorum shall be constituted where there is at least one Member representing each of [NGESO](#), NGET, SHETL, SPT and the OFTOs, unless the Secretary and the Panel has been notified in writing by a Member representing [NGESO](#), NGET, SHETL, SPT or the OFTOs that the matters to be discussed at such Panel meeting do not materially affect it and in which case that Member (with the consent of the other Members forming the quorum) may waive their right to attend.

4.9.3 Where a quorum is not present, the Secretary shall seek to adjourn the Panel meeting to a later date unless it is the third consecutive Panel meeting that has been required to be adjourned as a consequence of the failure to attend by a particular Member, in which case, the Panel meeting shall nonetheless proceed and subsequent ratification of decisions taken at the Panel meeting by such non-attending Member shall not be required unless the lack of attendance by such Member (on any of the three occasions) was as a consequence of an omission to send such Member the details of the Panel meeting required pursuant to subparagraph 4.9.2.

4.10 Attendance by Other Persons

4.10.1 A Member may, with the agreement of the other Members, invite any person other than a person already entitled to attend under Paragraph 4.6 to attend any part of a Panel meeting and to speak at such meeting, where that person so attends.

4.11 Removal from Office

4.11.1 A person shall cease to hold office as a Member or an Alternate Member:

- (a) in the case of Offshore Transmission Owner Members only, upon expiry of his term of office unless re-appointed;
- (b) if he:
 - (i) resigns by notice delivered to the Secretary;
 - (ii) becomes bankrupt or makes any arrangement or composition with his creditors generally;
 - (iii) is or may be suffering from mental disorder and either is admitted to hospital in pursuance of an application under the Mental Health Act 1983 or the Mental Health (Scotland) Act 1960 or an order is made by a court having jurisdiction in matters concerning mental disorder for his detention or for the appointment of a receiver, *curator bonis* or other person with respect to his property or affairs;
 - (iv) becomes prohibited by law from being a director of a company under the Companies Act 1985;
 - (v) dies; or
 - (vi) is convicted on an indictable offence; or
- (c) if the Panel resolves (and the Authority does not veto such resolution by notice in writing to the Secretary within 15 Business Days) that he should cease to hold office on grounds of his serious misconduct.

4.11.2 A Panel resolution under Paragraph 4.11.1 (c) shall, notwithstanding any other Paragraph, require the vote in favour of at least all Members less one (other than the Member or Alternate Member who is the subject of such resolution) and for these purposes an abstention shall count as a vote cast in favour of the

resolution. A copy of any such resolution shall forthwith be sent to the Authority by the Secretary.

4.11.3 A person shall not qualify for appointment as a Member or Alternate Member if at the time of the proposed appointment he would be required by the above Paragraph to cease to hold that office.

4.11.4 The Secretary shall give prompt notice by electronic means to all Members and the Authority of the appointment or re-appointment of any Member or Alternate Member or of any Member or Alternate Member ceasing to hold office.

5 Modification of the SQSS

5.1 General

5.1.1 Each Member shall keep under review whether any possible change to the SQSS would better facilitate achievement of the SQSS Objectives and shall, in accordance with this Section 5 and to the extent that such matter is not covered by a Modification Proposal, raise a Modification Proposal which, in the Member's opinion, would do so.

5.1.2 The Members shall endeavour at all times to act pursuant to this Section 5:

- (i) in an efficient, economical and expeditious manner taking account of the complexity, importance and urgency of a particular modification proposal; and
- (ii) with a view to ensuring that the SQSS facilitates achievement of the SQSS Objectives.

5.1.3 The SQSS Modification process flow chart is shown in Annex 2. Paragraph 5.2 presents a more detailed account of the Modification process.

5.2 The SQSS Modification Process

5.2.1 Modification Proposal

5.2.1.1 A Modification Proposal may be made by any of the following:

- (a) a Member;
- (b) the Authority; or
- (c) relevant interested person

referred to in this Section 5 as the 'Proposer'.

5.2.1.2 A Modification Proposal made pursuant to sub-paragraph 5.2.1.1 shall be submitted to the Secretary in the form of Annex 3 which may be amended by the Panel from time to time.

5.2.1.3 If a Modification Proposal fails to contain any information required under sub-paragraph 5.2.1.2, the Secretary shall notify the Proposer, who may submit a revised request in compliance with this sub-paragraph 5.2.1.2.

5.2.1.4 Upon receipt of a Modification Proposal made pursuant to and in compliance with sub-paragraph 5.2.1.2, the Secretary shall as soon as reasonably practicable:

- (a) send a copy of the Modification Proposal to the Members, the Authority and any relevant interested person;

- (b) subject to the provisions of Paragraph 4.8, put the request on the agenda for the next Panel meeting; and
- (c) add the new Modification Proposal to the SQSS Modification Register (“Modification Register”) as further provided for and defined in Paragraph 5.2.7.

5.2.1.5 It shall be a condition to the right to raise an SQSS Modification Proposal under this Paragraph 5.2.1 that the Proposer:

- (a) grants a non-exclusive royalty-free licence to all Parties who request the same covering all present and future rights, Intellectual Property Rights and moral rights it may have in such request (as regards use or application in Great Britain and its Offshore Waters); and
- (b) warrants that, to the best of its knowledge, information and belief, no other person has asserted to the Proposer that such person has any Intellectual Property Rights or moral rights or rights of confidence in such proposal inconsistent with the Parties' rights to make, publish or use such request, and, in making a request, a shall be deemed to have granted the licence and given the warranty contained in sub-paragraphs (a) and (b) above respectively.

5.2.1.6 The Proposer may withdraw its Modification Proposal on notice to the Secretary at any time, in which case, the Secretary shall promptly notify the Members and the Authority and then, 5 Business Days after issue of such notice by the Secretary, shall:

- (a) revise the Modification Register; and
- (b) remove the Modification Proposal from the agenda of the next Panel meeting (as relevant);

5.2.2 Review of Modification Proposals at Panel Meetings

5.2.2.1 The Panel shall consider a Modification Proposal (if compliant with sub-paragraph 5.2.1.2 and not withdrawn under sub-paragraph 5.2.1.6) at the next Panel meeting and at such meeting shall use all reasonable endeavours to decide (as and where relevant) whether:

- (a) the Members require additional information in order to assess whether the request would better facilitate achievement of the SQSS Objectives;
- (b) pursuant to sub-paragraph 5.2.2.5, to amalgamate the request with any other Proposed Modification.

5.2.2.2 Where, pursuant to sub-paragraph 5.2.2.1 (a) above, the Panel decides not to take the Modification Proposal further, the Secretary shall notify the Proposer explaining why the proposal has been rejected. The Secretary shall also amend the Modification Register as appropriate.

- 5.2.2.3 Where, pursuant to sub-paragraph 5.2.2.1 (a) above, the Panel decides that additional information is required or the Panel cannot reach a decision on such matters, the Panel shall refer the Modification Proposal to a Workgroup to carryout such analysis as set out under sub-paragraph 5.2.3.
- 5.2.2.4 Where, pursuant to sub-paragraph 5.2.2.1 (a) above, the Panel decides that additional information is not required, the Panel shall proceed directly to Industry Consultation under sub-paragraphs 5.2.4.
- 5.2.2.5 The Panel may decide to amalgamate a Modification Proposal with one or more other Modification Proposal(s) where the subject matter is sufficiently proximate to justify amalgamation on the grounds of efficiency and/or where such Modification Proposal(s) are logically dependent on each other.
- 5.2.2.6 Where Modification Proposals are amalgamated pursuant to sub-paragraph 5.2.2.5:
 - (a) such Modification Proposals shall be treated as a single Modification Proposal;
 - (b) references in this Section 5 to a Modification Proposal shall include and apply to a group of two or more Modification Proposals so amalgamated; and
 - (c) the Proposers of each such amalgamated Modification Proposal shall cooperate in deciding which of them shall constitute the Proposer of such amalgamated Modification Proposals, failing which agreement, the Modification Proposals shall continue separately as before.

5.2.3 Evaluation and Assessment by a Workgroup

- 5.2.3.1 Following referral of a Modification Proposal, pursuant to sub-paragraph 5.2.2.3, to a Workgroup, the Panel shall invite representations or commission such studies, convene industry workshops and other evaluation as it deems appropriate in order that the Panel is provided with sufficient information such that it can assess whether the Modification Proposal would better facilitate achievement of the SQSS Objectives.
- 5.2.3.2 The Panel shall use its reasonable endeavours in order to ensure that evaluation and assessment by a Workgroup takes no longer than 6 months from its referral under sub-paragraph 5.2.2.3 up to the submission of the Workgroup Report to the Panel under sub-paragraph 5.2.3.13 unless otherwise agreed by the Panel.
- 5.2.3.3 A Workgroup shall comprise at least 5 persons (who may be Panel Members) "Workgroup Quorum" or any such number of persons agreed by the Panel.

- 5.2.3.4 In addition to the Workgroup Quorum the Panel shall appoint a Workgroup Chair who will ensure that meetings are conducted in a professional, proper, impartial and efficient manner.
- 5.2.3.5 The Workgroup shall be assisted by a secretary who shall be appointed by the Panel. As soon as is practicable after each Workgroup meeting, the Secretary shall prepare and send to the Workgroup Members the minutes of such Workgroup meeting, which shall be approved (or amended and approved) by the Workgroup at the next Workgroup meeting after they were so sent and, when approved, the secretary shall publish the approved minutes (excluding any matter which it was agreed at such Workgroup meeting was not appropriate for such publication) on the [NGET-NGESO](#) website.
- 5.2.3.6 A representative of the Authority may attend any meeting of a Workgroup as an observer and may speak at any such meeting.
- 5.2.3.7 The Panel shall determine the terms of reference of each Workgroup and may change those terms of reference from time to time as it sees fit.
- 5.2.3.8 The terms of reference for a Workgroup must include provision in respect of the following matters:
- (a) detail the Workgroup's responsibilities for assisting the Panel in the evaluation of the Modification Proposal and consider whether it better facilitates achievement of the SQSS Objectives and to provide additional information to the Panel;
 - (b) detail the Modification Proposal;
 - (c) detail the work to be undertaken by the Workgroup to assist the Panel in the evaluation of the Modification Proposal;
 - (d) specify any matters which the Workgroup should address in its report;
 - (e) the timetable for the work to be done by the Workgroup;
 - (f) specify if the Workgroup is to comment upon any legal text.
- 5.2.3.9 Unless otherwise determined by the Panel the Workgroup shall develop and adopt its own internal working procedures for the conduct of its business.
- 5.2.3.10 A Workgroup Report will be submitted to the Panel responding to the matters detailed in the terms of reference and in accordance with the timetable set out in the terms of reference and will indicate the issues and views which arose in the Workgroup discussions and any recommendations made.

- 5.2.3.11 If a Workgroup is unable to reach agreement on any such matter, the Workgroup Report must reflect the views of the members of the Workgroup.
- 5.2.3.12 The Workgroup Report will be circulated in draft form to the Workgroup members for a period of not less than 5 Business Days for comment. Any unresolved comments made shall be reflected in the final Workgroup Report.
- 5.2.3.13 The final Workgroup Report shall be submitted to the Panel. Upon receipt of the Workgroup Report, the Secretary shall as soon as reasonably practicable:
- (a) send a copy of the Workgroup Report to the Members and the Authority; and
 - (b) subject to the provisions of Paragraph 4.8.1, put the Workgroup Report on the agenda for the next Panel meeting;
- 5.2.3.14 The Workgroup Chair or another person (nominated by the Workgroup Chair) shall be present at the Panel meeting at which that Workgroup Report is to be discussed and may be invited to present the findings and/or answer the questions of Panel Members.
- 5.2.3.15 Following receipt of any representations, study, Workgroup Report or other evaluation pursuant to sub-paragraph 5.2.3.1, the Panel shall consider whether the information provided is sufficient to form a view as to whether the Modification Proposal better facilitates achievement of the SQSS Objectives and may invite such further representations, studies, and other evaluation including sending matters back to the Workgroup as it deems appropriate until the Panel considers that the information provided is sufficient.

5.2.4 Industry Consultation

- 5.2.4.1 Following completion of the steps set out in sub-paragraphs 5.2.3.1 to 5.2.3.15 above (where relevant), the Secretary shall prepare a consultation document ("Consultation Document") setting out:
- (a) the Modification Proposal;
 - (b) the views and recommendations of the Panel as to whether the changes proposed in the Modification Proposal(s) should be made, including the analysis of whether (and, if so, to what extent) the Modification Proposal(s) would better facilitate achievement of the SQSS Objectives and the views and rationale in respect thereof;
 - (c) an analysis and impact assessment ("Assessment") which shall identify the likely effect of the Modification Proposal(s) on the assets and systems of Panel Members), including a description of any works necessary to implement the change and an

estimate of the development, capital and operating costs associated with implementing the changes to the SQSS;

- (d) the proposed implementation date of the Modification Proposal(s) as agreed by the Panel, failing which, as shall be proposed by the Proposer and, in the later case, accompanied by the written representations of the other Members giving their own opinion as to what the implementation date should be; and
- (e) any proposed text to modify the SQSS
- (f) (to the extent that such matters are not included pursuant to sub-paragraph (c)), an analysis of:
 - (i) the impact of the Modification Proposal(s) on the Core Industry Documents;
 - (ii) the changes which would be required to give effect to the Modification Proposal(s) in relation to the Core industry Documents;
 - (iii) the mechanism and likely timescale for making the changes referred to in sub-paragraph (ii);
 - (iv) the changes or developments which would be required to central computer systems and, if practicable, processes used in connection with the operation of arrangements established under the Core Industry Documents;
 - (v) the mechanism and likely timescale for making the changes referred to in sub-paragraph (iv);
 - (vi) an estimate of the costs associated with making and delivering the changes referred to in sub-paragraphs (ii) and (iv), such costs being expected to relate to: for (ii), the costs of implementing Modifications to the Industry Framework Document(s), and for (iv), the costs of changes to computer systems and possibly processes which are established for the operation of the Core industry Documents,

together with a summary of representations of the Panel in relation to such matters,

5.2.4.2 Pursuant to sub-paragraph 5.2.4.1, the Secretary shall:

- (a) circulate the Consultation Document to each of the Members and such persons or bodies as have responsibility for progressing changes to the Core Industry Documents and publish it on the [NGET-NGESO](#) website or otherwise in such manner as may be deemed appropriate by the Members to bring it to the attention of other persons who may have a relevant interest in the Modification Proposal;

- (b) invite representations in relation to the Consultation Document within 20 Business Days or such other period as the Panel shall determine; and
- (c) on receipt of representations pursuant to sub-paragraph (b), prepare a summary of such representations.

5.2.5 The Modification Report

- 5.2.5.1 Pursuant to sub-paragraph 5.2.4.2, the Panel shall consider the representations made in response to the Consultation Document and shall instruct the Secretary to prepare a report as in sub-paragraph 5.2.4.1 incorporating comments from the Consultation Document respondents and recommendations in light of those comments. This report shall form the “Modification Report”
- 5.2.5.2 If Members agree that Modification to the SQSS is not required, the Panel shall instruct the Secretary to prepare the Modification Report and send it to the Authority. The Secretary shall also update the Modification Register and publish the Modification Report on the [NGET-NGESO](#) website.
- 5.2.5.3 If Members agree that Modification to the SQSS is required, the Panel shall instruct the Secretary to prepare the Modification Report and send it to the Authority. Each Transmission Licensee Member will individually send a licence change request to the Authority based on the Modification Report. The Secretary shall also update the Modification Register and publish the Modification Report on the [NGET-NGESO](#) website.
- 5.2.5.4 If not all Members agree that Modification to the SQSS is needed, the Secretary shall record the range of recommendations which shall be incorporated into the Modification Report. The Panel shall instruct the Secretary or Workgroup Chair to prepare the Modification Report for subsequent submission to the Authority. Those Transmission Licensee Members that recommend Modification to the SQSS may send licence change requests to the Authority. The Secretary shall also update the Modification Register and publish the Modification Report on the [NGET-NGESO](#) website.
- 5.2.5.5 None of the facts, opinions or statements contained in the Modification Report may be relied upon by any other person.

5.2.6 Further versions of SQSS

- 5.2.6.1 If the Authority directs a change to the SQSS the Secretary shall provide a revised version of the SQSS in accordance with the terms of such notice, update the Modification Register and publish the revised SQSS on the [NGET-NGESO](#) website. The Transmission Licensees shall continue to apply the version of the SQSS referred to in their Transmission Licence.

- 5.2.6.2 A Modification to the SQSS shall take effect from the date and time as specified in the direction referred to in sub-paragraph 5.2.6.1.
- 5.2.6.3 The relevant Members shall be responsible for implementing any changes to their relevant computer systems and processes as necessary to effect the Approved Modification in accordance with this sub-paragraph 5.2.6.
- 5.2.6.4 Following implementation of licence changes by the Authority in relation to Approved Modifications, each relevant Member shall:
- (a) use its reasonable endeavours to progress changes made to the Core Industry Documents (to the extent that it is a party to them) in order to give full and timely effect to a Modification to the SQSS by the implementation date;
 - (b) do what is required to those of its systems and processes which support the operation of the SQSS as may be necessary in order to give full and timely effect to a Modification to the SQSS by the implementation date; and
 - (c) keep the Panel informed of any matter that may affect the ability for the implementation date to be met.
- 5.2.6.5 Without prejudice to the obligations of the Members under this sub-paragraph 5.2.6, the implementation date may be extended or shortened with the prior approval of, or at the direction of, the Authority.
- 5.2.6.6 Any relevant Member shall apply to the Authority for an extension of the implementation date if it becomes aware of any circumstances that are likely to cause a delay in the implementation of an Approved Modification.
- 5.2.6.7 A Modification made pursuant to and in accordance with this Paragraph 5.2 shall not be impaired or invalidated in any way by any inadvertent failure to comply with or give effect to this sub-paragraph 5.2.6.
- 5.2.7 The Modification Register
- 5.2.7.1 The Secretary shall establish and maintain a register (the "Modification Register") which shall record, in such form as the Panel may determine, the matters set out in sub-paragraph 5.2.8.3.
 - 5.2.7.2 The purpose of the Modification Register shall be to assist the Panel in the operation of the Modification process under this Governance Framework and to enable the Members and other interested third parties to be reasonably informed of the progress of Modification Proposals and Approved Modifications from time to time.
 - 5.2.7.3 The Modification Register shall record:

- (a) details of each Modification Proposal (including the name of the Proposer, the date raised and a brief description of the Modification Proposal);
- (b) the current status and progress of each Modification Proposal and the anticipated date for reporting to the Authority in respect thereof;
- (c) the current status and progress of each Approved Modification to the SQSS; and
- (d) such other matters as the Panel may consider appropriate from time to time in order to achieve the purposes set out in sub-paragraph 5.2.7.2.

5.2.7.4 The Modification Register shall, in addition to those matters set out in sub-paragraphs 5.2.7.3, also include details of:

- (a) each Modification Proposal which has been withdrawn pursuant to sub-paragraph 5.2.1.6 or rejected by the Panel; and
- (b) each Modification to the SQSS which has been implemented pursuant to sub-paragraph 5.2.7,

for a period of 6 months after such withdrawal, rejection or implementation, or such longer period as the Panel may determine.

5.2.7.5 The Secretary shall publish the Modification Register (as updated from time to time and indicating the revisions since the previous issue) on the [NGET-NGESO](#) website with such frequency as the Panel may agree, in order to bring it to the attention of interested third parties.

Annex 1 - Offshore Transmission Owner Election Process

A1.1 General

A1.1.1 Introduction

- A1.1.1.1 This Annex 1 sets out the basis for election of Offshore Transmission Owner Members and Offshore Transmission Owner Alternate Members which will apply except to the extent that the conditions in A1.1.1.5 are met.
- A1.1.1.2 This Annex 1 shall apply:
- (a) in relation to each year (the "Election Year") in which the term of office of Offshore Transmission Owner Members and Offshore Transmission Owner Alternate Members expires, for the purposes of electing Offshore Transmission Owner Members and Offshore Transmission Owner Alternate Members to hold office with effect from 01 April in that year;
 - (b) subject to and in accordance with Paragraph A1.4, upon a Offshore Transmission Owner Member and/or Offshore Transmission Owner Alternate Member ceasing to hold office before the expiry of his term of office.
- A1.1.1.3 For the purposes of an election under Paragraph A1.1.1.2(a) references to Offshore Transmission Owner are to persons who are an Offshore Transmission Owner as at 01 January in the Election Year.
- A1.1.1.4 The Secretary shall administer each election of Offshore Transmission Owner Members and Offshore Transmission Owner Alternate Members pursuant to this Annex 1.
- A1.1.1.5 Where the following conditions (a) and (b) in this Paragraph A1.1.1.5 are met, the Offshore Transmission Owner Member(s) and/or Offshore Transmission Owner Alternate Member(s) will be those notified to the Secretary as set out below:
- (a) each Offshore Transmission Owner Member as at 01 January in the relevant Election Year, has confirmed in writing to the Secretary that the Offshore Transmission Owner Member(s) and/or Offshore Transmission Owner Alternate Member(s) will be elected in accordance with a process other than that set out in Annex 1 ("Alternative OFTO Election Process"); and

- (b) each Offshore Transmission Owner Member as at 01 January in the relevant Election Year, has notified the Secretary in writing by 25 January of the relevant Election Year of the identity of the Offshore Transmission Owner Member(s) and/or Offshore Transmission Owner Alternate Member(s) elected through the Alternative OFTO Election Process, and each notification identifies the same individual(s).

Upon receipt of such notifications in accordance with the above, the provisions of this Annex 1, with exception of Paragraph A1.1.1.4, shall not apply until the following Election Year.

A1.1.2 Election timetable

A1.1.2.1 The Secretary shall not later than 01 February in the Election Year prepare and circulate to all Offshore Transmission Owners (by publication on the [NGET-NGESO](#) Website and, where relevant details are supplied, by electronic mail), with a copy to the Authority, an invitation to nominate candidates who must be willing to be either a Offshore Transmission Owner Member or an Alternate Member and a timetable for the election (the “Election Timetable”), setting out:

- (a) the date by which nominations of candidates are to be received, which shall not be less than three (3) weeks after the timetable is circulated;
- (b) the date by which the Secretary shall circulate a list of candidates and voting papers;
- (c) the date by which voting papers are to be submitted, which shall not be less than three (3) weeks after the date for circulating voting papers;
- (d) the date by which the results of the election will be made known, which shall not be later than 18 March in the Election Year.

A1.1.2.2 If for any reason it is not practicable to establish an Election Timetable in accordance with Paragraph A1.2.1.1 or to proceed on the basis of an Election Timetable which has been established, the Secretary may establish a different timetable, or revise the Election Timetable, by notice to all Offshore Transmission Owners, the Panel and the Authority, provided that such timetable or revised timetable shall provide for the election to be completed before 01 April in the Election Year.

A1.1.2.3 A nomination or voting paper received by the Secretary later than the respective required date under the Election Timetable (subject

to any revision under Paragraph A1.1.2.2) shall be disregarded in the election.

A1.2. **CANDIDATES**

A1.2.1 **Nominations**

- A1.2.1.1 Nominations for candidates shall be made in accordance with the Election Timetable.
- A1.2.1.2 Subject to Paragraph A1.1.1.3, each Offshore Transmission Owner may nominate one candidate for election by giving notice to the Secretary.

A1.2.2 **List of candidates**

- A1.2.2.1 The Secretary shall draw up a list of the nominated candidates and circulate the list to all Offshore Transmission Owners by the date specified in the Election Timetable.
- A1.2.2.2 The list shall specify the Offshore Transmission Owner by whom each candidate was nominated and any affiliations which the candidate may wish to have drawn to the attention of Offshore Transmission Owners.
- A1.2.2.3 Except where Paragraphs A1.4.3 or A1.4.4 apply, if two (2) or fewer candidates are nominated no further steps in the election shall take place and such candidate(s) shall be treated as elected as Offshore Transmission Owner Members and Paragraph A1.3.2.4 shall apply in relation to such candidate(s).
- A1.2.2.4 Where Paragraph A1.4.3 applies, if only one (1) candidate is nominated, no further steps in the election shall take place and such candidate shall be treated as elected as a Member and Paragraph A1.3.2.4 shall apply in relation to such candidate.
- A1.2.2.5 Where Paragraph A1.4.4 applies, if two (2) or fewer candidates are nominated, no further steps in the election shall take place and such candidate(s) shall be treated as elected as Alternate Members and Paragraph A1.3.2.4 shall apply in relation to such candidate(s).

A1.3 **VOTING**

A1.3.1 **Voting papers**

- A1.3.1.1 Voting papers shall be submitted in accordance with the Election Timetable.

A1.3.1.2 Each Offshore Transmission Owner may submit one voting paper.

A1.3.2 Preference votes and voting rounds

A1.3.2.1 Each Offshore Transmission Owner submitting a voting paper shall vote by indicating on the voting paper a first, second and third preference ("Preference Votes") among the candidates.

A1.3.2.2 A voting paper need not indicate a second, or a third, preference, but the same candidate may not receive more than one Preference Vote in a voting paper.

A1.3.2.3 Candidates shall be elected in three voting rounds (together where necessary with a further round under Paragraph A1.3.6) in accordance with the further provisions of this Paragraph A1.3.

A1.3.2.4 The Secretary shall determine which candidates are elected and announce (to the Authority and all Offshore Transmission Owners) the results of the election in accordance with the Election Timetable.

A1.3.2.5 The Secretary shall not disclose the Preference Votes cast by Offshore Transmission Owners or received by candidates; but a Offshore Transmission Owner may request that the Authority scrutinise the conduct of the election, provided that such Offshore Transmission Owner shall bear the costs incurred by the Authority in doing so unless the Authority recommends that the election results should be annulled.

A1.3.2.6 Further references to voting papers in this Paragraph A1.3 do not include voting papers which are invalid or are to be disregarded (i.e. voting papers not made or submitted in accordance with this Annex 1).

A1.3.3 First voting round

A1.3.3.1 In the first voting round:

(a) the number of first Preference Votes allocated under all voting papers to each candidate shall be determined.

(b) the first round qualifying total shall be:

$$(T / N) + 1$$

Where

T is the total number of first Preference Votes in all voting papers;

N is the number of Offshore Transmission Owners' Members and/or Alternate Members to be elected.

A1.3.3.2 If the number of first Preference Votes allocated to any candidate is equal to or greater than the first round qualifying total, that candidate shall be elected.

A1.3.4 **Second voting round**

A1.3.4.1 In the second voting round:

(a) the remaining candidates are those which were not elected in the first voting round;

(b) the remaining voting papers are voting papers other than those under which the first Preference Votes were for candidates elected in the first voting round;

(c) the number of first and second Preference Votes allocated under all remaining voting papers to each remaining candidate shall be determined;

(d) the second round qualifying total shall be

$$(T' / N') + 1$$

Where

T' is the total number of first Preference Votes and second Preference Votes allocated under all remaining voting papers;

N' is the number of Members and/or Alternate Members remaining to be elected after the first voting round.

A1.3.4.2 If the number of first and second Preference Votes allocated to any remaining candidate is equal to or greater than the second round qualifying total, that candidate shall be elected.

A1.3.5 **Third voting round**

A1.3.5.1 In the third voting round:

(a) the remaining candidates are those which were not elected in the first or second voting rounds;

- (b) the remaining voting papers are voting papers other than those under which the first or second Preference Votes were for candidates elected in the first or second voting rounds;
- (c) the number of first, second and third Preference Votes allocated under all remaining voting papers to each remaining candidate shall be determined;
- (d) the third round qualifying total shall be

$$(T'' / N'') + 1$$

Where

T'' is the total number of first Preference Votes, second Preference Votes and third Preference Votes allocated under all remaining voting papers;

N'' is the number of Members remaining to be elected after the first and second voting rounds.

- A1.3.5.2 If the number of first, second and third Preference Votes allocated to any remaining candidate is equal to or greater than the third round qualifying total, that candidate shall be elected.

A1.3.6 **Further provisions**

- A1.3.6.1 If after any voting round the number of candidates achieving the required Preference Votes threshold exceeds the number of persons remaining to be elected, the following tie-break provisions shall apply between the tied candidates. In addition, if after the third voting round any Member(s) or Alternate Member(s) remain to be elected the following tie-break provisions shall apply between the remaining candidates:

- (a) the tied or remaining candidates (as applicable) shall be ranked in order of the number of first Preference Votes allocated to them, and the candidate(s) with the greatest number of such votes shall be elected;
- (b) in the event of a tie between two or more candidates within Paragraph (a), the candidate(s) (among those tied) with the greatest number of second Preference Votes shall be elected;
- (c) in the event of a tie between two or more candidates within Paragraph (b), the Secretary shall select the candidate(s) (among those tied) to be elected by drawing lots.

A1.3.7 Members and Alternate Members

- A1.3.7.1 Except where Paragraphs A1.4.3 or A1.4.4 apply, the two (2) candidates receiving the greatest number of votes shall be elected as Offshore Transmission Owners' Members and the next two (2) shall be elected as Offshore Transmission Owners' Alternate Members.
- A1.3.7.2 Where Paragraph A1.4.3 applies the number of candidate(s) up to and including the number of Member Interim Vacancies receiving the greatest number of votes pursuant to the Interim Panel and Alternate Election Process shall be elected as Offshore Transmission Owners' Member(s) and the remaining candidates up to and including the number of Alternate Member Interim Vacancies receiving the greatest number of votes shall be elected as Alternate Member(s).
- A1.3.7.3 Where Paragraph A1.4.4 applies the two (2) candidates receiving the greatest number of votes pursuant to the Alternate Election Process shall be elected as Alternate Members.

A1.4 VACANCIES

A1.4.1 General

- A1.4.1.1 If a Member ceases to hold office pursuant to Paragraph 4.11.1 (b) (i) then Paragraph A1.4.2 shall apply.
- A1.4.1.2 If a Member ceases to hold office pursuant to Paragraph 4.11.1 (a), 4.11.1 (b) (ii) to (vi) (inclusive) or 4.11.1 (c) then Paragraph A1.4.3 shall apply.
- A1.4.1.3 If an Alternate Member ceases to hold office pursuant to Paragraph 4.11 (the "Resigning" Alternate Member) then Paragraph A1.4.4 shall apply.
- A1.4.1.4 The provisions of Paragraph A1.2.1.2 shall apply, mutatis mutandis, to any replacement Member or any replacement Alternate Member under this Paragraph A1.4.

A1.4.2 Replacement of a Member who ceases to hold office pursuant to Paragraph 4.11.1 (b) (i)

- A1.4.2.1 Where this Paragraph A1.4.2 applies, and in accordance with the duties set out in Paragraph 4.2, such Member may appoint a replacement Member (subject to Paragraph A1.4.2.2) for the remainder of the term of office of such Member and shall notify the Secretary of a replacement Member at the same time as they

resign. If such Member does not appoint a replacement at the time of notifying the Secretary of their resignation then such Member will be replaced in accordance with Paragraph A1.4.3 and this Paragraph A1.4.2.1 shall no longer apply.

A1.4.2.2 A Member shall only appoint an Alternate Member to be his replacement pursuant to Paragraph A1.4.2.1 and such Alternate Member chosen to be a Member shall then become a Resigning Alternate Member and be replaced in accordance with Paragraph A1.4.4.

A1.4.3 Replacement of a Member who ceases to hold office pursuant to Paragraph 4.11.1 (a), 4.11.1 (b) (ii) to (vi) or 4.11.1 (c)

A1.4.3.1 Subject to Paragraph A1.4.3.2, such Member shall, where one or more Alternate Member(s) hold office, be replaced by the Alternate Member who previously received the highest number of cumulative Preference Votes but if there were a tie-break in relation to such Preference Votes then the tie-break provisions set out in Paragraph A1.3.6.1 shall apply, in either circumstance such Alternate Member selected to be a Member shall then become a Resigning Alternate Member and be replaced in accordance with Paragraph A1.4.4.

A1.4.3.2 If there are no Alternate Members in office upon a Member ceasing to hold office then:

(a) Where there are not less than six (6) months remaining until the next full election further Members shall be elected in accordance with Paragraphs A1.2, A1.3 and subject to the following Paragraphs A1.4.3.3 to A1.4.3.5 (inclusive) (the "Interim Panel and Alternate Election Process").

(b) Where there are less than six (6) months remaining until the next full election no further Members or Alternate Members shall be elected pursuant to this Paragraph A1.4.3 and the positions shall remain vacant until the next full election.

A1.4.3.3 Where this Paragraph A1.4.3.3 applies the Secretary shall indicate in the invitation referred to at Paragraph A1.1.2.1 the number of vacancies for both Member(s) ("Member Interim Vacancies") and Alternate Member(s) ("Alternate Member Interim Vacancies") for which the Interim Panel and Alternate Election Process is being held.

A1.4.3.4 Any Member(s) or Alternate Member(s) elected pursuant to the Interim Panel and Alternate Election Process shall cease to hold office at the next full election.

A1.4.3.5 The timetable for the Interim Panel and Alternate Election Process shall be expedited and the Secretary shall prepare a timetable accordingly.

A1.4.4 Replacement of a Resigning Alternate Member

A1.4.4.1 Subject to Paragraph A1.4.4.2 a Resigning Alternate Member shall not be replaced.

A1.4.4.2 If there are no Alternate Members remaining in office following the resignation of an Alternate Member or their appointment as a Member in accordance with A1.4.2 or A1.4.3 then:

(a) Where there are not less than six (6) months remaining until the next full election further Alternate Members shall be elected in accordance with Paragraphs A1.2, A1.3 and subject to the following paragraphs A1.4.4.3 to A1.4.4.5 (inclusive) (the “Alternate Election Process”).

(b) Where there are less than six (6) months remaining until the next full election no further Alternate Members shall be elected and the positions shall remain vacant until the next full election.

A1.4.4.3 Where this Paragraph A1.4.4.3 applies, a reference in Paragraphs A1.2 and A1.3 to an Offshore Transmission Owners’ Member shall not apply except in the case of Paragraph A1.3.5.1 (d) where the reference to “Members” shall be read and construed as a reference to “Alternate Members”.

A1.4.4.4 Any Alternate Member(s) elected pursuant to the Alternate Election Process shall cease to hold office at the next full election.

A1.4.4.5 The timetable for the Alternate Election Process shall be expedited and the Secretary shall prepare a timetable accordingly.

Annex 2 - SQSS Modification Process Flow Chart

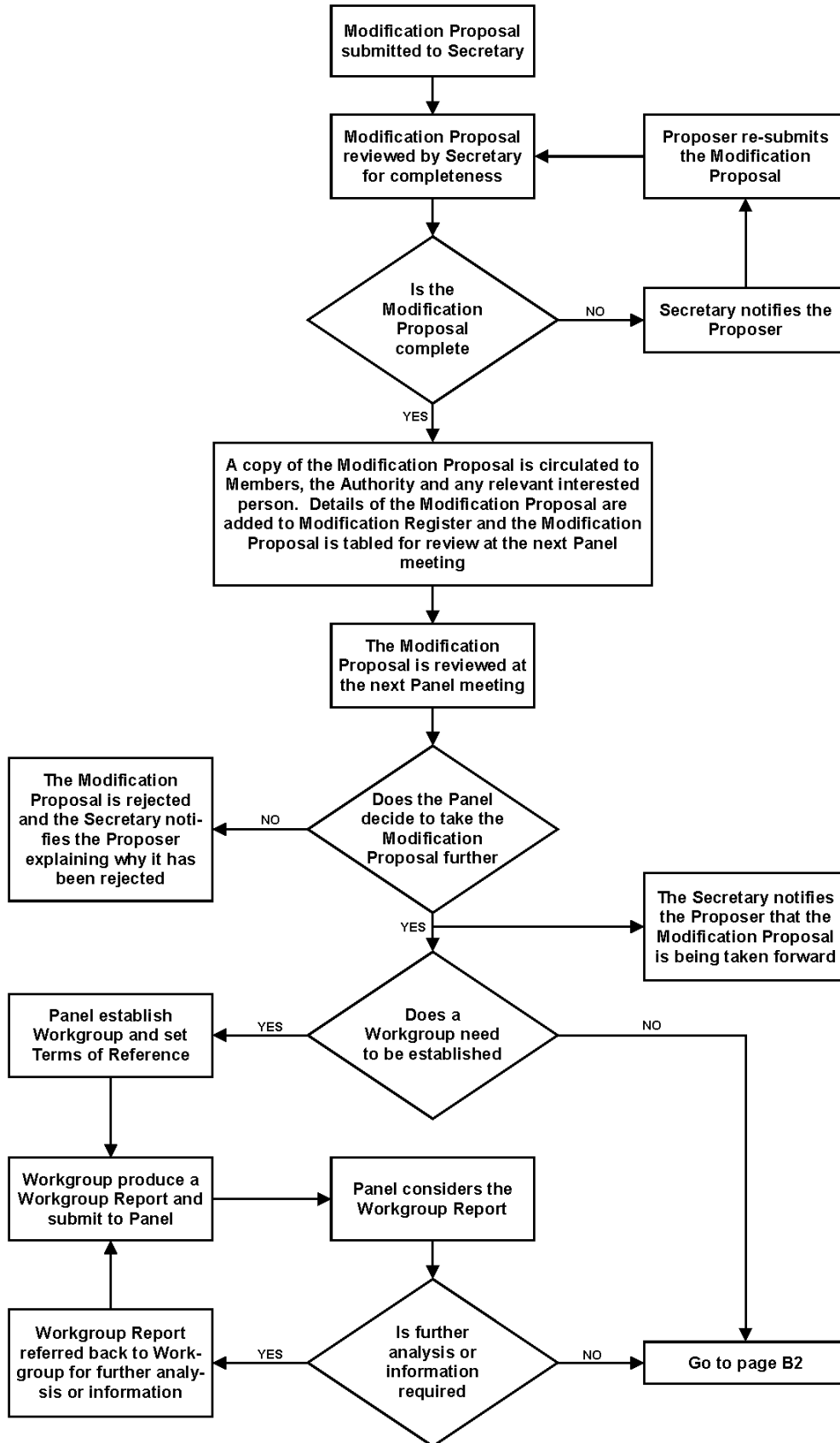

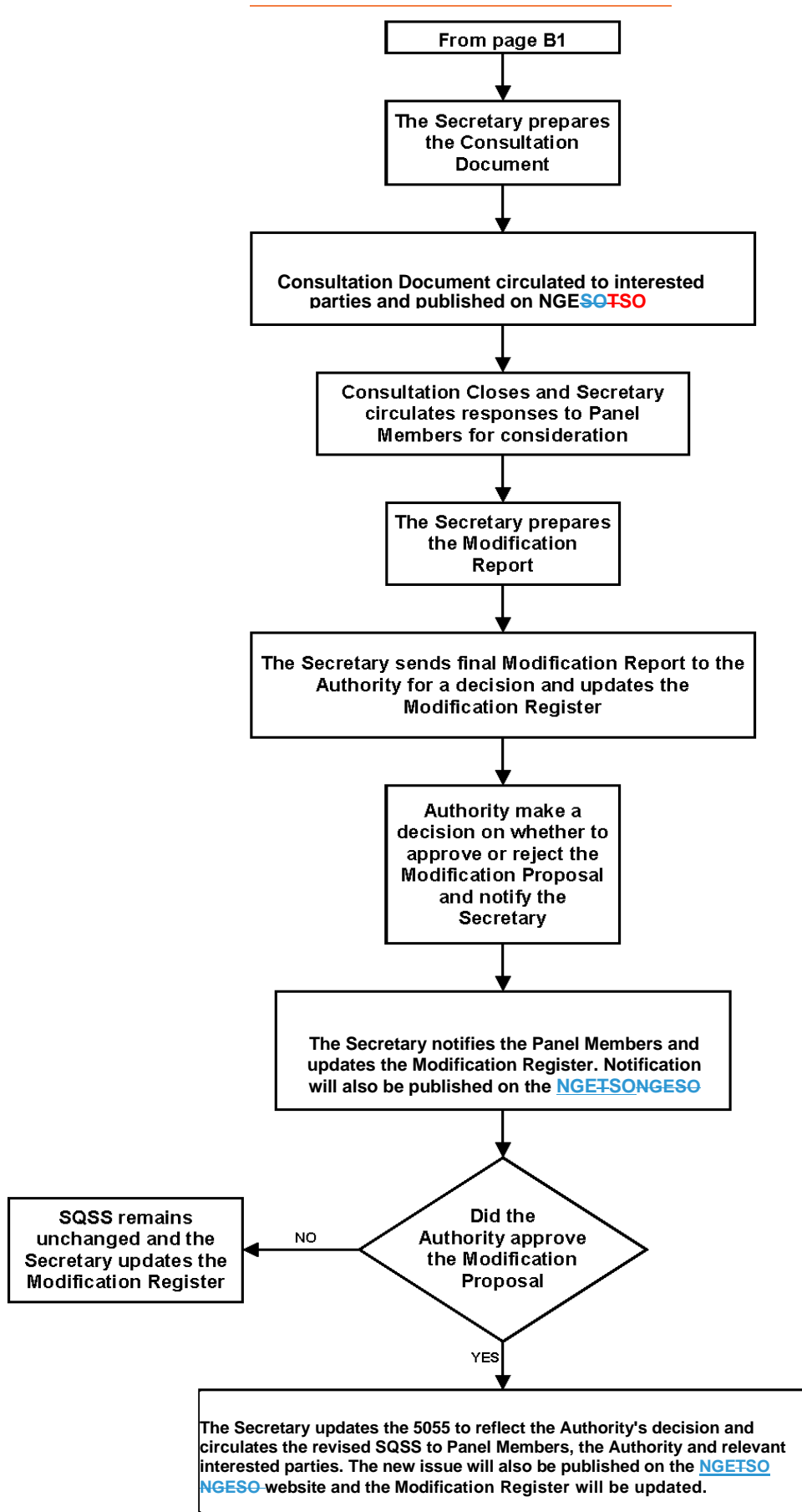

Annex 3 - Modification Proposal Form

A copy of the Modification Proposal Form can be found electronically on the [NGET-NGESO](#) website at:

<http://www.nationalgrid.com/uk/Electricity/Codes/gbsqsscode/DocLibrary/reviewdocs/>

GSR024 National Grid Legal Separation SQSS Changes

Views are invited upon the proposals outlined in this consultation. Please submit your formal responses on this form to box.SQSS@nationalgrid.com no later than **4pm on 5 July 2018**.

The proposals set out in this consultation are intended to better meet the NETS SQSS Objectives. To achieve this, they are intended to facilitate efficient and economic connection arrangements whilst ensuring there is no impact on the safety and security of the transmission system.

These responses will be included in the Report to the Authority which is drafted by National Grid and submitted to the Authority for a decision.

| | |
|---|---|
| Respondent: | <i>Alan Creighton</i> |
| Company Name: | <i>Northern Powergrid</i> |
| 1. Do you agree with the general approach to account for the legal separation of the system operator and transmission owner within the SQSS? | Yes |
| 2. Do you believe that GSR024 better facilitates the appropriate NETS SQSS objectives? | <p>Yes</p> <p><i>For reference the applicable NETS SQSS objectives are:</i></p> <p><i>(i) facilitate the planning, development and maintenance of an efficient, coordinated and economical system of electricity transmission, and the operation of that system in an efficient, economic and coordinated manner;</i></p> <p><i>(ii) ensure an appropriate level of security and quality of supply and safe operation of the National Electricity Transmission System;</i></p> <p><i>(iii) facilitate effective competition in the generation and supply of electricity, and (so far as consistent therewith) facilitating such competition in the distribution of electricity; and</i></p> <p><i>(iv) facilitate electricity Transmission Licensees to comply with their obligations under EU law.</i></p> |

| | |
|---|--|
| <p>3. Do you generally support the modifications to amend the SQSS and the Industry Governance Framework as set out? If not, please clarify your concerns.</p> | <p>Yes</p> |
| <p>4. Are there any further technical or commercial considerations that need to be taken into account?</p> | <p><i>Not that we are aware of.</i></p> |
| <p>5. Please provide any other comments you feel are relevant to the proposed changes.</p> | <p><i>1 Parag 2.2 of the Industry Governance Framework suggests that NGENSO own a transmission system as the proposed text refers to 'their' system. It may be better to tease out the roles of NGET/SPT/SHET and NGENSO:</i></p> <p><i>2.2</i> NGET, SHETL and SPT have an obligation under the Transmission Licence to plan, develop and operate their systems in accordance with, amongst other things, the SQSS.</p> <p>NGESO has an obligation under the Transmission Licence to plan, develop and operate the NETS in accordance with, amongst other things, the SQSS.</p> <p>In addition NGENSO's Transmission Licence places an obligation on NGENSO to co-ordinate and direct the flow of electricity onto and over the National Electricity Transmission System, in accordance with, amongst other things, the SQSS</p> <p><i>2 In the Industry Governance Framework NGENSO is defined as: shall mean National Grid Electricity System Operator Limited with company number 11014226;</i></p> <p><i>In SQSS, NGENSO is defined as : National Grid Electricity Transmission Limited (No. 11014226) whose registered office is 1-3 Strand, London WC2N 5EH as the holder of the transmission licence granted, or treated as granted, pursuant to Section 6(1)(b) of the Act and in which section C of the standard transmission licence conditions applies.</i></p> <p><i>Is the SQSS definition correct?</i></p> |

| | |
|---|--|
| <p>6. The definition of ‘Onshore Transmission Licensee’ has been amended by this proposal so that it makes reference to both the named parties and the specific type of license held. Do you think this additional clarification assist parties when reviewing the SQSS?</p> | <p>Yes, the additional text helps to confirm the parties who are Onshore Transmission Licensees.</p> |
|---|--|

If you wish to submit a confidential response please note the following:

- i. Information provided in response to this consultation will be published on National Grid’s website unless the response is clearly marked “Private and Confidential”. We will contact you to establish the extent of the confidentiality. A response marked “Private and Confidential” will be disclosed to the Authority in full but, unless agreed otherwise, will not be shared with the NETS SQSS Review Panel and/or Grid Code Review Panel or the industry and may therefore not influence the debate to the same extent as a non-confidential response.
- ii. Please note an automatic confidentiality disclaimer generated by your IT System will not in itself mean that your response is treated as if it had been marked “Private and Confidential”.

GSR024 National Grid Legal Separation SQSS Changes

Views are invited upon the proposals outlined in this consultation. Please submit your formal responses on this form to box.SQSS@nationalgrid.com no later than **4pm on 5 July 2018**.

The proposals set out in this consultation are intended to better meet the NETS SQSS Objectives. To achieve this, they are intended to facilitate efficient and economic connection arrangements whilst ensuring there is no impact on the safety and security of the transmission system.

These responses will be included in the Report to the Authority which is drafted by National Grid and submitted to the Authority for a decision.

| | |
|--|---|
| Respondent: | <i>Rachel Woodbridge-Stocks</i> <i>Rachel.woodbridgestocks@nationalgrid.com</i> |
| Company Name: | <i>National Grid</i> |
| 7. Do you agree with the general approach to account for the legal separation of the system operator and transmission owner within the SQSS? | Yes |
| 8. Do you believe that GSR024 better facilitates the appropriate NETS SQSS objectives? | We believe GSR024 better facilitates objective (i): <i>(i) facilitate the planning, development and maintenance of an efficient, coordinated and economical system of electricity transmission, and the operation of that system in an efficient, economic and coordinated manner;</i> This modification facilitates an independent System Operator and aligns the role and responsibilities of NGET as the Transmission Owner with those of the other Transmission Owners and in line with the modified NGET Transmission Licence obligations. |
| 9. Do you generally support the modifications to amend the SQSS and the Industry Governance Framework as set out? If not, please clarify your concerns. | Yes |
| 10. Are there any further technical or commercial considerations that need to be taken into account? | No |

| | |
|--|------------|
| <p>11. Please provide any other comments you feel are relevant to the proposed changes.</p> | |
| <p>12. The definition of ‘Onshore Transmission Licensee’ has been amended by this proposal so that it makes reference to both the named parties and the specific type of license held. Do you think this additional clarification assist parties when reviewing the SQSS?</p> | <p>Yes</p> |

If you wish to submit a confidential response please note the following:

- iii. Information provided in response to this consultation will be published on National Grid’s website unless the response is clearly marked “Private and Confidential”. We will contact you to establish the extent of the confidentiality. A response marked “Private and Confidential” will be disclosed to the Authority in full but, unless agreed otherwise, will not be shared with the NETS SQSS Review Panel and/or Grid Code Review Panel or the industry and may therefore not influence the debate to the same extent as a non-confidential response.
- iv. Please note an automatic confidentiality disclaimer generated by your IT System will not in itself mean that your response is treated as if it had been marked “Private and Confidential”.