

Power Potential DER Technical Requirements v2.5.5

August 2020



Contents

Contents.....	1
Definitions, acronyms and abbreviations.....	3
List of referenced documents	4
1 Introduction	5
1.1 Purpose and scope.....	5
1.2 Project Background	5
2 System architecture and responsibilities	6
2.1 Substation DER interface	7
2.1.1 UK Power Networks domain.....	7
2.1.2 DER substation customer domain.....	8
2.2 Aggregator interface	8
3 Functional requirements.....	9
3.1 Real power control set-point signal – for active power service	9
3.2 Voltage droop control set-point signal – for non-synchronous DER reactive power service	9
3.3 Voltage control set-point signal – for synchronous DER in reactive power service	9
3.4 Time of response to voltage set point in reactive power service	9
3.5 Reactive power limit set-point	10
3.6 Power Factor control set-point signal	10
3.7 DER operation mode	10
3.8 Watchdog function.....	10
4 Non-functional requirements	12
4.1 Interface to DER substation	12
4.1.1 Communications protocol.....	12
4.1.2 IP addressing.....	12
4.1.3 Physical requirements	12
4.1.4 System Availability.....	13
4.1.5 Power supply	13
4.1.6 Communication link	13
4.1.7 Cable installations	14
4.1.8 Analogue measurements.....	14
4.1.9 Digital indications and alarms.....	14
4.2 Interface to Aggregators.....	14
4.3 Cyber Security requirements	14
4.3.1 Security Incident Management.....	15
4.3.2 Physical & Environment Security	15
4.3.3 Malicious Software	15
4.3.4 Site communications and control equipment interface requirements	15

5	Approach to DER assessment and testing.....	17
5.1	Initial Desktop Assessment	17
5.2	DER Commissioning Test	17
5.2.1	Laboratory Based Pre-commissioning Test	17
5.2.2	Site Based Commissioning Test	17
5.2.3	Overview of Tests.....	18
5.2.4	DER's Response to Technical Requirements	18
6	Appendices	19
6.1	DER interface signals	19
6.2	Desktop assessment of possible relaxation of the DER's PF range	19
6.3	DER Performance Testing	21
6.4	Frequently asked questions on DER Interface requirements.....	25
a)	Which communications protocol is used to communicate with the RTU?	25
b)	What if the supplier for DER controller does not support DNP3 protocol?	25
c)	What type of cable is used to communicate with the RTU?.....	25
d)	Will a marshalling box be required for the RTU and DER controller interface cable?	25

Definitions, acronyms and abbreviations

Term	Definition
DER control system	The native control system used by the DER customer to operate and control the DER plant and that interfaces with the UK Power Networks equipment.
Distributed Energy Resources Management System (DERMS)	The centralised software based control system within UK Power Networks that dispatches energy resources to provide active and reactive power services to National Grid as part of the Power Potential project.
Distributed Network Protocol (DNP3)	Communication protocol widely used within the utilities industry and also used by UK Power Networks for its SCADA system.
DNO	Distribution Network Operator
GSM	Global System for Mobile Communications
LAN	Local Area Network
NG ESO	National Grid Electricity System Operator
Point of connection (POC)	The interface between the UK Power Networks' equipment (main fuse, energy meter) and the consumer's equipment (supply panel).
PowerON	The end-to-end system that UK Power Networks is using at control centre level to manage its distribution network.
Ramp rate (Ramp-up rate and Ramp-down rate)	The ramp-up and ramp-down rate refers to the rate-of-change of site/DER power export.
SCADA	Supervisory Control and Data Acquisition: centralised computer-based systems that monitor and control the electricity distribution network.
RTU	Remote Terminal Unit
UKPN	UK Power Networks

Scope of changes from previous version of this document:

v 2.5.5 (August 2020) Clarification of 4% voltage droop in sections 6.2 and 6.3

v 2.5.4 (July 2019) Change to new template with change to National Grid ESO, website links updated, various minor clarifications, removal of detailed table of DER signals (now covered by separate DER Interface Schedule), removal of time-synchronisation requirement for RTU (data captured by synchronised DERMS and PowerOn historian systems)

List of referenced documents

	Document Title	Document Reference
1	Civils Drawing – Substation layout, Steelwork and concrete base details for UK Power Networks satellite dish	EDS 07-0020-05 http://library.ukpowernetworks.co.uk/library/asset/5e852042-0b9c-4d67-a7c8-4db484f973eH/EDS+07-0020+Drawings.pdf
2	Telecommunications for operational tripping, timed and flexible connections Technical Solution Summary	https://www.ukpowernetworks.co.uk/internet/en/our-services/documents/Operational_trip_control_logic_communications.pdf
3	DER Interface Schedule (MS Excel document)	https://www.nationalgrideso.com/document/119536/download
4	DER Technical Characteristics Submission Spreadsheet and associated Guidance Document	https://www.nationalgrideso.com/document/106416/download
5	DER Test Specification	https://www.nationalgrideso.com/document/130871/download
6	DER Commissioning Test Procedure	ECP 11-0702 - the detailed test requirements, procedure and test form followed by UK Power Networks' engineers to confirm a DER may participate in the trial. Internal document, to be shared with participating DER and published later in the trial as project learning
7	DERMS Web Interface User Guide	To be supplied on request by UK Power Networks to participating DER
8	IST 01 005 Information Security Standard for Service Providers	To be supplied on request by UK Power Networks

1 Introduction

1.1 Purpose and scope

This document provides the standard technical requirements of UK Power Networks (UKPN) for the connection of Distributed Energy Resources (DERs) in order to dispatch active and reactive power services to National Grid Electricity System Operator (NG ESO) as part of the Power Potential project trial. It is a key guidance document to all the parties involved in designing, building and integrating the DER control system to UKPN' infrastructure.

This document specifies technical requirements including both functional and non-functional requirements. It also clarifies responsibilities and demarcations and where relevant it makes reference to specific industry standards or good practices.

The scope of this document only covers the requirements that are associated with the interface involving real time data exchange between DER and UKPN. This document does not cover requirements involving non-real time data exchange such as commercial availability, technical DER capability and costs. These are covered online via the Distributed Energy Resources Management System (DERMS) Web Interface. Also, the standard design specifications (civils, protection, etc.) are covered by the corresponding UKPN design standards and drawings that are referenced within this document where applicable.

1.2 Project Background

The Power Potential project (previously called the Transmission and Distribution Interface 2.0 project) is a joint effort between NG ESO and UKPN to find an innovative solution to the technical constraints experienced at the transmission level.

The project is focused in the South East area of England and there are four existing Grid Supply Points (GSP) in scope for the project: Bolney, Ninfield, Sellindge and Canterbury North. The transmission network, and the areas within the distribution network at this location are at the limit of capacity for transferring generation away from the area. This means for particular faults or conditions on the transmission network, voltage levels at certain points could reach values that can violate statutory voltage limits. This constraint is preventing additional generation from being able to connect to the South East transmission or distribution networks. To enable more generation to connect, large-scale network investment is traditionally required. The Power Potential project aims to help manage transmission constraints by providing power services to NG ESO from DER connected to UKPN's distribution network. This will ultimately facilitate faster and cheaper alternative DER connections and will reduce the operating costs currently being incurred in managing the existing limitations in this area.

The project aims to create a regional reactive power market for the first time in the world, which will help defer network reinforcement needs in the transmission system. DER can also bid for active power services in the Power Potential project. The project has the following key deliverables:

- A commercial framework using market forces to create new services provided from DER to NG ESO via UKPN.
- A technical and market solution known as DERMS to support technical and commercial optimisation and dispatch. It includes gathering bids from DER and presenting an optimised view of the services to NG ESO split by GSP. The DERMS will be installed in UKPN's control room.

At a high level, the project solution is envisaged to work as follows:

- Gather commercial availability, capability and costs from each DER;
- Run power flow assessments to calculate possible availability of each service at the GSP. Once the assessment is complete, a range of service availability and costs will be presented to NG ESO as intra-day availability (or 24 hour rolling window) taking into consideration DER bids, their effectiveness and what the distribution network can allow at

the time of service due to current running arrangements. With this information, NG ESO will decide the level of services to be procured; and

- On the day of the response, NG ESO will instruct the services to UKPN, the DERMS solution will instruct each DER to change their set-point as required and will monitor their response.

2 System architecture and responsibilities

The DER can interface to UKPN' infrastructure via two methods. The first one is via the substation installation with a hard wired Local Area Network (LAN) connection between UKPN and DER equipment installed within the DER substation premises. The second one is via the secure enterprise connection between the aggregator and the UK Power Networks Wide Area Network (WAN). The second method is only valid for aggregators which can also choose to connect their DER assets using the first method (if feasible). Figure 1 shows the high level system architecture and interfaces to DER substation and aggregator.

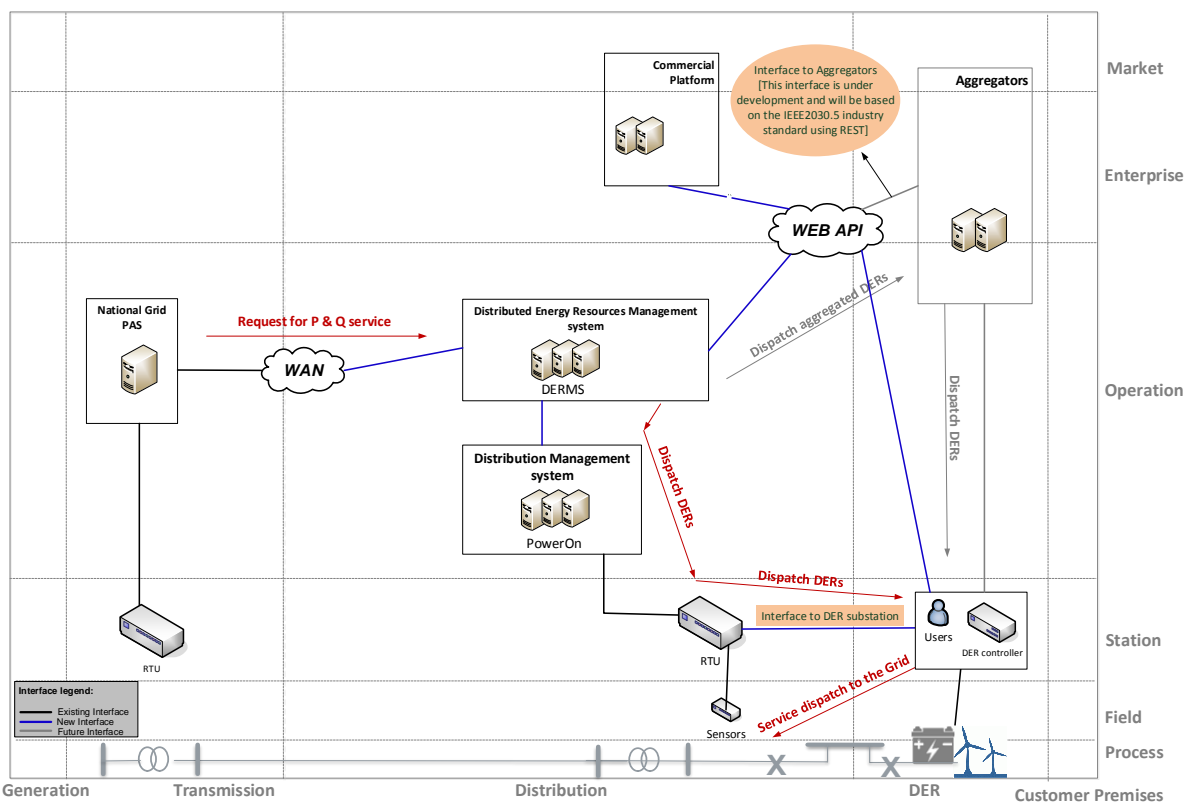

Figure 1: High level system architecture showing two DERMS interfaces to DER

2.1 Substation DER interface

This section defines the responsibilities and the demarcations within the DER substation of the DER and UKPN areas of the substation.

Figure 2: DER substation diagram showing demarcation represents a high-level architecture of the substation showing core components involved in the service dispatch process. The dotted red line represents demarcation between the UKPN domain and the DER customer's domain. This diagram does not represent the actual layout of the equipment on site. For an indicative schematic layout with the full list of cabin equipment, refer to the relevant engineering drawings in the Appendices. Full responsibilities of the site will be covered by the Site Responsibility Schedule for each site.

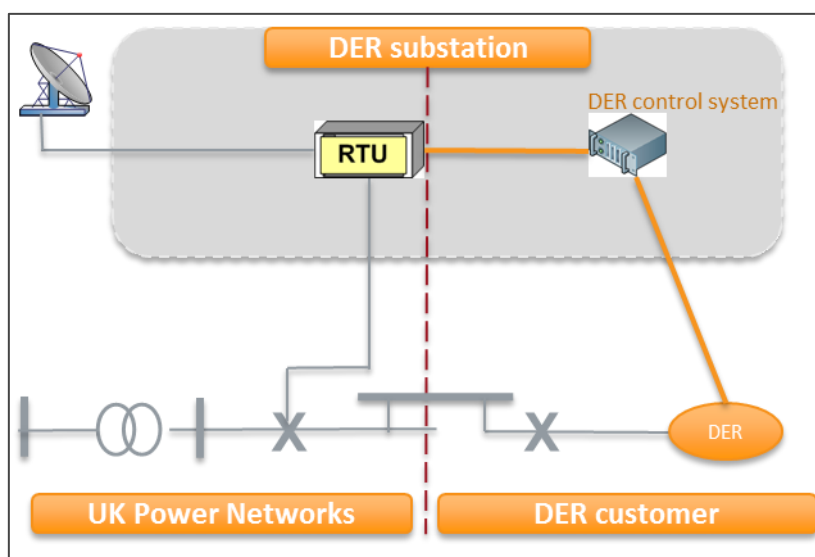

Figure 2: DER substation diagram showing demarcation

2.1.1 UK Power Networks domain

The UKPN domain includes all the equipment that is owned and maintained by the distribution network operator and may not include the building structure if owned by the DER customer. For new build DER substation, the structure shall be designed to have capability of supporting all the wall mounted equipment; should the walls require structural strengthening this will be the responsibility of the DER customer and is to be completed prior to the installation of UKPN equipment. Note clearance dimensions are to be maintained for access and maintenance. Refer to drawing [EDS 07-0020-05](#) for an indicative schematic layout.

2.1.1.1 Communications equipment

As a standard installation the Remote Terminal Unit (RTU) shall use the satellite communications link to the UKPN control centre. (Refer to section 4.1.3 for details on satellite dish and the drawing for the specification of the ground mounted satellite dish). The RTU also has a second communications link as a back-up using a wireless GSM (Global System for Mobile Communications) based technology. For new build DER substations, this drawing shall be included as part of the DER customer's planning application for the site.

For any reasons, if a DER customer wishes to have a non-standard communications link from the UKPN control centre to UKPN RTU, this can be accommodated based on the telecommunications solutions options outlined in the Technical solution summary bulletin. Please refer to Appendices.

2.1.1.2 RTU and DER interface

The RTU is a wall mounted cabinet that is installed in close proximity to the communications equipment cabinet. The RTU will interface with the DER control equipment. Refer to drawing HQ-

2000-4760 for dimensions of the cabinet and details of power supply equipment. Note clearance dimensions are to be maintained for access and maintenance.

2.1.2 DER substation customer domain

The DER customer is responsible for all the equipment within this domain. As per Figure 2: DER substation diagram showing demarcation, the RTU interfaces with the DER control system equipment via a hard wired communications link owned by the customer. For clarity, responsibilities for both parties are described in

Table 1. Full responsibilities of the site will be covered by the Site Responsibility Schedule document.

No	Items	UK Power Networks	DER customer
1	UK Power Networks RTU	Responsible for supplying, installing, commissioning and maintaining the equipment	N/A
2	DER control system	Responsible for specifying the interface requirements between the RTU and the DER control system	Responsible for supplying, installing, commissioning and maintaining the equipment
3	Communication link between the UK Power Networks RTU and the DER control system	Responsible for specifying the cables and terminating within the equipment	Responsible for supplying, installing, commissioning and maintaining the cables
4	Local Area Network (interface between UK Power Networks RTU and DER control system)	Responsible for specifying the IP addressing for both DER control system and local RTU	Responsible for configuring and maintaining the IP addressing supplied by UK Power Networks.
5	Cyber security	Responsible to design and maintain cyber security of its own equipment	Responsible to design and maintain cyber security of its own equipment

Table 1: Responsibility matrix

2.2 Aggregator interface

The DER aggregator is expected to connect via the UKPN IT infrastructure. The aggregator interface does not currently exist as a standard connection in the UKPN design. As part of the Power Potential project, this interface is currently being developed with reference to industry standards and engagement with the aggregators. Communications to the aggregator will be directly from DERMS via a web Application Programming Interface (API) gateway. The future aggregator solution will implement IEEE 2030.5 as the industry standard for how the DERMS interface should be developed and specifies the use of REST.

3 Functional requirements

The following functional requirements must be met by the DER customer in order to commission the DER for the service dispatch function as part of the Power Potential project. The customer must consult the expertise of appropriate parties at the earliest stage of the project to be able to plan, procure, design and deliver the solution in accordance to the detailed requirements set in this document.

The DER control system must be capable to operate in Power Factor (PF) mode maintaining PF within pre-defined limits¹. The DER control system must be able to change its mode of operation from PF to voltage control and then be able to comply with a target voltage set-point. For a detailed list of signals exchanged between UKPN and DER please refer to the 'DER Interface Schedule' spreadsheet provided on the Power Potential website (see list of referenced documents).

3.1 Real power control set-point signal – for active power service

- a. Where DER participates in the active power service, UKPN must have control over the real power import and export of the DER. To this effect UKPN will issue the following analogue set-point signals to the DER.
 - a. Active power set-point
 - b. Upper active power limit set-point
 - c. Lower active power limit set-point
- b. The DER control system shall accept a set-point signal which controls the active power output of the DER over its full rated range (i.e. granular control within its declared capability and not simply on/off). The set-points will be issued within the DER plant limits.
- c. The Active power set-point issued to DER will not alter their normal operation but it aims to utilise the spare capacity offered under Power Potential.

3.2 Voltage droop control set-point signal – for non-synchronous DER reactive power service

Where a non-synchronous DER participates in the reactive power service, it will be required to operate in voltage droop control mode and UKPN must have control over the voltage set-point of the DER. To this effect UKPN will issue the following analogue set-point signals to the DER.

- a. Voltage set-point
- b. Upper Voltage limit set-point
- c. Lower Voltage limit set-point

3.3 Voltage control set-point signal – for synchronous DER in reactive power service

Where a synchronous DER participates in the reactive power service, UKPN must have control over the voltage set-point of the DER to adjust the generator terminal voltage. To this effect UKPN will issue the following analogue set-point signals to the DER.

- a. Voltage set-point

3.4 Time of response to voltage set point in reactive power service

When participating in the reactive power service, participants will be expected to be online (armed) to allow DER to automatically deliver changes in reactive power in response to system voltage changes.

¹ This document is written on the basis of DER operating in PF mode when not available for the Power Potential reactive power service – however DER already operating by default in voltage control mode are also able to participate and specific signals from the DER Interface Schedule would be agreed as not relevant to such DER.

In addition, the DER plant should be capable of moving its operating point in response to a voltage signal. For comparability with existing services from generators on the transmission network, the Trial must include DER who expect to be capable of achieving 90% of the possible change from full lead (importing reactive power) to full lag (exporting reactive power) within 2 seconds. However the Project is interested in engaging with all DER who would like to participate in Power Potential.

Actual DER response times and end-to-end system response times will be evaluated as part of commissioning tests and Trial.

3.5 Reactive power limit set-point

Where DER participates in the voltage control service, changing reactive power output in response to voltage fluctuations, UK Power Networks must have the ability to set the reactive power import and export limits of the DER onto UKPN network. To this effect UK Power Networks will issue the following analogue signals to the DER.

- a. Upper reactive power limit set-point
- b. Lower reactive power limit set-point

Note: that these reactive power limits do not interfere with the control system of the DER but will be used to define the safe operating range for both for the DER and the distribution network. Should these reactive power limits be exceeded by the DER for a predetermined period then protective action may be taken by UK Power Networks. The reactive power upper and lower limits are expected to be preconfigured values in UK Power Network RTUs based on pre-agreed limits at the DER point of connection.

3.6 Power Factor control set-point signal

The DER may be required to adjust its power factor based on UKPN's signal. To this effect UKPN will issue the following analogue set-point signals to the DER.

- a. Power Factor leading limit set-point
- b. Power Factor lagging limit set-point

3.7 DER operation mode

UKPN may instruct the DER to enable or disable a particular mode of operation. The DER control system must be able to change its mode of operation from PF to voltage control once receiving a target voltage set-point. Depending on the services the DER is participating, the DER control system shall act on the relevant signals. These modes include:

- Active power mode – upper and lower
- Voltage mode – upper and lower
- Reactive power mode
- Power factor mode

It is expected that any change in operating mode received electronically should be acted on within 10 seconds. For non-synchronous DER, this includes the lead time (in seconds) to sweep between power factor control and voltage droop control (for non-synchronous DER). For synchronous DER this includes the lead time (in seconds) to sweep between power factor control and target voltage control.

3.8 Watchdog function

The DERMS is required to be notified if any DER interface is disconnected to ensure the service dispatch process is accurately optimised. UKPN RTU shall continuously monitor the communications link with DER by using DNP3. As such, any sustained failure in communications

with the DER will be notified to the DERMS by the RTU. The same principles shall apply to the interface with the aggregators.

4 Non-functional requirements

The following non-functional requirements must be met by the DER customer in order to commission the DER for the service dispatch function as part of the Power Potential project. Where a requirement is related to the DER customer's solution, UKPN may provide a recommendation based on best industry practice. Customers must consult appropriate parties at the earliest stage of the project to be able to plan, procure, design and deliver the solutions in accordance to the detailed requirements set in this document.

4.1 Interface to DER substation

This section refers to the requirements when the DER interfaces with the UKPN equipment via local communications link at the DER substation.

4.1.1 Communications protocol

- a. The communications protocol for the interface between the UKPN RTU and DER control system shall be DNP3 over Transmission Control Protocol/Internet Protocol (TCP/IP). This shall apply to all new build DER connections. However for the existing DER installations, the Power Potential project team may explore other methods of communications such as the hard wired interface subject to approval. The customer is responsible to ensure their solution is capable of supporting this requirement before procuring their equipment.
- b. The UKPN RTU shall be the DNP3 master and the DER equipment shall be the DNP3 slave.

4.1.2 IP addressing

- a. The IP address and the subnet mask of the interface of the DER control system shall be specified by UK Power Networks within the DER interface schedule.

4.1.3 Physical requirements

The following shall apply to all new build DER substations. The existing DER installations may already have most of the equipment pre-installed.

- a. Physical space: Secure indoor substation to house all the Distribution Network Operator's (DNO) equipment with 24 hours access for UKPN staff.
- b. Indoor fixture: The UKPN RTU is housed in a wall mounted Cubicle of 800 mm x 600 mm. For indoor aerial, refer to section 2.1.1.1. Refer to drawing HQ-2000-4760 for other equipment details. The RTU cubicle may already be present in the existing DER substation.
- c. External fixture: External wall-mounted or ground mounted satellite dish of 1.2 metre diameter. The dish is either pole-mounted on the side of the substation or ground mounted with a maximum of 20 metres cable length from the substation. In some cases where the Global System for Mobile Communications signal is poor, the standard indoor magnetic dipole aerial may be replaced by a high gain di-pole radio aerial. The communications equipment may already be present in the existing DER substation.
- d. Earthing: Earth bonding point shall be provided for the DNO equipment to the customer substation main earth bar.

4.1.4 System Availability

It is recommended for the customer to design their control system architecture with the highest level of system availability so that impact on service dispatch and post-dispatch settlement process can be minimised.

4.1.5 Power supply

For detailed power supply requirements, refer to the relevant UKPN design documentations. See

Table 2: Power consumption table for power consumption details of the equipment.

- a. Direct Current supply with battery back-up for customer equipment to maintain system resilience.
- b. Provision of Alternating Current power supply for testing and commissioning purposes.

Equipment	Power consumption	Units
RTU cabinet	24	Watts
Satellite indoor cabinet	31	Watts
Total	55	Watts

Table 2: Power consumption table

4.1.6 Communication link

- a. Customer is responsible for the provision and maintenance of all communication cables from the customer's DER control system to UK Power Networks' equipment. UKPN recommends the customer to adopt the highest standards to ensure the reliability of this link as the DER service dispatch process may be impacted whenever this link fails.
- b. The communications cables include a minimum of an Ethernet link and a hard-wired link unless otherwise specified.
- c. The Ethernet link can be CAT5e or CAT6 cable if the total length of the cable run is under 50 metres and only runs indoors (not between buildings).
- d. The Ethernet link must be optical fibre cable if the total length of the cable run is over 50 metres or runs outdoors between buildings. Wireless radio link is not permitted.
- e. The fibre cable must have a minimum of 4 cores (2 main and 2 backup).
- f. The fibre cable must be single mode with LC connector at the UKPN end of the cable.
- g. The customer fibre transceiver must be compatible with the UKPN fibre transceiver of 100-BaseFX standard and single mode 1310/1310 nm (Tx/Rx) wavelength.

4.1.7 Cable installations

- a. The communications cable shall be adequately protected. UK Power Networks recommends using galvanised steel copex tubing of 25mm diameter, low smoke and fume sheath and IP54 rating.
- b. The copex gland shall be supplied for entry to the UK Power Networks cabinet.
- c. Installation, testing and commissioning of fibre circuits should be strictly carried out according to the best practice in the industry. Fibre patch panel is not necessary but installers need to comply with the maximum bending radius through the cable run.
- d. A minimum length of 3 metres of spare cable shall be presented at the UK Power Networks cabinet.

4.1.8 Analogue measurements

- a. UK Power Networks RTU shall monitor DER analogue measurement data from the UK Power Networks owned measurement equipment in the DER substation.

4.1.9 Digital indications and alarms

- a. UK Power Networks equipment sends a number of digital indications and alarms to the customer DER control system in order to provide visibility of the system operation. UK Power Networks recommends the customer to present these signals directly to the DER operations team as to avoid unnecessary liaisons with UK Power Networks control centre.

4.2 Interface to Aggregators

The non-functional requirements for the interface to aggregators are being developed as part of Power Potential, in consultation with aggregator customers, and as such, this document will be updated in 2019.

4.3 Cyber Security requirements

The following high level requirements apply to DER customers connecting via the substation interface.

- a. UK Power Networks maintains multiple layers of security controls within its infrastructure. The customer shall design their network in compliance with the relevant industry standards and guidelines.
- b. The customer shall design their network such that no malicious software or code is introduced or permitted into the information technology environment of UK Power Networks network so to safeguard against computer viruses, worms, trojans, malware, spyware, or any form of unauthorised electronic activity whether accidental or otherwise.
- c. The customer's DER control system shall use the IP addressing and subnetting as per section 4.1.2.
- d. Where possible, the Ethernet data communications link shall be point to point between UK Power Networks and the customer's control equipment (i.e. via a separate physical interface not via a LAN)
- e. If a separate physical interface is not available or control equipment is also connected to a LAN or other IP-based network, adequate security controls shall be implemented in order to separate (logically) the UKPN data traffic to the rest of the data traffic.

From a cybersecurity perspective, customers connecting via the aggregator interface must comply with the UK Power Networks Information Security Standard for Service Providers (see list of referenced documents).

Further detailed cybersecurity requirements are set out below.

4.3.1 Security Incident Management

- a. The DER shall report any anticipated or known Security Incidents that directly or indirectly affect the DER IT Environment as connected to the UK Power Networks IT Environment.
- b. The DER shall maintain and operate a Security Incident management plan for the purpose of reporting and resolving Security Incidents. The plan shall include, but not be limited to, an escalation process and procedures designed to ensure the availability, integrity and confidentiality of the Information exchanged and the connected IT Environments between the DER and UK Power Networks.
- c. UK Power Networks shall have the right to be present and involved in the resolution of a Security Incident that impacts UK Power Networks' IT Environment or Information and shall have the right to decide how the Security Incident may be resolved.
- d. Should a Security Incident in UK Power Networks sole opinion (acting reasonably) have a significant adverse effect on the UK Power Networks IT environment, business operations, reputation or employees, UK Power Networks in its sole discretion may require a formal investigation of the Security Incident. UK Power Networks shall have the right, should it deem it necessary, to insist that such an investigation be handled by UK Power Networks own employees or its nominated representative. The DER shall do all things necessary to co-operate with UK Power Networks in carrying out such an investigation.

4.3.2 Physical & Environment Security

- a. The DER shall protect its IT Environment against unauthorised physical access and criminal or terrorist attack. The DER shall protect its equipment against fire, flood, environmental and other natural hazards. The DER shall protect its IT Environment against power outages.
- b. The DER shall restrict physical access to the Information and the IT Environment to those persons who require access in relation to performance of the obligations under this document.
- c. The DER will ensure physical access control mechanisms are in operation for communications rooms, server rooms or any rooms providing storage, connectivity or transport of Information used in the relation to this document.
- d. The DER shall ensure that any third party requiring access to provide support or maintenance for any equipment that is directly or indirectly involved under this document shall be logged into and out of the relevant premises, the reason for the visiting recorded and the persons supervising their visit.
- e. The DER will ensure that logs will be maintained recording access to those parts of the premises that host Information used in the delivery of the Power Potential Service. The DER shall monitor these logs for any breaches of security procedures.

4.3.3 Malicious Software

The DER shall take all reasonable measures to ensure no malicious software or code is introduced or permitted into the Information or the IT Environment so to safeguard against computer viruses, worms, trojans, malware, spyware, or any form of unauthorised electronic activity whether accidental or otherwise.

4.3.4 Site communications and control equipment interface requirements

- a. The DER shall comply with all the technical and cyber security requirements as specified by UK Power Networks and as stated in this document and varied from time to time and shall be governed by the following core principles;
- b. Where the interfaces between UK Power Networks' communications and control equipment and the DER's communications and control equipment are provided by Serial data communications links, these shall be secured physically to the same standard as normally used for control system cabling. Where the data communications protocol allows, UK Power Networks' communications and control equipment and the DER's

communications and control equipment shall use known master/slave node address pairings only.

- c. Where the interfaces between UK Power Networks' communications and control equipment and the DER's communications and control equipment are provided by Ethernet data communications links, these shall be secured physically to the same standard as normally used for control cabling.
- d. Where UK Power Networks' communications and control equipment and the DER's communications are connected by a point to point Ethernet data communications link such requirement will be configured to use known master/slave node address pairings only.
- e. Where UK Power Networks' communications and control equipment is connected to DER equipment via a LAN or other IP-based network all communications will use an agreed IP addresses and system protocols (e.g. DNP3) with agreed protocol commands. UK Power Networks' IT environment will enforce technical controls to ensure only the allowed IP addresses, protocols and commands are permitted to communicate with UK Power Networks' IT equipment.
- f. UK Power Networks may temporarily cease or permanently deny data communications with the DERs communications and control equipment if the communications being received from the DER presents a tangible risk to the security or operational health of UK Power Networks' IT environment.

5 Approach to DER assessment and testing

5.1 Initial Desktop Assessment

Once a DER has submitted its Technical Characteristics Submission Spreadsheet (see list of reference documents), in order to participate in the Power Potential Trial the DER equipment is required to pass an initial desktop assessment confirming that the DER is:

- Within the Trial area
- Is already connected to the UKPN distribution system or will be connected early in the Trial period
- Evaluating DER's Technical Characteristics Spreadsheet (e.g. speed of response to real and reactive power instructions)
- Evaluating DER's confirmation of having a control system capable of changing mode of operation from PF to voltage control mode and vice versa
- Operation of DER in voltage control mode does not violate the Recommendation P28 voltage step change limits and statutory distribution network voltage limits.

For each DER, a series of desktop based simulation studies will then be conducted as described in Appendix 6.2 to assess whether the power factor limits in the DER connection agreement could be relaxed. Appendix 6.2 also provides illustration of PF mode of operation and voltage mode of operation expected to be implemented in Power Potential project. Figure 2 and Figure 3 in Appendix 6.2 illustrate the requirements defined in Section 3 which DER must comply with when participating in Power Potential.

5.2 DER Commissioning Test

If a DER wishes to participate in the Trial, it must be set up to comply with the functional and non-functional requirements set out in this document (sections 3 and 4). Compliance with these requirements will be assessed via DER Commissioning Tests. There are two parts to the DER Commissioning Tests which must occur to allow the DER to participate in the Trial – laboratory-based and then site-based.

5.2.1 Laboratory Based Pre-commissioning Test

- a. UKPN requires the interface between the DNO RTU and the DER control system to be tested and proven as early as possible. It is recommended to plan the testing a minimum of two weeks before the site commissioning date. The objective of testing is to identify and resolve all integration issues in a test environment thereby, preventing the waste of time and costs of doing so during the commissioning stage. The Laboratory Test is not a full test of functional and non-functional requirements.
- b. Where possible, the integration test shall be carried out at UKPN laboratory based in London using the test RTU and test DER control equipment.
- c. The DER control system is expected to switch from PF mode to voltage control mode once receiving a target voltage set-point.
- d. The laboratory based pre-commissioning stage is strongly advised since it reduces the risk of issues arising at final site-based commissioning; however it is not mandatory for all DER to participate in laboratory testing or to demonstrate full system integration in the laboratory.

5.2.2 Site Based Commissioning Test

- a. Tests against the requirements set out in sections 3 and 4 of this document will be detailed in the DER Commissioning Test Specification; the tests to this specification will be conducted according to the DER Commissioning Test Procedure.

- b. The commissioning of the DER equipment shall be carried out based on the Power Potential DER Commissioning Test Procedure.

5.2.3 Overview of Tests

The following schematic summarises the three main stages of tests where DER will be involved:

Initial Desktop Assessment	DER Commissioning Tests
<p><u>Confirming that the DER is:</u></p> <ul style="list-style-type: none"> • Within the Trial area. • Is already connected to the UK Power Networks distribution system or will be connected early in the Trial period. <p><u>Evaluating:</u></p> <ul style="list-style-type: none"> • The DER’s Technical Characteristics Spreadsheet • The DER’s confirmation of having a control system capable of changing mode of operation from PF to voltage control mode and vice versa. • Operation of DER in voltage control mode does not violate the Recommendation P28 voltage step change limits and statutory distribution network voltage limits. • By desktop simulation, evaluating whether power factor limits in the DER’s connection agreement may be relaxed for the Trial. 	<p><u>Laboratory Based Pre-commissioning Testing (strongly advised):</u></p> <ul style="list-style-type: none"> • Interface between the DNO RTU and the DER control system. • System integration between DERMS↔PowerOn↔RTU↔DER. • The capability of DER’s control system to change mode of operation from PF to voltage control mode and vice versa. <p><u>Site-Based DER Commissioning Testing (mandatory):</u></p> <ul style="list-style-type: none"> • Interface between the DNO RTU and the DER control system. • System integration between DERMS↔PowerOn↔RTU↔DER. • The capability of DER’s control system to change mode of operation from PF to voltage control mode and vice versa.

Completion of site-based commissioning will confirm that the DER can participate in the Power Potential Trials.

5.2.4 DER’s Response to Technical Requirements

The DER are obligated to read this Technical Requirements Document and fully respond to the DER Technical Characteristics Submission Spreadsheet (Referenced Document No. 4) confirming their control system capability meets the requirements specified in this document.

The Power Potential DER Framework Agreement (contract) between UK Power Networks and DER will reference this Technical Requirements document. Signing of the contract will acknowledge these requirements. DER will also need to sign a corresponding Variation Agreement relating to their Connection Agreement, to acknowledge that the generator will operate in voltage control mode during the trial and to specify the range of reactive power import and export, consistent with the Framework Agreement. Signing the contracts and completion of site-based commissioning against the DER Commissioning Test Specification will in combination confirm that a DER can participate in the Power Potential Trials.

6 Appendices

6.1 DER interface signals

The full list of signals can be found in the DER Interface Schedule, provided on the Power Potential [website](#). The “Data Exchange” tab contains the full list of signals along with their functions, types, source and destination. The source and destination indicate if the signal is sent from a DER to the RTU or vice versa. HIGH indicates a digital signal with a value of 1. The “DNP3 Protocol Configuration” tab details the required DNP3 configuration for all signals.

6.2 Desktop assessment of possible relaxation of the DER’s PF range

The DER control system must be able to operate in Power Factor (PF) mode from unity to lead/lag PF limits. The PF limits and envelopes of operation are defined in the customer’s connection agreements. The possible relaxation of the DER’s PF range will be assessed with desktop simulations whilst ensuring the Engineering Recommendation P28 voltage step change limits and statutory distribution network voltage limits are not violated under N-1 contingency scenarios. A general 3% transient voltage change limit is recommended in P28. The Statutory Voltage Requirements are presented in

Table 4: Statutory Voltage Requirements:

Voltage Level	Operational Standard
132kV	±10%
33kV	±6%
≤11kV	+10%, -6%

Table 4: Statutory Voltage Requirements

The DER customer will be informed if their PF range can be relaxed beyond what is defined in their connection agreement. The new PF range must not increase the pre-agreed apparent power injection limit (MVA) into distribution network. The DER are flexible to declare their preferred real and reactive power availabilities to participate in Power Potential market as long as their pre-agreed apparent power injection limit (MVA) is not exceeded. An example of PF mode is presented in Figure 2:

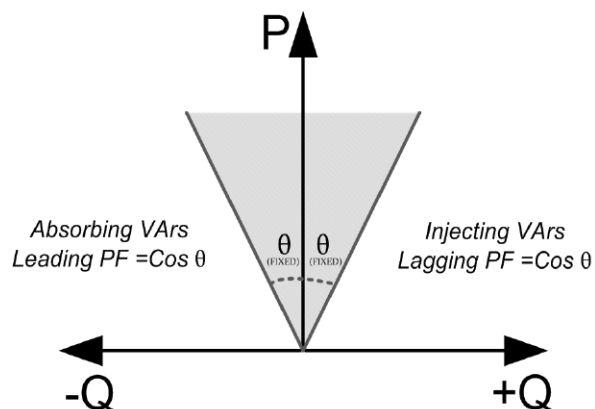

Figure 2: Power Factor envelope defining the range of operation

Where:

θ = Power factor angle

P: real power

The DER control system must be able to change their mode of operation into voltage control mode whilst still maintaining their PF range limits. The activation of DER's voltage control model will be based on DER receiving a target voltage set-point. Once operating in voltage control mode, the DER is expected to operate within their defined PF range at all times.

The DER providing reactive power service must be capable of continuous changes to the reactive power supplied to the distribution system in order to contribute to voltage control. The reactive power is varied to regulate the voltage with limits. Figure 3 illustrates a reactive voltage droop compensation which could be applied at a DER's Point of Connection (PoC) for non-synchronous Generators:

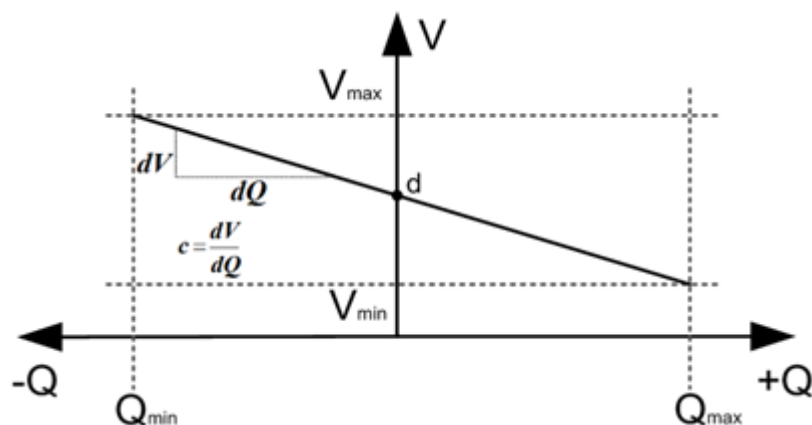

Figure 3: DER's Voltage Control Mode for non-synchronous DER

V: Terminal Voltage

V_{max} = +6% of nominal voltage

V_{min} = -6% of nominal voltage

P: real or active power

Q: reactive power

Q_{max} = Reactive capability offered (lag), as specified in variation to connection agreement

c: Linear factor (gradient)

c = 4% droop (fixed) – interpreted as described on page 24 of this document

Q_{min} = Reactive capability offered (lead), as specified in variation to connection agreement

d: Point of inflection

Where:

The DER control system is expected to be capable to change its voltage droop gradient if required (e.g. from 4% to 5%).

For Synchronous Generators, a target voltage set-point will be sent to DER's control system to control the Terminal Bus Bar voltage using generator's Automatic Voltage Regulation (AVR).

6.3 DER Performance Testing

DER performance testing is part of the site-based commissioning. The DER performance tests are expected to cover the following three stages. However, the DER Test Specification/DER Commissioning Test Procedure documents will (prevail and) define these tests and assessment criteria in detail.

DER achieving voltage set-point instructions

These tests are to verify that the Distributed Energy Resource (DER) is equipped with a continuously-acting automatic voltage control that meets the requirements for the reactive power service defined in this document. The tests require the application of a voltage step to the Distributed Energy Resource reference voltage target. A new voltage reference set-point will be issued to the DER control system and UK Power Networks will measure how long it took for the DER control system to receive the new instruction and how long it takes for the new voltage set-point to be achieved at DER's Point of Connection:

Figure 4: Voltage set-point instructions test

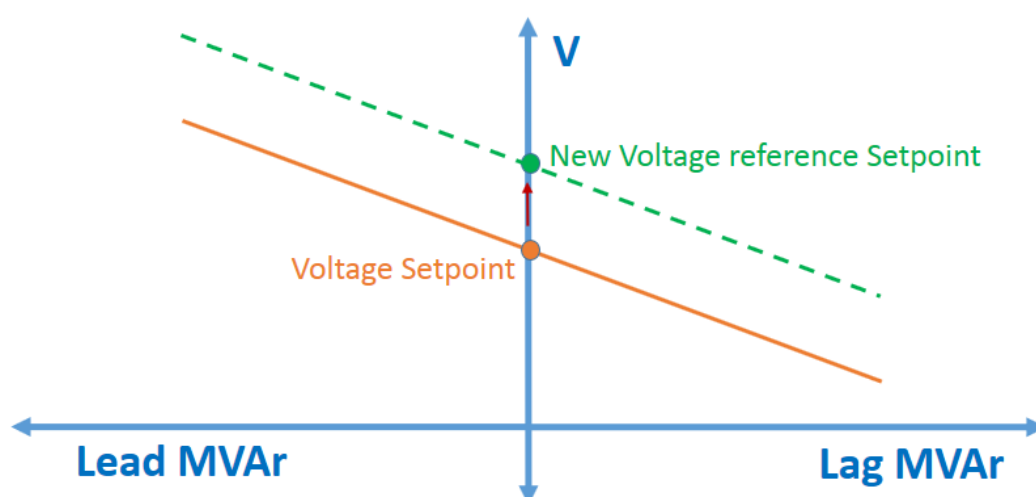

The test will record the following results:

- DER successfully operating in voltage control mode.
- DER successfully achieving new voltage set-point.
- kW - Active power at the applicable measurement point.
- kVAr - Reactive power at the applicable measurement point.
- Voltage at controlled busbar, usually the Connection Point.
- Voltage Set-point or Voltage Reference.
- Recording the time it takes for the DER control system to receive new instruction. This is the time taken for the signal to reach DER Control System following DERMS optimization calculation (e.g. DERMS→PowerOn→RTU→DER Control System).
- Recording the time it takes for the DER to achieve the voltage instruction at its point of connection (i.e. this is the time taken for the DER Control System to process instructions and physically achieve the new voltage reference set-point at its point of connection).
- Other signals relevant to the control action of the voltage controller as specified by UKPN.

DER speed of response to real and reactive power service instructions

These tests will examine the DER’s speed of response capability to achieving real and reactive power service instructions issued to DER’s control system. The following diagrams illustrate measuring how long it takes for DER to achieve a new real power (MW) set-point at its point of connection. The DER test results are expected to match with DER Technical Characteristics Submission Spreadsheet (Referenced Document No. 4) or the Framework Agreement where this provides updated values:

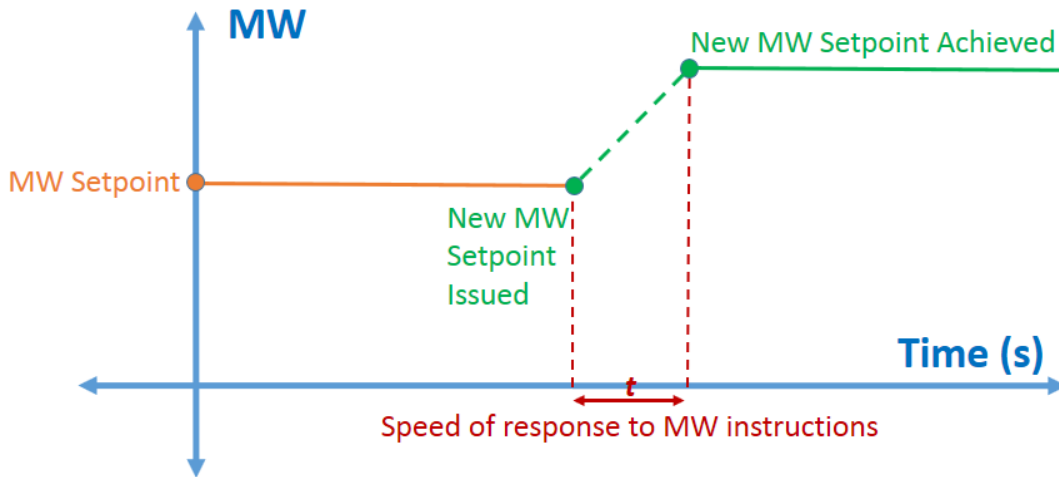

Figure 5: Real power set-point speed of response test

The following diagram illustrates how long it takes DER to achieve a final reactive power import/export at its point of connection following the issue of a voltage set-point instruction. The DER’s are expected to achieve 90% of the possible change from full lead (importing reactive power) to full lag (exporting reactive power) within the time declared in their DER Technical Characteristics Submission Spreadsheet (Referenced Document No. 4):

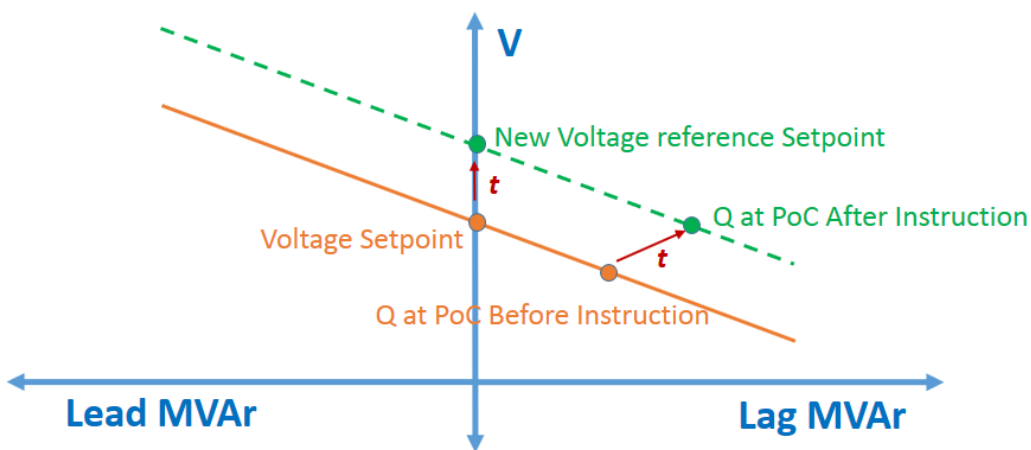

Figure 6: Reactive power service set-point speed of response test

The test will record the following results:

- kW - Active power at the applicable measurement point.
- kVAr - Reactive power at the applicable measurement point.

- Voltage at controlled busbar, usually the Connection Point.
- Voltage Set-point or Voltage Reference.
- Recording the time it takes for the DER control system to receive new instruction.
- Recording the time it takes for the DER to achieve the voltage instruction at its point of connection.
- Recording the time it takes for the DER to achieve a final reactive power at its point of connection.
- Recording the time it takes for the DER to achieve a new MW set-point instruction.
- Other signals relevant to the control action of the voltage controller as specified by UKPN.

DERMS/DER response to voltage step change.

These tests are to verify that the Distributed Energy Resource (DER) is equipped with a continuously-acting automatic voltage control that meets the requirements for the reactive power service defined in this document.

These tests will examine the response of DERMS and DER to external voltage step changes caused on the distribution network.

The tests create a series of voltage step changes on the distribution network through tapping of an external upstream tapchanger or a network switching (e.g. changes in network running arrangements or circuits switched out of service). It is suggested that the tests are conducted by applying a series of positive and negative steps with an example provided below:

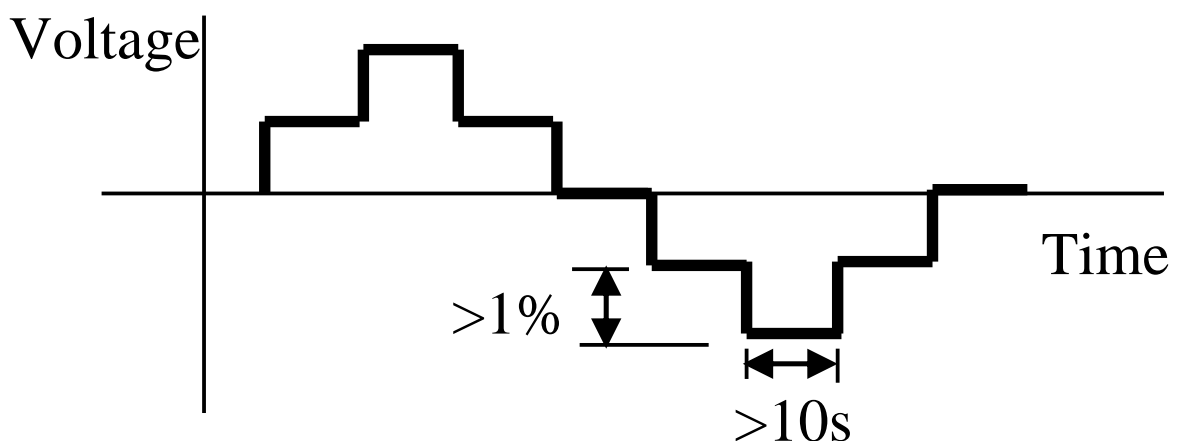

Figure 7: Voltage step change test

The test will record the following results:

- kW - Active power at the applicable measurement point.
- kVAr - Reactive power at the applicable measurement point.
- Voltage at controlled busbar, usually the Connection Point.
- Voltage Set-point or Voltage Reference.
- Voltage at relevant DER Connection Point.
- Voltage at received from 400kV relevant GSP
- Voltage Set-point or Voltage Reference received from DERMS
- Recording the time it takes for the DERMS' response to voltage step change.
- Recording the time it takes for the DER's response to voltage step change.
- System frequency to allow synchronising of data.
- Other signals relevant to the control action of the voltage controller as specified by UKPN.

DERMS PoC Voltage Set-point Delta Calculation with 4% Droop

DERMS sends voltage set-points to the DER, and DERMS recalculates these as required.

POC indicates voltage measured by UK Power Networks at the point of connection.

This section demonstrates how DERMS calculates the DER voltage set-point delta in order to ensure the DER correctly interprets the Voltage set-point instructions it receives from DERMS when a droop of 4% is used in the DER's control system.

The difference between voltage set-point and actual terminal POC voltage (V) = $0.04 \text{ (droop)} * \text{Nominal POC Voltage (V)} * Q \text{ kVAr requested} / Q_{\text{max}}$ (please refer to Figure 3 on page 20, note that Q_{max} is defined as the maximum lag value).

Please see below a number of examples demonstrating voltage set-point delta calculation:

- For a 33 kV connected DER with a 1000 kVar Q_{max} , 1000 kVar Q demand would require a set-point corresponding to a delta of $0.04 * 33000 * 1 / 1 = 1.32\text{kV} = 1320 \text{ V}$.
- For a 132 kV connected DER with a 10 Mvar Q_{max} , for a 10 MVAR Q demand, DERMS would issue a set-point corresponding to a delta of $0.04 * 132000 * 10/10 = 5.28 \text{ kV} = 5280 \text{ V}$ to get 10,000 kvar.
- For a 33 kV connected DER with a 10 Mvar Q_{max} , for a 1 MVAR demand DERMS would issue a set-point corresponding to a delta of $0.04 * 33000 * 1/10 = 0.132\text{kV} = 132\text{V}$ to get 1000 kvar.
- For a 33 kV connected DER with a 10 Mvar Q_{max} , for a 10 MVAR demand DERMS would issue a set-point corresponding to a delta of $0.04 * 33000 * 10/10 = 0.132\text{kV} = 1320 \text{ V}$ to get 10,000 kvar.

6.4 Frequently asked questions on DER Interface requirements

a) Which communications protocol is used to communicate with the RTU?

DNP3 over TCP/IP. See section 4.1.1.

b) What if the supplier for DER controller does not support DNP3 protocol?

For new installations, it is the customer's responsibility to ensure they procure the solutions that meets our requirements as specified in this document. For existing installations other options can be explored on a case by case basis subject to approval from the UK Power Networks standards and Cyber security teams.

c) What type of cable is used to communicate with the RTU?

CAT5e or optical fibre cable depending on the distance or cable routings. This falls under customer's responsibility. See sections 2 and 4.1.6.

d) Will a marshalling box be required for the RTU and DER controller interface cable?

It is up to the customer as this falls under the customer's responsibility. The requirement is to provide a point to point connection from the DER control system to the RTU.

UK Power Networks, Energy House, Carrier Business Park
Hazelwick Ave, Three Bridges, Crawley, West Sussex, RH10 1EX

www.ukpowernetworks.co.uk

National Grid ESO, Faraday House, Warwick Technology Park,
Gallows Hill, Warwick, CV34 6DA

<https://www.nationalgrideso.com/innovation/projects/power-potential>



nationalgridESO