

Risk Assessment of Loss of Mains Protection

20 May 2013

Dr. Adam Dyśko
University of Strathclyde
Glasgow, UK
e-mail: a.dysko@strath.ac.uk

Outline



- DNO data
- Final results
 - WP1: Laboratory testing of NDZ assessment
 - WP2: Initial risk calculations

DNO Data

SSE Load Data – Load Case 1

- Mixed residential industrial load – 6 days over 1 year
- Sampling period 5s – resampled to 1s with linear interpolation

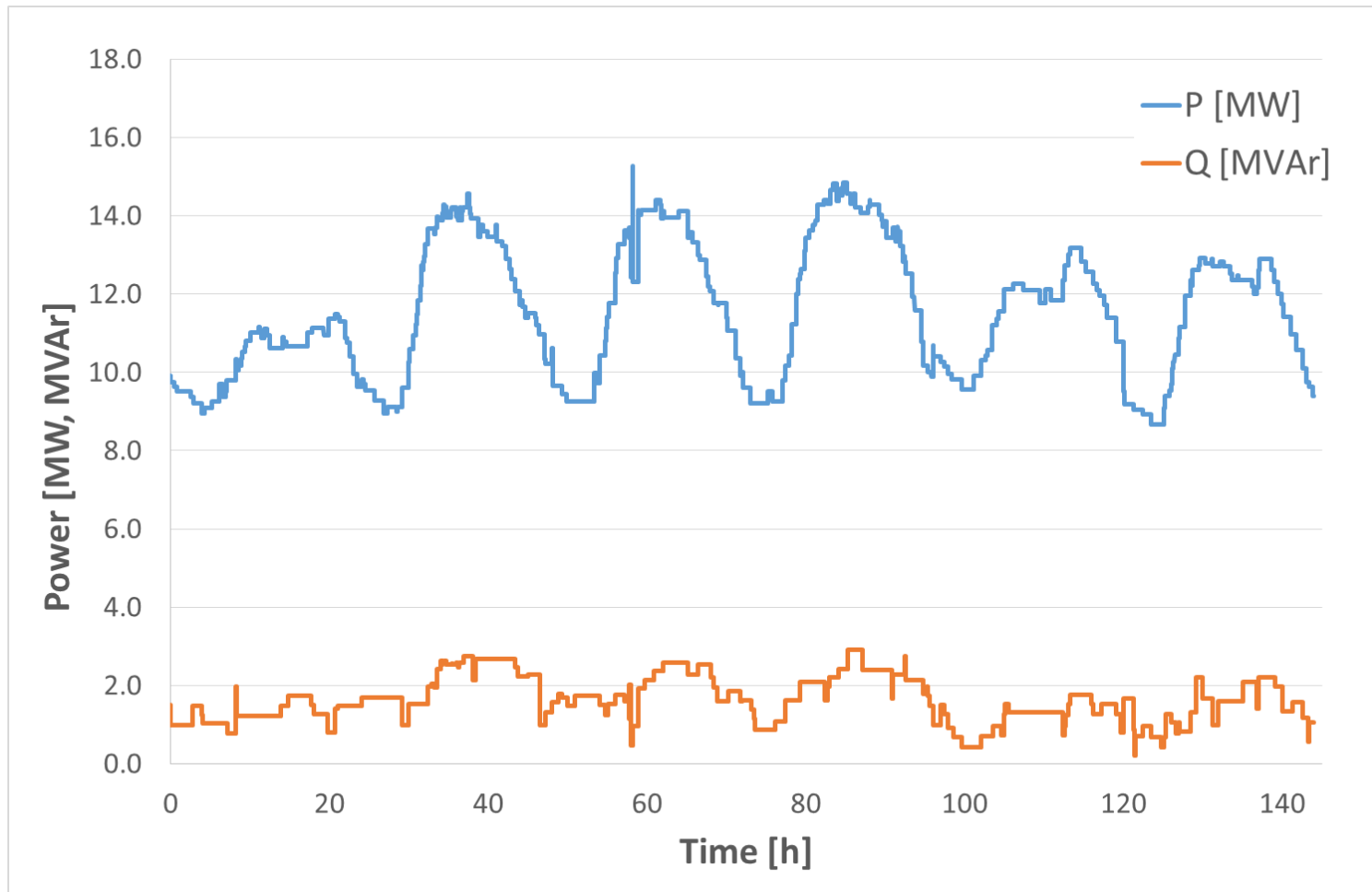

SPM Load Data – Load Case 2

- Combined 3 rural primes – 1 day
- Sampling period 5s – resampled to 1s with linear interpolation

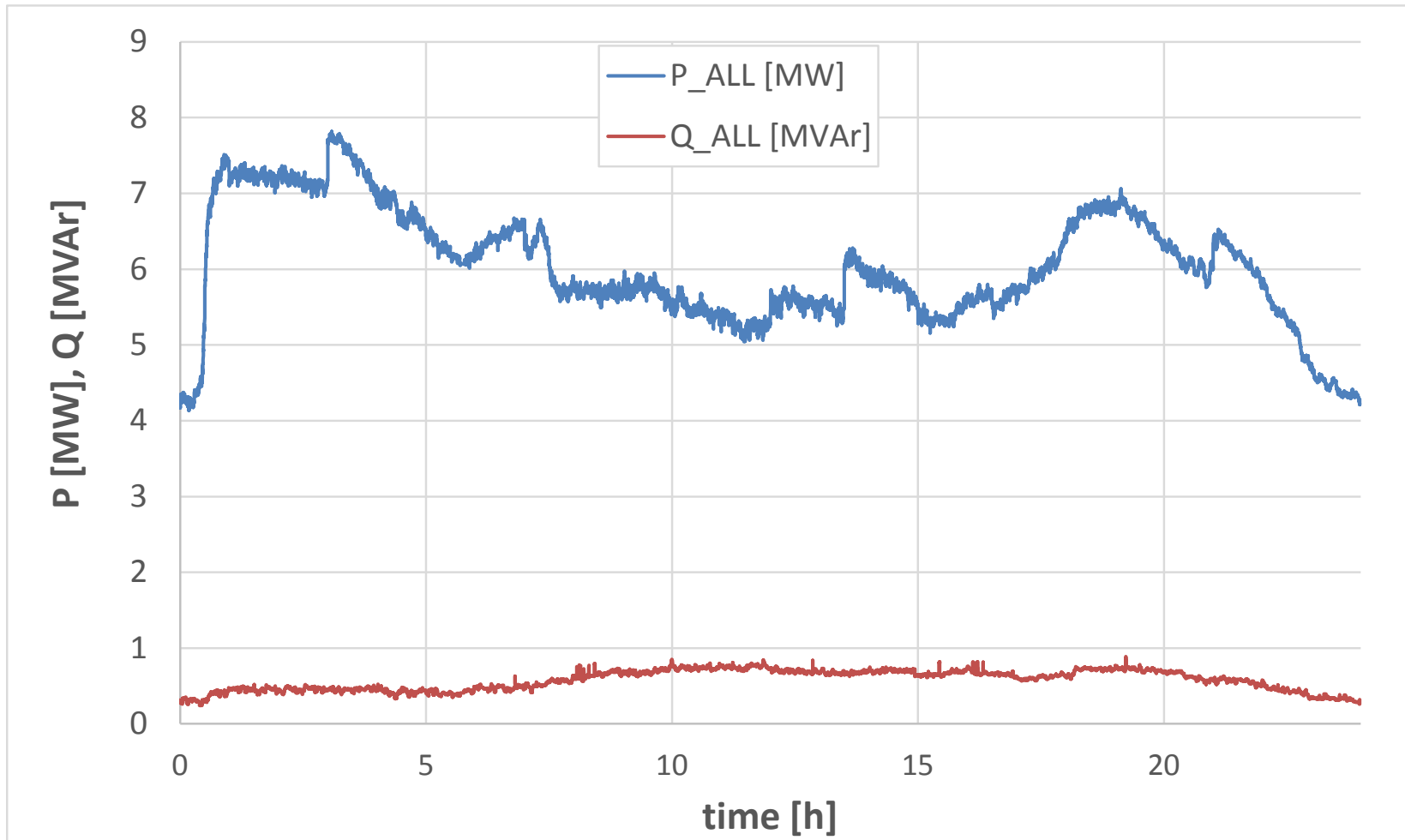

SPM Load Data – Liverpool

- Combined 9 primary transformers (T1,...,T9) – 1 year
- Sampling period 30min

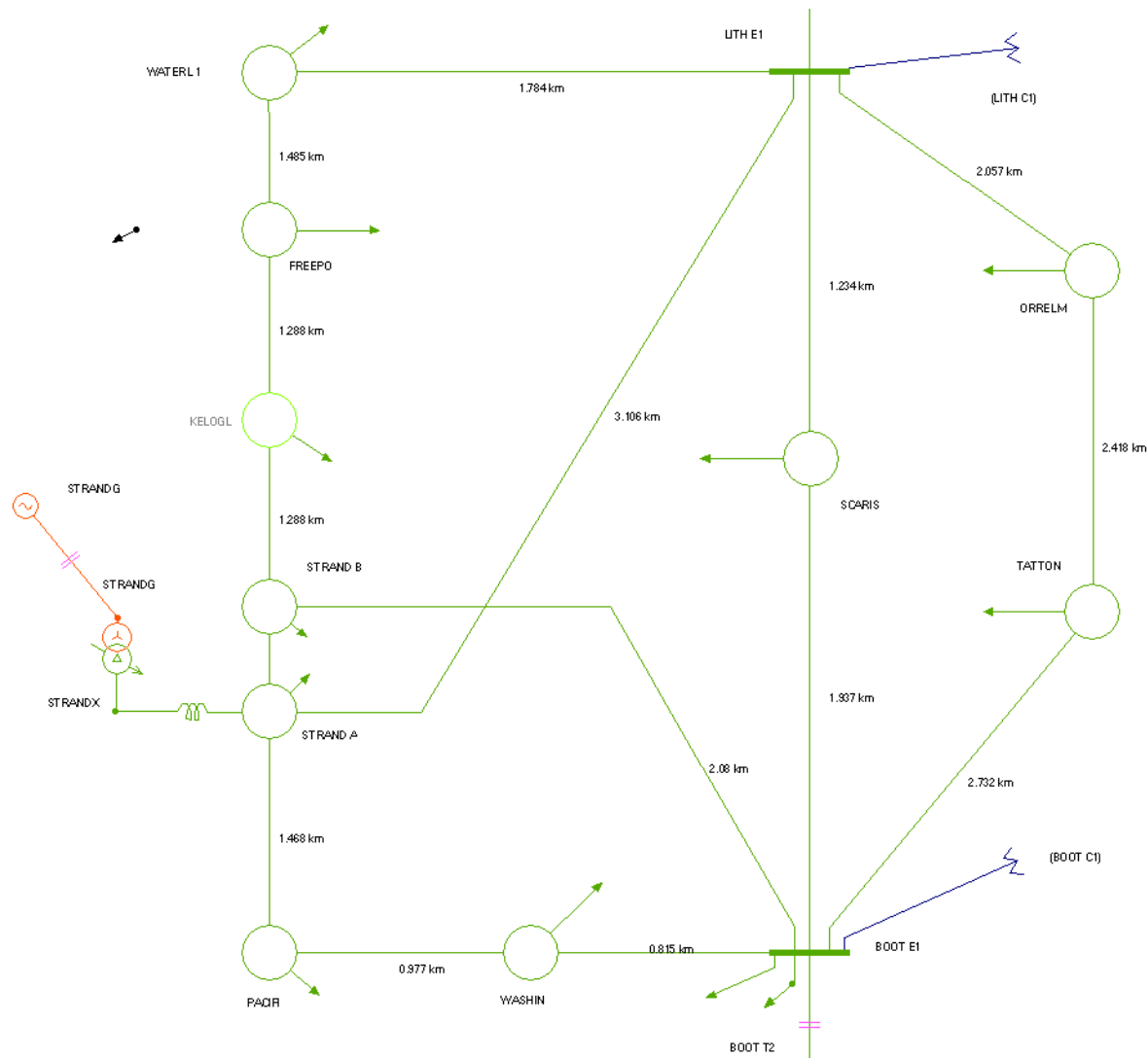

SPM Load Data – Load Case 3

- Combined 9 primary transformers (T1,...,T9) – 1 year
- Sampling period 30min – resampled to 2min with linear interpolation

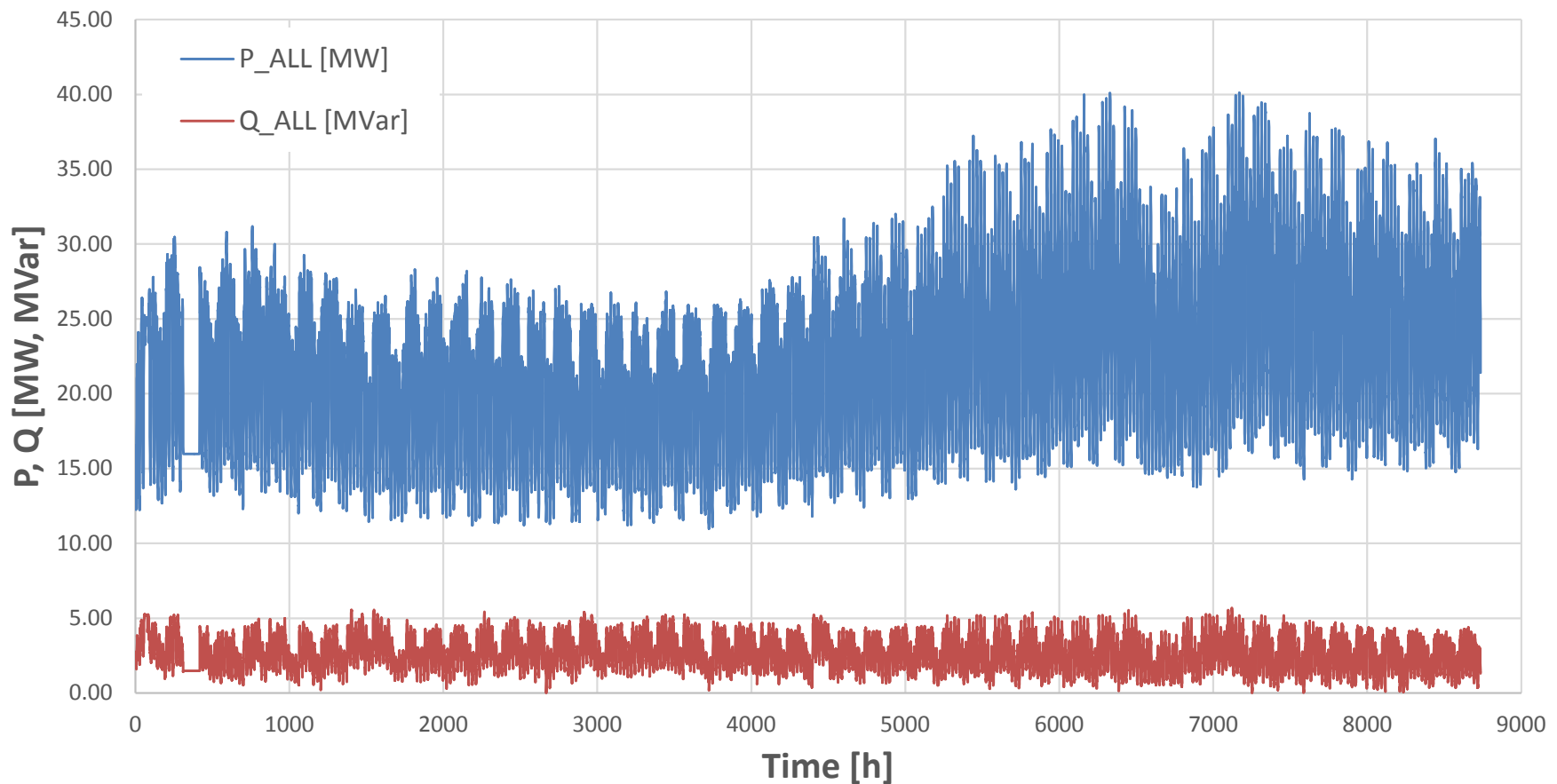

SPM Generation Data

- 30MW DG – 1 year
- Sampling period 30min
- Average pf = 0.994 (lagging)
- Mostly constant output and pf

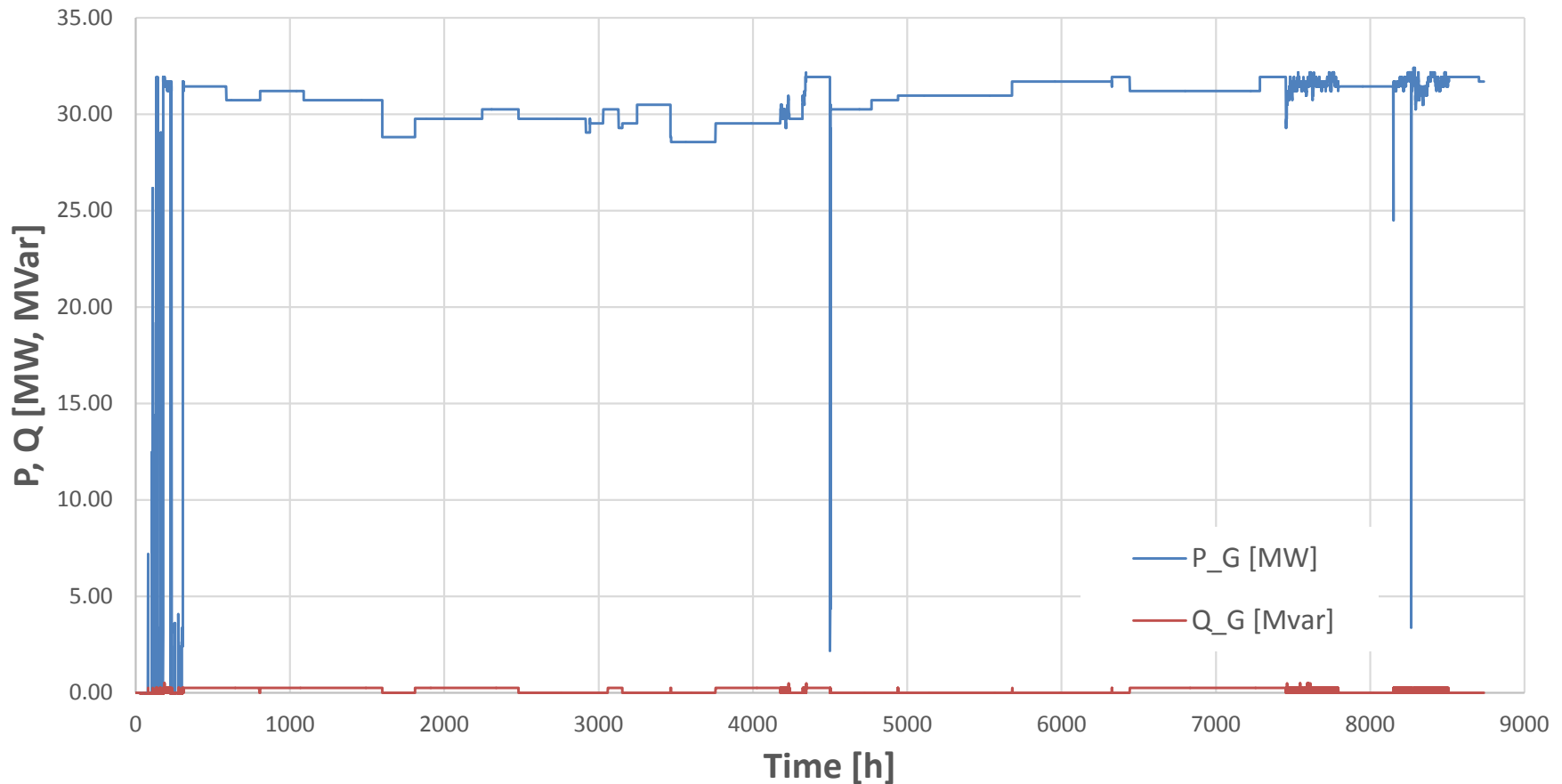

SPM Load Data – Load Case 4

- 2 combined primary transformers (T7, T8) – 1 year
- Sampling period 30min – resampled to 1min with linear interpolation

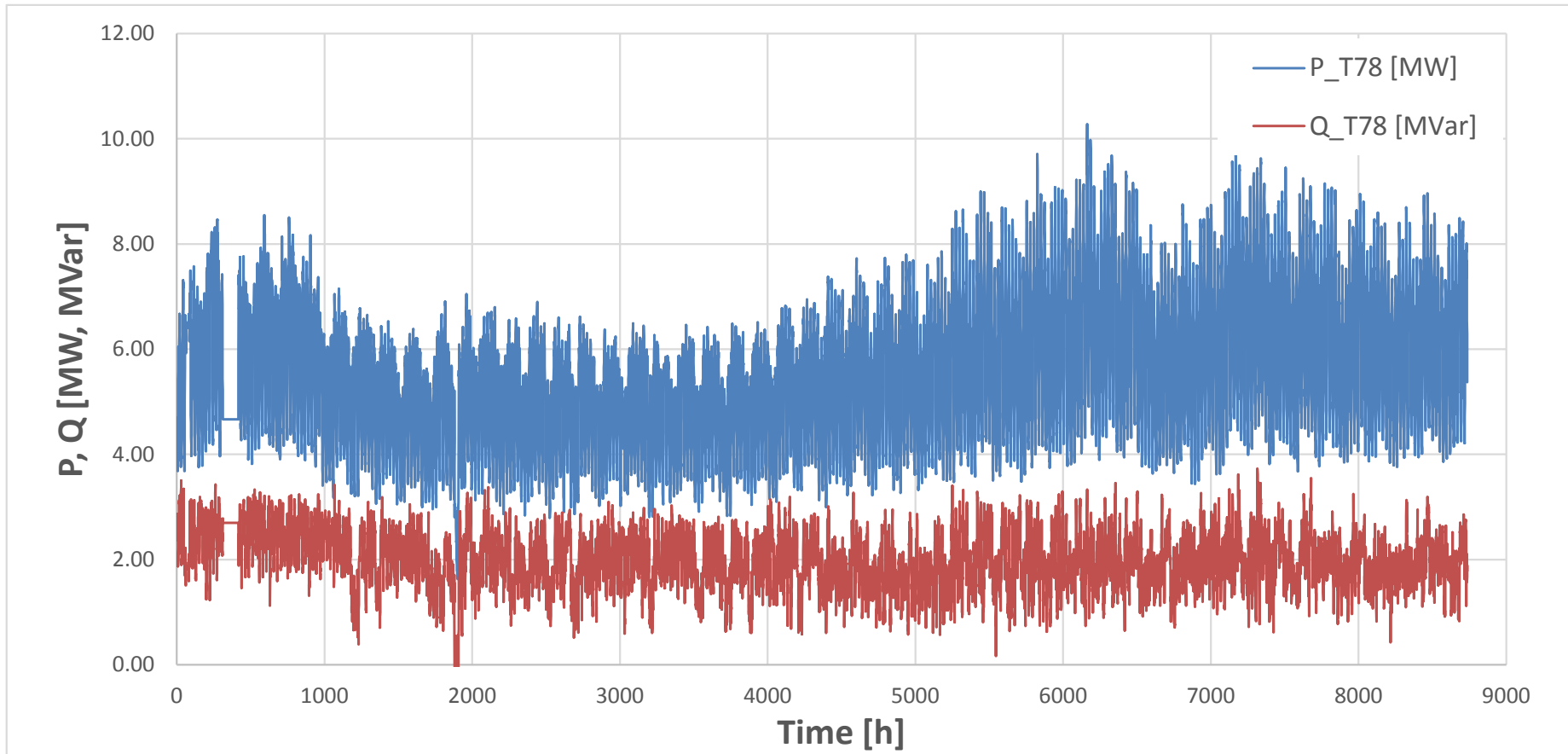

SPM Load Data – Load Case 5

- 4 combined primary transformers (T4, T5, T7, T8) – 1 year
- Sampling period 30min – resampled to 1min with linear interpolation

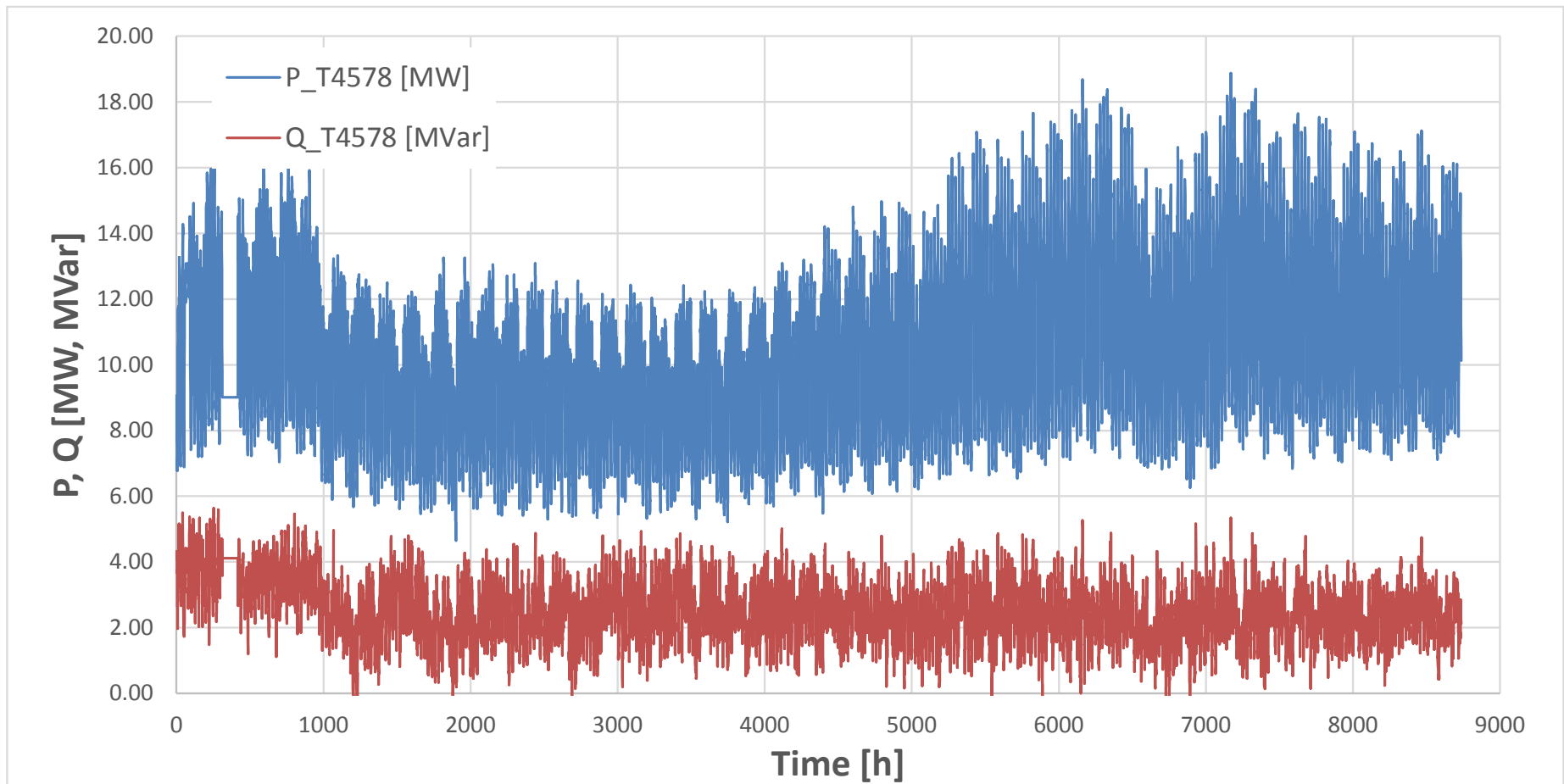

SPM Load Data – Load Case 6

- 6 combined primary transformers (T2, T3, T4, T5, T7, T8) – 1 year
- Sampling period 30min – resampled to 1min with linear interpolation

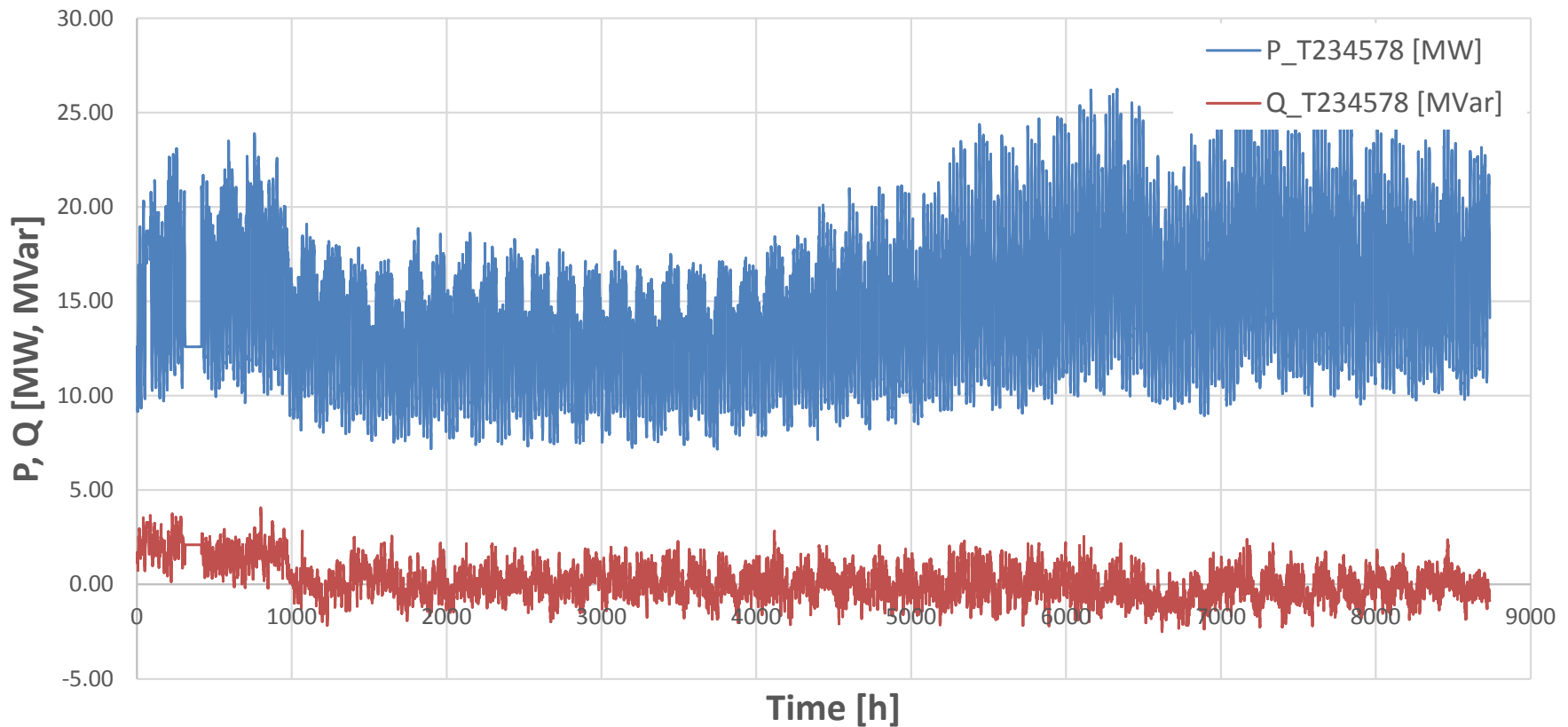

ENW Load Data – Load Case 7

- 6.6kV (2x11.5MVA) – 4 days of measured data combined as a week
- Urban area primary – sampling period 1s

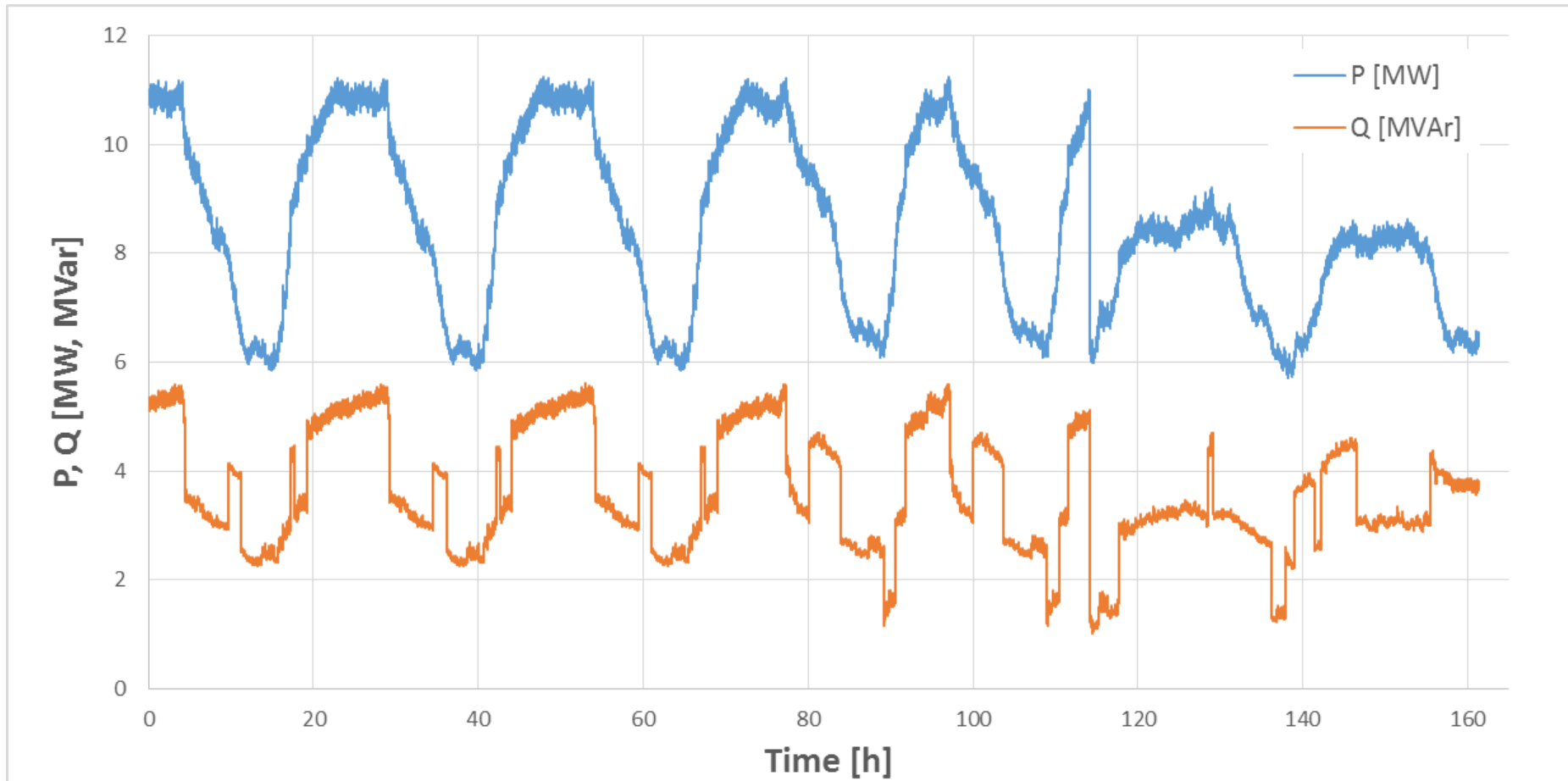

ENW Load Data – Load Case 8

- 6.6kV (2x11.5MVA) – 4 days of measured data combined as a week
- Suburban area primary – sampling period 1s

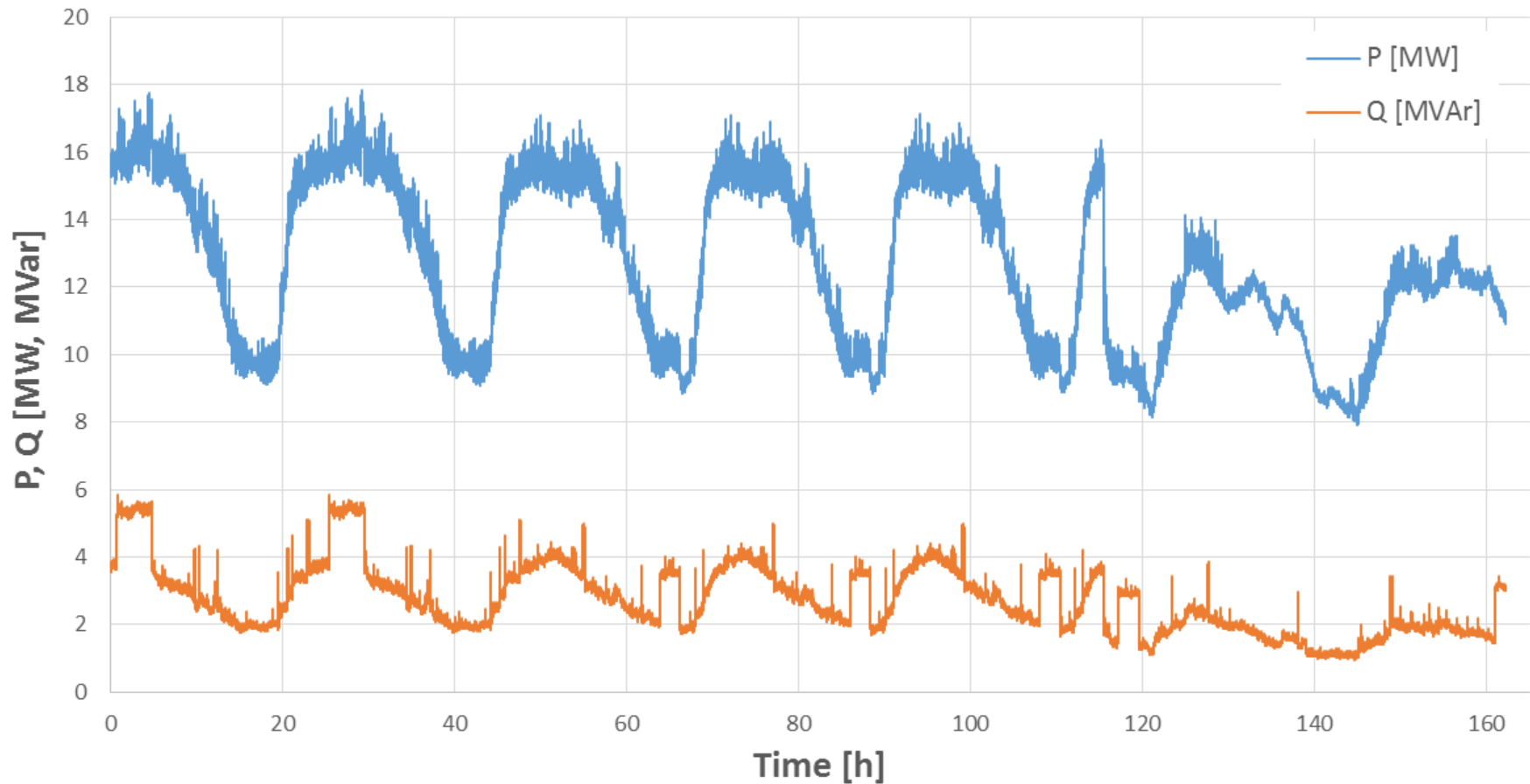

WP1 – NDZ assessment

WP1 - Simulation based assessment of Non Detection Zone (NDZ)

- RTDS real-time model of 30MVA machine connected to 33kV level (3MVA also machine considered for 'spot' checks)
- Laboratory hardware testing using a commercial relay with 11 setting options
- Load modelling as fixed impedance and fixed power
- Generator control considered as P/pf and P/V

Setting Option	ROCOF [Hz/s]	Time Delay [s]	Dead Band applied
1	0.5	0.0	No
2	0.5	0.5	No
3	1.0	0.0	No
4	1.0	0.5	No
5	0.5	0.0	Yes
6	0.5	0.5	Yes
7	1.0	0.0	Yes
8	1.0	0.5	Yes
9	0.12	0.0	No
10	0.13	0.0	No
11	0.2	0.0	No

RTDS Model – network diagram

Grid infeed

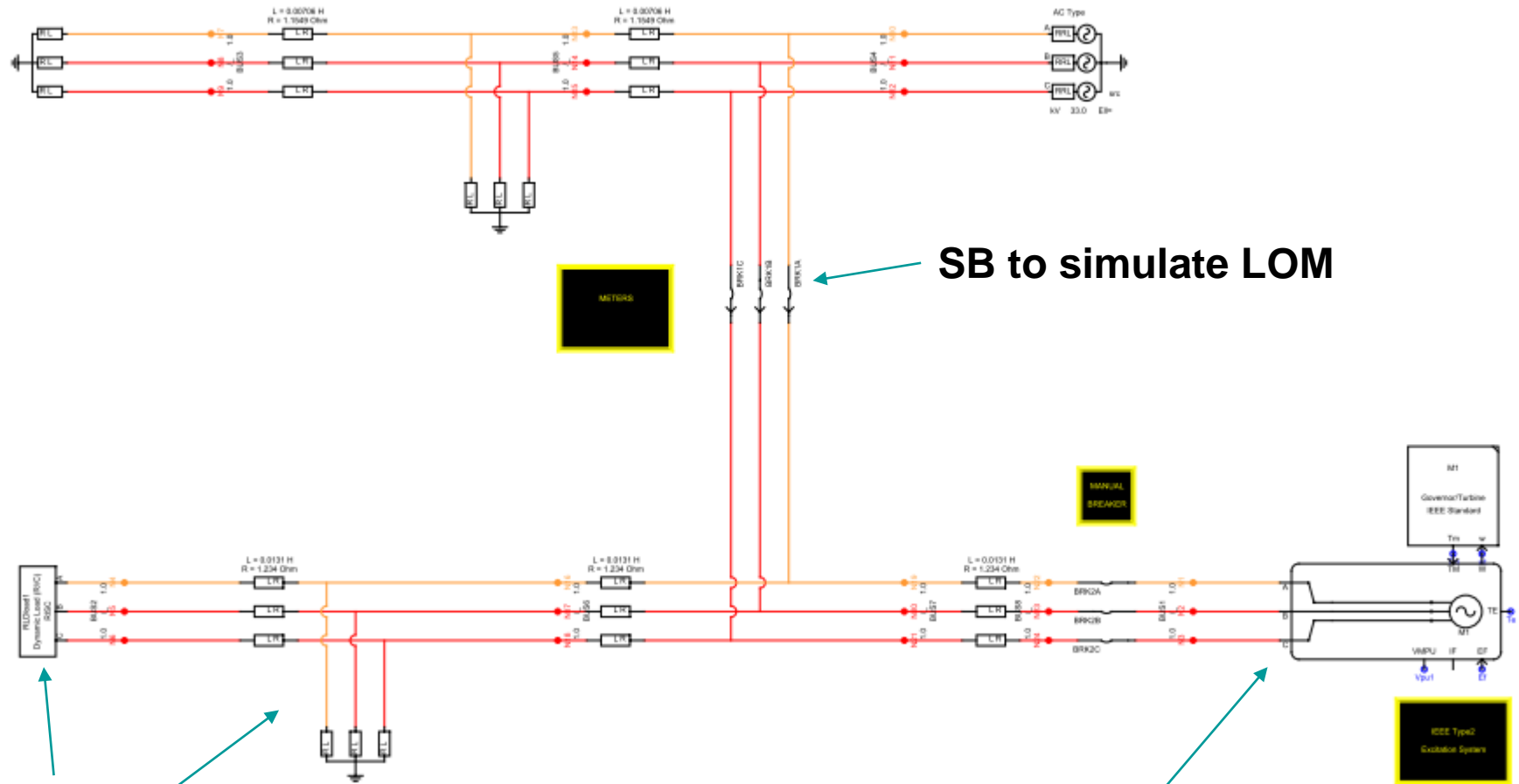

Adjustable loads

Generator with controllers

Generator data

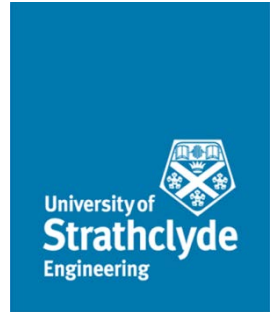

General parameters

	33kV connected generator	11kV connected generator
Rated MVA	30MVA	3MVA
Rated voltage	33kV	440V
Rated frequency	50Hz	50Hz

Generator reactances (PU):

	33kV connected generator	11kV connected generator
X_d	2.25	3.326
X_d'	0.38	0.22
X_d''	0.23	0.107
X_q	1.14	1.644
X_q'	0.38	1.644
X_q''	0.23	0.23

Time constants (s):

	33kV connected generator	11kV connected generator
T_{do}'	8.5	12.5
T_{do}''	0.06	0.05
T_{qo}'	3	1
T_{qo}''	0.13	0.05

Inertia H (s):

33kV connected generator	3
11kV connected generator	1.3

Generator controller data

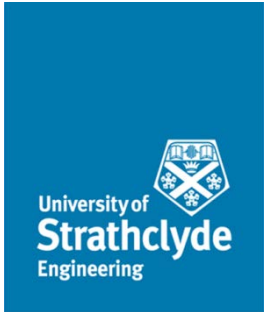

Voltage regulator parameters:

	33kV connected generator	11kV connected generator
Gain	60	60
Time constant (s)	0.001	0.01
Limits	+/-8	+/-8

Excitation parameters:

Gain	1
Time constant (s)	1e-4
E1	7
SE1	0.05
E2	8
SE2	0.4

Reactive power PI controller:

P gain	1.2
I gain	1.5

Governor gains:

K1	14.3
K2	0.7
K3	1

Governor time constants (s):

T1	1
T2	1
T3	0.02
T4	0.673
T5	3
T6	0.45

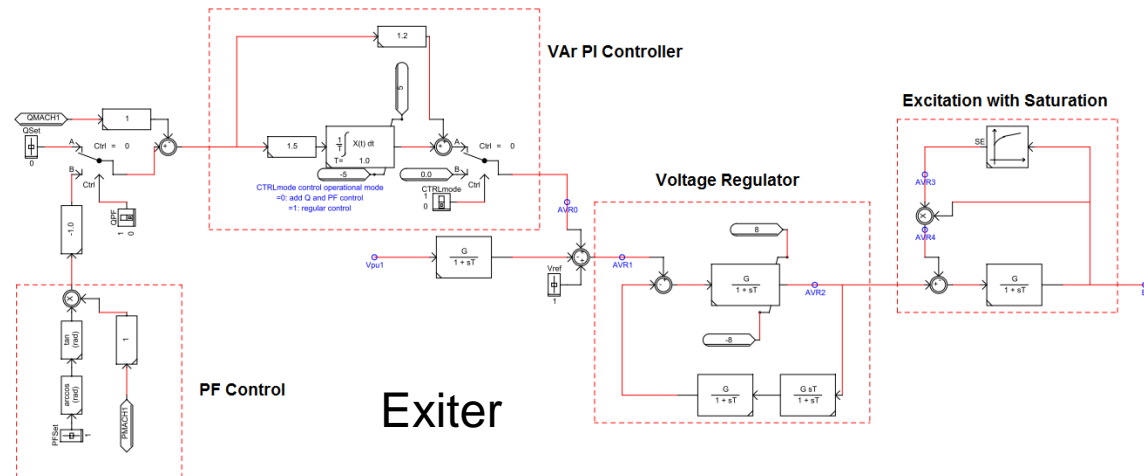
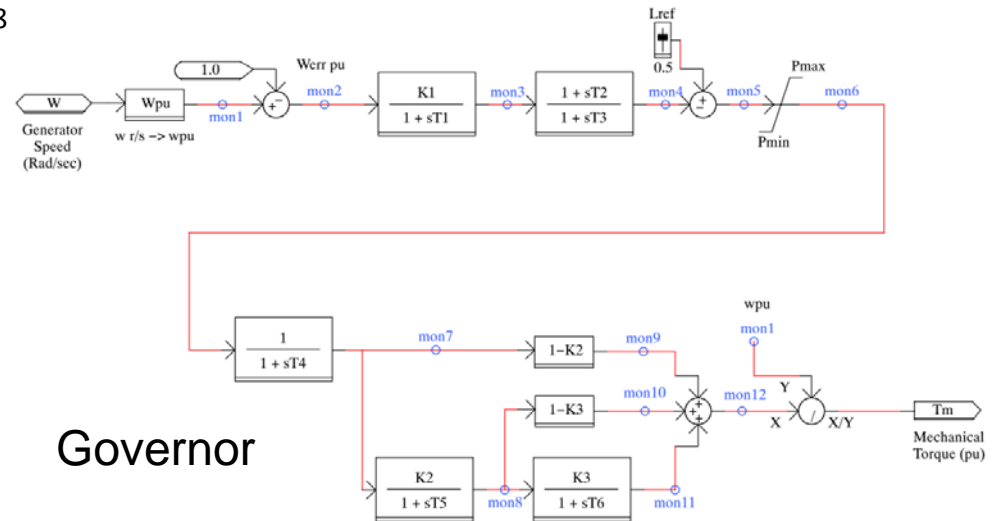

Real Power NDZ – 30MVA generator



Setting Option	ROCOF [Hz/s]	Time Delay [s]	Dead Band applied	NDZP _g , NDZP _d [%]			
				P/V control		P/pf control	
				Fixed power load	Fixed imp. load	Fixed power load	Fixed imp. load
1	0.5	0.0	No	-6.1,5.9	-7.1,6.9	-0.6,0.0	0.0,0.2
2	0.5	0.5	No	-7.2,7.2	-7.6,7.6	-7.7,0.0	-0.5,0.6
3	1.0	0.0	No	-12.4,11.5	-13.9,14.1	-13.8,0.0	-0.4,0.4
4	1.0	0.5	No	-14.6,14.6	-15.2,16.0	-16.7,0.0	-0.8,1.2
5	0.5	0.0	Yes	-8.4,8.4	-8.8,8.8	-9.9,0.0	-0.4,0.8
6	0.5	0.5	Yes	-10.6,10.2	-12.4,11.3	-12.2,0.0	-1.8,1.1
7	1.0	0.0	Yes	-13.1,12.5	-14.2,14.2	-15.7,0.0	-0.5,0.8
8	1.0	0.5	Yes	-17.7,18.9	-18.2,18.5	-18.8,0.0	-2.3,2.0
9	0.12	0.0	No	-1.3,1.2	-1.7,1.7	0.0,0.0	0.0,0.0
10	0.13	0.0	No	-1.6,1.5	-1.8,1.8	0.0,0.0	0.0,0.0
11	0.2	0.0	No	-2.4,2.4	-2.9,2.9	0.0,0.0	0.0,0.0

Real Power NDZ – 30MVA generator

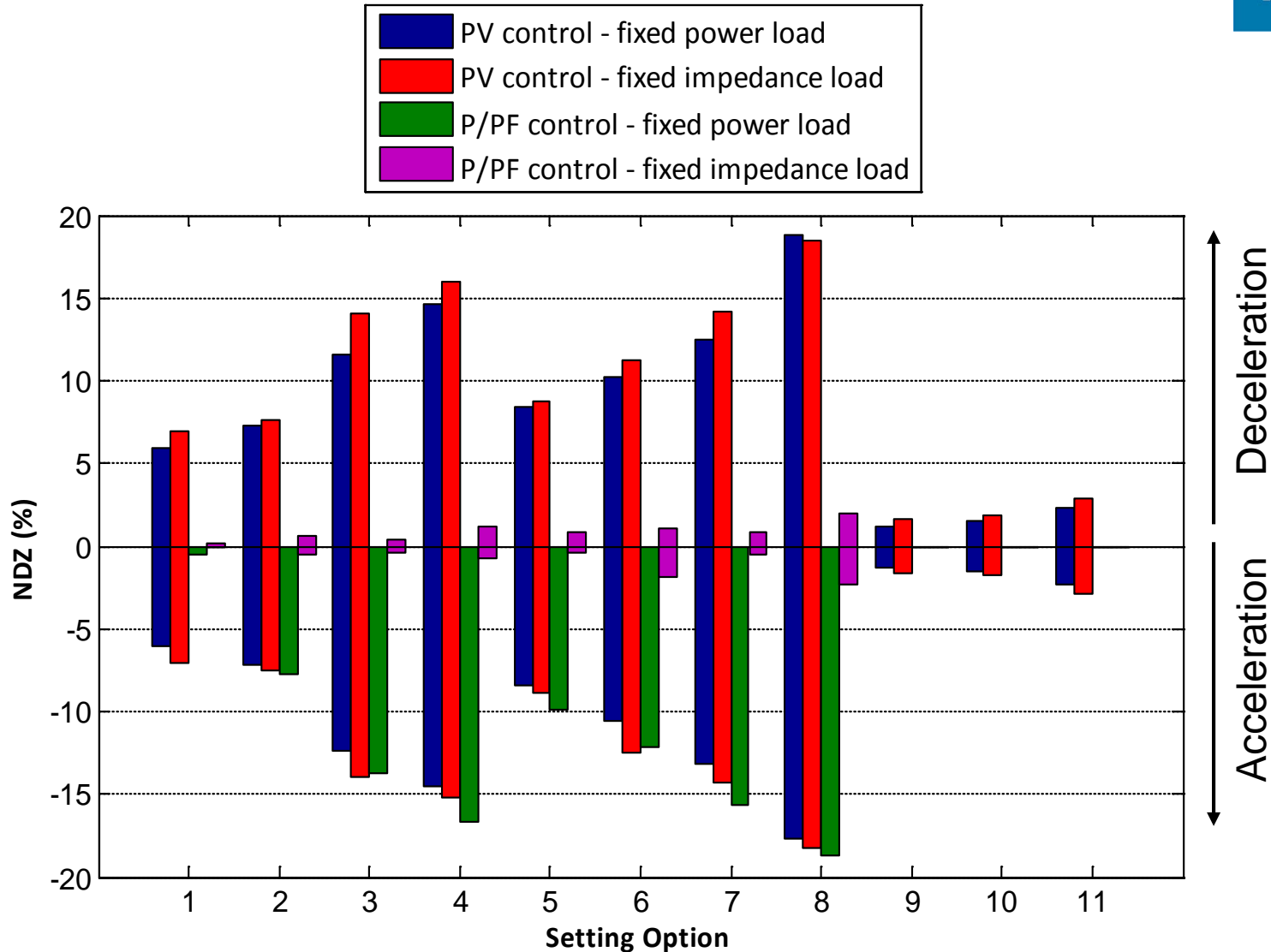

Reactive Power NDZ – 30MVA generator



Setting Option	ROCOF [Hz/s]	Time Delay [s]	Dead Band applied	NDZQ _g , NDZQ _d [%]			
				P/V control		P/pf control	
				Fixed power load	Fixed imp. load	Fixed power load	Fixed imp. load
1	0.5	0.0	No	-17.6, 23.6	-11.3, 13.4	-19.8, 0.0	-0.1, 0.0
2	0.5	0.5	No	-88.9, 70.6	-74.3, 66.1	-20.0, 0.0	-0.2, 0.2
3	1.0	0.0	No	-38.9, 35.5	-22.4, 28.6	-27.1, 0.0	0.2, 0.1
4	1.0	0.5	No	-95.7, 87.7	-99.9, 88.5	-28.3, 0.0	-0.4, 0.4
5	0.5	0.0	Yes	-92.3, 54.2	-42.2, 52.0	-19.6, 0.0	-0.2, 0.4
6	0.5	0.5	Yes	-95.6, 84.2	-81.3, 85.4	-19.9, 0.0	-0.6, 0.5
7	1.0	0.0	Yes	-92.5, 61.1	-48.0, 60.7	-27.5, 0.0	-0.3, 0.1
8	1.0	0.5	Yes	-96.0, 100.0	-100.0, 100.0	-28.2, 0.0	-0.6, 0.5
9	0.12	0.0	No	-5.7, 4.8	-2.9, 2.6	0.0, 0.0	0.0, 0.0
10	0.13	0.0	No	-6.9, 4.1	-3.6, 3.2	0.0, 0.0	0.0, 0.0
11	0.2	0.0	No	-11.2, 7.0	-4.7, 4.6	0.0, 0.0	0.0, 0.0

Reactive Power NDZ – 30MVA generator

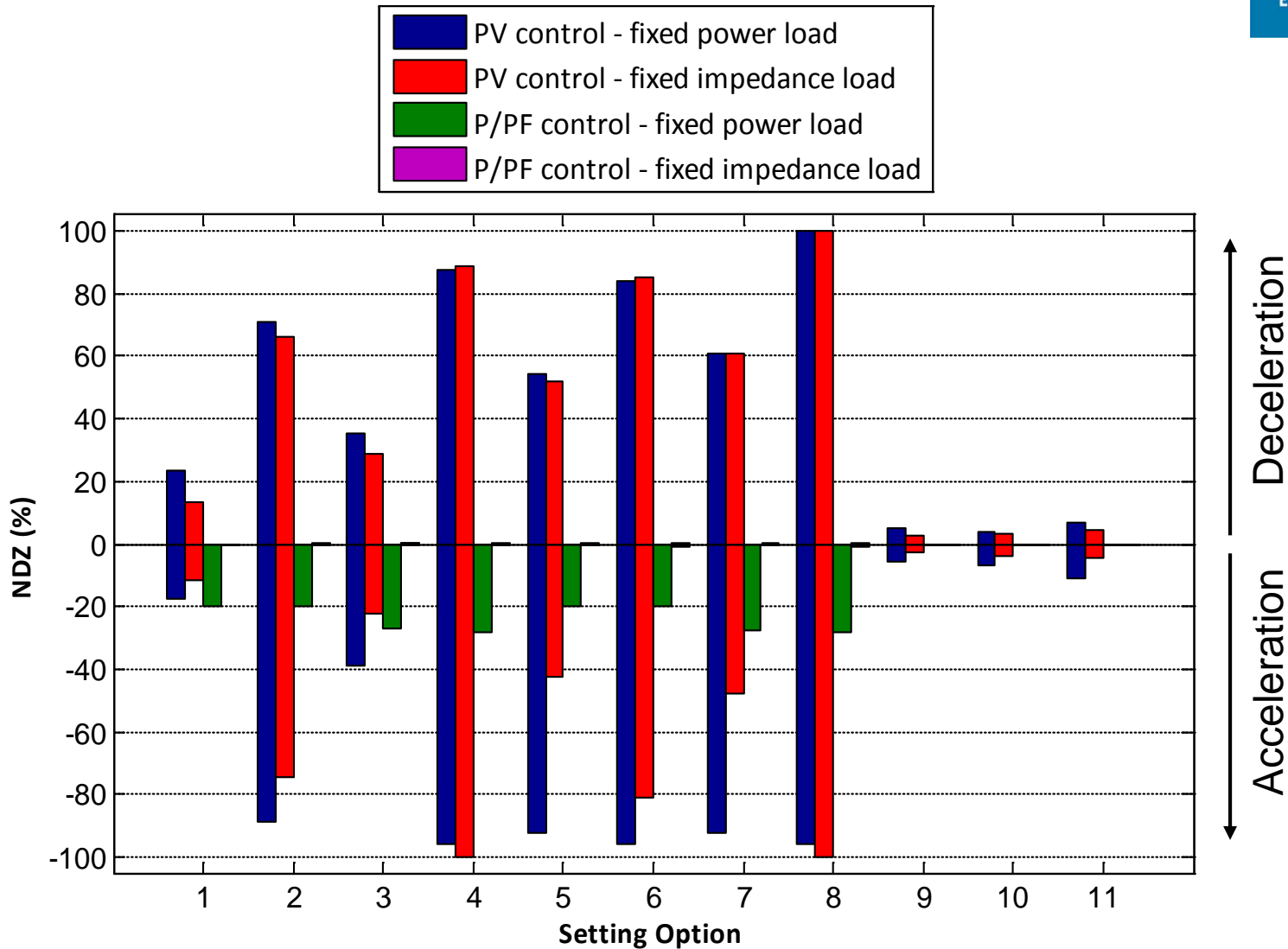

Real Power NDZ – 3MVA generator ($H=3s$)

Setting Option	ROCOF [Hz/s]	Time Delay [s]	Dead Band applied	$NDZP_a, NDZP_d$ [%]			
				P/V control		P/pf control	
				Fixed power load	Fixed imp. load	Fixed power load	Fixed imp. load
1	0.5	0.0	No	-3.2, 3.3	-2.8, 3.3	-2.4, 0.0	-2.0, 2.0
6	0.5	0.5	Yes	-8.0, 8.2	-9.0, 9.6	-7.3, 0.0	-1.6, 2.3
10	0.13	0.0	No	-0.7, 0.7	-0.8, 0.6	-0.7, 0.0	-0.2, 0.5

Real Power NDZ – 30MVA generator ($H=1.3s$)

Setting Option	ROCOF [Hz/s]	Time Delay [s]	Dead Band applied	$NDZP_a, NDZP_d$ [%]			
				P/V control		P/pf control	
				Fixed power load	Fixed imp. load	Fixed power load	Fixed imp. load
1	0.5	0.0	No	-6.1, 5.9	-7.1, 6.9	-0.6, 0.0	0.0, 0.2
6	0.5	0.5	Yes	-10.6, 10.2	-12.4, 11.3	-12.2, 0.0	-1.8, 1.1
10	0.13	0.0	No	-1.6, 1.5	-1.8, 1.8	0.0, 0.0	0.0, 0.0

Reactive Power NDZ – 3MVA generator ($H=3s$)

Setting Option	ROCOF [Hz/s]	Time Delay [s]	Dead Band applied	$NDZQ_a, NDZQ_d$ [%]			
				P/V control		P/pf control	
				Fixed power load	Fixed imp. load	Fixed power load	Fixed imp. load
1	0.5	0.0	No	-49.1, 41.5	-8.7, 8.3	-49.6, 0.0	-3.2, 3.1
6	0.5	0.5	Yes	-62.9, 51.2	-45.5, 38.2	-49.8, 0.0	-0.7, 63.5
10	0.13	0.0	No	-8.6, 7.3	-1.6, 2.1	0.0, 0.0	0.0, 0.0

Real Power NDZ – 30MVA generator ($H=1.3s$)

Setting Option	ROCOF [Hz/s]	Time Delay [s]	Dead Band applied	$NDZQ_a, NDZQ_d$ [%]			
				P/V control		P/pf control	
				Fixed power load	Fixed imp. load	Fixed power load	Fixed imp. load
1	0.5	0.0	No	-17.6, 23.6	-11.3, 13.4	-19.8, 0.0	-0.1, 0.0
6	0.5	0.5	Yes	-95.6, 84.2	-81.3, 85.4	-19.9, 0.0	-0.6, 0.5
10	0.13	0.0	No	-6.9, 4.1	-3.6, 3.2	0.0, 0.0	0.0, 0.0

WP2 – Risk level calculation

LOM Assessment Probability Tree

P_1

Loss-Of-Grid
connection (e.g. loss
of primary substation)

AND

P_{LOM}

AND

IR or *OA*

Safety hazard, or
risk of damage to
generator

P_2

Load/Generation in
close balance (both P
and Q within NDZ)

AND

P_{PER} or P_{AR}

AND

Persons in the
vicinity
injured/killed, or
out-of-synch auto-
reclose

P_3

Non-detection zone
duration longer than
the acceptable limit,
e.g. 3s

AND

WP2 – Risk level calculation at varying NDZ

■ Assumptions

- ❑ Generation range considered 5MW – 50MW
- ❑ Existing Synchronous DG Generation included only
- ❑ 6 different load profiles included
- ❑ Generator output is 100% its rating at $pf=0.99$ (lagging) – based on SPM generation record
- ❑ Max. permissible length of undetected island is $T_{NDZmax}=3s$.
- ❑ Loss of supply occurrence – 96 times in 7 years a population of 440 substations.
- ❑ P and Q NDZ assumed from the WP1 results
- ❑ All SM generators have ROCOF

Results with ROCOF protection enabled only

Results (P/V controlled DG) – ROCOF only

Load Case	Setting Option	Fixed power load				Fixed impedance load			
		T_{NDZavr} [min]	$N_{LOM,1DG}$	$P_{LOM,1DG}$	P_{LOM}	T_{NDZavr} [min]	$N_{LOM,1DG}$	$P_{LOM,1DG}$	P_{LOM}
1	1	141.18	2.20E-03	5.90E-07	1.08E-04	157.43	2.54E-03	7.60E-07	1.39E-04
	2	160.92	2.61E-03	8.00E-07	1.46E-04	180.16	2.91E-03	9.97E-07	1.82E-04
	3	285.16	4.46E-03	2.42E-06	4.43E-04	321.03	5.14E-03	3.14E-06	5.74E-04
	4	313.77	5.33E-03	3.18E-06	5.82E-04	329.11	5.68E-03	3.56E-06	6.51E-04
	5	184.90	3.27E-03	1.15E-06	2.11E-04	195.02	3.39E-03	1.26E-06	2.30E-04
	6	250.43	3.97E-03	1.89E-06	3.46E-04	280.97	4.43E-03	2.37E-06	4.34E-04
	7	296.79	4.75E-03	2.68E-06	4.90E-04	314.67	5.20E-03	3.12E-06	5.70E-04
	8	425.18	6.62E-03	5.36E-06	9.80E-04	424.16	6.70E-03	5.40E-06	9.89E-04
	9	34.75	2.77E-04	1.83E-08	3.35E-06	30.31	1.39E-04	8.02E-09	1.47E-06
	10	38.58	3.17E-04	2.32E-08	4.25E-06	44.67	2.91E-04	2.47E-08	4.51E-06
	11	61.11	7.31E-04	8.49E-08	1.55E-05	62.06	7.04E-04	8.30E-08	1.52E-05
2	1	3.34	1.96E-03	1.23E-08	2.24E-06	4.59	2.23E-03	1.93E-08	3.53E-06
	2	5.14	2.32E-03	2.25E-08	4.11E-06	5.28	2.42E-03	2.41E-08	4.42E-06
	3	8.88	3.99E-03	6.70E-08	1.23E-05	9.49	4.56E-03	8.19E-08	1.50E-05
	4	9.61	4.77E-03	8.67E-08	1.59E-05	12.35	5.08E-03	1.19E-07	2.18E-05
	5	5.30	2.76E-03	2.75E-08	5.04E-06	5.24	2.81E-03	2.78E-08	5.08E-06
	6	5.92	3.36E-03	3.75E-08	6.86E-06	8.92	3.94E-03	6.64E-08	1.22E-05
	7	8.48	4.31E-03	6.91E-08	1.26E-05	9.12	4.43E-03	7.65E-08	1.40E-05
	8	11.69	5.34E-03	1.18E-07	2.17E-05	11.95	5.63E-03	1.27E-07	2.33E-05
	9	0.82	1.96E-04	2.86E-10	5.24E-08	0.44	4.13E-05	3.09E-11	5.65E-09
	10	0.94	2.61E-04	4.44E-10	8.12E-08	0.69	1.05E-04	1.27E-10	2.32E-08
	11	1.19	5.68E-04	1.24E-09	2.26E-07	1.50	4.30E-04	1.19E-09	2.18E-07
3	1	112.89	1.09E-03	2.34E-07	4.27E-05	129.55	1.25E-03	3.09E-07	5.65E-05
	2	133.92	1.30E-03	3.31E-07	6.05E-05	140.78	1.37E-03	3.66E-07	6.69E-05
	3	224.15	2.15E-03	9.16E-07	1.68E-04	261.04	2.52E-03	1.25E-06	2.29E-04
	4	271.64	2.62E-03	1.36E-06	2.48E-04	290.00	2.81E-03	1.55E-06	2.83E-04
	5	157.60	1.52E-03	4.55E-07	8.33E-05	164.52	1.58E-03	4.95E-07	9.06E-05
	6	193.92	1.87E-03	6.89E-07	1.26E-04	222.73	2.13E-03	9.04E-07	1.65E-04
	7	239.88	2.31E-03	1.05E-06	1.93E-04	265.57	2.56E-03	1.29E-06	2.36E-04
	8	339.60	3.31E-03	2.14E-06	3.91E-04	342.98	3.33E-03	2.18E-06	3.98E-04
	9	24.75	1.71E-04	8.02E-09	1.47E-06	33.21	1.29E-04	8.16E-09	1.49E-06
	10	28.60	2.29E-04	1.24E-08	2.28E-06	35.79	1.70E-04	1.16E-08	2.12E-06
	11	43.56	4.21E-04	3.48E-08	6.37E-06	54.47	3.43E-04	3.55E-08	6.50E-06
4	1	115.12	1.16E-03	2.54E-07	4.65E-05	100.92	6.31E-04	1.21E-07	2.22E-05
	2	148.99	1.78E-03	5.05E-07	9.24E-05	156.21	1.87E-03	5.55E-07	1.02E-04
	3	224.16	2.85E-03	1.21E-06	2.22E-04	229.15	3.04E-03	1.33E-06	2.43E-04
	4	283.02	3.53E-03	1.90E-06	3.47E-04	300.03	3.75E-03	2.14E-06	3.91E-04
	5	171.19	2.06E-03	6.71E-07	1.23E-04	176.55	2.14E-03	7.20E-07	1.32E-04
	6	207.43	2.52E-03	9.95E-07	1.82E-04	234.86	2.90E-03	1.29E-06	2.37E-04
	7	250.68	3.11E-03	1.48E-06	2.72E-04	279.06	3.44E-03	1.83E-06	3.34E-04
	8	361.99	4.40E-03	3.03E-06	5.55E-04	365.25	4.48E-03	3.12E-06	5.70E-04
	9	23.40	2.07E-05	9.21E-10	1.69E-07	30.63	1.69E-05	9.86E-10	1.80E-07
	10	28.59	2.17E-05	1.18E-09	2.16E-07	37.08	2.21E-05	1.56E-09	2.85E-07
	11	42.46	6.91E-05	5.58E-09	1.02E-06	45.05	4.53E-05	3.88E-09	7.10E-07

Results (P/V controlled DG) – ROCOF only

Load Case	Setting Option	Fixed power load				Fixed impedance load			
		T_{NDZavr} [min]	$N_{LOM,1DG}$	$P_{LOM,1DG}$	P_{LOM}	T_{NDZavr} [min]	$N_{LOM,1DG}$	$P_{LOM,1DG}$	P_{LOM}
5	1	111.15	1.96E-03	4.15E-07	7.59E-05	113.05	1.64E-03	3.54E-07	6.47E-05
	2	138.78	2.54E-03	6.70E-07	1.23E-04	146.51	2.67E-03	7.45E-07	1.36E-04
	3	228.17	4.21E-03	1.83E-06	3.34E-04	260.76	4.82E-03	2.39E-06	4.38E-04
	4	280.88	5.18E-03	2.77E-06	5.06E-04	299.86	5.51E-03	3.14E-06	5.75E-04
	5	162.96	2.98E-03	9.25E-07	1.69E-04	170.03	3.11E-03	1.01E-06	1.84E-04
	6	200.57	3.67E-03	1.40E-06	2.56E-04	228.40	4.20E-03	1.83E-06	3.34E-04
	7	246.50	4.55E-03	2.13E-06	3.91E-04	273.76	5.05E-03	2.63E-06	4.81E-04
	8	347.68	6.44E-03	4.26E-06	7.80E-04	351.00	6.50E-03	4.34E-06	7.94E-04
	9	24.39	1.36E-04	6.28E-09	1.15E-06	28.14	1.06E-04	5.65E-09	1.03E-06
	10	29.27	1.59E-04	8.83E-09	1.62E-06	30.74	1.36E-04	7.94E-09	1.45E-06
	11	42.05	3.44E-04	2.75E-08	5.03E-06	46.18	2.86E-04	2.51E-08	4.60E-06
6	1	99.05	1.16E-03	2.18E-07	3.99E-05	87.60	5.43E-04	9.04E-08	1.66E-05
	2	135.29	2.01E-03	5.17E-07	9.47E-05	141.98	2.12E-03	5.72E-07	1.05E-04
	3	223.39	3.31E-03	1.41E-06	2.57E-04	230.30	3.47E-03	1.52E-06	2.79E-04
	4	272.13	4.04E-03	2.09E-06	3.82E-04	288.60	4.31E-03	2.37E-06	4.33E-04
	5	157.30	2.35E-03	7.03E-07	1.29E-04	164.35	2.45E-03	7.65E-07	1.40E-04
	6	193.56	2.88E-03	1.06E-06	1.94E-04	221.90	3.29E-03	1.39E-06	2.54E-04
	7	239.88	3.55E-03	1.62E-06	2.97E-04	265.29	3.94E-03	1.99E-06	3.64E-04
	8	340.04	5.05E-03	3.27E-06	5.98E-04	342.69	5.09E-03	3.32E-06	6.07E-04
	9	24.83	2.03E-05	9.55E-10	1.75E-07	32.43	7.59E-06	4.68E-10	8.56E-08
	10	29.28	3.69E-05	2.05E-09	3.76E-07	33.44	1.22E-05	7.73E-10	1.41E-07
	11	40.76	1.75E-04	1.35E-08	2.48E-06	43.68	3.29E-05	2.73E-09	5.00E-07
7	1	1.39	3.86E-04	9.82E-10	1.80E-07	4.45	9.35E-05	7.83E-10	1.43E-07
	2	2.75	1.42E-03	7.30E-09	1.34E-06	2.68	1.53E-03	7.65E-09	1.40E-06
	3	4.59	2.03E-03	1.76E-08	3.21E-06	3.88	1.60E-03	1.16E-08	2.13E-06
	4	8.19	2.88E-03	4.46E-08	8.17E-06	8.56	3.03E-03	4.90E-08	8.97E-06
	5	2.74	1.71E-03	8.74E-09	1.60E-06	2.69	1.84E-03	9.23E-09	1.69E-06
	6	4.04	2.32E-03	1.76E-08	3.22E-06	6.22	2.60E-03	3.06E-08	5.59E-06
	7	7.18	2.72E-03	3.68E-08	6.74E-06	7.80	2.89E-03	4.25E-08	7.79E-06
	8	5.46	3.62E-03	3.72E-08	6.82E-06	6.08	3.79E-03	4.35E-08	7.97E-06
	9	0.40	1.05E-06	7.02E-13	1.28E-10	0.00	0.00E+00	0.00E+00	0.00E+00
	10	0.42	1.95E-06	1.36E-12	2.50E-10	0.28	6.24E-07	2.77E-13	5.07E-11
	11	0.50	1.01E-05	8.61E-12	1.58E-09	1.43	2.52E-06	6.61E-12	1.21E-09
8	1	1.89	1.08E-03	3.77E-09	6.91E-07	2.13	1.12E-03	4.43E-09	8.10E-07
	2	2.16	1.30E-03	5.21E-09	9.53E-07	2.22	1.38E-03	5.69E-09	1.04E-06
	3	3.63	2.03E-03	1.38E-08	2.53E-06	4.51	2.27E-03	1.93E-08	3.52E-06
	4	4.58	2.39E-03	2.06E-08	3.76E-06	4.68	2.56E-03	2.26E-08	4.13E-06
	5	2.54	1.48E-03	7.01E-09	1.28E-06	2.60	1.52E-03	7.36E-09	1.35E-06
	6	2.97	1.81E-03	1.01E-08	1.84E-06	3.65	2.01E-03	1.38E-08	2.53E-06
	7	4.16	2.17E-03	1.70E-08	3.11E-06	4.54	2.32E-03	1.99E-08	3.63E-06
	8	5.74	2.99E-03	3.24E-08	5.93E-06	5.66	2.99E-03	3.20E-08	5.85E-06
	9	0.37	7.79E-05	4.75E-11	8.69E-09	0.50	7.13E-05	6.08E-11	1.11E-08
	10	0.46	8.54E-05	6.68E-11	1.22E-08	0.54	8.92E-05	8.37E-11	1.53E-08
	11	0.61	2.93E-04	3.11E-10	5.70E-08	0.76	1.68E-04	2.27E-10	4.15E-08

Results (P/pf controlled DG) – ROCOF only

Load Case	Setting Option	Fixed power load				Fixed impedance load			
		T_{NDZavr} [min]	$N_{LOM,1DG}$	$P_{LOM,1DG}$	P_{LOM}	T_{NDZavr} [min]	$N_{LOM,1DG}$	$P_{LOM,1DG}$	P_{LOM}
1	1	24.98	1.79E-05	8.50E-10	1.56E-07	0.00	0.00E+00	0.00E+00	0.00E+00
	2	180.16	8.34E-04	1.13E-07	2.06E-05	14.91	3.13E-06	8.86E-11	1.62E-08
	3	321.03	1.58E-03	3.29E-07	6.02E-05	0.00	0.00E+00	0.00E+00	0.00E+00
	4	329.11	1.86E-03	4.40E-07	8.05E-05	23.99	1.23E-05	5.58E-10	1.02E-07
	5	195.02	1.09E-03	1.69E-07	3.09E-05	24.93	9.85E-07	4.66E-11	8.53E-09
	6	280.97	1.36E-03	2.45E-07	4.48E-05	20.57	1.95E-05	7.62E-10	1.39E-07
	7	314.67	1.77E-03	3.78E-07	6.93E-05	14.91	2.74E-06	7.76E-11	1.42E-08
	8	424.16	2.17E-03	5.55E-07	1.01E-04	30.46	2.86E-05	1.65E-09	3.02E-07
	9	30.31	0.00E+00	0.00E+00	0.00E+00	0.00	0.00E+00	0.00E+00	0.00E+00
	10	44.67	0.00E+00	0.00E+00	0.00E+00	0.00	0.00E+00	0.00E+00	0.00E+00
	11	62.06	0.00E+00	0.00E+00	0.00E+00	0.00	0.00E+00	0.00E+00	0.00E+00
2	1	4.59	3.62E-05	9.05E-12	1.66E-09	0.00	0.00E+00	0.00E+00	0.00E+00
	2	5.28	1.39E-03	9.20E-09	1.68E-06	0.00	0.00E+00	0.00E+00	0.00E+00
	3	9.49	2.60E-03	4.23E-08	7.73E-06	0.00	0.00E+00	0.00E+00	0.00E+00
	4	12.35	2.98E-03	5.76E-08	1.05E-05	0.22	1.80E-07	5.69E-14	1.04E-11
	5	5.24	1.94E-03	1.49E-08	2.72E-06	0.00	0.00E+00	0.00E+00	0.00E+00
	6	8.92	2.46E-03	3.06E-08	5.61E-06	0.17	1.38E-07	3.07E-14	5.61E-12
	7	9.12	2.90E-03	5.17E-08	9.47E-06	0.00	0.00E+00	0.00E+00	0.00E+00
	8	11.95	3.37E-03	5.74E-08	1.05E-05	0.24	1.37E-06	4.83E-13	8.84E-11
	9	0.44	0.00E+00	0.00E+00	0.00E+00	0.00	0.00E+00	0.00E+00	0.00E+00
	10	0.69	0.00E+00	0.00E+00	0.00E+00	0.00	0.00E+00	0.00E+00	0.00E+00
	11	1.50	0.00E+00	0.00E+00	0.00E+00	0.00	0.00E+00	0.00E+00	0.00E+00
3	1	129.55	4.13E-05	3.97E-10	7.26E-08	2.36	1.36E-07	5.96E-13	1.09E-10
	2	140.78	5.87E-04	7.22E-08	1.32E-05	7.59	3.05E-06	4.38E-11	8.02E-09
	3	261.04	1.08E-03	2.39E-07	4.38E-05	0.00	0.00E+00	0.00E+00	0.00E+00
	4	290.00	1.32E-03	3.62E-07	6.61E-05	13.41	1.09E-05	2.76E-10	5.06E-08
	5	164.52	7.62E-04	1.20E-07	2.20E-05	9.43	4.80E-06	8.56E-11	1.57E-08
	6	222.73	9.49E-04	1.87E-07	3.41E-05	19.78	2.26E-05	8.47E-10	1.55E-07
	7	265.57	1.24E-03	3.16E-07	5.78E-05	8.07	3.64E-06	5.55E-11	1.01E-08
	8	342.98	1.51E-03	4.70E-07	8.60E-05	24.17	3.50E-05	1.60E-09	2.94E-07
	9	33.21	0.00E+00	0.00E+00	0.00E+00	0.00	0.00E+00	0.00E+00	0.00E+00
	10	35.79	0.00E+00	0.00E+00	0.00E+00	0.00	0.00E+00	0.00E+00	0.00E+00
	11	54.47	0.00E+00	0.00E+00	0.00E+00	0.00	0.00E+00	0.00E+00	0.00E+00
4	1	100.92	5.34E-07	4.69E-12	8.59E-10	2.00	1.77E-08	6.58E-14	1.20E-11
	2	156.21	1.25E-05	8.83E-10	1.62E-07	7.43	2.18E-07	3.07E-12	5.61E-10
	3	229.15	3.71E-05	3.62E-09	6.62E-07	0.00	0.00E+00	0.00E+00	0.00E+00
	4	300.03	5.52E-05	6.40E-09	1.17E-06	12.21	1.15E-06	2.65E-11	4.85E-09
	5	176.55	1.92E-05	1.45E-09	2.66E-07	8.83	4.57E-07	7.64E-12	1.40E-09
	6	234.86	2.93E-05	2.67E-09	4.89E-07	13.22	2.33E-06	5.84E-11	1.07E-08
	7	279.06	5.01E-05	5.56E-09	1.02E-06	5.00	2.81E-07	2.64E-12	4.84E-10
	8	365.25	6.64E-05	7.63E-09	1.40E-06	16.00	4.19E-06	1.27E-10	2.32E-08
	9	30.63	0.00E+00	0.00E+00	0.00E+00	0.00	0.00E+00	0.00E+00	0.00E+00
	10	37.08	0.00E+00	0.00E+00	0.00E+00	0.00	0.00E+00	0.00E+00	0.00E+00
	11	45.05	0.00E+00	0.00E+00	0.00E+00	0.00	0.00E+00	0.00E+00	0.00E+00

Results (P/pf controlled DG) – ROCOF only

Load Case	Setting Option	Fixed power load				Fixed impedance load			
		T_{NDZavr} [min]	$N_{LOM,1DG}$	$P_{LOM,1DG}$	P_{LOM}	T_{NDZavr} [min]	$N_{LOM,1DG}$	$P_{LOM,1DG}$	P_{LOM}
5	1	113.05	1.84E-05	2.34E-10	4.28E-08	2.00	8.26E-08	3.06E-13	5.61E-11
	2	146.51	2.51E-04	2.62E-08	4.80E-06	3.98	1.78E-06	1.33E-11	2.43E-09
	3	260.76	4.86E-04	7.49E-08	1.37E-05	0.00	0.00E+00	0.00E+00	0.00E+00
	4	299.86	6.11E-04	1.05E-07	1.93E-05	7.66	7.02E-06	1.02E-10	1.86E-08
	5	170.03	3.30E-04	4.10E-08	7.50E-06	5.39	3.05E-06	3.10E-11	5.68E-09
	6	228.40	4.24E-04	5.99E-08	1.10E-05	11.62	1.64E-05	3.60E-10	6.59E-08
	7	273.76	5.65E-04	9.42E-08	1.72E-05	4.14	2.01E-06	1.56E-11	2.86E-09
	8	351.00	7.09E-04	1.32E-07	2.41E-05	13.59	2.57E-05	6.63E-10	1.21E-07
	9	28.14	0.00E+00	0.00E+00	0.00E+00	0.00	0.00E+00	0.00E+00	0.00E+00
	10	30.74	0.00E+00	0.00E+00	0.00E+00	0.00	0.00E+00	0.00E+00	0.00E+00
	11	46.18	0.00E+00	0.00E+00	0.00E+00	0.00	0.00E+00	0.00E+00	0.00E+00
6	1	87.60	6.29E-05	6.84E-10	1.25E-07	4.00	2.73E-09	2.05E-14	3.76E-12
	2	141.98	8.68E-04	1.18E-07	2.17E-05	5.78	7.58E-08	8.26E-13	1.51E-10
	3	230.30	1.86E-03	4.79E-07	8.76E-05	0.00	0.00E+00	0.00E+00	0.00E+00
	4	288.60	2.29E-03	7.27E-07	1.33E-04	12.35	2.76E-07	6.46E-12	1.18E-09
	5	164.35	1.08E-03	1.87E-07	3.42E-05	7.80	1.09E-07	1.61E-12	2.95E-10
	6	221.90	1.37E-03	2.90E-07	5.30E-05	14.44	5.79E-07	1.59E-11	2.90E-09
	7	265.29	2.13E-03	6.32E-07	1.16E-04	6.44	7.37E-08	8.97E-13	1.64E-10
	8	342.69	2.58E-03	9.29E-07	1.70E-04	19.15	1.05E-06	3.81E-11	6.96E-09
	9	32.43	0.00E+00	0.00E+00	0.00E+00	0.00	0.00E+00	0.00E+00	0.00E+00
	10	33.44	0.00E+00	0.00E+00	0.00E+00	0.00	0.00E+00	0.00E+00	0.00E+00
	11	43.68	0.00E+00	0.00E+00	0.00E+00	0.00	0.00E+00	0.00E+00	0.00E+00
7	1	4.45	0.00E+00	0.00E+00	0.00E+00	0.00	0.00E+00	0.00E+00	0.00E+00
	2	2.68	0.00E+00	0.00E+00	0.00E+00	0.00	0.00E+00	0.00E+00	0.00E+00
	3	3.88	0.00E+00	0.00E+00	0.00E+00	0.00	0.00E+00	0.00E+00	0.00E+00
	4	8.56	0.00E+00	0.00E+00	0.00E+00	0.00	0.00E+00	0.00E+00	0.00E+00
	5	2.69	0.00E+00	0.00E+00	0.00E+00	0.00	0.00E+00	0.00E+00	0.00E+00
	6	6.22	0.00E+00	0.00E+00	0.00E+00	0.00	0.00E+00	0.00E+00	0.00E+00
	7	7.80	0.00E+00	0.00E+00	0.00E+00	0.00	0.00E+00	0.00E+00	0.00E+00
	8	6.08	0.00E+00	0.00E+00	0.00E+00	0.00	0.00E+00	0.00E+00	0.00E+00
	9	0.00	0.00E+00	0.00E+00	0.00E+00	0.00	0.00E+00	0.00E+00	0.00E+00
	10	0.28	0.00E+00	0.00E+00	0.00E+00	0.00	0.00E+00	0.00E+00	0.00E+00
	11	1.43	0.00E+00	0.00E+00	0.00E+00	0.00	0.00E+00	0.00E+00	0.00E+00
8	1	2.13	2.41E-06	2.63E-13	4.81E-11	0.00	0.00E+00	0.00E+00	0.00E+00
	2	2.22	9.73E-05	1.39E-10	2.53E-08	0.12	1.31E-06	1.85E-13	3.38E-11
	3	4.51	2.21E-04	4.62E-10	8.46E-08	0.00	0.00E+00	0.00E+00	0.00E+00
	4	4.68	2.90E-04	7.94E-10	1.45E-07	0.20	7.27E-06	2.01E-12	3.67E-10
	5	2.60	1.38E-04	2.68E-10	4.90E-08	0.15	2.83E-06	5.14E-13	9.41E-11
	6	3.65	1.74E-04	3.28E-10	6.00E-08	0.26	1.23E-05	4.87E-12	8.92E-10
	7	4.54	2.70E-04	7.13E-10	1.30E-07	0.13	1.59E-06	2.38E-13	4.36E-11
	8	5.66	3.51E-04	9.84E-10	1.80E-07	0.32	2.38E-05	1.22E-11	2.22E-09
	9	0.50	0.00E+00	0.00E+00	0.00E+00	0.00	0.00E+00	0.00E+00	0.00E+00
	10	0.54	0.00E+00	0.00E+00	0.00E+00	0.00	0.00E+00	0.00E+00	0.00E+00
	11	0.76	0.00E+00	0.00E+00	0.00E+00	0.00	0.00E+00	0.00E+00	0.00E+00

P_{LOM} (Load Case 1) – ROCOF only

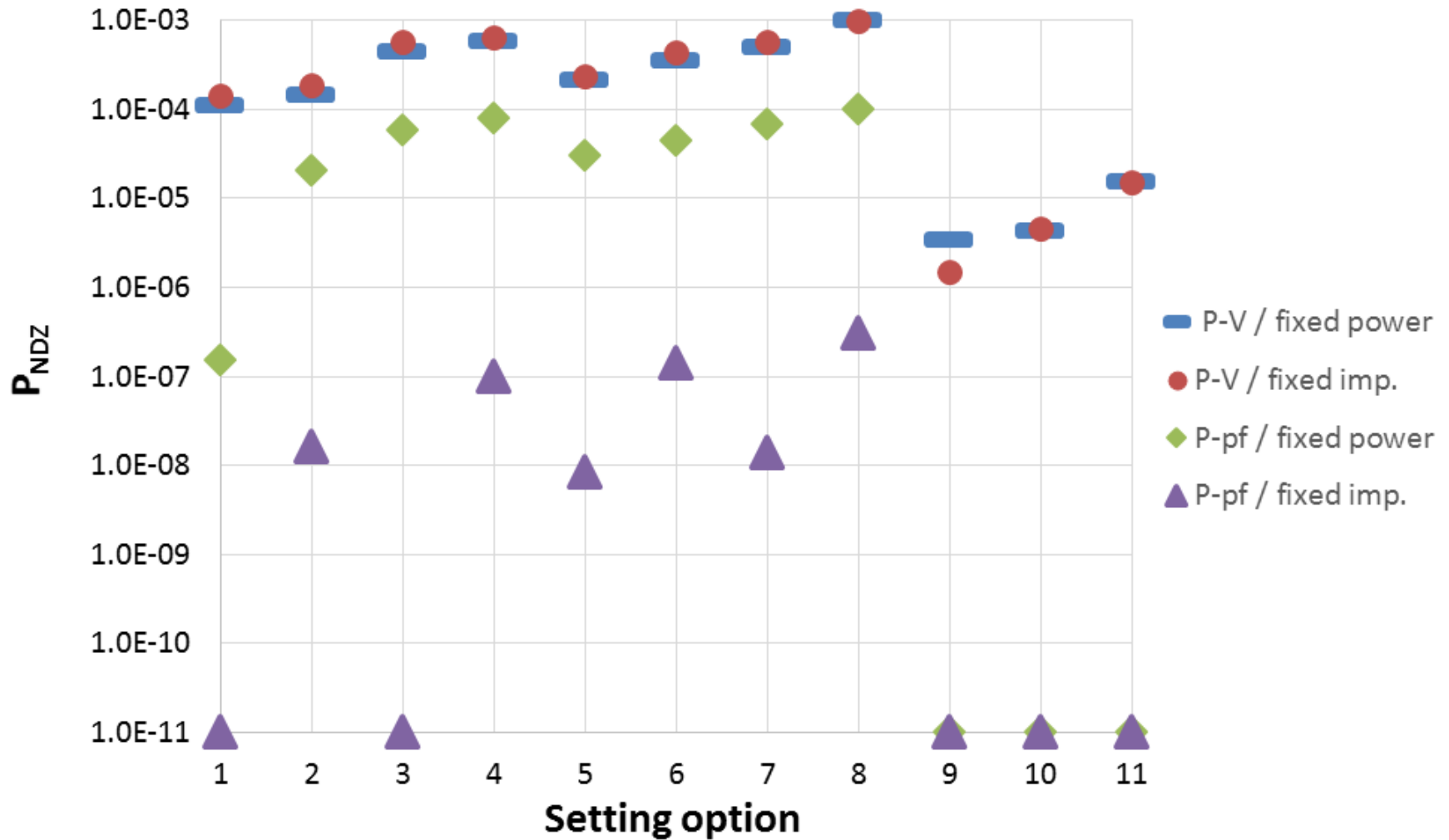

P_{LOM} (Load Case 2) – ROCOF only

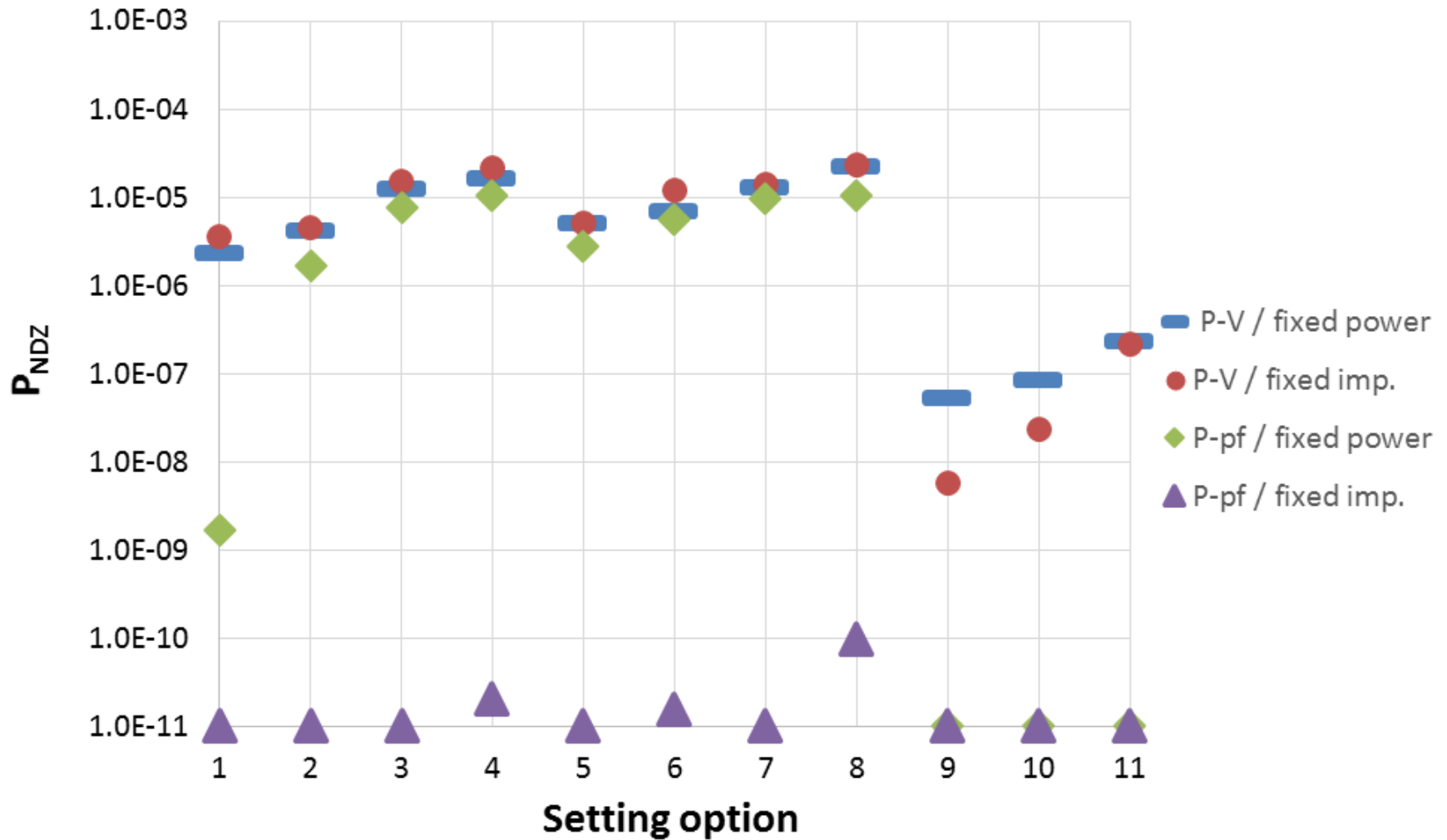

P_{LOM} (Load Case 3) – ROCOF only

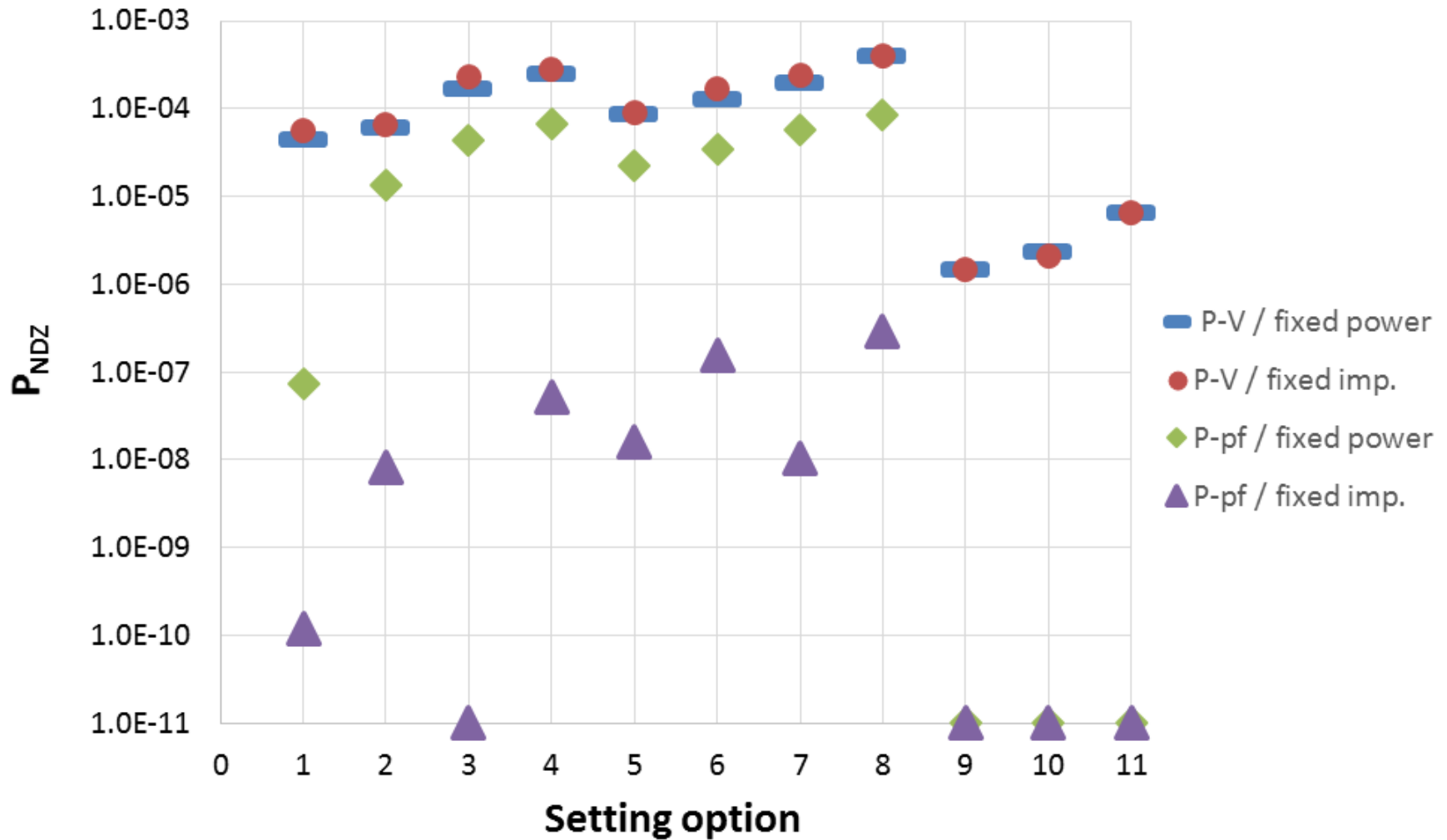

P_{LOM} (Load Case 4) – ROCOF only

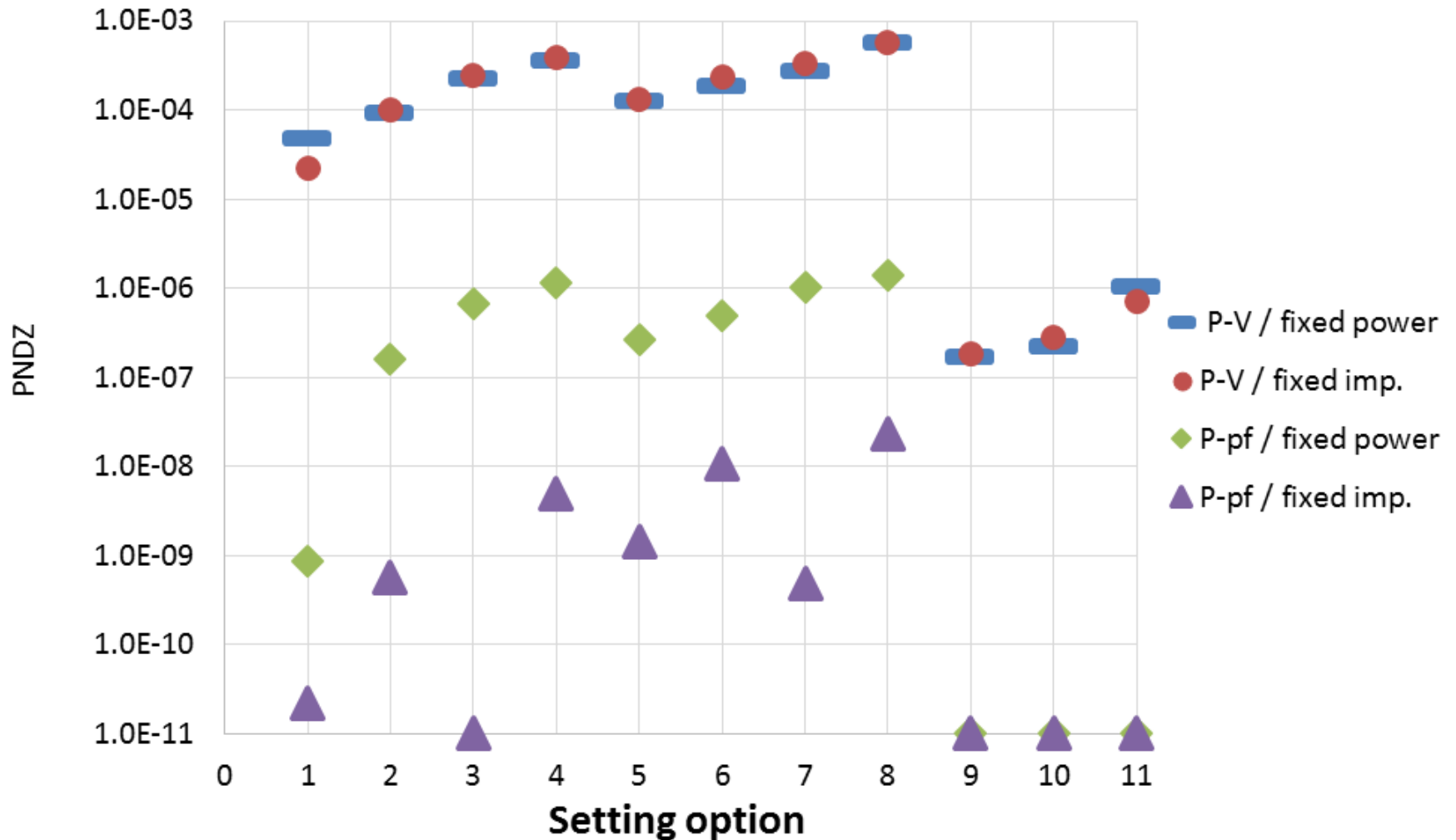

P_{LOM} (Load Case 5) – ROCOF only

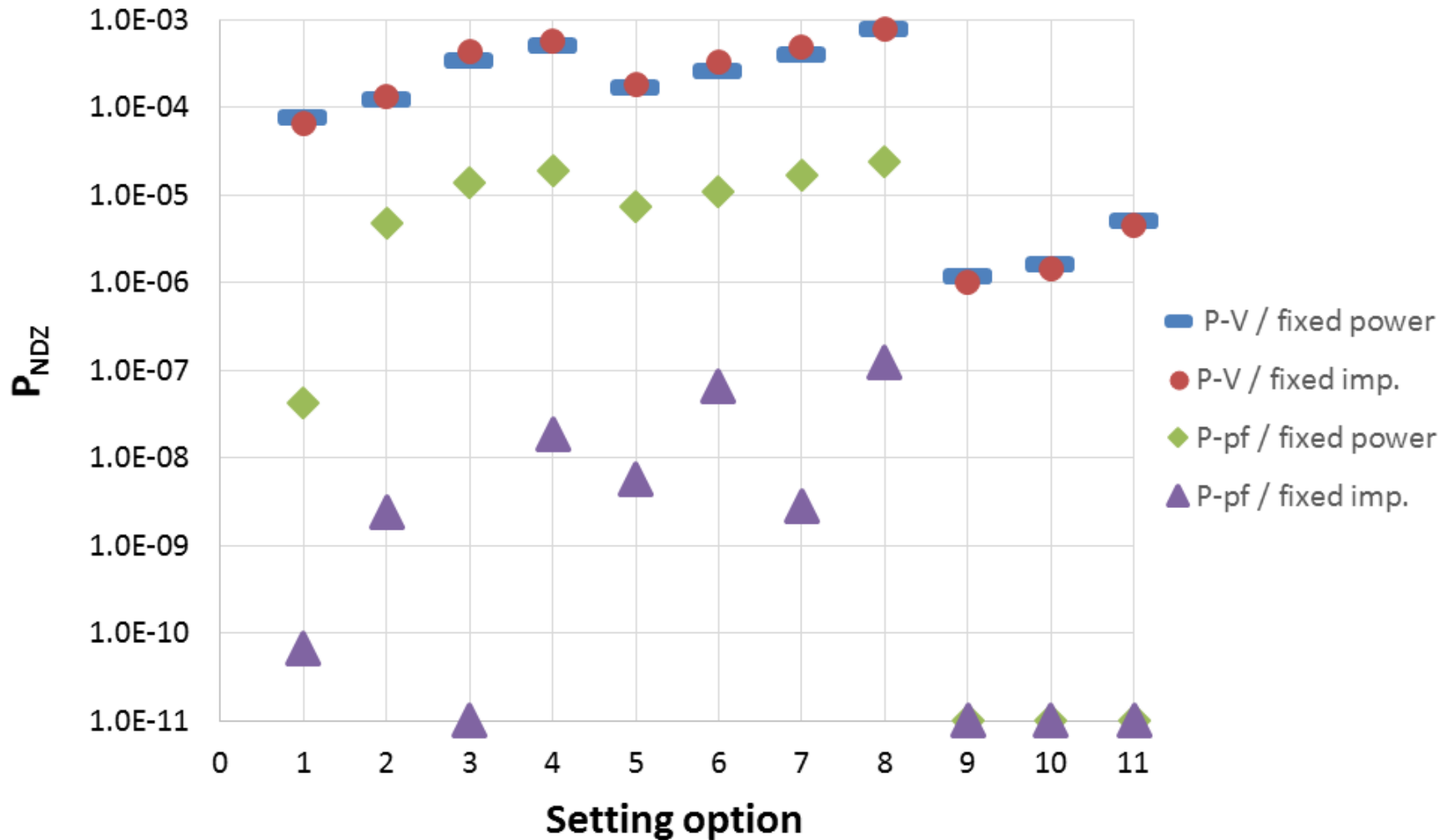

P_{LOM} (Load Case 6) – ROCOF only

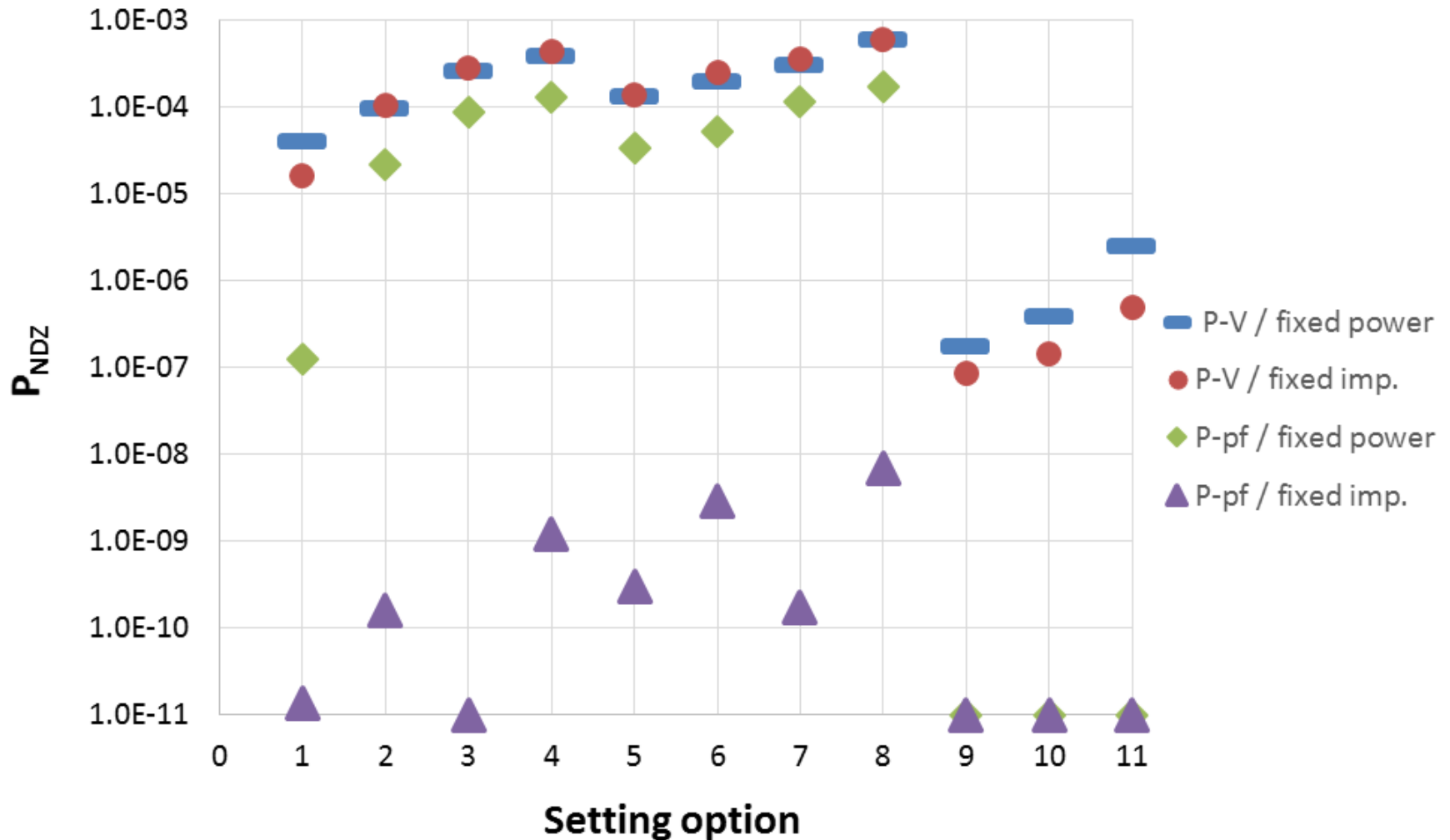

P_{LOM} (Load Case 7) – ROCOF only

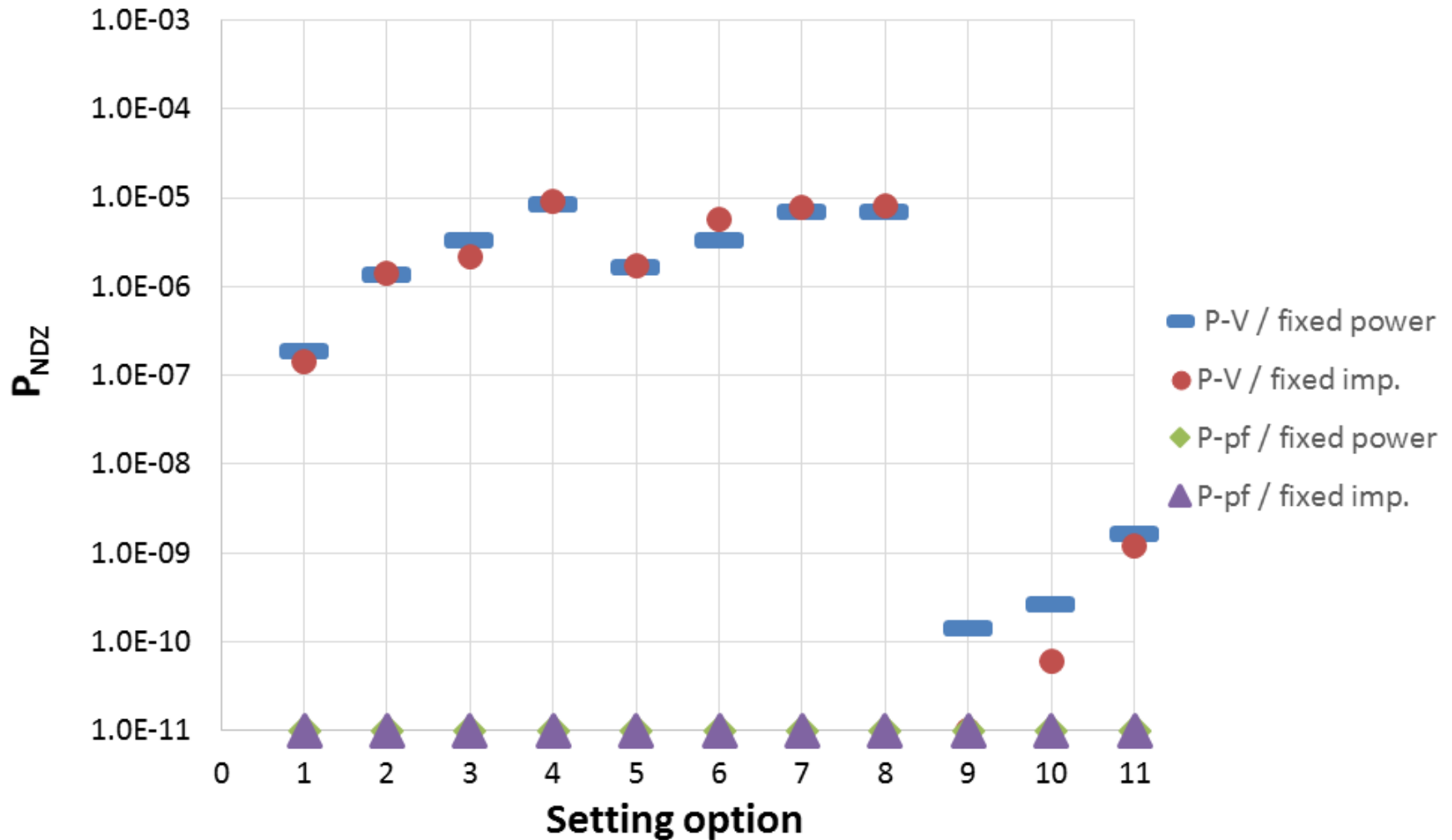

P_{LOM} (Load Case 8) – ROCOF only

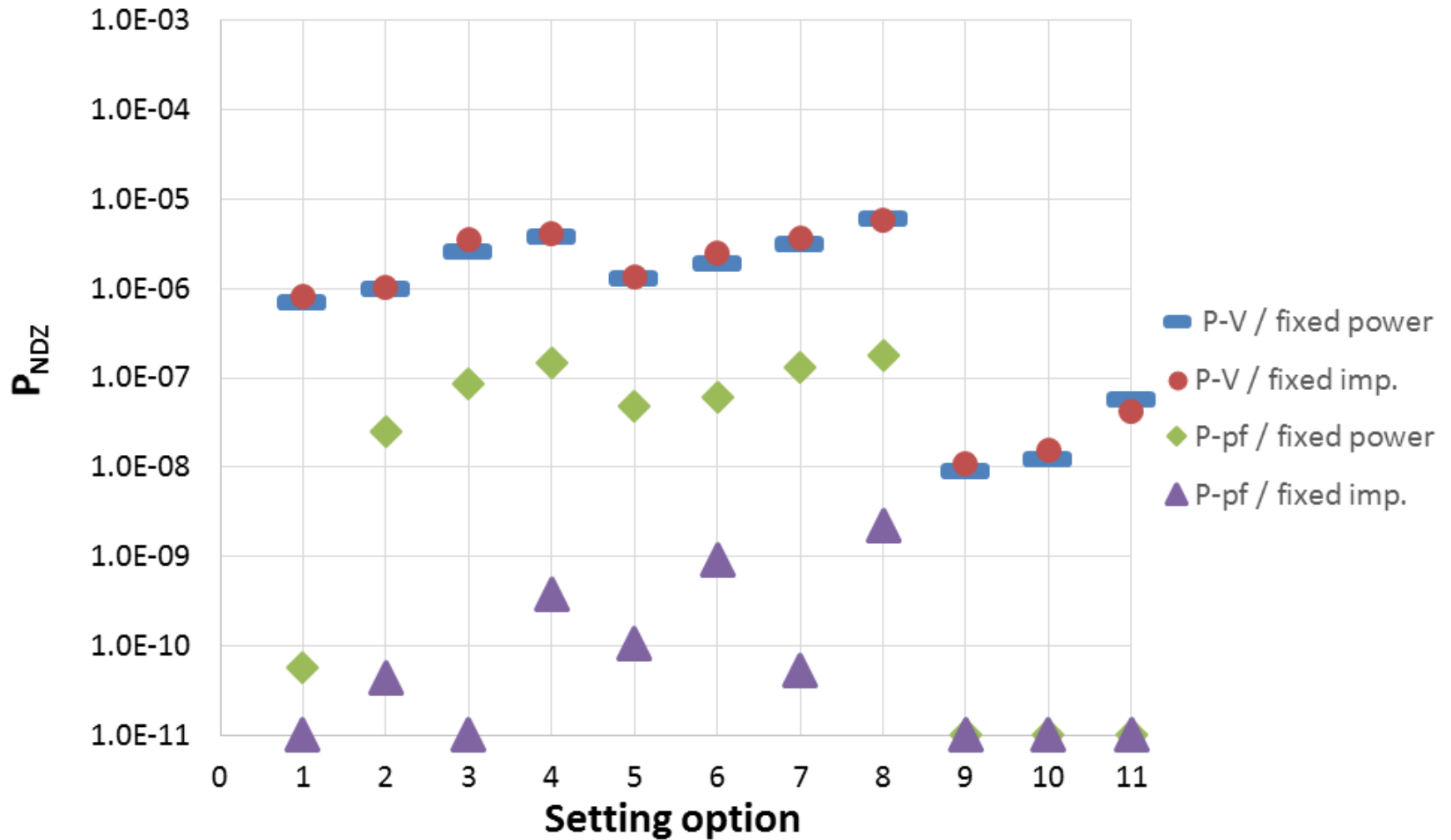

Sensitivity of the result to sampling rate (Load case 8)

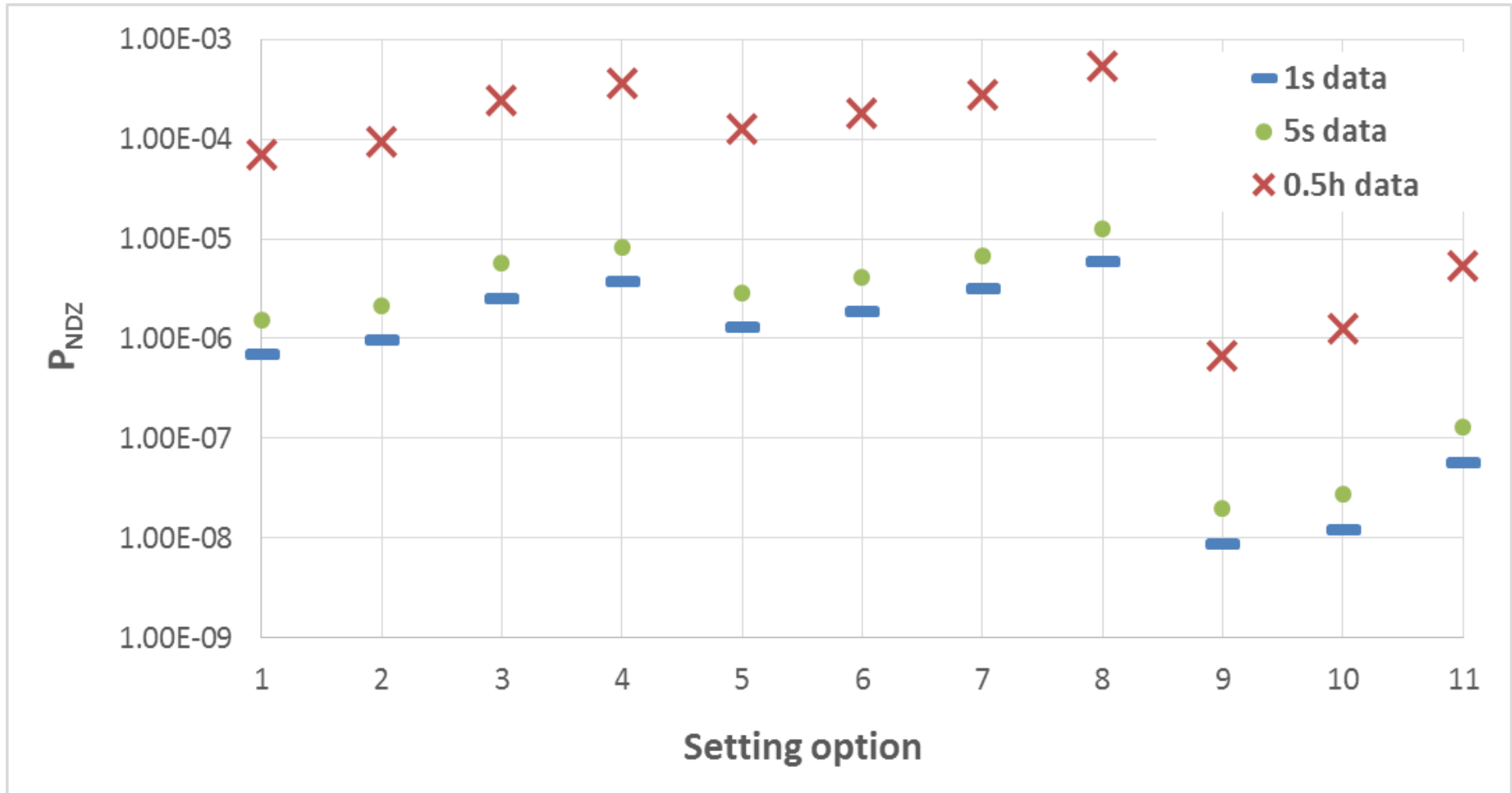

Results with all DG protection enabled

P_{LOM} (Load Case 2) – ROCOF only

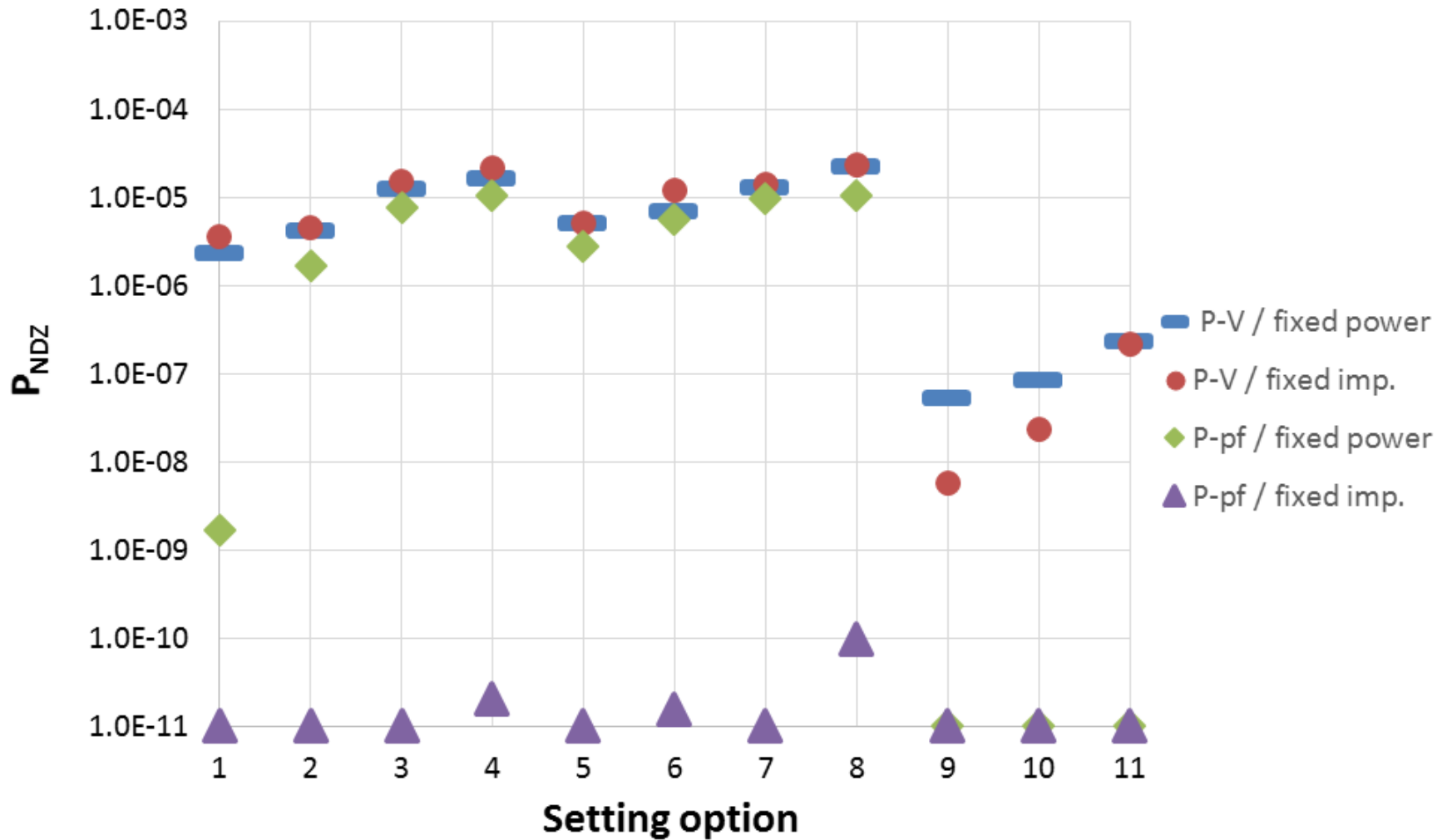

P_{LOM} (Load Case 2) – all DG protection

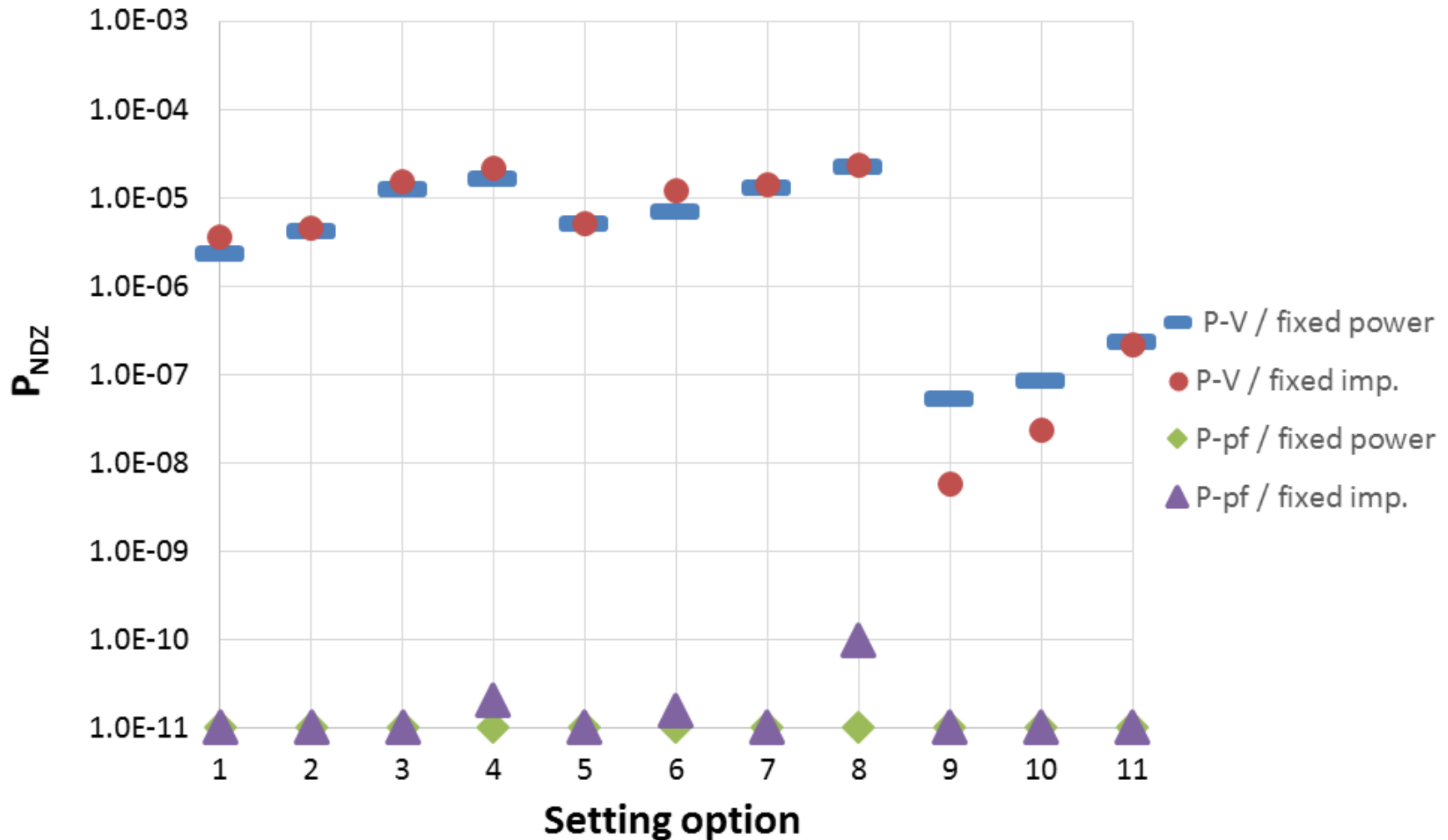

P_{LOM} (Load Case 7) – ROCOF only

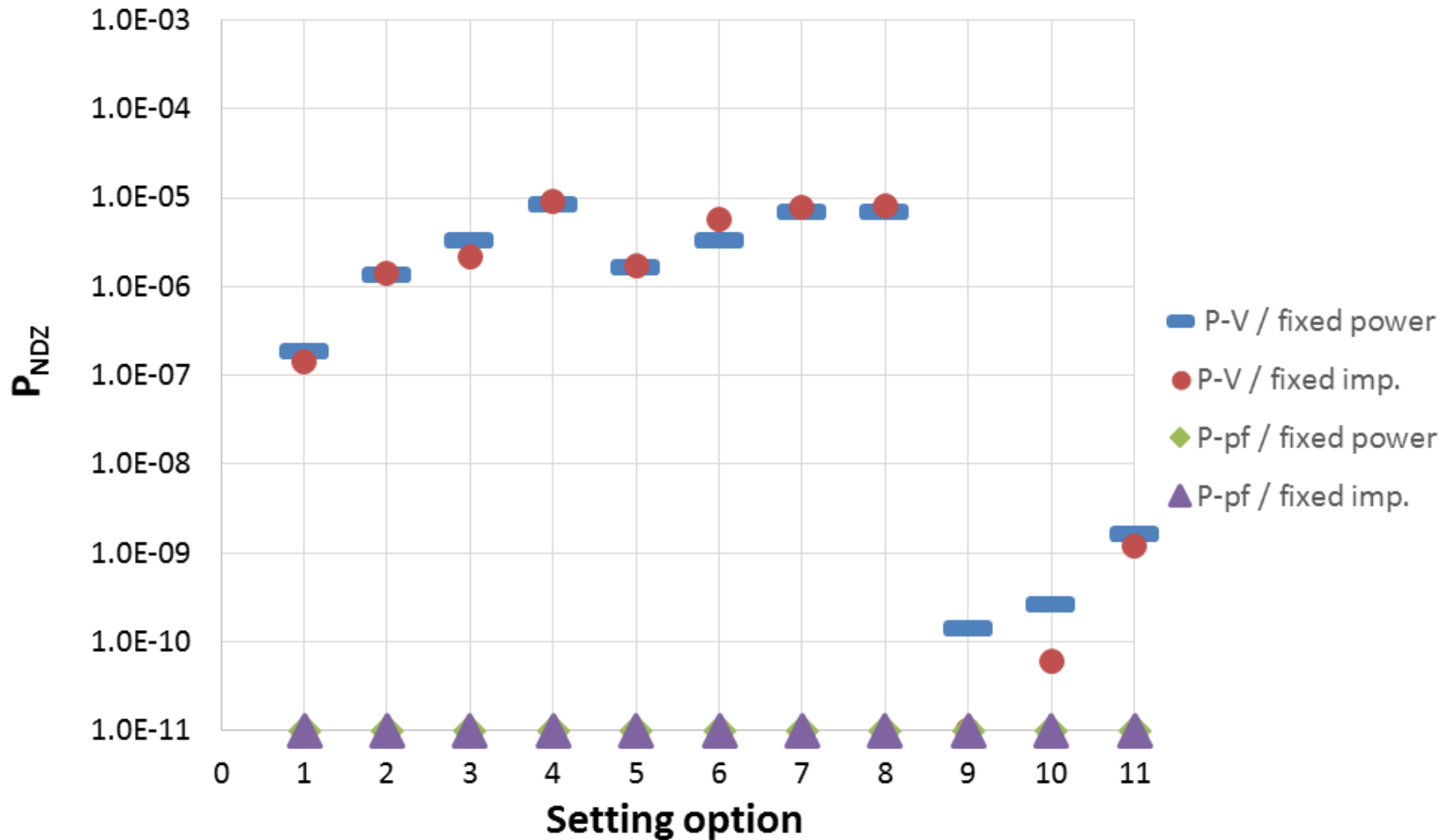

P_{LOM} (Load Case 7) – all DG protection

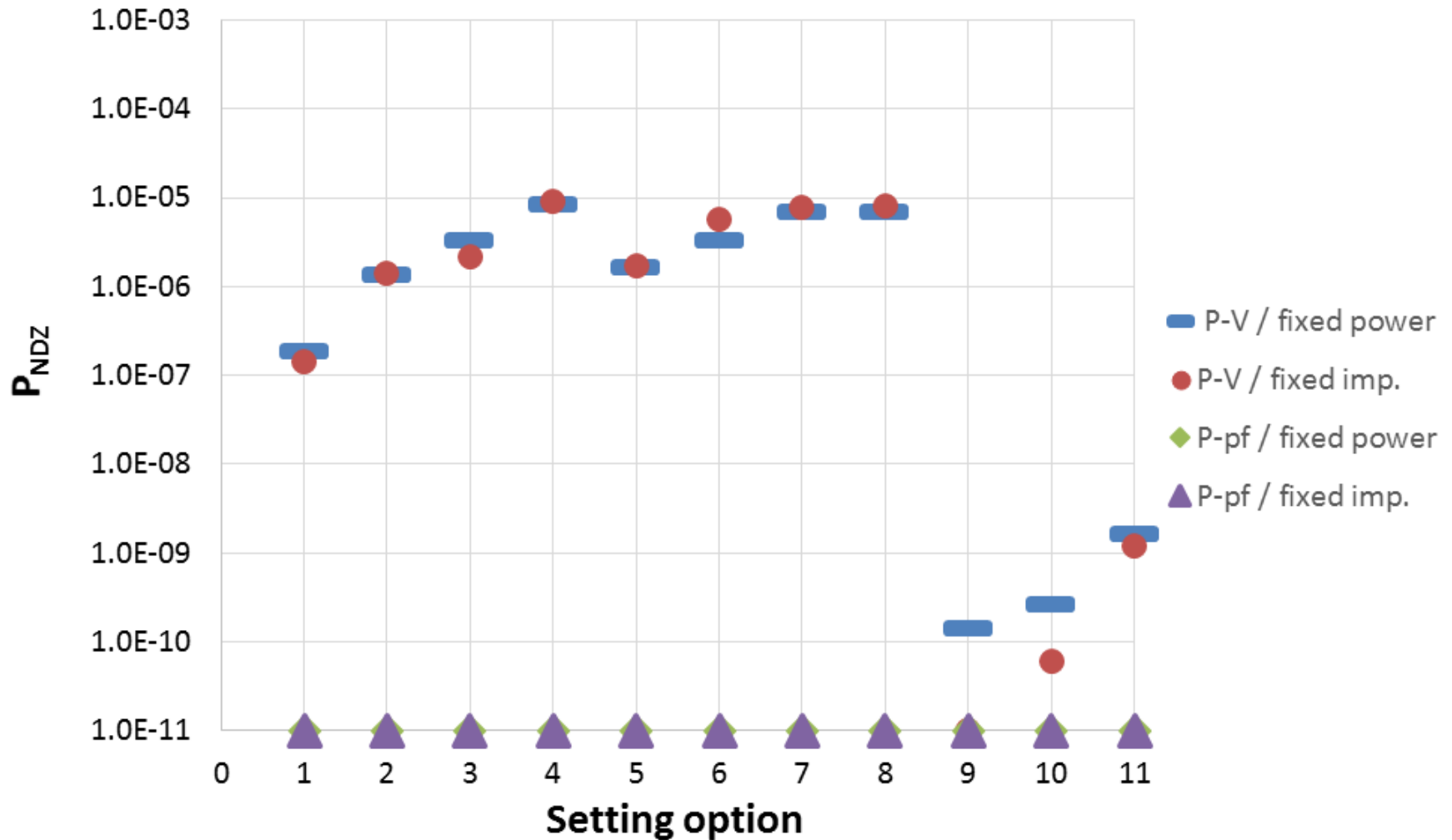

P_{LOM} (Load Case 8) – ROCOF only

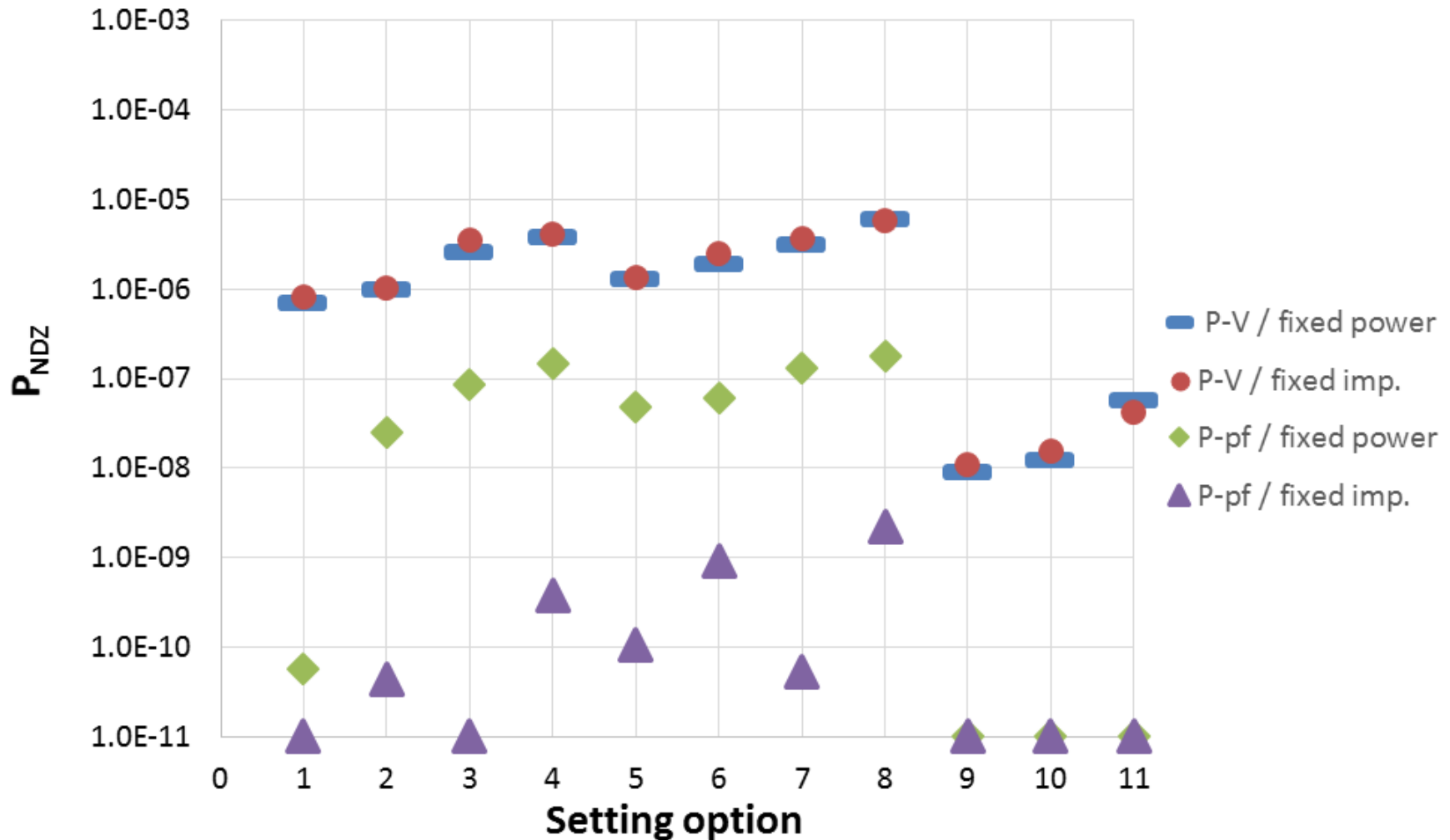

P_{LOM} (Load Case 8) – all DG protection

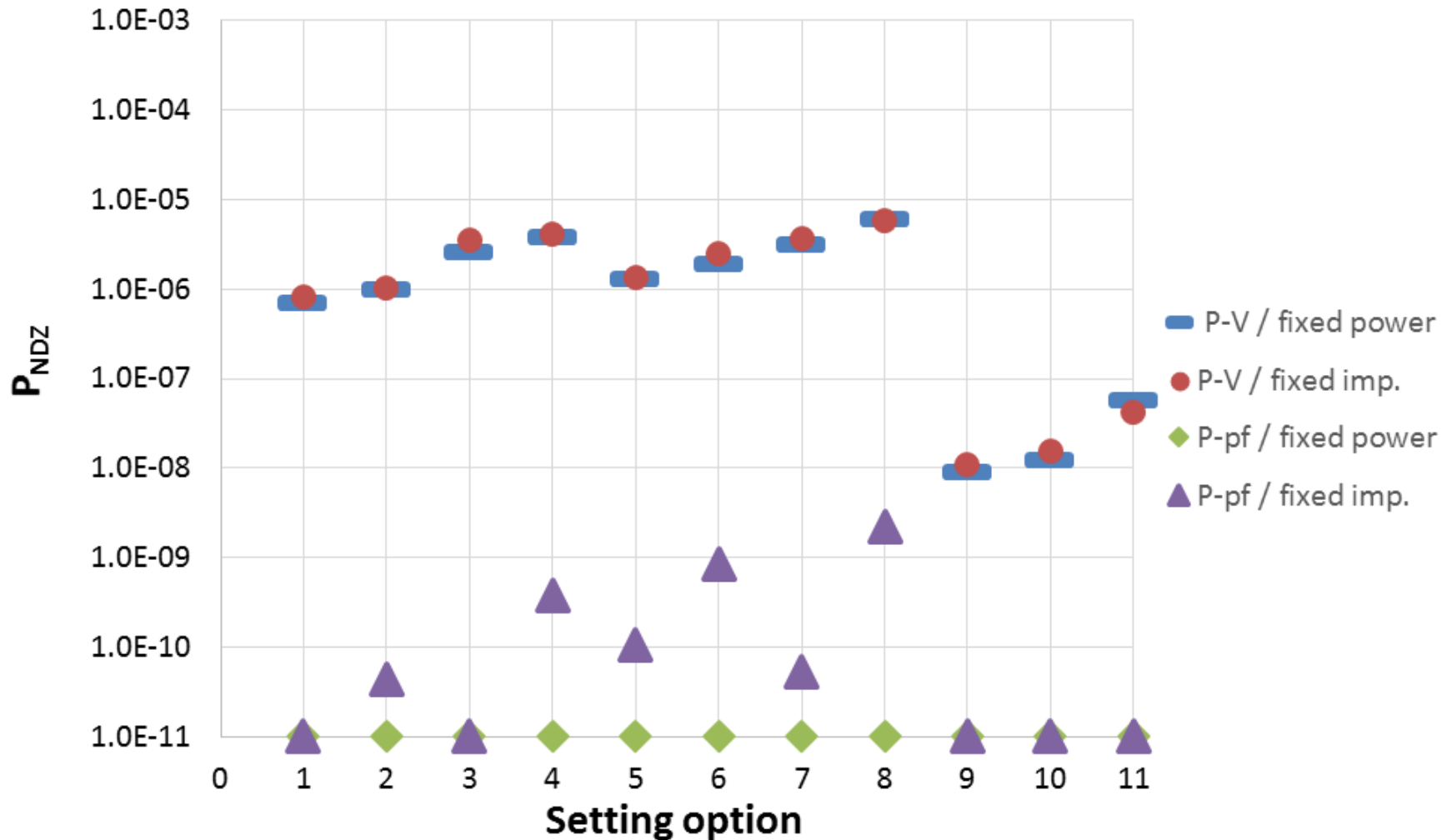

Worst case results (based on load cases 2, 7 and 8)



- Individual risk

$$IR = P_{LOM} \cdot P_{PER}$$

where P_{PER} is the probability of a person in close proximity to an undetected islanded part of the system being killed ($P_{PER} = 10^{-2}$ was assumed).

- Probability of Out-of-phase Auto-reclosing

$$OA = P_{LOM} \cdot P_{AR}$$

where P_{AR} is the probability of out-of-phase auto-reclosing action following a disconnection of a circuit ($P_{AR} = 0.8$ was assumed).

Worst case results (based on load cases 2, 7 and 8)

Setting Option	ROCOF [Hz/s]	Time Delay [s]	Dead Band applied	P_{LOM}	IR	OA
1	0.5	0	No	3.53E-06	3.53E-08	2.83E-06
2	0.5	0.5	No	4.42E-06	4.42E-08	3.53E-06
3	1	0	No	1.50E-05	1.50E-07	1.20E-05
4	1	0.5	No	2.18E-05	2.18E-07	1.74E-05
5	0.5	0	Yes	5.08E-06	5.08E-08	4.07E-06
6	0.5	0.5	Yes	1.22E-05	1.22E-07	9.73E-06
7	1	0	Yes	1.40E-05	1.40E-07	1.12E-05
8	1	0.5	Yes	2.33E-05	2.33E-07	1.87E-05
9	0.12	0	No	5.24E-08	5.24E-10	4.19E-08
10	0.13	0	No	8.12E-08	8.12E-10	6.50E-08
11	0.2	0	No	2.26E-07	2.26E-09	1.81E-07

What level of risk can be accepted?

Health and Safety at Work Act 1974

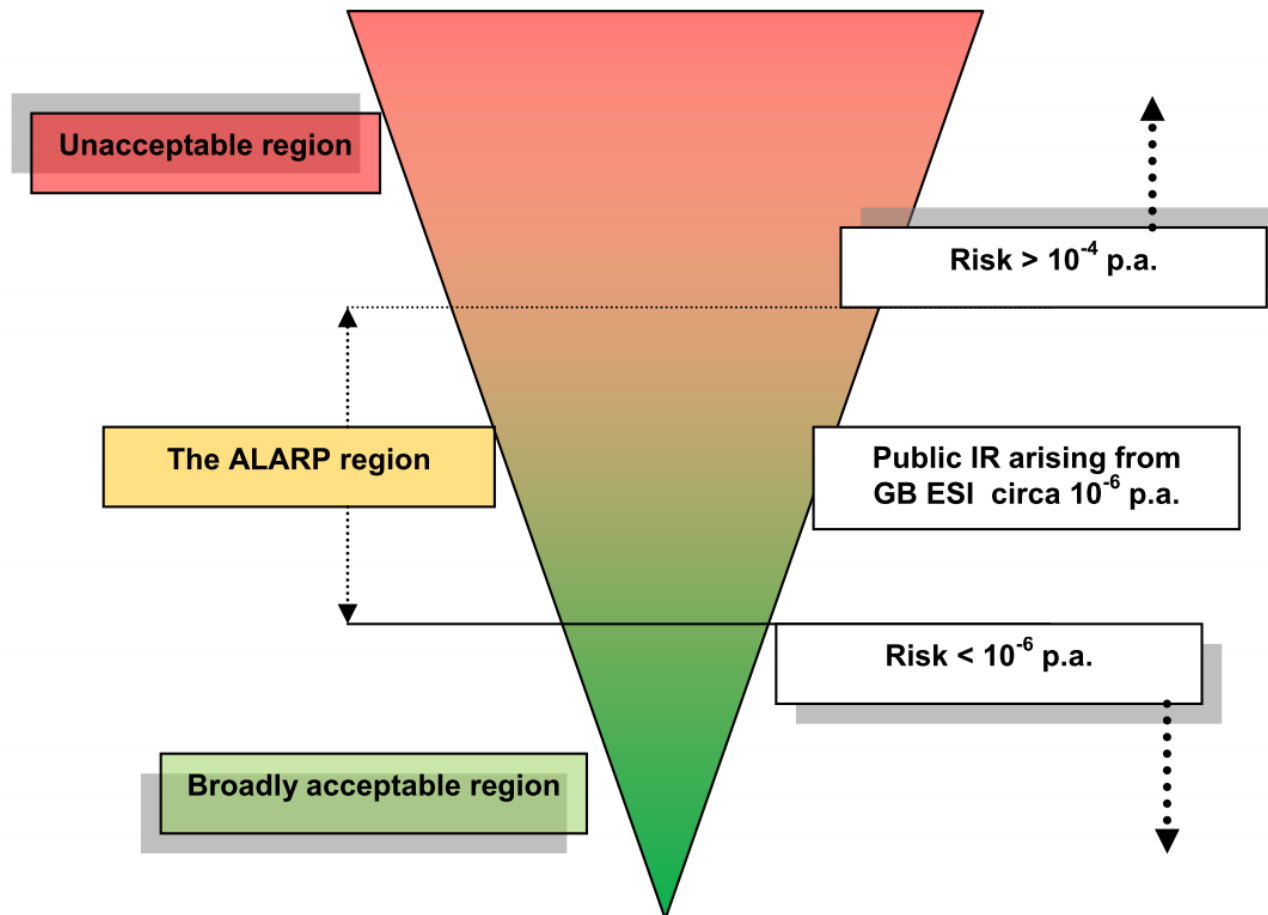

Conclusions (1/2)



- The generator control strategy has a fundamental impact on its ability to sustain islanded operation
- The probability of sustained islanded operation is highly unlikely with any protection settings, when the existing prevailing control strategy based on fixed real power output and unity pf is applied
- There is a significant difference in the probability of undetected islanded operation under the existing recommended ROCOF settings and all proposed setting options (between 1 and 5 orders of magnitude)
- There are significant differences between the proposed setting options but less pronounced than those between the existing G59/2 and the new setting options

Conclusions (2/2)

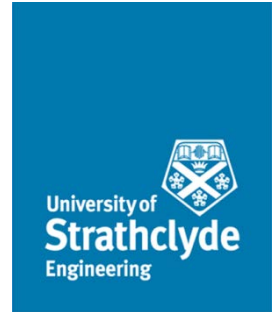

- Individual Risk based on the worst case results lies in the broadly acceptable region for all setting options
- Risk of out of phase auto-reclosing lies mainly in the broadly acceptable region except for the setting option with ROCOF = 1Hz/s.
- Future risk levels should rise proportionally to the increase of DG connection numbers.