

Stage 03: Report to the Authority

National Electricity Transmission System Security and Quality of Supply Standards (NETS SQSS)

GSR016: Small and Medium Embedded Generation Assumptions

01	Workgroup Report
02	Industry Consultation
03	Report to the Authority

This proposal seeks to modify the NETS SQSS to ensure that the embedded small and medium power stations are adequately represented in transmission network planning studies such that the system is reinforced to the right level and that the operational criteria of the NETS SQSS can be met.

This report is submitted to the Authority to assist in its decision in relation to the implementation of the NETS SQSS Modification proposed.

Published on: 28 February 2018



The Workgroup recommends:

Implementation of the modifications proposed to the NETS SQSS



High Impact:

None identified



Medium Impact:

Transmission Licensees
Generators



Low Impact:

Networks Operators

Contents

1. Executive Summary	3
2. Purpose & Scope of Workgroup	6
3. Why Change?	8
4. Workgroup Discussions	12
5. Impact & Assessment	39
6. Workgroup Recommendations	42
7. Consultation Responses	43
Annex 1 – Terms of Reference	45
Annex 2 – Proposed Legal Text for the NETS SQSS	49
Annex 3 – Statements of Support	53



Any Questions?

Contact:

Tingyan Guo

Code Administrator



tingyan.guo@nationalgrid.com



019 2665 4290

Proposer:

Xiaoyao Zhou

National Grid



xiaoyao.zhou@nationalgrid.com



019 2665 4846

About this Document

This report outlines the information required for interested parties to form an understanding of how embedded Small and Medium Power Stations are treated in the NETS SQSS and the concerns arising from this treatment, the proposals to modify the NETS SQSS to address these concerns, how Transmission System Users might be affected by the proposal, and the feedback received on the proposals through an industry consultation.

This report is intended to provide the Authority with the information necessary to inform their decision on the implementation of the modifications proposed.

The revisions to the NETS SQSS proposed by National Grid and sent to the Authority require approval by that body and will, if approved, come into force from such date (or dates) of which Authorised Electricity Operators will be notified by National Grid, in accordance with the Authority's approval.

Document Control

Version	Date	Author	Change Reference
1.0	28/02/2018	Bieshoy Awad	Final Report submitted to the Authority

GSR016

Report to the Authority

28/02/2018

Version 1.0

Page 2 of 57

1. Executive Summary

- 1.1 The GSR016 Workgroup was formed to investigate how to ensure that embedded Small Power Stations and embedded Medium Power Stations are adequately represented in investment planning studies when assessing compliance against Section 2 and Section 4 criteria of the NETS SQSS.
- 1.2 The Workgroup was also tasked to investigate whether there is a need to modify the NETS SQSS to ensure that the National Electricity Transmission System is developed in a manner that allows the operational criteria of Section 5 of the NETS SQSS to be met at all times even with an increasing generation capacity that is not active in the Balancing Mechanism.

Modelling of embedded Small and Medium Power Stations in Investment Planning Studies

- 1.3 The Workgroup identified that some of the existing criteria of the NETS SQSS allow for adequate and consistent representation of embedded Small Power Stations and embedded Medium Power Stations in investment planning studies. These criteria are:
 - 1.3.1 Limits to Loss of Power Infeed Risks – clauses 2.5 to 2.7;
 - 1.3.2 Generation Connection Capacity Requirements – clauses 2.8 to 2.13; and
 - 1.3.3 Minimum Transmission Capacity Requirements Under conditions in the course of a year of operation – clauses 4.7 to 4.10.

On the other hand, other criteria require separate, and potentially inconsistent, treatment of embedded Small Power Stations and embedded Medium Power Stations. These criteria are:

- 1.3.4 Minimum Transmission Capacity Requirements at ACS peak demand with an intact system – clauses 4.4 to 4.6.
- 1.4 This potential inconsistent treatment under clauses 4.4 to 4.6 arise from the generation despatch rules. Appendix C and Appendix E of the NETS SQSS stipulate specific despatch rules for transmission connected Power Stations and embedded Large Power Stations at the ACS Peak Demand conditions. On the other hand, there are no specific rules to estimate contributions of embedded Small Power Stations and embedded Medium Power Stations to the gross demand at the time of the ACS Peak Demand. This resulted in different Transmission Licensees and Distribution Network Operators using different methodologies in their calculations. Some of these methodologies have been reviewed in this report.
- 1.5 There are various risks that could increase due to this inconsistent treatment of generation. The transmission system could be reinforced to a level that is neither economic nor efficient; network constraints could unduly prevent embedded Small and Medium Power Stations from contributing to demand security; and the fixed despatch levels could force transmission connected generation to be despatched at an unrealistic level in the long term planning studies.
- 1.6 In order to ensure the consistent modelling of embedded Small and Medium Power Stations, the Workgroup proposed to:

- 1.6.1 modify the definition of the ACS Peak Demand such that it refers to the gross demand;
- 1.6.2 modify the definition of the Plant Margin, Economy Planned Transfer Conditions, and Planned Transfer Conditions, and Security Planned Transfer Conditions such that they no longer excluded embedded Small Power Stations and embedded Medium Power Station; and
- 1.6.3 revise Appendix C, Appendix D, and Appendix E to remove any exclusions to embedded Small Power Stations and embedded Medium Power Stations.

The legal text of the NETS SQSS with all the Modifications proposed is shown in Annex 2.

- 1.7 In order to achieve the full benefit of this NETS SQSS Modification, it will be necessary to ensure that the data submitted by Distribution Network Operators, and the System Operator as a part of the Standard Planning Data (Week 24 submissions) and Connection Applications (Statement of Works); and the data exchanged between the System Operator and Transmission Owners as a part of the Future Energy Scenarios and Construction Planning Assumptions would need to include demand data related to the gross demand and generation data for all embedded Power Stations.
- 1.8 This would require a change to the Grid Code to require that
 - 1.8.1 the Standard Planning Data (Week 24 submissions) include embedded generation data, potentially in an aggregated format, for generation with capacity below the 1MW threshold that is currently defined in the Grid Code;
 - 1.8.2 include additional demand data and embedded generation contribution data corresponding to the time of the national peak gross demand, the Grid Supply Point peak gross demand, and the national minimum gross demand; and;
 - 1.8.3 require Users to provide the additional data so that the System Operator can estimate the times of the national peak gross demand and the national minimum gross demand.
- 1.9 It is expected that the process of changing the Grid Code could run over a period ranging from 6 months to 2 years. During this period, and in order to reduce the risks arising from the inconsistent treatment of embedded Small and Medium Power Stations, the Workgroup proposes that, where it necessary to use Week 24 submissions, Transmission Licensees should make the best use of the data that is currently available.
- 1.10 Although the absence of this data would not result in any non-compliance, it is intended that this should only be an interim solution as the provision of the additional data would improve the consistency of the Future Energy Scenarios and would reduce any approximation errors introduced in any other process where Week 24 submissions are utilised. However, any change to the Grid Code would be subject to Grid Code governance. A Grid Code Workgroup would probably need to be established to assess the benefits of having this additional data compared to applying the interim solution on an enduring basis outweighed any additional DNO costs of providing the additional data.

Ensuring that Operational Criteria Can Be Met

- 1.11 In relation to the operability challenges that arise due to the increased capacity of generation that is not active in the Balancing Mechanism, the view of the Workgroup is that the NETS SQSS currently requires Transmission Owners together with the

System Operator to develop and maintain a transmission system that is capable of meeting the operational criteria for all conditions that can be reasonably expected to arise during a year of operation. This includes scenarios with high output of generation that is not active in the Balancing Mechanism during periods of low demand, typical maintenance outages, and foreseen construction outages.

- 1.12 It is expected that Transmission Owners, when assessing connections of new Power Stations, whether directly connected or embedded, will work with the System Operator to identify these operability risks and the measures required to mitigate them. These measures will need to be implemented ahead of the connection of the affected Power Station. The cost of implementing any operational measures would need to be taken into account whilst assessing the potential of deferring any investment. It is currently not clear how some of these measures would be funded.
- 1.13 In order to ensure that the operability challenges that arise from the increased capacity of generation that is not active in the Balancing Mechanism are identified, the System Operator will need to ensure that the Construction Planning Assumptions
 - 1.13.1 highlight whether a Power Station is active in the Balancing Mechanism or not; and
 - 1.13.2 show any operational arrangements that are planned to manage these Power Stations.

The steps required to achieve this will need to be agreed via the STC's Joint Planning Committee.

A Housekeeping Change

- 1.14 The Workgroup proposed a housekeeping Modification to correct the references in Paragraphs 2.13, 2.15, 2.17, and 2.18 of the NETS SQSS and in the definition of Fault Outage

The Industry Consultation

- 1.15 The NETS SQSS Review Panel approved the report submitted by the Workgroup. The NETS SQSS Review Panel recommended that the report is issued for a combined industry consultation on the changes proposed to the NETS SQSS.
- 1.16 An Industry Consultation was published on 5 December 2017 for 20 business days. No responses were received.
- 1.17 Statements of supports were submitted by ScottishPower Transmission and Scottish Hydro Electricity Transmission. These Statements are enclosed in Annex 3.

Recommendation

- 1.18 Based on the findings of the Workgroup and the statements of support received from affected parties, National Grid recommends that the NETS SQSS is changed to include the modifications proposed by the Workgroup and detailed in Annex 2 of this report.

2. Purpose & Scope of Workgroup

- 2.1 A NETS SQSS Modification Proposal was raised at the July 2013 NETS SQSS Review Panel Meeting in relation to the treatment of Embedded Small Power Stations and Embedded Medium Power Stations under Section 4 of the NETS SQSS.
- 2.2 The NETS SQSS Review Panel recommended the formation of a Small and Medium Embedded Workgroup. The Workgroup was tasked to review the extent to which small and medium embedded power stations are modelled in the economy planned transfer conditions.
- 2.3 Another NETS SQSS Modification Proposal was then raised at the 7th October 2015 NETS SQSS Review Panel Meeting requesting a comprehensive review of both the Security and Economy Background Assumptions under Section 4 of the NETS SQSS.
- 2.4 Due to the interactivity between the two Modification Proposals, the NETS SQSS revised the scope of the GSR016 Workgroup in order to ensure that each Workgroup stands on its own and that the conclusion from one Workgroup would not be impacted by the recommendation of the other.
- 2.5 The revised scope of the GSR016 Workgroup was specified to look at how different generation backgrounds required to be considered under Section 2 and Section 4 and how these need to be modified to take into account that
- 2.5.1 a significant percentage of the generation fleet is now made of Embedded Small Power Stations and Embedded Medium Power Stations; and that
- 2.5.2 a significant percentage of the generation are no longer available to the System Operator to manage via the Balancing Mechanism.

This revised scope of GSR016 Workgroup and the demarcation between this Workgroup and other Workgroups is summarised in **Figure 1**.

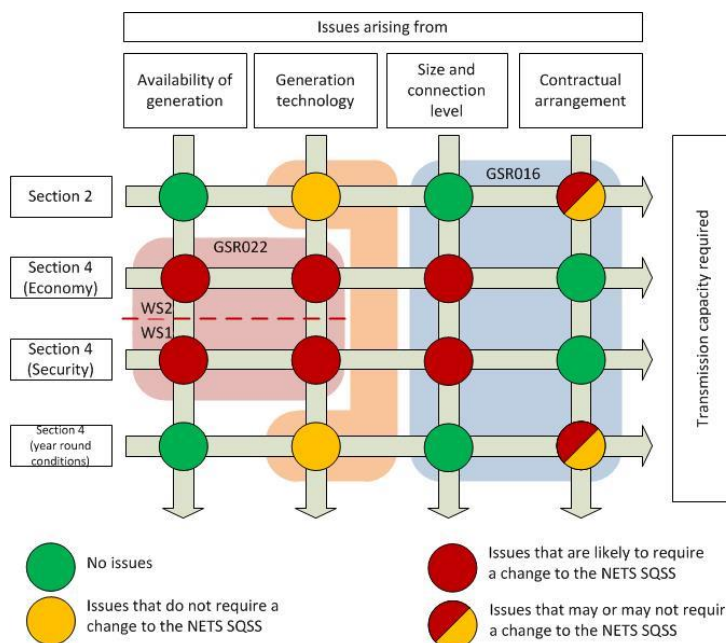

Figure 1: Issues and interactions when applying NETS SQSS due to increasing level of small and medium EG

- 2.6 The Workgroup was tasked to report on the following points:
- 2.6.1 the extent to which embedded generation is currently taken into account in NETS SQSS Section 2 and Section 4 studies;
 - 2.6.2 the risks arising from this approach;
 - 2.6.3 potential Modifications to NETS SQSS Section 2 and Section 4, including the relevant appendices and definitions, to ensure that all generation is adequately accounted for;
 - 2.6.4 potential risks of non-compliance with Post Fault Criteria in NETS SQSS Sections 2 and 4 in general and Clauses 2.12 and 4.9 of the NETS SQSS in particular due to the System Operator's restricted ability to constrain some embedded generation;
 - 2.6.5 general outline for the scenarios that need to be studied to identify such risks;
 - 2.6.6 potential solutions, including transmission reinforcements and operational measures, that can be implemented to mitigate these risks;
 - 2.6.7 criteria to determine the preferred solution;
 - 2.6.8 where necessary, proposals to modify the NETS SQSS to allow the scenarios outlined to be studied and the solutions identified to be implemented;
 - 2.6.9 opportunities for achieving some benefits from any Modifications to the NETS SQSS that the Workgroup proposes using the datasets that are currently being exchanged between DNOs, the SO, and the TOs; and
 - 2.6.10 the changes to these datasets that would be necessary to exploit the full benefit if the Modifications proposed were to be implemented in full.

Terms of Reference

- 2.7 A copy of the final Terms of Reference is included in Annex 1.

Timescales

- 2.8 It was agreed that this Workgroup would report back to the June 2017 NETS SQSS Review Panel.
- 2.9 Verbal updates on the progress of this Workgroup have been provided at the NETS SQSS Review Panel Meetings.

3. Why Change?



Background

- 3.1 The NETS SQSS classifies power stations based on their capacity into three categories. These categories are Large Power Stations, Medium Power Stations, and Small Power Stations. This classification is illustrated in Table 1 for the various transmission areas on the National Electricity Transmission System.

Table 1. Classification of Power Stations based on their Registered Capacity.

Area	Large Power Station	Medium Power Station	Small Power Station
NGET	$\geq 100\text{MW}$	$< 100\text{MW}$ and $\geq 50\text{MW}$	$< 50\text{MW}$
SPT	$\geq 30\text{MW}$	Not Applicable	$< 30\text{MW}$
SHET	$\geq 10\text{MW}$	Not Applicable	$< 10\text{MW}$
Offshore	$\geq 10\text{MW}$	Not Applicable	$< 10\text{MW}$

- 3.2 The NETS SQSS also classifies power stations based on their connection level into two categories. These are directly connected Power Stations, which have a direct connection to the National Electricity Transmission System, and embedded Power Stations, which are connected to a User System (usually a Distribution Network).
- 3.3 Embedded Small Power Stations and embedded Medium Power Stations are not required to be the subject of an agreement between the System Operator (NGET) and the Generator and are not required to participate in the Balancing Mechanism.
- 3.4 On the other hand, transmission connected Power Stations and embedded Large Power Stations are required to be the subject of a Bilateral Agreement between the System Operator (NGET) and the Generator. This Bilateral Agreement could be a Bilateral Connection Agreement (BCA), a Bilateral Embedded Generation Agreement (BEGA), or a Bilateral Embedded License Exemptible Large Power Station Agreement (BELLA). The terms and conditions of these Bilateral Agreements are generally set by the CUSC and they determine whether the Power Station will be active in the Balancing Mechanism or not. This is summarised in Table 2. Generators are required to participate in the Balancing Mechanism if their Power Station(s) are the subject of a BCA or a BEGA. Generators may choose to participate in the Balancing Mechanism if their Power Station(s) are the subject of a BELLA.
- 3.5 The active participation of a Power Station in the Balancing Mechanism provides the System Operator with visibility of what their planned power output would be and with a tool to alter this power output via accepting bids or offers. This visibility and flexibility are essential to allow the System Operator to meet their Licence obligation of directing the flows on the National Electricity Transmission System in accordance with the NETS SQSS.

Table 2. Contractual Arrangements between NGET and Generators.

Connection	Transmission Area	Registered Capacity	Contractual Arrangement	Participation in the Balancing Mechanism
Directly connected Power Station	All areas	Any	BCA	Mandatory
	All areas	$\geq 100\text{MW}$	BEGA	Mandatory
Embedded Power Station	SPT	$< 100\text{MW}$, $\geq 30\text{MW}$	BEGA BELLA	Mandatory Optional
	SHET	$< 100\text{MW}$, $\geq 10\text{MW}$	BEGA BELLA	Mandatory Optional
	NGET	$< 100\text{MW}$, $\geq 50\text{MW}$	Not required	Not required
	All areas	Small Power Station	Not required	Not required

In general, a Generator can request an agreement that is over and above what is normally required by CUSC. For example, an embedded Small Power Station can request a BEGA arrangement. However, these are very limited individual cases

- 3.6 In the recent years, the nature of the generation fleet in GB has seen a significant

Timeline

Workgroup Meeting

Dates

- M1- 12 November 2013
- M2- 28 November 2013
- M3- 21 January 2014
- M4- 04 February 2014
- M5- 14 April 2014
- M6- 10 September 2014
- M7- 6 June 2016
- M8- 11 January 2017

GSR016

Report to the Authority

28/02/2018

Version 1.0

Page 8 of 57

change. The total capacity of embedded Small and Medium Power Stations has seen a rapid increase. This increase took place at a rate that is higher than originally anticipated. This is illustrated by Figure 2 which shows the generation capacity forecasts for Gone Green Future Energy Scenario 2013 and 2016.

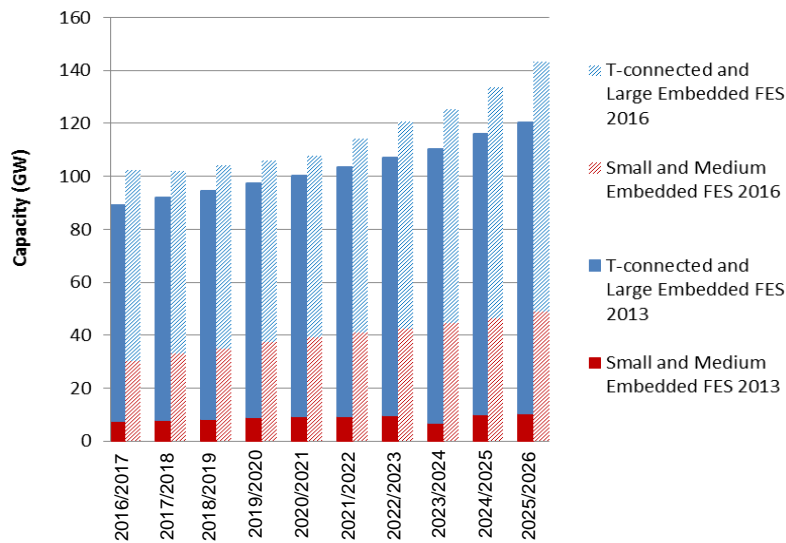

Figure 2: GB electricity supply capacity in different generation types forecasted under Gone Green Scenario according to FES 2013 and FES 2016.

3.7 Due to the increase in the total capacity of embedded Small and Medium Power Stations; and due to the ability of Generators to opt for a BELLA arrangement for their embedded Large Power Stations of capacity less than 100MW in Scotland, there has been a subsequent increase in the total generation capacity that is not active in the Balancing Mechanism. This trend is forecast to continue as illustrated by Figure 3 and Figure 4. This increases the challenges faced by the System Operator in managing the flows across certain boundaries where the majority of generation is not active in the Balancing Mechanism.

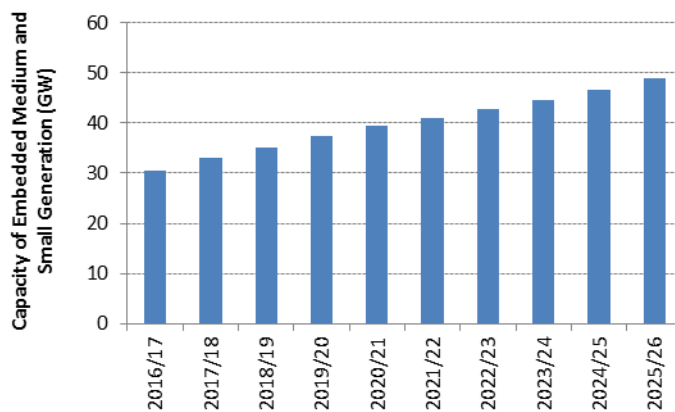

Figure 3: GB Embedded Medium and Small electricity supply capacity in FES 2016 Gone Green Scenario.

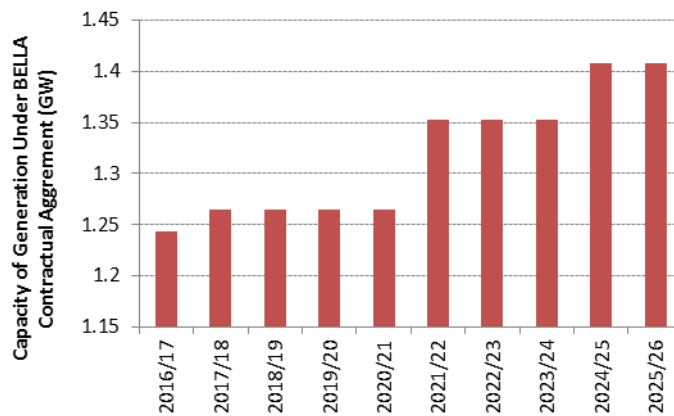

Figure 4: GB electricity supply capacity under BELLA Contractual Arrangement in FES 2016 Gone Green Scenario.

- 3.8 The NETS SQSS was originally written at a time when the total capacity of embedded Small and Medium Power Stations was negligible and, hence, does not include specific rules on how to treat these embedded Small and Medium Power Stations. Therefore, there is a risk that the increased capacity of that generation could be modelled incorrectly in planning studies. This could potentially result in a transmission system that is neither economic nor efficient.
- 3.9 With the continuous erosion of the percentage of generation capacity that is active in the Balancing Mechanism, there is a risk that NGET, in their capacity as the System Operator, will not be able to manage network flows in accordance with Section 5 of the NETS SQSS.
- 3.10 In order to address these two risks, it was necessary to initiate a review of the planning section of the NETS SQSS to ensure that embedded Small and Medium Power Stations are taken correctly into account in design timescales such that
 - 3.10.1 the most economic and efficient level of reinforcements is identified; and
 - 3.10.2 that, where necessary, sufficient operational tools that could be used to manage the output of generation that is not active in the Balancing Mechanism are identified and provided.

Issues for Transmission Licensees

- 3.11 Transmission Licensees are required to develop and maintain an economic and efficient transmission system where the right balance between the costs of any additional investment required to accommodate embedded Small and Medium Power Stations, on one side, and the cost of constraints arising from them connecting to the system on the other side, is attained.
- 3.12 Transmission Licensees are also required to ensure that the system can be operated in a safe and secure manner under prevailing system conditions. This is to ensure that maintenance and construction outages can be permitted and unplanned system outages could be managed without
 - 3.12.1 subjecting personnel and public to any health and safety risks;
 - 3.12.2 subjecting transmission equipment to the risk of damage due to being

stressed beyond its proven capability; or

3.12.3 result in any unnecessary loss of supply capacity.

3.13 In order to achieve this, it is necessary that the NETS SQSS provides

3.13.1 a consistent methodology of modelling all generation on the whole system that takes into account the operational regimes of this generation irrespective of its size (Small and Medium Power Stations versus Large Power Stations) or connection level (Power Stations that are directly connected to the transmission system versus Power Stations that are embedded within a User's System); and

3.13.2 the flexibility that allows the identification of any operational arrangements that are required to mitigate the operability risks arising from the reduced active participation in the Balancing Mechanism.

3.14 It will also be necessary to ensure that the data exchange processes between Generators, Distribution Network Operators, the System Operator and Transmission Owners provide sufficient details to Transmission Licensees to be able to model embedded Small and Medium Power stations adequately.

Issues for Distribution Network Operators

3.15 Distribution Network Operators aim to facilitate the connection of embedded Power Stations to their system whilst ensuring that this connection does not reduce the security of supply at their Grid Supply Points below acceptable levels, e.g. due to the System Operator having to disconnect an entire exporting Grid Supply Point in order to ensure the integrity of the Transmission System.

3.16 In order to achieve this, DNOs would seek to

3.16.1 assist Transmission Licensees in the efficient planning and operation of the transmission system;

3.16.2 understand any additional data that Transmission Licensees reasonably require to achieve the above, whilst minimising any changes from the present arrangements; and

3.16.3 work towards harmonising the approaches regarding planning and operating the total system across the Transmission/Distribution boundary.

4. Workgroup Discussions

- 4.1 The first Workgroup meeting was held on 12 November 2013. The Workgroup met 8 times over the period between 12 November 2013 and 11 January 2017.
- 4.2 The following issues were discussed by the Workgroup:

Embedded Small and Medium Power Stations within the NETS SQSS – Current Practice

- 4.3 This section only relates to the provision of transmission capacity rather than the ability to operate the system.

Section 2:

- 4.4 For the Loss of Power Infeed Risk criterion, the sum of the registered capacities of all Generating Units disconnected from the system is used to calculate the loss of power infeed resulting from a secured event on the onshore transmission system. Hence, the same rules that are used for directly connected Power Stations and embedded Large Power Stations are used for embedded Small and Medium Power Stations.
- 4.5 For Generation Connection Capacity criterion, the background conditions require the Power Station under consideration is set to operate at its registered capacity irrespective of whether it is embedded or transmission connected and irrespective of whether it is a Small, a Medium or a Large Power Station. Other Power Stations, irrespective of their size or connection level, are set to what ought to be reasonably expected. Hence, the same modelling rules are applied on all power stations.
- 4.6 Therefore there is no discrepancy between embedded Small and Medium Power Stations and other power stations that could arise under Section 2.

Section 4:

- 4.7 In the design of the Main Interconnected Transmission System (MITS), for the minimum transmission capacity requirements under “conditions in the course of a year of operation,” the background conditions and the criteria that the MITS shall meet apply to any Power Station. This should not result in any discrepancy between the treatment of embedded Small and Medium Power Stations and other power stations.
- 4.8 For the “minimum transmission capacity requirements at ACS peak demand with an intact system under both the Security and Economy background conditions,” the ACS Peak Demand is defined as the peak net Transmission System demand. That is equal to the underlying (gross) demand minus contribution from Embedded Small and Medium Power Stations, as shown in Fig 5. Therefore, the contribution of embedded Small and Medium Power Stations would be exactly the same for both the security and the economy planned transfer conditions, and would be generally different to that of transmission connected Power Stations of the same technology, and capacity.
- 4.9 In addition, the method used to calculate the contributions of embedded Small and Medium Power Stations is not defined. Hence, there could be some discrepancies between method applied by various DNOs when preparing their Standard Planning Data submissions for Week 24 and that applied by NGET when preparing the Future Energy Scenarios.

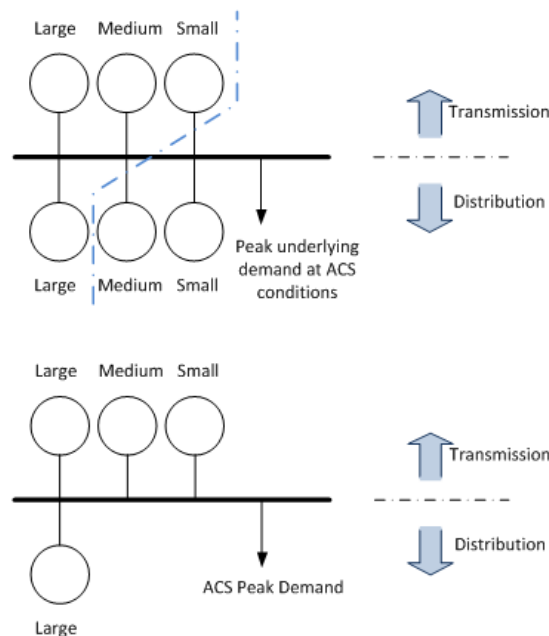

Figure 5. Definition of ACS Peak demand: the peak underlying demand at ACS conditions minus contribution from embedded Small and Medium Power Stations.

Risks Arising from The Discrepancy Identified

Simplified Case Study

- 4.10 The Workgroup investigated the risks arising from the above approach to define ACS Peak Demand. A simple example was given to show the discrepancy that could arise due to the way the SQSS is worded. Although the issue is relevant to wider system boundary, only a small group of power plants is considered here for simplicity. As shown in Fig 6, an 180MW wind farm is connected to the transmission network at the Grid Supply Point (GSP) and the peak underlying demand at ACS condition at the GSP is 100 MW. Two 90 MW wind farms are embedded at the distribution network in Fig. 6 (a) whilst directly connected to the transmission network in Fig. 6 (b).
- 4.11 The Planned Transfer under both the economy background and the security background assumptions for the two systems in Figure 6 are shown in Table 3 with three different assumptions on the output of embedded wind.
- 4.12 The figures in Table 3 illustrate that, under the current practice, the same power station could be treated in many different ways based on whether it is connected directly to the transmission system or embedded within a specific distribution system. This could result in boundaries being reinforced to a requirement that is either a lot higher or a lot lower than the optimal capacity, and therefore over investment on certain boundaries or excessive constraints costs on other boundaries, or demand not being met because of restrictions on the transmission system.
- 4.13 The level of risk would vary depending on the size of the group under consideration. For a small group of power stations, similar to the example, the reinforcements triggered by Section 2 and Section 3 criteria would usually exceed that triggered by Section 4 criteria. Hence this would mitigate the risks arising from the inconsistent modelling of embedded Small and Medium Power Stations under Section 4.

However, for large system boundaries, with reinforcements triggered by Section 4 exceeding that triggered by Section 2 and Section 3, the risk will be high.

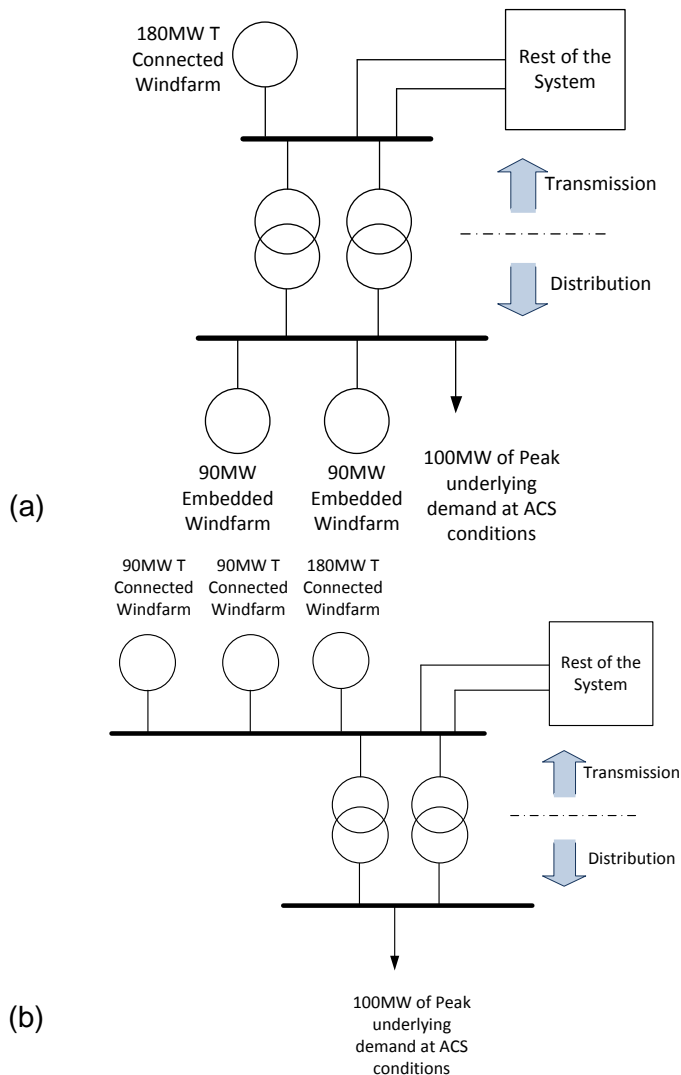

Figure 6. A small group of power stations connected at different levels of a GSP. (a) Medium generation embedded at distribution level; (b) Medium generation directly connected at transmission level.

Table 3: Impact of assumptions made on the output of embedded windfarms for the system shown in Figure 6.

System Shown in		Fig. 6 (a)		Fig. 6 (b)
underlying demand at the time of the ACS Peak Demand	100MW			100MW
Assumed contribution from embedded wind	15MW x 2	30MW x 2	45MW x 2	N/A
ACS Peak demand	70MW	40MW	10MW	100MW
Security background				
Contribution of Transmission connected wind (0%)	0MW			0MW
Planned Transfer (Importing)	70MW	40MW	10MW	100MW
Economy background				
Contribution of Transmission connected wind (70%)	126MW			252MW
Planned Transfer (Exporting)	56MW	86MW	116MW	152MW

Risks associated with the restrictions that could affect Capacity Mechanism Units

4.14 The current approach could also cause risks of not having sufficient network capacity to allow the utilisation of some of the Capacity Mechanism Units (CMUs). Table 3 shows the number, total capacity and percentage of total capacity of the CMUs in different range of Power Stations. Up to 6.8 GW of CMUs are Small and Medium Power Stations. Although the data does not show whether these Small and Medium Power Stations are embedded or not, netting off the Embedded Small and Medium Power Stations from the Underlying Demand in long term planning may result in insufficient network capability. As the Capacity Mechanism Auction Clearing Price is £22.5 m / GW / year (2015/16 Prices) and the value of lost load, according to the Capacity Market assumptions, is £6m/GWh, a 1 GW of CMU that is required to run for 1 hour and is sterilised due to a transmission constraint could cost the consumers £28.5m. The probability of such event will be determined by whether there is enough plant margin available at high demand conditions or not and whether there are any CMUs that are behind a constrained boundary or not.

Table 3. Capacity Mechanism Units in different range of Power Stations.

Min MW	Max MW	No.	CMU	
			GW	%
0	10	181	1.06	2.02
10	30	151	2.95	5.64
30	100	59	2.79	5.33
100		92	45.62	87.02

Examples of the Assumptions Made on the Output of Embedded Small and Medium Power Stations

Future Energy Scenarios

4.15 In Future Energy Scenarios (FES), the Net Demand is calculated by netting off 70% and 0% Embedded Wind from the Gross Demand, in Economy and Security background, respectively. Figure 7 shows the gross, economy and security winter peak Gone Green GB demand in FES 2016.

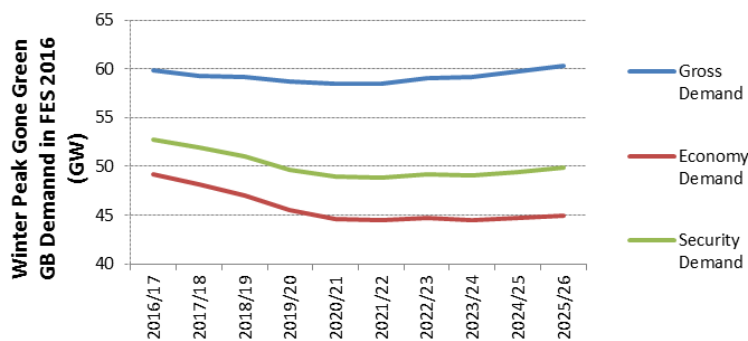

Figure 7. Gross, economy and security winter peak Gone Green GB demand in FES 2016

Electricity Ten Year Statement 2016 – Security background studies

4.16 In general, the Electricity Ten Years Statement (ETYS) would be based on Future Energy Scenarios. However, ETYS2016 assumed that all embedded Small Power Stations in Scotland have zero contribution to demand for the Security Background.

Standard Planning Data Submitted by DNOs at Week 24

- 4.17 For Standard Planning Data Submitted by Distributed Network Operators (DNOs), DNOs provide the net power flow through the Super Grid Transformers and the assumed contribution from embedded Small and Medium Power Stations at the times and dates requested by NGET (e.g. GB peak demand time, GB minimum demand time and the connection point peak demand time, etc.). Neither the Grid Code nor the guidance published by NGET specify a methodology that DNOs have to apply when calculating the forecast of netted off contribution of embedded Small and Medium Power Stations.
- 4.18 In general, the forecast contribution of embedded Small and Medium Power Stations is based on historic data of metered generation output. Some DNOs use the metered values from the previous year whereas others use a long run average. Also, some DNOs would only take into account generation that is already connected to the system whereas others would consider forecast growth in generation connections.

General Comments

- 4.19 The absence of a specific methodology to calculate the contribution of embedded Small and Medium Power Stations allows different parties to make their own assumptions. As these assumptions could differ from one party to another, it is very likely that they would cause some discrepancy in modelling between
- 4.19.1 two power stations of the same size, the same technology, at the same location with one of them connected to the transmission system while the other is embedded in a User's System; and between
 - 4.19.2 two embedded power stations of the same size, the same technology, but connected to two different User's System.

High Level Assumptions

- 4.20 The Workgroup agreed a set of high level assumptions in relation to the methodology of setting the background conditions, the operational regimes of different plants, and the market behaviour. These assumptions aim to limit the interaction with other NETS SQSS Modification Proposals and with existing market arrangements. These assumptions are listed below.

Methodology and background assumptions:

- 4.21 The Workgroup assumed that current methodology and background assumptions produce the most economic transmission solution for transmission connected generation and do not result in erroneous or infeasible assumptions on generation output. The Workgroup recognises that the appropriateness of these assumptions are currently being reviewed by the NETS SQSS GSR022 Workgroup in order to maintain them up to date.

Plant Operational Regimes:

- 4.22 The Workgroup assumed that the operational regime for directly scaled generation, as defined under the economy background, will be the same for the same type of power station irrespective to its size or connection level.
- 4.23 This assumption was made because:
- 4.23.1 it is unlikely that the registered capacity of nuclear stations and coal-fired and gas-fired stations fitted with Carbon Capture and Storage, pumped storage stations, and interconnectors be low enough for them to have an

operational regime that is different to any Large Power Station of the same technology; and

4.23.2 stations powered by wind, wave and tides are driven by the availability of the renewable resource driving them and therefore their operational regime should not be related to their size or connection level;

4.24 It was noted that solar generation is not currently considered under the economy background conditions and that battery storage is treated in a manner similar to pumped storage.

4.25 The Workgroup assumed that the availability factors for different generation types, as defined under the security background, will be exactly the same for the same type of power station irrespective to its size or connection level. This is due to the fact that the stations powered by wind, wave, or tides will operate according to the availability of the resource irrespective of size or connection level; and that Interconnectors of any MW capacity trade in the market using the same set of rules.

4.26 Although the availability factors in the security background and the scaling factors of the economy background could be changed as a result of the NETS SQSS GSR022 Workgroup, the plant operational regimes and also the principles set out in this report are not likely to be affected.

Market Arrangements

4.27 The Workgroup assumed that the energy market will deliver an optimal despatch for all plants including embedded Small and Medium Power Stations. i.e. these plants will only run when these are in merit. This is likely to be true for wind and solar generation as these will always be in merit when the resource is available. It is also likely to be true for the other generation technologies that do not receive Feed-in Tariffs.

4.28 The Workgroup noted an exception when some plants that receive Feed-in Tariffs could operate when they are not in merit. These plants are combined heat and power plants of capacity up to 2kW and anaerobic digestions plants and hydro plants of capacity up to 5MW. An accurate estimate of how much generation would fall into this category is not available as Future Energy Scenarios provide an aggregated number of all generation of the same technology with capacity between 1MW and 99.9MW and because there is no separate category for Anaerobic digestion plants. In England and Wales only, this capacity could be anywhere between 0.5% and 15.2% of the total capacity of embedded Small and Medium Power Stations. However, the most likely level would be around 1%. This suggests that the error introduced by assuming these plants would operate in the market in-line with other plants would be minimal.

4.29 The Workgroup also assumed that at some time in the future there will have to be a mechanism available to National Grid to alter the output of embedded Small and Medium Power Stations in real time to ensure that the system remains balanced at all times. This mechanism will be essential to operate the system in a safe and secure manner once the total capacity of embedded Small and Medium Power stations reaches a certain level.

4.30 It was noted that such mechanism has not been established yet and that some potential issues that arise from the absence of this mechanism has been discussed in later sections.

Achieving Consistency

- 4.31 Based on the high level assumptions discussed in Paragraphs 4.20 to 4.27, it would be necessary to apply consistent despatch rules for all forms of generation irrespective of their size and/or connection level. To achieve this;
- 4.31.1 no change is required to Section 2 since there is no discrepancy between Small and Medium Embedded Power Stations and other power stations that could arise from there; and
 - 4.31.2 no change is required to Section 4 in the section of minimum transmission capacity required under conditions in the course of year operation since there is no discrepancy between Small and Medium Embedded Power Stations and other power stations that could arise from this section. However;
 - 4.31.3 changes are required to be made to Section 4 in both Economy and Security backgrounds, including definitions of ACS Peak Demand, Plant Margin, Economy Planned Transfer Conditions, Planned Transfer and Security Planned Transfer Conditions, and Appendices C, D, and E, from which the discrepancy between Small and Medium Embedded Power Stations and other power stations arises.
- 4.32 The text required to give effect to these changes is contained in Annex 2 of this document.

Impact of the Proposal on the Required Transfer Capability: Economy Background

- 4.33 To show the impact of modelling of embedded Medium and Small Power Stations on ETYS boundaries in Economy background, three case studies were carried out by the Workgroup. The high level descriptions of the three cases are included in **Error! eference source not found..** Case 1E is what has been used in ETYS2016. Case 2E is a variation based on the data submitted by one DNO, and Case 3E is in line with this proposal.

Table 4: Case Studies – Economy Background

Case	ACS Peak Demand	Contribution from Small and Medium Embedded Power Stations
Case 1E	Net transmission system demand	Using the same scaling factors provided by FES
Case 2E	Net transmission system demand	For wind generation: 15% of the capacity of Year 1 For other technologies: As per FES Year 1
Case 3E	Gross demand	Despatched according to the rules used to despatch transmission connected Power Stations

- 4.34 Fig. 5 shows the scaling factors for the non-directly scaled generation in the three cases. The minimum scaling factor in each case is listed in Table 5. In all cases, as the total capacity of directly scaled generation increases, the scaling factors for non-directly scaled generation decreases. In Case 1E, the increased contribution from embedded Small and Medium Power Stations reduced the net demand below the total output of directly scaled generation resulting in negative scaling factors beyond year 2032. Negative scaling factors were not noticed in Case 2E as the contribution from embedded Small and Medium Power Stations was assumed not to increase and, hence, demand always remained higher than the total contribution from directly scaled generation technologies. In Case 3E, as the contribution of non-directly scaled embedded Small and Medium Power Stations is scaled down, negative

scaling factors did not occur.

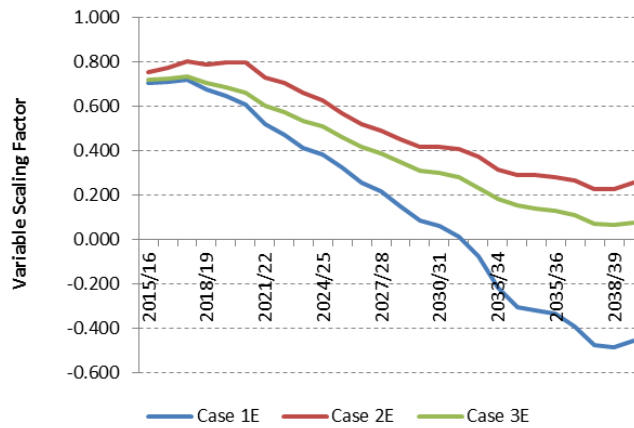

Figure 5. Scaling factors for non-directly scaled generation in three different cases under the economy background.

Table 5: Minimum scaling factor for non-directly scaled generation.

Case Study	Minimum Scaling Factor
Case 1E	-0.485
Case 2E	0.225
Case 3E	0.065

4.35 The results for the northernmost boundary B0 are discussed in details to illustrate the differences between the three cases. Implications of using the different assumptions.

4.36 The demand behind B0 is plotted in Fig. 6 for the three cases. Demand in Case 1E is negative as the total output of embedded Small and Medium Power Stations was assumed to be higher than the gross demand. This negative demand increases as generation capacity increases. In Case 2E, as embedded Small and Medium Power Stations powered by wind were assumed to be running at 15% in Year 1, the net demand for year 1 was positive. As the contribution from embedded Small and Medium Power Stations was assumed not to increase over the years, demand in Case 2E increased at the same rate as the gross demand. The demand in Case 3E is the gross demand.

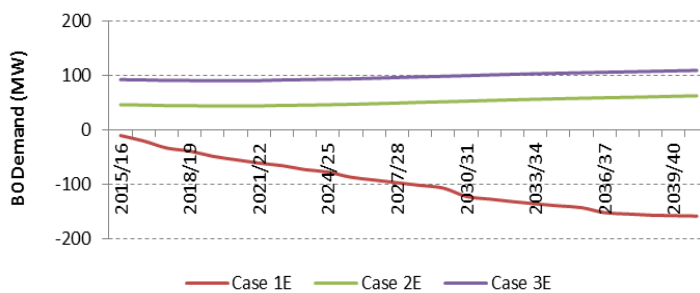

Figure 6. Demand of B0 under economy background

4.37 The generation behind B0 is plotted in Fig. 7. Whereas the curves are almost identical for Case 1E and Case 2E, generation in Case 3E has a higher value as it includes the output from embedded Small and Medium Power Stations.

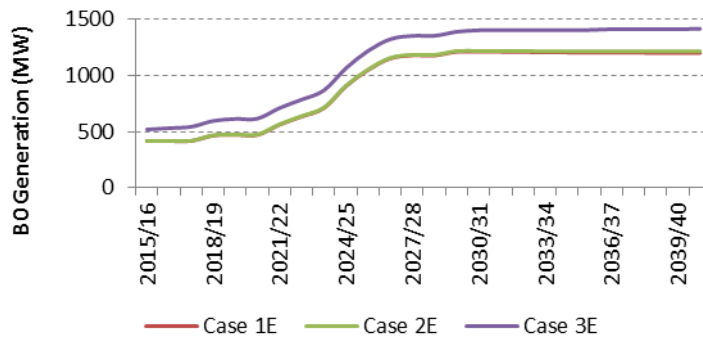

Figure 7. Generation of B0 under economy background

4.38 The planned transfer, Figure 8, is the difference between generation and demand. Case 1E has the highest planned transfer. The planned transfer in Case 2E is lower than that in Case 1E as contributions from embedded Small and Medium Power Stations are lower in Case 2E than in Case 1E. Planned transfer in Case 3E is only slightly lower than that in Case 1E due to the reduction in the output of non-directly scaled embedded Small and Medium Power Stations.

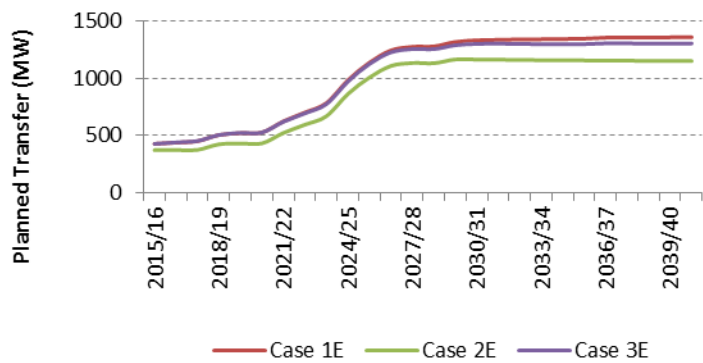

Figure 8. Planned Transfer of B0 under economy background

4.39 The boundary allowance, Figure 9, for a small boundary, is proportional to the sum of generation and demand behind the boundary. Hence, Case 1E, with negative demand and low generation would have the lowest boundary allowance. On the other hand, Case 3E, with the highest demand and highest generation, has the highest boundary allowance.

4.40 The required transfer, Figure 10, is the sum of the planned transfer and the boundary allowance. For B0, the required transfer is higher in Case 3E than the other two Cases.

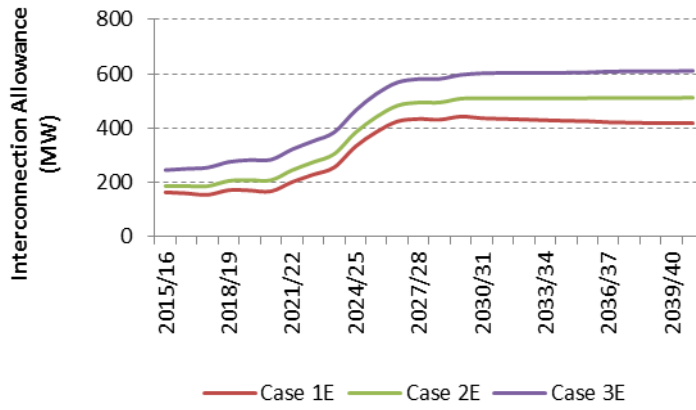

Figure 9. Interconnection Allowance of B0 under economy background

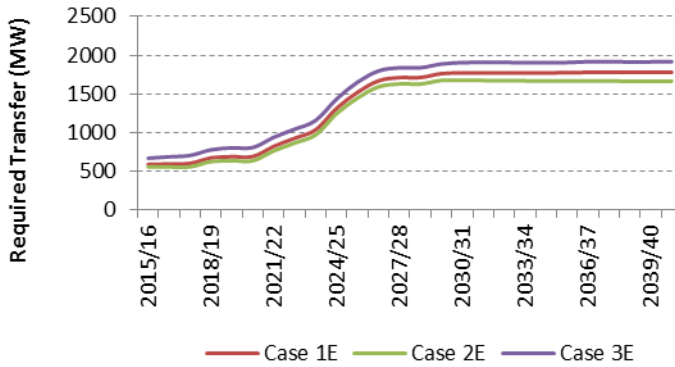

Figure 10. Required Transfer of B0 under economy background

4.41 The required transfers of some other boundaries are shown in Fig. 11, Fig. 12, Fig.13 and Fig. 14. Many boundaries do not see any significant difference between Case 1E and Case 3E. The required transfer for small boundaries, e.g. B0, will be higher in Case 3E than in Case 1E due to the increase in boundary allowance. The required transfer for large demand driven boundaries, e.g. B14, will be higher in Case 3E than in Case 1E. However, this change is triggered by the reduction in the output of any local non-directly scaled embedded Small and Medium Power Stations.

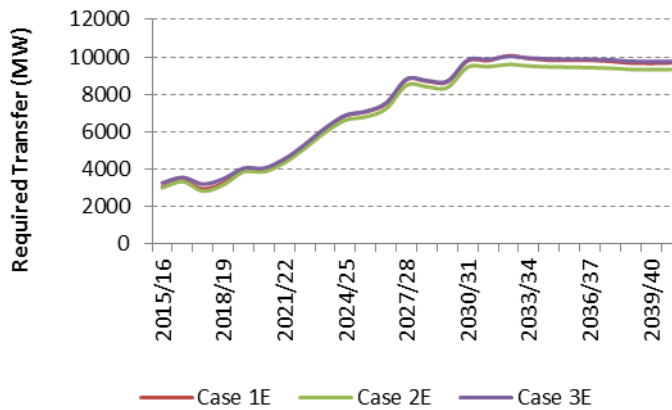

Figure 11. Required Transfer of B4 under economy background

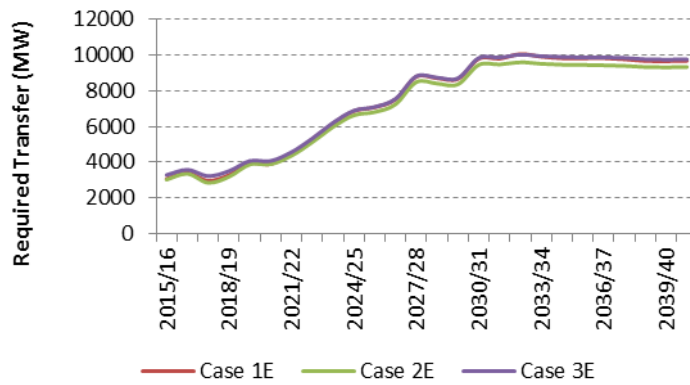

Figure 12. Required Transfer of B6 under economy background

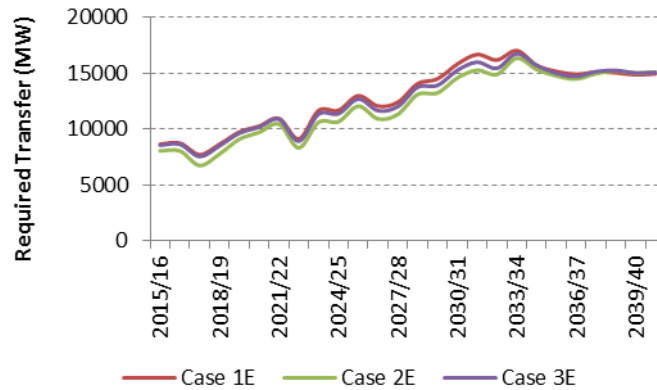

Figure 13. Required Transfer of B8 under economy background

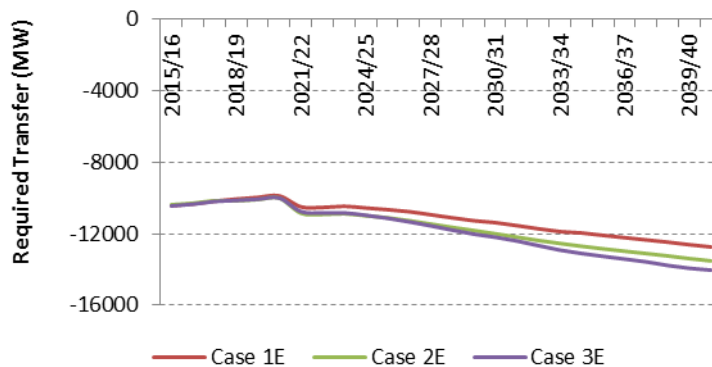

Figure 14. Required Transfer of B14 under economy background

Impact of the Proposal on the Required Transfer Capability: Security Background

4.42 To show the impact of modelling of Medium and Small Embedded Generation on ETYS boundaries in Security background, the same three case studies that were used in the previous section were used with two additional sensitivities. The high level descriptions of all cases are included in Table 6 **Error! Reference source not found.** Case 1S-B uses the same assumptions that were used in the Security Background studies for ETYS2016 with embedded Small and Medium Power Stations in Scotland set to run at zero output. Case 3S-B extends the same assumption of zero output from embedded Small and Medium Power Stations to

Table 6: Case Studies – Security Background

Case	ACS Peak Demand	Contribution from Small and Medium Embedded Power Stations
Case 1S-A	Net transmission system demand	Using the same scaling factors provided by FES
Case 1S-B	Net transmission system demand	In England and Wales: Using the same scaling factors provided by FES In Scotland: Zero
Case 2S	Net transmission system demand	For wind generation: 15% of the capacity of Year 1 For other technologies: As per FES Year 1
Case 3S-A	Gross demand	Despatched according to the rules used to despatch transmission connected Power Stations
Case 3S-B	Gross demand	Zero

4.43 Fig. 15 shows the scaling factors for all the five cases. The maximum scaling factor over the years in each case is listed in Table 6. Case 1s-B is only slightly different from Case 1S-A in terms of scaling factors. Case 2S and Case 3S-B have scaling factors higher than Case 1S-A (which is the base case) and hence would exacerbate the problem of generation being despatched at output that exceeds its capacity. Case 3s-A, with embedded Medium and Small Power Stations scaled up/down as required, shows a reduction in the scaling factors.

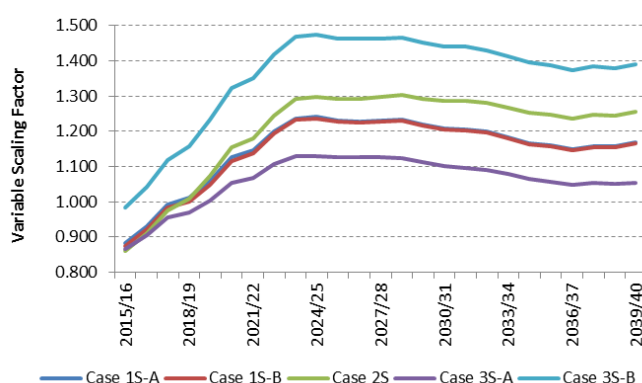

Figure 15. Scaling factors in five different cases under the security background

Table 7: Maximum scaling factor from year 2015/16 to year 2040/2041 in five different cases

Case	ACS Peak Demand
Case 1S-A	1.24
Case 1S-B	1.24
Case 2S	1.3
Case 3S-A	1.13
Case 3S-B	1.47

4.44 For simplicity, only the results related to the base case (Case 1S-A) and the proposal (Case 3S-A) for selected boundaries (B0, B4, B6, B10, B13 and B14) are shown in the graphs below. As the percentage of contributory embedded Small and

Medium Power Stations behind a specific boundary increases, the difference between the Required Transfer for that boundary also increases.

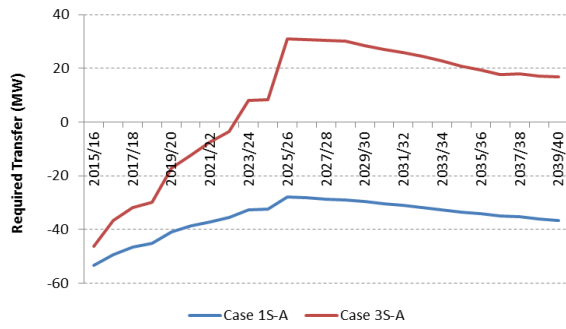

Figure 16. Required Transfer of B0 under security background

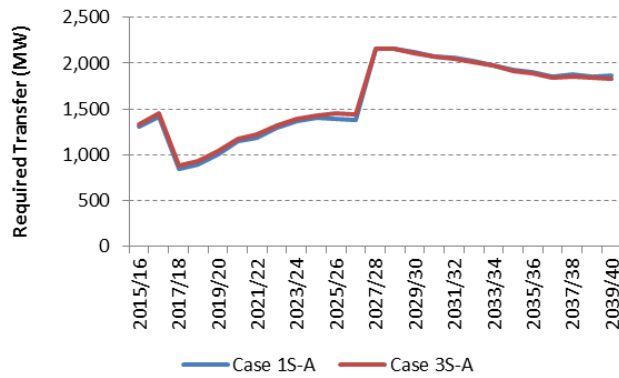

Figure 17. Required Transfer of B4 under security background

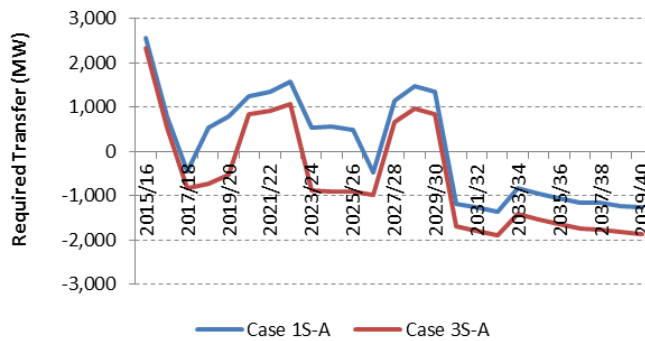

Figure 18. Required Transfer of B6 under security background

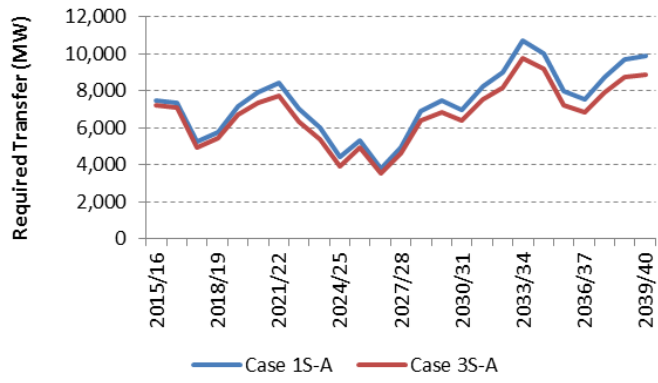

Figure 19. Required Transfer of B8 under security background

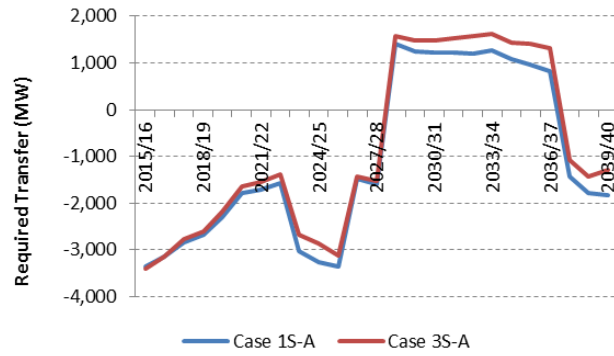

Figure 19. Required Transfer of B10 under security background

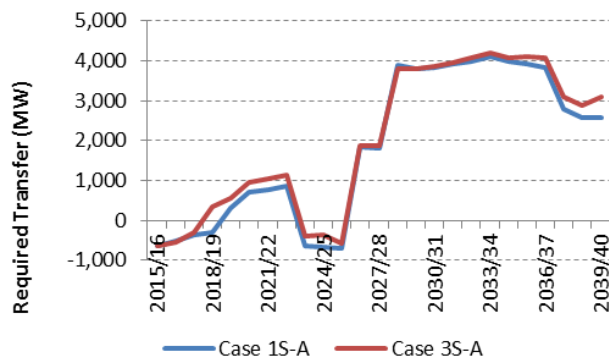

Figure 20. Required Transfer of B13 under security background

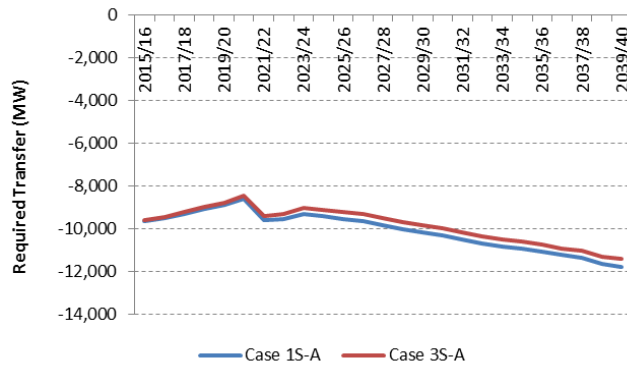

Figure 21. Required Transfer of B14 under security background

Operability Criteria in the NETS SQSS

- 4.45 The NETS SQSS places a requirement on Transmission Owners to provide the System Operator with a Transmission System that can be operated in accordance with the operational security criteria set out in Section 5 and Section 9 of the NETS SQSS. This is explicitly stated in Paragraphs 2.12 and 2.13 which would ensure the operability of local boundaries with a local system outage in the background. It is also explicitly stated in Paragraphs 4.7 to 4.10 which apply over the whole system under conditions which ought reasonably to be foreseen to arise in the course of a year of operation.
- 4.46 These clauses have been met via
- 4.46.1 provision of transmission capacity in accordance with the deterministic criteria set out in other clauses of the NETS SQSS;
 - 4.46.2 utilisation of operational measures, e.g. rearrangement of outages, and balancing services; and
 - 4.46.3 provision of additional transmission capacity if the saving in operational costs justifies the additional investment.
- 4.47 Historically, the active participation of more than 90% of the generation fleet in the Balancing Mechanism provided a guarantee that the operability clauses of Section 2 and Section 4 of the NETS SQSS are met at almost all times with the exception being the periods when Generators could not submit sufficient Bids due to their Generating Units running near their Stable Export Limits. Other operational measures, e.g. intertrips and bilateral commercial contracts, were used as means of reducing operational costs rather than means to ensure compliance.
- 4.48 As a significant level of generation is no longer active in the Balancing Mechanism, due to them being embedded Small Power Stations, embedded medium Power Stations, or embedded Larger Power Stations that opted for a BELLA arrangement, the operability clauses are no longer guaranteed to be met. This risk increases as, under Connect and Manage, generation is now connected ahead of the completion of some of the reinforcements required to fully comply with the NETS SQSS and as reinforcements could be further delayed based on the outcome of the Network Options Assessment process.

Operation of a Compliant Network

- 4.49 Generation needs to be constrained for a variety of reasons: to balance generation and demand; to facilitate the provision of ancillary services such as frequency response, system inertia and voltage control; and to ensure the system is secured for the next fault. The latter is the focus of the Workgroup due to the growing concern that as the capacity of generation which cannot be constrained increases, the ability of the System Operator to comply with the operational criteria of Section 5 of the NETS SQSS decreases especially during outage periods.
- 4.50 For example, a compliant wider system boundary would see no constraints at the time of winter peak with a maximum of 70% of wind generation, 85% of nuclear generation and 50% of pumped storage. If the demand drops – i.e. off peak demand, the generation increases – e.g. wind output increases and all nuclear plants are running at full capacity, or if the boundary capability drops – e.g. due to an outage or due to reduced summer rating, the System Operator would need to constrain generation behind this boundary – via the Balancing Mechanism – to ensure that the operational criteria of Section 5 are met. Where the total active power constraint is lower than the generation that is available in the Balancing Mechanism, there will be no risk. Where the total active power constraint is higher than the generation that is available in the Balancing Mechanism, the System Operator would not be able to meet the operational criteria of Section 5 via the Balancing Mechanism.

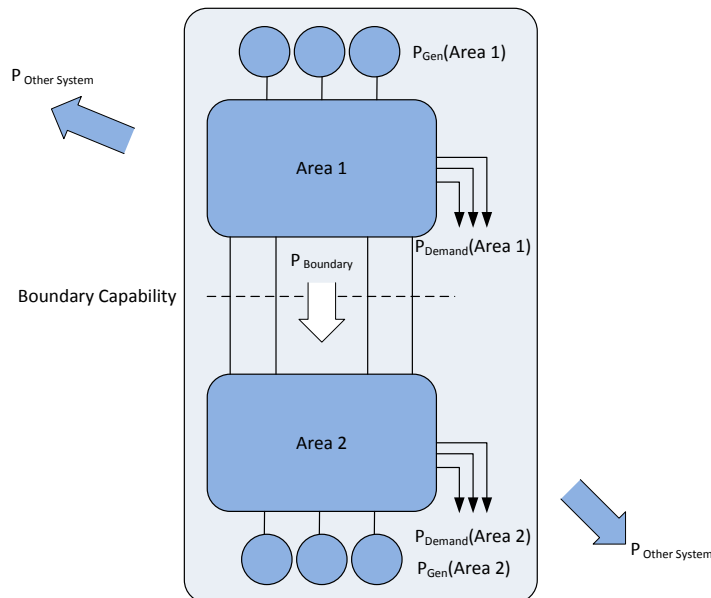

Figure 22. Illustration of boundary capability

- 4.51 A similar issue is illustrated by Fig. 23 with two double-circuit overhead lines of different capacity connect a switching substation to the rest of the system. A Grid Supply Point with embedded generation is double teed into one of the two overhead lines. Assuming no background flows on the lines, a connection design that meets Section 2 criteria would allow connecting embedded generation of a capacity that exceeds the minimum demand by roughly 2x89MW. This would result in no post fault overloads following a fault on the other double circuit overhead line. In order to allow an outage on any of the two transformers at the Grid Supply Point, the System

Operator would need to restrict the export of the Grid Supply Point to a maximum of roughly 89MW. This would require constraining almost half of the generation capacity connected at that Grid Supply Point. If the majority of generation at this Grid Supply Point is not active in the Balancing Mechanism, the System Operator would not be able to secure the system during the outage.

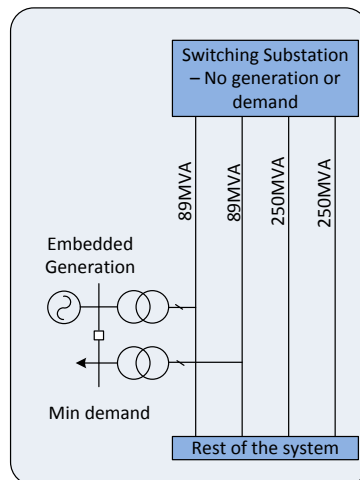

Figure 23. Local boundary issues that may be caused due to generation constrain

Operation of a Non-Compliant Network

- 4.52 Under Connect and Manage, generation is allowed to connect to the system ahead of the completion of some of the transmission reinforcements that are required for compliance with the NETS SQSS criteria. This essentially increases the level of constraints both on local and wider system boundaries and increases the risk that active power constraints could exceed the output of the generation that is available to manage via the Balancing Mechanism.
- 4.53 For example, an additional 89MW could be connected to the Grid Supply Point shown in Figure 23 under Connect and Manage, ahead of any reinforcements to the overhead lines. This would make the total active power export of the Grid Supply Point roughly 267MW. The System Operator would need to constrain this export to 178MW at intact system conditions or to 89MW with a planned single circuit outage.
- 4.54 In addition with the introduction of the Network Options Assessment (NOA) process, some of the reinforcements that are required to comply with the NETS SQSS criteria could be further delayed or even completely ruled out, where it is assessed to be more economical to pay constraint costs rather than invest. If alternative operational measures are not provided, this increase in constraints will further increase the risks arising from the lack of generation that is active in the Balancing Mechanism if no alternative measures have been identified to manage such risks.

Examples of Operability Risks – Local System Boundaries

- 4.55 The Workgroup discussed two examples where the constraints could exceed the generation capacity that is active in the Balancing Mechanism. One example is live on the system and is currently managed via emergency instructions. The other example is still in planning timescales and will be managed via an operational

intertripping scheme,

- 4.56 The first example is an event of inadequate local Negative Reserve Active Power Margin (NRAPM) that has been issued for the Caithness group, Northern Scotland. The event took place around 18:50 hours on Tuesday 15th November 2016. During that day, one Shin/Alness 132kV circuit was on a planned outage and the System Operator was required to secure the system for an additional fault on the other Shin/Alness 132kV circuit. This fault would push all the output of the group through the Thurso/Dounreay circuits (rated at 103MVA pre-fault/123MVA post fault). The post fault flows are marked in red in Figure 24. These flows are close to the line rating.
- 4.57 On that day, the wind generation output remained high for a period that was longer than expected across Northern Scotland. An Inadequate Localised NRAPM warning for Northern Scotland was issued to request generators within the constraint group to review their flexibility and to indicate to them that Emergency Instructions (EIs) may be required. The Localised NRAPM was issued to cover the period 18:50 to 20:00hrs after which agreed trades with BELLA wind farms in the area would have become active. After the Localised NRAPM warning was issued wind generation in the group decreased, negating the requirement for emergency instructions pre-fault although there were no bids available within the Balancing Mechanism as none of the Generators in that group is an active participant in the Balancing Mechanism.
- 4.58 The risk would have been higher if the outage was taken during summer (less demand and lower circuit rating), if the wind output increased, or if the weather conditions dictated that the System Operator should secure for a double circuit fault on the Dounreay Beaulieu 275kV overhead line which would have left the whole group connected to the system via one Shin/Alness circuit.
- 4.59 The second example is in the South West of England, shown in Figure 25. The boundary at risk, shown by the green line in the figure, cuts through four transmission circuits. With a planned outage on one circuit, the System Operator would need to constrain generation within that group in order to secure for a double circuit fault. With 3GW of embedded Small and Medium Power Stations connected in that group, the total active power constraint during any period of low demand would exceed the total capacity of generation that is active in the Balancing Mechanism. Hence the connection offers made to the Distribution Network Operator in relation to these embedded Small and Medium Power Stations were conditional on having the ability to constrain their output during these outage periods.

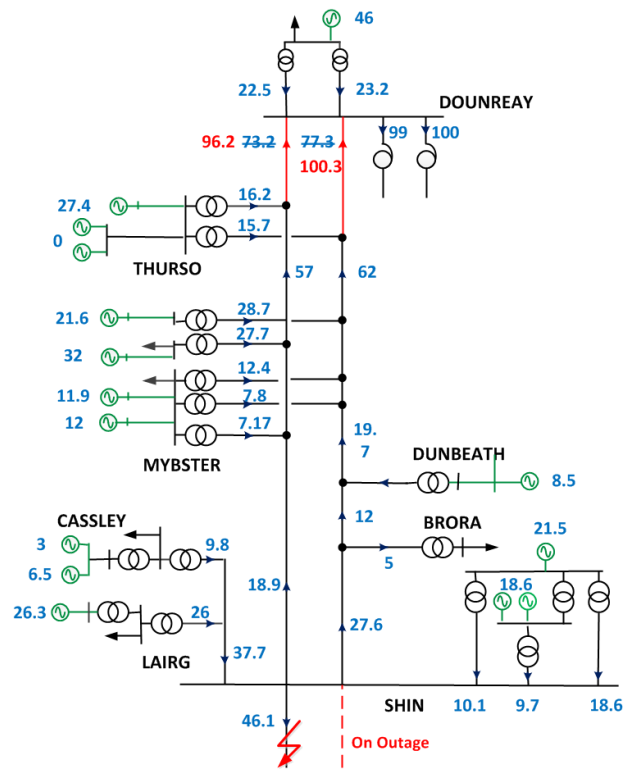

Figure 24. Local boundary example in Caithness

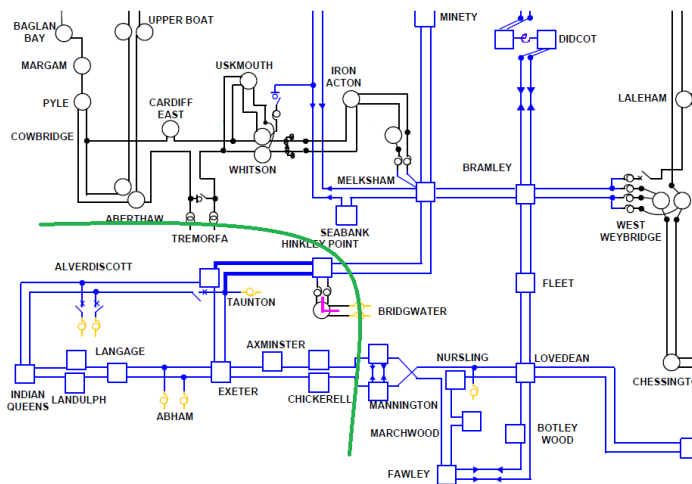

Figure 25. Local boundary example in South West of England

Assessment of the Operability Risks – Wider System Boundaries

- 4.60 To assess the risk that wider boundaries are exposed to, seven operational scenarios were considered. The despatch levels for these scenarios are listed in Table 7. In that table, non-directly scaled generation is generation that could be scaled up/down to balance the difference between generation and demand.
- 4.60.1 The first scenario is a worst case scenario (based on FES Data) with all generation that is not active in the Balancing Mechanism, other than storage, running at full output.
- 4.60.2 The second scenario assumes that only wind, wave, and tidal generation that is not active in the Balancing Mechanism would be running at their full capacity.
- 4.61 The other scenarios are intended as sensitivities. For example, scenario 5 highlights the risk when the total output of wind generation that is not active in the Balancing Mechanism exceeds 60% of the total wind capacity that the system is designed to accommodate.
- 4.62 For all scenarios, generation was scaled to the levels specified in Table 7. The difference between generation and demand in all minor zones was then calculated. The results were used to estimate the flows across the wider system boundaries.

Table 8: Scenarios used for wider system boundary assessment

Scenario	Scenario						
	1	2	3	4	5	6	7
Demand	AM Minimum						
Nuclear	100%						
Solar	0%						
Storage	-100%						
Embedded Wind, Wave and Tidal	100%	100%	100%	80%	60%	40%	20%
Transmission connected Wind, Wave and Tidal	Non-directly scaled		100%	80%	60%	40%	20%
Other embedded generation	100%	Non-directly scaled					
Other generation	Non-directly scaled						

4.63 The boundary capability was then calculated for all boundaries for two distinct cases.

4.63.1 The first case assumes that boundaries will always be compliant. i.e. they will always have a capability that is equal to that required by the economy background assumptions.

4.63.2 The second case assumes that boundaries will not be reinforced at all over the whole study period. i.e. they will always have a capability that is equal to their current capability. This corresponds to a worst case assumption that the output of the Network Options Assessment analysis indicates that all the future network reinforcements proposed are not economical.

A 70% generic derating factor was then applied on all boundary capabilities. This derating was used to take into account the reduction in boundary capability due to planned single circuit outages and reduced summer ratings. This factor has been based on analysis done on selected boundaries. It is recognised that, in reality, each boundary will have a different derating factor however as the purpose of this assessment is to highlight a high level issue, the generic assumption was deemed acceptable.

4.64 The boundary flows for all scenarios were then compared to the boundary capabilities for the two cases. The number of years where the flow exceeded the derated capability for the boundaries considered are listed in Table 8 and Table 9.

4.65 The Workgroup noted that, as the total capacity of non-controllable generation exceeded the demand in scenarios 1 to 4, and as the system had to be balanced, some transmission connected generation was despatched to a negative output. This is one of the discrepancies that arises because of the current despatch methodology. As a result, the risks of flows exceeding boundary capabilities are underestimated.

4.66 For a fully compliant network, the first set of figures in Table 8 suggests that, over the whole 26 year study period, there will be a 5 year period with the System Operator potentially unable to meet the operational criteria of Section 5 for a planned single circuit outage on any of the B7 circuits if Scenario 1, that is all generation that is not active in the Balancing Mechanism choosing to run at its rated output, materialises. There will also be a 6 years period with the System Operator having the same problem if Scenario 6, that is the total output of wind generation contributing to the flows on that boundary during the outage period exceeds 40% of the total wind capacity that the boundary has been designed to accommodate, materialises.

4.67 For a non-compliant network, the second set of figures in Table 8 suggests that the number of years this risk could materialise would increase to 13 years for scenario 1 and 16 years for scenario 6.

4.68 Similar conclusions could be drawn for other boundaries.

4.69 The Workgroup noted that, for some boundaries, for example B6, scenario 2 shows a higher risk of being inoperable than scenario 1. This is due to the higher negative output of transmission connected generation – as discussed in paragraph 4.65 – having a higher impact in Scenario 1 compared to Scenario 2.

4.70 The Workgroup noted that the risk could significantly increase during construction outages if these are to take place over an extended period or if it includes multiple concurrent outages.

Table 9: No. of years transfer could exceed the approximated summer boundary capability with a prior outage

Scenario	Capabilities assume a fully compliant Based on a compliant system							Capabilities assume no reinforcement take place beyond 2017						
	1	2	3	4	5	6	7	1	2	3	4	5	6	7
B0	0	0	26	26	0	0	0	26	26	26	26	26	23	17
B1	0	0	3	0	0	0	0	0	0	20	13	2	0	0
B2	0	0	6	0	0	0	0	0	2	22	20	19	3	0
B3	0	0	18	0	0	0	0	10	13	25	19	19	19	19
B4	0	0	21	5	0	0	0	0	2	22	20	19	4	0
B5	0	0	14	5	0	0	0	0	0	20	19	7	0	0
B6	0	0	26	26	15	0	0	7	14	26	26	26	22	1
B7	5	6	26	26	13	6	0	13	13	26	26	26	16	0
B8	1	2	21	16	9	2	0	0	0	15	10	0	0	0
B9	1	5	16	11	9	4	1							
B10	0	0	0	0	0	0	0							
B11	0	2	17	15	11	1	0	0	1	13	12	8	1	0
B12	0	0	0	0	0	0	0	0	0	14	6	0	0	0
B13	7	1	0	0	0	0	0							
B14	0	0	0	0	0	0	0							
B15	0	0	0	0	0	0	0							
B16	0	0	7	6	0	0	0	0	0	3	0	0	0	0
B17	0	0	0	0	0	0	0							
SW1	0	0	0	0	0	0	0							
B32/B7a	8	8	26	26	19	9	3	14	13	12	12	12	12	12
NW4/B36	0	6	6	6	6	6	0							
EC5/B40	2	2	26	26	26	19	2							
EC4/B39b	1	5	14	11	9	4	1							
SW4/B42	0	0	0	0	0	0	2							
B39/B9a	1	5	14	11	9	4	1							
B15a	0	0	0	0	0	0	0							
NW1	13	13	13	13	13	13	13							
NW2	0	0	6	6	6	6	0							
NW3	0	0	6	6	3	0	0							
EC1	0	0	0	0	0	0	0							
EC3	0	0	12	6	4	0	0							
SC1	0	0	0	0	0	0	0							
B1a	0	0	6	0	0	0	0							

Management of Operability Risks

- 4.71 The Workgroup discussed the scope of Paragraphs 2.12 and 2.13 and Paragraphs 4.7 to 4.10 of the NETS SQSS. It was agreed that these paragraphs require Transmission Owners, with the necessary input from the System Operator, to study a wide range of scenarios, identify the risks, and identify measures to mitigate these risks. Therefore, there is no need to modify the NETS SQSS in this respect.
- 4.72 The Workgroup discussed the options that could be used to ensure that the System Operator will remain able to meet the operational criteria of Section 5 of the NETS SQSS with the increased level of generation that is not active in the Balancing Mechanism especially with the increased level of constraints. These options include
- 4.72.1 provision of additional transmission capacity ahead of connecting generation to the system;
 - 4.72.2 provision of additional operational measures, e.g. intertripping schemes;
 - 4.72.3 identification of potential network reconfiguration arrangements that could be used to reduce the risk while still meeting the demand security criteria;
 - 4.72.4 making connection offers subject to the Generator signing a BEGA agreement;
 - 4.72.5 progressing a wider CUSC/BSC Modification and introducing a commercial mechanism, similar to the Balancing Mechanism, that allows the System Operator to manage generation that is not currently active in the Balancing Mechanism.
- 4.73 Options 4.72.1 to 4.72.4 would need to be considered on a case by case basis at the connection offer stage. Transmission Owners would need to identify their preferred option and that option would need to be implemented ahead of the connection date – in line with CUSC Paragraph 13.2.4.3 which requires that the Minimum Enabling Works include all the enable NGET to operate the National Electricity Transmission System in a safe manner. Options appraisal would need to take into account implementation costs, technical feasibility – e.g. availability of communications routes, and the complexity of the solution.
- 4.74 Additional reinforcements, option 4.72.1, could require additional funding and/or could be difficult to justify economically. It will also result in delaying the connection of the affected embedded Small and Medium Power Stations.
- 4.75 The assessment of whether a specific reinforcement is economic or not, as a part of the Network Options Assessment process, would need to take into account the cost of any operational measures required to manage generation in the absence of this reinforcement.

4.76 Options 4.72.1 to 4.72.4 would only be sufficient for a time until total generation capacity that is not active in the Balancing Mechanism reaches a the level at which

4.76.1 the credible total output of that generation plus the output of any other generation that is required to run to provide ancillary services exceeds the demand; or

4.76.2 the complexity of the operational solutions required to manage that generation becomes prohibitive.

Any further increase in this capacity would only be feasible following the wider CUSC/BSC change – option 4.72.5.

Requirement for Additional Data

4.77 In order to be able to appropriately model embedded Small and Medium Power Stations in investment planning studies, Transmission Licensees will need to know sufficient data about the these Power Stations. This data need to be communicated as a part of the Standard Planning Data, Connection Applications, Future Energy Scenarios and Constriction Planning Assumptions.

Standard Planning Data

Grid Code PC.A.2, PC.A.3, PC.A.4, and DRC Schedule 12

4.78 On Week 24, Distribution Network Operators submit the following data – for the current year and the following 6 years – to the System Operator

4.78.1 forecast transmission system demand at all Grid Supply Point at the time of the peak transmission system demand, minimum transmission system demand, maintenance period demand, and peak Grid Supply Point demand;

4.78.2 forecast contribution of embedded Small and Medium Power Stations considered when calculating the forecast demand; and

4.78.3 forecast connection dates and capacity of embedded Small and Medium Power Stations connecting at the Grid Supply Point.

4.79 In all cases, the gross demand at a Grid Supply Point will be the sum of the transmission demand and the contribution of embedded Small and Medium Power Stations. However, the following additional data needs to be provided

4.79.1 Forecast transmission system demand at all Grid Supply Points at the time of the peak total system gross demand, minimum total system gross demand, and peak Grid Supply Point gross demand;

4.79.2 Forecast contribution of embedded Small and Medium Power Stations considered when calculating the forecast demand; and

4.79.3 Aggregated capacity of Embedded Small Power Stations with capacity below 1MW, categorised in accordance with generation technologies.

4.80 In order to allow the provision of the data described in 4.79.1 and 4.79.2, the System Operator would need additional data that allows forecasting the times of the

peak national gross demand and the minimum national gross demand. The extent of this data has not been discussed by the Workgroup.

- 4.81 Provision of data described in 4.79.3 has been previously discussed by the GC0042 Grid Code Workgroup. At that stage, the Workgroup decided not to include the data related to embedded Small Power Stations with capacity below 1MW due to concerns related to the accuracy of the data available. The accuracy of the data available to Distribution Networks Operators has improved since then with DNOs having details of embedded generation with capacity as low as 100kW and best estimates for embedded generation with capacity less than 100kW. Hence, provision of such data is not now expected to be an issue.
- 4.82 The Workgroup recommends that the issue is raised at the Grid Code Review Panel to discuss how to instigate the Grid Code Modification(s) that are necessary to allow Transmission Licensees to better meet the NETS SQSS criteria following the approval of this Modification proposal.
- 4.83 The Workgroup noted that the timescales for proposing and implementing, if approved, a change to the Grid Code could range from 6 months to 2 years depending on the complexity of the Modification. Hence, in order to reduce the risks arising from inconsistent treatment of embedded generation, it is proposed that, up until the conclusion of the relevant Grid Code Modification, Transmission Licensees make the best use of the data that is currently available and use best estimates for the data that is missing. This would involve
- 4.83.1 supplementing the embedded generation data submitted by Distribution Network Operators with best estimates from the Future Energy Scenarios for embedded generation units with capacity less than 1MW; and
 - 4.83.2 assuming that the time of the peak transmission demand coincides with time of the peak gross demand.

It is the intention that such approximation will only be used for a short period of time to ensure that the increase in the capacity of embedded generation with capacity less than 1MW and the increase in the total contribution of embedded generation at the time of peak demand do not introduce significant approximation errors.

Construction Planning Assumptions

- 4.84 Construction Planning Assumptions are the background comprising information held by the System Operator relating to the National Electricity Transmission System, and User System(s) (as appropriate), including data submitted pursuant to or included within the Grid Code, CUSC Contracts and any other data held by System Operator. These are prepared, updated, and provided to Transmission Owners in order to assist in the preparation of TO Construction Offers.
- 4.85 Construction Planning Assumptions are generally based on contracted generation. It has always included transmission connected Power Stations and embedded Large Power Stations and has been recently extended to include transmission contracted embedded Small and Medium Power Stations and the contractual arrangements, i.e. BELLA/BEGA, for embedded Large Power Stations.
- 4.86 In order to facilitate that Transmission Owners assess operability risks arising from the increase in the total capacity of generation that is not active in the Balancing Mechanism, any special arrangements, e.g. intertrips, that are set up to manage this embedded generation outside the Balancing Mechanism in order to facilitate

compliance with the operational criteria of the NETS SQSS will need to be included with sufficient details in the Construction Planning Assumptions. It is noted that this change is not triggered by the Modification proposed in this Workgroup Report.

Future Energy Scenarios

- 4.87 Future Energy Scenarios are datasets produced by the System Operator to provide an insight about potential future scenarios and inform the network design processes. These scenarios cover the spectrum of the political and economic factors that would affect energy supply and demand.
- 4.88 These datasets use multiple inputs including the Standard Planning Data submitted by Distribution Network Operators, Electralink data, Third Party Data sources, Feed in Tariff Register, and Renewable Obligation Certificates to produce the datasets. These inputs are validated against each other for consistency and to ensure all gaps are filled as appropriate. Therefore, the additional data that needs to be submitted by Distribution Network Operators, as highlighted in Paragraph 4.79, would help improve the quality of the Future Energy Scenarios datasets especially as the total installed capacity of embedded generation with individual unit capacity of less than 1MW increases from the current level of 5% of the total installed generation capacity to 15% of that capacity according to 2016 Gone Green Scenario.
- 4.89 The Future Energy Scenarios datasets produced include data about gross demand, transmission connected generation, and embedded generation – including embedded generation with capacity below 1MW. There is no need to require additional datasets to be produced as a part of Future Energy Scenarios in order to allow the implementation of the NETS SQSS Modification proposed in this report.

Risk Assessment for the Interim Arrangements

- 4.90 The criteria affected by this modification, Section 4 of the NETS SQSS, are applied by Transmission Licensees when
- 4.90.1 assessing boundary requirements and boundary capability a part of the Electricity Ten Years Statement,
 - 4.90.2 assessing compliance as a part of the annual Regulatory Reporting Package, and
 - 4.90.3 and making investment decisions as a part of the Network Options Assessment process.

These are all based on the Future Energy Scenarios datasets. Therefore, it is the completeness and the accuracy of the Future Energy Scenarios datasets that guarantees enduring compliance with these NETS SQSS criteria. As these datasets are complete, in the sense that they include all the relevant data that are required to run the studies, and are of reasonable accuracy

- 4.91 It is the view that there is no risk of non-compliance that would arise from this modification due to the absence of some datasets from the Standard Planning Data. However, it is necessary to ensure that the additional data is provided in order to improve the consistency of the Future Energy Scenarios.

A Housekeeping Modification

- 4.92 The Workgroup proposed a housekeeping Modification to the following paragraphs of the NETS SQSS

- 4.92.1 Paragraph 2.13 to refer to Paragraph 2.12 instead of referring to itself;
- 4.92.2 Paragraphs 2.15, 2.17, and 2.18 to refer to Paragraph 2.16 instead of Paragraph 2.17;
- 4.92.3 The definition of Fault Outage to refer to Primary Transmission Equipment rather than Primary Transmission Apparatus

5. Impact & Assessment

Impact on the NETS SQSS

- 5.1 The Workgroup recommends the following amendments to the NETS SQSS:
- 5.1.1 changing the definition of the ACS Peak Demand such that it refers to the gross demand rather than the net transmission system demand;
 - 5.1.2 changing the definitions of Plant Margin, Economy Planned Transfer Conditions, Planned Transfer Conditions and Security Planned Transfer Condition such that the exclusions of embedded small power stations and embedded medium power station are removed; and
 - 5.1.3 changing Appendix C, Appendix D and Appendix E of the NETS SQSS such that the exclusions of embedded small power stations and embedded medium power station are removed.
- 5.2 The text required to give effect to this proposal is contained in Annex 2 of this document.

Impact on the National Electricity Transmission System (NETS)

- 5.3 The Modification proposed removes the inconsistency of modelling generation due to size of the connection (small and medium vs large) and the connection point (transmission vs embedded). The resulting consistency allows more realistic levels of generation dispatch in long term investment planning.
- 5.4 The Modification also changes the required capability for certain boundaries, due to the calculation of the demand, generation and interconnection allowance with all embedded generation treated the same as directly connected generation.

Impact on Transmission Licensees

- 5.5 Transmission Licensees will need to change how they model the distribution system to ensure that the gross demand and embedded generation are modelled with enough details.
- 5.6 The change to embedded generation assumptions will impact the Required Transfer Capability for certain boundaries, as discussed in Section 4. This could trigger additional reinforcements on some boundaries and fewer reinforcements on other boundaries. The extent to which these changes will be reflected in the investment plan would be subject to further economic assessment as a part of the Network Options Assessment process.
- 5.7 Based on the interpretation of the operability criteria currently stipulated in the NETS SQSS, and in order to ensure that operability schemes that are required to manage generation that is not active in the Balancing Mechanism are identified and implemented,
- 5.7.1 such issues will need to be assessed as a part of the Connection Application process and the Network Options Assessment; and
 - 5.7.2 information related to such schemes will need to be communicated to all Transmission Owners through the Construction Planning Assumptions.

Impact on Transmission System Users

- 5.8 There is no immediate impact on any Transmission System User as a consequent of this proposal. However, as the assumptions made on embedded Power Stations

change, the input to the models used to determine the Transmission Network Use of System Charge will change. This would result in some change to the transmission charges for individual parties.

Assessment against NETS SQSS Objectives

5.9 The Workgroup considers that the proposed amendments would better facilitate the NETS SQSS objectives:

- (i) **facilitate the planning, development and maintenance of an efficient, coordinated and economical system of electricity transmission, and the operation of that system in an efficient, economic and coordinated manner;**

The Modification proposal removes the inconsistency between the modelling of Small and Medium Embedded Power Stations and that of Transmission connected Power Stations and Embedded Large Power Stations in long term investment planning. It ensures that all generation is adequately accounted for, makes both the economic and security background generation dispatch and therefore the required transfer calculation for boundaries more realistic.

- (ii) **ensure an appropriate level of security and quality of supply and safe operation of the National Electricity Transmission System;**

The adequate representation of embedded generation in investment studies reduce the risk that the shortage in transmission capacity could undermine the ability of generation to meet the demand.

- (iii) **facilitate effective competition in the generation and supply of electricity, and (so far as consistent therewith) facilitating such competition in the distribution of electricity; and**

The Modification proposal has no impact on this NETS SQSS objective.

- (iv) **facilitate electricity Transmission Licensees to comply with their obligations under EU law.**

The Modification proposal has no impact on this NETS SQSS objective.

Impact on Core Industry Documents

- 5.10 Following the approval of this Modification, it will be necessary to modify the Planning Code and the Data Registration Code Grid such that Distribution Network Operators are required to provide
- 5.10.1 demand forecasts for their individual Grid Supply Points at the times of the peak gross national demand, the peak gross GSP demand, and the minimum gross national demand ; and
 - 5.10.2 aggregated data related to embedded Power Stations with capacity less than 1MW of different generation technologies.

Impact on Other Industry Documents

- 5.11 The proposed Modification does not impact on any other industry documents.

Implementation

- 5.12 The Workgroup proposes that, should the proposals be taken forward, the proposed changes be implemented 10 business days after an Authority decision.

6. Workgroup Recommendations

- 6.1 The Workgroup proposed a Modification to the NETS SQSS to
- 6.1.1 change the definition of the ACS Peak Demand such that it refers to the gross demand rather than the net transmission system demand;
 - 6.1.2 change the definitions of Plant Margin, Economy Planned Transfer Conditions, Planned Transfer Conditions, and Security Planned Transfer Conditions to remove the exclusions of embedded Small Power Stations and embedded Medium Power Stations; and
 - 6.1.3 Revise Appendix C, Appendix D, and Appendix E of the NETS SQSS to remove the exclusions of embedded Small Power Stations and embedded Medium Power Stations
- 6.2 The Workgroup proposed a housekeeping change to the NETS SQSS to correct the reference in Paragraphs 2.15, 2.17, and 2.18.
- 6.3 The Workgroup agreed that Transmission Owners, together with the System Operator, should assess operability risks arising from generation that is not active in the Balancing Mechanism and propose measures to mitigate these risks as a part of Connection Application process. Detailed implementation of such assessment will need to be agreed via the Joint Planning Committee set up under the STC. The Workgroup notes that this does not constitute an additional requirement to what is already covered in the NETS SQSS.
- 6.4 The Workgroup, after having identified the data required to achieve the full benefit of this proposal and the gaps between the data currently available as a part of the Standard Planning Data – submitted at Week24, Construction Planning Assumptions, Future Energy Scenarios, and Connection Applications, proposed that a Modification to the Grid Code is instigated to ensure that the Standard Planning Data submitted by Distribution Network Operators include data corresponding to the time of the peak gross demand and includes embedded generation of capacity less than 1MW.
- 6.5 Due to the timescales necessary for the Grid Code Modification process to conclude, the Workgroup proposed an interim arrangement in order to reduce the risk of inadequate representation of embedded Small and Medium Power Stations. This arrangement is to
- 6.5.1 continue to use the data currently provided, which corresponds to the time of the peak transmission system demand as an approximation to the actual values, which should correspond to the time of the gross system demand; and
 - 6.5.2 where necessary, use data of embedded generation with capacity less than 1MW that is available through Future Energy Scenarios and Connection Applications to supplement Week24 submissions.
- However, the Workgroup noted the importance of requiring the additional data to be submitted as this data will improve the quality of the datasets of the Future Energy Scenarios in relation to gross demand estimates and embedded generation forecasts.
- 6.6 The Workgroup believes that the Terms of Reference has been discharged and invites the NETS SQSS Review Panel to approve this Workgroup Report.

7. Consultation Responses

- 7.1 Views were invited upon the proposals outlined in the consultation. Responses were requested to be emailed to box.SQSS@nationalgrid by 03 January 2018 using the proforma provided.
- 7.2 It was pointed out that the proposals set out in the consultation were intended to better meet the NETS SQSS Objectives. To achieve this, they are intended to facilitate efficient and economic connection arrangements whilst ensuring there is no impact on the safety and security of the transmission system.
- 7.3 Responses were invited to provide their views on the following questions:
1. Do you agree with the general approach of treating Small, Medium and Large Power Stations consistently in the NETS SQSS planning studies irrespective of whether they are connected to the transmission system or embedded within a distribution system?
 2. Do you believe that GSR016 better facilitates the appropriate NETS SQSS objectives?
 3. Do you generally support the Modifications proposed by the Workgroup? If not, please clarify your concerns.
 4. Do you agree that the current treatment of embedded Small Power Stations and embedded Medium Power Stations in the NETS SQSS under the security background conditions could lead to a transmission system that could unduly restrict this embedded generation from supplying the demand? If not, please clarify why.
 5. Do you agree that the current treatment of embedded Small Power Stations and embedded Medium Power Stations in the NETS SQSS under the economy and background conditions could lead to a transmission system that could lead to an investment that is neither economic nor efficient? If not, please clarify why.
 6. Are there any other issues that could arise due to the current methodology of accounting for embedded generation in investment planning studies? If yes, please clarify what these are.
 7. The Workgroup has based their conclusions on a set of assumptions (Paragraphs 4.20 to 4.30). Do you agree with these assumptions? If not, what would be the impact on the proposal?
 8. Does the Modification proposed mitigate the risks identified? If not, please clarify where it fails to do so and how could these issues be addressed.
 9. The data provided under the Grid Code is generally not sufficient to allow Transmission Licensees to fully meet the Modifications proposed. The Workgroup has identified an interim arrangement assuming that a subsequent change to the Grid Code will provide the additional data. Do you agree with these arrangements? If not, please clarify the risks envisaged and the potential solutions.
 10. Do you agree with the view taken by the Workgroup that the NETS SQSS, in its current state, provides enough justification to economically justified additional reinforcements and/or alternative operational measures where

these are required to manage the system in the absence of sufficient participation in the Balancing Mechanism? If not, please clarify the reasons.

11. Are there any further technical considerations that need to be taken into account?
12. Please provide any other comments you feel are relevant to the proposed changes.

7.4 No responses were received.

7.5 Scottish Power Transmission and Scottish Hydro Electric Transmission have since submitted statements of support to the proposal. These statements are enclosed in Annex 3. National Grid, having been involved in the development of the proposal, is also supporting the implementation of this proposal.

7.6 With the main affected parties fully supporting the implementation of the modification detailed in Annex 2, it is recommended that these modifications are implemented.

National Electricity Transmission System Security and Quality of Supply Standards

GSR016

Medium and Small Embedded Generation Assumptions TERMS OF REFERENCE

Governance

The “Embedded Generation Assumptions” Workgroup was established by the National Electricity Transmission System Security and Quality of Supply Standards (NETS SQSS) Review Panel at the October 2013 NETS SQSS Review Panel meeting.

The Workgroup shall formally report to the NETS SQSS Review Panel.

Membership

The Workgroup shall comprise a suitable and appropriate cross-section of experience and expertise from across the industry, which shall include:

Name	Role	Representing
Xiaoyao Zhou	Chair	-
Tingyan Guo	Technical Secretary	-
Bieshoj Awad	SO Representative	National Grid - SO
Richard Proctor	SO Representative	National Grid - SO
Peter Stanton	TO Representative	National Grid - TO
Bless Kuri	TO Representative	Scottish Hydro Electric Transmission
David Adam	TO Representative	Scottish Power Transmission
Alan Creighton	DNO Representative	Northern Power Grid
	Authority Representative	Ofgem
	Observer	

Meeting Administration

The frequency of Workgroup meetings shall be defined as necessary by the Workgroup chair to meet the scope and objectives of the work being undertaken at that time.

National Grid shall provide technical secretary resource to the Workgroup and handle administrative arrangements such as venue, agenda and minutes.

The Workgroup will have a dedicated section on the National Grid website to enable information such as minutes, papers and presentations to be available to a wider audience.

Scope

A pictorial representation of the issues covered by the scope of this workgroup is shown in the figure below. The workgroup will only be considering issues and interactions that arise when applying NETS SQSS Section 2 and Section 4 criteria due to the size of the connection (small and medium vs large), the connection point (transmission vs embedded), and the contractual arrangement (BM Participant

vs Non-BM Participant). Other issues marked in the figure will be addressed via a different workgroup or in a different forum.

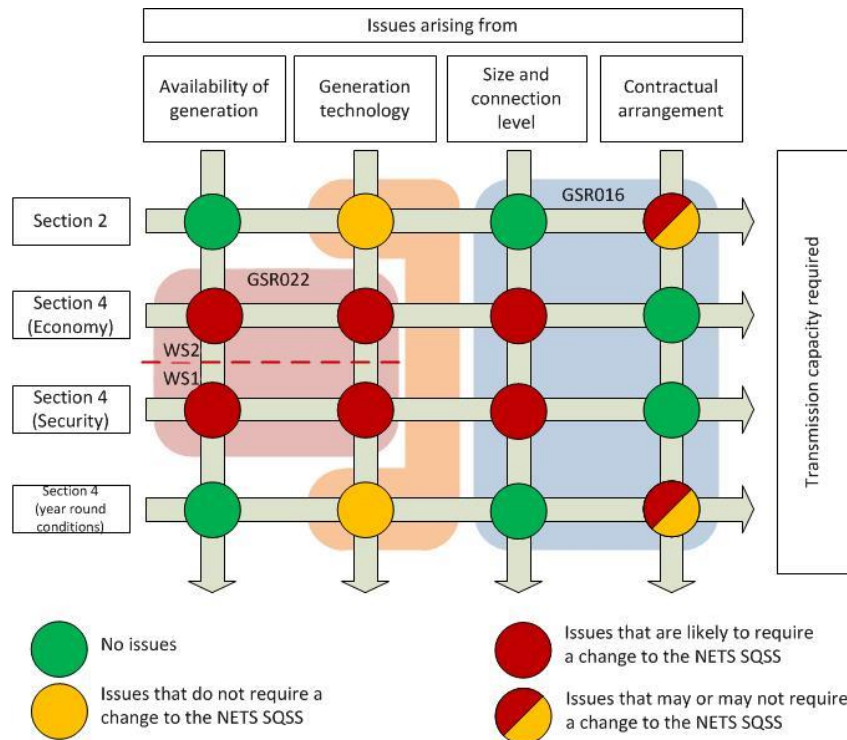

The Workgroup shall consider and report on the following

- the extent to which embedded generation is currently taken into account in NETS SQSS Section 2 and Section 4 studies;
- the risks arising from this approach;
- potential modifications to NETS SQSS Section 2 and Section 4, including the relevant appendices and definitions, to ensure that all generation is adequately accounted for;
- potential risks of non-compliance with Post Fault Criteria in NETS SQSS Sections 2 and 4 in general and Clauses 2.12 and 4.9 of the NETS SQSS in particular due to the System Operator's restricted ability to constrain some embedded generation;
- general outline for the scenarios that need to be studied to identify such risks;
- potential solutions, including transmission reinforcements and operational measures, that can be implemented to mitigate these risks;
- criteria to determine the preferred solution;
- where necessary, proposals to modify the NETS SQSS to allow the scenarios outlined to be studied and the solutions identified to be implemented;
- opportunities for achieving some benefits from any modifications to the NETS SQSS that the workgroup proposes using the datasets that are currently being exchanged between DNOs, the SO, and the TOs; and
- the changes to these datasets that are necessary to exploit the full benefit if the modifications proposed.

The scope of the Workgroup shall not include:

- Any modifications to the methodology applied to calculate the Economy Planned Transfer conditions or the Security Planned Transfer conditions other than what is required to ensure that embedded generation is correctly accounted for.
- Any revision to the scaling factors and/or the availability factors that are currently defined under Appendix C and Appendix E of the NETS SQSS.

Deliverables

The Workgroup shall provide updates and a Workgroup Report to the NETS SQSS Review Panel which will:

- Detail the findings of the Workgroup;
- Draft, prioritise and recommend any changes required to the NETS SQSS and any associated documents in order to implement the findings of the Workgroup; and
- Highlight any consequential changes which are or may be required.

Timescales

It is anticipated that this Workgroup shall provide an update to each NETS SQSS Review Panel meeting and present a Workgroup Report to the August 2016 NETS SQSS Review Panel meeting.

If for any reason the Workgroup is in existence for more than one year, there is a responsibility for the Workgroup to produce a yearly update report, including but not limited to; current progress, reasons for any delays, next steps and likely conclusion dates.

This section contains the proposed legal text to give effect to the Workgroup proposals. The proposed new text is in red and is based on NETS SQSS Version 2.3, Dated February 2017.

2. Generation Connection Criteria Applicable to the Onshore Transmission System

Background Conditions with a Local System Outage

2.13 Where necessary to satisfy the criteria set out in paragraph ~~2.13~~ 2.12, investment should be made in transmission capacity except where operational measures suffice to meet the criteria in paragraph ~~2.13~~ 2.12 provided that maintenance access for each transmission circuit can be achieved and provided that such measures are economically justified. The operational measures to be considered include rearrangement of transmission outages and appropriate reselection of generating units from those expected to be available, for example through balancing services. Guidance on economic justification is given in Appendix G.

Variations to Connection Designs

2.15 Variations, arising from a generation customer's request, to the generation connection design necessary to meet the requirements of paragraphs 2.5 to 2.14 shall also satisfy the requirements of this Standard provided that the varied design satisfies the conditions set out in paragraphs ~~2.16.1~~ ~~2.17.4~~ to ~~2.16.3~~ ~~2.17.3~~. For example, such a generation connection design variation may be used to take account of the particular characteristics of a *power station*.

2.16 Any generation connection design variation must not, other than in respect of the generation customer requesting the variation, either immediately or in the foreseeable future:

2.16.1 reduce the security of the MITS to below the minimum planning criteria specified in Section 4; or

2.16.2 result in additional investment or operational costs to any particular customer or overall, or a reduction in the security and quality of supply of the affected customers' connections to below the planning criteria in this section or Section 3, unless specific agreements are reached with affected customers; or

2.16.3 compromise any transmission licensee's ability to meet other statutory obligations or licence obligations.

2.17 Should system conditions subsequently change, for example due to the proposed connection of a new customer, such that either immediately or in the foreseeable future, the conditions set out in paragraphs ~~2.16.1~~ ~~2.17.4~~ to ~~2.16.3~~ ~~2.17.3~~ are no longer satisfied, then alternative arrangements and/or agreements must be put in place such that this Standard continues to be satisfied.

2.18 The additional operational costs referred to in paragraph ~~2.16.2~~ ~~2.17.2~~ and/or any potential reliability implications shall be calculated by simulating the expected operation of the national electricity transmission system in accordance with the operational criteria set out in Section 5 and Section 9. Guidance on economic justification is given in Appendix G.

11. Terms and Definitions

ACS Peak Demand

The estimated unrestricted winter peak demand (MW and MVar) on ~~the total system national electricity transmission system~~ for the *average cold spell* (ACS) condition. This represents the demand to be met by *large power stations* (directly connected or embedded), *medium power stations (directly connected or embedded)* and *small power stations (directly connected or embedded)* ~~which are directly connected to the national electricity transmission system~~ and by electricity imported into the *onshore transmission system* from *external systems* across *external interconnections* (and which is not adjusted to take into account demand management or other techniques that could modify demand).

Fault Outage

An outage of one or more items of *primary transmission apparatus equipment* and/or generation plant initiated by automatic action unplanned at that time, which may or may not involve the passage of fault current.

Plant Margin

The amount by which the total installed capacity of ~~directly-connected power stations and embedded large power stations~~ exceeds the net amount of the ACS peak demand minus the total imports from *external systems*. This is often expressed as a percentage (e.g. 20%) or as a decimal fraction (e.g. 0.2) of the net amount of the ACS peak demand minus the total imports from *external systems*.

Economy Planned Transfer Conditions

The condition arising from scaling the *registered capacity* of each ~~directly-connected power station and embedded large power station~~ according to the type of generation such that the total of the scaled capacities is equal to the ACS peak demand. This scaling shall follow the techniques described in Appendix E.

Planned Transfer Conditions

The condition arising from scaling the *registered capacities* of each ~~directly-connected power station and embedded large power station~~ such that the total of the scaled capacities is equal to the ACS peak demand minus imports from *external systems*. This scaling shall follow the techniques described in Appendix C.

Security Planned Transfer Conditions

The condition arising from scaling the *registered capacity* of each ~~directly-connected power station and embedded large power station~~ that is considered able to reliably contribute to peak demand security such that the total of the scaled capacities is equal to the ACS peak demand. Generation powered by intermittent sources (e.g. wind, wave, solar) and imports from *external systems* are not included in this condition. This scaling shall follow the techniques described in Appendix C.

Appendix C

C.3 In some circumstances apparent future *plant margins* may exceed 20%. This may arise where NGET has been notified of increases in future generation capacity but has not yet been formally notified of future reductions in generation capacity due to plant closures. The ranking order technique

maintains the output of ~~directly connected power stations and embedded large power stations~~ considered more likely to operate at times of ACS peak demand at more realistic levels and treats those less likely to operate as non-contributory.

C.4 This is achieved by ranking all directly connected power stations, ~~and embedded large power stations,~~ and groups of embedded medium power stations and embedded small power stations aggregated based on their generation technology and their location in order of likelihood of operation at times of ACS peak demand. Those power stations considered least likely to operate at peak are progressively removed and treated as non-contributory until a plant margin of 20% or just below is achieved. The output of the remainder is then calculated using the same scaling method as used in the straight scaling technique described in paragraphs C.5 and C.6 below.

C.5 In this technique, all ~~directly connected power stations and embedded large power stations on the system~~ at the time of the ACS peak demand are considered contributory and their output is calculated by applying a scaling factor to their registered capacity proportional to an availability representative of the generating plant type at the time of ACS peak demand such that their aggregate output is equal to the forecast ACS peak demand minus total imports from external systems.

C.6 P_{Ti} = the output of the i th ~~directly connected or embedded large~~ power station of generating plant type T

A_T = an availability representative of generating plant type T at the time of ACS peak demand

R_{Ti} = the registered capacity of the i th ~~directly connected or embedded large~~ power station of generating plant type T

P_{loss} = total national electricity transmission system active power losses at time of ACS peak demand

L_j = the active power demand at the j th national electricity transmission system demand site at the time of ACS peak demand

Appendix D

Figure D.1 – Notes

2. 'Generation' shall comprise

(a) the output from large power station, ~~medium power stations, and small power stations whether these are embedded or directly connected to the national electricity transmission system~~

~~(b) the output from directly connected small and medium power stations~~

(be) imports into the national electricity transmission system from external systems

Appendix E

E.5 All remaining ~~directly connected power stations and embedded large power~~

~~stations~~ on the system at the time of the *ACS peak demand* are considered contributory and their output is calculated by applying a scaling factor to their *registered capacity* such that their aggregate output is equal to the forecast *ACS peak demand* minus the total output of directly scaled plant.

E.6 P_{Ti} = the output of the i th ~~directly connected or embedded large~~ power station of generating plant type T

D_T = the direct scaling factor for directly scaled generation of plant type T

R_{DTk} = the *registered capacity* of the k th ~~directly connected or embedded~~
~~large~~ power station of generation plant type DT in the directly scaled category

R_{VTn} = the *registered capacity* of the n th ~~directly connected or embedded~~
~~large~~ power station of generation plant type VT in the variably scaled category

P_{loss} = total *national electricity transmission system* active power losses at time of *ACS peak demand*

L_j = the active power demand at the j th *national electricity transmission system* demand site at the time of *ACS peak demand*

Bless Kuri
Scottish Hydro Electric Transmission plc
Inveralmond House
200 Dunkeld Road
Perth, PH1 3AQ

Taran Heir
Code Administrator
National Grid
National Grid House
Warwick Technology Park
Warwick, CV34 6DA

01 February 2018

Dear Taran,

GSR016 Small and Medium Embedded Generation Assumptions – Consultation response

Scottish Hydro Electric Transmission plc (SHE Transmission) welcomes the opportunity to respond to the consultation on GSR016 – Small and medium embedded generation. SHE Transmission was represented on the GSR016 working group and at the SQSS Panel in the development of the proposals for small and medium embedded generation assumptions.

Having helped identify the issues cited in the modification proposal, and worked with the working group, we believe that the GSR016 proposals better facilitate the appropriate NETS SQSS objectives. We are therefore in support of the GSR016 modification proposals. We provide answers to specific consultation questions in Annex 1 to this letter.

Yours sincerely,

Bless Kuri

NETS SQSS and Grid Code Industry Consultation Response Proforma

GSR016 Small and Medium Embedded Generation Assumptions

Respondent:	<i>Bless Kuri</i> <i>07342027888</i> <i>bless.kuri@sse.com</i>
Company Name:	<i>Scottish Hydro Electric Transmission</i>
1. Do you agree with the general approach of treating Small, Medium and Large Power Stations consistently in the NETS SQSS planning studies irrespective of whether they are connected to the transmission system or embedded within a distribution system?	<i>Yes</i> <i>This allows a consistent background to facilitate coordinated system planning</i>
2. Do you believe that GSR016 better facilitates the appropriate NETS SQSS objectives?	<i>Yes</i>
3. Do you generally support the modifications proposed by the workgroup? If not, please clarify your concerns.	<i>Yes</i>
4. Do you agree that the current treatment of embedded Small Power Stations and embedded Medium Power Stations in the NETS SQSS under the security background conditions could lead to a transmission system that could unduly restrict this embedded generation from supplying the demand? If not, please clarify why.	<i>Yes</i> <i>Increasingly, more embedded generation is connecting to distribution systems resulting in some GSPs exporting power to the transmission system during the time of winter peak demand. It therefore means that the transmission system should be designed so as not to unduly restrict embedded generation from contributing to demand security.</i>
5. Do you agree that the current treatment of embedded Small Power Stations and embedded Medium Power Stations in the NETS SQSS under the economy and background conditions could lead to a transmission system that could lead to an investment that is neither economic nor efficient?	<i>Yes</i>

If not, please clarify why.	
<p>6. Are there any other issues that could arise due to the current methodology of accounting for embedded generation in investment planning studies? If yes, please clarify what these are.</p>	-
<p>7. The Workgroup has based their conclusions on a set of assumptions (Paragraphs 4.20 to 4.30). Do you agree with these assumptions? If not, what would be the impact on the proposal?</p>	Yes
<p>8. Does the modification proposed mitigate the risks identified? If not, please clarify where it fails to do so and how could these issues be addressed.</p>	Yes
<p>9. The data provided under the Grid Code is generally not sufficient to allow Transmission Licensees to fully meet the modifications proposed. The workgroup has identified an interim arrangement assuming that a subsequent change to the Grid Code will provide the additional data. Do you agree with these arrangements? If not, please clarify the risks envisaged and the potential solutions.</p>	Yes
<p>10. Do you agree with the view taken by the workgroup that the NETS SQSS, in its current state, provides enough justification to any additional reinforcements and/or operational measures where these are required to manage the system in the absence of sufficient participation in the Balancing Mechanism? If not, please clarify the reasons.</p>	<p>Yes</p> <p><i>There are sufficient provisions within the SQSS to cover these conditions.</i></p>
<p>11. Are there any further technical considerations that need to be taken into account?</p>	
<p>12. Please provide any other comments you feel are relevant to the proposed changes.</p>	

By e-mail –
box.SQSS@nationalgrid.com

Taran Heir
National Grid
Technology Park
Gallows Hill
Warwick
CV34 6DA

Your ref
GSR016
Our Ref

Date
23 January 2018
Contact / Extension
David Adam
0141 614 1866

Dear Taran

GSR016 - Small and Medium Embedded Generation Assumptions

With reference to the recently closed GSR016 consultation, we would like to note that we have been closely involved with the working group that developed this SQSS modification proposal. Therefore, SPT is in full support of the proposed GSR016 modification.

Yours sincerely



Cornel Brozio
System Analysis Manager
SP Energy Networks

SP House, 320 St Vincent Street, Glasgow. G2 5AD

Telephone: 0141 614 0008

www.spenergynetworks.co.uk