

G59 and G83 Protection Requirements

Stakeholder Workshop

8th May 2013, London

Introduction

Graham Stein

Technical Policy Manager

Network Strategy

National Grid

graham.stein@nationalgrid.com

Purpose of workshop

- Provide information on potential changes to G59 and G83
- Explain why changes are being considered and how they would be implemented
- Inform affected parties how they can get involved in the decision making progress
- To seek views on
 - how to resolve some technical questions
 - How best to engage affected parties throughout the process

Agenda

Welcome and introductions

Control of system frequency – recent events and the need for change

Graham Stein

Distribution Networks and Distributed Generation – design philosophy

Martin Lee

European Network Codes – effects on small generators

Graham Stein

Change Road Map – G83/G59

Martin Lee

Discussion Session

All

Summary and Next Steps

Introduction



Electricity Supply System

■ Structure

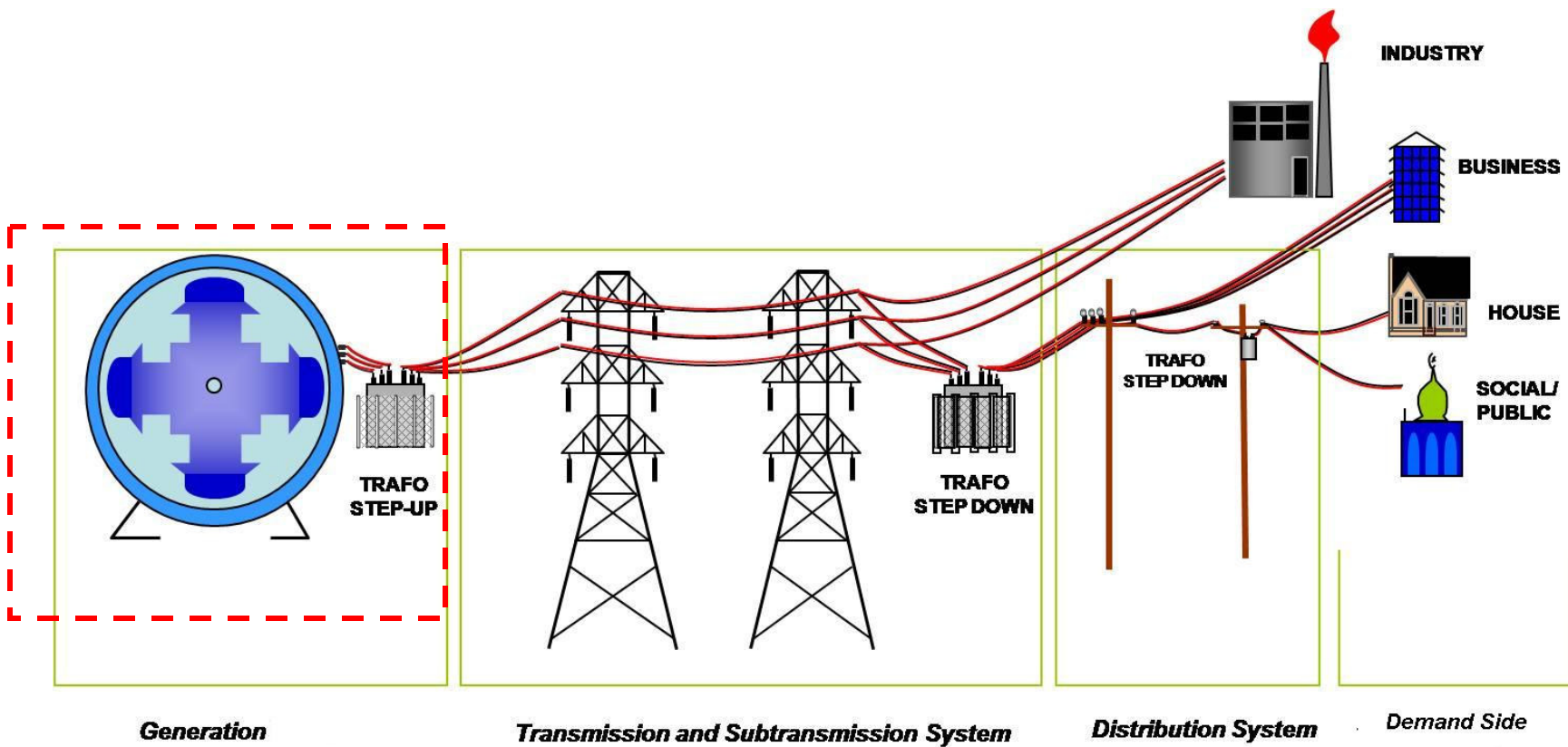

Electricity Transmission



Scotland and Offshore

132kV =< Transmission
132KV > Distribution



England and Wales

275kV =< Transmission
275kV > Distribution

Electricity Transmission

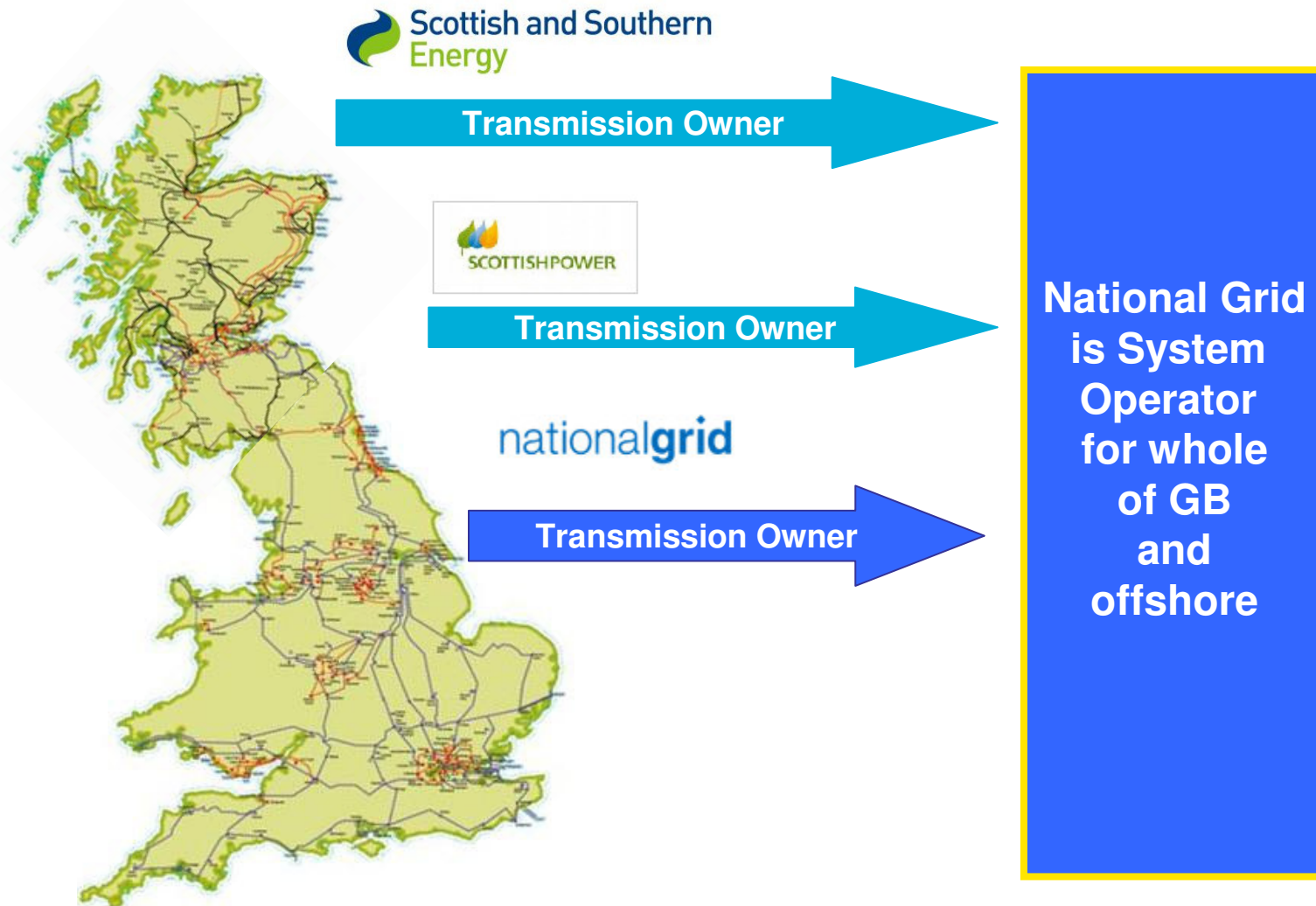

What is...

A Transmission Owner...the entity that owns and maintains the asset(s)

A System Operator...the entity who is responsible for monitoring and controlling the system in real time...

National Grid as System Operator

What we do:

Economically balance supply and demand, second by second for GB to keep frequency within statutory limits

Facilitate the energy market by maintaining adequate transmission capability within agreed security standards

Distribution Network

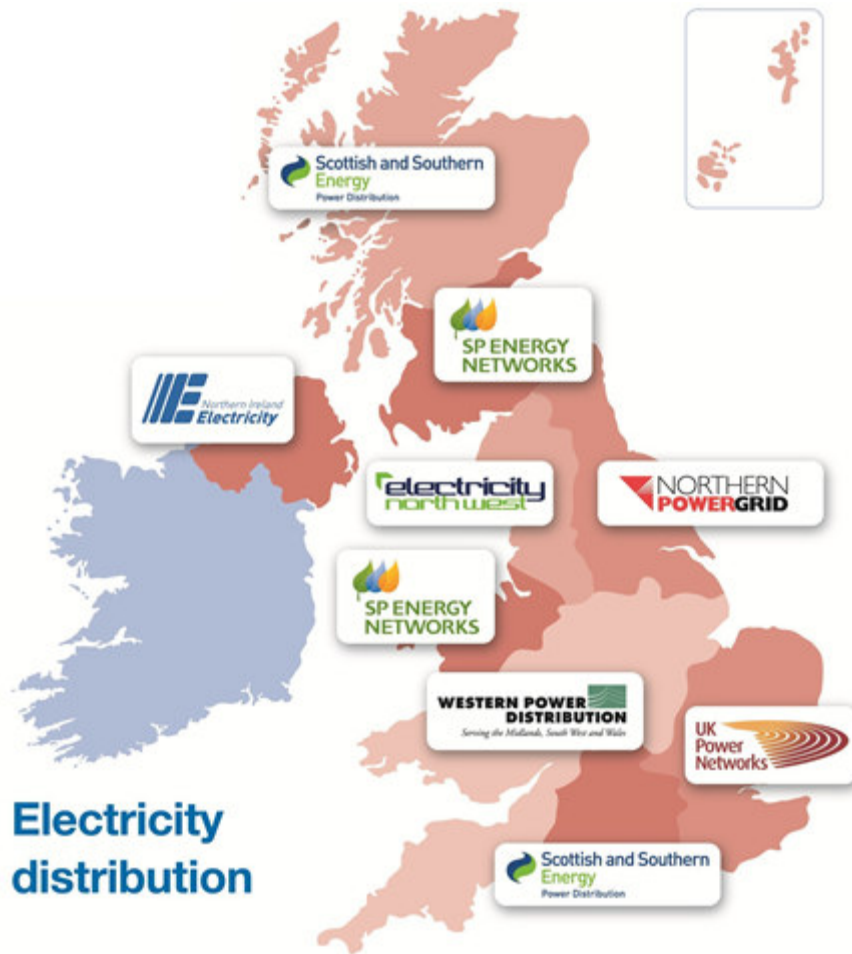

Area	Company
North Scotland	SSE Power Distribution
South Scotland	SP Energy Networks
North East England	Northern Powergrid
North West England	Electricity North West Limited
Yorkshire	Northern Powergrid
East Midlands	Western Power Distribution
West Midlands	Western Power Distribution
Eastern England	UK Power Networks
South Wales	Western Power Distribution
Southern England	SSE Power Distribution
London	UK Power Networks
South East England	UK Power Networks
South West England	Western Power Distribution
North Wales, Merseyside and Cheshire	SP Energy Networks

Statutory framework for Electricity Transmission

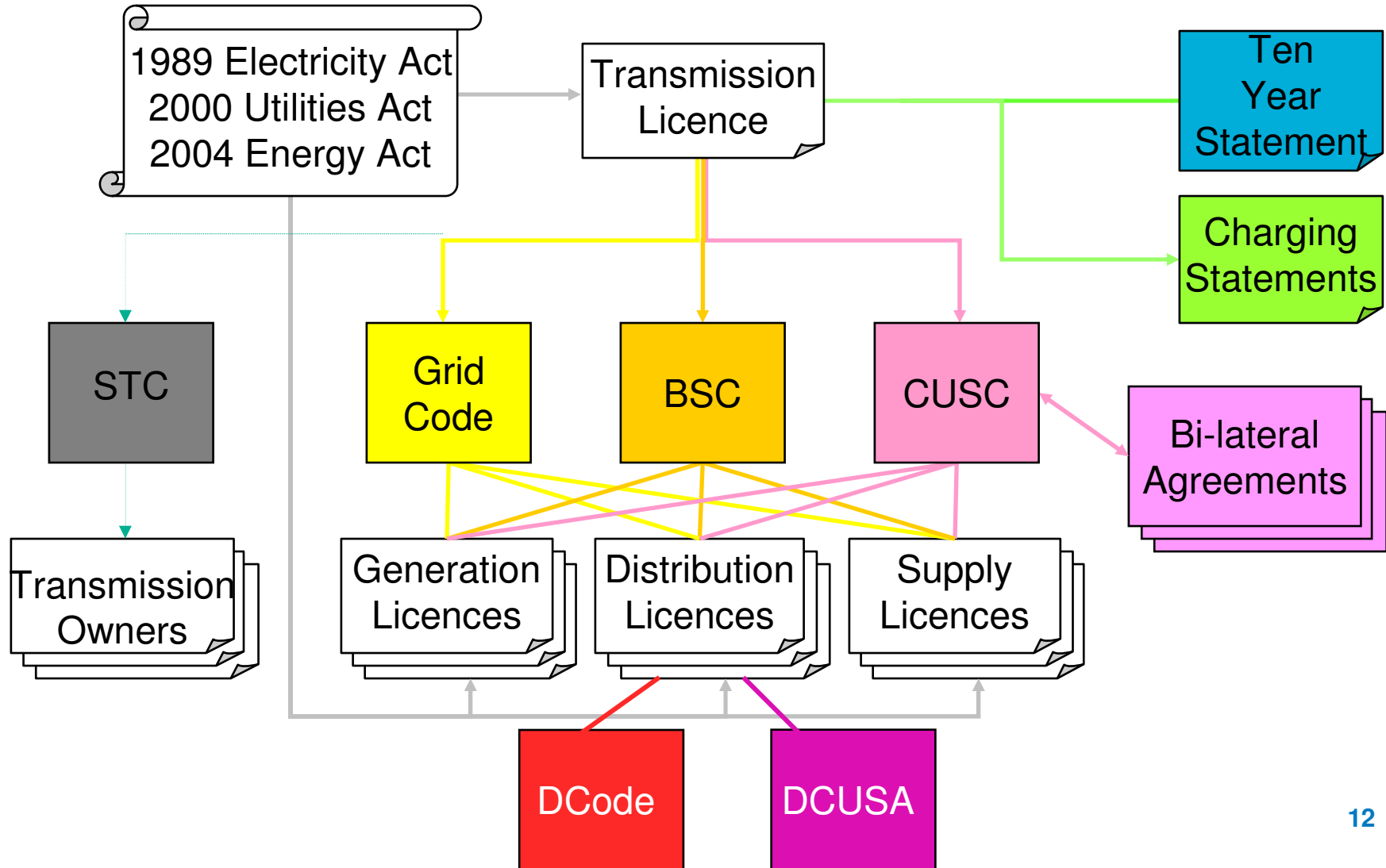

The Industry Framework / Obligations nationalgrid

Distribution

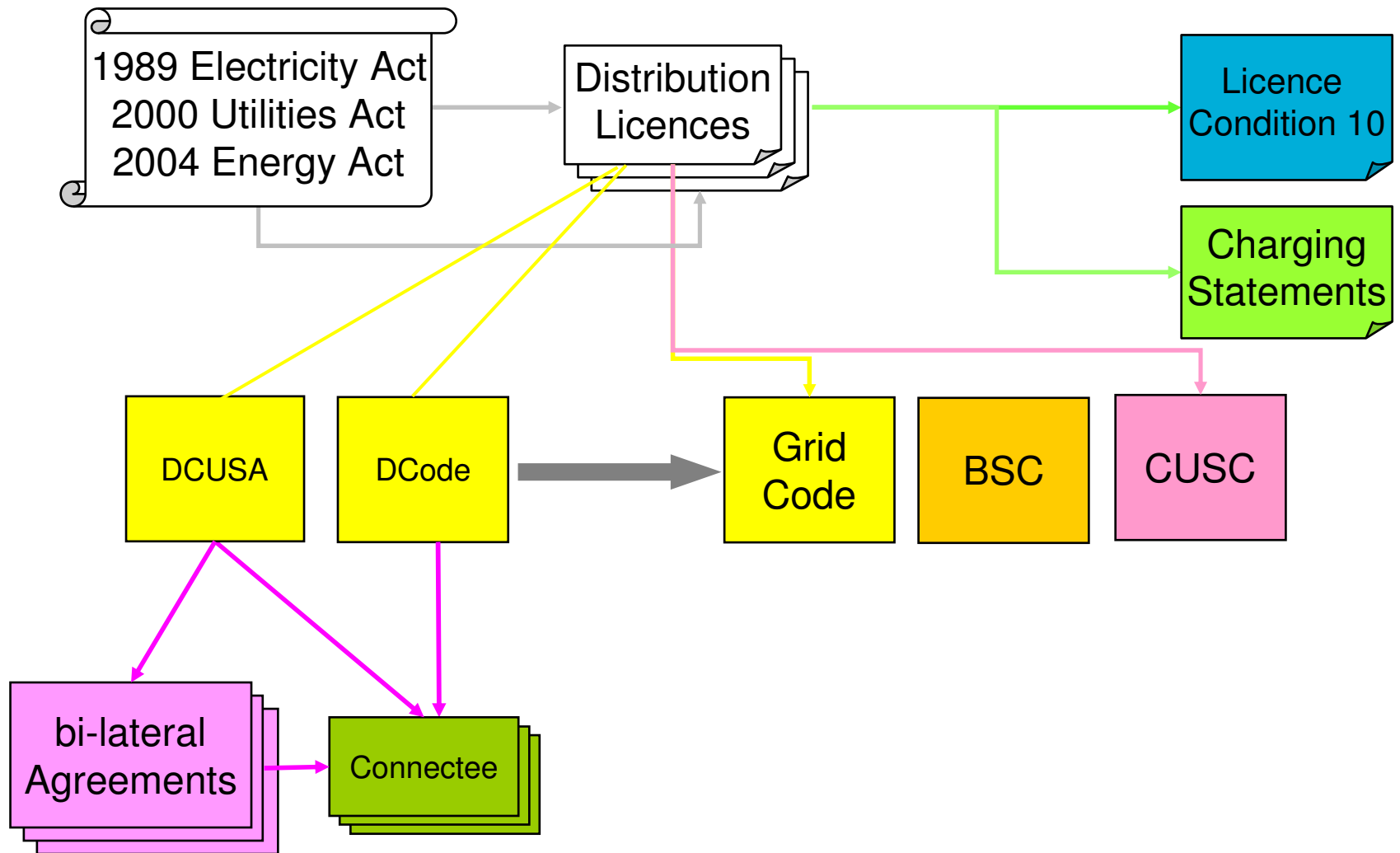

Changing the Grid Code

- The licence says
 - The licensee shall periodically review (including upon the request of the Authority) the Grid Code and its implementation
 - The review shall involve an evaluation of whether any revision or revisions to the Grid Code would better facilitate the achievement of the Grid Code objectives and, where the impact is likely to be material, this shall include an assessment of the quantifiable impact of any such revision on greenhouse gas emissions
 - Following any such review, the licensee shall send to the Authority
 - a report on the outcome of such review
 - any proposed revisions to the Grid Code
 - any written representations or objections from authorised electricity operators liable to be materially affected
- This process is enacted via the Grid Code Review Panel (GCRP) and its associated working groups

Changing the Distribution Code

- The licence says
 - The licensee shall periodically review (including upon the request of the Authority) the Distribution Code and its implementation
 - The review shall involve an evaluation of whether any revision or revisions to the Distribution Code would better facilitate the achievement of the Distribution Code objectives and, where the impact is likely to be material, this shall include an assessment of the quantifiable impact of any such revision on greenhouse gas emissions
 - Following any such review, the licensee shall send to the Authority
 - a report on the outcome of such review
 - any proposed revisions to the Distribution Code
 - any written representations or objections from authorised electricity operators liable to be materially affected
- This process is enacted via the Distribution Code Review Panel (DCRP) and its associated working groups

Frequency Control



Summer and winter demand

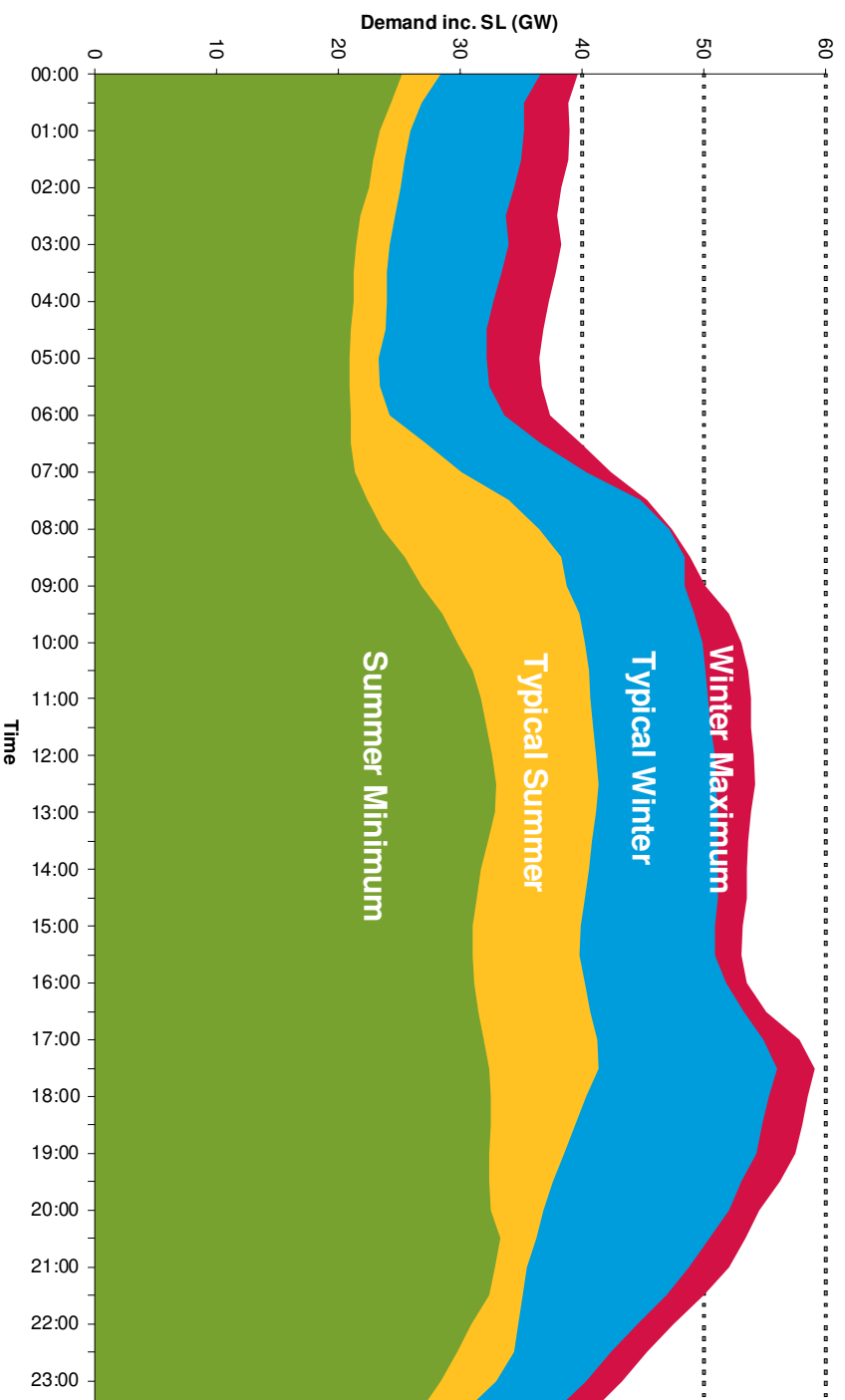

Electricity Demand weather effects

Weather Effect

Demand Response

Generating Units



Temperature
(1 °C fall in **freezing** conditions)

+ 1%



Wind
(10kt rise in **freezing** conditions)

+2%



Cloud cover
(clear sky to thick cloud)

+3%



Precipitation
(no rain to heavy rain)

+2%



Temperature
(1 °C rise in **hot** conditions)

+1%



AC Current

- Alternating Current (AC) Sinusoidal Waveform

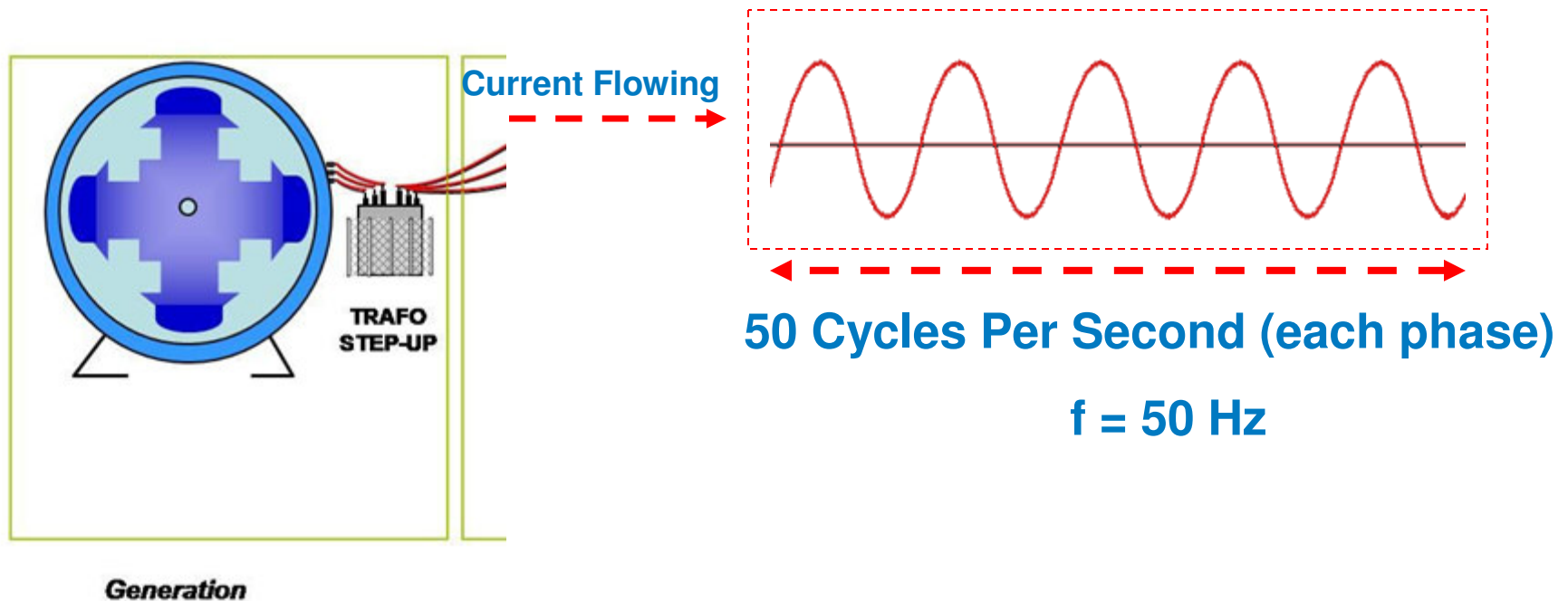

Frequency Limits

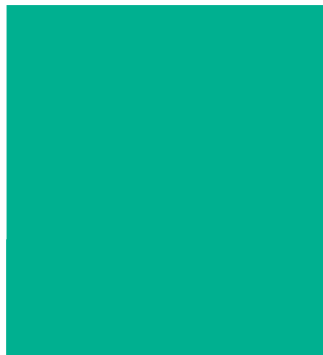

Generation

Demand

50.0 Hz

- 52.0 Upper Operating Limit
- 50.5 Upper statutory limit
- 50.0 Normal operating frequency
- 49.5 Lower statutory limit
- 48.8 Demand disconnection starts
- 47.8 Demand disconnection complete
- 47.5 Lower Operating Limit

Frequency and Inertia

- What is Inertia?
 - Combination of the mass of the object in motion and its speed or velocity
 - A rotating mass tends to keep rotating after force is removed
 - The heavier the object the greater the inertia

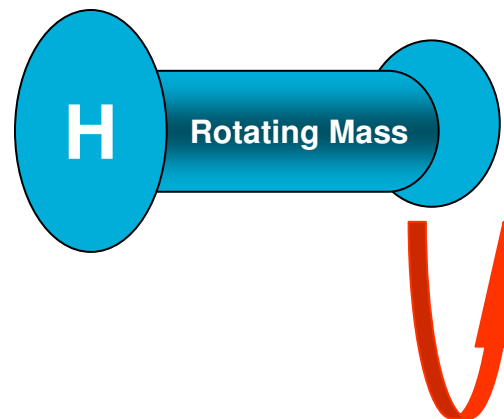

Frequency recovery after a Loss

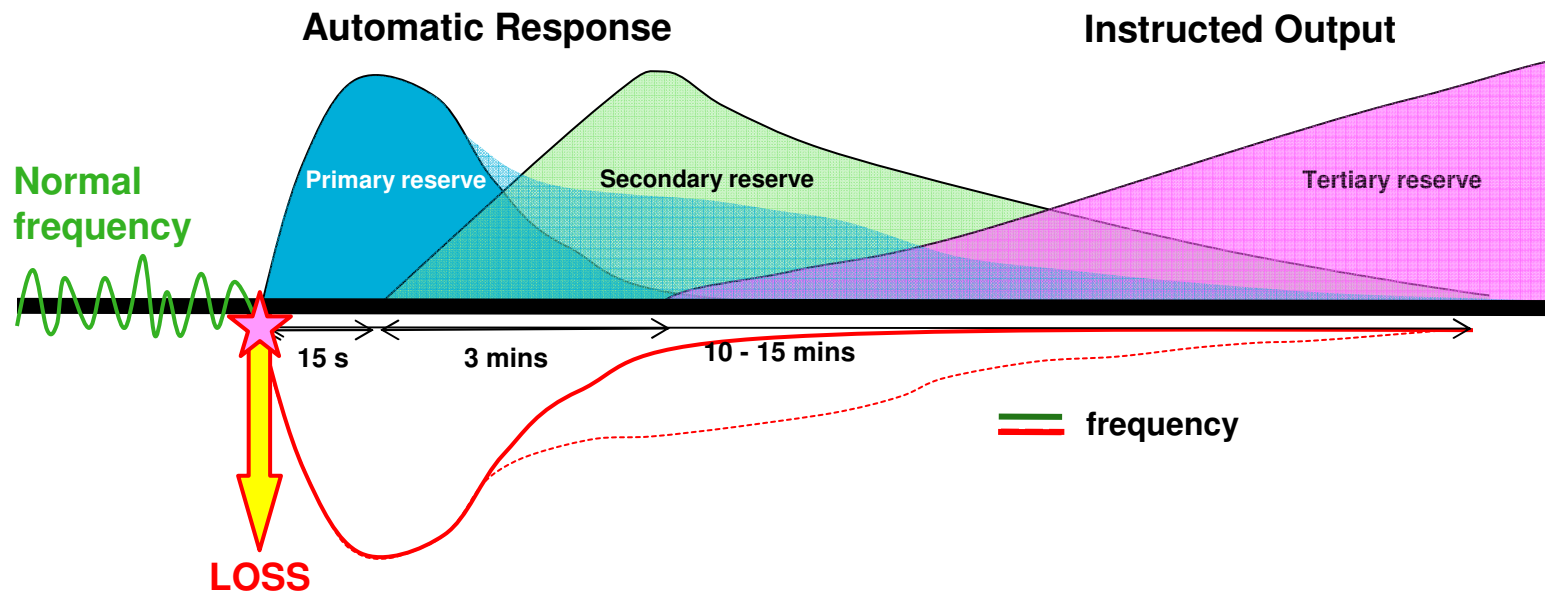

- Loss occurs and frequency response arrests the frequency change, Instructions are then despatched manually to restore response within 10-15 minutes

Frequency recovery after a Loss: a real example

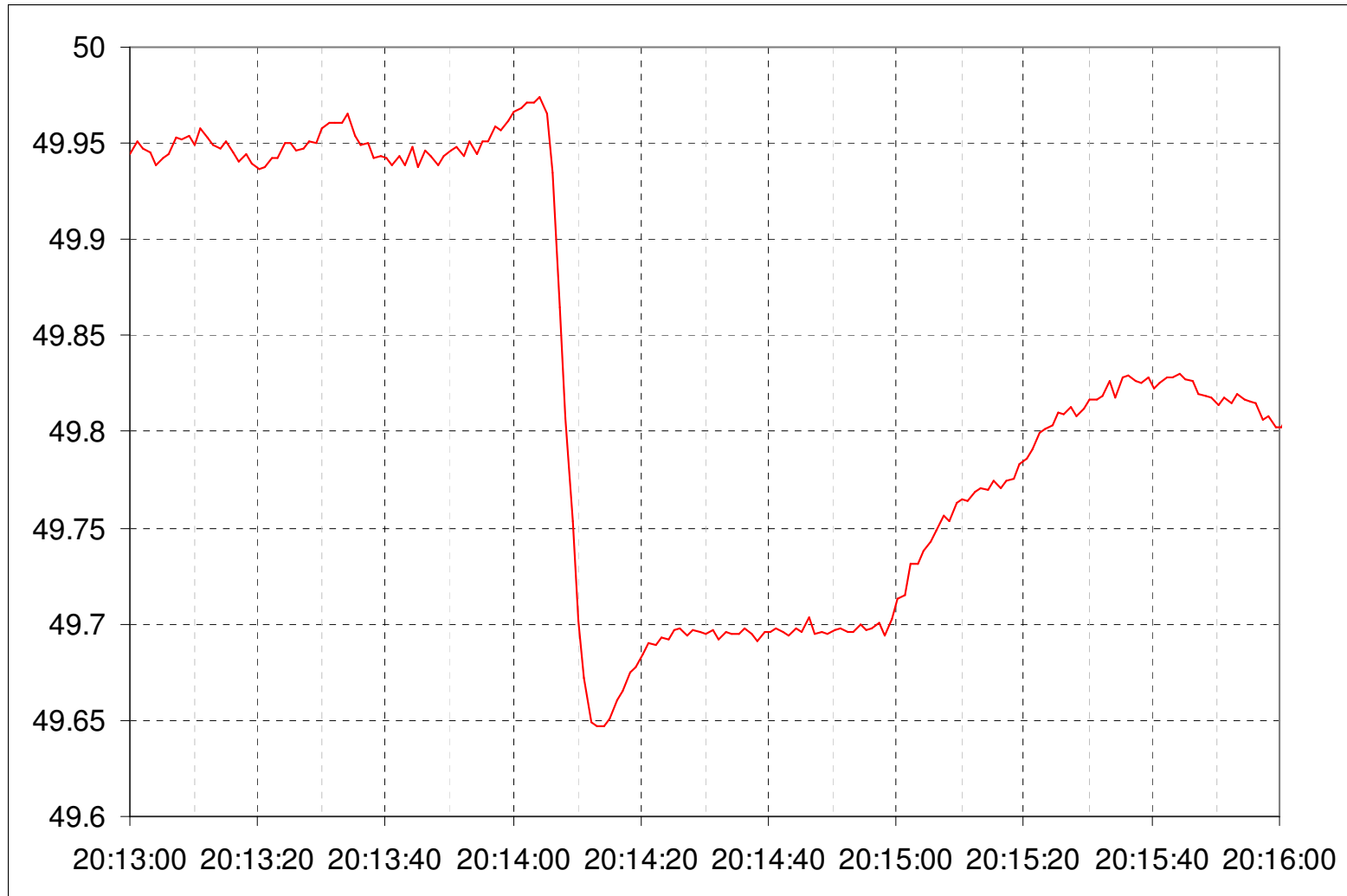

Rate of Change of Frequency

The link between Frequency Control and G59 and G83

Technical Background

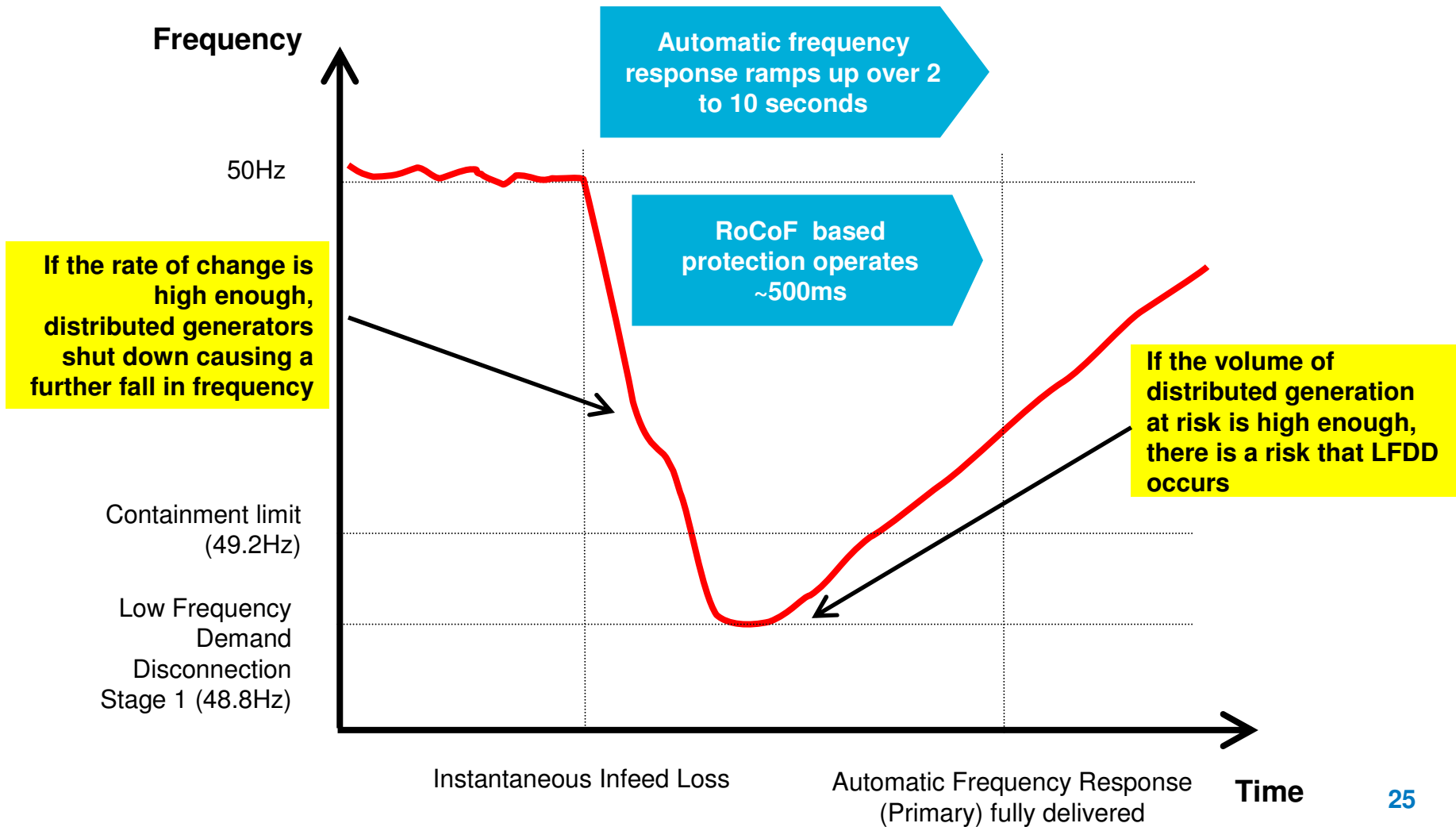

Technical Background

Stored Energy in Transmission Contracted Synchronised Generation for the 1B Cardinal Point (overnight minimum demand period)

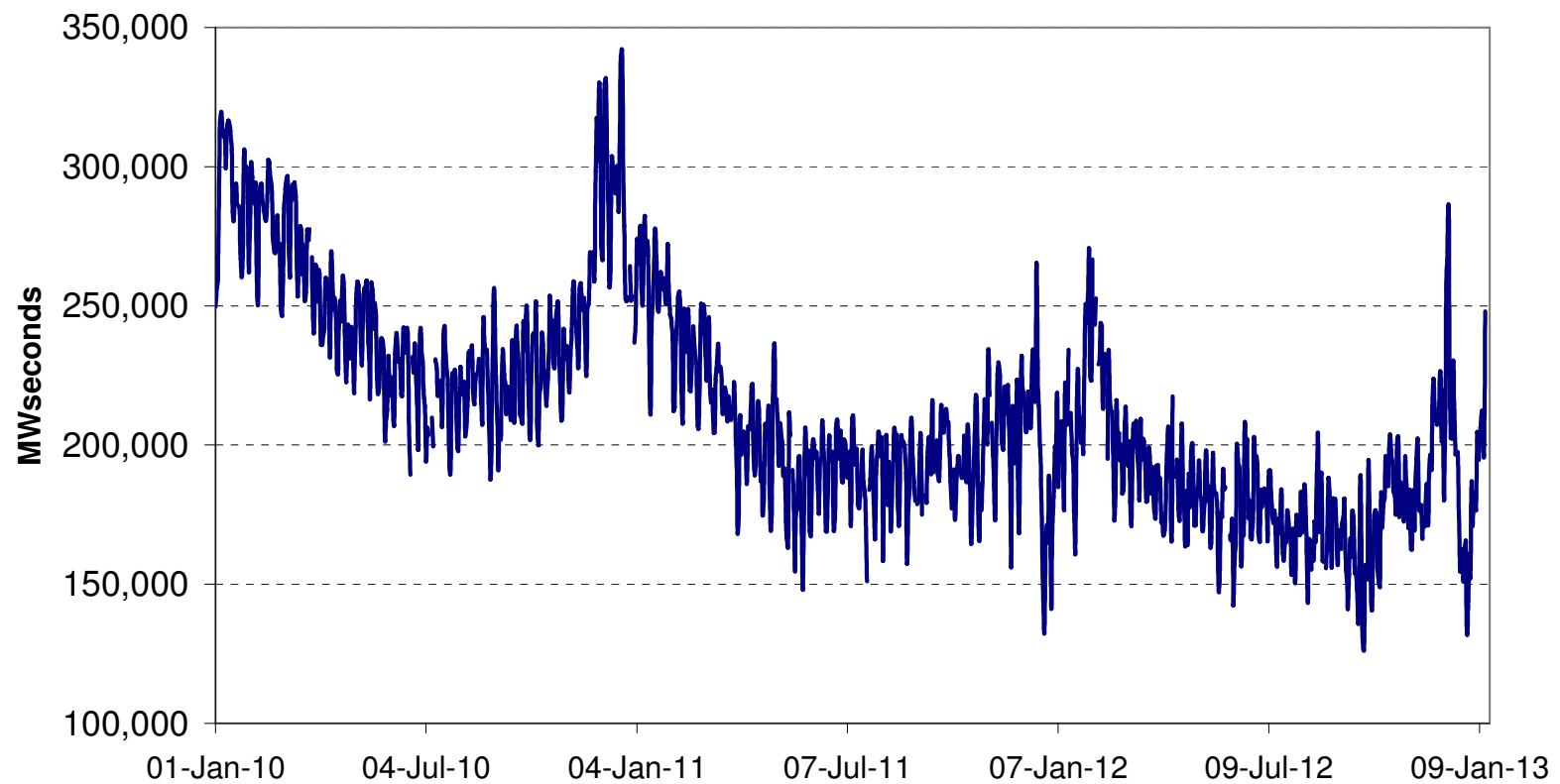

Technical Assessment

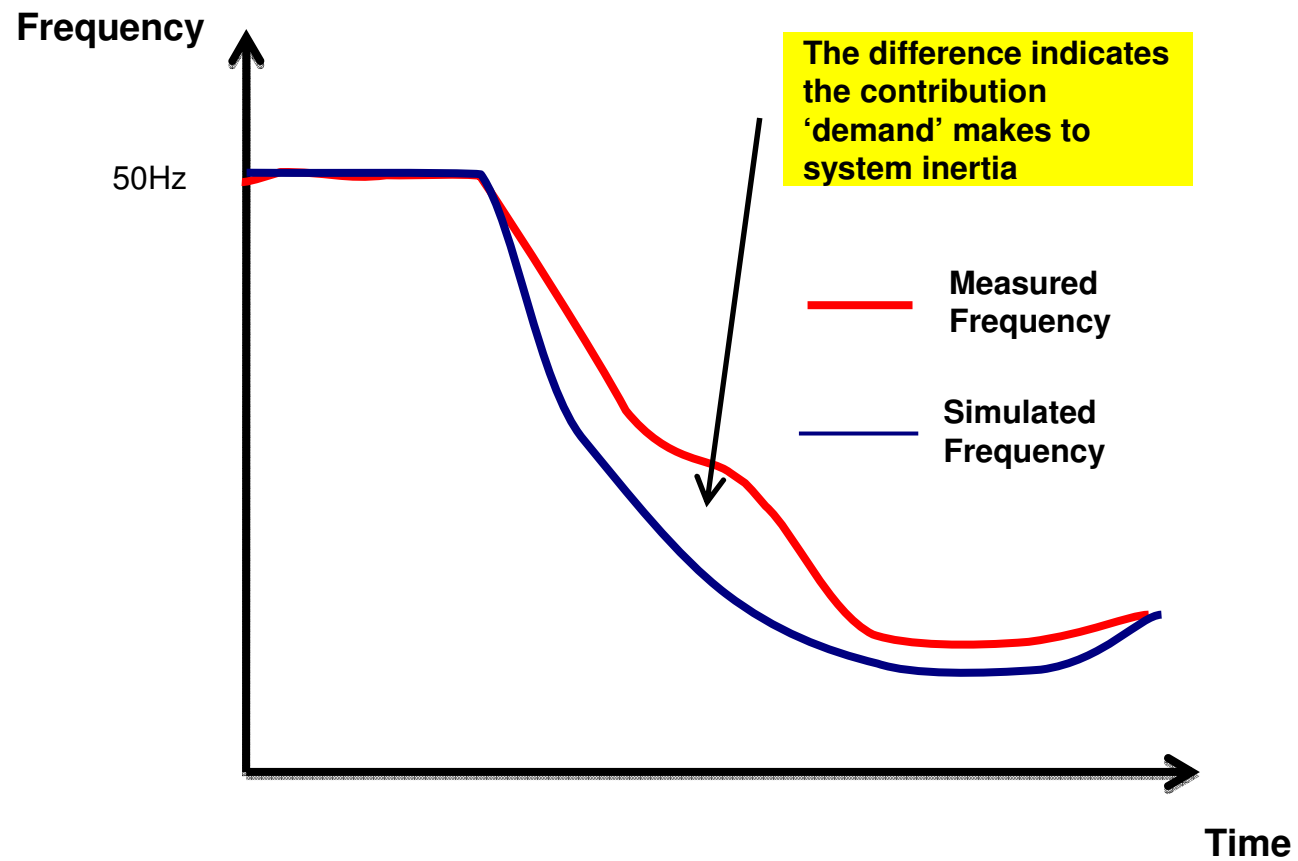

Technical Assessment

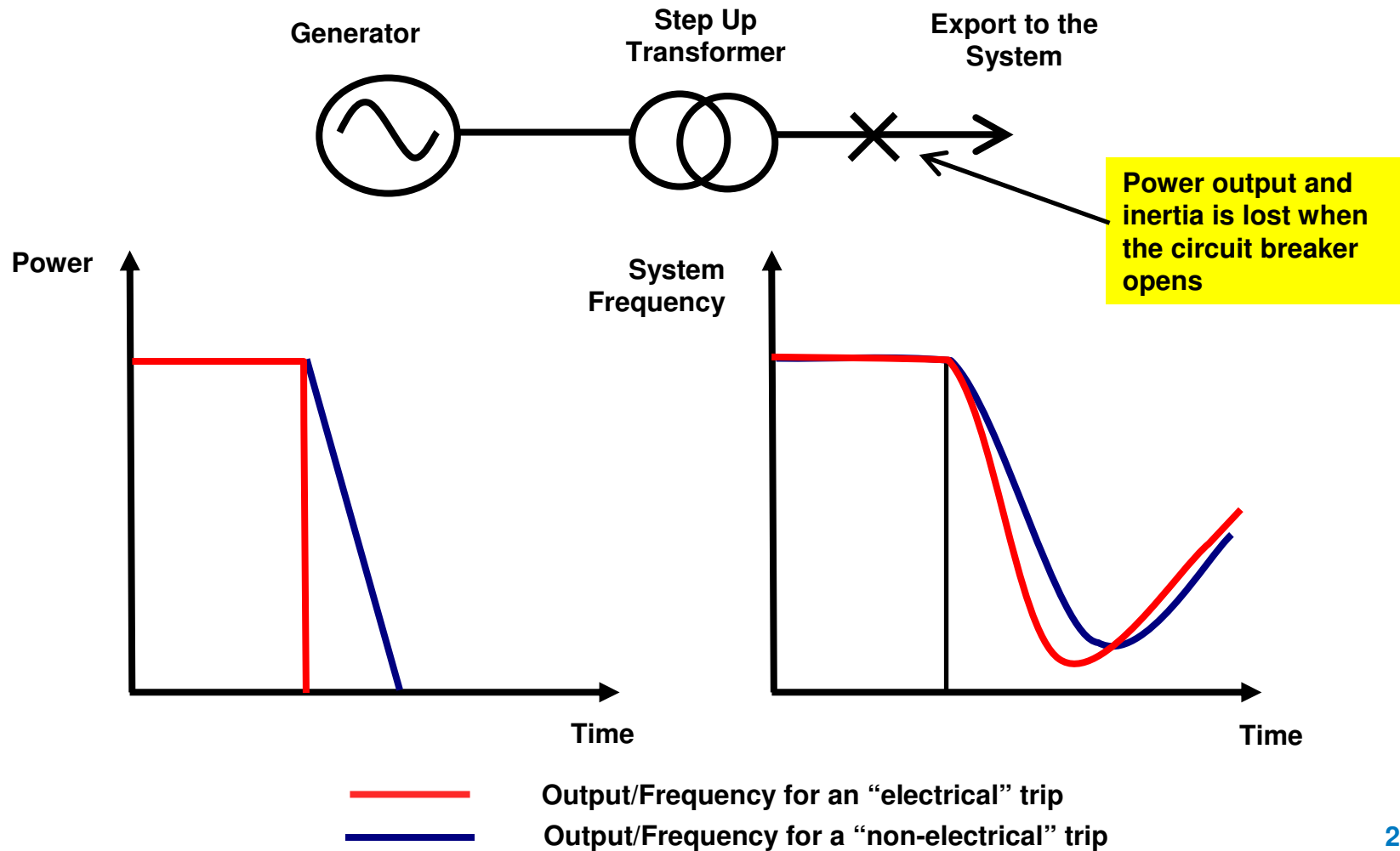

Technical Assessment

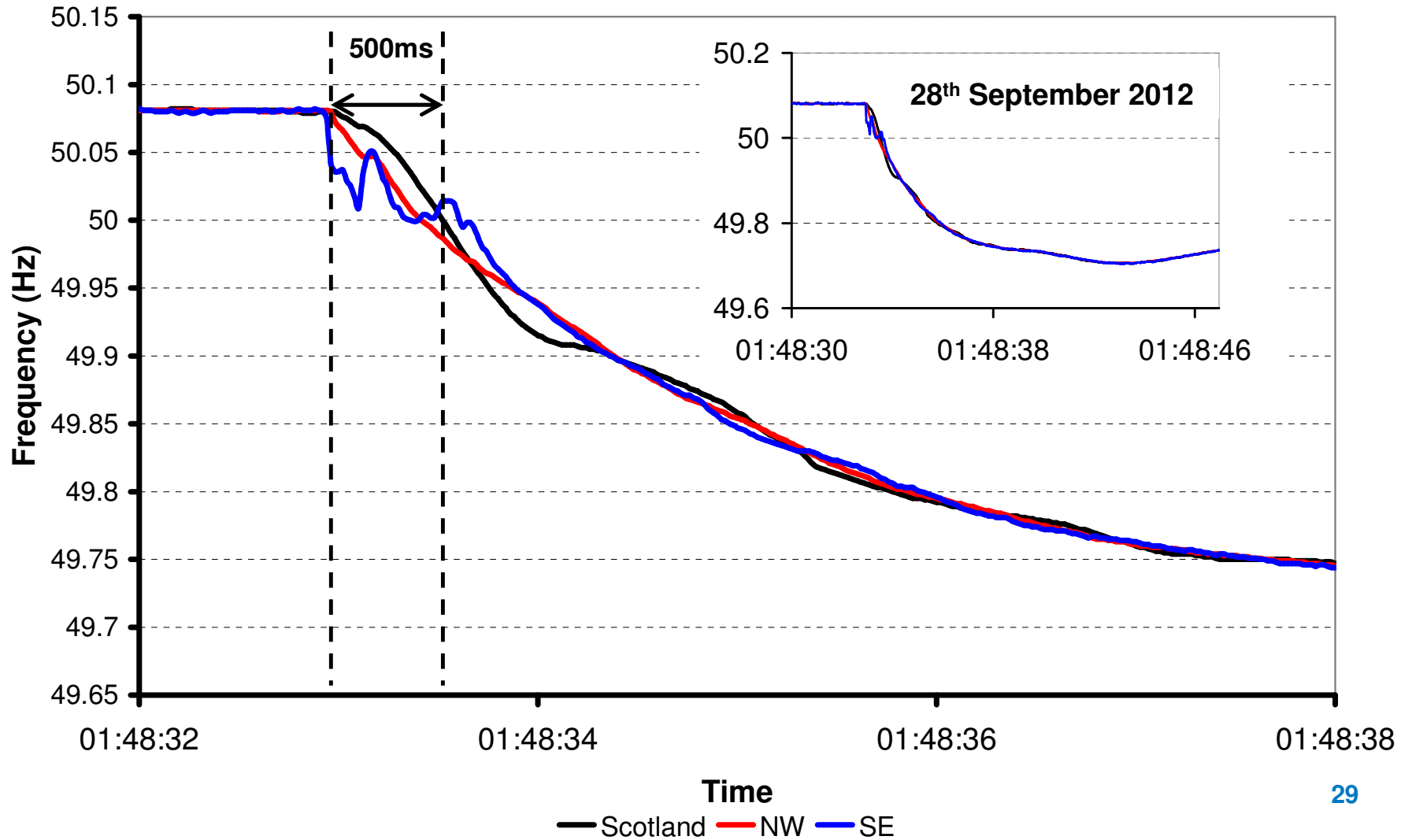

Summary of the RoCoF Risk

- The maximum rate of change risk occurs when demand is low and there is a large instantaneous infeed or offtake risk to manage
- The maximum rate of change is rising because
 - Synchronous generation is being displaced by non-synchronous plant – interconnectors and wind
 - There will be larger infeed losses in the future
 - There are trends within consumer demand which are reducing system inertia

Commercial Assessment

- Interaction with other system issues

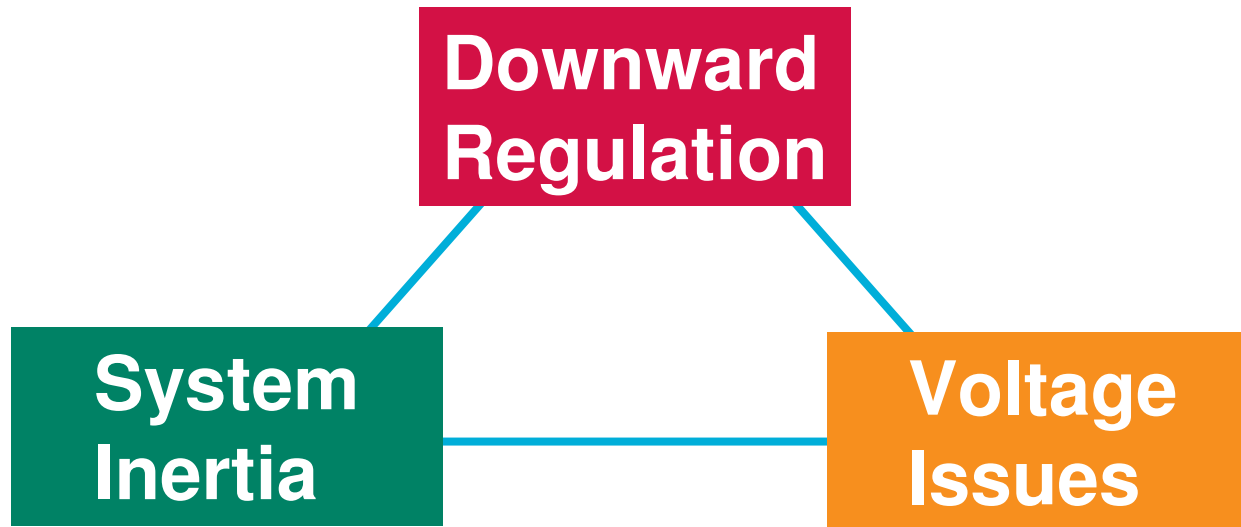

- Issues are all most prevalent overnight under high wind/import conditions
- System must be optimised to all three issues concurrently

Technical Solutions

- Options for Managing the Risk
 - Limiting the largest loss limits the rate of change
 - Increasing inertia by synchronising additional plant reduces the rate of change
 - Limiting the Rate of Change using automatic action (not currently feasible)
 - Changing or Removing RoCoF based protection

Changing or Removing RoCoF based protection

- Change proposals are being considered by a joint DCRP and GCRP workgroup
- DNOs, National Grid and Generators are represented

Name	Role	Representing
Mike Kay	Chair	Electricity North West
Robyn Jenkins	Technical Secretary	National Grid
Graham Stein	Member	National Grid
William Hung	Member	National Grid
Geoff Ray	Member	National Grid
Jane McArdle	Member	SSE (Generator)
Joe Duddy	Member	RES (Generator)
Paul Newton	Member	EON (Generator)
Joe Helm	Member	Northern Power Grid (DNO)
Martin Lee	Member	SSEPD (DNO)
John Knott	Member	SP Energy Networks (DNO)
Andrew Hood	Member	Western Power Distribution
Adam Dyśko	Technical Expert	University of Strathclyde
Julian Wayne	Authority Representative	Ofgem

Changing or Removing RoCoF based protection

- The workgroup has
 - Published an open letter to stakeholders
 - Informing of a possible change with widespread impact
 - Stating how policy decisions will be made
 - How to get involved (workshops scheduled end of April)
 - Set in motion further information gathering on actual relay settings
 - Initiated a reviewed of international practice
 - Including recent proposal in Ireland

Changing or Removing RoCoF based protection

- The workgroup has also
 - Developed a view of future frequency rates of change
 - Risk of rates of up to 1Hzs^{-1} plausible by 2020
 - Agreed the scope of a hazard assessment for RoCoF setting changes
 - To 0.5Hzs^{-1} and to 1Hzs^{-1} , using variable 'delay'
 - Encompassing 'larger' distributed generation (5MVA and 50MVA connected to 33kV voltage level)
 - Building on previous LoM and NVD work

Changing or Removing RoCoF based protection

- The workgroup intends to
 - Table its proposals for generating plant of 5MW and greater in July
 - Proposals will include a view of costs, benefits and risks for affected parties
 - Any changes will be subject to a consultation to follow
 - Develop a program of works to address
 - Generators of less than 5MW
 - Multi-machine islands
 - Small Inverter based technologies
 - Withstand criteria

Q & A

Distribution Networks and Distributed Generation

Design Philosophy

Frequency Resilience WG



Distribution Network Operators Design Approaches to Distributed Generation

Martin Lee

Scottish and Southern Energy Power Distribution plc.

8th May, London

- Of the public
- For DNO staff and their contractors
- Equipment – belonging to anyone/everyone

This is the primary purpose of the existing arrangements – and is the driver for the legislation.

Power islands are not expected, and should not be allowed to form.

- Energy Act 1983
- Electricity Supply Regulations 1988 and
- Electricity Safety, Quality and Continuity Regulations 2002

Prior to the 1983 Act it was almost impossible to generate in parallel with the public supply.

ER G59 was first written to deal explicitly with the issues perceived at that time and was published in 1985

ESR 1988 quoted chunks of G59 directly in Schedule 3

ESQCR 2002 removed the prescriptive text and revoked the ESR 1988, but still expected compliance with G59/1 (1991) (cited explicitly in the guidance notes to ESQCR)

Prevention of Islands

- Loss of mains protection is designed to avoid problems for the following technical issues
 - Out of synchronism re-closure
 - Earthing of an energised network
 - Protection
 - Control of Voltage and Frequency

Out of synchronism re-closure

- DNOs employ auto-reclose systems at all voltages
- Typical dead times are between 3s and 120s but can be as fast as 1s
- After the dead time the circuit will automatically be re-energized (though it may trip again if the fault is still present on the system)
- If the generator has continued to generate, there is a high probability that the system and the generator will be out of phase
- This will impose a shock on both the system and the generator
- For some generating plant this may cause severe damage – and create a potentially dangerous situation

- DNO High Voltage systems are only earthed at one point, at the source
- If a generator supports an electrical island within a DNO network, in most cases this will not include the source transformers for that network
- The island will then be unearthed
- This is dangerous as an earth fault on the HV system will be undetected and can give rise to danger to persons, it is also not allowed under ESQCR 2002
- ESQCR section 8 part 1 and part 2a place this responsibility upon both the generator and the distributor, (DNO in most cases)

Earthing

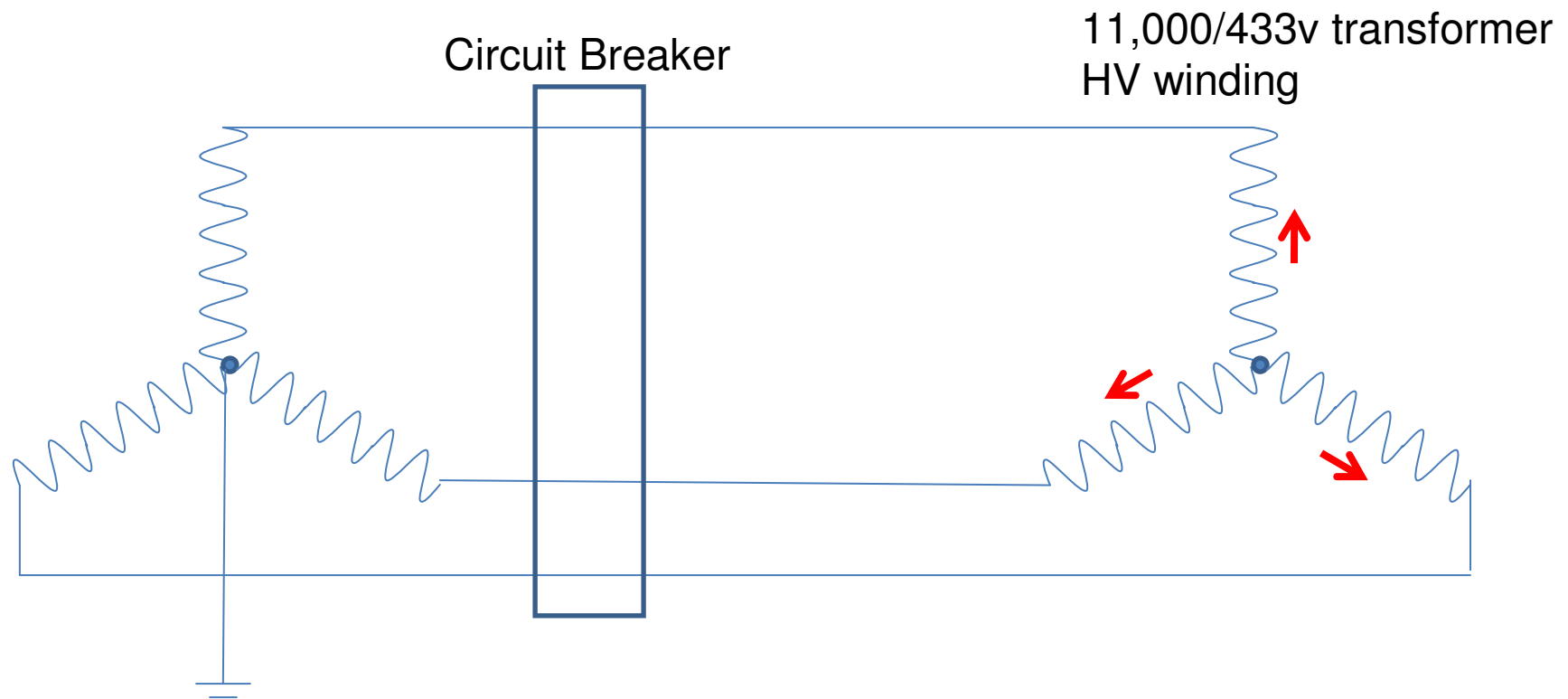

Earthing

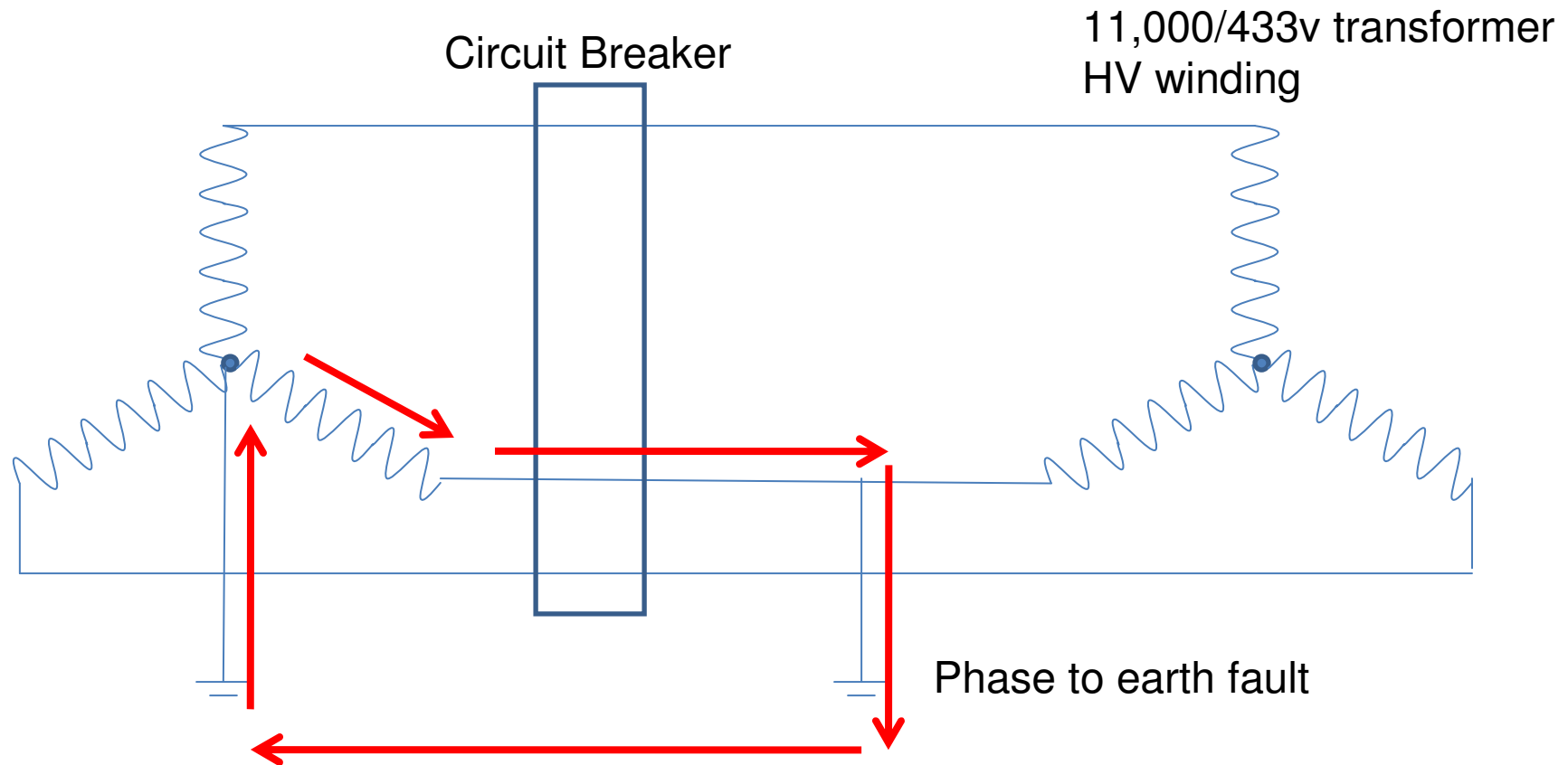

Fault current detected by protection on DNO circuit breaker and CB opened

Earthing

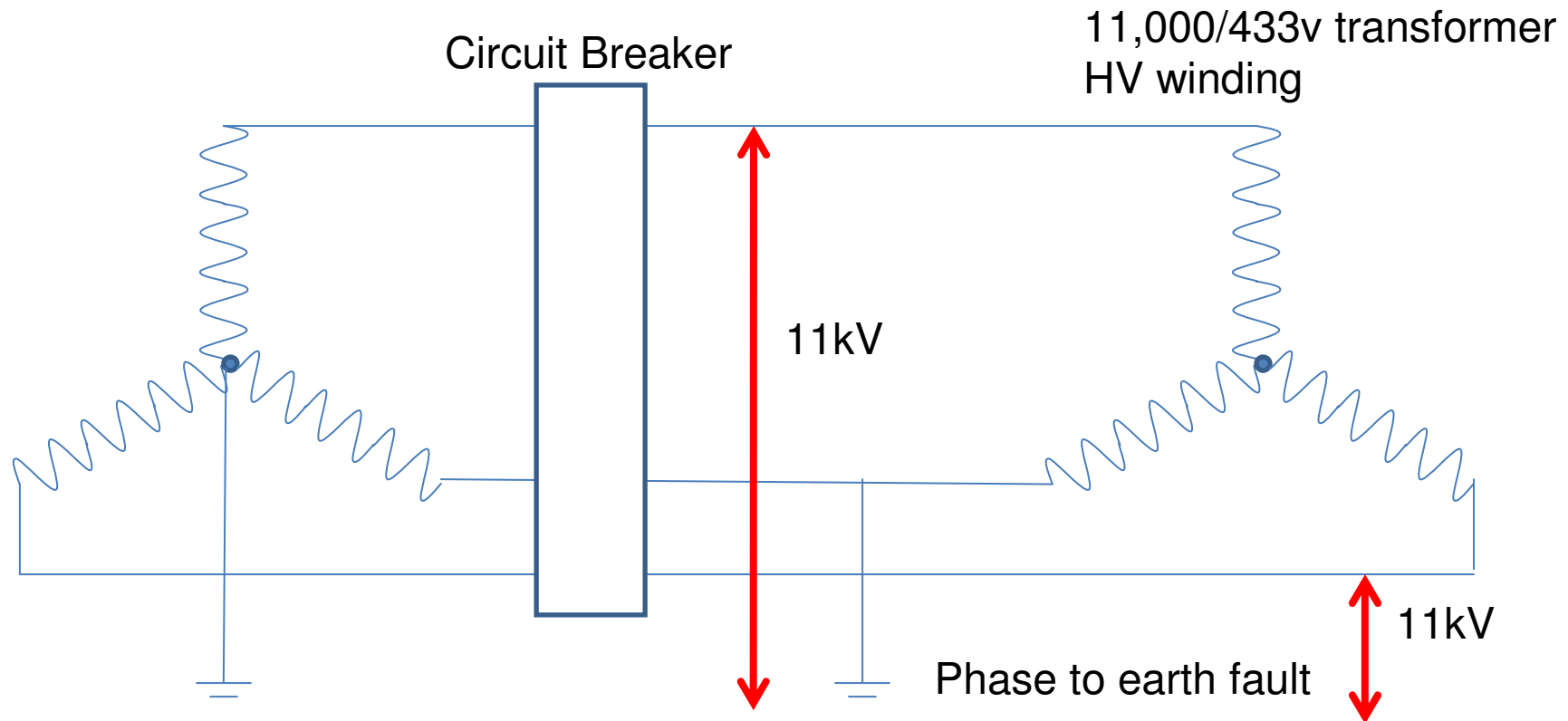

One phase earthed by fault, other two phases rise to line to line voltage from Earth potential.

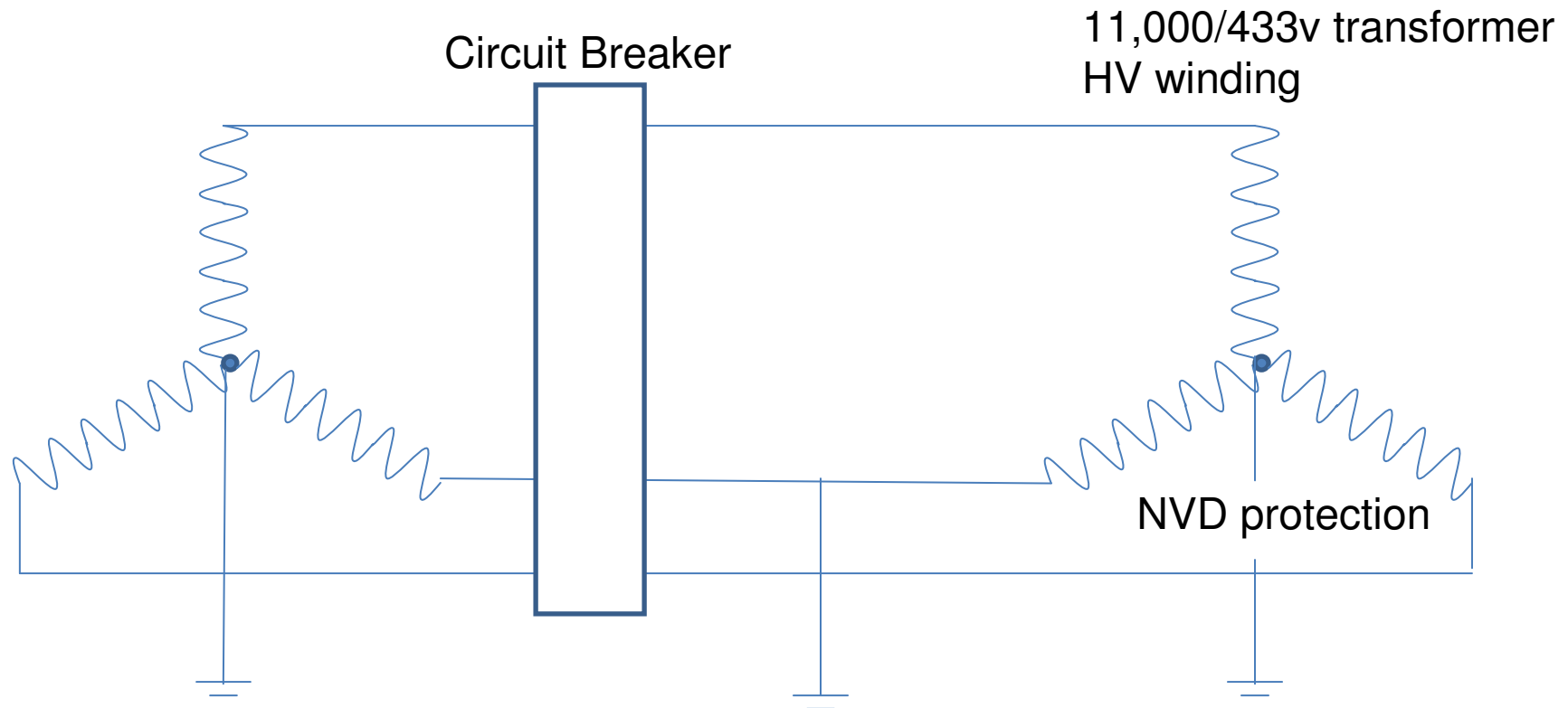

- It is this risk that makes Neutral Voltage Displacement protection appropriate in some cases

- DNOs protection against faults usually relies on high fault currents to operate protection
- The source of the DNOs system has a low impedance
- A generator supporting an island of the DNOs system will have a much higher source impedance and may not provide sufficient current to operate the DNO's protection systems.
- The worst case scenario is that many small generators contribute a small amount of fault current which is not sufficient to trip the generators but which does not provide sufficient current to operate the DNO protection.
- Again Neutral Voltage Displacement protection may be appropriate to clear unbalanced earth faults, but this may also bring a considerable financial penalty

Control of Voltage and Frequency

- A generator supplying an island of DNO's network will be controlling (either deliberately or inadvertently) the voltage and frequency of the island – and the voltage and frequency provided to customers
- If the generator has not been designed to maintain these within acceptable limits, customers' equipment might be damaged
- There is no clear contractual path, or case law, for the consequent liabilities
- Having functioning loss of mains protection is the generator's responsibility
- Note that for system stability reasons the over and under voltage, and frequency protection settings in G59 and G83 are set well outside the quoted range of voltage and frequency.

Loss of Mains Protection

- An effective loss of mains protection is Reverse Power detection – however if the generator wished to export, this approach cannot be used.
- The use of dedicated inter-tripping circuits is also very effective but incurs a high capital and revenue cost and is not appropriate for smaller DG
- Traditionally, two methods for the detection of loss of mains, based on frequency measurements have been considered suitable, though they both suffer from nuisance tripping during faults on associated networks. For all its difficulties, Rate of Change of Frequency (RoCoF) protection has been believed to be the best compromise, though Vector Shift (VS) protection can be very effective when used with asynchronous generating units

- As shown earlier by National Grid it is appropriate to review the overall approach to the use of RoCoF and VS as loss of mains techniques.
- Ride through tests for RoCoF and VS will be required to ensure that embedded generation can contribute to the total system demand in a secure way in the future. G83/2 has already brought in stability tests which will be compulsory for sub 16A generating units by the end of February 2014, and this is to be extended to Type tested equipment in G59/3 which is currently out for consultation. Though these only require stability tests for RoCoF events of 0.19Hz per second and much larger figures are expected to be required in the future.

Q & A

European Network Codes

Impact on small generators

European Network Codes

Network Code	Content
Requirements for Generators	Sets functional requirements which new generators connecting to the network (both distribution and transmission) will need to meet, as well as responsibilities on TSOs and DSOs .
Demand Connection	Sets functional requirements for new demand users and distribution network connections to the transmission system, basic Demand Side Response capabilities, as well as responsibilities on TSOs and DSOs.
HVDC	Sets functional requirements for HVDC connections and offshore DC connected generation.
Operational Security	Sets common rules for ensuring the operational security of the pan European power system.
Operational Planning & Scheduling	Explains how TSOs will work with generators to plan the transmission system in everything from the year ahead to real time.
Load Frequency Control & Reserves	Provides for the coordination and technical specification of load frequency control processes and specifies the levels of reserves (back-up) which TSOs need to hold and specifies where they need to be held.
Capacity Allocation & Congestion Management	Creates the rules for operating pan-European Day Ahead and Intraday markets, explains how capacity is calculated and explains how bidding zones will be defined.
Balancing	Sets out the rules to allow TSOs to balance the system close to real time and to allow parties to participate in those markets.
Forward Capacity Allocation	Sets out rules for buying capacity in timescales before Day Ahead and for hedging risks.

Thresholds

- Under the ENTSO-E Provisions Type A – C Power Generating Modules are connected below 110kV and ranging in size between 800 W – 30MW
- Type D is any Power Generating Module which is connected at or above 110kV or is 30MW or above
- In summary Type A – C Power Generating Modules will be connected to the Distribution Network and need to comply with the requirements of the Distribution Code
- Type D Generating Modules will either be directly connected and need to comply with the requirements of the Grid Code or Embedded and need to meet the requirements of the Distribution Code and Grid Code

Frequency Stability Requirements

- applicable to all unit types (800W and above)

Article	Topic
Article 8 (1) (a)	Frequency range
Article 8 (1) (b)	Rate of Change of Frequency
Article 8 (1) (c)	Limited Frequency Sensitive Mode – Over- frequency
Article 8 (1) (d)	Maintenance of target Active Power output regardless of changes in System Frequency
Article 8 (1) (e)	Active Power output not to fall more than prorata with frequency

Frequency Range

1. Type A Power Generating Modules shall fulfil the following requirements referring to Frequency stability:
 - a) With regard to Frequency ranges:
 - 1) A Power Generating Module shall be capable of staying connected to the Network and operating within the Frequency ranges and time periods specified by table 2.
 - 2) While respecting the provisions of Article 4(3), wider Frequency ranges or longer minimum times for operation can be agreed between the Relevant Network Operator in coordination with the Relevant TSO and the Power Generating Facility Owner to ensure the best use of the technical capabilities of a Power Generating Module if needed to preserve or to restore system security. If wider Frequency ranges or longer minimum times for operation are economically and technically feasible, the consent of the Power Generating Facility Owner shall not be unreasonably withheld.
 - 3) While respecting the provisions of Article 8(1) (a) point 1) a Power Generating Module shall be capable of automatic disconnection at specified frequencies, if required by the Relevant Network Operator. While respecting the provisions of Article 4(3), Terms and settings for automatic disconnection shall be agreed between the Relevant Network Operator and the Power Generating Facility Owner.

Frequency Range

Synchronous Area	Frequency Range	Time period for operation
Great Britain	47.0 Hz – 47.5 Hz	20 seconds
	47.5 Hz – 48.5 Hz	90 minutes
	48.5 Hz – 49.0 Hz	To be defined by each TSO while respecting the provisions of Article 4(3), but not less than 90 minutes
	49.0 Hz – 51.0 Hz	Unlimited
	51.0 Hz – 51.5 Hz	90 minutes
	51.5 Hz – 52.0 Hz	15 minutes

Frequency Rate of Change

- b) With regard to the rate of change of Frequency withstand capability, a Power Generating Module shall be capable of staying connected to the Network and operating at rates of change of Frequency up to a value defined by the Relevant TSO while respecting the provisions of Article 4(3) other than triggered by rate-of-change-of-Frequency-type of loss of mains protection. This rate-of-change-of-Frequency-type of loss of mains protection will be defined by the Relevant Network Operator in coordination with the Relevant TSO and subject to notification to the National Regulatory Authority. The modalities of that notification shall be determined in accordance with the applicable national regulatory framework.

Key Points

- The Requirements For Generators Network Code has been recommended to the European Commission for adoption by ACER (the European Regulators)
 - Implementation of its provisions within Great Britain is under discussion
 - A number of options for implementation are currently being considered
- Many of its parameters are subject to National choices
 - For example, the rate of change of frequency parameter
- As with all framework changes, provisions could have retrospective effect
 - Subject to cost benefit analysis

Change Road Map for G83/G59



Timelines

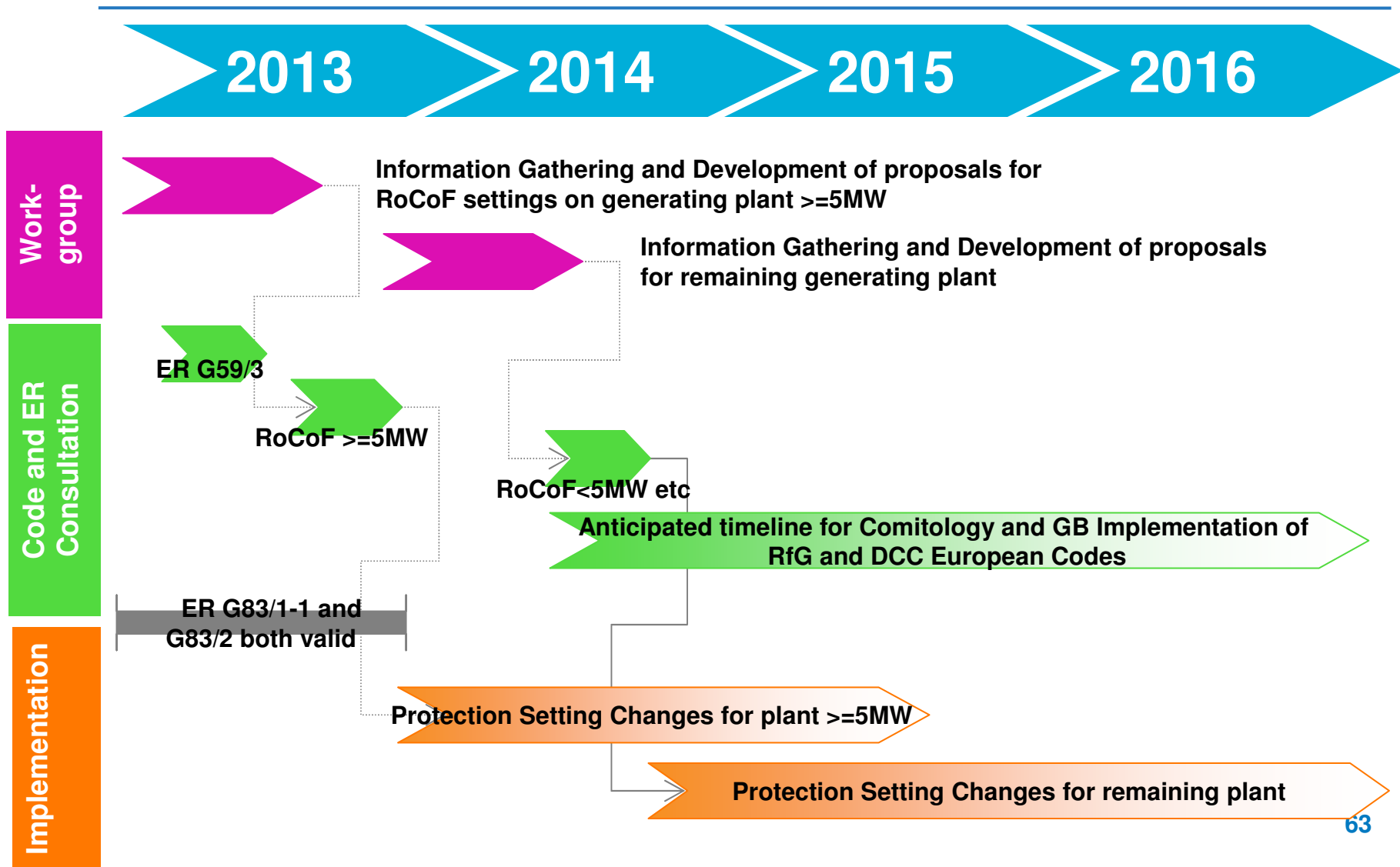

Discussion



Discussion Topics

Question	Explanation
How would you feel if setting changes were required a number of times?	<i>The electricity supply system is changing continuously. It is possible that the workgroup may make proposals which have to be revisited meaning settings have to be changed twice.</i>
At what point is it appropriate (and practicable) to re-think how power islands are treated?	<i>Currently, power islands are deemed unsafe. What are the consequences of making the changes to ensure that power islands are safe and sustainable?</i>
Are RoCoF techniques viable in the long term?	<i>It may not be possible to come up with parameters that adequately discriminate between a 'normal' generation loss and an islanding event. What alternatives are there for Loss of Mains detection?</i>
What's the best way of getting information on what equipment already (or about to be) installed and how it behaves as frequency changes?	<i>A wide variety of equipment is now installed in thousands of locations. How do we best establish how it would behave in a Loss of Mains situation if settings change and ensure that safety is maintained?</i>
How should interested parties who don't normally participate in working groups be involved in the work?	<i>Workgroups are comprised of a small number industry representatives. How should other interested parties be involved?</i>
What needs to be considered if retrospective changes are required?	<i>Retrospective changes generally cost more than the value they deliver and in this case could involve many parties. However, it is possible that there is no alternative in the long term.</i>
What aspects are the workgroup missing?	<i>Is there new thinking or are there alternative approaches?</i>
What roles could manufacturers and installers have?	<i>Are manufacturers and installers able to contribute and if so, how can this be encouraged appropriately?</i>

Summary and Conclusions



Thank You