

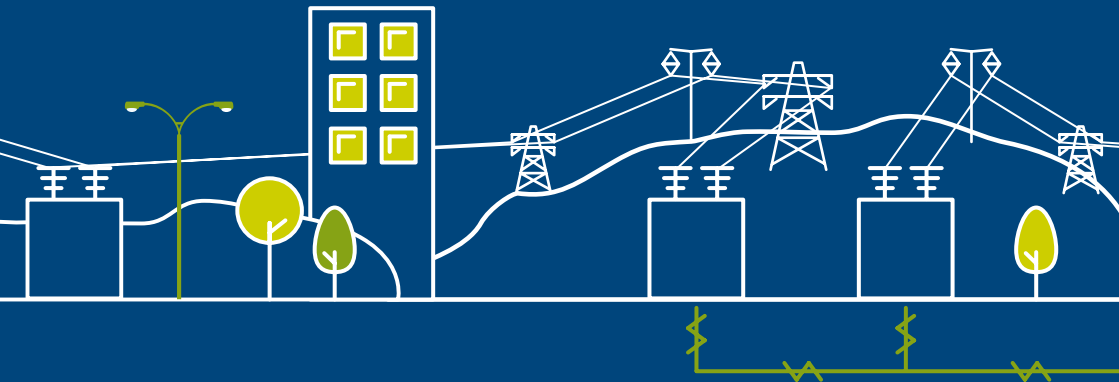

Network Options Assessment 2017/18

UK electricity transmission



How to use this interactive document

To help you find the information you need quickly and easily we have published *NOA* as an interactive document.

Home

This will take you to the contents page. You can click on the titles to navigate to a section.



A to Z

You will find a link to the glossary on each page.



Arrows

Click on the arrows to move backwards or forwards a page.



Hyperlinks

Hyperlinks are highlighted in bold throughout the report. You can click on them to access further information.

For the past couple of years our *Future Energy Scenarios (FES)* publication has highlighted how we are in the midst of an energy revolution. Our *Network Options Assessment (NOA)* publication, along with our other System Operator (SO) publications, aims to help our industry ensure a secure, sustainable and affordable energy future.



We publish the NOA as part of our SO role. The NOA describes the major projects considered to meet the future needs in GB's electricity transmission system as outlined in the *Electricity Ten Year Statement (ETYS) 2017*, and recommends which investments in the year ahead would best manage the capability of the GB transmission networks against the uncertainty of the future.

To be transparent in our processes and to ensure that the SO is impartial throughout, we follow the *NOA* methodology, approved by Ofgem earlier in the year. This methodology sets out how we base our recommendations on the data and analysis of the 2017 *FES* and *ETYS*.

The news about SO separation from the National Grid Transmission Owner was announced earlier in the year. I do not foresee that this results in significant change to the *NOA* itself although the changing roles and responsibilities of different parties will be reflected in future methodologies. We are also planning how *NOA* can continue to evolve over the coming years to maximise consumer benefit.

Investment decision

The SO considered the investment options proposed by the Transmission Owners. A couple of the highlights are:

- Recommendation for investment of £21.6m in 2018/19 across 22 projects to potentially deliver projects worth almost £3.2bn.
- Analysis suggests a total interconnection capacity of 17.4GW between GB and European markets by 2030 would provide optimal benefit.

The *NOA* represents a balance between asset investment and network management to achieve the best use of bill payers' money. How the future energy landscape could look is uncertain, and the SO's recommendations are there to help make sure the GB transmission network is fit for the future. In producing this year's *NOA* we have listened to and acted on your feedback. We welcome your views on the changes we have made and in helping further shape the publication to meet your needs.

Julian Leslie

Head of Network Capability,
Electricity

Contents

Chapter one

Aim of the report	10
1.1 Introduction	11
1.2 How the <i>NOA</i> fits in with the <i>FES</i> and <i>ETYS</i>	12
1.3 What <i>NOA</i> can do	13
1.4 What <i>NOA</i> cannot do	14
1.5 The <i>NOA</i> report methodology	15
1.6 Navigating through the document	16
1.7 What's new?	17
1.8 Stakeholder engagement and feedback	19

Chapter two

Methodology	20
2.1 Introduction	21
2.2 <i>NOA</i> process	22
2.3 Economic analysis	25
2.4 The <i>NOA</i> Committee	32
2.5 How the <i>NOA</i> connects to the <i>SWW</i> process	33
2.6 Interaction between the <i>NOA</i> results and the <i>FES</i>	35
2.7 Other options	36

Chapter three

Boundary descriptions	38
3.1 Introduction	39
3.2 Scotland and the North of England region	40
3.3 The South and East of England region	52
3.4 Wales and West Midlands region	59

Chapter four

Proposed options	62
4.1 Introduction	63
4.2 Reinforcement options – Scotland and the North of England region	64
4.3 Reinforcement options – the South and East of England region	72
4.4 Reinforcement options – Wales and West Midlands region	76

Chapter five

Investment recommendations	78
5.1 Introduction	79
5.2 Interpretation of the <i>NOA</i> outcomes	81
5.3 <i>NOA</i> outcomes	83
5.4 Recommendation for each option	95

Chapter six

Interconnection analysis	102
6.1 Introduction	103
6.2 Interconnection theory	105
6.3 Current and potential interconnection	106
6.4 Methodology	107
6.5 Outcome	111
6.6 Summary	121

Chapter seven

Stakeholder engagement	122
7.1 Introduction	123
7.2 Continuous development	124
7.3 Stakeholder engagement	125

Chapter eight

Appendix A – Economic analysis results	127
Appendix B – <i>SWW</i> Projects	133
8.1 Shetland Link	133
8.2 Orkney Link	135
8.3 Western Isles Link	137
8.4 Eastern Network Reinforcement	139
8.5 South East Network Reinforcement	143
Appendix C – List of four-letter codes	145
Appendix D – Meet the <i>NOA</i> team	148
Appendix E – Glossary	149
Disclaimer	153

Executive summary

Using the 2017 *FES*, *ETYS* 2017 and following the methodology approved by Ofgem, the System Operator (SO) recommends the options which the GB Transmission Owners (TOs) should invest in for the upcoming year. Below, we present a summary of the key points of the *NOA* 2017/18.

Key points

- The SO recommends investment of £21.6m in 2018/19 across 22 projects to maintain the option to deliver projects worth almost £3.2bn. This year's investment will allow us to manage the future capability of the GB transmission networks against the uncertainty of the future. This will make sure that the networks can continue supporting the transition to the future energy landscape in an efficient, economical and coordinated way.
- As the energy landscape is uncertain, the SO must make sure that any network investment is truly necessary. Our reviewed methodology was approved by Ofgem and included improvements to minimise the potential for 'false-positive' recommendations. The first improvement was the introduction of implied scenario probabilities. Implied probabilities calculate how probable we need to believe a scenario is in order to make the same decision under a conventional decision-making process. The second was the inception of a *NOA* Committee. This Committee, comprised of SO representatives, provides scrutiny of the results in a transparent and rigorous way.
- The *NOA* is about getting the right decision, balancing potential constraint costs against investment costs for an uncertain future. The *NOA* Committee identified two reduced-build options that could create significant consumer value. As the SO, we requested the TOs bring forward more reduced-build options in the future.
- We performed analysis of 76 different reinforcement options in this *NOA*. Twenty-one options are given either a Stop or Do not start recommendation as they are not optimal at this time. We also recommend 31 optimal options to be put on Hold where investment decisions could be made when there is greater certainty in the future. This ensures that a recommendation for an investment is made at the most efficient time. Where the recommendation cannot be delayed any further, our economic analysis assesses the cost impact of not investing in this financial year. Based on this analysis the SO recommends deferring the spend of £8.6m on four options in 2018/19. Table 0.1 is an overview of the investment recommendations where the decision must be made this year.

Executive summary

- This year the recommended investment spend is lower, primarily due to two factors. Since the publication of the NOA 2016/17 the Hinkley–Seabank project has progressed to a position and is now included in the baseline. Secondly, the South Coast reactive compensation scheme (due to commission in 2018) has progressed to the final delivery stage where most of the capital cost has already been incurred before this year’s analysis.
- All Eastern Links (2GW HVDC links and the Torness to north east England AC reinforcement) have had their earliest in service dates delayed by two to four years for this year’s analysis. This has delayed several reinforcements because they only provide benefit once the links are in service. Due to the delay in the earliest in service dates of the Eastern Links combined with higher north–south flows, we identified the opportunity of implementing an operational measure to deliver up to £600m of consumer benefit. In parallel, we’ve requested the TOs investigate the feasibility of accelerating the delivery of the Eastern Link options. We will therefore look to pursue these options in more detail next year.
- This year’s interconnection analysis suggests that a total interconnection capacity of 17.4 GW between GB and European markets by 2030 would provide optimal consumer benefit. Many other factors outside the scope of this analysis will influence the outcome for GB interconnection over the next decade and beyond.

It is important to recognise that these recommendations represent the best view at a snap-shot in time. Investment decisions taken by any business should always consider these recommendations in the light of subsequent events and developments in the energy sector. The project options we have recommended in this NOA will make sure that the GB transmission network can continue supporting the transition to the future energy landscape in an efficient, economical and coordinated way.

This year the NOA identifies which options we recommend to proceed are likely to meet Ofgem’s criteria for onshore competition. The competition assessment for SWW is in accordance with the Ofgem agreed methodology and the outcomes are described in Chapter 5.

Table 0.1
Summary of investment recommendations (the options are in order from north to south)

Option	EISD ¹	Two Degrees	Consumer Power	Slow Progression	Steady State	Local Contracted A	Local Contracted B	No Local Contracted A	No Local Contracted B	NO4 2016/17 Recommendation	NO4 2017/18 Recommendation	Reasons for Change
E4DC Eastern subsea HVDC Link from Peterhead to Hawthorn Pit (Potential SWW)	2028	2028	2028	2028	2028	N/A	N/A	N/A	N/A	Proceed	Proceed	No change
ECU2 East Coast onshore 275kV upgrade (Potential SWW)	2023	2023	2023	2023	2023	N/A	N/A	N/A	N/A	Delay	Proceed	Generation background changes
ECUP East Coast onshore 400kV incremental reinforcement (Potential SWW)	2026	2026	2026	2026	2026	N/A	N/A	N/A	N/A	Delay	Proceed	Generation background changes
DWNO Derry to Wishaw 400kV reinforcement	2028	2028	2028	2028	2030	N/A	N/A	N/A	N/A	No decision required	Proceed	Generation background changes
HNNO Hunterston East–Neilston 400kV reinforcement	2023	2023	2023	2023	2023	N/A	N/A	N/A	N/A	N/A	Proceed	New reinforcement
E2DC Eastern subsea HVDC Link from Torness to Hawthorn Pit (Potential SWW)	2027	2027	2027	2027	N/A	N/A	N/A	N/A	N/A	Proceed	Proceed	No change
TLNO Torness to north east England AC reinforcement	2030	N/A	N/A	N/A	N/A	N/A	N/A	N/A	N/A	Proceed	Hold for SWW	The EISD is delayed ²
HAEU Harker SGT6 replacement	2021	2029	2021	2021	2021	N/A	N/A	N/A	N/A	Do not proceed	Proceed	Generation background changes
WHT1 ³ Turn-in of West Boldon to Hartlepool circuit at Hawthorn Pit	2021	2021	N/A	2021	N/A	N/A	N/A	N/A	N/A	Proceed	Proceed	No change
NOR1 Reconductor 13.75km of Norton to Osbaldwick 400kV double circuit	2021	2021	2021	2021	2023	N/A	N/A	N/A	N/A	Proceed	Proceed	No change
CPRE Reconductor sections of Penwortham to Padiham and Penwortham to Carrington	2021	2021	N/A	N/A	N/A	N/A	N/A	N/A	N/A	No decision required	Proceed	Generation background changes
MRUP Upgrade the Penwortham to Washway Farm to Kirkby 275kV double circuit to 400kV	2023	N/A	N/A	N/A	N/A	N/A	N/A	N/A	N/A	Proceed	Proceed	No change ²

¹ Earliest In Service Date – the earliest year that a project can be delivered.

² For more information please refer to Chapter 5 – Investment recommendations.

³ We assessed the same reinforcement for one year's later delivery (denoted WHT2). It is optimal under the Consumer Power and Steady State scenarios.

Executive summary

Table 0.1
Summary of investment recommendations continued

Option	EISD	Two Degrees	Consumer Power	Slow Progression	Steady State	Local Contracted A	Local Contracted B	No Local Contracted A	No Local Contracted B	MOA 2016/17 Recommendation	MOA 2017/18 Recommendation	Reasons for Change
LDQB Lister Drive quad booster	2020	N/A	N/A	2021	N/A	N/A	N/A	N/A	N/A	Proceed	Proceed	No change ⁴
OENO Central Yorkshire reinforcement	2026	2027	2027	2027	N/A	N/A	N/A	N/A	N/A	Proceed	Hold	Depends on Eastern links to provide capability and hence optimal timing.
TDH1 Drax to Thornton 2 circuit thermal uprating	2019	2019	2020	2019	N/A	N/A	N/A	N/A	N/A	N/A	Proceed	Generation background changes
BMMS 3X225MVA _r MSC at Burwell Main	2023	2023	2023	2023	2023	2023	2023	2023	2023	Proceed	Proceed	No change
BTNO Bramford to Twinstead OHL	2025	2027	2029	2030	N/A	2025	2028	2027	2027	No decision required	Delay	Critical in one sensitivity ⁴
WYTI Wymondley turn-in	2021	2021	2021	2021	2023	2021	2021	2021	2021	Delay	Proceed	Interconnector flows changes
ESC1 New Second Elstree to St John's Wood 400kV cable circuit	2022	2022	2025	2025	2032	2022	2022	2022	2022	N/A	Delay	New reinforcement
TKRE Tilbury to Grain and Tilbury to Kingsnorth upgrade	2025	2025	2025	2025	2027	2025	2025	2025	2025	N/A	Proceed	Interconnector flows changes
KLRE Kemsley–Littlebrook circuits reconductoring	2020	2020	2020	2020	2020	2020	2020	2020	2020	Proceed	Proceed	No change
FLR2 Fleet–Lovedean reconductoring	2020	2020	2020	2020	2023	2020	2020	2020	2020	Proceed	Proceed	No change
SCN2 New Transmission Route between south London and the South East Coast Indicative Option 2 (Potential SWW)	2027	N/A	N/A	2027	2027	2027	2027	N/A	N/A	Do not proceed	Proceed	Interconnector flows changes
SCRC South East Coast reactive compensation	2018	2018	2018	2018	2018	2018	2018	2018	2018	Proceed	Proceed	No change
SEEU Reactive Compensation Auto-Switching Scheme	2021	2021	2021	2021	2022	2021	2021	2022	2022	Proceed	Proceed	No change
BNRC Bolney and Ninfield additional reactive compensation	2022	2022	N/A	2023	N/A	2022	2022	2022	2022	No decision required	Proceed	Required for importing interconnector flows

⁴For more information please refer to Chapter 5 – Investment recommendations.

We welcome your views

We want to continue to develop the *NOA* and we welcome your views on how to improve it. Chapter 7 – Stakeholder engagement describes how you can contact us with your views.

Future energy publications

National Grid has an important role to play in leading the energy debate across our industry and working with you to make sure that together we secure our shared energy future. As System Operator (SO), we are perfectly placed as an enabler, informer and facilitator. The SO publications that we produce every year are intended to be a catalyst for debate, decision making and change.

The starting point for our flagship publications is the *Future Energy Scenarios (FES)*. The *FES*

is published every year and involves input from stakeholders from across the energy industry. These scenarios are based on the energy trilemma (security of supply, sustainability and affordability) and provide supply and demand projections out to 2050. We use these scenarios to inform the energy industry about network analysis and the investment being planned, which will benefit our customers.

We build our long-term view of the electricity transmission capability and operability in our *Future Energy Scenarios (FES)*, *Electricity Ten Year Statement (ETYS)*, *Network Options Assessment (NOA)*, and electricity *System Operability Framework (SOF)* publications. To help shape these publications, we seek your views and share information across the energy industry that can inform debate.

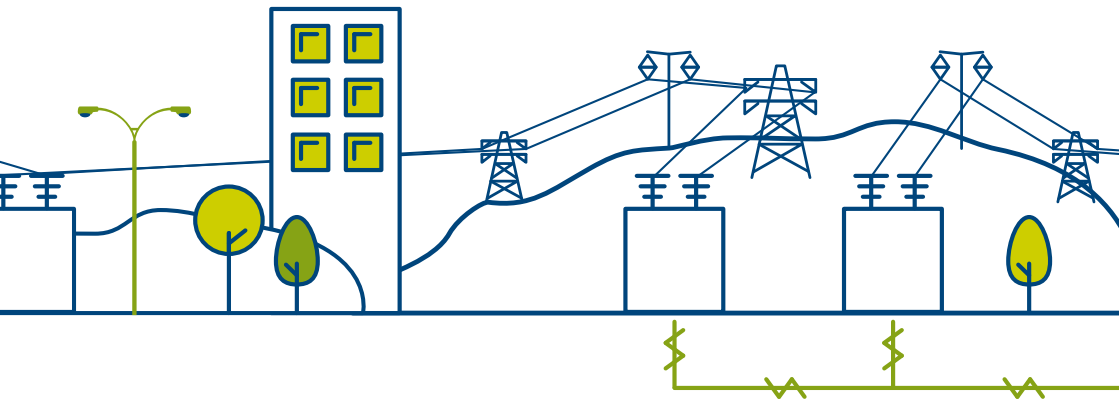

Chapter one

Aim of the report

11

Aim of the report

1.1 Introduction

This chapter introduces the *Network Options Assessment (NOA)*, and explains how it works alongside the other publications that National Grid produces as the System Operator (SO).

The *NOA* 2017/18 is the third assessment to be published. It's produced for you, our stakeholders, and we'll use your feedback to develop it further.

The *NOA* is the vehicle for developing an efficient, coordinated and economic system of electricity transmission, consistent with the National Electricity Transmission System (NETS) Security and Quality of Supply Standard (SQSS). Its purpose is to assess a range of options to make recommendations to the Transmission Owners (TOs) across Great Britain (GB) as to which major NETS reinforcement projects to proceed with to meet the future network requirements, as defined in the *Electricity Ten Year Statement (ETYS)*. It also identifies which projects meet the criteria for onshore competition, providing relevant information to stakeholders.

This report is one of the publications underpinned by the data in our *Future Energy Scenarios (FES)*. This means that the *NOA* and the *ETYS* have a consistent base for assessing the potential development of the electricity transmission networks. When read together, the *ETYS* and the *NOA* give a full picture of requirements and potential options for the NETS.

The *NOA* 2017/18 was published in January 2018 and is based on the *FES* 2017.

Chapter 6 is our interconnection assessment. The analysis is undertaken to inform the industry of the potential benefits of future interconnection, with the goal of providing a market signal to facilitate the development of efficient interconnector capacity with the GB market.

For this year's analysis we have undertaken further improvements to the methodology, which were approved by Ofgem. We have included locational impacts on the GB transmission network in addition to the welfare and capital cost implications considered last year. We have also used the output from this year's *NOA* as the baseline network reinforcement assumptions for the *NOA* for Interconnectors (*NOA IC*) analysis: this provides greater consistency between the *NOA* and *NOA IC* analysis which we believe will be of added value to our stakeholders.

1.2 How the NOA fits in with the FES and the ETYS

The SO produces a suite of publications on the future of energy for Great Britain (see page 8). These publications aim to inform the whole energy debate by addressing specific issues in each document. The *FES*, *ETYS* and *NOA* can be read together to form an evolutionary and consistent voice in the development of GB's electricity network.

We use the *FES* to assess the network requirements for power flows across the GB NETS. These requirements were published in the *ETYS* in November 2017, and the TOs responded with options for reinforcing the network. Our economic analysis of these options then forms the foundation for the *NOA* publication. Further explanation of this process and each of the publications can be found in Chapter 2 – Methodology.

In the *NOA* we summarise reinforcement options and our economic analysis of those options by regions. The criterion by which a region is defined is that an option may not appear in more than one region (this is to prevent an option being evaluated more than once, with the risk of two different answers). Based on the economic analysis, the report also identifies our recommended option or options for each of the regions. For some options we have included a summary of the Strategic Wider Works (SWW) analysis in this document.

It is important to note that while we recommend options to meet system needs, the TOs or other relevant parties will ultimately decide on what, where and when to invest.

Some of the alternative options we have evaluated are reduced-build options as explained in Chapter 4 – Proposed options. The *NOA* emphasises the need to reinforce the network, and we are keen to embrace innovative ways to do so.



Future Energy Scenarios
July 2017



Electricity Ten Year Statement
November 2017



Network Options Assessment
January 2018

Aim of the report

1.3 What the NOA can do:

- Recommend the most economic options to proceed to meet bulk power transfer requirements as outlined by the *ETYS*.
- Recommend what options, whether build or no-build, and where and when investments should be made on the transmission networks to facilitate an efficient, coordinated and economic future transmission system.
- Recommend whether the TOs should start, continue, delay or stop reinforcement projects to make sure they are completed at a time that will deliver the most benefit to consumers.
- Indicate to the market the optimum level of interconnections to other European electricity grids – as well as any reinforcements required to facilitate those interconnections – to maximise European socio-economic welfare based on market-driven analysis.
- Indicate to the TOs whether they should begin developing the Needs Case for potential SWW options.
- Indicate to Ofgem and other relevant stakeholders whether options are eligible for onshore competition.

1.4 What the NOA cannot do:

- Insist that options be pursued. We can only recommend options based on our analysis. The TOs or other relevant parties are ultimately responsible for what, when and where they invest.
- Make recommendations for system needs other than bulk power transfer at present, e.g. local voltage issues.
- Comment on the specific details on any specific option, such as how it could be planned or delivered. It is the TOs or other relevant parties who decide how they implement their options.
- Evaluate the specific designs of any option, such as the choice of equipment, route or environmental impacts. These types of decisions can only be made by the TOs or other relevant parties when the options are in a more advanced stage.
- Assess network asset replacement projects which do not provide network capability uplifts or individual customer connections.
- List all of the options that the TOs develop as, for instance, some reach only a low level of maturity and are discarded early. It is for the TOs to develop options and consult with stakeholders on variations on options.
- Evaluate the operability challenges of possible interconnectors. It can only evaluate the socio-economic welfare that a completed interconnector would provide.
- Forecast or recommend future interconnection levels. It indicates the optimum level of interconnection.

With the introduction of new technologies and business models, the electricity industry is experiencing significant change with the opportunity to deliver great value, for consumers and society. As the SO we have a key role in facilitating the transition to a more decentralised, low carbon electricity industry model. One area we are developing is our approach to assessing network capability and operability needs as well as the options to meet them, of which the NOA is a key part.

We will be publishing a roadmap this spring which will set out where we want to get to with the developments in the long term and the steps that are likely to be needed to get there. As a starting point we are expanding the NOA approach to consider more local or regional challenges, such as local

voltage issues. We are also opening it up to invite a wider range of participants who can compete to meet the transmission system needs at least cost. This includes Distribution Network Operators (DNOs), market participants such as storage providers, the SO and TOs. This is expected to result in more cost-effective options in the long term. This could be through using market based or distribution network solutions to reduce constraint costs while larger network assets are built or could be the cost effective solution to delay to avoid large asset investment. We are running several trials to develop the processes and capability we need to involve new parties in the NOA and incorporate local voltage challenges. We'll be working closely with our stakeholders on the developments and will publish the results through the year as they become available.

Aim of the report

1.5 The *NOA* report methodology

The *NOA* report methodology sets out how the *NOA* process should work, and establishes the finer detail. We started the *NOA* report methodology in early 2017, working with the onshore TOs and Ofgem. The initial draft of the methodology for the *NOA* 2017/18 was published for consultation in May 2017.

After more discussions and refinement the methodology was submitted to Ofgem in July 2017, and subsequently published on our website. The methodology was approved by Ofgem in September 2017.

We describe the methodology further in Chapter 2 – Methodology.

1.6 Navigating through the document

We have structured the *NOA* document in a logical manner to help you understand how we have reached our recommendations and conclusions.

Chapter two

Methodology page 20

Chapter 2 describes the *NOA* process and the economic theory behind it. This is a good overview if you are unfamiliar with the *NOA*, or if you'd like to understand more about how we perform the economic analysis of options.

Chapter three

Boundary descriptions page 38

Chapter 3 describes how we divide the GB network into boundaries and regions for analysis, and gives a description of each boundary, as well as an overview of the types of generation you can find within each boundary. This is a good introduction if you'd like to improve your understanding of the GB network.

Chapter four

Proposed options page 62

Chapter 4 introduces and describes the reinforcement options that can increase the NETS capability. This is a good description of the types of options being proposed by the TOs.¹

Chapter five

Investment recommendations page 78

Chapter 5 presents our investment recommendations for 2018/19. This is an important chapter if you are interested in whether we recommend options to be proceeded for this investment year. It also summarises the eligibility assessment for competition in onshore electricity transmission.

Chapter six

Interconnection analysis page 102

Chapter 6 presents our interconnection analysis results. We describe the optimum levels of interconnection between GB and European markets, and explain the economic theory behind the benefit of interconnectors to the consumer. This is an important chapter if you are interested in the future of European interconnection.

Chapter seven

Stakeholder engagement page 122

Chapter 7 discusses how we can work with you to improve the *NOA* in future publications. This is a useful chapter if you'd like to give us your feedback and opinion.

¹ Some options are not in our *NOA* process analysis but are described in Chapter 4 – Proposed Options. Chapter 2 – Methodology covers why these other options are kept separate from our analysis.

Aim of the report

1.7 What's new?

Acting on stakeholder feedback we continue to evolve and improve the *NOA* together. The following areas are new additions for the *NOA* 2017/18:

1.7.1 Implied probability

It has been highlighted in the *NOA* methodology review in March 2017 that the current single year least regret analysis approach could potentially lead to 'false-positive' investment recommendations, especially when options are determined by a single scenario or driver. To further improve the robustness of the decision-making process,

we have introduced 'implied probabilities' to provide additional insights to the single year least regret analysis results. This additional step at the end of our economic analysis will further assure our *NOA* recommendations are well justified and reduce the risk of them being 'false-positive'.

1.7.2 Changes to the *NOA* governance structure

We've created a *NOA* Committee to review our *NOA* recommendations to provide an additional level of scrutiny to the results that are considered to be marginal. This includes those that are driven by a single scenario or driver, or are considered to be sensitive. The *NOA* Committee considers information

such as implied probabilities and other additional evidence, together with insights of the holistic needs of the system to ensure that the *NOA* recommendations are robust and credible. For more information about the *NOA* Committee, please refer to Chapter 2 – Methodology.

1.7.3 Changes to the *NOA* recommendation terminologies and definitions

We've reviewed the terminologies and definitions for our *NOA* recommendations. The new terminologies and definitions will ensure that our recommendations can be

clearly interpreted by our stakeholders without ambiguities. The new recommendation terminologies and definitions are explained in Chapter 5 – Investment Recommendations.

1.7.4 Changes to the presentation of the economic analysis results

The *NOA* economic analysis is a sophisticated process that produces results in different stages. We've been exploring more intuitive ways to express our economic analysis results that ultimately lead to our final

recommendations. To this end, we've moved tables containing detailed economic analysis results to Appendix A, and we've created new diagrams in Chapter 5 to better visualise the results.

1.7.5 Changes to the *NOA* for Interconnectors

This year's *NOA* for Interconnectors analysis has been enhanced by taking into consideration the locational impacts of potential interconnectors in addition to the welfare and capital cost implications which were considered last year, as well as using the *NOA* 2017/18 background.

We always want to hear suggestions on how we can continue improving the *NOA* so don't hesitate to let us know how we can further develop it to meet your needs.

Aim of the report

1.8 Stakeholder engagement and feedback

Feedback isn't limited to the questions we've included in this publication, and we'd be delighted to hear from you by any appropriate means. We are also keen to know how you'd prefer to share your views and help us develop the *NOA*. Please see Chapter 7 – Stakeholder engagement for more information.

To help encourage your feedback, you will see that we've included prompts such as this for engagement throughout the publication and these highlight areas in each section where we'd like your views.

Chapter two

Methodology

21

Methodology

2.1 Introduction

This chapter highlights the methodology used for the *NOA*, and explains the economic theory behind our analysis. It also explains how the *NOA* ties in with the *SWW* process.

2.2 The NOA process

The NOA methodology describes how we assess Major National Electricity Transmission System (NETS) Reinforcements to meet the requirements that we find from our analysis of the *Future Energy Scenarios (FES)*. We have published this year's methodology on our website. It also includes the methodologies for interconnectors and SWW. As the NOA is derived from the Network Development Policy (NDP), the two methodologies are similar. You can find a copy of our NDP methodology alongside the NOA methodology on our website below:



www.nationalgrid.com/noa

In accordance with our licence condition, Major National Electricity Transmission System Reinforcements are defined in Paragraph 1.30 of the NOA Report methodology. We define them as:

“a project or projects in development to deliver additional boundary capacity or alternative system benefits, as identified in the *Electricity Ten Year Statement* or equivalent document.”

Some users' connection agreements have major reinforcements as their enabling works. This means that the NOA may recommend a change to the delivery of these works. If this happens, we will work with those stakeholders and keep them informed but their connection date remains the same.

Figure 2.1 shows the steps we take to produce the NOA. It follows the five stages of the NOA report process.

Methodology

Figure 2.1
NOA process

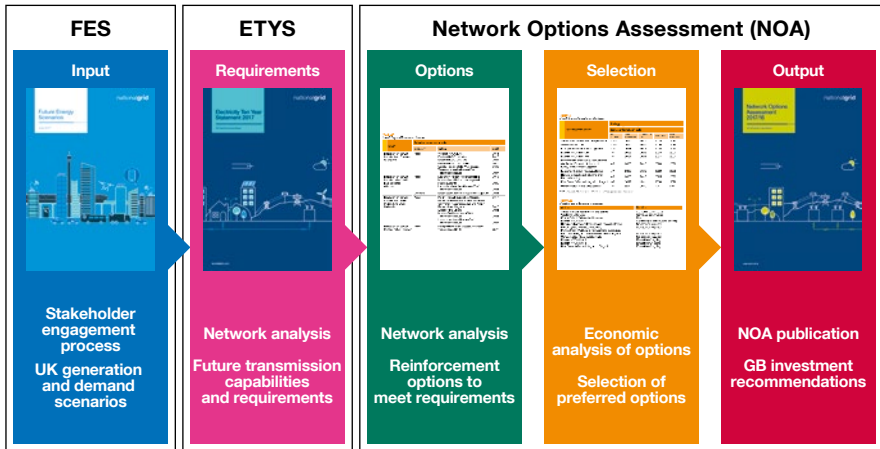

2.2.1 Future Energy Scenarios

The NOA process for the NETS planning starts with the FES. They are a plausible range of future background conditions to assess against, and form the foundation for our studies and economic analysis. The four scenarios are:

- **Two Degrees**
- **Slow Progression**
- **Steady State**
- **Consumer Power.**

For more information on our FES and how they are created, please see the FES 2017, which you can find at:



fes.nationalgrid.com
> FES document.

2.2.2 Electricity Ten Year Statement

The *ETYS* is the second stage in the *NOA* process. We apply the *FES* to transmission system models and calculate the power flow requirements across the transmission network. To do this we have developed the concept of boundaries. Boundaries don't exist physically, but are instead a conceptual split of the network into two adjacent parts. As power transfers between these areas, we can see which parts of the network are under the most stress and where network reinforcement would be most suitable. The capability of the network and its future requirements are published in the *ETYS* 2017, which you can find at:



www.nationalgrid.com/etys

2.2.3 Network Options Assessment

In order to create an electricity transmission network that is fit for the future, we engage equally with all TOs in order for them to propose options to meet the system capability requirements outlined by the *ETYS*. We encourage a range of options that include upgrading existing assets or creating new assets to ensure that we have a wide selection of options to assess.

As well as these build options, both the TOs and SO can propose opportunities for reduced-build options. Reduced-build options are solutions that require very little build and instead maximise use of existing assets often in innovative ways. You can find a full list of the options that we analysed in Chapter 4 – Proposed options.

With this varied list of options, we move onto the fourth stage of the *NOA* process, 'Selection'. We use our understanding of constraint costs to carry out economic analysis of all the options. This narrows the list of proposed options into a list of our preferred options, which we believe are the ones that provide the most benefit for consumers. You can find the full list of our recommended options in Chapter 5 – Investment recommendations. How we perform economic analysis is described in greater detail in the following section.

Methodology

2.3 Economic analysis

2.3.1 Theory

To understand our investment recommendations it is important to first understand why we recommend that the TOs invest in their networks.

The transfer of energy across our network boundaries occurs because generation and demand are typically situated in different locations. When the power transfer required across a transmission system boundary is above that boundary's capability, our control room must reduce the power transfer to avoid dangerously overloading the transmission assets. This limiting of power transfer across a boundary is referred to as 'constraining' the network.

When we constrain the network, we ask generators on the exporting side of the stressed boundaries to limit their output. In order to maintain an energy balance, we replace this energy with generation on the importing side

of these boundaries. Balancing the network by switching generation on and off costs money, and if we are constraining the network by large amounts regularly then these constraint costs begin to accumulate.

Assessment of these future constraint costs is an important factor in our decision-making process. It enables us to evaluate and recommend investments such as creating new overhead lines and underground cables for the future transmission network. We refer to these potential investments as 'options', and although they cost money they also raise the capability of the network, meaning that more power can be transferred across boundaries without the need to constrain. We work together with the TOs to upgrade the transmission networks at the right time in the right places to find the best balance between investing in the network and constraining it.

2.3.2 Optimum years

To maximise benefit to consumers, we must recommend that the TOs invest in the right options at the right time. However, it takes time for the TOs to upgrade the network, with some options taking longer to implement than others. The earliest year that an option can be delivered is an important factor in our analysis. It's called the 'Earliest In Service Date' (EISD) and an option can't be delivered before this. We need to take this into account when we consider the optimal timing of options. We don't want to invest too early unnecessarily, or incur potentially high constraint costs by investing too late. Getting this balance right will achieve the best value for consumers. Consequently, each economically viable option has an

optimum year of delivery that realises the most benefit, and we aim to time an option to be delivered in its optimum year.

If an option's optimum year of delivery is later than its EISD, then no recommendation on whether to proceed with the option needs to be made yet. However, if an option's optimum year is the same year as its EISD, then a recommendation on whether to proceed cannot be delayed any longer without risking missing its optimum year. Such an option is then considered 'critical'. All critical options are entered into our single year least regret analysis, where we ultimately decide the investment recommendations for this year.

2.3.3 Single year least regret analysis

The uncertainty of the future means that the optimum year of delivery for an option will likely not be the same for each of the energy scenarios. Therefore, we must understand the

risk between recommending that the TOs proceed with a critical option so it may be delivered on its EISD, or delaying it so it may be delivered closer to its optimum year.

Table 2.1
Example of a critical option’s optimum years of delivery

	EISD	Optimum Year of Delivery			
		Scenario A	Scenario B	Scenario C	Scenario D
Critical Option	2019	2019	2019	2020	2021

In the above example, the earliest year that the option can be delivered is 2019. The optimum year of delivery varies across the scenarios, but for Scenarios A and B it’s 2019, therefore this is a critical option. For those scenarios, the right recommendation would be for the TOs to proceed with this option to maintain its EISD of 2019. However for scenarios C and D, the right recommendation would be to not proceed with this option this year, and allow its EISD to slip back by one year to 2020. If the EISD of an option cannot slip back by a year without carrying out some aspects of the work, a delay cost should be submitted for economic

analysis. To make a recommendation to the TOs, we must analyse the potential ‘regret’ of making one recommendation and not the other.

As we are only interested in making investment recommendations for critical options, we utilise ‘single year least regret’ analysis. As each critical option can either be recommended to ‘proceed’ or ‘delay’, there are a number of courses of action we could recommend. For example, two critical options in the same region would produce four different possible courses of action, as demonstrated in Table 2.2.

Methodology

Table 2.2

Possible courses of action for two critical options in a region

Course of action 1	Proceed both Options A and B
Course of action 2	Proceed Option A but delay Option B
Course of action 3	Proceed Option B but delay Option A
Course of action 4	Delay both Options A and B

In order to balance the level of investment and exposure to risk, we utilise the concept of 'economic regret'.

Single year least regret analysis allows us to recommend to the TOs to invest just the right amount so an option can be progressed forward by one year and maintain its EISD. As our energy landscape is changing, our recommendations for an option may adapt accordingly. This means that an option

that we recommended to proceed last year may be recommended to be delayed this year and vice versa. The robustness of the single year least regret analysis is that an ongoing project is revaluated each year to ensure that its planned completion date remains best for the consumer.

2.3.4 Economic regret

Once a reinforcement option is delivered, constraint costs decrease due to the additional capability it brings to the network. However, all options have a cost associated with their implementation, and therefore the net benefit an option brings over its lifetime is the difference between the savings in constraint costs and the total cost of the option.

In the single year least regret analysis, we investigate all possible courses of action presented by critical options for the next

investment year. These courses of action are treated as different investment strategies. Economic regrets are calculated under each scenario with respect to different strategies to help us identify and quantify the maximum risk each course of action poses across different scenarios. Selecting the strategy with the lowest maximum regret leaves consumers exposed to the least amount of risk. The following descriptions demonstrate how economic regrets are calculated in the single year least regret analysis.

Table 2.3*Example of the costs and benefits of different investment strategies under Scenario A*

	Strategy 1	Strategy 2	Strategy 3
Initial investment cost	£40m	£20m	£60m
Savings in constraint costs	£420m	£220m	£460m
Net benefit	£380m	£200m	£400m
Regret	£20m	£200m	£0m

In economic analysis, a strategy's 'regret' is defined as the difference in benefit of that strategy and the benefit of the best strategy. Therefore the best strategy will have a regret of zero, and the other strategies will have different levels of regret depending on how they compare to the best strategy. In table 2.3 Strategy 3 is the best strategy, so there is no regret in choosing it. If we were to select Strategy 1 we would see a net benefit of £380 million, which is almost as good. But we would regret the decision as we didn't select Strategy 3, which is £20 million better. Clearly, choosing the strategy with least regret makes economic sense.

However as we face an uncertain future, we must consider the regret of our investments across each of the four energy scenarios. The same strategy won't always deliver the same value across every scenario: it will have more regret in some scenarios and less in others. As a result, the best strategy for one scenario might not be the best strategy for another scenario. Table 2.3's regret results were for just one scenario. We cannot predict the future, so we analyse a strategy's regret across all four credible scenarios and note the worst regret we could potentially incur by selecting that strategy.

Table 2.4*Example of net benefits from different strategies across multiple scenarios*

		Strategy 1	Strategy 2	Strategy 3
Net Benefit	Scenario A	£380m	£200m	£400m
	Scenario B	£120m	£165m	£125m
	Scenario C	£350m	£50m	£250m
	Scenario D	£160m	£150m	£185m

Methodology

Table 2.5

Example of least regret analysis, with Strategy 1 having the lowest worst regret

		Strategy 1	Strategy 2	Strategy 3
Regret	Scenario A	£20m	£200m	£0m
	Scenario B	£45m	£0m	£40m
	Scenario C	£0m	£300m	£100m
	Scenario D	£25m	£35m	£0m
Worst regret		£45m	£300m	£100m

The preferred strategy is selected based upon which strategy has the lowest worst regret. In the above example, each scenario has a best choice and a worst choice. Strategy 3 may be the best choice for Scenarios A and D, but would be a much poorer choice under either of the other two scenarios. Least regret

analysis shows that Strategy 1 minimises risk across all four scenarios, as its regret will be no more than £45 million. This approach provides a more stable and robust decision against the range of uncertainties, and minimises exposure to significant regret.

2.3.5 Implied probability

The single year least regret analysis will always find the strategy that minimises the worst regret across different scenarios. However in some circumstances, the approach may lead to ‘false-positive’ recommendations, especially when recommendations given by the preferred strategy are driven by a single scenario with the highest level of congestion on the system. To mitigate the risks of giving ‘false-positive’ recommendations, implied probability weightings on scenarios are calculated to help interrogate the preferred strategy. In this additional step, a-priori probability weights are not directly applied to any scenarios, instead the probability weights implied by the single year least regret decision are calculated.

In order for the single year least regret chosen strategy to be preferred, the weighted net benefit of the chosen strategy must be greater than for any other strategy. We can therefore compare each competing strategy against the single year least regret chosen strategy and compute the probabilities, which would make us indifferent between the two.

In the example shown in Table 2.5, we can see that it is mainly Scenario B and C deciding the single year least regret analysis results. Scenario C produces the highest regret for strategy 2 and 3, and so is the main driver behind strategy 1 being chosen. The scenario at the opposite end of the need for strategy 1 is scenario B, which provides us with the

largest regret for strategy 1 with respect to strategy 2 and 3. In order for the same decision as the least regret decision to be made under expected net benefit maximisation, it must be that the expected net benefit of strategy 1 is greater than the expected net benefit of strategy 2 or 3. For example, to choose strategy 1 over strategy 2, it must be that:

$$350p+120(1-p)\geq 50p+165(1-p)$$

where p is the probability of scenario C, and $1-p$ is the probability of scenario B; the net benefit provided by Strategy 1 is £350m and £120m under Scenario C and B respectively, and the net benefit provided by Strategy 2 is £50m and £165m under Scenario C and B respectively.

Solving for p we find that $p\geq 13.04\%$. This means that we need to believe that Scenario C is greater than 13.04% likely to happen against Scenario B for us to make the same decision as single year least regret analysis suggests. Conversely, we would need to believe that scenario B is less than 86.96% likely when compared with scenario C.

2.3.6 Economic tools

We use a constraint costs assessment tool to analyse and establish the benefits to consumers of the different options. Historically, we've used the Electricity Scenario Illustrator (ELSI) to determine these costs. In March 2016 we purchased a new economic tool, BID3, from Pöyry Management Consulting. We began using it from 2016/17 for econometric analysis work. It forecasts the costs of constraints, which are an important factor in the full cost-benefit analysis of the NOA. We use this information to help us identify the most economic investment strategies, taking into account all the future energy scenarios that we described in Chapter 2 of the *ETYS 2017*.

To ensure a successful transition to BID3, the model has been extensively benchmarked against the ELSI, and two independent reviewers (Professor Keith Bell, University of Strathclyde, and Dr Iain Staffell, Imperial College London) were appointed to review our work, BID3 configuration and benchmarking.

The future energy landscape is uncertain, so the information we use in our cost-benefit analysis changes over time. We revisit our data, assumptions and analysis results every year to make sure that the preferred strategy is still the best solution. So, when we respond to market- or policy-driven changes, this approach allows us to be flexible, while also keeping the cost associated with this flexibility to the minimum.

Methodology

Figure 2.2
BID3 tool inputs

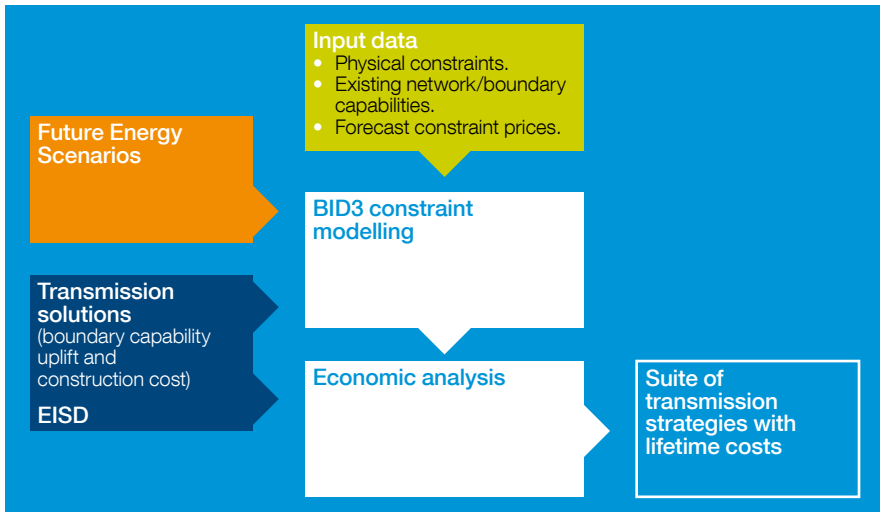

Figure 2.2 shows the various inputs to BID3. The inputs fall broadly into three categories:

Existing boundary capabilities and their future development – These were calculated using a separate power system analysis package. BID3 is the tool for calculating the market-driven flow across the boundaries, and takes capabilities as an input. The input to BID3 includes the increase in capability that the option provides, its capital cost and the EISD.

Future Energy Scenarios – BID3 assesses all options for network reinforcements against each of the detailed *Future Energy Scenarios*. The resulting analysis takes us up to 2037 (the values from 2038 are extrapolated from 2037 forecasts so we can estimate full lifetime costs).

Assumptions – BID3’s other input data takes account of fuel cost forecasts, plant availabilities and prices in interconnected European member states.

If you want to know more about BID3, there are a number of resources available on our website. A copy of the independent reviewers’ report is available, as well as our *Long Term Market and Network Constraint Modelling Report*, which provides further information on why we selected BID3, what we will use it for, and more detail on the inputs to BID3. The reports are available at the main NOA webpage.



2.4 The *NOA* Committee

This year we've created the *NOA* Committee – consisting of SO senior management – to add an additional, transparent level of scrutiny to our *NOA* recommendations. In this final step, the investment recommendations from our economic analysis are presented to the *NOA* Committee. The *NOA* Committee focuses on marginal recommendations that are driven by a single scenario or driver, or are considered to be sensitive, and then challenges their single year least regret analysis results with implied probabilities and other evidence.

The *NOA* Committee also provides holistic energy industry insight, and takes into account whole-system needs to support or revise those marginal investment recommendations. In preparation for the *NOA* Committee meeting, the SO discusses the details of economic analysis results with both internal stakeholders and the TOs to make sure the final recommendations are robust. The TOs will be invited to present information at the *NOA* Committee if at least one of their options (or joint options) is to be discussed.

We've brought in the *NOA* Committee and use implied probabilities to strengthen the methodology. How did you find the explanations for these new parts of the *NOA* process?

Methodology

2.5 How the NOA connects to the SWW process

We use the NOA process to look at the costs and benefits of potential options, and put forward our recommended options. If an option is recommended but it involves large infrastructure that satisfies one of the criteria shown below, then this option is referred to as SWW. SWWs are led by the TOs, who develop the Needs Case for such an option. An option in England and Wales needs to meet at least one of the criteria below to be considered as SWW. All costs are in 2009/10 prices:

- The option has a forecast cost of more than £500 million.
- The option has a forecast cost of between £100 million and £500 million, is supported by only one customer, and is not required in most scenarios.
- The option has a forecast cost of less than £100 million, is supported by only one customer, and is not required in most scenarios, but would require consents.

An option in Scotland needs to meet all of the criteria shown below. Once again, all costs are in 2009/10 prices:

- The option has total delivery costs of more than £50 million for SHE Transmission and £100 million for SP Transmission.
- The output will deliver additional cross-boundary (or sub-boundary) capability, or wider system benefits.
- Costs cannot be recovered under any other provision of the TO's price control settlement.

It's important to note that the relevant TO leads on developing Needs Cases for SWW projects, but we support the TO with the economic analysis. The TO initiates the Needs Case work for SWW projects depending on certain factors, including the forecast costs, and whether they trigger the SWW funding formula. Another important factor is the time taken to deliver the option.

This, combined with the date at which the option is needed in service, determines when to start building. The closer this date is, the sooner the TO needs to pursue the detailed analysis to justify the SWW's funding.

We have published our methodology for the SO process for input into TO-led SWW Needs Case submissions on our website.



www.nationalgrid.com/noa

2.5.1 Summary of SWW economic analysis methodology

When an option is deemed to be an SWW, cost–benefit analysis examines the economic benefit of a range of reinforcement options against the base network across their lifetimes. The base is usually 'do nothing' or 'do minimum', and usually has no associated capital costs. Constraint costs are forecast for the base and each network option across all scenarios.

We calculate the present value (PV) of constraint savings compared to the base for each network solution. These are then subtracted from the PV of capital expenditure associated with each network option, giving a net present value (NPV) for each of the network options. Taking these NPVs, we use lifetime least regret analysis to determine a preferred network option and an optimal delivery year. The results are analysed to determine how changing project capital costs and constraint savings would affect the recommendations.

The Joint Regulators Group on behalf of the UK's economic and competition regulators recommend a discounting approach that discounts all costs (including financing costs as calculated based on a weighted average cost of capital or WACC) and benefits at HM Treasury's social time preference rate (STPR). This is known as the Spackman approach and is used for all our reinforcements.

We may vary the process where modelling the base network is not straightforward. Such variations are assessed, case by case, with Ofgem.

Methodology

2.6 Interaction between the *NOA* results and the *FES*

In the *NOA*, we set out our vision for the future of the electricity transmission networks and European interconnection. Chapter 5 – Investment recommendations explains our recommended options for onshore reinforcements, based on providing the maximum benefit for GB consumers, and Chapter 6 – Interconnection analysis describes the future optimum interconnection capacity between GB and European markets. This year, the investment recommendations for onshore

reinforcements detailed in Chapter 5 form an input to the interconnection analysis in Chapter 6. This is an improvement on last year's *NOA*, ensuring the interconnection analysis is based on the most up-to-date onshore reinforcement recommendations. Both sets of results will influence our 2018 *FES* analysis, and will therefore contribute to the credible assumptions for the 2018/19 *ETYS* and *NOA*. We've described the methodology for interconnection analysis in Chapter 6 – Interconnection analysis.

2.7 Other options

2.7.1 Excluded options

While this report looks at options that could help meet major NETS reinforcement needs, it doesn't include:

- projects with no boundary benefit (unless they are specifically included for another reason, such as links to the Scottish islands that trigger the SWW category)
- options that provide benefits, such as voltage control over the summer minimum, but no boundary capability improvement (this is an area where we would welcome your feedback)
- analysis of options where, by inspection, the costs for the expected benefits would be prohibitive
- long-term conceptual options submitted by the TOs to support the analysis; this is explained in more detail in the next section.

We will include a summary in the *NOA* for projects where the TO has started the SWW Needs Case process, even though they won't provide boundary capability. The following projects to connect to the Scottish islands are in this category:

- Orkney link
- Western Isles link
- Shetland link.

The SWW Needs Case for Hinkley–Seabank project has been established. Therefore the project is considered in the base networks and not assessed for cost and benefit in this *NOA*.

The North West Coast Connection project is driven by a customer, and its SWW Needs Case process was initiated in December 2016. Since the customer has paused their development consent order, the SWW Needs Case has been deferred indefinitely while the customer reviews its plans. Therefore the project is not considered in this *NOA*.

Work on the Wylfa–Pentir second double circuit has already started and should continue due to a local customer agreement in place. Therefore the project is considered in the base networks in this *NOA*.

Methodology

2.7.2 Long-term conceptual options

Through the *NOA* process, we state our recommended options for the upcoming investment year, and optimum delivery dates for options over the next few decades. This process provides a long-term strategy through which the TOs are able to constantly evolve and develop their electricity transmission networks to deliver the best value for consumers.

For this, we receive a wide range of options provided by the TOs for analysis and comparison, and which we assess for cost and benefit. However, development of reinforcement in the network will be a continuous process where the designs and costs for some reinforcements in the distant future are unknown. In order to represent these long-term eventual reinforcements in our economic analysis, the TOs also provide us with more conceptualised reinforcements to support the long-term future network.

Chapter three

Boundary descriptions

39

Boundary descriptions

3.1 Introduction

This section provides a short introduction to the boundaries on the NETS. You will find a fuller description in this year's ETYS.

Figure 3.1 shows all the boundaries we have considered for this year's analysis.

Figure 3.1
ETYS GB boundaries

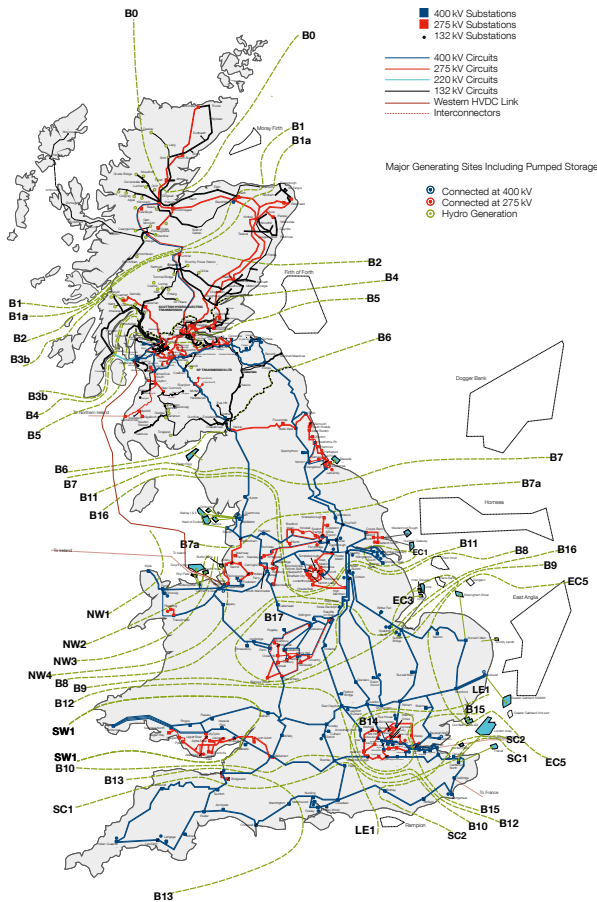

3.2 Scotland and the North of England region

3.2.1 Introduction

The following section describes the NETS in Scotland and Northern England. The onshore transmission network in Scotland is owned by

SHE Transmission and SP Transmission, but is operated by National Grid as SO.

Boundary descriptions

3.2.2 Boundary B0 – Upper North SHE Transmission

Figure B0.1
Geographic representation of boundary B0

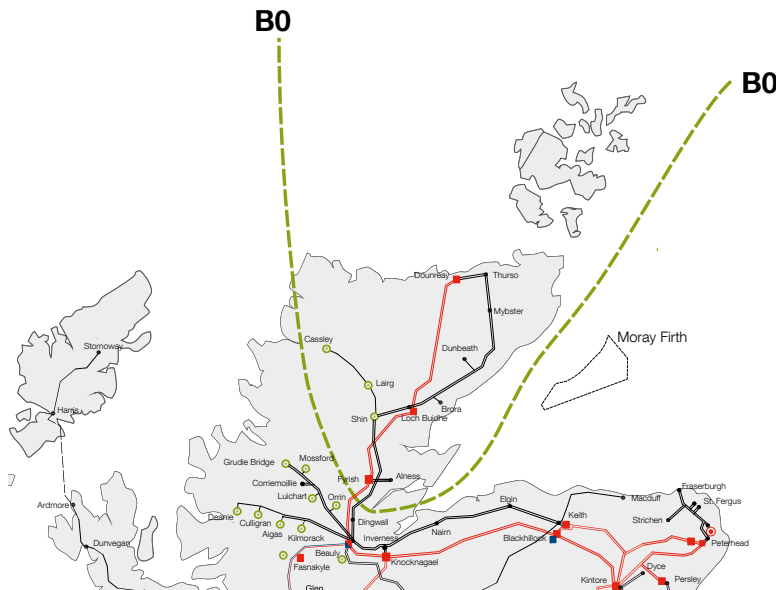

Boundary B0 separates the area north of Beauly, comprising north Highland, Caithness, Sutherland and Orkney. The existing transmission infrastructure north of Beauly is relatively sparse, although the Caithness–Moray reinforcement project presently being implemented will strengthen the network.

The boundary cuts across the existing 275kV double circuit and 132kV double circuit overhead lines extending north from Beauly. The 275kV overhead line takes a direct route north from Beauly to Dounreay, while the 132kV overhead line takes a longer route along the east coast, and serves the local grid supply points at Alness, Shin, Brora, Dunbeath, Mybster and Thurso. Orkney is connected via a 33kV subsea link from Thurso. High renewables output causes high transfers across this boundary.

3.2.3 Boundary B1 – North West SHE Transmission

Figure B1.1
Geographic representation of boundary B1

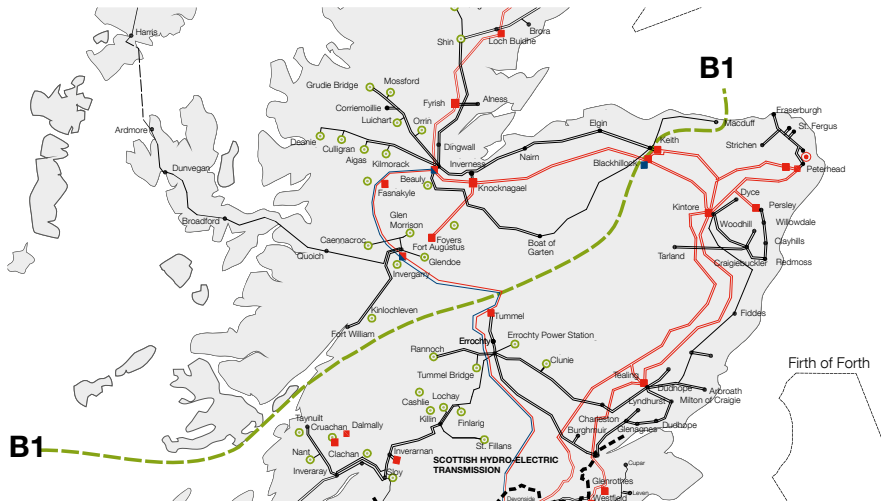

Boundary B1 runs from the Moray coast near Macduff to the west coast near Oban, separating the North West of Scotland from the southern and eastern regions. The area to the north and west of boundary B1 includes Moray, north Highland, Caithness, Sutherland, Western Isles, Skye, Mull and Orkney.

The boundary crosses the 275kV double circuit running eastwards from Knocknagael to Blackhillock, the 275/132kV interface at Keith and the 400/275kV double circuit running south from Fort Augustus. High renewables output causes high transfers across this boundary.

Boundary descriptions

3.2.4 Boundary B1a – North West 1a SHE Transmission

Figure B1a.1
Geographic representation of boundary B1a

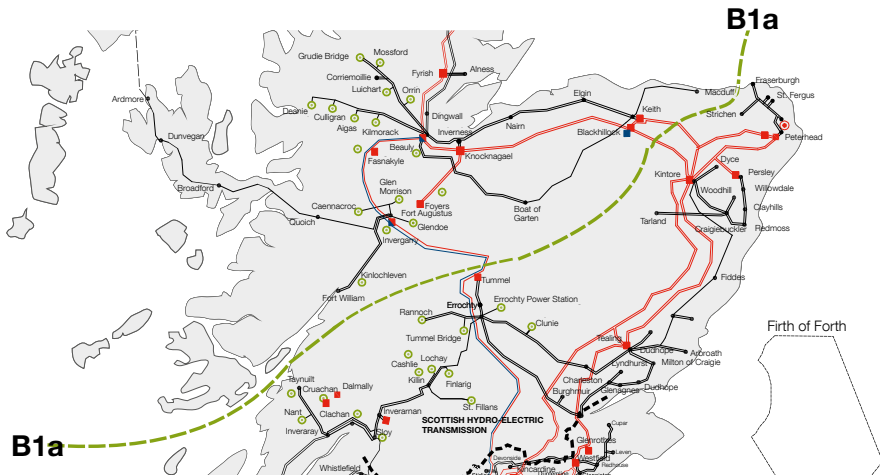

Boundary B1a runs from the Moray coast near Macduff to the west coast near Oban, separating the North West of Scotland from the southern and eastern regions. The boundary crosses the 275kV double circuit running eastwards from Blackhilllock to Kintore on a direct route, and another 275kV double circuit running eastwards from Keith to Peterhead and Kintore, as well as the 400/275kV double circuit running south from Fort Augustus. High renewables output causes high transfers across this boundary.

Boundary B1a was introduced in the ETYS 2016, published in November 2016, specifically to consider the critical circuits between Blackhilllock and Kintore. Its main difference from the B1 boundary is that Blackhilllock substation is north of the boundary. Additional generation between boundaries B1 and B1a drives the requirement for transmission reinforcement across B1a.

3.2.5 Boundary B2 – North to South SHE Transmission

Figure B2.1
Geographic representation of boundary B2

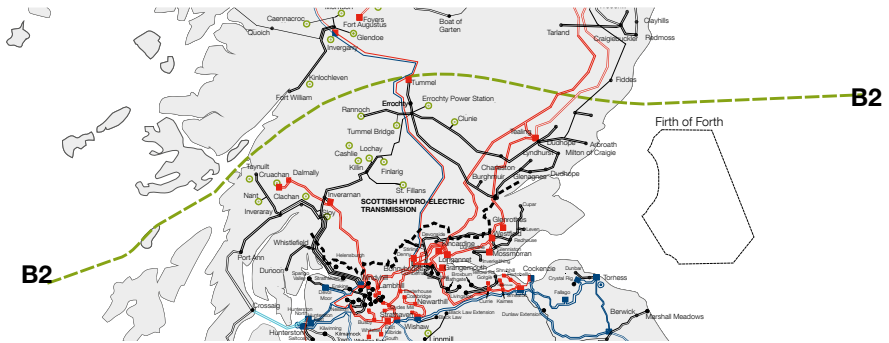

Boundary B2 cuts across the Scottish mainland from the east coast between Aberdeen and Dundee to near Oban on the west coast. The boundary cuts across the two 275kV double circuits and a 132kV single circuit in the east, as well as the 400/275kV

double circuit overhead line running south from Fort Augustus. As a result it crosses all the main north–south transmission routes from the North of Scotland. High renewables output causes high transfers across this boundary.

Boundary descriptions

3.2.6 Boundary B4 – SHE Transmission to SP Transmission

Figure B4.1
Geographic representation of boundary B4

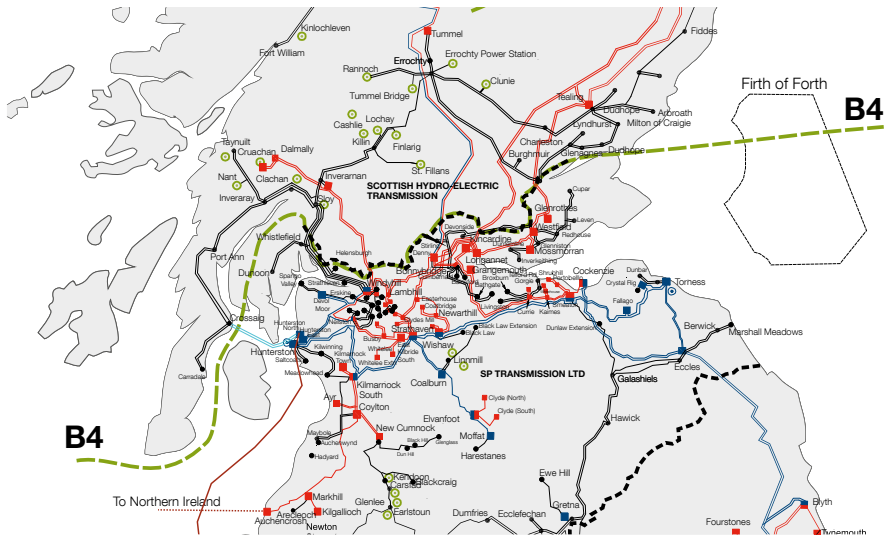

Boundary B4 separates the transmission network at the SP Transmission and SHE Transmission interface, running from the Firth of Tay in the east to near the head of Loch Long in the west. The boundary is crossed by 275kV double circuits to Kincardine and Westfield in the east and two 132kV double

circuits from Sloy to Windyhill in the west, as well as the 220kV cables between Crossaig in Kintyre and Hunterston, the 400/275kV double circuit overhead line into Denny North and the 275/132kV interface at Inverarnan. High renewables output causes high transfers across this boundary.

3.2.7 Boundary B5 – North to South SP Transmission

Figure B5.1
Geographic representation of boundary B5

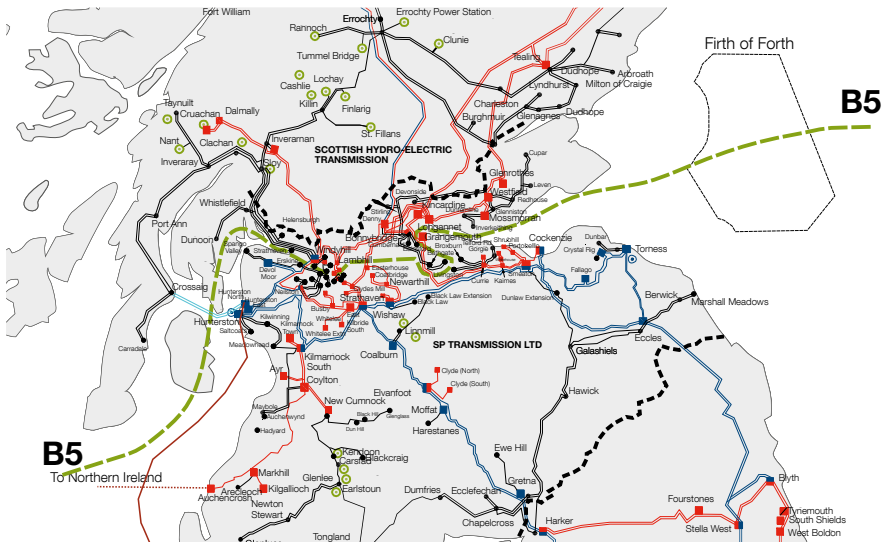

Boundary B5 is internal to the SP Transmission system and runs from the Firth of Clyde in the west to the Firth of Forth in the east. The pumped storage station at Cruachan, together with the demand groups served from Windyhill, Lambhill, Bonnybridge, Mossmorran and Westfield 275kV substations, are located between B4 and B5. The existing transmission

network across the boundary comprises three 275kV double circuit routes: one from Windyhill 275kV substation in the west; and one from each of Kincardine and Longannet 275kV substations in the east. The 220kV cables between Crossraig in Kintyre and Hunterston also cross the boundary.

Boundary descriptions

3.2.8 Boundary B6 – SP Transmission to National Grid Electricity Transmission (NGET)

Figure B6.1
Geographic representation of boundary B6

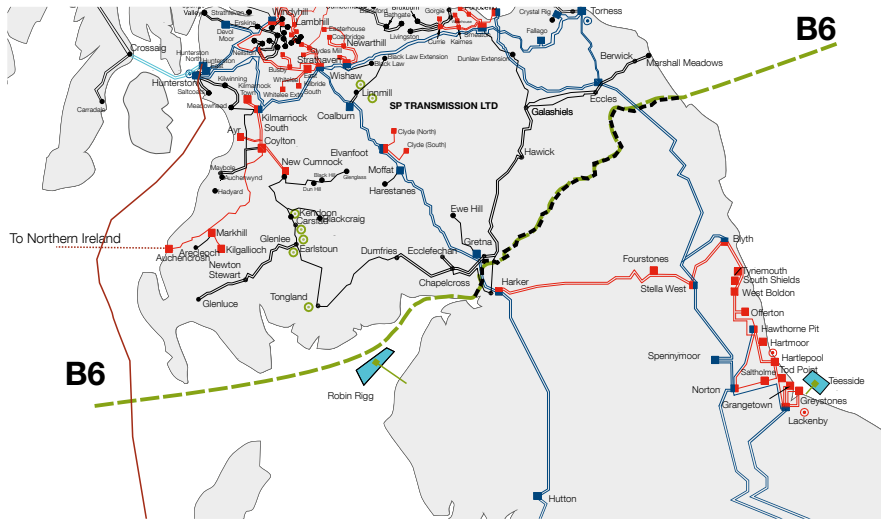

Boundary B6 separates the SP Transmission and the NGET systems. The existing transmission network across the boundary primarily consists of two double-circuit 400kV routes. There are also some limited capacity 132kV circuits across the boundary. The key 400kV routes are from Gretna to Harker and from Eccles to Blyth/Stella West and the new Western HVDC link from Hunterston in Ayrshire

to Connah's Quay in North Wales. Scotland contains significantly more installed generation capacity than demand, increasingly from wind farms. Peak power flow requirements are typically from north to south at times of high renewable generation output, while large south-to-north power flows can occur during periods of low renewable generation output.

3.2.9 Boundary B7 – Upper North

Figure B7.1
Geographic representation of boundary B7

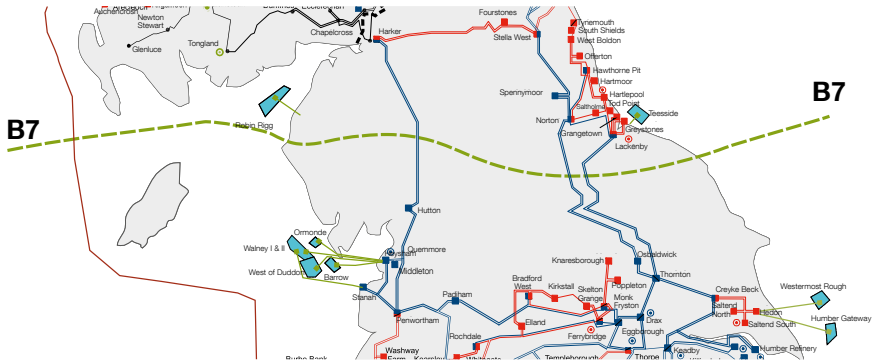

Boundary B7 bisects England south of Teesside, cutting across Cumbria. As well as the new Western HVDC link from Hunterston to Connah's Quay, it is characterised by three 400kV double circuits: two in the east; and

one in the west. Net generation output from between the B6 and B7 boundaries is small, so north-to-south exports across B7 tend to be driven by renewables output in Scotland.

Boundary descriptions

3.2.10 Boundary B7a – Upper North

Figure B7a.1
Geographic representation of boundary B7a

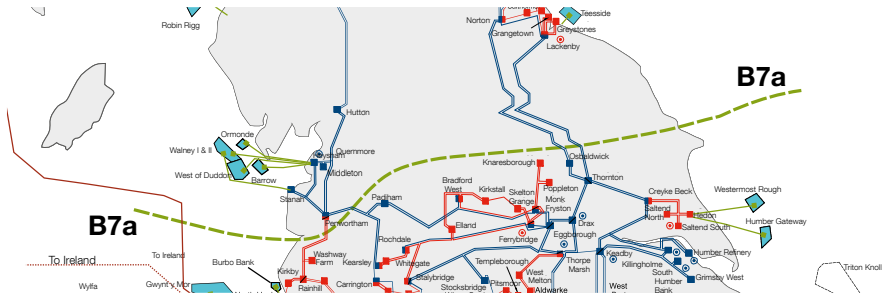

Boundary B7a bisects England south of Teesside, across Lancashire and into the Mersey Ring area. It is characterised by three 400kV double circuits (two in the east, one in the west), one 275kV circuit and the new Western HVDC link. B7a is a modified version

of B7 in which the west side is brought south to below Penwortham. This move puts the group of generation around Heysham north of the boundary and allows closer monitoring of the circuit heading south from Penwortham.

3.2.11 Boundary B8 – North to Midlands

Figure B8.1
Geographic representation of boundary B8

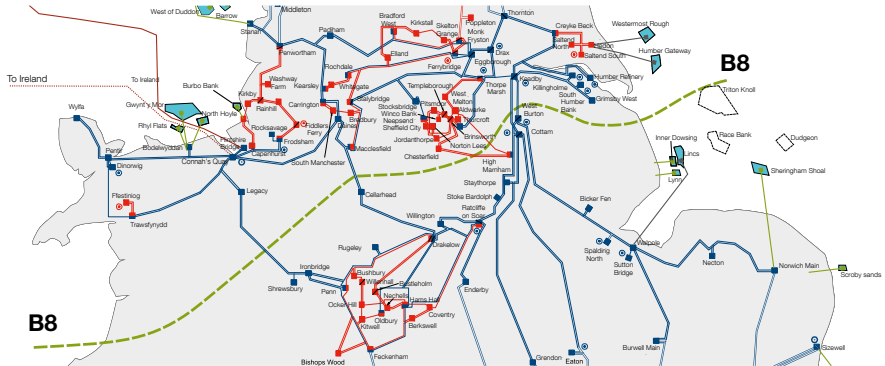

The North-to-Midlands boundary B8 is one of the wider boundaries that intersects the centre of GB, separating the northern generation zones – including Scotland, Northern England and North Wales – from the Midlands and southern demand centres. The boundary

crosses four major 400kV double circuits, with two of these passing through the East Midlands, the other two passing through the West Midlands, and a limited 275kV connection to South Yorkshire.

Boundary descriptions

3.2.12 Boundary B9 – Midlands to South

Figure B9.1
Geographic representation of boundary B9

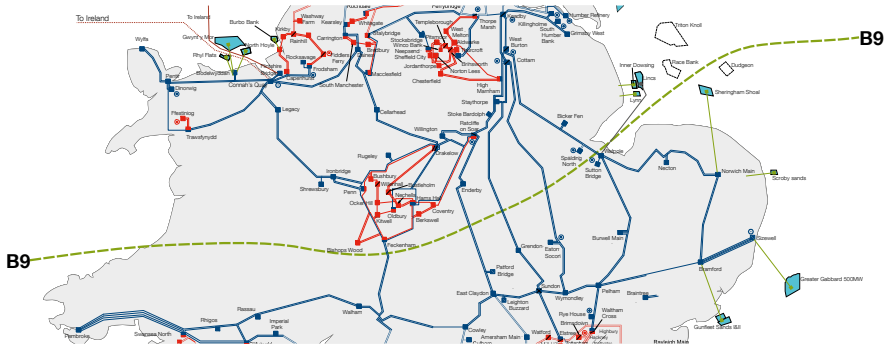

The Midlands-to-South boundary B9 separates the northern generation zones and the Midlands from the southern demand centres. The boundary crosses five major

400kV double circuits, transporting power from the north over a long distance to the southern demand hubs, including London.

3.3 The South and East of England region

3.3.1 Introduction

The South and East region includes East Anglia, London and stretches along the south coast to Devon and Cornwall. It has a high concentration of power demand and generation, with much of the demand found

in London and generation in the Thames Estuary. Interconnection to continental Europe is present on the south coast, and influences power flows in the region by being able to import and export power with Europe.

Boundary descriptions

3.3.2 Boundary EC5 – East Anglia

Figure EC5.1
Geographic representation of boundary EC5

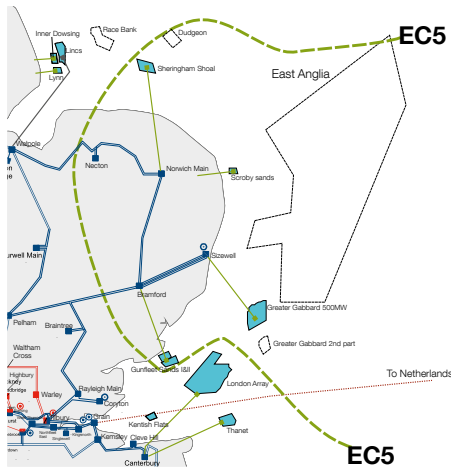

Boundary EC5 is a local boundary enclosing most of East Anglia, with 400kV substations at Norwich, Sizewell and Bramford. It crosses four 400kV circuits that mainly export power towards London.

The existing nuclear generation site at Sizewell is one of the approved sites selected for new nuclear generation development.

The coastline and waters around East Anglia are attractive for the connection of offshore wind projects, including the large East Anglia Round 3 offshore zone that lies directly to the east.

3.3.3 Boundary B14 – London

Figure B14.1
Geographic and single-line representation of boundary B14

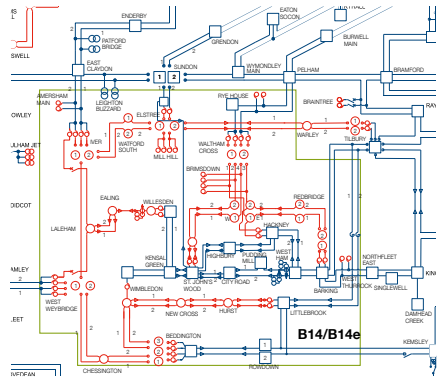
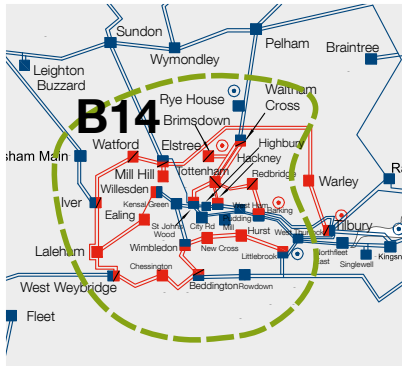

Boundary B14 encloses London, and is characterised by high local demand and a small amount of generation. The circuits entering from the north can be heavily loaded

during winter peak conditions. The circuits are further stressed when the European interconnectors export to the continent.

Boundary descriptions

3.3.4 Boundary LE1 – South East

Figure LE1.1
Geographic representation of boundary LE1

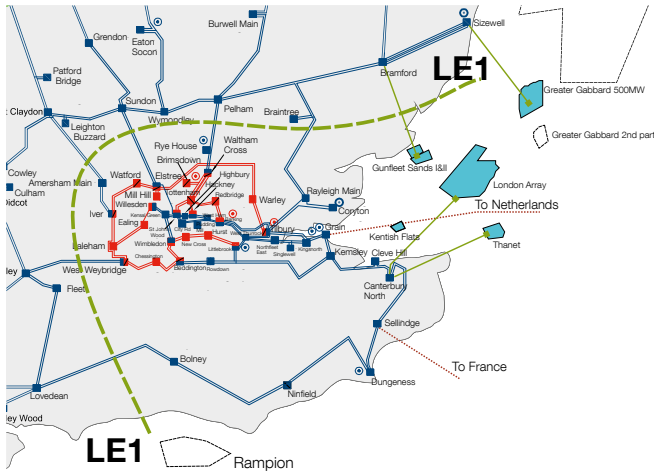

Boundary LE1 covers London and the areas to the south and east of it. Within London there is high local demand and relatively small levels of generation. The south east part contains both high demand and relatively high levels of generation. In addition there are several

current and potential future interconnectors to mainland Europe. Six 400kV double circuits cross the boundary, and loadings on these circuits depend more and more on flows on interconnectors to or from GB.

3.3.5 Boundary SC1 – South Coast

Figure SC1.1
Geographic representation of boundary SC1

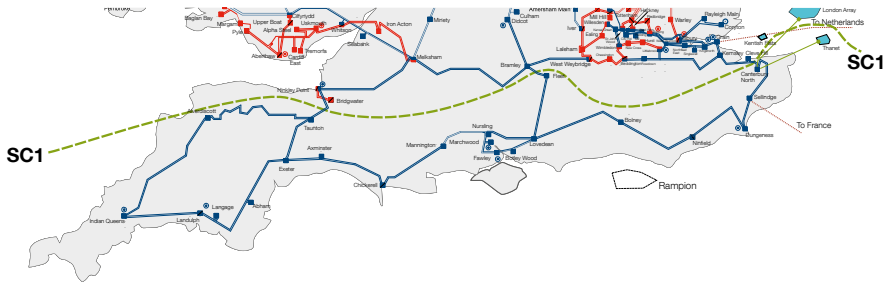

The south coast boundary SC1 runs parallel with the south coast of England between the Severn and Thames estuaries. At times of peak winter GB demand, the power flow is typically north to south across the boundary.

Interconnector activity significantly influences boundary power flow. Crossing the boundary are three 400kV double circuits, with one in the east, one in the west, and one midway between Fleet and Bramley.

Boundary descriptions

3.3.6 Boundary SC2 – South East Coast

Figure SC2.1
Geographic representation of boundary SC2

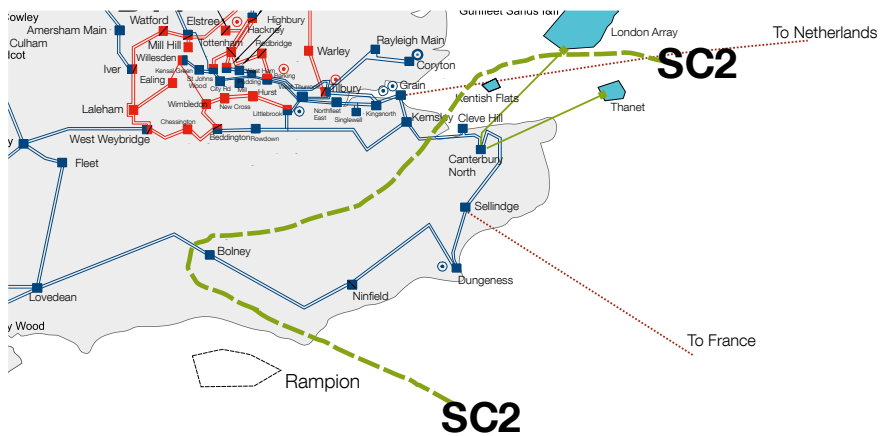

The south coast boundary SC2 takes in the relatively long 400kV route between Kemsley and Lovedeane. It connects significant demand,

and connects both large generators and interconnection to continental Europe.

3.3.7 Boundary B13 – South West

Figure B13.1
Geographic representation of boundary B13

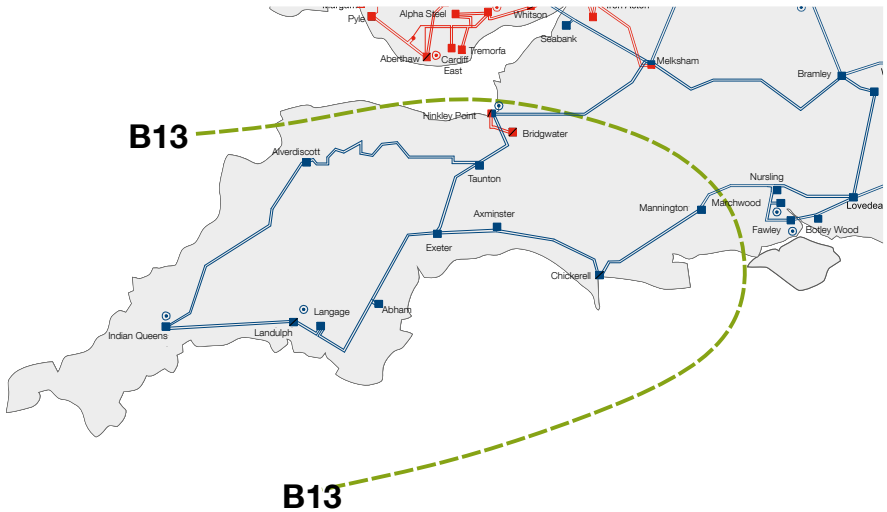

Wider boundary B13 is defined as the southernmost tip of GB, below the Severn Estuary, encompassing Hinkley Point in the south west and stretching as far east

as Mannington. The boundary crossing circuits are the Hinkley Point to Melksham 400kV double circuit, and the 400kV circuits from Mannington to Nursing and Fawley.

Boundary descriptions

3.4 Wales and West Midlands region

3.4.1 Introduction

The Wales and West Midlands region is dominated by North Wales boundaries while other boundaries in the region aren't active.

3.4.2 Boundary NW2 and NW3 North Wales

Figure NW.1
 Geographic representation of North Wales boundaries NW2 and NW3

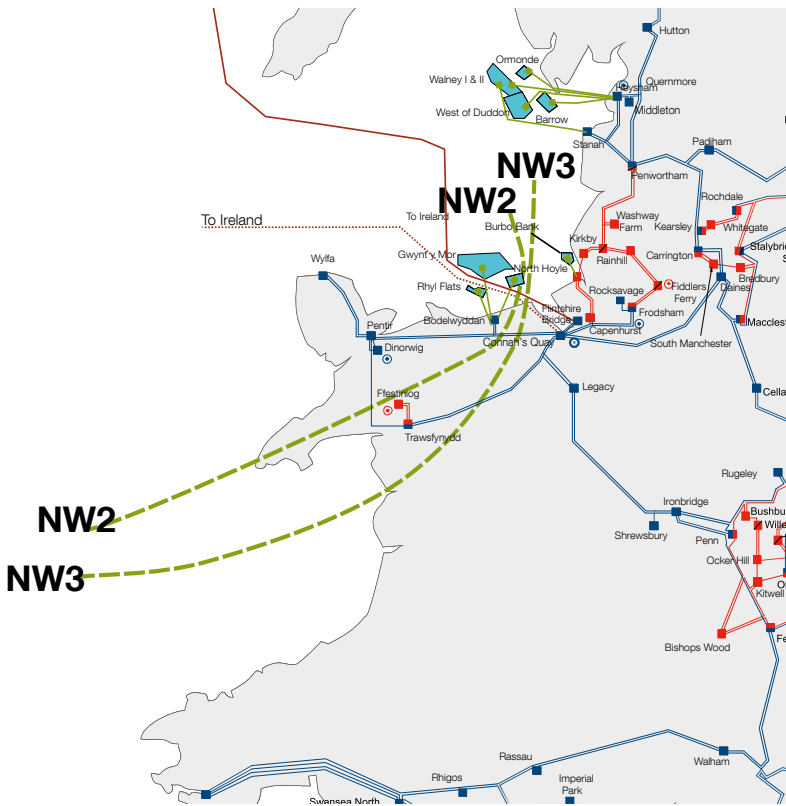

The onshore network in North Wales comprises a 400kV circuit ring that connects Penrhy, Deeside/Connah's Quay and Trawsfynydd substations. A short 400kV double-circuit cable spur from Penrhy connects Dinorwig pumped-storage power station.

Penrhy and Trawsfynydd are within the Snowdonia National Park, and are connected by a single 400kV circuit, which is the main limiting factor for capacity in this area. The two 'NW' boundaries are local boundaries.

Boundary descriptions

Boundary NW2 – Anglesey and Caernarvonshire

Boundary NW2 bisects the North Wales mainland close to Anglesey. It crosses through the Pentir to Deeside/Connah's Quay 400kV double circuit and the Trawsfynydd 400kV single circuit.

Boundary NW3 – Anglesey, Caernarvonshire and Merionethshire

Boundary NW3 provides capacity for further generation connections, in addition to those behind NW2. It is defined by a pair of 400kV double circuits from Pentir to Deeside/Connah's Quay, and from Trawsfynydd to the Treuddyn Tee.

Chapter four

Proposed options

63

Proposed options

4.1 Introduction

This chapter lists the reinforcement options that could increase the NETS boundary capability as part of network planning.

We have included the options for connecting the Scottish islands, although radial rather than benefiting particular boundaries, because they are SWW. Appendix B includes options that have started the SWW process. For each option we have included the status of the option, whether it is build or reduced-build, and some background.

The NOA methodology gives more details about options that are classed as reduced-build, but these typically include operational solutions or asset-light options. Asset-light options are options that require little expenditure, and do not typically require the addition or replacement of large assets. Such options can include things like overhead line conductor re-profiling to increase operating temperature limits, or additional cooling on existing assets.

For NOA 2017/18 we have carried out assessments to identify options that could provide a benefit for boundary transfers. Because of the changes to generation and demand patterns this year, the reduced-build options are limited to the thermal uprating or re-profiling options that the TOs have submitted.

As SO, we also have a role in identifying any offshore options that may provide an alternative solution to onshore options to meet the identified boundary transfer requirements. The feasibility of introducing interconnection between offshore generation depends on the status and timing of such offshore connections. Any additional offshore works (regardless of whether developer associated or non-developer associated) will require the participation of relevant current Offshore Transmission System Development

User Works (OTSDUW) Users, as it will affect their design and construction programme. In addition to that, the technology used in offshore connections is still developing, and hence there is a level of uncertainty in the design of the connection. This makes it harder to finalise the works required for the Offshore Wider Works (OWW). The cost of establishing any OWW after generators have been connected incurs high cost and major modifications to the offshore transmission networks owned by multiple Offshore TOs (OFTOs). For these reasons, no offshore options have been identified this year. We are planning further consultations with relevant parties on potential offshore interconnected designs – based on cost–benefit analysis – as certainty on technology choices increase and integration opportunities arise.

Our methodology for the SO's assessment of OWW is available for viewing and comment alongside the NOA methodology.



www.nationalgrid.com/noa

4.2 Reinforcement options – Scotland and the North of England region

Caithness to Shetland 600 MW subsea link

Status: Design/development and consenting
Boundary affected: Radial

Install a 600MW HVDC link between the Caithness–Moray HVDC link, via the HVDC switching station at Noss Head in Caithness, and a new substation at Kergord on Shetland to form a three-terminal HVDC scheme.

Caithness to Shetland 450 MW subsea link

Status: Scoping
Boundary affected: Radial

Install a 450MW HVDC link between the Caithness–Moray HVDC link, via the HVDC switching station at Noss Head in Caithness, and a new substation at Kergord on Shetland to form a three-terminal HVDC scheme.

Moray to Shetland subsea link

Status: Scoping
Boundary affected: Radial

Install a 600MW HVDC link between the 400kV substation at Blackhillock, on the mainland in Moray, and a new substation at Kergord on Shetland.

Dounreay to Orkney, Finstown subsea link

Status: Design/development and consenting
Boundary affected: Radial

Install a 220kV HVAC link between Dounreay, on the mainland on the north coast of Caithness, and a new substation at Finstown on the Orkney Islands. The link will comprise both land and subsea cable.

Dounreay to Orkney, Orphir subsea link

Status: Design/development and consenting
Boundary affected: Radial

Install a 220kV HVAC link between Dounreay, on the mainland on the north coast of Caithness, and a new substation at Orphir on the Orkney Islands. The link will comprise both land and subsea cable.

Beauly to Western Isles, Gravir 450MW HVDC link

Status: Scoping
Boundary affected: Radial

Install a 450MW HVDC link between a new 400kV substation at Beauly, on the mainland near Inverness, and a new substation at Gravir on the Western Isles via Dundonnell on the west coast of Scotland. The link will comprise both land and subsea cable.

Beauly to Western Isles, Arnish 450MW HVDC link

Status: Design/development and consenting
Boundary affected: Radial

Install a 450MW HVDC link between a new 400kV substation at Beauly, on the mainland near Inverness, and a new substation at Arnish on the Western Isles via Dundonnell on the west coast of Scotland. The link will comprise both land and subsea cable.

Proposed options

Beauly to Western Isles, Arnish 600MW HVDC link

Status: Design/development and consenting

Boundary affected: Radial

Install a 600MW HVDC link between a new 400kV substation at Beauly, on the mainland near Inverness, and a new substation at Arnish on the Western Isles via Dundonnell on the west coast of Scotland. The link will comprise both land and subsea cable.

FBRE

Beauly to Fyrish 275kV double circuit reconductoring

Status: Scoping

Boundary affected: B0

Reconductor the existing 275kV double circuit overhead line between Beauly and Fyrish (substation under construction) with a higher-rated conductor.

TURC

Reactive compensation at Tummel

Status: Scoping

Boundaries affected: B1, B1a, B2

Establish a 275kV double busbar at Tummel substation and install shunt reactive compensation.

ECU2

East Coast onshore 275kV upgrade

Status: Optioneering

Boundaries affected: B1, B1a, B2, B4

Establish a new 275kV substation at Alyth, re-profile the 275kV circuits between Kintore, Fetteresso, Alyth and Kincardine, and Tealing, Westfield and Longannet, and uprate the cable sections at Kincardine and Longannet to match the enhanced rating. Extend Tealing 275kV substation and install two phase-shifting transformers. Install shunt reactive compensation at the new Alyth substation.

ECUP

East Coast onshore 400kV incremental reinforcement

Status: Optioneering

Boundaries affected: B1, B1a, B2, B4

The option builds on the East Coast onshore 275kV upgrade (ECU2) and upgrades the 275kV infrastructure on the east coast for 400kV operation. Establish new 400kV substations at Rothienorman and Kintore, and uprate Alyth substation (proposed under ECU2) for 400kV operation. Re-insulate the 275kV circuits between Blackhillock, Rothienorman, Kintore, Fetteresso, Alyth and Kincardine for 400kV operation. Install phase-shifting transformers at Blackhillock on the 275kV circuits from Knocknagael and 400/275kV transformers at Kincardine, Alyth, Fetteresso, Kintore and Rothienorman.

ECU4**East Coast onshore 400kV reinforcement**

Status: Optioneering

Boundaries affected: B1, B1a, B2, B4

Upgrade the 275kV infrastructure on the east coast for 400kV operation by establishing new 400kV substations at Rothienorman, Kintore and Alyth, and re-insulating the 275kV circuits between Blackhillock, Rothienorman, Kintore, Fetteresso, Alyth and Kincardine to 400kV. Install phase-shifting transformers at Blackhillock on the 275kV circuits from Knocknagael and 400/275kV transformers at Kincardine, Alyth, Fetteresso, Kintore and Rothienorman. Re-profile the 275kV circuits between Tealing, Westfield and Longannet, and uprate the cable sections at Longannet to match the enhanced rating.

WLT1**Windyhill–Lambhill–Longannet 275kV circuit turn-in to Denny North 275kV substation**

Status: Design

Boundary affected: B5

Turn the Windyhill–Lambhill–Longannet 275kV circuit into Denny North 275kV Substation to create a 275kV Windyhill–Lambhill–Denny North circuit and a Denny North–Longannet No.2 275kV circuit.

DNEU**Denny North 400/275kV SuperGrid Transformer 2**

Status: Scoping

Boundaries affected: B1, B1a, B2

Installation of a new 400/275kV 1000MVA supergrid transformer (SGT2) at Denny North 400kV substation.

DWNO**Denny to Wishaw 400kV reinforcement**

Status: Optioneering

Boundaries affected: B4, B5, B6

Construct a new 400kV double circuit overhead line from Bonnybridge to Newarthill, and reconfigure associated sites to establish a fourth north-to-south double circuit Supergrid route through the Scottish central belt. One side of the new overhead line will operate at 400kV, the other at 275kV. This reinforcement will establish Denny–Bonnybridge, Bonnybridge–Wishaw, Wishaw–Strathaven No.2 and Wishaw–Torness 400kV circuits, and a Denny–Newarthill–Easterhouse 275kV circuit.

HNNO**Hunterston East–Neilston 400kV Reinforcement**

Status: Scoping

Boundary affected: B5

Modification of the Hunterston East–Devol Moor 400kV circuit to become the Hunterston East–Neilston 400kV double circuit overhead line (OHL), and development of a new 400/275kV supergrid transformer (SGT4) at Neilston 400kV substation.

EHRE**Elvanfoot to Harker reconductoring**

Status: Scoping

Boundary affected: B6

Replace the double circuit conductors in the Elvanfoot to Harker circuits with a higher-rated conductor to increase their thermal ratings.

Proposed options

E2DC

Eastern subsea HVDC Link from Torness to Hawthorn Pit

Status: Scoping

Boundaries affected: B5, B6, B7, B7a, B8

Construct a new offshore 2 GW HVDC subsea link from the Torness area to Hawthorn Pit to provide additional transmission capacity. The onshore works involve the construction of AC/DC converter stations and the associated AC works at Torness and Hawthorn Pit.

TLNO

Torness to north east England AC reinforcement

Status: Scoping

Boundaries affected: B6, B7, B7a, B8

This option provides additional transmission capacity by installing a double circuit from a new 400kV substation in the Torness area to a suitable connection point in north east England.

E4DC

Eastern subsea HVDC Link from Peterhead to Hawthorn Pit

Status: Scoping

Boundaries affected: B1, B1a, B2, B4, B5, B6, B7, B7a, B8

Construct a new offshore 2GW HVDC subsea link from Peterhead in the north east of Scotland to Hawthorn Pit in the north of England. The onshore works involve the construction of AC/DC converter stations at Peterhead and Hawthorn Pit, and the associated AC works. In Scotland, the onshore works include the construction of new 400kV substations at Peterhead and Rothienorman and the re-insulation of the Peterhead to Blackhilllock 275kV route to 400kV.

WHT/WHT2

Turn-in of West Boldon to Hartlepool circuit at Hawthorn Pit

Status: Scoping

Boundaries affected: B6, B7, B7a

Turn-in the West Boldon to Hartlepool circuit, which currently passes the Hawthorn Pit site to connect to it. This would create new West Boldon to Hawthorn Pit and Hawthorn Pit to Hartlepool circuits. This would ensure better load flow sharing and increased connectivity in the north east 275kV ring. The two options have different delivery years.

HAE2

Harker SuperGrid Transformer 5 replacement

Status: Project not started

Boundaries affected: B6, B7, B7a

Replacing an existing transformer at Harker substation with a new one of higher rating to prevent overloading following transmission system faults.

HAEU

Harker SuperGrid Transformer 6 replacement

Status: Project not started

Boundaries affected: B6, B7, B7a

Replacing an existing transformer at Harker substation with a new one of higher rating to prevent overloading following transmission system faults.

HSUP**Uprate Harker to Fourstones, Fourstones to Stella West and Harker to Stella West 275kV circuit to 400kV**

Status: Project not started

Boundaries affected: B6, B7, B7a, B8, B9

Reinsulate the Harker to Fourstones, Fourstones to Stella West and Harker to Stella West circuits to allow operation at 400kV. Other associated works are to reconfigure Harker and Stella West substations to connect the 400kV circuits, new interbus transformers to Fourstones and a pair of quad boosters to ensure controllability. This will prevent thermal overloads, and balance the flows between the east and west of the country.

HSRE**Reconductor Harker to Fourstones, Fourstones to Stella West and Harker to Stella West 275kV circuit**

Status: Project not started

Boundaries affected: B6, B7, B7a, B8, B9

Replace the conductors from Harker to Fourstones, Fourstones to Stella West and Harker to Stella West 275kV circuits with higher-rated conductor to increase the circuits' thermal ratings.

LNRE/LNR2**Reconductor Lackenby to Norton single 400kV circuit**

Status: Design

Boundaries affected: B7, B7a

Replace the conductors in the Lackenby to Norton single circuit with higher-rated conductor, and replace the cable with larger cable of higher rating to increase the circuit's thermal rating. The two options have different conductor types that provide different ratings.

NOR1**Reconductor 13.75km of Norton to Osbaldwick 400kV double circuit**

Status: Scoping

Boundaries affected: B7, B7a

Replace some of the conductors in the Norton to Osbaldwick double circuit with higher-rated conductor to increase the circuits' thermal rating.

NOR2**Reconductor 13.75km of Norton to Osbaldwick number 1 400kV circuit**

Status: Project not started

Boundaries affected: B7, B7a

Replace some of the conductors in Norton to Osbaldwick 1 circuit with higher-rated conductor to increase the circuit's thermal rating.

NOR4**Reconductor 13.75km of Norton to Osbaldwick number 2 400kV circuit**

Status: Project not started

Boundaries affected: B7, B7a

Replace some of the conductors in Norton to Osbaldwick 2 circuit with higher-rated conductor to increase the circuit's thermal rating.

NOWH**Thermal uprate 55km of the Norton to Osbaldwick 400kV double circuit**

Status: Project not started

Boundaries affected: B7, B7a

Thermal upgrade of the Norton to Osbaldwick circuits to allow them to operate at higher temperatures and increase their thermal rating.

Proposed options

LTR3

Lackenby to Thornton 1 circuit thermal upgrade

Status: Project not started

Boundaries affected: B7, B7a

Thermal upgrade of the Lackenby to Thornton 1 circuit to allow it to operate at higher temperatures and increase its thermal rating.

SPDC

Stella West to Padiham HVDC Link

Status: Project not started

Boundaries affected: B6, B7, B7a, B8, B9

Construct a new onshore 1 GW HVDC Link from Stella West to Padiham to improve the power flow around the eastern side of the network. The works involve the construction of AC/DC converter stations, and reconfiguration of Stella West and Padiham substations.

HPNO

New east-west circuit between the north east and Lancashire

Status: Project not started

Boundary affected: B8

Construct a new 400kV double circuit in the north of England, to increase power export capability from the north of England into the rest of the transmission system. At this time the exact landing points are to be determined. This is the first of two outline options.

NPNO

New east-west circuit between the north east and Lancashire

Status: Project not started

Boundary affected: B8

Construct a new 400kV double circuit in the north of England, to increase power export capability from the north of England into the rest of the transmission system. At this time the exact landing points are to be determined. This is the second of two outline options.

CPRE

Reconductor sections of Penwortham to Padiham and Penwortham to Carrington

Status: Project not started

Boundary affected: B7a

Replace some of the conductor sections in the Penwortham to Padiham and Penwortham to Carrington circuits with higher-rated conductor to increase the circuits' thermal rating.

CPR2

Reconductor the remaining sections of Penwortham to Padiham and Penwortham to Carrington

Status: Project not started

Boundary affected: B7a

Replace the remaining conductor sections on the Penwortham to Padiham and Penwortham to Carrington circuits with higher-rated conductor to increase the circuits' thermal rating. This follows another scheme (CPRE) to uprate the circuits.

OTHW

Osbaldwick to Thornton 1 circuit thermal upgrade

Status: Project not started

Reduced build option

Boundaries affected: B7, B7a, B8

Thermal upgrade of the Osbaldwick to Thornton 1 circuit to allow it to operate at higher temperatures and increase its thermal rating.

LDQB

Lister Drive quad booster

Status: Design

Boundary affected: B7a

Replacing the series reactor at Lister Drive with a quad booster to allow better control of power flows through the single cable to Birkenhead and avoid thermal overloads in the Mersey Ring area.

MRUP**Upgrade the Penwortham to Washway Farm to Kirkby 275kV double circuit to 400kV**

Status: Design

Boundary affected: B7a

Reinsulate the Penwortham to Washway Farm to Kirkby double circuit to allow operation at 400kV. Other associated works are at Kirkby substation to transform voltage from 400kV to 275kV and replace the Washway Farm 275/132kV transformers with 400/132kV transformers. The option would prevent thermal overloads on these circuits.

OENO**Central Yorkshire reinforcement**

Status: Optioneering

Boundaries affected: B7, B7a, B8

Construct a new 400kV double circuit in central Yorkshire to facilitate power transfer requirements across the relevant boundaries. Substation works might be required to accommodate the new circuits.

THS1**Install series reactors at Thornton**

Status: Project not started

Boundaries affected: B7, B7a, B8, B9

Install series reactors at Thornton substation. These would connect the parts of the site at present operated disconnected from one another to limit fault levels. The reactors would allow some flow sharing between the different parts of the site and reduce thermal overloads on connected circuits.

TDH1**Drax to Thornton 2 circuit thermal uprating**

Status: Project not started

Reduced build option

Boundaries affected: B7, B7a, B8

Thermal upgrade of the Drax to Thornton 2 circuit to allow it to operate at higher temperatures and increase its rating.

TDH2**Drax to Thornton 1 circuit thermal uprating**

Status: Project not started

Reduced build option

Boundaries affected: B7, B7a, B8

Thermal upgrade of the Drax to Thornton 1 circuit to allow it to operate at higher temperatures and increase its rating.

TDRE**Reconductor Drax to Thornton double circuit**

Status: Project not started

Boundary affected: B8

Replace the conductors in the Drax to Thornton double circuit with higher-rated conductor to increase the circuits' thermal rating.

GKRE**Reconductor the Garforth Tee to Keadby leg of the Creyke Beck to Keadby to Killingholme Circuit**

Status: Project not started

Boundaries affected: B7, B7a, B8

Replace the conductor on the Keadby leg of the Creyke Beck to Keadby to Killingholme three-ended circuit. This would raise the circuit's thermal rating.

Proposed options

DREU

Generator circuit breaker replacement to allow Thornton to run a two-way split

Status: Project not started

Boundaries affected: B7, B7a, B8, B9

This reinforcement is to replace generator-owned circuit breakers with higher-rated equivalents including substation equipment. This would allow higher fault levels, which in turn improves load sharing on circuits connecting to the substation.

CDRE

Cellarhead to Drakelow reconductoring

Status: Project not started

Boundaries affected: B8/B9/NW4/B17

Replace the conductors on the existing double circuit from Cellarhead to Drakelow with higher-rated conductor to increase their thermal rating.

RYEU

Substation reconfiguration and 225MVar MSC at Ryhall

Status: Project not started

Boundary affected: B9

Reconfigure Ryhall 400kV substation and install a 225MVar switched capacitor (MSC) and associated circuit breakers to provide voltage support across the Midlands area as system flows increase in the future.

4.3 Reinforcement options – the South and East of England region

<p>BMMS 225MVAr MSCs at Burwell Main Status: Scoping Boundary affected: EC5</p>	<p>Three new 225 MVAr switched capacitors (MSCs) at Burwell Main would provide voltage support to the East Anglia area as system flows increase in future.</p>
<p>BRRE Reconductor remainder of Bramford to Braintree to Rayleigh route Status: Project not started Boundary affected: EC5</p>	<p>Replace the conductors in the parts of the existing Bramford to Braintree to Rayleigh overhead line that have not already been reconducted with higher-rated conductor, to increase the circuits' thermal rating.</p>
<p>NBRE Reconductor Bramford to Norwich double circuit Status: Project not started Boundary affected: EC5</p>	<p>The double circuit that runs from Norwich to Bramford would be reconducted with a higher-rated conductor.</p>
<p>BTNO A new 400kV double circuit between Bramford and Twinstead Status: Project not started Boundary affected: EC5</p>	<p>Construct a new 400kV double circuit between Bramford substation and Twinstead tee point to create double circuits that run between Bramford to Pelham and Bramford to Braintree to Rayleigh Main. It would increase power export capability from East Anglia into the rest of the transmission system.</p>
<p>CTRE Reconductor remainder of Coryton South to Tilbury circuit Status: Project not started Boundary affected: EC5</p>	<p>Replace the conductors on the remaining sections of the Coryton South to Tilbury circuit, which have not recently been reconducted with higher-rated conductor. These would increase the circuit's thermal rating.</p>
<p>RTRE Reconductor remainder of Rayleigh to Tilbury circuit Status: Project not started Boundaries affected: EC5, B15</p>	<p>Replace the conductors on the remaining sections of the Rayleigh to Tilbury circuit, which have not recently been reconducted with higher-rated conductor. These would increase the circuit's thermal rating.</p>
<p>TKRE Tilbury to Grain and Tilbury to Kingsnorth Upgrade Status: Project not started Boundary affected: B15</p>	<p>Replace the conductors in the Tilbury to Grain and Tilbury to Kingsnorth with higher-rated conductors, and replace the associated cables with larger cables of higher rating, including Tilbury, Grain and Kingsnorth substation equipment. This will increase the circuits' thermal rating.</p>

Proposed options

GKEU

Thermal upgrade for Grain and Kingsnorth 400kV Substation

Status: Project not started
Boundaries affected: SC1, B15

Thermal upgrade of the 400kV Grain and Kingsnorth substation equipment to increase its thermal capacity, supporting future load flow within the area.

COSC

Series Compensation south of Cottam

Status: Project not started
Boundaries affected: LE1, B14e

Install series capacitors at Cottam feeder circuits connecting to Grendon, Ryhall and Staythorpe. This will increase the stability when the circuits are highly loaded.

COVC

Two hybrid STATCOMS at Cottam

Status: Project not started
Boundary affected: LE1

Install two hybrid STATCOMS at Cottam. This will increase the voltage stability when the circuits are highly loaded.

ESC1

Second Elstree to St John's Wood 400kV circuit

Status: Project not started
Boundaries affected: B14, B14e, LE1

New second 400kV cable transmission circuit from Elstree to St. Johns Wood in the existing tunnel, and carry out associated work, including modifying Elstree 400kV and St. John's Wood 400kV substations. This will improve the power flow into London.

SER1

Elstree to Sundon reconductoring

Status: Project not started
Boundaries affected: B14, B14e, LE1

Replace the conductors from Elstree to Sundon circuit 1 with higher-rated conductor to increase their thermal rating.

SER2

Elstree–Sundon 2 circuit turn-in and reconductoring

Status: Project not started
Boundaries affected: B14, B14e, LE1

Turn-in the Elstree to Sundon circuit 2, which currently passes the Elstree 400kV substation, to connect to it and replace the conductor with higher-rated conductor. This would ensure better load flow sharing and increase the thermal rating.

HWUP

Uprate Hackney, Tottenham and Waltham Cross 275kV to 400kV

Status: Project not started
Boundaries affected: B14, B14e, LE1

Hackney, Tottenham and Waltham Cross substation uprate from 275kV to 400kV, and the double circuit route connecting them. This will strengthen the power flow into London, via Rye House, down to Hackney.

WYTI

Wymondley turn-in

Status: Project not started
Boundaries affected: B14, B14e, LE1

Modify the existing circuit that runs from Pelham to Sundon. Turn-in the circuit at Wymondley to create two separate circuits that run from Pelham to Wymondley and from Wymondley to Sundon to improve the balance of flows.

WYQB**Wymondley quad boosters**

Status: Project not started
Boundaries affected: B14, B14e, LE1

Install a pair of quad boosters on the double circuits running from Wymondley to Pelham at the Wymondley 400kV substation. The quad boosters would improve the capability to control the power flows on the North London circuits.

BFHW**Bramley to Fleet circuits thermal uprating**

Status: Project not started
Reduced build option
Boundary affected: SC1

Thermal upgrade of the Bramley to Fleet circuits to allow them to operate at higher temperatures, and increase their thermal rating.

BFRE**Bramley to Fleet reconductoring**

Status: Project not started
Boundary affected: SC1

Replace the conductors in the Bramley to Fleet circuits with a higher-rated conductor to increase their thermal ratings.

SCRC**South East coast reactive compensation**

Status: Scoping
Boundaries affected: SC1, SC2, B15

Install dynamic voltage support (SVC) on the south east coast. This would provide reactive post-fault power to help maintain voltage stability on the south east coast.

BNRC**Bolney and Ninfield additional reactive compensation**

Status: Project not started
Boundaries affected: SC1, SC2, B10, B12

Provide additional reactive compensation equipment at Bolney and Ninfield substations, to maintain voltages within acceptable operational limits in future network operating conditions.

SEEU**Reactive compensation protective switching scheme**

Status: Design
Boundaries affected: SC1, SC2, B10, B12

Provide a new communications system, and other equipment, to allow existing reactive equipment to be switched in or out of service very quickly following transmission system faults. This would allow better control of system voltages following faults.

SCN1/SCN2**New 400kV transmission route between south London and the South Coast (there are two alternative designs for this option)**

Status: Project not started
Boundaries affected: SC1, SC2, B10, B12, B15

Construct a new transmission route from the south coast to south London, and carry out associated work. These works would provide additional transmission capacity between the south of London and the south coast.

FLRE/FLR2**Fleet to Lovedean reconductoring**

Status: Design/development
Boundaries affected: SC1, SC2, B10, B12

Replace the conductors in the Fleet to Lovedean circuits with a higher-rated conductor to increase their thermal ratings. The two options have different conductor types that provide different ratings.

Proposed options

KLRE

Kemsley to Littlebrook circuits uprating

Status: Design/development
Boundaries affected: B15, SC1, B14

The 400kV circuits running from Kemsley via Longfield Tee to Littlebrook would be reconducted with higher-rated conductor.

HMHW

Hinkley Point to Melksham circuits thermal uprating

Status: Project not started
Reduced build option
Boundary affected: B13

Thermal upgrade of the Hinkley Point to Melksham circuits to allow them to operate at higher temperatures, and increase their thermal rating.

THRE

Reconductor Hinkley Point to Taunton double circuit

Status: Project not started
Boundaries affected: B13, SC1

Replace the conductors in the Hinkley Point to Taunton circuits with higher-rated conductor to increase the circuits' thermal rating.

4.4 Reinforcement options – Wales and West Midlands region

<p>BCRE</p> <p>Reconductor the Connah's Quay legs of the Pentir to Bodelwyddan to Connah's Quay 1 and 2 circuits</p> <p>Status: Project not started Boundary affected: NW3</p>	<p>Replace the conductors in the sections between Bodelwyddan and Connah's Quay on the Pentir to Bodelwyddan to Connah's Quay double circuit with higher-rated conductor to increase the circuits' thermal rating.</p>
<p>PBRE</p> <p>Reconductor Pentir legs of the Pentir to Bodelwyddan to Connah's Quay 1 and 2 circuits</p> <p>Status: Project not started Boundaries affected: NW2/NW3</p>	<p>Replace the conductors in the sections between Pentir and Bodelwyddan on the Pentir to Bodelwyddan to Connah's Quay double circuit with higher-rated conductor to increase the circuits' thermal rating.</p>
<p>PTNO</p> <p>Pentir to Trawsfynydd second circuit</p> <p>Status: Project not started Boundary affected: NW2</p>	<p>Create a second Pentir to Trawsfynydd 400kV circuit by using the existing circuit infrastructure and corridor, including constructing new cable sections.</p>
<p>PTC1</p> <p>Pentir to Trawsfynydd 1 cable replacement – single core per phase</p> <p>Status: Project not started Boundary affected: NW2</p>	<p>Replacing cable sections of the Pentir to Trawsfynydd 1 circuit with large cable sections, increasing the circuit's thermal rating.</p>
<p>PTC2</p> <p>Pentir to Trawsfynydd 1 and 2 cables – second core per phase and reconductor of an overhead line section on the existing Pentir to Trawsfynydd circuit</p> <p>Status: Project not started Boundary affected: NW2</p>	<p>Replace the conductors in part of the circuits between Pentir and Trawsfynydd with higher-rated conductor. Construct a second single core per phase cable section on these circuits. These two activities would increase the circuits' thermal rating.</p>
<p>PTRE</p> <p>Pentir to Trawsfynydd circuits – reconductor the remaining overhead line sections</p> <p>Status: Project not started Boundary affected: NW2</p>	<p>Replace the conductors in the remaining parts of the circuits between Pentir and Trawsfynydd with higher-rated conductor to further increase the circuits' thermal rating.</p>

Chapter four

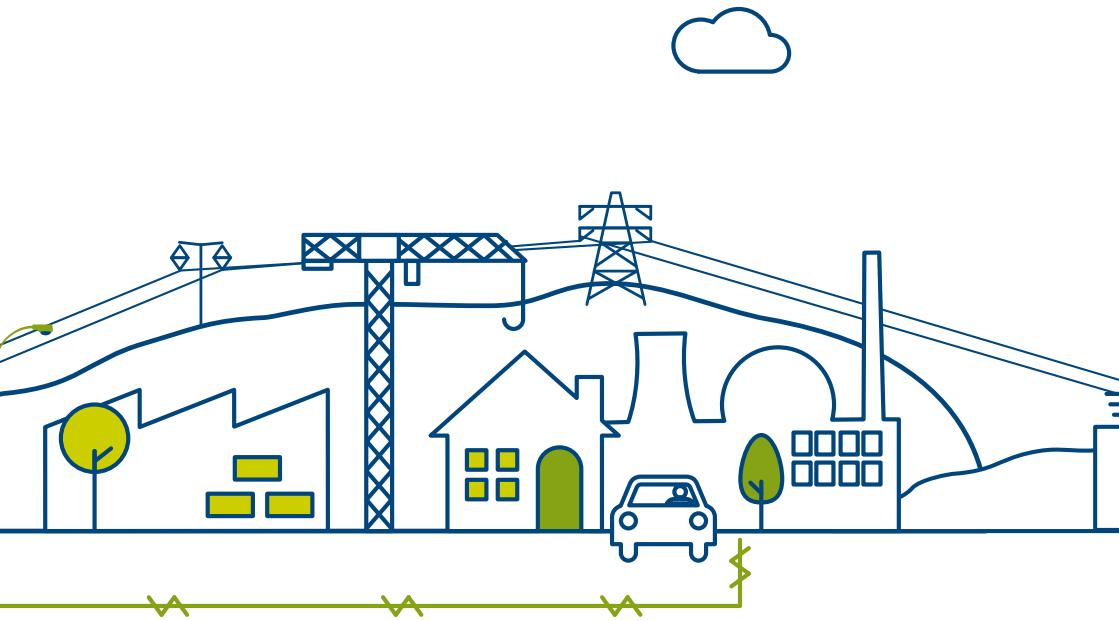

Chapter five

Investment recommendations

79

Investment recommendations

5.1 Introduction

Chapter 5 presents our investment recommendations from our economic analysis. The results give the most economic investment strategy for each scenario, and enable us to identify our preferred options and the recommended next steps for works required in each region.

Key statistics

In 2018/19 the TOs are recommended to invest £21.57 million on reinforcement options that have a total investment of almost £3.24 billion over their lifetime. Of the 76 options submitted for evaluation, 22 options have a Proceed recommendation. Our analysis considered what is truly necessary as the energy landscape changes and, as a result, significant savings are possible from deferring expenditure. We recommend deferring the delivery of

four projects that may have committed over £8.55 million of spend this investment year. Our NOA 2017/18 recommendations are based on robust economic analysis results which have been subject to further scrutiny by our newly established NOA Committee¹. This will ensure that development of the GB transmission network can continue supporting the transition to the future energy landscape in an efficient, economical and coordinated way.

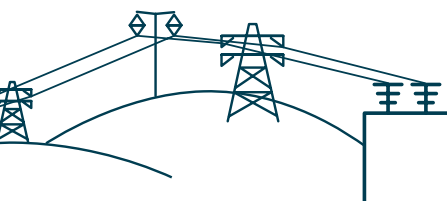

£21.57m

Investing £21.57m this year

22

Through 22 options

£3.24bn

Total worth of £3.24bn

¹ For more information about the NOA Committee, please refer to Chapter 2 – Methodology.

Figure 5.1
How the options went through the process

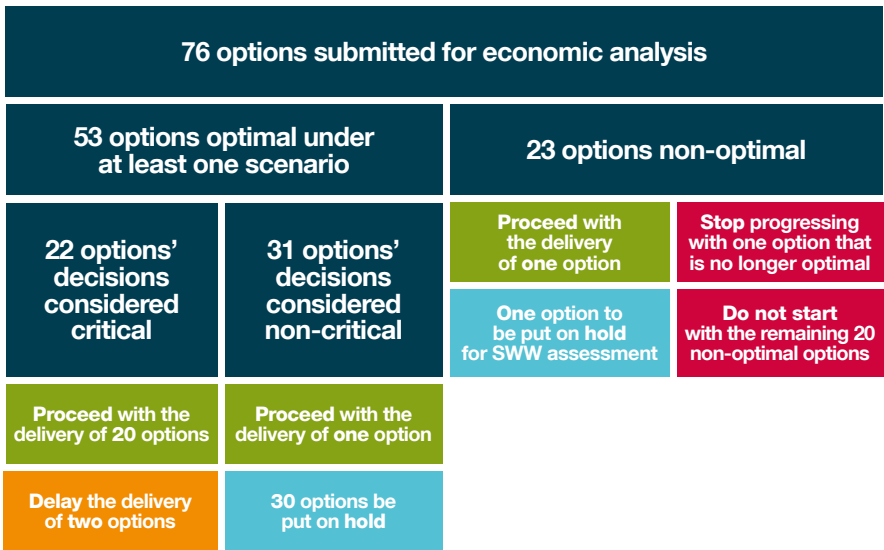

Investment recommendations

5.2 Interpretation of the NOA outcomes

This section explains how to interpret the *NOA* outcomes including the economic analysis results and our investment recommendations underpinned by the results.

Optimal path and optimum delivery date

The cost–benefit analysis investigates the benefits of transmission network solutions in economic terms with respect to different combinations of reinforcement options across four future energy scenarios. Under each scenario, an optimal investment strategy is found in the form of an optimal path, where a selection of options should be delivered in a certain sequence to maximise the benefits for GB consumers. An option is only deemed optimal if it is included in the optimal path of at least one scenario. In contrast it is non-optimal at this time if it does not appear in any optimal paths.

The optimal path not only shows which options are considered to be the most economic under that scenario, but also when their optimum completion years are. If an option's optimum delivery date is its current Earliest In Service Date (EISD) in at least one scenario then it is considered a critical option. This is because an investment decision must be made by the TOs this year to be able to meet the optimum delivery date. If under all scenarios the optimum delivery dates of an option are later than its EISD then the option is non-critical and a decision can be put on hold until there is greater certainty in the future.

Critical options' single year least regret analysis

All critical options must have a decision made this year and so advance onto our single year least regret analysis. This measures and compares the regret associated with delivering each critical option against the regret of not delivering it. If a region has multiple critical options then we compare the regret associated with delivering different combinations of critical options. For each region, we will always recommend the option, or combination of options, that minimises the levels of regret across all scenarios. If an option is being driven by a single scenario then we will investigate the drivers behind that option further to ensure that the right recommendation really is being made.

Investment recommendations

Following the cost–benefit analysis and single year least regret analysis, the results are presented to the *NOA* Committee for additional scrutiny. Attention is focused on the marginal options where recommendations indicated by the economic analysis, are driven by a single scenario or factor, or are considered to be sensitive.

Economic regret

In economic analysis the 'regret' of an investment strategy is defined as the difference in benefit for that strategy against the benefit of the best strategy for that scenario. Therefore in each scenario the best strategy will have a regret of zero,

and the other strategies will have different levels of regret depending how they compare to the best strategy. We always choose the strategy with the least regret across all scenarios. For more information, please see Chapter 2 – Methodology.

The NOA Committee brings expertise from across the SO, including knowledge on operability challenges, network capability development, commercial operations and insight into future energy landscapes. It then provides a final set of recommendations for the marginal options. With the endorsement from the NOA Committee, we are in a position to recommend a decision for each option. All options will be allocated to one of the following outcomes:

- **Proceed:** Work should continue or commence in order to maintain the EISD.
- **Delay:** The option is optimal and critical, but it is not economical to be delivered by its EISD. Delivery of this option should be delayed by one year.
- **Hold:** The option is optimal but not critical and so an investment decision should be put on hold. Delivery of this option should be delayed by at least one year.
- **Stop:** The option is non-optimal at this time. Delivery of this option should not be continued.
- **Do not start:** The option is non-optimal at this time. Delivery of this option should not commence.

It should be noted that an option we don't recommend to proceed with can still be considered in the SWW assessment.

As our energy landscape is changing, our recommendations for an option may adapt accordingly. This means that an option that we recommended to proceed last year may be recommended to be delayed this year, and vice versa. The benefit of the single year least regret analysis is that an ongoing project is revaluated each year to ensure that its planned completion date remains best for the consumer.

Eligibility for onshore competition

Ofgem published their decision on 'Extending Competition In Transmission' (ECIT²) in November 2016 which set the future direction of travel for competition in onshore electricity transmission under the Competitively Appointed Transmission Owner (CATO) model. However, following Ofgem's latest update on ECIT in June 2017³, the development of the CATO regime has now been deferred due to a delay in introducing relevant legislation. Ofgem is pursuing competition in alternative forms during the RIIO-T1 period, but it has indicated that it still intends to develop long-term arrangements for introducing competition in onshore electricity transmission along with other broader regulatory frameworks for the RIIO-T2 period.

Therefore we believe it is sensible and pragmatic to continue to include an assessment for competition in this NOA for major network reinforcement options. This includes options we recommend to proceed this year and SWW projects with Needs Case initiated, as the timescales for delivery of many of these investments now fall into the RIIO-T2 timeframe.

In the competition assessment, we use three criteria: '**new**', '**separable**' and '**high value**', proposed by Ofgem in the November 2016 ECIT publication, as indicators that an option is eligible for onshore competition. The option must fulfil all criteria in order to be considered.

- To assess whether the option meets the 'new' criterion, we test the options against whether they involve the implementation of completely new assets or the complete replacement of an existing transmission asset.
- To assess whether the option meets the 'separable' criterion, we test the options against whether the new assets can be clearly delineated from other (existing) assets.
- To assess whether the option meets the 'high value' criterion, we assess whether the capex for the assets which meet the new and separable criteria is £100 million or more. We use the costs that the TO(s) have provided, which are scrutinised as part of our NOA process.

² https://www.ofgem.gov.uk/system/files/docs/2016/11/ecit_november_2016_decision.pdf

³ https://www.ofgem.gov.uk/system/files/docs/2017/06/update_on_extending_competition_in_transmission.pdf

Investment recommendations

5.3 NOA outcomes

This section presents the results of the economic analysis followed by investment recommendations and eligibility for onshore competition.

In the economic analysis, the GB network was separated into three distinct regions: Scotland and the North of England; the South and East of England, and Wales and West Midlands, where reinforcement options proposed for one region have little or no impact with the other two. The economic analysis results are presented on this basis for the best view of the outcomes.

For each region we focus on the following aspects, ultimately leading to our final investment recommendations:

- The optimal paths by scenario, which highlight optimal options and their optimum delivery dates.
- Critical options from the optimal paths and associated single year least regret analysis, which produces the 'Proceed' and 'Delay' recommendations.
- Drivers behind our recommendations such as system needs or changes to the energy landscape and network.

The main outputs of the economic analysis, including optimal paths and initial investment recommendations, are illustrated in Tables 5.1 to 5.3 with respect to the three regions. The optimal options are listed in four-letter codes (as detailed in Chapter 4) with the optimum delivery dates for those options highlighted with different colours for different scenarios or sensitivities. If an option is not in the optimal path of a scenario or sensitivity, then no optimum delivery year for that scenario or sensitivity will be highlighted.

As there are a number of critical options that could be progressed this year, there are several combinations, one of which will have the lowest value of regret across all scenarios. The options that make up this combination will be recommended to proceed.

The initial recommendations for optimal options from our economic analysis are indicated by different shadings in Tables 5.1 to 5.3 where green is 'Proceed', amber is 'Delay' and blue is 'Hold'. We also found 23 options that were not optimal under any of the scenarios at this time and are therefore not included in those tables. The initial recommendation for those non-optimal options is either 'Do not start' or 'Stop' depending on whether there is any associated work already in progress.

The economic analysis results and initial recommendations were then further scrutinised by the NOA Committee and the final recommendation for each of the options is available to view in Tables 5.4 to 5.6. You will find differences between initial and final recommendations for some options. Explanations for those are included as part of our regional narratives. In the interests of transparency, minutes from the NOA Committee meetings will be published on our website.

A full list of optimal options for each region with descriptions and optimum delivery dates can be found in Appendix A.1-3. Critical options are in **bold**. Some options are marked as 'N/A' as they are not optimal under that particular scenario or sensitivity.

Results for the top performing combinations from our single year least regret analysis can be found in Appendix A.4-5. The worst regret for each combination is in **bold** and the combination with the smallest worst regret across the energy scenarios is highlighted in **green**.

Investment recommendations

5.3.1 Scotland and the North of England region

Table 5.1
Scotland and the North of England region

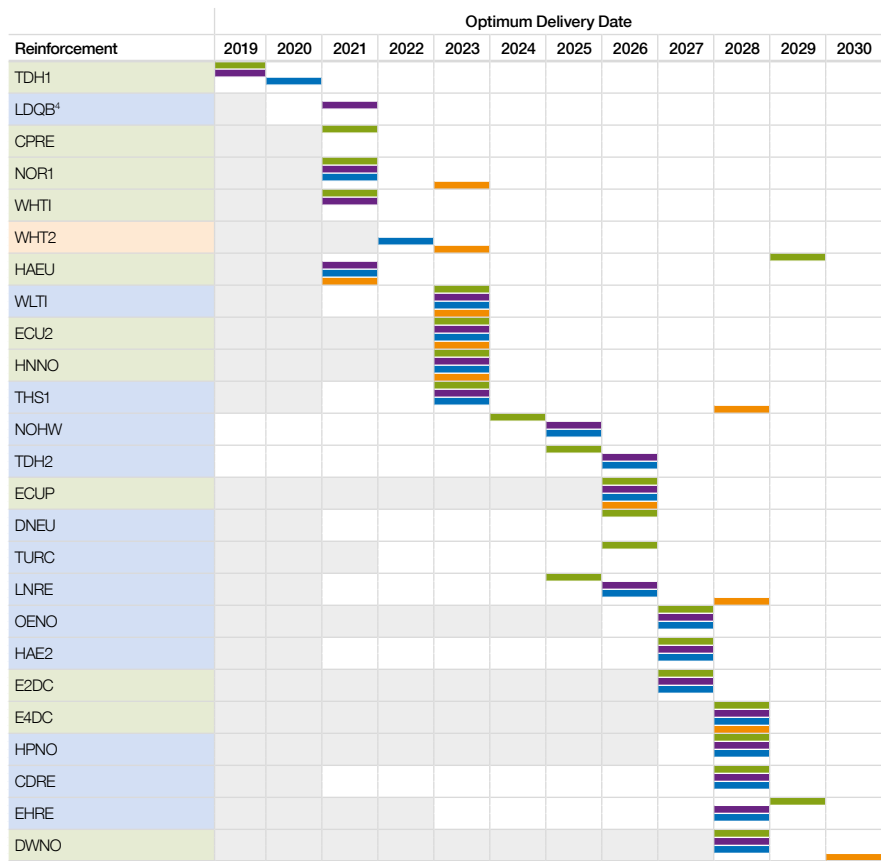

Key

- Optimum year indicator for Two Degrees
- Optimum year indicator for Slow Progression
- Optimum year indicator for Consumer Power
- Optimum year indicator for Steady State
- EISD not yet reached
- Critical option to 'Proceed'
- Critical option to 'Delay'
- Non-critical option to 'Hold'

For Scotland and the North of England region, we identified 25 optimal options as illustrated in Table 5.1. The optimum delivery dates for those options are highlighted in different colours for different scenarios, where 'Green' is for Two Degrees, 'Blue' is for Consumer Power, 'Purple' is for Slow Progression and 'Amber' is for Steady State.

Among the 25 optimal options, 12 are critical and they could present 4096 different possible combinations of 'Proceed' and 'Delay' recommendations. The options 'East Coast onshore 275kV upgrade' (ECU2), 'East Coast onshore 400kV incremental reinforcement' (ECUP), 'Eastern subsea HVDC Link from Peterhead to Hawthorn Pit' (E4DC) and 'Hunterston East–Neilston 400kV Reinforcement' (HNNO) have optimum years of delivery that are the same as their EISDs for all scenarios. This means that there is no requirement to perform single year least regret analysis for these four options, as progressing them to maintain their EISDs is the optimum course of action under all scenarios.

Having taken account of ECU2, ECUP, E4DC and HNNO, this leaves this region with eight critical options and therefore 256 different possible combinations of the following reinforcements:

- **Drax to Thornton 2 circuit thermal uprating** (TDH1).
- **Turn-in of West Boldon to Hartlepool circuit at Hawthorn Pit** (WHT1).
- **Turn-in of West Boldon to Hartlepool circuit at Hawthorn Pit** (WHT2)⁵.
- **Reconductor sections of Penwortham to Padiham and Penwortham to Carrington** (CPRE).
- **Reconductor 13.75km of Norton to Osbaldwick 400kV double circuit** (NOR1)
- **Harker SuperGrid Transformer 6 replacement** (HAEU).
- **Eastern subsea HVDC Link from Torness to Hawthorn Pit** (E2DC).
- **Denny to Wishaw 400kV reinforcement** (DWN0).

We performed the single year least regret analysis on all 256 combinations. The least regret strategy is to proceed with all critical options in Scotland and the North of England region with the exception of WHT2. The top 10 performing combinations for this region are listed in Appendix A.4.

The above results are explained in more detail as follows:

- This year the TOs have reviewed the Eastern Link options, including E2DC, E4DC and TLNO. These options involve large infrastructure construction onshore and/or offshore which will trigger the SWW process. Following a more detailed programme review and building on learned experience from delivering similar programmes, it is now recognised that the delivery of these options will come later than anticipated in the last NOA. The agreed EISDs of E2DC, E4DC and TLNO are now 2027, 2028 and 2030 respectively; whereas in the last NOA they were 2024, 2024 and 2028.
- From our economic analysis, we still see the need to have E2DC and E4DC delivered as early as possible. TLNO is no longer optimal as its EISD is too late.
- Some development work has been carried out in the past on ECU2 and ECUP options and neither project was recommended to proceed because the timing for their delivery was not optimal in NOA 2016/17. These projects, which involve upgrades to existing routes, are now both recommended to proceed for delivery in 2023 and 2026 respectively. This is because they are now critical and progressing with them delivers the most benefit.

⁴The NOA Committee concluded the final recommendation for LDQB to be 'Proceed'.

⁵The EISD and spend profile of option WHT2 are different to that of WHT1 although the scope of work for the two options is exactly the same; hence they are treated as alternative options in the economic analysis.

Investment recommendations

- To further justify the need for the Eastern Link options, we conducted a sensitivity study of an operational tripping scheme. This sensitivity considered a 1 GW operational tripping scheme with associated costs to improve the capability of boundaries B6, B7 and B7a between 2022 and 2026. The optimal paths were recreated as the additional capability significantly reduces constraint costs during those four years before E2DC becomes available. However, little change was found in the optimal path of Two Degrees as the network is still under-reinforced and no change was found in that of Steady State. Delivery of some smaller reinforcements, such as THS1 and LDQB, are pushed back or no longer required due to the operational tripping scheme under Consumer Power and Slow Progression. However no critical options are affected by the inclusion of the operational tripping scheme.
- We recognise that the Eastern Link options will cause great impact to the optimal paths. Hence another sensitivity study was conducted to evaluate the potential benefit of having E4DC and E2DC delivered sooner than the given EISDs. Although expediting the delivery of the two options will cost more, we found that if both options were to be commissioned by 2026, it could create significant benefit (from £300m to £740m) for our consumers across all energy scenarios.
- Due the scale and complexity of the Eastern Link projects, options E2DC, E4DC, TLNO, ECU2, ECUP and ECU4 should all be available for consideration in the upcoming SWW Needs Case submission this year, and it should be widened to other options to provide a whole system view. As a result of the NOA, we recommend that the TOs proceed with E2DC, E4DC ECU2 and ECUP but put TLNO on hold until it is further assessed in the SWW process.
- There are options whose optimum delivery dates are closely related to that of the Eastern Link options; OENO was recommended to proceed last year to maintain its EISD of 2026, while this year we recommend to keep it on hold until E2DC is delivered in 2027. It should be noted that the optimum delivery date for OENO is only one year later than its current EISD. Therefore we would expect to see this option resubmitted next year with its EISD delayed by one year.
- LDQB and MRUP were both recommended to proceed last year, while this year's analysis results suggest stopping the delivery of MRUP and putting LDQB on hold. This is driven by several reasons such as the year-to-year differences in east and west flows in the North of England area and the location of the critical limiting fault. As a result the congestion in the East Coast is found more prominent in this NOA and therefore the benefit of LDQB and MRUP is reduced. We've further investigated the issue and found the conditions that would trigger a 'Proceed' recommendation for both options were very close to the conditions that would suggest the opposite, i.e. additional flows of 100MW to the west will make both options 'critical' and worth recommending to proceed. These two options were presented to the NOA Committee due to the marginal nature of the results. The Committee considered the additional evidence and agreed to overturn the results from the economic analysis so that the final recommendation for LDQB and MRUP is 'Proceed'.
- We recommend that the TOs proceed with TDH1, NOR1, HAEU and HNNO. These options are critical under multiple scenarios.
- CPRE is solely driven by the Two Degrees scenario, where constraint costs are heavily built up around boundaries B6, B7 and B7a during 2021 to 2025. Having further investigated the scenario, it was found that the rapid growth in wind generation and interconnection are the main drivers for this option. These assumptions on regional generation are deemed credible. The implied probability suggested that we only have to believe the conditions driving the option are 0.7% likely to happen to make 'Proceed' a rational decision. This option was presented to the NOA Committee which considered the evidence and supported the analysis results recommending to proceed with CPRE.

- WHTI although supported by Two Degrees and Slow Progression has a single driving factor. The low front end cost and high regret values under the Two Degrees scenario resulted in the implied probability of this factor only having to be 0.5% likely to happen to make ‘Proceed’ a rational decision. This option was presented to the NOA Committee for additional scrutiny, which endorsed the recommendation to proceed with WHTI.

In conclusion, we recommend that the TOs progress with the following reinforcements in Scotland and the North of England region.

- TDH1 to meet its EISD of 2019.
- LDQB to meet its EISD of 2020.
- WHTI to meet its EISD of 2021.
- CPRE to meet its EISD of 2021.
- NOR1 to meet its EISD of 2021.
- HAEU to meet its EISD of 2021.
- ECU2 to meet its EISD of 2023.
- HNNO to meet its EISD of 2023.
- MRUP to meet its EISD of 2023.
- ECUP to meet its EISD of 2026.
- E2DC to meet its EISD of 2027.
- E4DC to meet its EISD of 2028.
- DWNO to meet its EISD of 2028.

We believe that there could be significant benefit of the use of an operational tripping scheme to mitigate the constraint costs ahead of reinforcements. We request the TOs to bring forward tripping schemes to address this need and to review the possibility of accelerating the asset investment programmes.

Following the above results, we conducted eligibility assessment for onshore competition for all reinforcements that we recommended to proceed this year in Scotland and the North of England region. We identified the following options meet the competition criteria proposed by Ofgem in the November 2016 ECIT publication:

- **Eastern subsea HVDC Link from Peterhead to Hawthorn Pit (E4DC).**
- **Eastern subsea HVDC Link from Torness to Hawthorn Pit (E2DC).**
- **East Coast onshore 400kV incremental reinforcement (ECUP).**
- **Orkney link⁵.**
- **Western Isles link⁵.**
- **Shetland link⁵.**

The East Coast onshore 400kV incremental reinforcement (ECUP) would have to be split up to meet the competition criterion for separability. It also includes some new assets that might be built earlier for one or more other projects. As a result this could affect the value of ECUP and its eligibility for competition. We will review this as the plans for the network are developed.

Following feedback about NOA 2016/17, we restructured chapter 5 so that it contained more narrative and less raw data. This data has moved to a new Appendix A. Please tell us your views on how we’ve changed chapter 5.

⁵In addition to the NOA reinforcements, projects to connect to the Scottish islands were also assessed for onshore competition.

Investment recommendations

5.3.2 The South and East of England region

Table 5.2a
The South and East of England region by energy scenarios

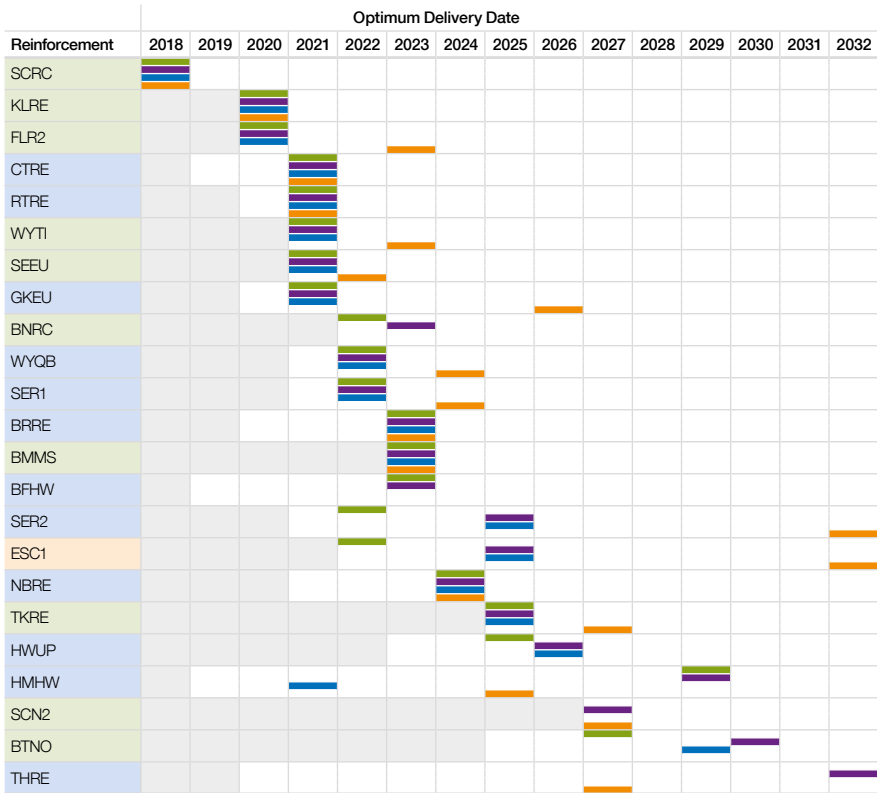

Key

- █ Optimum year indicator for Two Degrees
- █ Optimum year indicator for Slow Progression
- █ Optimum year indicator for Consumer Power
- █ Optimum year indicator for Steady State
- █ EISD not yet reached
- █ Critical option to 'Proceed'
- █ Critical option to 'Delay'
- █ Non-critical option to 'Hold'

Table 5.2b
The South and East of England region by local sensitivities

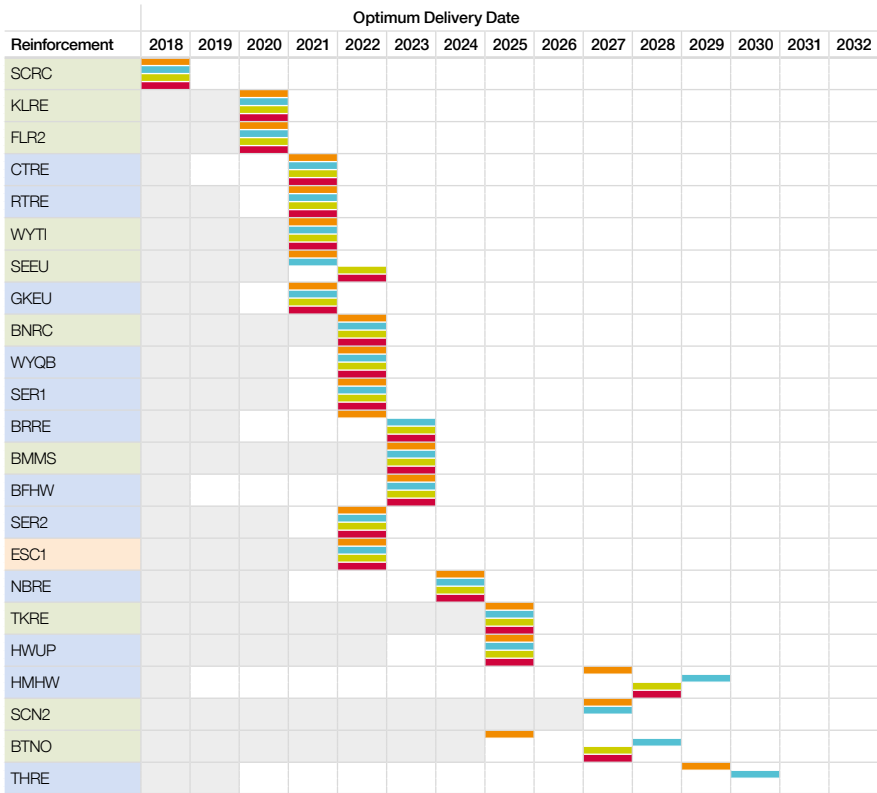

Key

- Optimum year indicator for LoCon A
- Optimum year indicator for LoCon B
- Optimum year indicator for NoCon A
- Optimum year indicator for NoCon B
- EISD not yet reached
- Critical option to 'Proceed'
- Critical option to 'Delay'
- Non-critical option to 'Hold'

Investment recommendations

For the South and East of England region, we identified 23 optimal options as shown in the optimal paths in Table 5.2. Among these, 11 are critical and they could present 2048 different possible combinations of 'Proceed' and 'Delay' recommendations. The options 'South East coast reactive compensation' (SCRC), 'Kemsley to Littlebrook circuits uprating' (KLRE) and '225MVar MSCs at Burwell Main' (BMMS) have optimum years of delivery that are the same as their EISDs for all scenarios. This means that there is no requirement to perform single year least regret analysis for these three options, as progressing them to maintain their EISDs is the optimum course of action under all scenarios.

Having taken account of SCRC, KLRE and BMMS this leaves this region with eight critical options and therefore 256 different possible combinations of the following reinforcements:

- **Fleet to Lovedean reconducting (option 2)** (FLR2).
- **Reactive compensation protective switching scheme** (SEEU).
- **Wymondley turn-in** (WYTI)
- **Tilbury to Grain and Tilbury to Kingsnorth Upgrade** (TKRE).
- **Second Elstree to St John's Wood 400kV circuit** (ESC1).
- **Bolney and Ninfield additional reactive compensation** (BNRC).
- **A new 400kV double circuit between Bramford and Twinstead** (BTNO).
- **New 400kV transmission route between south London and the South Coast (option 2)** (SCN2).

We performed the single year least regret analysis on all 256 combinations. The least regret strategy is to proceed with all critical options in the South and East of England region except ESC1. The top 10 performing combinations for this region are listed in Appendix A.5.

The above results are explained in more detail as follows:

- This year we've combined 'the South' and 'the East' into one region. We have several reinforcement options which benefit multiple boundaries across those two regions; hence they have to be considered in a single combined region to avoid getting two sets of results.
- In addition to the four energy scenarios, we've also included two sets of 'Local contracted' and 'No local contracted' sensitivities. The first set of sensitivities are named 'LoCon A' and 'NoCon A', representing the 'Local Contracted' and 'No Local Contracted' backgrounds around the East Anglia area; the second set of sensitivities are named 'LoCon B' and 'NoCon B', representing the 'Local Contracted' and 'No Local Contracted' backgrounds along the South East Coast. This was because there is potential for a large amount of local generation and interconnection that could significantly alter the investment recommendations.
- We recommend SCRC, FLR2 (alternative to FLRE), SEEU and KLRE to proceed this year which is the same as our recommendation last year. These options are required on the South East Coast where a large amount of interconnector capacity is due to connect. The EISD of KLRE has been reviewed by the TO so it can now be delivered in 2020 instead of 2021 to achieve maximum benefit.
- The recommendation for WYTI was 'Delay' in the NOA 2016/17. As a result, its EISD has slipped from 2020 to 2021 this year. This year we recommend WYTI to proceed as it is driven by exporting conditions on B14, which is consistent with what we observed last year.

- BTNO has an EISD of 2025, and our analysis recommends that the TO proceed with the option as delaying it under the Local Contracted sensitivity of the East Anglia area will result in significant regret of £148m. The option is optimal under Two Degrees, Consumer Power and Slow Progression, however non-critical for any of them. The Local Contracted sensitivity is a modification of the Two Degrees scenario which includes an additional 7.4GW of offshore wind from today's level by 2025, whereas the Two Degrees scenario only has an additional 1.25GW. Together with other local generation, the total installed capacity in the Local Contracted sensitivity is over 10GW by 2025. Because of the significant differences between the Local Contracted sensitivity and the Two Degrees scenario, the sensitivity driving the option seems less credible. Further investigations were then conducted to find out the exact amount of additional generation needed to trigger a 'Proceed' recommendation, and that is 500MW above the level in Two Degrees by 2025. We regarded this as too high to be credible in this timeframe. This option was referred to the NOA Committee due to its marginal nature, and considering the evidence presented about the generation mix the Committee agreed that the final recommendation for BTNO is 'Delay'.
- BNRC has an EISD of 2021 and is only required to be delivered on its EISD under the Two Degrees scenario. The option is mainly triggered by importing conditions of the interconnectors connected to the South Coast in 2022 which significantly contribute to the constraints build up on boundaries SC1 and SC2. We believe the interconnector assumptions are credible. The low front end cost and considerably large regret of delaying the option indicate that we only have to believe the conditions driving the option are 0.5% likely to happen to make 'Proceed' a rational decision. This was another marginal option presented to the NOA Committee who, based on the evidence provided, endorsed the recommendation to proceed with BNRC.
- SCN2 has an EISD of 2027 and is required to be delivered by its EISD under Slow Progression and Steady State. Following significant changes in generation mix in the FES 2017, the requirement for this option is mainly driven by the constraints build up in the Thames estuary area as early as 2023. No effective reinforcement is available with an earlier EISD to alleviate the congestion in that part of the network. Delaying the option could result in significant regret under Slow Progression and Steady State up to £103m, while the regret to proceed with the option this year of less than £1m is much lower due to the low front end cost. We only have to believe the conditions under Slow Progression and Steady State are 1.2% and 0.7% likely to happen to make 'Proceed' a rational decision for this option. This option involves large infrastructure construction which triggers the SWW process. Due to the scale and complexity of this option, it was referred to the NOA Committee for additional scrutiny. They supported the recommendation to proceed with SCN2 this year for SWW submission.
- TKRE is found critical under multiple scenarios. The reinforcement benefits multiple boundaries along the South Coast once SCN2 is built. Therefore we recommend that the TO proceed with TKRE.
- Hinkley Point to Seabank new double circuit (HSNO) was assessed in the NOA 2016/17 and recommended to proceed. This year the option has progressed sufficiently far through the SWW process and Ofgem's decision published in January 2018⁶ confirmed their view that there is a clear economic and technical case that it is beneficial for GB consumers for the project to progress. The project is therefore no longer assessed in the NOA. Instead, we have included the option in the base network for our analysis.

⁶ https://www.ofgem.gov.uk/system/files/docs/2018/01/decision_on_hsb_final_needs_case.pdf

Investment recommendations

In conclusion, we recommend progressing with the following reinforcements in the South and East of England region:

- SCRC to meet its EISD of 2018.
- BMMS to meet its EISD of 2023.
- TKRE to meet its EISD of 2025.
- SCN2 to meet its EISD of 2027.
- WYT1 to meet its EISD of 2021.
- BNRC to meet its EISD of 2021.
- KLRE to meet its EISD of 2020.
- FLR2 to meet its EISD of 2020.
- SEEU to meet its EISD of 2021.

Following the above results, we conducted eligibility assessment for onshore competition for all reinforcements that we recommended to proceed this year in the South and East of England region. We identified one option which meets the competition criteria proposed by Ofgem in the November 2016 ECIT publication:

- **New 400kV transmission route between south London and the south coast (option 2) (SCN2)**

5.3.3 Wales and West Midlands region

Table 5.3
Wales and West Midlands region

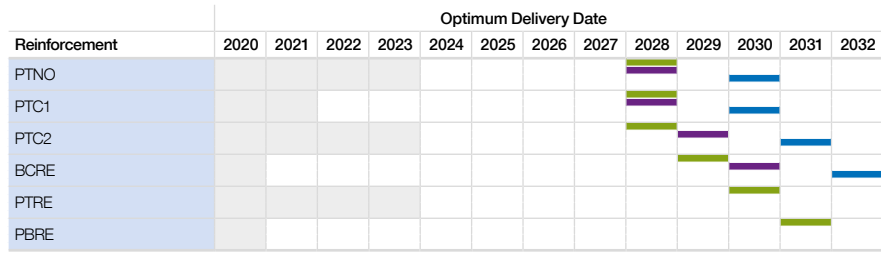

Key

- Optimum year indicator for Two Degrees
- Optimum year indicator for Slow Progression
- Optimum year indicator for Consumer Power
- Optimum year indicator for Steady State
- EISD not yet reached
- Non-critical option to 'Hold'

For Wales and West Midlands region, we identified six optimal options as shown in the four optimal paths in Table 5.3; however none of them are critical this year. The results are similar to that of last year, where no significant

constraints are found in the early 2020s. Therefore we recommend that the TO hold any investment decisions in this region until we have more information in later years.

Investment recommendations

5.4 Recommendation for each option

This section presents the recommendation for each option assessed in *NOA 2017/18*.

In addition, we present the recommendation from last year's *NOA* for comparison and to give an indication whether an option could be an SWW. This year we also include cost bands

for options with a 'Proceed' recommendation and that satisfy the competition criteria. These options and their associated cost bands are highlighted in red.

Table 5.4
Scotland and the North of England region

Option four-letter code	Description (and cost band)	Potential SWW?	NOA 2016/17 recommendation	NOA 2017/18 recommendation
CDRE	Cellarhead to Drakelow reconductoring	No	Not featured in NOA 2016/17	Hold
CPR2	Reconductor the remaining sections of Penwortham to Padiham and Penwortham to Carrington	No	Not featured in NOA 2016/17	Do not start
CPRE	Reconductor sections of Penwortham to Padiham and Penwortham to Carrington	No	Not featured in NOA 2016/17	Proceed
DNEU	Denny North 400/275kV Super Grid Transformer 2	No	Not featured in NOA 2016/17	Hold
DREU	Generator circuit breaker replacement to allow Thornton to run a two-way split	No	Do not proceed	Do not start
DWNO	Denny to Wishaw 400kV reinforcement	No	No decision required	Proceed
E2DC	Eastern subsea HVDC Link from Torness to Hawthorn Pit Cost band: £500m–£1000m	Yes	Proceed	Proceed
E4DC	Eastern subsea HVDC Link from Peterhead to Hawthorn Pit Cost band: £1000m–£1500m	Yes	Proceed	Proceed
ECU2	East Coast onshore 275kV upgrade	Yes	No decision required	Proceed
ECU4	East Coast onshore 400kV reinforcement	Yes	Do not proceed	Do not start
ECUP	East Coast onshore 400kV incremental reinforcement Cost band: £100m–£500m	Yes	No decision required	Proceed

Table 5.4
Scotland and the North of England region continued

Option four-letter code	Description (and cost band)	Potential SWW?	NOA 2016/17 recommendation	NOA 2017/18 recommendation
EHRE	Elvanfoot to Harker reconductoring	No	Not featured in NOA 2016/17	Hold
FBRE	Beauly to Fyrish 275kV double circuit reconductoring	No	Do not proceed	Do not start
GKRE	Reconductor the Garforth Tee to Keadby leg of the Creyke Beck to Keadby to Killingholme Circuit	No	Do not proceed	Do not start
HAE2	Harker SuperGrid Transformer 5 replacement	No	Not featured in NOA 2016/17	Hold
HAEU	Harker SuperGrid Transformer 6 replacement	No	Do not proceed	Proceed
HNNO	Hunterston East–Neilston 400kV Reinforcement	No	Not featured in NOA 2016/17	Proceed
HPNO	New east–west circuit between the north east and Lancashire	Yes	No decision required	Hold
HSRE	Reconductor Harker to Fourstones, Fourstones to Stella West and Harker to Stella West 275kV circuit	No	Not featured in NOA 2016/17	Do not start
HSUP	Uprate Harker to Fourstones, Fourstones to Stella West and Harker to Stella West 275kV circuit to 400kV	Yes	Not featured in NOA 2016/17	Do not start
LDQB	Lister Drive quad booster	No	Proceed	Proceed
LNR2	Reconductor Lackenby to Norton single 400kV circuit (with a different conductor type to LNRE)	No	Not featured in NOA 2016/17	Do not start
LNRE	Reconductor Lackenby to Norton single 400kV circuit (with a different conductor type to LNR2)	No	Delay	Hold
LTR3	Lackenby to Thornton 1 circuit thermal upgrade	No	Not featured in NOA 2016/17	Do not start
MRUP	Uprate the Penwortham to Washway Farm to Kirkby 275kV double circuit to 400kV	No	Proceed	Proceed
NOHW	Thermal uprate 55km of the Norton to Osbaldwick 400kV double circuit	No	Do not proceed	Hold
NOR1	Reconductor 13.75km of Norton to Osbaldwick 400kV double circuit	No	Proceed	Proceed
NOR2	Reconductor 13.75km of Norton to Osbaldwick number 1 400kV circuit	No	No decision required	Do not start
NOR4	Reconductor 13.75km of Norton to Osbaldwick number 2 400kV circuit	No	Not featured in NOA 2016/17	Do not start
NPNO	New east–west circuit between the north east and Lancashire	Yes	No decision required	Do not start

Investment recommendations

Table 5.4
Scotland and the North of England region continued

Option four-letter code	Description (and cost band)	Potential SWW?	NOA 2016/17 recommendation	NOA 2017/18 recommendation
OENO	Central Yorkshire reinforcement	No	Proceed	Hold
OTHW	Osbalwick to Thornton 1 circuit thermal upgrade	No	Do not proceed	Do not start
RYEU	Substation reconfiguration and 225MVar MSC at Ryhall	No	Not featured in NOA 2016/17	Do not start
SPDC	Stella West to Padiham HVDC Link	Yes	Not featured in NOA 2016/17	Do not start
TDH1	Drax to Thornton 2 circuit thermal uprating	No	Not featured in NOA 2016/17	Proceed
TDH2	Drax to Thornton 1 circuit thermal uprating	No	Not featured in NOA 2016/17	Hold
TDRE	Reconductor Drax to Thornton double circuit	No	Do not proceed	Do not start
THS1	Install series reactors at Thornton	No	No decision required	Hold
TLNO	Torness to north east England AC reinforcement	Yes	Proceed	Hold for SWW
TURC	Reactive compensation at Tummel	No	Do not proceed	Hold⁷
WHT2	Turn-in of West Boldon to Hartlepool circuit at Hawthorn Pit (with a different delivery year to WHT1)	No	Not featured in NOA 2016/17	Delay
WHT1	Turn-in of West Boldon to Hartlepool circuit at Hawthorn Pit (with a different delivery year to WHT2)	No	Proceed	Proceed
WLTI	Windyhill to Lambhill to Longannet 275kV circuit turn-in to Denny North 275kV substation	No	No decision required	Hold

⁷The NOA recommendations are based on our economic assessment of options to deliver boundary capability. Some options assessed may be listed as enabling works in users' connection agreements. This may be for a number of reasons. An option not receiving a 'Proceed' recommendation could still be proceeded by the TO(s) if required for other reasons than delivering boundary capability.

Table 5.5
The South and East of England region

Option four-letter code	Description (and cost band)	Potential SWW?	NOA 2016/17 recommendation	NOA 2017/18 recommendation
BFHW	Bramley to Fleet circuits thermal uprating	No	Do not proceed	Hold
BFRE	Bramley to Fleet reconductoring	No	Not featured in NOA 2016/17	Do not start
BMMS	225MVAr MSCs at Burwell Main	No	Proceed	Proceed
BNRC	Bolney and Ninfield additional reactive compensation	No	No decision required	Proceed
BRRE	Reconductor remainder of Bramford to Braintree to Rayleigh route	No	No decision required	Hold
BTNO	A new 400kV double circuit between Bramford and Twinstead	No	No decision required	Delay ⁸
COSC	Series Compensation south of Cottam	No	Not featured in NOA 2016/17	Do not start
COVC	Two hybrid STATCOMS at Cottam	No	Not featured in NOA 2016/17	Do not start
CTRE	Reconductor remainder of Coryton South to Tilbury circuit	No	No decision required	Hold
ESC1	Second Elstree to St John's Wood 400kV circuit	No	Not featured in NOA 2016/17	Delay
FLR2	Fleet to Lovedean reconductoring (with a different conductor type to FLRE)	No	Not featured in NOA 2016/17	Proceed
FLRE	Fleet to Lovedean reconductoring (with a different conductor type to FLR2)	No	Proceed	Stop
GKEU	Thermal upgrade for Grain and Kingsnorth 400kV Substation	No	Not featured in NOA 2016/17	Hold
HMHW	Hinkley Point to Melksham circuits thermal uprating	No	Not featured in NOA 2016/17	Hold
HWUP	Uprate Hackney, Tottenham and Waltham Cross 275kV to 400kV	No	Not featured in NOA 2016/17	Hold
KLRE	Kemsley to Littlebrook circuits uprating	No	Proceed	Proceed
NBRE	Reconductor Bramford to Norwich double circuit	No	No decision required	Hold
RTRE	Reconductor remainder of Rayleigh to Tilbury circuit	No	No decision required	Hold

⁸ The NOA recommendations are based on our economic assessment of options to deliver boundary capability. Some options assessed may be listed as enabling works in users' connection agreements. This may be for a number of reasons. An option not receiving a 'Proceed' recommendation could still be proceeded by the TO(s) if required for other reasons than delivering boundary capability.

Investment recommendations

*Table 5.5
The South and East of England region continued*

Option four-letter code	Description (and cost band)	Potential SWW?	NOA 2016/17 recommendation	NOA 2017/18 recommendation
SCN1	New 400kV transmission route between south London and the south coast (an alternative design to SCN2)	Yes	Do not proceed	Do not start⁹
SCN2	New 400kV transmission route between south London and the south coast (an alternative design to SCN1) Cost band: £500m–£1000m	Yes	Do not proceed	Proceed
SCRC	South East coast reactive compensation	No	Proceed	Proceed
SEEU	Reactive compensation protective switching scheme	No	Proceed	Proceed
SER1	Elstree to Sundon reductoring	No	Not featured in NOA 2016/17	Hold
SER2	Elstree–Sundon 2 circuit turn-in and reductoring	No	Not featured in NOA 2016/17	Hold
THRE	Reconductor Hinkley Point to Taunton double circuit	No	Do not proceed	Hold
TKRE	Tilbury to Grain and Tilbury to Kingsnorth Upgrade	No	Not featured in NOA 2016/17	Proceed
WYQB	Wymondley quad boosters	No	No decision required	Hold
WYTI	Wymondley turn-in	No	Delay	Proceed

⁹ The NOA recommendations are based on our economic assessment of options to deliver boundary capability. Some options assessed may be listed as enabling works in users' connection agreements. This may be for a number of reasons. An option not receiving a 'Proceed' recommendation could still be proceeded by the TO(s) if required for other reasons than delivering boundary capability.

Table 5.6
Wales and West Midlands region

Option four-letter code	Description (and cost band)	Potential SWW?	NOA 2016/17 recommendation	NOA 2017/18 recommendation
BCRE	Reconductor the Connah's Quay legs of the Pentir to Bodelwyddan to Connah's Quay 1 and 2 circuits	No	No decision required	Hold
PBRE	Reconductor Pentir legs of the Pentir to Bodelwyddan to Connah's Quay 1 and 2 circuits	No	Do not proceed	Hold
PTC1	Pentir to Trawsfynydd 1 cable replacement – single core per phase	No	No decision required	Hold
PTC2	Pentir to Trawsfynydd 1 and 2 cables – second core per phase and reconductor of an overhead line section on the existing Pentir to Trawsfynydd circuit	No	No decision required	Hold
PTNO	Pentir to Trawsfynydd second circuit	No	No decision required	Hold
PTRE	Pentir to Trawsfynydd circuits – reconductor the remaining overhead line sections	No	Do not proceed	Hold

Chapter five



Chapter six

Interconnection analysis

103

Interconnection analysis

6.1 Introduction

Chapter 6 presents our latest interconnection analysis, which aims to facilitate the development of interconnector capacity as part of an efficient, coordinated and economical electricity transmission system.

6.1.1 The purpose of this analysis

The analysis is undertaken to inform the industry of the potential benefits of future interconnection, with the goal of providing a market signal to facilitate the development of efficient interconnector capacity with the GB market. The analysis provides an indication as to socioeconomic benefits of interconnection; it does not provide any project-specific information and the output of the analysis does not determine or have any impact on a project's viability.

The *NOA* for Interconnectors (*NOA IC*) is a market and network assessment of the optimal level of interconnection based on Social Economic Welfare (SEW), capex costs of both the interconnection capacity and network reinforcements, and constraint costs. To achieve this market signal it is necessary

to establish a base case which can then be incrementally adjusted to identify potential interconnection capacities, network connection locations and reinforcement requirements. As the output concentrates on optimal capacities, it will generate the greatest balance of socioeconomic welfare, system constraints and capex costs. The final insights are largely independent of specific current and future projects.

The purpose of the *NOA IC* is to inform and facilitate discussion: National Grid does not make any investment decisions based on the outcome of this interconnector analysis.

Key statistics

- This year's interconnection analysis suggests that a total interconnection capacity of 17.4 GW between GB and European markets by 2030 would provide the lowest risk for GB consumers.
- The analysis demonstrates that the GB consumer can benefit from more interconnection beyond the Cap and Floor window 2 projects.
- Additional interconnection to Ireland and Norway over and above that included within the base case provides the least regret opportunity for GB and European consumers.
- Europe and GB would benefit both economically and environmentally from increased interconnection.

For this year's analysis we have undertaken further improvements to the methodology, which were approved by Ofgem. We have included locational impacts on the GB transmission network in addition to the welfare and capital cost implications considered last year.

We have also used the output from this year's *NOA* as the baseline network reinforcement assumptions for the *NOA IC* analysis; this provides greater consistency between the *NOA* and *NOA IC* analysis which we believe will be of added value to our stakeholders.

Interconnection analysis

6.2 Interconnection theory

Electricity interconnectors allow the transfer of electricity between nations. Currently GB has ~4 GW of interconnection with other European markets, however our *Future Energy Scenarios (FES) 2017* see an increase to between 10 GW in Steady State and 19 GW in Two Degrees by 2030. Ofgem's Cap and Floor window 2 would take the total GB interconnection capacity to 15.9 GW by 2025.

Increases in interconnection can deliver benefits to both industry and consumers in a number of ways:

- **Greater security of supply** – both markets can access increased levels of generation to secure their energy needs.
- **Greater access to renewable energy** – increased access to intermittent renewable generation, consequently displacing domestic non-renewable generation.
- **Increased competition** – increased access to cheaper generation and more consumers leads to increased competition allowing some participants in both markets to benefit financially. These benefits are measured as Socio Economic Welfare.

Socio Economic Welfare (SEW) is a common indicator used in cost-benefit analysis of projects of public interest. It captures the overall benefit, in monetary terms, to society from a given course of action. It is an aggregate of multiple parties' benefits – so some groups within society may lose money as a result of the option taken. In this analysis, SEW captures the financial benefits and detriments seen by market participants as a result of increased

interconnection. Increased SEW is primarily attained through the following benefits:

- **Reduced price for consumers in the higher priced market** – suppliers have increased access to cheap renewable generation.
- **Increased revenue for generators in the lower priced market** – generators can now access more customers.
- **Revenue for interconnector businesses** – income generated from selling capacity across their interconnectors.

In addition, SEW must also capture the associated detriments that some market participants will face:

- **Reduced revenue for generators in the higher priced market** – now competing against cheaper overseas generation.
- **Increased price for consumers in the cheaper market** – they now share their access to cheaper generation with more consumers.

The increase in SEW must also be balanced against the capital costs of the delivery of the increased interconnection capacity and any associated reinforcement costs. As capacity is increased between two suitable markets and SEW is consequently gained, prices between the two markets begin to converge until further interconnection brings no benefit. We then consider the interconnection capacity as optimised as the benefits derived from interconnection are at a maximum.

6.3 Current and potential interconnection

As stated within the *FES 2017*, interconnection capacity increases in all four scenarios, although it is lower than stated in the *FES 2016* as a result of stakeholder feedback. Table 6.1 shows the current and planned interconnection levels which have formed the basis for this study's base interconnection capacity. This included commissioned interconnectors, projects included within Ofgem's Cap and Floor (C&F) window 1, projects included within C&F window 2 that Ofgem are minded to grant a cap and floor regime to in principle and projects with an approved exemption¹.

Following stakeholder feedback, due to the unique properties of the Icelandic market, whereby plentiful renewable generation results in a very low wholesale electricity price, any interconnection that appears within the *FES* is treated as a generator. Further Icelandic interconnection was excluded from the process. It can be seen that if all the projects included within the base case do successfully connect on time, then this will represent roughly a quadrupling in GB interconnection capacity over the next eight years.

Table 6.1
Current interconnection capacities and 2025 base case

	Belgium	Denmark	France	Germany	Ireland	Netherlands	Norway	Spain	Total
2017 Capacity (GW)	0	0	2	0	1	1	0	0	4
2025 Base Case (GW)	1	1.4	6.8	1.4	1.5	1	2.8	0	15.9

¹The Aquind interconnector was not included within the baseline for this year's report, as at the time of setting the base case level of interconnection Aquind had not received a formal exemption pursuant to Regulation (EC) no 714/2009. Subsequently Aquind's application for exemption has been formally acknowledged by Ofgem and CRE (Regulatory Commission of Energy for France) and the assessment is ongoing. We would expect Aquind to be included within the base case for next year's analysis, should Ofgem approve Aquind's request for an exemption, as Aquind will then satisfy the regulatory certainty criteria within the current methodology.

Interconnection analysis

6.4 Methodology

The methodology was developed in consultation with our stakeholders. The interconnection analysis aims to identify the optimal level of interconnection capacity across the eight European markets shown in Table 6.1 for

a selection of study years. Details of the choice of markets, study years and further details of the methodology and the rationale for the approach taken are available on the *NOA* website².

6.4.1 Developments to methodology

This year, in addition to the welfare and capital cost implications considered last year, we have modelled the impact of location of the interconnector on the GB network and the level of onshore reinforcement required to be built to accommodate the interconnector. We have also used the recommendations from this year's *NOA* as the baseline network reinforcement assumptions for the *NOA IC* analysis: this provides greater consistency between the *NOA* and *NOA IC* analysis. Last year's methodology produced the optimal interconnection development path for each future energy scenario: this year we have used least worst regret after each iteration to identify

which option should be taken forward. This results in a single path. For this year's *NOA IC*, like last year, we modelled GB interconnection levels using studies within our electricity market modelling software BID3. The studies involved a step-by-step process, where the market was modelled with a base level of interconnection, including current interconnection levels and projects with regulatory certainty totalling 15.9 GW. An iterative process then directed where the additional interconnection should be implemented. Figure 6.1 provides a high-level overview of the process.

² <https://www.nationalgrid.com/sites/default/files/documents/NOA%20for%20IC%20methodology%20final.pdf>

Figure 6.1
Iterative process for interconnection optimisation

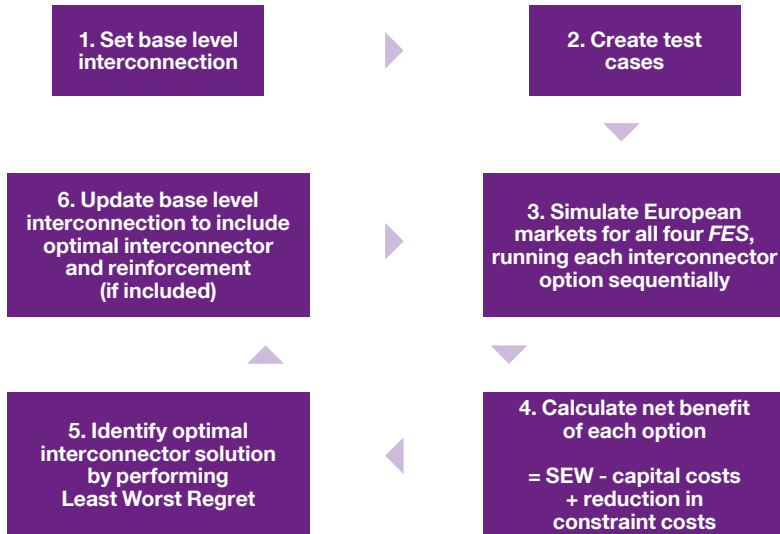

The selected method of arriving at a recommendation for capacity development is an iterative optimisation including a 'least worst regret' calculation across all four scenarios. The iterative optimisation approach attempts to maximise the present value, equal to SEW less CAPEX less Attributable Constraint Costs (ACC). The iterative process is as follows:

1) Set base level of interconnection

The base level of interconnection was the total capacity GB has with each of the eight studied markets at the start of the iteration. All interconnectors that are in the NOA IC baseline are included within the model.

2) Create test cases

To test the effect of additional capacity for each market, 1GW of interconnection was added in each of the European markets to the base level of interconnection. For each country's additional interconnector, a small number of zones and reinforcement combinations were studied. In total 30 options of country, GB connection zone and reinforcement were modelled. In options where a reinforcement upgrade is selected, an additional 1GW of capability is added to the relevant boundary. These options are shown in table 6.2. Additional interconnection is modelled to connect in 2025, 2027 and 2030, in order to understand the effects of varying commissioning dates on SEW and attributable constraint costs.

Interconnection analysis

Table 6.2
Interconnector connecting country, zone and reinforcement options

Interconnected Country	GB connection zone	Reinforcement on boundary
None (base)	None	None
Belgium	4	EC5
Belgium	4	None
Belgium	6	None
Belgium	6	SC1+B15
Denmark	4	EC5
Denmark	4	None
Denmark	7	None
France	5	None
France	5	SC1
France	5	SC1+B15
France	6	None
France	6	SC1
Germany	4	EC5
Germany	4	None
Germany	7	None
Ireland	2	B8
Ireland	2	None
Ireland	3	None
Ireland	3	SW1
Norway	1	B6+B8
Norway	1	None
Norway	2	B8
Norway	2	None
Spain	5	None
Spain	5	SC1
The Netherlands	4	EC5
The Netherlands	4	None
The Netherlands	6	None
The Netherlands	6	SC1+B15

3) Simulate European markets

Run all 30 combinations for each 2017 FES for all European countries then calculate SEW and attributable constraint costs.

4) Calculate net benefit of each combination

Calculate $PV = SEW - CAPEX - \text{Attributable Constraint Costs}$ for each option of country, GB connection zone, reinforcement and connecting year for each scenario.

5) Identify optimal solution

Perform Least Worst Regret for all 30 options of country, GB connection zone

and reinforcement across all four FES and across three time periods (interconnectors commissioning in 2025, 2027 and 2030).

6) Update base level interconnection

Add optimal solution to base level of interconnection and repeat steps 3 to 6.

The iterative process finishes when it is deemed to have converged, that is when 'None' is the option with the least worst regret. Once this result is achieved, the incremental capacity will be reduced to 500MW to analyse whether there is any benefit of a further 500MW of interconnection.

Estimation of interconnection construction costs

The cost of building interconnection capacity varies significantly between different projects, with key drivers including converter technology, cable length and capacity of cable. Estimating costs for generic interconnectors between European markets and GB is therefore challenging. The capital costs were derived from a publicly available ACER (Agency for the Cooperation of Energy Regulators) document³, based on surveys carried out on a range of European projects, and approximations of median possible cable lengths.

Estimation of network reinforcement costs

The network has been divided into seven high level zones which have been determined by areas of significant constraints on the network or areas of high interconnection. These are illustrated in Figure 6.2.

Figure 6.2
GB network high level zones and boundaries

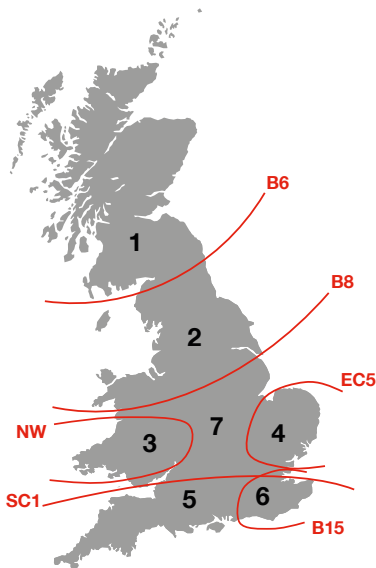

The baseline boundary capabilities were determined by using the outputs published in this NOA. Generic reinforcements were created for each boundary, using costs from NOA 2016/17 and ACER as a guide.

³http://www.acer.europa.eu/Official_documents/Acts_of_the_Agency/Publication/UIC%20Report%20%20-%20Electricity%20infrastructure.pdf

Interconnection analysis

6.5 Outcome

The market studies that were undertaken generated SEW for each of the test options and base cases that were analysed. This section presents where future interconnection was a benefit to the GB consumer, and to Europe as a whole. The output is presented in four parts:

1. Optimal Path for European SEW.
2. GB consumer benefit.
3. Interaction of interconnectors and constraints.
4. Benefits of overall increase in interconnection.

6.5.1 Optimal Path for European SEW

This section explores the optimal creation of European SEW through the development of interconnection. The final result shows the markets to connect to, whether reinforcement of the GB network was necessary and the years to connect in, in order to maximise SEW. It is important to interpret the results in the context of the methodology undertaken:

- Projects to markets that are not in the optimal paths may well be beneficial, but simply not the most beneficial based on the assumptions made in this study.
- The attractiveness of different markets varies across the scenarios. Consequently there is uncertainty as to where the best opportunities lie, due to the uncertainty in future market conditions.
- The results should not be interpreted as a forecast: many other factors will influence the outcome for interconnection over the next decade and beyond.
- Variations in network constraint and construction costs will have a major impact on the attractiveness of projects.
- The optimal path is the most efficient way to optimise interconnection, but other pathways could result in a higher total level of interconnection and generate similar levels of SEW.
- Potential benefits of interconnection providing ancillary services to the GB network are outside the scope of this study.

The starting interconnection capacities shown in Table 6.1 include projects that are already in operation or have a high level of regulatory certainty. This base case level of interconnection of 15.9 GW represents a near quadrupling of existing interconnection capacity, which causes considerable price convergence between GB and mainland Europe as seen within the modelling. As the SEW generated by additional interconnection depends on the price differential between GB and European markets, the interconnectors that form the base case potentially diminish the level of additional SEW further interconnection can bring.

The iterative process finished after two iterations: no further capacity alterations yielded a higher overall present value than the base case. This resulted in an additional 1.5 GW of interconnection capacity: 1 GW from iteration 1 and 0.5 GW from iteration 2. The use of the output from this year's *NOA* for the baseline network reinforcement assumptions in the *NOA* IC analysis broadly results in a reduction in the constraint savings across the interconnector options. The optimal solutions from the two iterations are shown in Table 6.3

Table 6.3
Optimal interconnection in addition to the base case level

Iteration	Capacity	Country	Reinforcement	Connecting Zone	Connection Year
1	1000MW	Ireland	None	Zone 2	2030
2	500MW	Norway	B6 + B8	Zone 1	2025

The additional 1.5GW interconnection capacity from the two iterations, combined with the base case interconnection capacity of 15.9GW, results in a combined optimal level

of interconnection of 17.4GW between GB and European markets by 2030. Figure 6.3 presents the optimal level of interconnection to each European market for the optimal path.

Figure 6.3
Optimal level of interconnection to each European market

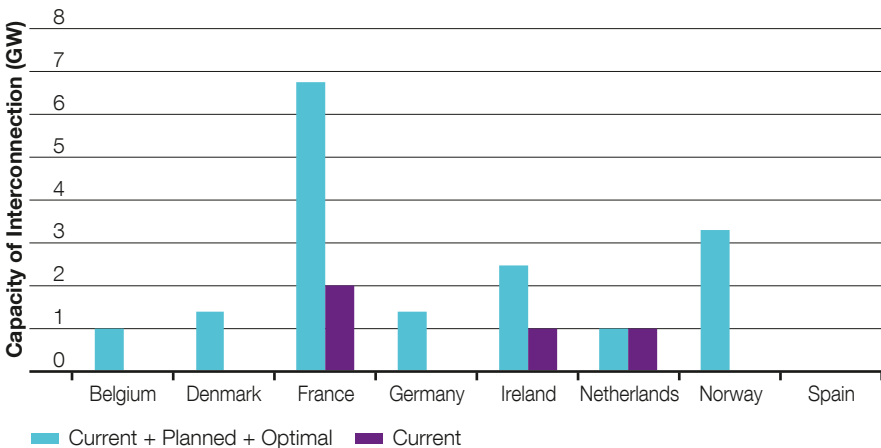

The optimisation analysis for iteration 1 resulted in Ireland representing the most beneficial market for increased interconnection. The average Irish wholesale price is modelled as generally higher than GB. A second mechanism which generates welfare is the alleviation of Ireland’s synchronous generation constraint,

where there is an imposed limit on how much Irish demand can be met by wind. These effects result in Irish exports to Britain to avoid wind curtailment, and British exports to Ireland to exploit arbitrage. Both sets of flows generate welfare.

Interconnector analysis

Figure 6.4 shows a sample of the results of iteration 1 for one scenario only, that is

Two Degrees and for the interconnector options connecting in 2030.

Figure 6.4
Net Present Value relative to base case for Iteration 1, for Two Degrees scenario and interconnector options connecting in 2030

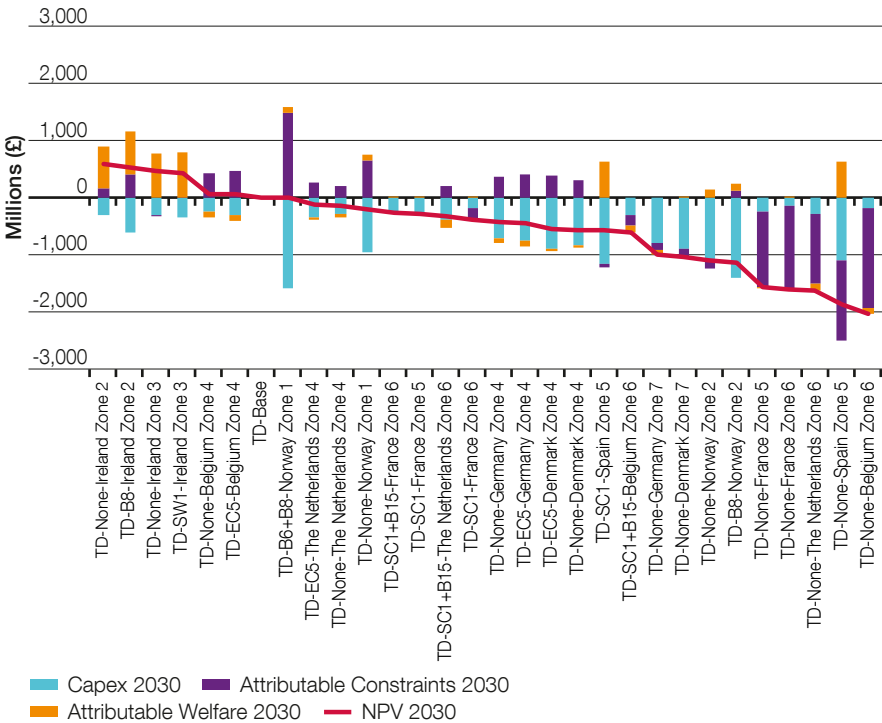

The results have been ordered by highest to lowest net present value for each option. It can be seen from Figure 6.4 that for this particular scenario and connection year Ireland is the only market that clearly shows welfare benefits outweighing estimated costs, although two of the Belgium options are also marginally positive.

However a number of other markets show positive attributable welfare and constraint costs benefits relative to the base case. The chart also shows the impact of GB interconnection zone and associated boundary reinforcements on attributable constraint costs.

The optimisation analysis for iteration 2 resulted in Norway representing the most beneficial market for increased interconnection.

Figure 6.5 shows a sample of the results of iteration 2 for one scenario only, that is Slow

Progression and for the interconnector options connecting in 2025.

Figure 6.5
Net Present Value relative to base case for Iteration 2, Slow Progression scenario and interconnector options connecting in 2025

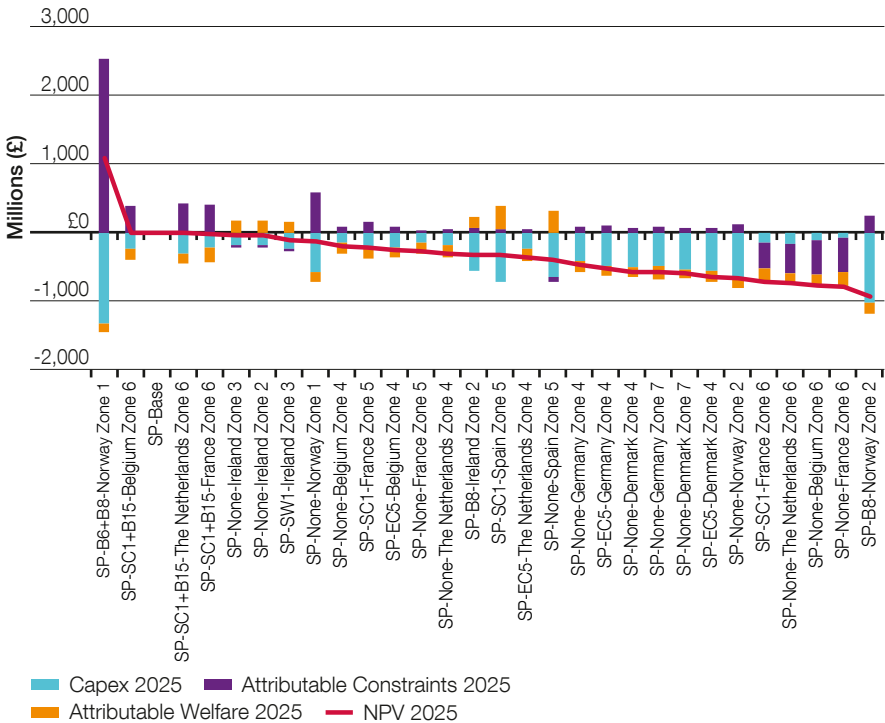

Although the option of Norway interconnector with additional reinforcement of the B6 and B8 boundaries results in the largest capex costs, this is more than offset by the significant increase in constraint savings that the interconnector offers.

options negative. This is because this year's NOA IC analysis uses the recommendations from this year's NOA as the baseline network reinforcement assumptions, leading to lower additional constraint savings from additional interconnection. Figure 6.5 also shows that for the majority of cases the attributable welfare relative to the base case is negative, indicating that there is no additional welfare benefit for adding an additional interconnector in those particular options.

The chart also shows that apart from the option of Norway interconnector with additional reinforcement of the B6 and B8 boundaries, the constraint savings relative to the base case are often very small, and for some

Interconnection analysis

Figure 6.6
SEW for GB and connecting country only for Iteration 1, Consumer Power scenario

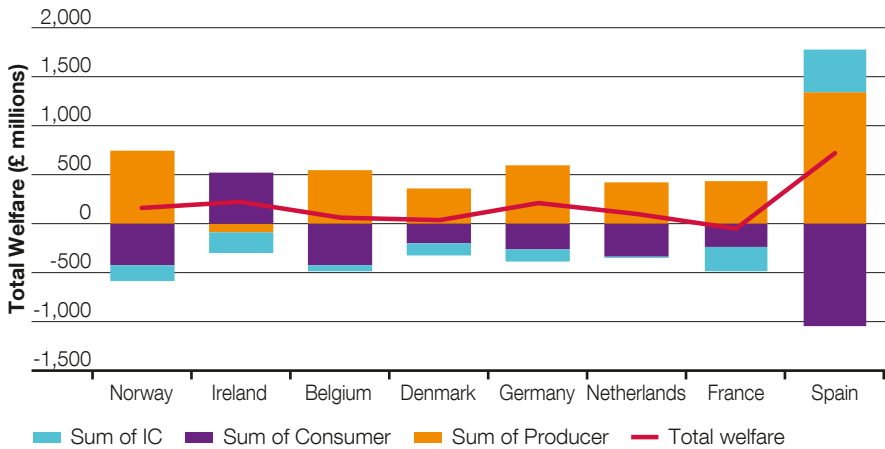

Figure 6.6 shows the levels of welfare for only GB and the connecting country for each interconnector, relative to the base case. It shows there is additional welfare for GB and the connecting country in nearly all instances. It clearly shows the consumer welfare benefit of Ireland being able to access

cheaper electricity within the GB market and shows the producer welfare benefit of cheaper Norwegian and Spanish generation being able to access the GB market. This shows that the negative welfare values in Figure 6.5 are being driven by markets other than GB.

6.5.2 GB consumer benefit

The GB consumer gains from interconnection to cheaper wholesale electricity markets.

Figure 6.7
Average price difference between GB and European markets.

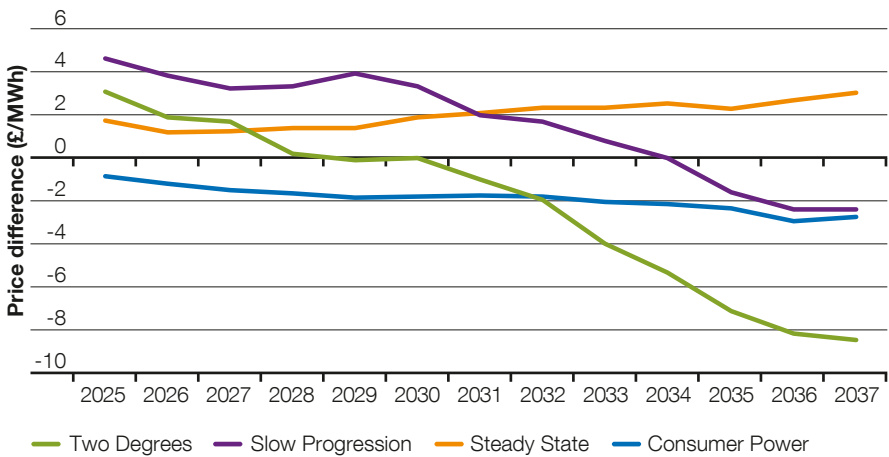

Figure 6.7 shows the average wholesale price difference between GB and European markets for all four scenarios and for the B6+B8 Norway Zone 1 option for iteration 2. GB and European prices have been demand weighted. The chart shows that the price difference between the markets is lower than in last year's analysis as the base case contains more interconnection that drives greater convergence between the markets. Steady State shows the most consistent higher price within the GB market, suggesting that GB consumers would benefit

from cheaper renewable power imported from European markets. These benefits are rapidly eroded under Two Degrees, and to a lesser extent under Slow Progression, as GB's domestic renewable generation assets grow. However, as these renewable sources of generation continue to grow in subsequent years, particularly within Two Degrees, and with the associated continued reduction in GB wholesale price, this drives the opportunity for exporting supplies to Europe.

Interconnection analysis

6.5.3 Interaction of interconnectors and constraints

The impact on GB constraints costs is dependent on the location of the interconnector on the GB network and the level of onshore reinforcement built to accommodate the interconnector. Constraint costs are incurred on the network when power within the merit order is limited from outputting due to network restrictions. In this event, the System Operator will incur balancing mechanism costs to turn down the generation which is not able to output and offer on generation elsewhere on the system to alleviate the constraint. Interconnection to different markets provides the System Operator with another balancing option. The inclusion of additional interconnection to GB may either help or hinder

system balancing, as balancing mechanism costs increase or decrease as network boundaries are further strained or relieved. This can be seen in Figures 6.4 and 6.5 by the wide range of positive and negative attributable constraint costs relative to the base case. Flows across the GB network can be summarised as flowing from high levels of generation in the north to high levels of demand in the south. Interconnectors connected in the north may help alleviate constraints when exporting from GB and increase constraints when importing to GB. Conversely interconnectors connected to the south of England may reduce network constraints when importing and exacerbate constraints when exporting.

6.5.4 Benefits of overall increase in interconnection

Increased levels of interconnection bring significant benefits to GB and European consumers, both in terms of lower wholesale energy prices and greater use of renewable power.

6.5.4.1 Overall impact on wholesale prices

The additional interconnection drives down the average European price as cheaper generation is able to displace more expensive generation.

These price changes drive increases in European welfare. However as stated previously, as capacity is increased, prices between the two markets converge and

additional SEW benefits are reduced. This is shown in Figure 6.8, which shows increase in welfare for all interconnector options and scenarios, relative to the base case.

Figure 6.8
Combined increases in welfare for all years, all Europe

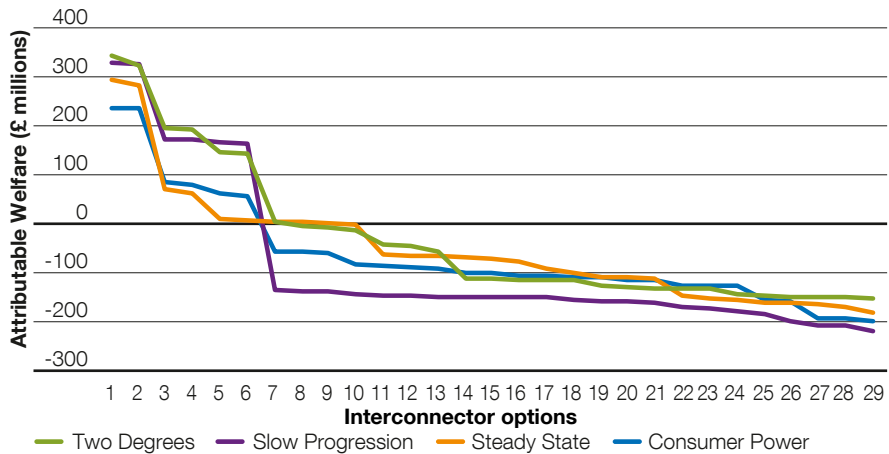

Figure 6.8 shows the total European welfare relative to the base case for all 29 interconnector options for all four scenarios, with the interconnector options connecting in 2025. The horizontal axis shows the 29 interconnector options from Table 6.2 (excluding the base case). The results have been ordered from

highest to lowest in each scenario. It can be seen that while some options produce significant positive welfare relative to the base case, the majority produce less. This is a result of the high level of interconnection already included within the base case.

Interconnection analysis

6.5.4.2 Environmental implications

Interconnectors can also increase access to renewable sources of power. Interconnection allows surplus power to be exported, rather than curtailed. The exported power may replace more expensive sources of generation, which may well use fossil fuels. Figure 6.9 shows how

there is a reduction in the level of carbon dioxide output over the length of the study, as the requirement to curtail clean renewable energy sources is reduced as interconnection capacity increases.

Figure 6.9
Reduction in CO₂ output over the optimal path

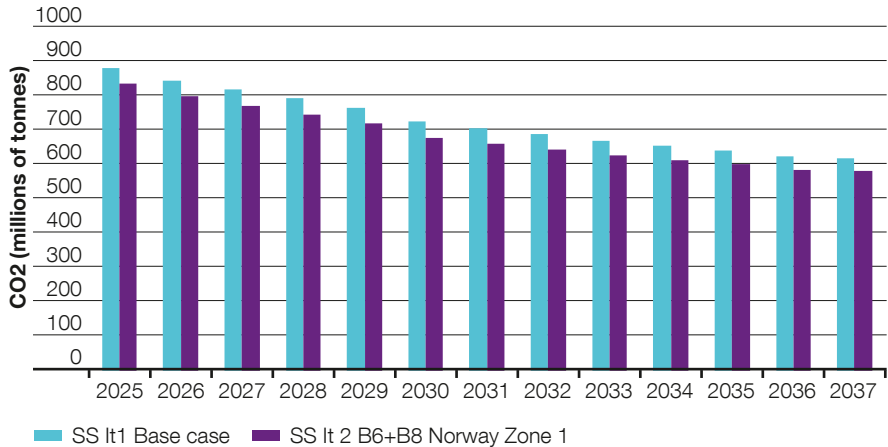

Figure 6.9 shows the annual CO₂ emissions for the optimal path from iteration 2 with the inclusion of the additional interconnectors to Ireland and Norway, and for the base case for

iteration 1 that includes neither. The additional interconnection results in an increased reduction in CO₂ emissions of over 550 million tonnes over the thirteen-year period modelled.

Table 6.4
Reduction in Renewable Energy Source (RES) curtailment

Scenario & option	RES curtailment (MWh)	
	2025	2037
Steady State It2 B6+B8 Norway Zone 1	29,824	8,387
Consumer Power It2 B6+B8 Norway Zone 1	1,561,370	35,384
Slow Progression It2 B6+B8 Norway Zone 1	3,511,188	203,550
Two Degrees It2 B6+B8 Norway Zone 1	6,794,181	523,105

Table 6.4 shows the reduction in RES curtailment within the optimal interconnector solution for all four scenarios. The reduction in RES curtailment is considerably higher within the Two Degrees scenario due to the

much greater levels of renewable generation. The Two Degrees optimal path results in a RES curtailment reduction of over 6 million MWh.

Interconnection analysis

6.6 Summary

The analysis shows that increased levels of interconnection continue to present an opportunity for creating value for GB and Europe, both economically and environmentally. Interconnection enables the more efficient dispatch of generation across Europe, leading to savings for consumers, increased profits for generators and income for interconnector developers. The analysis added an additional 1.5GW of interconnection capacity to the 15.9GW already included within the interconnection base case, resulting in a total interconnection capacity of 17.4GW. This is more than a quadrupling of existing GB interconnection capacity of 4GW. It is important to restate that this is not a forecast, as many other factors outside the scope of this analysis will influence the outcome for

GB interconnection over the next decade and beyond. Uncertainty in future market conditions, variations in network constraint and construction costs and potential additional benefits of interconnection providing ancillary services to the GB network are just some of the variables which will have an impact on future interconnection.

Uncertainty regarding developments in the physical network, the make-up of Europe's energy landscape and further opportunities for creating value from interconnection mean this study can only represent a partial snapshot of the future of GB interconnection, but the analysis does show that potential opportunities still remain for additional GB interconnection.

This year we developed the NOA for Interconnectors methodology based on stakeholder feedback. We want to hear your feedback on this year's analysis. We also want to know how we can continue to improve this analysis to increase its value to you. For NOA for Interconnectors 2018/19 we intend to investigate the operability challenges and solutions interconnectors can offer, including the provision of ancillary services. We look forward to your involvement in the NOA for Interconnectors consultation in 2018.

Chapter seven

Stakeholder engagement

123

Stakeholder engagement

7.1 Introduction

We'd like your feedback and comments on this *NOA* publication, and your help to improve it. Please take part in our 2018 stakeholder engagement programme so we know what you need.

7.2 Continuous development

Your feedback is an important part of the way we continue revising and developing the *NOA* and the *ETYS*. And because the two documents are closely related, we'll make sure that the way we communicate and consult with you reflects this. We'll make sure that the *NOA* publication continues to add value by:

- identifying and understanding our stakeholders' views and opinions
- providing opportunities for constructive debate throughout the process
- creating open and two-way communication with our stakeholders to discuss assumptions, drivers and outputs; and
- telling you how your views have been considered, and reporting back on the engagement process.

The *NOA* annual review process will help us to develop the publication. We'll encourage all interested parties to get involved, which will help us improve the publication every year. After we published the first *NOA* in March 2016 we received some very helpful feedback. We used this to make changes to the second *NOA*, and since then feedback has been very specialised and less about the report's design. Having explained more about the cost–benefit process in our methodology chapter we have looked to improve this area further.

We would like to hear more about how we can improve the *NOA* publication. As mentioned in Chapter 1, we have a number of developments planned to drive further value from the *NOA*. We will be

publishing a long-term roadmap in the spring and your views will be important in shaping that before and after the publication. We will also publish results of the trials throughout the year as they emerge and your views will help shape how the extended approach is built into the annual *NOA* process. We will be sharing and testing the developments with a wide range of industry participants. If you would like to get involved or for a member of the team to attend an event to talk about them please get in contact via the email address on the following page.

We have sought your views at various points through this *NOA* which we list again here:

- We've brought in the *NOA* Committee and use implied probabilities to strengthen the methodology. How did you find the explanations for these new parts of the *NOA* process?
- Following feedback about *NOA* 2016/17, we restructured chapter 5 so that it contained more narrative and less raw data. This data has moved to a new appendix A. Please tell us your views on how we've changed chapter 5.
- This year we developed the *NOA* for Interconnectors methodology based on stakeholder feedback. We want to hear your feedback on this year's analysis. We also want to know how we can continue to improve this analysis to increase its value to you.

Stakeholder engagement

7.3 Stakeholder engagement

We are always happy to listen to your views:

- at consultation events such as our customer seminars
- through responses to transmission.ety@nationalgrid.com
- at bilateral stakeholder meetings; and
- through any means convenient for you.

Now that the NOA is published we'll start the review process, and we are looking forward to having conversations with you from now to June 2018. This consultation will cover the methodology, as well as the publication and its contents. Because some part of the NOA process starts in May, we have been looking further ahead and have started on some of the methodology's higher level aspirations already.

We have taken account of feedback and amended Chapter 5, which describes the investment recommendations. It has more visual content and narrative. We have also moved some of the more detailed data to appendix A. We welcome your views on these changes and if it improves readability of the document.

Figure 7.1
ETYS/NOA stakeholder activities programme

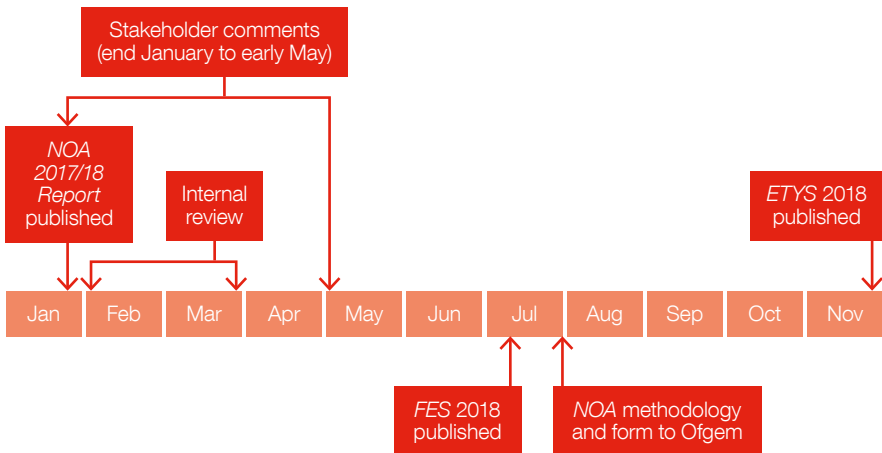

Chapter eight

Appendix A – Economic analysis results

Appendix B – SWW projects

Appendix C – List of four-letter codes

Appendix D – Meet the team

Appendix E – Glossary

Disclaimer

Appendix A

Economic analysis results

Tables A.1–3 present the results from our cost–benefit analysis. The results highlight optimal options with optimum delivery dates across different scenarios and sensitivities.

Options with an optimum delivery date that is the same as their EISD are deemed 'critical'. Critical options are in **bold**.

Table A.1
Optimum Delivery Dates – Scotland and the North of England region

Option Code	Description	EISD	Optimum Delivery Date			
			Two Degrees	Slow Progression	Consumer Power	Steady State
CDRE	Cellarhead to Drakelow reconductoring	2021	2028	2028	2028	N/A
CPRE	Reconductor sections of Penwortham to Padiham and Penwortham to Carrington	2021	2021	N/A	N/A	N/A
DNEU	Denny North 400/275kV Super Grid Transformer 2	2021	2026	N/A	N/A	N/A
DWNO	Denny to Wishaw 400kV reinforcement	2028	2028	2028	2028	2030
E2DC	Eastern subsea HVDC Link from Torness to Hawthorn Pit	2027	2027	2027	2027	N/A
E4DC	Eastern subsea HVDC Link from Peterhead to Hawthorn Pit	2028	2028	2028	2028	2028
ECU2	East Coast onshore 275kV upgrade	2023	2023	2023	2023	2023
ECUP	East Coast onshore 400kV incremental reinforcement	2026	2026	2026	2026	2026
EHRE	Elvanfoot to Harker reconductoring	2023	2029	2028	2028	N/A
HAE2	Harker SuperGrid Transformer 5 replacement	2022	2027	2027	2027	N/A
HAEU	Harker SuperGrid Transformer 6 replacement	2021	2029	2021	2021	2021
HNNO	Hunterston East–Neilston 400kV reinforcement	2023	2023	2023	2023	2023
HPNO	New east–west circuit between the north east and Lancashire	2027	2028	2028	2028	N/A
LDQB	Lister Drive quad booster	2020	N/A	2021	N/A	N/A
LNRE	Reconductor Lackenby to Norton single 400kV circuit	2021	2025	2026	2026	2028
NOHW	Thermal uprate 55km of the Norton to Osbaldwick 400kV double circuit	2019	2024	2025	2025	N/A
NOR1	Reconductor 13.75km of Norton to Osbaldwick 400kV double circuit	2021	2021	2021	2021	2023
OENO	Central Yorkshire reinforcement	2026	2027	2027	2027	N/A
TDH1	Drax to Thornton 2 circuit thermal uprating	2019	2019	2019	2020	N/A
TDH2	Drax to Thornton 1 circuit thermal uprating	2019	2025	2026	2026	N/A
THS1	Install series reactors at Thornton	2022	2023	2023	2023	2028
TURC	Reactive compensation at Tummel	2022	2026	N/A	N/A	N/A
WHT2	Turn-in of West Boldon to Hartlepool circuit at Hawthorn Pit (with a different delivery year to WHT1)	2022	N/A	N/A	2022	2023
WHT1	Turn-in of West Boldon to Hartlepool circuit at Hawthorn Pit	2021	2021	2021	N/A	N/A
WLTI	Windyhill to Lambhill to Longannet 275kV circuit turn-in to Denny North 275kV substation	2021	2023	2023	2023	2023

*Table A.2
Optimum Delivery Dates – the South and East of England region*

Option Code	Description	EISD	Optimum Delivery Date							
			Two Degrees	Slow Progression	Consumer Power	Steady State	Local Contracted A	Local Contracted B	No Local Contracted A	No Local Contracted B
BFW	Bramley to Fleet circuits thermal uprating	2019	2023	2023	N/A	N/A	2023	2023	2023	2023
BMMS	225MVAr MSCs at Burwell Main	2023	2023	2023	2023	2023	2023	2023	2023	2023
BNRC	Bolney and Ninfield additional reactive compensation	2022	2022	2023	N/A	N/A	2022	2022	2022	2022
BRRE	Reconductor remainder of Bramford to Braintree to Rayleigh route	2020	2023	2023	2023	2023	2022	2023	2023	2023
BTNO	A new 400kV double circuit between Bramford and Twinstead	2025	2027	2030	2029	N/A	2025	2028	2027	2027
CTRE	Reconductor remainder of Coryton South to Tilbury circuit	2019	2021	2021	2021	2021	2021	2021	2021	2021
ESC1	Second Elstree to St John's Wood 400kV circuit	2022	2022	2025	2025	2032	2022	2022	2022	2022
FLR2	Fleet to Lovedean reconducting (with a different conductor type to FLRE)	2020	2020	2020	2020	2023	2020	2020	2020	2020
GKEU	Thermal upgrade for Grain and Kingsnorth 400kV substation	2020	2021	2021	2021	2026	2021	2021	2021	2021
HMHW	Hinkley Point to Melksham circuits thermal uprating	2019	2029	2029	2021	2025	2027	2029	2028	2028
HWUP	Upgrade Hackney, Tottenham and Waltham Cross 275kV to 400kV	2023	2025	2026	2026	N/A	2025	2025	2025	2025
KLRE	Kemsley to Littlebrook circuits uprating	2020	2020	2020	2020	2020	2020	2020	2020	2020
NBRE	Reconductor Bramford to Norwich double circuit	2021	2024	2024	2024	2024	2024	2024	2024	2024
RTRE	Reconductor remainder of Rayleigh to Tilbury circuit	2020	2021	2021	2021	2021	2021	2021	2021	2021
SCN2	New 400kV transmission route between south London and the south coast (an alternative design to SCN1)	2027	N/A	2027	N/A	2027	2027	2027	N/A	N/A

Appendix A

Economic analysis results

Table A.2
Optimum Delivery Dates – the South and East of England region continued

Option Code	Description	EISD	Optimum Delivery Date							
			Two Degrees	Slow Progression	Consumer Power	Steady State	Local Contracted A	Local Contracted B	No Local Contracted A	No Local Contracted B
SCRC	South East coast reactive compensation	2018	2018	2018	2018	2018	2018	2018	2018	2018
SEEU	Reactive compensation protective switching scheme	2021	2021	2021	2021	2022	2021	2021	2022	2022
SER1	Elstree to Sundon reconductoring	2021	2022	2022	2022	2024	2022	2022	2022	2022
SER2	Elstree–Sundon 2 circuit turn-in and reconductoring	2021	2022	2025	2025	2032	2022	2022	2022	2022
THRE	Reconductor Hinkley Point to Taunton double circuit	2021	N/A	2032	N/A	2027	2029	2030	N/A	N/A
TKRE	Tilbury to Grain and Tilbury to Kingsnorth Upgrade	2025	2025	2025	2025	2027	2025	2025	2025	2025
WYQB	Wymondley quad boosters	2021	2022	2022	2022	2024	2022	2022	2022	2022
WYTI	Wymondley turn-in	2021	2021	2021	2021	2023	2021	2021	2021	2021

*Table A.3
Optimum Delivery Dates – Wales and West Midlands region*

Option Code	Description	EISD	Optimum Delivery Date			
			Two Degrees	Slow Progression	Consumer Power	Steady State
BCRE	Reconductor the Connah's Quay legs of the Pentir to Bodelwyddan to Connah's Quay 1 and 2 circuits	2021	2029	2030	2032	N/A
PBRE	Reconductor Pentir legs of the Pentir to Bodelwyddan to Connah's Quay 1 and 2 circuits	2021	2031	N/A	N/A	N/A
PTC1	Pentir to Trawsfynydd 1 cable replacement – single core per phase	2022	2028	2028	2030	N/A
PTC2	Pentir to Trawsfynydd 1 and 2 cables – second core per phase and reconductor of an overhead line section on the existing Pentir to Trawsfynydd circuit	2024	2028	2029	2031	N/A
PTNO	Pentir to Trawsfynydd second circuit	2024	2028	2028	2030	N/A
PTRE	Pentir to Trawsfynydd circuits – reconductor the remaining overhead line sections	2024	2030	N/A	N/A	N/A

Appendix A

Economic analysis results

Tables A.4–5 present the results from our single year least regret analysis. The top 10 investment strategies are listed with their economic regrets across different scenarios and sensitivities. The best strategy with the

least worst regret is highlighted in **green**. There is no critical option found for the Wales and West Midlands region, hence no result for the region is presented.

Table A.4
Regrets for Scotland and the North of England region options

Combination	Two Degrees	Slow Progression	Consumer Power	Steady State	Worst regret
(1) Progress all critical options except WHT2	£0.05m	£1.12m	£0.22m	£3.47m	£3.47m
(2) Progress all critical options except WHT2 and TDH1	£0.71m	£1.11m	£6.18m	£3.36m	£6.18m
(3) Progress all critical options except TDH1	£0.74m	£0.81m	£6.20m	£3.36m	£6.20m
(4) Progress all critical options except HAEU	£0.03m	£15.58m	£6.10m	£10.66m	£15.58m
(5) Progress all critical options except HAEU and TDH1	£0.69m	£15.58m	£12.06m	£10.55m	£15.58m
(6) Progress all critical options except HAEU, CPRE and WHT2	£30.73m	£15.67m	£5.86m	£10.44m	£30.73m
(7) Progress all critical options except HAEU and CPRE	£30.76m	£15.37m	£5.89m	£10.45m	£30.76m
(8) Progress all critical options except CPRE	£30.81m	£0.59m	£0.03m	£3.25m	£30.81m
(9) Progress all critical options except HAEU, TDH1, CPRE and WHT2	£31.39m	£15.67m	£11.82m	£10.33m	£31.39m
(10) Progress all critical options except HAEU, TDH1 and CPRE	£31.42m	£15.36m	£11.84m	£10.33m	£31.42m

*Table A.5
Regrets for the South and East of England region options*

Combination	Two Degrees	Slow Progression	Consumer Power	Steady State	Local Contracted A	Local Contracted B	No Local Contracted A	No Local Contracted B	Worst regret
(1) Progress all critical options except ESC1	£0.01m	£0.00m	£0.00m	£0.00m	£0.02m	£0.01m	£0.00m	£0.01m	£0.02m
(2) Progress all critical options	£0.00m	£0.00m	£0.00m	£0.00m	£0.00m	£0.00m	£0.03m	£0.00m	£0.03m
(3) Progress all critical options except WYTI	£0.21m	£0.62m	£0.02m	£0.00m	£0.75m	£0.82m	£0.80m	£0.84m	£0.84m
(4) Progress all critical options except WYTI and ESC1	£0.21m	£0.62m	£0.02m	£0.00m	£0.77m	£0.83m	£0.77m	£0.85m	£0.85m
(5) Progress all critical options except SEEU	£2.34m	£1.39m	£4.18m	£0.00m	£4.24m	£6.94m	£0.03m	£0.00m	£6.94m
(6) Progress all critical options except ESC1 and SEEU	£2.34m	£1.39m	£4.18m	£0.00m	£4.26m	£6.95m	£0.00m	£0.01m	£6.95m
(7) Progress all critical options except WYTI SEEU	£2.54m	£1.93m	£4.20m	£0.00m	£4.99m	£7.74m	£0.80m	£0.84m	£7.74m
(8) Progress all critical options except WYTI, ESC1 and SEEU	£2.55m	£1.93m	£4.20m	£0.00m	£5.01m	£7.76m	£0.77m	£0.85m	£7.76m
(9) Progress all critical options except BNRC	£7.20m	£0.00m	£0.00m	£0.00m	£9.64m	£10.59m	£6.91m	£2.65m	£10.59m
(10) Progress all critical options except BNRC and ESC1	£7.21m	£0.00m	£0.00m	£0.00m	£9.66m	£10.61m	£6.93m	£2.66m	£10.61m

Appendix B

SWW Projects

8.1 Shetland Link

1. Background

Shetland possesses attractive renewable resources that developers have targeted, seeking to invest in onshore wind projects. At present, there is no connection between Shetland and the GB Main Interconnected Transmission System (MITS). There is a total of 496MW of generation connected and contracted for connection. This excludes 67MW of diesel generation at Lerwick Power Station and 15MW of export from the Sullom Voe Terminal. There are further interests from developers of onshore wind energy projects of up to 105MW.

As a consequence of these projects a link to the Scottish mainland will be required to facilitate export into the GB MITS.

2. Option development

A number of reinforcement options have been considered to provide transmission capacity between Shetland and the Scottish mainland to facilitate the connection of the island generation. The Shetland link reinforcement would also help to improve the security of supply on the Shetland Island. The factors taken into account in developing the options include:

- Corridor (the geographical route between Shetland and the MITS on the UK mainland).
- Technology (High Voltage Direct Current (HVDC) technology versus Alternating Current (AC) technology).
- Capacity (MW rating including the potential for future growth in renewables on the island).

Details of the options considered are given below.

2.1 Options

(a) *Caithness to Shetland 600MW subsea link*
Construct a 278km, 600MW Voltage Sourced Converter (VSC) HVDC connection between Shetland (at Kergord) and the Caithness to Moray HVDC link due to be completed in 2018 via the HVDC Switching Station at Noss Head (in Caithness) to form a three-terminal HVDC scheme. The work includes a 132kV AC Gas Insulated Switchgear (GIS) substation and a 600MW VSC HVDC converter at Kergord.

(b) *Caithness to Shetland 450MW subsea link*
Construct a 278km, 450MW VSC HVDC connection between Shetland (at Kergord) and the Caithness to Moray HVDC link due to be completed in 2018 via the HVDC Switching Station at Noss Head (in Caithness) to form a three-terminal HVDC scheme. The work includes a 132kV AC GIS substation and a 450MW VSC HVDC converter at Kergord.

(c) *Moray to Shetland 600MW subsea link*
Construct a 343km, 600MW VSC HVDC connection between Shetland (at Kergord) and the Blackhillock substation in Moray. The work includes a 132kV AC GIS substation and a 600MW VSC HVDC converter at Kergord and a 600MW converter at Blackhillock.

2.2 Current lead option

Following an optioneering exercise that was undertaken to identify the most economic, efficient and coordinated option, the Caithness to Shetland 600MW HVDC subsea link option was identified as the lead option. This is because there are high wind load factors on Shetland and the 450MW HVDC link option would leave too much generation being constrained when there is a large penetration of wind on the islands. The additional cost of the 600MW HVDC link reinforcement is more than recovered by reductions in constraint costs under the high wind penetration scenario and therefore the 600MW HVDC link is identified as the least worst regret option.

2.3 Status

On 12 October 2017, the UK Government confirmed the intention to include remote Scottish Island generation schemes in the next emerging technologies Contracts for Difference auction in 2019. It is expected that the results of this auction will be known by October 2019, allowing approval of the Needs Case and award of the construction contract in the first quarter of 2020. Construction would be expected to be complete towards the end of 2023, and the option in service by the first quarter of 2024. Over the next six months the key activities on this project include:

- Progression of key planning and consenting activities.
- Preparation of a Needs Case submission.
- Continuation of stakeholder engagement.
- Completion of engineering design.
- Commencement of outstanding procurement.

Appendix B

SWW Projects

8.2 Orkney Link

1. Background

The Orkney archipelago is rich in renewable resources with developers seeking to invest in particular in marine and onshore wind projects. At present there is no transmission infrastructure on Orkney and the island is supplied by Scottish Hydro Electric Power Distribution (SHEPD) via two 33kV subsea cable connections from Thurso Grid Supply Point on the GB Main Interconnected Transmission System (MITS). SHEPD operates a flexible solution on the island through an Active Network Management (ANM) scheme. This has enabled connection of additional generation beyond the 'firm' limit of the 33kV cables. The ANM scheme is now operating at full capacity. There is a total of 461 MW of generation that is contracted for connection to the MITS. In addition, there have been a number of embedded generators that have applied to SHEPD for connection as a consortia.

As a consequence of this commitment, SHE Transmission is proposing a new transmission link from Orkney to the Scottish mainland to facilitate the connection and export of the generation to the MITS.

2. Option development

Several reinforcement options have been considered to provide additional transmission capacity between Orkney and the Scottish mainland to facilitate the connection of the islands' generation. The Orkney Link reinforcement, while providing connection and export of new generation from the island, would also help to improve the security of power supply to the island. The criteria considered in developing the options include:

- Stakeholder Engagement.
- Alternative commercial arrangements.
- Corridor (the geographical route between Orkney and the MITS on the UK mainland).
- Environmental considerations and planning consent (this include both onshore and offshore considerations).
- Technology (High Voltage Direct Current (HVDC) technology versus Alternating Current (AC) technology).
- Capacity (MW rating including the potential for future growth in renewables on the islands).

Details of the preferred options considered are given below.

2.1 Options

(a) Dounreay to Orkney, Finstown subsea link

Install a 220MW 220kV HVAC cable link approximately 70km in length (55km subsea and 15km land) between Dounreay and Finstown in the Orkney Island with landfall around Billia Croo on the west coast of Orkney. At Dounreay the 220kV cable is proposed to connect on the 275kV busbar via a 275/220kV SuperGrid Transformer (SGT) and similarly at Finstown the cable will connect to a new 132kV double busbar via a 220/132kV SGT. The Finstown substation 132kV double busbar will interface with the new 132kV local transmission infrastructure to facilitate generation connection and export from the island.

(b) Dounreay to Orkney, Orphir subsea link

Install a 220MW 220kV HVAC cable link approximately 60km in length (46km subsea and 14km land) between Dounreay and Orphir in the Orkney Island with landfall around Rackwick Bay on Hoy. At Dounreay the 220kV cable is proposed to connect on the 275kV busbar via a 275/220kVSGT and similarly at Orphir the cable will connect to a new 132kV double busbar via a 220/132kV SGT. The Orphir substation 132kV double busbar will interface with the new 132kV local transmission infrastructure to facilitate generation connection and export from the island.

2.2 Current lead option

After carrying out the route assessment the SHE Transmission preference is for the Dounreay to Orkney, Finstown subsea link route option. A further optioneering exercise is being carried out to investigate the impact of the design, timing and capacity of the proposed link.

2.3 Status

In order to meet the Orkney link target completion date of 2022, it is expected that the submission of the SWW Needs Case will be in Q1 2018 followed by a Project Assessment in Q3. The construction work would be expected to start in 2020. Over the next six months the key activities include:

- Continuation of stakeholder engagement.
- Conclusion of cost–benefit analysis with the SO.
- Submission of the SWW Needs Case in Q1 2018.
- Public consultation on alternative commercial arrangements in Q1 2018.
- Continuation of key planning and consenting activities.
- SWW Project Assessment submission in Q2 2018.

Appendix B

SWW Projects

8.3 Western Isles Link

1. Background

The Western Isles possess attractive renewable resources which developers have targeted, seeking to invest in wind and marine generation projects. At present the existing Western Isles system operates with a restricted 132kV connection to the Scottish mainland¹. A total generation capacity of 431 MW is made up of generation either connected or contracted for connection.

As a consequence of these generation projects a higher capacity link to the Scottish mainland will be required to facilitate export onto the GB Main Interconnected Transmission System (MITS).

2. Option development

A number of reinforcement options have been developed to provide additional transmission capacity between the Western Isles and the Scottish mainland in order to facilitate the connection of the island generation. The Western Isles link reinforcement would also help to improve the security of supply on the Western Isles and reduce the requirement on two diesel stand-by generation facilities currently in place.

The factors taken into account in developing the link reinforcement options include:

- Corridor (the geographical route between Western Isles and the MITS on the UK mainland).
- Technology (High Voltage Direct Current (HVDC) technology versus Alternating Current (AC) technology).
- Capacity (MW rating including the potential for future growth in renewables on the island).

Details of the options considered are given below.

2.1 Options

(a) Beauly to Western Isles, Gravir 450MW HVDC Link

Construct a 450MW Voltage Sourced Converter (VSC) HVDC connection between Beauly on the Scottish mainland (located north west of Inverness) and Gravir on the east coast of the Isle of Lewis via Dundonnell on the west coast of Scotland. The circuit will be a mix of onshore cable (77km between Beauly and Dundonnell) and offshore cable (80km between Dundonnell and Gravir). The 450MW converter stations will be located at Beauly and Gravir. At Beauly, the circuit will interface with the GB MITS via a 400kV GIS substation. At Gravir the circuit will interface with the local Lewis infrastructure via a 132kV GIS substation.

(b) Beauly to Western Isles, Arnish 450MW HVDC Link

Construct a 450MW VSC HVDC connection between Beauly on the Scottish mainland (located north west of Inverness) and Arnish on the east coast of the Isle of Lewis via Dundonnell on the west coast of Scotland. The circuit will be a mix of onshore cable (77km between Beauly and Dundonnell) and offshore cable (79km between Dundonnell and Arnish) cable. The 450MW converter stations will be located at Beauly and Arnish. At Beauly, the circuit will interface with the GB Main Interconnected Transmission System (MITS) via a 400kV GIS substation. At Arnish the circuit will interface with the local Lewis infrastructure via a 132kV GIS substation.

¹ Single circuit connection from Fort Augustus which includes a 33kV subsea cable section between Ardmores and Harris.

(c) Beaully to Western Isles, Arnish 600MW HVDC Link

Construct a 600MW VSC HVDC connection between Beaully on the Scottish mainland (located north west of Inverness) and Arnish on the east coast of the Isle of Lewis via Dundonnell on the west coast of Scotland. The circuit will be a mix of onshore cable (77km between Beaully and Dundonnell) and offshore cable (79km between Dundonnell and Arnish). The 600MW converter stations will be located at Beaully and Arnish. At Beaully, the circuit will interface with the GB MITS via a 400kV GIS substation. At Arnish the circuit will interface with the local Lewis infrastructure via a 132kV GIS substation.

2.2 Current lead option

An optioneering exercise was undertaken to identify the most economic, efficient and coordinated development option. Based on the initial cost–benefit analysis, the current lead option is the 450MW HVDC Link to Arnish. The TO is currently progressing a retender exercise for provision of the HVDC Link. The optioneering work will need to be revisited when this is concluded. This may result in an alternative least worst regret option.

2.3 Status

On 12 October 2017, the UK Government confirmed the intention to include remote Scottish Island generation schemes in the next emerging technologies Contracts for Difference auction in 2019. It is expected that the results of this auction will be known by October 2019, allowing approval of the Needs Case and award of the construction contract in the first quarter of 2020. Construction would be expected to be complete in early 2023, and the option in service by the end of that year. Over the next six months the key activities include:

- Conclusion of tender negotiations and appointment of a Preferred Contractor.
- Progression of key planning and consenting activities.
- Preparation of Needs Case submission.
- Continuation of stakeholder engagement.

Appendix B

SWW Projects

8.4 Eastern Network Reinforcement

1. Background

The scope of the reinforcements included for the eastern network in the northern region includes offshore HVDC links as well as onshore reinforcement. These reinforcement projects increase capability on one or multiple of the MITS boundaries B1, B1a, B2, B4, B5, B6, B7, B7a. The objective is to increase the north to south transfer capability on the east coast of the Scottish and northern England Transmission system between boundaries B1 in the Scottish Hydro Electric Transmission (SHE Transmission) area and B7a in the National Grid Electricity Transmission (NGET) area arising from predominantly new renewable generation in Scotland. This includes key boundaries between SHE Transmission and SP Transmission (B4) and between SP Transmission (SPT) and NGET (B6).

A number of reinforcements are proposed to improve the transfer capability in accordance with the NETS SQSS² and pursuant to the Transmission Owners' obligations in their transmission licences. Of these reinforcements, there are two offshore eastern subsea HVDC links – one from Peterhead in north east Scotland to Hawthorn Pit in north east England (E4DC), the other from Torness in south east Scotland to Hawthorn Pit (E2DC). Both options involve the construction of a 2GW HVDC link and associated AC onshore works on either end of the link. E4DC increases transfer capability on boundaries B1 down to B7a. E2DC increases transfer capability on boundaries B6 down to B7a.

The scope of the eastern onshore reinforcements involves increasing the capacity of the eastern onshore circuits between Blackhillock and Kincardine that cross B1a, B2 and B4 by initially augmenting their capability at 275kV. Further uplift in capacity will be delivered by uprating these circuits to operate at 400kV.

The recommendation from the 2017 NOA process is to progress the following reinforcements for the eastern network in the northern region this year to maintain the earliest in-service date (EISD):

- East Coast onshore 275kV upgrade (ECU2) – EISD of 2023.
- East Coast onshore 400kV incremental reinforcement (ECUP) – EISD of 2026.
- E2DC – EISD of 2027.
- E4DC – EISD of 2028.

The requirement to reinforce the transmission network is driven fundamentally by the growth of predominantly renewable generation in the SHE Transmission and SPT areas, including offshore windfarms situated in the Moray Firth and in the Firth of Forth. Figure 8.1 and Figure 8.2 show the Required Transfers³ for boundaries B4 and B6 for the four scenarios in the 2016 and 2017 *Future Energy Scenarios (FES)*. The figures also show the current network capabilities across the two boundaries as well as capability increases for approved reinforcements. The difference between the Required Transfers and the network capability shows a requirement for further network reinforcement.

² The NETS SQSS is the National Electricity Transmission System Security and Quality of Supply Standard. GB Transmission Owners have licence obligations to develop their transmission systems in accordance with the NETS SQSS.

³ The Required Transfer figures shown take into account interconnectors connecting to the GB Transmission system in the 2016 and 2017 *Future Energy Scenarios*.

Figure 8.1
Boundary B4 (SHE Transmission/ SPT) required transfer and capability

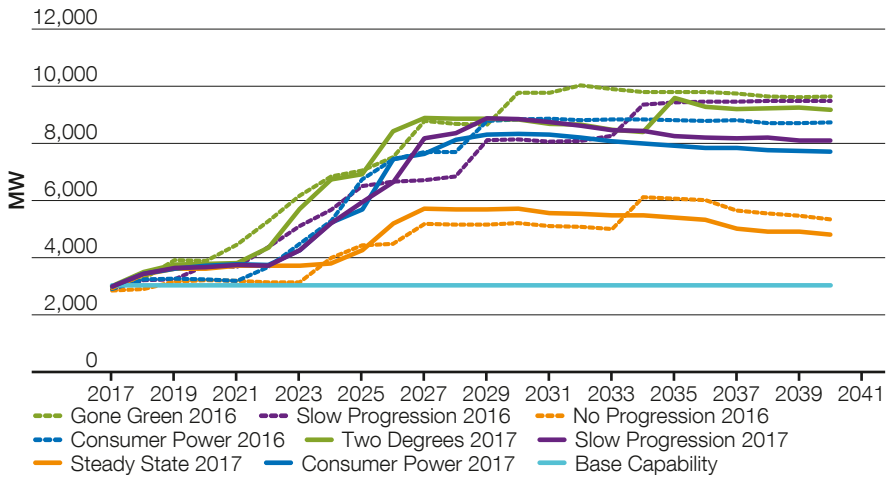
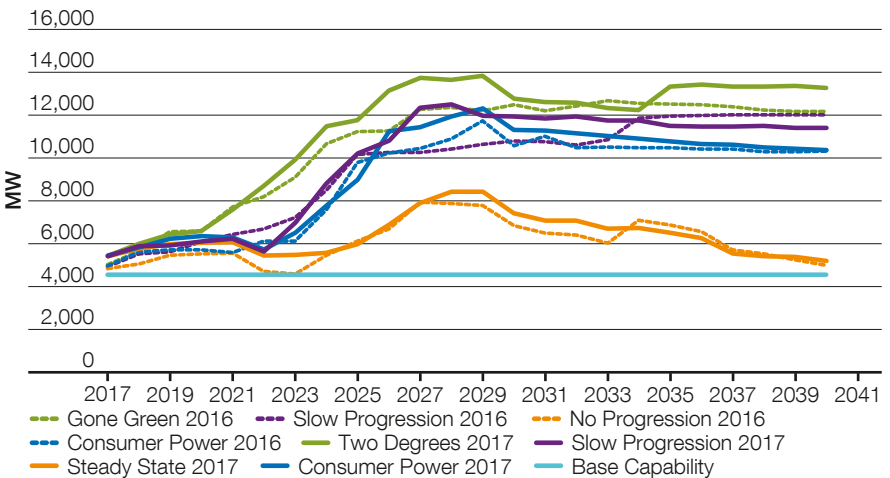

Figure 8.2
Boundary B6 (SPT/NGET) required transfer and capability



Appendix B

SWW Projects

2. Option development

A number of reinforcement options have been developed for the eastern network in the northern region to improve boundary capability across boundaries B1 to B7a. These options consider onshore and offshore solutions.

2.1 Options

(a) **East Coast onshore 275kV upgrade (ECU2)**
Establish a new 275kV substation at Alyth, including shunt reactive compensation at Alyth, extend Tealing 275kV substation and install two phase-shifting transformers, re-profile the 275kV circuits between Kintore, Alyth and Kincardine, and Tealing, Westfield and Longannet, and uprate the cable sections at Kincardine and Longannet. This reinforcement option provides additional transmission capacity across boundaries B1, B1a, B2 and B4.

(b) **East Coast onshore 400kV incremental reinforcement (ECUP)**
Following ECU2, establish new 400kV substations at Rothienorman and Kintore, uprate Alyth substation for 400kV operation, re-insulate the 275kV circuits between Blackhillock, Rothienorman, Kintore, Fetteresso, Alyth and Kincardine for 400kV operation and install phase-shifting transformers at Blackhillock. This reinforcement option provides additional transmission capacity across boundaries B1, B1a, B2 and B4.

(c) **East Coast onshore 400kV reinforcement (ECU4)**
Establish new 400kV substations at Rothienorman, Kintore and Alyth, re-insulate the 275kV circuits between Blackhillock, Rothienorman, Kintore, Fetteresso, Alyth and Kincardine for 400kV operation, install phase-shifting transformers at Blackhillock, re-profile the 275kV circuits between Tealing, Westfield and Longannet, and uprate the cable sections at Longannet. This reinforcement option provides additional transmission capacity across boundaries B1, B1a, B2 and B4.

(d) **Eastern subsea HVDC Link from Peterhead to Hawthorn Pit (E4DC)**

Construct a new offshore 2GW HVDC subsea link from Peterhead (north east of Scotland) to Hawthorn Pit (north of England), including AC/DC converter stations and associated AC onshore works at the Peterhead and Hawthorn Pit ends of the link. The AC onshore works at the Peterhead end include the upgrade of the 275kV circuits along the Blackhillock–Rothienorman–Peterhead route to 400kV operation. The AC onshore works at Hawthorn Pit include a new 400kV Hawthorn Pit GIS substation, uprating of the Hawthorn Pit–Norton circuit and associated circuit reconfiguration works in the area. This reinforcement option provides additional transmission capacity across boundaries B1, B1a, B2, B4, B5, B6, B7, and B7a.

(e) **Eastern Scotland to England Link: Torness to Hawthorn Pit Offshore HVDC (E2DC)**

Construct a new offshore 2GW HVDC subsea link from the Torness area to Hawthorn Pit, including AC/DC converter stations and associated AC works at Torness and Hawthorn Pit. The AC onshore works in the vicinity of the Torness end include extension of the pre-existing 'Branxton 400kV substation' by two 400kV GIS bays to provide connection to the 'Branxton Converter Station'. The AC onshore works at Hawthorn Pit include a new 400kV Hawthorn Pit GIS substation, uprating of the Hawthorn Pit–Norton circuit and associated circuit reconfiguration works in the area. This reinforcement option provides additional transmission capacity across boundaries B6, B7 and B7a.

(f) **Eastern Scotland to England Link: Torness to north east England AC reinforcement (TLNO)**

Install a new double circuit from a new 400kV substation in the Torness area to a connection point on the transmission system in north east England. Construct a new 400kV double circuit from the Torness area to the SPT/NGET border. Continue construction of the double circuit into a suitable connection point in north east England, providing additional substation equipment where required. This reinforcement option provides additional thermal capacity across boundaries B6, B7 and B7a.

2.2 Current lead options

In the NOA3, E4DC, E2DC, ECUP, ECU2 and DWNO have been identified as the most efficient and economical reinforcements.

(a) Eastern subsea HVDC Link from Peterhead to Hawthorn Pit (E4DC)

Based on *FES* 2017 generation background, E4DC is identified in the optimal path and critical in all four scenarios. It can provide boundary capabilities across B1 to B7a, which helps transfer renewable energy surplus to north east England. It has a 'proceed' recommendation.

(b) Eastern Scotland to England Link: Torness to Hawthorn Pit Offshore HVDC (E2DC)

E2DC is in optimal path for **Two Degrees, Slow Progression and Consumer Power**. As required from the EISD 2027, it is critical and has a 'proceed' recommendation. It unlocks transmission constraints across boundary B5 to B7a, working together with other reinforcements in the B7a and B8 area.

(c) East Coast onshore 275kV upgrade (ECU2)

ECU2 has a 'proceed' recommendation in NOA3. It is justified reinforcement in all four *FES* scenarios this year and it is critical. It reinforces boundary B1 to B6, especially working well in B4.

(d) East Coast onshore 400kV incremental reinforcement (ECUP)

ECUP is in the optimal path and critical in all four scenarios. It unlocks system constraints from B1 to B6, especially meeting the needs for the B4 boundary. As per regret analysis, ECUP has a 'proceed' recommendation.

Other options that feature in the NOA 2017/18 analysis for Scotland and the north of England region but that fall below the SWW threshold are likely to be considered in the SWW analysis. This is because they are interdependent to meet the common need of improving boundary transfer capability.

3. Status

A joint team has been established among the three onshore TOs to take the NOA options and examine them in more detail as part of the preparation of a SWW initial Needs Case submission to the regulator. This team has been organised initially to consider system requirements and project delivery. The TOs are working with the SO, who will undertake a cost-benefit analysis of the reinforcement options in more detail, to help identify optimum sequence and delivery dates for the reinforcements.

Current plans are for preliminary subsea cable routeing and survey work carried out some time ago to be refreshed. Further technical and environmental surveys will be required. For E4DC, planning permission for the 400kV substation at Peterhead has been granted and a preferred location for the convertor station at Peterhead has been identified. Design checks will be required for increasing the operating voltage of the overhead line between Peterhead and Blackhillock. For E4DC and E2DC, further preliminary works at the Hawthorn Pit end of the link will be required to establish the details of requirements in the area. It is expected in this NOA that the construction of the HVDC projects will take place between 2025 and 2028. The onshore projects in the SHE Transmission and SPT areas are scheduled for earlier delivery in the period 2023 for the 275kV works and 2026 for the 400kV uprate.

Appendix B

SWW Projects

8.5 South East Network Reinforcement

1. Background

The South East region has a high concentration of both power demand and generation, with much of the demand found in London and generation in the Thames Estuary. Interconnection to Europe is present along the South East Coast and influences power flows in the region by importing and exporting power with continental Europe. The relevant boundaries are SC1, SC2, B10, B12, B15 and LE1. The South Coast boundary SC1 runs parallel with the South Coast of England between the Severn and Thames Estuaries. It is connected to the rest of the GB system by three double circuits and currently connects one interconnector. In the next 10 years, the capacity of interconnectors connecting along this transmission route is forecast to reach circa 7 GW, with a further 4 GW at Grain and Kingsnorth.

As the number of interconnectors as well as other new generation capacity increases over time, the losses in these long circuits at high transfer level will lead to low voltage and system collapse should certain faults occur unless the SO constrains generation and/or interconnectors. This limits the boundary transfer capacity.

Reinforcements are therefore required to develop the network in order to maintain the voltage in the South Coast at compliance levels, and to increase the thermal capability of the circuits connecting the region for the forecast increase in generation and interconnectors. Further increases in capacity will be delivered by new reactive compensation and circuit uprating, as recommended by NOA3 in the South Coast area.

2. Option development

A number of reinforcement options have been developed for the South East Coast network in the South East region to improve boundary capability across boundaries SC1, SC2, B10, B12, B15 and LE1. These options consider a new transmission route, uprating existing route and reactive compensations.

2.1 Options

While the consideration of a new double circuit is at a very early stage, other recommendations from the NOA process include progressing the following reinforcements for the South Coast region this year to maintain the earliest in-service date (EISD):

- South East Coast reactive compensation (SCRC) – EISD: 2018.
- Kemsley to Littlebrook circuits uprating (KLRE) – EISD: 2020.
- Fleet to Lovedean reconductoring (FLRE/FLR2) – EISD: 2020.
- Tilbury to Grain and Tilbury to Kingsnorth Upgrade (TKRE) – EISD: 2025.

These options apart from TKRE are sufficiently developed. The SO and TO will continue to investigate alternative options including operational intertrip schemes.

2.2 Current lead option

A new cost-effective transmission route between south London and the South East (option 2, SCN2) has been recommended to improve the voltage depression and thermal capacity in accordance with the NETS SQSS and pursuant to the Transmission Owner's obligations. The reinforcement consists of constructing a new 400kV double circuit from the South Coast area to south London. SCN2 will increase the transfer capability on boundaries SC1, SC2, B10, B12, B15 and LE1.

3. Status

There has been limited work carried out for the new transmission route between south London and the South East Coast (option 2, SCN2). National Grid will work with stakeholders in advance of an SWW Initial Needs Case submission.

Appendix C

List of four-letter codes

The list below is of the options assessed in this *NOA* publication together with their four-letter codes. The four-letter codes appear throughout the report in tables and charts. The list below is in alphabetical order. We've included the scheme number where it is available. Some options do not have scheme numbers, for instance if the option is new and/or has never been given the recommendation

to proceed in previous assessments. Other options have more than one scheme number where schemes have been combined for an option. Some options that might have scheme numbers are omitted if they do not provide a boundary benefit for *NOA*. The TORI number is the Transmission Owner Reinforcement Instruction number and applies in Scotland.

Four-letter code	Description	TORI or scheme number
BCRE	Reconductor the Connah's Quay legs of the Pentir to Bodelwyddan to Connah's Quay 1 and 2 circuits	32018L1
BFHW	Bramley to Fleet circuits thermal uprating	
BFRE	Bramley to Fleet reconductoring	
BMMS	225MVA MSCs at Burwell Main	33452
BNRC	Bolney and Ninfield additional reactive compensation	33698, 33699
BRRE	Reconductor remainder of Bramford to Braintree to Rayleigh route	33458
BTNO	A new 400kV double circuit between Bramford and Twinstead	21847, 20834-1, 20834-4, 20834-3, 20834-5, 20834-6, 20834-2, 20834-2C, 20834_2A, 20834-2Q
CDRE	Cellarhead to Drakelow reconductoring	
COSC	Series Compensation South of Cottam	
COVC	Two hybrid STATCOMS at Cottam	
CPRE	Reconductor sections of Penwortham to Padiham and Penwortham to Carrington	
CPR2	Reconductor the remaining sections of Penwortham to Padiham and Penwortham to Carrington	
CTRE	Reconductor remainder of Coryton South to Tilbury circuit	21850-1
DNEU	Denny North 400/275kV SuperGrid Transformer 2	
DREU	Generator circuit breaker replacement to allow Thornton to run two-way split	
DWNO	Denny to Wishaw 400kV reinforcement	SPT-RI-003
E2DC	Eastern subsea HVDC Link from Torness to Hawthorn Pit	SPT-RI-126
E4DC	Eastern subsea HVDC Link from Peterhead to Hawthorn Pit	SHET-RI-025a, SHET-RI-025b, SHET-RI-025c, SHET-RI-025d
ECU2	East Coast onshore 275kV upgrade	SHET-RI-009
ECU4	East Coast onshore 400kV reinforcement	Variant of SHET-RI-093, SHET-RI-026
ECUP	East Coast onshore 400kV incremental reinforcement	SHET-RI-093, SHET-RI-026
EHRE	Elvanfoot to Harker reconductoring	SPT-RI-231
ESC1	Second Elstree to St John's Wood 400kV circuit	
FBRE	Beauly to Fyrish 275kV double circuit reconductoring	Alternative to SHET-RI-058

Four-letter code	Description	TORI or scheme number
FLRE	Fleet to Lovedean reconductoring	31671-2
FLR2	Fleet to Lovedean reconductoring (alternative conductor)	
GKEU	Thermal upgrade for Grain and Kingsnorth 400kV substation	
GKRE	Reconductor Garforth Tee to Keadby leg of the Creyke Beck to Keadby to Killingholme Circuit	
HAE2	Harker SuperGrid Transformer 5 replacement	
HAEU	Harker SuperGrid Transformer 6 replacement	
HMHW	Hinkley Point to Melksham circuits thermal uprating	
HNNO	Hunterston East–Neilston 400kV reinforcement	
HPNO	New east–west circuit between the north east and Lancashire	
HSRE	Reconductor Harker to Fourstones, Fourstones to Stella West and Harker to Stella West 275kV circuit	
HSUP	Uprate Harker to Fourstones, Fourstones to Stella West and Harker to Stella West 275kV circuit to 400kV	
HWUP	Uprate Hackney, Tottenham and Waltham Cross 275kV to 400kV	
KLRE	Kemsley to Littlebrook circuits uprating	20846-4
LDQB	Lister Drive quad booster	21590
LNRE	Reconductor Lackenby to Norton single 400kV circuit	20669
LN2	Reconductor Lackenby to Norton single 400kV circuit (alternative conductor)	
LTR3	Lackenby to Thornton 1 circuit thermal upgrade	
MRUP	Uprate the Penwortham to Washway Farm to Kirkby 275kV double circuit to 400kV	
NBRE	Reconductor Bramford to Norwich double circuit	11630, 11630I, 11630F
NOHW	Thermal uprate 55km of the Norton to Osbaldwick 400kV double circuit	
NOR1	Reconductor 13.75km of Norton to Osbaldwick 400kV double circuit	20640
NOR2	Reconductor 13.75km of Norton to Osbaldwick number 1 400kV circuit	33705
NOR4	Reconductor 13.75km of Norton to Osbaldwick number 2 400kV circuit	
NPNO	New east–west circuit between the north east and Lancashire	
OENO	Central Yorkshire reinforcement	
OTHW	Osbaldwick to Thornton 1 circuit thermal upgrade	
PBRE	Reconductor Pentir legs of the Pentir to Bodelwyddan to Connah's Quay 1 and 2 circuits	32018L2
PTC1	Pentir to Trawsfynydd 1 cable replacement – single core per phase	33711
PTC2	Pentir to Trawsfynydd 1 and 2 cables – second core per phase and reconductor of an overhead line section on the existing Pentir to Trawsfynydd circuit	33708
PTNO	Pentir to Trawsfynydd second circuit	30311, 30311-1L, 30311-1S, 30311-2, 30311-3C, 30311-6
PTRE	Pentir to Trawsfynydd circuits – reconductor the remaining overhead line sections	33712
RTRE	Reconductor remainder of Rayleigh to Tilbury circuit	21850-1
RYEU	Substation reconfiguration and 225MVar MSC at Ryhall	
SCN1	New 400kV transmission route between south London and the south coast (there are two alternative designs for this option)	31832-2, 31832-3
SCN2	New 400kV transmission route between south London and the south coast (outline option 2)	
SCRC	South East coast reactive compensation	31338, 31339, 21497-5

Appendix C

List of four-letter codes

Four-letter code	Description	TORI or scheme number
SEEU	Reactive compensation protective switching scheme	33702
SER1	Elstree to Sundon reconductoring	
SER2	Elstree–Sundon 2 circuit turn-in and reconductoring	
SPDC	Stella West to Padiham HVDC Link	
TDH1	Drax to Thornton 2 circuit thermal uprating	
TDH2	Drax to Thornton 1 circuit thermal uprating	
TDRE	Reconductor Drax to Thornton double circuit	
THRE	Reconductor Hinkley Point to Taunton double circuit	
THS1	Install series reactors at Thornton	33506
TKRE	Tilbury to Grain and Tilbury to Kingsnorth Upgrade	
TLNO	Torness to north east England AC reinforcement	
TURC	Reactive compensation at Tummel	SHET-RI-69
WHT1	Turn-in of West Boldon to Hartlepool circuit at Hawthorn Pit	21898-1
WHT2	Turn-in of West Boldon to Hartlepool circuit at Hawthorn Pit (delivered a year later than WHT1)	
WLTI	Windyhill to Lambhill to Longannet 275kV circuit turn-in to Denny North 275kV substation	SPT-RI-004
WYQB	Wymondley quad boosters	32581S
WYTI	Wymondley turn-in	32586S

Appendix D

Meet the *NOA* team

Julian Leslie

Head of Network Capability, Electricity
Julian.Leslie@nationalgrid.com

The Network Capability (Electricity) team addresses the engineering challenges of electricity network operability by studying from the investment options stage in a changing energy landscape through to network access just a day ahead of real time.

Nicholas Harvey

Head of Network Development
Nicholas.Harvey@nationalgrid.com

The Network Development team is to ensure the development of an efficient and operable GB and offshore electricity transmission system by understanding present capabilities and working out the best options to meet the possible requirements that future energy scenarios show might happen.

Network Development

In addition to publishing the *NOA* we are responsible for developing a holistic strategy for the NETS. This includes performing the following key activities:

- Testing the *FES* against models of the GB NETS to identify potential transmission requirements and publish in the *ETYS*.
- Supporting Needs Case studies of reinforcement options as part of the *SWW* process.
- Supporting cost–benefit studies of different connections designs.
- Developing strategies to enable a secure and operable GB transmission network in the long term against the network development and industry evolution background.

You can contact us to discuss about:
 The *Network Options Assessment*

Hannah Kirk-Wilson

Technical Economic Assessment Manager
Hannah.Kirk-Wilson@nationalgrid.com

Cost–benefit analysis and the
Network Options Assessment

Marc Vincent

Economics Team Manager
Marc.Vincent@nationalgrid.com

Network requirements and the *Electricity Ten Year Statement*

James Whiteford

GB System Capability Manager
James.Whiteford@nationalgrid.com

Supporting parties

Strategic network planning and production of the *NOA* requires support and information from many people. Parties who provide support and information that makes our work possible include:

- National Grid Electricity Transmission Asset Management

- SHE Transmission
- SP Transmission
- our customers.

Don't forget you can also email us with your views on *NOA* at:
transmission.ety@nationalgrid.com

Appendix E

Glossary

Acronym	Word	Description
ACS	Average cold spell	Average cold spell is defined as a particular combination of weather elements which gives rise to a level of winter peak demand which has a 50% chance of being exceeded as a result of weather variation alone. There are different definitions of ACS peak demand for different purposes.
BEIS	Department of Business, Energy & Industrial Strategy	A UK government department. The Department of Business, Energy & Industrial Strategy (BEIS) works to make sure the UK has secure, clean, affordable energy supplies and promote international action to mitigate climate change. These activities were formerly the responsibility of the Department of Energy and Climate Change (DECC) which closed in July 2016.
BID3		BID3 is an economic dispatch optimisation model supplied by Pöry Management Consulting. It can simulate all European power markets simultaneously including the impact of interconnection between markets. BID3 has been specifically developed for National Grid to model the impact of electricity networks in GB, allowing the System Operator to calculate constraint costs it would incur to balance the system, post-gate closure.
	Boundary allowance	An allowance in MW to be added in whole or in part to transfers arising out of the NETS SQSS economy planned transfer condition, to take some account of year-round variations in levels of generation and demand. This allowance is calculated by an empirical method described in Appendix F of the security and quality of supply standards (SQSS).
	Boundary transfer capacity	The maximum pre-fault power that the transmission system can carry from the region on one side of a boundary to the region on the other side of the boundary while ensuring acceptable transmission system operating conditions will exist following one of a range of different faults.
CBA	Cost–benefit analysis	A method of assessing the benefits of a given project in comparison to the costs. This tool can help to provide a comparative base for all projects to be considered.
	Contracted generation	A term used to reference any generator who has entered into a contract to connect with the National Electricity Transmission System (NETS) on a given date while having a transmission entry capacity (TEC) figure as a requirement of said contract.
	Double circuit overhead line	In the case of the onshore transmission system, this is a transmission line which consists of two circuits sharing the same towers for at least one span in SHE Transmission's system or NGET's transmission system or for at least two miles in SP Transmission system. In the case of an offshore transmission system, this is a transmission line which consists of two circuits sharing the same towers for at least one span.
DNO	Distribution Network Operator	Distribution network operators own and operate electricity distribution networks.
EISD	Earliest In Service Date	The earliest date when the project could be delivered and put into service, if investment in the project was started immediately.
	Embedded generation	Power generating stations/units that don't have a contractual agreement with the National Electricity Transmission System Operator (NETSO). They reduce electricity demand on the National Electricity Transmission System.
ETYS	<i>Electricity Ten Year Statement</i>	The <i>Electricity Ten Year Statement</i> is an annual publication by National Grid illustrating National Electricity Transmission System capability, future needs and opportunities.
FES	<i>Future Energy Scenarios</i>	The <i>FES</i> is a range of credible futures which has been developed in conjunction with the energy industry. They are a set of scenarios covering the period from now to 2050, and are used to frame discussions and perform stress tests. They form the starting point for all transmission network and investment planning, and are used to identify future operability challenges and potential solutions.
GW	Gigawatt	1,000,000,000 watts, a measure of power
GWh	Gigawatt hour	1,000,000,000 watt hours, a unit of energy
GB	Great Britain	A geographical, social and economic grouping of countries that contains England, Scotland and Wales.

Acronym	Word	Description
HVAC	High voltage alternating current	Electric power transmission in which the voltage varies in a sinusoidal fashion, resulting in a current flow that periodically reverses direction. HVAC is presently the most common form of electricity transmission and distribution, since it allows the voltage level to be raised or lowered using a transformer.
HVDC	High voltage direct current	The transmission of power using continuous voltage and current as opposed to alternating current. HVDC is commonly used for point to point long-distance and/or subsea connections. HVDC offers various advantages over HVAC transmission, but requires the use of costly power electronic converters at each end to change the voltage level and convert it to/from AC.
	Interconnector	Electricity interconnectors are transmission assets that connect the GB market to Europe and allow suppliers to trade electricity between markets.
	Load factor	The average power output divided by the peak power output over a period of time.
	Marine technologies	Tidal streams, tidal lagoons and energy from wave technologies.
MW	Megawatt	1,000,000 watts, a measure of power.
MWh	Megawatt hour	1,000,000 watt hours, a measure of power usage or consumption in 1 hour.
	Merit order	An ordered list of generators, sorted by the marginal cost of generation.
MITS	Main Interconnected Transmission System	This comprises all the 400kV and 275kV elements of the onshore transmission system and, in Scotland, the 132kV elements of the onshore transmission system operated in parallel with the supergrid, and any elements of an offshore transmission system operated in parallel with the supergrid, but excludes generation circuits, transformer connections to lower voltage systems, external interconnections between the onshore transmission system and external systems, and any offshore transmission systems radially connected to the onshore transmission system via single interface points.
NETS	National Electricity Transmission System	The National Electricity Transmission System comprises the onshore and offshore transmission systems of England, Wales and Scotland. It transmits high-voltage electricity from where it is produced to where it is needed throughout the country. The system is made up of high-voltage electricity wires that extend across Britain and nearby offshore waters. It is owned and maintained by regional transmission companies, while the system as a whole is operated by a single system operator (SO).
NETSO	National Electricity Transmission System Operator	National Grid acts as the NETSO for the whole of Great Britain while owning the transmission assets in England and Wales. In Scotland, transmission assets are owned by Scottish Hydro Electricity Transmission Ltd (SHE Transmission) in the north of the country and Scottish Power Transmission SP Transmission in the south.
NETS SQSS	National Electricity Transmission System Security and Quality of Supply Standards	A set of standards used in the planning and operation of the National Electricity Transmission System of Great Britain. For the avoidance of doubt the National Electricity Transmission System is made up of both the onshore transmission system and the offshore transmission systems.
NGET	National Grid Electricity Transmission plc	National Grid Electricity Transmission plc (No. 2366977) whose registered office is 1-3 Strand, London, WC2N 5EH
	Network access	Maintenance and system access is typically undertaken during the spring, summer and autumn seasons when the system is less heavily loaded and access is favourable. With circuits and equipment unavailable the integrity of the system is reduced. The planning of the system access is carefully controlled to ensure system security is maintained.
NOA	<i>Network Options Assessment</i>	The NOA is the process for assessing options for reinforcing the National Electricity Transmission System (NETS) to meet the requirements that the system operator (SO) finds from its analysis of the <i>Future Energy Scenarios (FES)</i> .
OFGEM	Office of Gas and Electricity Markets	The UK's independent National Regulatory Authority, a non-ministerial government department. Their principal objective is to protect the interests of existing and future electricity and gas consumers.
	Offshore	This term means wholly or partly in offshore waters.
	Offshore transmission circuit	Part of an offshore transmission system between two or more circuit breakers which includes, for example, transformers, reactors, cables, overhead lines and DC converters but excludes busbars and onshore transmission circuits.

Appendix E

Glossary

Acronym	Word	Description
	Onshore	This term refers to assets that are wholly on land.
	Onshore transmission circuit	Part of the onshore transmission system between two or more circuit breakers which includes, for example, transformers, reactors, cables and overhead lines but excludes busbars, generation circuits and offshore transmission circuits.
	Operational intertripping	The automatic tripping of circuit breakers to remove generating units and/or demand. It does not provide additional transmission capacity and must not lead to unacceptable frequency conditions for any secured event.
	Peak demand	The maximum power demand in any one fiscal year: Peak demand typically occurs at around 5:30pm on a week-day between December and February. Different definitions of peak demand are used for different purposes.
PV	Photovoltaic	A method of converting solar energy into direct current electricity using semi-conducting materials.
	Planned transfer	A term to describe a point at which demand is set to the National Peak when analysing boundary capability.
	Power supply background (aka generation background)	The sources of generation across Great Britain to meet the power demand.
	Ranking order	A list of generators sorted in order of likelihood of operation at time of winter peak and used by the NETS SQSS.
	Reactive power	Reactive power is a concept used by engineers to describe the background energy movement in an alternating current (AC) system arising from the production of electric and magnetic fields. These fields store energy which changes through each AC cycle. Devices which store energy by virtue of a magnetic field produced by a flow of current are said to absorb reactive power; those which store energy by virtue of electric fields are said to generate reactive power.
	Real power	This term (sometimes referred to as 'active power') provides the useful energy to a load. In an AC system, real power is accompanied by reactive power for any power factor other than 1.
	Seasonal circuit ratings	The current carrying capability of circuits. Typically, this reduces during the warmer seasons as the circuit's capability to dissipate heat is reduced. The rating of a typical 400kV overhead line may be 20% less in the summer than in winter.
	SHE Transmission	Scottish Hydro-Electric Transmission (No.SC213461) whose registered office is situated at Inveralmond HS, 200 Dunkeld Road, Perth, Perthshire PH1 3AQ.
	SP Transmission plc	A company registered in Scotland with number SC189126 whose registered office is at Ochil House, Hamilton International Technology Park, Hamilton, G72 0HT.
	Summer minimum	The minimum power demand off the transmission network in any one fiscal year: Minimum demand typically occurs at around 06:00am on a Sunday between May and September.
	Supergrid	That part of the National Electricity Transmission System operated at a nominal voltage of 275kV and above.
SGT	Supergrid transformer	A term used to describe transformers on the NETS that operate in the 275–400kV range.
	Switchgear	The term used to describe components of a substation that can be used to carry out switching activities. This can include, but is not limited to, isolators/disconnectors and circuit breakers.
	System operability	The ability to maintain system stability and all of the asset ratings and operational parameters within pre-defined limits safely, economically and sustainably.
SOF	<i>System Operability Framework</i>	The SOF identifies the challenges and opportunities which exist in the operation of future electricity networks and identifies measures to ensure the future operability.

Acronym	Word	Description
SO	System Operator	An entity entrusted with transporting energy in the form of natural gas or power on a regional or national level, using fixed infrastructure. Unlike a TSO, the SO may not necessarily own the assets concerned. For example, National Grid operates the electricity transmission system in Scotland, which is owned by Scottish Hydro Electricity Transmission and Scottish Power.
	System stability	With reduced power demand and a tendency for higher system voltages during the summer months, fewer generators will operate and those that do run could be at reduced power factor output. This condition has a tendency to reduce the dynamic stability of the NETS. Therefore network stability analysis is usually performed for summer minimum demand conditions as this represents the limiting period.
SWW	Strategic Wider Works	This is a funding mechanism as part of the RII0-T1 price control that allows TOs to bring forward large investment projects that have not been funded in the price control settlement.
	Transmission circuit	This is either an onshore transmission circuit or an offshore transmission circuit.
TEC	Transmission entry capacity	The maximum amount of active power deliverable by a power station at its grid entry point (which can be either onshore or offshore). This will be the maximum power deliverable by all of the generating units within the power station, minus any auxiliary loads.
	Transmission losses	Power losses that are caused by the electrical resistance of the transmission system.
TO	Transmission Owners	A collective term used to describe the three transmission asset owners within Great Britain, namely National Grid Electricity Transmission, Scottish Hydro-Electric Transmission Limited and SP Transmission Limited.
TSO	Transmission System Operators	An entity entrusted with transporting energy in the form of natural gas or power on a regional or national level, using fixed infrastructure.
	Turn-in	At some substations, a transmission circuit passes the substation without connecting to that substation. A turn-in breaks the transmission circuit and diverts it into the substation.

Disclaimer

The information contained within this *Network Options Assessment* Report document ('the Document') is published by National Grid Electricity Transmission plc ('NGET') without charge and in accordance with Standard Condition C27 ('C27') of the NGET transmission licence.

Whilst the information within the Document has been prepared and published in accordance with the requirements of C27, no warranty can be or is made as to the accuracy and completeness of the information contained within the Document and parties using information within the report should make their own enquiries as to its accuracy and suitability for the purpose for which they use it. Neither NGET nor the other companies within the National Grid group (nor the directors or the

employees of any such company) shall be under any liability for any error or misstatement or opinion on which the recipient of the Document relies or seeks to rely (other than fraudulent misstatement or fraudulent misrepresentation) and does not accept any responsibility for any use which is made of the information or Document or (to the extent permitted by law) for any damages or losses incurred. Copyright National Grid 2018, all rights reserved.

No part of this Document may be reproduced in any material form (including photocopying and restoring in any medium or electronic means and whether or not transiently or incidentally) without the written permission of National Grid except in accordance with the provisions of the Copyright, Designs and Patents Act 1988.

Continuing the conversation

Join our mailing list to receive email updates for **NOA**.

www.nationalgrid.com/noa

Email us with your views on **NOA** at:

transmission.etics@nationalgrid.com and we will get in touch.

Access our current and past **NOA** documents and data at:

www.nationalgrid.com/noa

Keep up to date on key issues relating to National Grid via our **Connecting** website:

www.nationalgridconnecting.com

You can write to us at:

NOA Team
Electricity Network Development
National Grid House
Warwick Technology Park
Gallows Hill
Warwick
CV34 6DA





National Grid plc
National Grid House,
Warwick Technology Park,
Gallows Hill, Warwick.
CV34 6DA United Kingdom
Registered in England and Wales
No. 4031152