

Stage 04: Code Administrator Consultation

Grid Code

GC0100 EU Connection Codes GB Implementation – Mod 1

What stage is this document at?

01	Initial Written Assessment
02	Workgroup Consultation
03	Workgroup Report
04	Code Administrator Consultation
05	Draft Grid Code Modification Report
06	Final Grid Code Modification Report

This modification will set out within the Grid Code the following compliance obligations in the EU Connection Codes:

1. Scope and applicability of the RfG, DCC and HVDC requirements for GB users
2. Set the four Type (A-D) MW banding levels for GB, as required in RfG
3. Set the GB Fast Fault Current Injection parameters, as set out in RfG
4. Set the GB Fault ride through requirements, as set out in RfG and HVDC

This Code Administration Consultation contains the discussion and conclusions of the Workgroup which formed in July 2017 to develop and assess the proposal.

Published on: 12 January 2018

Length of Consultation: 15 Working Days

Responses by: 2 February 2018



The Workgroup voted on the 6 December 2017 and voted by majority that the Original solution better facilitated the Grid Code objectives.

High Impact:



Developers of: New generation schemes (800 Watts capacity and up), new HVDC schemes (including DC-connected Power Park Modules); GB System Operator; Distribution Network Operators



Medium Impact:

Transmission Owners (including OFTOs); Operators of existing generation, HVDC schemes considering modernisation

Contents

1	Summary	3
2	Original Proposal	6
3.	Solution	9
	Workgroup Consultation Responses – overview	33
4.	Workgroup Discussions	138
5.	Alternatives	162
6.	Workgroup Vote	182
7.	Relevant Objectives – Assessment by Proposer	185
8.	Implementation	187
9.	Code Administrator Consultation: how to respond	188
	Annex 1 – Grid Code Legal text	189
	Annex 2- Terms of Reference	190
	Annex 3- Workgroup Consultation responses	190
	Annex 4- References	190
	Annex 5 - System Study Results in Slide format	190
	Annex 6- Fast Fault Current Injection supporting documents	190
	Annex 7 – Mapping for Grid Code (and Distribution Code)	191
	Annex 8 – Industry Responses to GC0048 consultation on potential GB banding levels.....	191
	Annex 9 – Alternative form stringency – not official alternative	191

Timetable

Timetable following Workgroup Consultation

Workgroup Consultation issued to the Industry	19 October 2017
Modification concluded by Workgroup	22 December 2017
Workgroup Report submitted/presented to the Grid Code Review Panel	22 December 2017/ 10 January 2018
Workgroup Report presented to the Distribution	4 January 2018



Any questions?

Code Administrator:
Chrissie Brown



@nationalgrid.com



telephone:
01926 65 3328

Proposer:

Rob Wilson, National
Grid



Rob.wilson@nationalgrid.com



07799 656402

Code Review Panel	
Code Administration Consultation Report issued to the Industry	12 January 2018
Draft Final Modification Report presented to the Grid Code Review Panel	8 February 2018
Draft Final Modification Report presented to the Distribution Code Review Panel	8 February 2018
Grid Code Review Panel Recommendation Vote	8 February 2018
Final Modification Report issued the Authority	16 February 2018
Decision implemented in the Grid and Distribution Codes	Ahead of 18 May 2018

About this document

This document is the Code Administrator Consultation for GC0100 which includes the deliberations of the Workgroup, responses to the Workgroup Consultation and the conclusions of the Workgroup. The Code Administrator is seeking views from Industry parties on the Conclusions of the Workgroup.

An electronic version of this document and all other GC0100 related documentation can be found on the National Grid website via the following link:

<https://www.nationalgrid.com/uk/electricity/codes/grid-code/modifications/eu-connection-codes-gb-implementation-mod-1>

Document Control

Version	Date	Author	Change Reference
0.1	11 September 2017	Workgroup	Workgroup Consultation to Industry
0.2	18 December 2017	Workgroup	Draft Workgroup Report
0.3	22 December 2017	Workgroup	Final Workgroup Report to Panel
1.0	10 January 2018	Code Administrator	Code Administration Consultation Report

1 Summary

1.1 This report outlines the initial Proposal, the Proposer's Solution, Alternative Solutions and corresponding Workgroup Discussions.

There is also additional material for justification and to aid understanding.

- 1.2 GC0100 was proposed by National Grid and was submitted to the Grid Code Review Panel for their consideration on 30 May 2017 and the Distribution Code Review Panel.
- 1.3 The Grid Code Review Panel decided to send the Proposal to a Workgroup to be developed and assessed against the Grid Code Applicable Objectives.
- 1.4 Section 2 (Original Proposal) and Section 3 (Proposer's solution) are sourced directly from the Proposer and any statements or assertions have not been altered or substantiated/supported or refuted by the Workgroup. Section 4 of the Workgroup contains the discussion by the Workgroup on the Proposal and the potential solution.
- 1.5 The Grid Code Review Panel detailed in the Terms of Reference the scope of work for the GC0100 Workgroup and the specific areas that the Workgroup should consider. This can be found in Annex 5.
- 1.6 **Please note that following the Workgroup Consultation for GC0100, GC0101 and GC0102 any discussions and amendments to the Distribution Code documents will be covered in the GC0102 Workgroup Report.**

Workgroup Conclusion

- 1.9 The Workgroup met on the 6 December 2017 and voted. Twelve of the sixteen members eligible to vote stated that the Original proposal better facilitated the Grid Code objectives. The full vote can be located in Section 6.
- 1.8 The workgroup voted in favour of the Original proposal rather than the alternative (maximum banding thresholds permissible) with the reasoning for this including that this provided better system support, that it was closer to existing GB levels, and that it demarcated better between technologies (specifically diesel engines and larger gas turbines).
- 1.9 The Workgroup are satisfied that they have fulfilled their Terms of Reference. A compliance matrix is also attached (Annex 10) to aid navigation of the legal text for the Authority, Grid Code Panel and Industry members.

National Grid view

- 1.10 National Grid as the GB SO supports the original proposal for the RfG banding thresholds in GC0100. The decision on this is required to be based on evidence of the best balance between generator obligations and system benefit. The original is a better harmonised solution with

other member states and existing GB thresholds and better facilitates the connection of small scale generation whilst providing greater total system benefits. While evidence of the benefit to the system is included in the report, no evidence of generator costs in choosing the lower, potentially more onerous settings as in the original proposal has been provided. Also, in progressing the work on RfG parameters it was found necessary to provide demarcation between smaller reciprocating engine driven plant and larger gas turbines to avoid compromising a class of generator while also maintaining operational support hence the need for a B/C threshold of 10MW.

Section 2 (Original Proposal) is sourced directly from the Proposer and any statements or assertions have not been altered or substantiated/supported or refuted by the Workgroup. Section 4 of the Workgroup Consultation contains the discussion by the Workgroup on the Proposal and the potential Solution.

What

- 2.9 Full sections of the Grid Code, for example the Connection Conditions (CCs), and the Distribution Code and its daughter documents, will need to be extended to set out the new EU standards to which impacted users will need to comply with.
- 2.10 This will be a combination of completely new requirements inserted into the Grid Code and Distribution Codes, or adjustments/continuation of corresponding existing GB requirements to line up with equivalents in the new EU codes.
- 2.11 In general the fast fault current injection and Fault ride through requirements for HVDC Connections (Title II) would be the same as the GB proposals for Type D Power Park Modules.
- 2.12 For DC Connected Power Park Modules the fast fault current and Fault ride through requirements would be the same as Type D Power Park Modules but an allowance would be made for alternative arrangements depending upon technology type but any such requirement would still need to be within the framework of the RfG Code.
- 2.13 For a slightly more detailed overview of the proposals and an Executive Summary, the reader is encouraged to refer to Section 3.

Why

- 2.6 Guidance from BEIS and Ofgem was to apply the new EU requirements within the existing GB regulatory frameworks. This would provide accessibility and familiarity to GB parties, as well as putting in place a robust governance route to apply the new requirements in a transparent and proportionate way.
- 2.7 This modification needs to be undertaken in timely manner to ensure affected users are aware of their compliance obligations - particularly in relation to procurement of equipment, testing and operational requirements. This modification is also therefore, critical to facilitate/demonstrate member state compliance to these three EU Network Codes.
- 2.8 This proposal is one of a number of proposals which seek to implement relevant provisions of a number of new EU network codes/guidelines which have been introduced in order to enable progress towards a competitive and efficient internal market in electricity.
- 2.9 Some EU network guidelines are still in development and these may in due course require a review of solutions developed for codes that come into force beforehand. The full set of EU network codes are:
- Regulation 2015/1222 – Capacity Allocation and Congestion Management (CACM) which entered into force 14 August 2015
 - Regulation 2016/1719 – Forward Capacity Allocation (FCA) which entered into force 17 October 2016
 - **Regulation 2016/631 - Requirements for Generators (RfG) which entered into force 17 May 2016**
 - **Regulation 2016/1388 - Demand Connection Code (DCC) which entered into force 7 September 2016**
 - **Regulation 2016/1447 - High Voltage Direct Current (HVDC) which entered into force 28 September 2016**
 - Regulation 2017/1485 – Electricity Transmission system Operation Guideline (TSOG) which entered into force 14 September 2017
 - Regulation 2017/2196 – Electricity Emergency and Restoration (E&R) Guideline which entered into force 4 December 2017
- 2.10 RfG, DCC and HVDC were drafted to facilitate greater connection of renewable generation; improve security of supply; and enhance competition to reduce costs for end consumers, across EU member states.
- 2.11 These three codes specifically set harmonised technical standards for the connection of new equipment for generators, demand, and HVDC systems (including DC-connected Power Park Modules respectively).

- 2.12 Significant work to progress GB understanding of the codes and consider the approach for implementation has been undertaken in Grid Code/Distribution Code issue groups GC0048 (RfG); GC0090 (HVDC) and GC0091 (DCC).
- 2.13 These have been widely attended, including DNOs and smaller parties. Additional stakeholder holder engagement has been undertaken to ensure the impacts of the three EU codes is understood, as well as to provide an opportunity to feed into the approach.
- 2.14 Through proposing these modifications under Open Governance, we will finalise the proposals; and undertake a final industry consultation to confirm they are appropriate, before submitting papers to Ofgem to request a decision.

How

- 2.15 With the support of the industry, we will use this modification to finalise proposals to apply the EU Connection Codes requirements, before consulting with the wider industry and submitting to Ofgem for a decision.
- 2.16 Previously, Grid Code and Distribution Code issue groups were formed (GC0048, GC0090, GC0091) to:
1. Comprehensively review the code to form a local interpretation of the requirements;
 2. Undertake a mapping between the EU and GB codes to understand the extent for possible code changes;
 3. Form proposals, which will now be taken forward as formal modifications.

Proposals:

- GB Banding levels for Type A, B, C and D
- GB requirement for Fast Fault Current Injection for Generators and HVDC systems (including DC-Connected Power Park Modules)- including multiple options for delivering this capability requirement for Fault ride through for Generators and HVDC systems (including DC-Connected Power Park Modules) – represented in voltage against curves
- Proposals for amendments to the Distribution Code and its associated Engineering Recommendations that implement the above requirements for users connected to Distribution systems.

3. Solution

Section 3 (Solution) is sourced directly from the Proposer and any statements or assertions have not been altered or substantiated/supported or refuted by the Workgroup. Section 4 of the Workgroup Consultation contains the discussion by the Workgroup on the Proposal and the potential Solution.

3.1. Scope and applicability of the RfG, DCC and HVDC Requirements for GB User's

The applicability to 'new' Users of the three EU connection Network Codes is explicitly set in the legal text. In limited circumstances the EU connection Network Codes may also be applicable to 'existing' connected Users. Therefore no interpretation is needed to apply these requirements.

Legal text for Users to determine their status as 'existing' (i.e. and therefore not to be bound by the EU Connection Codes) and 'new' (i.e. bound by the EU Connection Codes) is set out in Annex 1. This legal text includes the potential for 'existing' users to be bound by the EU requirements if they undertake modernisation or replacement of equipment to such an extent that a new connection agreement is required or a Cost Benefit Analysis is undertaken in accordance with the EU Connection Network Codes.

3.2. Set the four RfG Type (A-D) MW banding levels for GB¹

	Type A	Type B	Type C	Type D
Connection Voltage:	<110kV	<110kV	<110kV	≥110kV
Unit MW	800W – 0.999MW	1MW- 9.999MW	10MW- 49.999MW	50MW+

3.2.1. Justification for nominated values

System Operators need to continue to define requirements which are reasonable, efficient and proportionate against a rapidly changing Generation background. RfG mandates TSOs to propose and justify the appropriate and necessary generation banding thresholds for their area of operation.

The proposal would apply the same technical requirements across the whole of GB. In view of the growth in embedded small scale generation witnessed over the last few years, the technical requirements applicable in the North of Scotland and Offshore should be equally applicable, for new

¹ Note that if a generator connects to the system at a voltage of ≥110kV this means that the generator will default to type D; if however the connection voltage is <110kV then the type will be determined by the generator capacity and may be any of types A-D'

generation wherever they are connecting across the whole of GB. It is expected this issue would have needed to have been addressed under GB code governance in the near future, irrespective of the introduction of the EU Network Codes.

In order for the GB System Operator and Transmission licensee's to discharge their obligations to permit the development, maintenance and operation of a reasonable, efficient and proportionate system for the transmission of electricity and to embody the high levels of network reliability and operation, the GC0100 proposer believes these proposed generator banding levels provide a reasonable compromise between the needs of the system against the minimum costs to which newly connecting Generators are exposed to.

In comparing the banding level proposals for nearby synchronous areas, the Continental Europe power system is of the order of ten times larger than the GB System. The majority of European TSOs for Member States in Continental Europe are proposing generator banding levels lower than the maximum permitted under RfG, many of which, if not being comparable with the proposed GB levels, are lower than that proposed for GB. The proposer therefore believes there is a greater likelihood of harmonisation with Continental European neighbours with a lesser banding level than the maximum (noting that NRA approval is required to set these levels).

The GC0048 workgroup previously considered the pros and cons of applying a low banding level, similar to that of the Irish synchronous area. Whilst the proposer believes a case could be made for similar values in GB, they accept the points raised by the industry during the previous consultation phase (please see Annex 11), and so will not be proposing these in GC0100.

In regards to specifics of the proposer's solution for banding, a Type B/C Threshold of 10MW for GB would provide a greater proportion of Generation inherently capable of contributing to frequency response, noting that commercial facilitation is not in the scope of RfG to consider, as RfG deals only with technical capability, but will be a factor when it comes to market participation.

There is a close relationship between Fast Fault Current Injection (FFCI) and the Fault Ride Through parameters.

Without FFCI as proposed, the proposal will need to lower the value of U_{ret} (from 0.1pu to 0.05pu) and even then, this value would only be appropriate in the short term before a further review is likely to be required. There is also a cost of tripping synchronous generation in a higher band (10MW – 50MW) which could result in a potential increase in holding additional reserve costs alone of £9 million / annum.

Following stakeholder discussions a U_{ret} of 0.3pu for newly connecting Type B Synchronous plant is recommended by the Proposer (See Reference [2]). Larger Synchronous Generators, e.g. those derived from steam, gas or

hydro turbines are not believed to suffer from the same Fault Ride Through issue. A Type B / C Threshold of 10MW would enable Band B Synchronous Generators derived from reciprocating engines to satisfy the proposed Fault Ride Through requirements without presenting system security concerns.

The GB System Operator feels that adopting these values are the most equitable level balancing the needs of the system and obligations of users to support, without incurring material compliance costs.

3.3. Fault Ride Through parameters for GB

3.3.1. Setting the RfG Fault Ride Through parameters for GB

3.3.1.1. Introduction

The RfG Fault Ride Through requirements for Power Generating Modules are detailed in Article 14(3), Article 16(3) and Article 17(3).

Unlike the GB Grid Code, the RfG requirements segregate the requirements between Synchronous Plant and Asynchronous Plant. The requirements also differ dependent on RfG Generator 'Type', with varying requirements applying between Type B, C and D Power Generating Modules connected below 110kV and Type D Power Generating Modules connected at or above 110kV.

A further complication of the RfG structure is that the requirements are incremental, building up from Type A (the least onerous) to Type D (the most onerous). For example, all the requirements applicable to Type C Power Generating Modules also include the requirements applicable to Type A and B Power Generating Modules

The fundamental RfG Fault Ride Through principles are defined for Type B Power Generating Modules and above (Article 14 (3)). The requirements applicable to Type D² Power Generating Modules connected at 110kV or above are simply an extension of the Type B requirements but with more onerous voltage against time parameters.

The Fault Ride Through requirement is defined by a voltage against time profile which applies at the new Power Generating Module connection point.

The voltage against time profile describes the conditions in which the newly connected power generating module must be capable of remaining connected to the network and continuing to operate stably after the power system has been disturbed by secured faults on the Transmission system; an example is shown in figure 3.1 below.

² And Type C.

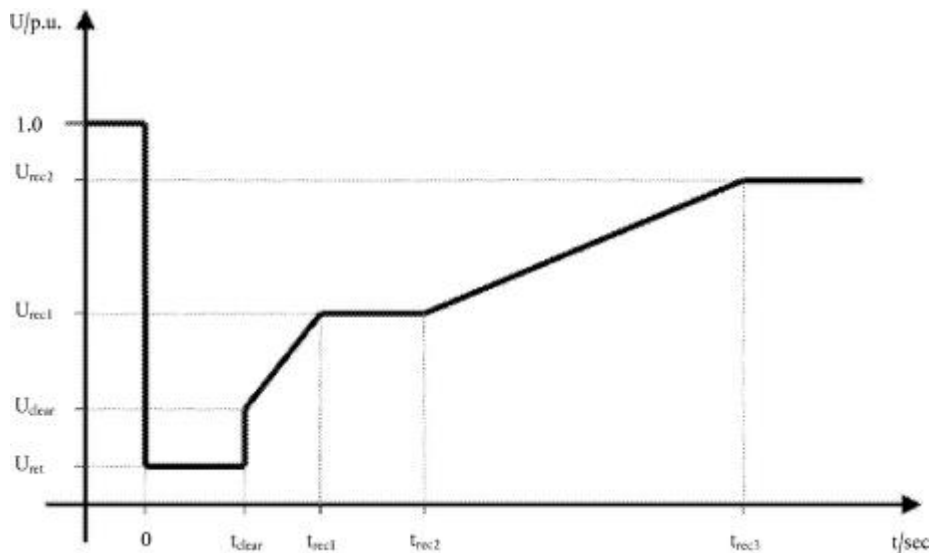

Figure 3.1 – Voltage Against Time Curve – Reproduction of RfG Fig 3

The Voltage against time curve is designed to express the lower limit of the actual phase to phase voltage at the Connection Point during a symmetrical fault, as a function of time before, during and after the fault.

3.3.1.2. Type D Synchronous Power Generating Module connected at or above 110kV

3.3.1.2.1. Permitted Ranges for Voltage against time curve

For a Type D Synchronous Power Generating Module, the range of voltage limits available for the TSO to select in accordance with Article 14(3)(a) – Figure 3.1 which is reproduced below as Table 3.1.

Voltage parameters (pu)		Time parameters (seconds)	
U_{ret} :	0	t_{clear} :	0,14-0,15 (or 0,14-0,25 if system protection and secure operation so require)
U_{clear} :	0,25	t_{rec1} :	$t_{clear}-0,45$
U_{rec1} :	0,5-0,7	t_{rec2} :	$t_{rec1}-0,7$
U_{rec2} :	0,85-0,9	t_{rec3} :	$t_{rec2}-1,5$

Table 3.1 – Extract of Table 7.1 from RfG

In accordance with the RfG requirements, each TSO is required to make publicly available the pre and post fault conditions for Fault Ride Through in terms of:-

The pre-fault minimum short circuit capacity at the Connection Point expressed in MVA

The pre-fault operating point of the power generating module expressed as active power output and reactive power output at the connection point and voltage at the Connection Point (i.e. Maximum MW output, Full MVAR lead and typical operating voltage).

The post fault minimum short circuit capacity at the connection point expressed in MVA.

It is envisaged that general maximum and minimum short circuit data would be included in the Electricity Ten Year Statement (ETYS) and in the case of

Transmission-connected generation the exact calculated figures at the Connection Point for newly connecting Users would be specified in Appendix F of the Bilateral Connection Agreement.

For distribution connected Power Generating Modules it is envisaged that DNOs will publish appropriate typical figures (probably in the Long Term Development Statements) with more site specific values produced on request.

In addition Article 14(3)(vi) states the protection settings of the new Power Generating Facility should not jeopardise Fault Ride Through performance which includes the under voltage protection at the Connection Point.

3.3.1.2.2. Determination of RfG Voltage against time parameters

The GB RfG Fault Ride Through parameter is shown in Table 3.2 and represented graphically in Figure 3.2.

Voltage Parameters [pu]		Time Parameters [seconds]	
U_{ret} :	0	t_{clear} :	0.14
U_{clear} :	0.25	t_{rec1} :	0.25
U_{rec1} :	0.5	t_{rec2} :	0.45
U_{rec2} :	0.9	t_{rec3} :	1.5

Table 3.2 – Proposed GB Parameters for the Fault Ride Through Capability of a Type D Synchronous Power Generating Module connected at or above 110kV

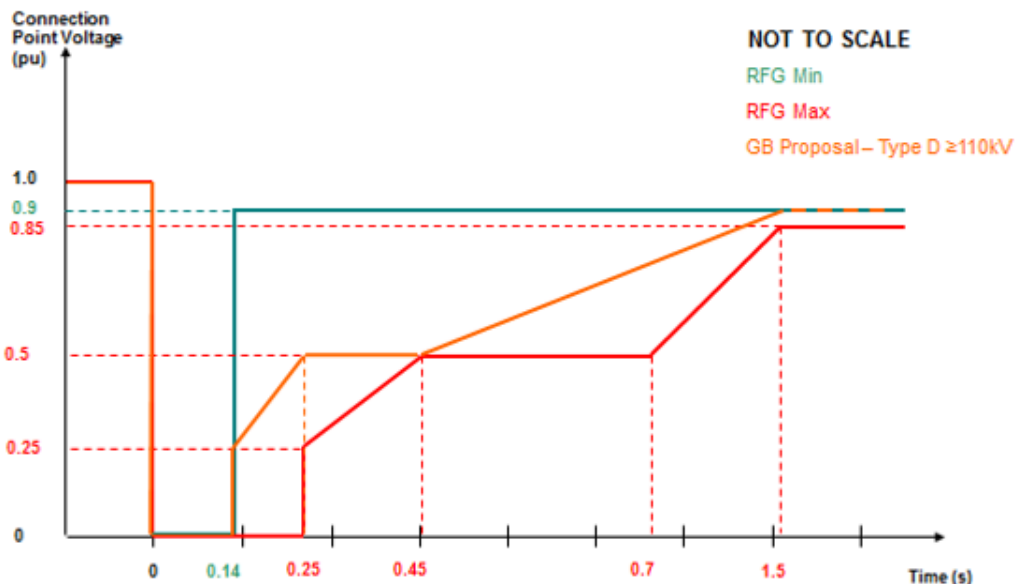

Figure 3.2 – Proposed GB Voltage against time curve for a Type D Synchronous Power Generating Module connected at or above 110kV

It is worth noting that the voltage against parameters for Type D Power Generating Modules connected at or above 110kV (RfG Tables 7.1 and 7.2) are different to those for Type D Power Generating Modules connected below 110kV (RfG Tables 3.1 and 3.2), in which case the latter fall into the

same range as values specified for Type B and C Power Generating Modules.

It should further be noted that the parameter ranges vary depending upon the type of Power Generating Module (i.e. a Synchronous Power Generating Module or Power Park Module).

Taking the extreme ends of these parameter ranges (Table 3.2 above), it is possible to plot a graph showing the parameter ranges available to TSO's at a National level. This is shown in Figure 3.3 below.

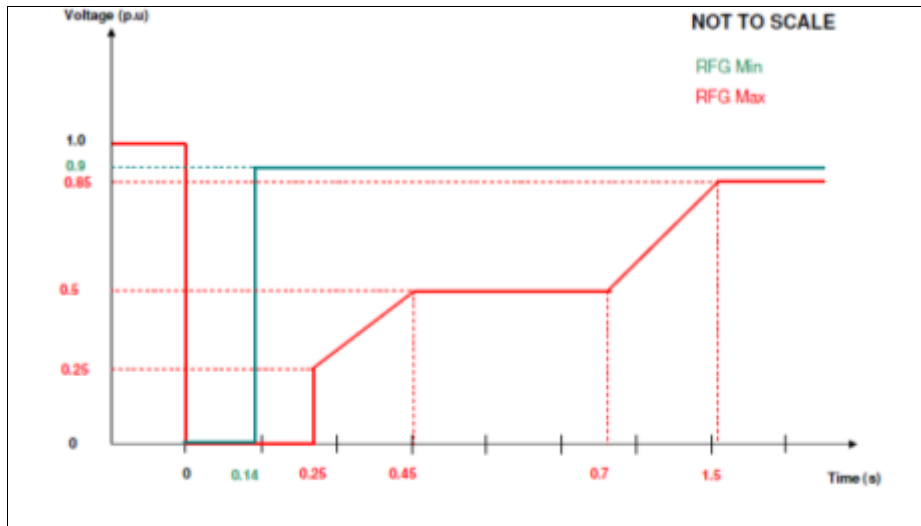

Figure 3.3 – Range of RfG Voltage Against Time Parameters available to TSOs

The green curve ('RFG Min') refers to the minimum voltage drop against time curve. Under this case, the post fault voltage profile would require a reasonably stiff system. The implication being that Generator tripping would be permitted under the least onerous of conditions. On the other hand, the red curve is the most onerous requiring the generating unit to remain connected and stable for quite severe post fault voltage recovery conditions.

At first glance and reading RfG, it would appear that the TSO should be able to select a voltage against time profile anywhere between the Green and Red line. In practice this is not strictly true as the range of parameters in Table 3.1 (RfG Table 7.1) do limit the ability of the TSO to select certain values between these ranges. These restrictions are shown in Figure 3.4 below. This limitation was also reflected back to ENTSO-E but it is not believed it will cause an issue.

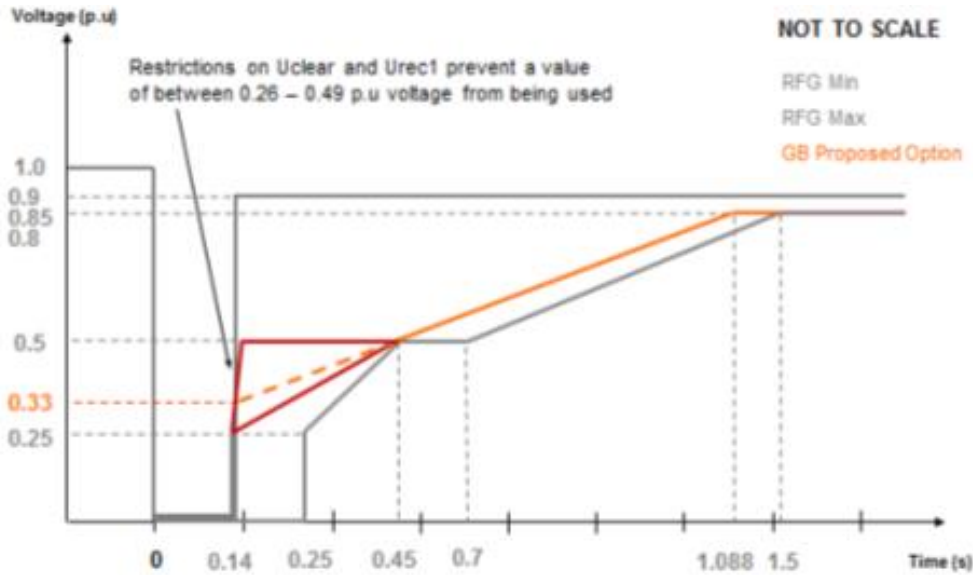

Figure 3.4 – Limitations on voltage against time curves

A Generator has to ensure the post fault voltage profile is maintained above the defined voltage against time curve. The general understanding is that the post fault voltage profile will be dictated largely by the System rather than the performance of the Power Generating Module.

For the purposes of compliance, a 140ms three phase short circuit fault would be applied at the nearest Transmission system Connection Point for the Generator. Provided the Generator remains connected and stable and the post fault voltage profile remains above the defined voltage against time curve the Power Generating Module would be deemed compliant. In the event that the Power Generating Module were to pole slip, then the post fault voltage as seen from the Generator would result in oscillations beyond the defined voltage against time curve under which generator tripping would be permitted.

Under CC.6.3.15.1(a) of the GB Grid Code, currently a directly connected existing generator would be required to remain connected and stable for a solid three phase short circuit fault for up to 140ms in duration. In other words, the Generator could be exposed to zero volts for 140ms. Translating this into the RfG voltage against time curve therefore sets the value of U_{ret} to zero and t_{clear} to 0.14 seconds.

The subsequent points on the voltage against time curve are more complex to determine. In general, the post fault voltage profile is more a function of the pre and post fault short circuit level at the connection point rather than the characteristics of the Synchronous Power Generating Module itself. However, it is important that an achievable characteristic is set, which on one hand is not so onerous that it could result in the generator to pole slip whilst on the other that is so lenient that the generator would be permitted to trip for minor faults.

In practice, an assessment of stability will be made at the Transmission Connection application stage. The Transmission system Owner will design

the Transmission Network in accordance with the requirements of the Security and Quality of Supply Standards (SQSS). During the application stage, stability studies will be run which will detail the specification of the excitation system (e.g. onload ceiling voltage and rise time). This specification being an important criterion upon which the stability requirements are assessed.

So far as the voltage against time curve is concerned, the curve needs to cater for credible system events but not those which would either be unduly pessimistic or beyond the requirements of the SQSS as these are covered under Mode B faults (i.e. faults in excess of 140ms which are currently required in the GB Code but not in RfG). As part of this work it is proposed to adopt the RfG requirements (which apply only to secured faults) and retain the GB provisions for faults in excess of 140ms which was revised following Grid Code Consultation GC0062.

The proposer believes vitally important that the Generator does not set its under-voltage protection settings to the same value as the voltage against time curve as this would result in premature tripping. As such, the voltage against time curve needs to consider credible voltage variations caused by high post fault MVA_r demands.

Returning back to the derivation of the voltage against time curve, the value of U_{clear} is fixed at 0.25. As this marks the start of the voltage recovery (i.e. immediately on fault clearance) this point would also take place at 140ms, and therefore is set by t_{clear}.

The next stage is to consider the remaining parameters of the voltage against time curve, U_{rec1}, U_{rec2}, t_{rec1}, t_{rec2} and t_{rec3}. These are more complex due to the potential arbitrary nature of the points that can be selected for the voltage against time curve. Taking into account the effect of post fault voltage oscillations, particularly where there may be high MVA_r demands and the analysis undertaken, the voltage against time curve needs to be robust enough to cater for system disturbances cleared in main protection operating times whilst ensuring it is not sufficiently onerous that the requirement is not achievable.

An example of the current voltage against time curve applied by the French TSO (RTE) is shown in Figure 3.5. In summary this requires the generator to withstand a 100% voltage dip for a period of 150ms, a 50% voltage dip for a further 550ms (total 700ms) and restoration to 1.0pu volts a further 800ms (total 1500ms) later.

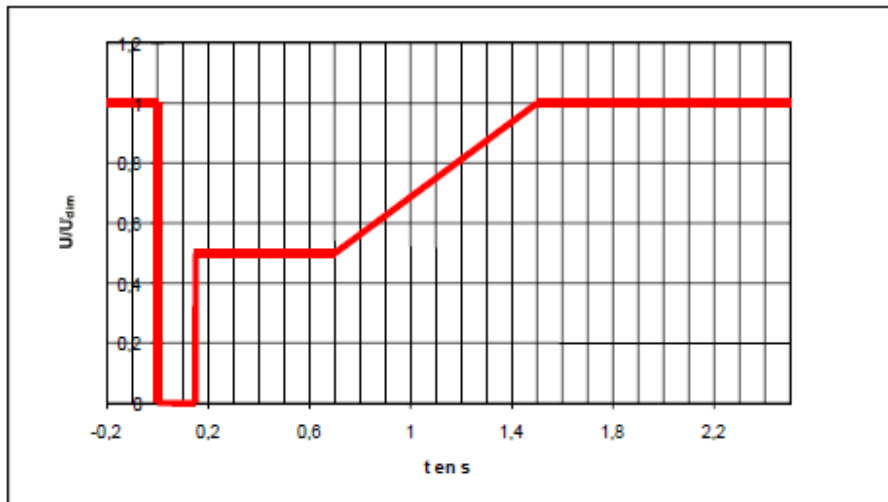

Gabarit de creux de tension pour les réseaux d'interconnexion

Figure 3.5 – French RTE Low Voltage Ride Through Voltage Against Time Curve

In deriving a GB voltage against time curve, there is always a concern under high MVar demands that the post fault voltage could struggle to return to 0.5 pu at 140ms instantaneously. On this basis and to take this effect into account, the Proposer recommends that the value of Urec1 is set at 0.5pu and trec1 set at 0.25s.

Should the voltage still struggle further to recover, then a plateau needs to be introduced but it becomes fairly straight forward to determine these values in terms of voltage and time. As a plateau is introduced the value of Urec1 remains at 0.5 pu and the time trec1 would need to be at or less than the breaker fail operating time of typically 500ms.

Based on the fact that the Mode B Fault Ride Through requirements are considered separately from RfG and the study work contained in Annex 8 of Reference [1], it was considered, by the Proposer, that a value of 450ms would be appropriate for trec2.

As Mode B faults are designed to cover unsecured faults which could result in potentially small voltage deviations (say a voltage dip of 0.15pu; retained voltage 0.85pu) for a considerable length of time (e.g. 3 minutes) and based on the analysis contained in Appendix 5 of Reference [1], it seems reasonable to the Proposer, that the voltage against time curve should be set to a condition of 0.9pu at 1.5 seconds. This therefore sets the time trec3.

Based on the analysis completed and the approach adopted internationally, a value of 1.5s for trec3 would not, according to the Proposer, be seemed to be unreasonable. This is not however to be confused with compliance where a solid three phase short circuit fault should be applied for 140ms with the post fault voltage returning to a value of between 1.0 pu - 0.9 pu being agreed between the User and National Grid.

3.3.1.3. Type C and D Synchronous Power Generating Modules connected below 110kV

3.3.1.3.1. Permitted Ranges for Voltage against time curve

The principles in deriving the voltage against time curve for Type C and D Synchronous Power Generating Modules connected below 110kV are broadly the same as those for Type D Synchronous Power Generating Modules connected at 110kV or above other than the parameter ranges specified in the RfG code.

Article 14(3)(a)(i) - Table 3.1 defines the voltage against time parameter ranges for Type B, C and D Synchronous Power Generating Modules connected below 110kV which is reproduced below as Table 3.3.

Voltage parameters [pu]		Time parameters [seconds]	
U_{ret}	0.05 – 0.3	t_{clear}	0.14 – 0.15 (or 0.14 – 0.25 if system protection and secure operation so require)
U_{clear}	0.7 – 0.9	t_{rec1}	t_{clear}
U_{rec1}	U_{clear}	t_{rec2}	$t_{rec1} - 0.7$
U_{rec2}	0.85 – 0.9 and $\geq U_{clear}$	t_{rec3}	$t_{rec2} - 1.5$

Table 3.3

Representing Table 3.3 in graphical format results in Figure 3.6:

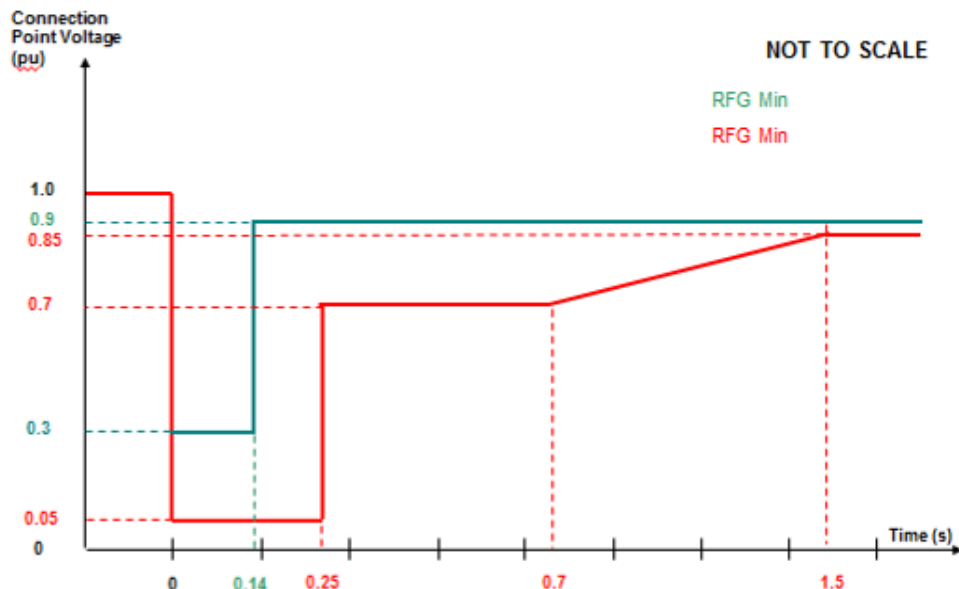

Figure 3.6 – Available range of voltage against time curves for Synchronous Power Generating Modules connected below 110kV

3.3.1.3.2. Determination of RfG Voltage against time parameters

Determination of the proposals for the Type C and Type D requirement for Synchronous Power Generating Modules connected below 110kV follows a similar methodology for Type D Synchronous Power Generating Modules connected at or above 110kV.

The following criteria have been used:

t_{clear}	set at 140ms based on maximum protection operating times for a Transmission system fault
U_{ret}	set at 0.10pu. This value has been set at 0.1pu based on the fast fault current injection studies referred to in section 3 of this report. If the volume of fast fault current is not delivered as proposed in Section 3 of this report, consideration would have to be given to reducing U_{ret} to 0.05pu.
U_{clear}	fixed to the lower of 0.7pu in line with RfG requirements. Based on system studies run under the GC0062 Grid Code Workgroup (Annex 4 Reference [1]) this is believed to be achievable
t_{rec2}	set to 0.45s. System studies (GC0062 Workgroup Report – Annex 4 Ref [1]) demonstrated pole slipping would tend to occur for longer time durations than 450ms at 0.5pu).
U_{rec2}	set to 0.9pu the upper limit based on steady state recovery voltages
t_{rec3}	set to 1.5 seconds, based on protection having operated within this time, the ability of synchronous plant to withstand longer duration high impedance faults and study work demonstrated that synchronous plant does generally not have a problem for retained high voltages over a longer time frame

Transposing the values defined above into a graphical form and plotting these between the maximum and minimum RfG values results in Figure 3.7 below.

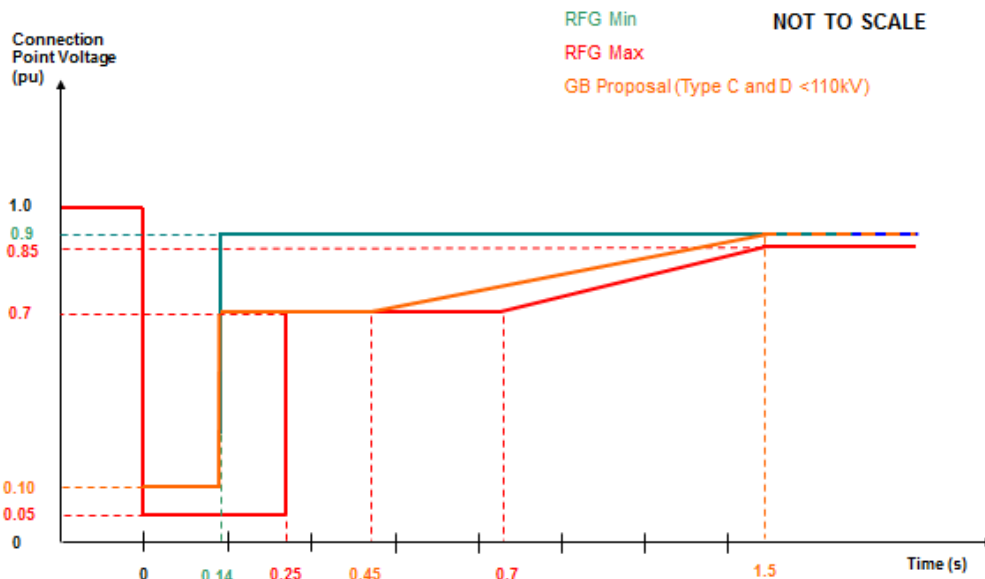

Figure 3.7 – Proposed voltage against time curve for Type, C and D Synchronous Power Generating Modules connected below 110kV.

Representing these values in tabular form results in the Table 3.4 below.

Voltage parameters [pu]	Time parameters [seconds]
-------------------------	---------------------------

U_{ret}	0.10	t_{clear}	0.14
U_{clear}	0.7	t_{rec1}	0.14
U_{rec1}	0.7	t_{rec2}	0.45
U_{rec2}	0.9	t_{rec3}	1.5

Table 3.4 Proposed voltage against time paramters for Type, C and D Synchronous Power Generating Modules connected below 110kV.

3.3.1.4. Type B Synchronous Power Generating Modules

3.3.1.4.1. Permitted Ranges for Voltage against time curve

The principles for deriving the voltage against time curve proposal for Type B Synchronous Power Generating Modules follows the same as methodology used to form the proposal for Type C and D Synchronous Power Generating Modules below 110kV.

The voltage against time parameters available to TSO's for Type B Synchronous Power Generating Modules are the same as those for Type C and D Synchronous Power Generating Modules connected below 110kV and as shown in Table 3.3 and Figure 3.6.

3.3.1.4.2. Determination of RfG Voltage against time parameters

During the GC0048 Workgroup deliberations, AMPS members (i.e. representatives of Small Synchronous Generator manufacturers) identified that retained voltages dropping below 0.3pu would cause serious design issues and even then a Fault Ride Through compliant Type B Synchronous Power Generating Module would be exposed to significantly higher costs than a standard Generator (see Annex 4 Reference [2]). Even with these provisions in place, AMPS members have advised that there is currently no known technical or economical solution to achieving lower retained voltages unless techniques such as the connection of a Power Electronic Converter was connected to the Generator. This, in addition to having very high costs would also require Generators to satisfy the fault ride through Power Park Module requirements not the Synchronous Power Generating Module requirements.

Other than the retained voltage (U_{ret}) being set at 0.3pu the other values would be set to the same values for Type C and D Synchronous Power Generating Modules as detailed above. Plotting this in graphical format between the RfG maximum and minimum values results in Figure 3.8.

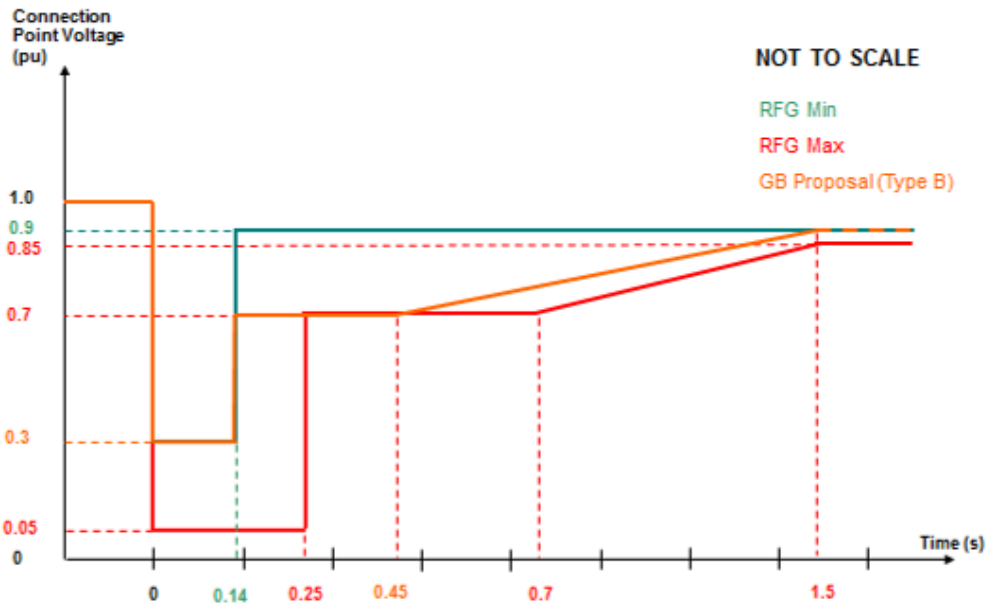

Figure 3.8 – Proposed voltage against time curve for Type, B Synchronous Power Generating Modules

Representing these values in tabular form results in the Table 3.5 below.

Voltage parameters [pu]		Time parameters [seconds]	
U_{ret}	0.3	t_{clear}	0.14
U_{clear}	0.7	t_{rec1}	0.14
U_{rec1}	0.7	t_{rec2}	0.45
U_{rec2}	0.9	t_{rec3}	1.5

Table 3.5 Proposed voltage against time paramters for Type B Synchronous Power Generating Modules connected below 110kV.

3.3.1.5. Type D Power Park Modules connected at or above 110kV

3.3.1.5.1. Permitted Ranges for Voltage against time curve

The voltage against time curve for Type D Power Park Modules connected at 110kV or above follow the same principles as defined above although the parameters available to TSO's are fundamentally different thereby resulting in a different shaped curve. This is shown by Table 3.6 and Figure 3.9 below.

Voltage parameters [pu]		Time parameters [seconds]	
U_{ret}	0	t_{clear}	0.14 – 0.15 (or 0.14 – 0.25 if system protection and secure operation so require)
U_{clear}	U_{ret}	t_{rec1}	t_{clear}
U_{rec1}	U_{clear}	t_{rec2}	t_{rec1}
U_{rec2}	0.85	t_{rec3}	1.5 – 3.0

Table 3.6 – Range of voltage against time parameters for Type D Power Park Modules connected at or above 110kV (Reproduced from Table 7.2 of RfG Article 16(3)(a)(i))

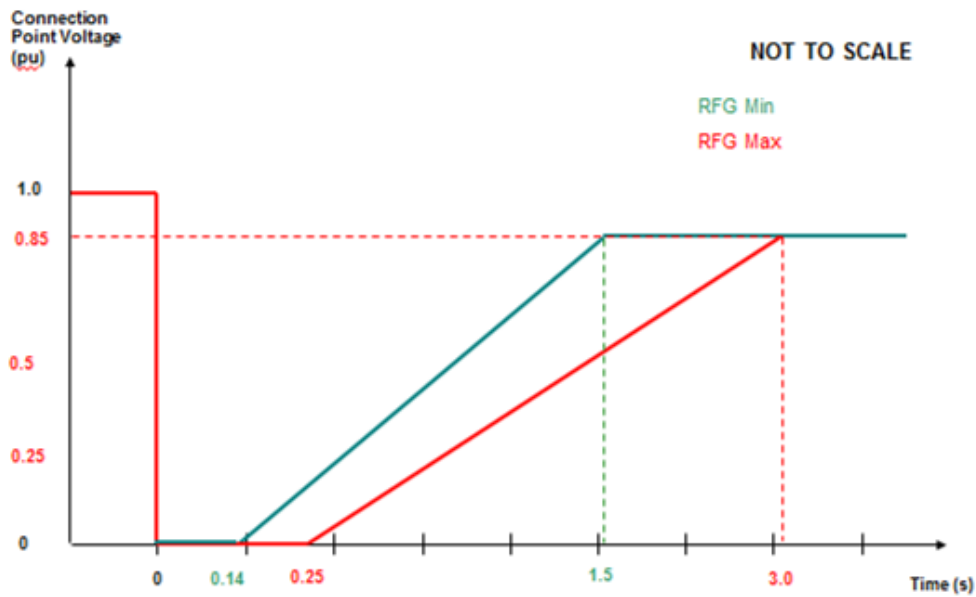

Figure 3.9 – Range of voltage against time parameters for Type D Power Park Modules connected at or above 110kV

3.3.1.5.2. Determination of RfG Voltage against time parameters

Determination of the parameters for Type D Power Park Modules connected at or above 110kV follows a similar methodology to that of Synchronous Generators above although it is noted that the parameter ranges available to the TSO as specified in the RfG restrict the options available. Values for each point on the voltage against time curve have been set in the following way.

U_{ret}	Set to zero. This would equate to a solid three phase short circuit fault on the Transmission system which could be adjacent to a Power Generating Module.
t_{clear}	set to 140ms for protection operating times (as per synchronous power generating modules)
U, t	All other parameters (U_{clear} , U_{rec1} , t_{rec1} and t_{rec2}) are defined by RfG other than t_{rec3} .
U_{rec2}	Fixed at 0.85pu.

t_{clear}	Set to 2.2 seconds to line up with the SQSS – See Note 1
-------------	--

Note 1 - Under the SQSS an important value is a voltage of 0.9pu voltage at 2.2 seconds. It therefore seems appropriate to round trec3 up to 0.85pu at 2.2 seconds.

Whilst not so much of an issue for Transmission connected Power Park Modules, there is concern amongst the DNO community of the potentially slow voltage recovery of some wind farms connected to rural Distribution Network feeders. An example of this is shown in Figure 3.10 below in which a 132kV fault with a two transformer grid substation feeding generation connected at 33kV.

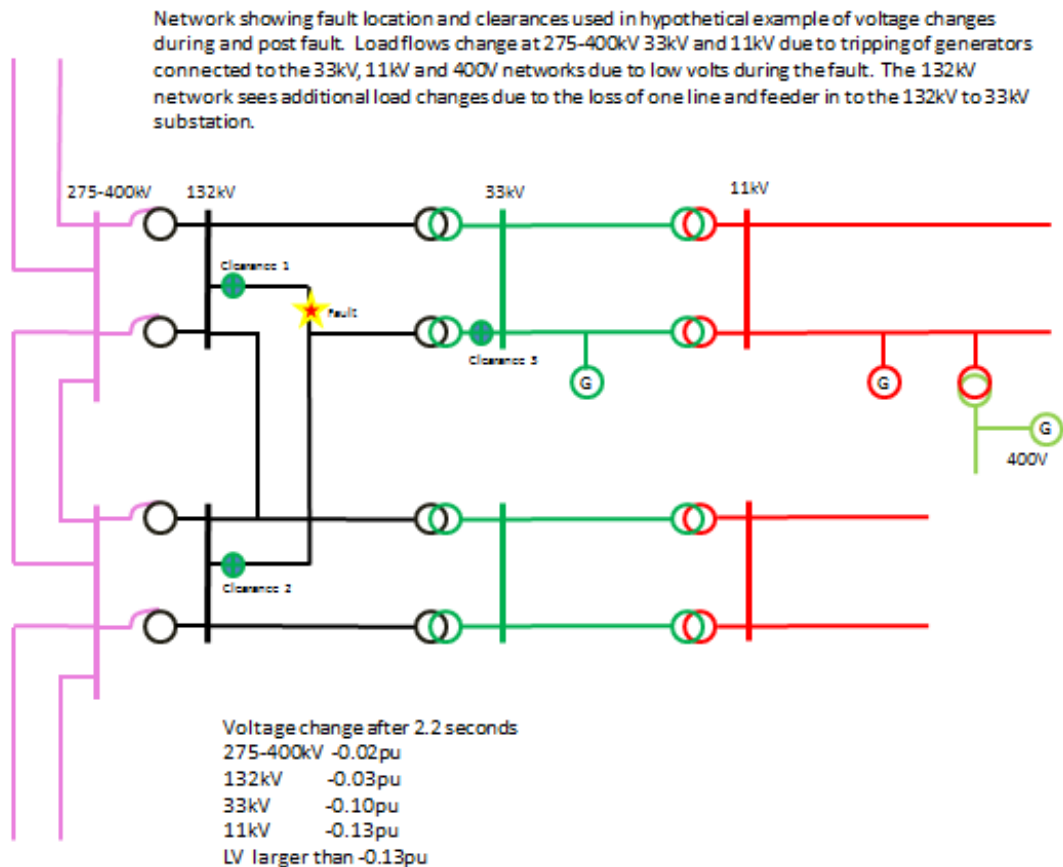

Figure 3.10

The response from this fault is shown in figure 3.11, with the 1st 132kV end clearing at 100ms, the second 132kV end clears at 130ms and the 33kV protection operation clears at 440ms. Tap changer operation starts at 60 seconds and restores voltage to target at 110 seconds. The vertical line at 180 seconds to at least meet the statutory min voltage levels for the connection in question is typically 0.94 pu but without a defined end point.

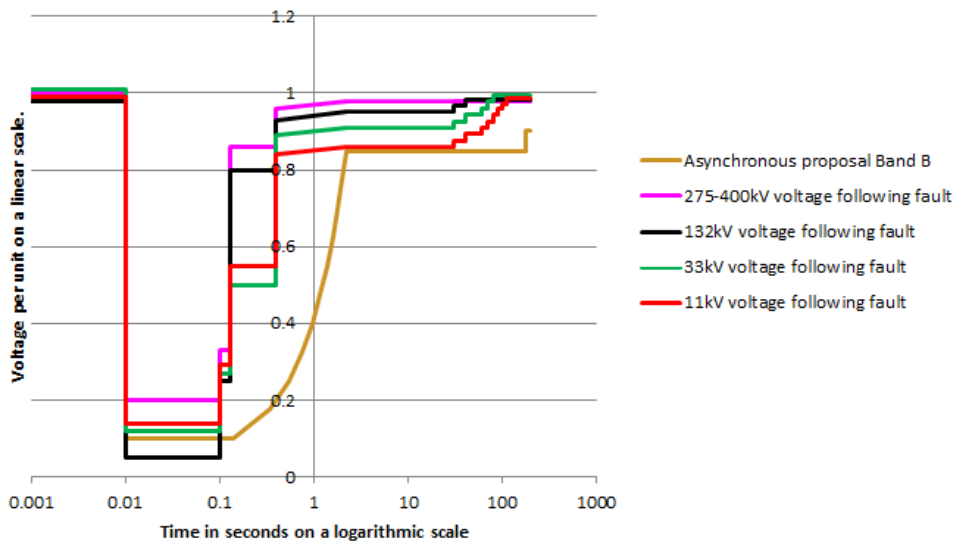

Figure 3.11 – Example of a 132kV fault with a two transformer grid substation feeding generation connected at 33kV

Taking this effect into account, it is important that Power Park Modules remain connected for the initial fault and then trips off as a result in the slow recovery of the voltage. This criterion is important in defining the period between 0.85pu voltage for 3 minutes and would apply to all Power Park Modules of Type B and above. As a result, the voltage against time curve for a Type D Power Park Module is shown in Figure 3.12 below with the corresponding list of parameters shown in Table 3.7.

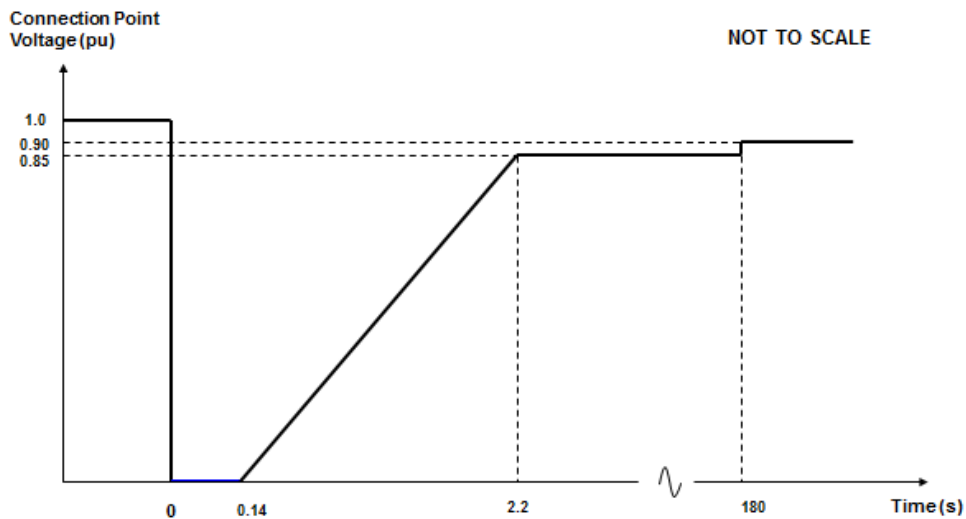

Figure 3.12 – Voltage against time curve for Type D Power Park Modules connected at or above 110kV

Voltage parameters [pu]		Time parameters [seconds]	
U_{ret}	0	t_{clear}	0.14
U_{clear}	0	t_{rec1}	0.14
U_{rec1}	0	t_{rec2}	0.14

U_{rec2}	0.85	t_{rec3}	2.2
------------	------	------------	-----

Table 3.7 – Range of voltage against time parameters for Type D Power Park Modules connected at or above 110kV

3.3.1.6. Type B, C and D Power Park Modules connected below 110kV

3.3.1.6.1. Permitted Ranges for Voltage against time curve

The voltage against time curve for Type B, C and D Power Park Modules connected below 110kV follows a similar methodology for determining the requirement as used for Type D Power Park Modules connected at or above 110kV. Under RfG Article 14 (3)(a)(iii) the requirements of Table 3.2 applies which is reproduced here in Table 3.8 below. This is shown graphically in Figure 3.13.

Voltage parameters [pu]		Time parameters [seconds]	
U_{ret}	0.05 – 0.15	t_{clear}	0.14 – 0.15 (or 0.14 – 0.25 if system protection and secure operation so require)
U_{clear}	$U_{ret} - 0.15$	t_{rec1}	t_{clear}
U_{rec1}	U_{clear}	t_{rec2}	t_{rec1}
U_{rec2}	0.85	t_{rec3}	1.5 – 3.0

Table 3.8 - Range of voltage against time parameters for Type B, C and D Power Park Modules connected below 110kV (Reproduced from Table 3.2 of RfG Article 14(3)(a)(iii))

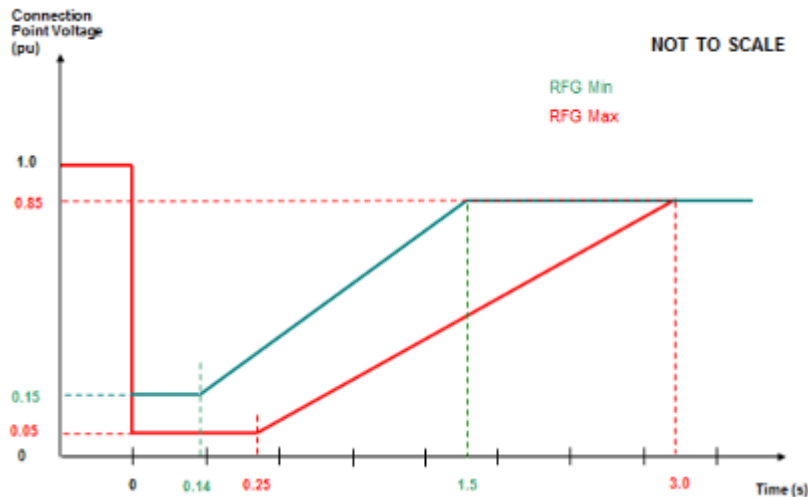

Figure 3.13 - Range of voltage against time parameters for Type B, C and D Power Park Modules connected below 110kV

3.3.1.6.2. Determination of RfG Voltage against time parameters

t_{clear}	set at 0.14s – consistent with Transmission protection operating times and that required for Type D Power Park
-------------	--

	Modules connected at or above 110kV.
U_{ret}	set at 0.1pu. based on the fast fault current injection studies referred to in section 3 of this report. If the volume of fast fault current is not delivered as proposed in Section 3 of this report, consideration would have to be given to reducing U_{ret} to 0.05pu.
U_{rec2}	set at 0.85pu which is fixed by RfG. This simply marks the point on the voltage against time curve but would need to be interpolated to 0.9pu to align with the SQSS and the minimum steady state operating voltage as defined in CC.6.1.4 (RfG) Article 16(2)(a) – Tables 6.1 and 6.2).
t_{rec3}	Set to 0.85pu at 2.2 seconds.

Taking the above criteria into account results in the following voltage against time curve parameters which is shown in Table 3.9 and Figure 3.14.

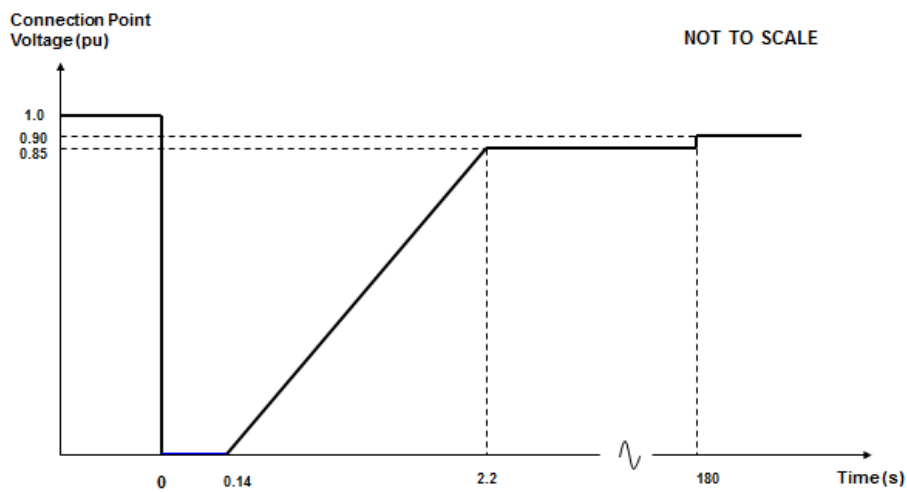

Figure 3.14 – GB Voltage against time curve for Type B, C and D Power Park Modules connected below 110kV

Voltage parameters [pu]		Time parameters [seconds]	
U_{ret}	0.1	t_{clear}	0.14
U_{clear}	0.1	t_{rec1}	0.14
U_{rec1}	0.1	t_{rec2}	0.14
U_{rec2}	0.85	t_{rec3}	2.2

Table 3.9 – GB Voltage against time parameters for Type B, C and D Power Park Modules connected below 110kV

For Type B, C and D Power Park Modules connected at any voltage, the value of U_{rec2} is set at 0.85pu at a value of t_{rec3} of 2.2 seconds. Based on RfG Tables 6.1 and 6.2 of Article 16, the steady state operating voltages are set at a lower value of 0.9pu for network voltages of 110kV and above.

3.3.1.7. Interaction between Voltage against time curves and G59 Protection [Distribution Users]

The proposed voltage against time curves for Type B – D Power Generating Modules are detailed above. For those Power Generating Modules which are connected to the Distribution Network, stakeholders noted that there would be a conflict with the G59 under voltage Stage 2 protection which is currently set at 0.8pu for 500ms. Whilst this was marginal in the case of the voltage against time curve for Synchronous Power Generating Modules it was more severe in the case of Power Park Modules where even the minimum RfG voltage against time criteria would have been incompatible with the current G59 Stage 2 under-voltage protection settings.

These issues are shown in Figures 3.15(a) and 3.15(b).

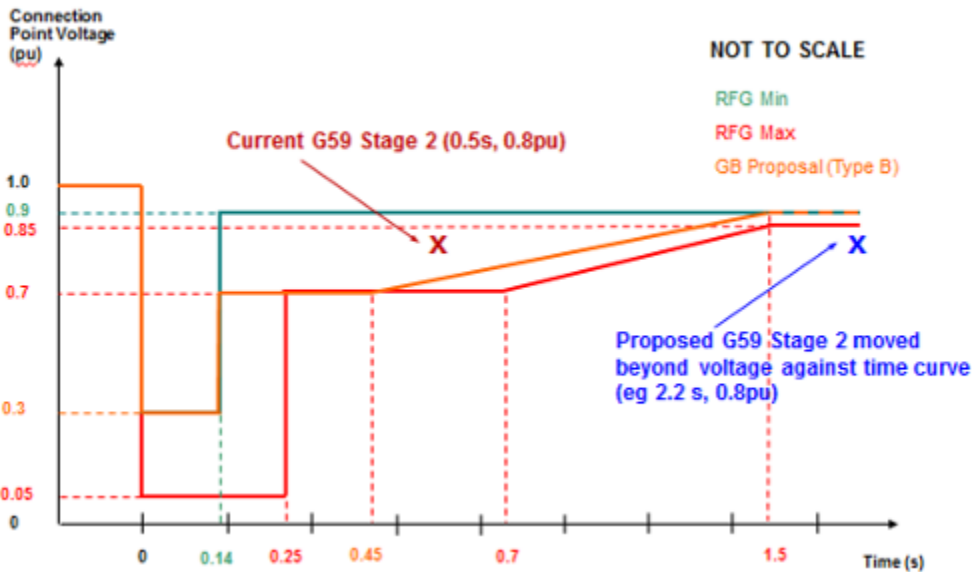

Figure 3.15(a) – GB Proposed Voltage Against Time Curve of a Type B Synchronous Power Generating Module showing the conflict with Stage 2 G59 Undervoltage Protection

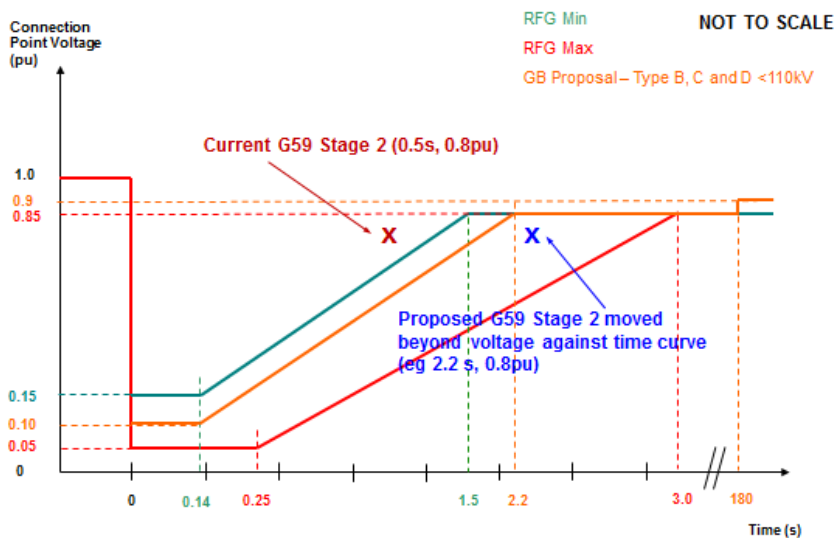

Figure 3.15(b) – GB Proposed Voltage Against Time Curve of a Type B, C or D Power Park Module connected below 110kV showing the conflict with Stage 2 G59 Undervoltage Protection

The Workgroup discussed this and The Proposer decided that the best policy for their original solution would be to move the G59 Stage 2 undervoltage protection to 0.8pu at 2.5s. This requirement would apply to all new connecting plant and would be equally applicable to Synchronous Power Generating Modules and Power Park Modules.

It was not believed that changing the G59 Stage 2 Undervoltage protection would cause a significant problem however it was included as a consultation question. The Grid Code/Distribution Code workgroups GC0035 and GC0079 continue to investigate the issues associated with changing RoCoF protection settings for distribution connected generators and have undertaken a risk assessment of Distribution system protection requirements. The analysis for this has been performed by the University of Strathclyde.

The University of Strathclyde were asked to comment on whether the proposed change to a single undervoltage protection would introduce any new risks. Their analysis pointed out that as the RfG only applies to new installations, it does not affect the risk profile for existing plant.

For new installations there is the opportunity to assess any and all risks as part of the connection process, and in addition as the risk assessment is undertaken assuming a 3s window, a trip on undervoltage at 2.5s is within the expected bounds of fault situations, thus presenting no additional risk.

For further information on the risk assessment techniques and assumptions see the GC0035 WG report, Annex 5, Reference [5].

3.3.2. Other RfG Fault Ride Through Requirements

Fault Ride Through is considered as a transient event and allowing for tap changer operation, it is therefore considered that under worst case conditions the maximum permitted amount of time that a Generator is required to remain connected and stable would be where the connection point voltage would be at 0.85pu between 2.2 seconds and 180 seconds as described above. Even then, this would need to be considered on a case by case basis depending upon where the Generator is connected to the network.

3.3.2.1. Unbalanced Faults

Article 14(3)(c) and Article 16(3)(c) of RfG define the Fault Ride Through capabilities in case of asymmetrical faults shall be specified by each TSO. There are potentially two separate options here these being either:-

- Adopt the same principles as RfG using a voltage against time curve. In this case the Power Generating Module would need to ride through any balanced or unbalanced voltage where the phase to phase or phase to earth voltage is above the heavy black line shown in each of the voltage against time curves above; or

- Retain the same approach as currently documented in the GB Grid Code – i.e. remain connected and stable for any unbalanced fault up to 140ms in duration.

This issue has been mentioned as part of the GC0048 Workgroup but not in any level of detail. An unbalanced fault will always be less onerous to the Generator than a balanced fault. It considered that adopting the same approach to that defined under RfG for unbalanced faults would provide greater clarity to developers and manufacturers in addition to ensuring consistency of requirements.

As such the proposed legal text covered in Annex 1 has been drafted on the basis of applying to balanced and unbalanced faults. A specific consultation question has also been raised on this issue to ensure Stakeholders are comfortable with this approach. It is also noted that in practice there is little difference between the RfG requirement and current GB practice – both requirements would necessitate the Power Generating Module to remain connected and stable for an unbalanced Transmission system fault for up to 140ms in duration.

3.3.2.2. Active Power Recovery

Article 17(3) – (Type B, C and D Synchronous Power Generating Modules) and Article 20(3) - (Type B, C and D Power Park Modules) define that the requirements for Active Power Recovery shall be specified by the relevant TSO.

The requirements for Power Park Modules are slightly more detailed than that for Synchronous Power Generating Modules but in general the requirements for Active Power Recovery would follow existing GB Grid Code practice which effectively states that following clearance of the fault, 90% of the Active Power before the occurrence of the fault shall be restored within 0.5 seconds.

For Power Park Modules the detailed requirements for Active Power recovery are also included in the requirements for fast fault current injection (Article 20(3)).

For Power Generating Modules of Types B – D, the requirement would be to retain the current GB requirement of 90% of Active Power within 0.5 seconds of fault clearance.

3.3.2.3. Fault ride through Requirements during single phase auto-reclosures or Delayed Auto Reclosures (DAR)

RfG Article 15(4)(c) states that “Power Generating Modules shall be capable of remaining connected to the network during single phase or three phase auto-reclosures on meshed network lines, if applicable to the

network to which they are connected. The details of that capability shall be subject to co-ordination and agreements on protection schemes and settings as referred to in point (b) of Article 14(5)".

In GB there is only place where a fast single phase auto reclose scheme is employed. In general, GB practice at a Transmission system level advocates the use of Delayed Auto Reclose Schemes (DAR). In the event of a line subject to a transient fault (e.g. lightning) the circuit will trip, the transient effects are allowed to decay away and the protection will automatically close the circuit breakers at the ends of the line.

An example of a situation which could occur is shown in Figure 3.16 below. In this example, the double circuit between substations A, B and C is subject to a transient fault which recloses by DAR operation 15 - 20 seconds later. Under this scenario the Generator connected to substation C would be permitted to trip, however the Generator connected to substation B is still connected to a healthy circuit and would be expected to remain connected and stable during the DAR event.

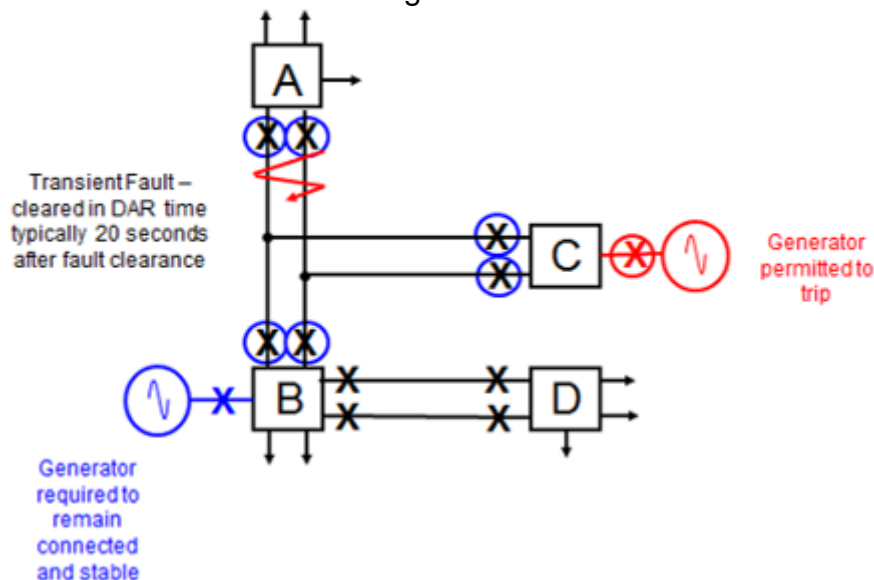

Figure 3.16 – Effect of DAR Operation and required Generator performance expected

As mentioned above, it is not standard practice for fast single phase auto re-closure schemes to be employed within GB, but if there were, the requirements applicable to them would need to be considered on a case by case basis.

In the case of Delayed Auto Reclose Schemes, the requirements of RfG Article 15(4)(c) would not apply where the Generator was connected to an unhealthy circuit (i.e. the Generator connected to substation C but would be applicable where the Generator connected to a healthy circuit (i.e. the Generator connected to Substation B. In GB there is no requirement to ride through auto-reclose sequences on Distribution systems.

3.3.2.4. Fault ride through requirements for Offshore Power Park Modules

RfG Article 26(2) states that the Fault Ride Through requirements laid down in point (a) of Article 14(3) and point (a) of Article 16(3) shall apply to AC Connected Offshore Power Park Modules.

GB is unique from the rest of Europe in that it has an Offshore Transmission regime. In summary this segregates the requirements from Offshore Transmission from Offshore Generation. Under the current GB Grid Code, Offshore Generators have the option of satisfying the Fault Ride Through requirements either at the Offshore Grid Entry Point or at the Interface Point (i.e. where the Offshore Transmission system connects to the Onshore Transmission system).

It is further complicated by the fact that the Offshore Grid Entry Point (i.e. the point where the Offshore Generator connects to the Offshore Transmission system) can vary as agreed between the Offshore Generator and Offshore Transmission Licensee. The default position is generally accepted as the LV side of the Offshore Platform but this can vary as agreed between the parties to be anywhere on the platform.

It should also be noted that the RfG requirements apply only to Offshore Power Park Modules, not Offshore Synchronous Power Generating Modules. The GB Grid Code does require Fault Ride Through to apply to all types of Offshore Generation. However, this is not relevant for newly connecting Offshore Synchronous Power Generating Modules.

The concern raised at the GC0048 Workgroup is that the current GB Grid Code enables Offshore Generators to satisfy the Fault Ride Through requirements either at the Offshore Grid Entry Point or the Interface Point. Unfortunately this option will no longer be available in a European Network Code environment however it may have limited practical impact.

For a Type D Offshore Power Park Module connected at the LV side of the Offshore Platform (which would typically have a connection voltage of 33kV) the Offshore Power Park Module would have to meet the voltage against time curve for a Type B, C or D Power Park Module connected below 110kV. The retained voltage at the connection point would be 10% which is slightly more onerous than the current GB requirement but this has been amended to take account of the fall in the overall volume of synchronous generation.

In terms of Fast Fault Current Injection, as mentioned above there would be no difference in the requirements to Offshore Power Park Modules compared to their Onshore counterparts of the Fast Fault Current Injection requirements

3.3.3. Fast Fault Current Injection and Fault ride through Requirements for DC Connected Power Park Modules and Remote End HVDC Converters (Title III)

For DC Connected Power Park Modules, Article 38 of the HVDC Code stipulates that the requirements for DC Connected Power Park Modules shall be the same as those specified in the RfG Code.

There is an important distinction to be made here. The current RfG requirements define the parameters and ranges for Fast Fault Current Injection and Fault Ride Through. The actual detail of the settings and parameters are however defined by the TSO.

It is recognised that the configuration of DC Connected Power Park Modules continues to evolve as new technology is continually being introduced. In view of this and the need to satisfy the requirements of RfG, it is proposed that DC Connected Power Park Modules have to meet the same GB proposals for Fast Fault Current and Fault Ride Through as Type D AC-Connected Offshore Power Park Modules.

With regard to the priority of Active or Reactive Power for DC Connected Power Park Modules as defined in Article 40(3) of the HVDC Code, these requirements more or less replicate the requirements in RfG. As such it is proposed that the same requirements would apply as per the proposals for Type D Power Park Modules but allowing for an alternative as noted in the above paragraph.

With regard to remote end HVDC Converters, Article 46 of the HVDC Code states that the requirements of Articles 11 to 39 shall apply to remote end HVDC Converter Stations subject to the specific requirements provided for in Articles 47 to 50. With regard to Articles 47 to 50 there are no specific requirements in relation to Fast Fault Current Injection or Fault Ride Through.

It is therefore concluded to adopt a similar approach to that applied for DC Connected Power Park Modules – i.e. that the same proposals shall be adopted as per HVDC Connections under Title II but allowing for the specific clarification unless National Grid has agreed to an alternative requirement. It must be stressed however that any alternative agreed would still need to comply with the requirements of the HVDC Code ((Regulation EU) 2016/1447) but it does give the flexibility to change parameters and settings to reflect the technology.

Workgroup Consultation Responses – overview

CONSULTATION RESPONSES

The Workgroup Consultation was issued on the 11 September and closed on the 2 October 2017. Twenty-one responses were received to the Consultation and an overview of these can be found below. The full responses can be found in Annex 6.

Response From	Q1: Do you believe that GC0100 Original proposal, or any potential alternatives for change that you wish to suggest, better facilitates the Grid Code Objectives?
<i>Paul Youngman, DRAX</i>	GC0100 satisfies objective (iv) to the extent that it introduces into the Grid code EU Regulation 2016/631. The modification can also be seen as enabling aspects of Objective (i) and (iii) relating to the efficient maintenance and operation of the system and enhancing aspects of security of supply. It is not clear that the provisions and method of implementation will satisfy and enhance competition (ii) or that the chosen option of a wider implementation scope, rather than a narrow minimum implementation meets the efficiency criteria in section (v)
<i>Christian Merchan, GE Power</i>	Yes. Please refer to comments below.
<i>Tom Chevalier, AMO</i>	No comment
<i>PThomas, Nordex</i>	See below
<i>Marko Grizelj, Siemens</i>	No comment indicated
<i>Greg Middleton, AMPS</i>	The original proposal better facilitates the objectives.

Response From	Q1: Do you believe that GC0100 Original proposal, or any potential alternatives for change that you wish to suggest, better facilitates the Grid Code Objectives?
<i>Alan Creighton, Northern Powergrid</i>	The original proposal and the potential alternative proposal on banding would both better facilitate the Grid Code and Distribution Code objectives. We are not convinced that the potential alternative related to the 'stringency' concern would better facilitate these objectives.
<i>DONG</i>	We believe GC0100 Original Proposal facilitates the Grid Code and discharges the requirement of national implementation of RfG. However, as has been pointed out in many workgroup meetings, the requirement of FFCI Option 1 and Option 2 are very onerous on the developers. Please see below for further explanation.
<i>Konstantinos Pierros, ENERCON GmbH</i>	Please see the answers to the questions with respect to FFCI below.
<i>Christopher Smith, National Grid Interconnector Holdings Ltd</i>	No comments offered
<i>Kamran Sharifabadi, Statoil</i>	<ul style="list-style-type: none"> • Statoil believes that the issue of fault current injection has not been sufficiently assessed in order to rush for implementing the changes for the ongoing revision of the grid codes. The Requirements for Generators (RfG) network code does not imply any necessary changes to the current reactive current injection of today's UK grid code. The recently updated IGDs (and the new HPoPIPS) suggest the possible need for technological changes to meet stated requirements. But to face such technology changes, the industry requires a basis of verified data, as a result of system studies and firmly established system design criteria. • The proposed reactive current injection requirements would exceed today's industry standards, leading to additional costs related to increasing the current hardware capabilities, R&D, certification, testing and validation costs. It's worth to mention that specific UK only requirements should not force manufacturers to

Response From	Q1: Do you believe that GC0100 Original proposal, or any potential alternatives for change that you wish to suggest, better facilitates the Grid Code Objectives?
	<p>change their hardware for the rest of the markets as well. Therefore the system operator should consider to incentivise the development of such capabilities under an ancillary services market,</p> <ul style="list-style-type: none"> • Statoil believes that imposing requirements exceeding the industry standards and current technology capabilities must be based on a comprehensive Cost Benefit Analysis. <p><input type="checkbox"/> It is critical to have a common understanding of system needs for scenarios today and in the future. European discussions on power system needs with high renewable penetration levels of variable renewable energy sources and power electronics levels have been focusing on aspects with a time horizon beyond May 2018 to prepare necessary frameworks allowing national TSOs to specify minimum technical requirements. This is currently addressed in the ENTSO-E expert group on fast fault current. We do not understand why for National grid is so imperative to include such requirements in the upcoming revision of the grid code.</p> <p><input type="checkbox"/> On the concept of grid forming converter controls, the wind industry believes that TSOs should focus on breaking down the characteristics of being grid forming and developing a framework for defining future requirements. National TSOs should use such frameworks specifying the minimum technical requirements needed at the connection point to maintain system stability. Minimum technical specification should be technology neutral where possible. They should not be translated into specific and/or preferred technical solutions like e.g. Virtual Synchronous Machines. The development of specific technical solutions should be left open for the industry.</p> <p><input type="checkbox"/> To avoid unnecessary system costs, the specification of future system requirements must be based on transparent system studies and firmly established system design criteria. This will result in a common rationale and technical background for new requirements. The result will also be that potential later adjustments will have a much more robust starting point. In general, a more transparent common rationale will also result in a clearer signal to the industry in order to understand what longer-term developments are needed to support future system security while efficiently integrating renewables.</p> <p><input type="checkbox"/> Scientific system studies modelling the behaviour of network and connected equipment are essential to define proper connection & operation requirements. However, system studies need to be complemented by simulations and real tests to fully understand the potential behaviour of different technologies under all situations (normal, during and after faults). Not doing so risks an under/over estimation of technology performance during</p>

Response From	Q1: Do you believe that GC0100 Original proposal, or any potential alternatives for change that you wish to suggest, better facilitates the Grid Code Objectives?
	times of system stress.
<i>Isaac Gutierrez, Scottishpower Renewable ltd (UK)</i>	Yes, to some extent. Please refer to comments on objectives
<i>Graeme Vincent, SP Energy Networks</i>	We believe that the proposals outlined in the GC0100 Original Proposal better facilitate the Grid Code Objectives.
<i>Daniel Fraile, Wind Europe</i>	<p>In order to avoid unnecessary system costs, the specification of future system requirements must be based on transparent system studies and firmly established system design criteria. This will result in a common rationale and technical background for new requirements. The result will also be that potential later adjustments will have a much more robust starting point.</p> <p>In general, a more transparent common rationale will also result in a clearer signal to the industry in order to understand what longer-term developments are needed to support future system security while efficiently integrating renewables.</p>
<i>Garth Graham, SSE</i>	<p>ORIGINAL</p> <p>We do not believe that GC0100 does better facilitate the Grid Code Objectives as it <u>fails to</u> discharge the obligations imposed upon the licensee by its license and to comply with the Electricity Regulation and any relevant legally binding decisions of the European Commission and/or the Agency.</p>

Response From	Q1: Do you believe that GC0100 Original proposal, or any potential alternatives for change that you wish to suggest, better facilitates the Grid Code Objectives?
	<p>As the National Grid presentation to EnergyUK on 23rd May 2017 noted, in respect of the three connection codes (RfG, DCC and HVDC), the aim of these Network Codes is to “<i>Set consistent technical requirements across EU for new connections of user equipment (e.g. generation / interconnectors)</i>”. This accords with the recitals of the RfG, DCC and HVDC Network Codes.</p> <p>However, as both the Proposer’s explanations to the Workgroup and the legal text makes clear there is not even to be a set of consistent technical requirements across GB (let alone with the EU) for new connections as a result of GC0100 as, for example, apparently many of these multiple technical requirements are, instead, to be determined by the network operate alone, in a non-open / non-transparent way, and applied differently to each new connection. This non-harmonised approach is inconsistent with the EU Network Codes.</p> <p>Furthermore, the imposition of additional costs (such as the twelve items listed on pages 59-60 of the Workgroup consultation document) will affect cross border trade between Member States as well as within the Member State (between GB and Northern Ireland) and as such will not be in compliance with Article 8(7) of Regulation 714/2009.</p> <p>In addition to not being better in terms of Objective (iv) the GC0100 Original does better facilitate the Grid Code Objectives (ii), (iii) and (v) as it:</p> <ul style="list-style-type: none"> fails to facilitate competition in the generation and supply of electricity (by not complying with EU law – see above – and imposing additional costs on GB generation); fails to promote security and efficiency in electricity generation (by not complying with EU law – see above); and fails to promote efficiency in the implementation and administration of the Grid Code arrangements (by not complying with EU law – see above). <p>POTENTIAL ATLERNATIVE (a)</p>

Response From	Q1: Do you believe that GC0100 Original proposal, or any potential alternatives for change that you wish to suggest, better facilitates the Grid Code Objectives?
---------------	---

For the reasons set out above, given that this potential alternative (as described on page 54 of the Workgroup consultation) is based on the Original then it too fails to better facilitates the Grid Code Objectives in terms, primarily, of (iv) but also (i), (iii) and (v).

Nevertheless, in respect of the specific aspect of this potential alternative as regards the level of banding; and taking into account the previous substantial body of evidence provided by Workgroup members and stakeholders as part of the GC048 Workgroup deliberations and consultations; then taken in isolation this aspect would (absent the Original) better facilitate the Grid Code Objectives in terms, primarily, of (ii) competition in the generation and supply of electricity for the reasons provided to the GC048 Workgroup deliberations and consultations.

POTENTIAL ATLERNATIVE (b)

We do believe that potential alternative (b) (as described on page 55-62) of the Workgroup consultation) does better facilitate the Grid Code Objectives as it ensures the discharging of the obligations imposed upon the licensee by its license and to comply with the Electricity Regulation and any relevant legally binding decisions of the European Commission and/or the Agency.

As the National Grid presentation to EnergyUK on 23rd May 2017 noted, in respect of the three connection codes (RfG, DCC and HVDC), the aim of these Network Codes is to “*Set consistent technical requirements across EU for new connections of user equipment (e.g. generation / interconnectors)*”. This accords with the recitals of the RfG, DCC and HVDC Network Codes.

It is clear that this potential alternative (b) seeks to ensure that only those obligations applicable to newly connecting parties that fall within the scope of the EU Network Codes will be implemented into the GB national network codes (such as, but not limited to, the Grid Code and Distribution Code) as required by those EU Network Codes.

Response From	Q1: Do you believe that GC0100 Original proposal, or any potential alternatives for change that you wish to suggest, better facilitates the Grid Code Objectives?
	<p>As detailed on pages 55-62 of the Workgroup consultation document there are clear reasons as to why this is required.</p> <p>In addition to being better in terms of Objective (iv) the potential alternative (b) also better facilitate the Grid Code Objectives (ii), (iii) and (v) as it:</p> <p>as by complying with EU law – see above – and not imposing additional costs (over and above those required by law) on GB generation it facilitates competition in the generation and supply of electricity;</p> <p>as by complying with EU law – see above – and not imposing additional costs (over and above those required by law) on GB generation it promotes security and efficiency in electricity generation; and</p> <p>as by complying with EU law – see above – and not imposing additional costs (over and above those required by law) on GB generation it promotes efficiency in the implementation and administration of the Grid Code arrangements.</p>
<i>Andy Vaudin, EDF Energy</i>	Yes, we agree that GC0100 Original proposal facilitates the Grid Code objectives.
<i>Alastair Frew, ScottishPower Generation Ltd</i>	Yes as it implements European Law.
<i>Senvion</i>	Yes
<i>Rob Wilson, NGET</i>	The original proposal for GC0100 better facilitates the Grid Code Objectives.

Response From	Q1: Do you believe that GC0100 Original proposal, or any potential alternatives for change that you wish to suggest, better facilitates the Grid Code Objectives?
	<p>An assessment of the original proposal against the Grid Code objectives is as follows:</p> <ul style="list-style-type: none"> <li data-bbox="331 517 1917 587">i. <i>To permit the development, maintenance and operation of an efficient, coordinated and economical system for the transmission of electricity</i> <p>Positive. In developing this code modification the task of the workgroup has been to find a balance between the costs that will be incurred by owners of equipment in complying with a more onerous specification and the benefit to the system in avoiding operational costs that would otherwise be incurred in providing support due to the connection of less capable equipment. This is also the aim of the European Network Codes as stated by ENTSO-E and is particularly important given the development of the system and the shift in the generation portfolio from larger, centrally despatched units to smaller and embedded renewable generation.</p> <ul style="list-style-type: none"> <li data-bbox="331 865 1939 1008">ii. <i>To facilitate competition in the generation and supply of electricity (and without limiting the foregoing, to facilitate the national electricity transmission system being made available to persons authorised to supply or generate electricity on terms which neither prevent nor restrict competition in the supply or generation of electricity)</i> <p>Positive. Ofgem have made clear during the workgroup proceedings that their decisions will be based on evidence in both directions – ie that where choices are made these are based on a tipping point being reached where the costs of choosing more onerous settings is evidenced to outweigh the operational benefit.</p> <ul style="list-style-type: none"> <li data-bbox="331 1168 1939 1270">iii. <i>Subject to sub-paragraphs (i) and (ii), to promote the security and efficiency of the electricity generation, transmission and distribution systems in the national electricity transmission system operator area taken as a whole</i> <p>Positive, as stated above, in making balanced choices for the overall benefit of the end consumer.</p> <ul style="list-style-type: none"> <li data-bbox="331 1350 1872 1417">iv. <i>To efficiently discharge the obligations imposed upon the licensee by this license and to comply with the Electricity Regulation and any relevant legally binding decisions of the European Commission and/or the</i>

Response From	Q1: Do you believe that GC0100 Original proposal, or any potential alternatives for change that you wish to suggest, better facilitates the Grid Code Objectives?
	<p><i>Agency; and</i></p> <p>Positive. This modification is required to implement elements of the 3 European Connection Codes forming part of the suite of European Network Codes resulting from the EU 3rd Package legislation (EC 714/2009).</p> <p>v. <i>To promote efficiency in the implementation and administration of the Grid Code arrangements</i></p> <p>Neutral. Although noting that this is the first comprehensive modification to be taken through Grid Code Open Governance and therefore the first Grid Code modification to go through an official workgroup consultation which will be followed on acceptance of the workgroup report by the Grid Code Panel by a Code Administrator consultation.</p> <p>So as noted above, the GC0100 original proposal better facilitates objectives (i)-(iv) and is neutral against objective (v).</p> <p>Providing that this is evidenced, the alternative proposal for the type or banding thresholds fulfils the same objectives. Currently this alternative is however not evidenced and also lacks a solution to the demarcation needed in determining Uret values as referenced below to allow optimum system support but avoid setting values with which sectors of the generation businesses cannot comply.</p> <p>The 'more stringent' alternative fulfils none of the objectives as summarised below.</p> <p>Assessment of the 'more stringent' alternative against the Grid Code objectives:</p> <p>i. <i>To permit the development, maintenance and operation of an efficient, coordinated and economical system for the transmission of electricity</i></p> <p>Negative. The 'more stringent' alternative does not embody the minimum solution as required by Ofgem for implementation of the European Network Codes and so does not permit efficient development.</p>

Response From	Q1: Do you believe that GC0100 Original proposal, or any potential alternatives for change that you wish to suggest, better facilitates the Grid Code Objectives?
	<p data-bbox="331 443 1939 587"><i>ii. To facilitate competition in the generation and supply of electricity (and without limiting the foregoing, to facilitate the national electricity transmission system being made available to persons authorised to supply or generate electricity on terms which neither prevent nor restrict competition in the supply or generation of electricity)</i></p> <p data-bbox="309 612 1946 804">Negative. The ‘more stringent’ alternative is not achievable in the time available and proposes striking out of national code requirements without which system security will be compromised and new connections will be unable to proceed under safety rules and due to a lack of clarity over equipment specifications. Further, due to the time that solving these issues will take the ability of new entrants to meet their European Connection Code obligations will be compromised as the leadtime that they will have prior to compliance being required will be reduced.</p> <p data-bbox="331 826 1939 928"><i>iii. Subject to sub-paragraphs (i) and (ii), to promote the security and efficiency of the electricity generation, transmission and distribution systems in the national electricity transmission system operator area taken as a whole</i></p> <p data-bbox="309 954 1917 1024">Negative. The ‘more stringent’ alternative will prevent secure connection of new entrants and stifle development of efficient solutions.</p> <p data-bbox="331 1046 1872 1155"><i>iv. To efficiently discharge the obligations imposed upon the licensee by this license and to comply with the Electricity Regulation and any relevant legally binding decisions of the European Commission and/or the Agency; and</i></p> <p data-bbox="309 1177 1738 1216">Negative. The ‘more stringent’ alternative is not a minimum or efficient solution as required by Ofgem.</p> <p data-bbox="331 1232 1738 1270"><i>v. To promote efficiency in the implementation and administration of the Grid Code arrangements</i></p> <p data-bbox="309 1289 1926 1359">Negative’ The ‘more stringent’ alternative will require comprehensive and unnecessary modifications to the existing national codes.</p>

Response From	Q1: Do you believe that GC0100 Original proposal, or any potential alternatives for change that you wish to suggest, better facilitates the Grid Code Objectives?
<i>Frank Martin, Siemens Gamesa Renewable Energy (SGRE)</i>	./.
<i>Athanasios Krontiris & Grant McKay, ABB HVDC</i>	No comment indicated

Response From	Q2: Do you support the proposed implementation approach?
<i>Paul Youngman, DRAX</i>	<p>We offer qualified support of the proposals. From workgroup discussion it is clear that the proposer has included all changes mandated by the regulation to ensure compliance, and also defined additional requirements that are not mandated.</p> <p>We feel it may have been more efficient to implement an enabling mod that would implement the EU requirements, and then separately define elements that need to be enhanced in the national codes.</p>
<i>Christian Merchan, GE</i>	Please refer to comments below.

Response From	Q2: Do you support the proposed implementation approach?
<i>Power</i>	
<i>Tom Chevalier, AMO</i>	No comment
<i>PThomas, Nordex</i>	Yes
<i>Marko Grizelj, Siemens</i>	No comment indicated
<i>Greg Middleton, AMPS</i>	Yes
<i>Alan Creighton, Northern Powergrid</i>	Yes
<i>DONG</i>	Yes, we fully support the implementation approach and efforts by the proposer to keep the industry informed.
<i>Konstantinos Pierros, ENERCON GmbH</i>	We could not find a clear implementation approach. Perhaps include it in a separate section?
<i>Christopher Smith, National Grid Interconnector Holdings Ltd</i>	No comments offered

Response From	Q2: Do you support the proposed implementation approach?
<i>Kamran Sharifabadi, Statoil</i>	No
<i>Isaac Gutierrez, Scottishpower Renewable Ltd (UK)</i>	No, timescale are too short which are not allowing current wind farm tenderers to exactly know what grid code requirements they have to meet. The implementation date of 17 May 2018 does not provide enough room for timely decision making in regards to electrical balance of plant and wind turbines electrical specifications. SPR considers that a grace period should be implemented until December 2018 so any contract signed after December 2018 should comply with the Grid Code changes otherwise the implementation date of 17 May 2018 will highly impact developers in particular the requirements of FFCL as they are specifically for wind turbines frequency converters (requirement that will not only impact wind turbine frequency converter but the turbine system as a whole please refer to answer below in question 3)
<i>Graeme Vincent, SP Energy Networks</i>	Yes
<i>Daniel Fraile, Wind Europe</i>	No comment indicated
<i>Garth Graham, SSE</i>	We note the proposed implementation approach set out in Section 7 and support this.
<i>Andy Vaudin, EDF Energy</i>	We support the proposed implementation approach of amending the existing Grid Code and Distribution Code
<i>Alastair Frew, ScottishPower Generation Ltd</i>	Yes

Response From	Q2: Do you support the proposed implementation approach?
<i>Senvion</i>	No
<i>Rob Wilson, NGET</i>	Yes
<i>Frank Martin, Siemens Gamesa Renewable Energy (SGRE)</i>	./.
<i>Athanasios Krontiris & Grant McKay, ABB HVDC</i>	No comment indicated

Response From	Q3: Do you have any other comments?
<i>Paul</i>	No

Response From	Q3: Do you have any other comments?
<i>Youngman, DRAX</i>	
<i>Christian Merchan, GE Power</i>	n/a
<i>Tom Chevalier, AMO</i>	<p>I have some comments on the drafting. I have briefly reviewed the text and have the following comments:</p> <p>G98-2, figure 1 – the export and import meters are shown as separate devices. In practice they are normally a single device which measures the import & export energy. So suggest show as a single meter with text to describe as an import/export meter. It should be noted that this applies to SMETS2 and existing HH meters.</p> <p>G98-2, figure 2 and Figure 3 – after the metering equipment there is a CB or switch fuse shown. This will typically also break the neutral, so single phase would be double pole isolator.</p> <p>G89-2, appendix 2 Note – Rather than just ‘inform’ the meter operator I would suggest the text should prompt the installer/customer to “...to confirm appropriate metering with the Meter Operator...”</p> <p>Similar points to above in respect of G98-1</p>
<i>PThomas, Nordex</i>	No
<i>Marko Grizelj, Siemens</i>	No comment indicated
<i>Greg Middleton, AMPS</i>	See comments elsewhere in this document about Uret.

Response From	Q3: Do you have any other comments?
<i>Alan Creighton, Northern Powergrid</i>	No
<i>DONG</i>	No
<i>Konstantinos Pierros, ENERCON GmbH</i>	<p>Physical quantities (voltage, current) and the grid-event related terminology (incident that leads to a certain response, fault inception, fault clearance, blocking, etc) must be clearly defined and must not be left open to interpretation. The base of the pu system should be clearly defined and explained through examples.</p> <p>There are minor typos in the report that should be corrected before the Workgroup issues the report.</p>
<i>Christopher Smith, National Grid Interconnector Holdings Ltd</i>	No comments offered
<i>Kamran Sharifabadi, Statoil</i>	No comments offered
<i>Isaac Gutierrez, Scottishpower Renewable Ltd (UK)</i>	No
<i>Graeme Vincent, SP</i>	In general, it would have been helpful to have provided further information (eg summary of results and what on the studies which have been undertaken which have enabled NGET certain conclusions to be reached. Reading

Response From	Q3: Do you have any other comments?
Energy Networks	through
Daniel Fraile, Wind Europe	No comment indicated
Garth Graham, SSE	<p>We note the Workgroup deliberations in respect of the <i>affect on cross border trade</i>. The Workgroup may wish to take due notice of the Commission’s guidance in this regard which is available at:</p> <p>http://eur-lex.europa.eu/legal-content/EN/TXT/?uri=URISERV%3A126113</p> <p>It sets out the following:</p> <p>“the concept of “trade between EU countries”: <i>the concept of “trade” is not limited to traditional exchanges of goods and services across borders. It is a wider concept, covering all cross-border economic activity including establishment. This interpretation is consistent with the fundamental objective of the Treaty to promote free movement of goods, services, persons and capital. The requirement that there must be an effect on trade “between EU countries” implies that there must be an impact on cross-border economic activity involving at least two EU countries;</i></p> <p>the notion “may affect”: <i>the function of the notion “may affect” is to define the nature of the required impact on trade between EU countries. According to the standard test developed by the Court of Justice, the notion “may affect” implies that it must be possible to foresee with a sufficient degree of probability on the basis of a set of objective factors of law or fact that the agreement or practice may have an influence, direct or indirect, actual or potential, on the pattern of trade between EU countries. In cases where the agreement or practice is liable to affect the competitive structure inside the EU, EU law jurisdiction is established”.</i></p>
Andy Vaudin, EDF Energy	No

Response From	Q3: Do you have any other comments?
<i>Alastair Frew, ScottishPower Generation Ltd</i>	No
<i>Senvion</i>	The time frame given for the industry consultation is not sufficient to develop a clear alternative proposal. Proposal is given within comments. If the opportunity arises, a more specific proposal can be developed. The consultations, most of them with very short response times and running through the summer, are not helping stakeholders to consolidate their views in the most constructive way.
<i>Rob Wilson, NGET</i>	No
<i>Frank Martin, Siemens Gamesa Renewable Energy (SGRE)</i>	VSM is not only fast fault current. Additional technical information is needed for manufacturers to be able to assess the technical requirements and cost impact of providing these services. Ideally if any converter connected generator is to provide system services required to support other types of generation, then an incentive scheme should be considered, as all renewable generators are competing to provide energy at the lowest possible cost. SGRE believes that the desire to have a converter connected generation control that can be simulated at the RMS level (GC0100 – Effects of VSM, slide 8) needs to be carefully considered. With a low bandwidth primary controller (5Hz) then an outer loop (fast acting) control will be required to act, under certain system conditions to prevent converter overcurrent (this will be similar to existing fast current limiting control with current control schemes). This presents a non-linear control system which cannot be simulated at the RMS level, and it is arguably during a severe system transient that this control change will take place. Consideration of the point at which such change in controls takes place needs discussed.
<i>Athanasios</i>	No comment indicated

Response From	Q3: Do you have any other comments?
<i>Krontiris & Grant McKay, ABB HVDC</i>	

Response From	Q4: Do you wish to raise a WG Consultation Alternative Request for the Workgroup to consider?
<i>Paul Youngman, DRAX</i>	No
<i>Christian Merchan, GE Power</i>	No
<i>Tom Chevalier, AMO</i>	No
<i>PThomas, Nordex</i>	No
<i>Marko Grizelj, Siemens</i>	No comment indicated
<i>Greg Middleton, AMPS</i>	No
<i>Alan Creighton,</i>	No

Response From	Q4: Do you wish to raise a WG Consultation Alternative Request for the Workgroup to consider?
<i>Northern Powergrid</i>	
<i>DONG</i>	No
<i>Konstantinos Pierros, ENERCON GmbH</i>	<p>We are unsure if we should raise a WG Consultation Alternative Request. We you like to see modelled the following, however:</p> <ul style="list-style-type: none"> - FRT voltage against time curves for Type B, C and D (below 110kV) with U_{ret} of 0.05pu and possibly below - minimum FFCL in line with or similar to the German VDE AR-N-4120 TAR Hochspannung - a rise time of <30ms and a settling time of <60ms - different characteristics for superior FFCL defined by NGET through remunerated FRT System Service
<i>Christopher Smith, National Grid Interconnector Holdings Ltd</i>	No comments offered
<i>Kamran Sharifabadi, Statoil</i>	No comments offered
<i>Isaac Gutierrez, Scottishpower Renewable ltd (UK)</i>	No
<i>Graeme Vincent, SP</i>	No

Response From	Q4: Do you wish to raise a WG Consultation Alternative Request for the Workgroup to consider?
<i>Energy Networks</i>	
<i>Daniel Fraile, Wind Europe</i>	No comment indicated
<i>Garth Graham, SSE</i>	No
<i>Andy Vaudin, EDF Energy</i>	No
<i>Alastair Frew, ScottishPower Generation Ltd</i>	No
<i>Senvion</i>	No
<i>Rob Wilson, NGET</i>	No
<i>Frank Martin, Siemens Gamesa Renewable Energy (SGRE)</i>	./.
<i>Athanasios Krontiris &</i>	No comment indicated

Response From	Q4: Do you wish to raise a WG Consultation Alternative Request for the Workgroup to consider?
<i>Grant McKay, ABB HVDC</i>	

Response From	Specific Q1: Removing More Stringent Requirements' concerns have been expressed by some Workgroup members that applying more stringent requirement on newly connecting parties (that fall within this scope of the EU Network Codes for generation, demand and HVDC systems) maybe incompatible with EU law. Do you have any views on this topic that could assist the Workgroup when they are considering the topic in due course?
<i>Paul Youngman, DRAX</i>	There is general agreement that the proposals introduce more stringent arrangements. The proposer provided information, consultants studies and explanations to outline the merit of theses 'more stringent' requirements. As a general rule minimum implementation of EU law into national codes is the preferred method of adoption. It is also clear that there is divergence between the proposer and others workgroup members regarding interpretation and compatibility of introducing more stringent arrangements, and the existing commitments made within the EU codes and regulation.
<i>Christian Merchan, GE Power</i>	No comment
<i>Tom Chevalier, AMO</i>	No comment
<i>PThomas, Nordex</i>	No
<i>Marko Grizelj, Siemens</i>	No comment indicated

Response From	Specific Q1: Removing More Stringent Requirements’ concerns have been expressed by some Workgroup members that applying more stringent requirement on newly connecting parties (that fall within this scope of the EU Network Codes for generation, demand and HVDC systems) maybe incompatible with EU law. Do you have any views on this topic that could assist the Workgroup when they are considering the topic in due course?
<i>Greg Middleton, AMPS</i>	AMPS support the view that the requirements must not be more stringent than the RfG, but the existing Grid Codes should also be observed where the RfG is silent.
<i>Alan Creighton, Northern Powergrid</i>	We are not convinced by the arguments put forwards, but have no specific comments on the legality of the original proposal. Legal guidance from BEIS and / or Ofgem would probably be beneficial.
<i>DONG</i>	<p>Although I am not fully aware of legal reasoning provided by alternative proposer, we believe any requirements that are existing in the current Grid Code and planned to taken forward with RfG should be thoroughly reviewed and CBA is conducted to verify this.</p> <p>From an Offshore Wind perspective, this is applicable for all the requirements planned to be taken forward for OTSDUW equipment. It is important to note that in an AC connected Offshore Wind Farm, OTSDUW equipment mainly consists of underground and submarine cables, transformers, harmonic filters, STATCOMs etc. Except STATCOMs, all the other equipment are passive equipment and hence their response will be a natural physical response and not a controlled response. In the context of FRT requirement, we are not entirely sure on whether or not this requirement will be applicable for all the transmission system such as TO equipment of overhead lines, transformers, underground cables built by NGET, SP, SSE etc. In addition, it is important to note that the mandate as per RfG (Requirements for Generators) and HVDC covers the requirements for generators and HVDC and not OTSDUW equipment. This is also not covered in Workgroup Terms of Reference.</p> <p>As already mentioned in the workgroup report by the Proposer, due to the way RfG is drafted, Offshore Wind Industry is losing options of where compliance for FRT can be proven, and more stringent requirements are applied than what they are now. In addition, if all the OTSDUW requirements are carried, it will be onerous for offshore wind developers in terms of compliance.</p>

Response From	Specific Q1: Removing More Stringent Requirements' concerns have been expressed by some Workgroup members that applying more stringent requirement on newly connecting parties (that fall within this scope of the EU Network Codes for generation, demand and HVDC systems) maybe incompatible with EU law. Do you have any views on this topic that could assist the Workgroup when they are considering the topic in due course?
<i>Konstantinos Pierros, ENERCON GmbH</i>	More stringent" needs to be clearly defined. It seems to stem from legal interpretation of terminology. It seems unreasonable to expect that technical requirements will remain unchanged forever, regardless of the changing technical requirement.
<i>Christopher Smith, National Grid Interconnector Holdings Ltd</i>	No comments offered
<i>Kamran Sharifabadi, Statoil</i>	No comments offered
<i>Isaac Gutierrez, Scottishpower Renewable ltd (UK)</i>	Although currently most SPR power generating plant is able to meet the current UK Grid Code requirements, there is certainly opposition from SPR to National Grid applying more stringent requirements than those currently in RfG to new generators as definitively there will be an impact in CAPEX and OPEX. SPR believes that there is incompatibility with European Law as some of the requirements that National Grid is trying to implement are more onerous than those set out in RfG
<i>Graeme Vincent, SP Energy Networks</i>	Whilst we have some sympathy with the views being expressed this is not the interpretation that we understand nor the expectation of those involved during the development and drafting process of the network codes at the European level.

Response From	Specific Q1: Removing More Stringent Requirements’ concerns have been expressed by some Workgroup members that applying more stringent requirement on newly connecting parties (that fall within this scope of the EU Network Codes for generation, demand and HVDC systems) maybe incompatible with EU law. Do you have any views on this topic that could assist the Workgroup when they are considering the topic in due course?
<i>Daniel Fraile, Wind Europe</i>	No comment indicated
<i>Garth Graham, SSE</i>	<p>We fully support the concerns set out on pages 55-62 of the Workgroup Consultation as regards the need to remove (from the proposed Original) the more stringent requirements when implementing the EU Network Codes into the GB national network codes (namely the Grid Code and Distribution Code).</p> <p>We note that to date the deliberations within the Workgroup have tended to be focused by those who hold a contrary view on the ‘policy’ position; namely that those who hold this contrary view (which is primarily network operators) seek to retain the existing status quo obligations set out in both the Grid Code and Distribution Code on new connecting parties who in the future will be encompassed within the scope of the EU Network Codes.</p> <p>However, this is at odds with both the position of BEIS and Ofgem who have both acknowledges that it may be necessary to remove or amend existing GB national network code obligations that conflict with the EU Network Code obligations.</p> <p>This position was most recently reaffirmed by Ofgem in their 30th August 2017 letter (in respect of GC0103):</p> <p><i>“To ensure the full and timely implementation of the EU Connection Codes, we are therefore encouraging the Grid Code Panel to focus on:</i></p> <p><i>a) bringing forward any new Grid Code provisions made necessary by virtue of the EU Connection Codes; <u>and</u></i> <i>b) <u>removing or amending any existing Grid Code provisions which may conflict with the EU Connection Codes.</u>”</i></p>

Response From	Specific Q1: Removing More Stringent Requirements’ concerns have been expressed by some Workgroup members that applying more stringent requirement on newly connecting parties (that fall within this scope of the EU Network Codes for generation, demand and HVDC systems) maybe incompatible with EU law. Do you have any views on this topic that could assist the Workgroup when they are considering the topic in due course?
	<p>[emphasis added]</p> <p>Whilst we can appreciate that some Workgroup members may hold a contrary view from a ‘policy’ perspective, we note that, in our view, this is a matter of ‘law’ (not ‘policy’) and that no counter legal arguments have been forthcoming.</p> <p>Furthermore, even if such arguments were to come forward we would strongly argue that the Workgroup should, nevertheless, put forward this potential alternative as a formal Alternative so that Ofgem (who are the correct body to consider this matter) are able to determine on this matter of law by choosing between the two (the Original and this potential alternative).</p> <p>Failure to put forward this as a formal Alternative runs the serious risk that Ofgem will either:</p> <ul style="list-style-type: none"> (a) be unable to determine on GC0100 (and have to send it back); or (b) (depending on the CMP261 deliberations around the legality or otherwise of post send back changes to WACMs) reject the Original proposal, and any other Alternative(s) related to it, as it does not address the ‘more stringent’ matter which is in contravention of EU law. <p>Either of these necessary additional aspects will, if applicable, delay the implementation of the GC0100 solution which is not in the wider interest of all concerned.</p> <p>Notwithstanding any Ofgem decision on GC0100 it should also be noted that all TSOs, DSO and relevant network operators are bound to comply with the applicable EU law even if this is in contravention of any national law provisions (such as, but not limited to, their respective licences or the national network codes including, but not</p>

Response From	Specific Q1: Removing More Stringent Requirements’ concerns have been expressed by some Workgroup members that applying more stringent requirement on newly connecting parties (that fall within this scope of the EU Network Codes for generation, demand and HVDC systems) maybe incompatible with EU law. Do you have any views on this topic that could assist the Workgroup when they are considering the topic in due course?
	limited to, the Grid Code or Distribution Code). They cannot, for example, rely on any national provisions that place them in contravention of their EU law duties. Newly connecting parties which fall within the scope of the EU Network Codes could, in those circumstances where EU law has been contravened, seek full legal redress against the contravening party or parties in the national and / or EU courts.
<i>Andy Vaudin, EDF Energy</i>	<p>We are not of the view that the Original proposal would apply more stringent requirements than the EU Network Codes allow.</p> <p>We are not clear what form the Grid Code would take under any “removing more stringent requirements” alternative proposal. A concern would be that many important requirements within the existing Grid Code would not be applicable to plant covered by the EU Codes. As an example, it could mean that the recent GC0077 sub-synchronous resonance modification was not applicable to new plant. It is our view that by removing important elements of the Grid Code, the “removing more stringent requirements” alternative proposal would work against Grid Code objectives (i) and (iii). We would expect National Grid to provide clear guidance to the workgroup as to any legal interpretations behind these “more stringent requirements” concerns.</p>
<i>Alastair Frew, ScottishPower Generation Ltd</i>	<p>Looking at the third package it consists of a number of directives and regulations, with the two key pieces of legislation relating to requirements on electricity providers being “Directive 2009/72/EC common rules for the internal market in electricity ...” and “Regulation 714/2009 on conditions for access to the network for cross-border exchanges in electricity ...”.</p> <p>These two pieces of legislation seem to split requirements into two with 2009/72/EC dealing with the safety and minimum technical requirements, whilst 714/2009 deals with setting cross-border rules on trade, energy flows</p>

Response From	Specific Q1: Removing More Stringent Requirements’ concerns have been expressed by some Workgroup members that applying more stringent requirement on newly connecting parties (that fall within this scope of the EU Network Codes for generation, demand and HVDC systems) maybe incompatible with EU law. Do you have any views on this topic that could assist the Workgroup when they are considering the topic in due course?
	<p>and charging. In terms of 2009/72/EC this was introduced in 2012 with GB responding indicating its minimum technical requirements were as follows “Article 5: Electricity Safety, Quality and Continuity Regulations 2002, Electricity Transmission Licence, Electricity Distribution Licence, Electricity Interconnector Licence attached. Technical codes including the Grid and Distribution Codes may be found at http://www.ofgem.gov.uk/Licensing/ElecCodes/Pages/ElecCode.aspx “</p> <p>Currently this consultation is dealing with the “Regulation 2016/631 Requirements for grid connection of generators” which has been produced as a deliverable from 714/2009. Given the scope of 714/2009 it is surprising that such a technically detailed version of 2016/631(RFG) has been produced on the bases of a three word title in Article 8 paragraph 6 (b) “network connection rules;”, however we are where we are. Specifically dealing with no more stringent requirements, this seems to be based on a premise that any technical requirements not included in the connection codes 2016/631(RFG), 2016/1388(DCC) or 2016/1447(HVDC) are more stringent, and hence is not permissible. As previously stated minimum technical requirements are detailed within 2009/72/EC and not 714/2009 which defines the criteria for 2016/631(RFG). This is further emphasized in the opening whereas section of 2016/431(RFG) where item (2) second sentence states “..... In addition Article 5 of Directive 2009/72/EC of 3 of 10 the European Parliament and of the Council (2) requires that Member States or, where Member States have so provided, regulatory authorities ensure, inter alia, that objective technical rules are developed which establish minimum technical design and operational requirements for the connection to the system. ...” . This indicates that 2016/631(RFG) is an addition to any rules set by 2009/72/EC. Moreover it is clear that it was not the indention for the new network codes to remove existing national codes as 714/2009 which defines the requirements for drafting the network codes has in Whereas (7) third sentence “The network codes prepared by the ENTSO for Electricity are not intended to replace the necessary national network codes for non-cross-border issues.” Given the above there does not seem to be any justification for the premise that technical requirements not included in the network codes are more severe and should not be allowed. In summary in GB the current accepted minimum technical</p>

Response From	Specific Q1: Removing More Stringent Requirements’ concerns have been expressed by some Workgroup members that applying more stringent requirement on newly connecting parties (that fall within this scope of the EU Network Codes for generation, demand and HVDC systems) maybe incompatible with EU law. Do you have any views on this topic that could assist the Workgroup when they are considering the topic in due course?
	standards appear to be the Electricity Safety, Quality and Continuity Regulations 2002, Electricity Transmission Licence, Electricity Distribution Licence, Electricity Interconnector Licence, the Grid and Distribution Codes with additional requirements of the network codes being added as they are enacted. The only issue which may exist is which version of the various documents is currently the approved version. Following the initial submission in 2012 there does not appear to be any clear evidence that the modification process in “Directive 98/34/EC laying down a procedure for the provision of information in the field of technical standards and regulations” has been followed.
<i>Senvion</i>	The EU Network Codes are in most areas flexibly worded to allow individual members to derive national requirements. Of highest importance is the focus on interconnection requirements rather than new more stringent requirements for individual generators. Current grid code review and other existing panels should be used to discuss and derive the requirement based on cost benefit analysis. NGET as network operator and member of ENTSO-e has significant input into the development of the EU Network Codes and should adhere to GB review and acceptance processes. EU Network Codes in its overall framework are not intended to interfere significantly with national matters and to drive higher requirements.
<i>Rob Wilson, NGET</i>	<p>This argument is not valid, is in contradiction to advice from Ofgem, and its persistent reiteration has wasted a great deal of time that could have been more profitably employed in completing implementation and giving developers and manufacturers greater leadtime for compliance.</p> <p>The European Connection Network Codes were intended to consider cross-border issues and to seek harmonisation. However, they were never intended to be a complete solution or to overwrite all national legislation.</p>

Response From	Specific Q1: Removing More Stringent Requirements’ concerns have been expressed by some Workgroup members that applying more stringent requirement on newly connecting parties (that fall within this scope of the EU Network Codes for generation, demand and HVDC systems) maybe incompatible with EU law. Do you have any views on this topic that could assist the Workgroup when they are considering the topic in due course?
	<p>Ofgem has advised industry in their 2014 decision³ on how to implement the European Network Codes of the need to adopt a minimum solution; this was explained to mean only bringing forward any new GB Code provisions required by virtue of the EU Connection Codes, and removing any conflicts with existing GB Code provisions. This advice was repeated in Ofgem’s decision letter on urgency⁴ for modification GC0103. In this letter, and in various other correspondence, Ofgem have also urged stakeholders to bring forward specific examples of where existing code provisions impact cross-border trade such that they can be dealt with through the existing code modification processes. No examples have been forthcoming.</p> <p>It is also worthy of note that article 7.3 of RfG (EU 2016/631; HVDC and DCC codes similar) states that: <i>‘When applying this Regulation, Member States, competent entities and system operators shall: (d) respect the responsibility assigned to the relevant TSO in order to ensure system security, including as required by national legislation.’</i></p> <p>To remove all national code provisions outside the scope of the European Codes by the ‘more stringent’ argument, unless it can be proven that cross-border trade is not impacted, would render the GB electricity system inoperable in contravention of this clause and would prevent any parties from connecting new equipment to the system until a full clause-by-clause review could be completed against both EU Connection Code requirements and the further legislation of other member states.</p> <p>None of the other 27 EU member states implementing the European Connection Codes are considering the ‘more</p>

³ <https://www.ofgem.gov.uk/ofgem-publications/92240/openletteronencimplementationandconsultationonnemodesignation-pdf>

⁴ <https://www.ofgem.gov.uk/publications-and-updates/gc0103-introduction-harmonised-applicable-electrical-standards-gb-ensure-compliance-eu-connection-codes-decision-urgency>

Response From	Specific Q1: Removing More Stringent Requirements’ concerns have been expressed by some Workgroup members that applying more stringent requirement on newly connecting parties (that fall within this scope of the EU Network Codes for generation, demand and HVDC systems) maybe incompatible with EU law. Do you have any views on this topic that could assist the Workgroup when they are considering the topic in due course?
	<p>stringent’ argument as valid. All are adopting a similar minimum approach to GB in implementation. Legal advice from ENTSO-E on this subject is that member states are allowed to introduce or maintain more detailed and in certain cases more stringent requirements.</p> <p>This is as follows:</p> <p><i>By virtue of Articles 2 and 4 of the Treaty on the Functioning of the European Union (TFEU), the EU does not have an exclusive but a shared competence on energy matters. According to Article 194 TFEU, Union policy on energy shall aim to ensure notably the functioning of the energy market and promote the interconnection of energy networks. An EU Member State could therefore adopt additional, national legislation to complement the CNCs. Nonetheless, this could only be to complement and render EU law more efficient and, by application of the principles of EU law direct effect and supremacy, could not be in contradiction to EU law, including the CNCs provisions.</i></p> <p><i>Regulation (EC) No 714/2009 of the European Parliament and of the Council of 13 July 2009 on conditions for access to the network for cross-border exchanges in electricity and repealing Regulation (EC) No 1228/2003 (“Regulation 714/2009”) allows for the adoption of additional provisions at national level under certain conditions:</i></p> <ul style="list-style-type: none"> - <i>Article 8(7) Regulation 714/2009 states that “the network codes shall be developed for cross-border network issues and market integration issues and shall be without prejudice to the Member States’ right to establish national network codes which do not affect cross-border trade”. The notion of “cross-border trade” is however not defined by Regulation 714/2009. The notion appears however to be interpreted in a broad fashion by the Commission in order not to limit the scope and applicability of the network codes.</i> - <i>Article 21 of Regulation 714/2009 allows Member States to maintain or introduce measures that contain more detailed provisions than those set in Regulation 714/2009 also related to cross-border trade issues;</i>

Response From	Specific Q1: Removing More Stringent Requirements’ concerns have been expressed by some Workgroup members that applying more stringent requirement on newly connecting parties (that fall within this scope of the EU Network Codes for generation, demand and HVDC systems) maybe incompatible with EU law. Do you have any views on this topic that could assist the Workgroup when they are considering the topic in due course?
	<p>- <i>The CNCs, in their whereas parts (Whereas (30) RfG, (22) DCC and (18) HVDC), clarifies that the CNCs form an integral part of Regulation 714/2009, so that Article 21 of this Regulation applies to them. In application of these considerations, a Member State can adopt at national level:</i></p> <ul style="list-style-type: none"> • <i>network codes which do not affect cross-border trade and do not contradict EU law. For instance, Article 3(2) RfG enumerates several cases in which the RfG does not apply at national level: in this case Member States are still competent to define requirements applicable at national level. In addition, the RfG does not set rules to determine the voltage level to connection point: it lies within the competence of Member States (see Whereas (10) RfG);</i> • <i>more detailed provisions also related to cross-border trade issues than those established in the CNCs provided that, in accordance with the principle of subsidiarity, it is the most relevant level of intervention and they do not contradict the CNCs requirements in order to complement the EU Regulations.</i> <p><i>A possible criterion to evaluate the feasibility of national measures in the framework of energy matters could be the TFEU rules. According to the TFEU, it is possible to introduce measures constituting a barrier to trade if these measures are justified on limited grounds such as these foreseen in Articles 36 and 114 of TFEU.</i></p> <p><i>Applied to the CNCs, the following cases could be considered:</i></p> <ul style="list-style-type: none"> - <i>Extension of CNCs requirements to an additional category of grid user</i> <p><i>A national measure could apply to type B power generating modules (PGMs) requirements that the RfG only applies to type C PGMs. The RfG harmonises the application of the said requirements to PGMs. The national measure could therefore only be valid provided:</i></p> <ul style="list-style-type: none"> - <i>it is demonstrated it provides for a wide range of automated dynamic response with greater resilience to operational events defined by whereas (12) RfG;</i> - <i>it is allowed by the requirement's aims defined in the CNC's whereas and the specific CNC's requirements;</i>

Response From	Specific Q1: Removing More Stringent Requirements’ concerns have been expressed by some Workgroup members that applying more stringent requirement on newly connecting parties (that fall within this scope of the EU Network Codes for generation, demand and HVDC systems) maybe incompatible with EU law. Do you have any views on this topic that could assist the Workgroup when they are considering the topic in due course?
	<p><i>and</i></p> <ul style="list-style-type: none"> - <i>it is demonstrated it does not affect cross-border trade, unless it is demonstrated the measure at national level merely details requirements of the CNCs.</i> <p><i>For instance :</i></p> <ul style="list-style-type: none"> - <i>Art. 4 RfG implies that type A and B existing power generating modules are not subject to RfG requirements even in case of substantial modifications. However, Member States can decide to extend the scope of application to such generating modules in order to improve CNCs’ application provided the above conditions are met;</i> - <i>According to Article 18 of RfG, the U-Q/max profile applies only to type C and D synchronous power generating modules. A national measure can extend its scope of application to type B if compatible with the type B requirements’ aims defined in whereas (12) RfG, the requirements’ aims (see whereas (24) RfG) and type B requirements relating to voltage stability according to Article 17(2)(a).</i> - <i>Introduction of requirements not covered by the CNCs</i> <p><i>The possibility to introduce requirements at national level is feasible in two different cases:</i></p> <ul style="list-style-type: none"> - <i>not - cross border issues (most cases). The fact that a requirement is not detailed in a CNC could indicate that it is not affecting cross-border trade but this needs to be assessed on a case-by-case basis ;</i> - <i>in other cases, to complement EU regulations, provided that they do not contradict EU law.</i> <p><i>In case the measure would constitute a barrier to trade, it could still be valid provided it is justified by either Art. 30 TFEU or is considered as reasonable according to EU case law.</i></p> <ul style="list-style-type: none"> - <i>Wider national ranges of parameters than defined by CNCs</i> <p><i>Several CNCs requirements set ranges within which parameters need to be defined at the national level. It could be considered to define nationally parameters outside of the set range.</i></p> <p><i>For some requirements, the CNCs expressly authorise to define national parameters beyond the set ranges (e.g. frequency withstand capability for PGM, under Art. 13(2)(b) RfG). National measures doing so are justified as long as they respect the conditions set in the CNCs relevant provisions.</i></p>

Response From	Specific Q1: Removing More Stringent Requirements’ concerns have been expressed by some Workgroup members that applying more stringent requirement on newly connecting parties (that fall within this scope of the EU Network Codes for generation, demand and HVDC systems) maybe incompatible with EU law. Do you have any views on this topic that could assist the Workgroup when they are considering the topic in due course?
	<p><i>When the national measures do not respect these conditions or the CNCs do not expressly authorise to define national parameters beyond the set ranges, any deviation would go against the CNCs and is therefore not admissible, unless it is demonstrated the measure does not constitute a trade restriction.</i></p> <p>In summary, and in keeping with Ofgem’s guidance, the proposals for GB implementation of the European Connection Codes are a minimum solution. Stakeholders are not precluded from identifying areas of further work where ‘more stringent’ requirements could be a restriction on cross-border trade but these do not have to be addressed now and are not part of the minimum solution for compliance.</p>
<i>Frank Martin, Siemens Gamesa Renewable Energy (SGRE)</i>	No response indicated.
<i>Athanasios Krontiris & Grant McKay, ABB HVDC</i>	Requirements in EU network codes are either exhaustive (values or value ranges set within the codes) or non-exhaustive (open for the relevant system operators to further specify). In the former case, more stringent requirements in national implementation than in the original EU network codes is not allowed, since this would undermine the general aim of EU-wide network codes, namely product and system harmonization. In addition to the distinction above, requirements in EU network codes are either mandatory (must be implemented on national level) or non-mandatory (can, but don’t have to be implemented on national level). It is not clear if additional requirements further than the non-mandatory requirements stated in the EU network codes can be added in the national implementation. Such further requirements, which may be specific to a particular system such as the UK

Response From	Specific Q1: Removing More Stringent Requirements’ concerns have been expressed by some Workgroup members that applying more stringent requirement on newly connecting parties (that fall within this scope of the EU Network Codes for generation, demand and HVDC systems) maybe incompatible with EU law. Do you have any views on this topic that could assist the Workgroup when they are considering the topic in due course?
	power system, appear in our opinion to be compatible with EU regulations, as long as they are technically justified and do not constitute unnecessary barriers to an integrated electricity market.

Response From	Specific Q2: Are you comfortable with using the EU definition of Maximum Capacity instead of the GB definition of “Registered Capacity”?
<i>Paul Youngman, DRAX</i>	Yes
<i>Christian Merchan, GE Power</i>	No comment
<i>Tom Chevalier, AMO</i>	No comment
<i>PThomas, Nordex</i>	Yes
<i>Marko Grizelj, Siemens</i>	No comment indicated
<i>Greg Middleton, AMPS</i>	No comment

Response From	Specific Q2: Are you comfortable with using the EU definition of Maximum Capacity instead of the GB definition of “Registered Capacity”?
<i>Alan Creighton, Northern Powergrid</i>	It is not really clear from the consultation documentation what the definition of Maximum Capacity is and how it differs from that of Registered Capacity. We note that the Distribution documents relate to Registered Capacity; it seems reasonable to continue to use this existing terminology where possible to help make the changes easier for customers to understand.
<i>DONG</i>	At the high level, both these definitions seem interchangeable. However, further investigation may be needed while other EU Network Codes are developing.
<i>Konstantinos Pierros, ENERCON GmbH</i>	We are happy with the proposal.
<i>Christopher Smith, National Grid Interconnector Holdings Ltd</i>	No comments offered
<i>Kamran Sharifabadi, Statoil</i>	Yes
<i>Isaac Gutierrez, Scottishpower Renewable ltd (UK)</i>	Yes, as long as there is consistency within the UK Grid Code using this definition
<i>Graeme</i>	As long as the definition is made clear and unambiguous and is used in a consistent manner by all parties and all

Response From	Specific Q2: Are you comfortable with using the EU definition of Maximum Capacity instead of the GB definition of “Registered Capacity”?
<i>Vincent, SP Energy Networks</i>	Codes then the use of maximum capacity as a definition should be okay. However, confusion may arise if the terms are used interchangeably and
<i>Daniel Fraile, Wind Europe</i>	No comment indicated
<i>Garth Graham, SSE</i>	<p>As we set out elsewhere in this consultation response, we believe that the EU Network Codes need to be fully implemented into the GB national network codes – which is not what the GC0100 Original does.</p> <p>In this respect we believe that all the definitions within the EU Network Codes (and not just limited to the ‘Maximum Capacity’ definition alone) should be used instead of the GB definitions where both exist.</p>
<i>Andy Vaudin, EDF Energy</i>	We have no objection to using Maximum Capacity, but do not believe that the implications of using this instead of Registered Capacity, if any, have been detailed in the workgroup report.
<i>Alastair Frew, ScottishPower Generation Ltd</i>	Yes
<i>Senvion</i>	No. Registered Capacity should stay. There could be some issues where the number of turbines exceed the available export capacity (sometimes known as overpowering), this is reasonably common with maximum production restricted to a level below the nameplate rating. In this case a PPM could unfairly end up in a higher band because of the nameplate rating of the equipment being used to determine the Maximum Capacity. It is noted that overpowering when considered with respect to dynamic operation, will be beneficial for the overall performance of the PPM and expected to be beneficial for the grid as well. If Maximum Capacity is legally binding for implementation, then Registered Capacity needs to be included additionally and relationship to Maximum Capacity shown.

Response From	Specific Q2: Are you comfortable with using the EU definition of Maximum Capacity instead of the GB definition of “Registered Capacity”?
<i>Rob Wilson, NGET</i>	Yes. As long as the final report to the Authority makes clear the development and application of this definition.
<i>Frank Martin, Siemens Gamesa Renewable Energy (SGRE)</i>	The term “Registered Capacity” is well known in the UK. By introducing a new definition as per EU definition it is important to adopt them consistently among the grid code (definitions, adopt these definitions in the specific parts where grid code requirements are specified).
<i>Athanasios Krontiris & Grant McKay, ABB HVDC</i>	Either term may be used. We recommend a clear definition in the UK grid code, potentially with a note if another term as the one in the original EU network code is used.

Response From	Specific Q3: What are your views on options 1, 2 and 3 as set out in paragraph 4.4 for Fast Fault Current Injection and which option (if any) would you prefer?
<i>Paul Youngman, DRAX</i>	The proposer highlights option 1 as their preferred option, highlighting that options 2 and 3 would need further development through an expert working group. We support the proposer on the basis that this would not preclude future development of options 2 and 3 by industry parties.
<i>Christian Merchan, GE</i>	The capacity limiting factor in a power electronic converter, in particular for the large type of converter adopted in HVDC, is the current carrying capability of the available power electronic devices. The operating DC voltage with

Response From	Specific Q3: What are your views on options 1, 2 and 3 as set out in paragraph 4.4 for Fast Fault Current Injection and which option (if any) would you prefer?
<i>Power</i>	<p>respect to ground is also an important determining factor as this influences the cost of the transmission circuit. These two factors then combine to provide the economic power transmission capacity of the transmission link. In general, the larger the indivisible “block” of power transmission (i.e., the larger the MegaWatt rating of the converter) the lower the cost of the converter per MegaWatt). This was true for the older technology of Line-Commutated Converter and remains so for Voltage Source converters. Reference is made to CIGRE Brochure 186, “Economic Assessment of HVDC Links”, Table 4.1.</p> <p>There is a fundamental difference between the operation of a synchronous machine and a power electronic based source under dynamic conditions. The machine, due to its construction will have a significant current carrying capability under dynamic (fault) conditions. However, a power electronic based source has a limited current capability due to the nature of power electronic devices. In addition, it must be highlighted that these power electronic devices have negligible thermal overload capability, that is, they are not able to operate beyond their rated current. Consequently, the fastest control associated with a converter is that which determines the instantaneous current flowing through the power electronics, and hence, being delivered to the AC system. Any demand of the converter to deliver current to the AC system (either real or reactive) must be regulated by the converter controller in order to protect the power electronics from catastrophic failure resulting in the loss of the plant.</p> <p>The concept of a VSM relies on the premise that the converter controller attempts to maintain an AC voltage irrespective of the consequential current, fundamentally, the current regulation described in the previous paragraph is omitted in the controller, inherently making the current response of the converter faster in the event of a dip in the AC voltage. Which, as highlighted above, risks the catastrophic loss of the converter.</p> <p>A solution, to permit the adoption of a VSM controller, would be to rate the converter such that the physical inductance within the converter limits the maximum current to a value within the capability of the power electronics. However, today, typically, the total linear inductance within the converter will be equivalent to approximately 0.3pu, making the inherent fault current 3.33pu. Hence, an unintentional consequence of the adoption of VSM would be</p>

Response From	Specific Q3: What are your views on options 1, 2 and 3 as set out in paragraph 4.4 for Fast Fault Current Injection and which option (if any) would you prefer?
	<p>to reduce the capacity of all future HVDC links by approximately one-third; significantly impacting on the return-on-investment of the infrastructure. It should be noted that, whilst it would be possible to increase the linear reactance of the converter, to some extent, this has a direct impact on both the maximum transmission capability of the converter and the losses associated with the AC-DC energy conversion, so, again, having a significant impact on the return-on-investment of the infrastructure.</p> <p>The operation of the converter as a VSM for remote faults, that is, those not demanding a current above the current rating of the converter is possible but the step of current regulation (to ensure that the current rating is not breached) must be maintained and this will impact on the speed of current injection.</p> <p>A pro-active approach, on the part of National Grid would be to engage the suppliers of HVDC equipment to establish what is practicable in terms of achieving a Fast Fault Current Injection response and to better define the current response envelope, noting that even a synchronous machines response is limited by its inherent reactance.</p> <p>Considering Option 2 it is understood that there is no requirement for active positive phase sequence current flow and hence all of the current carrying capability of the converter is available for reactive power. Under these circumstances it may be possible to achieve 1.25pu reactive current but this would affect the voltage rating of the converter, requiring a steady-state margin in the converter design to cope with this contingency. This margin would translate into a higher steady-state converter current, resulting in reduced maximum capacity and higher converter losses, (possibly more than a 50% increase). It would also increase the size of the converter.</p> <p>Clarification is sort with respect to the difference between Figure 4.4(a) and Figure 4.4(b), in particular, what is the associated AC voltage? The above comments are based on the definition of fault recovery being that the AC voltage has achieved a positive phase sequence rms voltage of 0.9pu or high. It would be beneficial to indicate the corresponding AC voltage characteristic. Also, Figure 4.4(a) should clarify the time of 'Fault Clearance'".</p> <p>Option 3 limits the maximum reactive current to 1.0pu. This would operate within the capability of today's VSC</p>

Response From	Specific Q3: What are your views on options 1, 2 and 3 as set out in paragraph 4.4 for Fast Fault Current Injection and which option (if any) would you prefer?
	converter design without increasing capital cost or losses and would also be consistent with the solution being sourced by the global market.
<i>Tom Chevalier, AMO</i>	No comment
<i>PThomas, Nordex</i>	Option 1 hasn't been considered by Nordex. Options 2&3
<i>Marko Grizelj, Siemens</i>	<p>Option 1 bears a heavy impact on the current designs of the converter system, both in terms of hardware and software. Successful implementation of Option 1 would require a coordinated and focused effort from the industry and the TSO to ensure that an economical and effective solution is developed.</p> <p>Option 2 simply bears an impact on the hardware costs. Supplying current over 1.0pu rated current may in some specific cases be possible to a certain degree (taking into consideration various project parameters). However, specifying a blanket 1.25 pu rated current supply will ensure that costs definitely increase and would further limit competitiveness of HVDC technology.</p> <p>Option 3 is the preferred solution given the current status of the technology and market. As mentioned previously, Siemens's understands that Option 3 on its own will not solve the predicted future issues with the network. Alternative options should be investigated in a dedicated and focused working group with the appropriate representation from the industry.</p>
<i>Greg Middleton, AMPS</i>	No comment

Response From	Specific Q3: What are your views on options 1, 2 and 3 as set out in paragraph 4.4 for Fast Fault Current Injection and which option (if any) would you prefer?
Alan Creighton, Northern Powergrid	Option 2 & 3 seem more realistic at the moment. If there is a need to implement option 1, then this would be best properly considered by a separate GCode WG. We understand the concerns about codifying a requirement to implement what is currently a non-proven solution.
DONG	<p>We believe that the issue of <i>fault current injection</i> has not been sufficiently assessed in order to rush for implementing the changes for the ongoing revision of the grid codes.</p> <p>The proposed reactive current injection requirements would exceed today's industry standards, leading to additional costs related to increasing the current hardware capabilities, R&D, certification, testing and validation costs. It's worth to mention that specific UK only requirements should not force manufacturers to change their hardware for the rest of the markets as well. Therefore the system operator should consider to incentivise the development of such capabilities under an ancillary services market. We believe that imposing requirements exceeding the industry standards and current technology capabilities must be based on a comprehensive Cost Benefit Analysis.</p> <p>It is critical to have a common understanding of system needs for scenarios today and in the future. European discussions on power system needs with high renewable penetration levels of variable renewable energy sources and power electronics levels have been focusing on aspects with a time horizon beyond May 2018 to prepare necessary frameworks allowing national TSOs to specify minimum technical requirements. This is currently addressed in the ENTSO-E expert group on fast fault current.</p> <p>To avoid unnecessary system costs, the specification of future system requirements must be based on transparent system studies and firmly established system design criteria. It has already been requested in the workgroup meetings that the simulation models used for VSM, Option 2 and Option 3 to be shared with the workgroup so that any realistic behaviour from Power Park Units can be incorporated. This will result in a common rationale and technical background for new requirements. The result will also be that potential later adjustments will have a much more robust starting point. In general, a more transparent common rationale will also result in a clearer signal to the industry in order to understand what longer-term developments are needed to support future system security while efficiently integrating renewables.</p> <p>Scientific system studies modelling the behaviour of network and connected equipment are essential to define</p>

Response From	Specific Q3: What are your views on options 1, 2 and 3 as set out in paragraph 4.4 for Fast Fault Current Injection and which option (if any) would you prefer?
	<p>proper connection & operation requirements. However, system studies need to be complemented by simulations and real tests to fully understand the potential behaviour of different technologies under all situations (normal, during and after faults). Not doing so risks an under/over estimation of technology performance during times of system stress.</p> <p>In addition, cost of this additional development leads to higher costs of the equipment which may be higher than additional costs for system operation without this facility and hence will be cascaded to higher energy prices for end consumers.</p> <p>We believe Option 3 is the best choice in terms of national implementation of RfG and as NGET recommends an expert group should be formed to look into details of this requirement going forward. In addition, we would like to highlight the FFCL in case of offshore wind farms are provided by each wind turbine based on the voltage seen at its individual terminals. Due to the transient nature of this requirement needing a quick response, and due to the time delay between instructions from park controller and wind turbines, we believe the requirements should be applied with an option to meet at Grid Entry Point or at each WTG terminals.</p>
<p><i>Konstantinos Pierros, ENERCON GmbH</i></p>	<p>At different points throughout, the Workgroup Consultation appears to be actively promoting the alleged capabilities of Virtual Synchronous Machines (Option 1 – VSMs). We do not understand how NGET can be proposing an immature technology, since, to our knowledge, equipment carrying such capability (similar really, because there is not consensus about what is meant with the term VSM) have been only tested in controlled conditions, at very small prototype scale, and their performance has not been observed in a real grid. We would also welcome NGET to include in the Workgroup Report references to strict peer-reviewed publications about VSM.</p> <p>We believe that NGET should focus on breaking down the necessary characteristics and developing a framework for defining future requirements. Minimum technical specification must be technology neutral. It must not be translated into specific and/or preferred technical solutions like e.g. VSMs. The development of specific technical solutions must be left open for the industry. NGET cannot be in the position to prescribe how a certain performance</p>

Response From	Specific Q3: What are your views on options 1, 2 and 3 as set out in paragraph 4.4 for Fast Fault Current Injection and which option (if any) would you prefer?
	<p>is to be implemented.</p> <p>The alternatives to Options 1 are either currently not easily feasible (Option 2, if we consider that the base of the “pu” is the current corresponding to the rated MVA, we also note that the RfG does not require setting reactive current value beyond 1pu) or outdated (Option 3, the German VDE AR-N-4120 TAR Hochspannung currently requires a rise time <30ms and a settling time of <60ms, making it much faster than Option 3).</p> <p>As it currently stands, we do not believe that we can support any of the three Options, but if we had to, it would be Option 3.</p>
<i>Christopher Smith, National Grid Interconnector Holdings Ltd</i>	<p>As explained below we believe that options 1 and 2 would have a significant impact on the technology provided and would significantly increase CAPEX cost threatening viability. Therefore National Grid Interconnectors Holdings Ltd would strongly support option 3. We would also support the setting up of a separate workgroup to consider a wider range of technical and market based solutions to the technical challenge that is being investigated.</p>
<i>Kamran Sharifabadi, Statoil</i>	<p>Option 3</p>
<i>Isaac Gutierrez, Scottishpower Renewable ltd (UK)</i>	<p>Option 1 is not viable in the short term neither in the long term as VSM is a new technology concept that is both undeveloped and untested hence it will take a considerable amount of time for the VSM technology to reach maturity and become commercially viable. In continental Europe none of EU members adhering to the RfG is implementing in their grid codes requirements for VSM. In addition, National Grid is not providing adequate substantiation for the need of VSM.</p> <p>Option 2 is not viable either from the point of view of CAPEX and OPEX as requiring reactive current priority up to a maximum of 1.25 pu for voltage depression below 0.65 pu will certainly increase the cost of the wind turbines due to the fact that bigger frequency converters will be required to meet this requirement. Not only manufacturers will need to look into the size of converters but also all other electrical and mechanical components within the wind turbine that interact to provide FFCI. In addition, it is not clear what amount of active current is required for voltage</p>

Response From	Specific Q3: What are your views on options 1, 2 and 3 as set out in paragraph 4.4 for Fast Fault Current Injection and which option (if any) would you prefer?
	<p>depression below 0.65 pu., The modification only states the amount of reactive current required and nothing is said in relation to active current. What shall be done with the active current below 0.65 pu voltage depressions, are we allowed to inject zero active current?. Additionally in regards to reactive current is the expectation to inject this amount of current for balance and unbalanced faults?. Is National Grid expecting negative sequence current injection? This might not be possible as for example a Y-delta transformer installed in the nacelle of a wind turbine will tend to block the negative sequence current. Also, it is not clear what should be the active current contribution for voltage depression above 0.65 pu against reactive current contribution i.e. proportion of active current and reactive current.</p> <p>Option 3 is to certain extent acceptable and this option is preferred by SPR as this will have no impact in CAPEX and OPEX but the requirement will need to be clarified in relation to the amount of active current that is required for voltage depression below 0.65 pu. The modification only states the amount of reactive current required and nothing is said in relation to active current. What shall be done with the active current below 0.65 pu voltage depressions, are we allowed to inject zero active current?. Additionally in regards to reactive current is the expectation to inject this amount of current for balance and unbalanced faults?. Is National Grid expecting negative sequence current injection? This might not be possible as for example a Y-delta transformer installed in the nacelle of a wind turbine will tend to block the negative sequence current. Also, clarifications will be required for active current contribution for voltage depression above 0.65 pu against reactive current contribution i.e. proportion of active current and reactive current.</p>
<p><i>Graeme Vincent, SP Energy Networks</i></p>	<p>No particular comment, though specification of a solution which is not yet commercially or technical proven at this level is perhaps not the ideal solution and we would support the establishment of an interim solution which would allow some further development period to establish a technologically proven solution.</p>
<p><i>Daniel Fraile, Wind Europe</i></p>	<p>WindEurope believes that the issue of <i>fault current injection</i> has not been sufficiently assessed and has been rushed for the implementation of the changes for the ongoing revision of the grid codes. The <i>Requirements for</i></p>

Response From	Specific Q3: What are your views on options 1, 2 and 3 as set out in paragraph 4.4 for Fast Fault Current Injection and which option (if any) would you prefer?
	<p><i>Generators</i> (RfG) network code does not imply any necessary changes to the current reactive current injection of today's UK grid code. The recently updated IGDs (and the new HPoPIPS) suggest the possible need for technological changes to meet stated requirements. But to face such technology changes, the industry requires a basis of verified data, as a result of system studies and firmly established system design criteria</p>
<p><i>Garth Graham, SSE</i></p>	<p>We are concerned about proposing technology which is still classified as 'experimental' (i.e. 'VSM') as a <i>mandatory</i> requirement for generators.</p> <p>We do not feel that the option of synchronous compensators which are proven sources of FFCI has yet been fully explored with accurate costs which reflect making use of existing generators rather than new build synchronous compensators.</p> <p>Intuitively it seems wrong not to investigate how existing large thermal plant and, in particular, embedded thermal rotating plant (that has recently been added to the system to take part in the capacity market) could be incentivised to provide this service when they are otherwise out of merit (e.g by means of retrospectively fitting clutches to enable them to run as synchronous compensators), particularly in light of recent reduction in 'embedded benefits'.</p> <p>Such a solution is technical demonstrable and if it could be incentivised by competitive tenders with time periods of > 4 years, could provide a cheaper and more certain means of providing FFCI than VSM.</p>
<p><i>Andy Vaudin, EDF Energy</i></p>	<p>The National Grid System Operability Framework (SOF) analysis shows low minimum Short Circuit Level at present, and declines in SCL in the coming decades. We share the National Grid operability concerns regarding falling Short Circuit Levels on the system and the consequent need for plant to be able to provide FFCI as one area of mitigation.</p> <p>However, we note that the VSM technology envisaged by the Proposer could only be regarded as emerging or at the development stage. We would expect National Grid to provide its view to the workgroup on the questions raised</p>

Response From	Specific Q3: What are your views on options 1, 2 and 3 as set out in paragraph 4.4 for Fast Fault Current Injection and which option (if any) would you prefer?
	in 5 below.
<i>Alastair Frew, ScottishPower Generation Ltd</i>	Option 1 appears to be a desire from NGET to introduce a Voltage Source Response, however this appears to be based on simulations and assumption of equipment capabilities. NGET indicated during the workgroup that the requested values were based on what they thought they wanted and not on the ability of equipment to achieve these requirements and hence a subsequent workgroup would be required to reset the values. On the bases that the values will need to be reset it is difficult to see the justification to code option 1 into legal text as insufficient work has been done to date and could end up leaving potential new generators with an unachievable requirement. In terms of the other options the preferred option would be option 3.
<i>Senvion</i>	Current grid code wording for zero FRT and maximum reactive current infeed as per technology capability are sufficient. It could be extended to include a definition of response timing and minimum amplitude performance of the fast fault current injection with reference to the voltage characteristic. 1 p.u fast reactive current injection (using nominal machine active current as base at 1pu voltage) is possible at present. Option 1 (VSM Concept). It should not be up to the network operator to drive technology development to a particular concept. VSM is a solution to a requirement and as such not a viable preferred option for a grid code. This is currently based on research only. The estimated/ presented benefits may not be real and applicable to the real wind turbine. It seems premature to make this a binding grid code requirement without substantially further and wider (e.g at European/international level) industry discussion. This position is already reflected in the discussion in the workgroup report. To provide more (Option 2) would require a new design of hardware components. Flexible wording of PPM rather than PPU performance and acceptance of project specific options would enable the use of additional equipment and enables project specific cost benefit analysis and remuneration as ancillary service. Wind turbines are capable of riding through a 0 p.u voltage fault at the MV terminals. The preference would be to specify a lower retained voltage and reduce the fast reactive current injection requirement. Therefore our preference would be for implementation of option 3.

Response From	Specific Q3: What are your views on options 1, 2 and 3 as set out in paragraph 4.4 for Fast Fault Current Injection and which option (if any) would you prefer?
<i>Rob Wilson, NGET</i>	<p>Option 1 sets the longer term direction of travel for equipment. It is valid that it is included to seek views but National Grid do not feel that it can be mandated at the current time. Further development with industry is required with a view to making the necessary code changes to progress this requirement from roughly 2021.</p> <p>Option 2 is in our view potentially the most balanced solution in deriving maximum operational benefit within the bounds of existing technology capability. However, we would welcome submissions from developers and manufacturers on potential costs so these can be taken into account.</p> <p>Option 3 was acknowledged in workgroup discussions to be achievable and represents a baseline.</p>
<i>Frank Martin, Siemens Gamesa Renewable Energy (SGRE)</i>	<p>As NGET outlines in the consultation document Option 1 falls outside the timescale of EU regulation implementation. These aspects should of course be investigated but should not be done under the umbrella of the RfG implementation – instead a separate WG should investigate these aspects. The document “EU Connection Codes GB Implementation – Mod 1” is describing “Option 1” as a way to deliver Fast Fault Current as specified by the RfG. However, the requirements for “Option 1” as outlined in “GC0100 - Effects of VSM (Option 1)” cover everything from inertial response, response to system imbalances and harmonics, and controller bandwidth limitations. While it is understood for the fast and short term response the focus of GC0100 should not shift to a broad range of aspects as it cannot be covered by this consultation. Option 1 requirements proposed in “GC0100 - Effects of VSM (Option 1)” represent a fundamental change to how power converters are designed and operated, how they interact with the power system, and the extent by which this is done. But given that grid forming converter control is a new, and compared to current control immature, technology for both the TSOs and for the converter manufacturers, there will be uncertainty in terms of both the performance it might deliver and the cost of a particular performance. The table on page 3 in “GC0100 - Effects of VSM (Option 1)” suggests that National Grid anticipates that grid forming converters will be able to deliver the required system services at a lower cost than the alternatives as e.g. synchronous compensators. The physical characteristics and limitations of the power converter needs to be respected no matter which control algorithm it is running, which means that any capability, or rather any combination of capabilities, that requires additional current carrying capability or dynamical power exchange needs to be designed into the power converter.</p>

Response From	Specific Q3: What are your views on options 1, 2 and 3 as set out in paragraph 4.4 for Fast Fault Current Injection and which option (if any) would you prefer?
	<p>If all capabilities are required at the same time, their requirements for current window and active power need added up and designed into the power converter, whereas an amount of sharing could be achieved if a prioritization is allowed. Furthermore it is not fully clear whether Option 1 is a WTG converter requirement or if it applies at PPM level. Also for offshore connected PPM it is important for the decision if capability is offered onshore or offshore. It is not clear what is driving the requirement for a 33% overproduction of active power for 20seconds. It is not clear what is driving the requirement for a 1.5pu overcurrent for 20seconds. Option 2 with related requirements to supply 1,25 p.u. of reactive current during a fault potentially disqualify existing hardware design. Furthermore it is not fully clear from the draft legal text how Option 2 requirements are understood for e.g. FRT requirements greater than 140 ms in duration where the grid code required provision of Active Power in proportion to the retained balances voltage. This also applies for Option 3. (Option 2 with 1pu current) Seen from described technical challenges and aspects and the outlined timeline for national implementation Option 3 is seen as the only feasible solution. From our point of view the NC RfG requirements does not imply any necessary changes to the current reactive current injection requirements of today's UK grid code.</p>
<p><i>Athanasios Krontiris & Grant McKay, ABB HVDC</i></p>	<p>In our view the proposal as well as the underlying studies do not clearly identify the specific system needs; in particular, it is unclear, whether challenges in future operation are related to voltage control or frequency control. Requirements need to fall into one of these categories to be assessed correctly. We believe that fast fault current injection can already be fulfilled with today's technology (current control with PLL). We cannot therefore concur with the statement in section 4.4. (page 35) that "in summary conventional PLL converters are slow to inject reactive current and this in turn will affect the retained voltage at the connection point". Requirements for fault current injection need to cover both control implementation (e.g. performance with regards to timing) and rating (maximum fault current needed). The proposal stipulates values for ratings (1.5 pu for option 1, 1.25 pu for option 2), however it is unclear how these requirements are derived from system needs.</p> <p>With respect to (fast) frequency control, a need for provision of synchronising torque and inertia can be expected in</p>

Response From	Specific Q3: What are your views on options 1, 2 and 3 as set out in paragraph 4.4 for Fast Fault Current Injection and which option (if any) would you prefer?
	<p>the future as the share of nonsynchronous generation increases. This need, and any related requirements, should be treated separately from fault current injection, although proposed technical solutions may address both aspects at the same time. A requirement for synchronising torque in the future seems reasonable, but –as studies by National Grid indicate– can be allocated to some generating plants only, or can be regulated by means of ancillary service markets. In our view, a market-based approach is more likely to ensure cost-optimization, since:</p> <ul style="list-style-type: none"> i) The requirements for option 1 (VSM) will introduce additional costs, and ii) The exact system needs are not known yet <p>Furthermore, a market-based approach could allow utilisation of already existing potential (e.g. in existing HVDC interconnections) potentially at a lower cost. Further comments on the proposed options:</p> <ul style="list-style-type: none"> - For option 1 (VSM), several additional features/benefits are indicated on pages 35- 36, including contribution to system inertia and rate of change of system frequency (RoCoF), compatibility with synchronous machines, and easy integration into existing grids, thus enabling greater market share for converter derived generator technologies. We would like to highlight that these features are not only specific to VSM, and similar behaviour can be reached by today’s current control (option 2 or 3). In particular, for a low share of non-synchronous generation, operating in current control may even be more robust than VSM control. - For options 2 and 3, it is not clear from figures 4.4 under which condition blocking is permitted (for instance, is this related to potential over-voltage after fault clearance? Or is blocking due to thermal protection for longer fault clearing times also allowed?) <p>Furthermore, what does temporary blocking imply for the requirement for active power recovery after the fault (§ECC.6.3.15.8.vi ?). In addition, the requirements for fault current injection (pu value) for fault clearing times longer than 140 ms are not given. Finally, there is no relation between remaining voltage at the PCC and required fault current injection; a requirement would need to be added defining this relation.</p>

Response From	Specific Q4: Do you have any alternative fast fault current injection solutions noting that the requirement applies to the Converter not the wider Power System?
<i>Paul Youngman, DRAX</i>	No
<i>Christian Merchan, GE Power</i>	<p>Response times required for Option 2 and Option 3 would appear to be consistent with today's technology.</p> <p>If this question specifically relates to Option 1, the VSM control of a converter then, as referenced in '3' above, it is suggested that National Grid engage with the supply chain for HVDC converters to establish what is practical. It must be borne in mind, however, that any UK special requirements that are over and above the global HVDC market need may result in an artificial restriction of the supply chain and hence a consequential increase in the capital cost.</p>
<i>Tom Chevalier, AMO</i>	No comment
<i>PThomas, Nordex</i>	<p>ECC.6.3.16.3.1</p> <ul style="list-style-type: none"> - Zero voltage does not really occur, can it be further specified what is meant by falling to zero (see also FRT) - Reactive current is required to reach at least 1.25 p.u. of the rating of the power park module. We propose to add a definition for this rating as rated active power. In other words to use active current at rated active power and $\cos(\phi) = 1$ as a basis. Considering the current ratings of expected modules used, this addition to the modification is very important to us. <p>The forbidden zone lies at either 1.0 p.u. or 1.25 p.u reactive current, where 1.25 p.u. is high. It would make sense and help to require the mean current after 120 ms to stay above this forbidden zone but allow the instantaneous current, due to oscillating behaviour, to temporarily be below 1.0 or 1.25 p.u. Or alternatively, to define a deadband below 1.25 p.u.</p>

Response From	Specific Q4: Do you have any alternative fast fault current injection solutions noting that the requirement applies to the Converter not the wider Power System?
<p><i>Marko Grizelj, Siemens</i></p>	<p>Siemens considers that current options discussed above are applicable to systems connected to the UK main network. The Options should not be forced on to Remote End Converters and DC Connected Power Park Modules, as the particulars of an offshore network and the related control systems are very different to those onshore*.</p> <p>Therefore flexibility should be included to allow an optimal solution for FFCI offshore. This can include wording to ensure that the remote end converter <u>and/or</u> DC Connected Power Park modules can coordinate their contribution according to the implementation of the protectionsystem and the limits of the technology.</p> <p>*AC Protection system for offshore applications can be design according to the implemented short circuit contributions from the respective systems.</p>
<p><i>Greg Middleton, AMPS</i></p>	<p>No</p>
<p><i>Alan Creighton, Northern Powergrid</i></p>	<p>No</p>
<p><i>DONG</i></p>	<p>Please see above in relation to applicability of FFCI requirement either at the Grid Entry Point or at each Power Park Unit terminals.</p>
<p><i>Konstantinos Pierros, ENERCON GmbH</i></p>	<p>Yes. Three-pronged:</p> <ul style="list-style-type: none"> - FRT voltage against time curves for Type B,C and D (below 110kV) with U_{ret} of 0.05pu and below - minimum FFCI in line with or similar to the German VDE AR-N-4120 TAR Hochspannung - a rise time of <30ms and a settling time of <60ms

Response From	Specific Q4: Do you have any alternative fast fault current injection solutions noting that the requirement applies to the Converter not the wider Power System?
	- different characteristics for superior FFCI defined by NGET through remunerated FRT System Service
<i>Christopher Smith, National Grid Interconnector Holdings Ltd</i>	No comments offered
<i>Kamran Sharifabadi, Statoil</i>	No comments offered
<i>Isaac Gutierrez, Scottishpower Renewable Ltd (UK)</i>	A solution applied to the converter to meet FFCI will definitively increase both CAPEX and OPEX for windfarms. As mentioned in SPR answer 3, not only manufacturers will need to look into the size of converters but also all other electrical and mechanical components within the wind turbine that interact to provide FFCI. There should be solutions implemented in the transmission system as well in addition to those that National Grid is seeking to implement on Generators. For example SPT's project Phoenix is an industry initiative that should not be ignored, including the outcome of the work related to the Commercial Model Development for new services essential to Grid Operation. (See slide pack attached from latest Stakeholder Engagement from page 23)
<i>Graeme Vincent, SP Energy Networks</i>	No response
<i>Daniel Fraile,</i>	On the concept of grid forming converter controls, the wind industry believes that TSOs should focus on breaking

Response From	Specific Q4: Do you have any alternative fast fault current injection solutions noting that the requirement applies to the Converter not the wider Power System?
<i>Wind Europe</i>	down the characteristics of being grid forming and developing a framework for defining future requirements. National TSOs should use such frameworks specifying the minimum technical requirements needed at the connection point to maintain system stability. Minimum technical specification should be technology neutral where possible. They should not be translated into specific and/or preferred technical solutions like e.g. Virtual Synchronous Machines. The development of specific technical solutions should be left open for the industry.
<i>Garth Graham, SSE</i>	See our answer to Question 3 above.
<i>Andy Vaudin, EDF Energy</i>	No
<i>Alastair Frew, ScottishPower Generation Ltd</i>	No
<i>Senvion</i>	The use of additional equipment within the PPM should not be ruled out. A STATCOM or inverter interfaced storage device could be used to provide additional/faster current injection.
<i>Rob Wilson, NGET</i>	No
<i>Frank Martin, Siemens Gamesa Renewable Energy (SGRE)</i>	./.

Response From	Specific Q4: Do you have any alternative fast fault current injection solutions noting that the requirement applies to the Converter not the wider Power System?
<p><i>Athanasios Krontiris & Grant McKay, ABB HVDC</i></p>	<p>With respect to fault current injection, we believe that current control should be sufficient; please refer to the answer in question 3 above. With respect to the provision of synchronizing torque, several solutions have been proposed for operating converters in a grid-forming matter. Concepts include among others: · Power synchronization control, refer to: "Power-Synchronization Control of Grid- Connected Voltage-Source Converters," L. Zhang, L. Harnefors, and H.-P. Nee, IEEE Transactions on Power Systems, vol. 25, pp. 809-820, 2010. · Swing-Equation-Based-Inertial-Response control, refer to: "Virtual synchronous machine", H.-P. Beck and R. Hesse, in 9th International Conference on Electrical Power Quality and Utilisation, 2007, pp. 1-6. · Inertia-Less Virtual Synchronous Machine (VSM0H) control, refer to: "Use of an Inertialess Virtual Synchronous Machine within Future Power Networks with High Penetrations of Converters", M. Yu, A.J. Roscoe, C.D. Booth, A. Dysko, R. Ierna, J. Zhu and H. Urdal, Power System Computation Conference (PSCC) 2016</p> <p>As mentioned in the proposal, work is ongoing within entso-e. A requirement for the provision of synchronizing torque is not stated in the EU network codes, and therefore would not necessarily need to be included in the UK implementation of the codes at this stage. Instead, we recommend a later introduction of such requirements based on the findings from the entso-e study and other studies specific to the UK power system.</p>

Response From	Specific Q5: In considering the three Fast Fault Current Injection options 1, 2 and 3 in paragraph 4.4 do you have any comments in relation to technology readiness, cost implications, and can they be implemented date within the context of product development timescales?.
<i>Paul Youngman, DRAX</i>	No
<i>Christian Merchan, GE Power</i>	Please refer to comments under '3'. Option 2 and Option 3 would, based on the assumptions stated, be practicable in the time frames stated. However, Option 1 is a major divergence from the HVDC technology applied to-date and something that the supply chain may not directly address. This would result HVDC converters connected to the UK grid being limited in power transmission capability significantly impacting on the return-on-investment and hence the economic justification for the HVDC link.
<i>Tom Chevalier, AMO</i>	No comment
<i>PThomas, Nordex</i>	See (4)
<i>Marko Grizelj, Siemens</i>	No comment indicated
<i>Greg Middleton, AMPS</i>	No comment
<i>Alan Creighton, Northern Powergrid</i>	No
<i>DONG</i>	Unfortunately, we are unable to provide any details regarding technology readiness, costs etc for the development of VSM type technology. However, we believe the R&D, implementation, & testing etc of VSM type technology may be significant. In

Response From	Specific Q5: In considering the three Fast Fault Current Injection options 1, 2 and 3 in paragraph 4.4 do you have any comments in relation to technology readiness, cost implications, and can they be implemented date within the context of product development timescales?.
	<p>addition, the additional energy storage requirement that comes along with VSM may be prohibitive cost for Offshore wind installation.</p> <p>Similarly, Option 2 will need a bigger power electronic converter to be installed inside the wind turbine. This leads to higher cost not just in terms of electrical equipment but also the civil structure.</p> <p>We believe Option 3, is a more viable option at this stage in terms of costs. Although, there is still a need for R&D, this may be considered to be most economically viable option and supporting the transmission system needs at the same time.</p>
<p><i>Konstantinos Pierros, ENERCON GmbH</i></p>	<p>Option 1 – far from readiness, severe cost implications throughout the product chain, far from implementation</p> <p>Option 2 – might require additional (spare) capacity through oversized dedicated converters and/or through ones for energy storage, moderate to high cost, possibility to be implemented within the context of product development timescales</p> <p>Option 3 – we are already beyond that point.</p>
<p><i>Christopher Smith, National Grid Interconnector Holdings Ltd</i></p>	<p>For HVDC systems the power electronics are the limiting technology. The very short thermal timeconstants in the power electronics results in the equipment being sized for the proposed overload capability, as stated in option 1 and option 2 as a full time rating. As a result, the HVDC equipment will need to be oversized for the rated capacity of the project.</p> <p><u>Example 1</u></p> <p>As an example the 1000MW HVDC links are being delivered with dc voltages of $\pm 320\text{kV}$. Under option 1 to achieve the overload capability the same 1000MW project would be required to delivered with a $\pm 500\text{kV}$. This has a number of issues for a developer.</p> <ul style="list-style-type: none"> • Underutilised equipment therefore a loss of cost efficiency. • Larger buildings, for example building heights would move from 20m to 24m. This can have a significant effect on the availability of locations and the ability to achieve planning consent.

Response From	Specific Q5: In considering the three Fast Fault Current Injection options 1, 2 and 3 in paragraph 4.4 do you have any comments in relation to technology readiness, cost implications, and can they be implemented date within the context of product development timescales?.
	<ul style="list-style-type: none"> • Reduced supply chain. The higher the operational voltage the smaller the number of suppliers with suitable experience at that voltage for both cables and converters. <p><u>Example 2</u></p> <p>The supply chain will be required to create a new product design just for the UK. This could possible include the higher rated devices. This has a number of issues for a developer.</p> <ul style="list-style-type: none"> • UK specific designs will attract a premium from the supply chain. • Potential reduction in number of suppliers as they may not chose to produce new products • Ongoing maintenance issues. Higher spares holdings will be required as supplier standard products are not being used. • Higher downtime as Original Equipment Manufacturer only has a small number of staff trained in the UK unique product. <p>The use of option 3 allows for a market driven solution and a wider variety of solutions to meet the issues.</p> <p>National Grid Interconnectors Holdings Ltd would also highlight that the consultation discusses Energy Storage. As per the Section 10 of the Electricity Act 1989, all licenced TSOs (which include all owners of interconnectors) must be certified as unbundled from generation or supply activities. This process of certification establishes the facts of the relationship between entities, and precludes TSOs from having control (not simply a >50% share holding) over a relevant producer or supplier.</p> <p>As per Ofgem’s recent announcement that storage will be licenced as a sub-set of generation, all battery storage is classified as generation. While Section 10 of the Electricity Act does allow Ofgem to exercise some discretion (whereby they can approve certification even if they find that the TSO has control of a producer or supplier) the specific prohibition on exercising this discretion found in Section 10F (9) applies:</p>

Response From	Specific Q5: In considering the three Fast Fault Current Injection options 1, 2 and 3 in paragraph 4.4 do you have any comments in relation to technology readiness, cost implications, and can they be implemented date within the context of product development timescales?.
	<p>“(9A) Except where subsection (9B) applies, the Authority may treat one or more of the five tests in this section as passed if...</p> <p>...(9B) This subsection applies where the applicant, or a person who controls or has a majority shareholding in the applicant, controls or has a majority shareholding in a person (“A”) who operates a generating station and—</p> <p>(a) A is a relevant producer or supplier; and</p> <p>(b) the generating station is directly physically connected to anything that forms part of the applicant’s transmission system or electricity interconnector.”</p> <p>This section of the act specifically prohibits Ofgem utilising their discretion to certify where the storage in question is connected to the licensees interconnector.</p> <p>Therefore, requiring interconnector owners to install battery storage appears incongruent with the regulations.</p>
<i>Kamran Sharifabadi, Statoil</i>	No comments offered
<i>Isaac Gutierrez, Scottishpower Renewable ltd (UK)</i>	Please refer to comments in question 3. Additionally some manufacturers have intimated to SPR that there will be a negative cost-benefit case for not offering products to the UK market as is not on their interest to meet these new requirements (as their manufacturing cost will increase and the profits will be extremely marginal) which could definitively lead to increased energy cost in the electricity markets due to unavailability of wind turbines options. In this scenario, the developer will be forced to buy (or not) few products available to the UK market as there will not be a choice of wind turbines. This could also push developers to not go ahead with certain projects at all due to the increased investment costs. In absence of financial support from the government on onshore wind for example,

Response From	Specific Q5: In considering the three Fast Fault Current Injection options 1, 2 and 3 in paragraph 4.4 do you have any comments in relation to technology readiness, cost implications, and can they be implemented date within the context of product development timescales?.
	wind farm developers are changing their economic/investment models (e.g. subsidies are being replaced for Power Purchase Agreement) on onshore windfarms and technical requirement like FFCl (option 1 and 2) could harm this kind of ventures and definitely affect development of onshore wind.
<i>Graeme Vincent, SP Energy Networks</i>	See response to 3 above.
<i>Daniel Fraile, Wind Europe</i>	The proposed reactive current injection requirements would exceed today's industry standards, leading to additional costs-related to increasing the current hardware capabilities, R&D, certification, testing and validation costs. It's worth to mention that specific UK only requirements should not force manufacturers to change their hardware for the rest of the markets as well. Therefore the system operator should consider to incentivise the development of such capabilities under an ancillary services market,
<i>Garth Graham, SSE</i>	No comment indicated
<i>Andy Vaudin, EDF Energy</i>	We do not have this information, but believe that these are important areas for the workgroup to consider.
<i>Alastair Frew, ScottishPower Generation Ltd</i>	No
<i>Senvion</i>	Option 1 (VSM Concept). This is a solution and not a requirement. There are different solutions to the requirement and choosing one concept excludes competitive options and technology development. Option 2 (1.25 p.u fast reactive current)

Response From	Specific Q5: In considering the three Fast Fault Current Injection options 1, 2 and 3 in paragraph 4.4 do you have any comments in relation to technology readiness, cost implications, and can they be implemented date within the context of product development timescales?.
	<p>This requirement could be achieved, however requires upgrade and extension of current hardware designs and would need sufficient lead time for the development. Cost consideration to fulfil the requirements include R&D, Certification/Test and Validation. Option 3 (1.0 p.u fast reactive current) This option can be achieved at present, however some R&D effort will be required to adjust to this performance.</p>
<p><i>Rob Wilson, NGET</i></p>	<p>Option 2 has been agreed and put in the Bilateral Connection Agreement of a recent interconnector project so is technically achievable. Information on costs would help to finalise the selection of these options.</p>
<p><i>Frank Martin, Siemens Gamesa Renewable Energy (SGRE)</i></p>	<p>Option 1 represents an entirely new converter control and will very likely introduce a host of new stability and control issues that each manufacturer need to deal with and get under control. This will require intensive R&D work for the industry as well as extensive simulations / testing to investigate and understand all effect in all relevant operational modes of the WT's and WPP's. In our point of view the technology is not presently commercially ready and it will be very difficult to realize this by January 2021. An intermediate step that would reduce the risk for all involved parties (TSO, manufacturers) might be to do a demonstration project using existing power hardware to:</p> <ol style="list-style-type: none"> 1) Let NGET see if the perceived potential of this type control is realized in an actual setting with actual power hardware 2) Let the industry get more knowledge and experience about what the propose converter control will mean in practise for their converter design 3) Be able to properly assess the cost vs benefit of grid forming converter to compare against competing technologies such as synchronous condensers <p>These steps should be followed by a dedicated WG so possible conclusions can be taken be made for future system needs. Option 2 / Option 3 of the consultation document outlines that these Options would apply for PPM's which have signed "mayor plant items" after 17th of May 2018. Even for Option 2 / Option 3 R&D work by the</p>

Response From	Specific Q5: In considering the three Fast Fault Current Injection options 1, 2 and 3 in paragraph 4.4 do you have any comments in relation to technology readiness, cost implications, and can they be implemented date within the context of product development timescales?.
	<p>industry is required and various compliance aspects need to be worked on (e.g. testing, simulation and studies) which means more time to comply with these requirements is necessary. Therefore a transition period of at least 1 year is suggested.</p>
<p><i>Athanasios Krontiris & Grant McKay, ABB HVDC</i></p>	<p>Option 3 is state-of-the-art. Option 2 does not introduce any additional R&D requirements for the control of converters. Therefore, it can be considered as commercially available. However, it may have some cost implications. Raising the fault current contribution to 1.25 pu means that the converter must be overrated. For HVDC converters, the requirement for higher fault current may result in the short-term to a minor increase in investment cost. In the mid-term (3-5 years), this increase in cost may be further reduced by R&D activities and new products. For the assessment of option 1, one needs to differentiate: The requirement for increased fault current stated in the proposal (1.5 pu) will have some cost implications. For HVDC converters, it will result in the short-term to an increase in investment cost. Similar to the discussion for option 2 above, the requirement for higher fault current itself is no new feature and the technology to meet such a requirement is commercially available. On the other hand, the requirement for inertia contribution cannot be covered by the state-of-the-art technology. R&D activities are required to make the proposed VSM control concept commercially available. Additional costs are related to the converter itself and the storage required for the provision of inertia. The former depends on the expanded operating range: an increase by +33% according to Annex 6 will result in higher investment cost. The latter depends mainly on the requirement for inertia support. In the supporting documents in Annex 6 a value in the range of 2-7 MWs/MVA is stated, however there is no figure in the proposal. In particular, for HVDC systems energy storage on the DC side of the converter is unlikely to be technically and/or economically feasible due to the very high voltage; instead, a separate converter with lower voltage and storage facilities on the DC side would be required which has significant implication on investment costs as well as operating losses. It is, however, possible in HVDC systems to compensate for the energy needed for inertia support in the remote terminal, as long as the VSM requirements are not valid for both terminals.</p>

Response From	Specific Q5: In considering the three Fast Fault Current Injection options 1, 2 and 3 in paragraph 4.4 do you have any comments in relation to technology readiness, cost implications, and can they be implemented date within the context of product development timescales?.

Response From	Specific Q6: Do you have any evidence to support your views?
<i>Paul Youngman, DRAX</i>	n/a
<i>Christian Merchan, GE Power</i>	Please refer to above comments.
<i>Tom Chevalier, AMO</i>	No comment
<i>PThomas, Nordex</i>	Confidential
<i>Marko Grizelj, Siemens</i>	No comment indicated
<i>Greg Middleton, AMPS</i>	No comment
<i>Alan Creighton, Northern Powergrid</i>	n/a

Response From	Specific Q6: Do you have any evidence to support your views?
<i>DONG</i>	No. We are not able to provide any evidence at this stage.
<i>Konstantinos Pierros, ENERCON GmbH</i>	We are a wind turbine manufacturer with an in-house production of inverters that are the key component of the vast majority of the 46GW of our worldwide installed capacity.
<i>Christopher Smith, National Grid Interconnector Holdings Ltd</i>	See answer to question 5
<i>Kamran Sharifabadi, Statoil</i>	NG should ask the question to Vendors & manufactures of the equipment. We cannot share any of the Vendor material, development plans with a third party e.g. National Grid.
<i>Isaac Gutierrez, Scottishpower Renewable ltd (UK)</i>	SPR had conversation with wind turbines manufactures although exact details cannot be disclosed due to confidentiality issues. SPR prefers this information to be disclosed directly from wind turbine manufacturers to National Grid
<i>Graeme Vincent, SP Energy Networks</i>	No response
<i>Daniel Fraile,</i>	WindEurope believes that imposing requirements exceeding the industry standards and current technology

Response From	Specific Q6: Do you have any evidence to support your views?
<i>Wind Europe</i>	<p>capabilities must be based on a comprehensive Cost Benefit Analysis.</p> <p>It is critical to have a common understanding of system needs for scenarios today and in the future. European discussions on power system needs with high renewable penetration levels of variable renewable energy sources and power electronics levels have been focusing on aspects with a time horizon beyond May 2018 to prepare necessary frameworks allowing national TSOs to specify minimum technical requirements. This is currently addressed in the ENTSO-E expert group on fast fault current. We do not understand why for National grid is so imperative to include such requirements in the upcoming revision of the grid code.</p>
<i>Garth Graham, SSE</i>	<p>Clutches have been fitted to thermal rotating generators up to 300 MW in size and are routinely fitted to peaking plants in the US as a means of adding value by running as a Synchronous Compensator when out of merit.</p> <p>If there was a commercial market in providing FFCI services then it would incentivise manufacturers to design clutches that could be easily retrofitted.</p>
<i>Andy Vaudin, EDF Energy</i>	See 5
<i>Alastair Frew, ScottishPower Generation Ltd</i>	No
<i>Senvion</i>	Fault ride through documentation (including tests and models) have been submitted confidentially to NGET for our technology for various projects and for type registration, confirming our technology performance and control.
<i>Rob Wilson, NGET</i>	Benefits set out against the original proposal, other evidence expected from developers/manufacturers.
<i>Frank Martin, Siemens</i>	./.

Response From	Specific Q6: Do you have any evidence to support your views?
<i>Gamesa Renewable Energy (SGRE)</i>	
<i>Athanasios Krontiris & Grant McKay, ABB HVDC</i>	We are not aware of VSM control being implemented in any commercially available HVDC system offering. Furthermore, HVDC suppliers have not communicated to the market (press releases or publications) plans to incorporate VSM control into HVDC converters in the near future.

Response From	Specific Q7: Do you have any views on the specific costs related to the additional requirements?
<i>Paul Youngman, DRAX</i>	n/a

Response From	Specific Q7: Do you have any views on the specific costs related to the additional requirements?
<i>Christian Merchan, GE Power</i>	Option 3 , considering the stated assumptions, are not expected to impact on cost. Option 2 , will impact on both capital cost and losses. Option 1 would have a significant impact on the cost per MegaWatt, roughly increasing the cost by three times (x3).
<i>Tom Chevalier, AMO</i>	No comment
<i>PThomas, Nordex</i>	No
<i>Marko Grizelj, Siemens</i>	With respect to the Remote End Converters, the FFCI requirements would not only drive costs up for Option 1 and 2 and thus make HVDC offshore transmission significantly less competitive than its AC counterpart but it would also eliminate possible technological alternatives. This includes Siemens's offshore diode rectifier solution (SGA-DRU). The SGA-DRU was developed as a result of a focused effort to further reduce the cost of offshore transmission systems whilst still ensuring a reliable connection onshore. The passive nature of SGA-DRU would mean that the current requirements on FFCI would not be met. SGA-DRU would rely on the current contribution from the Power park modules.
<i>Greg Middleton, AMPS</i>	No comment
<i>Alan Creighton, Northern Powergrid</i>	No
<i>DONG</i>	Please see above
<i>Konstantinos Pierros, ENERCON</i>	Might be able to provide feedback confidentially.

Response From	Specific Q7: Do you have any views on the specific costs related to the additional requirements?
<i>GmbH</i>	
<i>Christopher Smith, National Grid Interconnector Holdings Ltd</i>	<p>Whilst National Grid Interconnectors Holdings Ltd cannot provide detailed cost information in the public domain we would highlight the following to the Regulator:</p> <p>The answer Question 5 provided an example 1. The Regulator can use the FPA submissions for IFA2 and NSL to ascertain an order of magnitude increase as follows:</p> <p>Converter Costs: The Converter for a 1000MW IFA2 type link would cost the same as the NSL link.</p> <p>Cable Costs: Whilst more difficult to directly relate a scaled NSL cost for the IFA2 length would provide an approximation.</p> <p>Developers would need to consider if the additional CAPEX would make investment worth while, irrespective of the present Regulatory regimes.</p> <p>National Grid Interconnectors Holdings Ltd would also re-iterate the reference to cost analysis form other TSO's which have indicated that alternative technologies, such as Synchronous Condensers, provide a cost advantage. http://www.eirgridgroup.com/site-files/library/EirGrid/System-Service-Provision-DNV-KEMA-Report-2012.pdf</p>
<i>Kamran Sharifabadi, Statoil</i>	Answer as above (question 6) Statoil, cannot share confidential information.
<i>Isaac Gutierrez,</i>	Yes, please refer to both answer 3 and 5

Response From	Specific Q7: Do you have any views on the specific costs related to the additional requirements?
<i>Scottishpower Renewable ltd (UK)</i>	
<i>Graeme Vincent, SP Energy Networks</i>	No response
<i>Daniel Fraile, Wind Europe</i>	No response indicated
<i>Garth Graham, SSE</i>	No response indicated
<i>Andy Vaudin, EDF Energy</i>	See 5
<i>Alastair Frew, ScottishPower Generation Ltd</i>	No
<i>Senvion</i>	A Larger LVRT funnel together with fast active power recovery will require additional R&D effort, hardware changes, testing and validation costs. If the time for active power recovery after fault is increased from 0,5s to 1s, as found in the rest of the world, will reduce this unnecessary additional cost for DFIG wind turbines. Full converter technologies will not have issues with the 0,5s. recovery time.
<i>Rob Wilson, NGET</i>	Benefits set out against the original proposal, other evidence expected from developers/manufacturers.

Response From	Specific Q7: Do you have any views on the specific costs related to the additional requirements?
<p><i>Frank Martin, Siemens Gamesa Renewable Energy (SGRE)</i></p>	<p>The proposed reactive current injection requirements (especially Option 1 and 2) would exceed today's industry standards, leading to additional costs related to increasing the current hardware capabilities, R&D, testing, validation and certification costs. It's worth to mention that specific UK only requirements should not force manufacturers to change their hardware for the rest of the markets as well. Therefore the system operator should consider to incentivise the development of such capabilities under an ancillary services market.</p> <p>Especially Option 1 will have the highest impact on costs as it represents a fundamental change on power converters. In addition Option 1 requirements will mean an extended capability which means available stored energy!! In order to dimension such additional energy storage capability, across what frequency range it is desired that a VSM with an inertial constant of between 2 and 7 is delivered? In order to dimension the converter overload requirements to support a VSM, the maximum RoCoF is required. Given that the installed converter connected generation capability is spread between banding levels (specifically PV within band A), it seems that loading the requirements to provide system inertia, via VSM, on banding levels B, C, D, penalises certain technologies. If it is desirable that converter connected generation in banding B, C, D provide system services such as FFC and VSM, which will result in additional capital equipment cost, then an incentive scheme should be considered that allows all generation types (Wind, PV..) to compete on equal terms.</p> <p>Why is VSM being considered within the context of fast fault current? VSM places additional requirements on converter connected generation beyond current rating, specifically transient energy requirements. These two aspects will impose significant costs to additional hardware. To develop, test / verify and certify these new control schemes and technologies will impose additional costs which can be characterised with the amount of developing a complete new converter system!! Option 2 may require changes to hardware (assessments necessary) and to controls. In addition to that, costs for verification and compliance needs to be added.</p>

Response From	Specific Q7: Do you have any views on the specific costs related to the additional requirements?
	<p>Option 3 is seen as the most cost effective solution seen from the hardware, design and compliance point of view. Imposing requirements exceeding the industry standards and current technology capabilities must be based on a comprehensive Cost Benefit Analysis. The lead times associated with providing Option 1 (beginning of 2021) but also Option 2 (may 2018) needs to be considered. WPP's already sold and in the design process cannot upgrade power hardware in a timescale of less than a year if the existing power hardware does not support the additional fast fault current injection requirement.</p>
<p><i>Athanasios Krontiris & Grant McKay, ABB HVDC</i></p>	<p>Please refer to our answer to question 5 above.</p>

Response From	Specific Q8: Is the current proposed wording for the remote end HVDC and DC Connected Power park modules sufficient to facilitate future new technology?
<p><i>Paul Youngman, DRAX</i></p>	<p>n/a</p>
<p><i>Christian Merchan, GE Power</i></p>	<p>As identified above further clarification is needed.</p>
<p><i>Tom Chevalier, AMO</i></p>	<p>No comment</p>
<p><i>PThomas,</i></p>	<p>n/a</p>

Response From	Specific Q8: Is the current proposed wording for the remote end HVDC and DC Connected Power park modules sufficient to facilitate future new technology?
<i>Nordex</i>	
<i>Marko Grizelj, Siemens</i>	<p>Siemens's view is that in the case of an offshore connection, the offshore system is decoupled from the onshore grid in using a HVDC connection. Therefore requirements as set out for onshore connected HVDC converters should not automatically apply to offshore as this severely limits innovation in the technology and imposes unnecessary costs that are eventually transferred to the end user.</p> <p>Siemens would ensure that alternative solutions, which still comply with onshore system stability requirements and retain expected reliability figures, should not be discounted due to excessively onerous offshore requirements, particularly when those same requirements can be met by the corresponding power park modules connected to the system.</p>
<i>Greg Middleton, AMPS</i>	No comment
<i>Alan Creighton, Northern Powergrid</i>	No response
<i>DONG</i>	<p>In case of DC Connected Power Park Modules, we believe the requirement for FRT is applicable. However, the requirement for FFCI doesn't seem to be valid as any reactive current produced by Power park units behind HVDC station will be masked by the HVDC providing the reactive current. On the contrary, the reactive current produced by power park units may raise the voltage and hence trigger unwanted control from HVDC. Hence, we believe it is important that simulations and analysis is required to prove the concept before implementation can be done.</p>
<i>Konstantinos Pierros, ENERCON GmbH</i>	n/a

Response From	Specific Q8: Is the current proposed wording for the remote end HVDC and DC Connected Power park modules sufficient to facilitate future new technology?
<i>Christopher Smith, National Grid Interconnector Holdings Ltd</i>	It would appear that the requirements offshore may result in innovative solutions, such as DC connected windfarms, not being allowed to be implemented.
<i>Kamran Sharifabadi, Statoil</i>	No
<i>Isaac Gutierrez, Scottishpower Renewable Ltd (UK)</i>	No, there should be explicit statements mentioning that new technologies can be utilised to meet the requirements
<i>Graeme Vincent, SP Energy Networks</i>	No response
<i>Daniel Fraile, Wind Europe</i>	No response indicated
<i>Garth Graham, SSE</i>	No response indicated
<i>Andy Vaudin, EDF Energy</i>	Whilst not being able to predict what future technology developments might be, we do agree that the proposed wording allows a reasonable degree of flexibility.

Response From	Specific Q8: Is the current proposed wording for the remote end HVDC and DC Connected Power park modules sufficient to facilitate future new technology?
<i>Alastair Frew, ScottishPower Generation Ltd</i>	No comment indicated
<i>Senvion</i>	We require more time to analyse the proposal
<i>Rob Wilson, NGET</i>	Yes
<i>Frank Martin, Siemens Gamesa Renewable Energy (SGRE)</i>	No. Due to the technical aspects of DC connected PPM's it is in our view not sufficiently evaluated and discussed if one of the Options specified is actually needed for such a configuration of DC connected PPM. The 3 Options have been evaluated mainly from the challenges seen in AC systems.
<i>Athanasios Krontiris & Grant McKay, ABB HVDC</i>	No comment indicated

Response From	Specific Q9: What are the specific costs related to the additional requirements?
----------------------	---

Response From	Specific Q9: What are the specific costs related to the additional requirements?
<i>Paul Youngman, DRAX</i>	We have no further information on specific costs other than to note that developers and operators will face additional costs due to any additional equipment and processes required to ensure compliance.
<i>Christian Merchan, GE Power</i>	No comment
<i>Tom Chevalier, AMO</i>	No comment
<i>PThomas, Nordex</i>	n/a
<i>Marko Grizelj, Siemens</i>	No comment indicated
<i>Greg Middleton, AMPS</i>	<p>The different banding proposals don't have any direct impact on small synchronous generators, except they must support the Uret of 0.3.</p> <p>Refer to evidence that has already been submitted to GC0048 on the economic impact on small synchronous generators with a lower value of Uret</p>
<i>Alan Creighton, Northern Powergrid</i>	No response
<i>DONG</i>	No comment received
<i>Konstantinos Pierros, ENERCON</i>	We can provide feedback confidentially.

Response From	Specific Q9: What are the specific costs related to the additional requirements?
<i>GmbH</i>	
<i>Christopher Smith, National Grid Interconnector Holdings Ltd</i>	No comments offered
<i>Kamran Sharifabadi, Statoil</i>	NG should ask the question to Vendors & manufactures of the equipment. Statoil cannot share any of the Vendor material, costing or development plans with a third party e.g. National Grid.
<i>Isaac Gutierrez, Scottishpower Renewable ltd (UK)</i>	Mainly for small generator Type A and B there will be associated cost with meeting FRT requirements
<i>Graeme Vincent, SP Energy Networks</i>	No response
<i>Daniel Fraile, Wind Europe</i>	No response indicated
<i>Garth Graham, SSE</i>	The specific costs related to requiring GB generators to operate to the lower banding thresholds (such as those proposed with the Original) when compared with the banding values set out in the Table 1 (Article 5) of the RfG have already been provided by us in response to the GC048 consultation response. For the sake of brevity we

Response From	Specific Q9: What are the specific costs related to the additional requirements?
	avoid repeating those detailed costings here as we understand the GC0100 Workgroup is already aware of this costing information.
<i>Andy Vaudin, EDF Energy</i>	We do not have any details on costs related to lowering the banding thresholds.
<i>Alastair Frew, ScottishPower Generation Ltd</i>	All new generators down to 10MW will now have additional cost for simulations to prove they are capable of fault ride through. In terms new generators connecting at 11kV to meet the fault ride through requirements, whilst currently would be provided without a generator transformer, going forward to demonstrate all auxiliaries will still function a 5 of 10 generator transformer will be required to ensure the station auxiliary busbars remain suitably above zero volts. There are also various other potential costs.
<i>Senvion</i>	No comments offered
<i>Rob Wilson, NGET</i>	Benefits set out against the original proposal, other evidence expected from developers/manufacturers. None yet identified other than for market participation which is not a RfG requirement.
<i>Frank Martin, Siemens Gamesa Renewable Energy (SGRE)</i>	See previous comments on Band A, on the lack of VSM requirements.
<i>Athanasios Krontiris & Grant McKay, ABB HVDC</i>	No comment indicated

Response From	Specific Q10: Do you have any views on the banding thresholds for the original and those suggest for the possible alternative?
<i>Paul Youngman, DRAX</i>	No
<i>Christian Merchan, GE Power</i>	No comment
<i>Tom Chevalier, AMO</i>	No comment
<i>PThomas, Nordex</i>	None
<i>Marko Grizelj, Siemens</i>	No comment indicated
<i>Greg Middleton, AMPS</i>	See comment 9
<i>Alan Creighton, Northern Powergrid</i>	We have a slight preference for the possible alternative banding threshold on the basis that it probably require less change now, particularly given that NGET can propose different thresholds in 3 years (from EIF) when there may be more experience and evidence of any additional cost. However the original proposal is likely to be more future proof and it would be reasonable to implement this if there is no evidence that it will materially increase costs.
<i>DONG</i>	No comment received
<i>Konstantinos Pierros, ENERCON</i>	We suppose that the “original” proposal is the one contained in the RfG and “alternative” contained in page 7. We are happy with the alternative proposal.

Response From	Specific Q10: Do you have any views on the banding thresholds for the original and those suggest for the possible alternative?
<i>GmbH</i>	
<i>Christopher Smith, National Grid Interconnector Holdings Ltd</i>	No comments offered
<i>Kamran Sharifabadi, Statoil</i>	No comments offered
<i>Isaac Gutierrez, Scottishpower Renewable ltd (UK)</i>	New proposed banding will affect connection in the transmission system in Scotland as SSE and SPT have a different approach to small, medium and large generators. For example Type C generator did not have to provide any frequency response now with the new requirements; the generators have to provide frequency response. Although SPR understands why frequency response is required at this level of generation, National Grid should make sure that the current ancillary services market is also implemented for the generator under the RfG requirements that are to be included in the UK Grid Code.
<i>Graeme Vincent, SP Energy Networks</i>	We agree with the proposed (original) proposal as the proposed thresholds more closely align with the existing requirements in Scotland and therefore continue to ensure the operation of the Electricity system in Scotland. We believe that this reflects the direction of travel required to adapt to the changing system background with an ever increasing penetration of distributed generation connecting to Distribution networks. Adopting a higher set more closely aligned to those of Central Europe does not seem to be an appropriate solution given the relative magnitude of the CE system compared to that in GB. In addition given the evidence that a number of European TSOs are actively trying to establish lower bandings than the maximum values proposed in the RfG, we believe alignment to these higher levels which other European TSOs are seeking to reduce is not an appropriate solution. We do appreciate that lowering these thresholds is likely to have an increase in associated compliance assessment and monitoring costs for other parties including DNOs, however, as stated within the document it is likely that exist

Response From	Specific Q10: Do you have any views on the banding thresholds for the original and those suggest for the possible alternative?
	smaller generators would need to have certain technical requirements to meet the future requirements for the management and operation of the national electricity transmission network.
<i>Daniel Fraile, Wind Europe</i>	No response indicated
<i>Garth Graham, SSE</i>	<p>Notwithstanding our comments under Question 1 (applicable objectives) above, we believe that the application of the banding values set out in the Table 1 (Article 5) of the RfG (and shown in yellow highlight on page 46 of the Workgroup Consultation) for a three year period is the pragmatic way forward.</p> <p>It ensures that newly connecting GB generators are not subject to the sub-optimal solution which would arise if the low banding levels proposed with the Original were to be adopted.</p>
<i>Andy Vaudin, EDF Energy</i>	<p>We understand the system security and operability justifications for proposing lower banding thresholds. We note that Continental Europe TSOs have in many cases also proposed lower banding. It does not seem to have been explained why the B banding threshold is proposed at the level of 1MW, when there could potentially be benefits for system security, particularly FRT capability with an amended threshold.</p>
<i>Alastair Frew, ScottishPower Generation Ltd</i>	<p>General Intension</p> <p>The proposer's banding levels appears to be based on a perceived local issue related to local system faults and not cross-border trade issues, which is the propose of 2016/631(RFG). The original intension of 714/2009 is to improve network access and remove obstacles reducing cost. Given this the proposer's banding proposal is reducing the banding levels from highest possible on the bases of a local issue and not a cross-border issue it is going against the original intension of the third package, by forcing smaller parties to increase their investment costs to cover the additional requirements . It is the view of this respondent that adopting the alternative proposal for the high option will not add additional cost to lower level participants and hence better address the original objectives by increasing access and reducing obstacles.</p> <p>Harmonisation</p>

Response From	Specific Q10: Do you have any views on the banding thresholds for the original and those suggest for the possible alternative?
	<p>The proposer’s justification for this reduced banding level states in section 3.2 fourth paragraph “The majority of European TSOs for Member States in Continental Europe are proposing generator banding levels lower than the maximum permitted under RfG, many of which, if not being comparable with the proposed GB levels, are lower than that proposed for GB. The proposer therefore believes there is a greater likelihood of harmonisation with Continental European neighbours with a lesser banding level than the maximum (noting that NRA approval is required to set these levels).” This justification is based on potential harmonisation across Europe which is similarly against the intensions of 714/2009 which states in whereas (29) “In particular, the Commission should be empowered to establish or adopt the Guidelines necessary for providing the minimum degree of harmonisation required to achieve the aims of this Regulation.” Again it is the view of this respondent that adopting the alternative proposal for the high option will not add additional cost to lower level participants and hence better address the original objectives by increasing access and reducing obstacles.</p> <p>Frequency Response</p> <p>The proposer’s justification then moves on in section 3.2 paragraph 6 to state “Threshold of 10MW for GB would provide a greater proportion of Generation inherently capable of contributing to frequency response, noting that commercial facilitation is not in the scope of RfG to consider, but a factor when it comes to cost.” Whilst it is accepted that if a lower banding level is used by default this must result in more frequency response capacity, however the real question is, will this not just be added to the current large amounts of unused frequency response capacity at additional cost to the generator? This view has been previously stated by this respondent in the previous banding consultation in April 2016 and a revised version using the proposer’s latest banding options is repeated below but due to the short timescales is still based on the late 2015 data, but this is still believed to be relevant.</p> <p>This analysis initially reviews the existing generation and proposed generation in 5 years’ time using data available in the TEC Register dated 16 November 2015, Embedded Register dated 16 November 2015 and 2015 week 24 data plus DNO ED1 allows comparisons between existing and future capacity. Summary tables 1a & b and 2a & b</p>

Response From	Specific Q10: Do you have any views on the banding thresholds for the original and those suggest for the possible alternative?
	<p>of this data which are referred to are given at the end of this section of text. Looking at the available frequency response if the proposed banding were to be applied to the current generation mix it can be seen in tables 1a & b both options would result in a range of the approximately 77 to 88 GW of plant available to provide response. The difference between the high and proposer's banding options only offers 11% increase or 10,000MW of generating capacity. The additional capacity then only equates to potentially 10% additional frequency response capacity of 1000MW comparing proposed banding to the highest banding option.</p> <p>Similarly looking forward at the potentially available frequency response if the proposed banding were to be applied to the end of 2021 generation mix it can be seen in tables 2a & b both options would result in a range of the approximately 127 to 139 GW of plant available to provide response. The difference between the high and proposed banding options only offers a 7% increase or 12,000MW of generating capacity. The additional capacity then only equates to potentially 10% additional frequency response capacity of 1,200MW comparing proposed banding to the highest banding option. It should also be noted that this has been applied to all generation and not just the generation connected after 2018 and in practice the proposer's banding option may only pick up an additional 2,000MW of generating capacity and not the 17,000MW. Based on the current frequency response average usage levels of Primary 657MW, Secondary 448MW and High 708MW (based on the average hourly usage volumes from December 2013 to September 2015) less than 7.5% of the current total available capacity is being utilised. If the proposers banding option was to be in place today the potential changes would be to reduce the current frequency response capacity usage to 6.6% of the available total. Looking forward 5 years assuming the infeed lose has not changed then the current response requirements should still be applicable in this scenario. Given that the available generation to provide response increases by just approximately 50GW from current levels under the high option with 70% of plant still providing response there should be in 6 years' time still adequate response margins, with utilisation levels even lower. Whilst still agreeing the proposer's banding option would result in an increase in frequency response capacity, its usage this is likely to be limited and is not clear what benefit this would provide. The high option would appear to suffice in terms of response requirements as there appear to be no detrimental cost implications.</p> <p>Tables 1a & b below summaries the data for current generation available volumes based on the TEC Register</p>

Response From	Specific Q10: Do you have any views on the banding thresholds for the original and those suggest for the possible alternative?
	<p>dated 16 November 2015, Embedded Register dated 16 November 2015 and DNO week 24 data 2015.</p> <p>{refer to response for the table)</p> <p>Fault Ride Through</p> <p>The proposer justification in section 3.2 paragraph 7 then moves on to fault ride through with a vague statement “There is also a cost of tripping synchronous generation in a higher band (10MW – 50MW) which could result in a potential increase in holding additional reserve costs alone of £9 million / annum”. As previously stated the perceived issue the proposer is trying to deal with relates to a need for generators down to 10MW to be capable of withstanding local network faults by providing new fault ride through capabilities which are not a current requirement. The argument seems to be based on the principle if there is a transmission system fault which results in a large 1800MW generator tripping off then the TSO cannot be expected to cover for any other generators tripping off. Given these fault ride through requirements are new it would have been thought that existing generators which currently are without these facilities would be tripping off due to network faults and currently causing issues. To monitor system issues NGET have been producing the Significant System Events Report since 1998 with the most recent version produced in January 2016 (note a 2017 version has not been produced yet). Within this report the largest consequential lose recorded is 400MW in 2011 due to an island being formed in the north of Scotland which then collapsed, equally there is no evidence of significant volumes of secondary generation being disconnected due system events, nor is there any evidence of an increase in this consequential loses as the generation mix has been changing with time. On the bases there appears to be no current issues from generation not having fault ride through capability adopting the high banding option as opposed to the proposer’s option would again not impose further cost increases to smaller new generators.</p> <p>Other Issues</p> <p>Although the RFG limits the banding levels to only new entrants other Network codes such as the 2017/1485</p>

Response From	Specific Q10: Do you have any views on the banding thresholds for the original and those suggest for the possible alternative?
	<p>Transmission System Operation Guidelines (TSOG) have adopted these banding levels and are applying them to both new and existing generators. Hence the actual full the cost implications of these banding levels will not be clear until exact implementation details of the other codes are developed the possible retrospective application to existing generators may require a sudden increase in communication links with unknown costs and other unknowns.</p> <p>Summary On the bases that for the next 5 years the high option suffices and as some potential costs implications will not be known until all the Network Codes are complete, applying the high option and then carrying out a further review if required in 3 years' time when all codes are complete appears to be the most pragmatic solution.</p>
<i>Senvion</i>	No comments offered
<i>Rob Wilson, NGET</i>	<p>The original proposals represent a good balance between cost and benefit delivering the optimum solution to end consumers. No evidence has been provided by developers or manufacturers of significant costs that are incurred in selecting the thresholds set out in the original proposal rather than the alternative (maximum) figures.</p> <p>The main contentious aspect of the banding thresholds has been the B/C threshold; this represents a move from a 'product standard' base in types A/B to a more interactive requirement for operational support in types C/D. Harmonisation is one of the stated aims of the European Network Codes. Publicly available positions in other member states are currently as follows:</p>

Response From **Specific Q10: Do you have any views on the banding thresholds for the original and those suggest for the possible alternative?**

Member State	Type Threshold Proposals			Status
	A/B	B/C	C/D	
BE	250 kW	25 MW	75 MW (25 MW if >110 kV)	Under discussion
CZ	A1: 11 KW A2: 100 KW	B1: 1 MW B2: 30 MW	75 MW	Under discussion
DE	135 KW	36 MW	45 MW	Under discussion
EE	0.5 MW	5 MW	15 MW	Preliminary proposal
ES	100 KW	5 MW	50 MW	Under discussion
FI	1 MW	10 MW	30 MW	Under discussion
FR	1 MW	18 MW	75 MW	Preliminary proposal
HR	500 kW	5 MW	10 MW	Under discussion
HU	200 KW	5 MW	25 MW	Under discussion
IE	100kW	5MW	10MW	Preliminary proposal
LU	135 KW	36 MW	45 MW	Under discussion
NL	1 MW	50 MW	60 MW	Under discussion
NO	1,5 MW	10 MW	30 MW	Under discussion
PL	1MW	50 MW	75MW	Preliminary proposal
PT	1 MW	10 MW	45 MW	Under discussion
RO	1 MW	5 MW	20 MW	Approved
SI	150 kW	5 MW	25 MW	Preliminary proposal
SK	100 KW	5 MW	20 MW	Under discussion

(only public domain positions included – status included correct at Sept 2017 which is mainly under discussion/in workgroup or equivalent)

The original proposal which has a B/C threshold of 10MW is generally aligned well with these positions. The nearest comparators for GB are probably Spain (5MW) and Norway (10MW) in terms of system size and strength. Proposals in the CE block need to be put into context as part of a much larger interconnected area, although it is

Response From	Specific Q10: Do you have any views on the banding thresholds for the original and those suggest for the possible alternative?
	<p>notable that France are still proposing a B/C threshold of 18MW.</p> <p>In RfG the maximums allowable for type thresholds are set by synchronous area in relation to the size of that area – so in the CE block for B/C this is 50MW, the Baltic and Nordic states have 10MW and Ireland 5MW. It should be noted that the GB synchronous area had an original maximum in the ENTSO-E draft of RfG of 10MW for the B/C threshold. GB stakeholders argued successfully that for reasons of harmonisation and to ensure evidence was provided this should be increased to match the CE block figure. A consultation was run through the workgroup in summer 2016 on the banding threshold proposals in GB. No evidence of costs was received in complying with the technical capabilities described in RfG in lowering the B/C banding threshold to 10MW. Costs were highlighted in participating in the balancing mechanism, which at the moment in GB would also be required to facilitate provision of frequency response, however this market participation is not mandated in RfG. Note also that generators choosing to participate in the BM also derive further revenue streams which are assumed to be positive since some embedded generators have done this voluntarily.</p> <p>The original proposals represent a coordinated and complete solution with fault ride through and fast fault current injection. In brief, and though explained in the report, system modelling and studies have shown that fast fault current injection is required to help support post-fault voltages. If the FFCI proposal as set out is accepted a retained voltage post-fault of 0.10pu will be achievable; without FFCI this will be 0.05pu which many generators will struggle to achieve leading to increased cascade tripping and further operational costs. A Uret (retained voltage) setting of 0.10pu is therefore required to avoid this. Workgroup discussion has highlighted that smaller reciprocating diesel generators cannot however comply with this and have a minimum Uret achievable of 0.30pu using current technology. This is due to a slower speed of controller response and inherent lack of inertia. To balance these technical limitations and the system need, therefore, a B/C threshold of 10MW enables Uret to be set at 0.10pu in type C and 0.30pu in type B which was generally accepted by the workgroup as a good compromise.</p> <p>In conclusion therefore, we continue to support the original proposal. No evidence has been provided to instead</p>

Response From	Specific Q10: Do you have any views on the banding thresholds for the original and those suggest for the possible alternative?
	choose the maximum figures as in the alternative. This would in any case leave some difficult choices to be made between an increased risk of cascade tripping and attendant operational costs/system security issues (if Uret was relaxed say to 0.30pu), and codifying a requirement that small generators could not meet (if it was not).
<i>Frank Martin, Siemens Gamesa Renewable Energy (SGRE)</i>	./.
<i>Athanasios Krontiris & Grant McKay, ABB HVDC</i>	No comment indicated

Response From	Specific Q11: Can you provide any feedback/comments on the associated legal text?
<i>Paul Youngman, DRAX</i>	n/a
<i>Christian Merchan, GE Power</i>	No comment
<i>Tom</i>	No comment

Response From	Specific Q11: Can you provide any feedback/comments on the associated legal text?
<i>Chevalier, AMO</i>	
<i>PThomas, Nordex</i>	See (4)
<i>Marko Grizelj, Siemens</i>	No comment indicated
<i>Greg Middleton, AMPS</i>	No comment
<i>Alan Creighton, Northern Powergrid</i>	<p>We have separately provided comments on the proposed legal text associated with the Distribution Code to the technical authors, in order that these comments could be factored into the legal text that is currently being drafted for GC0102. It is difficult to form a view of the legal text until a complete set of legal text, including the definitions, required to implement RfG is available.</p> <p>If any of the potential alternatives are developed, stakeholders will need to have visibility and the opportunity to comment on the legal text required to implement them.</p>
<i>DONG</i>	No comment received
<i>Konstantinos Pierros, ENERCON GmbH</i>	We are happy, but we would like to see the limits with more significant digits and not rounded (0.999MW and not 1MW).
<i>Christopher Smith, National Grid Interconnector</i>	No comments offered

Response From	Specific Q11: Can you provide any feedback/comments on the associated legal text?
<i>Holdings Ltd</i>	
<i>Kamran Sharifabadi, Statoil</i>	No comments offered
<i>Isaac Gutierrez, Scottishpower Renewable ltd (UK)</i>	Legal text seems ok although there are missing comments made during the legal text revision meeting. A second meeting just for legal text review shall be held
<i>Graeme Vincent, SP Energy Networks</i>	Whilst I appreciate that the track changes are present to assist the reader understand the changes which have been made, we did find it quite difficult to follow what a 'clean' version of the text would look like. Also as we have a limited time to read and review all the associated legal text associated with this modification and that of GC0101 (both distribution and transmission elements.) which has limited us to high level comments only at this stage.
<i>Daniel Fraile, Wind Europe</i>	No response indicated
<i>Garth Graham, SSE</i>	No response indicated
<i>Andy Vaudin, EDF Energy</i>	We agree with the form of the draft legal text, but note that it will require further workgroup review prior to being sent to Ofgem.
<i>Alastair Frew, ScottishPower Generation Ltd</i>	Section ECC.3.7 defines existing users, but in sub-section ECC.3.7.2 for demand facilities paragraphs (a), (b) & (c) contain the word "not" which means it is actually defining new users so the word "not" needs to be removed from these 3 sentences. The legal text as written appears to be fine for the ECC generation section with possible alternatives just changing

Response From	Specific Q11: Can you provide any feedback/comments on the associated legal text?
	<p>the MW levels. An addition section will also be required for the CC section to say it only applies to existing users potentially as follows:- “CC.3.6 The requirements set out in these Connection Conditions shall only apply to Existing Users as defined in ECC.3.7 all other users should refer to the [European Connection Conditions]. “</p>
<i>Senvion</i>	No comments offered
<i>Rob Wilson, NGET</i>	The legal text throughout is written to be as helpful and user-friendly to GB stakeholders as possible. A new European Connection Conditions section is proposed to be added to the Grid Code which combines European Connection Code and existing GB provisions such that compliance with this will for users satisfy all GB and EU requirements.
<i>Frank Martin, Siemens Gamesa Renewable Energy (SGRE)</i>	./.
<i>Athanasios Krontiris & Grant McKay, ABB HVDC</i>	No comment indicated

Response From	Specific Q12: Do you support the fault ride through voltage against time curves If not please state why you disagree, what alternative you would recommend and your justification for any alternative?
<i>Paul Youngman, DRAX</i>	Yes, and we would expect that this would minimise impacts to the underlying resilience of the network. We would also reasonably expect that significant changes to network characteristics would be notified to relevant parties.
<i>Christian Merchan, GE Power</i>	No comment
<i>Tom Chevalier, AMO</i>	No comment
<i>PThomas, Nordex</i>	<p>General Comment:-</p> <p>For multiple and sequential FRT performance it is very important that PPU's do not face unrealistic requirements. Whilst FRT tests at zero volt are done and passed in a test environment, Nordex have many hundreds of real FRT measurements. These are both single and multiple three phase faults on transmission connected wind farms taken over several years. The retained voltage has been well above zero volt at the PPU.</p> <p>For multiple / repetitive faults, actual FRT performance strongly depends on realistic values being specified for retained voltage.</p> <p>Nordex therefore believe the GCode requirements should distinguish between symmetrical and asymmetrical faults, and assume realistic retained voltage levels at the PPU.</p>
<i>Marko Grizelj, Siemens</i>	No comment indicated
<i>Greg</i>	Yes, if Uret remains at 0.3

Response From	Specific Q12: Do you support the fault ride through voltage against time curves If not please state why you disagree, what alternative you would recommend and your justification for any alternative?
<i>Middleton, AMPS</i>	
<i>Alan Creighton, Northern Powergrid</i>	No response
<i>DONG</i>	We support the FRT voltage time curves proposed for various kinds of generation.
<i>Konstantinos Pierros, ENERCON GmbH</i>	Support with one exception: NGET should model as well a curve for Type B,C and D (below 110kV) with U_{ret} of 0.05pu and possibly below. Justification: technology readiness
<i>Christopher Smith, National Grid Interconnector Holdings Ltd</i>	No comments offered
<i>Kamran Sharifabadi, Statoil</i>	NO, we don't support the proposal.
<i>Isaac Gutierrez, Scottishpower Renewable ltd (UK)</i>	Yes

Response From	Specific Q12: Do you support the fault ride through voltage against time curves If not please state why you disagree, what alternative you would recommend and your justification for any alternative?
<i>Graeme Vincent, SP Energy Networks</i>	No response
<i>Daniel Fraile, Wind Europe</i>	No response indicated
<i>Garth Graham, SSE</i>	We support the proposed FRT curves.
<i>Andy Vaudin, EDF Energy</i>	We support the FRT proposals in general. However, the report does not include the analysis, which would demonstrate that there will not be system security issues and associated costs to consumers, from setting the band B synchronous generator Uret to 0.3 p.u. rather than aligned with other band B generators at 0.1 p.u.
<i>Alastair Frew, ScottishPower Generation Ltd</i>	Yes
<i>Senvion</i>	We support the revised voltage against time curves, however we would comment that this does make the GB fast active power recovery more difficult to achieve. We have commented in the past that achieving this requirement is technically very challenging for larger rotor turbines (e.g. greater than 120m diameter). For DFIG wind turbines this will increase the technology costs.
<i>Rob Wilson,</i>	Yes. As noted above the FFCI/FRT/banding threshold proposals represent a complete and coordinated solution

Response From	Specific Q12: Do you support the fault ride through voltage against time curves If not please state why you disagree, what alternative you would recommend and your justification for any alternative?
<i>NGET</i>	achieving the best compromise between equipment costs and operational benefit for end consumers based on the evidence available.
<i>Frank Martin, Siemens Gamesa Renewable Energy (SGRE)</i>	The consultation document outlines that there is a close link between the proposed voltage against time curves and the fast fault current injection requirements (e.g. section 3.6). As state of the art WPP's (PPM's) are capable of supporting low retained voltage faults and supplying e.g. reactive current it seems that WPP's (PPM's) will be asked to extend their capabilities with the outlined Options to supply fast fault current injection in order to limit Uret (e.g. Figure 5.7). It cannot be responsibility of PPM's to provide more capabilities to limit requirements (e.g. voltage time curve) for other types of generation. A well-functioning ancillary services market should make sure that sufficient amounts of these power system services are available at all times to ensure robust operation of the power system.
<i>Athanasios Krontiris & Grant McKay, ABB HVDC</i>	The fault ride through curve for HVDC converters in Figure 7.3 is in accordance with the EU network code. However, the fault ride through is not related to fault current injection. Setting Ublock equal to zero practically disqualifies line-commutated converters. During drafting of the EU network code for HVDC, great care was taken to avoid such general disqualifications and we suggest that this may be reconsidered. We would like to further highlight that the instance of fault clearance needs a clear definition. The requirements for FRT and subsequent active power recovery up to 90% within 500 ms from fault clearance must be related to the instance the voltage returns in the 0.9-1.1 pu band. Otherwise significant overrating of the converter is necessary. Note that the term "fault clearance" is also used in Figures 4.4 and in section 4.4, however with another interpretation.

Response From	Specific Q13: Do you have any specific views about the proposal to modify the stage 2 under voltage protection for distributed generation interface protection?
<i>Paul</i>	No

Response From	Specific Q13: Do you have any specific views about the proposal to modify the stage 2 under voltage protection for distributed generation interface protection?
<i>Youngman, DRAX</i>	
<i>Christian Merchan, GE Power</i>	No comment
<i>Tom Chevalier, AMO</i>	No comment
<i>PThomas, Nordex</i>	No
<i>Marko Grizelj, Siemens</i>	No comment indicated
<i>Greg Middleton, AMPS</i>	AMPS supports this
<i>Alan Creighton, Northern Powergrid</i>	The proposal seems reasonable to help ensure that the ride through capability can be delivered in practice.
<i>DONG</i>	No comment indicated
<i>Konstantinos Pierros, ENERCON GmbH</i>	We are happy with the proposal. Facilitation of FRT should be a priority and DNOs must adhere to this.
<i>Christopher</i>	No comments offered

Response From	Specific Q13: Do you have any specific views about the proposal to modify the stage 2 under voltage protection for distributed generation interface protection?
<i>Smith, National Grid Interconnector Holdings Ltd</i>	
<i>Kamran Sharifabadi, Statoil</i>	No comments offered
<i>Isaac Gutierrez, Scottishpower Renewable ltd (UK)</i>	No
<i>Graeme Vincent, SP Energy Networks</i>	No we don't have any specific views on this aspect, though acknowledge that changes will be required to align with RfG requirements.
<i>Daniel Fraile, Wind Europe</i>	No response indicated
<i>Garth Graham, SSE</i>	We support in principle the proposed change which avoids the risk of tripping of G59 protection, subject to this not being more stringent than the requirements of the EU Network Codes.
<i>Andy Vaudin, EDF Energy</i>	We agree that this is a reasonable approach.
<i>Alastair Frew, ScottishPower</i>	Seem OK

Response From	Specific Q13: Do you have any specific views about the proposal to modify the stage 2 under voltage protection for distributed generation interface protection?
<i>Generation Ltd</i>	
<i>Senvion</i>	No response indicated
<i>Rob Wilson, NGET</i>	No
<i>Frank Martin, Siemens Gamesa Renewable Energy (SGRE)</i>	./.
<i>Athanasios Krontiris & Grant McKay, ABB HVDC</i>	No comments offered

Response From	Specific Q14: Does the Legal drafting contained in annex 2 and 3 deliver the intent of the solution outlined in section 3?
<i>Paul Youngman, DRAX</i>	It is currently unclear, given that the legal text is yet to be finalised, that the text reflects the intent of all the aspects of the modification.
<i>Christian</i>	No comment

Response From	Specific Q14: Does the Legal drafting contained in annex 2 and 3 deliver the intent of the solution outlined in section 3?
<i>Merchan, GE Power</i>	
<i>Tom Chevalier, AMO</i>	No comment
<i>PThomas, Nordex</i>	n/a
<i>Marko Grizelj, Siemens</i>	It is not immediately clear that alternative requirements can be agreed for Remote End Converters and DC Connected Power park modules (within the framework of the EU grid code).
<i>Greg Middleton, AMPS</i>	G98 drafts need considerable further work before they can be consulted on
<i>Alan Creighton, Northern Powergrid</i>	See response to 11
<i>DONG</i>	No comment indicated
<i>Konstantinos Pierros, ENERCON GmbH</i>	<p>Annex 2: It appears to be quite convoluted for the time being! Hard to go through it with all the changes. Perhaps introduce a clean version of it for people to comment from scratch.</p> <p>We note that a few points appear to be contradictory (not exhaustive);</p> <ul style="list-style-type: none"> - voltage against time curve for Type B, C and D Power Park Modules under ECC.6.3.15.5 have a U_{ret} of 0.15 and then ECC.6.3.15.9 (b) shows a curve with zero retained voltage for 0.140s? - voltage against time curves for voltage at different nodes (supergrid vs Grid/User System Entry Point)
<i>Christopher</i>	Yes

Response From	Specific Q14: Does the Legal drafting contained in annex 2 and 3 deliver the intent of the solution outlined in section 3?
<i>Smith, National Grid Interconnector Holdings Ltd</i>	
<i>Kamran Sharifabadi, Statoil</i>	No comments offered
<i>Isaac Gutierrez, Scottishpower Renewable ltd (UK)</i>	No as it is not taking into consideration yet the impact of FFCI. In the consultation document the following is mentioned: <i>“Without FFCI as proposed (does this mean VSM option?), the proposal will need to lower the value of Uret (from 0.1pu to 0.05pu) and even then, this value would only appropriate in the short term before a further review is likely to be required.”</i> . The final legal text will depend on both the consultation responses and defining values like Uref properly under the absence of VSM
<i>Graeme Vincent, SP Energy Networks</i>	Whilst I appreciate that the track changes are present to assist the reader understand the changes which have been made, we did find it quite difficult to follow what a ‘clean’ version of the text would look like but believe so.
<i>Daniel Fraile, Wind Europe</i>	No response indicated
<i>Garth Graham, SSE</i>	<p>We <u>do not</u> agree that the draft legal text contained in Annex 2 and 3 delivers the intent of the solution outlined in Section 3.</p> <p>This is because the intent of the GC0100 solution is to ensure that all the requisite applicable articles of the EU Network Codes (RfG, DCC and HVDC) are implemented into the national network codes (namely the Grid Code and Distribution Code).</p>

Response From	Specific Q14: Does the Legal drafting contained in annex 2 and 3 deliver the intent of the solution outlined in section 3?
	<p>However, there is <u>no evidence</u> provided that clearly maps over each of the EU Network Code obligations (that GC0100 is intended to implemented into the national network codes) to the draft legal text.</p> <p>It was clear from the August Workgroup review of the draft legal text for GC0100 that multiple gaps and inconsistency existed (at that time) between the draft legal text and the delivery of the intent of the solution outlined in Section 3 of the Workgroup consultation. Our review of the latest draft legal text shows that many gaps and inconsistencies still exist.</p> <p>Absent a clear mapping of the EU Network Code articles to the draft legal text we cannot see how either (a) the Workgroup; or (b) stakeholders; or (c) the requisite Code Panel(s); or (d) Ofgem can say that the draft legal text does deliver the solution outlined in Section 3.</p> <p>Notwithstanding the above, we also note that the draft legal text appears to be in direct contravention of the EU Network Codes.</p> <p>By way of example, the suggested use of the existing national definitions, amended in part by the EU Network Code requirements, has the unintended (or possibly intended?) consequence that it will not be clear to existing connected parties that, in fact, they are not actually bound by the EU Network Code amended definitions within the Grid Code (or Distribution Code) as this would be applying those EU Network Codes definitions (and associated obligations) to existing connected parties without either (1) a CBA being undertaken or (2) those parties having substantially modified their respective connection agreement(s) which would be in direct contravention of the RfG, DCC and HVDC Network Codes.</p> <p>Another, more specific example (one of many) is the suggested wording of ECC2.1:</p> <p><i>“For the purposes of the Grid Code, physical quantities such as current or voltage are not defined terms as their</i></p>

Response From	Specific Q14: Does the Legal drafting contained in annex 2 and 3 deliver the intent of the solution outlined in section 3?
	<p><i>meaning will vary depending upon the context of the obligation. For example, voltage could mean positive phase sequence root means square voltage, instantaneous voltage, phase to phase voltage, phase to earth voltage. The same issue equally applies to current, and it therefore felt that in view of these variations the terms current and voltage should remain undefined with the meaning depending upon the context of the application. <u>The European Connection Codes define requirements of current and voltage but they have not been adopted as part of EU implementation.</u>” [emphasis added]</i></p> <p>As the wording in ECC2.1 acknowledges, there is an EU Network Codes definition for ‘voltage’ (see RfG Article 2 (3)) namely:</p> <p><i>“‘voltage’ means the difference in electrical potential between two points measured as the root-mean-square value of the positive sequence phase-to-phase voltages at fundamental frequency”</i></p> <p>However, despite this, according to ECC2.1 this is not to be adopted for the purposes of GB.</p> <p>Not only is the entirely without merit and in contravention of the defect (as the objective of GC0100 is to implement the EU Network Codes in their entirety) it also begs a number of questions; such as:</p> <p>‘what other parts of the EU Connection Network Codes are also ‘conveniently’ to be ignored (according to the draft legal text) and not adopted as part of GC0100?’;</p> <p>‘what additional parts of the EU Connection Network Codes (not already included in the draft legal text) can also ‘conveniently’ now be ignored and not adopted as part of GC0100?’</p> <p>We were unaware that the implementation of the EU Network Codes within the GB national network codes was to be on the basis of such an ‘a la carte’ approach.</p>

Response From	Specific Q14: Does the Legal drafting contained in annex 2 and 3 deliver the intent of the solution outlined in section 3?
	This being the case we feel certain that generators, demand facilities and HVDC links newly connecting to the GB network will, likewise, wish to see this 'a la carte' approach being applied to other parts of the EU Network Codes when it comes to GB implementation that are 'convenient' to them.
<i>Andy Vaudin, EDF Energy</i>	We agree with the form of the draft legal text, but note that it will require further workgroup review prior to being sent to Ofgem
<i>Alastair Frew, ScottishPower Generation Ltd</i>	Yes, only question about the legal text changes is the text change in ECC.A.4A.2 paragraph 3 which appears to be just a clarification of existing text, should also be applied to CC.A.4A.2 paragraph 3? Looking at the EXXAX2.2 & 3 figures for all 3 options the time axis is not always titled and there are no units, similar for the voltage & current axis. On the example graphs for options 2 & 3 it might be useful if the requirement trace stopped at the point of fault clearance so as not to show parts where the response curve is less than the requirement curve.
<i>Senvion</i>	"The converter of each Type B, Type C and Type D Power Park Module... " Drafting implies that a PPM will only have 1 converter, which is not necessarily the case.
<i>Rob Wilson, NGET</i>	Yes
<i>Frank Martin, Siemens Gamesa Renewable Energy (SGRE)</i>	To some extent. As for example the legal draft (annex 2) presents the intended changes. Unfortunately it is not fully clear how the proposed options will be incorporated in the legal draft – e.g. ECC.6.3.15.9.2 b (ii) and fast fault current injection is not clear but is highly relevant for manufacturers.
<i>Athanasios Krontiris &</i>	No comments offered

Response From	Specific Q14: Does the Legal drafting contained in annex 2 and 3 deliver the intent of the solution outlined in section 3?
<i>Grant McKay, ABB HVDC</i>	

Response From	Specific Q15: Do you have any information based on the proposed solution in respect of implementation costs?
<i>Paul Youngman, DRAX</i>	No
<i>Christian Merchan, GE Power</i>	No comment
<i>Tom Chevalier, AMO</i>	No comment
<i>PThomas, Nordex</i>	No
<i>Marko Grizelj, Siemens</i>	No comment indicated
<i>Greg Middleton, AMPS</i>	Refer to costings previously supplied to GC0048
<i>Alan Creighton, Northern</i>	No response

Response From	Specific Q15: Do you have any information based on the proposed solution in respect of implementation costs?
<i>Powergrid</i>	
<i>DONG</i>	No comment indicated
<i>Konstantinos Pierros, ENERCON GmbH</i>	Depending on the option chosen, we might be able to provide feedback confidentially.
<i>Christopher Smith, National Grid Interconnector Holdings Ltd</i>	No comments offered
<i>Kamran Sharifabadi, Statoil</i>	Yes. But Statoil cannot share any of the Vendor material, CAPEX, development plans with a third party e.g. National Grid.
<i>Isaac Gutierrez, Scottishpower Renewable ltd (UK)</i>	No
<i>Graeme Vincent, SP Energy Networks</i>	No response

Response From	Specific Q15: Do you have any information based on the proposed solution in respect of implementation costs?
<i>Daniel Fraile, Wind Europe</i>	No response indicated
<i>Garth Graham, SSE</i>	Some of the additional implementation costs in respect of the proposed solution are set out on pages 59-60.
<i>Andy Vaudin, EDF Energy</i>	None
<i>Alastair Frew, ScottishPower Generation Ltd</i>	No
<i>Servion</i>	No response indicated
<i>Rob Wilson, NGET</i>	No
<i>Frank Martin, Siemens Gamesa Renewable Energy (SGRE)</i>	./.
<i>Athanasios Krontiris & Grant McKay, ABB HVDC</i>	No comments offered

4. Workgroup Discussions

4.1. Workgroup

The Workgroup convened seven times to discuss the issue, detail the scope of the proposed defect, devise solutions and assess the proposal in terms of the Grid Code Applicable Objectives.

The Proposer presented the defect that they had identified in the GC0100 proposal. The discussions and views of the Workgroup are outlined below.

4.2. Definitions

A complex area of this work has been the management of definitions between the defined terms used in the EU Network Codes and those used in the GB national network codes, such as Grid Code and Distribution Code.

Article 2 of RfG includes a number of definitions which relate to physical quantities for example, voltage and current. RfG does however define these terms for example

“Voltage” means the difference in electrical potential between two points measured as the root mean square of the positive sequence phase to phase voltages at fundamental frequency”

“Current” means the rate at which electric charge flows which is measured by the root mean square value of the positive sequence of the phase current at fundamental frequency.”

These definitions do create a number of issues, largely because there are many different connotations of these physical quantities. For example, in a three phase system the voltage could be the instantaneous phase to neutral voltage, the instantaneous phase to phase voltage, the positive phase sequence RMS voltage, the transient over voltage to name but a few. The same issue arises with other physical quantities such as current. In these circumstances it was suggested by the Proposer that it was far better if the correct term as defined in IEC standards or equivalent are used.

This issue was discussed amongst the Workgroup on a number of occasions. In general the GB Codes do not define terms such as current or voltage as a result of the different set of circumstances under which they would apply. After advice was sought from the ENTSO-E code drafting team, some Workgroup Members set out that physical quantities or other standard engineering terms did not need to be re-defined to implement the EU Connection Codes, and that the current GB definitions could therefore be used. In the main this approach was accepted by the workgroup membership.

However, one Workgroup member was concerned that substituting GB definitions for those in the EU Network Codes may have unintended consequences, including that it could (i) amount to applying more stringent obligations⁵ on 'new' connecting parties than required by the EU Network Codes and / or (ii) result in existing connected parties being obligated under the EU Network Codes without either (a) them having modified their facility to such an extent that their connection agreement required to be amended accordingly and / or (b) having not been the subject of a Cost Benefit Analysis undertaken in accordance with the EU Network Codes.

Some Workgroup members noted that whilst ENTSO-E's views on this topic were interesting, they had no vires to opine on this matter.

4.3. Interaction between Fast Fault Current Injection, Fault Ride Through and Banding

Article 20(2) of RfG defines the need for Relevant System Operators to define the requirements for Power Park Modules to supply Fast Fault Current Injection. The current GB Grid Code (CC.6.3.15) simply states that Generating Units and Power Park Modules should supply maximum reactive current without exceeding the transient rating of the Generating Unit or Power Park Module.

Some Workgroup Members noted that alone does not provide sufficient detail to satisfy the requirements in RfG. Moreover, the changing nature of the generation has seen a trend towards more converter based plant connecting to the Distribution system which in turn has started to displace conventional synchronous generation connected to the Transmission system. This, the Proposer noted, has started to have a significant effect on the behaviour of the Transmission system.

Unlike Synchronous Generation which can instantaneously supply 5 – 7 times its rated current upon fault inception, converter based generation is limited to supplying just over its maximum rated current (i.e. 1 – 1.2pu rated current) and even then, the injected current will be delayed some tens of milliseconds following fault inception.

The implication of this, according to the Proposer, is that the voltage profile seen across the system during the fault would be lower than that compared to a system comprising solely of synchronous generation; this has important implications for Fault Ride Through (FRT).

Fault Ride Through is the ability of Generation to remain connected and stable to a healthy circuit when the Transmission system has been subject to a fault. The principle being that under the Security and Quality of Supply Standards (SQSS) the GB System Operator caters for a maximum

⁵ The background associated with 'more stringent' obligations is explored later in this section under 'Potential Alternatives (b) Removing More Stringent Requirements'.

infrequent infeed loss of up to 1800MW but does not cater for the loss of the total infeed source⁶ connected to a healthy circuit. As such without Fault Ride Through there is the associated risk of cascade generation and / or interconnector tripping, frequency collapse and a black out situation.

Under RfG, Fault Ride Through is specified in respect of a voltage against time curve at the Connection Point, with the retained voltage (U_{ret}) being a key parameter. For Type B, C and D Power Generating Modules connected below 110kV the value of U_{ret} can be set at any value between 0.05pu – 0.3pu for Synchronous Power Generating Modules and 0.05 – 0.15pu for Power Park Modules.

The voltage profile observed across the system during a fault is a function of the reactive current injected; the greater the fault current injection, the higher the retained voltage.

It is known (as evidenced by Stakeholders during the GC0048 Workgroup – Annex 11) that synchronous generation driven by reciprocating engines (e.g. gas or diesel) which are typically up to a maximum of 5MW in size will be unable to ride through voltage dips below 0.3pu. There is currently no known technical or economic solution to this problem other than installation of Power Electronic converters. Other forms of synchronous derived generation (e.g. gas turbines, steam turbines or hydro plant) are not believed to suffer from these problems. If power electronic converters were fitted it not only increases the cost disproportionately but secondly the under the definitions of the RfG European Code, it would be classified as a Power Park Module for which a different set of fault ride through and fast fault current requirements would apply.

One Workgroup Member pointed out that there would be no issue with electronic converters having to be re-classified and highlighted that the main point is for small generators to be able to ride through and not fall off the grid by increasing the size of the contingency. The Workgroup Member further noted the need for the increase in costs to be compared alongside wider costs and benefits imposed by this type of generation.

Analysis conducted by the Proposer as part of this work has demonstrated that a value of U_{ret} of 0.1pu would be required for all Power Park Models above 1MW and all Synchronous Generators above 10MW. If the volumes of Fast Fault Current Injection were not forthcoming, then consideration would need to be given to reducing the value of the retained voltage even further typically to 0.05 pu.

Under RfG, it is not possible to split bands for the four generation Types (e.g. if Band B was set at 1- 50MW it is not possible to have one set of

⁶The SQSS caters for a maximum infrequent infeed loss of 1800MW which could be derived from Generation or an Interconnector. The SQSS does not however cater for a complete Power Station or Interconnector loss but rather a criteria on which the maximum volume of MW could be lost for a credible Transmission System fault.

Fault ride through parameters between 1 – 10MW and another parameter set between 10 – 50MW).

Following the GC0048 consultation on banding in 2016, no significant evidence was presented from the generator community other than the material cost threshold of £10,000 for compliance would be incurred as a result of lowering the GB banding level from the maximum permitted in the RfG; although some Workgroup members noted that the banding levels set in the RfG were, subsequently, used in some of the other EU Network Codes and associated documents (such as, for example, the System Operation Guideline and the Generation Load Data Provision Methodology).

Other costs and benefits associated with these proposals are described later in this report. However the volume of Fast Fault Current Injection is contingent on the value of retained voltage – a key parameter for Fault Ride Through which in turn affects the banding level.

The current Distribution Code does not specify a Fault Ride Through requirement for Small Embedded Power Stations. The Proposer noted that whilst Fault Ride Through requirements have been applied to Medium and Large Power Stations; this had been achieved through Grid Code requirements. The requirements that will apply, according to the RfG, to Type B and above generation will result in mandatory Fault Ride Through capabilities needing to be specifically written into the Distribution Code and associated Engineering Recommendations.

4.4. Fast Fault Current Injection

4.4.1. Fast Fault Current Injection Introduction

As has been described in section 3.3.3, Fast Fault Current Injection is currently only loosely defined in section CC.6.3.15 of the GB Grid Code which simply states that the Generating Unit or Power Park Module shall inject maximum fault current without exceeding the transient rating of the Generating Unit or Power Park Module.

RfG is silent on the fast fault current injection requirements for Synchronous Power Generating Modules and as a result no requirement is specified here as it is an inherent capability for these kinds of Power-Generating Facilities to inject high fault currents when subject to a disturbance.

So far as Power Park Modules are concerned, RfG Article 20(2)(b) defines the requirements for Fast Fault Current Injection. These requirements are far more specific than the current GB Grid Code requirements.

It is firstly important to state that under RfG, the System Operator in co-ordination with the relevant TSO shall have the right to specify that a Power Park Module must be capable of providing Fast Fault Current at the

connection point in the case of symmetrical (3-phase) faults and asymmetrical faults (1-phase or 2 phase).

System analysis has demonstrated the need for the injection of fast fault current. There are a number of options for this, including different control strategies, operational running regime, market solutions or the use of additional reactive compensation equipment such as Synchronous Compensators. In addition, the current GB Grid Code also defines in loose terms the need for Generating Units and Power Park Modules to inject reactive current. As there is a defined system need for reactive current injection then going forward any requirement for reactive current injection by new connecting Type B generation⁷ would need to comply with the requirements of RfG (whilst existing generation would continue to be subject to the current Grid Code requirements).

4.4.2. Setting the RfG Fast Fault Current Injection Parameters

To develop the requirements for fast fault current injection, the Proposer ran a number of detailed studies. These largely concentrated on the modelling and behaviour of the converter performance. As part of this study, the converter was modelled as a i) a negative demand (ie zero reactive current injection), ii) a standard Phase Locked Loop (PLL) Converter (ie conventional converter model iii) A Phase Locked Loop Converter model where the maximum ceiling current and rise time were varied and iv) the converter was modelled to have the same characteristics as a synchronous machine. This latter controller is referred to as the virtual synchronous machine or VSM.

In summary conventional PLL converters are slow to inject reactive current and this in turn will affect the retained voltage at the connection point which is a key criteria for fault ride through.

The Virtual Synchronous Machine model does however inject reactive current into the system immediately upon fault inception and on fault clearance immediately reduces reactive current injection and therefore gave significantly better results than the other models. This results in faster support for the network voltage during the fault but also avoids temporary overvoltage following fault clearance. However it is very much a solution to which there have been no real full scale commercial trials or application on public Grid Systems though there have been applications for its use in the Marine industry. It is also recognised that mandating such requirements by May 2018 is an unreasonable requirement. That said a lower requirement based on the current available capabilities of converter based technology is possible and as part of this work, three options are presented which are described later in this report. Full details of this study work are detailed in Annex 8 which concentrated on the South West but additional studies have shown that the conclusions of this study are equally applicable to other parts of the country.

⁷ Namely that generation which falls within the scope of the RfG Network Code.

An important part of this study is that to inject no reactive current is not an option and some degree of fast fault current injection will be necessary which will have to be specified as part of compliance with the RfG Code (Article 20).

In terms of overall performance, the higher the injected reactive current and the faster it can be supplied, the greater the retained voltage which is important in retaining an adequate voltage profile across the system, particularly for Fault Ride Through. It was notable that any delay in delivering fault current did have a notable effect on the retained voltage.

So far as the conclusions of the study (which can be located in Annex 8) are concerned, the virtual synchronous machine converter controller, in the view of the Proposer, provided very good performance. It is fully accepted that this is new and an evolving technology and requires further assessment. In addition to the benefits in contributing to fast fault current it also has the following features:-

- Contribution to synchronising torque
- Contribution to System inertia and Rate of Change of System Frequency (RoCoF)
- Compatible with Synchronous machines
- Reduced interaction and high frequency instability risks
- Can be modelled in Route Mean Square (RMS) studies
- It can be easily integrated into existing Grid Systems and enables greater market share for converter derived generator technologies
- It does however have the disadvantage of requiring Storage / overload capability and they suffer from the classical instability issues associated with conventional synchronous generators.

Most of the listed features can be obtained from the current generation of VSC converter controls, specifically; contribution to System Inertia, and RoCoF, compatible with synchronous machines, is not materially different in terms of interaction and high frequency instability, RMS modelling is not valid unless fully verified with EMT models and this applies both to existing VSC controls as well as VSM, VSC can be easily integrated.

It is acknowledged that whilst the Virtual Synchronous Machine did offer significant advantages compared to the other converter controller this needs to be put in the wider context of the System as a whole and what other solutions such as synchronous compensators or market based solutions could be used. That said, RfG is mandating a converter performance requirement which would be applicable to all Type B Power Park Modules and above. If a lower specification were adopted then there would still be a requirement for a minimum converter performance requirement but with some alternatives such as the use of Synchronous Compensation equipment installed around strategic parts of the system. Whilst installing synchronous compensators is a conventional, mature technology which is used in many parts of the world and other European countries (e.g. Norway) are considering this approach. The cost and

strategic location of these synchronous compensators would need to be fully understood.

It is probably worthy of note that whilst VSM technology is considered to be very much emerging, other developments around the world investigating this type of technology. ENTSO-E commissioned a one year study in the second half of last year (2016) to look at the effect of Grid Forming Converters which would include VSM type technology. This alone will fall outside the timescales of Rfg implementation. In addition, CIGRE are also looking at these types of concepts.

A Workgroup member engaged with a number of suppliers, developers and well renowned consultants in this particular area. A consensus was provided that Voltage Source PPM and HVDC have no inherent overload capability. Therefore any implementation of overload will lead to two key impacts for developers

Impact 1: Overload “headroom” will need to be created. This leads to a non-economically efficient technical solution to the developers and

Impact 2: UK specific products - The nett impact for developers would be increased cost and additional technology risk as new requirements create unique or unproven technologies.

In summary, the Proposer stated that the conclusions and subsequent proposals arising out of this study work were as follows:-

The current GB Grid Code requirement for Fast Fault Current Injection under CC.6.3.15 (inject maximum reactive current without exceeding the transient rating of the Generating Unit or Power Park Module) is not tenable in the longer term as it does not address the delays in injecting fault current nor the loss in synchronising torque which results in low values of retained voltage. To this end, a significant generation loss in the future with a low background of synchronous generation is more likely to result in a blackout situation rather than simply operation of low frequency demand disconnection relays.

Fast Fault Current Injection is a requirement, and proposals will need to be put in place to ensure consistency with RfG.

VSM type technology offers a possible solution in the longer term but this would need to be assessed against other alternatives such as other control schemes or synchronous compensation options but the total cost of all these solutions requires assessment.

4.4.3. Fast Fault Current Injection Options

With the GB Grid Code to be updated by May 2018 to ensure consistency with RfG, it is unreasonable to expect newly connecting Type B and above Generators to satisfy any form of VSM type requirement by this time. Three

options are therefore proposed for new Power Park Modules and HVDC equipment

Option 1 would effectively require new Type B and above Power Park Modules and HVDC Plant to act as a voltage source behind a constant reactance (i.e. VSM type technology). The Grid Code legal text (Annex 1 of this report) would simply define a functional performance requirement.

Option 2 requires a minimum volume of reactive current injection as shown in Figure 4.1(a) and (b). Blocking is permitted on fault clearance to prevent the risk of transient overvoltages). This option would apply to all New Type B and above Power Park Modules which had not signed their contract for major plant items by 17 May 2018 or HVDC Owners who had not signed their contract for major plant items by September 2018.

Option 3 is a duplicate of Option 2 above but the maximum ceiling current would be limited to 1.0pu as shown in Figure 4.2(a) and 4.2(b). This option would apply to all New Type B and above Power Park Modules which had not signed their contract for major plant items by 17 May 2018 or HVDC Owners who had not signed their contract for major plant items by September 2018.

Please note that following the Workgroup Consultation the Proposer has clarified that **Option 3** is their proposed solution which is reflected in the legal text in Annex 1.

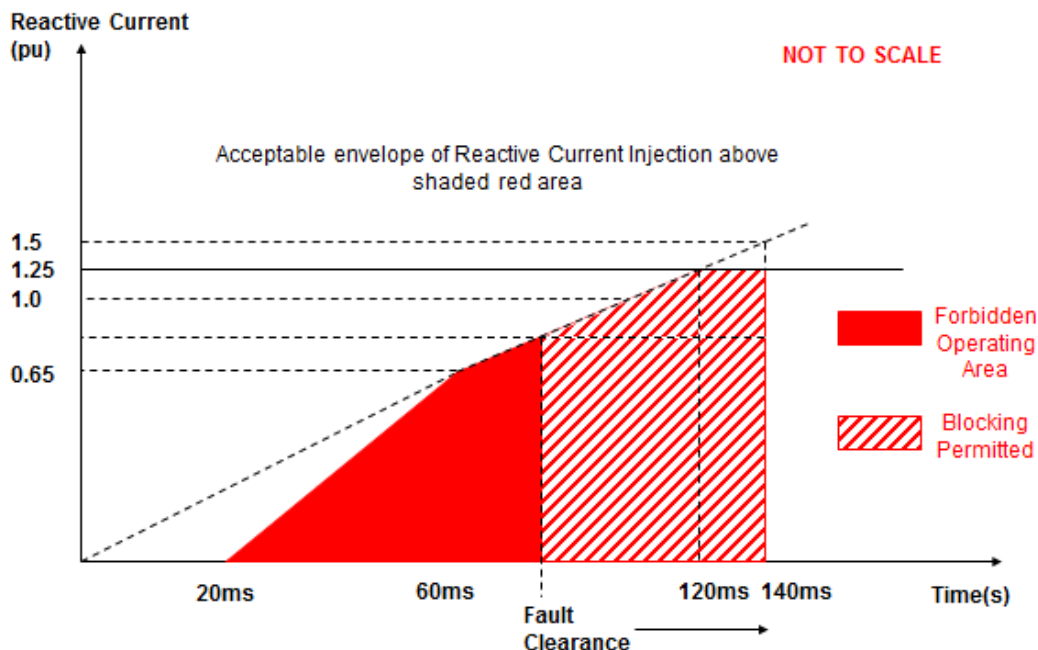

Figure 4.1 (a) Effect of Fast Fault Current Injection Option 2 on clearance time

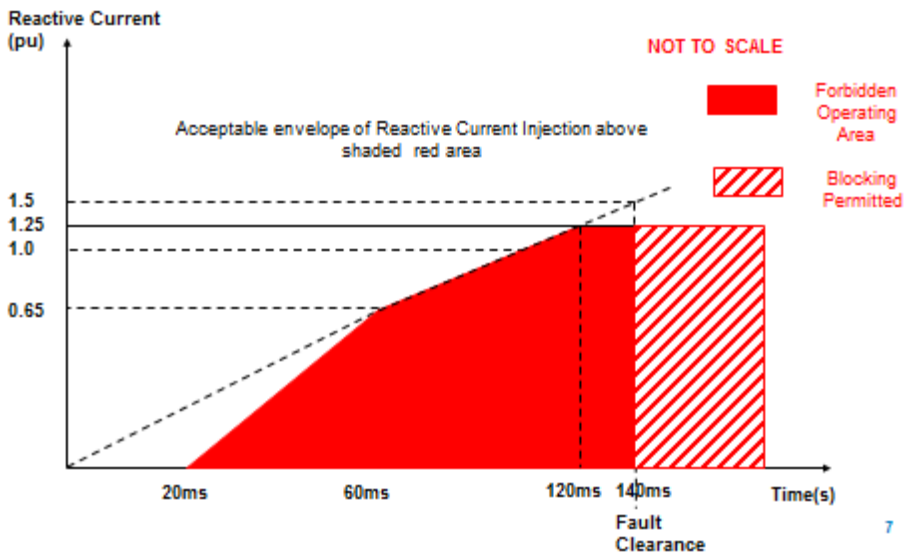

Figure 4.1 (b) Effect of Blocking Option 2 on slow fault clearance time up to a maximum of 140ms

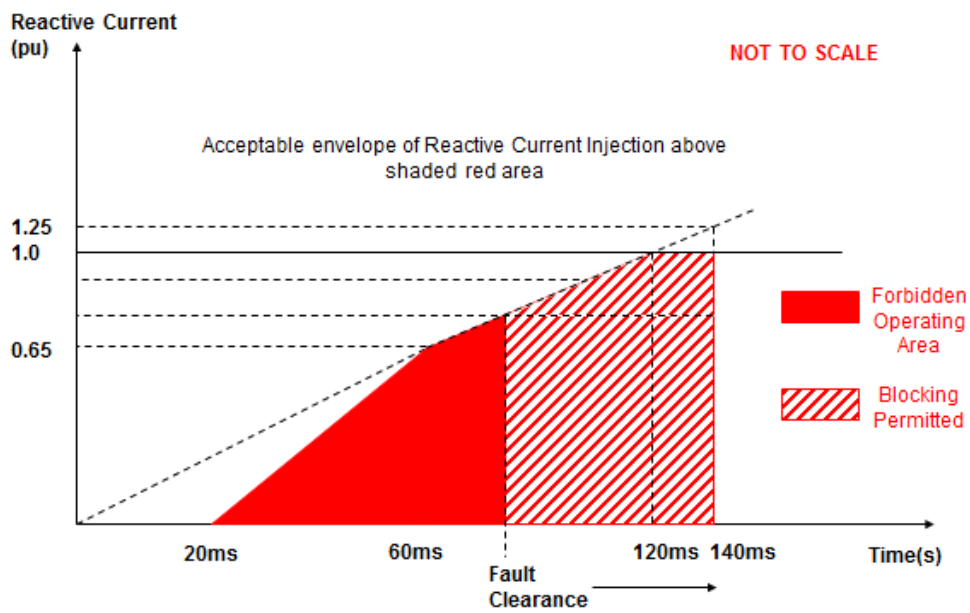

Figure 4.2 (a) Effect of Blocking Option 3 on a fast fault clearance time

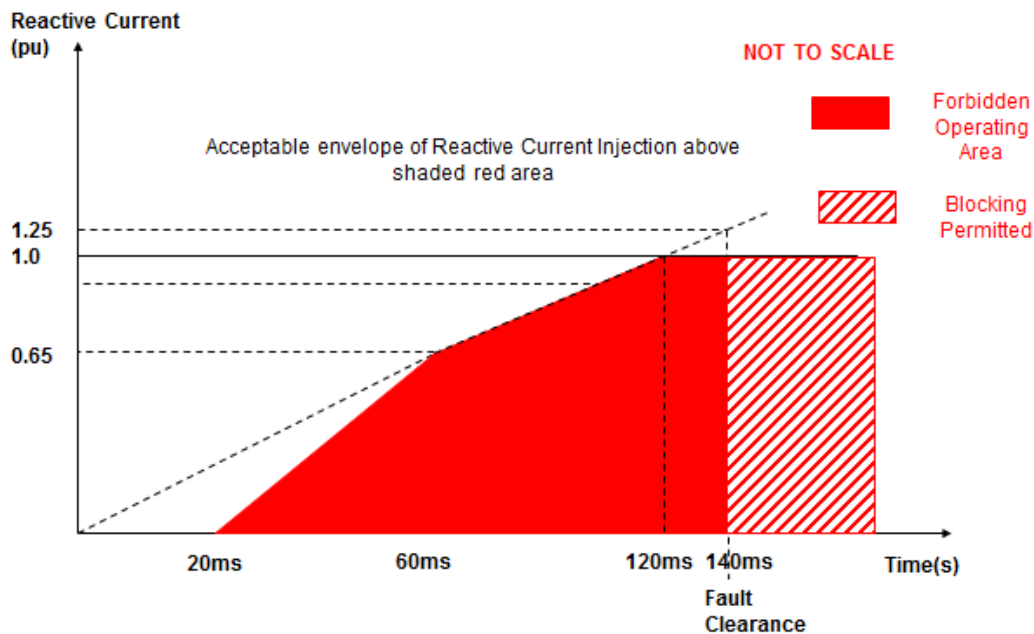

Figure 4.2 (b) Effect of Blocking Option 3 on slow fault clearance time up to a maximum of 140ms

The workgroup discussed all three options and corresponding legal text has also been developed as shown Annex 1. As a result of these discussions, a number of important points were noted. These being

- VSM technology (option 1) does have the potential to provide a significant number of system benefits.
- VSM technology is unproven and requires longer development timescales in addition to some form of international benchmarking.
- Other alternatives such as the use of Synchronous Compensation equipment needs to be considered in addition to the overall System costs.

From the System Operators perspective, there is the immediate short term need to implement the EU Connection codes which include the requirements for Fast Fault Current Injection. In the longer term, there is the need to ensure the robustness and integrity of the System in a reasonable, proportionate and efficient manner.

4.4.4. Application of Fast Fault Current Injection requirements to Offshore Power Park Modules

As stated in RfG Article 25(4) “The voltage stability requirements specified respectively in points (b) and (c) of Article 20(2) as well as in Article 21(3) shall apply to any AC connected Offshore Power Park Module.”

In terms of Fast Fault Current Injection, there would be no difference in the requirements to Offshore Power Park Modules as to their Onshore counterparts (i.e. an Offshore Power Park Module would have to meet either Option 1 or Option 2 of the fast fault current injection requirements).

4.4.5. HVDC Fast fault Current Injection and Fault ride through

4.4.5.1. Background

The HVDC Code deals with three types of equipment – HVDC Systems, DC Connected Power Park Modules and Remote End HVDC Converters. HVDC Systems covers Interconnector type installations between say one Synchronous Area and another be they current source or voltage source. All these configurations are covered under Title II of the HVDC Code.

On the other hand, Title III of the HVDC Code covers DC Connected Power Park Modules and Remote End HVDC Converters. These representations are shown in Figure 4.3(a) and (b).

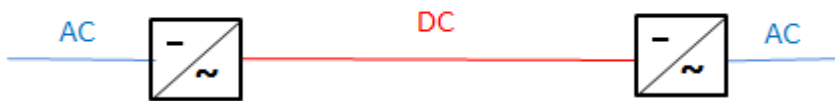

Figure 4.3 (a) – Illustration of a HVDC Connection caught under the requirements of Title II of the HVDC Code.

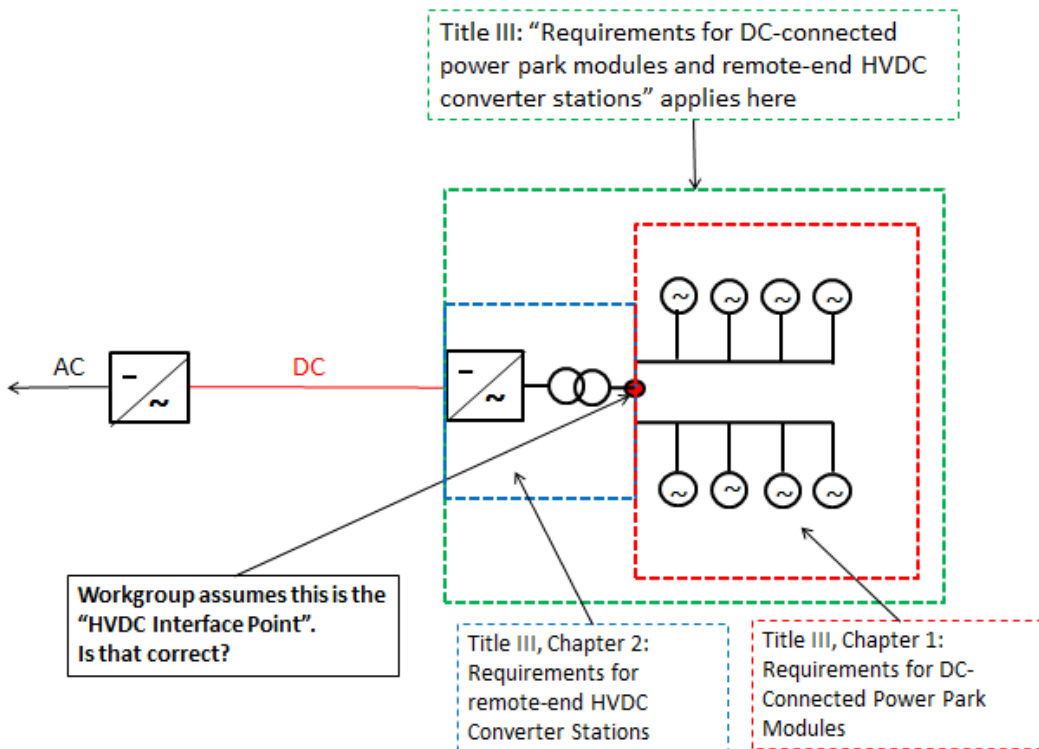

Figure 4.3(b) – Illustration of DC Connected Power Park Modules and Remote End HVDC Converters caught under the requirements of Title III of the HVDC Code in addition to the appropriate definitions used under the HVDC Code.

4.4.5.2. HVDC - Approach to Fault ride through and Fast Fault Current Injection

In developing the Fault Ride Through and Fast Fault Current Injection requirements for HVDC Connections, DC Connected Power Park Modules

and Remote End HVDC Converters the general approach adopted is to use the same requirements proposed for Type D Power Park Modules under the RfG Code, unless there is good reason not to do so. However, some Workgroup members were concerned that this would apply a more stringent⁸ requirement on newly connecting HVDC Connections, DC Connected Power Park Modules and Remote End HVDC Converters.

⁸ The background associated with 'more stringent' obligations is explored later in this section under 'Potential Alternatives (b) Removing More Stringent Requirements'.

4.4.5.3. Requirements for HVDC Connections (Title II)

The requirements for Short Circuit contribution during faults, Fault Ride Through and Post Fault Active Power recovery for HVDC Connections are detailed in Articles 19, 25 and 26 of Title II and Annex V of the HVDC Code.

The requirements for short circuit contribution during faults is defined in Article 19 of the HVDC Code. In summary, the HVDC requirements for short circuit contribution during faults are very similar to the requirements for fast fault current injection for Power Park Modules required under RfG. As with the RfG Code, the requirement for a Fast Fault Current Injection capability needs to be specified by the relevant System Operator.

As highlighted earlier in this report, system studies have demonstrated the importance of injecting sufficient volumes of fault current into the system, not least to ensure an adequate voltage profile across the system which is important for the determination of the Fault Ride Through parameters.

To this end and in view of the similar requirements with RfG it is therefore suggested that the same proposals for Fast Fault Current Injection under RfG are also applied to HVDC Connections caught under Title II of the HVDC Code. In summary, this proposal provides for two options, these being (i) – Option 1 the Converter behaves as a voltage source behind a constant impedance or (ii) the requirement to supply a minimum reactive current injection above a defined minimum criteria. Option 2 would be time limited with option 1 applying for main equipment contractual date commencing on or after 1 January 2021.

The requirements for Fault Ride Through for HVDC Connections caught under Title II of the HVDC Code are slightly different to those under RfG. In general, the principles are very similar to those of the RfG Code in respect of the need to withstand a voltage depression at the connection point. The difference however is that the voltage against time curve and parameters of that voltage against time curve are slightly different. Figure 4.4 below is a reproduction of the Voltage against time profile of an HVDC Converter Station which has been taken from Annex V of the HVDC Code.

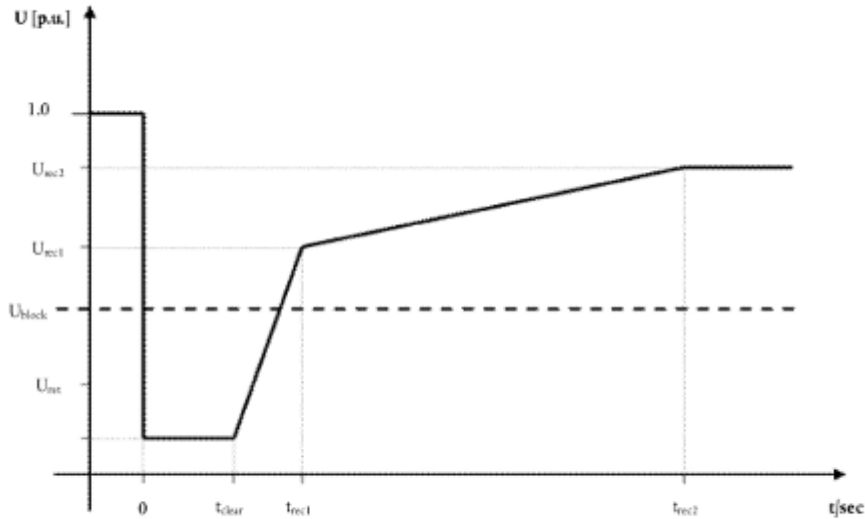

Figure 6: Fault-ride-through profile of an HVDC converter station. The diagram represents the lower limit of a voltage-against-time profile at the connection point, expressed by the ratio of its actual value and its reference 1 pu value in per unit before, during and after a fault. U_{ret} is the retained voltage at the connection point during a fault, t_{clear} is the instant when the fault has been cleared, U_{rec1} and t_{rec1} specify a point of lower limits of voltage recovery following fault clearance. U_{block} is the blocking voltage at the connection point. The time values referred to are measured from t_{fault} .

Figure 4.4 – Extract from Figure 6 of Annex V of the HVDC Code – Voltage against time curve

The range of parameters available to the TSO for the determination of this curve is as shown in Table 4.1 below.

Voltage Parameters (pu)		Time Parameters (Seconds)	
U_{ret}	0.00 – 0.30	t_{clear}	0.14 – 0.25
U_{rec1}	0.25 – 0.85	t_{rec1}	1.5 – 2.5
U_{rec2}	0.85 – 0.90	t_{rec2}	$t_{rec1} – 10.0$

Table 4.1 – Range of HVDC Fault ride through Parameters available to be selected by the TSO

The justification for the voltage against time curve proposed for HVDC Converter Stations follows a similar approach to RfG with the proposed values and the reasons given in Table 4.2 below.

U_{ret}	Set to zero. This would equate to a solid three phase short circuit fault on the Transmission system which could be adjacent to an HVDC Converter
t_{clear}	Set to 140ms for protection operating times (as per the RfG proposals)
U_{rec1}	Set to 0.85 to ensure consistency with RfG proposals for Type D Power Park Modules
t_{rec1}	Set to 2.2 seconds to ensure consistency with with RfG proposals for Type D Power Park Modules
U_{rec2}	Set to 0.85 to ensure consistency with RfG proposals for Type D Power Park Modules
t_{rec2}	Set to 10 seconds to ensure consistency with RfG proposals for Type D Power Park Modules
U_{block}	Not defined – see note below.

Table 4.2 – Proposed voltage against time parameters for HVDC Converter Stations under Title II of the HVDC Code.

Under the HVDC Code, TSO’s are allowed to specify a Blocking Voltage (U_{block}) which is the point at which the HVDC Converter will not supply any real or reactive power. As mentioned earlier in the report, the supply of fast fault current under Fault Ride Through conditions is vital to maintain an adequate voltage profile across the system. With no reactive current injected, this would undermine the desired system characteristics. Under the proposals for Fast Fault Current Injection, Option 2 or Option 3 does permit blocking but this is only upon fault clearance and is necessary to prevent the risk of overvoltage transients.

Representing Table 4.2 graphically results in Figure 4.5 below.

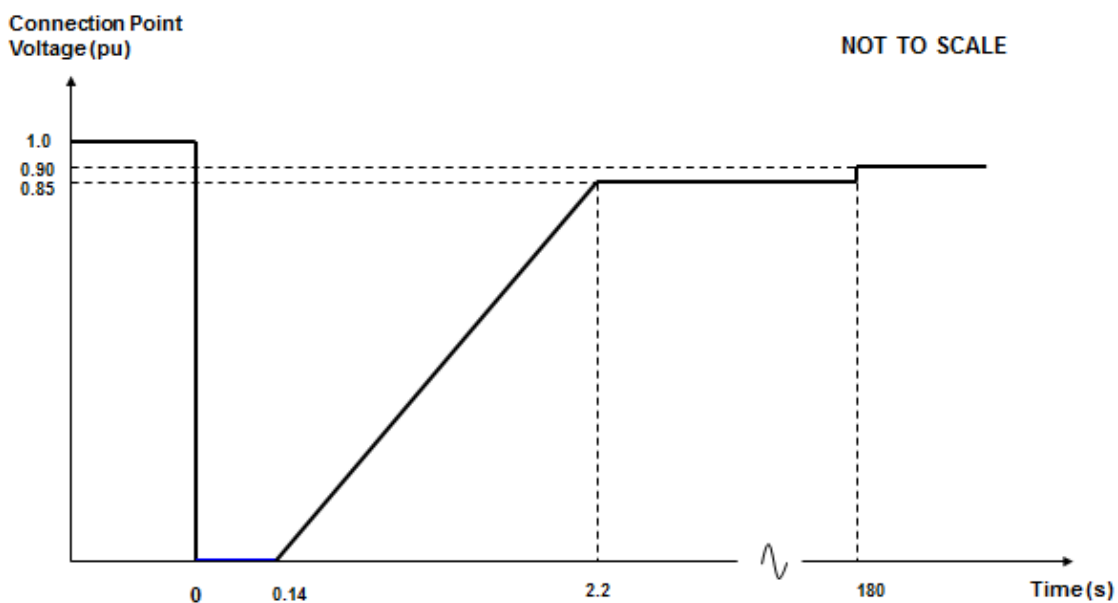

Figure 4.5 – Proposed Voltage against time curve for Title II HVDC Converters

In terms of Active Power Recovery as defined under Article 26 of the HVDC Code, 90% of the Active Power should be restored within 500ms of fault clearance. These requirements would be consistent with the RfG requirements.

4.5. Set the four RfG Generation Type (A-D) MW banding levels for GB

There were extensive discussions on banding in the previous GC0048 workgroup which culminated in a consultation on three options for the thresholds and a workgroup report that reflected the majority views of the workgroup at the time in recommending the highest allowable banding option [reference 6]. Further consideration and reflection on the evidence of costs and benefits however led the Proposer to submit through GC0100 a reduced set of banding thresholds. Since a number of workgroup members were still supportive of the original GC0048 recommendation this

has been raised as an alternative. To avoid wasting workgroup time, and given that the various arguments are already covered in the GC0048 Workgroup report, the proposer of the alternative has not repeated them and they are hence not included in detail in this section, which only deals with responses to and development of the Proposal. The Alternative's Proposer believes that these arguments are still valid. The Proposer of the original maintains that the basis for selection of the thresholds needs to be the balance of the costs and benefits as discussed further and consulted on in GC0100 and presented in this GC0100 report.

4.5.1. What does RfG banding do?

ENTSO-E provided the following guidance on how the four banding levels evolve power generating module technical capabilities to support the system:



	Type A	Type B	Type C	Type D
Connection Voltage:	<110kV	<110kV	<110kV	≥110kV
MW capacity range for Power Generating Modules:				
Continental Europe	800W-1 MW	1 MW-50MW	50 MW-75 MW	75 MW+
Great Britain	800W-1 MW	1 MW-50MW	50 MW-75 MW	75 MW+
Nordic	800W-1.5 MW	1.5 MW-10MW	10 MW-30 MW	30 MW+
Ireland and Northern Ireland	800W-0.1 MW	0.1 MW-5MW	5 MW-10 MW	10 MW+
Baltic	800W-0.5 MW	0.5 MW-10MW	10 MW-15 MW	15 MW+

Table 4.3 Adapted from RfG Article 5, Clause D, Table 1

It is worth noting that previous ENTSOE versions of the RfG text had maximum GB synchronous area banding levels at a lower level, closer aligning England and Wales with the historic Scottish TSO (SHE Transmission) designation of 'Large' Power Stations:

January 2014 RfG draft GB Levels:

	Type A	Type B	Type C	Type D
Connection Voltage	<110kV	<110kV	<110kV	≥110kV
MW range for Power Generating Modules	0.8KW-1MW	1MW-10MW	10-30MW	30MW+

4.5.2. Process for TSO's setting their banding level

RfG requires national TSOs to set their banding levels and ratify them via an industry consultation and National Regulatory Authority approval. This is required for implementation, but is also the same process for any subsequent review, as allowed at an interval of no less than three years. Subsequent iterations of the banding levels can never exceed the levels drafted into the RfG itself, which therefore provides a ceiling.

4.5.3. Assessing appropriate levels for GB level

Particular Workgroup focus was given to the MW level for the Type B-C boundary, the point at which the technical requirements evolve from a manufacturer standard and become associated with much more active real-time response capabilities (e.g. frequency control).

GB generation is currently grouped by Power Station net capacity for determining compliance obligations (Large/Medium/Small designations), whereas RfG refers to 'power-generating module' Type (by sizing bands) for determining significance. Understanding the nature of connections to GB synchronous area is important when considering RfG banding levels.

For example, will existing patterns of installed capacities continue when RfG applies, and are existing levels of response still fit for purpose?

A 'Transmission' connection in GB is defined as 132kV and above in Scotland and Offshore; in England and Wales it is above 132kV. RfG however does not have this distinction. Instead, it refers to connections of greater or less than 110kV. A power generating module directly connecting at greater than 110kV will, if it falls within the scope of the RfG, default to Type D; whilst connecting at below 110kV, the power generating module capacity will determine their band ('A-C').

The GB System Operator performs an annual evaluation of the existing and future connections to the GB energy network based on the best available information in a publication called the Future Energy Scenarios (FES)⁹. This in turn informs an in-depth analysis of system operation provided again by the GB System Operator in the System Operability Framework (SOF)¹⁰. The wider industry is consulted with in the formation of both documents.

Changes to the type and scale of generation, or concentrations in particular areas of the network, can add to the operational complexities which the System Operator manages, both in real-time and longer-term timescales, which would be a factor in setting the GB banding level.

⁹ <http://fes.nationalgrid.com/>

¹⁰ <http://www2.nationalgrid.com/UK/Industry-information/Future-of-Energy/System-Operability-Framework>

4.5.4. GB Generation mix

Commercial and political drivers have encouraged progressive connection of renewable generation sources throughout the GB energy network in recent years. This has, and continues to, displace traditional thermal plant. Not least has been the increasing trend to connect generation to the distribution network rather than the Transmission system which is starting to have a significant effect on the operational characteristics of the System as a whole.

This thermal plant has traditionally provided the majority of support to the GB System Operator for managing all nature of frequency deviations; either through its inherent inertial capability, or being operated in frequency sensitive mode and being available for response dispatch.

Increasing proliferation of intermittent (variable output) energy sources, which are also non-synchronously connected to the GB network, has increased the regularity and complexity of actions the GB System Operator has had to take in recent years.

Selected charts showing associated GB installed generation capacity trends from the 2017 FES are shown below in figures 4.6, 4.7 & 4.8, highlighting the change to the profile of generation on the system in future years and therefore the potential for increasing system management issues for the GB System Operator.

Figure 4.2
Generation capacity by type and proportion of decentralised generation

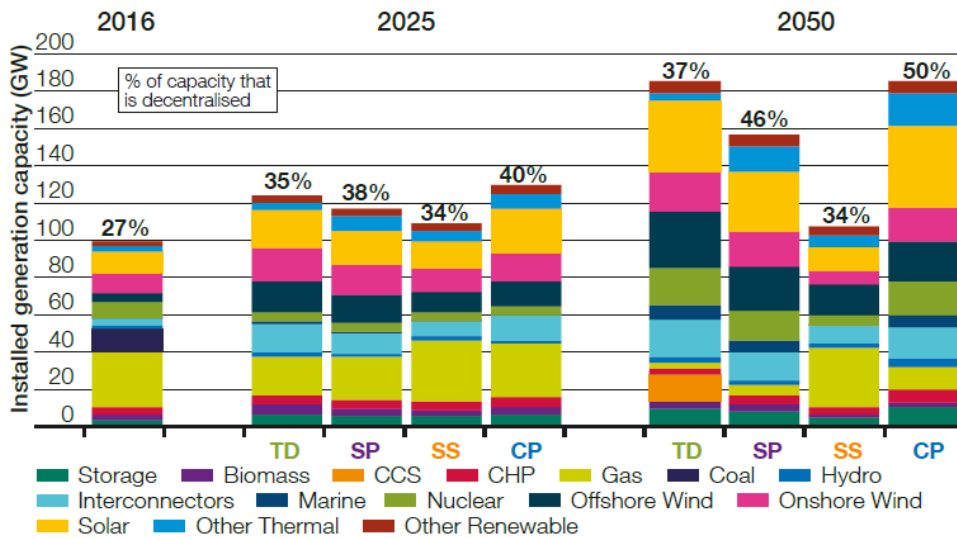

FES scenarios key:

TD – Two Degrees; SP – Slow Progression; SS - Steady State; CP – Consumer Power

Figure 4.6 Generating Capacity by fuel type projected forward

Solar installed capacity

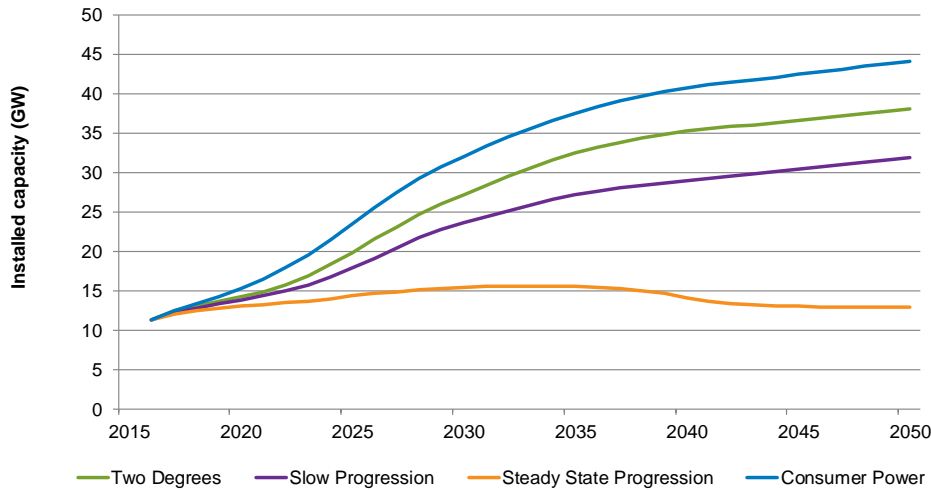

Figure 4.7 Installed solar capacity project forward

Distributed and micro (sub 1MW) capacity

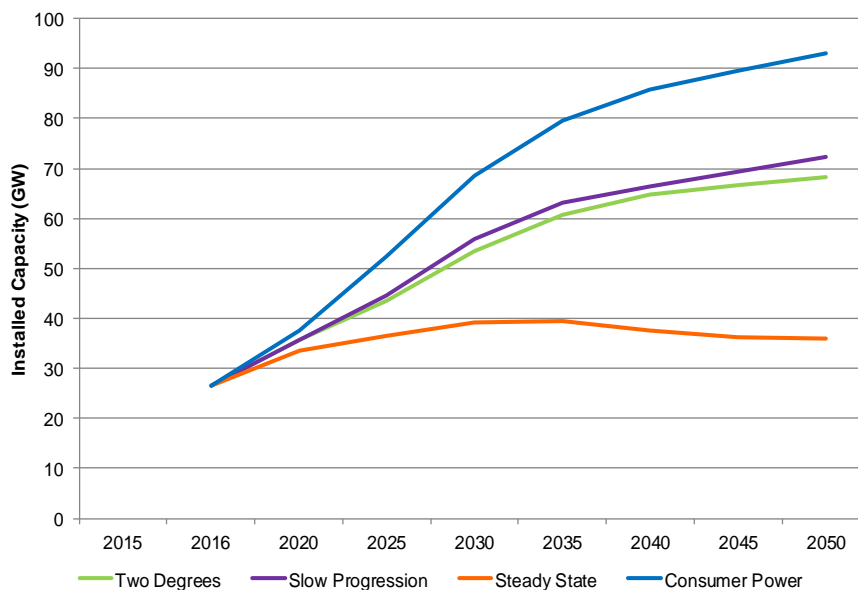

Figure 4.8 Distributed and micro capacity project forward

The primary concern from these charts for the GB System Operator is the significant decentralisation of energy from Transmission to Distribution, as well as rapid increases in variable load renewable technologies.

This will require active management, not least in demand forecasting but also issues with voltage caused by demand reduction, reduced inertia and consequently increased RoCoF.

The GB System Operator believes the banding setting process should address the above challenges, affected as it only applies to new generation connections from 2018 onwards.

Notwithstanding the above, these issues are not unique to GB and similar trends are being observed across Europe. As part of RfG implementation, many EU TSOs in other Member States (but not all) have put forward banding proposals which have tended to move away from the maximum levels stipulated in the RfG Network Code.

The Belgian TSO Elia, for example, set out their banding proposals in a public consultation ¹¹earlier in 2017. It included a table 4.5 of levels being recommended by adjacent Continental European TSOs.

	Belgium (Elia)	France (RTE)	The Netherland (TENNET BV) ⁹	German TSOs ¹⁰
Threshold B	0.25 MW	(0.25MW ¹¹) 1MW	1MW	0.135 MW
Threshold C	25MW	18MW	50MW	36MW
Threshold D	75MW	75MW	60MW	45MW

Table 4.5 Proposed banding levels in other EU countries GB

4.5.5. Costs of implementation

This part of the report, prepared by the Proposer, aims to explain the costs related to the proposals set out in this report, based on study work undertaken and included in Annex 8.

Under Transmission system fault conditions, the retained voltage at the connection on the network is a function of the reactive current injected; the greater the reactive current the higher the retained voltage. These conclusions have been demonstrated through the study work completed in the South West of the Transmission system and are believed to be representative of the wider System (see Table 4.6 below).

¹¹http://www.elia.be/~media/files/Elia/users-group/Public%20consultations/2017/20170519_Public-consultation-MAXIMUM-CAPACITY-THRESHOLDS_ENG.pdf

Area		GCD48 study			Future Of Energy documents					
		SCL studied 2025 (kA)	DG installed 2025 (MW)	DG studied 2025 (MW)	FES2025 max DG output (MW)	FES2025 min DG output (MW)	SOF regional SCL confidence min (kA)	SOF regional SCL 95% confidence min (kA)	SOF regional SCL 95% confidence max (kA)	SOF regional SCL max (kA)
1	North Scotland	N/A	N/A	N/A	1839.5	1167.6	6.8	11.9	16.5	18.6
2	South Scotland	N/A	N/A	N/A	2941.8	2024.4	9.5	13.1	20	21
3	North East England	N/A	N/A	N/A	1360.6	885.4	10.8	14.4	29.3	34.1
4	North West and West Midlands	N/A	N/A	N/A	3338.1	1990.1	0.7	5.7	21.1	22
5	East Midlands	N/A	N/A	N/A	3540.8	2029.3	2.7	7.1	24.4	28.4
6	North Wales	N/A	N/A	N/A	740.1	594.3	13.3	21.6	36.1	38
7	South Wales and West England	N/A	N/A	N/A	3677.3	2300.5	6.4	9.8	26.2	30.4
8	South West England	16.3	2522.4	2411	3213	1999.7	2.4	7.3	22.1	25.9
9	East England	N/A	N/A	N/A	3934.5	2543.1	9.1	17.4	41.5	45.6
10	Greater London	N/A	N/A	N/A	1716	1104.4	6.2	14.2	32.4	35.7
11	South East England	23.9534568	N/A	N/A	2059	1268.2	7.6	15.1	27.9	31.7

Table 4.6 – Comparison of Embedded Generation Backgrounds across GB when compared with South West England

In summary, based on the Fast Fault Current Injection requirements, if the volume of reactive current is delivered in line with FFCI Option 1, then a retained voltage (U_{ret}) for newly connecting Type B, C and D Generators of 0.1 pu can be accommodated. On a short term basis, if either FFCI Options 2 or 3 were selected, it is still possible to still have a retained voltage of 0.1pu but this would need review in the short term, with a view on having something in place by 2020. A conclusion of the study was that should there continue to be a diminishing fall in the volume of Fast Fault Current Injection, then consideration would have to be given to reducing the value of U_{ret} to 0.05pu. Again in the longer term, a value of 0.05pu would not be sustainable as the value of the retained voltage is dependent upon the volume of fast fault current injection. As the volume of fast fault current starts to fall off, then not only does this effect the retained voltage but equally with the drop off in synchronous Generation it becomes increasingly difficult to secure the system.

Further analysis conducted by [National Grid] demonstrated that if the Type B/C banding threshold was set at 50MW instead of 10MW then an additional 21MW of embedded generation would be lost as a result in the depressed voltage across the DNO system. In addition to carrying the infrequent infeed loss required under the SQSS this equates to a cost of approximately £9.2 million (21MW x £50MW/hr x 24x 365) assuming an average reserve cost holding of £50/MWhr. However, some Workgroup members questioned the validity of this number given that the GB System Operator already holds a number of GWs of reserves – given the dynamic, second by second nature of the electrical system it was difficult to envisage how this 21MW (less than 1% of the reserves currently held) of ‘extra’ reserve could, in practical terms, materialise operationally.

The Proposer noted that if the value of U_{ret} was set at 0.1pu without the volume of expected Fast Fault Current Injection then system studies performed by National Grid demonstrated that some 550MW of Embedded

Generation would be lost on top of that volume of reserve allocated for the infrequent infeed losses under the SQSS. If the average cost of reserve is assumed to be £50/MWhr then this would equate to an approximate cost of $550 \times £50 \times 24 \times 365 = £240.9$ million/annum. This is the reserve cost alone, it does not account for additional system measures to prevent system collapse under fault conditions or wider issues such as diminishing inertia which could be very much higher

As the National Grid studies have shown, Fast Fault current is a necessity; it is not an option to have no fault infeed, as the volume of synchronous plant starts to drop away

The Proposer noted that there are ways around this such as the installation of synchronous compensators or pre – curtailment of generation, but the lack of system inertia starts to become increasingly dominant after 2021. It is likely that even if FFCI Option 2 or 3 are used, there may be a need for the use of Synchronous Compensators which are known to address some of these issues. The use of Synchronous Compensators does however present several challenges. Firstly should synchronous compensators be installed by the Generator or the Network Operator and what is the relative cost of this. As a consequence of the physics of the transmission system it is not possible to transport large volumes of Reactive Power across the System. The issue of siting therefore becomes an issue, but equally the location of such devices, especially where there are high volumes of Embedded Generation.

In terms of cost, according to the Proposer a typical synchronous compensator would be estimated to be in the region of £100-£150k/MVAr, for a new installation although this is difficult to quantify as there is little information in the public domain on this subject.

One Workgroup member highlighted the following report <http://www.eirgridgroup.com/site-files/library/EirGrid/System-Service-Provision-DNV-KEMA-Report-2012.pdf>

Other Workgroup members believed the equipment cost was significantly less than this especially where old refurbished units could be used. Even so there is then the installation cost of the units, their strategic location and running costs. Having said that there may also be the need to install Synchronous compensation equipment within the DNO's networks which has a cost and also runs the risk of increasing fault levels, the latter issue has an indirect cost impact as there may be a need to uprate and change circuit breakers. There are other industry initiatives; such as project Phoenix, (<https://www.ofgem.gov.uk/publications-and-updates/electricity-nic-submission-scottish-power-transmission-phoenix>) are looking to address the costs above.

So far as FFCI Option 1 is concerned, the technology fits neatly with storage and solar technologies. In the case of solar technologies it is often common to fit battery technology with the converter. This provides an ideal solution for smaller scale installations and will also reduce the fault infeed

that would be observed within the DNO system especially when current limiting controls are added to the converter control.

For generators newly connected via converters and HVDC installations, the issue becomes more of a challenge as it is not usual to fit storage with these types of technologies. There are alternative approaches here these being (i) the plant is deloaded at times of low system inertia upon instruction from the GB System Operator or (ii) Synchronous Compensation equipment is installed within strategic parts of the electrical network. For example in the case of a 750MW HVDC link, without storage but capable of operating in VSM Mode utilising power from the remote end, it would be possible at times of high system inertia (when there is an abundance of synchronous plant on the system) that the link capacity could be increased to 1000MW transfer upon instruction from the GB System Operator. It is acknowledged that Interconnectors have restrictions in terms of their ability to own generation or storage on the same site but this needs to be balanced between commercial opportunities in the market as against technical capabilities.

Due to commercial confidentiality it is difficult to quantify the CAPEX and OPEX costs indicated in the options descriptions in Section 3.3. However, confidential engagement has indicated that these costs would not be insignificant, certainly in comparison with solar and storage applications where the installation of VSM type technology is believed to be modest. In addition, the use of storage technology coupled with say wind generation does offer the developer a number of choices in so far as the opportunity to participate in Commercial Ancillary Services such as Enhanced Frequency response or to hedge against imbalance which can result from trading in the wholesale electricity market. That said these costs are not insignificant to Generators particular in respect of offshore installations. The consultation will ensure that the ability to supply confidential information to the regulator is highlighted. This may address the concerns of manufacturers providing cost impact.

Finally there is one further cost that needs to be added into the equation which is the corresponding loss in System Inertia. At the present time, this volume is being made up from enhanced frequency response and commercial services for which there is a cost. As the volume of converter based plant increases in the future, this additional system cost can only increase and it is believed that the lowest overall system cost will need to be investigated.

VSM technology does offer some very promising (if yet unproven) capabilities. It is also fully acknowledged that the total costs and options are unclear. As Option 3 has been selected as the proposed solution for GC0100 National Grid will be proposing that an expert group is established to look at the technical capabilities of VSM type technology and other solutions. They envisage that the work would comprise of two elements – the first on the technical challenges of VSM technology and the second on the wider based system approach for managing the growth in converter based plant.

4.6. Workgroup discussions post Workgroup Consultation

The Workgroup met on the 5 October to review the twenty one Workgroup Consultation responses.

In terms of the proposals for fast fault current injection, the proposer clarified that they were supporting selection of option (iii) from the report which is the least onerous for converter connected technologies. Option (i) was included to facilitate discussion and the proposer further clarified that this option, for development of virtual synchronous machine FFCI performance from converters, would be taken forwards through formation of an expert group early in 2018. With the changing make-up of equipment connected to the GB system this is essential in the proposers' view to replace the FFCI performance currently obtained from synchronous machines but it was accepted that the technology is still in development and that there is a need for industry parties to work together on a solution.

The Proposer noted that there were a number of areas where they could address the proposed amendments to the proposed legal text. The Proposer subsequently addressed the amendments requested and the final proposed legal text can be located in Annex 1.

The workgroup vote for their preferred solution was 12-4 in favour of the original proposal rather than the alternative (maximum banding thresholds permissible) with the reasoning for this including that this provided better system support, that it was closer to existing GB levels, that no evidence had been provided that selecting the original over the alternative would impose a cost on generators, and that the B/C threshold being at 10MW as in the original demarcated more appropriately between smaller generators, typically diesels, and larger gas turbines.

The reasoning for those voting against the original was that it was more stringent and that a cost would be imposed on generators. The proposer felt that the costs being evidence-based these had never been demonstrated; the 'more stringent' argument ignored the process included by the Commission for selection of banding thresholds within the maximums permissible to obtain the best balance between generator requirements and system support and also, since this relies on a demonstration of impact on cross-border trade, should consider harmonisation with other member states. Currently the proposals being developed across Europe line up well with the GB values proposed in the

original, particularly when considering equivalently sized or outlying member states similar to GB such as Norway or Spain.

5. Alternatives

During the Workgroup meetings two potential alternatives to the Original proposal were explored by members of the Workgroup. These potential alternatives were related to (a) banding and (b) removing more stringent requirements - these are explored further below.

The potential alternative forms for this can be found after this text outlining the discussions.

(a) Banding

Workgroup members noted that during the GC0048 Workgroup deliberations three options for the GB banding levels for generation had been developed by that Workgroup and subsequently consulted upon with stakeholders. The option supported by the majority of the workgroup at the time and recommended in the GC0048 report [reference 6] mirrored the maximum values shown in Table 1 (Article 5) of RfG.

In the further development in the GC0100 workgroup that led to the reduced thresholds forming part of the original Proposal, hence a number of Workgroup members were supportive of a potential alternative to the GC0100 original proposal that would set the GB generator banding levels at the maximum levels permissible in the RfG.

Workgroup Alternative Vote

The GC0100 Workgroup met on the 24 October 2017 to assess whether the potential alternative outlined better facilitated the Grid Code Objectives than the baseline.

The Workgroup voted by majority that this proposal **does** better facilitate the Grid Code objectives. This is now an official Workgroup Alternative Code Modification that will be submitted to the Authority with the Original solution for their decision. This alternative will be WACM1. More detail can be found in the Alternative form on page 171.

(b) Removing More Stringent Requirements

At the second Workgroup meeting¹² the Proposer confirmed that they will set out in their proposed solution for GC0100 that existing obligations not superseded or replaced by the EU Connection Codes in the GB national network codes (such as, but not limited to, the Grid Code, the Distribution Code, the Engineering Requirements, the CUSC etc.,) would also apply to parties bound by the requirements in the RfG, HVDC and DCC Codes.

In other words the obligations in those EU Network Codes would be applied to future parties connecting, as well as the additional national network code

¹² Held on 6th July 2017

obligations - it was not intended that, in principle, any obligations for future connecting parties would be removed from the national network codes as a result of the GC0100 original proposal.

For the avoidance of doubt, the proposer set out that these requirements would be specific to establishing local connections with a Relevant System Operator where the RfG, HVDC or DCC code is ambiguous or silent; or in relation to operational or planning matters (out of the scope of the EU Connection Codes). The proposer did note that other EU Network Codes, such as System Operation Guideline (SOGL) and Electricity Balancing Guideline (EBGL), will likely supersede most of these specific aspects in future – e.g. data exchange.

However, a Workgroup member identified that this appeared to be incompatible with the requirements of the Third Package, and in particular Articles 8(7) and 21 of Regulation 714/2009¹³.

Article 8(7)

*“The network codes shall be developed for cross-border network issues and market integration issues and shall be without prejudice to the Member States’ right to establish national network codes **which do not affect cross-border trade.**” [emphasis added]*

Article 21

*“This Regulation shall be without prejudice to the rights of Member States to maintain or introduce measures that contain **more detailed provisions than those set out herein or in the Guidelines referred to in Article 18.**” [emphasis added]*

The Workgroup member highlighted that when the RfG was first drafted by ENTSOE (noting that the proposer of GC0100, National Grid, was an active member of the RfG drafting team for ENTSOE) they had included an Article 7, which was subsequently deleted by the Commission on 14th January 2014.

That old Article 7 said the following:

*“This Network Code shall be **without prejudice to the rights of Member States to maintain or introduce measures that contain more detailed or more stringent provisions than those set out herein,** provided that these measures are compatible with the principles set forth in this Network Code.” [emphasis added]*

The Workgroup member noted that the wording of particular relevance to the current discussion are the parts emphasised in bold.

The Workgroup member stated that in their opinion it was clear, by their drafting, that ENTSOE intended to be able to maintain (or introduce later) requirements contained in the existing national network codes¹⁴ where

¹³ <http://eur-lex.europa.eu/LexUriServ/LexUriServ.do?uri=OJ:L:2009:211:0015:0035:EN:PDF>

¹⁴ Such as, but not limited to, the Grid Code, the Distribution Code, the Engineering Requirements, the CUSC etc., in GB

those requirements were (or could be in the future) more stringent than the provisions set out in the EU Network Codes.

The Commission explicitly removed this proposed wording by ENTSOE.

Shortly after the Commission's deletion of the old Article 7 in January 2014, and at the prompting of GB stakeholders (including the Workgroup member who raised this potential alternative) Ofgem enquired of the Commission as to why that article had been deleted.

In their response dated 28th February 2014, the Commission wrote to Ofgem in the following terms:

*“1. that Article 21 of Regulation (EC) No 714/2009 already provided for the possibility for Member States to adopt **more detailed** measures and that there was thus no need to reiterate this possibility in the ENC RfG”* [emphasis added]

*“2. the adoption by Member States of measures more stringent than the ones of the ENC RfG (to the extent of measures with cross-border trade effect) **would not be in line with Article 21 of Regulation (EC) No 714/2009**, i.e. if the Member states were to adopt more stringent measures then it should be proved that there is no cross border trade effect of doing so”* [emphasis added]

This response was shared by Ofgem with GB stakeholders shortly after.

Over a year later, on 26th June 2015, the RfG (and later the DCC and HVDC) Network Code was approved via the Comitology procedure, noting that in doing so, it:

*“...**provide[s] a clear legal framework for grid connections**, facilitate Union-wide trade in electricity, ensure system security, facilitate the integration of renewable electricity sources, increase competition and allow more efficient use of the network and resources, for the benefit of consumers”¹⁵* [emphasis added]

As part of that approval process an arrangement was put in place by DECC (later BEIS) and Ofgem to canvass GB stakeholder views on any 'red line' items that the stakeholder(s) believed that DECC and Ofgem should seek to change in each of the respective EU Network Code prior to its approval. The Workgroup member could not recall National Grid identifying, as one of its 'red line' items, the need to allow for more stringent obligations (to those set out in the EU Network Codes) being placed on future connecting parties in GB.

The Workgroup member was also unaware of any other TSO in other Member States having, likewise, raised any similar concerns in respect of more stringent obligations in the intervening seventeen month period (from mid-January 2014 to late June 2015) as the RfG Network Code was proceeding through the approvals process.

¹⁵ RfG, 14th April 2016, Recital 3

The Workgroup member stated that in the intervening seventeen month period TSOs could, if they believed this issue to be important, have put forward 'more stringent' obligations if they were required; such as those, for example, needed for maintaining the security of the electrical system; for inclusion in the EU Network Codes. If this had been done at the time then, as such, they would not, in law, be 'more stringent' in terms of Article 8(7) or Article 21 as any obligation(s) would not be in the national network codes (but rather in the EU Network Codes). However, this was not done by the TSOs, despite there being time for them to do so if they wished.

The Workgroup member went on to explain that as part of the implementation of the EU Network Codes arrangements have been put in place for stakeholder involvement going forward (this is, for example, set out in Article 11 of the RfG, Article 10 of the DCC and Article 11 of the HVDC).

As a result a ('combined') stakeholder committee for the three connections codes¹⁶ (RfG, DCC and HVDC) was established in 2016. Chaired by ACER, with secretariat support from ENTSOE it brings together pan European trade associations etc., of stakeholders with interest in the three EU Network Codes relating to connections.

The Workgroup member stated that one of the questions that arose early on in the life of the connections codes stakeholder committee was around applying more stringent requirements within the national network codes.

This question was posed to the Commission in the following terms:

“Can a Member State impose more stringent requirements by a separate legislation than imposed by the network code Requirements for Generators (RfGNC)?”

The Commission's answer to the question was provided in its presentation to the stakeholder committee on 8th September 2016 (which was subsequently repeated at the 9th December 2016 and 7th June 2017 meetings). The answer is as follows:

“In general, no – not outside of the values provided for in the code. [emphasis added]

*•But: "the relevant system operator, in coordination with the relevant TSO, and the power-generating facility owner **may agree** on wider frequency ranges, longer minimum times for operation or specific requirements for combined frequency and voltage deviations to ensure the best use of the technical capabilities of a power-generating module, if it is required to preserve or to restore system security." Article 13. [emphasis added]*

¹⁶ Further details, including papers / minutes etc., can be found at <https://www.entsoe.eu/major-projects/network-code-implementation/stakeholder-committees/Pages/default.aspx>

- *"The network codes shall be developed for cross-border network issues and market integration issues and shall be without prejudice to the Member States' right to establish national network codes **which do not affect cross-border trade.**" Article 8, Regulation 714." [emphasis added]*

This issue had also been brought to the attention of GB stakeholders in the spring of 2014 via a presentation which was given to meetings of the three relevant GB stakeholder bodies at that time (ECCAFF, JESG and the joint DECC/Ofgem Stakeholder Group).

That spring 2014 presentation was also shared with the GC0100 Workgroup prior to meeting 3¹⁷ and can be found at Annex 8. The Workgroup member highlighted a number of points in that presentation (some of which have been set out already in the above few paragraphs so are not repeated here), including:

– *Firstly: burden of proof to say a particular "more stringent" national measure (over and above the ones of the ENCs) does not affect cross border trade resides with the Member State (not stakeholders)*

– *Secondly: the presumption for all "more stringent" national measures (over and above the ones of the ENCs) is that they are not legally binding unless and **until the Member State** (not stakeholders) **has "proved that there is no cross border trade effect"***¹⁸[emphasis added]

“• *In terms of Art 8 and Art 21 what do "...which do not affect cross-border trade..." and "... no cross border trade effect..." mean?*

• *Important to be mindful of very strong ENTSOe arguments about Type A generators – individually an 800W generator will not affect cross border trade but, cumulatively, they will have an affect on cross border trade”*¹⁹

“• *Single GB code* requirement:*

- *on one generator, maybe a case of there being no cross border affect?*
- *cumulatively on multiple generators, a case that there is an affect?*

• *Multiple GB code* requirements:*

- *cumulatively on one generator, some cross border affect?*
- *cumulatively on multiple generators, a clear affect?*

• *All GB code* requirements:*

- *cumulatively on one generator, some cross border affect?*
- *cumulatively on multiple generators, a clear affect?*

¹⁷ Held on 3rd August 2017

¹⁸ Slide titled 'Another point of view (3)'

¹⁹ Slide titled 'Another point of view (4)'

** document(s) where national requirements are set out - such as GC, DC, DCUSA, BSC, CUSC, Engineering Recommendations (G59 / G83) etc.”²⁰*

In respect of the effect on cross border trade of obligating future connecting parties in GB, such as generators²¹, to meet more stringent requirements than those set out in the respective EU Network Code, the Workgroup member highlighted to the Workgroup twelve examples of additional costs etc., which, in that scenario, a generator could (would?) face.

These examples were:

- 1) “pay for the extra obligations to be assessed and the solutions identified;*
- 2) pay for the extra equipment or pay for the extra procedures to be developed to meet the extra obligations;*
- 3) pay for the operation and maintenance of the extra equipment;*
- 4) pay for the extra operational costs of the procedures (including extra staff);*
- 5) pay for the extra equipment and procedures to be internally(*) tested (prior to the network operator compliance testing);*
- 6) pay for the network operator’s compliance testing of the extra equipment and procedures;*
- 7) have to include a risk premium for items (5) and (6) in terms of if the tests are failed or delayed and either (a) remedial actions / costs are incurred to put this right and / or (b) the delay results in the plant not commissioning on time (delaying the revenue income being received);*
- 8) in respect of (7) if the tests under items (5) and (6) fail, then pay for the extra equipment/ procedures changes plus the (re) testing of these elements (or the full rerun of the testing);*
- 9) pay for the replacement costs of the extra equipment either at the end of its design life or if the equipment fails during its operational lifetime;*
- 10) have to include a risk premium for the failure of the extra equipment resulting in the plant being non-compliant and the plant being placed off line till the repairs or replacement can be undertaken;*
- 11) in terms of (10) pay for the (re) testing (internal and / or compliance) of the repaired / replaced extra equipment; and (last, but not least)*

²⁰ Slide titled ‘Another point of view (5)’

²¹ But not limited to generators - the DCC Network Code concerns demand connections and the HVDC Network Code deals with the connection of HVDC systems.

12) pay the capital cost for all these extra items above, noting that last time we look as an industry at this, the WACC of GB generators was over twice and in some cases more than quadruple that of network operators.

(*) the test is undertaken for the internal purposes of the generator, although the actual testing itself maybe undertake by an external provider, such as the equipment supplier.”²²

The Workgroup member noted that this list is not comprehensive and that other generators may identify additional items that have, inadvertently, been omitted. (e.g. costs associated with compliance with other codes such as mandatory participation in the balancing mechanism for 132 kV connected generators in Scotland > 10 MW) (?)

In the view of the Workgroup member it was clear that the cumulative effect, of all these additional costs²³, on multiple generators in GB, could affect cross border trade; although the Workgroup member acknowledged, as per the Commission's statement²⁴ of 28th February 2014 to Ofgem, that it was not for the stakeholder, such as a generator, to prove that there was a cross border trade affect, but rather for *those who wish to apply more stringent requirements* (than those in the EU Network Codes) to prove that there is no cross border trade effect of doing so.

The Workgroup member was mindful that the GC0100 proposals would, in due course, be presented to the National Regulatory Authority (Ofgem) for determination. In this context, the Workgroup member was alive to the duty placed upon Ofgem (as the NRA for GB) "to ensure compliance with European Union Law". This was summarised under duties of the regulatory authority; in the Commission's interpretive note on Directive 2009/72 concerning the common rules for the internal market in Electricity (and the Gas equivalent) dated 22nd January 2010²⁵; in the following terms:

“Article 37(1)(b) of the Electricity Directive and Article 41(1)(b) of the Gas Directive state that the NRA has the duty of ‘ensuring compliance of transmission and distribution system operators, and where relevant, system owners, as well as of any electricity and natural gas undertakings, with their obligations under this Directive and other relevant Community legislation, including as regards cross border issues’.

It follows from this provision that, without prejudice to the rights of the European Commission as guardian of the Treaty on the functioning of the European Union, the NRA is granted a general

²² Shared with the Workgroup by email on 3rd August 2017

²³ Arising from having to comply with the more stringent national network code obligations which go beyond what is required by the EU Network Code(s)

²⁴ *“if the Member states were to adopt more stringent measures then it should be proved that there is no cross border trade effect of doing so”*

²⁵

https://ec.europa.eu/energy/sites/ener/files/documents/2010_01_21_the_regulatory_authorities.pdf

competence — and the resulting obligation — as regards ensuring general compliance with European Union law. The Commission’s services are of the opinion that Article 37(1)(b) of the Electricity Directive, and Article 41(1)(b) of the Gas Directive, are to be seen as a provision guaranteeing that the NRA has the power to ensure compliance with the entire sector specific regulatory ‘*acquis communautaire*’ relevant to the energy market, and this vis-à-vis not only the TSOs but any electricity or gas undertaking.”²⁶

In light of the above, and given the statement from the GC0100 Proposer noted at the start of this item; together with the presentations (and associated discussions of the ‘more stringent’ point in terms of compliance) at the 24th July 2017 ‘Compliance with the RfG’ hosted at the ENA; the Workgroup member believed that the original proposal was applying ‘more stringent’ requirements by applying those additional GB national network codes requirements (outlined above) to future GB connecting parties).

In conclusion, the workgroup member believed it would be incompatible with EU law for the reasons set out above²⁷ and would thus also not better facilitate Grid Code Applicable Objective (d)²⁸:

“To efficiently discharge the obligations imposed upon the licensee by this license and to comply with the Electricity Regulation and any relevant legally binding decisions of the European Commission and/or the Agency”

Therefore, the Workgroup member proposed to bring forward an alternative proposal to the GC0100 original proposal which would be to ensure that more stringent obligations contained within the GB national network codes would not be applicable to future connecting parties who fall within the scope of the RfG, DCC and HVDC Network Codes respectively; although, for the avoidance of doubt, those (GB) national network code obligations would continue to be applicable to ‘existing’ connected parties (as defined in the RfG, DCC and HVDC Network Codes respectively) unless and until they fall within the scope of the EU Network Codes for connection.

To set this in context the Workgroup member was mindful of the presentation given by the Proposer at the second Workgroup meeting setting out (in a tabular form) the items covered, in the case of generation, with the RfG Network Code for the four types of generation (A-D).

This table is shown below:

²⁶ Found at pages 14-15 of the Commission's interpretive note.

²⁷ As well as, potentially, with respect to Competition Law for the reasons outlined under Section 2 ‘Governance – Legal Requirements’ in the GC0103 proposal:

<http://www2.nationalgrid.com/UK/Industry-information/Electricity-codes/Grid-code/Modifications/GC0103/>

²⁸ Or the Distribution Code equivalent Applicable Objective (iv).

Technical Requirements	Type A	Type B	Type C	Type D
Operation across range of frequencies	•	•	•	•
Rate of change of System Frequency (ROCOF)	•	•	•	•
Limited Frequency Sensitive Mode Over Frequency (LFSM-O)	•	•	•	•
Output Power with falling Frequency	•	•	•	•
Logic Interface (input port) to cease active power production	•	•	•	•
Conditions for automatic reconnection	•	•	•	•
Operation across range of frequencies	•	•	•	•
Ability to reduce Active Power on instruction		•	•	•
Fault Ride Through and Fast Fault Current Injection		•	•	•
Conditions for automatic reconnection following disconnection		•	•	•
Protection and Control		•	•	•
Operational Metering		•	•	•
Reactive Capability		•	•	•
Active Power Controlability			•	•
Frequency Response including LFSM-U			•	•
Monitoring			•	•
Robustness			•	•
System Restoration / Black Start			•	•
Simulation Models			•	•
Rates of Change of Active Power			•	•
Earthing			•	•
Enhanced Reactive Capability and control			•	•
Voltage Ranges				•
Enhanced Fault Ride Through				•
Synchronisation				•
Excitation Performance				•

Using this summary table, the Workgroup member identified that with the potential alternative that Type A generators would only be obligated, in terms of their connection to the grid, to those items shown in the table (and so on for Types B, C and D). All other items would be considered more stringent unless it could be proven that there was no cross border trade affect of obligating generators to comply with further obligations over and above those in the RfG (and likewise in terms of the DCC for Demand and the HVDC for HCDV connecting parties).

The proposer, whilst not agreeing with the workgroup member's 'more stringent' interpretation set out above, or indeed that their own solution is 'more stringent', is satisfied that the GC0100 workgroup, the wider industry (through this consultation), the respective Code Panels, and in due course, the National Regulatory Authority, are capable of considering the merits of the respective proposals and that this was fully discussed during the workgroup development of the proposal.

The proposer does however note that whilst various European treaties give the EU competence in the area of energy and creation of the internal energy market, competence on these matters is shared with the Member State. As a general principle therefore, the EU regulations do not

encompass everything to do with energy; or mean that everything has to be, or should be, mandated at an EU level.

EU regulation 714/2009 and the Connection Codes themselves address this principle. Article 7 of RfG sets out 'Regulatory Aspects', including a provision in clause 3 that when applying the Regulation, Member States, competent entities and system operators shall: "(d) respect the responsibility assigned to the relevant TSO in order to ensure system security, including as required by national legislation;"

The proposer is therefore of the view that a test for stringency should solely be in respect of implementing the specific provisions in the Connection Codes. Other aspects subject to national legislation should not be subject to this test.

Workgroup Alternative Vote

The GC0100 Workgroup met on the 21 November 2017 to assess whether the potential alternative outlined better facilitated the Grid Code Objectives than the baseline.

The Workgroup voted by majority that this proposal **does not** better facilitate the Grid Code objectives. The Chairman of the Workgroup stated that this potential alternative **did not** better facilitate the Grid Code Objectives and as such this potential alternative did not become a formal WACM. The Chairman noted that there had not been any specific examples provided by either the Proposer of the proposed alternative or any Workgroup members throughout the mapping session that was held on the 20 November 2017. She noted that as a result no legal text would be able to be drafted and added to the report for decision from the Authority.

The proposed alternative from can be found at Annex 12.

Alternative request Proposal form

Grid Code

Modification potential alternative submitted to

GC0100 –WACM1

Mod Title: As per original (Banding)

Purpose of alternative Proposal:

As per the Original.

*Date submitted to Code Administrator: August 2017**You are: A Workgroup member**Workgroup vote outcome: Formal alternative*

What stage is this document at?

01	Potential Workgroup alternative
02	Formal Workgroup alternative

**Any Questions?**

Contact:

First Last

Chrissie Brown

[christine.brown1](#)[@nationalgrid.com](#)**01926 65 3328**

Alternative Proposer(s):

Alastair Frew

Company

**alastair.frew**[@scottishpower.com](#)

Contents

1	Alternative proposed solution for workgroup review.....	173
2	Difference between this proposal and Original	173
3	Justification for alternative proposal against Grid Code objectives	174
4	Impacts and Other Considerations.....	180
5	Implementation	180
6	Legal Text.....	181

Alternative proposed solution for workgroup review

Workgroup members noted that during the GC0048 Workgroup deliberations three options for the GB banding levels for generation had been developed by that Workgroup and subsequently consulted upon with stakeholders²⁹. This option was recommended by the GC0048 work group in the Workgroup Report and was option that mirrored the maximum values shown in Table 1 (Article 5) of the RfG. The reasons given for this option included:

This was the GC0048 Workgroup recommended banding option in the GC0048 Workgroup Report with justification induced there were also supportive responses from previous GC0048 consultation, hence a number of Workgroup members were supportive of a potential alternative to the GC0100 original proposal that would set the GB generator banding levels at the maximum level set in the RfG.

Difference between this proposal and Original

This proposal will use the RfG maximum values shown in Table 1 (Article 5) of the RfG.

²⁹ See, for example, "GC0048: Requirements for Generators – GB Banding Thresholds Report" dated 3rd March 2016

[https://www.nationalgrid.com/sites/default/files/documents/8589934729-Workgroup_Report_GC0048_RFG - Banding Thresholds.pdf](https://www.nationalgrid.com/sites/default/files/documents/8589934729-Workgroup_Report_GC0048_RFG_-_Banding_Thresholds.pdf)

Justification for alternative proposal against Grid Code objectives

General Intension

The proposer's banding levels appears to be based on a perceived local issue related to local system faults and not cross-border trade issues, which is the purpose of 2016/631(RfG). The original intension of 714/2009 is to improve network access and remove obstacles reducing cost. Given this the proposer's banding proposal is reducing the banding levels from highest possible on the bases of a local issue and not a cross-border issue it is going against the original intension of the third package, by forcing smaller parties to increase their investment costs to cover the additional requirements . It is the view of this respondent that adopting the alternative proposal for the high option will not add additional cost to lower level participants and hence better address the original objectives by increasing access and reducing obstacles.

Harmonisation

The proposer's justification for this reduced banding level states in section 3.2 fourth paragraph "The majority of European TSOs for Member States in Continental Europe are proposing generator banding levels lower than the maximum permitted under RfG, many of which, if not being comparable with the proposed GB levels, are lower than that proposed for GB. The proposer therefore believes there is a greater likelihood of harmonisation with Continental European neighbours with a lesser banding level than the maximum (noting that NRA approval is required to set these levels)." This justification is based on potential harmonisation across Europe which is similarly against the intensions of 714/2009 which states in whereas (29) "In particular, the Commission should be empowered to establish or adopt the Guidelines necessary for providing the minimum degree of harmonisation required to achieve the aims of this Regulation." Again it is the view of this respondent that adopting the alternative proposal for the high option will not add additional cost to lower level participants and hence better address the original objectives by increasing access and reducing obstacles.

Frequency Response

The proposer's justification then moves on in section 3.2 paragraph 6 to state "Threshold of 10MW for GB would provide a greater proportion of Generation inherently capable of contributing to frequency response, noting that commercial facilitation is not in the scope of RfG to consider, but a factor when it comes to cost." Whilst it is accepted that if a lower banding level is used by default this must result in more frequency response capacity, however the real question is, will this not just be added to the current large amounts of unused frequency response capacity at additional cost to the generator? This view has been previously stated by this respondent in the previous banding consultation in April 2016 and a revised version using the proposer's latest banding options is repeated below but due to the short timescales is still based on the late 2015 data, but this is still believed to be relevant.

This analysis initially reviews the existing generation and proposed generation in 5 years' time using data available in the TEC Register dated 16 November 2015,

Embedded Register dated 16 November 2015 and 2015 week 24 data plus DNO ED1 allows comparisons between existing and future capacity. Summary tables 1a & b and 2a & b of this data which are referred to are given at the end of this section of text.

Looking at the available frequency response if the proposed banding were to be applied to the current generation mix it can be seen in tables 1a & b both options would result in a range of the approximately 77 to 88 GW of plant available to provide response. The difference between the high and proposer's banding options only offers 11% increase or 10,000MW of generating capacity. The additional capacity then only equates to potentially 10% additional frequency response capacity of 1000MW comparing proposed banding to the highest banding option.

Similarly looking forward at the potentially available frequency response if the proposed banding were to be applied to the end of 2021 generation mix it can be seen in tables 2a & b both options would result in a range of the approximately 127 to 139 GW of plant available to provide response. The difference between the high and proposed banding options only offers a 7% increase or 12,000MW of generating capacity. The additional capacity then only equates to potentially 10% additional frequency response capacity of 1,200MW comparing proposed banding to the highest banding option. It should also be noted that this has been applied to all generation and not just the generation connected after 2018 and in practice the proposer's banding option may only pick up an additional 2,000MW of generating capacity and not the 17,000MW.

Based on the current frequency response average usage levels of Primary 657MW, Secondary 448MW and High 708MW (based on the average hourly usage volumes from December 2013 to September 2015) less than 7.5% of the current total available capacity is being utilised. If the proposers banding option was to be in place today the potential changes would be to reduce the current frequency response capacity usage to 6.6% of the available total. Looking forward 5 years assuming the infeed lose has not changed then the current response requirements should still be applicable in this scenario. Given that the available generation to provide response increases by just approximately 50GW from current levels under the high option with 70% of plant still providing response there should be in 6 years' time still adequate response margins, with utilisation levels even lower.

Whilst still agreeing the proposer's banding option would result in an increase in frequency response capacity, its usage this is likely to be limited and is not clear what benefit this would provide. The high option would appear to suffice in terms of response requirements as there appear to be no detrimental cost implications.

Tables 1a & b below summaries the data for current generation available volumes based on the TEC Register dated 16 November 2015, Embedded Register dated 16 November 2015 and DNO week 24 data 2015.

Total Generating capacity in MW in each band from each source				
Data source	Generator size band (MW)			
	0.8kW - 1MW	1 to 49.9	50 to 74.9	>75MW
DNO ED1	2880	14585	7199	0
TEC Register		1380.43	887.85	67702.9
Embedded Resister		1269.77	233.1	75
Total	2880	17235.2	8319.95	67777.9
Generator Banding				
Type A		2880		
Type B		15854.77		
Type C		7432.1		
Type D		70046.18		
Total		96213.05		
Total C + D		77478.28	Percentage	80.5

Table 1a – Analysis of current generating levels against high banding option.

Total Generating capacity in MW in each band from each source				
Data source	Generator size band (MW)			
	0.8kW - 1MW	1 to 9.9	10 to 49.9	>50MW
DNO ED1	2880	5226	9359	7199
TEC Register		0	1380.43	68590.75
Embedded Resister		119.15	1150.62	308.1
Total	2880	5345.15	11890.05	76097.75
Generator Banding				
Type A		2880		
Type B		5345.15		
Type C		10509.62		
Type D		77478.18		
Total		96213.05		
Total C + D		87987.8	Percentage	91.4

Table 1b – Analysis of current generating levels against proposed banding option.

Tables 2a & b below summaries the data for predicted generation available volumes in years' time (i.e. end of 2021) based on the TEC Register dated 16 November 2015, Embedded Register dated 16 November 2015 and DNO week 24 data 2015.

Total Generating capacity in MW in each band from each source				
Data source	Generator size band (MW)			
	0.8kW - 1MW	1 to 49.9	50 to 74.9	>75MW
DNO ED1	25062.4	21378.29	7199	750
TEC Register		3352.13	2669.15	112750.1
Embedded Resister		2336.57	283.1	75
Total	25062.4	27066.99	10151.25	113575.1
Generator Banding				
Type A		25062.4		
Type B		23714.86		
Type C		7482.1		
Type D		119596.4		
Total		175855.7		
Total C + D		127078.5	Percentage	72.2

Table 2a – Analysis of current generating levels against high banding option.

Total Generating capacity in MW in each band from each source				
Data source	Generator size band (MW)			
	0.8kW - 1MW	1 to 9.9	10 to 49.9	>50MW
DNO ED1	25062.4	11150.96	10227.33	7949
TEC Register		43.8	3308.28	115419.3
Embedded Resister		617.5	1719.07	358.1
Total	25062.4	11812.26	15254.68	123726.4
Generator Banding				
Type A		25062.4		
Type B		11768.46		
Type C		11946.4		
Type D		127078.48		
Total		175855.7		
Total C + D		139024.88	Percentage	79.1

Table 2b – Analysis of current generating levels against high banding option.

Fault Ride Through

The proposer justification in section 3.2 paragraph 7 then moves on to fault ride through with a vague statement “There is also a cost of tripping synchronous generation in a higher band (10MW – 50MW) which could result in a potential increase in holding additional reserve costs alone of £9 million / annum”. As previously stated the perceived issue the proposer is trying to deal with relates to a need for generators down to 10MW to be capable of withstanding local network faults by providing new fault ride through capabilities which are not a current requirement. The argument seems to be based on the principle if there is a transmission system fault which results in a large 1800MW generator tripping off then the TSO cannot be expected to cover for any other generators tripping off. Given these fault ride through requirements are new it would have been thought that existing generators which currently are without these facilities would be tripping off due to network faults and currently causing issues. To monitor system issues NGET have been producing the Significant System Events Report since 1998 with the most recent version produced in January 2016 (note a 2017 version has not been produced yet). Within this report the largest consequential loss recorded is 400MW in 2011 due to an island being formed in the north of Scotland which then collapsed, equally there is no evidence of significant volumes of secondary generation being disconnected due system events, nor is there any evidence of an increase in this consequential losses as the generation mix has been changing with time. On the bases there appears to be no current issues from generation not having fault ride through capability adopting the high banding option as opposed to the proposer’s option would again not impose further cost increases to smaller new generators.

Other Issues

Although the RFG limits the banding levels to only new entrants other Network codes such as the 2017/1485 Transmission System Operation Guidelines (TSOG) have adopted these banding levels and are applying them to both new and existing generators. Hence the actual full the cost implications of these banding levels will not be clear until exact implementation details of the other codes are developed the possible retrospective application to existing generators may require a sudden increase in communication links with unknown costs and other unknowns.

Summary

On the bases that for the next 5 years the high option suffices and as some potential costs implications will not be known until all the Network Codes are complete, applying the high option and then carrying out a further review if required in 3 years’ time when all codes are complete appears to be the most pragmatic solution.

Workgroup Alternative Vote

The GC0100 Workgroup met on the 24 October 2017 to assess whether the potential alternative outlined better facilitated the Grid Code Objectives than the baseline.

The Workgroup voted by majority that this proposal **does** better facilitate the Grid Code objectives. This is now an official Workgroup Alternative

Code Modification that will be submitted to the Authority with the Original solution for their decision. This alternative will be WACM1.

Impact of the modification on the Relevant Objectives:	
Relevant Objective	Identified impact
To permit the development, maintenance and operation of an efficient, coordinated and economical system for the transmission of electricity	Positive
To facilitate competition in the generation and supply of electricity (and without limiting the foregoing, to facilitate the national electricity transmission system being made available to persons authorised to supply or generate electricity on terms which neither prevent nor restrict competition in the supply or generation of electricity)	Positive
Subject to sub-paragraphs (i) and (ii), to promote the security and efficiency of the electricity generation, transmission and distribution systems in the national electricity transmission system operator area taken as a whole	Positive
To efficiently discharge the obligations imposed upon the licensee by this license and to comply with the Electricity Regulation and any relevant legally binding decisions of the European Commission and/or the Agency; and	Positive
To promote efficiency in the implementation and administration of the Grid Code arrangements	Neutral

In broad term the reasons why this proposal better meet the Applicable Objectives are as per the Original whilst, in addition, also being better in terms of competition in generation by not unduly burdening GB generators with connection obligations that are not commensurate with their plant size.

Impacts and Other Considerations

As per the Original.

Consumer Impacts

As per the Original.

Implementation

As per the Original.

Legal Text

As per the Original except for the following section, not yet agreed.

Type (A-D) MW banding levels for GB, as required in RfG

[Location and numbering TBC]

Type A which is a **Power-Generating Module** with a **Grid Entry Point or User System Entry Point** below 110 kV and a **Maximum Capacity** of 0.8 kW or greater but less than 1MW;

Type B which is a **Power-Generating Module** with a **Grid Entry Point or User System Entry Point** below 110 kV and **Maximum Capacity** of 1MW or greater but less than 50MW;

Type C which is a **Power-Generating Module** with a **Grid Entry Point or User System Entry Point** below 110 kV and a **Maximum Capacity** of 50MW or greater but less than 75MW;

Type D which is a **Power-generating Module**: with a **Grid Entry Point or User System Entry Point** at, or greater than, 110 kV; or with a **Grid Entry Point or User System Entry Point** below 110kV and with **Maximum Capacity** of 75MW or greater

This final alternative legal text can be found in Annex 1.

6. Workgroup Vote

The GC0100 Workgroup met on the 6 December to cast their Workgroup Vote. Twelve of the sixteen workgroup members voted that the Original solution was the best option.

Vote 1: Whether each proposal better facilitates the Applicable Grid

Code Objectives:

Workgroup member	Grid Code Objectives					Overall
	(a)	(b)	(c)	(d)	(e)	
Alan Creighton						
Original	Y	Y	Y	Y	N	Y
WACM1	Y	Y	Y	Y	N	Y
Voting statement: Both the Original and the Alternative are better than the baseline in that they implement the EU RfG Network Code, they promote competition in that they harmonise generation plant requirements and hence help improve overall efficiency.						
Alastair Frew						
Original	Neutral	Neutral	Neutral	Yes	Neutral	Yes
WACM1	Neutral	Neutral	Neutral	Yes	Neutral	Yes
Voting statement: Both options implement EU regulations. Best option is WACM 1 as per reasons I gave in the Alternate proposal form.						
Andrew Vaudin						
Original	N	Y	Y	Y	N	Y
WACM1	N	Y	Y	Y	N	Y
Voting statement: The original proposal is preferred based on the system security and operability justifications in the workgroup report for proposing lower banding thresholds.						
Chris Marsland						
Original	Y	Y	Y	Y	Y	Y
WACM1	Y	Y	Y	Y	Y	Y
Voting statement: The original is better than the WACM as the 10MW band B-C threshold enables separation of reciprocating generation in band B from turbines in band C, thus permitting the setting of Uret to levels that are economically achievable by the respective technologies.						
Christopher Smith						
Original	Y	Y	Y	Y	Y	Y
WACM1						
Voting statement: Banding provides a fairer set of requirements						
David Spillett						
Original	N	N	Y	Y	N	Y
WACM1	N	N	Y	Y	N	Y
Voting statement: Both the alternative and the original proposals are better than the baseline as they implement necessary legal compliance.						
Garth Graham						
Original	Neutral	Yes	Neutral	No	No	No
WACM1	Neutral	Yes	Neutral	No	No	No
Voting statement:						

<p>The Original and the WACM are, on the face of it, better in terms of better facilitating competition in the generation and supply of electricity as the EU Network Codes will achieve this.</p> <p>Of the two, the WACM1 with the Banding level that better reflects the cross border trade affects and competition aspects for GB generation is 'best' when compared with the Original.</p> <p>The Original and WACM1 (based on the legal text available prior to the vote on 6th December 2017) are more stringent than what is set out in the relevant legally binding decisions of the European Commission and thus the proposal(s) does not therefore efficiently discharge the obligations imposed upon the licensee.</p> <p>Furthermore, given that the Original and WACM1 are not better in respect of the relevant legally binding decisions of the European Commission they do not better promote efficiency in the implementation and administration of the Grid Code arrangements.</p> <p>Accordingly, overall the Original and WACM1 are not better.</p>						
Graeme Vincent						
Original	Y	-	Y	Y	-	Y
WACM1	Y	-	Y	Y	-	Y
Voting statement: Both the original and the WACM1 implement the European Regulations therefore they are better than the baseline.						
Gregory Middleton						
Original	Y	Y	Y	Y	Y	Y
WACM1	Y	Y	Y	Y	Y	Y
Voting statement: When compared to the baseline, either proposal better facilitates the objectives as it implements our legal obligations under the network codes.						
<p>The original is better than the WACM as the 10MW band B-C threshold enables separation of reciprocating generation in band B from turbines in band C, thus permitting the setting of Uret to levels that are economically achievable by the respective technologies.</p>						
Isaac Gutierrez						
Original	Y	N	N	N	Y	N
WACM1	Y	Y	Y	Y	Y	Y
Voting statement: The WACM1 Banding alternative reflects the real generator sizes that are connecting into the transmission system						
Marko Grizelj						
Original	Y	Y	Y	Y	Y	Y
WACM1	Y	Y	Y	Y	Y	Y
Voting statement: The original and WACM both facilitate the objectives better than the baseline as they ensure compliance with EU regulation.						
Mick Barlow						
Original	Yes	Yes	Yes	Yes	Yes	Y
WACM1	Yes	Yes	Yes	Yes	Yes	Y
Voting statement: Whereas I feel both the Original and WACM1 fulfil the objectives better than the baseline (baseline is not compliant), I feel that WACM1 will satisfy GCO(i) & (ii) more efficiently and cost effectively.						
Mike Kay						
Original	-	-	Y	Y	-	Y
WACM1	-	-	Y	Y	-	Y
Voting statement: Both the alternative and the original are better than the baseline in that they implement necessary legal compliance. Both should also assist in adding to the security of the system in the long term						
Paul Youngman						
Original	-	-	Y	Y	-	Y
WACM1	-	-	Y	Y	-	N
Voting statement: Preference for original change as it efficiently discharges GB EU						

obligations and compliance.						
Peter Woodcock						
Original	Y	Y	Y	Y	N	Y
WACM1	Y	Y	Y	Y	N	Y
Voting statement: The original takes into consideration the technology limitations of generating plant and it would be unfair to compromise this technology.						
Rob Wilson						
Original	Y	-	Y	Y	-	Y
WACM1	Y	-	Y	Y	-	Y
Voting statement: Both the alternative and the original are better than the baseline as they achieve ENC compliance. Both also help to support system operation by specifying technical requirements for generators.						

Vote 2: which option is considered to BEST facilitate achievement of the Applicable Grid Code Objectives. For the avoidance of doubt, this includes the existing baseline as an option.

Workgroup member	BEST Option
Alan Creighton	Original
Alastair Frew	WACM1
Andrew Vaudin	Original
Chris Marsland	Original
Christopher Smith	Original
David Spillett	Original
Garth Graham	WACM1
Graeme Vincent	Original
Gregory Middleton	Original
Isaac Gutierrez	WACM1
Marko Grizelj	Original
Mick Barlow	WACM1
Mike Kay	Original
Paul Youngman	Original
Peter Woodcock	Original
Rob Wilson	Original

Impact and Assessment

Impact on the Grid Code

This modification is necessary to ensure the Grid Code is consistent with the applicable European Network Code requirements identified for this modification.

To apply these requirements, a new section to the Grid Code Connection Conditions specific to EU requirements will be introduced. Users bound by these EU requirements (as determined in the Network Codes themselves) will need to comply with this new section. Existing Grid Code Users will not be bound by this a new section to the Grid Code Connection Conditions specific to EU requirements (unless and until they fall within the scope of those EU Network Codes).

Impact on the Distribution Code

A similar approach will be taken with the Distribution Code. Existing generating equipment will continue to be bound by G59 and G83 (as appropriate to the equipment's size) which will remain unchanged. New generating equipment will be required to be compliant with two new documents, G99 and G98 (again as appropriate to size and/or compliance arrangements)

Impact on Greenhouse Gas Emissions

The proposed modification should better facilitate connection of renewable low-carbon generation schemes in GB, thus having a positive impact on greenhouse gas emissions.

Impact on Core Industry Documents

Minor consequential changes are anticipated subsequent to this Grid Code modification in the STC and the Relevant Electrical Standards, to align them with the proposed changes.

Impact on EU Network Codes

This modification has been raised solely to implement EU Network Codes into the existing GB regulatory frameworks in a way that is not more stringent than required by those Network Codes. It is therefore fundamental in ensuring the (GB) Member State compliance with the EU Connection Codes specifically.

Impact on Consumers

This modification facilitates the implementation of consistent technical standards across the EU for the connection of new Generation or HVDC equipment. This should reduce development costs for new projects which should result in cost savings passed on to end consumers. Further consideration of compliance costs to these proposals is considered in the 'Costs of implementation' section below

Does this modification impact a Significant Code Review (SCR) or other significant industry change projects, if so, how?

The EU Network Code implementation is being undertaken as a significant programme of work within the GB industry. This mod forms part of that programme, but is not part of an on-going SCR.

7. Relevant Objectives – Assessment by Proposer

The below is the assessment by the Proposer. The Workgroup assessed the Original and WACM1 against the Grid Code objectives and this can be located in Section 6.

Impact of the modification on the Applicable Grid Code Objectives:

Relevant Objective	Identified impact (Positive/negative/neutral)
(a) To permit the development, maintenance and	Positive

operation of an efficient, coordinated and economical system for the transmission of electricity;	
(b) To facilitate competition in the generation and supply of electricity (and without limiting the foregoing, to facilitate the national electricity Transmission system being made available to persons authorised to supply or generate electricity on terms which neither prevent nor restrict competition in the supply or generation of electricity);	Positive
(c) Subject to sub-paragraphs (i) and (ii), to promote the security and efficiency of the electricity generation, transmission and Distribution systems in the national electricity Transmission system operator area taken as a whole;	Positive
(d) To efficiently discharge the obligations imposed upon the licensee by this license and to comply with the Electricity Regulation and any relevant legally binding decisions of the European Commission and/or the Agency; and	Positive
(e) To promote efficiency in the implementation and administration of the Grid Code arrangements	Neutral

The EU Connection Codes derive from the Third Energy Package legislation which is focused on delivering security of supply; supporting the connection of new renewable plant; and increasing competition to lower end consumer costs. It therefore directly supports the first three Grid Code objectives.

Furthermore, this modification is to ensure GB compliance of EU legislation in a timely manner, which positively supports the fourth Grid Code applicable objective.

8. Implementation

This modification must be in place to ensure the requirements of the EU Connection Codes are set out in the GB codes by two years from the respective Entry Into Force dates (set out earlier in this Consultation).

It is therefore crucial that this work is concluded swiftly to allow the industry the maximum amount of time to consider what they need to do to arrange compliance.

This modification is required to be implemented onto the Grid Code on 16 May 2018.

9. Code Administrator Consultation: how to respond

If you wish to respond to this Code Administrator Consultation, please use the response pro-forma which can be found under the 'Industry Consultation' tab via the following link:

<https://www.nationalgrid.com/uk/electricity/codes/grid-code/modifications/eu-connection-codes-gb-implementation-mod-1>

Responses are invited to the following questions:

1. Do you believe GC0100 or its alternative solution better facilitates the Applicable Grid Code Objectives? Please include your reasoning.
2. Do you support the proposed implementation approach? If not, please provide reasoning why.
3. Do you have any other comments?

Views are invited on the proposals outlined in this consultation, which should be received by 5pm on 2 February 2018. Please email your formal response to: grid.code@nationalgrid.com

If you wish to submit a confidential response, please note the following, information provided in response to this consultation will be published on National Grid's website unless the response is clearly marked 'Private & Confidential', we will contact you to establish the extent of this confidentiality. A response marked 'Private & Confidential' will be disclosed to the Authority in full by, unless agreed otherwise, will not be shared with the Grid Code Review Panel or the industry and may therefore not influence the debate to the same extent as a non-confidential response.

Please note an automatic confidentiality disclaimer generated by your IT System will not in itself, mean that your response is treated as if it had been marked 'Private & Confidential'

Annex 1 – Grid Code Legal text

The legal text supporting this consultation comprises the complete amended Glossary and Definitions (G&D) section of the Grid Code and an extract of the new European Connection Conditions (ECC) section relating only to the material covered in GC0100. The remainder of the ECC section is covered in GC0101 and GC0102. An alternative version of the Glossary and Definitions is also provided embodying the alternative banding threshold settings. For information only, the full ECC section and also ‘compare’ versions of both the original and alternative G&Ds to the current Grid Code are also included.

Annex 2- Terms of Reference

Annex 3- Workgroup Consultation responses

Annex 4- References

- [1] GC0062 Fault ride through Consultation available at:-
<http://www2.nationalgrid.com/WorkArea/DownloadAsset.aspx?id=45284>
- [2] H/04- Changes to Incorporate New Generation Technologies and DC Inter-connectors (Generic Provisions):- available at:-
<http://www2.nationalgrid.com/WorkArea/DownloadAsset.aspx?id=13419>
- [3] ENTSO-E- Frequently asked questions document :- available at:_
https://www.entsoe.eu/fileadmin/user_upload/library/consultations/Network_Code_RfG/120626_-_NC_RfG_-_Frequently_Asked_Questions.pdf
- [4] RTE Documentation technique de reference, Article 4.3 – Stabilité, Installation raccordée au réseau d'interconnexion: http://clients.rte-france.com/htm/fr/mediatheque/telecharge/reftech/01-09-14_complet.pdf available at:-https://clients.rte-france.com/htm/fr/mediatheque/telecharge/reftech/01-09-14_complet.pdf
- [5] GC0035 - Frequency Changes during Large Disturbances and their effect on the total system - Phase – available at:-
[1http://www2.nationalgrid.com/UK/Industry-information/Electricity-codes/Grid-code/Modifications/GC0035-GC0079/](http://www2.nationalgrid.com/UK/Industry-information/Electricity-codes/Grid-code/Modifications/GC0035-GC0079/)
- [6] GC0048 – Requirements for Generator – GB Banding Thresholds Workgroup Report – available at:-
https://www.nationalgrid.com/sites/default/files/documents/8589934729-Workgroup%20Report_GC0048%20RFG%20-%20Banding%20Thresholds.pdf

Annex 5 - System Study Results in Slide format

Annex 6- Fast Fault Current Injection supporting documents

Annex 7 – Mapping for Grid Code (and Distribution Code)

Annex 8 – Industry Responses to GC0048 consultation on potential GB banding levels

<http://nationalgrid.prod.acquia-sites.com/uk/electricity/codes/grid-code/modifications/gc0048-joint-gcrp-dcrp-workgroup-gb-application-rfq>

Annex 9 – Alternative form stringency – not official alternative