

# Grid Code Frequency Response Working Group System Inertia

Antony Johnson, System Technical Performance



**nationalgrid**  
The power of action.™

## Overview

---

- ◆ Background to System Inertia
- ◆ Transmission System need
- ◆ Future Generation Scenarios
- ◆ Initial Study Work
- ◆ International Experience and Manufacturer Capability
- ◆ Transmission System Issues
- ◆ Conclusions

## Frequency Change

- ◆ Under steady state the mechanical and electrical energy must be balanced
- ◆ When the electrical load exceeds the mechanical energy supplied, the system frequency will fall.
- ◆ The rate of change of frequency fall will be dependant upon the initial Power mismatch and System inertia
- ◆ The speed change will continue until the mechanical power supplied to the transmission system is equal to the electrical demand.

## Why is Inertia Important

- ◆ Inertia is the stored rotating energy in the system
- ◆ Following a System loss, the higher the System Inertia (assuming no frequency response) the longer it takes to reach a new steady state operating frequency.
- ◆ Directly connected synchronous generators and Induction Generators will contribute directly to System Inertia.
- ◆ Modern Generator technologies such as Wind Turbines or wave and tidal generators which decouple the prime mover from the electrical generator will not necessarily contribute directly to System Inertia
- ◆ Under the NGET Gone Green Scenario, significant volumes of new generation are unlikely to contribute to System Inertia

## What is inertia?

- ◆ The stored energy is proportional to the speed of rotation squared
- ◆ 3 types of event cause a change in frequency
  - ◆ Loss of generation (generator, importing HVDC link etc)
  - ◆ Loss of load
  - ◆ Normal variations in load and generator output

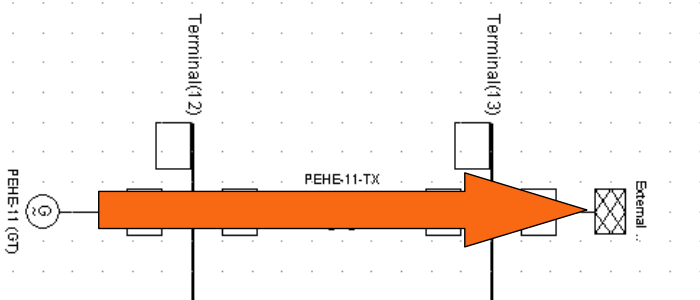

**Stored energy delivered to grid as MW**

**Loss of Generator  
on the system**



**Frequency Falls as  
demand > generation**

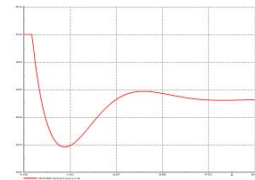

## The maths behind inertia

$$H = \frac{1/2 J \omega^2}{MVA}$$

H = Inertia constant in MWs / MVA  
J = Moment of inertia in kgm<sup>2</sup> of the rotating mass  
 $\omega$  = nominal speed of rotation in rad/s  
MVA = MVA rating of the machine

Typical H for a synchronous generator can range from 2 to 9 seconds (MWs/MVA)

$$\frac{\partial f}{\partial t} = \frac{\Delta P}{2H}$$

$\partial f / \partial t$  = Rate of change of frequency  
 $\Delta P$  = MW of load or generation lost  
2H = Two times the system inertia in MWs / MVA

## An NGET Future Scenario

### 'Gone Green 2020'

- ◆ Plant closures
  - ◆ 12GW Coal & oil LCPD
  - ◆ 7.5GW nuclear
  - ◆ Some gas & additional coal
- ◆ Significant new renewable
  - ◆ **29 GW wind (2/3 offshore)**
  - ◆ Some tidal, wave, biomass & solar PV
  - ◆ Renewable share of generation grows from 5% to 36%
- ◆ Significant new non renewable build
  - ◆ 3GW of new nuclear
  - ◆ 3GW of new supercritical coal (some with CCS)
  - ◆ 11GW of new gas
- ◆ Electricity demand remains flat (approx 60 GW)
  - ◆ Reductions from energy efficiency measures
  - ◆ Increases from heat pumps & cars

### Strategic Reinforcements

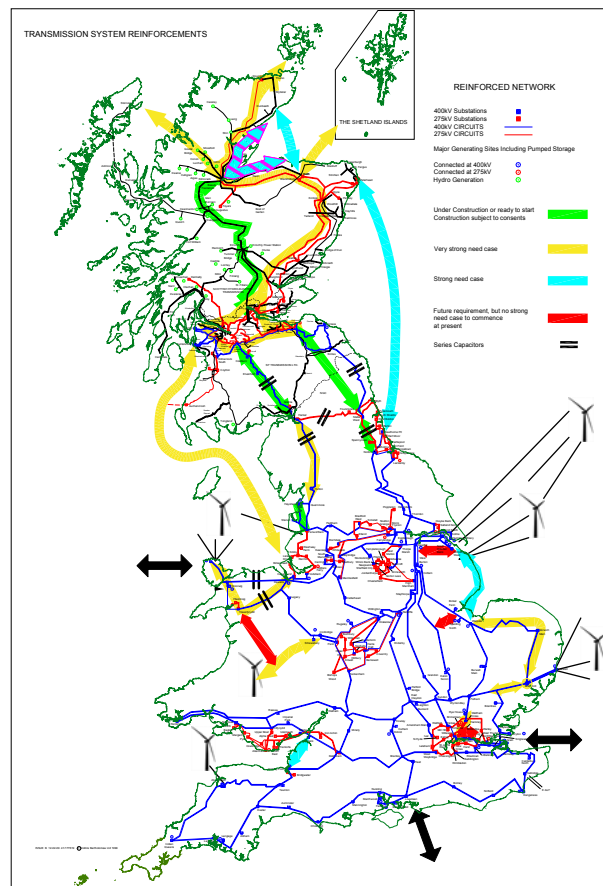

## Quantitative Analysis

---

- ◆ The effect of System Inertia is being quantitatively analysed through two methods:-
  - ◆ Energy Balance spread sheet approach
    - ◆ Utilising simple predictive output models based on an energy balance
  - ◆ System Study using a Test Network
    - ◆ Utilising Dynamic System Models



## Energy Balance Spread Sheet Approach

- ◆ System Considered
  - ◆ 16.5 GW of Wind, 6.9 GW Nuclear, 1.6 GW Carbon Capture
  - ◆ Load Response 2% per Hz
  - ◆ Assumed loss – 1800MW
  - ◆ System Balanced at  $t = 0$  seconds
  - ◆ Inertia considered in isolation
- ◆ General Conclusion
  - ◆ The higher the inertia the longer it takes for the steady state frequency to be reached.
  - ◆ See subsequent slides

## Energy Balance Spread Sheet – Results Wind Generation with and Without Inertia

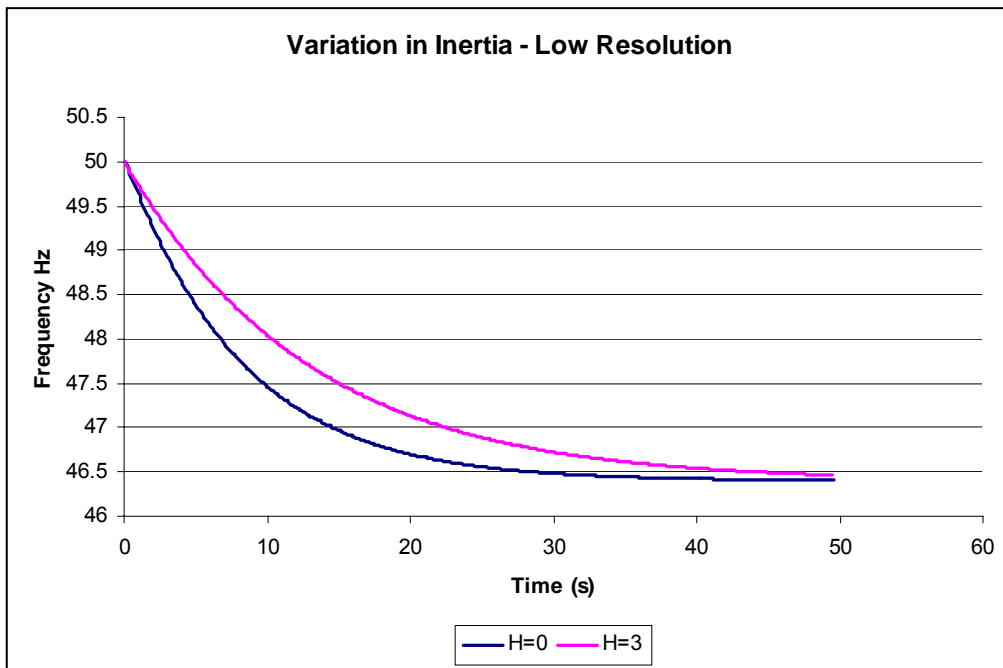

# Energy Balance Spread Sheet – Results

## Wind Generation with and Without Inertia

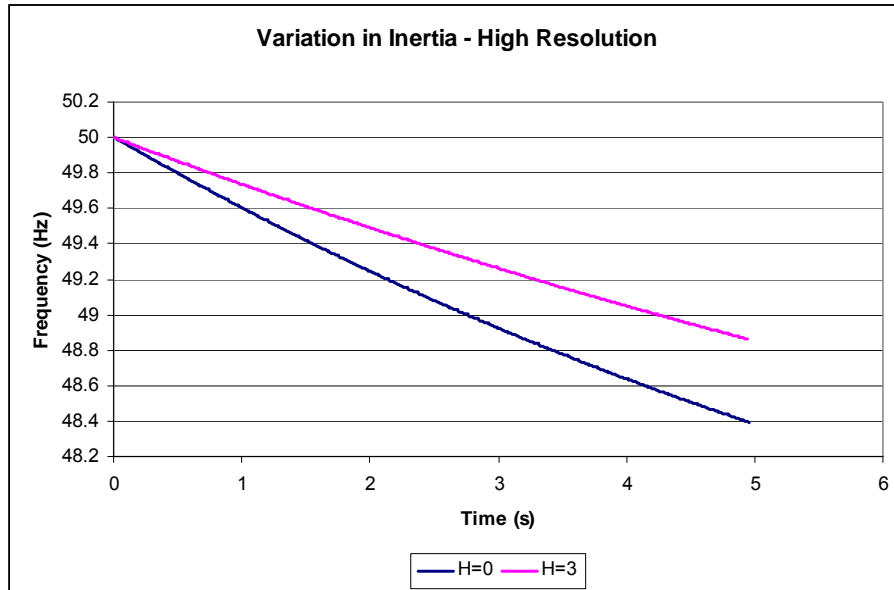

# Test network

- ◆ Basic GB system representation
- ◆ Approx 23GW demand
- ◆ 10 generators
- ◆ 5 generators providing frequency response
- ◆ 1320 MW load switched in (equivalent to loss of a 1320 MW generator)

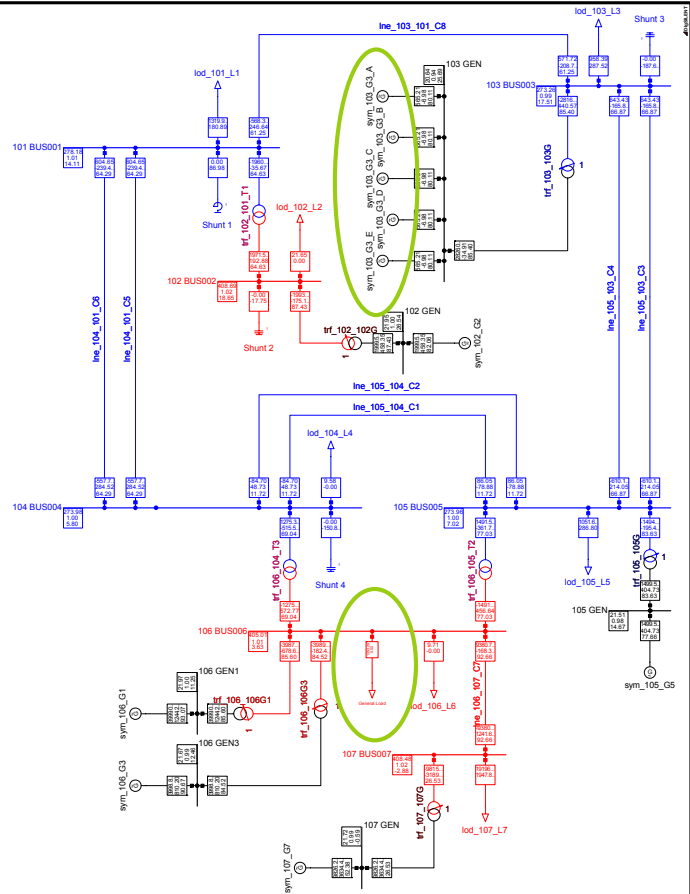

# Base case large disturbance – normal system inertia

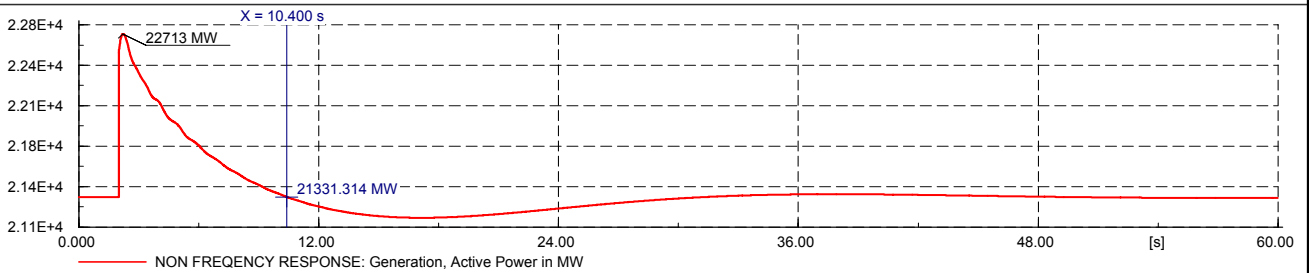
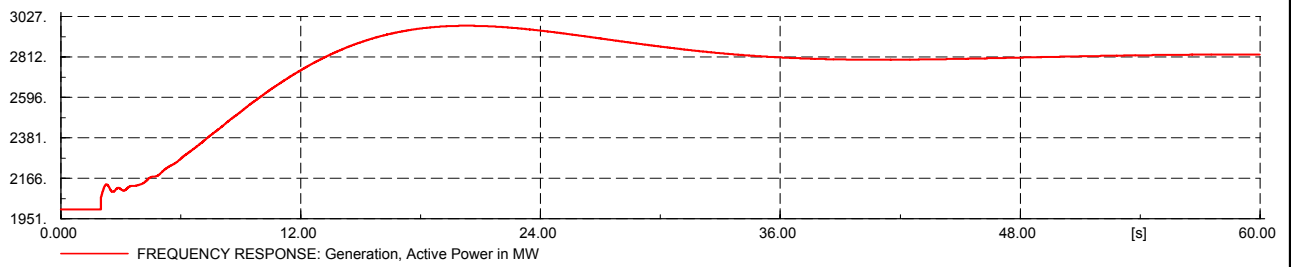
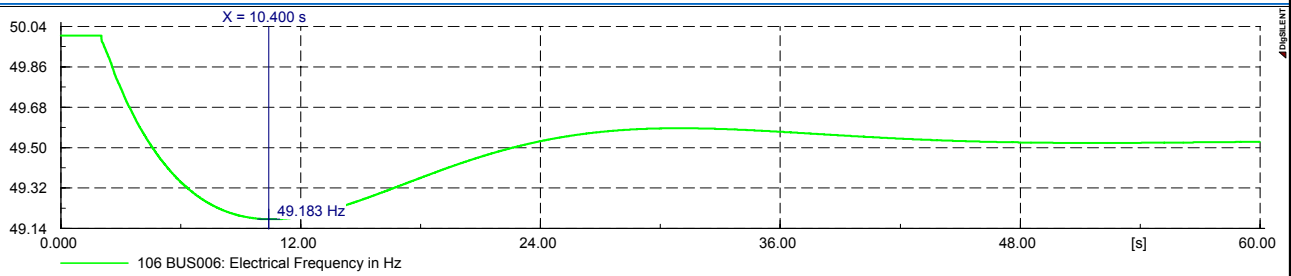

## Decreasing system inertia – large disturbance ( $\frac{1}{2}$ and $\frac{3}{4}$ base case inertia)

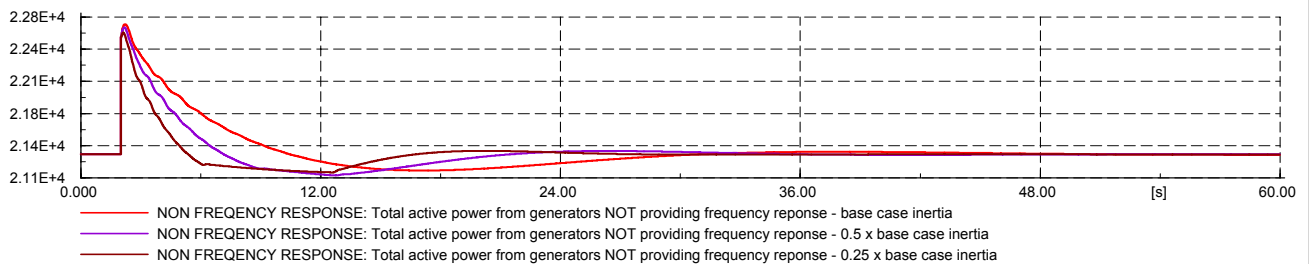
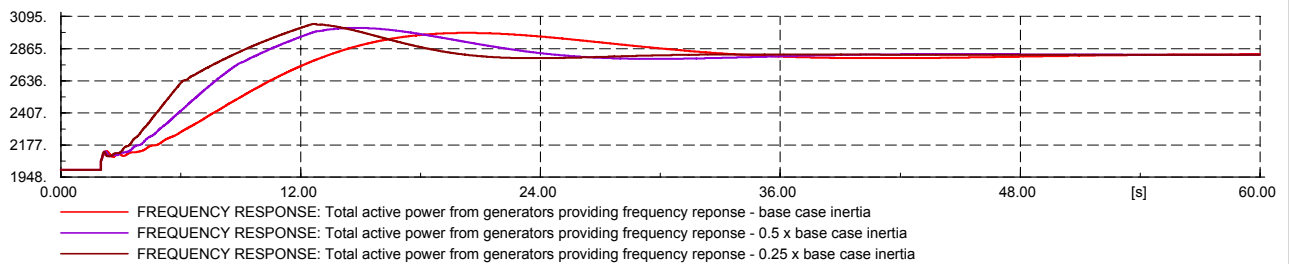
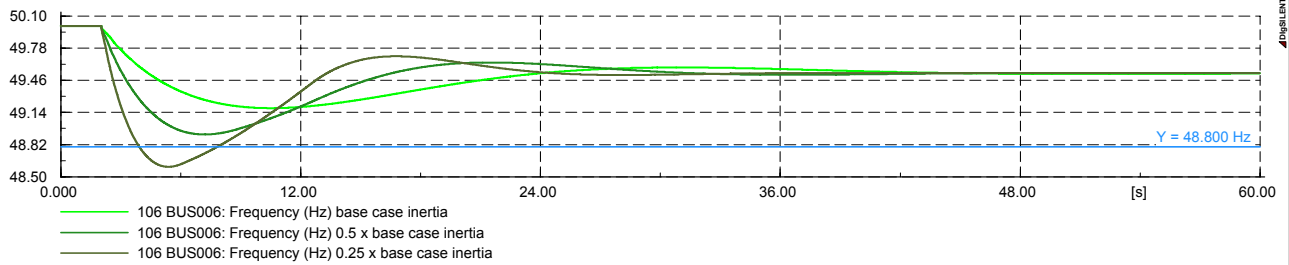

## International Experience and Manufacturer Capability

- ◆ Hydro Quebec requires Generating Units in a Power Plant to have an inertia constant which is compatible with the inertia constants of existing Power Plants in the same region. The minimum inertia for wind power must equate to 3.5s.
- ◆ GE Wind advertise a Wind Inertia Control on their Website
- ◆ Enercon have completed modelling and field tests on a wind turbine and published a paper on this subject
- ◆ Other manufacturers are believed to be investigating an inertial capability

## Transmission System Issues

- ◆ Optimum Performance Capability requirements based on the minimum needs of the Transmission System.
- ◆ Prevention of under and over frequency incidents
- ◆ Control System Design and performance
- ◆ Filtering requirements if any (Noise Generation?)
- ◆ Overall Co-ordination
  - ◆ Inertial contribution – Delivered from all plant
  - ◆ Primary Response – FSM – Containment
  - ◆ Secondary Response – FSM - Correction



## Conclusions

- ◆ Machine inertia significantly affects the rate and rise and rate of fall of System Frequency
- ◆ It is likely to be cheaper (although some form of quantitative analysis would be required) to require all generators to contribute to System Inertia rather than having no requirement and requiring larger volumes of fast acting frequency response?
- ◆ Non Discrimination
- ◆ The inertial delivery requirements needs to be quantified
  - ◆ Delivery / Capability
  - ◆ Control System Settings / Filtering