

**DRAFT EUROPEAN CONNECTION CONDITIONS LEGAL TEXT**

**DATED 13/12/17**

Formatted: Highlight

Key

- 1) Blue Text – From Grid Code
- 2) Black Text – Changes / Additional words
- 3) Orange/ Brown text – From RfG
- 4) Purple – From HVDC Code
- 5) Green – From DCC (not used in this document)
- 6) Highlighted Green text – Questions for Stakeholders / Consultation
- 7) Additional areas of uncertainty
- 8) The Baseline version is that issued with the mapping table on 9 November 2017. All updates from this version, including the comments received as part of the Workgroup Consultation, results of the legal drafting session held on 16<sup>th</sup>/17<sup>th</sup> November and the mapping session held on 20 November are in track change marked format.
- 9) Additional comments following issue of ECC's on 1 December 2017 and updated following E-Mail comments and discussion at the workgroup on 6 December 2017.
- 10) Additional comments following issue of ECC's on 6 December following National Grid Legal checks and discussions with Asset Policy.

**EUROPEAN CONNECTION CONDITIONS  
(ECC)**

**CONTENTS**

(This contents page does not form part of the Grid Code)

<u>Paragraph No/Title</u>	<u>Page Number</u>
<u>ECC.1 INTRODUCTION.....</u>	<u>2</u>
<u>CC.2 OBJECTIVE.....</u>	<u>2</u>
<u>CC.3 SCOPE.....</u>	<u>332</u>
<u>CC.4 PROCEDURE.....</u>	<u>5</u>
<u>CC.5 CONNECTION.....</u>	<u>5</u>
<u>CC.6 TECHNICAL, DESIGN AND OPERATIONAL CRITERIA.....</u>	<u>887</u>
<u>CC.7 SITE RELATED CONDITIONS.....</u>	<u>8583</u>
<u>CC.8 ANCILLARY SERVICES.....</u>	<u>9290</u>
<u>APPENDIX 1 - SITE RESPONSIBILITY SCHEDULES.....</u>	<u>9492</u>
<u>PROFORMA FOR SITE RESPONSIBILITY SCHEDULE.....</u>	<u>9896</u>
<u>APPENDIX 2 - OPERATION DIAGRAMS.....</u>	<u>104102</u>
<u>PART 1A - PROCEDURES RELATING TO OPERATION DIAGRAMS.....</u>	<u>104102</u>
<u>PART 1B - PROCEDURES RELATING TO GAS ZONE DIAGRAMS.....</u>	<u>107405</u>
<u>PART 2 - NON-EXHAUSTIVE LIST OF APPARATUS TO BE INCLUDED ON OPERATION DIAGRAMS.....</u>	<u>108106</u>
<u>APPENDIX 4 - FAULT RIDE THROUGH REQUIREMENTS.....</u>	<u>2</u>
<u>APPENDIX 4A.....</u>	<u>2</u>
<u>APPENDIX 5 - TECHNICAL REQUIREMENTS LOW FREQUENCY RELAYS FOR THE AUTOMATIC DISCONNECTION OF SUPPLIES AT LOW FREQUENCY.....</u>	<u>14</u>
<u>APPENDIX 6 - PERFORMANCE REQUIREMENTS FOR CONTINUOUSLY ACTING AUTOMATIC EXCITATION CONTROL SYSTEMS FOR ONSHORE SYNCHRONOUS GENERATING UNITS.....</u>	<u>17</u>
<u>APPENDIX 7 - PERFORMANCE REQUIREMENTS FOR CONTINUOUSLY ACTING AUTOMATIC VOLTAGE CONTROL SYSTEMS FOR ONSHORE NON-SYNCHRONOUS GENERATING UNITS, ONSHORE DC CONVERTERS, ONSHORE POWER PARK MODULES AND OTSDUW PLANT AND APPARATUS AT THE INTERFACE POINT.....</u>	<u>22</u>
<u>APPENDIX 7 - PERFORMANCE REQUIREMENTS FOR CONTINUOUSLY ACTING AUTOMATIC VOLTAGE CONTROL SYSTEMS FOR ONSHORE NON-SYNCHRONOUS GENERATING UNITS, ONSHORE DC CONVERTERS, ONSHORE POWER PARK MODULES AND OTSDUW PLANT AND APPARATUS AT THE INTERFACE POINT.....</u>	<u>22</u>
<u>APPENDIX 7 - PERFORMANCE REQUIREMENTS FOR CONTINUOUSLY ACTING AUTOMATIC VOLTAGE CONTROL SYSTEMS FOR ONSHORE NON-SYNCHRONOUS GENERATING UNITS, ONSHORE DC CONVERTERS, ONSHORE POWER PARK MODULES AND OTSDUW PLANT AND APPARATUS AT THE INTERFACE POINT.....</u>	<u>303029</u>
<u>CC.1 INTRODUCTION.....</u>	<u>2</u>
<u>E-CC.2 OBJECTIVE.....</u>	<u>2</u>
<u>E-CC.3 SCOPE.....</u>	<u>2</u>
<u>E-CC.4 PROCEDURE.....</u>	<u>45</u>
<u>E-CC.5 CONNECTION.....</u>	<u>5</u>
<u>E-CC.6 TECHNICAL, DESIGN AND OPERATIONAL CRITERIA.....</u>	<u>Error! Bookmark not defined.</u>
<u>E-CC.7 SITE RELATED CONDITIONS.....</u>	<u>8285</u>
<u>E-CC.8 ANCILLARY SERVICES.....</u>	<u>8992</u>
<u>APPENDIX 1 - SITE RESPONSIBILITY SCHEDULES.....</u>	<u>9194</u>

PROFORMA FOR SITE RESPONSIBILITY SCHEDULE.....	9598
APPENDIX 2 – OPERATION DIAGRAMS.....	101104
PART 1A – PROCEDURES RELATING TO OPERATION DIAGRAMS.....	101104
PART 1B – PROCEDURES RELATING TO GAS ZONE DIAGRAMS.....	104107
PART 2 – NON-EXHAUSTIVE LIST OF APPARATUS TO BE INCLUDED ON OPERATION DIAGRAMS.....	105108
APPENDIX 3 – MINIMUM FREQUENCY RESPONSE REQUIREMENT PROFILE AND OPERATING RANGE FOR NEW POWER STATIONS AND DC CONVERTER STATIONS.....	<del>Error! Bookmark not defined.</del>
APPENDIX 4 – FAULT RIDE THROUGH REQUIREMENTS.....	<del>Error! Bookmark not defined.</del>
APPENDIX 4A.....	<del>Error! Bookmark not defined.</del>
APPENDIX 4B.....	<del>Error! Bookmark not defined.</del>
APPENDIX 5 – TECHNICAL REQUIREMENTS LOW FREQUENCY RELAYS FOR THE AUTOMATIC DISCONNECTION OF SUPPLIES AT LOW FREQUENCY.....	14
APPENDIX 6 – PERFORMANCE REQUIREMENTS FOR CONTINUOUSLY ACTING AUTOMATIC EXCITATION CONTROL SYSTEMS FOR ONSHORE SYNCHRONOUS GENERATING UNITS POWER GENERATING MODULES.....	<del>Error! Bookmark not defined.</del>
APPENDIX 7 – PERFORMANCE REQUIREMENTS FOR CONTINUOUSLY ACTING AUTOMATIC VOLTAGE CONTROL SYSTEMS FOR ONSHORE NON-SYNCHRONOUS GENERATING UNITS, ONSHORE DC CONVERTERS, ONSHORE POWER PARK MODULES, HVDC CONVERTERS AT A DC CONVERTER STATION, DC CONNECTED POWER PARK MODULES, REMOTE END DC CONVERTERS AND OTSDUW PLANT AND APPARATUS AT THE INTERFACE POINT.....	<del>Error! Bookmark not defined.</del>

ECC.1 INTRODUCTION

ECC.1.1 The **European Connection Conditions** ("ECC") specify both:

(a) the minimum technical, design and operational criteria which must be complied with by:

(i) any ~~New User~~**EU Code User** connected to or seeking connection with the **National Electricity Transmission System**, or

(ii) ~~GB New Generator~~**EU Generator-s** (other than in respect of **Small Power Stations**) or **HVDC System Converter Station Owners** connected to or seeking connection to a **User's System** which is located in **Great Britain** or **Offshore**, and

~~(iii) Network Operators~~ but only in respect of ECC.3.1(f) and (g) alone.

(b) the minimum technical, design and operational criteria with which **NGET** will comply in relation to the part of the **National Electricity Transmission System** at the **Connection Site** with **Users**. In the case of any **OTSDUW Plant and Apparatus**, the **ECC** also specify the minimum technical, design and operational criteria which must be complied with by the **User** when undertaking **OTSDUW**.

(c) The requirements of **European Regulation (EU) 2016/631** shall not apply to

(i) **Power Generating Modules** that are installed to provide backup power and operate in parallel with the **Total System** for less than 5 minutes per calendar month while the **System** is in normal state. Parallel operation during maintenance or commissioning of tests of that **Power Generating Module** shall not count towards that five minute limit.

(ii) **Power Generating Modules** connected to the **Transmission System** or **Network Operators System** which are not operated in synchronism with a **Synchronous Area**.

(iii) **Power Generating Modules** that do not have a permanent **Connection Point** or **User System Entry Point** and used by **NGET** to temporarily provide power when normal **System** capacity is partly or completely unavailable.

ECC.2 OBJECTIVE

ECC.2.1 The objective of the **ECC** is to ensure that by specifying minimum technical, design and operational criteria the basic rules for connection to the **National Electricity Transmission System** and (for certain **Users**) to a **User's System** are similar for all **Users** of an equivalent category and will enable **NGET** to comply with its statutory and **Transmission Licence** obligations and ~~European Commission~~ Regulations.

ECC.2.2 In the case of any **OTSDUW** the objective of the **ECC** is to ensure that by specifying the minimum technical, design and operational criteria the basic rules relating to an **Offshore Transmission System** designed and constructed by an **Offshore Transmission Licensee** and designed and/or constructed by a **User** under the **OTSDUW Arrangements** are equivalent.

- Formatted: Font: Bold
- Formatted: Font: Bold
- Formatted: Font: Bold
- Formatted: Highlight
- Formatted: Font: Bold, Highlight
- Formatted: Highlight
- Formatted: Font: Bold
- Formatted: Font: Bold
- Formatted: Font: Not Bold
- Formatted: Font: Bold, Highlight
- Formatted: Numbered + Level: 1 +  
Numbering Style: i, ii, iii, ... + Start at: 1 +  
Alignment: Left + Aligned at: 3.24 cm + Indent at: 4.51 cm
- Formatted: Font: Bold
- Formatted: Font: Bold
- Formatted: Font: Bold
- Formatted: Font: Bold
- Formatted: Font: Bold
- Formatted: Font: Bold
- Formatted: Font: Bold
- Formatted: Font: Bold
- Formatted: Font: Not Bold
- Formatted: Font: Not Bold
- Formatted: Font: Not Bold
- Formatted: Font: Not Bold
- Formatted: Font: Not Bold
- Formatted: Font: Not Bold
- Formatted: Font: Not Bold
- Formatted: Font: Not Bold

ECC.2.3 Provisions of the **ECC** which apply in relation to **OTSDUW** and **OTSUA**, and/or a **Transmission Interface Site**, shall (in any particular case) apply up to the **OTSUA Transfer Time**, whereupon such provisions shall (without prejudice to any prior non-compliance) cease to apply, without prejudice to the continuing application of provisions of the **ECC** applying in relation to the relevant **Offshore Transmission System** and/or **Connection Site**. It is the case therefore that in cases where the **OTSUA** becomes operational prior to the **OTSUA Transfer Time** that a **EU Generator** is required to comply with this **ECC** both as it applies to its **Plant** and **Apparatus** at a **Connection Site/Connection Point** and the **OTSUA** at the **Transmission Interface Site/Transmission Interface Point** until the **OTSUA Transfer Time** and this **ECC** shall be construed accordingly.

Formatted: Font: Bold

Formatted: Not Highlight

ECC.2.4 In relation to **OTSDUW**, provisions otherwise to be contained in a **Bilateral Agreement** may be contained in the **Construction Agreement**, and accordingly a reference in the **ECC** to a relevant **Bilateral Agreement** includes the relevant **Construction Agreement**.

Formatted: Not Highlight

ECC.3 SCOPE

ECC.3.1 The **ECC** applies to **NGET** and to **EU Code New- Users**, which in the **ECC** means:

- (a) ~~GB New Generator~~ **EU Generator-s** (other than those which only have **Embedded Small Power Stations**), including those undertaking **OTSDUW** including **Power Generating Modules**, and **DC Connected Power Park Modules** which satisfy the conditions specified in **ECC.3.6**
- ~~(b) Network Operators~~ which satisfy the conditions specified in **ECC.3.6**;
- ~~(c) Non-Embedded Customers~~ which satisfy the conditions specified in **ECC.3.6**;
- ~~(d) HVDC System Converter Station Owners~~ which satisfy the conditions specified in **ECC.3.6**; and
- ~~(e) BM Participants and Externally Interconnected System Operators~~ in respect of **ECC.6.5** only.
- ~~(f) Network Operators~~ only in respect of **Embedded Medium Power Stations** not subject to a **Bilateral Agreement** as provided for in **ECC.3.2**, **ECC.3.3**, **EC3.4**, **EC3.5**, **ECC5.1**, **ECC.6.4.4** and **ECA.3.4**
- ~~(g) For the avoidance of doubt this ECC does not apply to Network Operators other than in respect of item ECC.3.1(f) above.~~

Comment [A1]: Definition to be changed to cater for EU definitions - need to ensure there are no unintended consequences for the PC, OC's and BC's.

Comment [A2]: Network Operators are removed from this drafting until the introduction of GC0104. The remaining sections of text will apply but are effectively switched off.

Formatted: Strikethrough

Formatted: Strikethrough

Formatted: Strikethrough

Formatted: Strikethrough, Not Highlight

Formatted: Strikethrough

Formatted: Strikethrough

Comment [A3]: Definition to be changed to cater for EU definitions - need to ensure there are no unintended consequences for the PC, OC's and BC's.

Comment [A4]: Removed temporarily until the introduction of GC0104

Formatted: Strikethrough

Formatted: Strikethrough

Formatted: Strikethrough, Not Highlight

Formatted: Strikethrough

Formatted: Strikethrough

Formatted: Indent: Left: 1.75 cm, Hanging: 1.5 cm

Formatted: Not Highlight

Formatted: Not Highlight

Formatted: Font: Bold

Formatted: Font: Bold

Formatted: Font: Bold

Formatted: Font: Bold

Formatted: Font: Bold

Comment [A5]: Note the requirements on new EU Network Operators and EU Non Embedded customers will be addressed as part of the GC0104 Workgroup.

ECC.3.2 The above categories of ~~New User~~ **EU Code User** will become bound by the **ECC** prior to them generating, distributing, supplying or consuming, as the case may be, and references to the various categories should, therefore, be taken as referring to them in that prospective role.-

ECC.3.3 **Embedded Medium Power Stations** not subject to a **Bilateral Agreement** and **Embedded HVDC Systems** ~~Converter Stations~~ not subject to a **Bilateral Agreement** Provisions.

The following provisions apply in respect of **Embedded Medium Power Stations** not subject to a **Bilateral Agreement** and **Embedded HVDC Systems** ~~Converter Stations~~ not subject to a **Bilateral Agreement**.

ECC.3.3.1

The obligations within the **ECC** that are expressed to be applicable to **EU Generators** in respect of **Embedded Medium Power Stations** not subject to a **Bilateral Agreement** and **HVDC System-Converter Station Owners** in respect of **Embedded HVDC Systems-Converter Stations** not subject to a **Bilateral Agreement** (where the obligations are in each case listed in ECC.3.3.2) shall be read and construed as obligations that the **Network Operator** within whose **System** any such **Medium Power Station** or **HVDC System-Converter Station** is **Embedded** must ensure are performed and discharged by the **EU Generator** or the **HVDC Converter Station Owner**. **Embedded Medium Power Stations** not subject to a **Bilateral Agreement** and **Embedded HVDC Systems-Converter Stations** not subject to a **Bilateral Agreement** which are located **Offshore** and which are connected to an **Onshore User System** will be required to meet the applicable requirements of the Grid Code as though they are an **Onshore Generator** or **Onshore HVDC System-Converter Station Owner** connected to an **Onshore User System Entry Point**.

Formatted: Font: Bold

Formatted: Font: Bold

ECC.3.3.2

The **Network Operator** within whose **System** a **Medium Power Station** not subject to a **Bilateral Agreement** is **Embedded** or a **HVDC System-Converter Station** not subject to a **Bilateral Agreement** is **Embedded** must ensure that the following obligations in the **ECC** are performed and discharged by the ~~EU New Generator~~ **EU Generator** in respect of each such **Embedded Medium Power Station** or the **HVDC System-Converter Station Owner** in the case of an **Embedded HVDC System-Converter Station**:

Formatted: Font: Bold

Formatted: Font: Bold

ECC.5.1

ECC.5.2.2

ECC.5.3

ECC.6.1.3

ECC.6.1.5 (b)

ECC.6.3.2, ECC.6.3.3, ECC.6.3.4, ECC.6.3.6, ECC.6.3.7, ECC.6.3.8, ECC.6.3.9, ECC.6.3.10, ECC.6.3.12, ECC.6.3.13, ECC.6.3.15, ECC.6.3.16

ECC.6.4.4

ECC.6.5.6 (where required by ECC.6.4.4)

In respect of ECC.6.2.2.2, ECC.6.2.2.3, ECC.6.2.2.5, ECC.6.1.5(a), ECC.6.1.5(b) and ECC.6.3.11 equivalent provisions as co-ordinated and agreed with the **Network Operator** and **EU Generator** or **HVDC System-Converter Station Owner** may be required. Details of any such requirements will be notified to the **Network Operator** in accordance with ECC.3.5.

Formatted: Font: Bold

ECC.3.3.3

In the case of **Embedded Medium Power Stations** not subject to a **Bilateral Agreement** and **Embedded HVDC Systems-Converter Stations** not subject to a **Bilateral Agreement** the requirements in:

ECC.6.1.6

ECC.6.3.8

ECC.6.3.12

ECC.6.3.15

ECC.6.3.16

ECC.6.3.17

that would otherwise have been specified in a **Bilateral Agreement** will be notified to the relevant **Network Operator** in writing in accordance with the provisions of the **CUSC** and the **Network Operator** must ensure such requirements are performed and discharged by the **Generator** or the **HVDC System-Converter Station** owner.

ECC.3.4 In the case of ~~Offshore Embedded Power Stations~~ **Power Generating Modules** connected to an **Offshore User's System** which directly connects to an **Offshore Transmission System**, any additional requirements in respect of such ~~Offshore Embedded Power Generating Modules-Stations~~ may be specified in the relevant **Bilateral Agreement** with the **Network Operator** or in any **Bilateral Agreement** between **NGET** and such **Offshore Generator**~~Embedded Power Station~~.

Formatted: Not Strikethrough

ECC.3.5 In the case of a **Generator** undertaking **OTSDUW** connecting to an **Onshore Network Operator's System**, any additional requirements in respect of such **OTSDUW Plant and Apparatus** will be specified in the relevant **Bilateral Agreement** with the **EU Generator**. For the avoidance of doubt, requirements applicable to **EU Generators** undertaking **OTSDUW** and connecting to a **Network Operator's User System**, shall be consistent with those applicable requirements of **Generators** undertaking **OTSDUW** and connecting to a **Transmission Interface Point**.

Formatted: Font: Bold

Formatted: Font: Bold

ECC.3.6 The requirements of this **ECC** shall apply to ~~New Generator~~**EU Code Users** in respect of **Power Generating Modules** (including **DC Connected Power Park Modules**)~~and~~ **HVDC Systems** and ~~New User EU Code User's~~ in respect of ~~Transmission Connected Demand Facilities, Transmission Connected Distribution Facilities, Network Operators Systems and Demand Units~~ used by a ~~Demand Facility or Closed Distribution System~~ to provide ~~Demand Side Response Services~~.

Formatted: Indent: Hanging: 2.5 cm

Comment [A6]: Propose we use Network Operator System rather than Distribution Facilities

Formatted: Not Highlight

Formatted: Not Highlight

#### ECC.4 PROCEDURE

ECC.4.1 The **CUSC** contains certain provisions relating to the procedure for connection to the **National Electricity Transmission System** or, in the case of **Embedded Power Stations** or **Embedded HVDC Systems-Converter Stations**, becoming operational and includes provisions relating to certain conditions to be complied with by ~~New User EU Code User-s~~ prior to and during the course of **NGET** notifying the **User** that it has the right to become operational. The procedure for an ~~New User EU Code User~~ to become connected is set out in the **Compliance Processes**.

#### ECC.5 CONNECTION

ECC.5.1 The provisions relating to connecting to the **National Electricity Transmission System** (or to a **User's System** in the case of a connection of an **Embedded Large Power Station** or **Embedded Medium Power Stations** or **Embedded HVDC System-Converter Station**) are contained in:

- (a) the **CUSC** and/or **CUSC Contract** (or in the relevant application form or offer for a **CUSC Contract**);
- (b) or, in the case of an **Embedded Development**, the relevant **Distribution Code** and/or the **Embedded Development Agreement** for the connection (or in the relevant application form or offer for an **Embedded Development Agreement**),

and include provisions relating to both the submission of information and reports relating to compliance with the relevant **European Connection Conditions** for that ~~New User~~**EU Code User**, **Safety Rules**, commissioning programmes, **Operation Diagrams** and approval to connect (and their equivalents in the case of **Embedded Medium Power Stations** not subject to a **Bilateral Agreement** or **Embedded HVDC Systems**~~Converter Stations~~ not subject to a **Bilateral Agreement**). References in the **ECC** to the "**Bilateral Agreement**" and/or "**Construction Agreement**" and/or "**Embedded Development Agreement**" shall be deemed to include references to the application form or offer therefor.

ECC.5.2 Items For Submission

ECC.5.2.1 Prior to the **Completion Date** (or, where the ~~New Generator~~**EU Generator** is undertaking **OTSDUW**, any later date specified) under the **Bilateral Agreement** and/or **Construction Agreement**, the following is submitted pursuant to the terms of the **Bilateral Agreement** and/or **Construction Agreement**:

- (a) updated **Planning Code** data (both **Standard Planning Data** and **Detailed Planning Data**), with any estimated values assumed for planning purposes confirmed or, where practical, replaced by validated actual values and by updated estimates for the future and by updated forecasts for **Forecast Data** items such as **Demand**, pursuant to the requirements of the **Planning Code**;
- (b) details of the **Protection** arrangements and settings referred to in ECC.6;
- (c) copies of all **Safety Rules** and **Local Safety Instructions** applicable at **Users' Sites** which will be used at the **NGET/User** interface (which, for the purpose of **OC8**, must be to **NGET's** satisfaction regarding the procedures for **Isolation** and **Earthing**. For **User Sites** in Scotland and **Offshore NGET** will consult the **Relevant Transmission Licensee** when determining whether the procedures for **Isolation** and **Earthing** are satisfactory);
- (d) information to enable **NGET** to prepare **Site Responsibility Schedules** on the basis of the provisions set out in Appendix 1;
- (e) an **Operation Diagram** for all **HV Apparatus** on the **User** side of the **Connection Point** as described in ECC.7;
- (f) the proposed name of the **User Site** (which shall not be the same as, or confusingly similar to, the name of any **Transmission Site** or of any other **User Site**);
- (g) written confirmation that **Safety Co-ordinators** acting on behalf of the **User** are authorised and competent pursuant to the requirements of **OC8**;
- (h) **RISSP** prefixes pursuant to the requirements of **OC8**. **NGET** is required to circulate prefixes utilising a proforma in accordance with **OC8**;
- (i) a list of the telephone numbers for **Joint System Incidents** at which senior management representatives nominated for the purpose can be contacted and confirmation that they are fully authorised to make binding decisions on behalf of the **User**, pursuant to **OC9**;
- (j) a list of managers who have been duly authorised to sign **Site Responsibility Schedules** on behalf of the **User**;
- (k) information to enable **NGET** to prepare **Site Common Drawings** as described in ECC.7;
- (l) a list of the telephone numbers for the **Users** facsimile machines referred to in ECC.6.5.9; and



(m) for **Sites** in Scotland and **Offshore** a list of persons appointed by the **User** to undertake operational duties on the **User's System** (including any **OTSDUW** prior to the **OTSUA Transfer Time**) and to issue and receive operational messages and instructions in relation to the **User's System** (including any **OTSDUW** prior to the **OTSUA Transfer Time**); and an appointed person or persons responsible for the maintenance and testing of **User's Plant** and **Apparatus**.

ECC.5.2.2 Prior to the **Completion Date** the following must be submitted to **NGET** by the **Network Operator** in respect of an **Embedded Development**:

- (a) updated **Planning Code** data (both **Standard Planning Data** and **Detailed Planning Data**), with any estimated values assumed for planning purposes confirmed or, where practical, replaced by validated actual values and by updated estimates for the future and by updated forecasts for **Forecast Data** items such as **Demand**, pursuant to the requirements of the **Planning Code**;
- (b) details of the **Protection** arrangements and settings referred to in ECC.6;
- (c) the proposed name of the **Embedded Medium Power Station** or **Embedded HVDC System** (which shall be agreed with **NGET** unless it is the same as, or confusingly similar to, the name of other **Transmission Site** or **User Site**);

ECC.5.2.3 Prior to the **Completion Date** contained within an **Offshore Transmission Distribution Connection Agreement** the following must be submitted to **NGET** by the **Network Operator** in respect of a proposed new **Interface Point** within its **User System**:

- (a) updated **Planning Code** data (both **Standard Planning Data** and **Detailed Planning Data**), with any estimated values assumed for planning purposes confirmed or, where practical, replaced by validated actual values and by updated estimates for the future and by updated forecasts for **Forecast Data** items such as **Demand**, pursuant to the requirements of the **Planning Code**;
- (b) details of the **Protection** arrangements and settings referred to in ECC.6;
- (c) the proposed name of the **Interface Point** (which shall not be the same as, or confusingly similar to, the name of any **Transmission Site** or of any other **User Site**);

ECC.5.2.4 In the case of **OTSDUW Plant and Apparatus** (in addition to items under ECC.5.2.1 in respect of the **Connection Site**), prior to the **Completion Date** (or any later date specified) under the **Construction Agreement** the following must be submitted to **NGET** by the **User** in respect of the proposed new **Connection Point** and **Interface Point**:

- (a) updated **Planning Code** data (**Standard Planning Data**, **Detailed Planning Data** and **OTSDUW Data and Information**), with any estimated values assumed for planning purposes confirmed or, where practical, replaced by validated actual values and by updated estimates for the future and by updated forecasts for **Forecast Data** items such as **Demand**, pursuant to the requirements of the **Planning Code**;
- (b) details of the **Protection** arrangements and settings referred to in ECC.6;
- (c) information to enable preparation of the **Site Responsibility Schedules** at the **Transmission Interface Site** on the basis of the provisions set out in Appendix E1.
- (d) the proposed name of the **Interface Point** (which shall not be the same as, or confusingly similar to, the name of any **Transmission Site** or of any other **User Site**);

ECC.5.3 (a) Of the items ECC.5.2.1 (c), (e), (g), (h), (k) and (m) need not be supplied in respect of **Embedded Power Stations** or **Embedded HVDC Systems** ~~**Converter Stations**~~,

Formatted: Not Highlight

- (b) item ECC.5.2.1(i) need not be supplied in respect of **Embedded Small Power Stations** and **Embedded Medium Power Stations** or **Embedded HVDC Systems**—~~Converter Stations~~ with a **Registered Capacity** of less than 100MW, and
- (c) items ECC.5.2.1(d) and (j) are only needed in the case where the **Embedded Power Station** or the **Embedded HVDC System**—~~Converter Station~~ is within a **Connection Site** with another **User**.

ECC.5.4 In addition, at the time the information is given under ECC.5.2(g), **NGET** will provide written confirmation to the **User** that the **Safety Co-ordinators** acting on behalf of **NGET** are authorised and competent pursuant to the requirements of **OC8**.

ECC.6 TECHNICAL, DESIGN AND OPERATIONAL CRITERIA

ECC.6.1 National Electricity Transmission System Performance Characteristics

ECC.6.1.1 **NGET** shall ensure that, subject as provided in the **Grid Code**, the **National Electricity Transmission System** complies with the following technical, design and operational criteria in relation to the part of the **National Electricity Transmission System** at the **Connection Site** with a **User** and in the case of **OTSDUW Plant and Apparatus**, a **Transmission Interface Point** (unless otherwise specified in ECC.6) although in relation to operational criteria **NGET** may be unable (and will not be required) to comply with this obligation to the extent that there are insufficient **Power Stations** or **User Systems** are not available or **Users** do not comply with **NGET's** instructions or otherwise do not comply with the **Grid Code** and each **User** shall ensure that its **Plant** and **Apparatus** complies with the criteria set out in ECC.6.1.5.

ECC.6.1.2 Grid Frequency Variations

ECC.6.1.2.1 Grid Frequency Variations for ~~New User~~ **EU Code User's** excluding **HVDC Equipment**

Formatted: Font: Not Bold

ECC.6.1.2.1.1 The **Frequency** of the **National Electricity Transmission System** shall be nominally 50Hz and shall be controlled within the limits of 49.5 - 50.5Hz unless exceptional circumstances prevail.

ECC.6.1.2.1.2 The **System Frequency** could rise to 52Hz or fall to 47Hz in exceptional circumstances. Design of **EU Code User's Plant** and **Apparatus** and **OTSDUW Plant and Apparatus** must enable operation of that **Plant** and **Apparatus** within that range in accordance with the following:

Formatted: Font: Bold

<u>Frequency Range</u>	<u>Requirement</u>
51.5Hz - 52Hz	Operation for a period of at least 15 minutes is required each time the Frequency is above 51.5Hz.
51Hz - 51.5Hz	Operation for a period of at least 90 minutes is required each time the Frequency is above 51Hz.
49.0Hz - 51Hz	Continuous operation is required
47.5Hz - 49.0Hz	Operation for a period of at least 90 minutes is required each time the Frequency is below 49.0Hz.
47Hz - 47.5Hz	Operation for a period of at least 20 seconds is required each time the Frequency is below 47.5Hz.

ECC.6.1.2.1.3 For the avoidance of doubt, disconnection, by frequency or speed based relays is not permitted within the frequency range 47.5Hz to 51.5Hz. ~~New Generator~~**EU Generators** should however be aware of the combined voltage and frequency operating ranges as defined in ECC.6.3.12 and ECC.6.3.13.

Formatted: Font: Bold

ECC.6.1.2.1.4 NGET in co-ordination with the Relevant Transmission Licensee and/or Network Operator and a User may agree on wider variations in frequency or longer minimum operating times to those set out in ECC.6.1.2.1.2 or specific requirements for combined frequency and voltage deviations. Any such requirements in relation to Power Generating Modules shall be in accordance with ECC.6.3.12 and ECC.6.3.13. An ~~New User~~**EU Code User** shall not unreasonably withhold consent to apply wider frequency ranges or longer minimum times for operation taking account of their economic and technical feasibility.

Formatted: Not Highlight

Formatted: Font: Bold

ECC.6.1.2.2 Grid Frequency variations for HVDC Systems and Remote End HVDC Converter Stations

ECC.6.1.2.2.1 HVDC Systems and Remote End HVDC Converter Stations shall be capable of staying connected to the System and remaining operable within the frequency ranges and time periods specified in Table ECC.6.1.2.2 below. This requirement shall continue to apply during the Fault Ride Through conditions defined in ECC.6.3.15

Formatted: Not Highlight

Frequency Range (Hz)	Time Period for Operation (s)
47.0 – 47.5Hz	60 seconds
47.5 – 49.0Hz	90 minutes and 30 seconds
49.0 – 51.0Hz	Unlimited
51.0 – 51.5Hz	90 minutes and 30 seconds
51.5Hz – 52 Hz	20 minutes

Table ECC.6.1.2.2 – Minimum time periods HVDC Systems and Remote End HVDC Converter Stations shall be able to operate for different frequencies deviating from a nominal value without disconnecting from the National Electricity Transmission System

Formatted: Not Highlight

ECC.6.1.2.2.2 NGET in coordination with the Relevant Transmission Licensee and a HVDC System Owner may agree wider frequency ranges or longer minimum operating times if required to preserve or restore system security. If wider frequency ranges or longer minimum times for operation are economically and technically feasible, the HVDC System Owner shall not unreasonably withhold consent.

ECC.6.1.2.2.3 Notwithstanding the requirements of ECC.6.1.2.2.1, an HVDC System or Remote End HVDC Converter Station shall be capable of automatic disconnection at frequencies specified by NGET and/or Relevant Network Operator.

ECC.6.1.2.2.4 In the case of Remote End HVDC Converter Stations where the Remote End HVDC Converter Station is operating at either nominal frequency other than 50Hz or a variable frequency, the requirements defined in ECC.6.1.2.2.1 to ECC.6.1.2.2.3 shall apply to the Remote End HVDC Converter Station other than in respect of the frequency ranges and time periods.

ECC.6.1.2.3 Grid Frequency Variations for DC Connected Power Park Modules

ECC.6.1.2.3.1 **DC Connected Power Park Modules** shall be capable of staying connected to the **Remote End DC Converter** network at the HVDC Interface Point and operating within the **Frequency** ranges and time periods specified in Table [ECC.6.1.2.3](#) below. Where a nominal frequency other than 50Hz, or a **Frequency** variable by design is used as agreed with **NGET** and the **Relevant Transmission Licensee** the applicable **Frequency** ranges and time periods shall be specified in the **Bilateral Agreement** which shall (where applicable) reflect the requirements in Table [ECC.6.1.2.3](#).

Formatted: Not Highlight

Frequency Range (Hz)	Time Period for Operation (s)
47.0 – 47.5Hz	20 seconds
47.5 – 49.0Hz	90 minutes
49.0 – 51.0Hz	Unlimited
51.0 – 51.5Hz	90 minutes
51.5Hz – 52 Hz	15 minutes

Table [ECC.6.1.2.3](#) – Minimum time periods a **DC Connected Power Park Module** shall be able to operate for different frequencies deviating from a nominal value without disconnecting from the **System**

Formatted: Not Highlight

ECC.6.1.2.3.2 **NGET** in coordination with the **Relevant Transmission Licensee** and a **Generator** may agree wider frequency ranges or longer minimum operating times if required to preserve or restore system security and to ensure the optimum capability of the **DC Connected Power Park Module**. If wider frequency ranges or longer minimum times for operation are economically and technically feasible, the ~~New Generator~~EU Generator shall not unreasonably withhold consent.

ECC.6.1.3 Not used

ECC.6.1.4 [Grid Voltage Variations](#)

ECC.6.1.4.1 [Grid Voltage Variations](#) for all **EU Code** User's excluding **DC Connected Power Park Modules and Remote End HVDC Converters**

Formatted: Font: Bold

Subject as provided below, the voltage on the 400kV part of the **National Electricity Transmission System** at each **Connection Site** with a **User** (and in the case of **OTSDUW Plant and Apparatus**, a **Transmission Interface Point**, excluding **DC Connected Power Park Modules** and **Remote End HVDC Converters**) will normally remain within  $\pm 5\%$  of the nominal value unless abnormal conditions prevail. The minimum voltage is  $-10\%$  and the maximum voltage is  $+10\%$  unless abnormal conditions prevail, but voltages between  $+5\%$  and  $+10\%$  will not last longer than 15 minutes unless abnormal conditions prevail. Voltages on the 275kV and 132kV parts of the **National Electricity Transmission System** at each **Connection Point** (and in the case of **OTSDUW Plant and Apparatus**, a **Transmission Interface Point**) will normally remain within the limits  $\pm 10\%$  of the nominal value unless abnormal conditions prevail. At nominal **System** voltages below 110kV the voltage of the **National Electricity Transmission System** at each **Connection Site** with a **User** (and in the case of **OTSDUW Plant and Apparatus**, a **Transmission Interface Point**), excluding **Connection Sites** for **DC Connected Power Park Modules** and **Remote End HVDC Converters**) will normally remain within the limits  $\pm 6\%$  of the nominal value unless abnormal conditions prevail. Under fault conditions, the voltage may collapse transiently to zero at the point of fault until the fault is cleared. The normal operating ranges of the **National Electricity Transmission System** are summarised below:

National Electricity Transmission System Nominal Voltage	Normal Operating Range	Time period for Operation
400kV	400kV $-10\%$ to $+5\%$ 400kV $+5\%$ to $+10\%$	Unlimited 15 minutes
275kV	275kV $\pm 10\%$	Unlimited
132kV	132kV $\pm 10\%$	Unlimited
110kV	110kV $\pm 10\%$	Unlimited
Below 110kV	Below 110kV $\pm 6\%$	Unlimited

**NGET** and a **New User/EU Code User** may agree greater or lesser wider variations or longer minimum time periods of operation in voltage to those set out above in relation to a particular **Connection Site**, and insofar as a greater or lesser variation is agreed, the relevant figure set out above shall, in relation to that **New User/EU Code User** at the particular **Connection Site**, be replaced by the figure agreed.

ECC.6.1.4.2 Grid Voltage Variations for all **DC Connected Power Park Modules**

ECC.6.1.4.2.1 All **DC Connected Power Park Modules** shall be capable of staying connected to the **Remote End HVDC Converter Station** at the **HVDC Interface Point** and operating within the voltage ranges and time periods specified in Tables ECC.6.1.4.2(a) and ECC.6.1.4.2(b) below. The applicable voltage range and time periods specified are selected based on the reference 1pu voltage.

Formatted: Font color: Auto

Formatted: Font color: Auto, Not Highlight

Formatted: Not Highlight

Voltage Range (pu)	Time Period for Operation (s)
0.85pu – 0.9pu	60 minutes

0.9pu – 1.1pu	Unlimited
1.1pu – 1.15pu	15 minutes

Table ECC.6.1.4.2(a) – Minimum time periods for which **DC Connected Power Park Modules** shall be capable of operating for different voltages deviating from reference 1pu without disconnecting from the network where the nominal voltage base is 110kV or above and less than 300kV.

Formatted: Not Highlight

Voltage Range (pu)	Time Period for Operation (s)
0.85pu – 0.9pu	60 minutes
0.9pu – 1.05pu	Unlimited
1.05pu – 1.15pu	15 minutes

Table ECC.6.1.4.2(b) – Minimum time periods for which **DC Connected Power Park Modules** shall be capable of operating for different voltages deviating from reference 1pu without disconnecting from the network where the nominal voltage base is from 300kV up to and including 400kV.

Formatted: Not Highlight

ECC.6.1.4.2.2 **NGET** and a ~~New Generator~~ **EU Generator in respect of a DC Connected Power Park Module** may agree greater voltage ranges or longer minimum operating times. If greater voltage ranges or longer minimum times for operation are economically and technically feasible, the **EU Generator** shall not unreasonably withhold any agreement .

Formatted: Font: Not Bold

Formatted: Font: Bold

ECC.6.1.4.2.3 For **DC Connected Power Park Modules** which have an **HVDC Interface Point** to the **Remote End HVDC Converter Station**, **NGET** in coordination with the **Relevant Transmission Licensee** may specify voltage limits at the **HVDC Interface Point** at which the **DC Connected Power Park Module** is capable of automatic disconnection.

ECC.6.1.4.2.4 For **HVDC Interface Points** which fall outside the scope of ECC.6.1.4.2.1, ECC.6.1.4.2.2 and ECC.6.1.4.2.3, **NGET** in coordination with the **Relevant Transmission Licensee** shall specify any applicable requirements at the **Grid Entry Point** or **User System Entry Point**.

ECC.6.1.4.2.5 Where the nominal frequency of the AC collector **System** which is connected to an **HVDC Interface Point** is at a value other than 50Hz, the voltage ranges and time periods specified by **NGET** in coordination with the **Relevant Transmission Licensee** shall be proportional to the values specified in Table [Table ECC.6.1.4.2\(a\)](#) and [Table ECC.6.1.4.2\(b\)](#) ~~3 and 4 of ECC.6.1.4.2.1.~~

ECC.6.1.4.3 Grid Voltage Variations for all Remote End HVDC Converters

ECC.6.1.4.3.1 All **Remote End HVDC Converter Stations** shall be capable of staying connected to the **HVDC Interface Point** and operating within the voltage ranges and time periods specified in Tables [ECC.6.1.4.3\(a\)](#) and [ECC.6.1.4.3\(b\)](#) below. The applicable voltage range and time periods specified are selected based on the reference 1pu voltage.

Formatted: Not Highlight

Formatted: Not Highlight

Voltage Range (pu)	Time Period for Operation (s)
0.85pu – 0.9pu	60 minutes
0.9pu – 1.1pu	Unlimited

1.1pu – 1.15pu	15 minutes
----------------	------------

Table [ECC.6.1.4.3\(a\)](#) – Minimum time periods for which a **Remote End HVDC Converter** shall be capable of operating for different voltages deviating from reference 1pu without disconnecting from the network where the nominal voltage base is 110kV or above and less than 300kV.

Formatted: Not Highlight

Voltage Range (pu)	Time Period for Operation (s)
0.85pu – 0.9pu	60 minutes
0.9pu – 1.05pu	Unlimited
1.05pu – 1.15pu	15 minutes

Table [ECC.6.1.4.3\(b\)](#) – Minimum time periods for which a **Remote End HVDC Converter** shall be capable of operating for different voltages deviating from reference 1pu without disconnecting from the network where the nominal voltage base is from 300kV up to and including 400kV.

Formatted: Not Highlight

ECC.6.1.4.3.2 **NGET** and a **HVDC System Owner** may agree greater voltage ranges or longer minimum operating times which shall be in accordance with the requirements of [ECC.6.1.4.2](#).

Formatted: Not Highlight

ECC.6.1.4.3.4 For **HVDC Interface Points** which fall outside the scope of [ECC.6.1.4.3.1](#) **NGET** in coordination with the **Relevant Transmission Licensee** shall specify any applicable requirements at the **Grid Entry Point** or **User System Entry Point**.

Formatted: Not Highlight

ECC.6.1.4.3.5 Where the nominal frequency of the AC collector System which is connected to an **HVDC Interface Point** is at a value other than 50Hz, the voltage ranges and time periods specified by **NGET** in coordination with the **Relevant Transmission Licensee** shall be proportional to the values specified in Table [ECC.6.1.4.3\(a\)](#) and Table [ECC.6.1.4.3\(b\)](#) ~~5 and 6 of [ECC.6.1.4.3.1](#)~~

Formatted: Not Highlight

#### Voltage Waveform Quality

ECC.6.1.5 All **Plant** and **Apparatus** connected to the **National Electricity Transmission System**, and that part of the **National Electricity Transmission System** at each **Connection Site** or, in the case of **OTSDUW Plant and Apparatus**, at each **Interface Point**, should be capable of withstanding the following distortions of the voltage waveform in respect of harmonic content and phase unbalance:

#### (a) Harmonic Content

The **Electromagnetic Compatibility Levels** for harmonic distortion on the **Onshore Transmission System** from all sources under both **Planned Outage** and fault outage conditions, (unless abnormal conditions prevail) shall comply with the levels shown in the tables of Appendix A of **Engineering Recommendation G5/4**. The **Electromagnetic Compatibility Levels** for harmonic distortion on an **Offshore Transmission System** will be defined in relevant **Bilateral Agreements**.

**Engineering Recommendation G5/4** contains planning criteria which **NGET** will apply to the connection of non-linear **Load** to the **National Electricity Transmission System**, which may result in harmonic emission limits being specified for these **Loads** in the relevant **Bilateral Agreement**. The application of the planning criteria will take into account the position of existing **User's** and **New-User EU Code User-s' Plant and Apparatus** (and **OTSDUW Plant and Apparatus**) in relation to harmonic emissions. **Users** must ensure that connection of distorting loads to their **User Systems** do not cause any harmonic emission limits specified in the **Bilateral Agreement**, or where no such limits are specified, the relevant planning levels specified in **Engineering Recommendation G5/4** to be exceeded.

Formatted: Font: Bold

(b) Phase Unbalance

Under **Planned Outage** conditions, the weekly 95 percentile of **Phase (Voltage) Unbalance**, calculated in accordance with IEC 61000-4-30 and IEC 61000-3-13, on the **National Electricity Transmission System** for voltages above 150kV should remain, in England and Wales, below 1.5%, and in Scotland, below 2%, and for voltages of 150kV and below, across GB below 2%, unless abnormal conditions prevail and **Offshore** (or in the case of **OTSDUW, OTSDUW Plant and Apparatus**) will be defined in relevant **Bilateral Agreements**.

The Phase Unbalance is calculated from the ratio of root mean square (rms) of negative phase sequence voltage to rms of positive phase sequence voltage, based on 10-minute average values, in accordance with IEC 61000-4-30.

ECC.6.1.6 Across GB, under the **Planned Outage** conditions stated in ECC.6.1.5(b) infrequent short duration peaks with a maximum value of 2% are permitted for **Phase (Voltage) Unbalance**, for voltages above 150kV, subject to the prior agreement of **NGET** under the **Bilateral Agreement** and in relation to **OTSDUW**, the **Construction Agreement**. **NGET** will only agree following a specific assessment of the impact of these levels on **Transmission Apparatus** and other **Users Apparatus** with which it is satisfied.

Voltage Fluctuations

ECC.6.1.7 Voltage changes at a **Point of Common Coupling** on the **Onshore Transmission System** shall not exceed:

(a) The limits specified in Table ECC.6.1.7 with the stated frequency of occurrence, where:

$$(i) \quad \% \Delta V_{\text{steadystate}} = \left| 100 \times \frac{\Delta V_{\text{steadystate}}}{V_0} \right|$$

and

$$\% \Delta V_{\text{max}} = 100 \times \frac{\Delta V_{\text{max}}}{V_0} ;$$

(ii)  $V_0$  is the initial steady state system voltage;

(iii)  $V_{\text{steadystate}}$  is the system voltage reached when the rate of change of system voltage over time is less than or equal to 0.5% over 1 second and  $\Delta V_{\text{steadystate}}$  is the absolute value of the difference between  $V_{\text{steadystate}}$  and  $V_0$ ;



- (iv)  $\Delta V_{\max}$  is the absolute value of the maximum change in the system voltage relative to the initial steady state system voltage of  $V_0$ ;
- (v) All voltages are the root mean square of the voltage measured over one cycle refreshed every half a cycle as per IEC 61000-4-30;
- (vi) The voltage changes specified are the absolute maximum allowed, applied to phase to ground or phase to phase voltages whichever is the highest change;
- (vii) Voltage changes in category 3 do not exceed the limits depicted in the time dependant characteristic shown in Figure ECC.6.1.7;
- (viii) Voltage changes in category 3 only occur infrequently, typically not planned more than once per year on average over the lifetime of a connection, and in circumstances notified to **NGET**, such as for example commissioning in accordance with a commissioning programme, implementation of a planned outage notified in accordance with **OC2** or an **Operation** or **Event** notified in accordance with **OC7**; and
- (ix) For connections where voltage changes would constitute a risk to the **National Electricity Transmission System** or, in **NGET**'s view, the **System** of any **User**, **Bilateral Agreements** may include provision for **NGET** to reasonably limit the number of voltage changes in category 2 or 3 to a lower number than specified in Table ECC.6.1.7 to ensure that the total number of voltage changes at the **Point of Common Coupling** across multiple **Users** remains within the limits of Table ECC.6.1.7.

**Comment [A7]:** House Keeping change - remove bold

Category	Maximum number of Occurrences	$\% \Delta V_{\max}$ & $\% \Delta V_{\text{steadystate}}$
1	No Limit	$ \% \Delta V_{\max}  \leq 1\% \&  \% \Delta V_{\text{steadystate}}  \leq 1\%$
2	$\frac{3600}{\sqrt[0.304]{2.5 \times \% \Delta V_{\max}}}$ occurrences per hour with events evenly distributed	$1\% <  \% \Delta V_{\max}  \leq 3\% \&  \% \Delta V_{\text{steadystate}}  \leq 3\%$
3	No more than 4 per day for Commissioning, Maintenance and Fault Restoration	For decreases in voltage: $\% \Delta V_{\max} \leq 12\%^1 \& \% \Delta V_{\text{steadystate}} \leq 3\%$ For increases in voltage: $\% \Delta V_{\max} \leq 5\%^2 \& \% \Delta V_{\text{steadystate}} \leq 3\%$ (see Figure ECC6.1.7)

Table ECC.6.1.7 - Limits for Rapid Voltage Changes

<sup>1</sup> A decrease in voltage of up to 12% is permissible for up to 80ms, as highlighted in the shaded area in Figure ECC.6.1.7, reducing to up to 10%

- after 80ms and to up to 3% after 2 seconds.
- <sup>2</sup> An increase in voltage of up to 5% is permissible if it is reduced to up to 3% after 0.5 seconds.

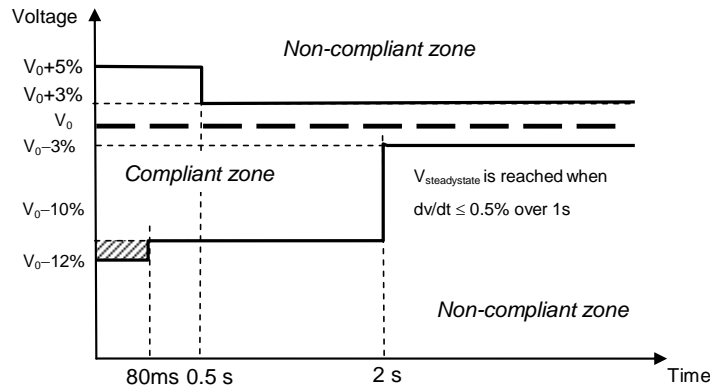

Figure ECC.6.1.7 -  
Time and magnitude limits for a category 3 Rapid Voltage Change

- (b) For voltages above 132kV, **Flicker Severity (Short Term)** of 0.8 Unit and a **Flicker Severity (Long Term)** of 0.6 Unit, for voltages 132kV and below, **Flicker Severity (Short Term)** of 1.0 Unit and a **Flicker Severity (Long Term)** of 0.8 Unit, as set out in **Engineering Recommendation P28** as current at the **Transfer Date**.

ECC.6.1.8 Voltage fluctuations at a **Point of Common Coupling** with a fluctuating **Load** directly connected to an **Offshore Transmission System** (or in the case of **OTSDUW, OTSDUW Plant and Apparatus**) shall not exceed the limits set out in the **Bilateral Agreement**.

Formatted: Indent: Left: 0 cm, Hanging: 2.5 cm

Sub-Synchronous Resonance and Sub-Synchronous Torsional Interaction (SSTI)

ECC.6.1.9 **NGET** shall ensure that **Users' Plant and Apparatus** will not be subject to unacceptable Sub-Synchronous Oscillation conditions as specified in the relevant **Licence Standards**.

ECC.6.1.10 **NGET** shall ensure where necessary, and in consultation with **Transmission Licensees** where required, that any relevant site specific conditions applicable at a **User's Connection Site**, including a description of the Sub-Synchronous Oscillation conditions considered in the application of the relevant **Licence Standards**, are set out in the **User's Bilateral Agreement**.

~~ECC.6.1.18.2 Where an HVDC System connects two or more control areas, the relevant TSOs shall consult each other in order to set a coordinated value of the maximum loss of active power injection as referred to in paragraph 1, taking into account common mode failures.~~

ECC.6.2 Plant and Apparatus relating to Connection Sites and Interface Points and HVDC Interface Points

The following requirements apply to **Plant and Apparatus** relating to the **Connection Point**, and **OTSDUW Plant and Apparatus** relating to the **Interface Point** (until the **OTSUA Transfer Time**), **HVDC Interface Points** relating to **Remote End HVDC Converters** and **Connection Points** which (except as otherwise provided in the relevant paragraph) each ~~New User~~ **EU Code User** must ensure are complied with in relation to its **Plant and Apparatus** and which in the case of ECC.6.2.2.2.2, ECC.6.2.3.1.1 and ECC.6.2.1.1(b) only, **NGET** must ensure are complied with in relation to **Transmission Plant and Apparatus**, as provided in those paragraphs.

Formatted: Not Strikethrough

Formatted: Not Highlight

Formatted: Not Highlight

Formatted: Not Highlight

ECC.6.2.1 General Requirements

ECC.6.2.1.1 (a) The design of connections between the **National Electricity Transmission System** and:

(i) any **Power Generating Module** ~~Generating Unit~~ (other than a **CCGT Unit** or **Power Park Unit**) **HVDC Equipment** ~~Converter~~, **Power Park Module** or **CCGT Module**, or

Formatted: Not Strikethrough

(ii) any **Network Operator's User System**, or

(iii) **Non-Embedded Customers** equipment;

will be consistent with the **Licence Standards**.

In the case of **OTSDUW**, the design of the **OTSUA's** connections at the **Interface Point** and **Connection Point** will be consistent with **Licence Standards**.

(b) The **National Electricity Transmission System** (and any **OTSDUW Plant and Apparatus**) at nominal **System** voltages of 132kV and above is/shall be designed to be earthed with an **Earth Fault Factor** of, in England and Wales or **Offshore**, below 1.4 and in Scotland, below 1.5. Under fault conditions the rated **Frequency** component of voltage could fall transiently to zero on one or more phases or, in England and Wales, rise to 140% phase-to-earth voltage, or in Scotland, rise to 150% phase-to-earth voltage. The voltage rise would last only for the time that the fault conditions exist. The fault conditions referred to here are those existing when the type of fault is single or two phase-to-earth.

(c) For connections to the **National Electricity Transmission System** at nominal **System** voltages of below 132kV the earthing requirements and voltage rise conditions will be advised by **NGET** as soon as practicable prior to connection and in the case of **OTSDUW Plant and Apparatus** shall be advised to **NGET** by the **EU Code User**.

ECC.6.2.1.2 Substation Plant and Apparatus

(a) The following provisions shall apply to all **Plant and Apparatus** which is connected at the voltage of the **Connection Point** (and **OTSDUW Plant and Apparatus** at the **Interface Point**) and which is contained in equipment bays that are within the **Transmission busbar Protection** zone at the **Connection Point**. This includes circuit breakers, switch disconnectors, disconnectors, **Earthing Devices**, power transformers, voltage transformers, reactors, current transformers, surge arresters, bushings, neutral equipment, capacitors, line traps, coupling devices, external insulation and insulation co-ordination devices. Where necessary, this is as more precisely defined in the **Bilateral Agreement**.

**Comment [A8]:** Onshore Generation behind HVDC Converters does not exist in GB arrangements. This requires further discussion as the effect of the drafting is such that the technical requirements are applied to all Generation assets.

~~(i) Plant and/or Apparatus prior to 1st January 1999~~

~~Each item of such Plant and/or Apparatus which at 1st January 1999 is either:~~

- ~~— installed; or~~
- ~~— owned (but is either in storage, maintenance or awaiting installation); or~~
- ~~— ordered;~~

~~and is the subject of a Bilateral Agreement with regard to the purpose for which it is in use or intended to be in use, shall comply with the relevant standards/specifications applicable at the time that the Plant and/or Apparatus was designed (rather than commissioned) and any further requirements as specified in the Bilateral Agreement.~~

(ii) Plant and/or Apparatus in respect of New User EU Code User's connecting post 1st January 1999 for to a new Connection Point (including OTSDUW Plant and Apparatus at the Interface Point )

Each item of such Plant and/or Apparatus installed in relation to a new Connection Point (or OTSDUW Plant and Apparatus at the Interface Point or Remote End HVDC Converter Station at the HVDC Interface Point) after 1st January 1999 shall comply with the relevant Technical Specifications and any further requirements identified by NGET, acting reasonably, to reflect the options to be followed within the Technical Specifications and/or to complement if necessary the Technical Specifications so as to enable NGET to comply with its obligations in relation to the National Electricity Transmission System or, in Scotland or Offshore, the Relevant Transmission Licensee to comply with its obligations in relation to its Transmission System. This information, including the application dates of the relevant Technical Specifications, will be as specified in the Bilateral Agreement.

**Comment [A9]:** Issue for Onshore HVDC Connections with Generation connected behind them. This arrangement is not captured in the current GB arrangements. This requires further thought.

(iii) New User EU Code User's Plant and/or Apparatus connecting post 1st January 1999 for to an existing Connection Point (including OTSDUW Plant and Apparatus at the Interface Point )

Each new additional and/or replacement item of such Plant and/or Apparatus installed in relation to a change to an existing Connection Point (or OTSDUW Plant and Apparatus at the Interface Point and Connection Point or Remote End HVDC Converter Stations at the HVDC Interface Point) after 1st January 1999 shall comply with the standards/specifications applicable when the change was designed, or such other standards/specifications as necessary to ensure that the item of Plant and/or Apparatus is reasonably fit for its intended purpose having due regard to the obligations of NGET, the relevant User and, in Scotland, or Offshore, also the Relevant Transmission Licensee under their respective Licences. Where appropriate this information, including the application dates of the relevant standards/specifications, will be as specified in the varied Bilateral Agreement.

**Comment [A10]:** Check with Legal - applicability of Remote End HVDC Converters

(iv) Used Plant and/or Apparatus being moved, re-used or modified

If, after its installation, any such item of Plant and/or Apparatus is subsequently:

- moved to a new location; or
- used for a different purpose; or

otherwise modified;

then the standards/specifications as described in (i) or (ii), ~~or (iii)~~ above as applicable will apply as appropriate to such **Plant** and/or **Apparatus**, which must be reasonably fit for its intended purpose having due regard to the obligations of **NGET**, the relevant **User** and, in Scotland or **Offshore**, also the **Relevant Transmission Licensee** under their respective **Licences**.

- (b) **NGET** shall at all times maintain a list of those **Technical Specifications** and additional requirements which might be applicable under this **ECC.6.2.1.2** and which may be referenced by **NGET** in the **Bilateral Agreement**. **NGET** shall provide a copy of the list upon request to any ~~New User~~ **EU Code User**. **NGET** shall also provide a copy of the list to any ~~new User~~ **EU Code User** upon receipt of an application form for a **Bilateral Agreement** for a new **Connection Point**.
- (c) Where the ~~New User~~ **EU Code User** provides **NGET** with information and/or test reports in respect of **Plant** and/or **Apparatus** which the ~~New User~~ **EU Code User** reasonably believes demonstrate the compliance of such items with the provisions of a **Technical Specification** then **NGET** shall promptly and without unreasonable delay give due and proper consideration to such information.
- (d) **Plant** and **Apparatus** shall be designed, manufactured and tested in premises with an accredited certificate in accordance with the quality assurance requirements of the relevant standard in the BS EN ISO 9000 series (or equivalent as reasonably approved by **NGET**) or in respect of test premises which do not include a manufacturing facility premises with an accredited certificate in accordance with BS EN 45001.
- (e) Each connection between a ~~New User~~ **User** and the **National Electricity Transmission System** must be controlled by a circuit-breaker (or circuit breakers) capable of interrupting the maximum short circuit current at the point of connection. The **Seven Year Statement** gives values of short circuit current and the rating of **Transmission** circuit breakers at existing and committed **Connection Points** for future years.
- (f) Each connection between a **Generator** undertaking **OTSDUW** or an **Onshore Transmission Licensee**, must be controlled by a circuit breaker (or circuit breakers) capable of interrupting the maximum short circuit current at the **Transmission Interface Point**. The **Seven Year Statement** gives values of short circuit current and the rating of **Transmission** circuit breakers at existing and committed **Transmission Interface Points** for future years.

Formatted: Font: Bold

ECC.6.2.2 Requirements at **Connection Points** or, in the case of **OTSDUW** at **Interface Points** that relate to **Generators** or **OTSDUW Plant and Apparatus**

ECC.6.2.2.1 Not Used.

ECC.6.2.2.2 ~~Power Generating Module~~ ~~Generating Unit~~, **OTSDUW Plant and Apparatus**, **HVDC Equipment** and **Power Station** Protection Arrangements

ECC.6.2.2.2.1 Minimum Requirements

**Protection of Power Generating Modules**~~Generating Units~~ (other than **Power Park Units**), **HVDC Equipment**~~Converters, OTSDUW Plant and Apparatus~~ or **Power Park Modules** and their connections to the **National Electricity Transmission System** shall meet the requirements given below. These are necessary to reduce the impact on the **National Electricity Transmission System** of faults on **OTSDUW Plant and Apparatus** circuits or circuits owned by **Generators** (including **DC Connected Power Park Modules**) or **HVDC Converter Station System Owners**.

#### ECC.6.2.2.2.2 Fault Clearance Times

(a) The required fault clearance time for faults on the **Generator's** (including **DC Connected Power Park Modules**) or **HVDC System**~~Converter Station Owner's~~ equipment directly connected to the **National Electricity Transmission System** or **OTSDUW Plant and Apparatus** and for faults on the **National Electricity Transmission System** directly connected to the **EU Generator** (including **DC Connected Power Park Modules**) or **HVDC System**~~Converter Station Owner's~~ equipment or **OTSDUW Plant and Apparatus**, from fault inception to the circuit breaker arc extinction, shall be set out in the **Bilateral Agreement**. The fault clearance time specified in the **Bilateral Agreement** shall not be shorter than the durations specified below:

- (i) 80ms at 400kV
- (ii) 100ms at 275kV
- (iii) 120ms at 132kV and below

but this shall not prevent the **User** or **NGET** or the **Relevant Transmission Licensee** or the **EU Generator** (including in respect of **OTSDUW Plant and Apparatus** and **DC Connected Power Park Modules**) from selecting a shorter fault clearance time on their own **Plant** and **Apparatus** provided **Discrimination** is achieved.

A longer fault clearance time may be specified in the **Bilateral Agreement** for faults on the **National Electricity Transmission System**. A longer fault clearance time for faults on the **EU Generator** or **HVDC**~~Converter Station System Owner's~~ equipment or **OTSDUW Plant and Apparatus** may be agreed with **NGET** in accordance with the terms of the **Bilateral Agreement** but only if **System** requirements, in **NGET's** view, permit. The probability that the fault clearance time stated in the **Bilateral Agreement** will be exceeded by any given fault, must be less than 2%.

(b) In the event that the required fault clearance time is not met as a result of failure to operate on the **Main Protection System(s)** provided, the **Generators** or **HVDC System**~~Converter Station Owners~~ or **Generators** in the case of **OTSDUW Plant and Apparatus** shall, except as specified below provide **Independent Back-Up Protection**. **NGET** will also provide **Back-Up Protection** and **NGET** and the **User's Back-Up Protections** will be co-ordinated so as to provide **Discrimination**.

Formatted: Font: Bold

Formatted: Font: Bold

Formatted: Font: Bold

On a **Power Generating Module** ~~Generating Unit~~ (other than a **Power Park Unit**), **HVDC Equipment** ~~Converter or Power Park Module~~ or **OTSDUW Plant and Apparatus** in respect of which the ~~Completion Date~~ is after 20 January 2016 and connected to the **National Electricity Transmission System** at 400kV or 275kV and where two **Independent Main Protections** are provided to clear faults on the **HV Connections** within the required fault clearance time, the **Back-Up Protection** provided by the **EU Generators** (including in respect of **OTSDUW Plant and Apparatus** and **DC Connected Power Park Modules**) and **HVDC Converter Station System Owners** shall operate to give a fault clearance time of no longer than 300ms at the minimum infeed for normal operation for faults on the **HV Connections**. Where two **Independent Main Protections** are installed the **Back-Up Protection** may be integrated into one (or both) of the **Independent Main Protection** relays.

Formatted: Font: Bold

On a **Power Generating Module** ~~Generating Unit~~ (other than a **Power Park Unit**), **HVDC Equipment** ~~Converter or Power Park Module~~ or **OTSDUW Plant and Apparatus** in respect of which the ~~Completion Date~~ is after 20 January 2016 and connected to the **National Electricity Transmission System** at 132 kV and where only one **Main Protection** is provided to clear faults on the **HV Connections** within the required fault clearance time, the **Independent Back-Up Protection** provided by the **Generator** (including in respect of **OTSDUW Plant and Apparatus** and **DC Connected Power Park Modules**) and the **HVDC System** ~~Converter Station~~ **Owner** shall operate to give a fault clearance time of no longer than 300ms at the minimum infeed for normal operation for faults on the **HV Connections**.

~~On a **Generating Unit** (other than a **Power Park Unit**), **DC Converter** or **Power Park Module** or **OTSDUW Plant and Apparatus** connected to the **National Electricity Transmission System** and on **Generating Units** (other than a **Power Park Unit**), **DC Converters** or **Power Park Modules** or **OTSDUW Plant and Apparatus** connected to the **National Electricity Transmission System** at 400 kV or 275 kV or 132 kV, in respect of which the ~~Completion Date~~ is before the 20 January 2016, the **Back-Up Protection** or **Independent Back-Up Protection** shall operate to give a fault clearance time of no longer than 800ms in England and Wales or 300ms in Scotland at the minimum infeed for normal operation for faults on the **HV Connections**.~~

**A Power Generating Module** ~~Generating Unit~~ (other than a **Power Park Unit**), **HVDC Equipment** ~~Converter or Power Park Module~~ or **OTSDUW Plant and Apparatus** with **Back-Up Protection** or **Independent Back-Up Protection** will also be required to withstand, without tripping, the loading incurred during the clearance of a fault on the **National Electricity Transmission System** by breaker fail **Protection** at 400kV or 275kV or of a fault cleared by **Back-Up Protection** where the **EU Generator** (including in the case of **OTSDUW Plant and Apparatus** or **DC Connected Power Park Module**) or **HVDC System** ~~Converter~~ is connected at 132kV and below. This will permit **Discrimination** between the **Generator** in respect of **OTSDUW Plant and Apparatus** or **DC Connected Power Park Modules** or **HVDC Converter Station System Owners' Back-Up Protection** or **Independent Back-Up Protection** and the **Back-Up Protection** provided on the **National Electricity Transmission System** and other **Users' Systems**.

Formatted: Font: Bold

- (c) When the **Power Generating Module** ~~Generating Unit~~ (other than **Power Park Units**), or the **HVDC Equipment** ~~Converter or Power Park Module~~ or **OTSDUW Plant and Apparatus** is connected to the **National Electricity Transmission System** at 400kV or 275kV, and in Scotland and **Offshore** also at 132kV, and a circuit breaker is provided by the **Generator** (including in respect of **OTSDUW Plant and Apparatus** or **DC Connected Power Park Modules**) or the **HVDC** ~~Converter Station~~ **System** owner, or **NGET**, as the case may be, to interrupt fault current interchange with the **National Electricity Transmission System**, or **Generator's System**, or **HVDC** ~~Converter Station~~ **System Owner's System**, as the case may be, circuit breaker fail **Protection** shall be provided by the **Generator** (including in respect of **OTSDUW Plant and Apparatus** or **DC Connected Power Park Modules**) or **HVDC System** ~~Converter Station~~ **Owner**, or **NGET**, as the case may be, on this circuit breaker. In the event, following operation of a **Protection** system, of a failure to interrupt fault current by these circuit-breakers within the **Fault Current Interruption Time**, the circuit breaker fail **Protection** is required to initiate tripping of all the necessary electrically adjacent circuit-breakers so as to interrupt the fault current within the next 200ms.
- (d) The target performance for the **System Fault Dependability Index** shall be not less than 99%. This is a measure of the ability of **Protection** to initiate successful tripping of circuit breakers which are associated with the faulty item of **Apparatus**.

ECC.6.2.2.3 Equipment including **Protection** equipment to be provided

**NGET** shall specify the **Protection** schemes and settings necessary to protect the **National Electricity Transmission System** ~~network~~, taking into account the characteristics of the **Power Generating Module** or **HVDC Equipment**.

The protection schemes needed for the **Power Generating Module** or **HVDC Equipment** and the **National Electricity Transmission System** ~~network~~ as well as the settings relevant to the **Power Generating Module** and/or **HVDC Equipment** shall be coordinated and agreed between **NGET** the relevant system operator and the **EU Generator** or **HVDC System Owner**. The agreed **Protection** schemes and settings will be specified in the **Bilateral Agreement** ~~power-generating facility owner.~~

The protection schemes and settings for internal electrical faults must not prevent jeopardise the performance of a **Power Generating Module** or **HVDC Equipment** from satisfying the requirements of the **Grid Code** although **EU Generators** should be aware of the requirements of ECC.6.3.13.1. **power-generating module, in line with the requirements set out in this Regulation;**

~~electrical~~ **Protection** of the **Power Generating Module** or **HVDC Equipment** shall take precedence over operational controls, taking into account the security of the **National Electricity Transmission System** and the health and safety of personnel ~~staff and of the public~~, as well as mitigating any damage to the **Power Generating Module** or **HVDC Equipment**.

ECC.6.2.2.3.1 Protection of Interconnecting Connections

The requirements for the provision of **Protection** equipment for interconnecting connections will be specified in the **Bilateral Agreement**. In this **ECC** the term "interconnecting connections" means the primary conductors from the current transformer accommodation on the circuit side of the circuit breaker to the **Connection Point** or the primary conductors from the current transformer accommodation on the circuit side of the **OTSDUW Plant and Apparatus** of the circuit breaker to the **Transmission Interface Point**.

- Formatted: Font: Bold
- Formatted: Font: Not Bold
- Formatted: Font: Not Bold
- Formatted: Font: Not Bold
- Formatted: Font: Bold
- Formatted: Not Strikethrough



ECC.6.2.2.3.2 Circuit-breaker fail Protection

The EU Generator or HVDC Converter Station System Owner will install circuit breaker fail **Protection** equipment in accordance with the requirements of the **Bilateral Agreement**. The EU Generator or HVDC Converter Station System Owner will also provide a back-trip signal in the event of loss of air from its pressurised head circuit breakers, during the **Power Generating Module-Generating Unit** (other than a **CCGT Unit** or **Power Park Unit**) or **CCGT Module** or **HVDC Equipment-Converter or Power Park Module** run-up sequence, where these circuit breakers are installed.

Formatted: Font: Bold

Formatted: Font: Bold

ECC.6.2.2.3.3 Loss of Excitation

The EU Generator must provide **Protection** to detect loss of excitation in respect of each of its ~~on a~~ **Generating Units** within a **Synchronous Power Generating Module** to initiate a **Generating Unit** trip.

Formatted: Font: Bold

ECC.6.2.2.3.4 Pole-Slipping Protection

Where, in **NGET's** reasonable opinion, **System** requirements dictate, **NGET** will specify in the **Bilateral Agreement** a requirement for EU Generators to fit pole-slipping **Protection** on their **Generating Units** within each **Synchronous Power Generating Module**.

Formatted: Font: Bold

ECC.6.2.2.3.5 Signals for Tariff Metering

EU Generators and HVDC Converter Station System Owners will install current and voltage transformers supplying all tariff meters at a voltage to be specified in, and in accordance with, the **Bilateral Agreement**.

ECC.6.2.2.3.6 Commissioning of Protection Systems

No EU Generator or HVDC System Owner equipment shall be energised until the Protection settings have been finalised. The EU Generator or HVDC System Owner shall agree with NGET (in coordination with the Relevant Transmission Licensee) and carry out a combined commissioning programme for the Protection systems, and generally, to a minimum standard as specified in the Bilateral Agreement.

Formatted: Underline

Formatted: Font: Bold

Formatted: Font: Bold

ECC.6.2.2.4 Work on Protection Equipment

No busbar **Protection**, mesh corner **Protection**, circuit-breaker fail **Protection** relays, AC or DC wiring (other than power supplies or DC tripping associated with the **Power Generating Module-Generating Unit**, **HVDC Equipment-Converter or Power Park Module** itself) may be worked upon or altered by the EU Generator or HVDC Converter Station System Owner personnel in the absence of a representative of **NGET** or in Scotland or **Offshore**, a representative of **NGET**, or written authority from **NGET** to perform such work or alterations in the absence of a representative of **NGET**.

Formatted: Font: Bold

ECC.6.2.2.5 Relay Settings

**Protection** and relay settings will be co-ordinated (both on connection and subsequently) across the **Connection Point** in accordance with the **Bilateral Agreement** and in relation to **OTSDUW Plant and Apparatus**, across the **Interface Point** in accordance with the **Bilateral Agreement** to ensure effective disconnection of faulty **Apparatus**.

ECC.6.2.2.6 Changes to Protection Schemes and HVDC System Control Modes

ECC.6.2.2.6.1 Any subsequent alterations to the protection settings (whether by **NGET**, the **Relevant Transmission Licensee**, the EU Generator or the HVDC System Owner) shall be agreed between **NGET** (in co-ordination with the **Relevant Transmission Licensee**) and the EU

Formatted: Font: Not Bold

Formatted: Font: Bold

Formatted: Font: Bold

**Generator or HVDC System Owner** in accordance with the Grid Code (ECC.6.2.2.5). No alterations are to be made to any protection schemes unless agreement has been reached between **NGET**, the **Relevant Transmission Licensee**, the **EU Generator or HVDC System Owner**.

Formatted: Font: Bold

~~ECC.6.2.2.6.2 No **Generator or HVDC System Owner** equipment shall be energised until the **Protection** settings have been finalised. The **Generator or HVDC System Owner** shall agree with **NGET** (in coordination with the **Relevant Transmission Licensee**) and carry out a combined commissioning programme for the **Protection** systems, and generally, to a minimum standard as specified in the **Bilateral Agreement**.~~

Comment [A11]: This is a re-worded version of Art 14(5)(b)(iv) - check with legal to make sure it is watertight. It also includes some words from the current Bilateral Agreement.

ECC.6.2.2.6.23 The parameters of different control modes of the **HVDC System** shall be able to be changed in the **HVDC Converter Station**, if required by **NGET** in coordination with the **Relevant Transmission Licensee** and in accordance with ECC.6.2.2.6.54.

ECC.6.2.2.6.34 Any change to the schemes or settings of parameters of the different control modes and protection of the **HVDC System** including the procedure shall be agreed with **NGET** in coordination with the **Relevant Transmission Licensee** and the **HVDC System Owner**.

ECC.6.2.2.6.45 The control modes and associated set points shall be capable of being changed remotely, as specified by **NGET** in coordination with the **Relevant Transmission Licensee**.

#### ECC.6.2.2.7 Control Schemes and Settings

ECC.6.2.2.7.1 The schemes and settings of the different control devices on the **Power Generating Module** and **HVDC Equipment** that are necessary for **Transmission System** stability and for taking emergency action shall be agreed with **NGET** in coordination with the **Relevant Transmission Licensee** and the **EU Generator or HVDC System Owner**.

Formatted: Font: Bold

ECC.6.2.2.7.2 Subject to the requirements of ECC.6.2.2.7.1 any changes to the schemes and settings, defined in ECC.6.2.2.7.1, of the different control devices of the **Power Generating Module** or **HVDC Equipment** shall be coordinated and agreed between **NGET**, the **Relevant Transmission Licensee**, the **EU Generator** and **HVDC System Owner**, in particular if they apply in the circumstances referred to in point (i) of paragraph 5(a);

Formatted: Font: Bold

Formatted: Font: Not Bold

#### ECC.6.2.2.8 Ranking of Protection and Control

ECC.6.2.2.8.1 **NGET in coordination with Relevant Transmission Licensees**, shall agree and coordinate the **Generators** are required to organise their protection and control devices of **EU Generators Plant and Apparatus** in accordance with the following general priority ranking (from highest to lowest):

Formatted: Font: Bold

Formatted: Font: Bold

Formatted: Font: Bold

Formatted: Font: Bold

- (i) The interface between the **National Electricity Transmission System** and ~~The **National Electricity Transmission System** network and and the **Power Generating Module** or HVDC Equipment **Protection** equipment;~~ synthetic inertia, if applicable;

Formatted: Font: Bold

Formatted: Font: Not Bold

- (ii) frequency control (active power adjustment);
- (iii) power restriction; and
- (iv) power gradient constraint;

ECC.6.2.2.8.2 A control scheme, specified by the **HVDC System Owner** consisting of different control modes, including the settings of the specific parameters, shall be coordinated and agreed between **NGET** in coordination with the **Relevant Transmission Licensee** ~~the relevant TSO, the relevant system operator~~ and the **HVDC System Owner**. These details would be specified in the **Bilateral Agreement**.

ECC.6.2.2.8.3 ~~NGET in coordination with Relevant Transmission Licensees, shall agree and coordinate the protection and control devices of HVDC System Owners Plant and Apparatus in accordance with the following general priority ranking (from highest to lowest) shall organise their protection and control devices in compliance with the following priority ranking, listed in decreasing order of importance, unless otherwise specified by NGET in coordination with the Relevant Transmission Licensee.~~

- (i) ~~The interface between the National Electricity Transmission System~~ **National Electricity Transmission System** network and **HVDC System Protection equipment**;
- (ii) **Active Power** control for emergency assistance  
~~synthetic inertia, if applicable;~~
- (iii) automatic remedial actions as specified in ~~ECC.6.3.6.1.23.5~~
- (iv) **Limited Frequency Sensitive Mode (LFSM)** of operation;
- (v) **Frequency Sensitive Mode of operation and Frequency control**; and
- (vi) power gradient constraint.

ECC.6.2.2.9 Synchronising

ECC.6.2.2.9.1 For any **Power Generating Module** directly connected to the **National Electricity Transmission System** or **Type D Power Generating Module**, **synchronisation shall be performed by the EU Generator only after instruction** by **NGET** in accordance with the requirements of BC.2.5.2.

ECC.6.2.2.9.2 Each **Power Generating Module** directly connected to the **National Electricity Transmission System** or **Type D Power Generating Module** shall be equipped with the necessary synchronisation facilities. Synchronisation shall be possible within the range of frequencies specified in ECC.6.1.2.

ECC.6.2.2.9.3 ~~NGET and the Generator shall agree on the settings of~~ **The requirements for synchronising equipment prior to the Completion Date shall be specified in accordance with the requirements in the Electrical Standards listed in the annex to the General Conditions. The** ~~The~~ synchronisation settings shall include the following elements **below. Any variation to these requirements which** shall be pursuant to the terms of the **Bilateral Agreement**.

- (a) voltage
- (b) **Frequency**
- (c) phase angle range
- (d) phase sequence
- (e) deviation of voltage and **Frequency**

Formatted: Font: Not Bold

Formatted: Font: Not Bold

Formatted: Font: Bold

Formatted: Font: Bold

Formatted: Font: Bold

Formatted: Font: Not Bold

Formatted: Not Highlight

Formatted: Indent: Left: 0 cm, First line: 0 cm

Formatted: Font: Bold

Formatted: Font: Not Bold

Formatted: Font: Bold

Formatted: Font: Not Bold

Formatted: Font: Bold

ECC.6.2.2.9.4 **HVDC Equipment** shall be required to satisfy the requirements of ECC.6.2.2.9.1 – ECC.6.2.2.9.3. In addition, unless otherwise specified by **NGET**, during the synchronisation of a **DC Connected Power Park Module** to the **National Electricity Transmission System**, any **HVDC Equipment** shall have the capability to limit any steady state voltage changes to the limits specified within ECC.6.1.7 or ECC.6.1.8 (as applicable) which shall not exceed 5% of the pre-synchronisation voltage. **NGET** in coordination with the **Relevant Transmission Licensee** shall specify any additional requirements for the maximum magnitude, duration and measurement of the voltage transients over and above those defined in ECC.6.1.7 and ECC.6.1.8 in the **Bilateral Agreement**.

ECC.6.2.2.9.5 **EU Generators** in respect of **DC Connected Power Park Modules** shall also provide output synchronisation signals specified by **NGET** in co-ordination with the **Relevant Transmission Licensee**.

Formatted: Font: Bold

ECC.6.2.2.9.6 In addition to the requirements of ECC.6.2.2.9.1 to ECC.6.2.2.9.5, **EU Generators** and **HVDC System Owners** should also be aware of the requirements of ECC.6.5.10 relating to busbar voltage

Formatted: Font: Bold

#### ECC.6.2.2.9.107 HVDC Parameters and Settings

ECC.6.2.2.9.107.1 The parameters and settings of the main control functions of an **HVDC System** shall be agreed between the **HVDC System** owner and **NGET**, in coordination with the **Relevant Transmission Licensee**. The parameters and settings shall be implemented within such a control hierarchy that makes their modification possible if necessary. Those main control functions are at least:

referred to in Articles 14 and 41;

(b) **Frequency Sensitive Modes** (FSM, LFSM-O, LFSM-U) referred to in Articles 15, 16 and 17;

(c) **Frequency** control, if applicable, referred to in Article 16;

(d) **Reactive Power** control mode, if applicable as referred to in Article 22;

(e) power oscillation damping capability, referred to Article 30;

(f) subsynchronous torsional interaction damping capability, referred to Article 31.

#### ECC.6.2.2.119 Automatic Reconnection

ECC.6.2.2.119.1 **EU Generators** in respect of **Type A, Type B, Type C** and **Type D Power Generating Modules** (including **DC Connected Power Park Modules**) which have signed a **CUSC Contract with NGET** are not permitted to automatically reconnect to the **Total System** without instruction from **NGET**. **NGET** will issue instructions for re-connection or re-synchronisation in accordance with the requirements of BC2.5.2. Where synchronising is permitted in accordance with BC2.5.2, the voltage and frequency at the **Grid Entry Point** or **User System Entry Point** shall be within the limits defined in ECC.6.1.2 and ECC.6.1.4 and the ramp rate limits pursuant to BC1.A.1.1. For the avoidance of doubt this requirement does not apply to ~~New Generator~~ **EU Generator-s** who are not required to satisfy the requirements of the Balancing Codes.

Formatted: Font color: Auto

Formatted: Underline, Font color: Auto

Formatted: Font color: Auto

Formatted: Font: Bold

Formatted: Font color: Auto

Formatted: Font: Bold

Formatted: Font: Bold

Formatted: Font color: Auto

Formatted: Font color: Auto

Formatted: Font color: Auto

#### ECC.6.2.2.9.129 Automatic Disconnection

ECC.6.2.2.9.129.1 No **Power Generating Module** or **HVDC Equipment** shall disconnect within the frequency range or voltage range defined in ECC.6.1.2 and ECC.6.1.4.

Formatted: Underline, Font color: Auto

Formatted: Font color: Auto

ECC.6.2.2.13 Special Provisions relating to Power Generating Modules embedded within Industrial Sites which supply electricity as a by-product of their industrial process ~~Temporary Islanding~~

Formatted: Underline

ECC.6.2.2.13.1 Generators in respect of Power Generating Modules which form part of an industrial network, where the Power Generating Module is used to supply critical loads within the industrial process shall be permitted to operate isolated from the Total System if agreed with NGET in the Bilateral Agreement.

Formatted: Font: Bold

Formatted: Font: Bold

Formatted: Font: Bold

Formatted: Font: Bold

Formatted: Font: Bold

Formatted: Font: Bold

Formatted: Font: Bold

Formatted: Font: Bold

Formatted: Font: Bold

ECC.6.2.2.13.2 Except for the requirements of ECC.6.3.3 and ECC.6.3.7.1, Power Generating Modules which are embedded within industrial sites are not required to satisfy the requirements of ECC.6.3.6.2.1 and ECC.6.3.9. In this case this exception would only apply to Power Generating Modules on industrial sites used for combined heat and power production which are embedded in the network of an industrial site where all the following criteria are met.

(a) The primary purpose of these sites is to produce heat for production processes of the industrial site concerned,

Formatted: Numbered + Level: 1 + Numbering Style: a, b, c, ... + Start at: 1 + Alignment: Left + Aligned at: 2.51 cm + Indent at: 3.15 cm

(b) Heat and power generation is inextricably interlinked, that is to say any change to heat generation results inadvertently in a change of active power generating and visa versa.

(c) The Power Generating Modules are of Type A, Type B or Type C.

Formatted: Font: Bold

Formatted: Font: Bold

Formatted: Font: Bold

Formatted: Font: Bold

Formatted: Font: Bold

Formatted: Font color: Auto

(d) Combined heat and power generating facilities shall be assessed on the basis of their electrical Maximum Capacity.

ECC.6.2.3 Requirements at Connection Points relating to Network Operators and Non-Embedded Customers

ECC.6.2.3.1 Protection Arrangements for ~~New User~~EU Code User's in respect of Network Operators and Non-Embedded Customers

ECC.6.2.3.1.1 Protection arrangements for ~~New User~~EU Code User's in respect of Network Operators and Non-Embedded Customers User Systems directly connected to the National Electricity Transmission System, shall meet the requirements given below:

Fault Clearance Times

(a) The required fault clearance time for faults on **Network Operator** and **Non-Embedded Customer** equipment directly connected to the **National Electricity Transmission System**, and for faults on the **National Electricity Transmission System** directly connected to the **Network Operator's** or **Non-Embedded Customer's** equipment, from fault inception to the circuit breaker arc extinction, shall be set out in each **Bilateral Agreement**. The fault clearance time specified in the **Bilateral Agreement** shall not be shorter than the durations specified below:

(i) 80ms at 400kV

(ii) 100ms at 275kV

(iii) 120ms at 132kV and below

but this shall not prevent the **User** or **NGET** or **Relevant Transmission Licensee** from selecting a shorter fault clearance time on its own **Plant** and **Apparatus** provided **Discrimination** is achieved.

For the purpose of establishing the **Protection** requirements in accordance with ECC.6.2.3.1.1 only, the point of connection of the **Network Operator** or **Non-Embedded Customer** equipment to the **National Electricity Transmission System** shall be deemed to be the low voltage busbars at a **Grid Supply Point**, irrespective of the ownership of the equipment at the **Grid Supply Point**.

A longer fault clearance time may be specified in the **Bilateral Agreement** for faults on the **National Electricity Transmission System**. A longer fault clearance time for faults on the **Network Operator** and **Non-Embedded Customers** equipment may be agreed with **NGET** in accordance with the terms of the **Bilateral Agreement** but only if **System** requirements in **NGET's** view permit. The probability that the fault clearance time stated in the **Bilateral Agreement** will be exceeded by any given fault must be less than 2%.

- (b) (i) For the event of failure of the **Protection** systems provided to meet the above fault clearance time requirements, **Back-Up Protection** shall be provided by the **Network Operator** or **Non-Embedded Customer** as the case may be.
  - (ii) **NGET** will also provide **Back-Up Protection**, which will result in a fault clearance time longer than that specified for the **Network Operator** or **Non-Embedded Customer Back-Up Protection** so as to provide **Discrimination**.
  - (iii) For connections with the **National Electricity Transmission System** at 132kV and below, it is normally required that the **Back-Up Protection** on the **National Electricity Transmission System** shall discriminate with the **Network Operator** or **Non-Embedded Customer's Back-Up Protection**.
  - (iv) For connections with the **National Electricity Transmission System** at 400kV or 275kV, the **Back-Up Protection** will be provided by the **Network Operator** or **Non-Embedded Customer**, as the case may be, with a fault clearance time not longer than 300ms for faults on the **Network Operator's** or **Non-Embedded Customer's Apparatus**.
  - (v) Such **Protection** will also be required to withstand, without tripping, the loading incurred during the clearance of a fault on the **National Electricity Transmission System** by breaker fail **Protection** at 400kV or 275kV. This will permit **Discrimination** between **Network Operator's Back-Up Protection** or **Non-Embedded Customer's Back-Up Protection**, as the case may be, and **Back-Up Protection** provided on the **National Electricity Transmission System** and other **User Systems**. The requirement for and level of **Discrimination** required will be specified in the **Bilateral Agreement**.
- (c) (i) Where the **Network Operator** or **Non-Embedded Customer** is connected to the **National Electricity Transmission System** at 400kV or 275kV, and in Scotland also at 132kV, and a circuit breaker is provided by the **Network Operator** or **Non-Embedded Customer**, or **NGET**, as the case may be, to interrupt the interchange of fault current with the **National Electricity Transmission System** or the **System** of the **Network Operator** or **Non-Embedded Customer**, as the case may be, circuit breaker fail **Protection** will be provided by the **Network Operator** or **Non-Embedded Customer**, or **NGET**, as the case may be, on this circuit breaker.
  - (ii) In the event, following operation of a **Protection** system, of a failure to interrupt fault current by these circuit-breakers within the **Fault Current Interruption Time**, the circuit breaker fail **Protection** is required to initiate tripping of all the

necessary electrically adjacent circuit-breakers so as to interrupt the fault current within the next 200ms.

- (d) The target performance for the **System Fault Dependability Index** shall be not less than 99%. This is a measure of the ability of **Protection** to initiate successful tripping of circuit breakers which are associated with the faulty items of **Apparatus**.

ECC.6.2.3.2 Fault Disconnection Facilities

- (a) Where no **Transmission** circuit breaker is provided at the **User's** connection voltage, the **User** must provide **NGET** with the means of tripping all the **User's** circuit breakers necessary to isolate faults or **System** abnormalities on the **National Electricity Transmission System**. In these circumstances, for faults on the **User's System**, the **User's Protection** should also trip higher voltage **Transmission** circuit breakers. These tripping facilities shall be in accordance with the requirements specified in the **Bilateral Agreement**.
- (b) **NGET** may require the installation of a **System to Generator Operational Intertripping Scheme** in order to enable the timely restoration of circuits following power **System** fault(s). These requirements shall be set out in the relevant **Bilateral Agreement**.

ECC.6.2.3.3 Automatic Switching Equipment

Where automatic reclosure of **Transmission** circuit breakers is required following faults on the **User's System**, automatic switching equipment shall be provided in accordance with the requirements specified in the **Bilateral Agreement**.

ECC.6.2.3.4 Relay Settings

**Protection** and relay settings will be co-ordinated (both on connection and subsequently) across the **Connection Point** in accordance with the **Bilateral Agreement** to ensure effective disconnection of faulty **Apparatus**.

ECC.6.2.3.5 Work on Protection equipment

Where a **Transmission Licensee** owns the busbar at the **Connection Point**, no busbar **Protection**, mesh corner **Protection** relays, AC or DC wiring (other than power supplies or DC tripping associated with the **Network Operator** or **Non-Embedded Customer's Apparatus** itself) may be worked upon or altered by the **Network Operator** or **Non-Embedded Customer** personnel in the absence of a representative of **NGET** or in Scotland, a representative of **NGET**, or written authority from **NGET** to perform such work or alterations in the absence of a representative of **NGET**.

ECC.6.2.3.6 Equipment including **Protection** equipment to be provided

**NGET** in coordination with the **Relevant Transmission Licensee** shall specify and agree the **Protection** schemes and settings required to protect the **National Electricity Transmission System-network** in accordance with the characteristics of the **Network Operators** or **Non Embedded Customers System**. **NGET** in coordination with the **Relevant Transmission Licensee** and the **Network Operator** or **Non Embedded Customer** ~~transmission-connected demand facility owner or the transmission-connected distribution system operator~~ shall agree on the protection schemes and settings in respect of the busbar protection zone in respect of each **Grid Supply Point**. relevant for the transmission-connected demand facility or the transmission-connected distribution system ~~electrical~~ **Protection** of the **Network Operators** or **Non Embedded Customers System** shall take precedence over operational controls whilst respecting the security of the **National Electricity Transmission System** and the health and safety of **personnel staff and of the public**.

ECC.6.2.3.6.1 Protection of Interconnecting Connections

The requirements for the provision of **Protection** equipment for interconnecting connections will be specified in the **Bilateral Agreement**.

- Formatted: Highlight
- Formatted: Not Strikethrough, Highlight
- Formatted: Highlight



ECC.6.2.3.7 Changes to Protection Schemes

Any subsequent alterations to the busbar protection settings (whether by **NGET**, the **Relevant Transmission Licensee**, the **Network Operator** or the **Non Embedded Customer**) shall be agreed between **NGET** (in co-ordination with the **Relevant Transmission Licensee**) and the **Network Operator** or **Non Embedded Customer** in accordance with the Grid Code (ECC.6.2.3.4). No alterations are to be made to any busbar protection schemes unless agreement has been reached between **NGET**, the **Relevant Transmission Licensee**, the **Network Operator** or **Non Embedded Customer**.

No **Network Operator** or **Non Embedded Customer** equipment shall be energised until the **Protection** settings have been finalised. The **Network Operator** or **Non Embedded Customer** shall agree with **NGET** (in coordination with the **Relevant Transmission Licensee**) and carry out a combined commissioning programme for the **Protection** systems, and generally, to a minimum standard as specified in the **Bilateral Agreement**.

ECC.6.2.3.8 Control Requirements

ECC.6.2.3.8.1 **NGET** in coordination with the **Relevant Transmission Licensee** and the **Network Operator** or **Non Embedded Customer** shall agree on the control schemes and settings of the different control devices of the **Network Operators** or **Non Embedded Customers System** relevant for ~~system~~ security of the **National Electricity Transmission System**. Such requirements would be pursuant to the terms of the **Bilateral Agreement** which shall also cover at least the following elements:

- (a) Isolated (~~network~~ **National Electricity Transmission System**) operation
- (b) Damping of oscillations
- (c) Disturbances to the **National Electricity Transmission System**
- (d) Automatic switching to emergency supply and restoration to normal topology
- (e) Automatic circuit breaker re-closure (on 1-phase faults)

ECC.6.2.3.8.2 Subject to the requirements of ECC.6.2.3.8.1 any changes to the schemes and settings, defined in ECC.6.2.3.8.1 of the different control devices of the **Network Operators** or **Non-Embedded Customers System** at the **Grid Supply Point** shall be coordinated and agreed between **NGET**, the **Relevant Transmission Licensee**, ~~the~~ **Network Operator** or **Non Embedded Customer**.

**Comment [A12]:** Legal comment - we will need to change the template (Appendix F) of the Bilateral Agreement to include these elements - in the majority of cases they would be swithced off (ie not applicable).

**Formatted:** Font: Not Bold

ECC.6.2.3.9 Ranking of Protection and Control

ECC.6.2.3.9.1 ~~With regard to priority ranking of protection and control,~~ The **Network Operator** or the **Non Embedded Customer** shall set the **Protection** and control devices of its **System**, in compliance with the following priority ranking, organised in decreasing order of importance:

- (a) **National Electricity Transmission System Protection;**
- (b) **Protection** equipment at each **Grid Supply Point;**
- (c) **Frequency** control (**Active Power** adjustment);
- (d) **Power** restriction.

**Comment [A13]:** Check DCC Art 17(4) to ensure consistency with GB Code

ECC.6.2.3.10 Synchronising

ECC.6.2.3.10.1 Each **Network Operator** or **Non Embedded Customer** directly connected to the **National Electricity Transmission System** shall be capable of synchronisation within the range of frequencies specified in ECC.6.1.2.

ECC.6.2.3.10.2 **NGET** and the **Network Operator** or **Non Embedded Customer** shall agree on the settings of the synchronisation equipment prior to the **Completion Date**. The synchronisation settings shall include the following elements which shall be pursuant to the terms of the **Bilateral Agreement**.

- (a) voltage
- (b) **Frequency**
- (c) phase angle range
- (d) deviation of voltage and **Frequency**

ECC.6.3 GENERAL POWER GENERATING MODULE, OTSDUW AND HVDC EQUIPMENT-GENERATING UNIT (AND OTSDUW) REQUIREMENTS

ECC.6.3.1 This section sets out the technical and design criteria and performance requirements for **Power Generating Modules** and ~~HVDC Equipment-DC Converters and Power Park Modules~~ (whether directly connected to the **National Electricity Transmission System** or **Embedded**) and (where provided in this section) **OTSDUW Plant and Apparatus** which each **Generator** or **HVDC System Owner** must ensure are complied with in relation to its **Power Generating Modules, HVDC Equipment** ~~Generating and Power Park Modules~~ and **OTSDUW Plant and Apparatus** but does not apply to ~~Small Power Stations~~ or individually to ~~Power Park Units~~. References to **Power Generating Modules-Units, HVDC Equipment and Power Park Modules** in this ECC.6.3 should be read accordingly.

Plant Performance Requirements

ECC.6.3.2 REACTIVE CAPABILITY

ECC.6.3.2.1 Reactive Capability for Type B Synchronous Power Generating Modules

ECC.6.3.2.1.1 When operating at **Maximum Capacity**, all **Type B Synchronous Power Generating Modules** must be capable of continuous operation at any points between the limits of 0.95 **Power Factor** lagging and 0.95 **Power Factor** leading at the **Grid Entry Point** or **User System Entry Point** unless otherwise agreed with **NGET** or relevant **Network Operator**. At **Active Power** output levels other than **Maximum Capacity**, all **Generating Units** within a **Type B Synchronous Power Generating Module** must be capable of continuous operation at any point between the **Reactive Power** capability limits identified on the **HV Generator Performance Chart** unless otherwise agreed with **NGET** or relevant **Network Operator**.

ECC.6.3.2.2 Reactive Capability for Type B Power Park Modules

ECC.6.3.2.2.1 When operating at **Maximum Capacity** all **Type B Power Park Modules** must be capable of continuous operation at any points between the limits of 0.95 **Power Factor** lagging and 0.95 **Power Factor** leading at the **Grid Entry Point** or **User System Entry Point** unless otherwise agreed with **NGET** or relevant **Network Operator**. At **Active Power** output levels other than **Maximum Capacity**, each **Power Park Module** must be capable of continuous operation at any point between the **Reactive Power** capability limits identified on the **HV Generator Performance Chart** unless otherwise agreed with **NGET** or **Network Operator**.

ECC.6.3.2.3 Reactive Capability for Type C and D Synchronous Power Generating Modules

- ECC.6.3.2.3.1 In addition to meeting the requirements of ECC.6.3.2.3.2 – ECC.6.3.2.3.5, ~~New Generator~~**EU Generator-s** which connect a **Type C** or **Type D Synchronous Power Generating Module(s)** to a **Non Embedded Customers System** or private network, may be required to meet additional reactive compensation requirements at the point of connection between the **System** and the **Non Embedded Customer** or private network where this is required for **System** reasons.
- ECC.6.3.2.3.2 All **Type C** and **Type D Synchronous Power Generating Modules** shall be capable of satisfying the **Reactive Power** capability requirements at the **Grid Entry Point** or **User System Entry Point** as defined in Figure ECC.6.3.2.3 when operating at **Maximum Capacity**.
- ECC.6.3.2.3.3 At **Active Power** output levels other than **Maximum Capacity**, all **Generating Units** within a **Synchronous Power Generating Module** must be capable of continuous operation at any point between the **Reactive Power** capability limit identified on the **HV Generator Performance Chart** at least down to the **Minimum Stable Operating Level**. At reduced **Active Power** output, **Reactive Power** supplied at the **Grid Entry Point** (or **User System Entry Point** if **Embedded**) shall correspond to the **HV Generator Performance Chart** of the **Synchronous Power Generating Module**, taking the auxiliary supplies and the **Active Power** and **Reactive Power** losses of the **Generating Unit** transformer or **Station Transformer** into account.

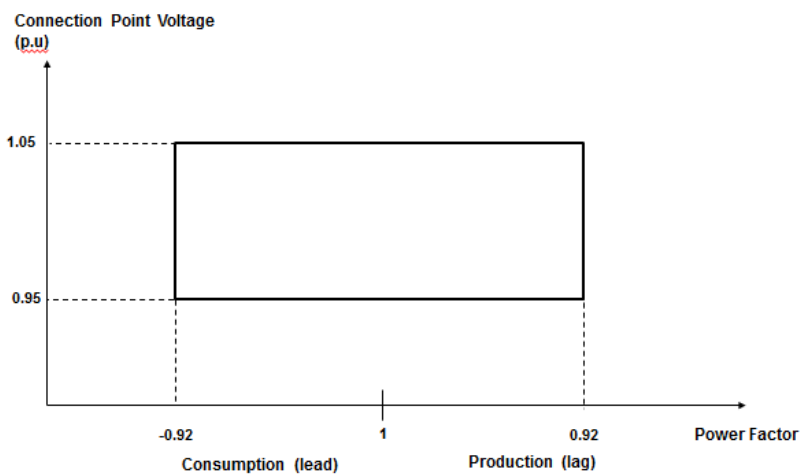

Figure ECC.6.3.2.3

- ECC.6.3.2.3.4 In addition, to the requirements of ECC.6.3.2.3.1 – ECC.6.3.2.3.3 the short circuit ratio of all **Onshore Synchronous Generating Units** with an **Apparent Power** rating of less than 1600MVA shall not be less than 0.5. The short circuit ratio of **Onshore Synchronous Generating Units** with a rated **Apparent Power** of 1600MVA or above shall be not less than 0.4.
- ECC.6.3.2.4 Reactive Capability for **Type C** and **D Power Park Modules, HVDC Equipment** and **OTSDUW Plant and Apparatus** at the **Interface Point**

ECC.6.3.2.4.1

~~New Generator~~EU Generator-s or HVDC System Owners which connect an Onshore Type C or Onshore Type D Power Park Module or HVDC Equipment to a Non Embedded Customers System or private network, may be required to meet additional reactive compensation requirements at the point of connection between the System and the Non Embedded Customer or private network where this is required for System reasons.

ECC.6.3.2.4.2

All Onshore Type C Power Park Modules and Onshore Type D Power Park Modules or HVDC Converters at an HVDC Converter Station with a Grid Entry Point or User System Entry Point voltage above 33kV, or Remote End HVDC Converters with an HVDC Interface Point voltage above 33kV, or OTSDUW Plant and Apparatus with an Interface Point voltage above 33kV shall be capable of satisfying the Reactive Power capability requirements at the Grid Entry Point or User System Entry Point (or Interface Point in the case of OTSDUW Plant and Apparatus, or HVDC Interface Point in the case of a Remote End HVDC Converter Station) as defined in Figure ECC.6.3.2.4(a) when operating at Maximum Capacity (or Interface Point Capacity in the case of OTSUW Plant and Apparatus). In the case of Remote End HVDC Converters and DC Connected Power Park Modules, NGET in co-ordination with the Relevant Transmission Licensee may agree to alternative reactive capability requirements to those specified in Figure ECC.6.3.2.4(a), where it is demonstrated that it is uneconomic and inefficient to do so, for example in the case of new technologies or advanced control strategies. For the avoidance of doubt, the requirements for Offshore Power Park Modules and DC Connected Power Park Modules are defined in ECC.6.3.2.5 and ECC.6.3.2.6.

Comment [A14]: Need to check this internally

Formatted: Not Highlight

Formatted: Not Highlight

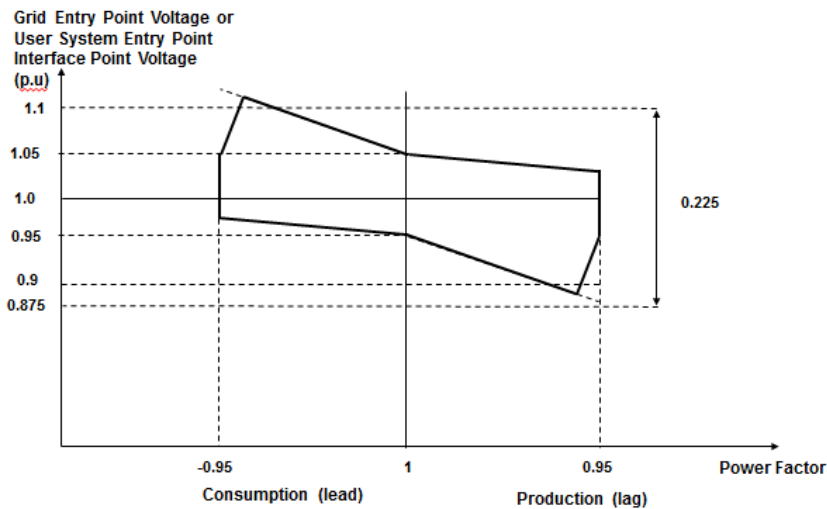

Figure ECC.6.3.2.4(a)

ECC.6.3.2.4.3

All **Onshore Type C** or **Type D Power Park Modules** or **HVDC Converters** at a **HVDC Converter Station** with a **Grid Entry Point** or **User System Entry Point** voltage at or below 33kV or **Remote End HVDC Converter Station** with an **HVDC Interface Point Voltage** at or below 33kV shall be capable of satisfying the **Reactive Power** capability requirements at the **Grid Entry Point** or **User System Entry Point** as defined in Figure ECC.6.3.2.4(b) when operating at **Maximum Capacity**. In the case of **Remote End HVDC Converters** **NGET** in co-ordination with the **Relevant Transmission Licensee** may agree to alternative reactive capability requirements to those specified in Figure ECC.6.3.2.4(b), where it is demonstrated that it is uneconomic and inefficient to do so, for example in the case of new technologies or advanced control strategies. For the avoidance of doubt, the requirements for **Offshore Power Park Modules** and **DC Connected Power Park Modules** are defined in [ECC.6.3.2.5](#) and [ECC.6.3.2.6](#).

Formatted: Not Highlight

Formatted: Not Highlight

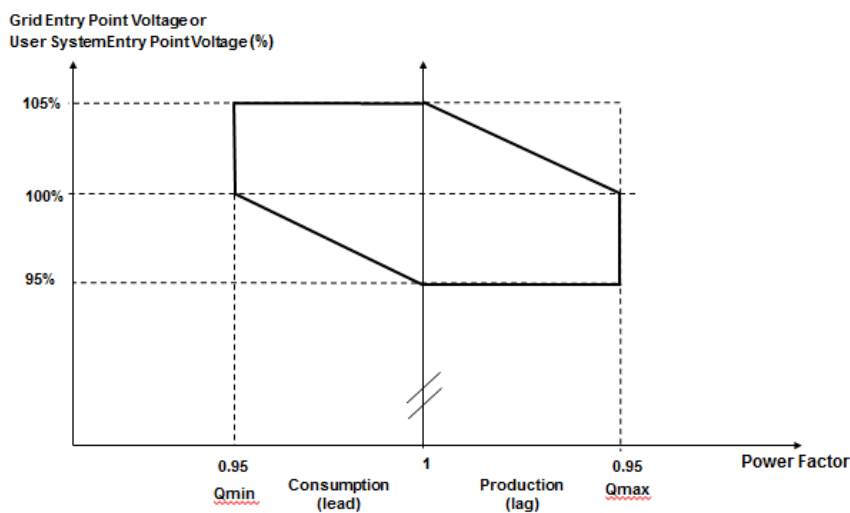

Figure ECC.6.3.2.4(a)

ECC.6.3.2.4.4

All **Type C** and **Type D Power Park Modules**, **HVDC Converters** at a **HVDC Converter Station** including **Remote End HVDC Converters** or **OTSDUW Plant and Apparatus**, shall be capable of satisfying the **Reactive Power** capability requirements at the **Grid Entry Point** or **User System Entry Point** (or **Interface Point Capacity** in the case of **OTSUW Plant and Apparatus** or **HVDC Interface Point** in the case of **Remote End HVDC Converter Stations**) as defined in Figure ECC.6.3.2.4(c) when operating below **Maximum Capacity**. With all **Plant** in service, the **Reactive Power** limits will reduce linearly below 50% **Active Power** output as shown in Figure ECC.6.3.2.4(c) unless the requirement to maintain the **Reactive Power** limits defined at **Maximum Capacity** (or **Interface Point Capacity** in the case of **OTSDUW Plant and Apparatus**) under absorbing **Reactive Power** conditions down to 20% **Active Power** output has been specified by **NGET**. These **Reactive Power** limits will be reduced pro rata to the amount of **Plant** in service. In the case of **Remote End HVDC Converters**, **NGET** in co-ordination with the **Relevant Transmission Licensee** may agree to alternative reactive capability requirements to those specified in Figure ECC.6.3.2.4(a), where it is demonstrated that it is uneconomic and inefficient to do so, for example in the case of new technologies or advanced control strategies. For the avoidance of doubt, the requirements for **Offshore Power Park Modules** and **DC Connected Power Park Modules** are defined in [ECC.6.3.2.5](#) and [ECC.6.3.2.6](#).

Formatted: Not Highlight

Formatted: Not Highlight

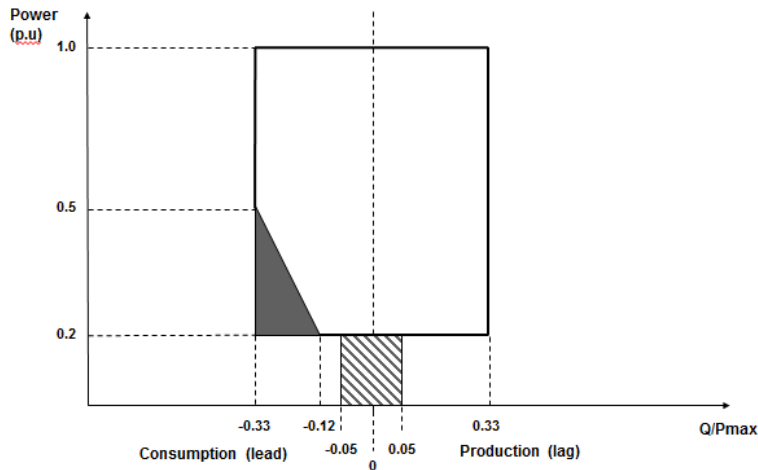

Figure ECC.6.3.2.4(c)

ECC.6.3.2.5 Reactive Capability for Offshore Synchronous Power Generating Modules, Configuration 1 AC connected Offshore Power Park Modules and Configuration 1 DC Connected Power Park Modules.

ECC.6.3.2.5.1 The short circuit ratio of any Offshore Synchronous Generating Units within a Synchronous Power Generating Module shall not be less than 0.5. All Offshore Synchronous Generating Units, Configuration 1 AC connected Offshore Power Park Modules or Configuration 1 DC Connected Power Park Modules must be capable of maintaining zero transfer of Reactive Power at the Offshore Grid Entry Point. The steady state tolerance on Reactive Power transfer to and from an Offshore Transmission System expressed in MVAR shall be no greater than 5% of the Maximum Capacity.

ECC.6.3.2.5.2 For the avoidance of doubt if an ~~New Generator~~ EU Generator (including those in respect of DC Connected Power Park Modules) wishes to provide a Reactive Power capability in excess of the minimum requirements defined in ECC.6.3.2.5.1 then such capability (including steady state tolerance) shall be agreed ~~it could consider the use of a commercial agreement~~ between the Generator, Offshore Transmission Licensee and NGET and/or the relevant Network Operator.

ECC.6.3.2.6 Reactive Capability for Configuration 2 AC Connected Offshore Power Park Modules and Configuration 2 DC Connected Power Park Modules.

ECC.6.3.2.6.1 All Configuration 2 AC connected Offshore Power Park Modules and Configuration 2 DC Connected Power Park Modules shall be capable of satisfying the minimum Reactive Power capability requirements at the Offshore Grid Entry Point as defined in Figure ECC.6.3.2.6(a) when operating at Maximum Capacity. NGET in co-ordination with the Relevant Transmission Licensee may agree to alternative reactive capability requirements to those specified in Figure ECC.6.3.2.6(a), where it is demonstrated that it is uneconomic and inefficient to do so, for example in the case of new technologies or advanced control strategies.

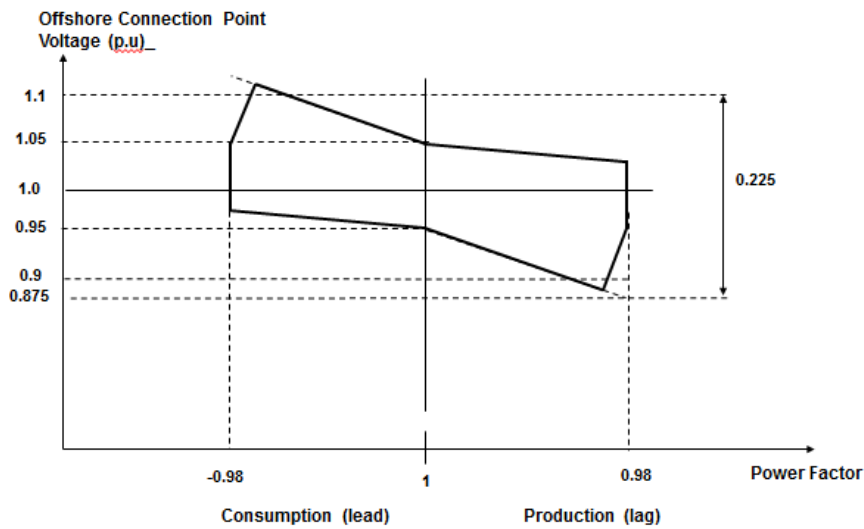

Figure ECC.6.3.2.6(a)

ECC.6.3.2.6.2

All AC Connected Configuration 2 Offshore Power Park Modules and Configuration 2 DC Connected Power Park Modules shall be capable of satisfying the Reactive Power capability requirements at the Offshore Grid Entry Point as defined in Figure ECC.6.3.2.6(b) when operating below Maximum Capacity. With all Plant in service, the Reactive Power limits will reduce linearly below 50% Active Power output as shown in Figure ECC.6.3.2.6(b) unless the requirement to maintain the Reactive Power limits defined at Maximum Capacity (or Interface Point Capacity in the case of OTSDUW Plant and Apparatus) under absorbing Reactive Power conditions down to 20% Active Power output has been specified with NGET. These Reactive Power limits will be reduced pro rata to the amount of Plant in service. NGET in co-ordination with the Relevant Transmission Licensee may agree to alternative reactive capability requirements to those specified in Figure ECC.6.3.2.6(b), where it is demonstrated that it is uneconomic and inefficient to do so, for example in the case of new technologies or advanced control strategies.

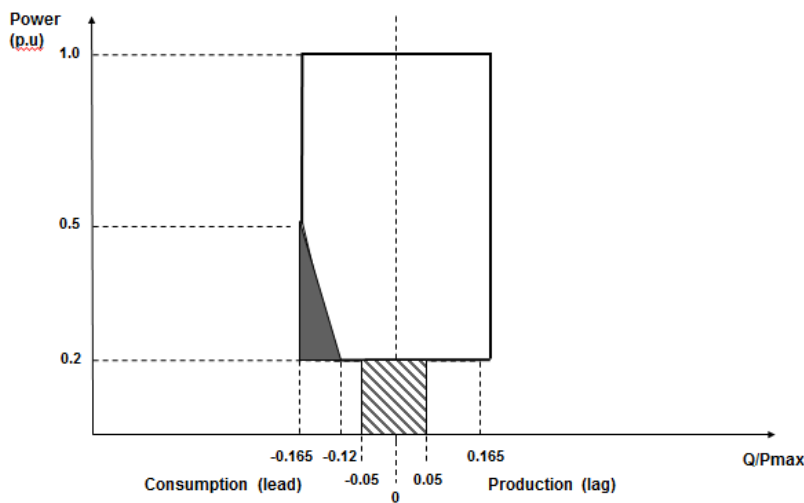

Figure ECC.6.3.2.6(b)

Formatted: Left, Indent: First line: 2.75 cm

ECC.6.3.2.6.3 For the avoidance of doubt if an ~~an New Generator~~EU Generator (including **Generators** in respect of **DC Connected Power Park Modules** referred to in ECC.6.3.2.6.2) wishes to provide a **Reactive Power** capability in excess of the minimum requirements defined in ECC.6.3.2.6.1 then such capability (including any steady state tolerance) shall be ~~agreed—it could consider the use of a commercial agreement~~ between the EU Generator, Offshore Transmission Licensee and **NET** and/or the relevant **Network Operator**.

Formatted: Font: Bold

Formatted: Font: Bold

Formatted: Font: Not Bold

### ECC.6.3.3 OUTPUT POWER WITH FALLING FREQUENCY

#### ECC.6.3.3.1 Output power with falling frequency for **Power Generating Modules** and **HVDC Equipment**

CC.6.3.3.1.1 Each **Power Generating Module** and **HVDC Equipment** must be capable of:

- (a) continuously maintaining constant **Active Power** output for **System Frequency** changes within the range 50.5 to 49.5 Hz; and



(b) (subject to the provisions of ECC.6.1.2) maintaining its **Active Power** output at a level not lower than the figure determined by the linear relationship shown in Figure ECC.6.3.3(a) for **System Frequency** changes within the range 49.5 to 47 Hz for all ambient temperatures up to and including 25°C, such that if the **System Frequency** drops to 47 Hz the **Active Power** output does not decrease by more than 5%. In the case of a **CCGT Module**, the above requirement shall be retained down to the **Low Frequency Relay** trip setting of 48.8 Hz, which reflects the first stage of the Automatic **Low Frequency Demand Disconnection** scheme notified to **Network Operators** under OC6.6.2. For **System Frequency** below that setting, the existing requirement shall be retained for a minimum period of 5 minutes while **System Frequency** remains below that setting, and special measure(s) that may be required to meet this requirement shall be kept in service during this period. After that 5 minutes period, if **System Frequency** remains below that setting, the special measure(s) must be discontinued if there is a materially increased risk of the **Gas Turbine** tripping. The need for special measure(s) is linked to the inherent **Gas Turbine Active Power** output reduction caused by reduced shaft speed due to falling **System Frequency**. Where the need for special measures is identified in order to maintain output in line with the level identified in Figure ECC.6.3.3(a) these measures should be still continued at ambient temperatures above 25°C maintaining as much of the **Active Power** achievable within the capability of the plant.

Formatted: Not Highlight

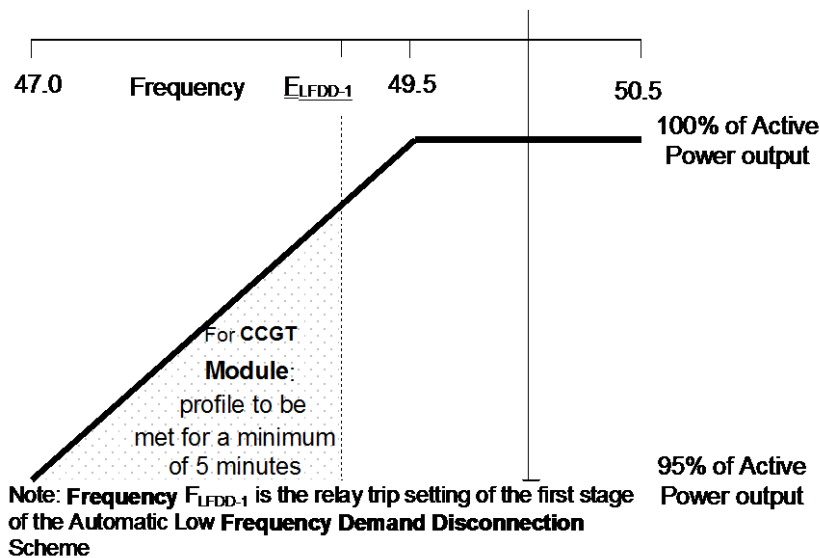

Figure ECC.6.3.3(a)

- (c) For the avoidance of doubt, in the case of a **Power Generating Module** including a **DC Connected Power Park Module** ~~Generating Unit or Power Park Module (or OTSDUW DC Converters at the Interface Point)~~ using an **Intermittent Power Source** where the mechanical power input will not be constant over time, the requirement is that the **Active Power** output shall be independent of **System Frequency** under (a) above and should not drop with **System Frequency** by greater than the amount specified in (b) above.
- (d) An **HVDC System** must be capable of maintaining its **Active Power** input (i.e. when operating in a mode analogous to **Demand**) from the **National Electricity Transmission System** (or **User System** in the case of an **Embedded HVDC System**) at a level not greater than the figure determined by the linear relationship shown in Figure ECC.6.3.3(b) for **System Frequency** changes within the range 49.5 to 47 Hz, such that if the **System Frequency** drops to 47.8 Hz the **Active Power** input decreases by more than 60%.

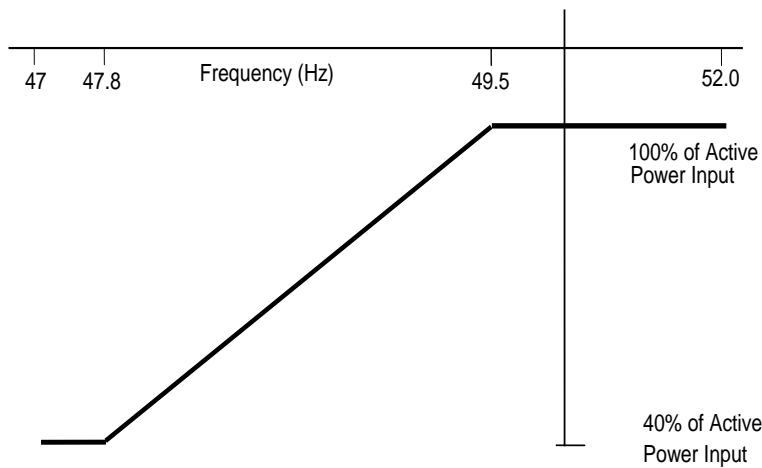

Figure ECC.6.3.3(b)

- (e) In the case of an **Offshore Generating Unit** or **Offshore Power Park Module** or **DC Connected Power Park Module** or **Remote End HVDC Converter** or **Transmission DC Converter** ~~Offshore DC Converter and OTSDUW DC Converter~~, the **EU Generator** shall comply with the requirements of ECC.6.3.3. **EU Generators** should be aware that Section K of the **STC** places requirements on **Offshore Transmission Licensees** which utilise a **Transmission DC Converter** as part of their **Offshore Transmission System** to make appropriate provisions to enable **EU Generators** to fulfil their obligations.
- (f) ~~In the case of a Transmission DC Converters and Remote End HVDC Converters OTSDUW the OTSDUW Plant and Apparatus~~ shall provide a continuous signal indicating the real time frequency measured at the **Interface Point** to the **Offshore Grid Entry Point** or **HVDC Interface Point** for the purpose of **Offshore Generators** or **DC Connected Power Park Modules** to respond to changes in **System Frequency** on the Main Interconnected **Transmission System**. A **DC Connected Power Park Module** or **Offshore Power Generating Module** shall be capable of receiving and processing this signal within 100ms.

**Formatted:** Font: Bold

**Formatted:** Font: Bold

**Formatted:** Font: Bold

ECC.6.3.4 **ACTIVE POWER OUTPUT UNDER SYSTEM VOLTAGE VARIATIONS**

ECC.6.3.4.1 At the **Grid Entry Point** or **User System Entry Point**, the **Active Power** output under steady state conditions of any **Power Generating Module** or **HVDC Equipment** directly connected to the **National Electricity Transmission System** or in the case of **OTSDUW**, the **Active Power** transfer at the **Interface Point**, under steady state conditions of any **OTSDUW Plant and Apparatus** should not be affected by voltage changes in the normal operating range specified in paragraph ECC.6.1.4 by more than the change in **Active Power** losses at reduced or increased voltage.

**Formatted:** Indent: Left: 0 cm, Hanging: 2.5 cm

ECC.6.3.5 **BLACK START**

ECC.6.3.5.1 **Black Start** is not a mandatory requirement, however **EU Code Users** may wish to notify **NGET** of their ability to provide a **Black Start** facility and the cost of the service. **NGET** will then consider whether it wishes to contract with the **EU Code User** for the provision of a **Black Start** service which would be specified via a **Black Start Contract**. Where an **New User/EU Code User** does not offer to provide a cost for the provision of a **Black Start Capability**, **NGET may make such a request if it considers System security to be at risk due to a lack of Black Start capability.**

**Formatted:** Font: Bold

**Formatted:** Font: Bold

**Formatted:** Font: Bold

ECC.6.3.5.2 It is an essential requirement that the **National Electricity Transmission System** must incorporate a **Black Start Capability**. This will be achieved by agreeing a **Black Start Capability** at a number of strategically located **Power Stations** and **HVDC Systems**. For each **Power Station** or **HVDC System**, **NGET** will state in the **Bilateral Agreement** whether or not a **Black Start Capability** is required.

ECC.6.3.5.3 Where an ~~an New User~~EU Code User~~EU Code User~~ has entered into a **Black Start Contract** to provide a **Black Start Capability** in respect of a **Type C Power Generating Module** or **Type D Power Generating Module** (including **DC Connected Power Park Modules**) the following requirements shall apply.

- (i) The **Power-Generating Module** or **DC Connected Power Park Module** shall be capable of starting from shutdown without any external electrical energy supply within a time frame specified by **NGET** in the **Black Start Contract**.
- (ii) Each **Power Generating Module** or **DC Connected Power Park Module** shall be able to synchronise within the frequency limits defined in ~~ECC.6.1.2~~laid down in point (a) of Article 13(1) and, where applicable, voltage limits specified ~~by the relevant system operator or in Article 16(2)~~ in ECC.6.1.4;
- (iii) The **Power Generating Module** or **DC Connected Power Park Module** shall be capable of connecting on to an unenergised **System**.
- (iv) The **Power-Generating Module** or **DC Connected Power Park Module** shall be capable of automatically regulating dips in voltage caused by connection of demand;
- (v) The **Power Generating Module** or **DC Connected Power Park Module** shall:
  - be capable of **Block Load Capability**,
  - be capable of operating in **LFSM-O** and **LFSM-U**, as specified in ECC.6.3.7.1 and ECC.6.3.7.2~~point (c) of paragraph 2 and Article 13(2)~~
  - control **Frequency** in case of overfrequency and underfrequency within the whole **Active Power** output range between the **Minimum Regulating Level** and **Maximum Capacity** as well as at houseload operation levels
  - be capable of parallel operation of a few **Power Generating Modules** including **DC Connected Power Park Modules** within an isolated part of the **Total System** that is still supplying **Customers**, and control voltage automatically during the system restoration phase;

ECC.6.3.5.4 Each **HVDC System** or **Remote End HVDC Converter Station** which has a **Black Start Capability** shall be capable of energising the busbar of an AC substation to which another **HVDC Converter Station** is connected. The timeframe after shutdown of the **HVDC System** prior to energisation of the AC substation shall be pursuant to the terms of the **Black Start Contract**. The **HVDC System** shall be able to synchronise within the **Frequency** limits defined in ~~ECC.6.1.2.1.2~~ and voltage limits defined in ~~ECC.6.1.4.1~~ unless otherwise specified in the **Black Start Contract**. Wider **Frequency** and voltage ranges can be specified in the **Black Start Contract** in order to restore **System** security. ~~(Art 37(3) – Not reflected as these elements should be covered by the Black Start Contract)~~

ECC.6.3.5.5 With regard to the capability to take part in operation of an isolated part of the **Total System** that is still supplying **Customers**:

Formatted: Font: Bold

Formatted: Font: Bold

Formatted: Not Highlight

Formatted: Not Highlight

- (i) **Power Generating Modules** including **DC Connected Power Park Modules** shall be capable of taking part in island operation if specified in the **Black Start Contract** required by **NGET** and:

the **Frequency** limits for island operation shall be those specified in ECC.6.1.2 established in accordance with point (a) of Article 13(1),

the voltage limits for island operation shall be those defined in ECC.6.1.4 established in accordance with Article 15(3) or Article 16(2), where applicable;

- (ii) **Power Generating Modules** including **DC Connected Power Park Modules** shall be able to operate in **Frequency Sensitive Mode** during island operation, as specified in ECC.6.3.7.3 ~~point (d) of paragraph 2~~. In the event of a power surplus, **Power Generating Modules** including **DC Connected Power Park Modules** shall be capable of reducing the **Active Power** output from a previous operating point to any new operating point within the ~~**Power Generating Module** Performance Chart, **P-Q Capability Diagram**~~. In that regard, the **Power Generating Modules** including **DC Connected Power Park Modules** shall be capable of reducing **Active Power** output as much as inherently technically feasible, but to at least 55 % of ~~its~~ **Maximum Capacity**;

The method for detecting a change from interconnected system operation to island operation shall be agreed between the ~~**New Generator**~~**EU Generator**, ~~power generating facility owner~~ **NGET** and the **Relevant Transmission Licensee**. ~~the relevant system operator in coordination with the relevant TSO~~. The agreed method of detection must not rely solely on **NGET**, **Relevant Transmission Licensee's** or **Network Operators** ~~system operator's~~ switchgear position signals;

- (iv) **Power Generating Modules** including **DC Connected Power Park Modules** shall be able to operate in **LFSM-O** and **LFSM-U** during island operation, as specified in ECC.6.3.7.1 ~~point (c) of paragraph 2~~ and ECC.6.3.7.2 ~~Article 13(2)~~;

ECC.6.3.5.6

With regard to quick re-synchronisation capability:

- (i) In case of disconnection of the **Power Generating Module** including **DC Connected Power Park Modules** from the **System**, the **Power Generating Module** shall be capable of quick re-synchronisation in line with the **Protection** strategy agreed between **NGET** and/or **Network Operator** in co-ordination with the **Relevant Transmission Licensee** ~~the relevant system operator in coordination with the relevant TSO~~ and the **Generator** ~~power generating facility~~;
- (ii) A **Power Generating Module** including a **DC Connected Power Park Module** with a minimum re-synchronisation time greater than 15 minutes after its disconnection from any external power supply must be capable of **Houseload Operation** from any operating point on ~~in its **P-Q Capability Diagram**~~ ~~**Power Generating Module** or **Performance Chart**~~. In this case, the identification of **Houseload Operation** must not be based solely on the ~~**Total System's**~~ ~~the~~ switchgear position signals;
- (iii) **Power Generating Modules** including **DC Connected Power Park Modules** shall be capable of **Houseload Operation**, irrespective of any auxiliary connection to the ~~**Total System**~~ ~~external network~~. The minimum operation time shall be specified by **NGET** ~~the relevant system operator in coordination with the relevant TSO~~, taking into consideration the specific characteristics of prime mover technology.

Formatted: Font: Bold

Formatted: Font: Not Bold

Formatted: Not Strikethrough

Formatted: Not Strikethrough

Formatted: Font: Bold

Formatted: Font: Bold

ECC.6.3.6 CONTROL ARRANGEMENTS

ECC.6.3.6.1 ACTIVE POWER CONTROL

ECC.6.3.6.1.1 Active Power control in respect of Power Generating Modules including DC Connected Power Park Modules

ECC.6.3.6.1.1.1 **Type A Power Generating Modules** shall be equipped with a logic interface (input port) in order to cease **Active Power** output within five seconds following receipt of a signal from **NGET**, ~~an instruction being received at the input port.~~ **NGET** shall specify the requirements for such facilities, including the need for remote operation, in the **Bilateral Agreement**. ~~NGET may specify any additional requirements where they are necessary for System reasons (including remote operation).~~

Formatted: Font: Bold

Formatted: Font: Bold

Formatted: Font: Bold

ECC.6.3.6.1.1.2 **Type B Power Generating Modules** shall be equipped with an interface (input port) in order to be able to reduce **Active Power** output following receipt of a signal from **NGET**, ~~an instruction at the input port.~~ **NGET** shall specify the requirements for such facilities, including the need for remote operation, in the **Bilateral Agreement** where they are necessary for **System** reasons. ~~NGET may specify any additional requirements (including remote operation).~~

ECC.6.3.6.1.1.3 **Type C and Type D Power Generating Modules and DC Connected Power Park Modules** shall be capable of adjusting the **Active Power** setpoint in accordance with instructions issued by **NGET**. ~~In the event the load controller or related control system is out of service, manual local measures may be permitted. In such cases NGET shall notify The Authority of the time required to reach any new Active Power setpoint together with the tolerance for the Active Power.~~

Comment [A15]: Not sure this is required - I am not sure we would permit this and even then notifying Ofgem of the parameters for each new load point would be a challenging task in itself. Suggest it is deleted but needs to be reflected in the mapping table.

ECC.6.3.6.1.2 Active Power control in respect of HVDC Systems and Remote End HVDC Converter Stations

ECC.6.3.6.1.2.1 ~~HVDC Systems and Remote End HVDC Converter Station~~ shall be capable of adjusting the transmitted **Active Power** upon receipt of an instruction from **NGET** which shall be in accordance with the requirements of BC2.6.1.

ECC.6.3.6.1.2.2 The requirements for **fast Active Power reversal** (if required) shall be specified by **NGET**. Where **Active Power** reversal is specified in the **Bilateral Agreement**, each **HVDC System** and **Remote End HVDC Converter Station** shall be capable of operating from maximum import to maximum export in a **time which is as fast as technically feasible or in a time that is** no greater than 2 seconds except where a **HVDC Converter Station Owner** has justified to **NGET** that a longer reversal time is required.

Formatted: Font: Bold

Formatted: Highlight

Formatted: Font: Bold

ECC.6.3.6.1.2.3 Where an **HVDC System** connects various **Control Areas** or **Synchronous Areas**, each **HVDC System** or **Remote End HVDC Converter Station** shall be capable of responding to instructions issued by **NGET** under the **Balancing Code** to modify the transmitted **Active Power** for the purposes of cross-border balancing. *(Note Article 13(2) and 13(3) get picked up as part of the OC's and BC's)*

ECC.6.3.6.1.2.4 An **HVDC System** shall be capable of adjusting the ramping rate of **Active Power** variations within its technical capabilities in accordance with instructions issued ~~sent~~ by **NGET** ~~relevant TSOs~~. In case of modification of **Active Power** according to ECC.6.3.15 and ~~ECC.6.3.6.1.2.2 points (b) and (c) of paragraph 1~~, there shall be no adjustment of ramping rate.

Formatted: Font color: Auto, Not Highlight

Formatted: Not Highlight

ECC.6.3.6.1.2.5 ~~If specified by NGET, a relevant TSO, in coordination with the Relevant Transmission Licensees adjacent TSOs, the control functions of an HVDC System shall be capable of taking automatic remedial actions including, but not limited to, stopping the ramping and blocking FSM, LFSM-O, LFSM-U and Frequency control. The triggering and blocking criteria shall be specified by NGET, relevant TSO and subject to notification to the regulatory authority. The modalities of that notification shall be determined in accordance with the applicable national regulatory framework.~~

Formatted: Font: Not Bold

ECC.6.3.6.2 MODULATION OF ACTIVE POWER

ECC.6.3.6.2.1 Each Power Generating Module (including DC Connected Power Park Modules) and Onshore HVDC Converters at an Onshore HVDC Converter Station must be capable of contributing to Frequency control by continuous modulation of Active Power supplied to the National Electricity Transmission System. For the avoidance of doubt each Onshore HVDC Converter at an Onshore HVDC Converter Station and/or OTSDUW DC Converter shall provide each ~~New User~~ EU Code User in respect of its Offshore Power Stations connected to and/or using an Offshore Transmission System a continuous signal indicating the real time Frequency measured at the Transmission Interface Point. A DC Connected Power Park Module or Offshore Power Generating Module shall be capable of receiving and processing this signal within 100ms.

ECC.6.3.6.3 MODULATION OF REACTIVE POWER

ECC.6.3.6.3.1 Notwithstanding the requirements of ECC.6.3.2, each Power Generating Module or HVDC Equipment (and OTSDUW Plant and Apparatus at a Transmission Interface Point and Remote End HVDC Converter at an HVDC Interface Point) (as applicable) must be capable of contributing to voltage control by continuous changes to the Reactive Power supplied to the National Electricity Transmission System or the User System in which it is Embedded.

ECC.6.3.7 FREQUENCY RESPONSE

ECC.6.3.7.1 Limited Frequency Sensitive Mode – Overfrequency (LFSM-O)

Formatted: Font: Not Bold, Underline

ECC.6.3.7.1.1 Each Power Generating Module (including DC Connected Power Park Modules) and HVDC Systems shall be capable of reducing Active Power output in response to Frequency on the Total System when this rises above 50.4Hz. For the avoidance of doubt, the provision of this reduction in Active Power output is not an Ancillary Service. Such provision is known as Limited High Frequency Response. The Power Generating Module (including DC Connected Power Park Modules) or HVDC Systems shall be capable of operating stably during LFSM-O operation. However for a Power Generating Module (including DC Connected Power Park Modules) or HVDC Systems operating in Frequency Sensitive Mode the requirements of LFSM-O shall apply when the frequency exceeds 50.5Hz.

Formatted: Underline

- ECC.6.3.7.1.2 (i) The rate of change of Active Power output must be at a minimum rate of 2 percent of output per 0.1 Hz deviation of System Frequency above 50.4Hz (ie a Droop of 10%) as shown in Figure ECC.6.3.7.1 below. ~~For the avoidance of doubt, this would not preclude a EU Generator or HVDC System Owner from designing their Power Generating Module with a Droop of less than 10% but in all cases the Droop should be 2% or greater. lower Droop setting, for example between 3 – 5%.~~
- (ii) The reduction in Active Power output must be continuously and linearly proportional, as far as is practicable, to the excess of Frequency above 50.4 Hz and must be provided increasingly with time over the period specified in (iii) below.

Formatted: Font: Bold

Formatted: Font: Bold

- (iii) As much as possible of the proportional reduction in **Active Power** output must result from the frequency control device (or speed governor) action and must be achieved within 10 seconds of the time of the **Frequency** increase above 50.4 Hz. The **Power Generating Module** (including **DC Connected Power Park Modules**) or **HVDC Systems** shall be capable of initiating a power **Frequency** response with an initial delay that is as short as possible. If the delay exceeds 2 seconds the **EU Generator** or **HVDC System Owner** shall justify the delay, providing technical evidence to **NGET**.
- (iv) The residue of the proportional reduction in **Active Power** output which results from automatic action of the **Power Generating Module** (including **DC Connected Power Park Modules**) or **HVDC System** output control devices other than the frequency control devices (or speed governors) must be achieved within 3 minutes for the time of the **Frequency** increase above 50.4Hz.

Formatted: Font: Bold

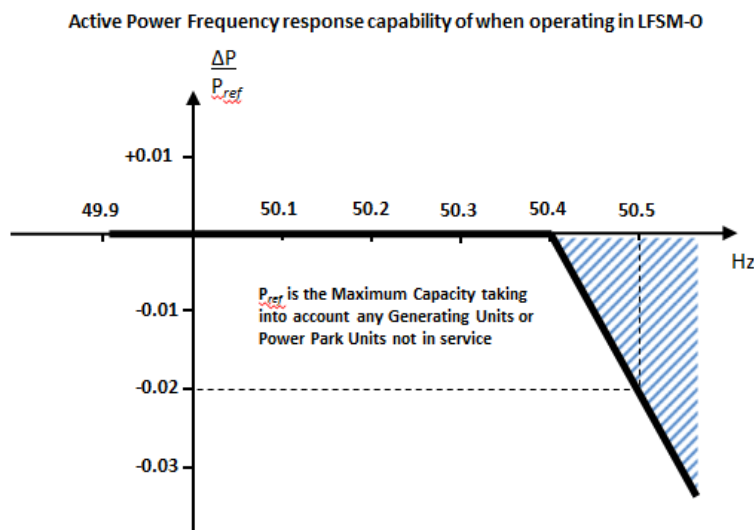

Formatted: Left

Figure ECC.6.3.7.1 –  $P_{ref}$  is the reference **Active Power** to which  $\Delta P$  is related and  $\Delta P$  is the change in **Active Power** output from the **Power Generating Module** (including **DC Connected Power Park Modules**) or **HVDC System**. The **Power Generating Module** (including **DC Connected Power Park Modules** or **HVDC Systems**) has to provide a negative **Active Power** output change with a droop of 10% or less based on  $P_{ref}$ .

ECC.6.3.7.1.3 Each **Power Generating Module** (including **DC Connected Power Park Modules**) or **HVDC Systems** which is providing **Limited High Frequency Response (LFSM-O)** must continue to provide it until the **Frequency** has returned to or below 50.4Hz or until otherwise instructed by **NGET**. ~~New Generator~~**EU Generator**s in respect of **Gensets** and **HVDC Converter Station Owners** in respect of an **HVDC System** should also be aware of the requirements in BC.3.7.2.2.

ECC.6.3.7.1.4

ECC.6.3.7.1.4 Steady state operation below the **Minimum Stable Operating Level** in the case of **Power Generating Modules** including **DC Connected Power Park Modules** or **Minimum Active Power**, ~~Transmission transfer Capacity capability~~ in the case of **HVDC Systems** – is not expected but if **System** operating conditions cause operation below the **Minimum Stable**

Formatted: Font: Bold

Formatted: Font: Bold



~~Operating Level-~~ or **Minimum Active Power Transmission Capacity**~~minimum Active Power transfer capability-~~ which could give rise to operational difficulties for the **Power Generating Module** including a **DC Connected Power Park Module** or **HVDC Systems** then the **EU Generator** or **HVDC Converter Station**~~System~~ **Owner** shall be able to return the output of the **Power Generating Module** including a **DC Connected Power Park Module** to an output of not less than the **Minimum Stable Operating Level** or **HVDC System** to an output of not less than the ~~Minimum Active Power Transmission Capacity~~~~minimum transfer capability~~.

Formatted: Font: Bold

ECC.6.3.7.1.5 All reasonable efforts should in the event be made by the **EU Generator** or **HVDC System Owner** to avoid such tripping provided that the **System Frequency** is below 52Hz in accordance with the requirements of ECC.6.1.2. If the **System Frequency** is at or above 52Hz, the requirement to make all reasonable efforts to avoid tripping does not apply and the **EU Generator** or **HVDC System Owner** is required to take action to protect its **Power Generating Modules** including **DC Connected Power Park Modules** or **HVDC Converter Stations**

Formatted: Font: Bold

Formatted: Font: Bold

ECC.6.3.7.2 Limited Frequency Sensitive Mode – Underfrequency (LFSM-U)

Formatted: Normal, Justified, Indent: Left: 0 cm, Hanging: 2.51 cm, Don't adjust space between Latin and Asian text, Don't adjust space between Asian text and numbers

ECC.6.3.7.2.1 Each **Type C Power Generating Module** and **Type D Power Generating Module** (including **DC Connected Power Park Modules**) or **HVDC Systems** operating in **Limited Frequency Sensitive Mode** shall be capable of increasing **Active Power** output in response to **System Frequency** when this falls below 49.5Hz. For the avoidance of doubt, the provision of this increase in **Active Power** output is not a mandatory **Ancillary Service** and it is not anticipated **Power Generating Modules** (including **DC Connected Power Park Modules**) or **HVDC Systems** are operated in an inefficient mode to facilitate delivery of **LFSM-U** response, but any inherent capability (where available) should be made without undue delay. The **Power Generating Module** (including **DC Connected Power Park Modules**) or **HVDC Systems** shall be capable of **stable** operation during **LFSM-U Mode**. For example, a ~~New Generator~~**EU Generator** which is operating with no headroom (eg it is operating at maximum output or is de-loading as part of a run down sequence and has no headroom) would not be required to provide **LFSM-U**.

Formatted: Font: Not Bold, Underline

ECC.6.3.7.2.2 (i) The rate of change of **Active Power** output must be at a minimum a rate of 2 percent of output per 0.1 Hz deviation of **System Frequency** below 49.5Hz (ie a **Droop** of 10%) as shown in Figure ECC.6.3.7.2.2 below. This requirement only applies if the **Power Generating Module** has headroom and the ability to increase **Active Power** output. In the case of a **Power Park Module** or **DC Connected Power Park Module** the requirements of Figure ECC.6.3.7.2.2 shall be reduced pro-rata to the amount of **Power Park Units** in service and available to generate. For the avoidance of doubt, this would not preclude an **EU Generator** or **HVDC System Owner** from designing their **Power Generating Module** with a lower **Droop** setting, for example between 3 – 5%.

Formatted: Font: Bold

(ii) As much as possible of the proportional increase in **Active Power** output must result from the **Frequency** control device (or speed governor) action and must be achieved for **Frequencies** below 49.5 Hz. The **Power Generating Module** (including **DC Connected Power Park Modules**) or **HVDC Systems** shall be capable of initiating a power **Frequency** response with minimal delay. If the delay exceeds 2 seconds the **EU Generator** or ~~HV-DC System Converter Station~~**Owner** shall justify the delay, providing technical evidence to **NGET**).

Formatted: Font: Bold

(iii) The actual delivery of **Active Power Frequency Response** in **LFSM-U** mode shall take into account

The ambient conditions when the response is to be triggered

The operating conditions of the **Power Generating Module** (including **DC Connected Power Park Modules**) or **HVDC Systems** in particular limitations on operation near **Maximum Capacity** or **Maximum HVDC Active Power Transmission Capacity**, ~~maximum transfer capacity~~ at low frequencies and the respective impact of ambient conditions as detailed in ECC.6.3.3.

Formatted: Font: Bold

Formatted: Not Highlight

The availability of primary energy sources.

- (iv) In **LFSM\_U Mode**, the **Power Generating Module** (including **DC Connected Power Park Modules**) and **HVDC Systems**, shall be capable of providing a power increase up to its **Maximum Capacity** or **Maximum HVDC Active Power Transmission Capacity** (as applicable).

Formatted: Font: Not Bold

Formatted: Font: Not Bold

Formatted: Font: Bold

Formatted: Font: Not Bold

Active Power Frequency response capability of when operating in LFSM-U

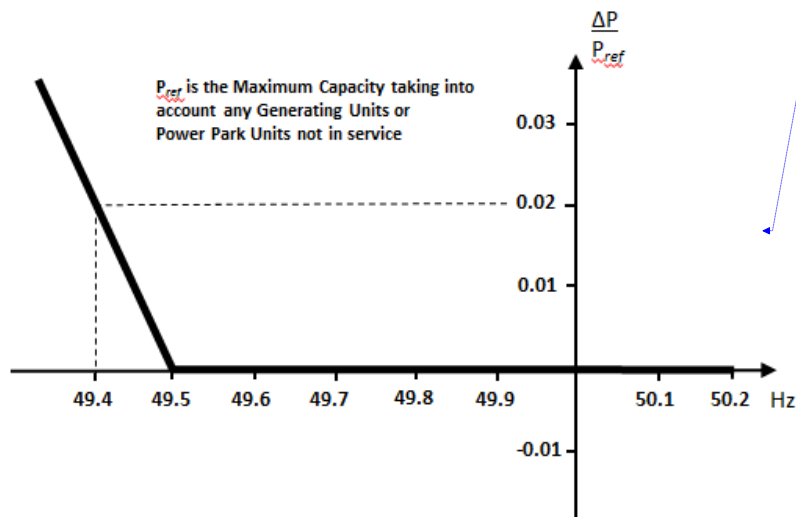

Formatted: Left

**Figure** ECC.6.3.7.2.2 –  $P_{ref}$  is the reference **Active Power** to which  $\Delta P$  is related and  $\Delta P$  is the change in **Active Power** output from the **Power Generating Module** (including **DC Connected Power Park Modules**) or **HVDC System**. The **Power Generating Module** (including **DC Connected Power Park Modules** or **HVDC Systems**) has to provide a positive **Active Power** output change with a droop of 10% or less based on  $P_{ref}$ .

ECC.6.3.7.3 Frequency Sensitive Mode – (FSM)

Formatted: Indent: Hanging: 2.5 cm

Formatted: Font: Not Bold, Underline

ECC.6.3.7.3.1 In addition to the requirements of ECC.6.3.7.1 and ECC.6.3.7.2 each **Type C Power Generating Module** and **Type D Power Generating Module** (including **DC Connected Power Park Modules**) or **HVDC Systems** must be fitted with a fast acting proportional **Frequency** control device (or turbine speed governor) and unit load controller or equivalent control device to provide **Frequency** response under normal operational conditions in accordance with **Balancing Code 3 (BC3)**. In the case of a **Power Park Module** including a **DC Connected Power Park Module**, the **Frequency** or speed control device(s) may be on the **Power Park Module** (including a **DC Connected Power Park Module**) or on each individual **Power Park Unit** (including a **Power Park Unit** within a **DC Connected Power Park Module**) or be a combination of both. The **Frequency** control device(s) (or speed governor(s)) must be designed and operated to the appropriate:

- (i) **European Specification**: or
- (ii) in the absence of a relevant **European Specification**, such other standard which is in common use within the European Community (which may include a manufacturer specification);

as at the time when the installation of which it forms part was designed or (in the case of modification or alteration to the **Frequency** control device (or turbine speed governor)) when the modification or alteration was designed.

The **European Specification** or other standard utilised in accordance with sub paragraph ECC.6.3.7.3.1 (a) (ii) will be notified to **NGET** by the ~~New Generator~~**EU Generator**- or **HVDC System Owner**:

- (i) as part of the application for a **Bilateral Agreement**; or
- (ii) as part of the application for a varied **Bilateral Agreement**; or
- (iii) in the case of an Embedded Development, within 28 days of entry into the Embedded Development Agreement (or such later time as agreed with **NGET**) or
- (iv) as soon as possible prior to any modification or alteration to the **Frequency** control device (or governor); and

ECC.6.3.7.3.2 The **Frequency** control device (or speed governor) in co-ordination with other control devices must control each **Type C Power Generating Module** and **Type D Power Generating Module** (including **DC Connected Power Park Modules**) or **HVDC Systems Active Power Output** or **Active Power** transfer capability with stability over the entire operating range of the **Power Generating Module** (including **DC Connected Power Park Modules**) or **HVDC Systems**; and

ECC.6.3.7.3.3 **Type C** and **Type D Power Generating Modules** and **DC Connected Power Park Modules** shall also meet the following minimum requirements:

- (i) capable of providing **Active Power Frequency** response in accordance with the performance characteristic shown in Figure 6.3.7.3.3(a) and parameters in Table 6.3.7.3.3(a)

Active Power Frequency Response capability of Power Generating Modules Including HVDC connected Power Park Modules when operating in FSM

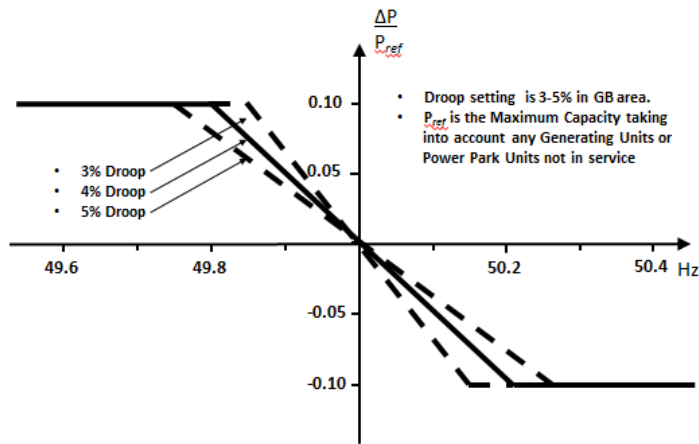

Figure 6.3.7.3.3(a) – Frequency Sensitive Mode capability of Power Generating Modules and DC Connected Power Park Modules

Parameter	Setting
Nominal System Frequency	50Hz
Active Power as a percentage of Maximum Capacity ( $\frac{\Delta P_{11}}{P_{max}}$ )	10%
Frequency Response Insensitivity in mHz ( $ \Delta f_i $ )	$\pm 15$ mHz
Frequency Response Insensitivity as a percentage of nominal frequency ( $\frac{ \Delta f_i }{f_n}$ )	$\pm 0.03\%$
Frequency Response Deadband in mHz	0 (mHz)
Droop (%)	3 – 5%

Table 6.3.7.3.3(a) – Parameters for Active Power Frequency response in Frequency Sensitive Mode including the mathematical expressions in Figure 6.3.7.3.3(a).

(ii) In satisfying the performance requirements specified in ECC.6.3.7.3(i) **EU Generators** in respect of each **Type C** and **Type D Power Generating Modules and DC Connected Power Park Module** should be aware:-

in the case of overfrequency, the **Active Power Frequency** response is limited by the **Minimum Regulating Level**,

in the case of underfrequency, the **Active Power Frequency** response is limited by the **Maximum Capacity**,

Formatted: Font: Bold

the actual delivery of **Active Power** frequency response depends on the operating and ambient conditions of the **Power Generating Module** (including **DC Connected Power Park Modules**) when this response is triggered, in particular limitations on operation near **Maximum Capacity** at low **Frequencies** as specified in ECC.6.3.3 and available primary energy sources.

The frequency control device (or speed governor) must also be capable of being set so that it operates with an overall speed **Droop** of between 3 – 5%. The **Frequency Response Deadband** and **Droop** must be able to be reselected repeatedly. For the avoidance of doubt, in the case of a **Power Park Module** (including **DC Connected Power Park Modules**) the speed **Droop** should be equivalent of a fixed setting between 3% and 5% applied to each **Power Park Unit** in service.

- (iii) In the event of a **Frequency** step change, each **Type C** and **Type D Power Generating Module** and **DC Connected Power Park Module** shall be capable of activating full and stable **Active Power Frequency** response (without undue power oscillations), in accordance with the performance characteristic shown in Figure 6.3.7.3.3(b) and parameters in Table 6.3.7.3.3(b).

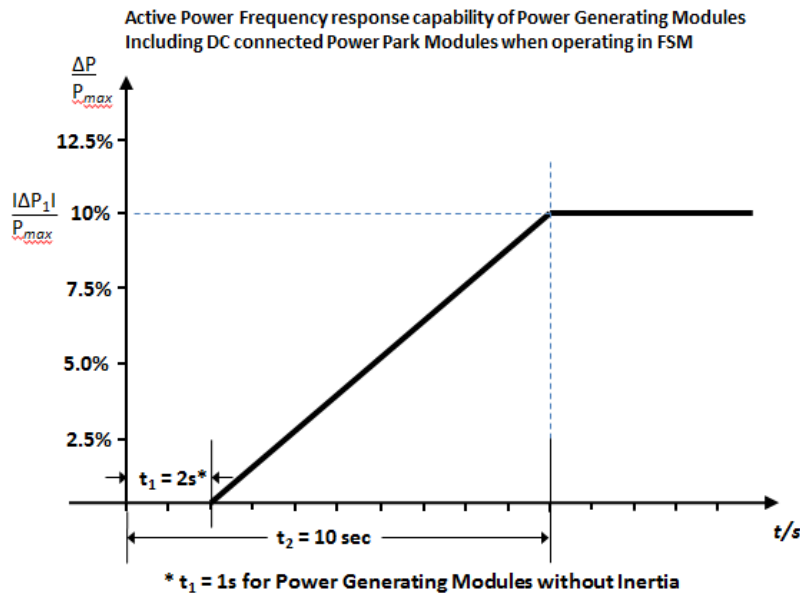

Figure 6.3.7.3.3(b) **Active Power Frequency Response** capability.

Formatted: Not Highlight

Parameter	Setting
<b>Active Power</b> as a percentage of <b>Maximum Capacity (frequency response range)</b> ( $\frac{ \Delta P_1 }{P_{max}}$ )	10%
<b>Maximum admissible initial delay <math>t_1</math></b> for <b>Power Generating Modules</b> (including <b>DC Connected Power Park Modules</b> )	2 seconds

with inertia unless justified as specified in ECC.6.3.7.3.3 (iv)	
Maximum admissible initial delay $t_1$ for <b>Power Generating Modules</b> (including <b>DC Connected Power Park Modules</b> ) which do not contribute to <b>System</b> inertia unless justified as specified in ECC.6.3.7.3.3 (iv)	1 second
Activation time $t_2$	10 seconds

Table 6.3.7.3.3(b) – Parameters for full activation of **Active Power Frequency** response resulting from a **Frequency** step change. Table 6.3.7.3.3(b) also includes the mathematical expressions used in Figure 6.3.7.3.3(b).

- (iv) The initial activation of **Active Power Primary Frequency** response shall not be unduly delayed. For **Type C** and **Type D Power Generating Modules** (including **DC Connected Power Park Modules**) with inertia the delay in initial **Active Power Frequency** response shall not be greater than 2 seconds. For **Type C** and **Type D Power Generating Modules** (including **DC Connected Power Park Modules**) without inertia, the delay in initial **Active Power Frequency** response shall not be greater than 1 second. If the **Generator** cannot meet this requirement they shall provide technical evidence to **NGET** demonstrating why a longer time is needed for the initial activation of **Active Power Frequency** response.
- (v) in the case of **Type C** and **Type D Power Generating Modules** (including **DC Connected Power Park Modules**) other than the **Steam Unit** within a **CCGT Module** the combined effect of the **Frequency Response Insensitivity** and **Frequency Response Deadband** of the **Frequency** control device (or speed governor) should be no greater than 0.03Hz (for the avoidance of doubt,  $\pm 0.015$ Hz). In the case of the **Steam Unit** within a **CCGT Module**, the **Frequency Response Deadband** should be set to an appropriate value consistent with the requirements of ECC.6.3.7.3.5(ii) and the requirements of BC3.7.2.2 for the provision of **LFSM-O** taking account of any **Frequency Response Insensitivity** of the **Frequency** control device (or speed governor);

Formatted: Not Highlight

ECC.6.3.7.3.4 **HVDC Systems** shall also meet the following minimum requirements:

- (i) **HVDC Systems** shall be capable of responding to **Frequency** deviations in each connected **AC System** by adjusting their **Active Power** import or export as shown in Figure 6.3.7.3.4(a)3(c) with the corresponding parameters in Table 6.3.7.3.4(a)3(c).

### Active Power Frequency response capability of HVDC systems when operating in FSM

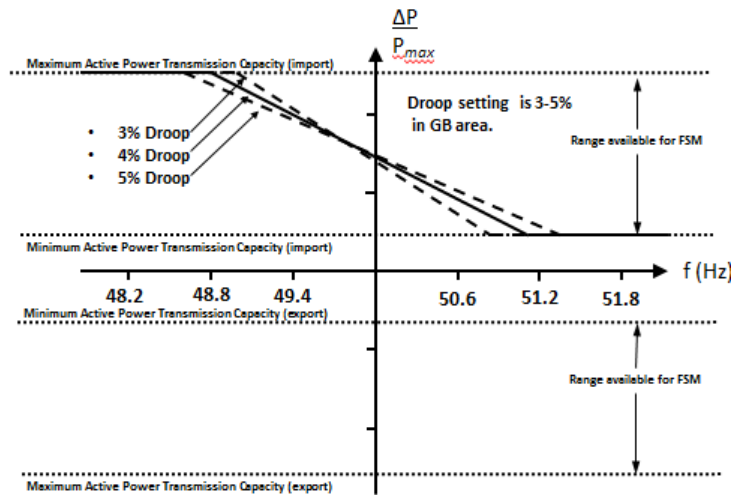

**Comment [A16]:** Diagram needs to be re-drawn - with GB parameters. There needs to be a reduction in the equations

Figure 6.3.7.3.4(a)3(c) – Active Power frequency response capability of a HVDC System operating in Frequency Sensitive Mode (FSM) illustrating the case of zero deadband and insensitivity with a positive active power setpoint (import mode).  $\Delta P$  is the change in active power output from the HVDC System.  $f_n$  is the target frequency in the AC network where the FSM service is provided and  $\Delta f$  is the frequency deviation in the AC network where the FSM service is provided.

Parameter	Setting
Frequency Response Deadband	0
Droop S1 and S2 (upward and downward regulation) where S1=S2.	3 – 5%
Frequency Response Insensitivity	±15mHz

Table 6.3.7.3.4(a)3(c) – Parameters for Active Power Frequency response in FSM including the mathematical expressions in Figure 6.3.7.3.43(c).

- (ii) Each HVDC System shall be capable of adjusting the Droop for both upward and downward regulation the frequency response deadband and the Active Power range over which Frequency Sensitive Mode of operation is available as defined in ECC.6.3.7.3.4.
- (iii) In addition to the requirements in ECC.6.3.7.4(i) and ECC.6.3.7.4(ii) each HVDC System shall be capable of:-
  - delivering the response as soon as technically feasible
  - delivering the response on or above the solid line in Figure 6.3.7.3.43(bd) in accordance with the parameters shown in Table 6.3.7.3.43(bd)

initiating the delivery of **Primary Response** in no less than 0.5 seconds unless otherwise agreed with **NGET**. Where the initial delay time ( $t_1$  – as shown in Figure 6.3.7.3.43(bd)) is longer than 0.5 seconds the **HVDC Converter Station Owner** shall reasonably justify it to **NGET**.

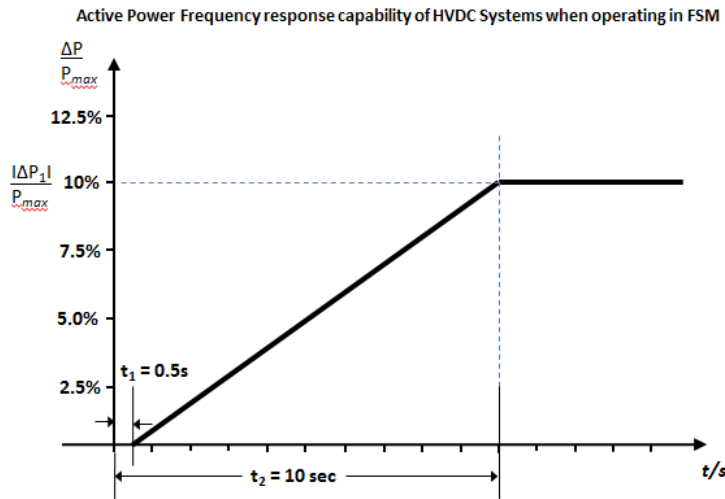

Figure 6.3.7.3.43(bd) **Active Power Frequency Response** capability of a **HVDC System**.  $\Delta P$  is the change in **Active Power** triggered by the step change in frequency

Parameter	Setting
<b>Active Power as a percentage of Maximum Capacity (frequency response range) (<math>\frac{ \Delta P_1 }{P_{max}}</math>)</b>	10%
Maximum admissible delay $t_1$	0.5 seconds
Maximum admissible time for full activation $t_2$ , unless longer activation times are agreed with <b>NGET</b>	10 seconds

Table 6.3.7.3.43(bd) – Parameters for full activation of **Active Power Frequency** response resulting from a **Frequency** step change.

- (iv) For **HVDC Systems** connecting various **Synchronous Areas**, each **HVDC System** shall be capable of adjusting the full **Active Power Frequency Response** when operating in **Frequency Sensitive Mode** at any time and for a continuous time period. In addition, the **Active Power** controller of each **HVDC System** shall not have any adverse impact on the delivery of frequency response.

ECC.6.3.7.3.5 For **HVDC Systems** and **Type C** and **Type D Power Generating Modules** (including **DC Connected Power Park Modules**), other than the **Steam Unit** within a **CCGT Module** the combined effect of the **Frequency Response Insensitivity** and



**Frequency Response Deadband**— of the **Frequency** control device (or speed governor) should be no greater than 0.03Hz (for the avoidance of doubt,  $\pm 0.015\text{Hz}$ ). In the case of the **Steam Unit** within a **CCGT Module**, the **Frequency Response Deadband** should be set to an appropriate value consistent with the requirements of ECC.6.3.7.3.5(ii) and the requirements of BC3.7.2.2 for the provision of **LFSM-O** taking account of any **Frequency Response Insensitivity** of the **Frequency** control device (or speed governor);

Formatted: Not Highlight

Formatted: Font: Bold

(i) With regard to disconnection due to underfrequency, **EU Generators** responsible for **Type C** and **Type D Power Generating Modules** (including **DC Connected Power Park Modules**) **capable of acting as a load**, including but not limited to **Pumped Storage** and tidal **Power Generating Modules**, **HVDC Systems** and **Remote End HVDC Converter Stations** ~~hydro pump-storage power-generating facilities~~, shall be **capable of disconnecting their load in case of underfrequency** which will be agreed with **NGET**. For the avoidance of doubt this requirement does not apply to station auxiliary supplies; **EU Generators** in respect of **Type C** and **Type D Pumped Storage Power Generating Modules** should also be aware of the requirements in OC.6.6.6.

Formatted: Font: Bold

Formatted: Font: Bold

(ii) Where a **Type C** or **Type D Power Generating Module**, **DC Connected Power Park Module** or **HVDC System** becomes isolated from the rest of the **Total System** but is still supplying **Customers**, the **Frequency** control device (or speed governor) must also be able to control **System Frequency** below 52Hz unless this causes the **Type C** or **Type D Power Generating Module** or **DC Connected Power Park Module** to operate below its **Minimum Regulating Level** or **Minimum Active Power Transmission Capacity** when it is possible that it may, as detailed in BC 3.7.3, trip after a time. For the avoidance of doubt **Power Generating Modules** (including **DC Connected Power Park Modules**) and **HVDC Systems** are only required to operate within the **System Frequency** range 47 - 52 Hz as defined in ECC.6.1.2 and for converter based technologies, the remaining island contains sufficient fault level for effective commutation;

Formatted: Font: Not Bold

(iii) Each **Type C** and **Type D Power Generating Module** and **HVDC Systems** shall have the facility to modify the **Target Frequency** setting either continuously or in a maximum of 0.05Hz steps over at least the range  $50 \pm 0.1\text{Hz}$  should be provided in the unit load controller or equivalent device.

ECC.6.3.7.3.6 In addition to the requirements of ECC.6.3.7.3 each **Type C** and **Type D Power Generating Module** and **HVDC System** shall be capable of meeting the minimum **Frequency** response requirement profile subject to and in accordance with the provisions of Appendix A3.

ECC.6.3.7.3.7 For the avoidance of doubt, the requirements of Appendix A3 do not apply to **Type A** and **Type B Power Generating Modules**.

ECC.6.3.8 EXCITATION AND VOLTAGE CONTROL PERFORMANCE REQUIREMENTS

ECC.6.3.8.1 Excitation Performance Requirements for Type B Synchronous Power Generating Modules

Formatted: Font: Not Bold

ECC.6.3.8.1.1 Each **Synchronous Generating Unit** within a **Type B Synchronous Power Generating Module** shall be equipped with a permanent automatic excitation control system that shall have the capability to provide constant terminal voltage at a selectable setpoint without instability over the entire operating range of the **Type B Synchronous Power Generating Module**.

ECC.6.3.8.1.2 In addition to the requirements of ECC.6.3.8.1.1, **NGET** or the relevant **Network Operator** will specify if the control system of the **Type B Synchronous Power Generating Module** shall contribute to voltage control or **Reactive Power** control or **Power Factor** control at the **Grid Entry Point** or **User System Entry Point** (or other defined busbar). The performance requirements of the control system including slope (where applicable) shall be agreed between **NGET** and/or the relevant **Network Operator** and the **EU Generator**.

Formatted: Font: Bold

ECC.6.3.8.2 Voltage Control Requirements for Type B Power Park Modules

ECC.6.3.8.2.1 **NGET** or the relevant **Network Operator** will specify if the control system of the **Type B Power Park Module** shall contribute to voltage control or **Reactive Power** control or **Power Factor** control at the **Grid Entry Point** or **User System Entry Point** (or other defined busbar). The performance requirements of the control system including slope (where applicable) shall be agreed between **NGET** and/or the relevant **Network Operator** and the **EU Generator**.

Formatted: Font: Bold

ECC.6.3.8.3 Excitation Performance Requirements for Type C and Type D Onshore Synchronous Power Generating Modules

ECC.6.3.8.3.1 Each **Synchronous Generating Unit** within a **Type C** and **Type D Onshore Synchronous Power Generating Modules** shall be equipped with a permanent automatic excitation control system that shall have the capability to provide constant terminal voltage control at a selectable setpoint without instability over the entire operating range of the **Synchronous Power Generating Module**.

ECC.6.3.8.3.2 The requirements for excitation control facilities are specified in ECC.A.6. Any site specific requirements shall be specified by **NGET** or the relevant **Network Operator**.

ECC.6.3.8.3.3 Unless otherwise required for testing in accordance with **OC5.A.2**, the automatic excitation control system of an **Onshore Synchronous Power Generating Module** shall always be operated such that it controls the **Onshore Synchronous Generating Unit** terminal voltage to a value that is

Formatted: Not Highlight

- equal to its rated value: or
- only where provisions have been made in the **Bilateral Agreement**, greater than its rated value.

ECC.6.3.8.3.4 In particular, other control facilities including constant **Reactive Power** output control modes and constant **Power Factor** control modes (but excluding VAR limiters) are not required. However if present in the excitation or voltage control system they will be disabled unless otherwise agreed with **NGET** or the relevant **Network Operator**. Operation of such control facilities will be in accordance with the provisions contained in **BC2**.

ECC.6.3.8.3.5 The excitation performance requirements for **Offshore Synchronous Power Generating Modules** with an **Offshore Grid Entry Point** shall be specified by **NGET**.

ECC.6.3.8.4 Voltage Control Performance Requirements for Type C and Type D Onshore Power Park Modules, Onshore HVDC Converters and OTSDUW Plant and Apparatus at the Interface Point

ECC.6.3.8.4.1 Each **Type C** and **Type D Onshore Power Park Module, Onshore HVDC Converter** and **OTSDUW Plant and Apparatus** shall be fitted with a **continuously acting automatic control system** to provide **control of the voltage** at the **Grid Entry Point** or **User System Entry Point** (or **Interface Point** in the case of **OTSDUW Plant and Apparatus**) **without instability over the entire operating range of the Onshore Power Park Module, or Onshore HVDC Converter or OTSDUW Plant and Apparatus.** Any **Plant or Apparatus** used in the provisions of such voltage control within an **Onshore Power Park Module** may be located at the **Power Park Unit** terminals, an appropriate intermediate busbar or the **Grid Entry Point** or **User System Entry Point**. In the case of an **Onshore HVDC Converter** at a **HVDC Converter Station** any **Plant or Apparatus** used in the provisions of such voltage control may be located at any point within the **User's Plant and Apparatus** including the **Grid Entry Point** or **User System Entry Point**. **OTSDUW Plant and Apparatus** used in the provision of such voltage control may be located at the **Offshore Grid Entry Point** an appropriate intermediate busbar or at the **Interface Point**. When operating below 20% **Maximum Capacity** the automatic control system may continue to provide voltage control using any available reactive capability. If voltage control is not being provided, the automatic control system shall be designed to ensure a smooth transition between the shaded area below 20% of **Active Power** output and the non-shaded area above 20% of **Active Power** output in Figure ECC.6.3.2.5(c) and Figure ECC.6.3.2.7(b) The performance requirements for a continuously acting automatic voltage control system that shall be complied with by the **User** in respect of **Onshore Power Park Modules, Onshore HVDC Converters** at an **Onshore HVDC Converter Station, OTSDUW Plant and Apparatus** at the **Interface Point** are defined in ECC.A.7.

ECC.6.3.8.4.3 In particular, other control facilities, including constant **Reactive Power** output control modes and constant **Power Factor** control modes (but excluding VAR limiters) are not required. However if present in the voltage control system they will be disabled unless otherwise agreed with **NGET** or the relevant **Network Operator**. Operation of such control facilities will be in accordance with the provisions contained in BC2. Where **Reactive Power** output control modes and constant **Power Factor** control modes have been fitted within the voltage control system they shall be required to satisfy the requirements of ECC.A.7.3 and ECC.A.7.4.

ECC.6.3.8.5 Excitation Control Performance requirements applicable to AC Connected Offshore Synchronous Power Generating Modules and voltage control performance requirements applicable to AC connected Offshore Power Park Modules, DC Connected Power Park Modules and Remote End HVDC Converters

ECC.6.3.8.5.1 A continuously acting automatic control system is required to provide control of **Reactive Power** (as specified in ECC.6.3.2.56 and ECC.6.3.2.67) at the **Offshore Grid Entry Point** (or **HVDC Interface Point** in the case of **Configuration 1 DC Connected Power Park Modules** and **Remote End HVDC Converters**) **without instability over the entire operating range of the AC connected Offshore Synchronous Power Generating Module or Configuration 1 AC connected Offshore Power Park Module or Configuration 1 DC Connected Power Park Modules or Remote End HVDC Converter.** The performance requirements for this automatic control system will be specified by **NGET** which would be consistent with the requirements of ECC.6.3.2.56 and ECC.6.3.2.67.

Formatted: Not Highlight

Formatted: Not Highlight

Formatted: Not Highlight

Formatted: Not Highlight

Formatted: Not Highlight

Formatted: Not Highlight

Formatted: Not Highlight

Formatted: Not Highlight

Formatted: Not Highlight

ECC.6.3.8.5.2 A continuously acting automatic control system is required to provide control of **Reactive Power** (as specified in ECC.6.3.2.8) at the **Offshore Grid Entry Point** (or **HVDC Interface Point** in the case of **Configuration 2 DC Connected Power Park Modules**) without instability over the entire operating range of the **Configuration 2 AC connected Offshore Power Park Module** or **Configuration 2 DC Connected Power Park Modules**. otherwise the requirements of ECC.6.3.2.67 shall apply. The performance requirements for this automatic control system are specified in ECC.A.8

ECC.6.3.8.5.3 In addition to ECC.6.3.8.5.1 and ECC.6.3.8.5.2 the requirements for excitation or voltage control facilities, including **Power System Stabilisers**, where these are necessary for system reasons, will be specified by **NGET**. Reference is made to on-load commissioning witnessed by **NGET** in BC2.11.2.

#### ECC.6.3.9 STEADY STATE LOAD INACCURACIES

ECC.6.3.9.1 The standard deviation of **Load** error at steady state **Load** over a 30 minute period must not exceed 2.5 per cent of a **Type C** or **Type D Power Generating Modules** (including a **DC Connected Power Park Module**) **Maximum Capacity**. Where a **Type C** or **Type D Power Generating Module** (including a **DC Connected Power Park Module**) is instructed to **Frequency** sensitive operation, allowance will be made in determining whether there has been an error according to the governor droop characteristic registered under the **PC**.

For the avoidance of doubt in the case of a **Power Park Module** allowance will be made for the full variation of mechanical power output.

#### ECC.6.3.10 NEGATIVE PHASE SEQUENCE LOADINGS

ECC.6.3.10.1 In addition to meeting the conditions specified in ECC.6.1.5(b), each **Synchronous Power Generating Module** will be required to withstand, without tripping, the negative phase sequence loading incurred by clearance of a close-up phase-to-phase fault, by **System Back-Up Protection** on the **National Electricity Transmission System** or **User System** located **Onshore** in which it is **Embedded**.

#### ECC.6.3.11 NEUTRAL EARTHING

ECC.6.3.11 At nominal **System** voltages of 110kV and above the higher voltage windings of a transformer of a **Power Generating Module** or **HVDC Equipment** or transformer resulting from **OTSDUW** must be star connected with the star point suitable for connection to earth. The earthing and lower voltage winding arrangement shall be such as to ensure that the **Earth Fault Factor** requirement of paragraph ECC.6.2.1.1 (b) will be met on the **National Electricity Transmission System** at nominal **System** voltages of 110/132kV and above.

Formatted: Indent: Left: 0 cm, Hanging: 2.5 cm

#### ECC.6.3.12 FREQUENCY AND VOLTAGE DEVIATIONS

ECC.6.3.12.1 As stated in ECC.6.1.2, the **System Frequency** could rise to 52Hz or fall to 47Hz. Each **Power Generating Module** (including **DC Connected Power Park Modules**) must continue to operate within this **Frequency** range for at least the periods of time given in ECC.6.1.2 unless **NGET** has specified any requirements for **combined Frequency and voltage deviations** which are required to ensure the best use of technical capabilities of **Power Generating Modules** (including **DC Connected Power Park Modules**) if required to preserve or restore system security.- Notwithstanding this requirement, **EU Generators** should also be aware of the requirements of ECC.6.3.13.

Formatted: Font: Bold

#### ECC.6.3.13 FREQUENCY, RATE OF CHANGE OF FREQUENCY AND VOLATGE PROTECTION SETTING ARRANGEMENTS

ECC.6.3.13.1 **EU Generators** (including in respect of **OTSDUW Plant and Apparatus**) and **HVDC System Owners** will be responsible for protecting all their **Power Generating Modules** (and **OTSDUW Plant and Apparatus**) or **HVDC Equipment** against damage should **Frequency** excursions outside the range 52Hz to 47Hz ever occur. Should such excursions occur, it is up to the **EU Generator** or **HVDC System Owner** to decide whether to disconnect his **Apparatus** for reasons of safety of **Apparatus, Plant** and/or personnel.

Formatted: Font: Bold

Formatted: Font: Bold

Formatted: Font: Bold

ECC.6.3.13.2 Each **Power Generating Module** when connected and synchronised to the **System**, shall be capable of withstanding without tripping a rate of change of **Frequency** up to and including 1 Hz per second as measured over a rolling 500 milliseconds period. Voltage dips may cause localised rate of change of **Frequency** values in excess of 1 Hz per second for short periods, and in these cases, the requirements under ECC.6.3.15 (fault ride through) supersedes this clause. For the avoidance of doubt, this requirement relates to the capabilities of **Power Generating Modules** only and does not impose the need for rate of change of **Frequency** protection nor does it impose a specific setting for anti-islanding or loss-of-mains protection relays.

Formatted: Font: Not Bold

ECC.6.3.13.3 Each **HVDC System** and **Remote End HVDC Converter Station** when connected and synchronised to the **System**, shall be capable of withstanding without tripping a rate of change of **Frequency** up to and including  $\pm 2.5$ Hz per second as measured over the previous 1 second period. Voltage dips may cause localised rate of change of **Frequency** values in excess of  $\pm 2.5$  Hz per second for short periods, and in these cases, the requirements under ECC.6.3.15 (fault ride through) supersedes this clause. For the avoidance of doubt, this requirement relates to the capabilities of **HVDC Systems** and **Remote End HVDC Converter Stations** only and does not impose the need for rate of change of **Frequency** protection nor does it impose a specific setting for anti-islanding or loss-of-mains protection relays.

Formatted: Font: Not Bold

ECC.6.3.13.4 Each **DC Connected Power Park Module** when connected to the **System**, shall be capable of withstanding without tripping a rate of change of **Frequency** up to and including  $\pm 2.0$ Hz per second as measured over the previous 1 second period. **Voltage** dips may cause localised rate of change of **Frequency** values in excess of  $\pm 2.0$  Hz per second for short periods, and in these cases, the requirements under ECC.6.3.15 (fault ride through) supersedes this clause. For the avoidance of doubt, this requirement relates to the capabilities of **DC Connected Power Park Modules** only and does not impose the need for rate of change of **Frequency** protection nor does it impose a specific setting for anti-islanding or loss-of-mains protection relays.

ECC.6.3.13.5 As stated in ECC.6.1.2, the **System Frequency** could rise to 52Hz or fall to 47Hz and the **System** voltage at the **Grid Entry Point** or **User System Entry Point** could rise or fall within the values outlined in ECC.6.1.4. Each **Type C** and **Type D Power Generating Module** (including **DC Connected Power Park Modules**) or any constituent element must continue to operate within this **Frequency** range for at least the periods of time given in ECC.6.1.2 and voltage range as defined in ECC.6.1.4 unless **NGET** has agreed to any simultaneous overvoltage and underfrequency relays and/or simultaneous undervoltage and over frequency relays which will trip such **Power Generating Module** (including **DC Connected Power Park Modules**), and any constituent element within this **Frequency** or voltage range.

Formatted: Font: Not Bold

#### ECC.6.3.14 FAST START CAPABILITY

ECC.6.3.14.1 It may be agreed in the **Bilateral Agreement** that a **Genset** shall have a **Fast-Start**

**Capability.** Such **Gensets** may be used for **Operating Reserve** and their **Start-Up** may be initiated by **Frequency-level** relays with settings in the range 49Hz to 50Hz as specified pursuant to **OC2**.

**ECC.6.3.15** FAULT RIDE THROUGH

**ECC.6.3.15.1** General **Fault Ride Through** requirements, principles and concepts applicable to **Type B, Type C** and **Type D Power Generating Modules** and **OTSDUW Plant and Apparatus** subject to faults up to 140ms in duration

**ECC.6.3.15.1.1** ECC.6.3.15.1 – ECC.6.3.15.8 section sets out the **Fault Ride Through** requirements on **Type B, Type C** and **Type D Power Generating Modules, OTSDUW Plant and Apparatus** and **HVDC Equipment** that shall apply in the event of a fault lasting up to 140ms in duration.

**ECC.6.3.15.1.2** Each **Power Generating Module, Power Park Module, HVDC Equipment** and **OTSDUW Plant and Apparatus** is required to remain connected and stable for any balanced and unbalanced fault where the voltage at the **Grid Entry Point** or **User System Entry Point** or (**HVDC Interface Point** in the case of **Remote End DC Converter Stations** or **Interface Point** in the case of **OTSDUW Plant and Apparatus**) remains on or above the heavy black line defined in sections **ECC.6.3.15.2 – ECC.6.3.15.7** below.

**ECC.6.3.15.1.3** The voltage against time curves defined in **ECC.6.3.15.2 – ECC.6.3.15.7** expresses the lower limit (expressed as the ratio of its actual value and its reference 1pu) of the actual course of the phase to phase voltage (or phase to earth voltage in the case of asymmetrical/unbalanced faults) on the **System** voltage level at the **Grid Entry Point** or **User System Entry Point** (or **HVDC Interface Point** in the case of **Remote End HVDC Converter Stations** or **Interface Point** in the case of **OTSDUW Plant and Apparatus**) during a symmetrical or asymmetrical/unbalanced fault, as a function of time before, during and after the fault. For the purposes of this section of the Grid Code, the term voltage is considered to be the positive phase sequence root mean square voltage that would be measured at the **Grid Entry Point** or **User System Entry Point** during a **System** fault or disturbed condition.

- Formatted: Not Highlight
- Formatted: Not Highlight
- Formatted: Not Highlight
- Formatted: Not Highlight

- Formatted: Font color: Auto
- Formatted: Font color: Auto

**ECC.6.3.15.2** Voltage against time curve and parameters applicable to **Type B Synchronous Power Generating Modules**

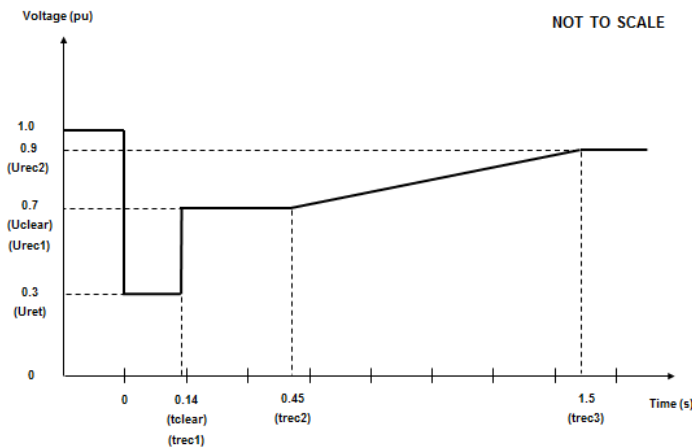

Figure ECC.6.3.15.2 - Voltage against time curve applicable to **Type B Synchronous Power Generating Modules**

Voltage parameters (pu)		Time parameters (seconds)	
Uret	0.3	tclear	0.14
Uclear	0.7	trec1	0.14
Urec1	0.7	trec2	0.45
Urec2	0.9	trec3	1.5

Table ECC.6.3.15.2 Voltage against time parameters applicable to **Type B Synchronous Power Generating Modules**

ECC.6.3.15.3 Voltage against time curve and parameters applicable to **Type C and D Synchronous Power Generating Modules** connected below 110kV

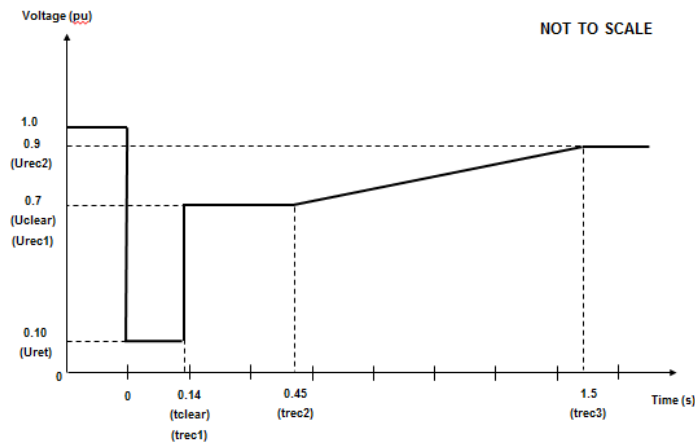

Figure ECC.6.3.15.3 - Voltage against time curve applicable to **Type C and D Synchronous Power Generating Modules** connected below 110kV

Voltage parameters (pu)		Time parameters (seconds)	
Uret	0.1	tclear	0.14
Uclear	0.7	trec1	0.14
Urec1	0.7	trec2	0.45
Urec2	0.9	trec3	1.5

Table ECC.6.3.15.3 Voltage against time parameters applicable to **Type C and D Synchronous Power Generating Modules** connected below 110kV

ECC.6.3.15.4 Voltage against time curve and parameters applicable to **Type D Synchronous Power Generating Modules** connected at or above 110kV

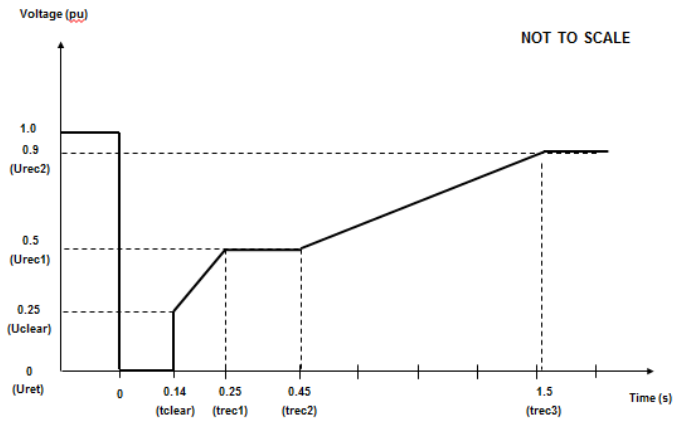

Figure ECC.6.3.15.4 - Voltage against time curve applicable to **Type D Synchronous Power Generating Modules** connected at or above 110kV

Voltage parameters (pu)		Time parameters (seconds)	
Uret	0	tclear	0.14
Uclear	0.25	trec1	0.25
Urec1	0.5	trec2	0.45
Urec2	0.9	trec3	1.5

Table ECC.6.3.15.4 Voltage against time parameters applicable to **Type D Synchronous Power Generating Modules** connected at or above 110kV

ECC.6.3.15.5 Voltage against time curve and parameters applicable to **Type B, C and D Power Park Modules** connected below 110kV

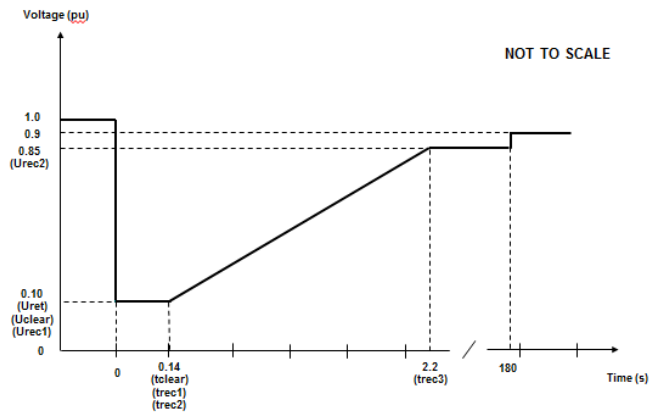

Figure ECC.6.3.15.5 - Voltage against time curve applicable to **Type B, C and D Power Park Modules** connected below 110kV

Voltage parameters (pu)		Time parameters (seconds)	
Uret	0.10	tclear	0.14
Uclear	0.10	trec1	0.14
Urec1	0.10	trec2	0.14



Urec2	0.85	trec3	2.2
-------	------	-------	-----

Table ECC.6.3.15.5 Voltage against time parameters applicable to **Type B, C and D Power Park Modules** connected below 110kV

ECC.6.3.15.6 Voltage against time curve and parameters applicable to **Type D Power Park Modules** with a **Grid Entry Point** or **User System Entry Point** at or above 110kV, **DC Connected Power Park Modules** at the **HVDC Interface Point** or **OTSDUW Plant and Apparatus** at the **Interface Point**.

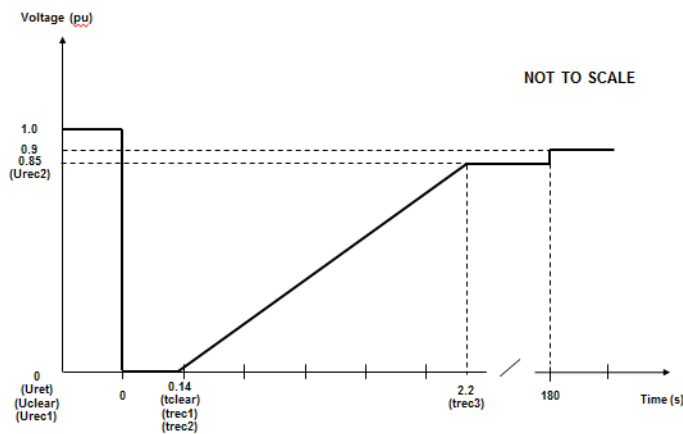

Figure ECC.6.3.15.6 - Voltage against time curve applicable to **Type D Power Park Modules** with a **Grid Entry Point** or **User System Entry Point** at or above 110kV, **DC Connected Power Park Modules** at the **HVDC Interface Point** or **OTSDUW Plant and Apparatus** at the **Interface Point**.

Voltage parameters (pu)		Time parameters (seconds)	
Uret	0	tclear	0.14
Uclear	0	trec1	0.14
Urec1	0	trec2	0.14
Urec2	0.85	trec3	2.2

Table ECC.6.3.15.6 Voltage against time parameters applicable to a **Type D Power Park Modules** with a **Grid Entry Point** or **User System Entry Point** at or above 110kV, **DC Connected Power Park Modules** at the **HVDC Interface Point** or **OTSDUW Plant and Apparatus** at the **Interface Point**.

ECC.6.3.15.7 Voltage against time curve and parameters applicable to **HVDC Systems** and **Remote End HVDC Converter Stations**

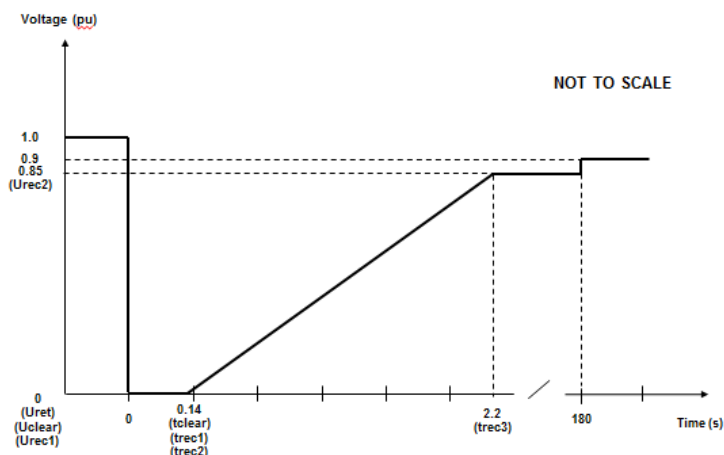

Figure ECC.6.3.15.7 - Voltage against time curve applicable to **HVDC Systems** and **Remote End HVDC Converter Stations**

Voltage parameters (pu)		Time parameters (seconds)	
Uret	0	tclear	0.14
Uclear	0	trec1	0.14
Urec1	0	trec2	0.14
Urec2	0.85	trec3	2.2

Table ECC.6.3.15.7 Voltage against time parameters applicable to **HVDC Systems** and **Remote End HVDC Converter Stations**

ECC.6.3.15.8 In addition to the requirements in ECC.6.3.15.1 – ECC.6.3.15.7:

- (i) Each **Type B, Type C** and **Type D Power Generating Module** at the **Grid Entry Point** or **User System Entry Point**, **HVDC Equipment** (or **OTSDUW Plant and Apparatus** at the **Interface Point**) shall be capable of satisfying the above requirements when operating at **Rated MW** output and maximum leading **Power Factor**.
- (ii) **NGET** will specify upon request by the **User** the pre-fault and post fault short circuit capacity (in **MVA**) at the **Grid Entry Point** or **User System Entry Point** (or **HVDC Interface Point** in the case of a remote end **HVDC Converter Stations** or **Interface Point** in the case of **OTSDUW Plant and Apparatus**).
- (iii) The pre-fault voltage shall be taken to be 1.0pu and the post fault voltage shall not be less than 0.9pu.
- (iv) To allow a **User** to model the **Fault Ride Through** performance of its **Type B, Type C** and/or **Type D Power Generating Modules** or **HVDC Equipment**, **NGET** will provide additional network data as may reasonably be required by the **EU Code User** to undertake such study work in accordance with PC.A.8. **Alternatively, NGET may provide generic values derived from typical cases.**
- (v) **NGET** will publish fault level data under maximum and minimum demand conditions in the **Electricity Ten Year Statement**.

Formatted: Font: Bold

**Comment [A17]:** TBC that this can be done - Note as of 19/10/2017 - Under the ten year statement we only publically provide the maximum fault level values not minimum. This requires further National Grid discussion

(vi) Each **EU Generator** (in respect of **Type B, Type C, Type D Power Generating Modules** and **DC Connected Power Park Modules**) and **HVDC System Owners** (in respect of **HVDC Systems**) shall satisfy the requirements in **ECC.6.3.15.8(i) – (vii) unless the protection schemes and settings for internal electrical faults trips the Type B, Type C and Type D Power Generating Module, HVDC Equipment** (or **OTSDUW Plant and Apparatus**) from the **System**. The protection schemes and settings should not jeopardise **Fault Ride Through** performance as specified in **ECC.6.3.15.8(i) – (vii)**. The undervoltage protection at the **Grid Entry Point** or **User System Entry Point** (or **HVDC Interface Point** in the case of a **Remote End HVDC Converter Stations** or **Interface Point** in the case of **OTSDUW Plant and Apparatus**) shall be set by the **EU Generator** (or **HVDC System Owner** or **OTSDUW Plant and Apparatus**) according to the widest possible range unless **NGET** and the **EU Code User** have agreed to narrower settings. All protection settings associated with undervoltage protection shall be agreed between the **EU Generator** and/or **HVDC System Owner** with **NGET** and **Relevant Transmission Licensee’s** and relevant **Network Operator** (as applicable).

Formatted: Font: Bold

Formatted: Not Highlight

Formatted: Font: Not Bold

Formatted: Not Highlight

Formatted: Font: Bold

Formatted: Font: Bold

(vii) Each **Type B, Type C and Type D Power Generating Module, HVDC System and OTSDUW Plant and Apparatus** at the **Interface Point** shall be designed such that upon clearance of the fault on the **Onshore Transmission System** and within 0.5 seconds of restoration of the voltage at the **Grid Entry Point** or **User System Entry Point** or **HVDC Interface Point** in the case of a **Remote End HVDC Converter Stations** or **Interface Point** in the case of **OTSDUW Plant and Apparatus** to 90% of nominal voltage or greater, **Active Power** output (or **Active Power** transfer capability in the case of **OTSDUW Plant and Apparatus** or **Remote End HVDC Converter Stations**) shall be restored to at least 90% of the level immediately before the fault. Once **Active Power** output (or **Active Power** transfer capability in the case of **OTSDUW Plant and Apparatus** or **Remote End HVDC Converter Stations**) has been restored to the required level, **Active Power** oscillations shall be acceptable provided that:

- The total **Active Energy** delivered during the period of the oscillations is at least that which would have been delivered if the **Active Power** was constant
- The oscillations are adequately damped.
- In the event of power oscillations, **Power Generating Modules** shall retain steady state stability when operating at any point on the **Power Generating Module Performance Chart**.

Formatted: Font color: Red

Formatted: Font: Bold

Formatted: Font: Bold

For AC Connected **Onshore** and **Offshore Power Park Modules** comprising switched reactive compensation equipment (such as mechanically switched capacitors and reactors), such switched reactive compensation equipment shall be controlled such that it is not switched in or out of service during the fault but may act to assist in post fault voltage recovery.

ECC.6.3.15.9 General **Fault Ride Through** requirements for faults in excess of 140ms in duration.

Formatted: Font: Not Bold

ECC.6.3.15.9.1 General **Fault Ride Through** requirements applicable to **HVDC Equipment** and **OTSDUW DC Converters** subject to faults and voltage dips in excess of 140ms.

Formatted: Font: Not Bold

Formatted: Font: Not Bold

ECC.6.3.15.9.1.1 The requirements applicable to **HVDC Equipment** including **OTSDUW DC Converters** subject to faults and voltage disturbances at the **Grid Entry Point** or **User System Entry Point** or **Interface Point** or **HVDC Interface Point**, including **Active Power** transfer capability shall be specified in the **Bilateral Agreement**.

Formatted: Font: Not Bold

ECC.6.3.15.9.2 Fault Ride Through requirements for Type C and Type D Synchronous Power Generating Modules and Type C and Type D Power Park Modules and OTSDUW Plant and Apparatus subject to faults and voltage disturbances on the Onshore Transmission System in excess of 140ms

ECC.6.3.15.9.2.1 The **Fault Ride Through** requirements for **Type C** and **Type D Synchronous Power Generating Modules** subject to faults and voltage disturbances on the Onshore Transmission System in excess of 140ms are defined in ECC.6.3.15.9.2.1(a) and the **Fault Ride Through Requirements for Power Park Modules and OTSDUW Plant and Apparatus** subject to faults and voltage disturbances on the Onshore Transmission System greater than 140ms in duration are defined in ECC.6.3.15.9.2.1(b).

- (a) Requirements applicable to **Synchronous Power Generating Modules** subject to **Supergrid Voltage** dips on the **Onshore Transmission System** greater than 140ms in duration.

In addition to the requirements of ECC.6.3.15.1 – ECC.6.3.15.8 each **Synchronous Power Generating Module** shall:

- (i) remain transiently stable and connected to the **System** without tripping of any **Synchronous Power Generating Module** for balanced **Supergrid Voltage** dips and associated durations on the **Onshore Transmission System** (which could be at the **Interface Point**) anywhere on or above the heavy black line shown in Figure ECC.6.3.15.9(a) Appendix E4 and Figures EA.4.3.2—(a), (b) and (c) provide an explanation and illustrations of Figure ECC.6.3.15.9(a); and,

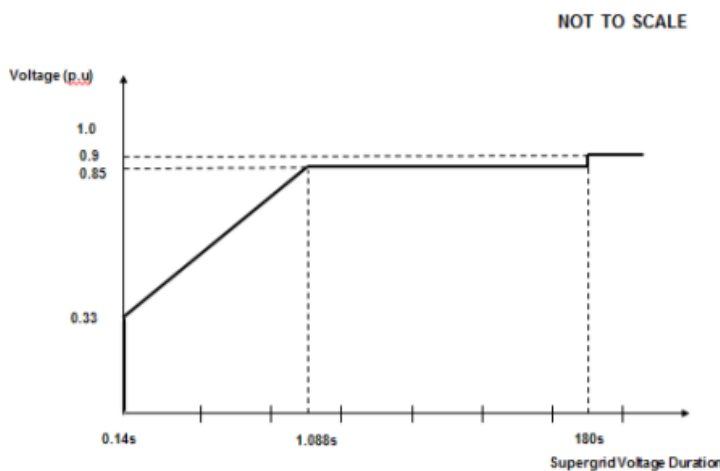

Figure ECC.6.3.15.9(a)

- (ii) provide **Active Power** output at the **Grid Entry Point**, during **Supergrid Voltage** dips on the **Onshore Transmission System** as described in Figure ECC.6.3.15.9(a), at least in proportion to the retained balanced voltage at the **Onshore Grid Entry Point** (for **Onshore Synchronous Power Generating Modules**) or **Interface Point** (for **Offshore Synchronous Power Generating Modules**) (or the retained balanced voltage at the **User System Entry Point** if **Embedded**) and shall generate maximum reactive current (where the voltage at the **Grid Entry Point** is outside the limits specified in ECC.6.1.4) without exceeding the transient rating limits of the **Synchronous Power Generating Module** and,

Formatted: Font: Not Bold  
 Formatted: Font: Not Bold  
 Formatted: Font: Not Bold  
 Formatted: Font: Not Bold  
 Formatted: Font: Not Bold  
 Formatted: Font: Not Bold  
 Formatted: Font: Not Bold, Underline  
 Formatted: Font: Not Bold

Formatted: Not Highlight  
 Formatted: Not Highlight  
 Formatted: Not Highlight

- (iii) restore **Active Power** output following **Supergrid Voltage** dips on the **Onshore Transmission System** as described in Figure ECC.6.3.15.9(a), within 1 second of restoration of the voltage to 1.0pu of the nominal voltage at the:

**Onshore Grid Entry Point** for directly connected **Onshore Synchronous Power Generating Modules** or,

**Interface Point** for **Offshore Synchronous Power Generating Modules**  
or,

**User System Entry Point** for **Embedded Onshore Synchronous Power Generating Modules**

or,

**User System Entry Point** for **Embedded Medium Power Stations** not subject to a **Bilateral Agreement** which comprise **Synchronous Generating Units** and with an **Onshore User System Entry Point** (irrespective of whether they are located **Onshore** or **Offshore**)

to at least 90% of the level available immediately before the occurrence of the dip. Once the **Active Power** output has been restored to the required level, **Active Power** oscillations shall be acceptable provided that:

- the total **Active Energy** delivered during the period of the oscillations is at least that which would have been delivered if the **Active Power** was constant
- the oscillations are adequately damped.

For the avoidance of doubt a balanced **Onshore Transmission System Supergrid Voltage** meets the requirements of ECC.6.1.5 (b) and ECC.6.1.6.

- (b) Requirements applicable to **Type C** and **Type D Power Park Modules** and **OTSDUW Plant and Apparatus** (excluding **OTSDUW DC Converters**) subject to **Supergrid Voltage** dips on the **Onshore Transmission System** greater than 140ms in duration.

In addition to the requirements of ECC.6.3.15.5, ECC.6.3.15.6 and ECC.6.3.15.8 (as applicable) each **OTSDUW Plant and Apparatus** or each **Power Park Module** and / or any constituent **Power Park Unit**, shall:

- (i) remain transiently stable and connected to the **System** without tripping of any **OTSDUW Plant and Apparatus**, or **Power Park Module** and / or any constituent **Power Park Unit**, for balanced **Supergrid Voltage** dips and associated durations on the **Onshore Transmission System** (which could be at the **Interface Point**) anywhere on or above the heavy black line shown in Figure ECC.6.3.15.9(b)-Appendix E4 and Figures EA.4.3.4 (a), (b) and (c) provide an explanation and illustrations of Figure ECC.6.3.15.9(b) ; and,

Formatted: Not Highlight

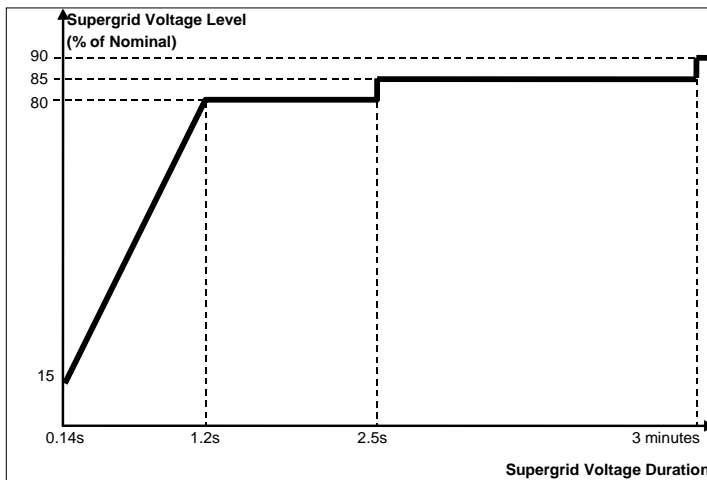

Figure ECC.6.3.15.9(b)

- (ii) provide **Active Power** output at the **Grid Entry Point** or in the case of an **OTSDUW, Active Power** transfer capability at the **Transmission Interface Point**, during **Supergrid Voltage** dips on the **Onshore Transmission System** as described in Figure ECC.6.3.15.9(b), at least in proportion to the retained balanced voltage at the **Onshore Grid Entry Point** (for **Onshore Power Park Modules**) or **Interface Point** (for **OTSDUW Plant and Apparatus** and **Offshore Power Park Modules**) (or the retained balanced voltage at the **User System Entry Point** if **Embedded**) except in the case of a **Non-Synchronous Generating Unit** or **OTSDUW Plant and Apparatus** or **Power Park Module** where there has been a reduction in the **Intermittent Power Source** or in the case of **OTSDUW Active Power** transfer capability in the time range in Figure ECC.6.3.15.9(b) that restricts the **Active Power** output or in the case of an **OTSDUW Active Power** transfer capability below this level.
- (iii) restore **Active Power** output (or, in the case of **OTSDUW, Active Power** transfer capability), following **Supergrid Voltage** dips on the **Onshore Transmission System** as described in Figure ECC.6.3.15.9(b), within 1 second of restoration of the voltage at the:

**Onshore Grid Entry Point** for directly connected **Onshore Power Park Modules** or,

**Interface Point** for **OTSDUW Plant and Apparatus** and **Offshore Power Park Modules** or,

**User System Entry Point** for **Embedded Onshore Power Park Modules** or ,

**User System Entry Point** for **Embedded Medium Power Stations** which comprise **Power Park Modules** not subject to a **Bilateral Agreement** and with an **Onshore User System Entry Point** (irrespective of whether they are located **Onshore** or **Offshore**)

Formatted: Justified

to the minimum levels specified in ECC.6.1.4 to at least 90% of the level available immediately before the occurrence of the dip except in the case of a **Non-Synchronous Generating Unit, OTSDUW Plant and Apparatus** or **Power Park Module** where there has been a reduction in the **Intermittent Power Source** in

the time range in Figure ECC.6.3.15.9(b) that restricts the **Active Power** output or, in the case of **OTSDUW, Active Power** transfer capability below this level. Once the **Active Power** output or, in the case of **OTSDUW, Active Power** transfer capability has been restored to the required level, **Active Power** oscillations shall be acceptable provided that:

- the total **Active Energy** delivered during the period of the oscillations is at least that which would have been delivered if the **Active Power** was constant
- the oscillations are adequately damped.

For the avoidance of doubt a balanced **Onshore Transmission System Supergrid Voltage** meets the requirements of ECC.6.1.5 (b) and ECC.6.1.6.

#### ECC.6.3.15.10 Other Fault Ride Through Requirements

- (i) In the case of a **Power Park Module**, the requirements in ECC.6.3.15.9 do not apply when the **Power Park Module** is operating at less than 5% of its **Rated MW** or during very high primary energy source conditions when more than 50% of the **Power Park Units** in a **Power Park Module** have been shut down or disconnected under an emergency shutdown sequence to protect **User's Plant** and **Apparatus**.
- (ii) In addition to meeting the conditions specified in ECC.6.1.5(b) and ECC.6.1.6, each **Non-Synchronous Generating Unit, OTSDUW Plant and Apparatus** or **Power Park Module** and any constituent **Power Park Unit** thereof will be required to withstand, without tripping, the negative phase sequence loading incurred by clearance of a close-up phase-to-phase fault, by **System Back-Up Protection** on the **Onshore Transmission System** operating at **Supergrid Voltage**.
- (iii) **Generators** in respect of **Type B, Type C** and **Type D Power Park Modules** and **HVDC System Owners** are required to confirm to **NGET**, their repeated ability to operate through balanced and unbalanced faults and **System** disturbances each time the voltage at the **Grid Entry Point** or **User System Entry Point** falls outside the limits specified in ECC.6.1.4. Demonstration of this capability would be satisfied by **EU Generators** and **HVDC System Equipment Owners** supplying the protection settings of their plant, informing **NGET** of the maximum number of repeated operations that can be performed under such conditions and any limiting factors to repeated operation such as protection or thermal rating; and
- (iv) Notwithstanding the requirements of ECC.6.3.15(v), **Power Generating Modules** shall be capable of remaining connected during single phase or three phase auto-reclosures to the **National Electricity Transmission System** and operating without power reduction as long as the voltage and frequency remain within the limits defined in ECC.6.1.4 and ECC.6.1.2; and
- (v) For the avoidance of doubt the requirements specified in ECC.6.3.15 do not apply to **Power Generating Modules** connected to either an unhealthy circuit and or islanded from the **Transmission System** even for delayed auto reclosure times.
- (vi) To avoid unwanted island operation, **Non-Synchronous Generating Units** in Scotland (and those directly connected to a **Scottish Offshore Transmission System**), **Power Park Modules** in Scotland (and those directly connected to a **Scottish Offshore Transmission System**), or **OTSDUW Plant and Apparatus** with an **Interface Point** in Scotland shall be tripped for the following conditions:
  - (1) **Frequency above 52Hz for more than 2 seconds**
  - (2) **Frequency below 47Hz for more than 2 seconds**
  - (3) **Voltage as measured at the **Onshore Connection Point** or **Onshore User System Entry Point** or **Offshore Grid Entry Point** or **Interface Point** in the**

Formatted: Font: Bold

Formatted: Font: Bold

Formatted: Highlight

Formatted: Indent: Left: 2.51 cm, Hanging: 0.74 cm

Formatted: Indent: Left: 3.78 cm, No bullets or numbering

Formatted: Indent: Left: 3.78 cm, Hanging: 0.22 cm, No bullets or numbering

case of **OTSDUW Plant and Apparatus** is below 80% for more than 2.5 seconds

Voltage as measured at the **Onshore Connection Point or Onshore User System Entry Point or Offshore Grid Entry Point or Interface Point** in the case of **OTSDUW Plant and Apparatus** is above 120% (115% for 275kV) for more than 1 second. The times in sections (1) and (2) are maximum trip times. Shorter times may be used to protect the **Non-Synchronous Generating Units, or OTSDUW Plant and Apparatus.**

Formatted: Level 3 Text, No bullets or numbering

ECC.6.3.15.11 HVDC System Robustness

ECC.6.3.15.11.1 The **HVDC System** shall be capable of finding stable operation points with a minimum change in **Active Power** flow and voltage level, during and after any planned or unplanned change in the **HVDC System** or **AC System** to which it is connected. **NGET** shall specify the changes in the System conditions for which the **HVDC Systems** shall remain in stable operation.

ECC.6.3.15.11.2 The **HVDC System** owner shall ensure that the tripping or disconnection of an **HVDC Converter Station**, as part of any multi-terminal or embedded **HVDC System**, does not result in transients at the **Grid Entry Point** or **User System Entry Point** beyond the limit specified by **NGET** in co-ordination with the **Relevant Transmission Licensee**.

ECC.6.3.15.11.3 The **HVDC System** shall withstand transient faults on HVAC lines in the network adjacent or close to the **HVDC System**, and shall not cause any of the equipment in the **HVDC System** to disconnect from the network due to autoreclosure of lines in the **System-network**.

ECC.6.3.15.11.4 The **HVDC System Owner** shall provide information to **NGET** on the resilience of the **HVDC System** to **AC System** disturbances.

ECC.6.3.16 FAST FAULT CURRENT INJECTION

Formatted: Font: Not Bold

ECC.6.3.16.1 General Fast Fault Current injection, principles and concepts applicable to Type B, Type C and Type D Power Park Modules and HVDC Equipment

Formatted: Font: Not Bold

Formatted: Font: Not Bold

Formatted: Font: Not Bold

ECC.6.3.16.1.1 Each **Type B, Type C** and **Type D Power Park Module** or **HVDC Equipment** shall be required to satisfy the following requirements.

Formatted: Font: Not Bold

Formatted: Font: Not Bold

Formatted: Font: Not Bold



ECC.6.3.16.1.2 For any balanced or unbalanced fault which results in the ~~positive phase sequence rms voltage on one or more phases~~ voltage on one or more phases falling outside the limits specified in ECC.6.1.2 to zero at the **Grid Entry Point** or **User System Entry Point**, each **Type B, Type C and Type D Power Park Module** or **HVDC Equipment** shall, unless otherwise agreed with NGET, be required to inject a reactive current above the shaded ~~red~~ area shown in Figure ECC.16.3.16(a) and Figure 16.3.16(b). For the purposes of this requirement, the maximum rated current is taken to be the maximum current each Power Park Module (or constituent each Power Park Unit) or HVDC Converter is capable of can-supplying when operating at rated **Active Power** and rated zero **Reactive Power** (as required under ECC.6.3.2) at a nominal voltage of 1.0pu. For example, in the case of a 100MW Power Park Module the Rated Active Power would be taken as 100MW and the rated Reactive Power would be taken as 32.8MVARs (ie Rated MW output operating at 0.95 Power Factor lead or 0.95 Power Factor lag as required under ECC.6.3.2.4). For the avoidance of doubt, where the phase voltage at the Grid Entry Point or User System Entry Point is not zero, the reactive current injected shall be in proportion to the retained voltage at the Grid Entry Point or User System Entry Point but shall still be required to remain above the shaded area in Figure 16.3.16(a) and Figure 16.3.16(b). (In other words unity Power Factor).

Formatted: Font: Not Bold

Formatted: Font: Not Bold

Formatted: Font: Not Bold

Formatted: Font: Calibri, 11 pt

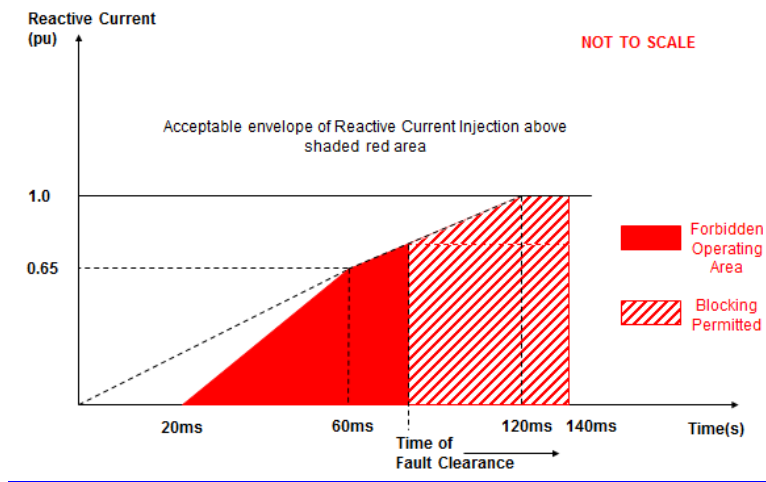

Figure ECC.16.3.16(a)

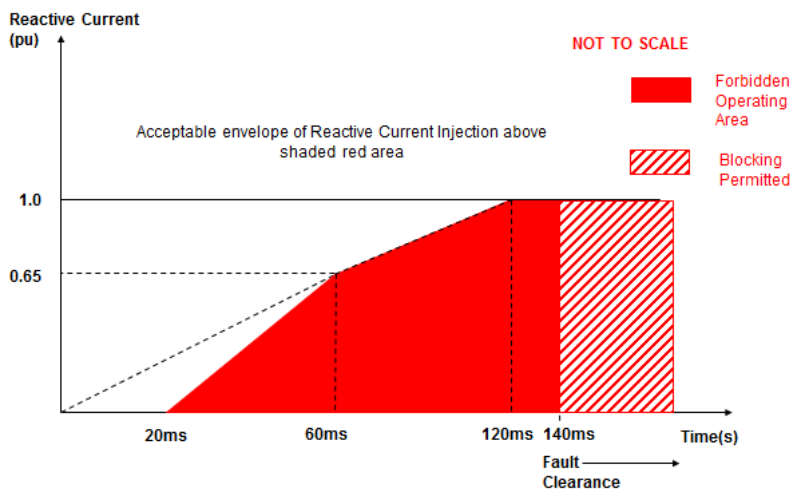

Figure ECC.16.3.16(b)

ECC.6.3.16.1.3 The converter(s) of each **Type B, Type C and Type D Power Park Module or HVDC Equipment** is permitted to block upon fault clearance in order to mitigate against the risk of instability that would otherwise occur due to transient overvoltage excursions. Figure ECC.16.3.16(a) and Figure ECC.16.3.16(b) shows the impact of variations in fault clearance time which shall be no greater than 140ms. The requirements for the maximum transient overvoltage withstand capability and associated time duration, shall be agreed between the **EU Code User** and **NGET** as part of the **Bilateral Agreement**. Where the **EU Code User** is able to demonstrate to **NGET** that blocking is required in order to prevent the risk of transient over voltage excursions as specified in ECC.6.3.16.1.5, **EU Generators and HVDC System Owners** are required to both advise and agree with **NGET** of the control strategy, which must also include the approach taken to de-blocking. Notwithstanding this requirement, **EU Generators and HVDC System Owners** should be aware of their requirement to fully satisfy the fault ride through requirements specified in ECC.6.3.15.

Formatted: Font: Bold

Formatted: Font: Bold

Formatted: Not Highlight

Formatted: Font: Bold

Formatted: Font: Bold

ECC.6.3.16.1.4 In addition, the reactive current injected from each **Power Park Module or HVDC Equipment** shall be injected in proportion and remain in phase to the change in **System** voltage at the **Connection Point or User System Entry Point** during the period of the fault. For the avoidance of doubt, a small delay time of no greater than 20ms from the point of fault inception is permitted before injection of the in phase reactive current. ~~For voltage depressions of 0.65p.u or below, reactive current injection shall take priority over active current injection up to a maximum of 1.0p.u. of the rating of the Power Park Module or HVDC Converter Equipment.~~

ECC.6.3.16.1.5 Each **Type B, Type C and Type D Power Park Module or HVDC Equipment** shall be designed to reduce the risk of transient over voltage levels arising following clearance of the fault. **EU Generators or HVDC System Owners** shall be permitted to block where the anticipated transient overvoltage would otherwise exceed the maximum permitted values specified in ECC.6.1.7. Any additional requirements relating to transient overvoltage performance will be specified by **NGET**.

Formatted: Font: Bold

ECC.6.3.16.1.6 In addition to the requirements of ECC.6.3.15, **Generators** in respect of **Type B, Type C and Type D Power Park Modules** and **HVDC System Owners** are required to confirm to **NGET**, their repeated ability to supply **Fast Fault Current** to the **System** each time the voltage at the **Grid Entry Point** or **User System Entry Point** falls outside the limits specified in ECC.6.1.4. **EU Generators** and **HVDC Equipment Owners** should inform **NGET** of the maximum number of repeated operations that can be performed under such conditions and any limiting factors to repeated operation such as protection or thermal rating; and

Formatted: Font: Bold

ECC.6.3.16.1.7 In the case of a **Power Park Module** or **DC Connected Power Park Module**, where it is not practical to demonstrate the compliance requirements of ECC.6.3.16.1.1 to ECC.6.3.16.1.6 at the **Grid Entry Point** or **User System Entry Point**, **NGET** will accept compliance of the above requirements at the **Power Park Unit** terminals.

ECC.6.3.16.1.8 An illustration and examples of the performance requirements expected are illustrated in Appendix 4EC.

ECC.6.3.17 **SUBSYNCHRONOUS TORSIONAL INTERACTION DAMPING CAPABILITY, POWER OSCILLATION DAMPING CAPABILITY AND CONTROL FACILITIES FOR HVDC SYSTEMS**

ECC.6.3.17.1 **Subsynchronous Torsional Interaction Damping Capability**

ECC.6.3.17.1.1 ~~Notwithstanding the requirements of ECC.6.1.9 and ECC.6.1.10,~~ **HVDC System Owners, or Generators** in respect of **OTSDUW DC Converters** or **Network Operators** in the case of an **Embedded HVDC Systems** not subject to a **Bilateral Agreement** must ensure that any of their **Onshore HVDC Systems** or **OTSDUW DC Converters** will not cause a sub-synchronous resonance problem on the **Total System**. Each **HVDC System** or **OTSDUW DC Converter** is required to be provided with sub-synchronous resonance damping control facilities. **HVDC System Owners** and **EU Generators** in respect of **OTSDUW DC Converters** should also be aware of the requirements in **ECC.6.1.9 and ECC.6.1.10**.

Formatted: Not Highlight

Formatted: Not Highlight

Formatted: Font: Bold

Formatted: Not Highlight

Formatted: Not Highlight

ECC.6.3.17.1.2 Where specified in the **Bilateral Agreement**, each **OTSDUW DC Converter** is required to be provided with power oscillation damping or any other identified additional control facilities.

ECC.6.3.17.1.3 Each **HVDC System** shall be capable of contributing to the damping of power oscillations on the **National Electricity Transmission System**. ~~in connected AC networks~~. The control system of the **HVDC System** shall not reduce the damping of power oscillations. **NGET** in coordination with the **Relevant Transmission Licensee** ~~(as applicable)~~ shall specify a frequency range of oscillations that the control scheme shall positively damp and the **System**— conditions when this occurs, at least accounting for any dynamic stability assessment studies undertaken by **NGET** ~~in coordination with~~ the **Relevant Transmission Licensee** or **NGET** ~~(as applicable)~~ to identify the stability limits and potential stability problems on the **National Electricity Transmission System**. The selection of the control parameter settings shall be agreed ~~between~~ **NGET** in coordination with the **Relevant Transmission Licensee** and the **HVDC System Owner**.

Formatted: Not Highlight

Formatted: Font: Bold

Formatted: Font: Bold

ECC.6.3.17.1.4 **NGET** shall specify the necessary extent of SSTI studies and provide input parameters, to the extent available, related to the equipment and relevant system **conditions on the National Electricity Transmission System in its network**. The SSTI studies shall be provided by the **HVDC System Owner**. The studies shall identify the conditions, if any, where SSTI exists and propose any necessary mitigation procedure. ~~Member States may provide that~~ The responsibility for undertaking the studies in accordance with these requirements is ~~Article~~ lies with **the Relevant Transmission Licensee in co-ordination with NGET, the TSO**. All parties shall be informed of the results of the studies.

Formatted: Highlight

Formatted: Font: Bold, Highlight

Formatted: Highlight

Formatted: Not Highlight

Formatted: Highlight

Formatted: Font: Bold, Highlight

Formatted: Highlight

Formatted: Font: Bold, Highlight

Formatted: Highlight

Formatted: Not Highlight

ECC.6.3.17.1.5 All parties identified by NGET as relevant to each Grid Entry Point or User System Entry Point (if Embedded), including the Relevant TSO Transmission Licensee, shall contribute to the studies and shall provide all relevant data and models as reasonably required to meet the purposes of the studies. NGET The relevant TSO shall collect this data input and, where applicable, pass it on to the party responsible for the studies in accordance with Article 10 of European Regulation 2016/1447. Specific information relating to the interface schedules, input/output requirements, timing and submission of any studies or data would be agreed between the User and NGET and specified (where applicable) in the Bilateral Agreement.

Formatted: Font: Bold

Formatted: Font: Bold

ECC.6.3.17.1.6 The NGET in coordination with the Relevant Transmission Licensee TSO shall assess the result of the SSTI studies. If necessary for the assessment, NGET in coordination with the Relevant Transmission Licensee TSO may request that the HVDC System Owner perform further SSTI studies in line with this same scope and extent.

ECC.6.3.17.1.7 The NGET in coordination with the Relevant Transmission Licensee SO may review or replicate the study. The HVDC System Owner shall provide NGET the relevant TSO with all relevant data and models that allow such studies to be performed. Submission of this data to Relevant Transmission Licensee's shall be in accordance with the requirements of Article 10 of European Regulation 2016/1447 XXX.

Formatted: Font: Bold

Formatted: Not Highlight

ECC.6.3.17.1.8 Any necessary mitigating actions identified by the studies carried out in accordance with paragraphs ECC.6.3.17.1.4 or ECC.6.3.17.1.6, and reviewed by NGET in coordination with the Relevant Transmission Licensees TSOs, shall be undertaken by the HVDC System Owner as part of the connection of the new HVDC Converter Station.

Formatted: Not Highlight

Formatted: Not Highlight

ECC.6.3.17.1.9 As part of the studies and data flow in respect of ECC.6.3.17.1 – ECC.6.3.17.8 the following data exchange would take place with the time scales being pursuant to the terms of the Bilateral Agreement.

Information supplied by NGET and Relevant Transmission Licensees

Studies provided by the User

User review

NGET review

Changes to studies and agreed updates between NGET, the Relevant Transmission Licensee and User

Final review

ECC.6.3.17.2 Interaction between HVDC Systems or other User's Plant and Apparatus equipment

Formatted: Font: Bold

ECC.6.3.17.2.1 Notwithstanding the requirements of ECC.6.1.9 and ECC.6.1.10, when several HVDC Converter Stations or other plants and User's Plant and Apparatus equipment are within close electrical proximity, NGET the relevant TSO may specify that a study is required, and the scope and extent of that study, to demonstrate that no adverse interaction will occur. If adverse interaction is identified, the studies shall identify possible mitigating actions to be implemented to ensure compliance with the requirements of ECC.6.1.9 the Grid Code this Regulation.

Formatted: Font: Bold

Formatted: Font: Bold

Formatted: Font: Bold

Formatted: Font: Bold

Formatted: Font: Bold

ECC.6.3.17.2.2 The studies shall be carried out by the connecting HVDC System Owner with the participation of all other parties User's identified by NGET in coordination with Relevant Transmission Licensees and Network Operators the TSOs as relevant to each Connection Point.

Formatted: Font: Bold

ECC.6.3.17.2.3 All ~~User's parties~~ identified by ~~NGET~~ the relevant TSO as relevant to each the cConnection Point, and where applicable including the Relevant Transmission Licensee's and Network Operators TSO, shall contribute to the studies and shall provide all relevant data and models as reasonably required to meet the purposes of the studies. ~~NGET~~ The relevant TSO shall collect this input and, where applicable, pass it on to the party responsible for the studies in accordance with Article 10 of European U Regulation 2016/1447. Specific information relating to the interface schedules, input/output requirements, timing and submission of any studies or data would be agreed between the User and ~~NGET~~ and specified (where applicable) in the **Bilateral Agreement**.

Formatted: Font: Bold

Formatted: Font: Not Bold

Formatted: Not Highlight

Formatted: Font: Bold

Formatted: Not Highlight

ECC.6.3.17.2.4 ~~NGET~~ in coordination with **Relevant Transmission Licensees** ~~The relevant TSO~~ shall assess the result of the studies based on their scope and extent as specified in accordance with ~~ECC.6.3.17.2.1 paragraph 1~~. If necessary for the assessment, ~~NGET~~ in coordination with the **Relevant Transmission Licensee** ~~SO~~ may request the **HVDC System Owner** to perform further studies in line with the scope and extent specified in accordance with ~~ECC.6.3.17.2.1 paragraph 1~~.

Formatted: Not Highlight

Formatted: Not Highlight

ECC.6.3.17.2.5 ~~NGET~~ in coordination with the **Relevant Transmission Licensee** ~~The relevant TSO~~ may review or replicate some or all of the studies. The **HVDC System Owner** shall provide ~~NGET~~ the relevant TSO all relevant data and models that allow such studies to be performed.

ECC.6.3.17.2.6 ~~Any necessary~~ The EU Code User and NGET, in coordination with the Relevant Transmission Licensee, shall agree any mitigating actions identified by the studies carried out following the site specific requirements and works, including any transmission reinforcement works and / or User works required to ensure that all sub-synchronous oscillations are sufficiently damped, in accordance with ~~ECC.6.3.17.2.2 to ECC.6.3.17.2.5 paragraphs 2 to 5~~ and reviewed by ~~NGET~~ in coordination with the **Relevant Transmission Licensee** the relevant TSO shall be undertaken by the **HVDC System Owner** as part of the connection of the new **HVDC Converter Station**.

Formatted: Font: Bold

Formatted: Font: Bold

Formatted: Font: Bold

Formatted: Font: Not Bold

Formatted: Font: Bold

Formatted: Not Highlight

Formatted: Not Highlight

ECC.6.3.17.2.7 ~~NGET~~ The relevant TSO may specify transient levels of performance associated with events for the individual **HVDC System** or collectively across commonly impacted **HVDC Systems**. This specification may be provided to protect the integrity of both the **National Electricity Transmission System** TSO equipment and that of grid **Users** in a manner consistent with its national the Grid Code.

**Comment [A18]:** Under the current HVDC Interconnector reference is made to the RES (TS.3.24.90\_RES). It is suggested that the new text remains in the Grid Code as is and the existing text in the Bilateral Agreement which refers to the RES retained.

ECC.6.1.17.3 Fast Recovery from DC faults

ECC.6.1.17.3.1 **HVDC Systems**, including DC overhead lines, shall be capable of fast recovery from transient faults within the **HVDC System**. Details of this capability shall be subject to the **Bilateral Agreement** ~~coordination and agreements on~~ and the protection requirements specified in ECC.6.2.2 ~~schemes and settings pursuant to Article 34~~.

ECC.6.1.17.4 Maximum loss of Active Power

ECC.6.1.14.4.1 An **HVDC System** shall be configured in such a way that its loss of **Active Power** injection in the **GB Synchronous Area** shall be in accordance with the requirements of the **SQSS**, ~~the~~

ECC.6.3.18 SYSTEM TO GENERATOR OPERATIONAL INTERTRIPPING SCHEMES

ECC.6.3.18.1 ~~NGET~~ may require that a **System to Generator Operational Intertripping Scheme** be installed as part of a condition of the connection of the **EU Generator**. Scheme specific details shall be included in the relevant **Bilateral Agreement** and shall, include the following information:

Formatted: Font: Bold

- (1) the relevant category(ies) of the scheme (referred to as **Category 1 Intertripping Scheme, Category 2 Intertripping Scheme, Category 3 Intertripping Scheme and Category 4 Intertripping Scheme**);
- (2) the ~~Generating Unit(s) or CCGT Module(s) or Power Park Module(s)~~ **Power Generating Module** to be either permanently armed or that can be instructed to be armed in accordance with BC2.8;
- (3) the time within which the ~~Power Generating Module Generating Unit(s) or CCGT Module(s) or Power Park Module(s)~~ **Power Generating Module** circuit breaker(s) are to be automatically tripped;
- (4) the location to which the trip signal will be provided by **NGET**. Such location will be provided by **NGET** prior to the commissioning of the ~~Power Generating Module Generating Unit(s) or CCGT Module(s) or Power Park Module(s)~~ **Power Generating Module**.

Formatted: Font: Bold

Formatted: Font: Bold

Formatted: Font: Bold

Where applicable, the **Bilateral Agreement** shall include the conditions on the **National Electricity Transmission System** during which **NGET** may instruct the **System to Generator Operational Intertripping Scheme** to be armed and the conditions that would initiate a trip signal.

ECC.6.3.18.2 The time within which the **Power Generating Module(s)** circuit breaker(s) need to be automatically tripped is determined by the specific conditions local to the **EU Generator**. This 'time to trip' (defined as the time from provision of the trip signal by **NGET** to the specified location, to circuit breaker main contact opening) can typically range from 100ms to 10sec. A longer time to trip may allow the initiation of an automatic reduction in the **Power Generating Module(s)** output prior to the automatic tripping of the **Power Generating Module(s)** circuit breaker. Where applicable **NGET** may provide separate trip signals to allow for either a longer or shorter 'time to trip' to be initiated.

Formatted: Font: Bold

#### ECC.6.4 General Network Operator And Non-Embedded Customer Requirements

ECC.6.4.1 This part of the **Grid Code** describes the technical and design criteria and performance requirements for **Network Operators** and **Non-Embedded Customers**.

#### Neutral Earthing

- ECC.6.4.2 At nominal **System** voltages of 132kV and above the higher voltage windings of three phase transformers and transformer banks connected to the **National Electricity Transmission System** must be star connected with the star point suitable for connection to earth. The earthing and lower voltage winding arrangement shall be such as to ensure that the **Earth Fault Factor** requirement of paragraph ECC.6.2.1.1 (b) will be met on the **National Electricity Transmission System** at nominal **System** voltages of 132kV and above.

#### Frequency Sensitive Relays

- ECC.6.4.3 As explained under **OC6**, each **Network Operator** and **Non Embedded Customer**, will make arrangements that will facilitate automatic low **Frequency Disconnection of Demand** (based on **Annual ACS Conditions**). ECC.A.5.5. of Appendix 5 includes specifications of the local percentage **Demand** that shall be disconnected at specific frequencies. The manner in which **Demand** subject to low **Frequency** disconnection will be split into discrete MW blocks is specified in OC6.6. Technical requirements relating to **Low Frequency Relays** are also listed in Appendix 5.

#### Operational Metering

- ECC.6.4.4 Where **NGET** can reasonably demonstrate that an **Embedded Medium Power Station** or **Embedded HVDC System-Converter Station** has a significant effect on the **National Electricity Transmission System**, it may require the **Network Operator** within whose **System** the **Embedded Medium Power Station** or **Embedded HVDC System-Converter Station** is situated to ensure that the operational metering equipment described in ECC.6.5.6 is installed such that **NGET** can receive the data referred to in ECC.6.5.6. In the case of an **Embedded Medium Power Station** subject to, or proposed to be subject to a **Bilateral Agreement**, **NGET** shall notify such **Network Operator** of the details of such installation in writing within 3 months of being notified of the application to connect under **CUSC** and in the case of an **Embedded Medium Power Station** not subject to, or not proposed to be subject to a **Bilateral Agreement** in writing as a **Site Specific Requirement** in accordance with the timescales in CUSC 6.5.5. In either case the **Network Operator** shall ensure that the data referred to in ECC.6.5.6 is provided to **NGET**.

Formatted: Font: Not Bold

#### ECC.6.5 Communications Plant

- ECC.6.5.1 In order to ensure control of the **National Electricity Transmission System**, telecommunications between **Users** and **NGET** must (including in respect of any **OTSDUW Plant and Apparatus** at the **OTSUA Transfer Time**), if required by **NGET**, be established in accordance with the requirements set down below.

#### ECC.6.5.2 Control Telephony and System Telephony

- ECC.6.5.2.1 **Control Telephony** is the principle method by which a **User's Responsible Engineer/Operator** and **NGET Control Engineers** speak to one another for the purposes of control of the **Total System** in both normal and emergency operating conditions. **Control Telephony** provides secure point to point telephony for routine **Control Calls**, priority **Control Calls** and emergency **Control Calls**.

- ECC.6.5.2.2 **System Telephony** is an alternate method by which a **User's Responsible Engineer/Operator** and **NGET Control Engineers** speak to one another for the purposes of control of the **Total System** in both normal operating conditions and where practicable, emergency operating conditions. **System Telephony** uses the Public Switched Telephony Network to provide telephony for **Control Calls**, inclusive of emergency **Control Calls**.

- ECC.6.5.2.3 Calls made and received over **Control Telephony** and **System Telephony** may be recorded and subsequently replayed for commercial and operational reasons.
- ECC.6.5.3 Supervisory Tones
- ECC.6.5.3.1 **Control Telephony** supervisory tones indicate to the calling and receiving parties dial, engaged, ringing, secondary engaged (signifying that priority may be exercised) and priority disconnect tones.
- ECC.6.5.3.2 **System Telephony** supervisory tones indicate to the calling and receiving parties dial, engaged and ringing tones.
- ECC.6.5.4 Obligations in respect of Control Telephony and System Telephony
- ECC.6.5.4.1 Where **NGET** requires **Control Telephony**, **Users** are required to use the **Control Telephony** with **NGET** in respect of all **Connection Points** with the **National Electricity Transmission System** and in respect of all **Embedded Large Power Stations** and **Embedded HVDC Systems**. **NGET** will install **Control Telephony** at the **User's Control Point** where the **User's** telephony equipment is not capable of providing the required facilities or is otherwise incompatible with the **Transmission Control Telephony**. Details of and relating to the **Control Telephony** required are contained in the **Bilateral Agreement**.
- ECC.6.5.4.2 Where in **NGET's** sole opinion the installation of **Control Telephony** is not practicable at a **User's Control Point(s)**, **NGET** shall specify in the **Bilateral Agreement** whether **System Telephony** is required. Where **System Telephony** is required by **NGET**, the **User** shall ensure that **System Telephony** is installed.
- ECC.6.5.4.3 Where **System Telephony** is installed, **Users** are required to use the **System Telephony** with **NGET** in respect of those **Control Point(s)** for which it has been installed. Details of and relating to the **System Telephony** required are contained in the **Bilateral Agreement**.
- ECC.6.5.4.4 Where **Control Telephony** or **System Telephony** is installed, routine testing of such facilities may be required by **NGET** (not normally more than once in any calendar month). The **User** and **NGET** shall use reasonable endeavours to agree a test programme and where **NGET** requests the assistance of the **User** in performing the agreed test programme the **User** shall provide such assistance.
- ECC.6.5.4.5 **Control Telephony** and **System Telephony** shall only be used for the purposes of operational voice communication between **NGET** and the relevant **User**.
- ECC.6.5.4.6 **Control Telephony** contains emergency calling functionality to be used for urgent operational communication only. Such functionality enables **NGET** and **Users** to utilise a priority call in the event of an emergency. **NGET** and **Users** shall only use such priority call functionality for urgent operational communications.
- ECC.6.5.5 Technical Requirements for Control Telephony and System Telephony
- ECC.6.5.5.1 Detailed information on the technical interfaces and support requirements for **Control Telephony** applicable in **NGET's Transmission Area** is provided in the **Control Telephony Electrical Standard** identified in the Annex to the **General Conditions**. Where additional information, or information in relation to **Control Telephony** applicable in Scotland, is requested by **Users**, this will be provided, where possible, by **NGET**.



ECC.6.5.5.2 **System Telephony** shall consist of a dedicated Public Switched Telephone Network telephone line that shall be installed and configured by the relevant **User**. **NGET** shall provide a dedicated free phone number (UK only), for the purposes of receiving incoming calls to **NGET**, which **Users** shall utilise for **System Telephony**. **System Telephony** shall only be utilised by the **NGET Control Engineer** and the **User's Responsible Engineer/Operator** for the purposes of operational communications.

ECC.6.5.6 Operational Metering

ECC.6.5.6.1 It is an essential requirement for **NGET** and **Network Operators** to have visibility of the real time output and status of indications of **User's Plant and Apparatus** so they can control the operation of the **System**.

ECC.6.5.6.2 **Type B, Type C and Type D Power Park Modules, HVDC Equipment, Network Operators and Non Embedded Customers** are required to be capable of exchanging operational metering data with **NGET** and **Relevant Transmission Licensees** (as applicable) with time stamping. Time stamping would generally be to a sampling rate of 1 second or better unless otherwise as specified by **NGET** in the **Bilateral Agreement**.

Formatted: Font: Not Bold

ECC.6.5.6.3 **NGET** in coordination with the **Relevant Transmission Licensee** shall specify in the **Bilateral Agreement** the operational metering signals to be provided by the **EU Generator, HVDC System Owner, Network Operator or Non-Embedded Customer**. In the case of **Network Operators** and **Non-Embedded Customers** detailed specifications relating to the operational metering standards and the data required are published as **Electrical Standards** in the Annex to the **General Conditions**.

Formatted: Font: Bold

Formatted: Not Highlight

Comment [A19]: We need to add this in as an additional electrical standard.

ECC.6.5.6.4 (a) **NGET** shall provide system control and data acquisition (SCADA) outstation interface equipment. ~~In addition to the requirements of ECC.6.5.6.5, each **New User EU Code User**~~ shall provide such voltage, current, **Frequency, Active Power and Reactive Power** measurement outputs and plant status indications and alarms to the **Transmission SCADA** outstation interface equipment as required by **NGET** in accordance with the terms of the **Bilateral Agreement**. In the case of **OTSDUW**, the **User** shall provide such SCADA outstation interface equipment and voltage, current, **Frequency, Active Power and Reactive Power** measurement outputs and plant status indications and alarms to the SCADA outstation interface equipment as required by **NGET** in accordance with the terms of the **Bilateral Agreement**.

Formatted: Not Highlight

Formatted: Not Highlight

(b) For the avoidance of doubt, for **Active Power** and **Reactive Power** measurements, circuit breaker and disconnector status indications from:

(i) **CCGT Modules** from **Type B, Type C and Type D Power Generating Modules**, the outputs and status indications must each be provided to **NGET** on an individual **CCGT Unit** basis. In addition, where identified in the **Bilateral Agreement**, **Active Power** and **Reactive Power** measurements from **Unit Transformers** and/or **Station Transformers** must be provided.

~~(iii) For **Type B, Type C and Type D Power Park Modules at Embedded Large Power Stations** and at directly connected **Power Stations**,~~ the outputs and status indications must each be provided to **NGET** on an individual **Power Park Module** basis. In addition, where identified in the **Bilateral Agreement**, **Active Power** and **Reactive Power** measurements from station transformers must be provided.

(iv) In respect of **OTSDUW Plant and Apparatus**, the outputs and status indications must be provided to **NGET** for each piece of electrical equipment. In addition, where identified in the **Bilateral Agreement**, **Active Power** and **Reactive Power**

measurements at the **Interface Point** must be provided.

- (c) For the avoidance of doubt, the requirements of ECC.6.5.6.4(a) in the case of a **Cascade Hydro Scheme** will be provided for each **Generating Unit** forming part of that **Cascade Hydro Scheme**. In the case of **Embedded Generating Units** forming part of a **Cascade Hydro Scheme** the data may be provided by means other than a **NGET** SCADA outstation located at the **Power Station**, such as, with the agreement of the **Network Operator** in whose system such **Embedded Generating Unit** is located, from the **Network Operator's** SCADA system to **NGET**. Details of such arrangements will be contained in the relevant **Bilateral Agreements** between **NGET** and the **Generator** and the **Network Operator**.
- (d) In the case of a **Power Park Module**, additional energy input signals (e.g. wind speed, and wind direction) may be specified in the **Bilateral Agreement**. ~~For **Power Park Modules** with a **Completion Date** on or after 1st April 2016~~ A **Power Available** signal will also be specified in the **Bilateral Agreement**. The signals would be used to establish the potential level of energy input from the **Intermittent Power Source** for monitoring pursuant to ECC.6.6.1 and **Ancillary Services** and will, in the case of a wind farm, be used to provide **NGET** with advanced warning of excess wind speed shutdown and to determine the level of **Headroom** available from **Power Park Modules** for the purposes of calculating response and reserve. For the avoidance of doubt, the **Power Available** signal would be automatically provided to **NGET** and represent the sum of the potential output of all available and operational **Power Park Units** within the **Power Park Module**. The refresh rate of the **Power Available** signal shall be specified in the **Bilateral Agreement**.

ECC.6.5.6.5 In addition to the requirements of the **Balancing Codes** ~~With regard to instrumentation for the operation~~, each **HVDC Converter** unit of an **HVDC system** shall be equipped with an automatic controller capable of receiving instructions from **NGET**. This automatic controller shall be capable of operating the **HVDC Converter** units of the **HVDC System** in a coordinated way. ~~NGET The relevant system operator shall specify the automatic controller hierarchy per HVDC Converter unit.~~

ECC.6.5.6.6 The automatic controller of the **HVDC System** referred to in paragraph ECC.6.5.6.5 shall be capable of sending the following signal types to **NGET** (where applicable) :

(a) operational metering signals, providing at least the following:

- (i) start-up signals;
- (ii) AC and DC voltage measurements;
- (iii) AC and DC current measurements;
- (iv) **Active** and **Reactive Power** measurements on the AC side;
- (v) DC power measurements;
- (vi) **HVDC Converter** unit level operation in a multi-pole type **HVDC Converter**;
- (vii) elements and topology status; and
- (viii) ~~Frequency Sensitive Mode, Limited Frequency Sensitive Mode Overfrequency and Limited Frequency Sensitive Mode Underfrequency Active Power~~ ranges (where applicable).

(b) alarm signals, providing at least the following:

- (i) emergency blocking;
- (ii) ramp blocking;
- (iii) fast **Active Power** reversal (where applicable)

ECC.6.5.6.7 The automatic controller referred to in ECC.6.5.6.5 shall be capable of receiving the following signal types from **NGET** (where applicable) :

(a) operational metering signals, receiving at least the following:

- (i) start-up command;
- (ii) **Active Power** setpoints;
- (iii) **Frequency Sensitive Mode** settings;
- (iv) **Reactive Power**, voltage or similar setpoints;
- (v) **Reactive Power** control modes;
- (vi) power oscillation damping control; and
- ~~(vii) synthetic inertia.~~

Formatted: Not Highlight

(b) alarm signals, receiving at least the following:

- (i) emergency blocking command;
- (ii) ramp blocking command;
- (iii) **Active Power** flow direction; and
- (iv) fast **Active Power** reversal command.

ECC.6.5.6.8 ~~With regards to each operational metering signal, the resolution and refresh rate required would be 1 second or better unless otherwise agreed with **NGET**. **NGET** will specify the resolution and refresh rate quality of the supplied signal.~~

Formatted: Font: Bold

Formatted: Not Highlight

Instructor Facilities

ECC.6.5.7 The **User** shall accommodate **Instructor Facilities** provided by **NGET** for the receipt of operational messages relating to **System** conditions.

Electronic Data Communication Facilities

ECC.6.5.8 (a) All **BM Participants** must ensure that appropriate electronic data communication facilities are in place to permit the submission of data, as required by the **Grid Code**, to **NGET**.

(b) In addition,

- (1) any **User** that wishes to participate in the **Balancing Mechanism**;
- or
- (2) any **BM Participant** in respect of its **BM Units** at a **Power Station** and the **BM Participant** is required to provide all **Part 1 System Ancillary Services** in accordance with ECC.8.1 (unless **NGET** has otherwise agreed)

must ensure that appropriate automatic logging devices are installed at the **Control Points** of its **BM Units** to submit data to and to receive instructions from **NGET**, as required by the **Grid Code**. For the avoidance of doubt, in the case of an **Interconnector User** the **Control Point** will be at the **Control Centre** of the appropriate **Externally Interconnected System Operator**.

- (c) Detailed specifications of these required electronic facilities will be provided by **NGET** on request and they are listed as **Electrical Standards** in the Annex to the **General Conditions**.

#### Facsimile Machines

ECC.6.5.9 Each **User** and **NGET** shall provide a facsimile machine or machines:

- (a) in the case of **Generators**, at the **Control Point** of each **Power Station** and at its **Trading Point**;
- (b) in the case of **NGET** and **Network Operators**, at the **Control Centre(s)**; and
- (c) in the case of **Non-Embedded Customers** and **HVDC Equipment** owners at the **Control Point**.

Each **User** shall notify, prior to connection to the **System** of the **User's Plant and Apparatus**, **NGET** of its or their telephone number or numbers, and will notify **NGET** of any changes. Prior to connection to the **System** of the **User's Plant and Apparatus** **NGET** shall notify each **User** of the telephone number or numbers of its facsimile machine or machines and will notify any changes.

ECC.6.5.10 Busbar Voltage

**NGET** shall, subject as provided below, provide each **Generator** or **HVDC System Owner** at each **Grid Entry Point** where one of its **Power Stations** or **HVDC Systems** is connected with appropriate voltage signals to enable the **Generator** or **HVDC Converter System** owner to obtain the necessary information to permit its **Power Generating Modules** (including **DC Connected Power Park Modules**) or ~~or~~ **HVDC System Converters** to be **Synchronised** to the **National Electricity Transmission System**. The term "voltage signal" shall mean in this context, a point of connection on (or wire or wires from) a relevant part of **Transmission Plant** and/or **Apparatus** at the **Grid Entry Point**, to which the **Generator** or **HVDC System Owner**, with **NGET's** agreement (not to be unreasonably withheld) in relation to the **Plant** and/or **Apparatus** to be attached, will be able to attach its **Plant** and/or **Apparatus** (normally a wire or wires) in order to obtain measurement outputs in relation to the busbar.

ECC.6.5.11 Bilingual Message Facilities

- (a) A Bilingual Message Facility is the method by which the **User's Responsible Engineer/Operator**, the **Externally Interconnected System Operator** and **NGET Control Engineers** communicate clear and unambiguous information in two languages for the purposes of control of the **Total System** in both normal and emergency operating conditions.

- (b) A Bilingual Message Facility, where required, will provide up to two hundred pre-defined messages with up to five hundred and sixty characters each. A maximum of one minute is allowed for the transmission to, and display of, the selected message at any destination. The standard messages must be capable of being displayed at any combination of locations and can originate from any of these locations. Messages displayed in the UK will be displayed in the English language.
- (c) Detailed information on a Bilingual Message Facility and suitable equipment required for individual **User** applications will be provided by **NGET** upon request.

ECC.6.6 Monitoring

ECC.6.6.1 System Monitoring

ECC.6.6.1.1 Each **Type C** and **Type D Power Generating Module** including **DC Connected Power Park Modules** shall be equipped with a facility to provide fault recording and monitoring of dynamic system behaviour. These requirements are necessary to record conditions during **System** faults and detect poorly damped power oscillations. This facility shall record the following parameters:

- voltage,
- **Active Power**,
- **Reactive Power**, and
- **Frequency**.

ECC.6.6.1.2 Detailed specifications for fault recording and dynamic system monitoring equipment including triggering criteria and sample rates are listed as **Electrical Standards** in the **Annex** to the **General Conditions**. For Dynamic System Monitoring, the specification for the communication protocol and recorded data shall also be included in the **Electrical Standard**.

Formatted: Not Highlight

ECC.6.6.1.3 **NGET** in coordination with the **Relevant Transmission Licensee** shall specify any requirements for **Power Quality Monitoring** in the **Bilateral Agreement**. The power quality parameters to be monitored, the communication protocols for the recorded data and the time frames for compliance shall be agreed between **NGET**, the **Relevant Transmission Licensee** and **EU Generator**.

Formatted: Font: Bold

ECC.6.6.1.4 **HVDC Systems** shall be equipped with a facility to provide fault recording and dynamic system behaviour monitoring of the following parameters for each of its **HVDC Converter Stations**:

- (a) AC and DC voltage;
- (b) AC and DC current;
- (c) **Active Power**;
- (d) **Reactive Power**; and
- (e) **Frequency**.

ECC.6.6.1.5 **NGET** in coordination with the **Relevant Transmission Licensee** may specify quality of supply parameters to be complied with by the **HVDC System**, provided a reasonable prior notice is given.

ECC.6.6.1.6 The particulars of the fault recording equipment referred to in ECC.6.6.1.4, including analogue and digital channels, the settings, including triggering criteria and the sampling rates, shall be agreed between the **HVDC System Owner** and **NGET** in coordination with the **Relevant Transmission Licensee**.

ECC.6.6.1.7 All dynamic system behaviour monitoring equipment shall include an oscillation trigger, specified by **NGET**, in coordination with the **Relevant Transmission Licensee**, with the purpose of detecting poorly damped power oscillations.

ECC.6.6.1.8 The facilities for quality of supply and dynamic system behaviour monitoring shall include arrangements for the **HVDC System Owner** and **NGET** and/or **Relevant Transmission Licensee** to access the information electronically. The communications protocols for recorded data shall be agreed between the **HVDC System Owner**, **NGET** and the **Relevant Transmission Licensee**.

ECC.6.6.2 Frequency Response Monitoring

ECC.6.6.2.1 Each **Type C** and **Type D Power Generating Module** including **DC Connected Power Park Modules** shall be fitted with equipment capable of monitoring the real time **Active Power** output of a **Power Generating Module** when operating in **Frequency Sensitive Mode**.

ECC.6.6.2.2 with regard to real time monitoring of FSM: (i) To monitor the operation of **Active Power** frequency response as detailed in ECC.6.6.2.1, each **EU Generator** shall be equipped with a communication interface capable of transferring at the least the following **Frequency response data signals** in real time and in a secured manner from the **Power Station to NGET**: the network control centre of the relevant system operator or the relevant TSO.

- status signal of FSM (on/off),
- scheduled **Active Power** output,
- actual value of the **Active Power** output,
- actual parameter settings for **Active Power Frequency** response,
- droop and deadband;

the relevant system operator or the relevant TSO Each **EU Generator** shall provide such of the above signals as are required by **NGET**.

Detailed specifications of the **Active Power Frequency** response requirements including the communication requirements are listed as **Electrical Standards** in the **Annex** to the **General Conditions**.

ECC.6.6.2.3<sup>2</sup> **NGET** in co-ordination with the **Relevant Transmission Licensee** shall specify additional signals to be provided by the **EU Generator** by monitoring and recording devices in order to verify the performance of the **Active Power Frequency** response provision of participating **Power Generating Modules**.

ECC.6.6.3 Compliance Monitoring

ECC.6.6.3.1 For all on site monitoring by **NGET** of witnessed tests pursuant to the **CP** or **OC5** or **ECP** the **User** shall provide suitable test signals as outlined in either **OC5.A.1** or **ECP.A.4** (as applicable).

ECC.6.6.3.2 The signals which shall be provided by the **User** to **NGET** for onsite monitoring shall be of the following resolution, unless otherwise agreed by **NGET**:

Formatted: Highlight  
Formatted: Font: Bold, Highlight  
Formatted: Highlight

Formatted: Indent: Left: 0 cm, Hanging: 2.5 cm  
Formatted: Font: Bold, Highlight  
Formatted: Highlight  
Comment [A20]: Removed as Art 15(2)(g) includes words to the effect "at the request of the Relevant System Operator or Relevant TSO" and hence is not considered to be mandatory.

Formatted: Font: Bold, Highlight  
Formatted: Highlight  
Formatted: Font: Bold  
Formatted: Not Highlight

- (i) 1 Hz for reactive range tests
  - (ii) 10 Hz for frequency control tests
  - (iii) 100 Hz for voltage control tests
- ECC.6.6.3.3 The **User** will provide all relevant signals for this purpose in the form of d.c. voltages within the range -10V to +10V. In exceptional circumstances some signals may be accepted as d.c. voltages within the range -60V to +60V with prior agreement between the **User** and **NGET**. All signals shall:
- (i) in the case of an **Onshore Power Generating Module** or **Onshore HVDC Converter Station**, be suitably terminated in a single accessible location at the **Generator** or **HVDC Converter Station** owner's site.
  - (ii) in the case of an **Offshore Power Generating Module** and **OTSDUW Plant and Apparatus**, be transmitted onshore without attenuation, delay or filtering which would result in the inability to fully demonstrate the objectives of the test, or identify any potential safety or plant instability issues, and be suitably terminated in a single robust location normally located at or near the onshore **Interface Point** of the **Offshore Transmission System** to which it is connected.
- ECC.6.6.3.4 All signals shall be suitably scaled across the range. The following scaling would (unless **NGET** notify the **User** otherwise) be acceptable to **NGET**:
- (a) 0MW to ~~Maximum Registered Capacity~~ **Interface Point Capacity** 0-8V dc
  - (b) Maximum leading **Reactive Power** to maximum lagging **Reactive Power** -8 to 8V dc
  - (c) 48 – 52Hz as -8 to 8V dc
  - (d) Nominal terminal or connection point voltage -10% to +10% as -8 to 8V dc
- ECC.6.6.3.5 The **User** shall provide to **NGET** a 230V power supply adjacent to the signal terminal location.
- ECC.7 SITE RELATED CONDITIONS
- ECC.7.1 Not used.
- ECC.7.2 Responsibilities For Safety
- ECC.7.2.1 In England and Wales, any **User** entering and working on its **Plant** and/or **Apparatus** (including, until the **OTSUA Transfer Time**, any **OTSUA**) on a **Transmission Site** will work to the **Safety Rules** of **NGET**.
- In Scotland or **Offshore**, any **User** entering and working on its **Plant** and/or **Apparatus** (including, until the **OTSUA Transfer Time**, any **OTSUA**) on a **Transmission Site** will work to the **Safety Rules** of the **Relevant Transmission Licensee**, as advised by **NGET**.
- ECC.7.2.2 **NGET** entering and working on **Transmission Plant** and/or **Apparatus** on a **User Site** will work to the **User's Safety Rules**. For **User Sites** in Scotland or **Offshore**, **NGET** shall procure that the **Relevant Transmission Licensee** entering and working on **Transmission Plant** and/or **Apparatus** on a **User Site** will work to the **User's Safety Rules**.

- ECC.7.2.3 A **User** may, with a minimum of six weeks notice, apply to **NGET** for permission to work according to that **Users** own **Safety Rules** when working on its **Plant** and/or **Apparatus** on a **Transmission Site** rather than those set out in ECC.7.2.1. If **NGET** is of the opinion that the **User's Safety Rules** provide for a level of safety commensurate with those set out in ECC.7.2.1, **NGET** will notify the **User**, in writing, that, with effect from the date requested by the **User**, the **User** may use its own **Safety Rules** when working on its **Plant** and/or **Apparatus** on the **Transmission Site**. For a **Transmission Site** in Scotland or **Offshore**, in forming its opinion, **NGET** will seek the opinion of the **Relevant Transmission Licensee**. Until receipt of such written approval from **NGET**, the **User** will continue to use the **Safety Rules** as set out in ECC.7.2.1.
- ECC.7.2.4 In the case of a **User Site** in England and Wales, **NGET** may, with a minimum of six weeks notice, apply to a **User** for permission to work according to **NGET's Safety Rules** when working on **Transmission Plant** and/or **Apparatus** on that **User Site**, rather than the **User's Safety Rules**. If the **User** is of the opinion that **NGET's Safety Rules** provide for a level of safety commensurate with that of that **User's Safety Rules**, it will notify **NGET**, in writing, that, with the effect from the date requested by **NGET**, **NGET** may use its own **Safety Rules** when working on its **Transmission Plant** and/or **Apparatus** on that **User Site**. Until receipt of such written approval from the **User**, **NGET** shall continue to use the **User's Safety Rules**.
- In the case of a **User Site** in Scotland or **Offshore**, **NGET** may, with a minimum of six weeks notice, apply to a **User** for permission for the **Relevant Transmission Licensee** to work according to the **Relevant Transmission Licensee's Safety Rules** when working on **Transmission Plant** and/or **Apparatus** on that **User Site**, rather than the **User's Safety Rules**. If the **User** is of the opinion that the **Relevant Transmission Licensee's Safety Rules**, provide for a level of safety commensurate with that of that **User's Safety Rules**, it will notify **NGET**, in writing, that, with effect from the date requested by **NGET**, that the **Relevant Transmission Licensee** may use its own **Safety Rules** when working on its **Transmission Plant** and/or **Apparatus** on that **User's Site**. Until receipt of such written approval from the **User**, **NGET** shall procure that the **Relevant Transmission Licensee** shall continue to use the **User's Safety Rules**.
- ECC.7.2.5 For a **Transmission Site** in England and Wales, if **NGET** gives its approval for the **User's Safety Rules** to apply to the **User** when working on its **Plant** and/or **Apparatus**, that does not imply that the **User's Safety Rules** will apply to entering the **Transmission Site** and access to the **User's Plant** and/or **Apparatus** on that **Transmission Site**. Bearing in mind **NGET's** responsibility for the whole **Transmission Site**, entry and access will always be in accordance with **NGET's** site access procedures. For a **User Site** in England and Wales, if the **User** gives its approval for **NGET's Safety Rules** to apply to **NGET** when working on its **Plant** and **Apparatus**, that does not imply that **NGET's Safety Rules** will apply to entering the **User Site**, and access to the **Transmission Plant** and **Apparatus** on that **User Site**. Bearing in mind the **User's** responsibility for the whole **User Site**, entry and access will always be in accordance with the **User's** site access procedures.



For a **Transmission Site** in Scotland or **Offshore**, if **NGET** gives its approval for the **User's Safety Rules** to apply to the **User** when working on its **Plant** and/or **Apparatus**, that does not imply that the **User's Safety Rules** will apply to entering the **Transmission Site** and access to the **User's Plant** and/or **Apparatus** on that **Transmission Site**. Bearing in mind the **Relevant Transmission Licensee's** responsibility for the whole **Transmission Site**, entry and access will always be in accordance with the **Relevant Transmission Licensee's** site access procedures. For a **User Site** in Scotland or **Offshore**, if the **User** gives its approval for **Relevant Transmission Licensee Safety Rules** to apply to the **Relevant Transmission Licensee** when working on its **Plant** and **Apparatus**, that does not imply that the **Relevant Transmission Licensee's Safety Rules** will apply to entering the **User Site**, and access to the **Transmission Plant** and **Apparatus** on that **User Site**. Bearing in mind the **User's** responsibility for the whole **User Site**, entry and access will always be in accordance with the **User's** site access procedures.

ECC.7.2.6 For **User Sites** in England and Wales, **Users** shall notify **NGET** of any **Safety Rules** that apply to **NGET's** staff working on **User Sites**. For **Transmission Sites** in England and Wales, **NGET** shall notify **Users** of any **Safety Rules** that apply to the **User's** staff working on the **Transmission Site**.

For **User Sites** in Scotland or **Offshore**, **Users** shall notify **NGET** of any **Safety Rules** that apply to the **Relevant Transmission Licensee's** staff working on **User Sites**. For **Transmission Sites** in Scotland or **Offshore** **NGET** shall procure that the **Relevant Transmission Licensee** shall notify **Users** of any **Safety Rules** that apply to the **User's** staff working on the **Transmission Site**.

ECC.7.2.7 Each **Site Responsibility Schedule** must have recorded on it the **Safety Rules** which apply to each item of **Plant** and/or **Apparatus**.

ECC.7.2.8 In the case of **OTSUA** a **User Site** or **Transmission Site** shall, for the purposes of this ECC.7.2, include a site at which there is an **Interface Point** until the **OTSUA Transfer Time** when it becomes part of the **National Electricity Transmission System**.

ECC.7.3 Site Responsibility Schedules

ECC.7.3.1 In order to inform site operational staff and **NGET Control Engineers** of agreed responsibilities for **Plant** and/or **Apparatus** at the operational interface, a **Site Responsibility Schedule** shall be produced for **Connection Sites** (and in the case of **OTSUA**, until the **OTSUA Transfer Time, Interface Sites**) in England and Wales for **NGET** and **Users** with whom they interface, and for **Connection Sites** (and in the case of **OTSUA**, until the **OTSUA Transfer Time, Interface Sites**) in Scotland or **Offshore** for **NGET**, the **Relevant Transmission Licensee** and **Users** with whom they interface.

ECC.7.3.2 The format, principles and basic procedure to be used in the preparation of **Site Responsibility Schedules** are set down in Appendix 1.

ECC.7.4 Operation And Gas Zone Diagrams

Operation Diagrams

ECC.7.4.1 An **Operation Diagram** shall be prepared for each **Connection Site** at which a **Connection Point** exists (and in the case of **OTSDUW Plant and Apparatus**, by **User's** for each **Interface Point**) using, where appropriate, the graphical symbols shown in Part 1A of Appendix 2. **Users** should also note that the provisions of **OC11** apply in certain circumstances.

ECC.7.4.2 The **Operation Diagram** shall include all **HV Apparatus** and the connections to all external circuits and incorporate numbering, nomenclature and labelling, as set out in **OC11**. At those **Connection Sites** (or in the case of **OTSDUW Plant and Apparatus, Interface Points**) where gas-insulated metal enclosed switchgear and/or other gas-insulated **HV Apparatus** is installed, those items must be depicted within an area delineated by a chain dotted line which intersects gas-zone boundaries. The nomenclature used shall conform with that used on the relevant **Connection Site** and circuit (and in the case of **OTSDUW Plant and Apparatus, Interface Point** and circuit). The **Operation Diagram** (and the list of technical details) is intended to provide an accurate record of the layout and circuit interconnections, ratings and numbering and nomenclature of **HV Apparatus** and related **Plant**.

ECC.7.4.3 A non-exhaustive guide to the types of **HV Apparatus** to be shown in the **Operation Diagram** is shown in Part 2 of Appendix 2, together with certain basic principles to be followed unless equivalent principles are approved by **NGET**.

#### Gas Zone Diagrams

ECC.7.4.4 A **Gas Zone Diagram** shall be prepared for each **Connection Site** at which a **Connection Point** (and in the case of **OTSDUW Plant and Apparatus**, by **User's** for an **Interface Point**) exists where gas-insulated switchgear and/or other gas-insulated **HV Apparatus** is utilised. They shall use, where appropriate, the graphical symbols shown in Part 1B of Appendix 2.

ECC.7.4.5 The nomenclature used shall conform with that used in the relevant **Connection Site** and circuit (and in the case of **OTSDUW Plant and Apparatus**, relevant **Interface Point** and circuit).

ECC.7.4.6 The basic principles set out in Part 2 of Appendix 2 shall be followed in the preparation of **Gas Zone Diagrams** unless equivalent principles are approved by **NGET**.

#### Preparation of Operation and Gas Zone Diagrams for Users' Sites and Transmission Interface Sites

ECC.7.4.7 In the case of a **User Site**, the **User** shall prepare and submit to **NGET**, an **Operation Diagram** for all **HV Apparatus** on the **User** side of the **Connection Point** (and in the case of **OTSDUW Plant and Apparatus**, on what will be the **Offshore Transmission** side of the **Connection Point** and the **Interface Point**) and **NGET** shall provide the **User** with an **Operation Diagram** for all **HV Apparatus** on the **Transmission** side of the **Connection Point** (and in the case of **OTSDUW Plant and Apparatus** on what will be the **Onshore Transmission** side of the **Interface Point**, in accordance with the timing requirements of the **Bilateral Agreement** and/or **Construction Agreement** prior to the **Completion Date** under the **Bilateral Agreement** and/or **Construction Agreement**.

ECC.7.4.8 The **User** will then prepare, produce and distribute, using the information submitted on the **User's Operation Diagram** and **NGET Operation Diagram**, a composite **Operation Diagram** for the complete **Connection Site** (and in the case of **OTSDUW Plant and Apparatus, Interface Point**), also in accordance with the timing requirements of the **Bilateral Agreement** and/or **Construction Agreement**.

ECC.7.4.9 The provisions of ECC.7.4.7 and ECC.7.4.8 shall apply in relation to **Gas Zone Diagrams** where gas-insulated switchgear and/or other gas-insulated **HV Apparatus** is utilised.

#### Preparation of Operation and Gas Zone Diagrams for Transmission Sites

- ECC.7.4.10 In the case of an **Transmission Site**, the **User** shall prepare and submit to **NGET** an **Operation Diagram** for all **HV Apparatus** on the **User** side of the **Connection Point**, in accordance with the timing requirements of the **Bilateral Agreement** and/or **Construction Agreement**.
- ECC.7.4.11 **NGET** will then prepare, produce and distribute, using the information submitted on the **User's Operation Diagram**, a composite **Operation Diagram** for the complete **Connection Site**, also in accordance with the timing requirements of the **Bilateral Agreement** and/or **Construction Agreement** .
- ECC.7.4.12 The provisions of ECC.7.4.10 and ECC.7.4.11 shall apply in relation to **Gas Zone Diagrams** where gas-insulated switchgear and/or other gas-insulated **HV Apparatus** is utilised.
- ECC.7.4.13 Changes to Operation and Gas Zone Diagrams
- ECC.7.4.13.1 When **NGET** has decided that it wishes to install new **HV Apparatus** or it wishes to change the existing numbering or nomenclature of **Transmission HV Apparatus** at a **Transmission Site**, **NGET** will (unless it gives rise to a **Modification** under the **CUSC**, in which case the provisions of the **CUSC** as to the timing apply) one month prior to the installation or change, send to each such **User** a revised **Operation Diagram** of that **Transmission Site**, incorporating the new **Transmission HV Apparatus** to be installed and its numbering and nomenclature or the changes, as the case may be. **OC11** is also relevant to certain **Apparatus**.
- ECC.7.4.13.2 When a **User** has decided that it wishes to install new **HV Apparatus**, or it wishes to change the existing numbering or nomenclature of its **HV Apparatus** at its **User Site**, the **User** will (unless it gives rise to a **Modification** under the **CUSC**, in which case the provisions of the **CUSC** as to the timing apply) one month prior to the installation or change, send to **NGET** a revised **Operation Diagram** of that **User Site** incorporating the ~~new User~~ EU Code User HV Apparatus to be installed and its numbering and nomenclature or the changes as the case may be. **OC11** is also relevant to certain **Apparatus**.
- ECC.7.4.13.3 The provisions of ECC.7.4.13.1 and ECC.7.4.13.2 shall apply in relation to **Gas Zone Diagrams** where gas-insulated switchgear and/or other gas-insulated **HV Apparatus** is installed.
- Validity
- ECC.7.4.14 (a) The composite **Operation Diagram** prepared by **NGET** or the **User**, as the case may be, will be the definitive **Operation Diagram** for all operational and planning activities associated with the **Connection Site**. If a dispute arises as to the accuracy of the composite **Operation Diagram**, a meeting shall be held at the **Connection Site**, as soon as reasonably practicable, between **NGET** and the **User**, to endeavour to resolve the matters in dispute.
- (b) The composite **Operation Diagram** prepared by **NGET** or the **User**, as the case may be, will be the definitive **Operation Diagram** for all operational and planning activities associated with the **Interface Point** until the **OTSUA Transfer Time**. If a dispute arises as to the accuracy of the composite **Operation Diagram** prior to the **OTSUA Transfer Time**, a meeting shall be held at the **Interface Point**, as soon as reasonably practicable, between **NGET** and the **User**, to endeavour to resolve the matters in dispute.
- (c) An equivalent rule shall apply for **Gas Zone Diagrams** where they exist for a **Connection Site**.

Formatted: Font: Bold

Formatted: Font: Bold

ECC.7.4.15 In the case of **OTSUA**, a **User Site** and **Transmission Site** shall, for the purposes of this ECC.7.4, include a site at which there is an **Interface Point** until the **OTSUA Transfer Time** when it becomes part of the **National Electricity Transmission System** and references to **HV Apparatus** in this ECC.7.4 shall include references to **HV OTSUA**.

ECC.7.5 Site Common Drawings

ECC.7.5.1 **Site Common Drawings** will be prepared for each **Connection Site** (and in the case of **OTSDUW**, each **Interface Point**) and will include **Connection Site** (and in the case of **OTSDUW**, **Interface Point**) layout drawings, electrical layout drawings, common **Protection/control** drawings and common services drawings.

Preparation of Site Common Drawings for a User Site and Transmission Interface Site

ECC.7.5.2 In the case of a **User Site**, **NGET** shall prepare and submit to the **User**, **Site Common Drawings** for the **Transmission** side of the **Connection Point** (and in the case of **OTSDUW Plant and Apparatus**, on what will be the **Onshore Transmission** side of the **Interface Point**), and the **User** shall prepare and submit to **NGET**, **Site Common Drawings** for the **User** side of the **Connection Point** (and in the case of **OTSDUW**, on what will be the **Offshore Transmission** side of the **Interface Point**) in accordance with the timing requirements of the **Bilateral Agreement** and/or **Construction Agreement**.

ECC.7.5.3 The **User** will then prepare, produce and distribute, using the information submitted on the **Transmission Site Common Drawings**, **Site Common Drawings** for the complete **Connection Site** (and in the case of **OTSDUW**, **Interface Point**) in accordance with the timing requirements of the **Bilateral Agreement** and/or **Construction Agreement** .

Preparation of Site Common Drawings for a Transmission Site

ECC.7.5.4 In the case of a **Transmission Site**, the **User** will prepare and submit to **NGET Site Common Drawings** for the **User** side of the **Connection Point** in accordance with the timing requirements of the **Bilateral Agreement** and/or **Construction Agreement**.

ECC.7.5.5 **NGET** will then prepare, produce and distribute, using the information submitted in the **User's Site Common Drawings**, **Site Common Drawings** for the complete **Connection Site** in accordance with the timing requirements of the **Bilateral Agreement** and/or **Construction Agreement**.

ECC.7.5.6 When a **User** becomes aware that it is necessary to change any aspect of the **Site Common Drawings** at a **Connection Site** (and in the case of **OTSDUW**, **Interface Point**) it will:

- (a) if it is a **User Site**, as soon as reasonably practicable, prepare, produce and distribute revised **Site Common Drawings** for the complete **Connection Site** (and in the case of **OTSDUW**, **Interface Point**); and
- (b) if it is a **Transmission Site**, as soon as reasonably practicable, prepare and submit to **NGET** revised **Site Common Drawings** for the **User** side of the **Connection Point** (and in the case of **OTSDUW**, **Interface Point**) and **NGET** will then, as soon as reasonably practicable, prepare, produce and distribute, using the information submitted in the **User's Site Common Drawings**, revised **Site Common Drawings** for the complete **Connection Site** (and in the case of **OTSDUW**, **Interface Point**).

In either case, if in the **User's** reasonable opinion the change can be dealt with by it notifying **NGET** in writing of the change and for each party to amend its copy of the **Site Common Drawings** (or where there is only one set, for the party holding that set to amend it), then it shall so notify and each party shall so amend. If the change gives rise to a **Modification** under the **CUSC**, the provisions of the **CUSC** as to timing will apply.

ECC.7.5.7 When **NGET** becomes aware that it is necessary to change any aspect of the **Site Common Drawings** at a **Connection Site**(and in the case of **OTSDUW, Interface Point**) it will:

- (a) if it is a **Transmission Site**, as soon as reasonably practicable, prepare, produce and distribute revised **Site Common Drawings** for the complete **Connection Site** (and in the case of **OTSDUW, Interface Point**); and
- (b) if it is a **User Site**, as soon as reasonably practicable, prepare and submit to the **User** revised **Site Common Drawings** for the **Transmission** side of the **Connection Point** (in the case of **OTSDUW, Interface Point**) and the **User** will then, as soon as reasonably practicable, prepare, produce and distribute, using the information submitted in the **Transmission Site Common Drawings**, revised **Site Common Drawings** for the complete **Connection Site** (and in the case of **OTSDUW, Interface Point**).

In either case, if in **NGET's** reasonable opinion the change can be dealt with by it notifying the **User** in writing of the change and for each party to amend its copy of the **Site Common Drawings** (or where there is only one set, for the party holding that set to amend it), then it shall so notify and each party shall so amend. If the change gives rise to a **Modification** under the **CUSC**, the provisions of the **CUSC** as to timing will apply.

#### Validity

ECC.7.5.8 (a) The **Site Common Drawings** for the complete **Connection Site** prepared by the **User** or **NGET**, as the case may be, will be the definitive **Site Common Drawings** for all operational and planning activities associated with the **Connection Site**. If a dispute arises as to the accuracy of the **Site Common Drawings**, a meeting shall be held at the **Site**, as soon as reasonably practicable, between **NGET** and the **User**, to endeavour to resolve the matters in dispute.

(b) The **Site Common Drawing** prepared by **NGET** or the **User**, as the case may be, will be the definitive **Site Common Drawing** for all operational and planning activities associated with the **Interface Point** until the **OTSUA Transfer Time**. If a dispute arises as to the accuracy of the composite **Operation Diagram** prior to the **OTSUA Transfer Time**, a meeting shall be held at the **Interface Point**, as soon as reasonably practicable, between **NGET** and the **User**, to endeavour to resolve the matters in dispute.

ECC.7.5.9 In the case of **OTSUA**, a **User Site** and **Transmission Site** shall, for the purposes of this ECC.7.5, include a site at which there is an **Interface Point** until the **OTSUA Transfer Time** when it becomes part of the **National Electricity Transmission System**.

#### Access

ECC.7.6.1 The provisions relating to access to **Transmission Sites** by **Users**, and to **Users' Sites** by **Transmission Licensees**, are set out in each **Interface Agreement** (or in the case of **Interfaces Sites** prior to the **OTSUA Transfer Time** agreements in similar form) with, for **Transmission Sites** in England and Wales, **NGET** and each **User**, and for **Transmission Sites** in Scotland and **Offshore**, the **Relevant Transmission Licensee** and each **User**.

ECC.7.6.2 In addition to those provisions, where a **Transmission Site** in England and Wales contains exposed **HV** conductors, unaccompanied access will only be granted to individuals holding an **Authority for Access** issued by **NGET** and where a **Transmission Site** in Scotland or **Offshore** contains exposed **HV** conductors, unaccompanied access will only be granted to individuals holding an **Authority for Access** issued by the **Relevant Transmission Licensee**.

ECC.7.6.3 The procedure for applying for an **Authority for Access** is contained in the **Interface Agreement**.

ECC.7.7 Maintenance Standards

ECC.7.7.1 It is the **User's** responsibility to ensure that all its **Plant** and **Apparatus** (including, until the **OTSUA Transfer Time**, any **OTSUA**) on a **Transmission Site** is tested and maintained adequately for the purpose for which it is intended, and to ensure that it does not pose a threat to the safety of any **Transmission Plant, Apparatus** or personnel on the **Transmission Site**. **NGET** will have the right to inspect the test results and maintenance records relating to such **Plant** and **Apparatus** at any time

ECC.7.7.2 For **User Sites** in England and Wales, **NGET** has a responsibility to ensure that all **Transmission Plant** and **Apparatus** on a **User Site** is tested and maintained adequately for the purposes for which it is intended and to ensure that it does not pose a threat to the safety of any **User's Plant, Apparatus** or personnel on the **User Site**.

For **User Sites** in Scotland and **Offshore**, **NGET** shall procure that the **Relevant Transmission Licensee** has a responsibility to ensure that all **Transmission Plant** and **Apparatus** on a **User Site** is tested and maintained adequately for the purposes for which it is intended and to ensure that it does not pose a threat to the safety of any **User's Plant, Apparatus** or personnel on the **User Site**.

The **User** will have the right to inspect the test results and maintenance records relating to such **Plant** and **Apparatus** on its **User Site** at any time.

ECC.7.8 Site Operational Procedures

ECC.7.8.1 **NGET** and **Users** with an interface with **NGET**, must make available staff to take necessary **Safety Precautions** and carry out operational duties as may be required to enable work/testing to be carried out and for the operation of **Plant** and **Apparatus** (including, prior to the **OTSUA Transfer Time**, any **OTSUA**) connected to the **Total System**.

ECC.7.9 **Generators** and **HVDC System** owners shall provide a **Control Point** in respect of each **Power Station** directly connected to the **National Electricity Transmission System** and **Embedded Large Power Station** or **HVDC System** to receive and act upon instructions pursuant to OC7 and BC2 at all times that **Power Generating Modules** at the **Power Station** are generating or available to generate or **HVDC Systems** are importing or exporting or available to do so. The **Control Point** shall be continuously manned except where the **Bilateral Agreement** in respect of such **Embedded Power Station** specifies that compliance with BC2 is not required, where the **Control Point** shall be manned between the hours of 0800 and 1800 each day.

ECC.8 ANCILLARY SERVICES

ECC.8.1 System Ancillary Services

The **ECC** contain requirements for the capability for certain **Ancillary Services**, which are needed for **System** reasons ("**System Ancillary Services**"). There follows a list of these **System Ancillary Services**, together with the paragraph number of the **ECC** (or other part of the **Grid Code**) in which the minimum capability is required or referred to. The list is divided into two categories: Part 1 lists the **System Ancillary Services** which

- (a) **Generators** in respect of **Type C** and **Type D Power Generating Modules** (including **DC Connected Power Park Modules**) ~~Large Power Stations~~ are obliged to provide ~~(except Generators in respect of Large Power Stations which have a Registered Capacity of less than 50MW and comprise Power Park Modules)~~; and,
- ~~(b) HVDC System Converter Station Owners~~ are obliged to have the capability to supply;

Formatted: Not Highlight

- (c) **Generators** in respect of **Medium Power Stations** (except **Embedded Medium Power Stations**) are obliged to provide in respect of **Reactive Power** only:

and Part 2 lists the **System Ancillary Services** which **Generators** will provide only if agreement to provide them is reached with **NGET**:

Part 1

- (a) **Reactive Power** supplied (in accordance with ECC.6.3.2) ~~otherwise than by means of synchronous or static compensators (except in the case of a **Power Park Module** where synchronous or static compensators within the **Power Park Module** may be used to provide **Reactive Power**)~~
- (b) **Frequency Control** by means of **Frequency** sensitive generation - ECC.6.3.7 and BC3.5.1

Formatted: Not Highlight

Part 2

- (c) **Frequency Control** by means of **Fast Start** - ECC.6.3.14
- (d) **Black Start Capability** - ECC.6.3.5
- (e) **System to Generator Operational Intertipping**

ECC.8.2

Commercial Ancillary Services

Other **Ancillary Services** are also utilised by **NGET** in operating the **Total System** if these have been agreed to be provided by a **User** (or other person) under an **Ancillary Services Agreement** or under a **Bilateral Agreement**, with payment being dealt with under an **Ancillary Services Agreement** or in the case of **Externally Interconnected System Operators** or **Interconnector Users**, under any other agreement (and in the case of **Externally Interconnected System Operators** and **Interconnector Users** includes ancillary services equivalent to or similar to **System Ancillary Services**) ("**Commercial Ancillary Services**"). The capability for these **Commercial Ancillary Services** is set out in the relevant **Ancillary Services Agreement** or **Bilateral Agreement** (as the case may be).

## APPENDIX E1 - SITE RESPONSIBILITY SCHEDULES

### FORMAT, PRINCIPLES AND BASIC PROCEDURE TO BE USED IN THE PREPARATION OF SITE RESPONSIBILITY SCHEDULES

#### ECC.A.1.1 Principles

##### Types of Schedules

ECC.A.1.1.1 At all **Complexes** (which in the context of this ECC shall include, **Interface Sites** until the **OTSUA Transfer Time**) the following **Site Responsibility Schedules** shall be drawn up using the relevant proforma attached or with such variations as may be agreed between **NGET** and **Users**, but in the absence of agreement the relevant proforma attached will be used. In addition, in the case of **OTSDUW Plant and Apparatus**, and in readiness for the **OTSUA Transfer Time**, the **User** shall provide **NGET** with the necessary information such that **Site Responsibility Schedules** in this form can be prepared by the **Relevant Transmission Licensees** for the **Transmission Interface Site**:

- (a) Schedule of **HV Apparatus**
- (b) Schedule of **Plant, LV/MV Apparatus**, services and supplies;
- (c) Schedule of telecommunications and measurements **Apparatus**.

Other than at **Power Generating Module** (including **DC Connected Power Park Modules**) ~~Generating Unit, DC Converter, Power Park Module~~ and **Power Station** locations, the schedules referred to in (b) and (c) may be combined.

##### New Connection Sites

ECC.A.1.1.2 In the case of a new **Connection Site** each **Site Responsibility Schedule** for a **Connection Site** shall be prepared by **NGET** in consultation with relevant **Users** at least 2 weeks prior to the **Completion Date** (or, where the **OTSUA** is to become **Operational** prior to the **OTSUA Transfer Time**, an alternative date) under the **Bilateral Agreement** and/or **Construction Agreement** for that **Connection Site** (which may form part of a **Complex**). In the case of a new **Interface Site** where the **OTSUA** is to become **Operational** prior to the **OTSUA Transfer Time** each **Site Responsibility Schedule** for an **Interface Site** shall be prepared by **NGET** in consultation with relevant **Users** at least 2 weeks prior to the **Completion Date** under the **Bilateral Agreement** and/or **Construction Agreement** for that **Interface Site** (which may form part of a **Complex**) (and references to and requirements placed on “**Connection Site**” in this **ECC** shall also be read as “**Interface Site**” where the context requires and until the **OTSUA Transfer Time**). Each **User** shall, in accordance with the timing requirements of the **Bilateral Agreement** and/or **Construction Agreement**, provide information to **NGET** to enable it to prepare the **Site Responsibility Schedule**.

##### Sub-division

ECC.A.1.1.3 Each **Site Responsibility Schedule** will be subdivided to take account of any separate **Connection Sites** on that **Complex**.

##### Scope

ECC.A.1.1.4 Each **Site Responsibility Schedule** shall detail for each item of **Plant** and **Apparatus**:

- (a) **Plant/Apparatus** ownership;

Formatted: Not Highlight



- (b) Site Manager (Controller) (except in the case of **Plant/Apparatus** located in **SPT's Transmission Area**);
- (c) Safety issues comprising applicable **Safety Rules** and **Control Person** or other responsible person (**Safety Co-ordinator**), or such other person who is responsible for safety;
- (d) Operations issues comprising applicable **Operational Procedures** and control engineer;
- (e) Responsibility to undertake statutory inspections, fault investigation and maintenance.

Each **Connection Point** shall be precisely shown.

#### Detail

- ECC.A.1.1.5 (a) In the case of **Site Responsibility Schedules** referred to in ECC.A.1.1.1(b) and (c), with the exception of **Protection Apparatus** and **Intertrip Apparatus** operation, it will be sufficient to indicate the responsible **User** or **Transmission Licensee**, as the case may be.
- (b) In the case of the **Site Responsibility Schedule** referred to in ECC.A.1.1.1(a) and for **Protection Apparatus** and **Intertrip Apparatus**, the responsible management unit must be shown in addition to the **User** or **Transmission Licensee**, as the case may be.

- ECC.A.1.1.6 The **HV Apparatus Site Responsibility Schedule** for each **Connection Site** must include lines and cables emanating from or traversing<sup>1</sup> the **Connection Site**.

#### Issue Details

- ECC.A.1.1.7 Every page of each **Site Responsibility Schedule** shall bear the date of issue and the issue number.

#### Accuracy Confirmation

- ECC.A.1.1.8 When a **Site Responsibility Schedule** is prepared it shall be sent by **NGET** to the **Users** involved for confirmation of its accuracy.

- ECC.A.1.1.9 The **Site Responsibility Schedule** shall then be signed on behalf of **NGET** by its **Responsible Manager** (see ECC.A.1.1.16) and on behalf of each **User** involved by its **Responsible Manager** (see ECC.A.1.1.16), by way of written confirmation of its accuracy. For **Connection Sites** in Scotland or **Offshore**, the **Site Responsibility Schedule** will also be signed on behalf of the **Relevant Transmission Licensee** by its **Responsible Manager**.

#### Distribution and Availability

- ECC.A.1.1.10 Once signed, two copies will be distributed by **NGET**, not less than two weeks prior to its implementation date, to each **User** which is a party on the **Site Responsibility Schedule**, accompanied by a note indicating the issue number and the date of implementation.

- ECC.A.1.1.11 **NGET** and **Users** must make the **Site Responsibility Schedules** readily available to operational staff at the **Complex** and at the other relevant control points.

#### Alterations to Existing Site Responsibility Schedules

<sup>1</sup> Details of circuits traversing the **Connection Site** are only needed from the date which is the earlier of the date when the **Site Responsibility Schedule** is first updated and 15<sup>th</sup> October 2004. In Scotland or **Offshore**, from a date to be agreed between **NGET** and the **Relevant Transmission Licensee**.

- ECC.A 1.1.12 Without prejudice to the provisions of ECC.A.1.1.15 which deals with urgent changes, when a **User** identified on a **Site Responsibility Schedule** becomes aware that an alteration is necessary, it must inform **NGET** immediately and in any event 8 weeks prior to any change taking effect (or as soon as possible after becoming aware of it, if less than 8 weeks remain when the **User** becomes aware of the change). This will cover the commissioning of new **Plant** and/or **Apparatus** at the **Connection Site**, whether requiring a revised **Bilateral Agreement** or not, de-commissioning of **Plant** and/or **Apparatus**, and other changes which affect the accuracy of the **Site Responsibility Schedule**.
- ECC.A 1.1.13 Where **NGET** has been informed of a change by a **User**, or itself proposes a change, it will prepare a revised **Site Responsibility Schedule** by not less than six weeks prior to the change taking effect (subject to it having been informed or knowing of the change eight weeks prior to that time) and the procedure set out in ECC.A.1.1.8 shall be followed with regard to the revised **Site Responsibility Schedule**.
- ECC.A 1.1.14 The revised **Site Responsibility Schedule** shall then be signed in accordance with the procedure set out in ECC.A.1.1.9 and distributed in accordance with the procedure set out in ECC.A.1.1.10, accompanied by a note indicating where the alteration(s) has/have been made, the new issue number and the date of implementation.

#### Urgent Changes

ECC.A.1.1.15 When a **User** identified on a **Site Responsibility Schedule**, or **NGET**, as the case may be, becomes aware that an alteration to the **Site Responsibility Schedule** is necessary urgently to reflect, for example, an emergency situation which has arisen outside its control, the **User** shall notify **NGET**, or **NGET** shall notify the **User**, as the case may be, immediately and will discuss:

- (a) what change is necessary to the **Site Responsibility Schedule**;
- (b) whether the **Site Responsibility Schedule** is to be modified temporarily or permanently;
- (c) the distribution of the revised **Site Responsibility Schedule**.

**NGET** will prepare a revised **Site Responsibility Schedule** as soon as possible, and in any event within seven days of it being informed of or knowing the necessary alteration. The **Site Responsibility Schedule** will be confirmed by **Users** and signed on behalf of **NGET** and **Users** (by the persons referred to in ECC.A.1.1.9) as soon as possible after it has been prepared and sent to **Users** for confirmation.

#### Responsible Managers

ECC.A.1.1.16 Each **User** shall, prior to the **Completion Date** under each **Bilateral Agreement** and/or **Construction Agreement**, supply to **NGET** a list of Managers who have been duly authorised to sign **Site Responsibility Schedules** on behalf of the **User** and **NGET** shall, prior to the **Completion Date** under each **Bilateral Agreement** and/or **Construction Agreement**, supply to that **User** the name of its **Responsible Manager** and for **Connection Sites** in Scotland or **Offshore**, the name of the **Relevant Transmission Licensee's Responsible Manager** and each shall supply to the other any changes to such list six weeks before the change takes effect where the change is anticipated, and as soon as possible after the change, where the change was not anticipated.

#### De-commissioning of Connection Sites

ECC.A.1.1.17 Where a **Connection Site** is to be de-commissioned, whichever of **NGET** or the **User** who is initiating the de-commissioning must contact the other to arrange for the **Site Responsibility Schedule** to be amended at the relevant time.

**PROFORMA FOR SITE RESPONSIBILITY SCHEDULE**

\_\_\_\_\_ AREA

COMPLEX: \_\_\_\_\_

SCHEDULE: \_\_\_\_\_

CONNECTION SITE: \_\_\_\_\_

ITEM OF PLANT/ APPARATUS	PLANT APPARATUS OWNER	SITE MANAGER	SAFETY		OPERATIONS		PARTY RESPONSIBLE FOR UNDERTAKING STATUTORY INSPECTIONS, FAULT INVESTIGATION & MAINTENANCE	REMARKS
			SAFETY RULES	CONTROL OR OTHER RESPONSIBLE PERSON (SAFETY CO-ORDINATOR)	OPERATIONAL PROCEDURES	CONTROL OR OTHER RESPONSIBLE ENGINEER		

--	--	--	--	--	--	--	--	--

PAGE: \_\_\_\_\_ ISSUE NO: \_\_\_\_\_ DATE: \_\_\_\_\_

**PROFORMA FOR SITE RESPONSIBILITY SCHEDULE**

\_\_\_\_\_ AREA

COMPLEX: \_\_\_\_\_

SCHEDULE: \_\_\_\_\_

CONNECTION SITE: \_\_\_\_\_

ITEM OF PLANT/ APPARATUS	PLANT APPARATUS OWNER	SITE MANAGER	SAFETY		OPERATIONS		PARTY RESPONSIBLE FOR UNDERTAKING STATUTORY INSPECTIONS, FAULT INVESTIGATION & MAINTENANCE	REMARKS
			SAFETY RULES	CONTROL OR OTHER RESPONSIBLE PERSON (SAFETY CO-ORDINATOR)	OPERATIONAL PROCEDURES	CONTROL OR OTHER RESPONSIBLE ENGINEER		

NOTES:

SIGNE NAM COMPAN DATE  
D: \_\_\_\_\_ E: \_\_\_\_\_ Y: \_\_\_\_\_ :

SIGNE NAM COMPAN DATE  
D: \_\_\_\_\_ E: \_\_\_\_\_ Y: \_\_\_\_\_ :

SIGNE NAM COMPAN DATE  
D: \_\_\_\_\_ E: \_\_\_\_\_ Y: \_\_\_\_\_ :

SIGNE NAM COMPAN DATE  
D: \_\_\_\_\_ E: \_\_\_\_\_ Y: \_\_\_\_\_ :

PAGE: \_\_\_\_\_ ISSUE NO: \_\_\_\_\_ DATE: \_\_\_\_\_

**SP TRANSMISSION Ltd  
 SITE RESPONSIBILITY SCHEDULE  
 OWNERSHIP, MAINTENANCE AND OPERATIONS OF EQUIPMENT  
 IN JOINT USER SITUATIONS**

Sheet No. \_\_\_\_\_  
 Revision: \_\_\_\_\_  
 Date: \_\_\_\_\_

Network Area: \_\_\_\_\_

**SECTION 'A' BUILDING AND SITE**

OWNER	ACCESS REQUIRED:-
LESSEE	SPECIAL CONDITIONS:-
MAINTENANCE	LOCATION OF SUPPLY
SAFETY	TERMINALS:-
SECURITY	

**SECTION 'B' CUSTOMER OR OTHER PARTY**

NAME:-
ADDRESS:-
TEL NO:-
SUB STATION:-
LOCATION:-

**SECTION 'C' PLANT**

ITEM Nos.	EQUIPMENT	IDENTIFICATION	OWNER	SAFETY RULES APPLICABLE	OPERATION			MAINTENANCE		FAULT INVESTIGATION		TESTING		RELAY SETTINGS	REMARKS
					Tripping	Closing	Isolating	Earthing	Primary Equip.	Protection Equip.	Primary Equip.	Reclosure	Trip and Alarm		

**SECTION 'D' CONFIGURATION AND CONTROL**

ITEM No.	CONFIGURATION RESPONSIBILITY	TELEPHONE NUMBER	REMARKS

**ABBREVIATIONS:-**  
 O - SP AUTHORISED PERSON - DISTRIBUTION SYSTEM  
 NGC - NATIONAL GRID COMPANY  
 SPD - SP DISTRIBUTION Ltd  
 SPPS - POWERSYSTEMS  
 SPT - SP TRANSMISSION Ltd  
 ST - SCOTTISH POWER TELECOMMUNICATIONS  
 T - SP AUTHORISED PERSON - TRANSMISSION SYSTEM  
 U - USER

**SECTION 'E' ADDITIONAL INFORMATION**

SIGNED \_\_\_\_\_ FOR SP Transmission DATE \_\_\_\_\_  
 SIGNED \_\_\_\_\_ FOR SP Distribution DATE \_\_\_\_\_  
 SIGNED \_\_\_\_\_ FOR PowerSystems/User DATE \_\_\_\_\_



Scottish Hydro-Electric Transmission Limited

Site Responsibility Schedule

Substation Type	Number:					Revision:				
	Owner	Controller	Maintainer	Responsible System User	Responsible Management Unit	Control Authority	Safety Rules	Operational Procedures	Notes	

## APPENDIX E2 - OPERATION DIAGRAMS

### PART 1A - PROCEDURES RELATING TO OPERATION DIAGRAMS

FIXED CAPACITOR		SWITCH DISCONNECTOR	
EARTH		SWITCH DISCONNECTOR WITH INCORPORATED EARTH SWITCH	
EARTHING RESISTOR		DISCONNECTOR (CENTRE ROTATING POST)	
LIQUID EARTHING RESISTOR		DISCONNECTOR (SINGLE BREAK DOUBLE ROTATING)	
ARC SUPPRESSION COIL		DISCONNECTOR (SINGLE BREAK)	
FIXED MAINTENANCE EARTHING DEVICE		DISCONNECTOR (NON-INTERLOCKED)	
CARRIER COUPLING EQUIPMENT (WITHOUT VT)		DISCONNECTOR (POWER OPERATED)	
CARRIER COUPLING EQUIPMENT (WITH VT ON ONE PHASE)		DISCONNECTOR (POWER OPERATED) NA - NON-AUTOMATIC	
CARRIER COUPLING EQUIPMENT (WITH VT ON 3 PHASES)		DISCONNECTOR (POWER OPERATED) A - AUTOMATIC	
AC GENERATOR		DISCONNECTOR (POWER OPERATED) SO - SEQUENTIAL OPERATION	
SYNCHRONOUS COMPENSATOR		DISCONNECTOR (POWER OPERATED) FI - FAULT INTERFERING OPERATION	
CIRCUIT BREAKER		EARTH SWITCH	
CIRCUIT BREAKER WITH DELAYED AUTO RECLOSE		FAULT THROWING SWITCH (PHASE TO PHASE)	
WITHDRAWABLE METALCLAD SWITCHGEAR		FAULT THROWING SWITCH (EARTH FAULT)	
		SURGE ARRESTOR	
		THYRISTOR	

TRANSFORMERS  
(VECTORS TO INDICATE  
WINDING CONFIGURATION)

TWO WINDING



THREE WINDING

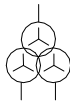

AUTO



AUTO WITH DELTA TERTIARY



EARTHING OR AUX. TRANSFORMER

(-) INDICATE REMOTE SITE  
IF APPLICABLE

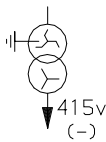

VOLTAGE TRANSFORMERS

SINGLE PHASE WOUND



THREE PHASE WOUND



SINGLE PHASE CAPACITOR



TWO SINGLE PHASE CAPACITOR



THREE PHASE CAPACITOR



\* CURRENT TRANSFORMER  
(WHERE SEPARATE PRIMARY  
APPARATUS)



\* COMBINED VT/CT UNIT  
FOR METERING

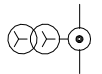

REACTOR



\* BUSBARS



\* OTHER PRIMARY CONNECTIONS



\* CABLE & CABLE SEALING END

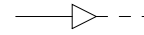

\* THROUGH WALL BUSHING

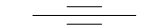

\* BYPASS FACILITY



\* CROSSING OF CONDUCTORS  
(LOWER CONDUCTOR  
TO BE BROKEN)

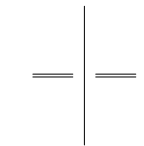

PREFERENTIAL ABBREVIATIONS

AUXILIARY TRANSFORMER	Aux T
EARTHING TRANSFORMER	ET
GAS TURBINE	Gas T
GENERATOR TRANSFORMER	Gen T
GRID TRANSFORMER	Gr T
SERIES REACTOR	Ser Reac
SHUNT REACTOR	Sh Reac
STATION TRANSFORMER	Stn T
SUPERGRID TRANSFORMER	SGT
UNIT TRANSFORMER	UT

\* NON-STANDARD SYMBOL

PORTABLE MAINTENANCE  
EARTH DEVICE



DISCONNECTOR  
(PANTOGRAPH TYPE)



QUADRATURE BOOSTER

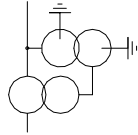

DISCONNECTOR  
(KNEE TYPE)



SHORTING/DISCHARGE SWITCH

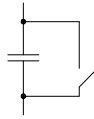

CAPACITOR  
(INCLUDING HARMONIC FILTER)



SINGLE PHASE TRANSFORMER (BR)  
NEUTRAL AND PHASE CONNECTIONS

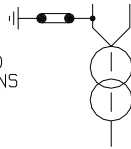

RESISTOR WITH INHERENT  
NON-LINEAR VARIABILITY,  
VOLTAGE DEPENDANT



**PART E1B - PROCEDURES RELATING TO GAS ZONE DIAGRAMS**

GAS INSULATED  
BUSBAR

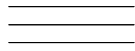

DOUBLE-BREAK  
DISCONNECTOR

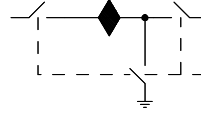

GAS BOUNDARY



EXTERNAL MOUNTED  
CURRENT TRANSFORMER  
(WHERE SEPARATE  
PRIMARY APPARATUS)



GAS/GAS BOUNDARY



STOP VALVE  
NORMALLY CLOSED



GAS/CABLE BOUNDARY



STOP VALVE  
NORMALLY OPEN



GAS/AIR BOUNDARY



GAS MONITOR



GAS/TRANSFORMER BOUNDARY



FILTER



MAINTENANCE VALVE

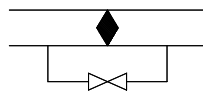

QUICK ACTING COUPLING



**PART E2 - NON-EXHAUSTIVE LIST OF APPARATUS  
TO BE INCLUDED ON OPERATION DIAGRAMS**

Basic Principles

- (1) Where practicable, all the **HV Apparatus** on any **Connection Site** shall be shown on one **Operation Diagram**. Provided the clarity of the diagram is not impaired, the layout shall represent as closely as possible the geographical arrangement on the **Connection Site**.
- (2) Where more than one **Operation Diagram** is unavoidable, duplication of identical information on more than one **Operation Diagram** must be avoided.
- (3) The **Operation Diagram** must show accurately the current status of the **Apparatus** e.g. whether commissioned or decommissioned. Where decommissioned, the associated switchbay will be labelled "spare bay".
- (4) Provision will be made on the **Operation Diagram** for signifying approvals, together with provision for details of revisions and dates.
- (5) **Operation Diagrams** will be prepared in A4 format or such other format as may be agreed with **NGET**.
- (6) The **Operation Diagram** should normally be drawn single line. However, where appropriate, detail which applies to individual phases shall be shown. For example, some **HV Apparatus** is numbered individually per phase.

Apparatus To Be Shown On Operation Diagram

- (1) Busbars
- (2) Circuit Breakers
- (3) Disconnecter (Isolator) and Switch Disconnecters (Switching Isolators)
- (4) Disconnectors (Isolators) - Automatic Facilities
- (5) Bypass Facilities
- (6) Earthing Switches
- (7) Maintenance Earths
- (8) Overhead Line Entries
- (9) Overhead Line Traps
- (10) Cable and Cable Sealing Ends
- (11) Generating Unit
- (12) Generator Transformers
- (13) Generating Unit Transformers, Station Transformers, including the lower voltage circuit-breakers.
- (14) Synchronous Compensators
- (15) Static Variable Compensators
- (16) Capacitors (including Harmonic Filters)
- (17) Series or Shunt Reactors (Referred to as "Inductors" at nuclear power station sites)

- (18) Supergrid and Grid Transformers
- (19) Tertiary Windings
- (20) Earthing and Auxiliary Transformers
- (21) Three Phase VT's
- (22) Single Phase VT & Phase Identity
- (23) High Accuracy VT and Phase Identity
- (24) Surge Arrestors/Diverters
- (25) Neutral Earthing Arrangements on HV Plant
- (26) Fault Throwing Devices
- (27) Quadrature Boosters
- (28) Arc Suppression Coils
- (29) Single Phase Transformers (BR) Neutral and Phase Connections
- (30) Current Transformers (where separate plant items)
- (31) Wall Bushings
- (32) Combined VT/CT Units
- (33) Shorting and Discharge Switches
- (34) Thyristor
- (35) Resistor with Inherent Non-Linear Variability, Voltage Dependent
- (36) Gas Zone

## APPENDIX E3 - MINIMUM FREQUENCY RESPONSE CAPABILITY REQUIREMENT PROFILE AND OPERATING RANGE FOR POWER GENERATING MODULES AND HVDC EQUIPMENT

The current text has been taken from Issue 5 Revision 16 of the Grid Code and will require checking to ensure consistency with latest version of the GB Grid Code.

### ECC.A.3.1 Scope

The frequency response capability is defined in terms of **Primary Response**, **Secondary Response** and **High Frequency Response**. In addition to the requirements defined in ECC.6.3.7 this appendix defines the minimum frequency response requirements for:-

- (a) each **Type C** and **Type D Power Generating Module**
- (b) each **DC Connected Power Park Module**
- (c) each **HVDC System**

For the avoidance of doubt, this appendix does not apply to **Type A** and **Type B Power Generating Modules**.

**OTSDUW Plant and Apparatus** should facilitate the delivery of frequency response services provided by **Offshore Generating Units** and **Offshore Power Park Units**.

The functional definition provides appropriate performance criteria relating to the provision of **Frequency** control by means of **Frequency** sensitive generation in addition to the other requirements identified in ECC.6.3.7.

In this Appendix 3 to the ECC, for a **Power Generating Module** including a **CCGT Module** or a **Power Park Module** or **DC Connected Power Park Module**, the phrase **Minimum Regulating Level** applies to the entire **CCGT Module** or **Power Park Module** or **DC Connected Power Park Module** operating with all **Generating Units Synchronised** to the **System**.

The minimum **Frequency** response requirement profile is shown diagrammatically in Figure ECC.A.3.1. The capability profile specifies the minimum required level of **Frequency Response Capability** throughout the normal plant operating range.

### ECC.A.3.2 Plant Operating Range

The upper limit of the operating range is the **Maximum Capacity** of the **Power Generating Module** or **Generating Unit** or **CCGT Module** or **HVDC Equipment**.

The **Minimum Stable Operating Level** ~~Regulating Level~~ level may be less than, but must not be more than, 65% of the **Maximum Capacity**. Each **Power Generating Module** and/or **Generating Unit** and/or **CCGT Module** and/or **Power Park Module** or **HVDC Equipment** must be capable of operating satisfactorily down to the **Minimum Regulating Level** as dictated by **System** operating conditions, although it will not be instructed to below its **Minimum Stable Operating Level**. If a **Power Generating Module** or **Generating Unit** or **CCGT Module** or **Power Park Module**, or **HVDC Equipment** is operating below **Minimum Stable Operating Level** because of high **System Frequency**, it should recover adequately to its **Minimum Stable Operating Level** as the **System Frequency** returns to **Target Frequency** so that it can provide **Primary** and **Secondary Response** from its **Minimum Stable Operating Level** if the **System Frequency** continues to fall. For the avoidance of doubt, under normal operating conditions steady state operation below the **Minimum Stable Operating Level** is not expected. The **Minimum Regulating Level** must not be more than 55% of **Maximum Capacity**.

Formatted: Font: Bold

Formatted: Font color: Auto

Formatted: Font color: Auto

Formatted: Font color: Auto

Formatted: Font color: Auto

Formatted: Font color: Auto

Formatted: Font color: Auto



In the event of a **Power Generating Module** or **Generating Unit** or **CCGT Module** or **Power Park Module** or **HVDC Equipment** load rejecting down to no less than its **Minimum Regulating Level** it should not trip as a result of automatic action as detailed in BC3.7. If the load rejection is to a level less than the **Minimum Regulating Level** then it is accepted that the condition might be so severe as to cause it to be disconnected from the **System**.

Formatted: Font color: Auto

Formatted: Font color: Auto

Formatted: Font color: Auto

#### ECC.A.3.3 Minimum Frequency Response Requirement Profile

Figure ECC.A.3.1 shows the minimum **Frequency** response capability requirement profile diagrammatically for a 0.5 Hz change in **Frequency**. The percentage response capabilities and loading levels are defined on the basis of the **Maximum Capacity** of the **Power Generating Module** or **CCGT Module** or **Power Park Module** or **HVDC Equipment**. Each **Power Generating Module** or and/or **CCGT Module** or **Power Park Module** (including a **DC Connected Power Park Module**) and/or **HVDC Equipment** must be capable of operating in a manner to provide **Frequency** response at least to the solid boundaries shown in the figure. If the **Frequency** response capability falls within the solid boundaries, the **Power Generating Module** or **CCGT Module** or **Power Park Module** or **HVDC Equipment** is providing response below the minimum requirement which is not acceptable. Nothing in this appendix is intended to prevent a **Power Generating Module** or **CCGT Module** or **Power Park Module** or **HVDC Equipment** from being designed to deliver a **Frequency** response in excess of the identified minimum requirement.

The **Frequency** response delivered for **Frequency** deviations of less than 0.5 Hz should be no less than a figure which is directly proportional to the minimum **Frequency** response requirement for a **Frequency** deviation of 0.5 Hz. For example, if the **Frequency** deviation is 0.2 Hz, the corresponding minimum **Frequency** response requirement is 40% of the level shown in Figure ECC.A.3.1. The **Frequency** response delivered for **Frequency** deviations of more than 0.5 Hz should be no less than the response delivered for a **Frequency** deviation of 0.5 Hz.

Each **Power Generating Module** and/or **CCGT Module** and/or **Power Park Module** or **HVDC Equipment** must be capable of providing some response, in keeping with its specific operational characteristics, when operating between 95% to 100% of **Maximum Capacity** as illustrated by the dotted lines in Figure ECC.A.3.1.

Formatted: Font color: Auto

At the **Minimum Stable Operating** level, each **Power Generating Module** and/or **CCGT Module** and/or **Power Park Module** and/or **HVDC Equipment** is required to provide high and low frequency response depending on the **System Frequency** conditions. Where the **Frequency** is high, the **Active Power** output is therefore expected to fall below the **Minimum Stable Operating** level.

The **Minimum Regulating Level** is the output at which a **Power Generating Module** and/or **CCGT Module** and/or **Power Park Module** and/or **HVDC Equipment**— has no **High Frequency Response** capability. It may be less than, but must not be more than, 55% of the **Maximum Capacity**. This implies that a **Power Generating Module** or **CCGT Module** or **Power Park Module** ) or **HVDC Equipment** is not obliged to reduce its output to below this level unless the **Frequency** is at or above 50.5 Hz (cf BC3.7).

#### ECC.A.3.4 Testing of Frequency Response Capability

The frequency response capabilities shown diagrammatically in Figure ECC.A.3.1 are measured by taking the responses as obtained from some of the dynamic step response tests specified by **NGET** and carried out by **Generators** and **HVDC System** owners for compliance purposes. The injected signal is a step of 0.5Hz ~~(an additional diagram may be required here)~~—from zero to 0.5 Hz **Frequency** change—over a ten second period, and is sustained at 0.5 Hz **Frequency** change thereafter, the latter as illustrated diagrammatically in figures ~~ECC.A.3.2 and ECC.A.3.3~~ ECC.A.3.4 and ECC.A.3.5.

Formatted: Font color: Auto

In addition to provide and/or to validate the content of **Ancillary Services Agreements** a progressive injection of a **Frequency** change to the plant control system (i.e. governor and load controller) is used. The injected signal is a ramp of 0.5Hz from zero to 0.5 Hz **Frequency** change over a ten second period, and is sustained at 0.5 Hz **Frequency** change thereafter, the latter as illustrated diagrammatically in figures ECC.A.3.2 and ECC.A.3.3. In the case of an **Embedded Medium Power Station** not subject to a **Bilateral Agreement** or **Embedded HVDC System** not subject to a **Bilateral Agreement**, **NGET** may require the **Network Operator** within whose System the **Embedded Medium Power Station** or **Embedded HVDC System** is situated, to ensure that the **Embedded Person** performs the dynamic response tests reasonably required by **NGET** in order to demonstrate compliance within the relevant requirements in the **ECC**.

The **Primary Response** capability (P) of a **Power Generating Module** or a **CCGT Module** or **Power Park Module** or **HVDC Equipment** is the minimum increase in **Active Power** output between 10 and 30 seconds after the start of the ramp injection as illustrated diagrammatically in Figure ECC.A.3.2. This increase in **Active Power** output should be released increasingly with time over the period 0 to 10 seconds from the time of the start of the **Frequency** fall as illustrated by the response from Figure ECC.A.3.2.

The **Secondary Response** capability (S) of a **Power Generating Module** or a **CCGT Module** or **Power Park Module** or **HVDC Equipment** is the minimum increase in **Active Power** output between 30 seconds and 30 minutes after the start of the ramp injection as illustrated diagrammatically in Figure ECC.A.3.2.

The **High Frequency Response** capability (H) of a **Power Generating Module** or a **CCGT Module** or **Power Park Module** or **HVDC Equipment** is the decrease in **Active Power** output provided 10 seconds after the start of the ramp injection and sustained thereafter as illustrated diagrammatically in Figure ECC.A.3.3. This reduction in **Active Power** output should be released increasingly with time over the period 0 to 10 seconds from the time of the start of the **Frequency** rise as illustrated by the response in Figure ECC.A.3.2.

#### ECC.A.3.5 Repeatability Of Response

When a **Power Generating Module** or **CCGT Module** or **Power Park Module** or **HVDC Equipment** has responded to a significant **Frequency** disturbance, its response capability must be fully restored as soon as technically possible. Full response capability should be restored no later than 20 minutes after the initial change of **System Frequency** arising from the **Frequency** disturbance.

[Figure ECC.A.3.1 - Minimum \*\*Frequency\*\* Response requirement profile for a 0.5 Hz frequency change from \*\*Target Frequency\*\*](#)

Figure ECC.A.3.1 – Minimum Frequency Response Capability Requirement Profile for a 0.5Hz change from Target Frequency

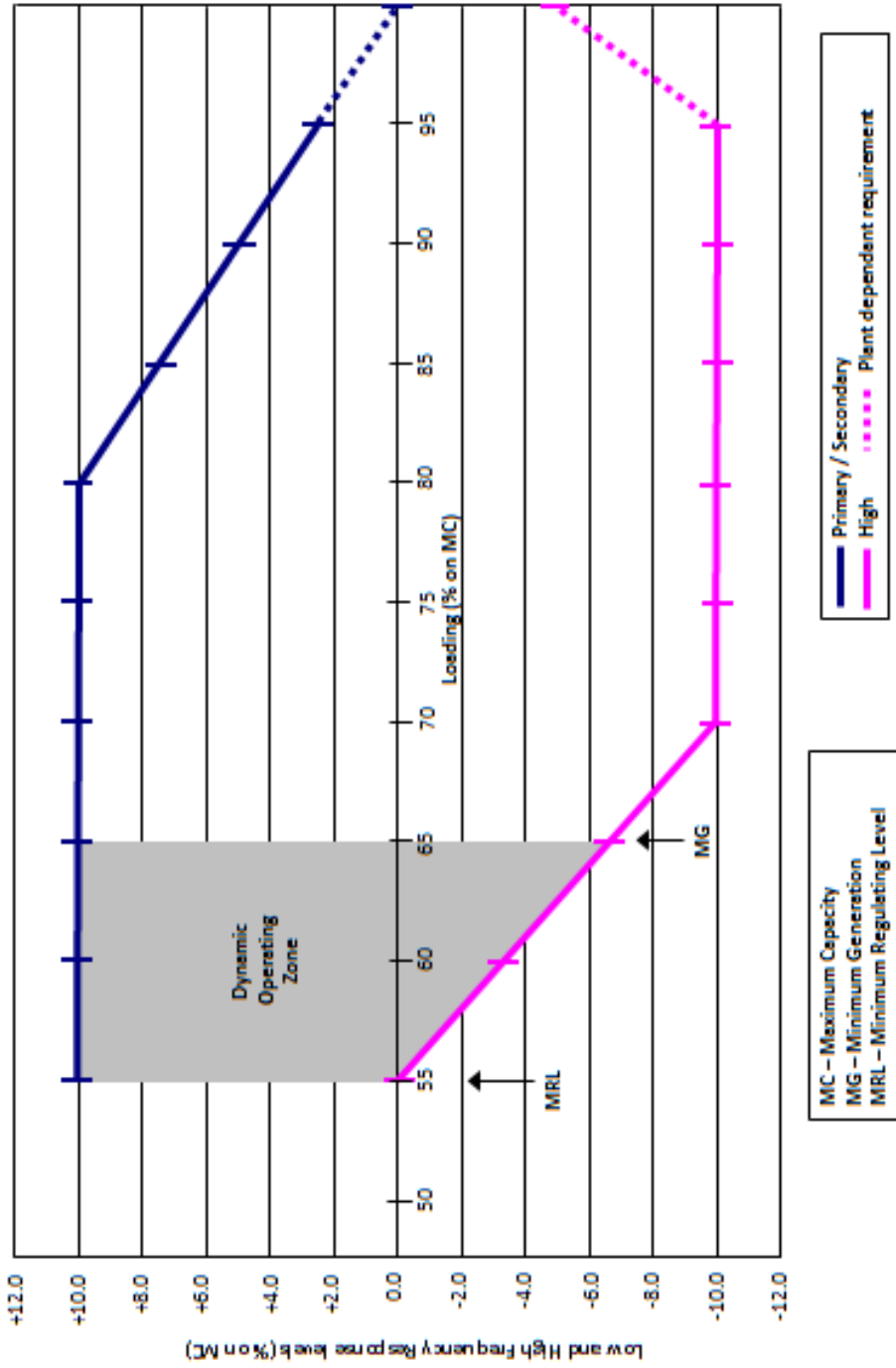

Figure ECC.A.3.2 – Interpretation of Primary and Secondary Response Service Values

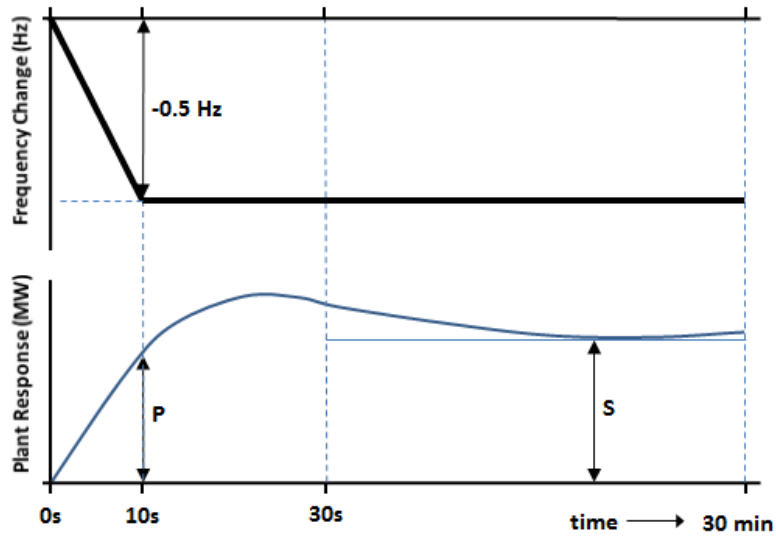

Figure ECC.A.3.3 – Interpretation of High Frequency Response Service Values

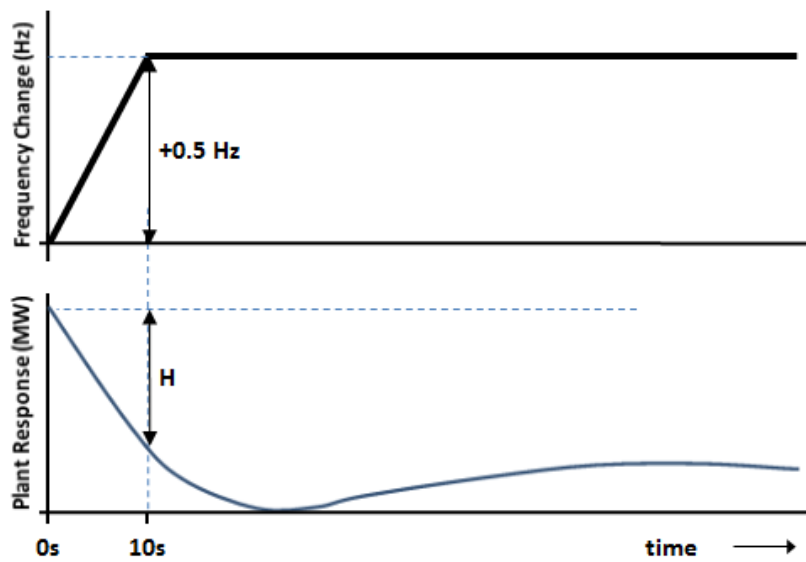

Figure ECC.A.3.4 – Interpretation of Low Frequency Response Capability Values

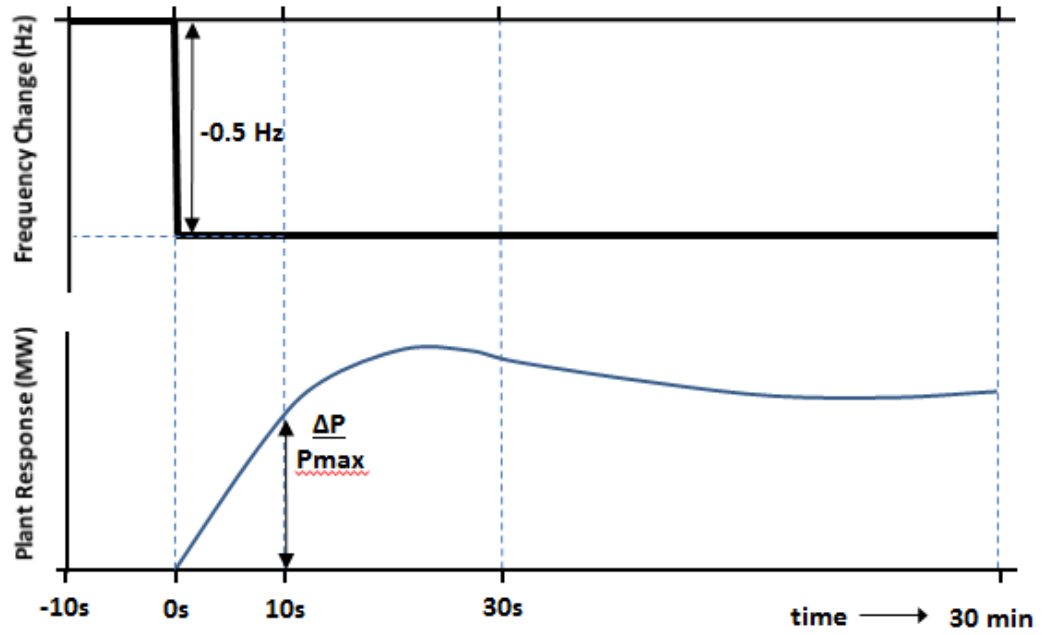
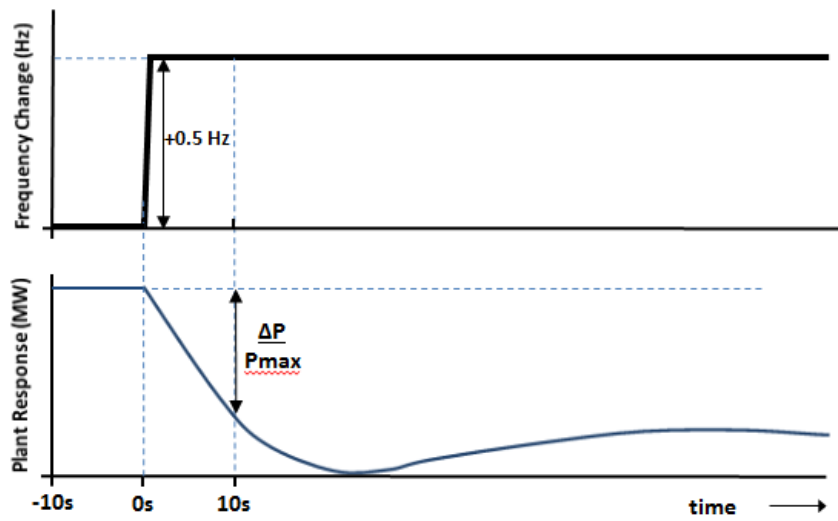

Figure ECC.A.3.5 – Interpretation of High Frequency Response Capability Values



## ECC.4 - APPENDIX 4 - FAULT RIDE THROUGH REQUIREMENTS

### FAULT RIDE THROUGH REQUIREMENTS FOR TYPE B, TYPE C AND TYPE D POWER GENERATING MODULES (INCLUDING OFFSHORE POWER PARK MODULES WHICH ARE EITHER AC CONNECTED POWER PARK MODULES OR DC CONNECTED POWER PARK MODULES), HVDC SYSTEMS AND OTSDUW PLANT AND APPARATUS

#### ECC.A.4A.1 [Scope](#)

The **Fault Ride Through** requirements are defined in ECC.6.3.15. This Appendix provides illustrations by way of examples only of ECC.6.3.15.1 to ECC.6.3.15.10 and further background and illustrations and is not intended to show all possible permutations.

#### ECC.A.4A.2 [Short Circuit Faults At Supergrid Voltage On The Onshore Transmission System Up To 140ms In Duration](#)

For short circuit faults at **Supergrid Voltage** on the **Onshore Transmission System** (which could be at an **Interface Point**) up to 140ms in duration, the **Fault Ride Through** requirement is defined in ECC.6.3.15. In summary any **Power Generating Module** (including a **DC Connected Power Park Module**) or **HVDC System** is required to remain connected and stable whilst connected to a healthy circuit. Figure ECC.A.4.A.2 illustrates this principle.

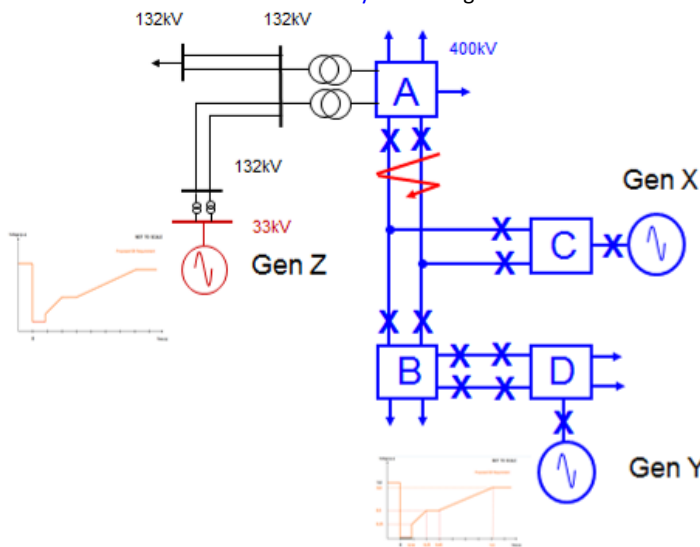

Figure ECC.A.4.A.2

In Figure ECC.A.4.A.2 a solid three phase short circuit fault is applied adjacent to substation A resulting in zero voltage at the point of fault. All circuit breakers on the faulty circuit (Lines ABC) will open within 140ms resulting in Generator X tripping. The effect of this fault, due to the low impedance of the network, will be the observation of a low voltage at each substation node across the **Total System** until the fault has been cleared. In this example, Generator Y and Generator Z (an Embedded Generator) would need to remain connected and stable as both are still connected to the **Total System** and remain connected to healthy circuits .

The criteria for assessment is based on a voltage against time curve at each **Grid Entry Point** or **User System Entry Point**. The voltage against time curve at the **Grid Entry Point** or **User System Entry Point** varies for each different type and size of **Power Generating Module** as detailed in ECC.6.3.15.2. – ECC.6.3.15.7.

The voltage against time curve represents the voltage profile at a **Grid Entry Point or User System Entry Point** that would be obtained by plotting the voltage at that **Grid Entry Point or User System Entry Point** before during and after the fault. This is not to be confused with a voltage duration curve (as defined under ECC.6.3.15.9) which represents a voltage level and associated time duration.

The post fault voltage at a **Grid Entry Point or User System Entry Point** is largely influenced by the topology of the network rather than the behaviour of the **Power Generating Module** itself. The **EU Generator** therefore needs to ensure each **Power Generating Module** remains connected and stable for a close up solid three phase short circuit fault for 140ms at the **Grid Entry Point or User System Entry Point**.

Two examples are shown in Figure EA.4.2(a) and Figure EA.4.2(b). In Figure EA.4.2(a) the post fault profile is above the heavy black line. In this case the **Power Generating Module** must remain connected and stable. In Figure EA.4.2(b) the post fault voltage dips below the heavy black line in which case the **Power Generating Module** is permitted to trip.

**Formatted: Font: Bold**

**Formatted: Not Highlight**

**Formatted: Not Highlight**

**Formatted: Not Highlight**

**Formatted: Not Highlight**

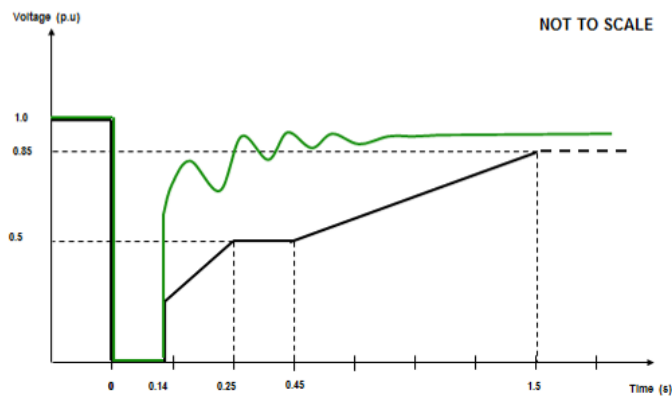

Figure EA.4.2(a)

**Formatted: Not Highlight**

**Formatted: Not Highlight**

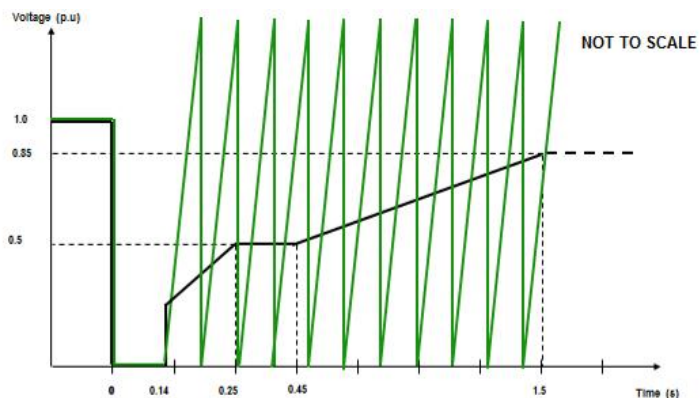

Figure EA.4.2(b)

**Formatted: Not Highlight**

The process for demonstrating **Fault Ride Through** compliance against the requirements of ECC.6.3.15 is detailed in ECP.A.3.5 and ECP.A.6.7 (as applicable).

**ECC.A.4A.3** [Supergrid Voltage Dips On The Onshore Transmission System Greater Than 140ms In Duration](#)



ECC.A.4A3.1 Requirements applicable to **Synchronous Power Generating Modules** subject to **Supergrid Voltage** dips on the **Onshore Transmission System** greater than 140ms in duration.

For balanced **Supergrid Voltage** dips on the **Onshore Transmission System** having durations greater than 140ms and up to 3 minutes, the **Fault Ride Through** requirement is defined in ECC.6.3.15.9.2.1(a) and Figure ECC.6.3.15.9(a) which is reproduced in this Appendix as Figure EA.4.3.1—and termed the voltage–duration profile.

Formatted: Font color: Auto

This profile is not a voltage-time response curve that would be obtained by plotting the transient voltage response at a point on the **Onshore Transmission System** (or **User System** if located **Onshore**) to a disturbance. Rather, each point on the profile (ie the heavy black line) represents a voltage level and an associated time duration which connected **Synchronous Power Generating Modules** must withstand or ride through.

Figures EA.4.3.2 (a), (b) and (c) illustrate the meaning of the voltage-duration profile for voltage dips having durations greater than 140ms.

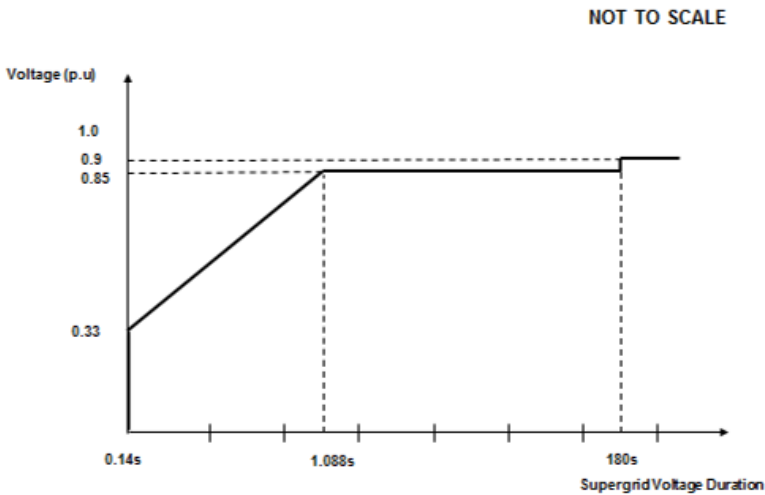

Figure EA.4.3.1

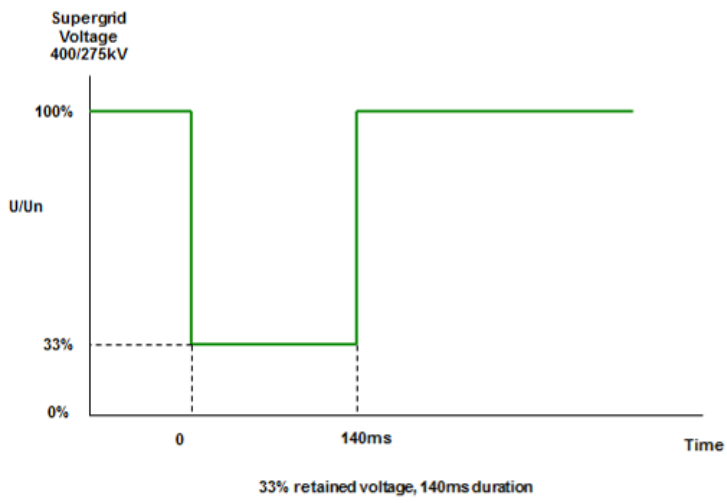

Figure EA.4.3.2 (a)

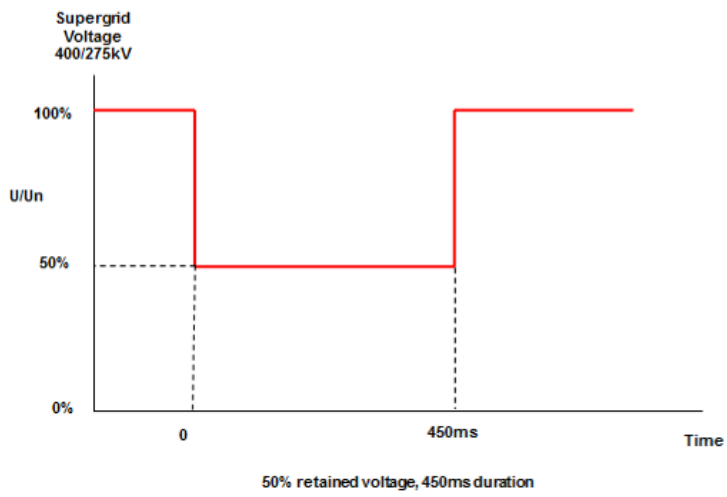

Figure EA.4.3.2 (b)

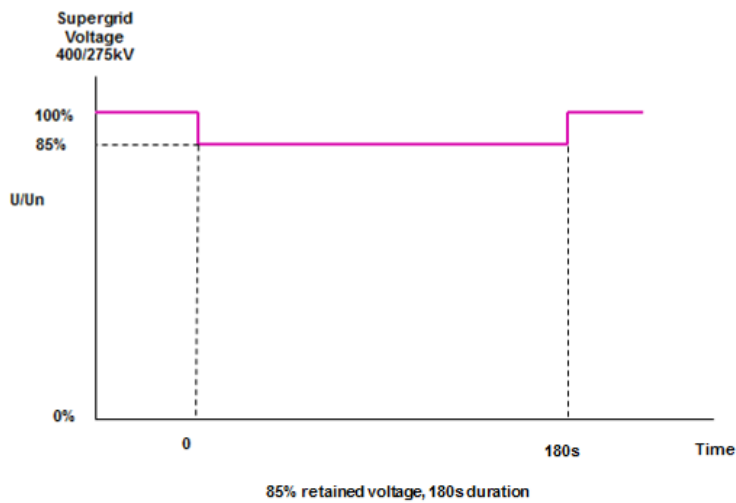

Figure EA.4.3.2 (c)

ECC.A.4A3.2 Requirements applicable to **Power Park Modules** or **OTSDUW Plant and Apparatus** subject to **Supergrid Voltage** dips on the **Onshore Transmission System** greater than 140ms in duration

For balanced **Supergrid Voltage** dips on the **Onshore Transmission System** (which could be at an **Interface Point**) having durations greater than 140ms and up to 3 minutes the **Fault Ride Through** requirement is defined in ECC.6.3.15.9.2.1(b) –and **Figure ECC.6.3.15.9(b)** which is reproduced in this Appendix as **Figure EA.4.3.3** and termed the voltage–duration profile.

Formatted: Not Highlight

This profile is not a voltage-time response curve that would be obtained by plotting the transient voltage response at a point on the **Onshore Transmission System** (or **User System** if located **Onshore**) to a disturbance. Rather, each point on the profile (ie the heavy black line) represents a voltage level and an associated time duration which connected **Power Park Modules** or **OTSDUW Plant and Apparatus** must withstand or ride through.

Figures EA.4.3.4 (a), (b) and (c) illustrate the meaning of the voltage-duration profile for voltage dips having durations greater than 140ms.

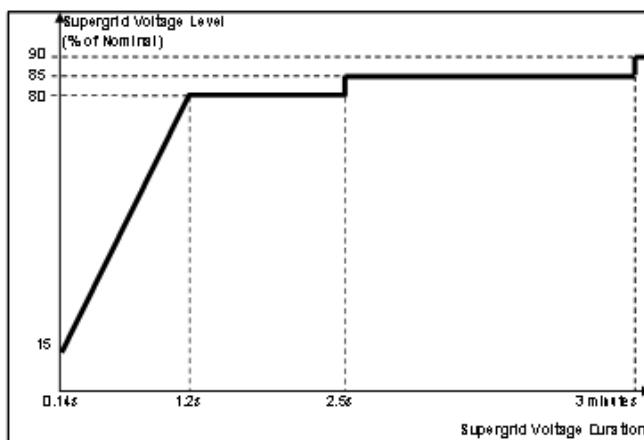

Figure EA.4.3.3

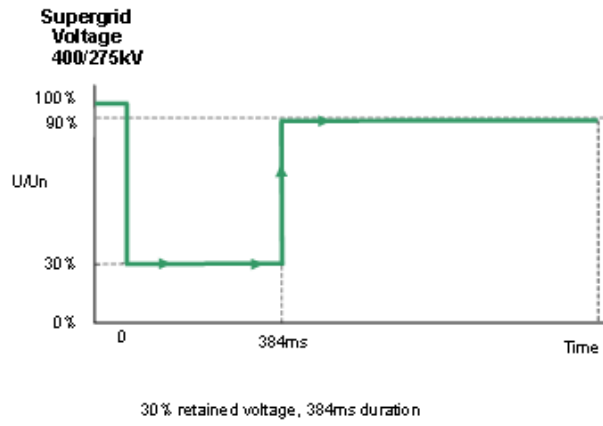

Figure EA.4.3.4(a)

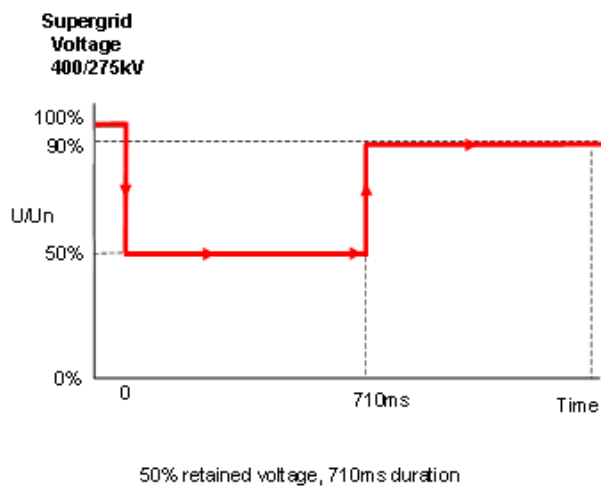

Figure EA.4.3.4 (b)

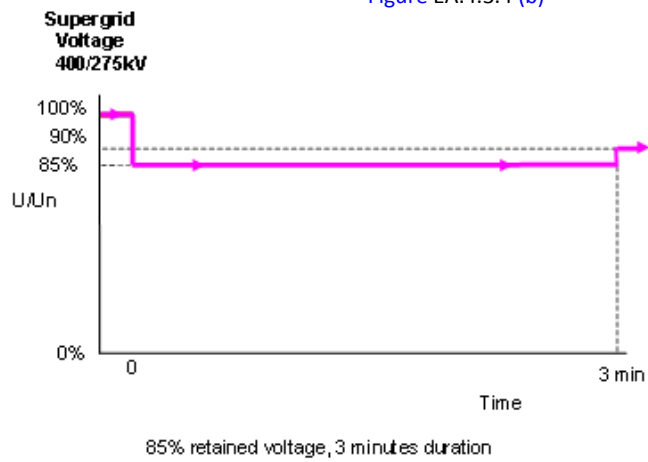

Figure EA.4.3.4 (c)

## APPENDIX 4EC – FAST FAULT CURRENT INJECTION REQUIREMENTS

### FAST FAULT CURRENT INJECTION REQUIREMENTS FOR POWER PARK MODULES, HVDC SYSTEMS, DC CONNECTED POWER PARK MODULES AND REMOTE END HVDC CONVERTERS

ECC.A.4EC1 Fast Fault Current Injection requirements

ECC.4EC1.1 Fast Fault Current Injection behaviour during a solid three phase close up short circuit fault lasting up to 140ms

ECC.4EC1.1.1 For a voltage depression at a **Grid Entry Point** or **User System Point**, the **Fast Fault Current** Injection requirements are detailed in ECC.6.3.16. Figure ECC4.1 shows an example of a 500MW **Power Park Module** subject to a close up solid three phase short circuit fault connected directly to the **Transmission System** operating at 400kV.

Formatted: Font: Bold

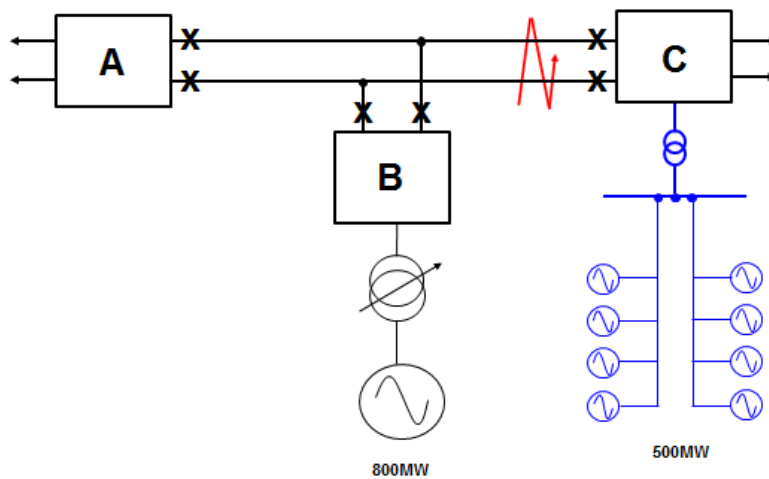

Figure ECC4.1

ECC.4EC1.1.2 Assuming negligible impedance between the fault and substation C, the voltage at Substation C will be close to zero until circuit breakers at Substation C open, typically within 80 – 100ms, subsequently followed by the opening of circuit breakers at substations A and B, typically 140ms after fault inception. The operation of circuit breakers at Substations A, B and C will also result in the tripping of the 800MW **gGenerator** which is permitted under the SQSS. The **Power Park Module** is required to satisfy the requirements of ECC.6.3.16, and an example of the deviation in system voltage at the **Grid Entry Point** and expected reactive current injected by the **Power Park Module** before and during the fault is shown in Figure ECC4.2(a) and (b). ~~For the purposes of this example it is assumed that the voltage at the **Grid Entry Point** is assumed to be the positive phase sequence voltage and the current is the positive phase sequence rms current at the **Grid Entry Point**.~~

Formatted: Font: Bold

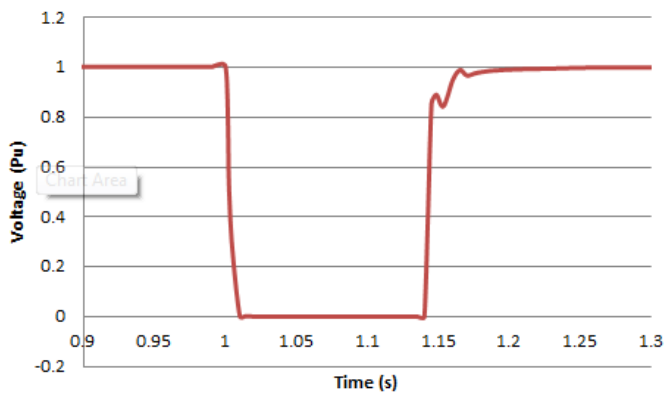

Figure ECC4.2(a) –Voltage deviation at Substation C

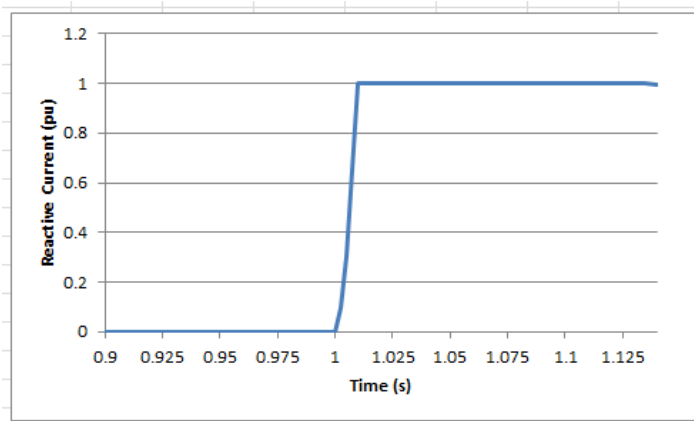

Figure ECC4.2(b) – Reactive Current Injected from the Power Park Module connected to Substation C

It is important to note that blocking is permitted upon fault clearance in order to limit the impact of transient overvoltages. This effect is shown in Figure ECC4.3(a) and Figure ECC4.3(b)

**Formatted:** Indent: Hanging: 1.75 cm, Tab stops: 2.5 cm, Left + Not at 2.25 cm

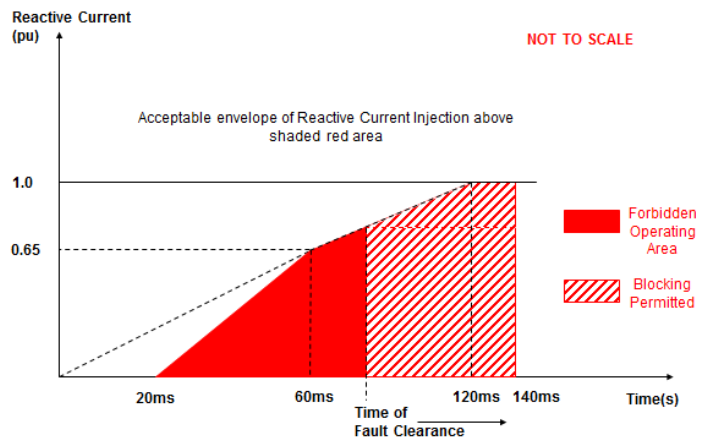

Figure ECC4.3(a)

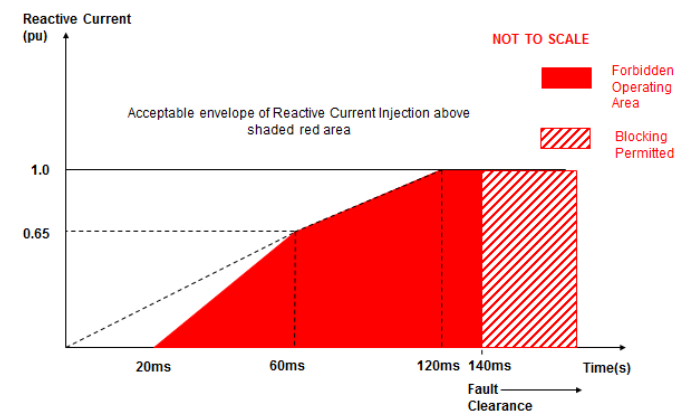

Figure ECC4.3(b)

ECC.4EC1.1.3 So long as the reactive current injected is above the shaded area as illustrated in Figure ECC4.3(a) or ECC4.3(b), the **Power Park Module** would be considered to be compliant with the requirements of ECC.6.3.16 Taking the example outlined in ECC.4EC1.1.1 where the fault is cleared in 140ms, the following diagram in Figure ECC4.4 results.



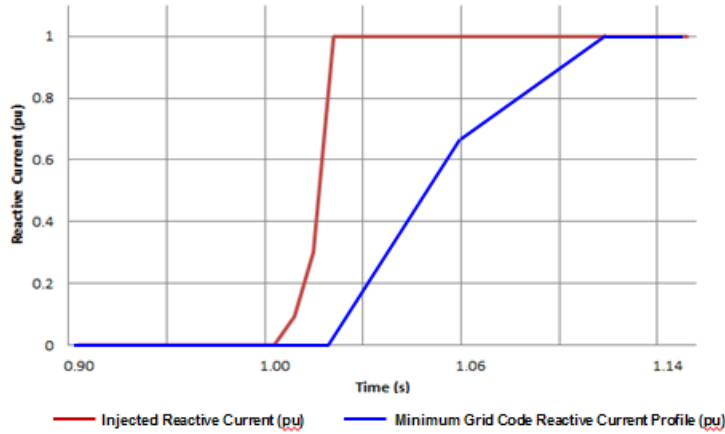

Figure ECC4.4 – Injected Reactive Current from Power Park Module compared to the minimum required Grid Code profile

ECC.4EC1.2 Fast Fault Current Injection behaviour during a voltage dip at the Connection Point lasting in excess of 140ms

ECC.4EC1.2.1 Under the fault ride through requirements specified in ECC.6.3.15.9 (*Voltage dips cleared in excess of 140ms*), **Type B, Type C and Type D Power Park Modules** are also required to remain connected and stable for voltage dips on the **Transmission System** in excess of 140ms. Figure ECC4.4 (a) shows an example of a 500MW **Power Park Module** connected to the **Transmission System** and Figure ECC4.4 (b) shows the corresponding voltage dip seen at the **Grid Entry Point** or **User System Point** which has resulted from a remote fault on the **Transmission System** cleared in a backup operating time of 710ms.

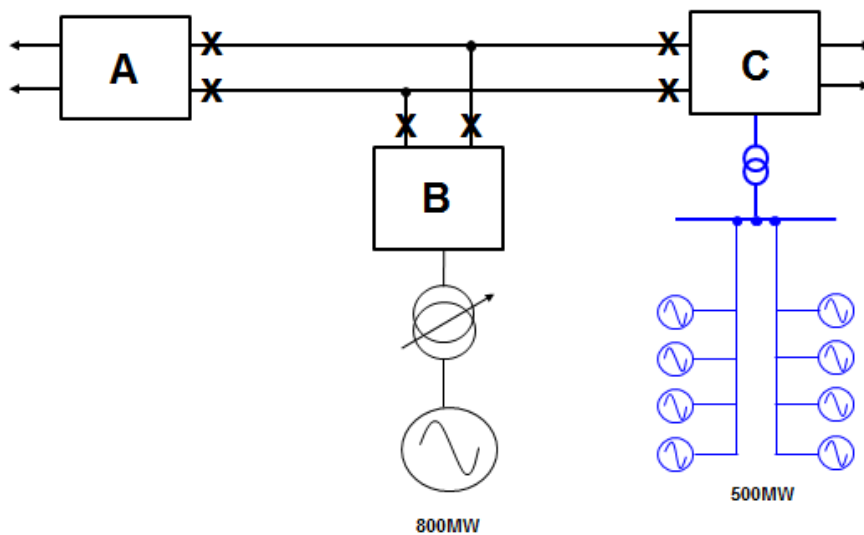

Figure ECC4.4(a)

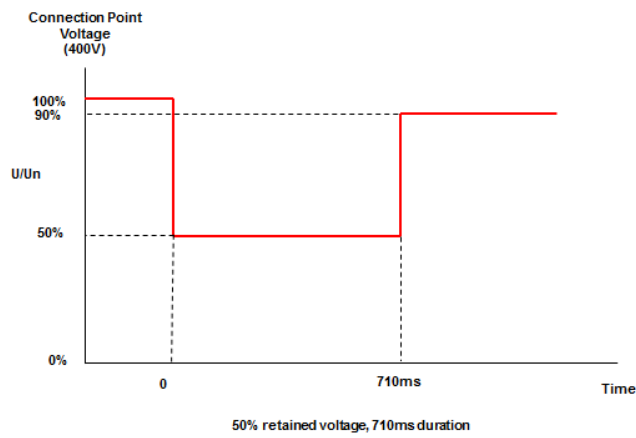

Figure ECC4.4 (b)

ECC.4EC1.2.1 In this example, the voltage dips to 0.5pu for 710ms. Under ECC.6.3.16 each **Type B**, **Type C** and **Type D Power Park Module** is required to inject reactive current into the **System** and shall respond in proportion to the change in **System** voltage at the **Grid Entry Point** or **User System Entry Point** up to a maximum value of 1.0pu of rated current. An example of the expected injected reactive current at the **Connection Point** is shown in Figure ECC4.5

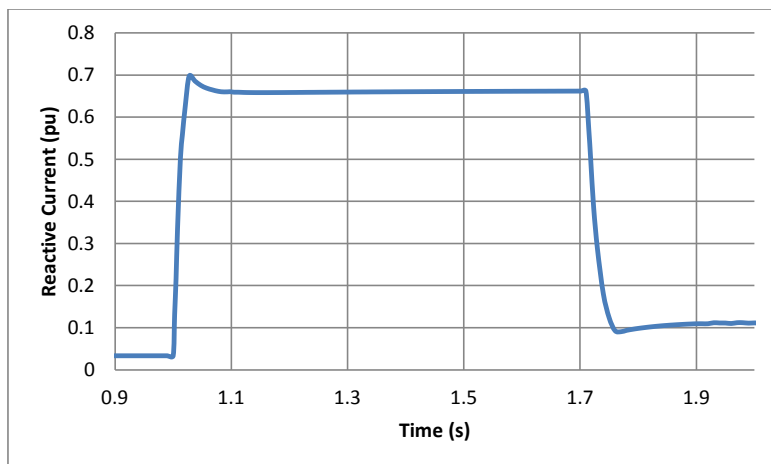

Figure ECC4.5 Reactive Current Injected for a 50% voltage dip for a period of 710ms

**APPENDIX E5 - TECHNICAL REQUIREMENTS  
LOW FREQUENCY RELAYS FOR THE AUTOMATIC  
DISCONNECTION OF SUPPLIES AT LOW FREQUENCY**

ECC.A.5.1 Low Frequency Relays

ECC.A.5.1.1 The **Low Frequency Relays** to be used shall have a setting range of 47.0 to 50Hz and be suitable for operation from a nominal AC input of 63.5, 110 or 240V. The following parameters specify the requirements of approved **Low Frequency Relays**:

- (a) **Frequency** settings: 47-50Hz in steps of 0.05Hz or better, preferably 0.01Hz;
- (b) Operating time: Relay operating time shall not be more than 150 ms;
- (c) Voltage lock-out: Selectable within a range of 55 to 90% of nominal voltage;
- (d) Facility stages: One or two stages of **Frequency** operation;
- (e) Output contacts: Two output contacts per stage to be capable of repetitively making and breaking for 1000 operations:
- (f) Accuracy: 0.01 Hz maximum error under reference environmental and system voltage conditions.  
0.05 Hz maximum error at 8% of total harmonic distortion  
**Electromagnetic Compatibility Level.**
- (h) Indications **Provide the direction of Active Power flow at the point of de-energisation.**

ECC.A.5.2 Low Frequency Relay Voltage Supplies

ECC.A.5.2.1 It is essential that the voltage supply to the **Low Frequency Relays** shall be derived from the primary **System** at the supply point concerned so that the **Frequency** of the **Low Frequency Relays** input voltage is the same as that of the primary **System**. This requires either:

- (a) the use of a secure supply obtained from voltage transformers directly associated with the grid transformer(s) concerned, the supply being obtained where necessary via a suitable automatic voltage selection scheme; or
- (b) the use of the substation 240V phase-to-neutral selected auxiliary supply, provided that this supply is always derived at the supply point concerned and is never derived from a standby supply **Power Generating Module-Generating Unit** or from another part of the **User System**.

ECC.A.5.3 Scheme Requirements

ECC.A.5.3.1 The tripping facility should be engineered in accordance with the following reliability considerations:

- (a) Dependability

Failure to trip at any one particular **Demand** shedding point would not harm the overall operation of the scheme. However, many failures would have the effect of reducing the amount of **Demand** under low **Frequency** control. An overall reasonable minimum requirement for the dependability of the **Demand** shedding scheme is 96%, i.e. the average probability of failure of each **Demand** shedding point should be less than 4%. Thus the **Demand** under low **Frequency** control will not be reduced by more than 4% due to relay failure.

(b) Outages

Low **Frequency Demand** shedding schemes will be engineered such that the amount of **Demand** under control is as specified in Table ECC.A.5.5.1a and is not reduced unacceptably during equipment outage or maintenance conditions.

ECC.A.5.3.2 The total operating time of the scheme, including circuit breakers operating time, shall where reasonably practicable, be less than 200 ms. For the avoidance of doubt, the replacement of plant installed prior to October 2009 will not be required in order to achieve lower total scheme operating times.

ECC.A.5.4 Low Frequency Relay Testing

ECC.A.5.4.1 **Low Frequency Relays** installed and commissioned after 1<sup>st</sup> January 2007 shall be type tested in accordance with and comply with the functional test requirements for **Frequency Protection** contained in Energy Networks Association Technical Specification 48-6-5 Issue 1 dated 2005 “ENA **Protection** Assessment Functional Test Requirements – Voltage and Frequency **Protection**”.

For the avoidance of doubt, **Low Frequency Relays** installed and commissioned before 1<sup>st</sup> January 2007 shall comply with the version of ECC.A.5.1.1 applicable at the time such **Low Frequency Relays** were commissioned.

ECC.A.5.5 Scheme Settings

ECC.A.5.5.1 Table CC.A.5.5.1a shows, for each **Transmission Area**, the percentage of **Demand** (based on **Annual ACS Conditions**) at the time of forecast **National Electricity Transmission System** peak **Demand** that each **Network Operator** whose **System** is connected to the **Onshore Transmission System** within such **Transmission Area** shall disconnect by **Low Frequency Relays** at a range of frequencies. Where a **Network Operator’s System** is connected to the **National Electricity Transmission System** in more than one **Transmission Area**, the settings for the **Transmission Area** in which the majority of the **Demand** is connected shall apply.

Frequency Hz	% <b>Demand</b> disconnection for each Network Operator in Transmission Area		
	<b>NGET</b>	<b>SPT</b>	<b>SHETL</b>
48.8	5		
48.75	5		
48.7	10		
48.6	7.5		10
48.5	7.5	10	
48.4	7.5	10	10

48.2	7.5	10	10
48.0	5	10	10
47.8	5		
<b>Total % Demand</b>	60	40	40

Table ECC.A.5.5.1a

Note – the percentages in table ECC.A.5.5.1a are cumulative such that, for example, should the frequency fall to 48.6 Hz in the **NGET Transmission Area**, 27.5% of the total **Demand** connected to the **National Electricity Transmission System** in the **NGET Transmission Area** shall be disconnected by the action of **Low Frequency Relays**.

The percentage **Demand** at each stage shall be allocated as far as reasonably practicable. The cumulative total percentage **Demand** is a minimum.

ECC.A.5.6 Connection and Reconnection

ECC.A.5.6.1 As defined under OC.6.6 once automatic low **Frequency Demand Disconnection** has taken place, the **Network Operator** on whose **User System** it has occurred, will not reconnect until **NGET** instructs that **Network Operator** to do so in accordance with OC6. The same requirement equally applies to **Non-Embedded Customers**.

ECC.A.5.6.1 Once **NGET** instructs the **Network Operator** or **Non Embedded Customer** to reconnect to the **National Electricity Transmission System** following operation of the **Low Frequency Demand Disconnection** scheme it shall do so in accordance with the requirements of ECC.6.2.3.10 and OC6.6.

ECC.A.5.6.2 **Network Operator** or **Non Embedded Customers** shall be capable of being remotely disconnected from the **National Electricity Transmission System** when instructed by **NGET**. ~~If required,~~ Any requirement for the automated disconnection equipment for reconfiguration of the **National Electricity Transmission System** in preparation for block loading and the time required for remote disconnection shall be specified by **NGET** in accordance with the terms of the **Bilateral Agreement**.

Formatted: Font: Bold

Formatted: Font: Bold

Formatted: Font: Bold

Formatted: Font: Bold

Formatted: Font: Not Bold

**APPENDIX E6 - PERFORMANCE REQUIREMENTS FOR CONTINUOUSLY ACTING AUTOMATIC EXCITATION CONTROL SYSTEMS FOR ONSHORE SYNCHRONOUS POWER GENERATING MODULES,**

ECC.A.6.1 Scope

ECC.A.6.1.1 This Appendix sets out the performance requirements of continuously acting automatic excitation control systems for **Type C** and **Type D Onshore Synchronous Power Generating Modules** that must be complied with by the **User**. This Appendix does not limit any site specific requirements where in **NGET's** reasonable opinion these facilities are necessary for system reasons.

ECC.A.6.1.2 Where the requirements may vary the likely range of variation is given in this Appendix. It may be necessary to specify values outside this range where **NGET** identifies a system need, and notwithstanding anything to the contrary **NGET** may specify values outside of the ranges provided in this Appendix 6. The most common variations are in the on-load excitation ceiling voltage requirements and the response time required of the **Exciter**. Actual values will be included in the **Bilateral Agreement**.

ECC.A.6.1.3 Should an **EU Generator** anticipate making a change to the excitation control system it shall notify **NGET** under the **Planning Code** (PC.A.1.2(b) and (c)) as soon as the **EU Generator** anticipates making the change. The change may require a revision to the **Bilateral Agreement**.

Formatted: Font: Bold

Formatted: Font: Bold

ECC.A.6.2 Requirements

ECC.A.6.2.1 The **Excitation System** of a **Type C** or **Type D Onshore Synchronous Power Generating Module** shall include an excitation source (**Exciter**), and a continuously acting **Automatic Voltage Regulator (AVR)** and shall meet the following functional specification. **Type D Synchronous Power Generating Modules** are also required to be fitted with a **Power System Stabiliser** in accordance with the requirements of ECC.A.6.2.5.

ECC.A.6.2.3 Steady State Voltage Control

ECC.A.6.2.3.1 An accurate steady state control of the **Onshore Synchronous Power Generating Module** pre-set **Synchronous Generating Unit** terminal voltage is required. As a measure of the accuracy of the steady-state voltage control, the **Automatic Voltage Regulator** shall have static zero frequency gain, sufficient to limit the change in terminal voltage to a drop not exceeding 0.5% of rated terminal voltage, when the output of a **Synchronous Generating Unit** within an **Onshore Synchronous Power Generating Module** is gradually changed from zero to rated MVA output at rated voltage, **Active Power** and **Frequency**.

ECC.A.6.2.4 Transient Voltage Control

ECC.A.6.2.4.1 For a step change from 90% to 100% of the nominal **Onshore Synchronous Generating Unit** terminal voltage, with the **Onshore Synchronous Generating Unit** on open circuit, the **Excitation System** response shall have a damped oscillatory characteristic. For this characteristic, the time for the **Onshore Synchronous Generating Unit** terminal voltage to first reach 100% shall be less than 0.6 seconds. Also, the time to settle within 5% of the voltage change shall be less than 3 seconds.

ECC.A.6.2.4.2 To ensure that adequate synchronising power is maintained, when the **Onshore Power Generating Module** is subjected to a large voltage disturbance, the **Exciter** whose output is varied by the **Automatic Voltage Regulator** shall be capable of providing its achievable upper and lower limit ceiling voltages to the **Onshore Synchronous Generating Unit** field in a time not exceeding that specified in the **Bilateral Agreement**. This will normally be not less than 50 ms and not greater than 300 ms. The achievable upper and lower limit ceiling voltages may be dependent on the voltage disturbance.

ECC.A.6.2.4.3 The **Exciter** shall be capable of attaining an **Excitation System On Load Positive Ceiling Voltage** of not less than a value specified in the **Bilateral Agreement** that will be:

not less than 2 per unit (pu)

normally not greater than 3 pu

exceptionally up to 4 pu

of **Rated Field Voltage** when responding to a sudden drop in voltage of 10 percent or more at the **Onshore Synchronous Generating Unit** terminals. **NGET** may specify a value outside the above limits where **NGET** identifies a system need.

ECC.A.6.2.4.4 If a static type **Exciter** is employed:

(i) the field voltage should be capable of attaining a negative ceiling level specified in the **Bilateral Agreement** after the removal of the step disturbance of ECC.A.6.2.4.3. The specified value will be 80% of the value specified in ECC.A.6.2.4.3. **NGET** may specify a value outside the above limits where **NGET** identifies a system need.

(ii) the **Exciter** must be capable of maintaining free firing when the **Onshore Synchronous Generating Unit** terminal voltage is depressed to a level which may be between 20% to 30% of rated terminal voltage

(iii) the **Exciter** shall be capable of attaining a positive ceiling voltage not less than 80% of the **Excitation System On Load Positive Ceiling Voltage** upon recovery of the **Onshore Synchronous Generating Unit** terminal voltage to 80% of rated terminal voltage following fault clearance. **NGET** may specify a value outside the above limits where **NGET** identifies a system need.

(iv) the requirement to provide a separate power source for the **Exciter** will be specified if **NGET** identifies a **Transmission System** need.

ECC.A.6.2.5 Power Oscillations Damping Control

ECC.A.6.2.5.1 To allow **Type D Onshore Power Generating Modules** to maintain second and subsequent swing stability and also to ensure an adequate level of low frequency electrical damping power, the **Automatic Voltage Regulator** of each **Onshore Synchronous Generating Unit** within each **Type D Onshore Synchronous Power Generating Module** shall include a **Power System Stabiliser** as a means of supplementary control.

ECC.A.6.2.5.2 Whatever supplementary control signal is employed, it shall be of the type which operates into the **Automatic Voltage Regulator** to cause the field voltage to act in a manner which results in the damping power being improved while maintaining adequate synchronising power.

- ECC.A.6.2.5.3 The arrangements for the supplementary control signal shall ensure that the **Power System Stabiliser** output signal relates only to changes in the supplementary control signal and not the steady state level of the signal. For example, if generator electrical power output is chosen as a supplementary control signal then the **Power System —Stabiliser** output should relate only to changes in the **Synchronous Generating Unit** electrical power output and not the steady state level of power output. Additionally the **Power System Stabiliser** should not react to mechanical power changes in isolation for example during rapid changes in steady state load or when providing frequency response.
- ECC.A.6.2.5.4 The output signal from the **Power System Stabiliser** shall be limited to not more than  $\pm 10\%$  of the **Onshore Synchronous Generating Unit** terminal voltage signal at the **Automatic Voltage Regulator** input. The gain of the **Power System Stabiliser** shall be such that an increase in the gain by a factor of 3 shall not cause instability.
- ECC.A.6.2.5.5 The **Power System Stabiliser** shall include elements that limit the bandwidth of the output signal. The bandwidth limiting must ensure that the highest frequency of response cannot excite torsional oscillations on other plant connected to the network. A bandwidth of 0-5Hz would be judged to be acceptable for this application.
- ECC.A.6.2.5.6 The **FU Generator** in respect of its **Type D Synchronous Power Generating Modules** will agree **Power System Stabiliser** settings with **NGET** prior to the on-load commissioning detailed in BC2.11.2(d). To allow assessment of the performance before on-load commissioning the **FU Generator** will provide to **NGET** a report covering the areas specified in ECP.A.3.2.1.
- ECC.A.6.2.5.7 The **Power System Stabiliser** must be active within the **Excitation System** at all times when **Synchronised** including when the **Under Excitation Limiter** or **Over Excitation Limiter** are active. When operating at low load when **Synchronising** or **De-Synchronising** an **Onshore Synchronous Generating Unit**, within a **Type D Synchronous Power Generating Module**, the **Power System Stabiliser** may be out of service.
- ECC.A.6.2.5.8 Where a **Power System Stabiliser** is fitted to a **Pumped Storage Unit** within a **Type D Synchronous Power Generating Module** it must function when the **Pumped Storage Unit** is in both generating and pumping modes.
- ECC.A.6.2.6 Overall **Excitation System** Control Characteristics
- ECC.A.6.2.6.1 The overall **Excitation System** shall include elements that limit the bandwidth of the output signal. The bandwidth limiting must be consistent with the speed of response requirements and ensure that the highest frequency of response cannot excite torsional oscillations on other plant connected to the network. A bandwidth of 0-5 Hz will be judged to be acceptable for this application.
- ECC.A.6.2.6.2 The response of the **Automatic Voltage Regulator** combined with the **Power System Stabiliser** shall be demonstrated by injecting similar step signal disturbances into the **Automatic Voltage Regulator** reference as detailed in ECPA.5.2 and ECPA.5.4. The **Automatic Voltage Regulator** shall include a facility to allow step injections into the **Automatic Voltage Regulator** voltage reference, with the **Onshore Type D Power Generating Module** operating at points specified by **NGET** (up to rated MVA output). The damping shall be judged to be adequate if the corresponding **Active Power** response to the disturbances decays within two cycles of oscillation.

Formatted: Font: Bold

Formatted: Font: Bold

Formatted: Font: Not Bold



ECC.A.6.2.6.3 A facility to inject a band limited random noise signal into the **Automatic Voltage Regulator** voltage reference shall be provided for demonstrating the frequency domain response of the **Power System Stabiliser**. The tuning of the **Power System Stabiliser** shall be judged to be adequate if the corresponding **Active Power** response shows improved damping with the **Power System Stabiliser** in combination with the **Automatic Voltage Regulator** compared with the **Automatic Voltage Regulator** alone over the frequency range 0.3Hz – 2Hz.

ECC.A.6.2.7 Under-Excitation Limiters

ECC.A.6.2.7.1 The security of the power system shall also be safeguarded by means of MVAR **Under Excitation Limiters** fitted to the **Synchronous Power Generating Module Excitation System**. The **Under Excitation Limiter** shall prevent the **Automatic Voltage Regulator** reducing the **Synchronous Generating Unit** excitation to a level which would endanger synchronous stability. The **Under Excitation Limiter** shall operate when the excitation system is providing automatic control. The **Under Excitation Limiter** shall respond to changes in the **Active Power** (MW) the **Reactive Power** (MVar) and to the square of the **Synchronous Generating Unit** voltage in such a direction that an increase in voltage will permit an increase in leading MVar. The characteristic of the **Under Excitation Limiter** shall be substantially linear from no-load to the maximum **Active Power** output of the **Onshore Power Generating Module** at any setting and shall be readily adjustable.

ECC.A.6.2.7.2 The performance of the **Under Excitation Limiter** shall be independent of the rate of change of the **Onshore Synchronous Power Generating Module** load and shall be demonstrated by testing as detailed in ECP.A.5.5. The resulting maximum overshoot in response to a step injection which operates the **Under Excitation Limiter** shall not exceed 4% of the **Onshore Synchronous Generating Unit** rated MVA. The operating point of the **Onshore Synchronous Generating Unit** shall be returned to a steady state value at the limit line and the final settling time shall not be greater than 5 seconds. When the step change in **Automatic Voltage Regulator** reference voltage is reversed, the field voltage should begin to respond without any delay and should not be held down by the **Under Excitation Limiter**. Operation into or out of the preset limit levels shall ensure that any resultant oscillations are damped so that the disturbance is within 0.5% of the **Onshore Synchronous Generating Unit** MVA rating within a period of 5 seconds.

ECC.A.6.2.7.3 The **EU Generator** shall also make provision to prevent the reduction of the **Onshore Synchronous Generating Unit** excitation to a level which would endanger synchronous stability when the **Excitation System** is under manual control.

Formatted: Font: Bold

ECC.A.6.2.8 Over-Excitation and Stator Current Limiters

ECC.A.6.2.8.1 The settings of the **Over-Excitation Limiter** and stator current limiter, ~~where it exists~~, shall ensure that the **Onshore Synchronous Generating Unit** excitation is not limited to less than the maximum value that can be achieved whilst ensuring the **Onshore Synchronous Generating Unit** is operating within its design limits. If the **Onshore Synchronous Generating Unit** excitation is reduced following a period of operation at a high level, the rate of reduction shall not exceed that required to remain within any time dependent operating characteristics of the **Onshore Synchronous Power Generating Module**.

ECC.A.6.2.8.2 The performance of the **Over-Excitation Limiter**, ~~where it exists~~, shall be demonstrated by testing as described in ECP.A.5.6. Any operation beyond the **Over-Excitation Limit** shall be controlled by the **Over-Excitation Limiter** or stator current limiter without the operation of any **Protection** that could trip the **Onshore Synchronous Power Generating Module**.

Formatted: Not Strikethrough

ECC.A.6.2.8.3 The **EU Generator** shall also make provision to prevent any over-excitation restriction of the **Onshore Synchronous Generating Unit** when the **Excitation System** is under manual control, other than that necessary to ensure the **Onshore Power Generating Module** is operating within its design limits.

Formatted: Font: Bold

**APPENDIX E7 - PERFORMANCE REQUIREMENTS FOR CONTINUOUSLY ACTING AUTOMATIC VOLTAGE CONTROL SYSTEMS FOR AC CONNECTED ONSHORE ~~NON-SYNCHRONOUS GENERATING UNITS, ONSHORE DC CONVERTERS, POWER PARK MODULES AND OTSDUW PLANT AND APPARATUS AT THE INTERFACE POINT HVDC SYSTEMS AND REMOTE END HVDC CONVERTER STATIONS~~**

ECC.A.7.1 Scope

ECC.A.7.1.1 This Appendix sets out the performance requirements of continuously acting automatic voltage control systems for ~~Onshore Non-Synchronous Generating Units, Power Park Modules, Onshore HVDC Converters~~ **Remote End HVDC Converter Stations** and **OTSDUW Plant and Apparatus** at the **Interface Point** that must be complied with by the **User**. This Appendix does not limit any site specific requirements where in **NGET's** reasonable opinion these facilities are necessary for system reasons. The control performance requirements applicable to **Configuration 2 AC Connected Offshore Power Park Modules** ~~and and~~ **Configuration 2 DC Connected Power Park Modules** are defined in Appendix E8.

Formatted: Font: Bold

ECC.A.7.1.2 Proposals by **EU Generators** or **HVDC System Owners** to make a change to the voltage control systems are required to be notified to **NGET** under the **Planning Code** (PC.A.1.2(b) and (c)) as soon as the **Generator** or **HVDC System Owner** anticipates making the change. The change may require a revision to the **Bilateral Agreement**.

Formatted: Font: Bold

ECC.A.7.1.3 In the case of a **Remote End HVDC Converter** at a **HVDC Converter Station**, the control performance requirements shall be specified in the **Bilateral Agreement**. These requirements shall be consistent with those specified in ~~ECC.6.3.2.46~~. In the case where the **Remote End HVDC Converter** is required to ensure the zero transfer of **Reactive Power** at the **HVDC Interface Point** then the requirements shall be specified in the **Bilateral Agreement** which shall be consistent with those requirements specified in ECC.A.8. In the case where a wider reactive capability has been specified in ~~ECC.6.3.2.46~~, then the requirements consistent with those specified in ECC.A.7.2 shall apply with any variations being agreed between the **User** and **NGET**.

Formatted: Not Highlight

Formatted: Not Highlight

Formatted: Not Highlight

ECC.A.7.2 Requirements

ECC.A.7.2.1 **NGET** requires that the continuously acting automatic voltage control system for the ~~Onshore Non-Synchronous Generating Unit, Onshore DC Converter or Onshore Power Park Module, Onshore HVDC Converter~~ or **OTSDUW Plant and Apparatus** shall meet the following functional performance specification. If a **Network Operator** has confirmed to **NGET** that its network to which an ~~Embedded Onshore Non-Synchronous Generating Unit, Onshore DC Converter, Onshore Power Park Module~~ or **Onshore HVDC Converter** or **OTSDUW Plant and Apparatus** is connected is restricted such that the full reactive range under the steady state voltage control requirements (ECC.A.7.2.2) cannot be utilised, **NGET** may specify alternative limits to the steady state voltage control range that reflect these restrictions. Where the **Network Operator** subsequently notifies **NGET** that such restriction has been removed, **NGET** may propose a **Modification** to the **Bilateral Agreement** (in accordance with the **CUSC** contract) to remove the alternative limits such that the continuously acting automatic voltage control system meets the following functional performance specification. All other requirements of the voltage control system will remain as in this Appendix.

ECC.A.7.2.2 Steady State Voltage Control

ECC.A.7.2.2.1 The ~~Onshore Non-Synchronous Generating Unit, Onshore DC Converter, Onshore Power Park Module, Onshore HVDC Converter or OTSDUW Plant and Apparatus~~ shall provide continuous steady state control of the voltage at the **Onshore Grid Entry Point (or Onshore User System Entry Point if Embedded)** (or the **Interface Point** in the case of **OTSDUW Plant and Apparatus** ) with a **Setpoint Voltage** and **Slope** characteristic as illustrated in Figure ECC.A.7.2.2a.

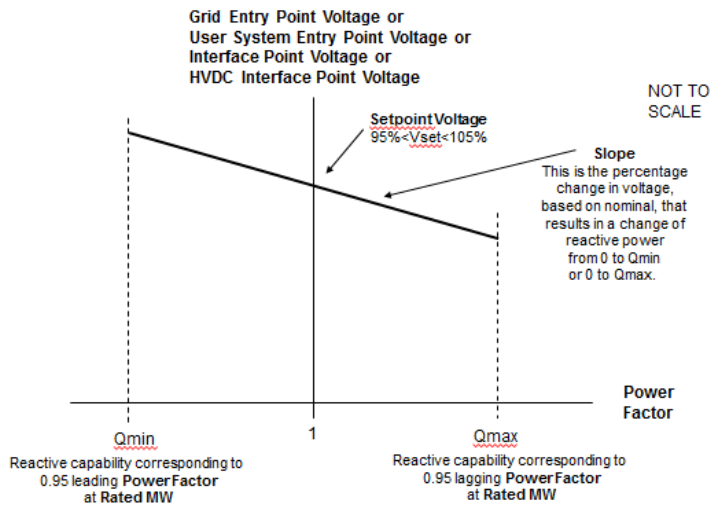

Figure ECC.A.7.2.2a

ECC.A.7.2.2.2 The continuously acting automatic control system shall be capable of operating to a **Setpoint Voltage** between 95% and 105% with a resolution of 0.25% of the nominal voltage. For the avoidance of doubt values of 95%, 95.25%, 95.5% ... may be specified, but not intermediate values. The initial **Setpoint Voltage** will be 100%. The tolerance within which this **Setpoint Voltage** shall be achieved is specified in BC2.A.2.6. For the avoidance of doubt, with a tolerance of 0.25% and a Setpoint Voltage of 100%, the achieved value shall be between 99.75% and 100.25%. **NGET** may request the **EU Generator** or **HVDC System Owner** to implement an alternative **Setpoint Voltage** within the range of 95% to 105%. For **Embedded Generators** and **Embedded HVDC System Owners** the **Setpoint Voltage** will be discussed between **NGET** and the relevant **Network Operator** and will be specified to ensure consistency with ECC.6.3.4.

Formatted: Font: Bold

Formatted: Font: Bold

ECC.A.7.2.2.3 The **Slope** characteristic of the continuously acting automatic control system shall be adjustable over the range 2% to 7% (with a resolution of 0.5%). For the avoidance of doubt values of 2%, 2.5%, 3% may be specified, but not intermediate values. The initial **Slope** setting will be 4%. The tolerance within which this **Slope** shall be achieved is specified in BC2.A.2.6. For the avoidance of doubt, with a tolerance of 0.5% and a **Slope** setting of 4%, the achieved value shall be between 3.5% and 4.5%. **NGET** may request the **EU Generator** or **HVDC System Owner** to implement an alternative slope setting within the range of 2% to 7%. For **Embedded Generators** and **Onshore Embedded HVDC Converter Station Owners** the **Slope** setting will be discussed between **NGET** and the relevant **Network Operator** and will be specified to ensure consistency with ECC.6.3.4.

Formatted: Font: Bold

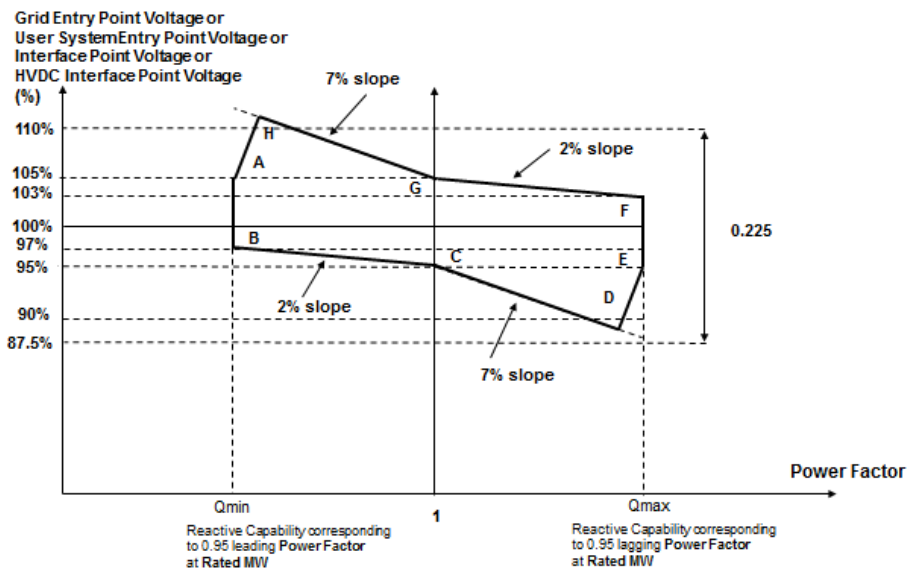

Figure ECC.A.7.2.2b

**Comment [A21]:** This diagram needs updating to include HVDC Interface Point Voltage

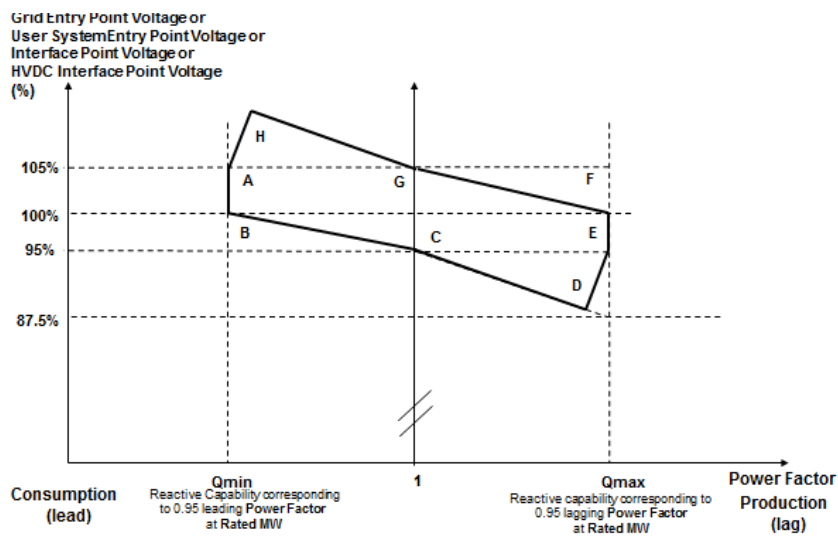

Figure ECC.A.7.2.2c

**Comment [A22]:** This diagram needs updating to include interface Point and HVDC Interface Point Voltage

ECC.A.7.2.2.4 Figure ECC.A.7.2.2b shows the required envelope of operation for -, **OTSDUW Plant and Apparatus, Onshore Power Park Modules and Onshore HVDC Converters** except for those **Embedded** at 33kV and below or directly connected to the **National Electricity Transmission System** at 33kV and below. Figure ECC.A.7.2.2c shows the required envelope of operation for **Onshore Power Park Modules Embedded** at 33kV and below, or directly connected to the **National Electricity Transmission System** at 33kV and below. The enclosed area within points ABCDEFGH is the required capability range within which the **Slope** and **Setpoint Voltage** can be changed.

ECC.A.7.2.2.5 Should the operating point of the, **OTSDUW Plant and Apparatus** or **Onshore Power Park Module**, or **Onshore HVDC Converter** deviate so that it is no longer a point on the operating characteristic (figure ECC.A.7.2.2a) defined by the target **Setpoint Voltage** and **Slope**, the continuously acting automatic voltage control system shall act progressively to return the value to a point on the required characteristic within 5 seconds.

Formatted: Font: Bold

ECC.A.7.2.2.6 Should the **Reactive Power** output of the **OTSDUW Plant and Apparatus** or **Onshore Power Park Module** or **Onshore HVDC Converter** reach its maximum lagging limit at a **Onshore Grid Entry Point** voltage (or **Onshore User System Entry Point** voltage if **Embedded** (or **Interface Point** in the case of **OTSDUW Plant and Apparatus** ) above 95%, the **OTSDUW Plant and Apparatus** or **Onshore Power Park Module** or **HVDC System** shall maintain maximum lagging **Reactive Power** output for voltage reductions down to 95%. This requirement is indicated by the line EF in figures ECC.A.7.2.2b and ECC.A.7.2.2c as applicable. Should the **Reactive Power** output of the **OTSDUW Plant and Apparatus** or **Onshore Power Park Module**, or **Onshore HVDC Converter** reach its maximum leading limit at a **Onshore Grid Entry Point** voltage (or **Onshore User System Entry Point** voltage if **Embedded** or **Interface Point** in the case of **OTSDUW Plant and Apparatus**) below 105%, the **OTSDUW Plant and Apparatus** or **Onshore Power Park Module**, or **Onshore HVDC Converter** shall maintain maximum leading **Reactive Power** output for voltage increases up to 105%. This requirement is indicated by the line AB in figures ECC.A.7.2.2b and ECC.A.7.2.2c as applicable.

ECC.A.7.2.2.7 For **Onshore Grid Entry Point** voltages (or **Onshore User System Entry Point** voltages if **Embedded**-or **Interface Point** voltages) below 95%, the lagging **Reactive Power** capability of the **OTSDUW Plant and Apparatus** or **Onshore Power Park Module** or **Onshore HVDC Converters** should be that which results from the supply of maximum lagging reactive current whilst ensuring the current remains within design operating limits. An example of the capability is shown by the line DE in figures ECC.A.7.2.2b and ECC.A.7.2.2c. For **Onshore Grid Entry Point** voltages (or **User System Entry Point** voltages if **Embedded** or **Interface Point** voltages) above 105%, the leading **Reactive Power** capability of the **OTSDUW Plant and Apparatus** or **Onshore Power Park Module** or **Onshore HVDC System Converter** should be that which results from the supply of maximum leading reactive current whilst ensuring the current remains within design operating limits. An example of the capability is shown by the line AH in figures ECC.A.7.2.2b and ECC.A.7.2.2c as applicable. Should the **Reactive Power** output of the **OTSDUW Plant and Apparatus** or **Onshore Power Park Module** or **Onshore HVDC Converter** reach its maximum lagging limit at an **Onshore Grid Entry Connection Point** voltage (or **Onshore User System Entry Point** voltage if **Embedded** or **Interface Point** in the case of **OTSDUW Plant and Apparatus**) below 95%, the **Onshore Power Park Module**, **Onshore HVDC Converter** shall maintain maximum lagging reactive current output for further voltage decreases. Should the **Reactive Power** output of the **OTSDUW Plant and Apparatus** or **Onshore Power Park Module** or **Onshore HVDC Converter** reach its maximum leading limit at a **Onshore Grid Entry Point** voltage (or **User System Entry Point** voltage if **Embedded** or **Interface Point** voltage in the case of an **OTSDUW Plant and Apparatus**) above 105%, the **OTSDUW Plant and Apparatus** or **Onshore Power Park Module** or **Onshore HVDC Converter** shall maintain maximum leading reactive current output for further voltage increases.

ECC.A.7.2.2.8 All **OTSDUW Plant and Apparatus** must be capable of enabling **EU Code Users** undertaking **OTSDUW** to comply with an instruction received from **NGET** relating to a variation of the **Setpoint Voltage** at the **Interface Point** within 2 minutes of such instruction being received.

Formatted: Font: Bold

ECC.A.7.2.2.9 For **OTSDUW Plant and Apparatus** connected to a **Network Operator's System** where the **Network Operator** has confirmed to **NGET** that its **System** is restricted in accordance with ECC.A.7.2.1, clause ECC.A.7.2.2.8 will not apply unless **NGET** can reasonably demonstrate that the magnitude of the available change in **Reactive Power** has a significant effect on voltage levels on the **Onshore National Electricity Transmission System**.

ECC.A.7.2.3 Transient Voltage Control

ECC.A.7.2.3.1 For an on-load step change in **Onshore Grid Entry Point** or **Onshore User System Entry Point** voltage, or in the case of **OTSDUW Plant and Apparatus** an on-load step change in **Transmission Interface Point** voltage, the continuously acting automatic control system shall respond according to the following minimum criteria:

- (i) the **Reactive Power** output response of the **OTSDUW Plant and Apparatus** or **Onshore Power Park Module** or **Onshore HVDC Converter** shall commence within 0.2 seconds of the application of the step. It shall progress linearly although variations from a linear characteristic shall be acceptable provided that the MVar seconds delivered at any time up to 1 second are at least those that would result from the response shown in figure ECC.A.7.2.3.1a.
- (ii) the response shall be such that 90% of the change in the **Reactive Power** output of the **OTSDUW Plant and Apparatus** or **Onshore Power Park Module**, or **Onshore HVDC Converter** will be achieved within
  - 2 seconds, where the step is sufficiently large to require a change in the steady state **Reactive Power** output from its maximum leading value to its maximum lagging value or vice versa and
  - 1 second where the step is sufficiently large to require a change in the steady state **Reactive Power** output from zero to its maximum leading value or maximum lagging value as required by ECC.6.3.2 (or, if appropriate ECC.A.7.2.2.6 or ECC.A.7.2.2.7);
- (iii) the magnitude of the **Reactive Power** output response produced within 1 second shall vary linearly in proportion to the magnitude of the step change.
- (iv) within 5 seconds from achieving 90% of the response as defined in ECC.A.7.2.3.1 (ii), the peak to peak magnitude of any oscillations shall be less than 5% of the change in steady state maximum **Reactive Power**.
- (v) following the transient response, the conditions of ECC.A.7.2.2 apply.

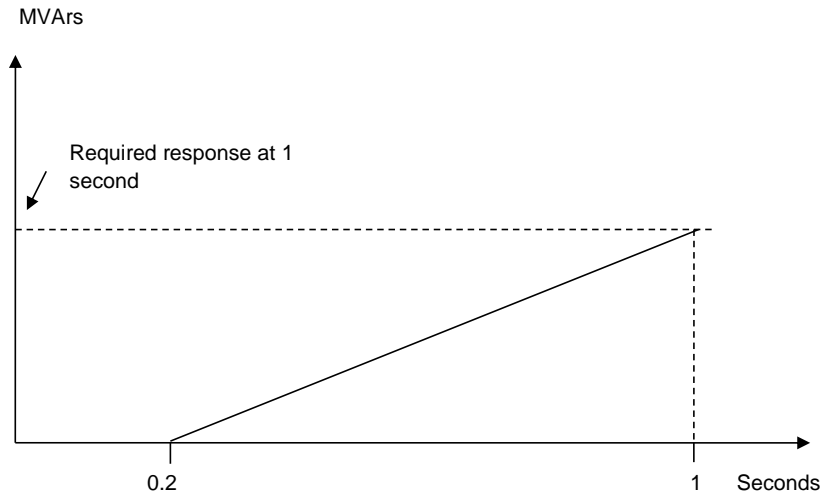

Figure ECC.A.7.2.3.1a

**ECC.A.7.2.3.2 OTSDUW Plant and Apparatus or Onshore Power Park Modules or Onshore HVDC Converters shall be capable of**

- (a) changing its **Reactive Power** output from its maximum lagging value to its maximum leading value, or vice versa, then reverting back to the initial level of **Reactive Power** output once every 15 seconds for at least 5 times within any 5 minute period; and
- (b) changing its **Reactive Power** output from zero to its maximum leading value then reverting back to zero **Reactive Power** output at least 25 times within any 24 hour period and from zero to its maximum lagging value then reverting back to zero **Reactive Power** output at least 25 times within any 24 hour period. Any subsequent restriction on reactive capability shall be notified to **NGET** in accordance with BC2.5.3.2, and BC2.6.1.

Formatted: Justified

In all cases, the response shall be in accordance to ECC.A.7.2.3.1 where the change in **Reactive Power** output is in response to an on-load step change in **Onshore Grid Entry Point** or **Onshore User System Entry Point** voltage, or in the case of **OTSDUW Plant and Apparatus** an on-load step change in **Transmission Interface Point** voltage.

**ECC.A.7.2.4 Power Oscillation Damping**

**ECC.A.7.2.4.1** The requirement for the continuously acting voltage control system to be fitted with a **Power System Stabiliser (PSS)** shall be specified if, in **NGET's** view, this is required for system reasons. However if a **Power System Stabiliser** is included in the voltage control system its settings and performance shall be agreed with **NGET** and commissioned in accordance with BC2.11.2. To allow assessment of the performance before on-load commissioning the **Generator** will provide to **NGET** a report covering the areas specified in ECP.A.3.2.2.

**ECC.A.7.2.5 Overall Voltage Control System Characteristics**



ECC.A.7.2.5.1 The continuously acting automatic voltage control system is required to respond to minor variations, steps, gradual changes or major variations in **Onshore Grid Entry Point** voltage (or **Onshore User System Entry Point** voltage if **Embedded** or **Interface Point** voltage in the case of **OTSDUW Plant and Apparatus**).

ECC.A.7.2.5.2 The overall voltage control system shall include elements that limit the bandwidth of the output signal. The bandwidth limiting must be consistent with the speed of response requirements and ensure that the highest frequency of response cannot excite torsional oscillations on other plant connected to the network. A bandwidth of 0-5Hz would be judged to be acceptable for this application. All other control systems employed within the **OTSDUW Plant and Apparatus** or **Onshore Power Park Module** or **Onshore HVDC Converter** should also meet this requirement

ECC.A.7.2.5.3 The response of the voltage control system (including the **Power System Stabiliser** if employed) shall be demonstrated by testing in accordance with ECP.A.6.

#### ECC.A.7.3 Reactive Power Control

ECC.A.7.3.1 As defined in ECC.6.3.8.3.4, **Reactive Power** control mode of operation is not required in respect of **Onshore Power Park Modules** or **OTSDUW Plant and Apparatus** or **Onshore HVDC Converters** unless otherwise specified by **NGET** in coordination with the relevant **Network Operator**. However where there is a requirement for **Reactive Power** control mode of operation, the following requirements shall apply.

ECC.A.7.3.2 The **Onshore Power Park Module** or **OTSDUW Plant and Apparatus** or **Onshore HVDC Converter** shall be capable of setting the **Reactive Power** setpoint anywhere in the **Reactive Power** range as specified in ~~ECC.6.3.2.4~~ with setting steps no greater than 5 MVAR or 5% (whichever is smaller) of full **Reactive Power**, controlling the reactive power at the **Grid Entry Point** or **User System Entry Point** if **Embedded** to an accuracy within plus or minus 5MVAR or plus or minus 5% (whichever is smaller) of the full **Reactive Power**.

Formatted: Not Highlight

ECC.A.7.3.3 Any additional requirements for **Reactive Power** control mode of operation shall be specified by **NGET** in coordination with the relevant **Network Operator**.

#### ECC.A.7.4 Power Factor Control

ECC.A.7.4.1 As defined in ECC.6.3.8.4.3, **Power Factor** control mode of operation is not required in respect of **Onshore Power Park Modules** or **OTSDUW Plant and Apparatus** or **Onshore HVDC Converters** unless otherwise specified by **NGET** in coordination with the relevant **Network Operator**. However where there is a requirement for **Power Factor** control mode of operation, the following requirements shall apply.

ECC.A.7.4.2 The **Onshore Power Park Module** or **OTSDUW Plant and Apparatus** or **Onshore HVDC Converter** shall be capable of controlling the **Power Factor** at the **Grid Entry Point** or **User System Entry Point** (if **Embedded**) within the required **Reactive Power** range as specified in ECC.6.3.2.2.1 and ~~ECC.6.3.2.4~~ with to a specified target **Power Factor** in steps no greater than 0.01. **NGET** shall specify the target **Power Factor** value (which shall be achieved within 0.01 of the set **Power Factor**), its tolerance and the period of time to achieve the target **Power Factor** following a sudden change of **Active Power** output. The tolerance of the target **Power Factor** shall be expressed through the tolerance of its corresponding **Reactive Power**. This **Reactive Power** tolerance shall be expressed by either an absolute value or by a percentage of the maximum **Reactive Power** of the **Onshore Power Park Module** or

Formatted: Not Highlight

**OTSDUW Plant and Apparatus** or **Onshore HVDC Converter**. The details of these requirements being pursuant to the terms of the **Bilateral Agreement**.

ECC.A.7.4.3 Any additional requirements for **Power Factor** control mode of operation shall be specified by **NGET** in coordination with the relevant **Network Operator**.

Formatted: Not Highlight

**APPENDIX E8 - PERFORMANCE REQUIREMENTS FOR CONTINUOUSLY ACTING AUTOMATIC VOLTAGE CONTROL SYSTEMS FOR CONFIGURATION 2 AC CONNECTED OFFSHORE POWER PARK MODULES AND CONFIGURATION 2 DC CONNECTED POWER PARK MODULES**

ECC.A.8.1 Scope

ECC.A.8.1.1 This Appendix sets out the performance requirements of continuously acting automatic voltage control systems for **Configuration 2 AC Connected Offshore Power Park Modules and Configuration 2 DC Connected Power Park Modules** that must be complied with by the **EU Code User**. This Appendix does not limit any site specific requirements that may be specified where in **NGET's** reasonable opinion these facilities are necessary for system reasons.

Formatted: Font: Bold  
Formatted: Font: Bold

ECC.A.8.1.2 These requirements also apply to **Configuration 2 DC Connected Power Park Modules**. In the case of a **Configuration 1 DC Connected Power Park Module** the technical performance requirements shall be specified by **NGET**. Where the **EU Generator** in respect of a **DC Connected Power Park Module** has agreed to a wider reactive capability range as defined under **ECC.6.3.2.5 and ECC.6.2.3.67.3** then the requirements that apply will be specified by **NGET** and which shall reflect the performance requirements detailed in **ECC.A.8.2** below but with different parameters such as droop and **Setpoint Voltage**.

Formatted: Font: Bold  
Formatted: Font: Bold  
Formatted: Not Highlight  
Formatted: Not Highlight  
Formatted: Not Highlight

ECC.A.8.1.3 Proposals by **EU Generators** to make a change to the voltage control systems are required to be notified to **NGET** under the **Planning Code** (PC.A.1.2(b) and (c)) as soon as the **Generator** anticipates making the change. The change may require a revision to the **Bilateral Agreement**.

Formatted: Font: Bold

ECC.A.8.2 Requirements

ECC.A.8.2.1 **NGET** requires that the continuously acting automatic voltage control system for the **Configuration 2 AC connected Offshore Power Park Module** and **Configuration 2 DC Connected Power Park Module** shall meet the following functional performance specification.

ECC.A.8.2.2 Steady State Voltage Control

ECC.A.8.2.2.1 The **Configuration 2 AC connected Offshore Power Park Module** and **Configuration 2 DC Connected Power Park Module** shall provide continuous steady state control of the voltage at the **Offshore Connection Point** with a **Setpoint Voltage** and **Slope** characteristic as illustrated in Figure ECC.A.8.2.2a.

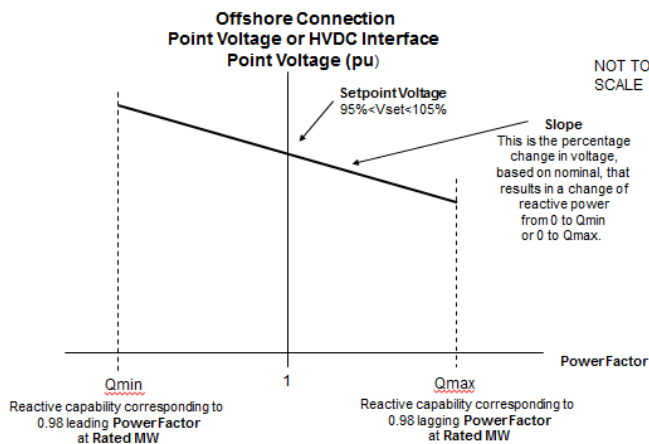

Figure ECC.A.8.2.2a

ECC.A.8.2.2.2 The continuously acting automatic control system shall be capable of operating to a **Setpoint Voltage** between 95% and 105% with a resolution of 0.25% of the nominal voltage. For the avoidance of doubt values of 95%, 95.25%, 95.5% ... may be specified, but not intermediate values. The initial **Setpoint Voltage** will be 100%. The tolerance within which this **Setpoint Voltage** shall be achieved is specified in BC2.A.2.6. For the avoidance of doubt, with a tolerance of 0.25% and a Setpoint Voltage of 100%, the achieved value shall be between 99.75% and 100.25%. **NGET** may request the **EU Generator** to implement an alternative **Setpoint Voltage** within the range of 95% to 105%.

Formatted: Font: Bold

ECC.A.8.2.2.3 The **Slope** characteristic of the continuously acting automatic control system shall be adjustable over the range 2% to 7% (with a resolution of 0.5%). For the avoidance of doubt values of 2%, 2.5%, 3% may be specified, but not intermediate values. The initial **Slope** setting will be 4%. The tolerance within which this **Slope** shall be achieved is specified in BC2.A.2.6. For the avoidance of doubt, with a tolerance of 0.5% and a **Slope** setting of 4%, the achieved value shall be between 3.5% and 4.5%. **NGET** may request the **EU Generator** to implement an alternative slope setting within the range of 2% to 7%.

Formatted: Font: Bold

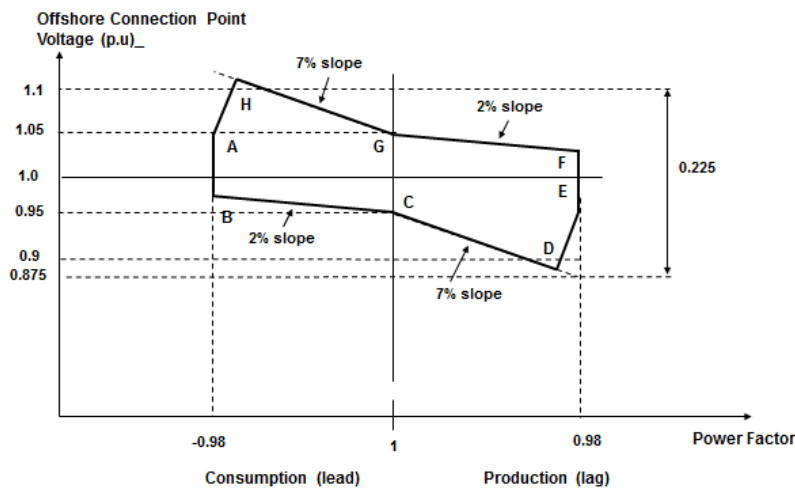

Figure ECC.A.8.2.2b

ECC.A.8.2.2.4 Figure ECC.A.8.2.2b shows the required envelope of operation for **Configuration 2 AC connected Offshore Power Park Module** and **Configuration 2 DC Connected Power Park Module**. The enclosed area within points ABCDEFGH is the required capability range within which the **Slope** and **Setpoint Voltage** can be changed.

Formatted: Font: Not Bold

ECC.A.8.2.2.5 Should the operating point of the **Configuration 2 AC connected Offshore Power Park or Configuration 2 DC Connected Power Park Module** deviate so that it is no longer a point on the operating characteristic (Figure ECC.A.8.2.2a) defined by the target **Setpoint Voltage** and **Slope**, the continuously acting automatic voltage control system shall act progressively to return the value to a point on the required characteristic within 5 seconds.

ECC.A.8.2.2.6 Should the **Reactive Power** output of the **Configuration 2 AC connected Offshore Power Park Module** or **Configuration 2 DC Connected Power Park Module** reach its maximum lagging limit at an **Offshore Grid Entry Point** or **Offshore User System Entry Point** or **HVDC Interface Point** voltage above 95%, the **Configuration 2 AC connected Offshore Power Park Module** or **Configuration 2 DC Connected Power Park Module** shall maintain maximum lagging **Reactive Power** output for voltage reductions down to 95%. This requirement is indicated by the line EF in figure ECC.A.8.2.2b. Should the **Reactive Power** output of the **Configuration 2 AC connected Offshore Power Park Module** or **Configuration 2 DC Connected Power Park Module** reach its maximum leading limit at the **Offshore Grid Entry Point** or **Offshore User System Entry Point** or **HVDC Interface Point** voltage below 105%, the **Configuration 2 AC connected Offshore Power Park Module** or **Configuration 2 DC Connected Power Park Module** shall maintain maximum leading **Reactive Power** output for voltage increases up to 105%. This requirement is indicated by the line AB in figures ECC.A.8.2.2b.

ECC.A.8.2.2.7 For **Offshore Grid Entry Point** or **User System Entry Point** or **HVDC Interface Point** voltages below 95%, the lagging **Reactive Power** capability of the **Configuration 2 AC connected Offshore Power Park Module** or **Configuration 2 DC Connected Power Park Module** should be that which results from the supply of maximum lagging reactive current whilst ensuring the current remains within design operating limits. An example of the capability is shown by the line DE in figures ECC.A.8.2.2b. For **Offshore Grid Entry Point** or **Offshore User System Entry Point** voltages or **HVDC Interface Point** voltages above 105%, the leading **Reactive Power** capability of the **Configuration 2 AC connected Offshore Power Park Module** or **Configuration 2 DC Connected Power Park Module** should be that which results from the supply of maximum leading reactive current whilst ensuring the current remains within design operating limits. An example of the capability is shown by the line AH in figures ECC.A.8.2.2b. Should the **Reactive Power** output of the **Configuration 2 AC connected Offshore Power Park Module** or **Configuration 2 DC Connected Power Park Module** reach its maximum lagging limit at an **Offshore Grid Entry Point** or **Offshore User System Entry Point** voltage or **HVDC Interface Point** voltage below 95%, the **Configuration 2 AC connected Offshore Power Park Module** or **Configuration 2 DC Connected Power Park Module** shall maintain maximum lagging reactive current output for further voltage decreases. Should the **Reactive Power** output of the **Configuration 2 AC connected Offshore Power Park Module** or **Configuration 2 DC Connected Power Park Module** reach its maximum leading limit at an **Offshore Grid Entry Point** or **Offshore User System Entry Point** voltage or **HVDC Interface Point** voltage above 105%, the **Configuration 2 AC connected Offshore Power Park Module** or **Configuration 2 DC Connected Power Park Module** shall maintain maximum leading reactive current output for further voltage increases.

### ECC.A.8.2.3 Transient Voltage Control

ECC.A.8.2.3.1 For an on-load step change in **Offshore Grid Entry Point** or **Offshore User System Entry Point** voltage or **HVDC Interface Point** voltage, the continuously acting automatic control system shall respond according to the following minimum criteria:

- (i) the **Reactive Power** output response of the **Configuration 2 AC connected Offshore Power Park Module** or **Configuration 2 DC Connected Power Park Module** shall commence within 0.2 seconds of the application of the step. It shall progress linearly although variations from a linear characteristic shall be acceptable provided that the MVA<sub>r</sub> seconds delivered at any time up to 1 second are at least those that would result from the response shown in figure ECC.A.8.2.3.1a.

- (ii) the response shall be such that 90% of the change in the **Reactive Power** output of the **Configuration 2 AC connected Offshore Power Park Module** or **Configuration 2 DC Connected Power Park Module** will be achieved within
  - 2 seconds, where the step is sufficiently large to require a change in the steady state **Reactive Power** output from its maximum leading value to its maximum lagging value or vice versa and
  - 1 second where the step is sufficiently large to require a change in the steady state **Reactive Power** output from zero to its maximum leading value or maximum lagging value as required by ECC.6.3.2 (or, if appropriate [ECC.A.8.2.2.6](#) or [ECC.A.8.2.2.7](#));
- (iii) the magnitude of the **Reactive Power** output response produced within 1 second shall vary linearly in proportion to the magnitude of the step change.
- (iv) within 5 seconds from achieving 90% of the response as defined in [ECC.A.8.2.3.1 \(ii\)](#), the peak to peak magnitude of any oscillations shall be less than 5% of the change in steady state maximum **Reactive Power**.
- (v) following the transient response, the conditions of [ECC.A.8.2.2](#) apply.

Formatted: Not Highlight

Formatted: Not Highlight

Formatted: Not Highlight

Formatted: Not Highlight

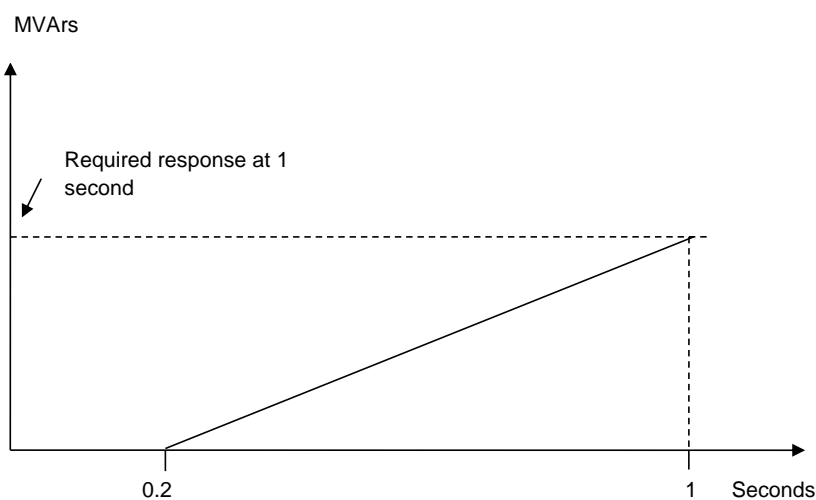

ECC.A.8.2.3.2 **Configuration 2 AC connected Offshore Power Park Module** or **Configuration 2 DC Connected Power Park Module** shall be capable of

- (a) changing their **Reactive Power** output from maximum lagging value to maximum leading value, or vice versa, then reverting back to the initial level of **Reactive Power** output once every 15 seconds for at least 5 times within any 5 minute period; and
- (b) changing **Reactive Power** output from zero to maximum leading value then reverting back to zero **Reactive Power** output at least 25 times within any 24 hour period and from zero to its maximum lagging value then reverting back to zero **Reactive Power** output at least 25 times within any 24 hour period. Any subsequent restriction on

reactive capability shall be notified to **NGET** in accordance with BC2.5.3.2, and BC2.6.1.

In all cases, the response shall be in accordance to **ECC.A.8.2.3.1** where the change in **Reactive Power** output is in response to an on-load step change in **Offshore Grid Entry Point** or **Offshore User System Entry Point** voltage or **HVDC Interface Point** voltage.

Formatted: Not Highlight

#### ECC.A.8.2.4 Power Oscillation Damping

ECC.A.8.2.4.1 The requirement for the continuously acting voltage control system to be fitted with a **Power System Stabiliser (PSS)** shall be specified if, in **NGET's** view, this is required for system reasons. However if a **Power System Stabiliser** is included in the voltage control system its settings and performance shall be agreed with **NGET** and commissioned in accordance with BC2.11.2. To allow assessment of the performance before on-load commissioning the **Generator** or **HVDC System Owner** will provide to **NGET** a report covering the areas specified in ECP.A.3.2.2.

#### ECC.A.8.2.5 Overall Voltage Control System Characteristics

ECC.A.8.2.5.1 The continuously acting automatic voltage control system is required to respond to minor variations, steps, gradual changes or major variations in **Offshore Grid Entry Point** or **Offshore User System Entry Point** or **HVDC Interface Point** voltage.

ECC.A.8.2.5.2 The overall voltage control system shall include elements that limit the bandwidth of the output signal. The bandwidth limiting must be consistent with the speed of response requirements and ensure that the highest frequency of response cannot excite torsional oscillations on other plant connected to the network. A bandwidth of 0-5Hz would be judged to be acceptable for this application. All other control systems employed within the **Configuration 2 AC connected Offshore Power Park Module** or **Configuration 2 DC Connected Power Park Module** should also meet this requirement

ECC.A.8.2.5.3 The response of the voltage control system (including the **Power System Stabiliser** if employed) shall be demonstrated by testing in accordance with **ECP.A.6**.

Formatted: Font color: Auto

#### ECC.A.8.3 Reactive Power Control

ECC.A.8.3.1 **Reactive Power** control mode of operation is not required in respect of **Configuration 2 AC connected Offshore Power Park Modules** or **Configuration 2 DC Connected Power Park Modules** unless otherwise specified by **NGET**. However where there is a requirement for **Reactive Power** control mode of operation, the following requirements shall apply.

ECC.A.8.3.2 **Configuration 2 AC connected Offshore Power Park Modules** or **Configuration 2 DC Connected Power Park Modules** shall be capable of setting the **Reactive Power** setpoint anywhere in the **Reactive Power** range as specified in ECC.6.3.2.8.2 with setting steps no greater than 5 MVAR or 5% (whichever is smaller) of full **Reactive Power**, controlling the **Reactive Power** at the **Offshore Grid Entry Point** or **Offshore User System Entry Point** or **HVDC Interface Point** to an accuracy within plus or minus 5MVAR or plus or minus 5% (whichever is smaller) of the full **Reactive Power**.

Formatted: Font: Bold

ECC.A.8.3.3 Any additional requirements for **Reactive Power** control mode of operation shall be specified by **NGET**.

#### ECC.A.8.4 Power Factor Control

ECC.A.8.4.1 **Power Factor** control mode of operation is not required in respect of **Configuration 2 AC connected Offshore Power Park Modules** or **Configuration 2 DC Connected Power Park Modules** unless otherwise specified by **NGET**. However where there is a requirement for **Power Factor** control mode of operation, the following requirements shall apply.

ECC.A.8.4.2 **Configuration 2 AC connected Offshore Power Park Modules** or **Configuration 2 DC Connected Power Park Modules** shall be capable of controlling the **Power Factor** at the **Offshore Grid Entry Point** or **Offshore User System Entry Point** or **HVDC Interface Point** within the required **Reactive Power** range as specified in [ECC.6.3.2.8.2](#) with a target **Power Factor**. **NGET** shall specify the target **Power Factor** (which shall be achieved to within 0.01 of the set **Power Factor**), its tolerance and the period of time to achieve the target **Power Factor** following a sudden change of **Active Power** output. The tolerance of the target **Power Factor** shall be expressed through the tolerance of its corresponding **Reactive Power**. This **Reactive Power** tolerance shall be expressed by either an absolute value or by a percentage of the maximum **Reactive Power** of the **Configuration 2 AC connected Offshore Power Park Module** or **Configuration 2 DC Connected Power Park Module**. The details of these requirements being specified by **NGET**.

Formatted: Not Highlight

ECC.A.8.4.3 Any additional requirements for **Power Factor** control mode of operation shall be specified by **NGET**.

< END OF EUROPEAN CONNECTION CONDITIONS >



